



HEWLETT  
PACKARD

MEASUREMENT • COMPUTATION • SYSTEMS  
For Science • Engineering • Business • Industry • Education • Medicine

1985





# HEWLETT PACKARD

## General Purpose Electronic Instruments & Systems

Amplifiers .....	416	Data Analyzers/ Generators.....	393	Displays.....	366
Analog VMs.....	153	Digital Circuit Testers.....	239	DMMs, DVMs .....	153
Board Test Systems .....	251	Digital IC Test Systems .....	236	Electronic Counters .....	276
Component Testers.....	204			Fiber Optics .....	510

## RF & Microwave Measurement

Amplifiers .....	416	Microwave Counters.....	278
Coaxial Test Equipment.....	494	Microwave Link Analyzers .....	147
Electronic Counters .....	276	Microwave Semiconductors .....	662
Frequency Synthesizers.....	419	Microwave Test Equipment .....	494

## Logic & Processor-Based Circuit Analysis

Board Test Systems .....	251	IC Troubleshooters .....	239
Data Generators/Analyzers .....	393	Logic Analyzers .....	260
Digital Circuit Testers.....	239	Logic Troubleshooting Systems .....	239
Digital IC Test Systems .....	236, 393		

## Digital Signal Analysis (Fourier)

Digital Vibration Control System .....	635	Plotters .....	96, 373
Fourier Analyzers.....	625	Spectrum Analyzers .....	578

## Data Acquisition, Control & Test

Board Test Systems .....	251	Data Acquisition, Test & Control Systems.....	172
Computers, Peripherals & Calculators .....	39	Digital Multimeters.....	153

## Telecommunications & Data Communications

Amplifiers .....	416	Frequency Synthesizers .....	433
Analyzers .....	528	Microwave Counters.....	278
Data Communications Testers.....	111	Microwave Radio Testing .....	136
Frequency Division Multiplexing.....	136	Microwave Test Equipment .....	494

## Hewlett-Packard Interface Bus (HP-IB) System Products

Analyzers .....	577	Data Acquisition, Test & Control.....	172
Board Test Systems .....	251	Digital Voltmeters .....	153
Component Testers.....	204	Electronic Counters .....	276
Computers & Peripherals.....	39	Graphics Display Systems.....	366
Data Analyzers/Generators.....	393	Graphics Tablet .....	104

## Computers, Peripherals & Calculators

Business Computers.....	86	Digitizers.....	104
Calculators.....	62	Disc Drives.....	59, 91
Computers, Peripherals .....	39	Engineering Workstations.....	73
CRT & Data Entry Systems.....	87	Graphics Display Systems .....	366
Data Acquisition Systems .....	172	Graphics Tablet .....	104

## Other Products

Analytical Instruments for Chemistry.....	660	CRT Displays .....	366
Cabinet Accessories.....	682	Digital Education Products .....	250
Cables and Adapters .....	680	Dimensional Measurement.....	664
		Frequency & Time Standards.....	300



**HP Computer Museum**  
**[www.hpmuseum.net](http://www.hpmuseum.net)**

**For research and education purposes only.**



F & T Standards .....	300	HP-IL.....	72	Power Supplies.....	322	Signal Conditioners .....	385
Frequency Synthesizers .....	419	Oscillators .....	419	Pulse Generators.....	401	Sweep Oscillators.....	467
Function Generators .....	419	Oscilloscopes .....	332	Recorders, Printers.....	373	Waveform Analyzers.....	334
HP-IB.....	668	Plotters.....	96, 373	Signal Analyzers.....	577		

Network Analyzers.....	528	Power Meters.....	516	Signal Generators .....	438
Noise Figure Meter .....	524	RF Impedance Meters.....	218	Sweep Oscillators.....	467
Oscilloscopes .....	332	RF Voltmeter.....	171	Transceiver Test Equipment .....	653
Plotters.....	96, 373	Signal Analyzers.....	577	Waveguide Test Equipment .....	494

Microprocessor Development System.....	264
Plotters.....	96, 373
Signature Analyzers .....	240, 251

Waveform Generator, Analyzers, Recorders .....	334
---	-----

Digitizer .....	104, 332	Hewlett-Packard Interface Bus.....	668	Recorders, Plotters & Printers .....	96, 373
Electronic Counters .....	276	Hewlett-Packard Interface Loop .....	72	Waveform Analyzers.....	334
Graphics Tablet .....	104	Multiprogrammers .....	199		

Network Analyzers.....	528	Pulse Code Modulation .....	128	Telecommunications Test.....	128
Noise Figure Meter .....	524	Pulse Generators.....	401	Transceiver Test Equipment .....	653
Plotters.....	96, 373	Signal Generators.....	438		
Power Meters.....	516	Sweep Oscillators.....	467		

Measurement & Control Processor .....	186	Plotters.....	96, 373	Sources.....	393, 401, 419, 438, 467
Multiprogrammers .....	192	Power Meter .....	516	Telecommunications Test.....	128
Noise Figure Meter .....	524	Power Supplies.....	322	Waveform Analyzers.....	334
Oscilloscopes .....	332	Pulse Generators.....	401		

Handheld Computers .....	62	Modems .....	84	Software, Supplies & Accessories.....	105
Hardcopy Terminals.....	87	Multiprogrammers .....	192	Support .....	107
Hewlett-Packard Interface Bus.....	668	Personal Computers.....	39	Tape Drives.....	93
Hewlett-Packard Interface Loop .....	72	Portable Computers.....	46	Technical Computers.....	73
Line Printers .....	95	Recorders, Printers & Plotters.....	96, 373	Terminals .....	87

Medical Instrumentation.....	658	Pressure & Temperature.....	666
Microwave Semiconductors .....	662	Training & Video Tapes.....	34
Operating Cases.....	692	Transit Cases .....	688
Optoelectronic Devices .....	662	X-Ray Systems .....	657

# CONTENTS

<b>ALPHABETICAL INDEX</b> .....	<b>1</b>
<b>MODEL NUMBER INDEX</b> .....	<b>12</b>
About Hewlett-Packard .....	24
Instrument Support .....	28
Publications .....	38
Information Request Cards .....	back of catalog
Ordering Information .....	694
Sales & Support Offices .....	695

## PRODUCT SECTIONS

Amplifiers .....	416	Microwave Test Equipment .....	494
Analytical Instruments for Chemistry .....	660	Network Analyzers .....	528
Cabinet Accessories .....	682	Noise Figure Meter .....	524
Cables & Adapters .....	680	Operating Cases .....	692
Circuit Test Systems .....	251	Oscilloscopes & Waveform Analyzers .....	332
Component & Semiconductor Measurement .....	204	Power Meters .....	516
Computers, Peripherals & Calculators .....	39	Power Supplies .....	308
Data Acquisition, Control & Test .....	172	Pressure & Temperature .....	666
Data Generators & Data Analyzers .....	393	Pulse Generators .....	401
Datacommunications Test Equipment .....	111	Recorders, Plotters & Printers .....	373
Digital Circuit Testers .....	239	Signal Analyzers .....	577
Dimensional Measurements .....	664	Signal Generators .....	438
Electronic Counters .....	276	Solid State Devices .....	662
Fiber Optic Test Equipment .....	510	Sweep Oscillators .....	467
Frequency & Time Standards .....	300	Telecommunications Test Equipment .....	128
Function Generators & Frequency Synthesizers .....	419	Training/Video Tapes .....	34
Graphics Displays .....	366	Transceiver Test Equipment .....	653
Hewlett-Packard Interface Bus .....	668	Transit Cases .....	688
Logic Analyzers & Development Systems .....	260	Voltmeters, Digital and Analog .....	153
Medical Instrumentation .....	658	X-Ray .....	657



Identifies products having the Hewlett-Packard Interface Bus (HP-IB) capability. HP-IB is our implementation of the IEEE Standard 488 and the identical ANSI Standard MC1.1, "Digital interface for programmable instrumentation." For the complete story, see pages 668-679.



Identifies products having Hewlett-Packard Interface Loop (HP-IL) capability. HP-IL provides serial loop interfacing for portable, battery-powered systems on the bench or in the field. See page 71.



Identifies newly introduced products or capabilities. New products are also indicated by **boldface** listings in the Model Number Index.

**Specifications** describe the product's performance.

Parameters that are described as **typical**, **nominal**, or **approximately** ( $\approx$ ) are supplemental characteristics intended to provide information useful to applying the product.



- A**
- AC
- Digital Voltmeter ..... 153-160
  - Probes ..... 155
  - True RMS Voltmeters ..... 157-159, 162, 168
- Access and Test System ..... 151
- Accessories
- Cabinets ..... 682
  - Cables/Connectors ..... 166, 571, 675, 680
  - Camera ..... 363
  - Camera, Solid State ..... 606, 608
  - Connectors, Adapters ..... 106, 573, 681
  - Graphics Software ..... 105, 379
  - Logic Analyzer ..... 274
  - Modular Enclosures (System II) ..... 685-688
  - Network Analyzer ..... 538-541, 547, 551, 559, 571-574
  - Oscilloscope ..... 357
  - PCM/TDM ..... 135
  - Signal Generator ..... 464
  - SLMS ..... 137-138, 141, 144
  - Spectrum Analyzer ..... 599, 622, 623, 625
  - Transit Cases ..... 688
  - Voltmeter ..... 166
- Active Probes ..... 246, 285, 570
- Adapters
- 50-75  $\Omega$  ..... 464, 540, 559, 622, 681
  - Cables/Connectors ..... 680
  - Quasi-Peak ..... 599
- Air Line Extensions ..... 495
- Alphanumeric LED Displays ..... 662
- Alphanumeric Printer ..... 392
- AM/FM Signal Generators ..... 440-455
- AM/FM/ $\phi$ M Modulation Analyzer ..... 648-650
- AM/FM/ $\phi$ M Signal Generator ..... 440-450
- AM/FM Test Source ..... 648-650
- Amplifiers
- Broadband Power ..... 416-418
  - Broadband Preamp ..... 418
  - Distribution ..... 306
  - Plug-Ins for Oscillographic Recorder ..... 385-388
  - Power Supply ..... 329
  - Microwave ..... 416
  - RF ..... 417, 418
- Analog Circuit Test System ..... 254-258
- Analog-to-Digital Converter ..... 75, 336, 677
- Cards, Multiprogrammer
    - High Speed ..... 197, 200
    - Low Level ..... 197, 200
- Analog Input/Output Cards, HP-1000 A-Series ..... 188
- Analog Voltmeters ..... 168-171
- Analyzers
- Audio ..... 651
  - Audio Spectrum ..... 612
  - Automatic Network ..... 560, 563
  - Automatic Scalar Network ..... 564
  - Automatic Spectrum ..... 585, 589-598, 625, 636
  - Correlation ..... 633
  - Data ..... 394
  - Data Line ..... 118
  - Digital Signal ..... 633
  - Digital Transmission ..... 133
  - Distortion ..... 633, 641-643, 651
  - Fourier (FFT) ..... 625, 633
  - Frequency Stability ..... 636, 638-640
  - Gain-Phase ..... 544, 548, 633
  - Logic ..... 270
  - Low Frequency Spectrum ..... 612, 633
  - Mechanical Impedance ..... 633
  - Microwave Link ..... 147
  - Modal ..... 633
  - Modulation ..... 633, 648-650
  - Network ..... 544, 548, 570-576
  - Phase Noise ..... 636-640
  - Phase Noise, Side Band ..... 636-640
  - Primary Multiplex ..... 130
  - Protocol ..... 114-116
  - RF Impedance ..... 214
  - RF Signal Modulation ..... 648-650
  - Selective Level ..... 119, 141
  - Semiconductor ..... 228
  - Spectrum ..... 585-625
  - Signature ..... 239-240, 243
  - Software Performance Analyzer ..... 267, 269
  - Structural Dynamics ..... 633
  - Telephone Line ..... 118
  - Training ..... 29-30
  - Transfer Function ..... 633
  - Vibration ..... 623, 633
  - Wave ..... 119, 141, 577, 588, 643
  - Waveform ..... 336
- Applications Manual, Optoelectronics ..... 662
- Applications Support ..... 31
- APC-3.5 series Adapters ..... 573, 681
- APC-7<sup>®</sup> series Adapters ..... 573, 681
- Assembler ROM ..... 54
- Atomic Clock/Frequency Standard ..... 301
- Attenuators
- 75-Ohm General Purpose ..... 147
  - Coaxial, Fixed ..... 496
  - Coaxial, Microwave, OEM ..... 496
  - Waveguide ..... 498
- Automatic
- Audio Distortion Analyzer ..... 651
  - Calibration DMM ..... 155, 157, 163
  - Capacitance Bridge ..... 222-223
  - Computer Aided Test System ..... 198
  - Data Acquisition Systems ..... 172-185, 193
  - Data Logger ..... 175-180
  - LCR Meter ..... 206-209
  - LCZ Meter ..... 210-213
  - Measurement & Analysis System ..... 193





- Network Analyzer ..... 560, 575  
 Scalar Network Analyzer ..... 534  
 Selective Level Meter ..... 137, 144  
 Synthesizer ..... 432-437, 440-450, 459, 462  
 Spectrum Analyzer ..... 585, 590-598, 625, 636  
 Test Systems ..... 203, 598, 640  
 Transceiver Test System ..... 653
- B**
- Balanced 2/4 Wire Audio Channel Selector ..... 130  
 Bar Code Decoder Board ..... 662  
 Bar Code Readers ..... 66, 662  
 Bar Code Wand, Digital ..... 67, 662  
 Bar Graph Array, LED ..... 662  
 Battery Operated  
   Calculators/Computers ..... 62-72  
   Counters ..... 294-297  
   Disc Drive ..... 59  
   DMM ..... 160-163  
   Microwave Power Meter ..... 516-523  
 Beam Lead Diode ..... 663  
 Bias Networks ..... 568, 573  
 Bit Error Rate Test Set ..... 121, 131-132  
 Bipolar Transistors ..... 663  
 BNC Series Adapters ..... 681  
 Board Test Fixtures ..... 254  
 Board Tester, Analog ..... 254-258  
 Board Tester, Digital ..... 254-258  
 Board Tester, Training ..... 30  
 Breadboard Cards, Multiprogrammer ..... 197, 200  
 Bridge, Directional ..... 536  
 Broadband Amplifiers ..... 416-418  
 Broadband Phase Comparator ..... 301  
 Broadband Sampling Voltmeter ..... 171  
 Business Computers ..... 86
- C**
- Cabinet Identification ..... 682, 686  
 Cable Assemblies ..... 680  
 Cables/Connectors ..... 106, 662, 680  
 Cables, HP-IB ..... 675  
 Calculators, Handheld Computers & Peripherals  
   **Bar Code Reader Module** ..... 66  
   **Bar Code Wand, Digital** ..... 67  
   Card Reader ..... 66  
   Cassette Drive ..... 67  
   Expansion Pod ..... 66  
   Financial Programmable ..... 62  
   I/O ROM ..... 67  
   Memory Modules ..... 65-66  
   Optical Wand ..... 66  
   Printer/Plotter ..... 66-67  
   Scientific Programmables ..... 62  
 Calibration Data, Attenuators ..... 497  
 Calibration Kits (Network Analyzer) ..... 561, 573  
 Calibration Service Agreements ..... 32  
 Calibrators  
   AM/FM (HP 8901A) ..... 648  
   Power Meter, for HP 432 Series ..... 522  
   Range, for HP 435A Power Meter ..... 519  
 Capacitance Bridges, Meters ..... 222-223  
 Cardiology/Cardiovascular Instrumentation ..... 658  
 Carrier Preamp ..... 386  
 Carrier Testing ..... 136  
 Cases, Combining ..... 686  
 Catalog, Computer Users Supplies and Accessories ..... 106  
 Cavity Frequency Meters ..... 505  
 Cellular Radio Test System ..... 656  
 Cesium Beam Frequency Standard ..... 301  
 Circuit Test Systems ..... 239, 254-259  
 Circuit Testers, Digital ..... 239, 246-249, 254-258  
 Clip, Logic ..... 248  
 Clock, Atomic ..... 300  
 Clock, Digital ..... 677  
 Clock, Thermal Printer ..... 392  
 Coaxial  
   Accessories ..... 495, 509, 681  
   Adapters ..... 681  
   Air Lines ..... 495  
   Attenuators ..... 496-500  
   Crystal Detectors ..... 504-505  
   Directional Couplers ..... 502  
   Directional Detectors ..... 503  
   Dual Directional Coupler ..... 502  
   Fixed Attenuators ..... 496  
   Filters ..... 285, 508  
   Frequency Meters ..... 505  
   Harmonic Mixer ..... 508  
   Low-Pass Filters ..... 285, 508  
   Noise Sources ..... 526  
   Pad Attenuators ..... 496  
   Power Sensors ..... 520, 523  
   Shorts ..... 507  
   Sliding Load ..... 507  
   Slotted Line Carriage ..... 506  
   Slotted Line ..... 506  
   Slotted Section ..... 506  
   Step Attenuators ..... 499  
   Switches ..... 509  
   Terminations ..... 507  
   Thermistor Mounts ..... 523  
   Thermocouple Mounts ..... 520  
   Waveguide Adapters ..... 495  
 Comb Generator ..... 622  
 Combining Cases ..... 686  
 Communications, Series 80 ..... 52  
 Communications Test Equipment ..... 118-119, 128-152,  
   432, 436-437  
 Communications Test Set ..... 123  
 Comparator, Logic ..... 248  
 Comparator, Phase ..... 301  
 Component Measurement ..... 204-238  
 Components, Solid State ..... 662-663  
 Component Testers  
   Digital IC Test System ..... 228-233, 236-237

Digital IC Tester ..... 236  
 Impedance, LCR Meters ..... 206–225  
 Semiconductor Parametric Test ..... 226–233  
 Computer-based Spectrum Analyzer ..... 598, 636  
 Computers & Peripherals  
 A, E & F-Series Computers ..... 82  
 A-Series Measurement & Control Cards ..... 188  
 Automatic Test Systems ..... 79, 193, 198, 203  
 Business Oriented Computer Systems ..... 86  
 Computer Support ..... 61, 107  
 Computer Users Catalog ..... 106  
 Disc Drives ..... 59, 91  
 Disc/Tape Drives ..... 92  
 Display Terminals, CRT ..... 87  
 Engineering Workstations ..... 73  
 Flexible Disc Drives ..... 59  
 Graphics Tablets ..... 104  
 Handheld Computers ..... 62  
 HP-IL Peripherals ..... 65  
 Interactive Terminals ..... 87  
 Laser Printers ..... 95  
 Line Printers ..... 95  
 MicroWinchester Disc Drives ..... 60  
 Modems ..... 84  
 Modular Computer ..... 74, 76, 79  
 Modular Run-Only Computer ..... 79  
 Personal Computers ..... 43–72  
 Plotters ..... 96–105  
 Speech Output Module ..... 94  
 Supplies and Accessories ..... 106  
 Support ..... 61, 107  
 Tape Drives ..... 93  
 Technical Computers ..... 73–83, 392  
 Workstation Printers ..... 57  
 Connector Adapters ..... 681  
 Connectors, Microwave Precision ..... 573, 681  
 Converters  
 A-to-D ..... 75, 159–163, 165, 174–185,  
 197, 200, 336, 677  
 D-to-A ..... 178, 182, 186, 197, 200, 338, 676  
 Serial-to-Parallel ..... 676  
 Counters, Electronic ..... 276–299  
 Counter/Synchronizer ..... 280  
 Counter/Timer ..... 276–277, 282, 286–299  
 Counter/Tracking Generator ..... 614  
 Digital Multimeter/Counter ..... 176, 182, 240  
 DVM ..... 288–293  
 HP-IB /HP-IL ..... 277  
 Low Cost ..... 294–299  
 Microwave ..... 278–281, 284  
 Microwave Source, Synchronizer ..... 280  
 Oscilloscope Expansion Module ..... 344  
 Plug-In Adapter ..... 283  
 Portable, Battery Operated ..... 294, 299  
 Pulsed RF ..... 284  
 Reciprocal ..... 176, 182, 282, 286–290, 294  
 Time Interval ..... 282, 286–293, 297  
 Time Interval Probes ..... 285  
 Universal ..... 276–277, 282, 285–299

Counter/Totalizer Card ..... 182, 186, 197, 200  
 Coupler, Acoustic ..... 67  
 Couplers, Directional (Coax and Waveguide) ..... 502  
 CP/M® System, Series 80 ..... 54  
 CRT Displays ..... 366  
 Crystal Detectors ..... 504  
 Crystal Oscillators ..... 305  
 Current Probe ..... 166  
 Current Tracer, Digital ..... 247

**D**

D/A Converter ..... 185, 196, 202, 338, 676  
 D/A Converter Cards, Multiprogrammer ..... 197, 200  
 Daisywheel Printer ..... 57

**Data**

Acquisition Systems ..... 173–186, 193  
 Acquisition System Training ..... 30  
 Analyzer ..... 394  
 Communications ..... 54, 111–127  
 Error Analyzer ..... 122  
 Generators ..... 133, 394, 399  
 Line Analyzer ..... 118  
 Logger ..... 175, 180  
 Transmission Test Set ..... 122

**DC**

Milliammeters ..... 155–163, 165–171  
 Voltage Source ..... 226  
 Voltmeters ..... 159–167

**DC Power Supplies**

Amplifier/Power Supply ..... 329  
 Autoranging ..... 318, 324, 326  
 Condensed Listing ..... 309  
 Constant-Current Sources ..... 311  
 Digitally Controlled ..... 328  
 Dual Tracking ..... 313–317  
 General Information ..... 308  
 General Purpose: 10-30 W Output ..... 313  
 General Purpose: 25-200 W Output ..... 316  
 General Purpose: 100-2000 W Output ..... 318, 320  
 General Purpose: 300-11,000 W Output ..... 322  
 HP-IB Programmable ..... 324–327  
 Precision Voltage Sources ..... 330  
 Programmable ..... 308–311, 324–327  
 Specifications Definitions ..... 312  
 Transistor Bias ..... 566, 573

**Decade Capacitors and Attenuators ..... 238**

**Degaussers ..... 301, 390**

**Delay Generator ..... 415**

**Detectors**

Adapter ..... 538  
 Coaxial, Microwave, OEM ..... 504, 538  
 Crystal, Coaxial and Waveguide ..... 504  
 Error ..... 132–133  
 Slotted Line ..... 506

**Development Station ..... 264**

**Development Systems, Logic ..... 264**



- Digital
- AC Voltmeters ..... 153–160, 168–171
  - Analyzer, Logic ..... 260
  - Analyzer, Signature ..... 239–243
  - Bar Code Reader Module ..... 66
  - Bar Code Wand ..... 67, 662
  - Board Tester ..... 254–258
  - Cassette Drive ..... 67
  - Circuit Test ..... 239–249, 254–258
  - Current Tracer ..... 247
  - DC Voltmeters ..... 153–160, 165–166
  - Education Course ..... 250
  - IC Tester ..... 226–237, 254–258
  - IC Test System ..... 236
  - Impedance Meter ..... 214–219
  - In-Circuit Board Test System ..... 254–258
  - LCR Meter ..... 206–209, 220–223
  - Microprocessor Troubleshooting ..... 239–243
  - Multimeter ..... 67, 159–162, 165, 239–240
  - Multimeter, Signature ..... 239–240
  - Noise Figure Meter ..... 526
  - PC Board Test System ..... 254–258
  - Pressure Gauge ..... 666
  - Programmable Power Supplies ..... 308–311, 324–327
  - Power Meter ..... 517–518
  - Signal Analyzers ..... 239–243, 577–652
  - Signal Generators ..... 460, 462
  - Signature Analyzer ..... 239–243
  - Spectrum Analyzers ..... 585, 588, 590–623, 625, 633, 638
  - Stimuli ..... 247
  - Test Sets, Digital Logic ..... 239, 244
  - Thermocouple Card, Multiprogrammer ..... 200
  - Thermometer ..... 176, 182, 187, 667
  - D/A Current Converter Card ..... 182, 187, 197, 200
  - D/A Voltage Converter Card ..... 182, 187, 197, 200
  - Transmission Analyzer ..... 133
  - Troubleshooting ..... 239–243, 246–249
  - Troubleshooting (Video Tape) ..... 34
  - Voltmeters ..... 153–160, 165
- Digital In-Circuit Board Test System ..... 254–258
- Digital Input/Analog Comparator Card ..... 197, 200
- Digital Input/Output Card
- HP-1000 A-Series ..... 188
- Digital Input/Output Module ..... 176, 182, 187, 190
- Digital Input Card, Multiprogrammer
- Common Ground ..... 197, 200
  - Isolated Input ..... 197, 200
- Digital-to-Analog Converters ..... 182, 197, 200, 327, 338, 676
- Digital Output Card, Multiprogrammer ..... 197, 200
- Digitizing Oscilloscopes ..... 332
- Dimensional Measurements ..... 664–665
- Diodes ..... 663
- Directional Bridge ..... 536
- Disc Drives ..... 59, 91
- Flexible ..... 59
  - Winchester, Microflop/Winchester ..... 60
- Disc/Tape Drives ..... 92
- Displays
- Cathode-ray Tube ..... 366
  - Display System ..... 372
  - Graphics Generator (HP-IB Interface) ..... 372
  - Imaging ..... 369
  - Instrumentation ..... 371
  - Large Screen ..... 372
  - LED ..... 662
- Distortion Analyzers ..... 633, 641–643
- Distribution Amplifier ..... 306
- Double Balanced Mixer ..... 508
- Doublers, Frequency ..... 464–465
- Down Converter (1.7–14.5 GHz to 70/140 MHz) ... 149, 621
- Drafting Plotters ..... 102
- Dual Tracking, Power Supply ..... 313–317
- Dual VHF Switch Module ..... 180
- Dynamic Signal Analyzer ..... 625, 627, 630, 633
- E**
- Eight Channel Bank Amplifiers ..... 388
- Eight-pen Plotters ..... 100–103
- Emitters/Detectors ..... 662
- Optical Reflective Sensor ..... 662
- Electronic Counters ..... 276–299
- HP-IB/HP-IL ..... 277
- EMI Measurement Software and Accessories ..... 599
- EMI Measurement System, Portable ..... 606
- Emulators, Microprocessor ..... 244, 265
- EPROM Development Kit ..... 75
- Error Rate Measurements ..... 131–133
- Exerciser, Microprocessor ..... 244
- Extenders, HP-IB ..... 678–679
- External Mixers ..... 621
- F**
- Faxitron® X-Ray Systems ..... 657
- FDM/Carrier Systems Testing ..... 136, 144
- FDM Network Surveillance Software ..... 139, 144
- Fiber Optics
- Cable ..... 662
  - Connectors ..... 662
  - Multiplexer ..... 662
  - Test Equipment ..... 510–515
  - Transmitters/Receivers ..... 662
- Filters
- Coaxial and Waveguide ..... 508
  - High Pass ..... 508, 539
  - Low Pass ..... 285, 508, 539, 608
- Fourier Analyzer ..... 625, 627, 630, 633
- FM Modulation Analyzer ..... 648
- FM Signal Generators ..... 440–455
- Frequency
- Counters ..... 276–299
  - Counter/Tracking Generator ..... 614
  - Doublers ..... 464–465



- Meters, Coaxial and Waveguide ..... 505  
 Stability Analyzer ..... 636  
 Synthesizer, Microwave ..... 459, 460, 462, 463  
 Frequency Reference Card, Multiprogrammer ..... 197, 200  
 Frequency Standards ..... 300  
   Cesium ..... 301  
   Distribution Amplifier ..... 306  
 Frequency and Time Standards  
   General Information ..... 300  
   Quartz ..... 305  
   Rubidium ..... 302  
   Standby Power Supplies ..... 307  
 Frequency Selective Meter and  
   Tracking Oscillator ..... 141, 435–436, 588  
 Frequency Stability Analyzer ..... 636  
 Frequency Synthesizers ..... 432–433, 436–437,  
   440–450, 460, 462–463  
 Function Generators ..... 422–433, 436–437  
 Furniture, Workstation ..... 106
- G**  
 Gas Chromatograph ..... 660  
 GC/Mass Spectrometer Systems ..... 660  
 General Purpose Interface  
   HP-IL ..... 67–72  
 General Purpose Integrator Preamp ..... 387  
 General Purpose Relay Module ..... 176, 182, 187, 190  
 Generators  
   Arbitrary Waveform ..... 338  
   Data ..... 133, 394  
   Delay ..... 412  
   Function ..... 419, 422–433, 436–437  
   Graphics ..... 372  
   Jitter ..... 134  
   Noise ..... 526  
   Pattern ..... 131–133  
   Pulse ..... 401  
   Signal ..... 438–464  
   Square Wave ..... 422, 424–425, 432, 459  
   Sweep ..... 425, 432, 434, 436–437, 467–493  
   Timing ..... 677  
   Tracking ..... 436–437, 602, 606, 612,  
     614, 616, 619  
 Graphics  
   Displays ..... 366  
   Generator (HP-IB Interface for displays) ..... 96, 372  
   Plotters ..... 96–103  
   Printers ..... 57–58, 95  
   Software ..... 49, 75, 77, 105  
   Supplies ..... 106  
   Tablets ..... 104  
   Terminals ..... 87  
 Guarded Digital Multimeter ..... 157, 160
- H**  
 Handheld Computers ..... 63–65  
 Hardware Support ..... 32  
 Harmonic Mixer (Coaxial and Waveguide) ..... 508, 621  
 Hewlett-Packard Interface Bus (HP-IB) ..... 668–679  
 Hewlett-Packard Interface Loop (HP-IL) ..... 63–65, 71, 176  
 High Gain DC Preamplifier ..... 386  
 High Power Attenuators ..... 496  
 High Power Sensors ..... 520  
 High Resistance Meter ..... 225  
 High Speed A/D Converter Card, Multiprogrammer ..... 197,  
   200  
 High Speed System Voltmeter ..... 157, 161  
 How to Solder (Video Tape) ..... 37  
 How to Use an Oscilloscope (Video Tape) ..... 37  
 HP-IB  
   Analog-to-Digital Converter ..... 75, 336, 677  
   ASCII-to-Parallel Converter ..... 676  
   Attenuator/Switch Driver ..... 499  
   Cables ..... 675  
   Controlled Attenuator/Switch Driver ..... 499  
   Controlled Channel Selector ..... 130  
   Digital Clock ..... 677  
   Digital-to-Analog Converter ..... 327, 338, 676  
   Extenders ..... 678–679  
   Frequency Counters ..... 277  
   General Information ..... 668  
   Graphics Tablet ..... 104  
   Relay Actuator ..... 500, 676  
   Switch/Control Unit (HP-IB) ..... 190  
   Switch Driver ..... 499  
   Timing Generator ..... 677  
   Training ..... 674  
   VHF Switch ..... 676  
 HP-IL ..... 63–65, 71, 176  
   Frequency Counters ..... 277, 298  
 Data Acquisition Systems ..... 176  
 Hybrid ROM Development System ..... 54
- I**  
 IC Tester, Digital ..... 236  
 IC Test System, Digital ..... 236  
 IC Testers, Parametric ..... 226–233  
 Impact Printer ..... 95  
 Impedance Analyzer ..... 214–217  
 Impedance Meters ..... 210–213, 218  
 Impedance Transformers (50–75  $\Omega$ ) ..... 622  
 In-circuit Functional Tester ..... 254–255  
 Indicators, LED ..... 662  
 Industrial Data Acquisition/Control System ..... 186  
 Ink Jet Printer ..... 67  
 Instrument Support ..... 28  
   Training Support ..... 29  
   Applications Support ..... 30  
   Software Support ..... 31  
   Hardware Support ..... 32  
 Insulation Resistance Meter ..... 157, 225  
 Integrators, Reporting ..... 661  
 Interface Bus (HP-IB) ..... 668  
 Interface Cards for Computers ..... 54, 74–77





Interface Loop (HP-IL)	71
Interface Kits	
HP-IL	68, 72
Logic Analyzer	269
Multiprogrammer	195, 199
Interfaces, Series 80	54
Interfacing Summary for Computers	83
Interference & Noise Test Set	140
Interference & Noise Measurement System	140
Interrupt Card, Multiprogrammer	197, 200
Isolators, Optical	662

**J**

Jitter Generator & Receiver	134
-----------------------------	-----

**K**

Kits, Overhead Transparency	105
Kits, Rack Mounting	682-683, 686
Kits, Fiber Optic Link	662

**L**

Laboratory Automation Systems	661
Laser Measurement System	664
Laser Measurement System Training	30
Laser Printers	95
LaserJet Printer	95
Laser Transducer System	665
LCR Meter	206-209, 220-221
LCZ Meter	210-213
LED Displays	662
LED Indicators	662
Light Bar Modules, LED	662
Light Emitting Diodes	662
Limiters	278-281, 284, 622
Liquid Chromatographs	661
Log Level Preamp	387
Logic	
Analyzer, and Development Systems	260
Analyzer Training Courses	29-30
Analyzers	270
Clip	248
Current Tracer	247
Comparator	248
Development System	264
Pattern Generator	399
Probes	246
Pulser	247
Signal Sources	393, 401
Troubleshooting System	239, 249
Low Distortion Generator	141, 437
Low Distortion Measurement	144
Low Frequency Spectrum Analyzer	612, 633-634
Low Gain Preamplifier	386
Low Level A/D Converter Card, Multiprogrammer	197, 200
Low Resistance Meter	158, 225

**M**

Machinery Analyzer	633
Magnetic Bubble Memory Card	78
Magnetic Tape Recorders, Analog	390
Mass Selective Detectors	660
Mass Spectrometers	660
Matrix Switch (HP-IB)	190, 509
Measurement and Control Cards,	
HP-1000 A-Series	188
Measurement and Analysis System	193, 337
Measurement and Control System	633
Measurement Graphics Software	379
Measurement Plotting System	378
Measuring Receiver	644-647
Mechanical Impedance Analyzer	633
Medical Instrumentation	658-659
Memory Card, Multiprogrammer	197, 200
Memory Modules, HP-41, HP-71 and HP-75	65-66
Memory Modules, Series 80	52
Meters	
AC	163-165
AC Resistance	225
Capacitance	206-223
Conductance	206-223
Digital Multimeter	153-160, 165
Distortion	641-642
Frequency	505
Impedance	214-219
LCR	206-224
LCZ	206-209
Milliammeter, DC	153-171
Milliohmmeter	159-163, 165, 225
Modulation	648-650
Multifunction	158-163, 170, 225
Noise Figure	526
Ohmmeter	159-170
Peak Power	523
Picoampere	226-227
Power (RF/Microwave)	517-523
Signature Multimeter	240
Standing-Wave-Ratio (SWR)	506
Susceptance	158
True RMS	162, 168
Vector Impedance	218-219
Microprocessor Exerciser	244
Microprocessor Training	250
Microprocessor Troubleshooting	239-244, 260
Microwave	
Amplifiers	416
Counters	278-281, 284
Diodes	504, 538, 663
Down-Converter	638
Link Analyzers	147
Measurement System	646
Network Analyzers	568, 575
Noise Figure Meter	526



- Power Measuring Equipment ..... 516–523
- Radio Testing ..... 136
- Semiconductors ..... 663
- Signal Generators ..... 456–463
- Source Synchronizer ..... 280
- Spectrum Analyzers ..... 590, 595, 602, 608, 618
- Sweep Oscillators ..... 467–493
- Synthesizers ..... 460–463
- Test Equipment ..... 494–509
- Transistors ..... 663
- Miliohmeter ..... 153–170, 225
- Miniature Fiber Optic Link ..... 662
- Mixers, Double-balanced ..... 508
- Mixers, Coaxial and Waveguide ..... 508, 621
- Modal Analysis ..... 633, 635
- Modems ..... 84
- Modular Run-Only Computer ..... 79
- Modulation Analyzer ..... 648–650
- Modulator/Demodulator ..... 84, 146
- Modulators, Absorptive ..... 465–466, 540
- Modulators, PIN ..... 465–466
- Modulation Test Source ..... 648–650
- Modules (HP-41, HP-71, HP-75) ..... 65, 69
- Motion Control ..... 662
- Multi-frequency LCR Meter ..... 206–209
- Multimeter ..... 153–170
- Multimeter, Signature ..... 240
- Multiplex (Primary) Analyzer ..... 130
- Multiprogrammers ..... 192
- N**
- Network Analysis, General Information ..... 528–533
- Network Analyzers ..... 534–576
- Automatic ..... 560, 575
- Automatic Scalar ..... 534
- Scalar ..... 535, 542
- Training Courses ..... 30
- Networking for HP 9000 Computers ..... 73
- Noise
- Figure Meter ..... 526
- Generator ..... 527
- Measurements ..... 524, 636, 638
- Noise and Interference Test Set ..... 140
- Noise and Interference Measurement System ..... 140
- Non-Impact Printers ..... 95
- O**
- OEM
- Computers ..... 74, 76, 79–80, 82, 86
- Displays, CRT ..... 366
- Graphics Plotters ..... 98–103
- HP-IL Interface Kit ..... 68
- Measurement Plotting System ..... 378
- Microwave Attenuators ..... 498
- Microwave Components ..... 498, 663
- Microwave Crystal Detectors ..... 504
- Microwave Switches ..... 509
- Optoelectronic Components ..... 662
- Power Supplies ..... 308
- X-Y Recorders ..... 378–384
- Ohmmeters ..... 158–165, 170
- Operating Cases ..... 692
- Optical Pulse Power Meter ..... 514
- Optical Receiver ..... 515
- Optical Shaft Encoders ..... 662
- Optical Signal Source ..... 512
- Optional Operational Systems, Series 80 ..... 52
- Optocouplers ..... 662
- Optoelectronics ..... 662
- OR Monitors ..... 659
- Oscillators
- Audio ..... 421
- Function ..... 422–425, 432
- General Information ..... 419–421
- Low Frequency ..... 432
- Sinewave ..... 421
- Squarewave ..... 422–425, 432
- Sweep ..... 425, 432, 436–437, 467–493
- Synthesized Sweep ..... 432, 436–437
- Oscillographic Recorders ..... 378, 385
- Oscilloscopes ..... 332
- Accessories ..... 357
- Camera ..... 363
- Digital Waveform Storage ..... 336
- Digitizing ..... 332, 340
- Measurement System ..... 344
- 100 MHz Third-Channel Trigger View
- Delta Time ..... 348
- Precision Time Interval ..... 352
- Variable Persistence Storage ..... 350
- 275 MHz Delta Time Measurements ..... 352
- 275 MHz Fast Variable Persistence Storage ..... 350
- Software, Oscilloscope Measurement System ..... 344
- Software, Waveform Measurement Library ..... 337
- Spectrum Analyzer Plug-In ..... 604, 606, 608
- Testmobiles ..... 364
- TV/Video Sync Retrofit Kit ..... 362
- Variable Persistence Storage ..... 350
- Overhead Transparency Kits ..... 105
- P**
- pA Meter ..... 226
- Pad, Coaxial Attenuator ..... 496
- Page Printers ..... 95
- Patient Monitors ..... 659
- Pattern Generator/Error Detector ..... 131–132
- PC Board Testers ..... 254–258
- PCM Test Equipment ..... 128–135
- Peak Power Meter, Analog ..... 523
- Peak Power Meter, Digital ..... 523
- Performance Board ..... 397
- Perinatal Instrumentation ..... 658



- Personal Calculators & Handheld Computers ..... 62-70  
 Personal Computers ..... 43-72  
 Phase Comparator ..... 301  
 Phase Meters ..... 290, 548  
 Phase Modulation Analyzer ..... 648-650  
 Phase Modulation, Signal Generator ..... 550-553  
 Phase Noise Measurement ..... 636, 640  
 Phase Sensitive Demodulator ..... 387  
 PIN Diodes ..... 663  
 PIN Modulators, Microwave ..... 465-466  
 PIN Photodiodes ..... 662  
 Plotter Accessories and Supplies ..... 105  
 Plotters, Drafting ..... 102  
 Plotters, Graphics ..... 98-103  
 Portable  
   Counters ..... 294-299  
   Computers ..... 46, 63  
   Data Logger/Data Acquisition System ..... 176  
   Power Meter ..... 519, 522  
   Spectrum Analyzers ..... 604-609, 623, 643  
   Voltmeter ..... 159-170  
 PORTABLE, The ..... 46  
 Power Amplifiers ..... 416-418  
 Power Dividers ..... 501  
 Power Meter Calibrators ..... 519-522  
 Power Meter/Measuring Receiver ..... 644-647  
 Power Meters, RF & Microwave ..... 517-523  
 Power Sensors, RF & Microwave ..... 520-523  
 Power Splitter ..... 540  
 Power Supplies  
   Amplifier/Power Supplies ..... 329  
   Atomic Clock ..... 307  
   Condensed Listing ..... 309  
   Constant Current Sources ..... 331  
   Digitally Controlled ..... 324-328  
   Dual Tracking ..... 313-317  
   Frequency Standards ..... 307  
   HP-IB Programmable ..... 324-327  
   Laboratory ..... 308  
   Multiprogrammer Control ..... 192, 308  
   Precision Voltage Sources ..... 330  
   Programmable ..... 308-311, 324-328  
   Specifications Definitions ..... 312  
   Standby ..... 307  
 Power Supply/Amplifier ..... 329  
 Practical Transistors (Video Tape) ..... 34  
 Preamplifiers ..... 285, 385-388, 418  
 Precision Coaxial Connectors ..... 681  
 Precision Frequency Source ..... 300  
 Precision Oscillator ..... 305  
 Preselector ..... 619  
 Pressure Gauge, Quartz ..... 666  
 Primary Multiplex Analyzer ..... 130  
 Printer, Graphics ..... 53-54, 58  
 Printer, Line ..... 58, 95  
 Printers, Letter Quality Daisywheel ..... 57  
 Printers, Thermal Graphics ..... 58  
 Printer, Thermal Instrumentation ..... 392  
 Probes ..... 246  
   Accessories ..... 166, 246, 285  
   Active ..... 285, 622  
   Digital Multimeter ..... 166  
   High Frequency ..... 166  
   Logic ..... 246  
   Miniature ..... 357  
   Slotted Line ..... 506  
   Temperature ..... 363, 667  
   Time Interval ..... 285  
   Voltage Divider ..... 166  
 Programmable Digitizers ..... 336  
 Programmable Modulation Analyzer ..... 648-650  
 Programmable ROM Module (for HP 80 Series) ..... 54  
 Programmable Signal Source ..... 338, 425, 431-432, 434,  
   436-437, 440-450, 467-487  
 Programming Development Aids, HP Series 80 ..... 54  
 Protocol Analyzers ..... 114-116  
 Pulse Adder, Splitter, Inverter ..... 414  
 Pulse Generators ..... 401  
   Configurable ..... 414  
   High Power ..... 403  
   Programmable ..... 404, 406  
 Pulse/Function Generators ..... 338, 401, 425, 428-429  
 Pulsers, Logic ..... 247
- Q**
- Q-Meter ..... 224  
 Quartz Frequency Standard ..... 305  
 Quasi-Peak Adapter ..... 599  
 Quartz Pressure Gauge ..... 666  
 Quartz Thermometer ..... 667
- R**
- Rack Mount Kits ..... 682-686  
 Rack Slides ..... 682-686  
 Range Calibrator (for HP 435A Power Meter) ..... 519  
 Readers, Card (HP-41 CV/CX) ..... 65  
 Receiver, Measuring ..... 644  
 Recorders  
   Oscillographic ..... 385  
   Instrumentation Tape ..... 390  
   Measurement Plotting System ..... 378  
   Waveform ..... 336, 378  
   X-Y ..... 381-384  
 Reflection/Transmission Test Sets ..... 571, 574  
 Relay Actuator (HP-IB) ..... 499, 676  
 Relay Output Card, Multiprogrammer ..... 197, 200  
 Remote Access and Test System ..... 151  
 Resistance Meter ..... 153-170  
 Retrofit, Signature Analysis ..... 244  
 Resuscitation Instrumentation ..... 658  
 RF Amplifiers ..... 418  
 RF Impedance Analyzer ..... 214-215



- RF Spectrum Analyzers ..... 585, 588, 592, 604, 606,  
614, 616, 627
- RF Test System ..... 653
- RMS Voltmeter ..... 159–162, 168
- ROMs, HP Series 80 ..... 52
- Rotary Air Line, Coaxial ..... 495
- Rotary Joint, Coaxial ..... 495
- Rotary Vane Attenuators, Waveguide ..... 498
- Rubidium Frequency Standard ..... 302
- S**
- S-Parameter Test Sets ..... 570, 572
- Scalar Network Analyzers ..... 534–543
- Scanner ..... 176, 182, 186, 189
- Scanner Cards, Multiprogrammer ..... 197, 200
- Schottky Diodes ..... 663
- Selective Level Measuring Set ..... 137
- Selective Level Voltmeters ..... 119, 137, 141, 588, 643
- Selective Voltmeter ..... 137
- Self-Test Digital Multimeter ..... 157–160
- Semiconductor/Component Test System ..... 230–231
- Semiconductor Parameter Analyzer ..... 228–229,  
233–234
- Sensor Modules ..... 645
- Sensors, Microwave Power ..... 520, 523
- Series 10 Professional Calculators ..... 62
- Series 10-500 Supplies and Accessories ..... 106
- Series 80 Communications ..... 52
- Series 80 Interfaces ..... 52
- Series 80 Optional Operating Systems ..... 52
- Series 80 Peripherals ..... 52
- Series 80 Personal Computers ..... 52
- Series 80 Programming Development Aids ..... 52
- Series 80 ROMs ..... 52
- Series 80 Software ..... 54
- Shaft Encoders, Optical ..... 662
- Shorts, Coaxial ..... 507, 573
- Shorts, Waveguide ..... 507
- Signal Analyzers ..... 577–652
- Audio ..... 651
- Automatic Spectrum ..... 585, 590–598, 625
- Digital ..... 243, 635
- Distortion ..... 119, 641, 651
- General Information ..... 577–584
- Modulation ..... 648–650
- Phase Noise ..... 636–638
- Spectrum ..... 585, 588, 590–623, 633–634
- Signal Analyzer, Digital ..... 243
- Signal Conditioners ..... 385–388
- Signal Generators
- Accessories ..... 464
- General Information ..... 438
- HF, VHF, UHF, SHF ..... 440–455
- Microwave ..... 455–463
- Programmable ..... 440–450, 459
- Pulse Modulator ..... 465–466
- Synthesized ..... 440–450, 459–463
- Signal Sources ..... 432, 434–437, 440–455
- Signal Sources, Programmable ..... 338, 432, 434–437,  
440–450
- Signature Analysis, Troubleshooting System ..... 239
- Signature Analysis ..... 240–244
- Signature Analysis Stimulus ..... 244
- Signature Analyzer, Digital ..... 240–243
- Signature Multimeter, Digital ..... 240
- Single Sideband Phase Noise ..... 638
- Slides for Rack Mounting ..... 682–686
- Sliding Load (Coaxial and Waveguide) ..... 507
- SLMS System Software ..... 139, 144
- Slotted Lines (Coaxial and Waveguide) ..... 506
- SMA, SMB, SMC Series Adapters ..... 681
- Software
- Applications Solutions ..... 31, 70, 75, 77
- Business ..... 70, 86
- Graphics ..... 49, 75, 77, 105, 379
- HP-41 ..... 70
- HP-71 ..... 70
- HP-75 ..... 70
- Logic State Analyzer ..... 264, 270
- Oscilloscope Measurement System ..... 344
- Series 10 ..... 70
- Series 80 ..... 54
- Spectrum Analyzer System ..... 598, 599, 636
- The PORTABLE ..... 48
- Touchscreen Personal Computers ..... 48
- Waveform Measurement ..... 337
- Waveform Generator ..... 339
- Software Pacs, Signal Generator Test ..... 647
- Software Pacs, Transceiver Test ..... 647
- Software Pacs, Cellular Radio Test ..... 656
- Software Support ..... 31, 56
- Solid State
- Displays, Lamps, Optocouplers, Fiber Optics ..... 662
- Diodes, Transistors, Integrated Products ..... 663
- Source, AM/FM Test ..... 450
- Source, Signal ..... 440–455
- Spectrophotometer, Diode Array ..... 661
- Spectrophotometric Detector, Hi Speed ..... 661
- Spectrum Analyzers, General Information ..... 577–584
- Spectrum Analyzers ..... 585, 590–623, 625,  
633, 636, 639
- Spectrum Analyzer Preselector ..... 619
- Speech Output Module ..... 94
- Stability Analyzer, Frequency ..... 636, 638–640
- Standards, Frequency and Time ..... 300
- Standby Power Supply ..... 307
- Standing Wave Ratio (SWR) Meter ..... 506
- Step Attenuators, Coaxial ..... 499
- Stepping Motor Control ..... 197, 200
- Storage-Normalizer ..... 543, 576
- Strip Chart Recorders ..... 378
- Structural Dynamics ..... 633
- Support, Computer ..... 61, 107
- Support, Instrument ..... 28–32





- Sweep Oscillators, General Information ..... 467-469  
 Sweep Oscillators ..... 425, 432, 436-437, 470-493  
 Sweep Signal Generator ..... 445  
 Sweeper Synthesizer ..... 432, 436-437  
 Switch Controller, HP-IB ..... 138, 499  
 Switches  
   AC Power Controller ..... 202  
   Access, Distribution and Bidirectional ..... 138  
   Actuators ..... 499  
   HP-IB Driver ..... 499  
   Coaxial, Microwave OEM ..... 509  
   Matrix Microwave ..... 509  
   Matrix (HP-IB) ..... 190  
   5-Port Coaxial ..... 176, 182, 186, 189-190, 509  
   SPDT ..... 509  
   VHF Switch, HP-IB ..... 190, 676  
 Swivel Adapter ..... 495  
 Synchronizer/Counter ..... 280  
 Synchronizer, Microwave Source ..... 280  
 Synthesized Function Generator ..... 432  
 Synthesized Signal Generators ..... 440-450, 459-463  
 Synthesized Signal Sources ..... 432-437, 440-450  
 Synthesized Sweep Oscillator ..... 432-437, 470  
 Synthesizer, Time ..... 415  
 Synthesizers, Automatic ..... 432-437, 440-450  
 Synthesizers, Frequency ..... 432-437, 440-450  
 System, Digital Diagnostic ..... 239  
 System, Logic Development ..... 264  
 System, Noise and Interference Measurement ..... 140  
 System, Waveform Generation ..... 339  
 System, Waveform Measurement ..... 337  
 System I, System II Cabinets ..... 682, 686  
 Systems, Automatic Test ..... 193, 198, 203  
 Systems, Modem ..... 84  
 Systems, Real Time Computer ..... 80
- T**
- Tablets, Graphics ..... 104  
 Tape Degausser ..... 390  
 Tape Drives ..... 93  
 Tape Recorders, Analog Magnetic ..... 389  
 Technical Computers and Peripherals ..... 73-83  
   Asynchronous Serial Interface ..... 77-78  
   BCD Input Interface ..... 75, 78  
   Breadboard Card ..... 75, 78  
   Bus Expander ..... 75, 78  
   Color Video Interface ..... 77-78  
   Eight-Channel Multiplex Card ..... 77-78  
   EPROM Card Datacommunications Interface ..... 75, 78  
   Flexible Disc Drives ..... 59, 91  
   General Interfaces ..... 73, 83  
   GPIO Interface ..... 75, 77-78  
   Graphics Tablets ..... 104  
   HP-IB Interface ..... 73-78  
   HP-IL/HP Series 80 Interface ..... 54  
   I/O Expander ..... 192  
   Interfacing Summary ..... 83  
   Local Area Network Interface ..... 77-78  
   Magnetic Bubble Memory Card ..... 78  
   Micro Winchester Disc Drives ..... 60  
   Multiprogrammer: I/O Expander & Converter ..... 192  
   Plotters, Graphics ..... 98-101  
   Programmable Datacomm Interface ..... 75, 78  
   RGB Color Video Interface ..... 78  
   RJE Interface ..... 77-78  
   Serial Interface ..... 75  
   Shared Resource Management Interface ..... 77-78  
   Thermal Graphics/Printers ..... 392  
   Two Channel DMA Controller Interface ..... 78  
 Telecommunications Test Equipment ..... 119, 128-152  
   Access Switch ..... 138  
   Amplifier, Error Detector Input ..... 135  
   Amplifier-IF ..... 147  
   Attenuator-75  $\Omega$  General Purpose ..... 147  
   Audio Channel Selector: HP-IB Controlled ..... 130  
   Balanced 2/4-wire Audio Channel Selector ..... 130  
   Bidirectional Switch ..... 138  
   Carrier Testing ..... 119, 136, 141, 144  
   Cellular Radio Test Equipment ..... 656  
   Controller, Switch ..... 138  
   Converter, 75  $\Omega$  Unbal/110  $\Omega$  Bal ..... 135  
   Data Generator ..... 133  
   Data Line Analyzers ..... 118  
   Detector, Error ..... 132-133  
   Digital Transmission Analyzer ..... 133  
   Down Converter ..... 149, 638  
   Error Rate Measurements ..... 131-133  
   FDM Measurements ..... 119, 136-139, 141, 144  
   FDM Surveillance Software ..... 119, 139, 144  
   HP-IB Controlled Channel Selector ..... 130  
   Isolator, PCM Test Equipment ..... 135  
   Jitter Generator & Receiver ..... 134, 585  
   Microwave Link Analyzers ..... 147  
   Microwave Network Analyzer ..... 568, 575  
   Microwave Radio Testing ..... 136  
   Modulation Analyzer ..... 644, 648  
   Modulator/Demodulator ..... 146  
   Noise and Interference Test Set ..... 140  
   Noise and Interference Measurement System ..... 140  
   Pattern Generator/Error Detector ..... 131-132  
   PCM Terminal Test Set ..... 129  
   PCM Testing ..... 128  
   Power Meters ..... 516-523  
   Primary Multiplex Analyzer ..... 130  
   Remote Access and Test System ..... 151  
   Remote Automatic Surveillance Systems ..... 139  
   Selective Level Measuring Set ..... 137, 141, 144  
   Selective Level Meter ..... 137, 141, 144  
   SLMS, Accessories ..... 138  
   Switch, Access ..... 138  
   Switch Controller ..... 138, 499  
   Telephone Line Analyzer ..... 118  
   Transmission Impairment Measuring Set ..... 120  
   Voice & Data Testing ..... 117



Temperature Measurement	172, 182, 186, 189, 667
Termination Panel, Multiprogrammer	202
Terminations, Coaxial and Waveguide	507
Test Sets, Digital Logic	249
Test Sets, Signal Generator	647
Thermal Printers	66–67, 392
Thermal Graphics Line Printers	58
Thermistor Sensors, Coaxial and Waveguide	523
Thermocouple Power Meters	518–519
Thermocouple Power Sensors	520
Thermocouple Scanning Card	182, 186, 189, 200
Thermometer, Quartz	667
ThinkJet Printer	57, 67
Time Base (HP 7035B)	384
Time Domain Network Measurement	562
Time Interval Counter	286
Time Interval Standard	362
Time Module, HP-41	65
Time Standard	300
Time Synthesizer	415
Timer/Pacer Card, Multiprogrammer	197, 200
Timing Generator, HP-IB	677
Touch-Hold Probe	166
Touchscreen Personal Computer	44
Tracer, Current	247
Tracking Generators	141, 436–437, 602, 606, 612, 614, 616, 619
Training, Logic	29–30, 250
Training, Microprocessor	250
Training Support	30
Training/Video Tapes	34–37
Transceiver Modulation Analyzer	648–650
Transceiver Test System	653
Transfer Function Analyzer	625
Transient Digitizers	336
Transient Generators	338
Transient Recorders	336
Transmission Impairment Measuring Set	120–127
Transmission Test Set	123
Transistor Bias Supply	573
Transistor Test Fixtures	570, 572
Transistors, Bipolar	663
Transit Cases	688
Troubleshooting, Digital	239, 243, 249
True RMS Voltmeter	157–159, 162, 166, 168
Tuners, Microwave	508
Two-Channel Real Time Spectrum Analyzer	630, 633–635
Type N Series Adapters	573, 681
Type N Short	507, 573

## U

UCSD p-System, Series 80	54
UHF Signal Generators	445–458

Ultrasound Imaging	658
Understanding Microprocessors (Video Tape)	34
Upconverter Simulator for Microwave Link Analyzer	150

## V

Vector Impedance Meters	218–219
Vector Network Analyzer	528, 550, 568
Vector Voltmeter	553
VHF Generator	451
VHF Switch Module	190
Vibration Analyzer	627, 630, 633–635
Video Interface	77
Video Tapes	34–37
Voice/Data Testing	117
Voltmeters	153–166
Analog	153–162, 165–167
Digital	153–160, 165, 293
RF	171

## W

Waveform Analyzers	334, 625, 627, 630, 633–635
Waveform Digitizers	332
Waveform Recorders	51, 336, 378
Waveguide	495
Attenuators	498
Coaxial Adapters	495
Crystal Detectors	505
Directional Couplers	503
Frequency Meters	505
Harmonic Mixer	508, 621
Holder	495
Low-Pass Filters	508
Movable Shorts	507
Reflection/Transmission Test Sets	574
Shorting Switch	507
Slide Screw Tuners	508
Sliding Loads	507
Sliding Shorts	507
Slotted Section	506
Stand	495
Terminations	507
Thermistor Mounts	523
Variable Attenuators	498
Waveguide-Waveguide Adapters	495
Wideband Amplifiers	416–418
Word Generator	398
Word Processing Printer and Accessories	57
Workstation Printers	57–58

## X

X-Ray Systems, Scientific & Industrial	657
X-Y Recorders	51, 378–384



HP-11C Advanced Scientific Programmable.....	62	442B Slotted Line RF Probe.....	506
HP-12C Advanced Financial Programmable.....	62	444A Slotted Line Untuned Probe.....	506
HP-15C Advanced Scientific Programmable with Matrices.....	62	447B Slotted Line Detector Probe.....	506
HP-16C Advanced Programmable for Digital Electronics and Computer Science.....	62	478A Coaxial Thermistor Mount.....	523
HP-41CV Advanced Calculator.....	63	486A Series Waveguide Thermistor Mounts.....	523
HP-41 CV/CX Opt. 001 Custom Calculator.....	67		
<b>HP-41 CX Advanced Calculator.....</b>	<b>63</b>	<b>500</b>	
<b>HP-71B Handheld Computer.....</b>	<b>63</b>	532 Series Waveguide Frequency Meters.....	505
HP-75D Handheld Computer.....	65	536A Coaxial Frequency Meter.....	505
HP-85B Personal Computer.....	52	537A Coaxial Frequency Meter.....	505
HP-86B Personal Computer.....	52	545A Logic Probe.....	246
		546A Logic Pulser.....	247
		547A Current Tracer.....	247
		548A Logic Clip.....	248
<b>100</b>			
105B Quartz Frequency Standards.....	305	<b>600</b>	
<b>HP 110 - The PORTABLE.....</b>	<b>46</b>	680 Strip Chart Recorder.....	260
141T System Spectrum Analyzers.....	610		
141T Spectrum Analyzer Mainframe.....	610	<b>700</b>	
<b>HP 150 Touchscreen Personal Computers.....</b>	<b>43</b>	752 Series Waveguide Directional Couplers.....	503
182T Large Screen Display Mainframe.....	604, 606, 608	774D Coaxial Dual Directional Coupler.....	502
197B Oscilloscope Camera.....	363	775D Coaxial Dual Directional Coupler.....	502
		776D Coaxial Dual Directional Coupler.....	502
		777D Coaxial Dual Directional Coupler.....	502
		778D Coaxial Dual Directional Coupler.....	502
		779D Coaxial Directional Coupler.....	502
		784C Directional Detector.....	503
		786D Coaxial Directional Detector.....	503
		787D Coaxial Directional Detector.....	503
		788C Coaxial Directional Detector.....	503
		789C Coaxial Directional Detector.....	503
		796D Coaxial Directional Coupler.....	502
		797D Coaxial Directional Coupler.....	502
		798C Coaxial Directional Coupler.....	502
		<b>800</b>	
		809C Slotted Line Carriage.....	506
		810B Series Waveguide Slotted Sections.....	506
		816A Coaxial Slotted Section.....	506
		853A Spectrum Analyzer Display.....	604, 606, 608
		870A Series Waveguide Slide Screw Tuners.....	508
		<b>900</b>	
		905A Coaxial Sliding Load.....	507
		908A Coaxial 50-Ohm Termination.....	507
		909A/C Coaxial 50-Ohm Termination.....	507
		910 Series Waveguide Terminations.....	507
		911A/C Coaxial Sliding Loads.....	507
		914 Series Waveguide Sliding Loads.....	507
		920 Series Waveguide Moving Shorts.....	507
		923A Waveguide Sliding Short.....	507
		930A Waveguide Shorting Switch.....	507
		932A Waveguide Harmonic Mixer.....	508
		934A Coaxial Harmonic Mixer.....	508
		938A Frequency Doubler Set.....	465
		940A Frequency Doubler Set.....	465
<b>200</b>			
200CD Wide Range Oscillator.....	421		
214B Pulse Generator.....	403		
HP 250 Business Computer System.....	86		
281 Series Coaxial-Waveguide Adapters.....	495		
292 Series Waveguide-Waveguide Adapters.....	495		
<b>300</b>			
334A Distortion Analyzer.....	642		
339A Distortion Measuring Set.....	635		
346A/B/C Noise Source.....	526		
355 Series Coaxial Step Attenuators.....	499		
360 Series Coaxial Low-pass Filters.....	508		
362A Series Waveguide Low-pass Filters.....	508		
375 Series Waveguide Variable Attenuators.....	498		
382 Series Waveguide Precision Variable Attenuators.....	498		
393A Coaxial Variable Attenuator.....	498		
394A Coaxial Variable Attenuator.....	498		
<b>400</b>			
400E & EL AC Voltmeters.....	169		
400F & FL AC Voltmeter.....	169		
400 GL AC Voltmeter.....	169		
410C Voltmeter.....	170		
415E SWR Meter.....	506		
420C Coaxial Crystal Detector.....	504		
422A Series Waveguide Crystal Detectors.....	505		
423A/B Coaxial Crystal Detectors.....	504		
424A Series Waveguide Crystal Detectors.....	505		
427A Voltmeter.....	170		
428B Clip-on DC Milliammeter.....	171		
432 Series Power Meters.....	522		
435B Power Meter.....	519		
436A Power Meter.....	518		
436A-E40 Power Sensor Calibration System.....	516		
438A Dual Power Meter.....	518		



## 1000

HP 1000 Computers and Systems.....	80
1000/26 Computer System.....	81
1000/27 Computer System.....	81
1000/29 Computer System.....	81
1000/60 Computer System.....	81
1000/65 Computer System.....	81
1006A Testmobile.....	364
1007A Testmobile.....	364
1008A Testmobile.....	364
1040A Spectrophotometric Detector.....	660
1051A & 1052A Combining Cases.....	685
1090 Liquid Chromatograph.....	661
1110B Current Probe.....	359
1111A AC Current Amplifier.....	359
1117B Testmobile, Oscilloscope.....	364
1120A 500 MHz Active Probe.....	360, 363
1121A AC Probe.....	558
1122A Probe Power Supply.....	359
1124A 100 MHz Active Probe.....	359
1304A 32 cm (13 in.) Display.....	370
1310B 48.3 cm (19 in.) Display.....	372
1311B 35.6 cm (14 in.) Display.....	372
1317B 43.2 cm (17 in.) Display.....	372
1332A Small Screen Display.....	369
1335A Small Screen Display.....	369
1336S Small Screen Display.....	369
1340A Display Module.....	370
1345A Digital Display.....	371
1347A HP-IB Display.....	371
1351A Graphics Generator.....	372
1351S Computer Graphics Display System.....	372
1630A/D/G Logic Analyzer.....	270
1630 A/D + 24D Logic Analysis Measurement Techniques.....	30
1645A Data Error Analyzer.....	122
1700 Series Oscilloscopes.....	348
1725A 275 MHz $\Delta$ Time Oscilloscope.....	352
1726A Time Interval Oscilloscope, 275 MHz.....	352
1727A 275 MHz Oscilloscope.....	350
1740A 100 MHz Oscilloscope, Third-Channel Trigger View.....	348
1741A 100 MHz Oscilloscope, Variable Persistence Storage, Third-Channel Trigger View.....	351
1744A 100 MHz Oscilloscope, Fast Variable Persistence Storage, Trigger View.....	351
1745A 100 MHz Oscilloscope, Large-Screen.....	348
1746A 100 MHz Oscilloscope, Large-Screen, $\Delta$ Time.....	348
1950A Two Channel Expansion Module.....	342
1965A Gated Universal Counter Module.....	344
1980 Oscilloscope Measurement System.....	344
1980B + 24A Waveform Measurement System Training.....	29

## 2000

2106BK Board Computer.....	82
2113E Computer.....	82
2117F Computer.....	82
2137A Computer.....	82
2139A Computer.....	82
2156B Computer.....	82
2178C Model 60 Computer Systems.....	81

2179C Model 65 Computer Systems.....	81
2196C/D Model 26 Computer Systems.....	81
2197C/D Model 27 Computer Systems.....	81
2199C/D Model 29 Computer Systems.....	81
<b>2225A ThinkJet Personal Printer.....</b>	<b>57</b>
2250 Measurement & Control Processor.....	186
<b>2285A Local Area Network.....</b>	<b>77</b>
<b>2392A Display Terminal.....</b>	<b>87</b>
2486A Micro 26 Computer System.....	81
2487A Micro 27 Computer System.....	81
2489A Micro 29 Computer System.....	81
2563A Line Printer.....	95
<b>2565A Line Printer.....</b>	<b>95</b>
<b>2566A Line Printer.....</b>	<b>95</b>
2601A Daisywheel Printer.....	57
2602A Daisywheel Printer.....	57
2623A Graphics Terminal.....	88
2624B Display Terminal.....	89
<b>2625A Dual System Display Terminal.....</b>	<b>89</b>
2626A Display Station.....	90
2627A Color Graphics Terminal.....	88
<b>2628A Word Processing Terminal.....</b>	<b>90</b>
2635B Printer Terminal.....	58
2671A Printer.....	58
2671G Graphics Printer.....	58
2673A Intelligent Graphics Printer.....	58
2680 Laser Printing System.....	95
<b>2686A LaserJet Printer.....</b>	<b>95</b>
2687A Page Printer.....	95
2688A Page Printer.....	95
2804A Quartz Thermometer.....	667
2813B Quartz Pressure Probe.....	666
2816A Pressure Signal Processor.....	666
2934A Dual-Mode Printer.....	58

## 3000

HP 3000 Series 37, 42, 48 & 68/Business Computer Systems.....	86
3046A/B Selective Level Measuring System.....	144
3047A Phase Noise Measurement System.....	636
3054A Automatic Data Acquisition/Control System.....	178
3054C Automatic Data Acquisition/Control System.....	181
3054DL Data Logger.....	180
3056DL Data Logger.....	175
<b>3060A/3061A/3062A User's Course.....</b>	<b>30</b>
3061A/3062A In-circuit Functional Test System (HP-IB).....	254
3065 Board Test Family (HP-IB).....	256
<b>3065C + 24D Board Test System User Training.....</b>	<b>30</b>
3310A Function Generator.....	422
3310B Function Generator.....	422
3311A Function Generator.....	423
3312A Function Generator.....	424
3314A Function Generator.....	425
3325A Function Generator/Frequency Synthesizer/Sweeper.....	432
<b>3326A Two-Channel Synthesizer (HP-IB).....</b>	<b>434</b>
3335A Frequency Synthesizer.....	436
3336A/B/C Synthesizer/Level Generator.....	141, 437





3350 Series Laboratory Automation Systems .....	661
3390A Reporting Integrator .....	661
3400A RMS Voltmeter .....	168
3406A Broadband Sampling Voltmeter .....	171
3421A Data Acquisition/Control Unit .....	176
3435A Digital Voltmeter .....	165
3437A High Speed Digital Voltmeter .....	161
3455A 6½ Digit DMM .....	160
3456A Systems DVM .....	157
3466A 4½ Digit Autoranging DMM .....	162
3468A/B 5½ Digit Multimeter (HP-IL) .....	163
3478A 5½ Digit Multimeter (HP-IB) .....	155
3488A Switch Control Unit (HP-IB) .....	190
3495A Scanner .....	189
3497A Data Acquisition/Control Unit .....	182
3529A Magnetometer Probe .....	171
3551A Transmission Test Set .....	123
3552A Transmission Test Set .....	123
<b>3561A Dynamic Signal Analyzer (HP-IB) .....</b>	<b>627</b>
<b>3562A Dynamic Signal Analyzer (HP-IB) .....</b>	<b>630</b>
3575A Gain/Phase Meter .....	548
<b>3577A Network Analyzer (HP-IB) .....</b>	<b>544</b>
3580A Spectrum Analyzer .....	623
3581A Wave Analyzer .....	643
3581C Selective Voltmeter .....	119
3582A Spectrum Analyzer .....	625
3585A Spectrum Analyzer .....	585
3586A/B Selective Level Meter .....	141
3586C Wave Analyzer .....	588
3702B IF/BB Receiver (70 MHz IF) .....	147
<b>3708A Noise and Interference Test Set .....</b>	<b>140</b>
<b>3708S Noise and Interference Measurement System .....</b>	<b>140</b>
3710A IF/BB Transmitter (70 MHz IF) .....	147
3711A IF/BB Transmitter (70/140 MHz IF) .....	147
3712A IF/BB Receiver (70/140 MHz IF) .....	147
3717A 70 MHz Modulator/Demodulator .....	146
3730B Down Converter: RF to IF .....	149
3736B RF Module (1.7 to 4.2 GHz) .....	149
3737B RF Module (3.7 to 8.5 GHz) .....	149
3738B RF Module (5.9 to 11.7 GHz) .....	149
3739B RF Module (10.7 to 14.5 GHz) .....	149
3743A IF Amplifier .....	148
3746A Selective Level Measuring Set (32 MHz) .....	137
3750A Attenuator, 75 Ω .....	148
3754A Access Switch .....	138
3755A Switch Controller .....	138
3756A 90 MHz Bi-directional Switch .....	138
3757A 8.5 MHz Access Switch .....	138
3762A Data Generator .....	133
3763A Error Detector .....	133
3764A Digital Transmission Analyzer .....	133
3770B Telephone Line Analyzer .....	118
3776A PCM Terminal Test Set .....	118, 129
3776B PCM Terminal Test Set .....	118, 129
3777A HP-IB-Controlled Channel Selector .....	130
3779C Primary Multiplex Analyzer (CEPT) .....	130
3779D Primary Multiplex Analyzer (Bell) .....	130
3780A Pattern Generator/Error Detector .....	131
3781A Pattern Generator (CEPT and CCITT Compatible) .....	132
3781B Pattern Generator (BELL Compatible) .....	132
3782A Error Detector (CEPT and CCITT Compatible) .....	132
3782B Error Detector (BELL Compatible) .....	132
3785A Jitter Generator & Receiver (CEPT) .....	134
3785B Jitter Generator & Receiver (Bell) .....	134
3964A Instrumentation Tape Recorder .....	390
3968A Instrumentation Tape Recorder .....	390
<b>4000</b>	
4061A Semiconductor/Component Test System .....	230
4062A Semiconductor/Parametric Test System .....	232
<b>4063A Semiconductor Parameter Analysis System .....</b>	<b>234</b>
4140B pA Meter/DC Voltage Source .....	226
4145A Semiconductor Parameter Analyzer .....	228
4191A RF Impedance Analyzer .....	214
4192A LF Impedance Analyzer .....	216
4193A Vector Impedance Meter .....	218
4261A Digital LCR Meter .....	220
4262A Digital LCR Meter .....	220
4274A LCR Meter .....	206
4275A LCR Meter .....	206
4276A LCZ Meter .....	210
4277A LCZ Meter/C-V Plotter .....	210
4280A 1 MHz C Meter .....	222
4328A Milliohmometer .....	225
4329A High Resistance Meter .....	225
4342A Q Meter .....	224
4440B Decade Capacitor .....	238
<b>4925B Bit Error Rate Test Set .....</b>	<b>121</b>
4935A Transmission Impairment Measuring Set .....	120
4936A Transmission Impairment Measuring Set .....	120
<b>4937A Transmission Impairment Measuring Set .....</b>	<b>127</b>
<b>4938A Network Circuit Access Test Set .....</b>	<b>126</b>
4945A Transmission Impairment Measuring Set .....	124
<b>4951A Protocol Analyzer .....</b>	<b>114</b>
<b>4953A Protocol Analyzer .....</b>	<b>115</b>
4955A Protocol Analyzer .....	116
4955A + 24A Protocol Analyzer User's Training .....	30
<b>5000</b>	
5001A Microprocessor Exerciser (6800) .....	244
5001B Microprocessor Exerciser (6802, 6808) .....	244
5001C Microprocessor Exerciser (8085) .....	244
5001D Microprocessor Exerciser (Z80) .....	244
5005A Signature Multimeter .....	240
5005B Signature Multimeter .....	240
5006A Signature Analyzer .....	243
5011T Logic Troubleshooting Kit .....	249
5021A Logic Troubleshooting Kit .....	249
5022A Logic Troubleshooting Kit .....	249
5023A Logic Troubleshooting Kit .....	249
5024A Logic Troubleshooting Kit .....	249
5035T Logic Lab .....	250
5036A Microprocessor Lab .....	250
5045A Digital IC Tester .....	236
5046S Digital IC Test System .....	236
5061A Cesium Beam Frequency Standard .....	301
5061A with Option 004 Tube .....	301
E21-5061A Flying Clock (Cesium) .....	301
5065A Rubidium Frequency Standard .....	301

E21-5065A Portable Rubidium Time Standard.....	301
5087A Distribution Amplifier.....	306
5089A Standby Power Supply.....	307
5150A Thermal Printer.....	392
5180A Waveform Recorder.....	336
5182A Waveform Recorder/Generator.....	338
5182S Waveform Generation System.....	339
5314A Universal Counter.....	297
5315A & 5315B Universal Counters.....	294
5316A Universal Counter.....	294
5328A Universal Counter.....	293
5334A Universal Counter.....	288
5335A Universal Counter.....	290
5340A Microwave Frequency Counter.....	281
5342A Microwave Frequency Counter.....	278
5343A Microwave Frequency Counter.....	278
5344S Microwave Source Synchronizer.....	280
5345A Electronic Counter.....	282
5355A Automatic Frequency Converter.....	284
5356A, B, C Frequency Converter Heads.....	284
5359A Time Synthesizer.....	415
5363B Time Interval Probes.....	285
5370B Universal Time Interval Counter.....	286
5381A Frequency Counter.....	299
5382A Frequency Counter.....	299
5383A Frequency Counter.....	299
5384A Frequency Counter.....	298
5385A Frequency Counter.....	298
5423A Structural Dynamics Analyzer.....	633
5427A Digital Vibration Control System.....	635
5501A Laser Transducer System.....	665
5528A Laser Measurement System.....	664
5880A Gas Chromatograph.....	660
5890A Gas Chromatograph.....	660
5970B Mass Selective Detector.....	660
5987A GC/Mass Spectrometer.....	660
5995B GC/Mass Spectrometer.....	660

**6000**

6002A Extended Range DC Power Supply.....	326
6011A 1000 Watt Autoranging Power Supply.....	318
6012B/200 Watt Autoranging Power Supply.....	318
<b>6023A 200 Watt Autoranging Power Supply.....</b>	<b>318</b>
6024A 200 Watt Autoranging DC Power Supply.....	318
<b>6031A 1000 Watt Autoranging System Power Supply.....</b>	<b>324</b>
<b>6032A 1000 Watt Autoranging System Power Supply.....</b>	<b>324</b>
<b>6033A 200 Watt Autoranging System Power Supply.....</b>	<b>324</b>
<b>6038A 200 Watt Autoranging System Power Supply.....</b>	<b>324</b>
6114A & 6115A Precision DC Power Supplies.....	330
6129C-6131C Digitally Controlled Voltage Sources.....	328
6140A Digital Current Source.....	328
6177C Precision DC Current Source.....	331
6181C Precision DC Current Source.....	331
6186C Precision DC Current Source.....	331
6200B-6209B DC Power Supplies.....	313-315
6212B-6218B DC Power Supplies.....	313-315
6227B Dual Tracking DC Power Supply.....	316
6228B Dual Tracking DC Power Supply.....	316
6234A Dual Output Power Supply.....	313-315
6235A Triple Output Power Supply.....	314

6236B Triple Output DC Power Supply.....	314
6237B Triple Output DC Power Supply.....	314
6253A Dual Output DC Power Supply.....	316
6255A Dual Output DC Power Supply.....	316
6259B DC Power Supply.....	320
6260B DC Power Supply.....	320
6261B DC Power Supply.....	320
6263B DC Power Supply.....	320
6264B DC Power Supply.....	320
6265B DC Power Supply.....	320
6266B DC Power Supply.....	320
6267B DC Power Supply.....	320
6268B DC Power Supply.....	320
6269B DC Power Supply.....	320
6274B DC Power Supply.....	320
6281A DC Power Supply.....	316
6282A DC Power Supply.....	316
6284A DC Power Supply.....	316
6286A DC Power Supply.....	316
6289A DC Power Supply.....	316
6291A DC Power Supply.....	316
6294A DC Power Supply.....	316
6296A DC Power Supply.....	316
6299A DC Power Supply.....	316
6434B DC Power Supply.....	322
6438B DC Power Supply.....	322
6443B DC Power Supply.....	322
6448B DC Power Supply.....	322
6453A DC Power Supply.....	322
6456B DC Power Supply.....	322
6459A DC Power Supply.....	322
6464C DC Power Supply.....	322
6466C DC Power Supply.....	322
6469C DC Power Supply.....	322
6472C DC Power Supply.....	322
6475C DC Power Supply.....	322
6477C DC Power Supply.....	322
6479C DC Power Supply.....	322
6483C DC Power Supply.....	322
6824A DC Power Supply/Amplifier.....	329
6825A DC Power Supply/Amplifier.....	329
6826A DC Power Supply/Amplifier.....	329
6827A DC Power Supply/Amplifier.....	329
6901S Measurement & Analysis System.....	193
6940B Multiprogrammer.....	199
6941B Multiprogrammer Extender.....	199
6942A Multiprogrammer.....	195
6942A + 24D Multiprogrammer User's Training.....	29
6942S Computer Aided Test System.....	198
6943A Multiprogrammer Extender.....	195
<b>6944A Series 200 Multiprogrammer.....</b>	<b>194</b>
<b>6944S Series 200 Multiprogrammer System.....</b>	<b>198</b>

**7000**

7015B X-Y Recorder.....	381
7035B X-Y Recorder.....	384
7045B X-Y Recorder.....	382
7046B X-Y Recorder.....	382
<b>7090A Measurement Plotting System.....</b>	<b>378</b>
7414A 4-Channel Oscillographic Recorder.....	385



7418A 6 to 8 Channel Oscillographic Recorder.....	385
7470A 2-Pen Graphics Plotter.....	98
7475A 6-Pen Graphics Plotter.....	98
<b>7550A 8-Pen Graphics Plotter.....</b>	<b>100</b>
7580B 8-Pen Drafting Plotter.....	102
7585B 8-Pen Drafting Plotter.....	102
<b>7586B 8-Pen Drafting Plotter.....</b>	<b>102</b>
7906 Disc Drive.....	91
7911 Disc/Tape Drive.....	92
7912 Disc/Tape Drive.....	92
7914 Disc/Tape Drive.....	92
<b>7914ST Disc/Tape Drive.....</b>	<b>92</b>
7920 Disc Drive.....	91
7925 Disc Drive.....	91
7933 Disc Drive.....	92
7935 Disc Drive.....	92
<b>7941A Disc Drive.....</b>	<b>91</b>
<b>7942A Disc/Tape Drive.....</b>	<b>91</b>
<b>7945A Disc Drive.....</b>	<b>91</b>
<b>7946A Disc/Tape Drive.....</b>	<b>91</b>
7970B/E 1/2" Magnetic Tape Subsystem.....	93
7971A 1/2" Tape Drive.....	93
7974A 1/2" Magnetic Tape Subsystem.....	93
<b>7978A 1/2" Magnetic Tape Subsystem.....</b>	<b>93</b>
<b>8000</b>	
8005B Pulse Generator.....	409
8007B Pulse Generator.....	412
8011A Pulse Generator.....	409
8012B Pulse Generator.....	410
8013B Pulse Generator.....	410
8015A Pulse Generator.....	411
8016A Word Generator.....	398
8018A Serial Data Generator.....	400
8080A Mainframe.....	414
8081A Repetition Rate Generator, 300 MHz.....	414
8082A Pulse Generator.....	413
8083A Output Amplifier, 300 MHz.....	414
8084A Word Generator, 300 MHz.....	414
8091A Repetition Rate Generator, 1 GHz.....	414
8092A Delay Generator/Frequency Divider.....	414
8093A Output Amplifier, 1 GHz.....	414
8111A 1 Hz-20 MHz Pulse/Function Generator.....	428
8112A Programmable Pulse Generator.....	404
8116A Pulse/Function Generator.....	429
8120-18XX Cables and Adapters.....	680
<b>8150A Optical Signal Source.....</b>	<b>512</b>
<b>8151A Optical Pulse Power Meter.....</b>	<b>514</b>
8160A Programmable Pulse Generator.....	406
8161A Programmable Pulse Generator.....	406
8165A Programmable Signal Source.....	431
8170A Logic Pattern Generator.....	399
8180A Data Generator.....	394
<b>8180/8182A + 24A Operating Techniques Course.....</b>	<b>30</b>
<b>8180/8182A + 24H Programming Techniques Course.....</b>	<b>30</b>
8181A Data Generator Extender.....	394
8182A Data Analyzer.....	394
8340A Synthesized Sweeper.....	459, 470-473
<b>8341A Synthesized Sweeper.....</b>	<b>459, 470-473</b>
8349A Microwave Amplifier.....	417
8350B Sweep Oscillator Mainframe.....	150, 474-477
8403A Modulator.....	466
8405A Vector Voltmeter.....	553
8406A Comb Generator.....	622
8408B Network Analyzer Subsystem.....	575
8408S Automatic Network Analyzer System.....	575
8409C + 24D Automatic Network Analyzer User's Course.....	30
8410C Network Analyzer Mainframe.....	569
8410S series Network Analyzers.....	568
8411A Harmonic Frequency Converter.....	569
8412B Phase-Magnitude Display.....	569
8414B Polar Display.....	569
8418B Auxiliary Power Supply.....	569
8443A Tracking Generator-Counter.....	614
8444A Tracking Generator.....	616
8444A Option 059 Tracking Generator.....	600, 602, 606, 619
8445B Automatic Preselector.....	619
8447 series Amplifiers.....	418
8450A Diode Array Spectrophotometer.....	661
8451A Diode Array Spectrophotometer.....	661
8470A/B Coaxial Crystal Detectors.....	504
8471A Coaxial Crystal Detector.....	504
8472A Coaxial Crystal Detector.....	504
8473B/C Coaxial Crystal Detectors.....	504
8477A Power Meter Calibrator.....	522
8478B Coaxial Thermistor Mount.....	523
8481A/B/H Power Sensors.....	520
8482A/B/H Power Sensors.....	520
8483A Power Sensor.....	520
8484A Power Sensor.....	520
8485A Power Sensor.....	520
8491A/B Coaxial Fixed Attenuators.....	496
8492A Coaxial Fixed Attenuator.....	496
8493A/B/C Coaxial Fixed Attenuators.....	496
8494A/B/G/H Coaxial Step Attenuators.....	499
8495A/B/D/G/H/K Coaxial Step Attenuators.....	499
8496A/B/G/H Coaxial Step Attenuators.....	499
8497K Coaxial Step Attenuator.....	499
8498A Coaxial Fixed Attenuator.....	496
8501A Storage-Normalizer.....	557
8502A/B Reflection Transmission Bridges.....	501, 552, 558
8503A/B S-Parameter Test Sets.....	558
8505A Network Analyzer.....	554
8507D Network Analyzer Subsystem.....	560
8507S Automatic Network Analyzer System.....	560
<b>8510A Network Analyzer.....</b>	<b>562</b>
<b>8510A + 24D Network Analyzer User's Course.....</b>	<b>567</b>
8510S Network Analyzers.....	562
<b>8510T Network Analyzer System.....</b>	<b>563</b>
<b>8511A Frequency Converter.....</b>	<b>564</b>
<b>8512A Reflection/Transmission Test Set (500 MHz-18 GHz).....</b>	<b>564</b>
<b>8513A Reflection/Transmission Test Set (45 MHz-26.5 GHz).....</b>	<b>564</b>
<b>8514A S-Parameter Test Set (500 MHz-18 GHz).....</b>	<b>564</b>
<b>8515A S-Parameter Test Set (45 MHz-26.5 GHz).....</b>	<b>564</b>
8552A Spectrum Analyzer—IF Section.....	610
8552B Spectrum Analyzer—IF Section.....	610
8553B Spectrum Analyzer, Tuning Section.....	614
8554B Spectrum Analyzer, Tuning Section.....	616
8555A Spectrum Analyzer, Tuning Section.....	618



8556A Spectrum Analyzer, Tuning Section .....	612
8557A Spectrum Analyzer .....	604
8558B Spectrum Analyzer .....	606
8559A Spectrum Analyzer .....	608
8565A Spectrum Analyzer .....	602
<b>8566B Spectrum Analyzer .....</b>	<b>590, 595</b>
8566A + 24D Spectrum Analyzer Programming .....	29
8566S Automatic Spectrum Analyzer .....	598
<b>8568B Spectrum Analyzer .....</b>	<b>590, 592</b>
8568A + 24D Spectrum Analyzer Programming .....	29
8568S Automatic Spectrum Analyzer .....	598
8569B Spectrum Analyzer .....	600
8614A Signal Generator .....	458
8616A Signal Generator .....	458
8620C Sweep Oscillator .....	150, 487-493
8640B AM/FM Signal Generator .....	451
8640B Option 004, Avionics Signal Generator .....	454
<b>8642A/B Synthesized Signal Generators .....</b>	<b>442</b>
8654A Signal Generator .....	455
8654B Signal Generator .....	455
<b>8656B Synthesized Signal Generator .....</b>	<b>440</b>
8660A Synthesized Signal Generator .....	448
8660C Synthesized Signal Generator .....	448
8662A Synthesized Signal Generator .....	445
8663A Synthesized Signal Generator .....	445
8671A Microwave Frequency Synthesizer .....	463
8672A Synthesized Signal Generator .....	460
8672S MW Synthesized Generator (0.1 to 18 GHz) .....	463
8673B Synthesized Generator (2 to 26.5 GHz) .....	460
8673C/D Synthesized Signal Generator (0.1 to 18/26 GHz) .....	462
8683A/B Signal Generators .....	456
8684A/B Signal Generators .....	456
8709A/B Phase-lock Synchronizer .....	568
8717B Transistor Bias Supply .....	573
8721A Coaxial Directional Bridge .....	501
8731-8735 series PIN Modulators .....	466
8743B Reflection/Transmission Test Unit .....	571
8745A S-Parameter Test Set .....	570
8746B S-Parameter Test Set .....	572
8747A/B series Waveguide Reflection/Transmission Test Units .....	574
8748A S-Parameter Test Set .....	551
8750A Storage-Normalizer .....	543, 576
8754A Network Analyzer .....	550, 552
8755C Scalar Network Analyzer Plug-in .....	543
8755S Scalar Network Analyzer .....	543
8756A Scalar Network Analyzer .....	542
<b>8757A Scalar Network Analyzer .....</b>	<b>535</b>
<b>8757S Automatic Scalar Network Analyzer System .....</b>	<b>534</b>
8761A & B Coaxial Switches .....	509
8801A Low Gain Preamplifier .....	386
8802A Medium Gain Preamplifier .....	386
8803A High Gain Preamplifier .....	386
8805A Carrier Preamplifier .....	386
8805B Carrier Preamplifier .....	386
8806B Phase Sensitive Demodulator .....	387
8808A Logarithmic Preamplifier .....	387
8809A Signal Coupler .....	387
8815A General Purpose Integrator .....	387
8821A DC Bank Amplifier .....	388

8900C/D Peak Power Meter .....	523
8901A Modulation Analyzer .....	648
8901B Modulation Analyzer .....	648
8902A Measuring Receiver .....	644
<b>8902S Microwave Measurement System .....</b>	<b>646</b>
8903A Audio Analyzer .....	651
8952A Signal Generator Test Set .....	647
8953A Transceiver Test Set .....	654
8954A Transceiver Interface .....	654, 655
8955A RF Test System .....	653
8956A System Interface .....	653, 655
<b>8957S Cellular Radio Test System .....</b>	<b>656</b>
<b>8958A Cellular Radio Interface .....</b>	<b>656</b>
8970A Noise Figure Meter .....	526

## 9000

HP 9000 Engineering Workstation .....	73
9020A/B/C/AS/AT HP 9000 Model 520 Computer .....	76
9030A HP 9000 Model 530 Computer .....	76
9040A/A/AM/AT/HP 9000 Model 540 Computer .....	76
9111A Graphics Tablet .....	104
<b>9114A Portable 3½" Microfloppy .....</b>	<b>59</b>
9121D/S 3½" Microfloppy Disc Drive .....	59
<b>9122D/S 3½" Microfloppy Disc Drive .....</b>	<b>59</b>
<b>9125S 5¼" IBM Compatible Drive .....</b>	<b>59</b>
<b>9133D 14.8 M Byte Winchester/3½" Microfloppy .....</b>	<b>60</b>
<b>9134D 14.8 M Byte Winchester .....</b>	<b>60</b>
<b>9144A ¼" Cartridge Tape Drive .....</b>	<b>60, 93</b>
9411B Switch Controller .....	203
9412A Modular Switch .....	203
9413A VHF Switch .....	203
9414A Matrix Switch .....	203
9816A/S Personal Technical Computer .....	74
<b>9817A/H Personal Modular Computer .....</b>	<b>74</b>
9826 A/S Technical Computer .....	74
9836A/C/U/CU/CS/S/T/CT Technical Computer .....	74
<b>9837H Technical Computer .....</b>	<b>74</b>
9876A Thermal Graphics Line Printer .....	58
9888A Bus Expander .....	76
9895A Flexible Disc Drive (8") .....	59
<b>9915B Modular Run-Only Computer .....</b>	<b>79</b>
9920A/U/S Modular Computer .....	74

## 10000

10001A 10:1 Divider Probe .....	358
10001B 10:1 Divider Probe .....	358
10002A 50:1 Divider Probe .....	358
10002B 50:1 Divider Probe .....	358
10003A 10:1 Divider Probe .....	358
10004D 10:1 Divider Probe .....	358
10005D 10:1 Divider Probe .....	358
10006D 10:1 Divider Probe .....	358
10007B 1:1 Probe .....	358
10008B 1:1 Probe .....	358
10011B BNC Adapter Tip .....	358
10013A 10:1 Divider Probe .....	358
10014A 10:1 Divider Probe .....	358
10016B 10:1 Divider Probe .....	358
10017A Miniature Divider Probe .....	357

# MODEL NUMBER INDEX

New product listings are printed in bold face type

10018A Miniature Divider Probe .....	357
10019A Cable Assembly .....	360
10020A Resistance Divider Probe .....	358
10021A Miniature 1:1 Probe .....	357
10022A Miniature 1:1 Probe .....	357
10023A Temperature Probe .....	166, 363
10024A IC Test Clip .....	361
10026A Miniature 1:1 Probe (50 Ω), 1 metre .....	357
10027A Miniature 1:1 Probe (50 Ω), 2 metres .....	357
10028A Jumper Cable .....	361
10029A TV/Video Sync Retrofit Kit .....	362
10034A Probe Ground Lead Kit .....	360
10035A Probe Tip Kit .....	360
10036B Probe Tip Kit .....	360
10037B Probe Tip Kit .....	360
10040A 10:1 Miniature Divider Probe .....	357
10041A 10:1 Miniature Divider Probe .....	357
10042A 10:1 Miniature Divider Probe .....	357
10080A Miniature 10:1 Probe .....	357
10081A Miniature 10:1 Probe .....	357
10082A Miniature 10:1 Probe .....	357
10083A Miniature 1:1 Probe .....	357
10084A Miniature 1:1 Probe .....	357
<b>10085A Test System Probe .....</b>	<b>357</b>
10100B 100 Ohm Feedthrough Termination .....	357
10100C 50 Ohm Feedthrough Termination .....	357
10110B BNC Male to Dual Banana Plug .....	681
10111A Shielded Banana Plug to BNC Female .....	681
10113A Triple Banana Plug to Dual BNC Female .....	681
10140A Viewing Hood for HP 1700 Series Oscilloscopes .....	361
10173A RFI Filter and Contrast Screen for HP 1700 Series Oscilloscopes .....	361
10221A 50 Ohm Probing Tee .....	360
10229A Retractable Hook Tip Adapter .....	361
10233A Printer Interconnect Cable for HP 1645A .....	122
10269A 5-Probe Interface (HP 1630A/D) .....	274
10269B 9-Probe Interface (HP 1630G) .....	274
10275A PDP-11 UNIBUS Interface .....	274
10276A LSI-11 Interface .....	274
10326A Time Interval Standard .....	362
10387A Interface, Type 303 Modems (HP 1645A) .....	122
10388A Interface, CCITT V35 (HP 1645A) .....	122
10389A Interface, Breakout Box (RS-232C) (HP 1645A) .....	122
10501A Cable Assembly .....	680
10502A Cable Assembly .....	680
10503A Cable Assembly .....	680
10514A Double-Balanced Mixer .....	508
10525E Logic Probe .....	246
10529A Logic Comparator .....	248
10533A BCD Interface Cable (HP 5150A, 5300A) .....	392
10534A Double-Balanced Mixer .....	508
10541A Reference Boards .....	248
10541B Preprogrammed Reference Boards .....	248
10590A Plug-in Adapter (HP 5345A) .....	283
10595A Board Extender Kit (HP 5345A) .....	283
10638A Degausser .....	304
10656A HP 5035T Texts & Lab Workbooks .....	250
10657A HP 5035T Component & Wire Kit .....	250
10833 A/B/C/D HP-IB Cables .....	392, 675
10834A HP-IB Cable Adapter .....	675

10842A Extender Board Kit (HP 5342/5343/5344S) .....	279
10844B/C Programming Interface Kit (HP 5045A) .....	237
10845A Program Card (HP 5045A) .....	237
10846A Program Card Coupon Book .....	237
10847A HP 5045A Service Kit .....	237
10855A Broadband Preamplifier .....	285, 293
10856A Low Pass Filter Kit .....	285, 293
10870A Service Kit .....	287
10871A Service Kit .....	336
10872A Parallel Interface .....	336
10873A Rack Mount Kit .....	336
10874A Slide Mount Kit .....	336

## 11000

11000A Cable Assembly .....	680
11001A Cable Assembly .....	680
11002A Test Leads .....	680
11003A Test Leads .....	680
11035A Cable Assembly .....	680
11036A AC Probe for HP 410C .....	170
11075A & 11076A Instrument Cases .....	687
11096B High Frequency Probe .....	166
11143A Cable Assembly .....	680
11340A/B/C HPIL Cable Assembly .....	177
11341A/B Carrying Case for HP 3421A .....	177
11500A/B Cable Assembly .....	680
11501A Cable Assembly .....	680
11509A Fuseholder .....	464
11511A Coaxial Short .....	507
11512A Coaxial Short .....	507, 553
11515A Waveguide Adapter .....	495
11516A Waveguide Adapter .....	495
11517A Mixer .....	621
11518A-11520A Waveguide Taper Sections .....	621
11524A APC-7 to N (female) Adapter .....	681
11525A APC-7 to N (male) Adapter .....	681
11533A APC-7 to SMA (male) Adapter .....	681
11534A APC-7 to SMA (female) Adapter .....	681
11536A Probe Tee for HP 8405A .....	553
11540A Waveguide Stand .....	495
11545A-11548A Waveguide Holders .....	495, 553
11549A Power Splitter for HP 8405A .....	553
11565A Coaxial Short .....	507
11566A Air Line Extension .....	495
11567A Air Line Extension .....	495
11570A Accessory Kit for HP 8405A .....	553
11581A Attenuator Set .....	496
11582A Attenuator Set .....	496
11583A Attenuator Set .....	496
11588A Swivel Adapter .....	495
11590B Bias Network .....	566, 573
11599A Quick-Connect Adapter for HP 8745A .....	574
11600B Transistor Fixture .....	570
11602B Transistor Fixture .....	570
11604A Universal Extension for HP 8745A .....	570
11605A Flexible Arm for HP 8743A .....	574
11606A Rotary Air Line .....	495
11607A Small Signal Adapter for HP 8745A .....	574
11608A Transistor Fixture .....	572
11609A Cable Kit for HP 8410S .....	573

11610B Test Port Extension Cable .....	571
11612A Bias Network .....	566
11635A Bias Decoupling Network .....	566
11636A/B Power Dividers .....	501
11650A Accessory Kit for HP 8410S .....	573
11664A/D/E Detector for HP 8755, 8756 and 8757 .....	538
11664C Detector Adapter for HP 8755, 8756 and 8757 .....	540
11665B Modulator for HP 8755, 8756 and 8757 .....	540
11667A/B Power Splitters .....	501, 540
11668A 50 MHz High Pass Filter for HP 8755, 8756 and 8757 .....	539
11672A Service Accessory Kit for HP 8660A/C .....	450
11675B Leveling Cable Assembly for HP 784C .....	150
11678A Low Pass Filter Kit .....	539
11679A/B Extension Cables for HP 8755, 8756 and 8757 .....	540
11683A Range Calibrator .....	519
11684/5/6/8/9A Low Pass Filters .....	539
11687A Adapter, 50 to 75 $\Omega$ .....	464
11690A Frequency Doubler .....	464
11691D Coaxial Directional Coupler .....	502
11692D Coaxial Dual Directional Coupler .....	502
11693A Limiter .....	622
11694A Matching Transformer, 50-75 $\Omega$ .....	622
11708A Attenuator (for Calibrating HP 8484A) .....	520
11710B Down Converter .....	464
11712A Service Support Kit (for HP 8671A, 8672A/S) .....	460, 463
11713A Attenuator/Switch Driver .....	499
11714A Service Support Kit (for HP 8662A, 8663A) .....	447
11715A AM/FM Test Source .....	650
11716A/B Interconnection Kits .....	499
11717A Attenuator/Switch Rack Mount Kit .....	499
11720A Pulse Modulator .....	465
11721A Frequency Doubler .....	464
11722A Sensor Module .....	645
11723B Software Application Pac for HP 8953A & 85B .....	654
11726A Support Kit for HP 8673B/C/D .....	461, 462
11729B Carrier Noise Test Set .....	638
11731A Frequency Extension Retrofit Kit .....	463
11732A Frequency Extension Retrofit Kit .....	463
<b>11740S Phase Noise Measurement System .....</b>	<b>640</b>
11790A/B Software Application Pac for HP 8953A & 9816, 9826, 9836 .....	654
11791A Software for HP 8955A, 9816S & 9836S .....	653
<b>11792A Sensor Module .....</b>	<b>646</b>
<b>11793A Microwave Converter .....</b>	<b>646</b>
<b>11794A Software Pac .....</b>	<b>646</b>
<b>11795A Software Pac .....</b>	<b>647</b>
<b>11797A Cellular Radio Test Software .....</b>	<b>656</b>
11850A/B Power Splitters .....	501, 551, 558
11851A RF Cable Kit for HP 8505A .....	551, 559
11852A 50-75 $\Omega$ Minimum Loss Pad .....	559
11853A 50 $\Omega$ Type N Accessory Kit .....	559
11854A 50 $\Omega$ BNC Accessory Kit .....	559
11855A 75 $\Omega$ Type N Accessory Kit .....	571
11856A 75 $\Omega$ BNC Accessory Kit .....	571
11857A/B Test Port Extension Cables for HP 8503A & B .....	553, 571
11858A Rigid Interconnect Adapter .....	571
11866A APC-7 Calibration Kit .....	573
11867A RF Limiter .....	622

11869A Adapter for HP 86200 Series Sweeper Plug-ins .....	486, 492
11870A Low Pass Filter .....	608
11873A Accuracy Enhancement Program (for HP 8408B) .....	575
11970 Series Harmonic Mixers .....	621
11971 Series Harmonic Mixers .....	621
11975A Microwave Power Amplifier .....	416

## 12000

12060B 8 Channel Analog Input Card .....	188
12061A 32 Channel Analog Input Expansion Card .....	188
12062A 4 Channel Analog Output Card .....	188
12063A 32 Channel Digital Multifunction Card .....	188

## 13000

13064A Tape Degausser .....	390
-----------------------------	-----

## 14000

14513A Rack Kit (for one unit, 3½ in. H) .....	315, 317
14515A Rack Kit (for one unit, 5¼ in. H) .....	317
14521B Rack Kit (for Bench Series) .....	315
14523A Rack Kit (for two units, 3½ in. H) .....	315
14525A Rack Kit (for two units, 5¼ in. H) .....	317
14533B Pocket Programmer .....	328
14534A Pocket Programmer Cable .....	328
14535A Interface Kit, DCPS-to-HP 1000 Computers .....	328
14536A DCPS Chaining Cable .....	328
14540A 1000 Cable Assembly, Multiprogrammer-to HP 1000 Computers .....	199
14541A Chaining Cable, HP 6940B or 6941B to HP 6941B .....	199
14550B Interface Kit, Multiprogrammer-to- HP 1000 Computers .....	199
14551A Multiprogrammer Service Kit .....	199
14558A Termination Panel .....	199
14750A Computer Aided Test Programming Package .....	198
14751A Computer Aided Test Programming Package .....	198

## 15000

15104A Pulse Adder/Splitter .....	414
15115A Pulse Splitter/Inverter .....	414
15116A Pulse Inverter .....	414
15179A Rack Adapter Frame .....	410
15406A-15423A HP 8180A/82A Accessories .....	396
15413A Tristate Pod for HP 8180A/81A .....	396
15414A Tristate Unit for HP 8180A/81A .....	396
<b>15424A Performance Board .....</b>	<b>397</b>
<b>15425A Test Head .....</b>	<b>397</b>
15426A Receptacles .....	397
<b>15427A DUT Board .....</b>	<b>397</b>
15428A Relays .....	397
15453A-15459A HP 8170A Accessories .....	399
<b>15475A Optical Cleaning Kit .....</b>	<b>515</b>
15507A Isolator .....	135
15508B Converter (75 $\Omega$ Unbal. - 110 $\Omega$ Bal.) .....	135
15508C Converter (75 $\Omega$ Unbal. - 120 $\Omega$ Bal.) .....	135
15509A/B Amplifier .....	135
15510A 75 $\Omega$ Cable Accessory .....	135
15511A 120 $\Omega$ Cable Accessory .....	135
15512A Cable .....	135



# MODEL NUMBER INDEX

New product listings are printed in bold face type

15513A Cable.....	135
15514A Transit Case.....	135
15515B Loop Holding Unit.....	135
<b>15518A/B/C Loop Holding Accessory.....</b>	<b>135</b>
15580A 20 MHz High-Impedance Active Probe.....	138
15581B 25 MHz High-Impedance Passive Probe.....	138
15582A Return Loss Kit.....	138
15589A Instrument Cart.....	138
15600A Isolator (3.7 to 4.2 GHz).....	149
15601A Isolator (5.9 to 6.5 GHz).....	149
15602A Isolator (7.1 to 8.1 GHz).....	149
15603A Isolator (10.7 to 11.7 GHz).....	149
15609A Remote Extender Cable.....	149

## 16000

16008A Resistivity Cell.....	225
16014A Series Loss Test Adapter.....	224
16023B DC Bias Controller.....	209
16034B Test Fixture for Chip Components.....	209
16047B Test Fixture with Safety Cover.....	209
16047C Test Fixture for High Frequencies.....	209
16048A Test Leads, BNC.....	209
16048B Test Leads, RF Miniature.....	209
16048C Test Leads with Alligator Clips.....	209
16048D Test Leads, BNC (2m).....	213
16061A Test Fixture.....	221
16062A Test Cables.....	221
16063A Test Cables.....	221
16064A Retrofit Kit.....	213
16065A External DC Bias Test Fixture.....	213
16079A System Test Module.....	234
16081A Test Leads.....	223
16082A Test Leads.....	223
16091A Coaxial Fixture Set.....	215
16092A Spring Clip Fixture.....	215
16093A Binding Post Fixture.....	215
16093B Binding Post Fixture.....	215
16094A Probe Fixture.....	209
16095A Probe Fixture.....	217
16096A 2-Port Component Test Fixture.....	217
16097A Accessory Kit.....	217
16099A Test Fixture Adapter.....	219
16145A Interconnection Cable Set.....	234
16146A Measurement Cable.....	234
16147A Text Fixture.....	234
16148A Extension Cable Fixture.....	234
16380A Decade Capacitors.....	238
16470A/B/C Reference Inductors.....	224
16800A Programmable Bar Code Reader.....	662
16801A Non-Programmable Bar Code Reader.....	662

## 17000

<b>17090A Measurement Graphics Software.....</b>	<b>379</b>
17108A Time Base.....	384
17580B HP-ISPP Software.....	105
17623A Graphics Tablet.....	104

## 18000

18107A External Oscillator (HP 2804A).....	667
--	-----

18110A Laboratory Probe and Cal Module, 26 mm (1 in.) (HP 2804A).....	667
18111A Laboratory Probe and Cal Module, 232 mm (9.1 in.) (HP 2804A).....	667

## 19000

19800A/B Waveform Measurement Library.....	344
19081A/B/C Waveform Measurement Library.....	344
19807A Service Extender for HP 1980 Expansion Modules.....	344
19811A Plot/Sequence ROM.....	344
19860A Digital Waveform Storage.....	344

## 20000

25501B 16 Channel High Speed Analog Input Card.....	187
25502B 32 Channel High Level Multiplexer Card.....	187
25503B 32 Channel Low Level Multiplexer Card.....	187
25503C 32 Channel Low Level Multiplexer with Thermocouple Reference Connector.....	187
25504B 16 Channel Relay Multiplexer Card.....	187
25504C 16 Channel Relay Multiplexer with Thermocouple Reference Connector.....	187
25510B 8 Channel Isolated Voltage/Current Analog Output Card.....	187
25511B 32 Channel Digital Input Card.....	187
25512B 4 Channel Counter Card.....	187
25513B 32 Channel Digital Output Card.....	187
25515B 4 Channel Pulse Output Card.....	187
25516B 16 Point In/16 Point Out Digital Multifunction Card.....	187
27110A HP-IB Interface.....	77
27112A General-Purpose Interface.....	77
27116A HP-CIO Extender Card.....	77
27122A RJE Interface.....	77
27123A SRM Interface.....	77
27128A Asynchronous Serial Interface.....	77
27130A Eight-Channel Multiplex Card.....	77
27201A Speech Output Module.....	94

## 30000

33300 Series Coaxial Step Attenuators.....	498
33311B/C Coaxial Switches.....	509
33311B-C04 Microwave Matrix Switch.....	509
33311B-C05 5-Port Switch.....	509
33320 Series Coaxial Step Attenuators.....	498
33330B/C Coaxial Crystal Detectors.....	504
33340A/B/C Coaxial Attenuator.....	496
34110A Carrying Case.....	166
34111A High Voltage Probe.....	166
34112A Touch-Hold Probe.....	166
34118A Test Lead Kit.....	166
37014B FDM Measurement Software.....	139
37016A FDM Network Surveillance Software.....	139
37050S FDM Network Monitoring System.....	139
37051S FDM Measurement System.....	139
37100S Remote Access and Test System.....	151
37201A HP-IB Extender.....	679
37203A HP-IB Extender.....	678
37203L HP-IB Extender (Plug-In Card).....	678



37212A Stand Alone Modem.....	84
37213A Modem Card.....	84
37214A Modem Interface Card.....	84
37215A Modem Interface Card.....	84
37216A Terminal Interface Card.....	84
37222A Integral Modem.....	84
37461A Display.....	137
39301A Fiber Optic Multiplexer.....	662

## 40000

43700 Flash X-Ray Systems.....	657
43855A Cabinet X-Ray Systems.....	657
44401A 10 Channel Low Thermal Relay Assembly.....	189
44402A 10 Channel Relay Actuator Assembly.....	189
44403A 9 Channel Reference Assembly With Thermocouple Compensation.....	189
44404A 20 Channel Low Thermal Relay Assembly.....	189
44405A 19 Channel Reference Assembly With Thermocouple Compensation.....	189
44413A High Speed Control Board.....	189
44462A 10 Channel Multiplexer Assembly.....	177
44463A Extra Connector Block.....	177
44464A Breadboard Assembly.....	177
44465A 8-Bit In, 8-Bit Out Digital I/O Assembly.....	177
44466A Extra Connector Block for HP 44465A.....	177
44468A Data Acquisition Pac for HP-41CV.....	177
44469A Six 10:1 Dividers.....	177
44538A Standard Test Fixture Kit.....	259
44539A Large Test Fixture Kit.....	259
44540A Dial Test Fixture Kit.....	259
44854A + 24A HP 3060A Enhancement Training.....	30

## 50000

50011A HP-IB Instrument System Training with HP Model 26 Controllers.....	29
<b>50015A Data Acquisition and Control</b>	
<b>Fundamentals.....</b>	<b>30</b>
<b>50016E HP-IB Instrument Programming with HP 1000E/F Series Computers.....</b>	<b>29</b>
50600B Instrument Application Services.....	31
51800A Waveform Measurement System.....	337
51820A Waveform Generator System.....	339
52126A Intel Multibus Interface.....	274
54001A 1-GHz Active Probe Pod.....	332
54002A 50Ω BNC Input Pod.....	332
54003A 1-MΩ Probe Pod.....	332
54050A Front Panel Cover for HP 54100A/D.....	332
54051A Probe Accessory Adaptor.....	332
<b>54100A 1-GHz Digitizing Oscilloscope.....</b>	<b>340</b>
<b>54100D 1-GHz Digitizing Oscilloscope with Logic Triggering.....</b>	<b>332</b>
<b>54300A Probe Multiplexer.....</b>	<b>341</b>
55005S Logic Troubleshooting System.....	239
55280A + 24A Basic Laser Measurement System Training.....	30
55283A + 24A Advanced Laser Measurement System Training.....	30
59301A ASCII-Parallel Converter.....	676
59303A Digital-to-Analog Converter.....	676

59306A HP-IB Relay Actuator.....	676
59307A HP-IB VHF Switch.....	676
59309A HP-IB Digital Clock.....	677
59313A HP-IB Analog-to-Digital Converter.....	677
59401A Bus System Analyzer.....	675
59500A Multiprogrammer HP-IB Interface.....	201
59501B HP-IB Power Supply Programmer.....	327, 677
K70-59992 Rack Mount Adapter Kit (HP 5342A, 5343A).....	279
K34-59991A Broadband Linear Phase Comparator.....	301

## 60000

64000 Logic Development System.....	264
64000 Logic Development System Training.....	30
64100A Development Station.....	265
64110A Development Station.....	265
64200S Series Emulators.....	266
64302A Logic Analyzer.....	266
64310A Software Performance Analyzer.....	267
64310A + 24A Software Performance Analyzer Training.....	29, 30
64330 High-Level Software Analyzer.....	264
64500S PROM Programmer.....	269
64600S Hardware/Timing Analyzer.....	268
64600S + 24F Hardware/Timing Analyzer Training.....	29
64620S Software/State Analyzer.....	267
64620S + 24F Advanced State/Software Training.....	29
64650A General Purpose Preprocessor Module.....	269
64817 + 24D 64000 System Pascal Programming Course.....	29
69280A Breadboard Card.....	200
69321B D/A Voltage Converter.....	200
69322A Quad D/A Voltage Converter Card.....	200
69330A Relay Output Card.....	200
69331B Digital Output Card.....	200
69332A Open Collector Output Card.....	200
69335A Stepping Motor Control Card.....	200
69336B Scanner Card.....	200
69351C Voltage Regulator Card.....	200
69370A D/A Current Converter Card.....	200
69380A Breadboard Output Card.....	200
69422A High Speed A/D Converter Card.....	200
69423A Low Level A/D Converter Card.....	200
69430A Isolated Digital Input Card.....	200
69431A Digital Input Card.....	200
69433A Relay Output With Readback Card.....	200
69434A Event Sense Card.....	200
69435A Pulse Counter Card.....	200
69436A Process Interrupt Card.....	200
69480A Breadboard Input Card.....	200
69500A Unloaded Resistance Output Card.....	200
69501A-69513A Power Supply Control Cards.....	200
69520A Power Supply Programming Card.....	200
69602B Timer/Pacer Card.....	200
69700A-69706A Resistance Output Card.....	196, 197
69709A Power Supply Control Card.....	196, 197
69720A Digital-to-Analog Voltage Converter Card.....	196, 197
69721A Digital-to-Analog Current Converter Card.....	196, 197
69730A Relay Output Card.....	196, 197
69731B Digital Output Card.....	196, 197



# MODEL NUMBER INDEX

New product listings are printed in bold face type

69735A Pulse Train Output/Stepping Motor Control Card.....	196, 197
69736A Timer/Pacer Card.....	196, 197
69750A Scan Control/Pacer Card.....	196, 197
69751A Analog-to-Digital Converter Card.....	196, 197
69752A 64 Channel FET Scanner Card.....	196, 197
69754A 32 Channel Relay Scanner Card.....	196, 197
69755A 16 Channel FET Scanner Card.....	196, 197
<b>69759A 500 kHz A/D Converter Card.....</b>	<b>196, 197</b>
69770A Isolated Digital Input Card.....	196, 197
69771A Digital Input/Analog Comparator Card.....	196, 197
69775A Counter/Totalizer Card.....	196, 197
69776A Interrupt Card.....	196, 197
69790B Memory Card.....	196, 197
<b>69791A/69792A 1 Megaword Memory System.....</b>	<b>196, 197</b>
69793A Breadboard Card.....	196, 197

## 80000

<b>81510A X/Y/Z Drive.....</b>	<b>515</b>
<b>81511A Optical Head, 550 to 950 nm.....</b>	<b>514</b>
<b>81512A Optical Head, 900 to 1750 nm.....</b>	<b>514</b>
<b>81519A Optical Receiver.....</b>	<b>515</b>
<b>81800A Software Pac.....</b>	<b>397</b>
82104A Card Reader (HP-41CV/CX).....	65
82143A Printer/Plotter (HP-41CV/CX).....	66
82153A Optical Wand (HP-41CV/CX).....	66
82160A HP-IL Module (HP-41CV/CX).....	66
82161A Digital Cassette Drive.....	67
82162A Printer/Plotter.....	67
82164A HP-IL/RS-232C Interface.....	67
82166C HP-IL Interface Kit.....	68
82168A Acoustic Coupler.....	67
82169A HP-IL/HP-IB Interface.....	68
82180A Extended Functions/Memory Module (HP-41CV).....	65
82181A Extended Memory Module.....	65
82182A Time Module (HP-41CV).....	65
82183A Extended I/O Module.....	65
82184A Plotter Module.....	66
<b>82400A Card Reader (HP-71B).....</b>	<b>66</b>
<b>82401A HP-IL Interface (HP-71B).....</b>	<b>66</b>
<b>82420A 4K Memory Module (HP-71B).....</b>	<b>66</b>
<b>82440A Software Development Utility (HP-71B).....</b>	<b>69</b>
<b>82441A FORTH/Assembler (HP-71B).....</b>	<b>69</b>
<b>82486A, B, C, D Custom Modules (HP-71B).....</b>	<b>69</b>
<b>82487A Custom Keyboard Overlays (HP-71B).....</b>	<b>69</b>
82500A/B Custom Modules.....	69
82501A Custom Keyboard Overlays (HP-41).....	69
82502A Custom Magnetic Cards (HP-41).....	69
82504A Custom Keyboard Touchpads.....	68
82505 Software Development System.....	69
82700A 8K-Byte Memory Module (HP-75).....	66
82713A Plug-in Module Simulator (HP-75).....	69
<b>82718A Expansion Pod (HP-75).....</b>	<b>66</b>
82720A, B, C, D HP-75 Custom ROM Modules.....	69
82721A Custom Keyboard Overlays (HP-75).....	69
82722A Custom Magnetic Cards (HP-71B, HP-75).....	69
<b>82725A Bar Code Reader Module (HP-75).....</b>	<b>66</b>
82821A Series 80 Data Communications Pac.....	54
82825A UCSD p-System/FORTRAN-77.....	54
82826A UCSD p-System Pascal.....	54

82827A UCSD Pascal Compiler.....	54
82828A FORTRAN-77 Compiler (HP-86B).....	54
82829A UCSD p-System Runtime Module (HP-86B).....	54
82900A HP-86B CP/M System.....	55
82900A Opt. 001 TERM/80 Terminal Emulation System.....	54
82901M Flexible Disc Memory (5¼").....	53
82902M Flexible Disc Memory (5¼").....	53
82905B Printer.....	53
82906A Graphics Printer.....	53, 57
82908A 64K Memory Module.....	53
82909A 128K Memory Module.....	53
82912A 9-Inch Monitor (HP-86B).....	53
82913A 12-Inch Monitor (HP-86B).....	53
82928A System Monitor.....	54
82929A Programmable ROM Module.....	54
82929A Opt. 001 Hybrid ROM Development System.....	54
82936A ROM Drawer.....	54
82937A HP-IB Interface.....	54
82938A HP-IL Interface.....	54, 68
82939A Serial Interface.....	54
82940A GPIO Interface.....	54
82941A BCD Interface.....	54
82949A Printer Interface.....	54
82950A Series 80 Modem.....	55
82966A Data Link Interface.....	54
82967A Speech Synthesis Module.....	54
83522A 0.01-2.4 GHz RF Plug-in for HP 8350B.....	480
83525A/B 0.01-8.4 GHz RF Plug-in for HP 8350B.....	480
83540A/B 2-8.4 GHz RF Plug-in for HP 8350B.....	482
83545A 5.9-12.4 GHz RF Plug-in for HP 8350B.....	482
83570A 18-26.5 GHz RF Plug-in for HP 8350B.....	484
83572A/B 26.5-40 GHz RF Plug-in for HP 8350B.....	484
83590A 2-20 GHz RF Plug-in for HP 8350B.....	478
83592A/B/C 0.01-20 GHz RF Plug-in for HP 8350B.....	478
83594A 2-26.5 GHz RF Plug-in for HP 8350B.....	478
83595A 0.01-26.5 GHz RF Plug-in for HP 8350B.....	478
84811A Peak Power Sensor.....	419
85011A System Software for HP 8507D.....	561
<b>85013A Basic Measurements Application Pac (HP 8510A).....</b>	<b>566</b>
<b>85014A Active Device Measurements Application Pac (HP 8510A).....</b>	<b>566</b>
85015A System Software for HP 8756S and 8757S.....	539
<b>85016A Transmission Line Test Software for HP 8756S and 8757A.....</b>	<b>538</b>
85020A/B RF Directional Bridge.....	536
85021A/B/C Microwave Directional Bridge.....	536
85022A System Cable Kit for HP 8756S and 8757S.....	539
85023A/B/C/D System Verification Kit for HP 8756S and 8757S.....	539
<b>85025A AC/DC Detector for HP 8757A.....</b>	<b>538</b>
85031A APC-7 Calibration and Verification Kit for HP 8507D.....	561
85032A 50 Ω Type-N Calibration Kit.....	561, 573
85033A SMA Calibration Kit.....	561, 573
85033B APC-3.5 Calibration Kit.....	573
85036A 75 Ω Type N Calibration Kit for HP 8507D.....	561
85040B Reflection/Transmission Test Set.....	574, 575
<b>85041A Transistor Test Fixture Kit.....</b>	<b>566</b>
<b>85043A System Rack Kit.....</b>	<b>563</b>
<b>85050A 7mm Calibration Kit.....</b>	<b>565</b>



<b>85051A 7mm Verification Kit</b> .....	<b>565</b>	98259A Magnetic Bubble Memory Card .....	78
<b>85052A 3.5mm Calibration Kit</b> .....	<b>565</b>	98620B Two Channel DMA Controller/Interface.....	78
<b>85053A 3.5mm Verification Kit</b> .....	<b>565</b>	98622A 16-Bit Interface .....	75
<b>85054A Type N Calibration Kit</b> .....	<b>565</b>	98623B BCD Interface.....	75
<b>85114A S-Parameter Test Set</b> .....	<b>564</b>	98624A HP-IB Interface.....	75
<b>85130A Special 3.5mm to 7mm Adapter Kit</b> .....	<b>565</b>	98628A Datacomm Interface.....	75
<b>85131A 3.5mm Test Port Return Cable</b> .....	<b>565</b>	<b>98640A Analog Input Interface</b> .....	<b>75</b>
<b>85131B 3.5mm Test Port Return Cable Set</b> .....	<b>565</b>	<b>98644A RS-232 Serial Interface</b> .....	<b>75</b>
<b>85132A 7mm Test Port Return Cable</b> .....	<b>565</b>	<b>98645A Measurement Library</b> .....	<b>75</b>
<b>85132B 7mm Test Port Return Cable Set</b> .....	<b>565</b>	98691A Programmable Datacomm Interface .....	75
85650A Quasi-Peak Adapter .....	599	9888A Bus Expander.....	75
85862A HPL Software Pac for HP 8566A/B or 8568A/B.....	598	98627A Color Video Interface.....	78
85863A BASIC Software Library for HP 8566A/B or 8568A/B.....	598		
<b>85864A EMI Measurement Software for HP 8566A/B or 8568A/B</b> .....	<b>599</b>	00041-15042 Automatic Start and Cassette Duplication Module (HP-41CV/CX) .....	66
86200 series RF Plug-ins for HP 8620C and 8350B.....	492	00041-15043 HP-IL Development Module (HP-41CV/CX).....	66
86222A/B RF Plug-ins for HP 8620C and 8350B .....	490	<b>00071-90068 Vol. I: Detailed Design Description</b> .....	<b>69</b>
86240A/B/C RF Plug-ins for HP 8620C and 8350B.....	491	<b>00071-90069 Vol. II: Entry Point and Poll Interfaces</b> .....	<b>69</b>
86251A 7.5-18.6 GHz RF Plug-in for HP 8620C and 8350B.....	493	<b>00071-90070 Vol. III: Operating System Source Listings</b> .....	<b>69</b>
86290B/C RF Plug-ins for HP 8620C and 8350B .....	489	<b>00075-15001 I/O ROM (HP-75)</b> .....	<b>67</b>
86720A Frequency Extension Unit.....	463	00085-150XX Series 80 ROMs.....	54
		00087-150XX Series 80 ROMs.....	54
		0960-0054 SMA-Female Short (50 Ohm) .....	507
		0960-0055 SMA-Male Short (50 Ohm).....	507
		1250-XXXX Series Adapters and Connectors .....	681
		1251-2277 Dual Banana Plug to BNC Female.....	681
		1251-2816 Dual Banana Plug (for Cable).....	681
		1460-XXXX Series Cabinet Parts.....	685
		1490-XXXX Series Slide Kits, Casters .....	687
		1494-XXXX Series Slide Kits .....	684
		5040-XXXX Series Rack Frames.....	686
		5060-0789 Cooling Kit .....	686, 687
		5060-0796 Cooling Kit .....	687
		5060-XXXX Control Panel Covers .....	687
		5060-XXXX Filler Panels.....	686
		5060-XXXX Rack Adapter Frames.....	686
		5060-XXXX Rack Mounting Kits.....	686
		5060-XXXX Series Racking Accessories, Covers.....	686, 687
		5061-XXXX Series System II Cabinet Parts.....	682
		<b>8060-XXXX Cable Assembly</b> .....	<b>680</b>
		9211-XXXX Series Operating Cases .....	692
		9211-XXXX Series Transit Cases .....	688
		<b>82401-90023 HP-IL</b> .....	<b>69</b>
<b>90000</b>			
90100A Practical Transistor Series (Videotape) VHS(SP).....	34		
90100B Practical Transistor Series (Videotape) BETA I.....	34		
90100D Practical Transistor Series (Videotape) U-matic .....	34		
90301RA Understanding Microprocessors (Videotape) VHS(SP).....	35		
90301RB Understanding Microprocessors (Videotape) BETA I .....	35		
90301RD Understanding Microprocessors (Videotape) U-matic .....	35		
90307RA Microprocessor Fundamentals (Videotape).....	36		
90420A Digital Troubleshooting (Videotape) VHS(SP).....	34		
90420B Digital Troubleshooting (Videotape) BETA I.....	34		
90420D Digital Troubleshooting (Videotape) U-matic .....	34		
90741A Understanding Oscilloscopes (Videotape).....	37		
90751A How to Solder (Videotape) .....	37		
90838A What's a dB?-Power (Videotape) .....	37		
92198A Mountain Computer HP-IL 80-Column Video Interface.....	67		
<b>92267A/B Digital Bar Code Wands</b> .....	<b>67</b>		
<b>97062A RGB Interface</b> .....	<b>77</b>		
98255A EPROM Card.....	75		



Hewlett-Packard Company is in the business of developing, manufacturing and marketing computing and measuring products used by people in science, engineering, business, industry, education and medicine. These products are known for their high quality, reliability and advanced technology and include calculators, computers and peripherals, electronic instruments, instruments for chemical analysis, medical instrumentation and electronic components.

Headquartered in Palo Alto, California, Hewlett-Packard employs approximately 76,000 people worldwide, of whom some 52,000 work in the U.S.A. Product research and manufacturing activity is highly decentralized, with facilities in the U.S., the UK, Europe, Japan, Southeast Asia, Latin America and Canada. The worldwide sales organization includes more than 100 sales and support offices in the U.S., and some 220 sales and support offices and distributorships in 70 other countries.

With 1983 sales in excess of 4.7 billion dollars, HP is ranked in the top 75 U.S. industrial corporations. About 40 percent of these sales were generated outside the United States.

#### HP Instruments

Hewlett-Packard's first product, developed in 1939, was an audio oscillator based on a new and innovative design. In the company's first 20 years, this oscillator was the foundation for an ever-broadening line of test and measurement instruments used primarily by engineers and scientists. The first HP catalog, published in 1943, used 24 pages to describe a total product offering of 12 instruments. This 1985 edition has 704 pages on which are detailed some 1,400 instruments, computers and accessories out of the company's total offering of more than 6,400 products.

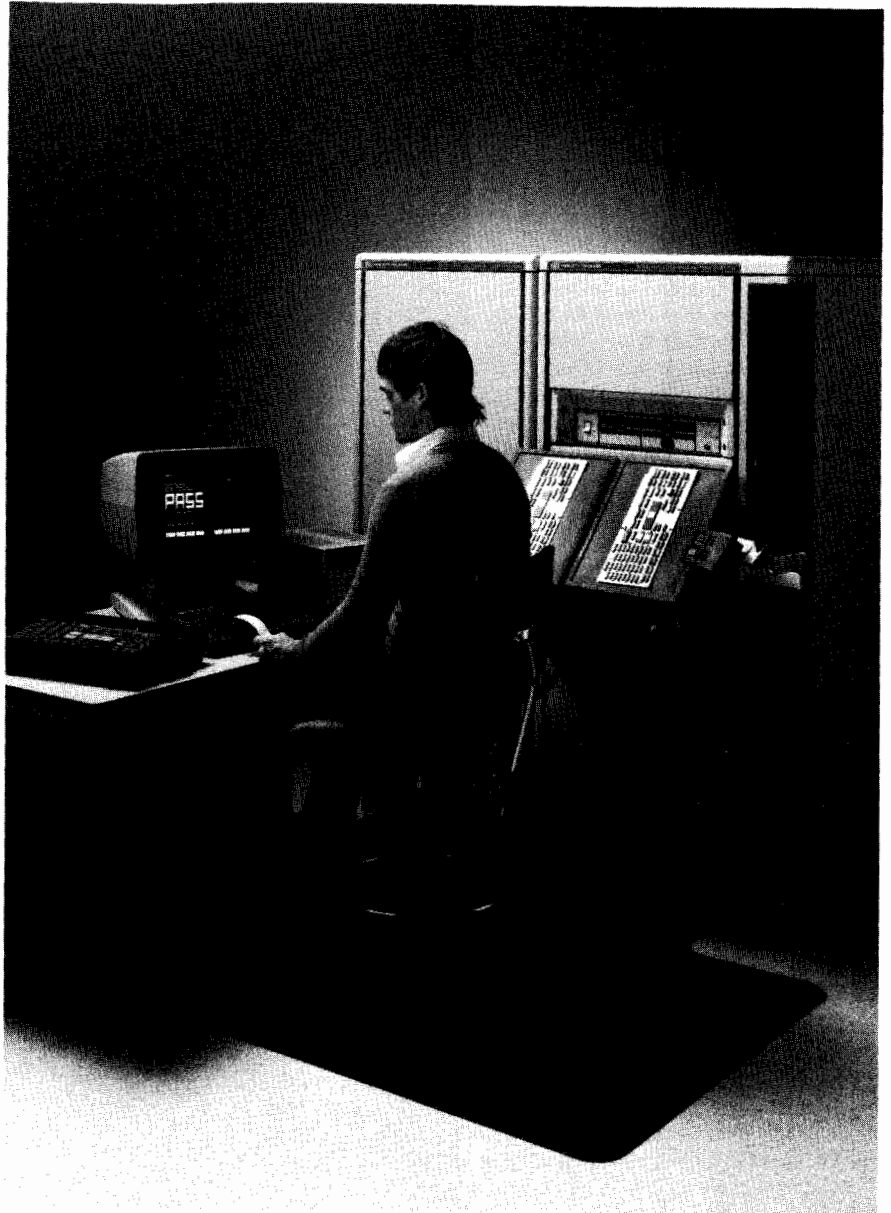

One example of HP's strong commitment to helping customers increase productivity is the HP 3065 family of circuit-board testers. In addition to speeding the testing of boards (30 ICs per second), these computer-aided systems can automatically acquire data from most CAD systems, provide improved diagnostic reporting to speed up analysis, and minimize operating problems through on-line remote testing.

Customers use HP instruments to evaluate the performance of their own electrical equipment, in developing products, in controlling quality and manufacturing processes, and in field service applications.

In addition to the electronics industry,

major markets for HP instruments include telecommunications, aerospace, aviation, and scientific research. In fact, HP instruments are used in almost every industry where precise testing, measurement and control are required.



The workstations of HP's Series 200 are popular choices for a wide variety of applications. Based on the MC 68000 microprocessor, this growing family of rack mountable and desktop workstations offers the processing performance and expandable memory to match complex demands and varying requirements for engineering, instrument control, and measurement systems applications.

#### HP Computers

HP's first computer was introduced in 1966. Its purpose was to gather and analyze the data produced by HP electronic instruments. Today, HP computers and their peripheral devices (terminals, mass storage devices, printers and plotters) are themselves a major product line and account for a substantial portion of the company's sales.

The broad range of HP computation products and systems offers solutions for businesses, manufacturers and individuals as well as engineers and scientists.

HP leadership in key technical computer markets has been the outgrowth of the company's strong familiarity with engineering, scientific and manufacturing applications.

By linking networks of personal computers and terminals, powerful HP mini-computers provide mainframe capabilities for thousands of businesses and industries. Other computers are optimized for control of instrument

systems, making it easier for customers to design and assemble electronic test systems.

HP's advanced data communications technology is the key to the enhanced productivity of such computerized systems. With the ability to combine words, data, and graphics, HP computer networks automate the many tasks involved. Specific application solutions along these lines are offered not only to engineers and scientists but also to manufacturers, distributors, retailers, financial institutions, hospitals, government agencies and schools.

#### HP Measurement Systems

Under the impact of a growing scarcity and rising cost of technical manpower, the need is accelerating for measurement systems, with their higher speed, accuracy, repeatability and productivity. HP instruments and computers are designed with systems in mind. In this catalog system-ready products are marked with the symbol



In 1965 HP set about creating its own internal standard for the interfacing of all future HP instruments and HP computers. That standard became a worldwide standard, IEEE-488, and it is used by more than 170 manufacturers in 14 countries. We call this standard HP-IB, the Hewlett-Packard Interface Bus.

In all cases the goal of HP systems is to provide essential information in useful form and in the most efficient and timely manner. The end result is improved productivity of our customers' processes and organizations—the unifying purpose of HP's business.

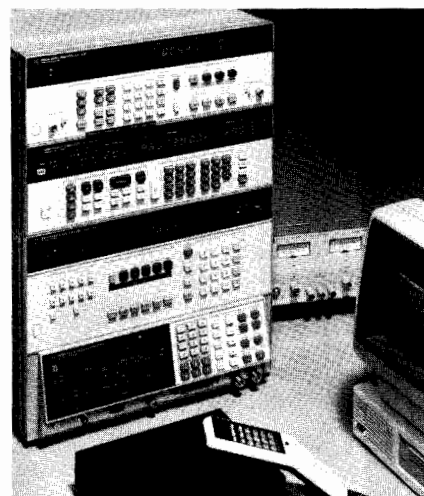

HP instruments are designed with systems in mind. Nearly all instruments introduced in the last several years have been equipped to operate on the Hewlett-Packard Interface Bus (HP-IB), HP's implementation of the internationally recognized IEEE-488 standard. This HP 8957S cellular-radio test set is an example of how the needs of a particular application can be met by combining specialized and more general-purpose instruments, interconnecting them via HP-IB, and controlling them with a desktop computer.



## Other HP Products

In addition to electronic measurement and computation products, HP manufactures a number of other product lines, all of them related by basic electronics technology. Among these are electronic components such as microwave semiconductor and optoelectronic devices. Other important fields of interest include medicine and analytical chemistry. Today, hospitals and clinics use HP equipment for patient monitoring, diagnosis and therapy, as well as data management. Analytical instruments are widely used in the chemical, energy, pharmaceutical and food industries, as well as in medical and chemical research programs for government and industry.

## HP Innovation

The continuing growth of Hewlett-Packard is based to a significant degree on a strong commitment to research and development. Between 8 and 10 percent of sales revenue is invested in R&D. In 1983 this amounted to 493 million dollars. This increasing investment has enabled HP to stay at the forefront of technology and to maintain a steady flow of new and useful products. More than two thirds of the company's 1983 orders were for products introduced during the previous four years, a clear indication of the importance of HP's product-development efforts.

Each of HP's 52 product divisions has the primary responsibility for developing its own products. Together, the divisions account for close to 85 percent of the company's annual R&D budget. The remaining 15 percent is invested in more basic, higher risk, longer term research undertaken by HP Laboratories, the central source of technical support for the divisions. Through endeavors in areas of science and technology, the corporate laboratories

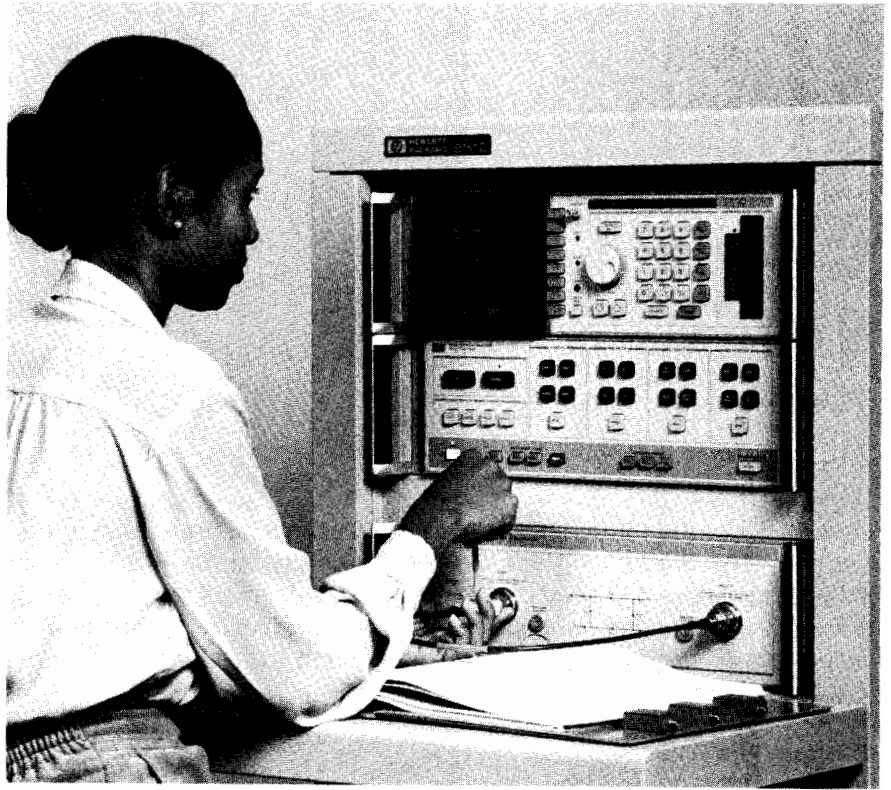

HP's heavy emphasis on research and development results in major contributions to established areas of measurement as well as entry into new areas. HP-engineered advances in microwave components, signal-processing, and high-speed computation give the HP 8510 network analyzer system high levels of measurement accuracy, speed, dynamic range, resolution, and versatility that set new standards in microwave measurement. The system makes error-corrected measurements fast enough to permit real-time adjustments on devices under test, and accuracy is 10 to 100 times better than previously possible.

also help the company develop new areas of business. Customers benefit through access to computers and instruments that are at the forefront of technology.

## HP Support

The same high level of engineering excellence that HP commits to the development of advanced products also goes into creating high quality support services. Hewlett-Packard's support organization consists of a worldwide sales and service net-

work staffed by highly trained engineers and technicians. Our support starts before you purchase an HP product and continues long after the product has been delivered.

Before you purchase a product or system, HP sales representatives are available to help you assess your needs and choose the product or system that meets your immediate and longer term requirements.

If your needs are best filled by an instrument system, we offer applica-





tions and training support to help you obtain full use of your system, hardware support to help maximize system up time, and software support to keep your system software current and productive.

To help you plan your system and its use, we offer the consulting and training expertise of experienced systems engineers. For the installation and maintenance of your system and its components, we offer the services of customer engineers. And for the long-term support of your system, HP offers an extensive menu of services. The menu includes contract or as-needed calibration and repair with on-site and at-HP options, as appropriate. Update services are available for both software and hardware, as is training for your own service personnel.

HP's worldwide support network ensures prompt availability of replacement parts throughout the production life of products and beyond. Replacement parts services also include parts stocking recommendations based on extensive component reliability histories and the numbers and mix of HP products to be supported.

For those products requiring consumable supplies, such as recording paper, ribbons and magnetic media, we offer fast, convenient service from well-stocked supply centers that can also provide personal computers and software, peripherals and terminals, cables and connectors, workstation furniture, books and learning aids.

HP's comprehensive support also includes extensive information services. In addition to supplying excellent hardware and software manuals, HP makes available a wide variety of no-charge publications to help you choose the HP products that best fill your needs, to help you

benefit from applications knowledge acquired by users inside and outside of HP, and to help you maintain your HP products. These publications range from new-product announcements, catalogs, product family brochures and single-product data sheets, through application notes and programming aids, to service notes and maintenance periodicals.

The support services outlined above are described in more detail in the back sections of this catalog. Your nearest HP office can either supply the support services you need or help you obtain them. The locations of HP offices are listed on the back pages of this catalog.

#### **The HP Catalog**

This catalog is divided into sections that are based on product families: circuit test systems, oscilloscopes, signal analyzers, telecommunications test equipment and so on. Many of these sections are prefaced by descriptions of basic kinds of measurements and the techniques of measurement that are associated with the featured products.

The catalog offers two different indexes. One is alphabetical by instrument type or name; the other is numerical by HP model number.

The product descriptions presented in the catalog are as complete as reasonably possible in a publication such as this. In some cases it will be necessary to refer to a data sheet for a full set of specifications. Data sheets are available on request at local HP sales offices.

The locations of HP sales and service offices are listed on the back pages of this catalog. The listing also indicates the types of products normally available through each office (not all offices handle the full line of HP products).

#### **Contacting HP**

Your calls to your local HP office will be routed to the person best qualified to give you assistance if you tell the operator your specific product interest: instruments, computers, medical, analytical, or components.

Our sales force is made up of specialists in each of these five major product areas. Staff engineers are always available during business hours to respond to your needs or to obtain answers from appropriate sources. Our HP sales representatives are supported by the HP systems engineering organization, which has specialists in measurement and computation systems.

Information on product availability, prices and order status is immediately available through our worldwide order processing network.

#### **Suggestions Welcomed**

The purpose of this catalog is to give you the most information possible about Hewlett-Packard products, along with some company background that may be useful in reaching decisions as to product and system needs. The major emphasis in this catalog is instrument products and systems, with some representation by HP's other product categories. Literature describing these other product categories is available through your local sales office.

If you have any comments and suggestions about how we can make this catalog more useful to you, please let us know by writing to:

Hewlett-Packard Co.  
Steve Duer  
Catalog Manager  
3200 Hillview Avenue  
Palo Alto, CA 94304

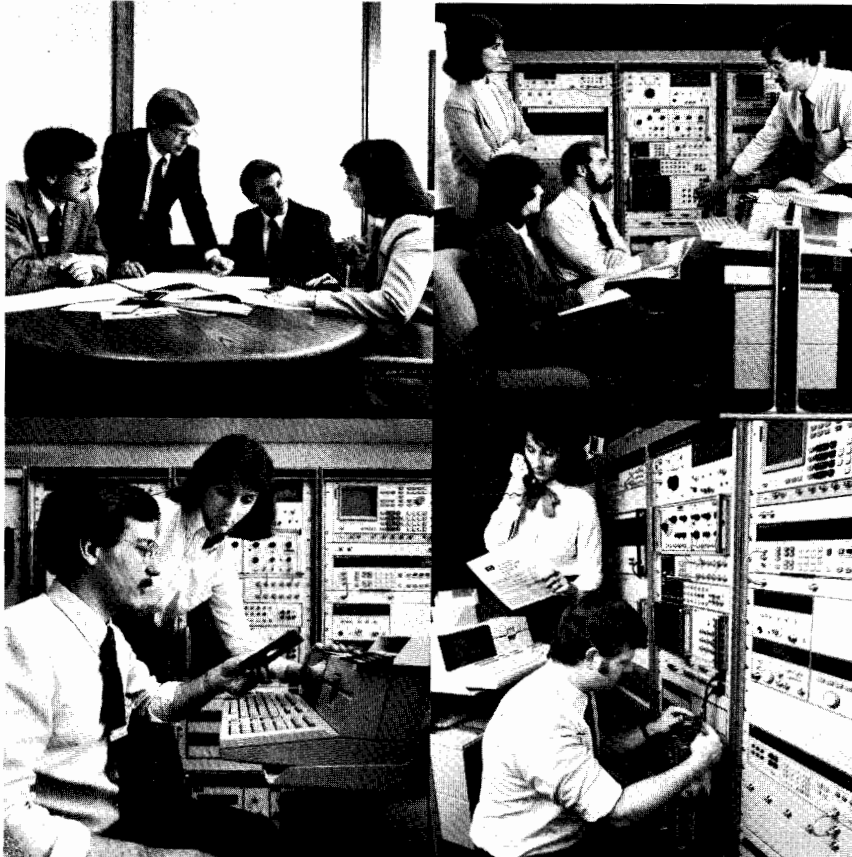

Hewlett-Packard offers you a complete solution. From instrumentation systems, to application consulting, training, software and hardware support, HP supports you throughout your application's life cycle. The pages that follow describe some support services available to you. For more information, contact your local HP Sales Office.

### Extending System Life

System Expansion or Reconfiguration • Hardware Upgrades and Refurbishment • System Software Upgrades • Application Software Performance Improvement • System Replacement

### Keeping the System Productive

System Calibration & Preventative Maintenance • Remedial Maintenance • System Software Updates and Support • Supplies Availability

### Planning and Evaluation

Needs Analysis and Requirements Definition • Authorization and Financing • System and Support Specifications • Cost of Ownership Analysis • Vendor Selection • Equipment Order

### Getting Ready

Implementation Planning • Application and Operator Training • Site Survey and Preparation • Information Gathering

### When the System Arrives

Hardware & Software Delivery • Racking, Cabling and Installation • Functional Test Design and Coding

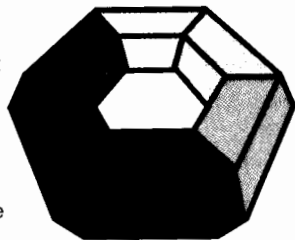

### Putting the System to Productive Use

Application & Test Design • Program Coding • Program and Test Documentation • Fixture Installation • Staff Training

## Introduction

### When Performance Must be Measured by Results...

Success in today's business environment depends on quickly obtaining high productivity from people and equipment. Selecting the right instrument system is essential to achieving proper results. Inefficient use of that system, however, can severely hamper your success.

### ... Results Can be Assured by Support

At Hewlett-Packard we understand that the efficient application of an instrument system involves much more than just purchasing the best equipment. That's why we are a world leader in instrument support services.

We want you to be successful with your HP instrumentation. HP offers applications and training support to help you obtain full use of your instrumentation's capabilities, hardware support to help maximize your system's uptime, and software support to keep your system software current and productive. Astute use of HP instrument support services throughout the life of your application can give you a competitive edge through increased productivity.

### HP's Complete Solution

We deliver support solutions tailored to your productivity needs. Support allows you to quickly realize the full performance potential of your HP equipment, to maximize its uptime and to prolong its useful life. Our support commitment starts before you purchase any equipment and continues long after your instruments have been delivered. When you purchase HP equipment and support together, you are purchasing a complete productivity solution.

### The Application Life Cycle

Your system implementation can be viewed as an application "life cycle". Each step of this cycle provides an opportunity to improve the use of your instruments to increase productivity.

Whether you are in the decision, implementation or sustained operation phase of this application life cycle, HP can provide the tools, knowledge and support to ensure success.

### Make HP Your Partner in Productivity

Hewlett-Packard can be your partner in test and measurement success. From your first consideration of a hardware purchase through the entire life cycle of your instrumentation, HP stands behind your success with a complete range of worldwide support services. Choose Hewlett-Packard as your instrument partner and you are assured of state-of-the-art hardware, software and support.

### Ordering Support is Easy

If you wish to design your own support program you may select the services you need from the product descriptions which follow. Or, if you prefer HP to configure a support plan for you, just contact your local HP sales office and an HP sales representative will provide a plan that fits your needs.



### Training For Your Success



Proper knowledge of measurement techniques and instrument capabilities will make you more productive. HP Instrument Training is designed to be a cost-effective method of quickly acquiring the knowledge and skills to obtain maximum success with your instrument application.

With HP Instrument Training you can gain a competitive advantage by minimizing start-up delays due to insufficient understanding of your system or its operation. Training can also acquaint you with new applications and operating techniques which can significantly improve your productivity.

#### Learn More . . .

HP Instrument Training provides you with an in-depth understanding of advanced measurement techniques and technology. Students will learn more in an HP class than they could reasonably expect to learn by spending the same amount of time teaching themselves.

#### Learn Faster . . .

HP Instrument Training is an intensive learning experience. Courses are designed to teach you quickly and efficiently how to use your equipment in new and productive ways.

Course material is presented in a logical and businesslike manner so that students can quickly assimilate vital information. No time is wasted on "salesy" presentations—the student's time is fully devoted to learning.

#### Learn Better . . .

The structured learning environment provided by HP's Instrument Training classes allows for full retention of course materials. A student will find that he or she can more quickly apply principles learned in a class, instead of trying to constantly learn through hit-or-miss experimentation.

The courses introduce key concepts and principles through illustrated study materials and lectures. Students then apply what they have learned through hands-on exercises and labs. In this way principles are immediately reinforced through actual experimentation.

#### . . . For Your Success

In today's fast-paced business environment, gaining the most productivity from your people and equipment is essential to your success.

HP Instrument Training can help you achieve this success. Choose from the courses listed here, or contact your local HP office for a training catalog (part number 5953-9608(D)) that includes complete course descriptions, training locations, prices and dates.

#### HP-IB Systems Oriented

The courses below will help you integrate various HP instruments into your own HP-IB configured system, and then help you gain maximum value from their operation.

#### HP-IB Instrument Programming With HP 1000 E/F Series Controllers

This three-day, hands-on training will teach you how to enhance the measurement power of your instruments by coupling them to an HP 1000 E/F Series computer. Learn how to program, monitor and implement a complete HP-IB system. To attend this course, order HP 50016E.

#### HP-IB Instrument System Training With Model 26 Controllers

This four-day lab-oriented course will enable you to set up and customize an HP-IB system to do various automatic test or measurement/control tasks. You will learn to create and document HP-IB programs by applying structured programming techniques using HP Series 200 Desktop Computers. To attend this course order HP 50011A.

#### HP 1980B Waveform Measurement System Training

This two-day lab-oriented course will speed your ability to make completely automated time domain measurements using the HP 1980B Oscilloscope in conjunction with the HP 19800A Waveform Measurement Library and HP 9826/9836 controllers. You will learn measurement algorithms and data structures that measure waveform voltage and timing parameters, and be able to create custom application programs. Ask for course HP 1980B+24A.

#### HP 6942A Multiprogrammer User's Course

This three-day course teaches you how to make measurements and perform stimulus/response or control for automation applications using the HP 6942A and the HP 85 computer. The course emphasizes practical applications and extensive hands-on experience with this important system component. Ask for HP 6942A+24D.

#### Logic Related Courses

Today's microprocessor technology demands high logic development and analysis skills. HP offers a variety of courses to meet your needs in this important technology.

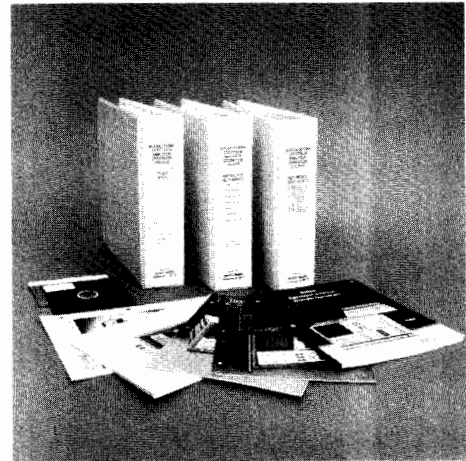

#### HP 64000 Logic Development System Training

To increase your productivity with the HP 64000 System, HP offers a group of modular courses. The HP 64000 System Overview Module teaches general system operation and capabilities and is a prerequisite for other modules. The 16-Bit Emulation Training Module presents the technical details of emulation. The Logic System Analysis Training Module covers advanced software and hardware analysis techniques. The User Definable Assembler Training Module presents the structure and building of assemblers and linkers. Together, these modules comprise an HP 64000 Logic Development System Training curriculum that will help you increase your HP 64000 productivity.

#### HP 64000 System Pascal Programming

HP offers two courses to help you use Pascal on your HP 64000 System. HP 64000 System Pascal Programming Course is a three-day introduction to the language using HOST Pascal. HP 64000 Pascal Microprocessors Course is a two-day applications oriented session designed to improve your microprocessor productivity using Pascal. If you are a software engineer, ask for HP 64000 System Pascal programming Course. Also ask about HP 64000 Pascal training for specific microprocessors.

#### Advanced Timing/Hardware Analysis Training

This one-day course teaches the concepts, applications and configurations of timing analysis using an HP 64600S 8-channel timing analyzer. You will learn to identify and solve timing related problems, understand the interaction of the timing and state modules, and theories and effects of skew and asynchronous triggering. Ask for HP 64600S+24F.

#### Software Performance Analysis Training

This one-day course will help you simplify your complex software development process using the HP 64310A Software Performance Analyzer. You will learn to measure memory activity and evaluate program activity, as well as determine time distribution of a module's execution and transitions, and





# INSTRUMENT SUPPORT

## Training Courses



evaluate Intermodule Bus measurements.

This course will help streamline all phases of your software development. Ask for HP 64310A+24A.

### HP 1630 Logic Analysis Measurement Techniques

This one-day lab-intensive course offers a systematic approach to problem solving using state, timing and software performance analysis with the HP 1630 logic analyzer. You will learn to match appropriate measurement techniques to specific problems using the interactive state and timing capabilities of the HP 1630. Ask for HP 1630A/D+24A.

### Board Test Courses

The accurate testing of IC boards is crucial to the productivity of many businesses. HP offers a variety of board test courses designed to enhance your use of HP board test equipment.

### HP 3060A, 3061A, 3062A User's Course

This ten-day course presents the knowledge necessary for testing analog and hybrid circuits with the HP 3060A/61A/62A board test systems. Included is software instruction on the HP Series 200 Desktop Computers, the Board Test Language (BTL) and the In-Circuit Program Generator (IPG). Time is spent on testing philosophies involving shorts, in-circuit and functional testing as well as semiconductor tests, guarding, phase-synchronous detection, digital testing and signature analysis. Ask for HP 3060A/61A/62A Board Test System User's Course.

### HP 3065 Board Test System User Training

This two-week course provides detailed programming and operating instruction for the HP 3065 board test system. Topics covered include system software and program development, board test topology, in-circuit testing digital scanner hardware, test language and test structure. Also included are reviews of BT BASIC, test optimization, fixturing, data logging, networking links and IPG II. Ask for HP 3065C+24D Training.

### HP 3060A Enhancement Training

This half-day course will shorten your start-up time using the HP Series 200 controller enhancement to your HP 3060A. You will learn to use the new Board Test Language (BTL) and In-Circuit Program Generator (IPG), as well as program editing and transfer on the Series 200. Ask for HP 44854+24A Training.

### RF & Microwave Related Courses

HP's RF & Microwave related courses provide you with practical training for your measurement applications.

### Basic Measurements Using The HP 8510 Network Analyzer System

This three-day, lab-intensive training will allow you to better apply the HP 8510 to your needs. You will learn microwave and network analyzer fundamentals, system operation, maintenance and self-test, as well as error correction, time domain and advanced operating techniques. This training will allow you to quickly take full advantage of the advanced capabilities of the HP 8510 Network Analyzer. Ask for HP 8510+24D Training.

### HP 8566A/8568A Spectrum Analyzer Operation

This four-day program will help accelerate the integration of your HP 8566A or HP 8568A into automatic test systems. You will learn to effectively use signal acquisition and process capabilities; as well as how to analyze and optimize accuracy, sensitivity, dynamic range and resolution in a system environment. To attend this training, order HP 8566A/8568A+24D.

### HP 8409 Series Automatic Network Analyzer Training

This four-day course will give you an in-depth understanding of the HP 8409, and will provide you with all the skills necessary to take full advantage of its capabilities. You will learn network measurement basics and automatic measurement fundamentals as well as one and two-port measurement techniques and modeling concepts. Ask for HP 8409C+24D Training.

### Additional Courses

HP offers a number of other courses to help you understand instrumentation applications and to help you use your HP equipment more effectively.

### Data Acquisition and Control Fundamentals

This three-day course is a hands-on introduction to the basic principles and concepts of data acquisition and control. After an overview of various system types, you will learn the techniques needed to measure various physical phenomena such as temperature and pressure. You will also learn the grounding and guarding techniques needed for good signal transmission, analog and digital input/output signal processing, and PID algorithm basics. The course is taught using an HP 3497A as the data acquisition/control unit, and an HP Series 200 Desktop Computer as the controller. To gain a deeper understanding of what data acquisition and control automation can do for you, ask for HP 50015A.



### HP 4955A Protocol Analyzer User Training

This one-day lab-intensive course is built around the concept of a short tutorial on troubleshooting techniques, immediately reinforced by gaining hands-on experience with the HP 4955A Protocol Analyzer. You will learn to configure the analyzer for character-oriented and byte-oriented protocols, custom data codes, and Level 2/Level 3 triggers. Ask for HP 4955A+24A Training.

### HP 5528A Laser Measurement System Training

Two, one-day courses are available to teach you laser measurement fundamentals and HP 5528A measurement techniques. The first course will give you the knowledge to properly install optics, align the laser beam to optical travel and set up the display for appropriate measurements, in addition to making accurate distance and angle measurements, the second course will teach you to make straightness and squareness measurements as well as how to manually and automatically record data. Ask for HP 5528A+24A and HP 55283A+24A Training.

### HP 8180A/8182A Operating and Programming Techniques

These courses will teach you how to use and program the HP 8180A Data Generator and HP 8182A Data Analyzer to perform basic propagation delay, set-up and hold time measurements for devices under test. The format of this course allows for maximum hands-on activities so that you will gain real-time practice in operating the instruments and developing programs.

### Ordering Information

To enroll in any of the courses listed here, or to find out more information on these and other Instrument Training courses offered by HP, just contact your local HP sales office. They will provide you with a schedule of local classes and complete registration information. You can also order a complete catalog of Instrument Training classes by requesting publication number 5953-9608(D).

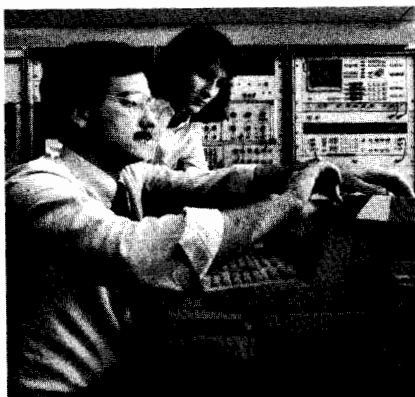

### Application Support Helping You be Successful With Your System

When you purchase a measurement or test system you want to make sure that the payback starts quickly. HP's Instrument Application Service (HP 50600B) provides assistance that allows you to develop your staff and ensure the effective use of your system. Instrument Application Services (IAS) feature the expertise of a Hewlett-Packard Systems Engineer (SE) trained in your application area and can be tailored to meet your own specific needs.

### Customized Training Improves Utilization

If your application requires training needs that fall outside the scope of HP's formal training courses, our Systems Engineering Organization can provide customized training to fit the demands of your particular application.

An HP SE skilled in your application area will work with you to determine the topics to be covered and the structure of the material he will present. The training can cover basic system start-up and operational techniques or can include more advanced material on your application. Each day of SE training could save your staff several days of start-up time and could improve your overall capabilities and operating efficiency.

### Application Support Speeds Solutions

Even if you require assistance beyond training, IAS can help. Under IAS an HP SE can provide application support designed to help you achieve the highest possible level of success with your HP ATE, data acquisition board test, logic development or other system.

### System Level Expertise Increases Productivity

If you have an existing measurement or test system and have partially or fully developed software or fixturing, IAS can help you fine tune the final implementation. An SE will come to your site and work with you to analyze system performance parameters and make recommendations to help optimize performance.

### Interactive Help

The interactive nature of IAS allows for maximum flexibility to improve your productivity. Since your needs determine the best mix of training, application advice or performance evaluation, an initial discussion with your HP representative will help define how IAS can benefit you. Our SE will then perform any research and preparation necessary and will come to your site to assist you or your designated system contact or do any training required.

### How to Order

The services provided by IAS are flexible and can be purchased in increments of one day (plus preparation time) or in larger blocks spaced out over longer periods. You may request IAS from the nearest HP sales office or by conferring with your HP Instrument Sales Representative or System Engineer. They will acquaint you with the procedure for defining your project and ordering the service.

### Software Support

#### Increase System Effectiveness

Your investment in system software doesn't end with the purchase of an instrument system. It continues as you develop or improve programs specific to your application needs. Through Hewlett-Packard's software support services (available for specific instrument systems) you will gain valuable tools to keep your system software and programmers operating at peak efficiency.

#### Real Benefits

With software support your programmers stay current with changes in system software. They can quickly implement new software enhancements or fixes to improve system productivity. And, there are no delays in getting new versions of software because HP will automatically send you copies as they become available.

Software support services can also help your programmers save time during their test development by providing access to an HP Systems Engineer for help in answering questions about the system software.

Above all, software support can help you stay competitive. Because software support keeps you constantly informed of software changes, additions and enhancements, you can be sure that your system's operation is not becoming outdated.

### Flexible Services

Because we realize that individual needs vary between users as well as over time, HP offers two types of software support. You can choose the level of support that best fits your needs.

If you want to keep current with developments in your system's software and are experienced on the use and operation of the software, then Software Materials Subscription (SMS) is for you. With SMS you will automatically receive Software Updates which include improvements to software performance, additional software elements, resolution of specific anomalies, and increases in software capabilities. You will also get Reference Manual Updates as well as Software Status Bulletins and a User's Newsletter, all of which contain information on the use, application, configuration and developments in the HP software.

### How to Order

When expert technical support is important to the ongoing success of your application, consider HP's application and software support services. Just call your local HP Sales Office for a complete description of how these services can help you.

Let HP help you make the best use of your system through software support. Software support products are purchased for an initial 12-month period for certain specified systems, and are billable quarterly or yearly in advance, as desired. Details on software support availability and on ordering software support may be obtained from the nearest HP Sales Office or by contacting your HP Instrument Sales Representative.



- A Service plan for every need
- Personalized service
- HP engineered quality

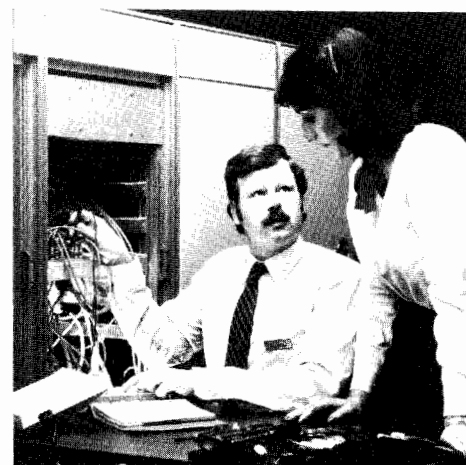
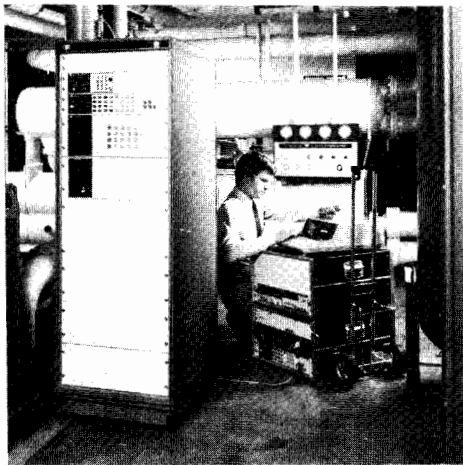

### **Hardware Support For Your Productivity**

You will gain a powerful tool when you invest in the engineering excellence of HP instruments and systems. Yet simply choosing productive HP hardware is often not enough to maintain your increased productivity. High performance equipment demands high performance maintenance in order to sustain your productivity. At HP we recognize this, and we have used our more than 40 years of engineering experience to design hardware support services that match the quality and performance of our instruments.

### **A Spectrum of Hardware Support Services**

At HP we understand that our customers have different maintenance requirements, from occasional repair to cal lab backup. That's why we've designed a complete spectrum of support products for you.

If you want cost-effective Maintenance Agreements that offer insurance-like protection, or per-incident service at low standardized prices — we have a plan for you. If you need on-site service for your systems, or fast return to HP service for your components — we have a plan for you. If you need instrument repair only or just calibration backup for your cal lab, or both — we have a plan for you.

### **Maintenance Agreements for HP Managed Support**

HP Maintenance Agreements offer you the best value for your maintenance dollar. The price of an agreement can represent important savings since all repairs are covered, even when expensive-to-repair microcircuits are involved.

Repair Agreements provide all the labor and parts needed to correct malfunctions whenever required during the term of the agreement. The only exceptions are abuse, misuse or accidental damage.

Calibration Agreements provide checking of instrument specifications by performing all the tests specified in the Performance Test procedure of the Instrument Manual. A certificate of conformance verifying that the equipment meets HP's published specifications and that the measurements are traceable to NBS or equivalent standards body.

Full Service Agreements combine the benefits of repair and calibration services at a cost saving compared to purchasing the services separately.

Agreements allow you to reduce downtime by eliminating quotation and approval, and priority status is given to Agreement covered instruments. Agreements also save you the risk of having to finance unusually costly repairs, and the fixed yearly charge gives you a known, budgetable service cost.

### **Keeping Your System Up and Running**

HP's system level Maintenance Agreements offer a number of practical advantages that keep your system's productivity high.

When you purchase a Basic System Maintenance Agreement, an experienced HP Customer Engineer is assigned to your account with the responsibility of managing an on-site maintenance program specifically designed for your system. Services include: site environment surveys to ensure your instruments operate under proper conditions; preventive maintenance to identify and correct potential problems before they occur; remedial maintenance to correct malfunctions; and engineering improvements to extend the useful life of your system.

Other features include same day, or faster, response on service requests placed during normal working hours at sites within 100 miles (160 km) of a support office, and work to completion once the Customer Engineer arrives. All necessary parts and labor are included, a loaner option is included, and when purchased at the same time as your hardware, warranty terms are extended to match agreement terms at no extra cost.

### **Keeping Your Instruments Up and Running**

An HP Maintenance Agreement can also make sense for you if you have individual instruments or system components that can be returned to HP. When you purchase an Instrument Repair Center Agreement you receive many of the same benefits described under our System Agreements.

Agreements are available to provide repair service, calibration service or both on return to HP bench. When your instrument arrives at one of our conveniently located Instrument Repair Centers around the world, it is given priority response and attended to by a skilled bench technician. All labor and parts required to perform the services are included.

### **Per-Incident Services for Support When You Want It**

If your maintenance needs are more limited, or if you prefer to manage your own maintenance program, HP Instrument Repair Center per-incident services offer you cost-effective maintenance.

For some 700 current instruments, standard repair and calibration prices have been established. These standard prices cover routine repair and calibration of HP instruments that break down in normal use. Even though our maintenance effort may vary from incident to incident, the work quality and prices remain standard.

### **Reduce Downtime = Increase Productivity**

Whether you prefer Agreements or Per-Incident services, you receive the same level of commitment to high quality. When you use HP support services you automatically plug into our worldwide network of service experts dedicated to supporting your success, no matter where in the world you need it. Their knowledge, backed up by HP factory engineers, can give you the confidence that you are doing all you can to reduce your downtime and increase your productivity.



### Support Life - Maintaining Your Productivity

Hewlett-Packard fully supports all products for a minimum of five years after production ceases, with selected products being supported for a minimum of ten years. After the expiration of the specified support period, HP will continue to offer support on a best effort basis. In this way HP can help assure your ability to use your equipment productively for as long as possible.

### Service Publications—Help You Maintain Your Instruments

The *Operating and Service Manual* supplied with Hewlett-Packard instrumentation contains maintenance, calibration, diagnostic and repair procedures, with troubleshooting charts, circuit diagrams and replacement parts lists. Most operating and service manuals, manual updates, and Service Notes are now available on COSATI standard, positive microfiche.

Bench Briefs, a periodic newsletter, has information to help repair and maintenance personnel get maximum performance from Hewlett-Packard instruments. It describes new Service Notes and other company publications as they become available. To become a regular subscriber, ask your local HP office to place your name on the mailing list.

### Warranty—Confidence in Quality and Reliability

As an expression of confidence that our products will continue to meet the high standards of reliability and performance that our customers expect, Hewlett-Packard products carry the following warranty:

*HP hardware products are warranted against defects in materials and workmanship. If HP receives notice of such defects during the warranty period, HP shall, at its option, either repair or replace hardware products which prove to be defective.*

*HP software and firmware products which are designated by HP for use with a hardware product, when properly installed on that hardware product, are warranted not to fail to execute their programming instructions due to defects in materials and workmanship. If HP receives notice of such defects during the warranty period, HP shall repair or replace software media and firmware which do not execute their programming instructions due to such defects. HP does not warrant that the operation of the software, firmware or hardware shall be uninterrupted or error free.*

*If HP is unable, within a reasonable time, to repair or replace any product to a condition as warranted, Buyer shall be entitled to a refund of the purchase price upon return of the product to HP.*

a. **SUPPLEMENTAL STATEMENT:** Supplemental statements setting forth the duration and implementation of warranty and installation are available for most product types. These statements, if applicable to purchased products, are attached hereto and incorporated herein.

b. **DURATION AND COMMENCEMENT OF WARRANTY PERIOD:** The warranty period for each product is specified in the supplemental statement of warranty and installation attached hereto and incorporated herein. The warranty period begins either on the date of shipment or, where the purchase price includes installation by HP, on the date of installation. If Buyer schedules or delays installation more than thirty (30) days after delivery, the warranty period begins on the thirty first (31st) day from the date of shipment.

c. **PLACE OF PERFORMANCE:** Within HP service travel areas, warranty and installation services for products installed by HP and

*certain other products designated by HP will be performed at Buyer's facility at no charge. Outside HP's service travel areas, warranty and installation services will be performed at Buyer's facility only upon HP's prior agreement and Buyer shall pay HP's round trip travel expenses and applicable additional expenses for such services.*

*On-site warranty services are provided only at the initial installation point. If products eligible for on-site warranty and installation services are moved from the initial installation point, the warranty will remain in effect only if Buyer purchases additional inspection or installation services at the new site.*

*Installation and on-site warranty services are available outside the country of initial purchase only if Buyer pays HP international prices. If Buyer transports a product from the country of initial purchase without having paid HP international prices, any remaining warranty covers parts and labor only and applies only if the product is returned to HP. However, Buyer may obtain on-site warranty service if the location is one where HP can normally provide on-site service for the product and the Buyer pays HP established travel charges. Service outside the country of initial purchase is subject to the conditions regarding HP service travel areas and initial installation point described above.*

*For product warranties requiring return to HP, products must be returned to a service facility designated by HP. Warranties requiring return to HP are not limited to the country of purchase. Buyer shall prepay shipping charges (and shall pay all duties and taxes) for products returned to HP for warranty service. Except for products returned to Buyer from another country, HP shall pay for return of products to Buyer.*

d. **LIMITATION OF WARRANTY:** The foregoing warranty shall not apply to defects resulting from:

1. Improper or inadequate maintenance by Buyer;
2. Buyer supplied software or interfacing;
3. Unauthorized modification or misuse;
4. Operation outside of the environmental specifications of the product; or
5. Improper site preparation and maintenance.

**THE WARRANTY SET FORTH ABOVE IS EXCLUSIVE AND NO OTHER WARRANTY, WHETHER WRITTEN OR ORAL, IS EXPRESSED OR IMPLIED. HP SPECIFICALLY DISCLAIMS THE IMPLIED WARRANTIES OF MERCHANTABILITY AND FITNESS FOR A PARTICULAR PURPOSE.**

### EXCLUSIVE REMEDIES

*The remedies provided herein are Buyer's sole and exclusive remedies. In no event shall HP be liable for direct, indirect, special, incidental or consequential damages (including loss of profits) whether based on contract, tort, or any other legal theory.*

### Certification—Traceability of Measurements to Known Standards

Products provided by Hewlett-Packard are thoroughly tested and calibrated to meet their published specifications. A Certificate of Conformance (certifying that the product meets its published specifications and that its calibration is traceable to appropriate National Standards) is available upon request at the time of purchase.

Hewlett-Packard's calibration measurements are traceable to National Standards—the National Bureau of Standards in the United States and to Standards authorities of comparable standing in other countries of manufacture.





# TRAINING/VIDEO TAPES

## Technical Training



### Training Alternatives

With Hewlett-Packard's extensive product line and worldwide customer mix there are two main avenues for technical customer training. These are live training sessions and videotapes. Live training sessions fall into three subcategories: applications, service and tutorial. Application seminars aimed at increasing your utilization of general purpose test instrumentation are often available at no charge. On the other hand seminars on the operation of dedicated systems are more specific in nature and generally have a fee for tuition. Service seminars are available on a supply and demand basis and also have a tuition fee. For detailed information on all HP seminars contact your Hewlett-Packard field engineer or call the Hewlett-Packard sales office nearest you—see page 695.

### HP Videotapes

#### A Better Way to Learn

The videotapes listed in this catalog have been produced by the Hewlett-Packard Television Network. These programs communicate important technical information. Their primary purpose is to clarify a variety of complex concepts and provide training for the operation and maintenance of a wide range of electronics equipment. Therefore, they offer detailed, practical and well-presented working information which has proven to be invaluable for technical training within Hewlett-Packard. We are sure you also will find the tapes useful for your own professional applications because you'll find they make it easier for your technical people to understand, use and repair your own valuable equipment.

#### Practical Transistor Series

The widely used Practical Transistor Series is a definitive, 15-cassette excursion into

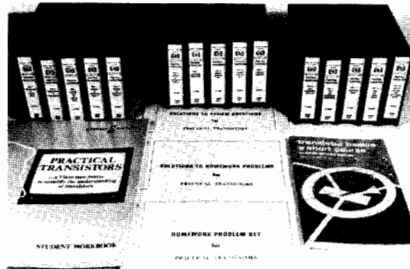

the exceedingly important (and mysterious) world of transistors. As outlined below, each highly informative program in the wide-ranging series is primarily concerned with examining the many practical aspects of transistors rather than just dwelling on theory and math. The end result, after viewing this popular series, will be a deeper working understanding of transistors which will make maintenance and trouble-shooting problems far easier and more efficient. The series is therefore highly recommended for electronics students, service personnel and engineers.

A supplementary textbook by transistor authority George Stanley Jr. (who also hosts the series), plus a complete set of homework problems and answers, is included with the nearly nine hours of videotaped material.\*



**Tapes 1-15, BW, time: 8 hrs., 53 mins.**

#### Stock No:

90100A	½" VHS (SP)	NTSC
90100B	½" BETA I	NTSC
90100D	¾" UMATIC	NTSC
90100C	½" VHS (SP)	PAL
90100E	½" BETA	PAL
90100F	¾" UMATIC	PAL

#### Digital Trouble-Shooting Series

This course was designed, developed, and made for technicians. It provides an appropriate path from transistors to digital electronics. It also can be used as a refresher course. Equivalent in coverage to a college term of 13 weeks, Digital Troubleshooting is presented in color on 14 videocassettes having a total running time of 5 hours and 31 minutes. The lab demonstrations shown in video are from the workbook included with the series. Also included is a 180 page text and a study guide.

There is ample use of reinforcement in the presentation and in the self-scoring quizzes at the end of most of the modules.

**Tapes 1-14 time: 5 hours, 31 minutes**

#### Stock No:

90420A	½" VHS(SP)	NTSC
90420B	½" BETA I	NTSC
90420D	¾" UMATIC	NTSC
90420C	½" VHS(SP)	PAL
90420E	½" BETA	PAL
90420F	¾" UMATIC	PAL

Lab experiments are used to reinforce learning. They require access to a digital experimenter's kit such as the HP5035T Logic Lab (not included with series).

#### Understanding Microprocessors

Developed to train HP technicians, this course provides a practical introduction to microprocessor systems.



Microprocessors are now found in the most familiar places: automobiles, kitchen appliances, toys, and home entertainment devices, as well as in modern electronic instruments. All electronic technicians must soon be able to trouble-shoot and repair this type of equipment.

Understanding Microprocessors consists of 5 videocassette lessons in color, a textbook/experiment book, and a study guide. Each lesson concludes with a self-scoring quiz. The HP 5036A Microprocessor Lab (not included) is recommended for performing assigned experiments. The lessons are aimed at technicians who already are able to trouble-shoot and repair equipment using digital circuitry. After completing this module, they should be ready for more advanced microprocessor trouble-shooting modules.

**Tapes 1-5, time: 2 hours, 46 minutes**

**Stock No:**

90301RA	1/2" VHS(SP)	NTSC
90301RB	1/2" BETA I	NTSC
90301RD	3/4" UMATIC	NTSC
90301RC	1/2" VHS(SP)	PAL
90301RE	1/2" BETA	PAL
90301RF	3/4" UMATIC	PAL

## What Is a Microprocessor?

### Lesson 1

This first lesson reviews the history of computers and microprocessor systems and provides an overview of the microprocessor video series. Microprocessors are graphically demonstrated along with the elements of microprocessor systems. Lesson 1 concludes with a summary and a short self-scoring quiz.

**Time: 17 minutes**

**Stock No:**

90302RA	1/2" VHS(SP)	NTSC
90302RB	1/2" BETA I	NTSC
90302RD	3/4" UMATIC	NTSC
90302RC	1/2" VHS(SP)	PAL
90302RE	1/2" BETA	PAL
90302RF	3/4" UMATIC	PAL

## Analog vs Digital Systems

### Lesson 2

The difference between analog and digital systems is never more apparent than when studying microprocessor systems. This program clearly describes these differences and goes on to explain the three-state bus concept, talkers, and listeners, and bus trouble-shooting techniques.

**Time: 40 minutes**

**Stock No:**

90303RA	1/2" VHS (SP)	NTSC
90303RB	1/2" BETA I	NTSC
90303RD	3/4" UMATIC	NTSC
90303RC	1/2" VHS (SP)	PAL
90303RE	1/2" BETA	PAL
90303RF	3/4" UMATIC	PAL

## Introduction to Programming

### Lesson 3

This brief review of programming defines a few terms, describes what a program is, why programs are necessary, and how to develop them. The concepts of low and high level programs and a review precede the self-scoring quiz.

**Time: 19 minutes**

**Stock No:**

90304RA	1/2" VHS (SP)	NTSC
---------	---------------	------

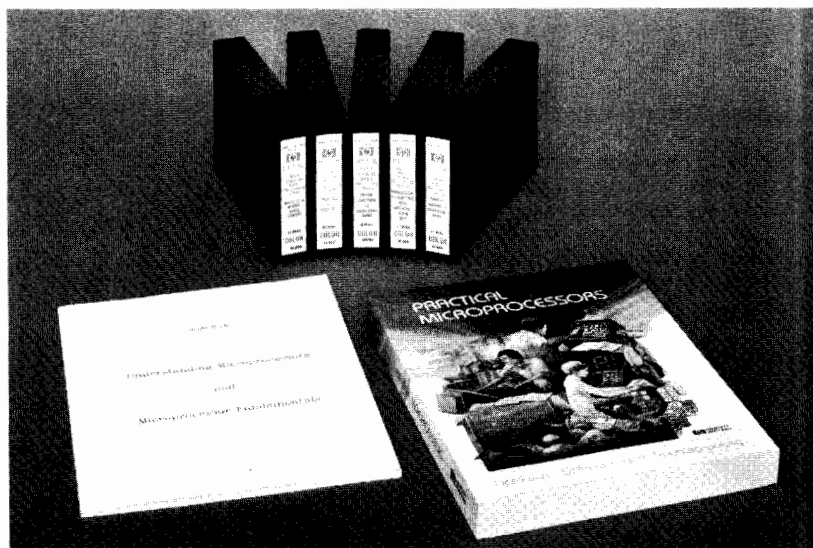

90304RB	1/2" BETA I	NTSC
90304RD	3/4" UMATIC	NTSC
90304RC	1/2" VHS (SP)	PAL
90304RE	1/2" BETA	PAL
90304RF	3/4" UMATIC	PAL

## Processor Registers and Instruction Set

### Lesson 4

This lesson describes the many registers contained on the microprocessor chip, including their uses in the operational sequence: fetch, execute and increment. The instruction set is described briefly to enable the viewer to follow the succeeding lessons.

**Time: 51 minutes**

**Stock No:**

90305RA	1/2" VHS (SP)	NTSC
90305RB	1/2" BETA I	NTSC
90305RD	3/4" UMATIC	NTSC
90305RC	1/2" VHS (SP)	PAL
90305RE	1/2" BETA	PAL
90305RF	3/4" UMATIC	PAL

## Simple Assembly Programming

### Lesson 5

Using the knowledge of the instruction set, the viewer is led through simple examples of assembly language programs. Translating the assembly language into machine language is shown, as well as how the program is stored in memory and executed by the processor. A program review precedes the self-scoring quiz.

**Time: 40 minutes**

**Stock No:**

90306RA	1/2" VHS (SP)	NTSC
90306RB	1/2" BETA I	NTSC
90306RD	3/4" UMATIC	NTSC
90306RC	1/2" VHS (SP)	PAL
90306RE	1/2" BETA	PAL
90306RF	3/4" UMATIC	PAL

**Stock**

No.	Books
05036-	Practical Microprocessors
90003	Textbook/Lab Workbook
90301RG	Understanding Microprocessors Study Guide

## Microprocessor Fundamentals

Microprocessor Fundamentals is the second module in the Microprocessor Trouble-shooting Series. It consists of 11 videocassette lessons and includes 1 copy of Practical Microprocessors (textbook/experiment book) 05036-90003, and a study guide.

**Tapes 1-11, Time 3 hours, 29 minutes**

**Stock No:**

90307RA	1/2" VHS (SP)	NTSC
90307RB	1/2" BETA I	NTSC
90307RD	3/4" UMATIC	NTSC
90307RC	1/2" VHS (SP)	PAL
90307RE	1/2" BETA	PAL
90307RF	3/4" UMATIC	PAL

## Algorithmic State Machines

This first lesson of Microprocessor Fundamentals describes algorithmic state machines as they appear around us. As the complexity of each succeeding algorithmic state machine is increased the program relates this complexity to the instruction decoder of a microprocessor. A self-scoring quiz completes the lesson.

**Time: 36 minutes**

**Stock No:**

90308RA	1/2" VHS (SP)	NTSC
90308RB	1/2" BETA I	NTSC
90308RD	3/4" UMATIC	NTSC
90308RC	1/2" VHS (SP)	PAL
90308RE	1/2" BETA	PAL
90308RF	3/4" UMATIC	PAL

## Basic Design and Terminology of Microcomputers

### Lesson 2

This lesson reviews the terms needed to understand microprocessors. Appliance and peripherals are discussed next, giving the student an overview of how microcomputers are used in modern electronics. The short self-scoring quiz gives a thorough review for the student.

**Time: 26 minutes**

**Stock No:**

90309RA	1/2" VHS(SP)	NTSC
90309RB	1/2" BETA I	NTSC
90309RD	3/4" UMATIC	NTSC
90309RC	1/2" VHS (SP)	PAL
90309RE	1/2" BETA	PAL
90309RF	3/4" UMATIC	PAL

# TRAINING/VIDEO TAPES

## Technical Training (cont.)

### Microprocessor Internal Hardware Lesson 3

This videocassette reviews the three main sections of the 8085 Microprocessor, with emphasis on the flag register. It then describes the multiplexed address and data pins. A self-scoring quiz at the end of the program tests viewer retention.

- Time: 29 minutes**  
**Stock No:**  
 90310RA 1/2" VHS (SP) NTSC  
 90310RB 1/2" BETA I NTSC  
 90310RD 3/4" UMATIC NTSC  
 90310RC 1/2" VHS (SP) PAL  
 90310RE 1/2" BETA PAL  
 90310RF 3/4" UMATIC PAL

### Stack Pointer Lesson 4

This videocassette continues the description of the internal registers of the Intel 8085 Microprocessor. The stack pointer is programmed to keep track of a storage area in read/write memory where the contents of these internal registers may be stored. A self-scoring quiz completes this program.

- Time: 18 minutes**  
**Stock No:**  
 90311RA 1/2" VHS (SP) NTSC  
 90311RB 1/2" BETA I NTSC  
 90311RD 3/4" UMATIC NTSC  
 90311RC 1/2" VHS (SP) PAL  
 90311RE 1/2" BETA PAL  
 90311RF 3/4" UMATIC PAL

### Timing Cycles Lesson 5

This videocassette describes the 8085 Microprocessor timing cycles. The "T" or time cycles, "M" or machine cycles, and instructions are correlated so that the viewer has a thorough understanding of this complex subject. A self-scoring quiz completes the program.

- Time: 18 minutes**  
**Stock No:**  
 90312RA 1/2" VHS (SP) NTSC  
 90312RB 1/2" BETA I NTSC  
 90312RD 3/4" UMATIC NTSC  
 90312RC 1/2" VHS (SP) PAL  
 90312RE 1/2" BETA PAL  
 90312RF 3/4" UMATIC PAL

### Status Signals Lesson 6

This videocassette describes five status and strobe signals appearing at the pins of the Intel 8085 Microprocessor. These signals can be used to trouble-shoot a microprocessor system. A self-scoring quiz allows viewer interaction with the program.

- Time: 23 minutes**  
**Stock No:**  
 90313RA 1/2" VHS (SP) NTSC  
 90313RB 1/2" BETA I NTSC  
 90313RD 3/4" UMATIC NTSC  
 90313RC 1/2" VHS (SP) PAL  
 90313RE 1/2" BETA PAL  
 90313RF 3/4" UMATIC PAL



### DMA and Handshaking Lesson 7

This videocassette describes how modern computer systems may input and output data using a technique called Direct Memory Access or DMA. In some systems handshaking is used to allow the microprocessor and a peripheral device to communicate during the DMA process. A self-scoring quiz allows a check of the viewer's retention.

- Time: 22 minutes**  
**Stock No:**  
 90314RA 1/2" VHS (SP) NTSC  
 90314RB 1/2" BETA I NTSC  
 90314RD 3/4" UMATIC NTSC  
 90314RC 1/2" VHS (SP) PAL  
 90314RE 1/2" BETA PAL  
 90314RF 3/4" UMATIC PAL

### Principles of Interrupts Lesson 8

Microprocessors can be much more efficient when interrupts are used correctly. This program discusses the hardware interrupt system designed into the Intel 8085 Microprocessor. A self-scoring quiz completes the lesson.

- Time: 21 minutes**  
**Stock No:**  
 90315RA 1/2" VHS (SP) NTSC  
 90315RB 1/2" BETA I NTSC  
 90315RD 3/4" UMATIC NTSC  
 90315RC 1/2" VHS (SP) PAL  
 90315RE 1/2" BETA PAL  
 90315RF 3/4" UMATIC PAL

### Using Interrupts Lesson 9

This program continues the description of the hardware interrupt system of the Intel

8085 Microprocessor and compares it to the software interrupt commands. A method of extending the external interrupts to as many as 64 is revealed. The self-scoring quiz completes the lesson.

- Time: 25 minutes**  
**Stock No:**  
 90316RA 1/2" VHS (SP) NTSC  
 90316RB 1/2" BETA I NTSC  
 90316RD 3/4" UMATIC NTSC  
 90316RC 1/2" VHS (SP) PAL  
 90316RE 1/2" BETA PAL  
 90316RF 3/4" UMATIC PAL

### Microprocessor Support Chips Lesson 10

Microprocessors need other circuits to function as a computer. These circuits: ROMs, RAMs, Decoders, and Ports are discussed in this program. How these devices are selected with the address bus is clearly explained. A quiz verifies the viewer's understanding of this important material.

- Time: 22 minutes**  
**Stock No:**  
 90317RA 1/2" VHS (SP) NTSC  
 90317RB 1/2" BETA I NTSC  
 90317RD 3/4" UMATIC NTSC  
 90317RC 1/2" VHS (SP) PAL  
 90317RE 1/2" BETA PAL  
 90317RF 3/4" UMATIC PAL

### Keyboards and Displays Lesson 11

Communicating with a microcomputer system usually is done with a keyboard and display system. How these systems are implemented using software and hardware is approached in this program. Some hardware failures are shown along with their usual re-



pair methods. The quiz completes this program.

**Time: 16 minutes**

**Stock No:**

90318RA	1/2" VHS (SP)	NTSC
90318RB	1/2" BETA I	NTSC
90318RD	3/4" UMATIC	NTSC
90318RC	1/2" VHS (SP)	PAL
90318RE	1/2" BETA	PAL
90318RF	3/4" UMATIC	PAL

**Stock**

**No: Books**

05036-	Practical Microprocessors
90003	Textbook/Lab Workbook
90301RG	Understanding Microprocessors Study Guide

## Oscilloscopes

### How to Use an Oscilloscope Series

The oscilloscope is one of the most versatile and widely used electronic test instruments. However, for best results it must be used properly. The purpose of this 3 videocassette series is to train electronic technicians in the basic techniques of waveform measurement using an oscilloscope. The HP1740A general purpose scope and the HP1741A storage scope are used in this series. However, the information presented will also help you operate other scopes.

**Tapes 1-3, time: 1 hour, 16 minutes**

**Stock No:**

90741A	1/2" VHS (SP)	NTSC
90741B	1/2" BETA I	NTSC
90741D	3/4" UMATIC	NTSC
90741C	1/2" VHS (SP)	PAL
90741E	1/2" BETA	PAL
90741F	3/4" UMATIC	PAL

### What's a dB?

The decibel is one of the most widely used and misused terms in electronics. Therefore, its meaning must be understood if dB measurements are to be useful. These programs explain the term and give examples to show how it is used.

#### Part 1—Power

Deals with power: power ratio to dB, dB to power ratio, and dBm.

**Time: 21 minutes**

**Stock No:**

90838A	1/2" VHS (SP)	NTSC
90838B	1/2" BETA I	NTSC
90838D	3/4" UMATIC	NTSC
90838C	1/2" VHS (SP)	PAL
90838E	1/2" BETA	PAL
90838F	3/4" UMATIC	PAL

#### Part 2—Voltage

Deals with voltage: voltage ratio to dB, and dB to voltage ratio.

**Time: 15 minutes**

**Stock No:**

90839A	1/2" VHS (SP)	NTSC
90839B	1/2" BETA I	NTSC

90839D	3/4" UMATIC	NTSC
90839C	1/2" VHS (SP)	PAL
90839E	1/2" BETA	PAL
90839F	3/4" UMATIC	PAL

### How to Solder

A poor solder connection can cause electronic equipment to fail. That is why proper soldering is so important. This program will help train new hires in manufacturing and servicing—including those who believe they already know how to solder and unsolder properly.

#### Part 1 (16 minutes) Covers

What is soldering?	Flux
Wetting	Soldering irons
Solder	Tinning

#### Part 2 (19 minutes) Shows

How to clean parts to be soldered  
The four basic soldering steps  
How to recognize a good solder connection  
How to detect a poor solder connection  
How to unsolder, using the vacuum bulb, the solder-sucker, and the desoldering wick.  
The program ends with a summary and a self-scoring quiz.

**Time: 35 minutes**

**Stock No:**

90751A	1/2" VHS (SP)	NTSC
90751B	1/2" BETA I	NTSC
90751D	3/4" UMATIC	NTSC
90751C	1/2" VHS (SP)	PAL
90751E	1/2" BETA	PAL
90751F	3/4" UMATIC	PAL

## Reliability

### Printed Circuit Board Reliability

The purpose of this videocassette is to improve quality and productivity in production. It contains information concerning the reliability of printed circuit boards. 35 MM slides are used to illustrate corrosion, contact, soldering and cleaning problems associated with P.C. boards.

The primary audience is composed of production people, engineers, supervisors, assembly, test and P.C. board production people. It also can be helpful to design engineers and materials engineers.

**Time: 36 minutes**

**Stock No:**

90660RA	1/2" VHS (SP)	NTSC
90660RB	1/2" BETA I	NTSC
90660RD	3/4" UMATIC	NTSC
90660RC	1/2" VHS (SP)	PAL
90660RE	1/2" BETA	PAL
90660RF	3/4" UMATIC	PAL

### P.C. Contact Reliability

This videocassette discusses contact reliability problems of the Edge Card Connector System. 35 MM slides are used to illustrate corrosion, contaminants, and cleaning methods.

**Time: 25 minutes**

**Stock No:**

90661RA	1/2" VHS (SP)	NTSC
---------	---------------	------

90661RB	1/2" BETA I	NTSC
90661RD	3/4" UMATIC	NTSC
90661RC	1/2" VHS (SP)	PAL
90661RE	1/2" BETA	PAL
90661RF	3/4" UMATIC	PAL

### Analysis of Multi-Layer Ceramic Capacitors

This videocassette discusses multi-layer ceramic capacitor construction, types of defects, and failure analysis using cross-sectioning techniques.

**Time: 27 minutes**

**Stock No:**

90662RA	1/2" VHS (SP)	NTSC
90662RB	1/2" BETA I	NTSC
90662RD	3/4" UMATIC	NTSC
90662RC	1/2" VHS (SP)	PAL
90662RE	1/2" BETA	PAL
90662RF	3/4" UMATIC	PAL

### Static Zap Makes Scrap

The purpose of this cassette is to raise awareness of static damage hazards to electronic components and to provide training for all employees who handle electronic equipment; also, to demonstrate correct procedures.

The topic of this program is static electricity, and the prevention of static "zaps" (damage) which can cause failures in electronic equipment. Static-safe work stations and protective packaging are described, and their use is demonstrated. This program is intended to be a training aid for personnel in electronic manufacturing, test and service facilities.

**Time: 30 minutes**

**Stock No:**

90383RA	1/2" VHS (SP)	NTSC
90383RB	1/2" BETA I	NTSC
90383RD	3/4" UMATIC	NTSC
90383RC	1/2" VHS (SP)	PAL
90383RE	1/2" BETA	PAL
90383RF	3/4" UMATIC	PAL

### Ordering Information

To order video programs, books, the HP 5035T Logic Lab or the 5036A Microprocessor Lab, please contact your local Hewlett-Packard sales office. Addresses are listed on pages 695-704.

Local taxes, shipping and handling will be added to all orders.

Videocassette formats in the NTSC standard are identified by an alpha suffix: "A" is for VHS(SP), "B" is for BETA I, and "D" is for U-matic. In the PAL standard "C" is for VHS(SP), "E" is for BETA and "F" is for U-matic.

### To Get a Videotape Catalog

The 1984 edition of the HP Videotape Catalog, *A Better Way to Learn* (5952-0190) can be obtained from your local HP sales office or by writing to Inquiries Manager, Hewlett-Packard Company, 1820 Embarcadero Road, Palo Alto, CA 94303.





# PUBLICATIONS

## Free Aids to Selecting, Using & Maintaining HP Products

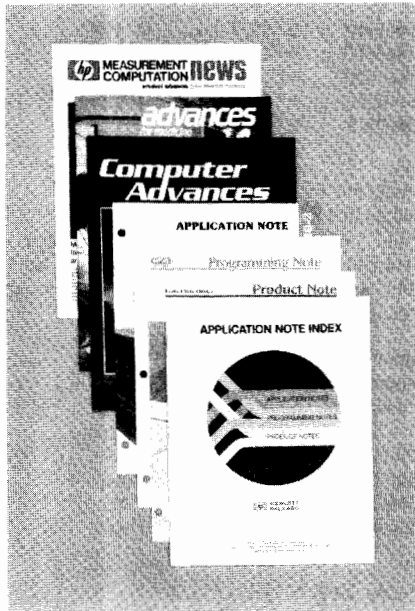

HP offers a variety of no-charge publications to help you choose the HP products that best fill your needs, to help you benefit from applications knowledge acquired by users inside and outside of HP, and to help you maintain your HP products. These publications range from new-product announcements, catalogs, product family brochures, and single-product technical data through application notes, product notes, and programming aids to service notes and general maintenance periodicals. Since the number and types of publications vary with product type, an outline of available publications organized by product type is provided below for your convenience.

### Instruments and Systems

#### Product Information

Measurement/Computation News

Data Sheets and Brochures

Catalogs

DC Power Supplies

Recorder Supplies

Coaxial & Waveguide Measurement

Accessories

Digital IC Tester Program

HP Journal

#### Application Information

Application Notes

Product Notes

Programming Notes

#### Service Information

Service Notes

Bench Briefs

### Computers, Peripherals & Calculators

#### Product Information

Computer Advances

Measurement/Computation News

Data Sheets & Brochures

Catalogs

Computer Supplies Catalog

HP Journal

### Application Information

Application Notes

Application Briefs

### Medical

#### Product Information

Advances for Medicine

Data Sheets & Brochures

HP Journal

#### Application Information

Application Notes

### Analytical

#### Product Information

Data Sheets & Brochures

HP Journal

#### Application Information

Application Notes

### Components

#### Product Information

Catalogs

Diode and Transistor Designer's Catalog

Optoelectronics Designer's Catalog

Microwave Integrated Products

Data Sheets

HP Journal

#### Application Information

Application Notes

Application Bulletins

### Measurement/Computation News

Six times a year M/C News brings you announcements of HP's latest electronic measuring instruments and their accessories; personal, desktop, and larger computers, their software, peripherals, and accessories; opto-electronic and semiconductor components; and new no-charge literature such as catalogs and application notes.

### Computer Advances

Every two months you get a free, colorful magazine on new HP business, engineering, and personal computers; peripherals; software and services. Computer Advances also gives you up-to-date information on local seminars, open houses, and training classes.

### Advances for Medicine

Advances for Medicine is a quarterly magazine that presents articles demonstrating the contributions of HP medical products to medical productivity, quality patient care, and efficient healthcare management.

### Application Briefs, Bulletins, and Notes

These aids to solving your measurement, computation, and design problems offer the benefit of the applications research and experience of both HP customers and HP engineers. Some are tutorial, others describe how-to procedures.

### Product Notes

Product Notes augment the Operating and Service Manuals supplied with HP electronic instruments by providing information on various topics that include specifications and characteristics, operation and use, applications and performance.

### Programming Notes

Programming Notes provide product-specific information on the use and operation of instruments in HP-IB systems. Some notes address the needs of inexperienced users and cover basic operation of an HP-IB instrument using a specific HP desktop computer. Others address the needs of experienced users.

### Application Note Index

Revised annually, the AN index lists and describes the contents of all Application Notes, Programming Notes, and Product Notes on electronic instruments, instrument systems, and solid-state components.

### Hewlett-Packard Journal

Published monthly to communicate technical information from the laboratories of HP to all of the fields served by HP, the Journal contains descriptions of current hardware and software products as well as more general information such as advances in technology.

### Service Notes

Service Notes contain product-specific service information for HP's electronic instruments. Subjects include product improvements, modifications, and procedures for troubleshooting, maintenance, and repair. Service Notes are published as appropriate throughout the life of a product. All new Notes are announced in Bench Briefs.

### Bench Briefs

Bench Briefs provides those who maintain HP instruments with timely information that has both specific and general application. Subjects include troubleshooting tips and descriptions of new technologies, components, tools, and equipment. Also, new Service Notes are listed in Bench Briefs as they become available.

### How to Obtain No-charge Publications

To obtain any of the publications described on this page, contact your nearest Hewlett-Packard office. Locations of HP offices are listed on the back pages of this catalog.

HP offices are also your best source of current information on the topics covered by Application Briefs, Application Bulletins, Application Notes, Product Notes, and Programming Notes.

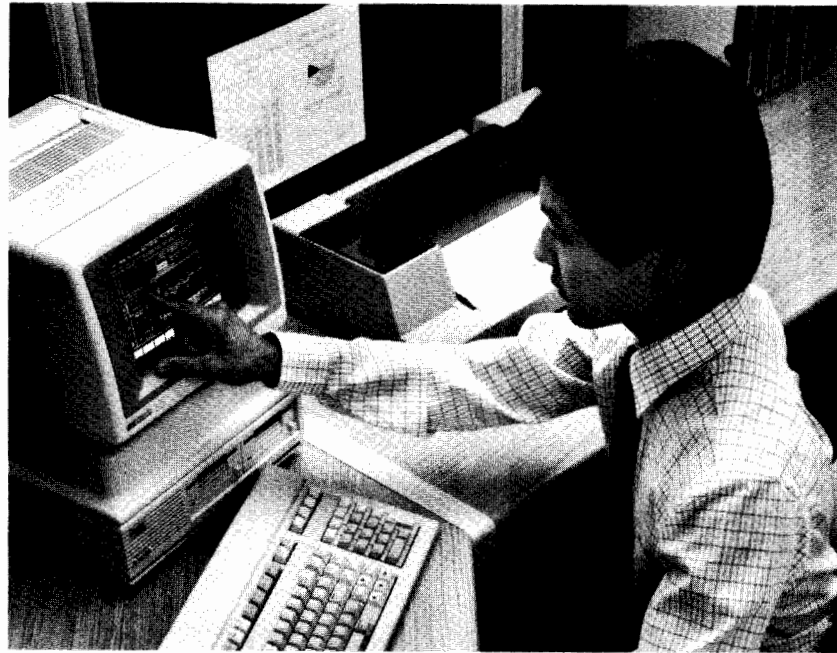

### Introduction to Computers

Hewlett-Packard computers are the heart of many computer-aided test, data acquisition, computer-aided engineering and process control systems. Our computers feature more than 2000 software solutions and are backed by complete service and support—judged best in the industry by independent researchers. HP computers and instruments provide an integrated, single-vendor solution to a wide variety of measurement and computation problems.

HP computers were first developed to meet a growing need for sophisticated automatic test systems in industry. In the nearly 20 years since the first HP computer was introduced, we've expanded our product line to include innovative personal computers for professionals, business and office systems, and advanced processors for measurement and computation.

HP computers are designed for technical and business professionals who demand more of a computer than data processing. Technically advanced HP computers are resistant to unfavorable environments. With many applications and programming aids built in, HP computers provide a range of computing power for both novices and sophisticated users.

Office professionals and managers, engineering and scientific professionals, data processing experts and factory automation managers all can find an HP system to fit their needs—as well as one that provides the level of assistance and support they require for a successful implementation.

Personal computers like the Touchscreen and Touchscreen MAX offer new users an easy introduction to computers—simply touching the screen gives you control of the system. Expert assistance for personal computer users is just a toll-free phone call away.

Advanced engineering workstations such as the HP 9000 computer offer the experienced engineer a powerful individual workstation that can be programmed to help solve time-consuming design problems.

Convenient software and easy-to-read displays make writing reports and memos, preparing spreadsheets and developing graphics quick and easy.

Graphics devices like printers and plotters improve the technical professional's ability to communicate the results of analysis quickly and clearly.

Fast real-time processors with special programming languages speed the task of data acquisition and control.

The complete range of HP computers is summarized in the table on pages 40 and 41, along with a description of the key programming languages, operation systems and features of the systems.

### Computer Aided Test

The control of IEEE-488 based measurement systems continues to be a major focus of HP computers. We offer the widest range of computers specifically designed with this application in mind. Add to that over 200 "designed for systems" instruments and HP can offer you an unequalled range of single vendor electronic test solutions.

Having the widest range of hardware isn't the whole answer. Support is the other half of your measurement solution. At HP, we can support you at every step of the design, implementation and operation of your measurement system. We provide complete and easy to understand documentation; system engineering support; on-site service; pre-written software; and training all based on over 15 years of experience in computer aided testing.

### Applications Solutions for Industry Data Acquisition and Control

HP computers and instruments combine to monitor and control production operations, processes and experiments. Many analog and digital inputs and outputs can be controlled by HP computers with a maximum of flexibility and a minimum of difficulty.

Because HP computers and instruments are compatible, designing systems for specific applications can be greatly simplified. Ready-to-run software helps alleviate much of the burden of program development, while tailored programming languages help the programmer who needs a custom design. Plug-in hardware modules simplify the task of system design and interconnection.

With the wide choice of computers from HP you can choose the right data acquisition system to fit your application. Our handheld computers provide portable power for data acquisition in the field, while desktop systems offer convenience for test-bench or lab applications. Larger systems can be designed for industrial applications.

Using one of HP's advanced computers as the heart of the system makes it easy to change the system as your needs change. Additional instruments, peripherals or connections can be added affordably, with quick installation to ensure fast application start-up.

Whether you obtain data from automatic test systems, control the performance of heavy machinery or monitor process flow, HP can help you develop the system that does what you want it to do.

Continued on page 42.



# COMPUTERS, PERIPHERALS & CALCULATORS

This chart briefly summarizes HP's wide range of computer products. We make everything from handheld calculators to engineer-

ing workstations to mainframe computers for manufacturing applications as well as a variety of peripherals such as printers, plotters

and data communications devices.

Most of the personal and desktop computers and all of the HP 1000 models are

	HP Computer Products	Applications		Operating System	Language	Display	Memory
		Focus	Software				
PERSONAL	The PORTABLE	portable personal computer	Built-in: 1-2-3™ from Lotus™, MemoMaker, terminal emulation, Personal Applications Manager (P.A.M.)  Optional: See pages 48/49/50/51	MS™ - DOS version 2.11	See optional software section on pages 48/49/50/51	16-line by 80-character LCD	384K CMOS ROM; 272K CMOS Continuous Static RAM
	Touchscreen Personal Computer Touchscreen MAX	personal computers	See pages 48/49/50/51	MS™ - DOS 2.0, Personal Applications Manager (P.A.M.)	See software section on pages 48/49/50/51	9-inch monitor, 512 x 390 high-resolution display	Standard 256K RAM memory expandable to 640K
	HP-85B	personal/technical/analysis/instrument control	See p. 54	ROM 56K	BASIC, Assembly	5" diagonal built-in	32 Kb
	HP-86B			standard ROM 56K; opt. CP/M*, opt. UCSD p-System	BASIC, Assembly, Pascal, FORTRAN 77	9" or 12" monitor	128-640Kb
	HP-41CV/41CX	science, business engineering		proprietary	RPN	12-character LCD alphanumeric	2.23 to 6.43 Kb/3.10 to 6.43 Kb
	HP-71B	science, business, engineering	FORTH/Assembler math, AC steady state circuit analysis, finance, surveying, curve fitting, text editor, games, utilities, software development utility	ROM BASIC 64Kb	BASIC (FORTH/Assembly optional)	22-character LCD, 96-character line, alphanumeric	17.5K-33.5K RAM; 16K-256K ROM; or combination
	HP-75D	portable personal for business, science, engineering	VisiCalc*, math, text formatter, surveying, data communications, graphics	ROM 48 Kb (CMOS Series 80 CPU)	BASIC	32-character LCD, 96-character line, alphanumeric	16 Kb-24 Kb RAM 96 Kb ROM
SCIENTIFIC	HP 9000 HP 9816 Model 216	high performance personal/technical analysis	Context MBA*, graphics presentations, statistics, terminal emulation, general business and technical	ROM- or RAM-based, proprietary, single user; opt. CP/M-68K*	BASIC, HPL, Pascal	CRT	128 Kb-2 Mb
	HP 9817 Model 217	engineering/controller	project management; graphics, statistics	RAM-based, proprietary, single user	BASIC, Pascal	remote, 14" green phosphor CRT	256Kb-4Mb
	HP 9826 Model 226	computer-aided test, instrument control	statistics, engineering design/analysis, VisiCalc*	ROM- or RAM-based, proprietary, single user, multi-user HP-UX	BASIC, HPL, Pascal	CRT	12Kb-7Mb
	HP 9836 Model 236	computer-aided engineering, graphics, ME					
	HP 9837 Model 237	computer-aided design, computation	project management; graphics, statistics	RAM-based, proprietary, single user	BASIC, Pascal	remote, 17" CRT	512Kb-7Mb
	HP 9920 Model 220	computer-aided test, engineering	graphics presentations, statistics, terminal emulation, general business and technical	ROM- or RAM-based, proprietary, single user, multi-user HP-UX	BASIC, Pascal, HPL	remote CRT	128Kb-7Mb
	HP 9020 Model 520	engineering workstations, stand-alone computation	data base mgt., graphics, datacomm, mech. design, EE	BASIC or HP-UX	BASIC, C, Pascal, FORTRAN	12" CRT B/W or color	512Kb-5Mb
	HP 9030 Model 530	engineering workstations, OEM, instrument control	data base mgt., graphics, mech. design, electrical engineering, software development	HP-UX	Pascal, C, FORTRAN	HP terminals	
	HP 9040 Model 540	single or multi-user workstation systems, OEM					
REAL TIME	HP 1000 Computer Microsystems	computer-aided manufacturing, real-time, space sensitive applications	data base management, graphics, datacom, process monitoring and control, quality management	multi-user, multi-tasking, real-time	FORTRAN 77, Pascal, BASIC, Assembler	CRT	512Kb-6Mb
	HP 1000 Real-Time Computer Systems	computer-aided manufacturing, real-time, general purpose OEM					512Kb-24Mb
BUSINESS	HP 250 Models 26, 30, 40, 50	small business, departments of large companies	OEM provided	basic operating system	BASIC/250	HP 2622D workstation	256-896Kb (64Kb user partitions)
	HP 3000 Family Series 37, Series 39, Series 42, Series 48, Series 68	Business/commercial minicomputers ranging in size from a distributed mainframe to a workgroup computer	Database Office - text/graphics/productivity, Financial Programmer Productivity Data Communications Material Production Management 3rd Party Solutions	MPE-V - multi-user, multi-tasking, multi-programming	FORTRAN, BASIC, Pascal, Cobol II, RPG, SPL, Transact	All HP terminals and personal computers	512 Kb to 8 Mb

VisiCalc\* is a U.S. registered trademark of VisiCorp.

UCSD p-System is a trademark of The Regents of the University of California.

Context MBA is a trademark of Context Management Systems.

CP/M-68K is a trademark of Digital Research, Inc.



HP-IB compatible. Use this chart to locate the type of computer you are interested in, and then turn to the page with complete in-

formation on that product.

If you have more questions about a computer or its usefulness for your application,

please call the local Hewlett-Packard Sales and Service Office listed in the telephone directory white pages or see page 695. Ask for the computer department.

HP Mass Storage	Interface Options	I/O Slots	Datacom	Graphics	HP Printers	For more info. see page
Built-in 176K electronic disc. 9114A double-sided, 3 1/2" 710K capacity, battery-powered microfloppy disc drive.	RS-232 (standard) HP-IL (standard)	-----	300-baud direct connect modem (standard). Portable-Desktop Link (optional)	Two-pen, 7470A with HP-IL interface or RS-232 interface; six-pen 7475A with RS-232 interface	ThinkJet with HP-IL interface (HP 2225B), dot-matrix 82905 with HP-IL interface, dot-matrix 2932A or 2934A with RS-232 interface, daisy-wheel 2601A or 2602A with RS-232 interface	46
(Touchscreen) — two 3 1/2 inch floppy disc drives with 710K formatted mass storage. (Touchscreen MAX) — 15 Mb (formatted capacity) hard disc and one 710K (formatted capacity) 3 1/2 inch microfloppy disc drive.	HP-IL, Centronics	Two accessory board slots available	Standard: HP-IB, RS-232/RS-422, RS-232; Optional: IBM 3278, 3Com Local Area Network	Two-pen 7470A with RS-232C or HP-IB interface; six-pen 7475A with RS-232C or HP-IB interface	Integral Thermal (2674A) printer, ThinkJet with HP-IB interface (2225A) or HP-IL interface (2225B) or Centronics interface (2225C), LaserJet with RS-232, daisy-wheel serial (2602A), dot-matrix (82906A).	44
3 1/2" floppies and Winchester drives	HP-IB, HP-IL, HP-IL/HP-IB, Serial (RS-232C), GPIO, BCD, parallel printer, data link	4	modem, datacom software pac, professional communications pac  modem, datacom software pac, TERM/80 and COM/80 terminal emulation systems, professional communications pac	7470A, 7475A, 7550A, 7580B, 7585B, 7586B, 9111A graphics tablet	82905B, 89206A, 2601A, 2602A, 2670 series, 2390 series, ThinkJet personal printer	52
memory and extension modules, 82161A cassette	HP-IL, HP-IB, RS-232C, Series 80, Video	4	82168A modem, extended I/O module	7470A	82143A, 82162A, 2225B, 82905B, 2671A/G	64
82400A mag card reader, 82420A memory module, 82161A cassette drive	HP-IL, HP-IB, RS-232C, Series 80, Video	1 (up to 30 peripherals)	82168A modem	7470A	82162A, 82905B, 2671A/G, 225B	68
built-in mag card reader, 82700A memory module, 82161A cassette drive	Digital bar code built-in, HP-IL built-in, HP-IB RS-232C, Series 80, Video	1 (up to 30 peripherals)	82718A expansion pod, 82168A modem, datacom software pac, I/O Utilities Solutions Book, I/O ROM	7470A	2225B, 82162A, 82905B, 2671A/G	68
flexible or hard discs	HP-IB, Serial, BCD, 16-bit parallel, datacom, color video	1	async, data link, shared resource management, terminal emulation	7580B, 7585B, 7470A, 7475A, 7530A, 9872T, 9111A graphics tablet	2602A, 2631G, 2671B/G, 2673G, 9876A, 2932A	74, 75
external flex and hard discs, EPROM, bubble	HP-IB, Serial HP-HIL, datacom	6	SRM			
flexible or hard discs	HP-IB, Serial, BCD, 16-bit parallel, datacom, color video	4	async, data link, shared resource management, terminal emulation			
external flex and hard discs, EPROM, bubble	HP-IB, Serial, HP-HIL, datacom, BCD, 16-bit parallel	16	SRM			
disc, EPROM, bubble memory	HP-IB, Serial, BCD, 16-bit parallel	7	async, data link	7580B, 7585B, 7470A, 9872T, 9111A	2602A, 2631G, 2671B/G, 2673G, 9876A, 2932A	
integrated flex/hard disc plus external flex and hard discs	HP-IB, 16-bit parallel, RS-232C, 8-channel multiplex, color video	4	async, RJE, Local Area Network, SRM	7470A, 7475A, 7580B, 7585B, 9111A	2608S, 2631B/G, 2563A, 2601A, 2602A, 2688A, 2703A	76 77
7908P, 7912P, 7914P, 7933H, 7935H, 82901M, 82902M, 9895A, 7971A, 9885M/S		7	async, RJE, Local Area Network			
CTU, hard disc, floppy, mag tape	Serial, 8-channel multiplex, HP-IB, multipoint, 8/16-bit duplex	7-10  13	async, bisync, HDLC, DSN, LAP-B(X.25), RJE	7470A, 7475A, 7550A, 7580B, 7585B, 7586B, 9111A graphics tablet	82905B, 2563A, 2671A/G, 2673A, 2932A, 2933A, 2934A	80
14.7Mb to 256 Mb	RS-232C HP-IB Current Loop	10 RS-232C and HP-IB Channels	DSN/DS, DSN/RJE, Network/250 LK 3000	7470A, 7220C/T, 7221C/T	2601/2, 293X, 2563A, 2687A	99
Disc drives - 28 Mb to 404 Mb 1/2" tape drives - 800/1600 cpi and 1600/6250 cpi 1/4" cartridge tape drive	HP-IB, RS-232, RS-422, CCITT/V.24, CCITT/V.35	1 to 48	Sync, Async, BSC, SDLC, HDLC, X.25, X.21, IBM 3270, IBM 2780/3780, MTS, IMF, DS, RJE, MRJE, NRJE, Satellite	7220, 7221, 7225, 7240, 7245, 7470, 7475, 7550, 7580, 7585, 9872	Serial, System, Line, Character, Laser—2563A, 2601A, 2602A, 2608A, 2631B, 2617A, 2619A, 2680A, 2687A, 2688A, 2932A, 2933A, 2934A	99

MS™ - DOS is a U.S. trademark of Microsoft, Inc.

1-2-3™ and Lotus™ are U.S. trademarks of Lotus Development Corp.

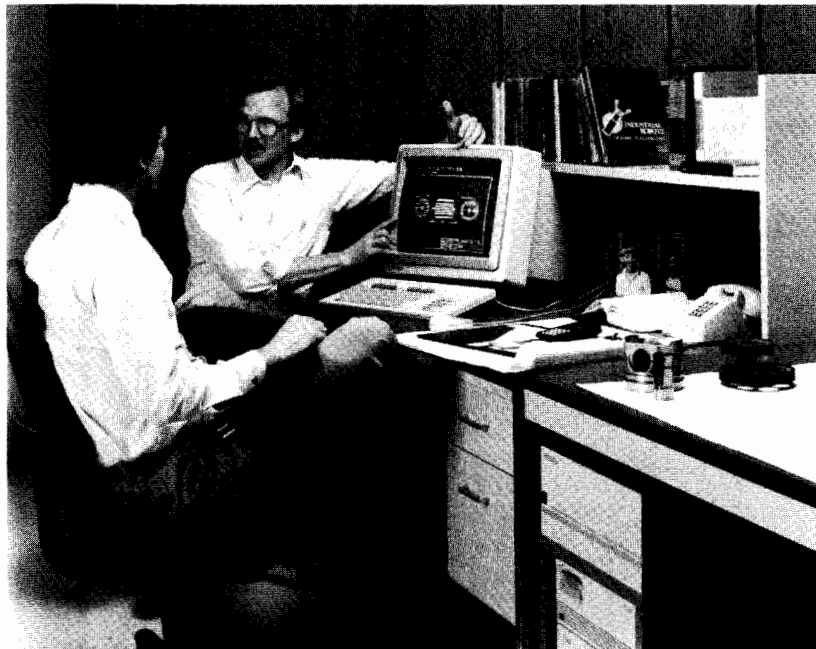

### Computer-Aided Engineering

HP engineering workstations are the choice of professional engineers who need quick solutions to design, simulation, modeling and test problems. HP's current products are the direct result of our own experience in laboratories, test and design areas throughout the world.

Our philosophy has been to develop the design tools that engineers need to perform their jobs with maximum productivity.

Providing engineering professionals with their own powerful computers, either singly or in networks, means the typical engineering cycle can be shortened considerably. Drafting, design and layout, modeling and test all can be expedited with HP computers. In addition, much of the engineering report-writing and routine tasks can be made easier and less tedious with computers.

HP's engineering workstations cover the full range of technical applications, from core engineering tasks through document preparation and information management. Local area networks link computers within engineering groups and allow you to share or add peripherals such as printers, plotters or other output devices.

There are over 200 software packages available through HP and the HP PLUS program for computer-aided engineering. These include finite element modeling, circuit analysis and simulation, as well as engineering management, statistics and numerical control.

### Manufacturing

Our ability to combine measurement and computation is particularly relevant to manufacturing. Applications where HP technologies and products are most widely used include operational planning and control

tasks such as Manufacturing Resource Planning (MRP), computer-aided testing, machine monitoring and control, process control, maintenance management, production control, quality management and factory automation.

Because we're a manufacturing company, we make extensive use of computer-based systems in our own operations. Many of these systems, after we've proven them in manufacturing, often are then made available as products. This lets our customers make similar achievements in productivity, profits and asset management.

While many of our products are complete manufacturing application solutions, technically knowledgeable customers — working with HP — can take advantage of various combinations of computers, instruments, software, documentation and systems consulting and support. This means that customers can quickly arrive at a solution at a lower cost than turnkey systems.

### Networking

Networking capabilities provide the links between computers, instruments and other devices in the Manufacturer's Productivity Network (MPN), a strategic blueprint that can help improve productivity and product. With MPN, your choice of products — controllers, computer systems, measurement and test instrumentation, applications software and communications products — can be linked together to fit many manufacturing applications. You can begin with a single HP solution and, one step at a time, add others to build a plant-wide computer-integrated manufacturing network.

The links in MPN are made through HP AdvanceNet, our name for our overall range of networking products.

HP AdvanceNet delivers efficient data communications, along with data and resource management, personal computer networking and system-to-system networking — for true multi-vendor solutions. These capabilities provide users with fast and effective communications, which can improve the productivity of programmers and users alike.

HP has been among the leaders in the development of industry-wide standards in the networking and communications area. HP computers, instruments, peripherals and other computers are linked today through implementation of ISO, IEEE and de facto industry standards.

HP is a participant in standards-setting activities within the computer industry as well as with other industries. This commitment to industry-wide standards helps ensure that your HP equipment is provided with the most effective means of connection to other systems.

HP computers provide a complete set of application solutions, innovative products, communications links and service and support for the technical computer user. The following section of the catalog provides in-depth information and specifications for these computer products.



### Meeting Your Management Needs

Hewlett-Packard's Touchscreen Personal Computer and Touchscreen MAX are designed to meet the needs of engineering and business professionals by helping them to manage their work through the use of personally developed programs and industry standard decision-making, information management, and data presentation tools.

The HP Touchscreen and Touchscreen MAX provide the processing power and memory space necessary to execute your applications, while maintaining a small and attractive system package. The base system is compatible with the HP 2623 block mode graphics terminal; and with a disc drive and Microsoft's MS-DOS 2.0 operating system, the system becomes a powerful personal computer. The following features are standard:

- Intel 8088 Processor
- HP Touch
- Personal Applications Manager (P.A.M.)
- High-resolution Graphics Display
- Low Profile Keyboard
- Flexible Data Communications Features
- Extensive Documentation
- Small Footprint

These and other features are described in the sections below.

### Intel 8088 Processor

The HP Touchscreen and Touchscreen MAX deliver maximum power through the Intel 8088 processor. This is a 16-bit processor with an 8-bit bus that runs at 8 Mz.

### Touchscreen

Unlike any other touch-sensitive display available today, HP Touch is totally integrated into the system. Other touch screens use overlays which distort the display. HP Touch does not interfere, either physically or visually, with the display. HP Touch is accomplished with a series of light emitting diodes (LED's) which are hidden along the vertical and horizontal sides of the display creating a matrix of light beams (14x21 LEDs). The electronics of HP Touch is such that every line and every other character can be accessed (27x40). HP Touch can be turned on and off with a keystroke.

### P.A.M.

The Personal Applications Manager (P.A.M.) is designed to be the primary interface between the user and the MS-DOS 2.0 operating system. P.A.M. is an operating system "shell" that provides a fast and easy-to-use alternative to complicated MS-DOS commands. P.A.M. is designed to work harmoniously with HP Touch to facilitate ease of use. For those desiring to use MS-DOS commands, P.A.M. can be easily bypassed.

### Graphics Display

The HP Touchscreen Personal Computers come standard with a high-resolution graphics capability. The 24-line by 80-column green phosphor display has a resolution of 512 horizontal pixels by 390 vertical pixels giving a 1:1 aspect ratio. Each on-screen character is formed by a 9 x 14-dot character cell. This display size is also compatible with the HP 2623 Graphics Terminal and Tektronix Plot 10 software.

### Keyboard

The low-profile 107-key keyboard has sculptured key-caps and dished home keys and includes full local editing keys (cursor control, display scroll, next page and previous page, and insert and delete keys for both single characters and lines). The keyboard also has a numeric pad which may be used as a graphics key pad for terminal applications, plus 12 function keys, full ASCII code, auto-repeat, and N-key rollover.



Hewlett-Packard's Touchscreen and Touchscreen MAX are ideally suited to engineering management and business applications.

### System Expansion

The HP Touchscreen Personal Computers come with two accessory slots which allow the addition of memory (up to 640K RAM) or an internal modem. In addition, the Touchscreen PC supports a wide variety of Hewlett-Packard printers, plotters, and other peripherals.

### Data Communications

The HP Touchscreen and Touchscreen MAX come standard with one RS-232-C port, one RS-232-C or RS-422 port, and one HP-IB port capable of supporting up to 15 peripherals. Additional data communications capabilities are available: For example, the EtherSeries®/150 local area network from 3Com® allows up to 100 Touchscreen or IBM PCs to be networked. The Etherseries/150 products are distributed and supported by Hewlett-Packard (see page 49).

Other capabilities include IBM 3278 terminal emulation with file transfer, VT100 emulation, and AdvanceLink/PC Monitor which allows file transfer between the Touchscreen and other computer systems including the HP 3000, HP 1000, HP 9000, as well as the IBM PC.

Communications to The PORTABLE is available through the Extended I/O Accessory card with Portable Data Link communication software.

EtherSeries® and 3Com® are U.S. trademarks of 3Com Corporation.





# COMPUTERS, PERIPHERALS & CALCULATORS

## Personal Computers

### Touchscreen & Touchscreen MAX



Touchscreen Personal Computer MAX



Touchscreen Personal Computer

**The Touchscreen Personal Computer and Touchscreen MAX** represent a new standard in personal computer excellence. This excellence will first be apparent in how easy to use and learn these computers are. Combined with sophisticated design and performance, ease of use makes these personal computers ideal all-purpose business tools.

#### Terminal

HP Touchscreen Personal Computers feature a built-in HP 2623A graphics terminal capability, plus the following additional features:

- Tektronix 4014 emulation (a superset of 4010)
- Complex polygonal area-fill—up to 105 vector perimeter
- Rubber-band line
- HP-IB printers supported
- HP Touch (easily controlled via escape sequences from the host system)
- Line drawing and Math character sets
- Transmit-only, "Security" fields are supported
- Data modify tag (improves forms efficiency)
- Edit checks (alpha, numeric, alpha-numeric)
- Fast vector generation (accepts vector escape sequences at 4800 baud without handshake)
- 30 second graphics hard-copy via optional HP 2674A internal printer

#### Documentation

Several levels of documentation and programming information are available for the HP Touchscreen and Touchscreen MAX computers. The following is a list of the advanced user documentation available:

- MS-DOS User's Guide
- Technical Reference Manual
- Programmer's Tools - includes four programming manuals (the Microsoft MS-DOS Operating System User's Guide and Macro-Assembler, the Programmer's Reference Guide, and the iAPX 88 Book) plus a disc with many advanced utilities such as File Compare, EDLIN, EXE2BIN, FIND, LINK, MASM, CREF, LIB, DEBUG, and SORT).

#### Software Solutions

Most of the best-selling software packages now run on the HP Touchscreen and HP Touchscreen MAX, giving you literally hundreds of applications to choose from. Such programs as Lotus 1-2-3™, dBASE II™, PFS®: File and PFS®: Report, and Picture Perfect™ will help you meet

all of your specific needs, from electronic spreadsheets and bookkeeping to data base management, and from word processing to graphics.

In addition, Hewlett-Packard is committed to a comprehensive third-party software development program. This new software is directly aimed at giving you more productivity tools for engineering, scientific, and analytical applications. The 378-page Hewlett-Packard Software Catalog (Summer, 1984) lists these packages in detail.

Programming language support is also provided for the HP Touchscreen systems. Among the high-level languages offered are BASIC, Pascal, and FORTRAN. This level of support also includes the Touchscreen Programmer's Tools, a package that contains an MS-DOS assembler, advanced utilities, and reference manuals to help you develop programs.

#### How to Order your Touchscreen or Touchscreen MAX

For more information on the Touchscreen or Touchscreen MAX, contact your HP sales representative or your local HP personal computer dealer.

**For your nearest dealer, call toll-free: 800-FOR-HPPC**

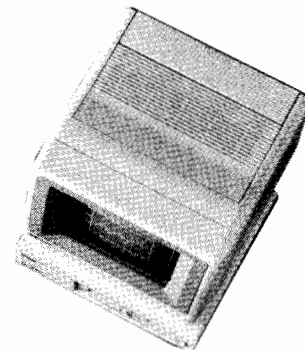

The Touchscreen Personal Computers are compact with a footprint of 150 square inches.

MS™ DOS is a U.S.A. trademark of Microsoft, Inc.





Hewlett-Packard's easy-to-use Personal Card File

#### Specifications

**Microprocessor/CPU:** Intel 8088 running at 8 MHz.

**Memory:** 256K RAM standard.

**Display:** 24-line by 80-column.  
Inverse video, underline, blinking, half-bright, security, and other enhancements.

**Character Set:** Roman 8 line-drawing, math standard, bold and italic, depending on application.  
Total of 896 characters.  
9 x 19-dot character cell.

**Keyboard:**  
Detachable with 8-foot coiled cable.  
Full ASCII code.  
Eight screen-labeled function keys.  
Auto repeat.  
N-key rollover.  
Cursos controls.  
18-key numeric pad.

**Weight:** 27.04 pounds (12.29 kg) including keyboard.

#### Size

**Display/Monitor:** 12 x 12 x 11.3 inches (305 mm x 305 mm x 287 mm).

**Keyboard:** flat: 18 x 8.9 x 1.4 inches (456 mm x 225 mm x 35 mm).  
Standing: 18 x 8.9 x 2.5 inches (456 mm x 225 mm x 63 mm).

#### Ordering Information

**HP 45610B** HP Touchscreen Terminal  
**HP 45650B** The Touchscreen Personal Computer comes with the MS-DOS 2.11 operating system, Personal Applications Manager (P.A.M.), five utility programs, Personal Card File, Winning Deal, MemoMaker, and full documentation. The Touchscreen system includes HP Touch, a 9-inch display, extended keyboard with numeric keypad, 256K of memory, two RS-232 ports, two expansion slots, and one demonstration disc. System storage consists of dual 710K (formatted capacity) 3 1/2-inch microfloppy disc drives.

**HP 4560B** The Touchscreen MAX Personal Computer comes with the above features, except it has 14.8M byte (formatted capacity) Winchester and 710K byte (formatted capacity) 3 1/2-inch double-sided microfloppy disc drive.  
Touchscreen Technical Reference Manual

**HP 45625A**

**HP 45624A**  
**HP 45435A**

Touchscreen MS-DOS User's Guide  
Touchscreen Programmer's Tools

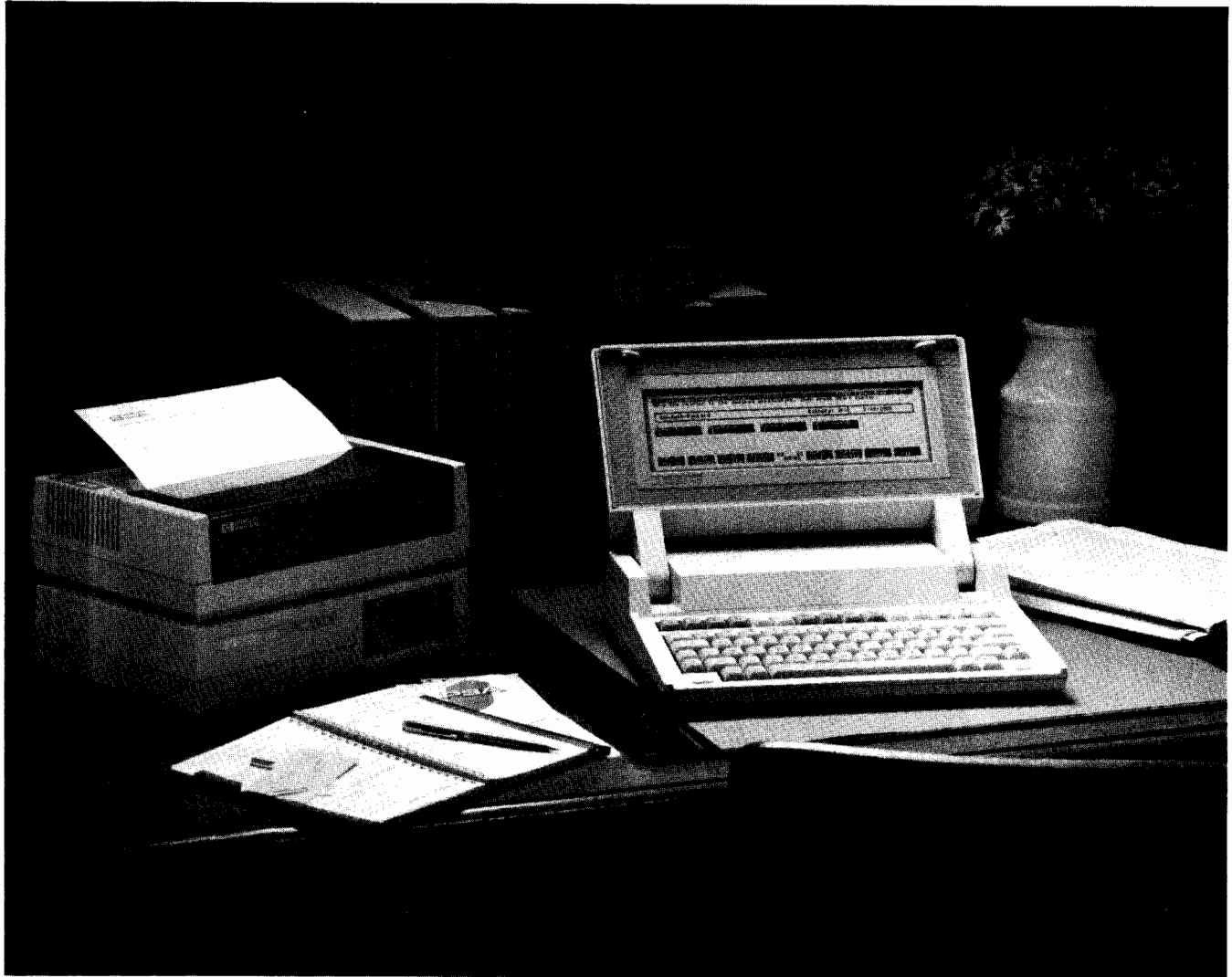

### A Personal Computer in a Portable Package

The PORTABLE from Hewlett-Packard lives up to its name. It is a fully functional personal computer that is truly portable. At just under nine pounds, this battery-powered computer will easily go wherever your needs take you.

HP packs a remarkable amount into this small package. In fact, The PORTABLE is faster and has more memory than most desktop personal computers.

HP has *built into* ROM some big surprises. There's the industry standard MST<sup>™</sup>-DOS operating system with our easy-to-use Personal Applications Manager (P.A.M.).

But, that's not all! You've got 1-2-3<sup>™</sup> from Lotus<sup>™</sup> (spreadsheets, graphics, and file management), MemoMaker (word processing), and Terminal Emulation (communications and file transfer). So you don't have to take discs or a disc drive with you every time you take The PORTABLE out for a spin.

### The Look of It

The top of The PORTABLE flips open to reveal its keyboard and display. This neat little package is about the size of a three-ring notebook binder. It may be child's play to tote around, but the design of this computer means business. Compact, durable, and elegant, The PORTABLE can go just about anywhere you do.

### The Basics

Inside The PORTABLE lurks a full 16-bit CMOS 8086 microprocessor. This makes The PORTABLE as powerful as personal computers that sit on a desk. The PORTABLE loads programs in about five seconds, which is 10 times faster than conventional personal computers. And once they are loaded, programs run up to twice as fast as they would on an IBM PC.

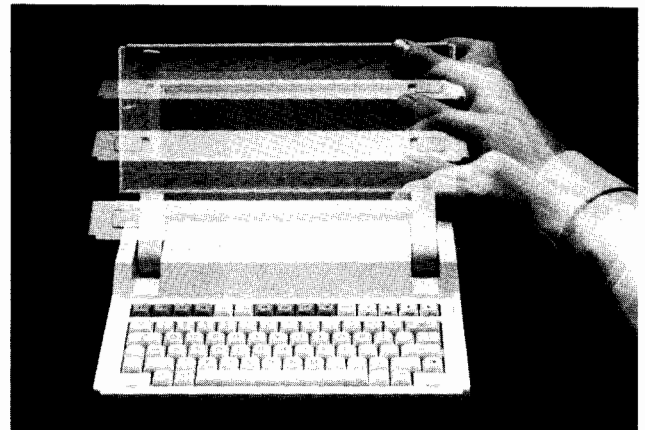

The PORTABLE has up to 272K bytes of user-memory (RAM). Up to 176K bytes of this user-memory can be designated as a built-in electronic disc drive. Keep in mind that you get this memory *in addition* to the 384K bytes of permanent (ROM) memory where all the internal software and the operating system are stored. And with the automatic memory protection feature, you don't have to worry about losing any information stored in memory.

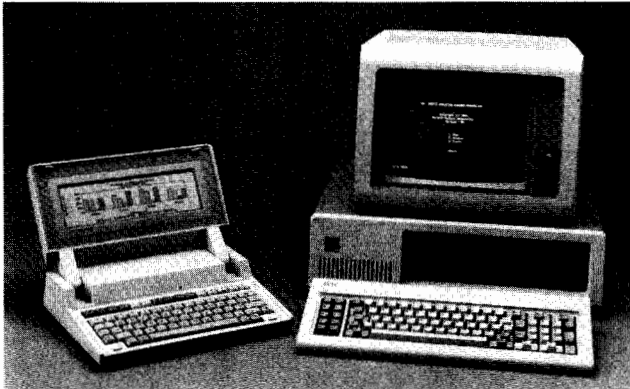

An RS-232C interface on The PORTABLE means you can link to other computers, including IBM.

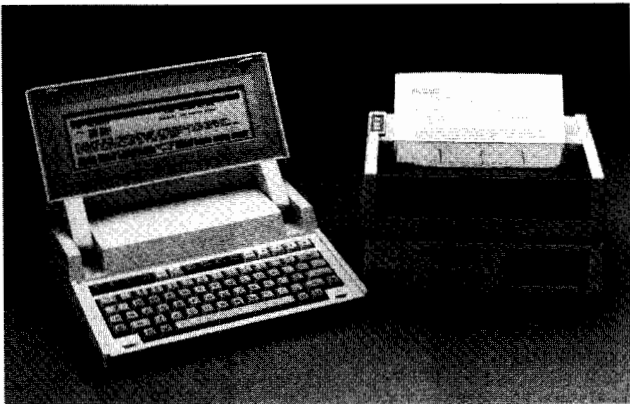

The completely portable system: The PORTABLE and battery-powered 9114A disc drive and ThinkJet printer.

#### Display

The PORTABLE uses the largest display of any battery-powered computer on the market. The liquid crystal display (LCD) is 16 lines by 80 columns, which means you can really get the big picture, even with Lotus™ graphics. You can also control the contrast of the display as you change environments.

#### Keyboard

The PORTABLE comes with a full, typewriter style keyboard, which makes typing easy. It also has eight function keys to simplify software operations.

#### The Power

Lead/Acid batteries provide The PORTABLE with a predictable and long-lasting power supply. The PORTABLE's batteries spend energy at an even rate so power doesn't drop off suddenly. And a built-in battery monitor tells you how much power you have left.

When your batteries run down to 20 percent, the monitor reminds you to recharge them. At five percent, the system locks you out temporarily, so your data will stay intact.

If you opt to plug into an AC outlet, you can still work on The PORTABLE while it recharges.

#### Long Distance Relationships

The built-in modem, communications software, and the RS-232C interface mean The PORTABLE can talk to other computers and information services. You can hook up to data bases like The Source<sup>SM</sup> and Dow Jones News/Retrieval. You can link to a Touchscreen, an IBM PC, or even an IBM mainframe.

You can implement HP's PORTABLE Desktop Link (see page 68) with the Touchscreen or Touchscreen MAX by using the Extended I/O Accessory (HP 45643A). With the IBM PC/XT, HP's PORTABLE Desktop Link can be implemented by using the HP-IL Interface Card (HP 82973A).

The PORTABLE's internal modem makes it easy to connect with the auto-answer/auto-dial feature. The internal modem runs at a rate of 300 baud and plugs into an ordinary phone jack.

#### Ports

The PORTABLE comes equipped with an industry standard RS-232C port which hooks up to most peripherals. Plus, it has an HP-IL port for its own battery-powered peripherals such as the 3½-inch, 710K byte, double-sided, HP 9114A microfloppy disc drive and the quiet ThinkJet printer. This highly efficient port can support up to 30 peripherals at one time.

#### Specifications

##### Microprocessor

Full 16-bit, CMOS 8086, running at 5.33 MHz clock rate.

##### Memory

384K bytes of CMOS ROM.

272K bytes of CMOS RAM.

Up to 256K bytes of user-memory.

Up to 176K bytes electronic disc.

##### Built-in Software

MS™-DOS version 2.11.

Personal Application Manager.

1-2-3™ from Lotus™: for spreadsheet/graphics/file management.

MemoMaker word processing.

Terminal Emulation: communications and file transfer.

##### Display

16 line x 80 column LCD.

128 x 480 pixel, bit-mapped graphics.

Keyboard contrast control.

##### Keyboard

Typewriter style.

75 keys, including eight special function keys.

##### Power Supply and Battery Life

Three permanently installed, lead/acid D-cell batteries.

16 hours of continuous use on one charge.

Over five years of service life.

##### Size and Weight

13 x 10 x 2½-inches (32cm x 25cm x 7cm).

8½ pounds (3.85 kg).

##### Input/Output

Hewlett-Packard Interface Loop (HP-IL).

Serial Interface (RS 232-C v.24/v.28).

##### Modem

300-baud direct connect.

Auto answer/auto dial.

Pulse and tone dial.

##### System Clock and Calendar

January 1, 1980 to December 31, 2039.

0.1 second resolution.

Alarm and appointment-keeping functions.

##### Temperature Constraints

32 - 130 F (0-55 C) while in storage.

32 - 115 F (0-45 C) while in operation.

##### Ordering Information

###### Product Number

HP 45670A

###### Description

The PORTABLE comes complete with MS-DOS 2.11 operating system, Personal Applications Manager (P.A.M.), 1-2-3 from Lotus, MemoMaker, and Terminal Emulation software. The PORTABLE features 272K bytes of RAM, a 300-baud modem, serial interface, HP-IL interface, a 16-line by 80-column LCD display, and full-size keyboard. The PORTABLE also includes full documentation, an HP-IL cable, battery recharger and a carrying case.

MS™-DOS is a U.S. trademark of Microsoft, Inc.

1-2-3™ and Lotus™ are U.S. trademarks of Lotus Development Corp.

The Source is a service mark of Source Telecomputing Corp., a subsidiary of Reader's Digest Association.

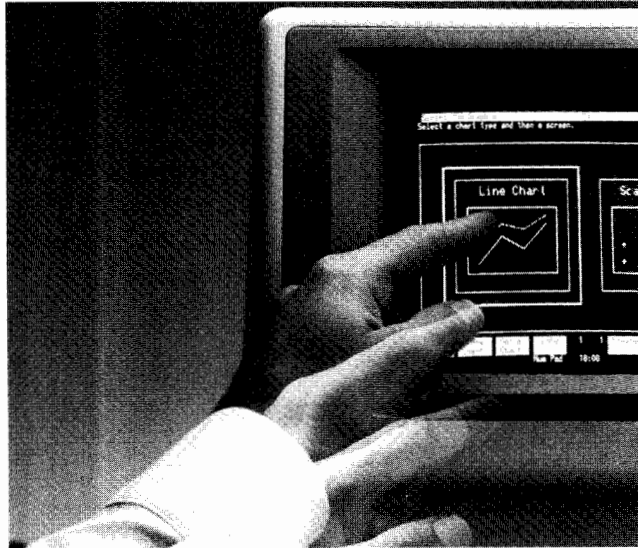

Software ease-of-use has taken on new meaning with Hewlett-Packard's instinctive HP Touch feature. All you have to do is point to get your point across.

#### Hewlett-Packard: Your Source for Software Solutions

The programs listed in this section are for use on the Touchscreen Personal Computer, the Touchscreen MAX, or The PORTABLE. A boldface note below each description indicates which system the software package is available for. All software is on 3 1/2-inch discs.

Whether you're an engineering manager working in a technical environment, or a small business owner looking for project management software, Hewlett-Packard provides you with a wide range of computing tools to choose from.

#### HP Touch Makes the Difference

Some of the world's most popular computer programs, such as WordStar®, VisiCalc®, Multiplan™, and PFS®: File and PFS®: Report, have been enhanced with HP Touch, making them even easier to use. Programs utilizing the HP Touch feature on the Touchscreen or Touchscreen MAX are indicated below. HP Touch is not available on software for The PORTABLE.

#### Software to Go

Hewlett-Packard supports The PORTABLE with a full library of software — 1-2-3™ from Lotus™ and MemoMaker are built-in. Using the high-capacity HP 9114A disc drive (see page 59), you can run software like WordStar for word processing, dBASE II® for data management, MultiPlan for spreadsheets, and BASIC for programming.

Whether you're enjoying the convenience of HP Touch with the HP Touchscreen or Touchscreen MAX, or taking the power with you on The PORTABLE, Hewlett-Packard is your source for software solutions.

#### Programming Speaking Your Computer's Language

**BASIC by Microsoft®** is a BASIC interpreter (compatible with Compiled BASIC by Microsoft®) that lets you write a program, correct it, and then test its logic with easy-to-use commands.

**Touchscreen/The PORTABLE** **45445D**

**Compiled BASIC by Microsoft®** executes programs faster and uses less memory than interpreted programs. It's also compatible with most of the interpreted syntax.

**Touchscreen/The PORTABLE** **45446D**

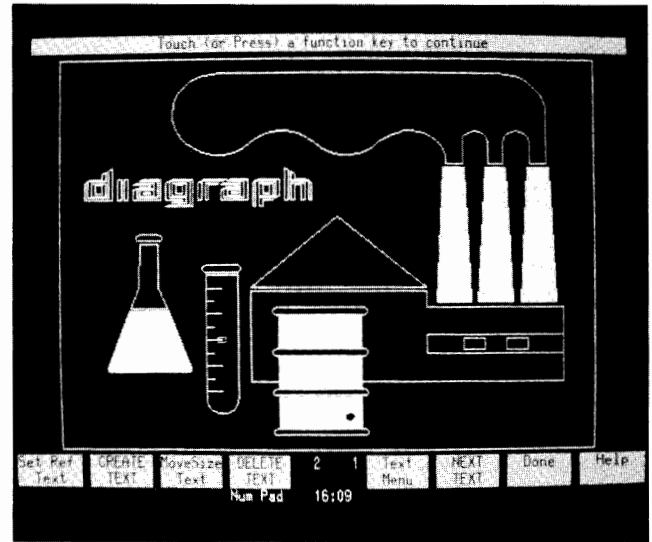

A graphics package with over 1,500 symbols, Diagram simplifies your production of presentation aids and charts.

**GW™ BASIC by Micro-soft®** combines the BASIC interpreter with a screen editor and a graphics command set.

**Touchscreen/The PORTABLE** **45450D**

**COBOL by Microsoft®** gives programmers using Microsoft® COBOL access to the HP Touchscreen with MS™-DOS.

**Touchscreen/The PORTABLE** **45448D**

**Cross Reference Utility** is a productivity aid for Touchscreen Programmers using BASIC by Microsoft. It provides a list of all variables and tells where and how they're used.

**Touchscreen** **92248BA**

**FORTRAN by Micro-soft®** is designed for use with MS-DOS. It is a Microsoft subset implementation of the ANSI standard V-77 FORTRAN. The program helps programmers implement computer-bound applications, while maintaining code transportability.

**Touchscreen** **45449A**

**Pascal by Microsoft®** is designed for use with MS-DOS. It accepts and compiles programs written according to the ISO standard and the full Microsoft Pascal syntax extensions.

**Touchscreen/The PORTABLE** **45447D**

**Programmer's Tools** contains MS-DOS software development utilities and documentation to help you develop or adapt programs for The PORTABLE.

**The PORTABLE** **45419C**

#### Accounting Systems When Your Work Really Counts

**BPI Accounts Payable** lets you select the accrual method of accounting, and maintain detailed vendor files with ease.

**Touchscreen** **45457A**

**BPI Accounts Receivable** brings flexibility and accuracy to the tracking of customer accounts. Provisions include finance charge statements, open item or balance forward and management reports.

**Touchscreen** **45456A**



## Accounting Systems (con't)

**BPI General Accounting** features computerized accounting procedures, a flexible chart of accounts, and fast data entry.  
**Touchscreen** 45455A

**BPI Inventory Control** lets you keep tabs on what's important to your business with three accounting methods to cost your inventory.  
**Touchscreen** 45460A

**BPI Job Cost** produces profit and loss, cost type analysis, job cost general ledger, and monthly job cost summary reports.  
**Touchscreen** 45461A

**BPI Payroll** offers complete flexibility for a customized company payroll system. Select method of payment, and determine how you want checks prepared, filed and reported.  
**Touchscreen** 45458A

**BPI Personal Accounting** brings the power of computers to the task of managing and tracking your assets, liabilities, net worth, income, and expenses.  
**Touchscreen** 45459A

## Communications Passing the Word

**Acculink™** is a data communications program for the Touchscreen Computers. It allows you to access remote computer systems and transfer both ASCII and binary files. It provides full emulation of VT 100 and VT 52 terminals.  
**Touchscreen** 45613A

**DataLink PC™** provides terminal emulation (VT 100, HP terminals and others) and data communications capability for The PORTABLE.  
**The PORTABLE** 45409C

**DSN/Link** transfers information between the HP Touchscreen Computers and the HP 3000, another Series 100 Computer and outside information services and host computers. With HP Touch.  
**Touchscreen** 45425A

**Touchscreen 3278 Emulation Accessory with File Transfer** gives you IBM terminal capability plus local computing convenience. You can leverage existing software and data bases on your company's host computer and move data files between the mainframe and your Touchscreen.  
**Touchscreen** 45641B

## EtherSeries™ Local Area Networking

**Products from 3com™** provide a cost-effective way to share information and peripherals, such as large-capacity discs and printers. Enhance office communications through easy-to-use electronic mail. Quickly and easily set up your Touchscreen as the hub of the Ethernet local area network. Link up with HP Touchscreens and IBM personal computers.

**EtherLink™/150** provides you with the hardware and software necessary to access the network.  
**Touchscreen** 45644A

**EtherShare™/150** is the server software for sharing information storage and work space. With HP Touch.  
**Touchscreen MAX** 45645A

**EtherPrint™/150** is the server software that allows people on the network to share printers.  
**Touchscreen** 45646A

**EtherMail™/150 Server Software** provides fast and efficient electronic mail service. With HP Touch.  
**Touchscreen MAX** 45647A

## Communications (con't)

**EtherMail/150 User Software** is the Touchscreen interface necessary when EtherMail is run from a personal computer other than a Touchscreen MAX server.  
45639A

**Monitor/IBM PC** works with DSN/Link to let you transfer ASCII and binary files between an IBM PC and an HP Touchscreen Personal Computer.  
**Touchscreen** 45439A

**Touchscreen Internal Modem** allows you to connect with online information services (such as The Source<sup>SM</sup> or Dow Jones News/Retrieval<sup>®</sup>), as well as transfer files between other personal computers or to minis like the HP 3000. It is an intelligent modem that operates at both 300 and 1,200-baud.  
**Touchscreen** 45640A

## Computation and Analysis Compiling Facts and Figures

**Financial Calculator** displays the keyboard of the HP-12C Calculator — the industry standard for calculators — right on screen! With HP Touch.  
**Touchscreen** 45423A

## Data Base Management Your Electronic Librarian

**Condor 1** file and data base management systems let you sort, analyze and report information on demand. With HP Touch.  
**Touchscreen** 45415A

**Condor 3** is a powerful, but easy-to-use, relational data base management system with advanced report writing features. You can incorporate your data base reports into memos, graphics and mailings. With HP Touch.  
**Touchscreen** 45416A

**Condor 1 to 3 Upgrade Kit** adds the advanced features of Condor 3 to the start-up Condor 1 system. With HP Touch.  
**Touchscreen** 45417A

**dBASE II®** helps you construct and manipulate data files for general ledger, check management and writing, and other functions.  
**Touchscreen/The PORTABLE** 45468D

**Link System DataFax™** is a freeform, relational filing system that gives you flexibility in the way you store and access your information.  
**The PORTABLE** 45408C

**Personal Card File** is an electronic file that looks and works like a Rolodex card file for keeping track of information. With HP Touch.  
**Touchscreen** 45422A

**PFS®: File and PFS®: Report** makes it easy to set up data files for managing information. Add totals and subtotals to your reports with single keystrokes. With HP Touch.  
**Touchscreen** 45488A

## Electronic Spreadsheets Informed Financial Decisions

**1-2-3™ from Lotus™** combines information management, spreadsheet analysis, and graphic capabilities, to help you make better business decisions. Built into The PORTABLE.  
**Touchscreen** 45482A

**Context MBA™** lets you work with telecommunications, data base management, spreadsheet, word processing, and graphics programs. With HP Touch.  
**Touchscreen** 45481A

**GraphPlan™** rates high marks for its spreadsheet and advanced graphics capabilities. Ask "what-if" and chart the results simply and quickly. With HP Touch.  
**Touchscreen** 45467A

# COMPUTERS, PERIPHERALS & CALCULATORS

## Personal Computers

### Software for the Touchscreen Personal Computers and The PORTABLE (cont'd)

#### Electronic Spreadsheets (con't)

**MicroPlan™** is a valuable aid for business people who need to analyze information in a rapidly changing environment. With HP Touch.  
Touchscreen 45465A

**MicroPlan™ Consolidation Module** lets you use MicroPlan for incorporating data you obtain from mainframe computers, timesharing services or other software packages. With HP Touch.  
Touchscreen 45466A

**Microsoft® Multiplan™** makes financial modeling, forecasting, and the calculation of engineering scientific formulas fast and easy. With HP Touch.  
Touchscreen/The PORTABLE 45473D

**VisiCalc®** is an enhanced version of the industry-standard planning tool for managers and professionals. It includes features such as individual column widths and extensive printing and formatting options. With HP Touch.  
Touchscreen 45405A

#### Graphics The Fine Art of Computing

**Diagraph™** is an interactive graphics software package that simplifies the production of presentation aids and charts.  
Touchscreen 45463A

**Graphwriter® Basic Set** offers a variety of charts optimized for high-resolution pen plotters, so your customized results have an artist's touch. With HP Touch.  
Touchscreen 45484A

**Picture Perfect™** is a versatile business package that can transform your data into a wide variety of charts. With HP Touch.  
Touchscreen 45462A

**Series 100/Graphics** from Hewlett-Packard is the all-in-one presentation graphics package. Touch the screen to create pie, bar, line and text charts. Touch again to make full-color plots for reports and presentations. With HP Touch.  
Touchscreen 45410A

#### Personal Solutions Productivity at Home

**The Calendar** is a personal time management program presented in a daily calendar format with options to review daily, monthly and yearly calendars.  
Touchscreen/The PORTABLE 35151D

**The List Manager** is a predefined data base program for individuals who need to collate lists of data like names, account numbers, addresses, and phone numbers. It also includes report generation and sorting capabilities. With HP Touch.  
Touchscreen/The PORTABLE 35152D

**The Planner** is an easy-to-learn spreadsheet program that's perfect for people who occasionally need to do spreadsheet analysis.  
Touchscreen/The PORTABLE 35155D

**The Speller** is an easy-to-use spelling checker that can be used with The Writer and other ASCII text files. With HP Touch.  
Touchscreen/The PORTABLE 35154D

**The Writer** is a powerful, yet simple, word processing package for people with occasional word processing needs. With HP Touch.  
Touchscreen/The PORTABLE 35153D

#### Word Processing Managing Text

**MailMerge®** can be used with WordStar to easily produce customized form letters, invoices, and mailing labels.  
Touchscreen 45401A

**MemoMaker** provides word processing without complicated commands. It's easy to create memos, business letters, and reports. And it's compatible with WordStar files. With HP Touch. Built into The PORTABLE.  
Touchscreen 45420A

**SpellStar®** corrects spelling errors and typos in your WordStar files. It contains an expandable 20,000-word spelling dictionary.  
Touchscreen 45402A

**WordStar®** features advanced text formatting, editing and print functions, on-screen preview and simple integration with other systems. With HP Touch.  
Touchscreen/The PORTABLE 45400D

**WordStar/SpellStar/MailMerge** offers complete word processing capabilities for one low package price. With HP Touch.  
Touchscreen 45404A

#### Entertainment Creative Challenges

**Adventure: The Original by Crowther and Woods** gives you a chance to go armchair spelunking. Explore magical Colossal Cave, studded with gold and priceless treasures. With HP Touch.  
Touchscreen 92243AA

**BARON: The Real Estate Simulation™** gives you a chance to become a land baron by buying, selling, and developing properties. With HP Touch.  
Touchscreen 92243KA

**Cyborg** provides puzzles that fit together to form a science fiction short story. You play as a Cyborg, half-man, half-machine! With HP Touch.  
Touchscreen 92243NA

**Deadline™** pits you against a 12-hour time limit and one of the cleverest, most baffling cases of the detective genre.  
Touchscreen/The PORTABLE 92243VA

**Enchanter™** presents you with the challenging task of freeing the land from the Evil Warlock.  
Touchscreen/The PORTABLE 92243UA

**Infidel™** takes you, a soldier of fortune, into the heart of the Egyptian Desert. You gain entry to the Lost Pyramid and unravel its mysteries one by one.  
Touchscreen/The PORTABLE 92243WA

**Milky Way Merchant** puts you in command of a merchant fleet of starships with a license to buy, sell, and transport supplies to outlying settlements. With HP Touch.  
Touchscreen 92243BA





## Entertainment (con't)

**MILLIONAIRE: The Stock Market Simulation™** gives you \$10,000 and 77 simulated weeks to make a fortune by buying and selling in response to stock market trends. With HP Touch.  
**Touchscreen** 92243JA

**Planetfall™** enlists you as a member of the Stellar Patrol. Carry a peaceful message to the thousands of worlds lost after the Great Collapse.  
**Touchscreen/The PORTABLE** 92243PA

**Ricochet™** features on-screen graphics that will remind you of a billiards table with additional barriers to increase the challenge. With HP Touch.  
**Touchscreen** 92243GB

**Sargon III** provides 45 brainteasing chess problems and 107 historical chess games played by the masters. For beginners and experts. With HP Touch.  
**Touchscreen** 92243MA

**Seastalker™** challenges you to save the Aquadome, the world's first undersea research station. More than just a game, Seastalker is an interactive story that encourages logical thinking, planning and organization as you develop creative solutions to problem solving.  
**Touchscreen/The PORTABLE** 92243ZA

**Sorcerer™** tries your valor in the quest for the title of Sorcerer. Now a full-fledged member of the Circle of Enchanters, it's up to you to rescue Belboz the Necromancer and save the kingdom.  
**Touchscreen/The PORTABLE** 92243YA

**Starcross™** launches you into the interior of a gargantuan starship in order to discover its mysterious purpose.  
**Touchscreen/The PORTABLE** 92243DA

**Suspended™** is a science fiction adventure game where you solve complex mysteries by manipulating six robots.  
**Touchscreen/The PORTABLE** 92243FA

**Temple of Apshai™** is one of the most popular adventure games ever written. Discover treasures, fight off monsters, slip through secret doors, and evade hidden traps. With HP Touch.  
**Touchscreen** 92243GA

**Touch Games I** provides four ways to amuse yourself when you want to take a break: blackjack Las Vegas style, 3-D tic-tac-toe, a novel approach to the age-old monster-in-the-maze puzzle, and a biorhythm chart generator. With HP Touch.  
**Touchscreen** 92248AA

## Entertainment (con't)

**TYCOON: The Commodity Market Simulation™** provides the excitement of speculating in the volatile commodities market. With HP Touch.  
**Touchscreen** 92243HA

**Type Attack™** improves touch typing skills by presenting combinations of letters which must be typed correctly. With HP Touch.  
**Touchscreen** 92243EA

**Winning Deal** tests your skill and luck with casino-style blackjack, the challenging classic, Concentration, and three novel versions of Solitaire. With HP Touch.  
**Touchscreen** 92248CA

**The Witness™** makes you a detective in February 1938. You have 12 hours to untangle an intricate knot of motives and alibis.  
**Touchscreen/The PORTABLE** 92243QA

**Zork® I** opens the door to an exciting underground empire. Escape, if you can, with your life and the 20 treasures of Zork.  
**Touchscreen/The PORTABLE** 92243CA

**Zork® II**, the second chapter in the story of the Great Underground Empire, takes you even deeper into the earth to discover the secrets and sorcery of the evil Wizard of Frobozz.  
**Touchscreen/The PORTABLE** 92243RA

**Zork® III**, the final, and most difficult, chapter in the Zork trilogy, thrusts you into a face-to-face encounter with the Dungeon Master.  
**Touchscreen/The PORTABLE** 92243TA

Acculink™ is a U.S. trademark of IE Systems, Inc.  
 DataLink™ and Data Fax™ are U.S. trademarks of Link Systems, Inc.  
 EtherSeries™ and 3COM™ are U.S. trademarks of 3COM Corporation.  
 "CONDOR" is a U.S. trademark of Condor Computer Corp.  
 dBASE II® is a U.S. registered trademark of Ashton-Tate.  
 PFS®: File and PFS®: Report are U.S. registered trademarks of Software Publishing Co.  
 BARON: The Real Estate Simulation™, MILLIONAIRE: The Stock Market Simulation™, and TYCOON: The Commodity Market Simulation™ are U.S. trademarks of Blue Chip Software, Inc.  
 Starcross™, Suspended™, Seastalker™, Sorcerer™, Interlogic™, Infocom Tales of Adventure™, Infidel™, Deadline™, The Witness™, Planetfall™, and Enchanter™ are U.S. trademarks of Infocom, Inc.  
 Ricochet™ and Temple of Apshai™ are U.S. trademarks of Epyx, Inc.  
 TYPE ATTACK™ is a U.S. trademark of Sirius Software, Inc.  
 Zork® is a U.S. registered trademark of Infocom, Inc.  
 Graphwriter® is a U.S. registered trademark of Graphics Communications, Inc.  
 Picture Perfect™ and Diagraph™ are U.S. trademarks of Computer Support Corp.  
 MS™-DOS, Multiplan™ and GW™-BASIC are U.S. trademarks of Microsoft, Inc.  
 Microsoft® is a U.S. registered trademark of Microsoft, Inc.  
 1-2-3™ and Lotus™ are U.S. trademarks of Lotus Development Corp.  
 MicroPlan™, MicroPlan™ Consolidation Module, and GraphPlan™ are U.S. trademarks of Chang Laboratories, Inc.  
 VisiCalc® is a U.S. registered trademark of VisiCorp.  
 WordStar®, MailMerge®, and SpellStar® are U.S. registered trademarks of MicroPro International Corporation.

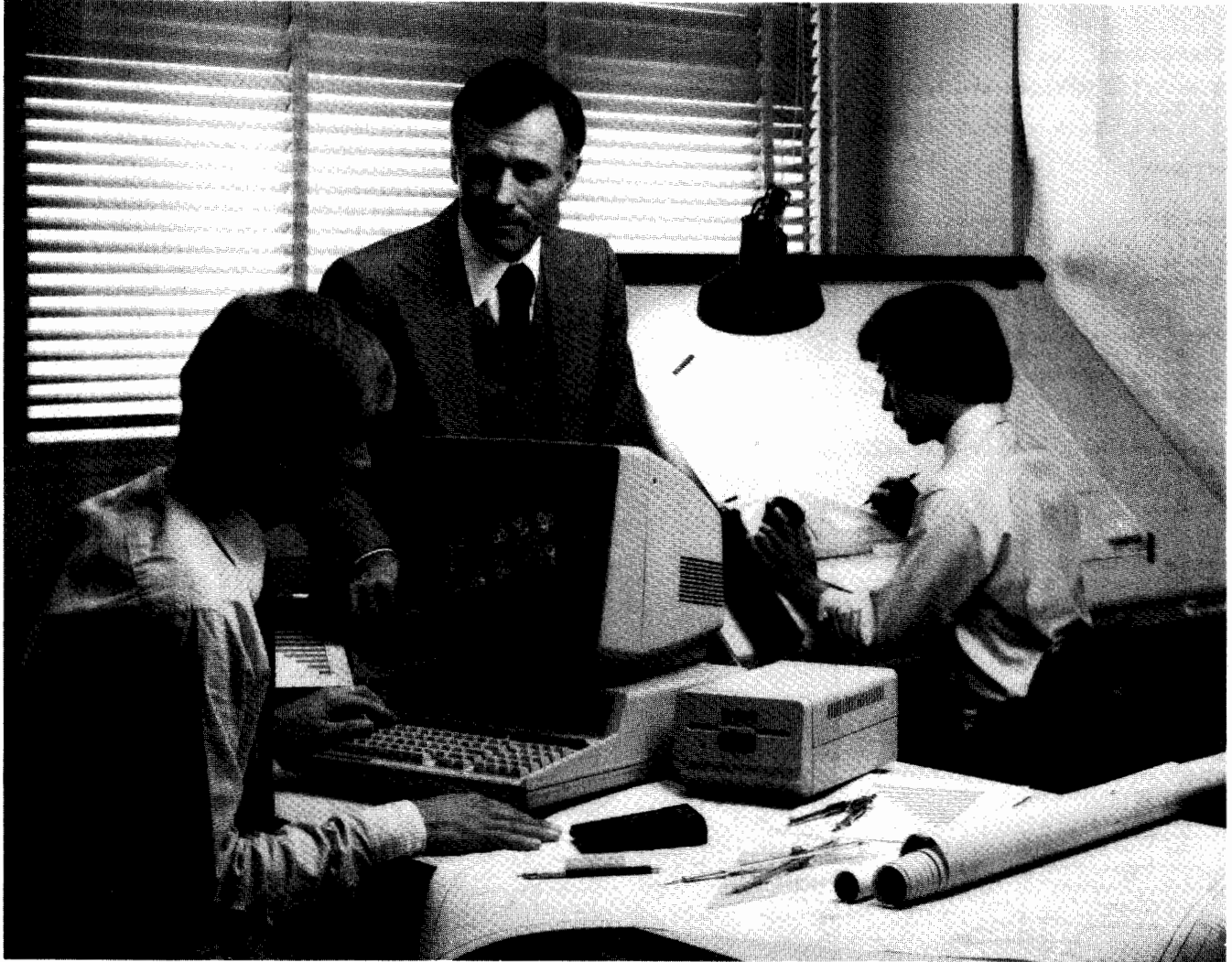

#### Series 80 Model HP-86B

When technical professionals look for a personal computer, they look for computers like the **HP Series 80 Personal Computers**. Series 80 Computers have the ability to act as instrument controllers and data acquisition devices. Both the HP-85B and HP-86B utilize a ROM-based operating system and enhanced HPBASIC (a superset of ANSI BASIC) with up to 350 commands and statements. There's also a broad line of HP Series 80 Personal Computer products including printers, plotters, firmware, interfaces, and software, all designed with the technical professional in mind.

#### The HP-85B Personal Computer

For the technical professional who needs an integrated system to perform analysis, testing, or instrument control, the HP-85B is the logical choice. The HP-85B features an integral thermal printer, custom CPU, 32K bytes of built-in RAM, tape-drive storage and Electronic Disc high-speed mass storage. Additional built-in features include an I/O ROM that gives you a universal set of 45 input/output commands and functions, as well as Mass Storage ROMs that let you use flexible disc and Winchester disc drives.

#### HP-85B Specifications

**User Memory (bytes):** 32K (standard and maximum).

**Electronic Disc Memory (bytes):** 32K (standard), 544K (maximum).

**CRT Display Area:** 12.7 cm (5 inches) diagonal.

**Display Capacity:** alphanumeric — 16 lines x 32 characters; graphics — 192 x 256 dots.

**Thermal Printer:** 32-character width, 2 line/sec., bidirectional, adjustable intensity.

**Magnetic Tape Cartridge:** 210K byte capacity, 42 separate files, search speed of 60 in./sec., read/write speed of 10 in./sec.

**Power Requirements:** 90 to 127 Vac (115 Vac line), 200 to 254 Vac (230 Vac line) switch selectable, frequency of 50 to 60 Hz.

**Size:** 15 x 41.9 x 45.2 cm (6.3 x 16.5 x 17.8 inches).



#### Series 80 Model HP-85B

#### The HP-86B Personal Computer

The other member of the HP Series 80 family, the HP-86B, was designed for the professional who needs a modular system that can be tailored to fit spacial, financial, and performance requirements. The HP-86B offers lots of memory, a choice of display screens, multiple operating systems, and a broad range of software. A choice of local language keyboards is also available.

#### HP-86B Specifications

**User memory (bytes):** 128K standard, 640K maximum.

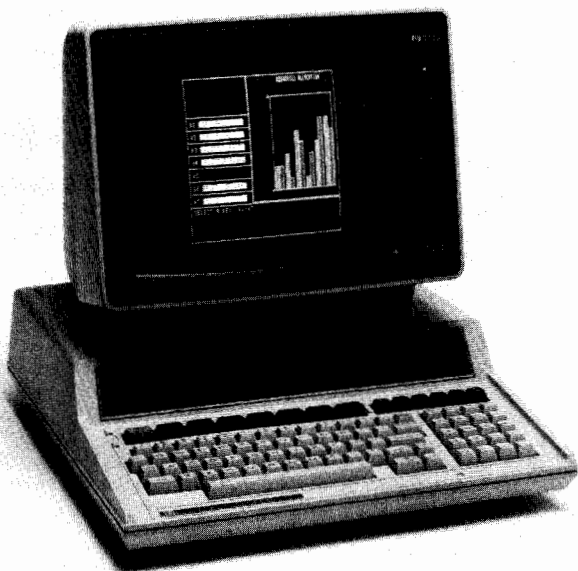

HP 86B



HP 85B



HP 32936A ROM Drawer

**Electronic Disc Memory (bytes):** Maximum built-in user memory that can be allocated as Electronic Disc—96K; maximum add-on—512K; maximum total—608K.

**Display Capacity:** alphanumeric — 16 or 24 lines (variable) x 80 characters; graphics — 400 or 544 (variable) x 240 dots.

**HP 82912A 9-inch Monitor Size:** 21.8 x 27 x 26.1 cm (8.5 x 10.5 x 10.2 inches).

**HP 82913A 12-inch Monitor Size:** 29.6 x 36 x 33 cm (11.5 x 14 x 12.8 inches).

**Power Requirements:** 90 to 127 Vac (115 Vac line), 200 to 254 Vac (230 Vac line), switch selectable. Frequency of 50 to 60 Hz.

#### System Expansion Capacity

##### Memory Modules

You can increase the internal read/write memory of an HP Series 80 Personal Computer with optional memory modules that plug into the expansion ports in the back of the computer. Add memory to your HP-86B with the HP 82908A 64K and HP 82909A 128K Memory Modules. You can also add the Electronic Disc memory on your HP-85B or HP-86B Personal Computer using the same memory modules.

#### Series 80 Peripherals

##### Mass Storage Units

Hewlett-Packard offers you a choice of mass storage units to fit your computing needs, from single and dual 3½-inch and 5¼-inch disc drives up to 10 Megabyte Winchester disc drives.

**Flexible Disc Systems:** HP 9121D (dual), 3½-inch; HP 3121S (single), 3½-inch; HP 82901M (dual), 5¼-inch; HP 82902M (single), 5¼-inch.

**Winchester Disc Systems:** HP 9133V, 4.8 Mb plus 3½-inch single disc drive; HP 9133V Opt. 004, 4.6 Mb plus 3½-inch single disc drive; HP 9133XV Opt. 010, 9.6 Mb plus 3½-inch single disc drive; HP 9134XV Opt. 010, 9.6 Mb Winchester only.

##### Printer Options

The listing below outlines the printers that can be used with Series 80 Personal Computers. For a detailed description of each, refer to Printers, beginning on page 57.

**General Purpose:** ThinkJet (HP 2225A), ink-jet printer; HP 82905B, dot-matrix printer; HP 82906A, dot-matrix printer; HP 2630 Series, impact printers; HP 2670 Series, thermal printers.

**Word-processing:** HP 2601A Daisy-wheel; HP 2602A Daisy-wheel.

##### Graphics Options

The listing below outlines the graphics options which can be used with HP Series 80 Personal Computers. For a detailed description, refer to Graphics Plotters, beginning on page 96, and Graphics Tablet, beginning on page 104.

**Graphics Plotters:** HP 7470A, 7475A, 7550A, 7580B, 7585B, 7586B.

**Graphics Tablet:** HP 9111A.

#### Ordering Information

HP-85B Personal Computer

HP-86B Personal Computer

HP 82912A 9-inch Monitor

HP 82913A 12-inch Monitor

HP 82908A 64K Memory Module

HP 82909A 128K Memory Module

HP 9121D 3½-inch Dual Flexible Disc Drive

HP 9121S 3½-inch Single Flexible Disc Drive

HP 82901M 5¼-inch Dual Flexible Disc Drive

HP 82902M 5¼-inch Single Flexible Disc Drive

HP 9133XV 5Mbyte Combination Winchester Disc Drive with 3½-inch single flexible disc drive.

HP 9133XV Opt. 004 same as above in 4-volume

HP 9133XV Opt. 010 10 Mbyte Combination Winchester disc drive with 3½-inch single flexible disc drive.

HP 9134XV Opt. 010 10 Mbyte Winchester Disc Drive

All printers and plotters equipped with HP-IB interface except where noted.

HP 82905B Opt. 002 Printer

HP 82906A Opt. 002 Printer

HP 2225A ThinkJet Printer

HP 2932A Opt. 046 Printer

HP 2671A Thermal Printer

HP 2671G Thermal Graphics Intelligent Graphics Printer

HP 2601A Daisy-wheel Printer (RS-232C Interface)

HP 2602A Opt. 046 Daisy-wheel Printer



# COMPUTERS, PERIPHERALS & CALCULATORS

## Personal Computers

### Series 80

**HP 7470A Opt. 002** Graphics Plotter  
**HP 7475A Opt. 002** Graphics Plotter  
**HP 7550A** Graphics Plotter  
**HP 7580B** Graphics Plotter  
**HP 7585B** Graphics Plotter  
**HP 7586B** Graphics Plotter  
**HP 9111A Opt. 085** Graphics Tablet for HP-85B  
**HP 9111A Opt. 086** Graphics Tablet for HP-86B

#### Series 80 Interfaces

**HP 82937A HP-IB Interface:** implements the IEEE 488-1978 Standard Digital Interface for programmable instrumentation and is required for interfacing all HP-IB peripherals or compatible instruments (An HP-IB Interface is built into the HP-86B).

**HP 82938A HP-IL Interface:** low-power, small size, low-cost bit-serial interface that allows you to hook up to as many as 30 devices with up to 10 meters of cable between each device.

**HP 82169A HP-IL/HP-IB Interface:** enables you to link HP-IL systems with HP-IB computers and lab equipment.

**HP 82939A Serial Interface:** provides RS-232C compatible I/O for communications with devices such as printers and terminals.

**Standard HP 82939A:** RS-232C female (DCE) connector.

**Option 001:** Serial Interface module with male connector for HP Series 80 computers; typically used with modems.

**Option 002:** Serial Interface module with current loop cable for HP Series 80 computers.

**HP 82940A GPIO Interface:** provides 16-bit general purpose input/output operations.

**HP 82941A BCD Interface:** provides the necessary hardware for connection to devices having BCD (binary coded decimal) outputs.

**HP 82966A Data Link Interface:** offers the ability to configure Series 80 Personal Computers with most other HP computer products on a common network.

**HP 82949A Printer Interface:** standard 8-bit Parallel Printer Interface module for connecting printers with a Centronics-type interface.

#### Series 80 ROMS

**HP 82936A ROM Drawer:** plugs into the back of an HP Series 80 Personal Computer and has slots for six 8K ROMs.

**Plotter/Printer ROM (00085-15002):** enables you to interface your HP-85 Personal Computer with Hewlett-Packard graphics plotters and printers.

**Plotter ROM (00087-15002):** enables you to interface your HP-86B Personal Computer with Hewlett-Packard graphics plotters (printer commands are built into the HP-86B).

**I/O ROM (00087-15003):** provides BASIC language extensions to HP Series 80 Personal Computers, allowing general I/O capability for a variety of interfaces and devices (built into HP-85B).

**Matrix ROM (00085-15004 or 00087-15004):** adds a powerful set of statements and functions to HP Series 80 Personal Computers for working with both matrices (two-dimensional arrays) and vectors (single-dimensional arrays).

**Advanced Programming ROM (00085-15005 or 00087-15005):** adds functions, statements, and commands to HP Series 80 Personal Computers that give you extended control over data, programs, and system operations.

**MIKSAM ROM (00087-15011):** aids applications programmers in creating and maintaining customized file management systems on an HP-86B Personal Computer.

#### Series 80 Programming Development Aids

**Assembler ROM (00085-15007 or 00087-15007):** lets you write customized assembly language programs to be executed out of RAM or EPROM on your HP Series 80 Personal Computer.

**HP 82928A System Monitor:** provides the hardware to debug assembly language programs on HP Series 80 Personal Computers.

**HP 82929A Opt. 001 Hybrid ROM Development System:** allows you to produce customized hybrid ROMs in BASIC and assembly languages for your HP-85B Personal Computer.

**HP 82929A Programmable ROM Module:** completes the tool package designed to develop EPROMs for HP Series 80 Computers. This product lets you use EPROMs that you have created on HP Series 80 Computers.

#### Series 80 Communications

**HP 82900A Opt. 001 TERM/80:** allows block and format terminal support at baud rates from 110 to 9,600 bits per second on an HP-86B. Includes HP 82900A Auxiliary Processor module.

**HP 82849A (Opt. 630 or 650) TERM/80 software only:** if you do not already own an HP 82900A CP/M System, you need to order HP 82900A Opt. 001 instead of HP 82849A.

**HP 82821A (Opt. 610, 630 or 650) Data Communications Pac:** supports character mode terminal support at baud rates from 50 to 9,600 bits per second on Series 80 Computers. This product also supports file transfer.

**HP 82950A Modem:** gives you the features of auto-dial and auto-answer on a character mode terminal support level for both the HP-85B and HP-86B computers. Offers baud rates of 110 and 300 bits per second, and accepts a modular phone plug.

**HP 82850A Opt. 630 or 650 (HP-85B) or HP 82851A Opt. 630 or 650 (HP-86B) Professional Communications Pack:** allows character mode terminal support for baud rates of 300 to 1,200 bits per second. Supports auto-dial and auto-answer plus file transfer.

**HP 92204A COM-80 with HP 92239A Remote Job Entry or HP 92239B Asynchronous Terminal Emulation Software:** supports 110 to 9,600 baud in character mode terminal support with file transfer features for both HP-85B and HP-86B computers.

**HP 82967A Speech Synthesis Module:** allows you to create human-sounding speech with your HP-85B or HP-86B Personal Computer.

#### Optional Operating Systems for HP-86B only

**HP 82825A UCSD p-System/FORTRAN-77:** complete p-System software development system with FORTRAN-77 compiler.

**HP 82826A UCSD p-System/Pascal:** complete p-System software development system with Pascal compiler.

**HP 82827A UCSD Pascal:** add-on Pascal compiler to be used with HP 82825A.

**HP 82828A FORTRAN-77:** add-on FORTRAN-77 compiler to be used with HP 82826A.

**HP 82829A UCSD p-System Run time Module:** lets you run software developed for CP/M on your HP-86B. Includes auxiliary processor.

**HP 82848A Opt. 630 or 650 CP/M System software only:** if you do not already own the HP 82900A Auxiliary Processor, you will need to order HP 82900A CP/M System instead of HP 82848A.

#### Ordering Information

HP 82937A HP-IB Interface

HP 82938A HP-IL Interface

HP 82169A HP-IL/HP-IB Interface

HP 82939A Serial Interface (RS-232C) Female Connector

HP 82939A Opt. 001 Serial Interface (RS-232C) Male Connector

HP 82939A Opt. 002 Serial Interface (RS-232C)

Current Loop

HP 82940A GPIO Interface

HP 82941A BCD Interface

HP 82966A Data Link Interface

HP 82949A Parallel Printer Interface

HP 82936A ROM Drawer

00085-15002 HP-85B Printer/Plotter ROM

00087-15002 HP-86B Plotter ROM

00087-15003 HP-86B I/O ROM

00085-15004 HP-85B Matrix ROM

00087-15004 HP-86B Matrix ROM

00085-15005 HP-86B Advanced Programming ROM

00087-15005 HP-86B Advanced Programming ROM

00087-15001 HP-86B MIKSAM ROM

00085-15007 HP-85B Assembler ROM

00087-15007 HP-86B Assembler ROM

HP 82928A System Monitor

HP 82929 Opt. 001 HP-85B Hybrid ROM Development System

HP 82929A Programmable ROM Module

**NOTE:** When ordering the following products, you must indicate **Opt. 630** for 3½-inch media or **Opt. 650** for 5¼-inch media. With HP-85B, **Opt. 610** indicates tape drive media. Software with **Opt. 610** available is asterixed (\*).

**HP 82900A Opt. 001** HP-86B TERM/80 (includes Auxiliary Processor plus 3½-inch and 5¼-inch media)



HP 82849A HP-86B TERM/80 software only  
 HP 82950A Series 80 Modem  
 HP 82821A\* Series 80 Data Communications Pack  
 HP 82967A Series 80 Speech Synthesis Module  
 HP 82825A HP-86B UCSD p-System/FORTRAN-77  
 HP 82826A HP-86B UCSD p-System/Pascal  
 HP 82827A HP-86B UCSD Pascal Compiler  
 HP 82828A HP-86B FORTRAN-77 Compiler  
 HP 82829A HP-86B UCSD p-System Run Time Module  
 HP 82900A HP-86B CP/M System (includes Auxiliary  
 Processor plus 3½-inch and 5¼-inch media)  
 HP 82848A HP-86B CP/M System (software only)

\*Opt. 610 available for this product.

### Series 80 Software

A wide range of software is available for the Series 80 Personal Computers. Because the list is so extensive, product descriptions have been eliminated. For more complete product descriptions see the **Series 80 Personal Computer Software Catalog**.

**Note:** You must specify **Opt. 630** or **Opt. 650** for 3½-inch or 5¼-inch media respectively. For **HP-85B only**, **Opt. 610** (tape drive media) is available. Those products with Opt. 610 are noted with an asterisk (\*).

CP/M® indicates software that runs with the CP/M system on HP-86B personal computers. p-System indicates software that runs with the UCSD p-System on HP-86B computers.

### Software Ordering Information

#### Productivity Packages

Personal Productivity Pack	HP 82846A	(HP-86B)
Perfect Pack (CP/M)	HP 98592JA	(HP-86B)

#### Spreadsheet Analysis

VisiCalc® Plus	HP 82800A*	(HP-85B)
	HP 82830A	(HP-86B)

Multiplan™ (CP/M)	HP 82855A	(HP-86B)
-------------------	-----------	----------

MicroPlan™ (CP/M)	HP 45502A	(HP-86B)
-------------------	-----------	----------

MicroPlan™ Consolidation Module (CP/M)	HP 45503A	(HP-86B)
--	-----------	----------

Graphics Presentations	HP 82801A*	(HP-85B)
	HP 82831A	(HP-86B)

#### Word Processing

WORD/80	HP 82823A	(HP-86B)
---------	-----------	----------

WordStar® (CP/M)	HP 45584A	(HP-86B)
------------------	-----------	----------

SpellStar® (CP/M)	HP 45588A	(HP-86B)
-------------------	-----------	----------

MailMerge® (CP/M)	HP 45587A	(HP-86B)
-------------------	-----------	----------

Perfect Writer/Speller® (CP/M)	HP 98593JA	(HP-86B)
--------------------------------	------------	----------

Text Editing	HP 82816A*	(HP-85B)
--------------	------------	----------

#### Data Management

FILE/80	HP 82824A	(HP-86B)
---------	-----------	----------

dBASEII® (CP/M)	HP 45583A	(HP-86B)
-----------------	-----------	----------

File Manager	HP 88103A	(HP-85B)
--------------	-----------	----------

	HP 88104A	(HP-85B)
--	-----------	----------

Information Management Pack	HP 82817A	(HP-85B)
-----------------------------	-----------	----------

#### Time and Project Management

Milestone® (CP/M)	HP 45580A	(HP-86B)
-------------------	-----------	----------

Datebook II™ (CP/M)	HP 45581A	(HP-86B)
---------------------	-----------	----------

Personal Datebook™ (CP/M)	HP 45582A	(HP-86B)
---------------------------	-----------	----------

#### Accounting

Peachtree™ General Ledger	HP 82883A	(HP-86B)
---------------------------	-----------	----------

Peachtree™ Accounts Receivables	HP 82884A	(HP-86B)
---------------------------------	-----------	----------

Peachtree™ Accounts Payable	HP 82885A	(HP-86B)
-----------------------------	-----------	----------

Peachtree™ Peach Pac	HP 82889A	(HP-86B)
----------------------	-----------	----------

Peachtree™ Inventory Control	HP 82886A	(HP-86B)
------------------------------	-----------	----------

PeachPay™ Payroll System	HP 82887A	(HP-86B)
--------------------------	-----------	----------

TAJ™ I-85 The Accounts Journal™	HP 82854A*	(HP-85B)
---------------------------------	------------	----------

#### Finance

Aardvark Personal Tax Plan (CP/M)	HP 45586A	(HP-86B)
-----------------------------------	-----------	----------

Aardvark Personal Tax Plan (p-System)	HP 82877A	(HP-86B)
---------------------------------------	-----------	----------

Aardvark Professional Tax Plan (CP/M)	HP 45585A	(HP-86B)
---------------------------------------	-----------	----------

Aardvark Professional Tax Plan (p-System)	HP 82876A	(HP-86B)
---	-----------	----------

Aardvark ESTATE TAX PLAN** (p-System)	HP 82878A	(HP-86B)
---------------------------------------	-----------	----------

Portfolio Management	HP 82814A*	(HP-85B)
	HP 82833A	(HP-86B)

Financial Decisions	HP 82803A*	(HP-85B)
	HP 82833A	(HP-86B)

#### Home Budget Manager

	HP 92248EA	(HP-86B)
--	------------	----------

#### Computation and Analysis

General Statistics	HP 82804A*	(HP-85B)
	HP 82834A	(HP-86B)

Basic Statistics & Data Manipulation	HP 82805A*	(HP-85B)
	HP 82835A	(HP-86B)

Regression Analysis	HP 82806A*	(HP-85B)
	HP 82836A	(HP-86B)

Statistical Analysis Multi Pack	HP 82807A*	(HP-85B)
	HP 82837A	(HP-86B)

Linear Programming	HP 82808A*	(HP-85B)
	HP 82838A	(HP-86B)

#### Engineering and Science

Waveform Analysis	HP 82809A*	(HP-85B)
	HP 82839A	(HP-86B)

AC Circuit Analysis	HP 82810A*	(HP-85B)
	HP 82840A	(HP-86B)

Math	HP 82811A*	(HP-85B)
	HP 82841A	(HP-86B)

Electronics Engineering Multi Pack	HP 82812A*	(HP-85B)
	HP 82842A	(HP-86B)

Surveying	HP 82813A*	(HP-85B)
	HP 82843A	(HP-86B)

#### Education

Basic Training Pack	HP 82802A*	(HP-85B)
	HP 82832A	(HP-86B)

#### Recreation

Games	HP 82818A*	(HP-85B)
-------	------------	----------

Games II	HP 82819A*	(HP-85B)
----------	------------	----------

Galaxy Patrol	HP 92248FA	(HP-86B)
---------------	------------	----------

Action Games	HP 92248DA	(HP-86B)
--------------	------------	----------

#### Additional Solutions

In addition to the software listed above, third-party software solutions exist, and are listed in the **Series 80 Personal Computer Software Catalog** and the **HP Series 80 Personal Computer Databook**. Please see your HP sales rep or HP Series 80 dealer for more information. The Series 80 Users' Library contains over 400 programs written by Series 80 owners.

#### Series 80 Solution Books

Ready to be typed programs fill these 16 books, with each book holding between nine and 12 programs. You can either type the programs in yourself or obtain the media version from the Series 80 Users' Library. Each book costs \$10.

UCSD p-System and UCSD Pascal are trademarks of the Regents of the University of California.

CP/M® is a registered trademark of Digital Research, Inc.

VisiCalc® is a U.S. registered trademark of VisiCorp.

WordStar®, MailMerge® and SpellStar® are U.S. registered trademarks of MicroPro International Corporation.

dBASE II® is a U.S. registered trademark of Ashton-Tate.

Milestone® is a registered trademark of Organic Software, Inc.

Datebook II™ and Personal Datebook™ are trademarks of Organic Software, Inc.

PeachPay™ is a trademark of Peachtree Software, Inc.

TAJ™ and The Accounts Journal™ are trademarks of Production Data Systems.

\*\*ESTATE TAX PLAN was developed under the supervision of Dr. William A. Raabe, CPA.

MicroPlan™ is a U.S. trademark of Chang Laboratories, Inc.

Perfect Writer/Speller® is a registered trademark of Perfect Software.

Multiplan™ is a U.S. trademark of Microsoft, Inc.



**Keeping In Touch**

For additional information about Hewlett-Packard personal computer products, see your nearest HP dealer or local Hewlett-Packard representative. For the address of the dealer nearest you, refer to the address lists at the end of this catalog, call toll-free **800-FOR-HPPC** in the U.S., or write to one of the addresses below.

**United States**

Hewlett-Packard Company  
Personal Computer Group  
11000 Wolfe Road  
Cupertino, CA 95014 USA

**European, Middle East and North Africa**

Hewlett-Packard SA  
150 Route du Nant-d'Avril  
P.O. Box CH-1217  
Meyrin 2 Geneva, Switzerland

**Canada**

Hewlett-Packard Ltd.  
6877 Goreway Drive  
Mississauga, Ontario  
L4V 1M8

**All other countries**

Intercontinental  
3495 Deer Creek Road  
Palo Alto, CA 94304 USA

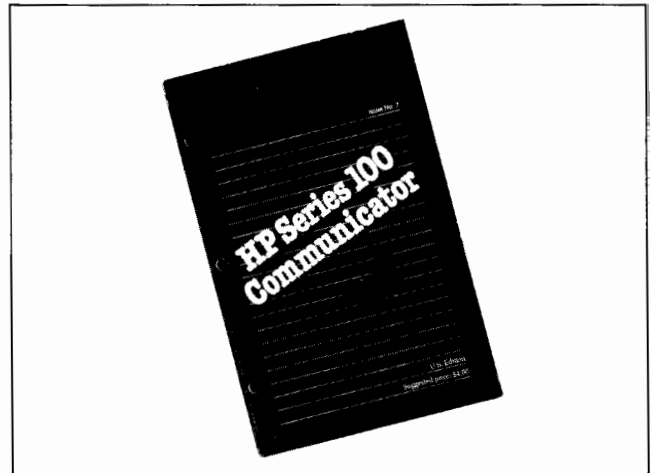
**We're There When You Need Us**

Hewlett-Packard remains interested in you after you've bought our products. A toll-free number provided with HP software gives you access to a nationwide telephone network for assistance.

**We've Got the Answers**

To subscribe to the **Series 100 Communicator** (a magazine with extensive product descriptions, problem solutions, and current reference information), or to order back issues, software and manual updates, supplies or accessories, call **Hewlett-Packard Computer Supplies Operation**, toll-free: **800-538-8787**. In California, Alaska or Hawaii, call **408-738-4133**.



# COMPUTERS, PERIPHERALS & CALCULATORS

57

## Personal Printers

Models ThinkJet, 82906A, 2601A, 2602A, 2934A

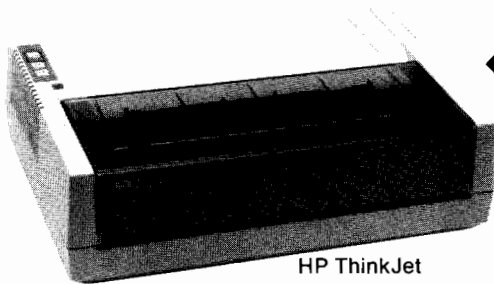

HP ThinkJet

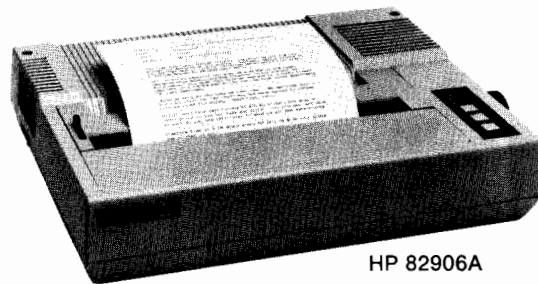

HP 82906A

### Personal Printers

Hewlett-Packard's personal printers offer compact convenience and economy without sacrificing performance.

#### ThinkJet Personal Printer

- 150-cps Printing
- Quiet Operation
- High-quality Text and Graphics
- Three Interface Versions: HP-IB, HP-IL, and Centronics-compatible

The low-cost ThinkJet family of personal printers offers fast, quiet, portable printing. The ThinkJet printers feature a disposable print head cartridge, high-quality printing, and both friction and pin-feed capability. Four different print pitches provide the flexibility you need for a variety of applications ranging from reports to spreadsheets.

#### The HP 82906A Graphics Printer

- 160-cps Bidirectional Printing
- 9 x 11 Dot Matrix Character Cell
- 72 Dots-Per-Inch Raster Graphics
- Last Form Tear-Off

The HP 82906A offers extensive forms handling features. In addition to raster graphics, its printing capabilities include six print pitches (printing up to 137 characters per 8" line), proportional spacing, bold printing, underlining, superscripts, and user-definable character sets. An optional tractor feed accommodates forms from 4" to 9.5" wide.

#### Word Processing Printers and Accessories

HP offers a range of word processing printers and accessories to meet a variety of application needs. You can choose from full-font daisywheel printers, a personal laser printer, and a dual-mode impact printer. All offer professional-looking copies of text with a minimum of operator interaction.

#### The HP 2601A and 2602A Daisywheel Printers

- Letter-Quality Output for Single-User and Shared-Printing Applications
- Comprehensive Selection of Printwheels
- Tractor Feed and Sheet Feeder Accessories
- Accommodates Paper Widths up to 15.25"

The HP 2601A and 2602A Daisywheel Printers offer excellent print quality and similar capabilities for high and low-end word processing requirements. Both printers feature proportional spacing, bold and shadow printing, and underlining. The 25-cps HP 2602A suits low-volume, single-user printing applications, while the 40-cps HP 2601A meets shared and higher-volume printing requirements. Both deliver attractive, accurate letters, memoranda, multipart forms and reports.

#### The HP 2934A Dual-mode Printer

- 200-cps Memo-Quality Printing
- 67- and 40-cps Letter-quality Printing
- 90 Dots-per-inch Graphics
- Word Processing Print Features
- Last-form Tearoff

The HP 2934A Dual-mode Printer offers selectable print speeds, 136-column printing, graphics capability, and a comprehensive selection of printing and paper handling features. When matched with the HP 29340S Single-bin Sheet Feeder, it provides an excellent single-printer solution for those who need letter-quality printing as well as data processing speed and multipart forms capability. Also available are the HP 2932A General Purpose Printer and the HP 2933A Factory Data Printer.

#### The LaserJet Personal Printer

The LaserJet Personal Printer can be found on page 95.

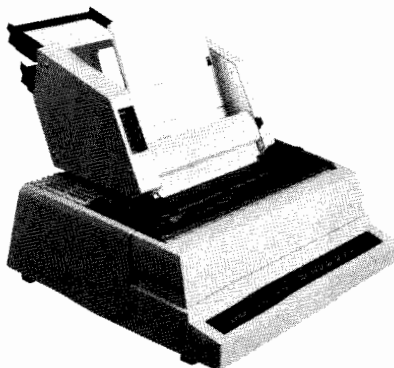

HP 2601A  
with sheet feeder.

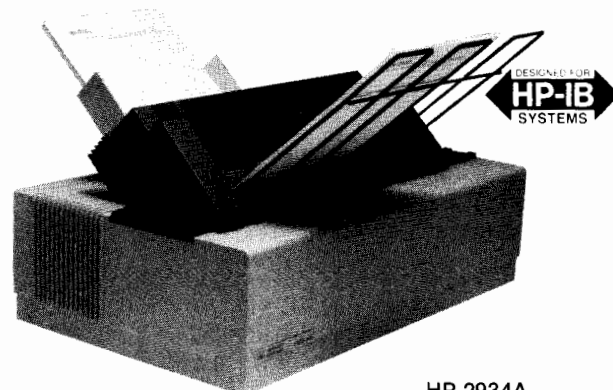

HP 2934A



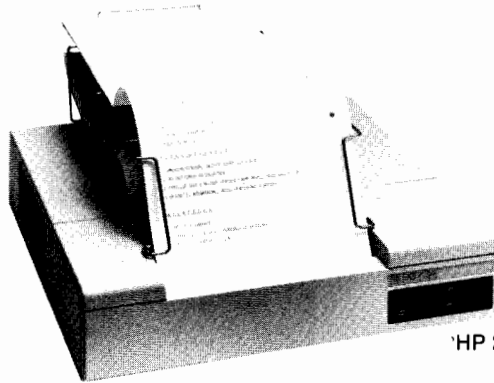

HP 2673A

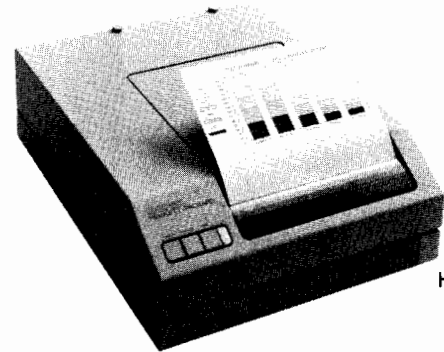

HP 9876A

**General Purpose Printers**

HP's general purpose printers include a range of non-impact and impact printers. The non-impact thermal printers offer quick, quiet printing. The impact printers offer both permanent copy and multipart forms capability.

**The HP 2670 Series Thermal Printers**

- 120-cps Bidirectional Printing
- 7 × 11 Dot Matrix Character Cell
- Interface Flexibility: HP-IB, RS-232C, HP or Centronics Parallel, Factory Data Link, HP-IL
- Fanfold or Roll Paper

**The HP 2671A Alphanumeric Printer**

The 2671A offers fast, quiet convenience printing for business or home. It features the full 128 USASCII, Roman Extension, and line drawing character sets. An ideal desktop printer for terminals, desktop computers, personal computers, or test systems, it generates copies of text pages, program output, or test results.

**The HP 2671G Graphics Printer**

The 2671A has 90-dots-per-inch raster graphics capability in addition to all the features of the HP 2671A.

**The HP 2673A Intelligent Graphics Printer**

The 2673A includes all the features of the 2671G, plus autocentering, windowing, offsets, expanded characters 5 cpi, high density printing, and framing. The 2673A also features JASCII, HPL, Katakana, and nine ISO languages.

Print features and formatting are selected via the control panel, and stored in the printer's nonvolatile memory. Once selected, features come up automatically at printer power-on. Escape sequence commands from the host turn features on or off without altering the setting in the memory.

**The HP 2674A Internal Printer**

The user-installable 2674A Printer for HP 150 users is a space-saving internal printer that offers fast text and graphics and helps preserve quiet in your work area.

**The HP 9876A Thermal Graphics Line Printer**

The 9876A offers fast, quiet line printing at 480 lines per minute. It is ideal for producing high-speed listings, working reports or quick plots and graphics. Featuring HP-IB, 8-bit parallel, and RS-232C interface options, the 9876A is compatible with a wide variety of computers and terminals.

**Ordering Information**

ThinkJet Printer  
 2225A ThinkJet Printer (HP-IB)  
 2225B ThinkJet Printer (HP-IL)  
 2601A Daisywheel Printer  
 26010D Dual-bin Sheet Feeder  
 2602A Daisywheel Printer  
 2671A Thermal Printer  
 2671G Thermal Printer  
 2673A Thermal Printer  
 2674A Internal Printer  
 2932A Impact Printer  
 2933A Bar Code Printer  
 2934A Dual-mode Printer  
 29340S Single-bin Sheet Feeder  
 82906A Impact Printer  
 9876A Thermal Printer

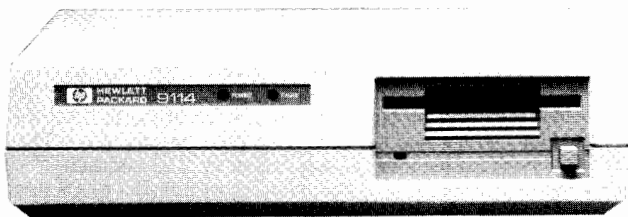

HP 9114A

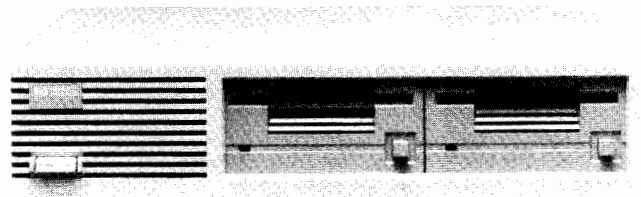

HP 9122D/S



Hewlett-Packard provides a family of low-cost disc drives designed to match the power of HP's wide range of computers and your varying application needs.

Featuring HP-IB or HP-IL interfacing, the personal mass storage family of 3 1/2", 5 1/4", 8" flexible disc drives and 5 1/4" Winchester disc drives provides access to volumes of information on HP portable, personal and technical desktop computers.

The range of disc drives covers the various price, capacity and performance needs of personal, heavy-usage and data interchange mass storage applications.

### 3 1/2" Microfloppy Mass Storage Systems

The 3 1/2" microfloppy disc drives combine reliability and removable media in a compact package. These features are ideal for business and professional applications such as spread sheets, graphics presentations and word processing.

The 3 1/2" media used in the drives is well protected. It is enclosed in a shirt-pocket sized, hard plastic shell. The auto shutter feature protects the recording surface from damage. Additionally, HP's unique Media Monitor tells you when it is time to replace each piece of media by flashing the drive light.

#### HP 9114A Portable 3 1/2" Disc Drive

The HP 9114A is a highly reliable, portable 3 1/2" microfloppy disc drive designed for HP's family of portable computers. It provides up to 710 Kbytes of formatted capacity in a portable, battery-operated package. The HP 9114A works with the portable computers within a closed-loop configuration with HP's Interface Loop (HP-IL) and is supported on the HP 110, Series 40 and Series 70.

The double-sided 3 1/2" drive mechanism and media are identical to those in the HP 9122D and HP 9133D. This allows you to transfer data between the HP 110 portable and the HP 150 personal computers. These 3 1/2" disc drives can also read, write and initialize double-sided media in single-sided format making them compatible with the single-sided drives currently in use.

#### HP 9122D Dual Drive—HP 9122S Single Drive

The new double-sided 3 1/2" microfloppy is available in both single and dual configurations for use with HP's personal and desktop computers. The HP 9122D provides you with up to 1420 Kbytes of formatted capacity and the HP 9122S provides you with up to 710 Kbytes of formatted capacity.

The new double-sided disc media can be formatted in two different formats with bytes per sector depending on mainframe support. The HP drive is supported on the HP 9000, Series 200 (Basic 3.0 and Pascal 3.0) and on the HP 150.

Single-sided 3 1/2" products are also available in a single, HP 9121S, and dual, HP 9121D, configuration for use with HP Series 80 and the HP 150A. The single-sided media stores 270 Kbytes of formatted data per disc.

### Data Interchange

#### HP 9125S

The HP 9125S is a single 5 1/4" disc drive that gives the Touchscreen (HP 150) data compatibility with the IBM PC via 5 1/4" discs. Connected by HP-IB to the HP 150, the drive can read, write and initialize discs in IBM format. Thus, 5 1/4" discs can be exchanged between the HP Touchscreen and the IBM PC for easy data exchange between systems.

The HP 9125S also provides data exchange between HP systems. Using this drive, HP 3 1/2" disc-based technical desktop computers are able to maintain disc compatibility with HP 5 1/4" disc-based desktop computers.

#### HP 9895A Dual Drive (Option 010 Single Drive) 8" Flexible Disc Drive

The HP 8" flexible disc drives provide 8" flexible disc media for large file backup or data exchange, CP/M® standard software or other media-format needs.

The HP 9895A dual drive provides 2.3 Mbytes of removable mass storage plus backup capability. Option 010 single drive provides 1.15 Mbyte capacity.

The HP 9895A reads and writes double-sided, double-density format on HP qualified media. Data exchange with HP and non-HP systems is through the HP 9895A as it can read, write and format industry standard IBM 3740 single-sided, single-density format when used with the appropriate mainframe utility. This is also the format used for CP/M standard data storage.

### Ordering Information

HP 9114A Double-sided Portable 3 1/2" Disc Drive

HP 9122D Double-sided 3 1/2" Dual Disc Drive

HP 9122S Double-sided 3 1/2" Single Disc Drive

HP 9121D Single-sided 3 1/2" Dual Disc Drive

HP 9121S Single-sided 3 1/2" Single Disc Drive

HP 92191A HP Qualified Media (Box of 10) Single-sided

HP 92192A HP Qualified Media (Box of 10) Double-sided

HP 9125S Single 5 1/4" Flexible Disc Drive

HP 91290A 5 1/4" HP Qualified Media (Box of 10)

HP 9895A Dual-drive 8" Master

HP 9895A Single Drive 8" Master (Opt. 010)

HP 92195A 8" HP Qualified media (Box of 10)

## Mass Storage Peripherals

Models HP 9133D, 9134D, 9144A



HP 9133D

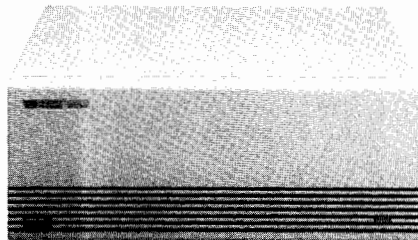

HP 9134D

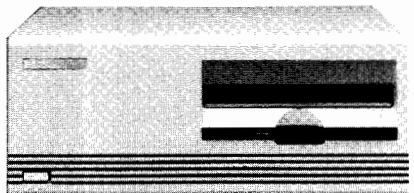

HP 9144A



### Winchester Mass Storage Systems

HP's Winchester systems provide up to 14.8 Mbytes of formatted capacity for HP computer systems, transfer rates of up to 150 Kbytes per second (system dependent), and a drive that is sealed from most contaminants. In addition to business applications, the HP 5/4" Winchester can satisfy the mass storage needs often found in production and other industrial applications. On-line, heavy-usage applications need the high-speed transfer rates, fast random access and large capacity of the HP Winchester mass storage systems. The high capacity of the Winchester systems allow you to keep entire software libraries resident on disc; this not only eliminates the time and trouble of re-loading frequently used programs but actually increases the speed with which most programs will run.

### HP 9133D Winchester/3 1/2" Microfloppy Combination System

The new HP 9133D combines the performance of the 14.8 Mbyte 5/4" Winchester with a double-sided 3 1/2" microfloppy disc drive. The Winchester provides high speed, large capacity, and durability for heavy-usage, while the double-sided microfloppy provides removable storage for loading operating systems, exchanging data among computers and selective file backup. The removable media is fully compatible with the HP 9122D/S and HP 9114A mass storage units. The disc drive can also read, write and initialize double-sided discs in single-sided format to give backward compatibility to single-sided microfloppy drives.

### HP 9134D Winchester (Stand-alone)

The HP 9134D is a 14.8 Mbyte stand-alone Winchester mass storage system for those who have previously purchased a floppy disc system and now need to add Winchester capabilities.

### Tape Backup for Winchester Disc Drives HP 9144A 1/4" Tape Cartridge Subsystem

The HP 9144A is the right backup choice for the Winchester discs. Both individual workstation and small multi-user systems with data base applications such as accounting, engineering graphics, and other technical operations need the backup protection offered by the cartridge tape drive. Designed for disc backup at up to 2 Mbytes/minute (depending on the host), the drive can back up an entire 14.8 Mbyte Winchester in under 8 minutes.

The drive automatically protects valuable data three ways. Error correction capabilities provide data protection during both read and write operations. A built-in media monitor warns when media is becoming worn and should no longer be used.

### Ordering Information

HP 9133D 14.8 Mbyte Winchester plus 3 1/2" Microfloppy

HP 9134D 14.8 Mbyte Winchester, choice of 1-10 volumes

HP 9144A 1/4" Tape Cartridge Subsystem

HP Mainframe Support Table

	9114A	9121D/S	9122D/S	9125S	9133D	9134D	9895A	9144A
Handheld & Portables Series 40, Series 70	x							
Personal Computers Series 80		x					x	
Series 100 HP 110	x	x	x				x	
HP 150A		x						
Touchscreen		x	x	x	x	x		x
Desktop Computers HP 9000 Series 200		x	x	x	x	x	x	x
Series 500							x	x
Mini-Computers HP 1000 Series E/F							x	
A Series		x					x	x
Business Computers HP 3000							Opt. 010	x

Additional support hardware may be required.

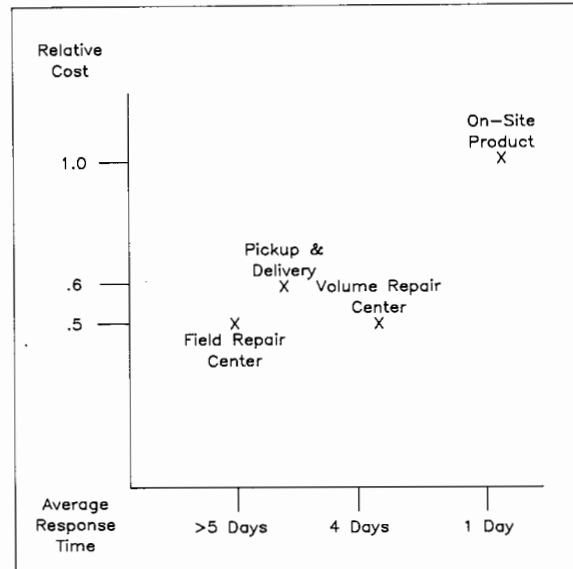

Price/Performance Graph

## Maintenance Returns Lasting Value

For you to receive long-term value from your investment in HP equipment, HP designed a range of maintenance services geared to the features and functions of personal computers and peripherals. Any one of these services will provide the maintenance which keeps your equipment operating at peak performance levels.

While workstation products used as part of a computer system can be covered under that system's maintenance agreement, it is usually more economical to obtain separate coverage for them. Since there are often many of these products at a single location and they are easily transported for maintenance, the services designed for them reflect these characteristics.

Refer to the Price/Performance Graph to compare services on the basis of cost versus turnaround time. In most cases, the annual cost of a maintenance agreement is less than the charge for the parts and labor involved in a single service call. And with an annual agreement, the cost is fixed for the entire year of coverage. Customers under contractual agreement at the beginning of the warranty period for the product receive the additional benefits of that agreement for the entire warranty period at no extra charge.

## On-Site Product Maintenance

This service offers the convenience of an on-site visit from an HP Customer Engineer within one working day of your call if you are located within 100 miles of an HP support office. For locations beyond 100 miles, on-site service is available with an increase in response time and cost. After Coverage Hours support and improved response time are available on a per-incident basis for emergency situations.

## Volume Repair Center Service

This service offers the lowest cost on-site support for your HP workstation products. With a minimum of 25 eligible units, an HP Customer Engineer will make scheduled weekly visits to a single, central site which you may specify. This site must be located within 100 miles of an HP service office.

## Pickup and Delivery Service

For convenience and low cost, this service provides on-site pickup of your workstation product. It is packed and delivered to an HP service center, and, in most cases, returned to you within five days of your call.

## Field Repair Center Service

For sites not located in a Pickup and Delivery zone, Field Repair Center Service offers return-to-HP service for your workstation products. Once a product reaches the center, an HP Customer Engineer repairs it within three days and ships it back to you, prepaid, via normal land freight.

## Dealer Repair Center

Many of HP's personal computing product dealers offer service on the computers and peripherals that they sell. They offer warranty repair and their own ranges of contractual and per-incident repair services.

# COMPUTERS, PERIPHERALS & CALCULATORS

## Personal Computation

Models HP-12C, HP-11C, HP-15C, HP-16C

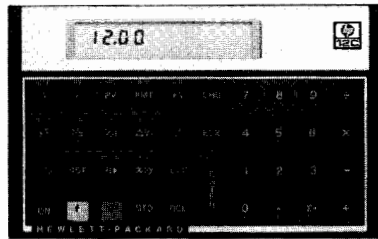

HP 12C

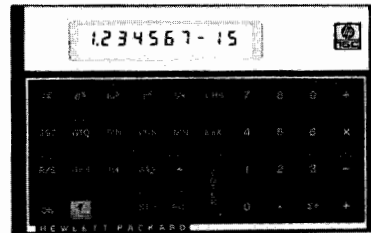

HP 15C

### What's Right for You?

Whether it's a professional calculator, an advanced calculator, or a handheld computer, Hewlett-Packard products can give you the sense of pride that comes from knowing you own a computational tool that has been designed—in every detail—to be the finest of its kind.

HP Series 10 Professional Calculators meet the needs of three groups: business, engineering, and computer science. Use them to solve specific problems and save time by freeing yourself from unnecessary repetitive calculations. All Series 10 calculators are both preprogrammed and programmable. So you can enter a series of keystrokes as a program, store it in memory, and execute it on command.

HP-41 Advanced Calculators can adapt to your task, whether it's performing arithmetic calculations, analyzing data, or controlling a system. There are two powerful models from which to choose. Each is expandable, portable, highly customizable, and runs lots of available software.

The HP-71B Handheld Computer provides the versatility of an advanced calculator and the power of a computer in one portable product. Create your own hardware, software, firmware, and interfaces using complete documentation that lists the HP-71's internal specifications. Expand and customize the HP-71 to suit yourself with Custom ROMs.

The HP-75D Handheld Computer is ideal as a remote data collection and information processing tool, whether operated from the keyboard or used with a bar code wand. Use it in field service and sales reporting, inventory control, tracking work in process, and more. The HP-75D, too, is expandable and customizable.

To assemble completely portable HP-41, HP-71, and HP-75 systems, as well as communicate with instruments and computers, use the versatile HP-IL Interface. It is built into many of the growing family of portable products, and is also available as a separate module. It serves the basic function of interfacing controllers, instruments, and peripherals.

### Series 10 Professional Calculators

#### HP-12C Advanced Financial Programmable with Continuous Memory

Bankers, real estate agents, investors, and other business professionals will find the HP-12C to be invaluable.

The HP-12C is HP's most powerful dedicated financial calculator. With its special functions, programmability, Continuous Memory, and liquid-crystal display, this calculator is ideal for solving most business and financial problems in or out of the office. The HP-12C features basic time and money functions, Net Present Value, Internal Rate of Return, plus a bond function which calculates yield-to-maturity and price. For additional push-button solutions, write your own programs, or take advantage of HP's prewritten software solutions for specific applications.

The HP-12C comes complete with detailed Owner's Handbook and Problem-Solving Guide, long-life disposable batteries, and a soft carrying case.

**Size:** 12.7 x 8.0 x 1.5 cm (5 x 3 1/8 x 5/8 in)

Scientists, engineers, and mathematicians may choose from the potent combination of preprogrammed functions, power and programmability offered by the HP-11C and HP-15C.

#### HP-11C Advanced Programmable Scientific

Programming on the HP-11C is easy to learn and easy to use. The HP-11C has subroutine and indirect addressing capability, conditional tests and flags. Insert new instructions by using the "Go To" key to access any part of a program. Delete a program line by pressing the "Backarrow" key. A convenient User Mode saves time and keystrokes—at the touch of a single key, branch to any one of five independent programs. Dedicated functions include: trigonometrics, hyperbolics and inverses, permutations and combinations, and a random number generator.

The HP-11C comes complete with Owner's Handbook and Problem-Solving Guide, long-life disposable batteries, and a soft carrying case.

**Size:** 12.7 x 8 x 1.5 cm (5 x 3 1/8 x 5/8 in)

#### HP-15C Advanced Programmable with Continuous Memory and Matrix Functions

The HP-15C is an advanced programmable calculator with special functions that let you solve problems involving matrices and complex arithmetic. The HP-15C function set and programming tools are combined in a slim-line design to provide maximum portability. With built-in matrix functions, you can operate with up to five matrices (a maximum of 64 elements). Perform transpositions, determine norms, and find determinants with the HP-15C. The calculator has two parallel stacks, one for the real and another for the imaginary part of a complex number. It also can perform calculations with complex matrices. The HP-15C has solve and integrate functions. Advanced programming features include 448 program lines, label addressing, insert/delete editing, 7 subroutine levels, program review, 10 flags, and conditional tests.

The HP-15C comes complete with Owner's Handbook, long-life disposable batteries, and a soft carrying case.

**Size:** 12.7 x 8 x 1.5 cm (5 x 3 1/8 x 5/8 in)

#### HP-16C Programmable Calculator for Computer Science

The HP-16C is a programmable calculator specifically designed for computer science and digital electronic applications. With the HP-16C number base modes, it is easy to convert between binary, octal, decimal, and hexadecimal bases. The advanced programmability of the HP-16C lets you call and edit programs easily. The HP-16C has extensive bit manipulation capability: shift, rotate, set, test, checksum, and mask. Select word size, 1's and 2's complements, and unsigned mode. Through a program, you can emulate instructions of most available processors. The calculator has four logical Boolean operators: AND, OR, XOR, and NOT.

The HP-16C comes complete with Owner's Handbook, long-life disposable batteries, and a soft carrying case.

**Size:** 12.7 x 8.0 x 1.5 cm (5 x 3 1/8 x 5/8 in)



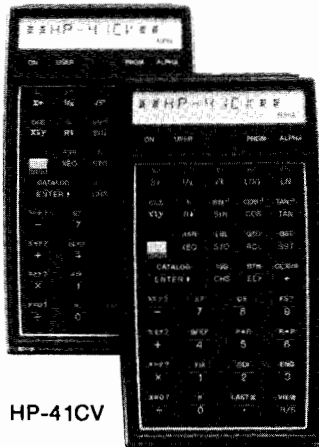

HP-41CV

HP-41CX



HP-71B



## HP-71B Handheld Computer

The HP-71 Handheld Computer is a portable, 12-ounce package that puts a powerful calculation mode, BASIC language, and expansion potential at your fingertips.

Its 64K-byte operating system supports an enhanced BASIC language, a sophisticated file management system, and the advanced calculator mode (CALC). This operating system can be further enhanced by using FORTH or assembler languages.

The HP-71 has 17.5K bytes of built-in user memory. Its versatility is enhanced by the four RAM/ROM ports, which can be added to in any combination of RAM or ROM modules. Using these ports, the HP-71 can have a maximum of 320K bytes of ROM, or a maximum of 33.5K bytes of RAM. A total of 512K bytes of ROM or RAM can be directly addressed. Any of the RAM can be reserved for program or data storage, so you can locate files quickly and protect them from inadvertent RAM removal.

Powerful CALC mode, combined with a 10-digit key pad, allows not only quick solutions, but also fast, easy input of numeric data. Expressions are keyed in from left to right in algebraic format, and intermediate results develop as you go along. Twelve decimal digits of accuracy assure you of precise results. CALC mode interacts with BASIC, too. A variable assigned a value in BASIC retains that value in CALC mode, and vice versa. Any numeric expression that can be keyed in and evaluated in BASIC can also be evaluated in CALC mode. Perform computations on up to 15 independent variables using built-in statistics functions. And use a complete set of trig functions to evaluate complex equations.

Over 240 instructions complement the HP-71 built-in BASIC language. Parameters can be passed from main programs to sub-programs. Enhanced HP-71 BASIC supports the IEEE Radix Independent Floating-Point Math Standard to give more control and accuracy in computations.

Built-in typing aids reduce your program and data entry time. And each key on the keyboard (except the blue and gold shift keys) can be redefined.

A built-in quartz-crystal clock can be set with an accuracy of one second per month or better, and runs even when your HP-71 is turned off. Create and use clock/calendar dependent programs that must begin and run when you can't be there to control the process.

Optional HP-IL interfacing provides access to a broad array of accessories, peripherals, instruments, and other computers, and provides data transfer rates of up to 5,000 bytes per second.

Applications can be customized with plug-in Custom ROM Modules to add unique problem-solving capabilities and a means of permanent, private storage.

The HP-71 is an "open machine," too. HP has documented the internal specifications, and made them available. Hardware and software developers are encouraged to dig deeper and develop hardware, software, interfaces, and firmware. (See the Custom Products and Programming Development Aids on page 68 for publication names and numbers.)

**Size:** 19 x 9.7 x 2.5 cm (7.5 x 3.8 x 1.0 in)

## HP-41 Advanced Calculators

The HP-41CX and HP-41CV Advanced Calculators provide the heart of expanding computational, data acquisition or instrument control systems. They combine the speed, power, and accuracy of computers with the portability, touch-key simplicity, and low cost of handheld calculators. The HP-41CV has 2,237 bytes of main memory, and the HP-41CX has 3,105 bytes of main and extended memory. Each of them can be expanded to a maximum of 6,437 bytes, or 919 data registers by adding Extended Memory Modules. In addition to all the built-in functions of the HP-41CV, the HP-41CX features built-in Time and Extended Functions/Memory modules, a text-file editing function, and 19 other functions not available in the HP-41CV.

The HP-41 RPN (Reversed Polish Notation) logic system lets you solve complicated calculations with ease. The intermediate results of each operation are shown, making it easy to recover from errors.

The alpha capability of the HP-41 lets you label programs with easy-to-remember names. Each program is autonomous and each can have up to 100 different local labels for branching within a program. The HP-41 also features up to six levels of subroutines, 10 conditional tests, 56 internal flags, powerful loop control, indirect addressing, and both local and global branching.

Over 200 separate operations (over 128 in the HP-41CV) reside in the HP-41CX function catalog, with 58 of these right on the keyboard. Functions and programs can be assigned to almost any key. The HP-41 comes with keyboard overlays and a set of user labels to help facilitate customization.

Key in any combination of letters and numbers up to 24 characters wide and display 12 characters at a time. A complete system of status annunciators indicates mode conditions. Error messages pinpoint calculation errors and ten different tones provide audible feedback. Continuous Memory saves programs and data even when the computer is turned off. (For additional specifications, refer to the Comparison Chart on page 64.)

A variety of dedicated, plug-in peripherals expand the capabilities of the HP-41. In addition, both calculators are HP-IL compatible. Simply plug in the HP 82160A HP-IL Module to connect up to 30 HP-IL devices using only one port. Through HP-IL, the HP-41 is capable of transmitting and receiving data, and performing a wide variety of control functions. With the help of HP-IL interface converters, HP-41 Advanced Calculators can communicate with larger computers, peripherals, modems, terminals, and instruments.

Surrounding the HP-41 is a broad range of software solutions. Choose from HP-written Application Pacs and Solutions Books, and Users' Library programs. Hewlett-Packard offers a Custom Products Program for those who require customized software solutions in large quantities. (See page 68 for more information on Custom Products.)

**Size:** 3.3 x 7.9 x 14.2 cm (1.3 x 3.1 x 5.7 in).



# COMPUTERS, PERIPHERALS & CALCULATORS

## Personal Computation Comparison Chart

	Calculators					Handheld Computer
	Financial	Scientific	Computer Science	Advanced		
	HP-12C	HP-11C	HP-15C	HP-16C	HP-41CV/CX	HP-71B
<b>Operating Features</b>						
Continuous Memory	•	•	•	•	•	•
RPN logic system	•	•	•	•	•	•
Algebraic system						•
BASIC language						•
FORTH/Assembler languages						S
Error recovery (last x)	•	•	•	•	•	•
Maximum number of storage registers	20	21	67	101R	919*	•
Maximum number of digits displayed	10	10	10	10F	10	12
Number of digits used in computation	10	10	10	10D	10	12
Rechargeable batteries/AC recharger					•	•
Long-life disposable batteries	•	•	•	•	•	•
AC Adapter						•
<b>Software Support</b>						
Application Pacs (with modules)					•	•
Application Pacs (with magnetic cards)						•
Solution Books/Handbooks	•	•	•		•	•
Users' Library programs					•	•
<b>Accessory Support</b>						
Memory Modules					•+	•
Extended Memory Modules					•	•
Enhancement Modules					•	•
Multipurpose rechargeable battery pack					•	•
AC Adapter						•
<b>General Features</b>						
One-year limited warranty	•	•	•	•	•	•
Display separates thousands (in BASIC on HP-71B, by program control)	•	•	•	•	•	•
Diagnostic self-check	•	•	•	•	•	•
Error codes/messages	•	•	•	•	•	•
Redefinable keys						•
Alpha mode/display/keyboard						•
Status annunciators	•	•	•	•	•	•
Automatic power off	•	•	•	•	•	•
Audible tones						•
<b>Programming Features</b>						
Maximum number of program lines	99	203	448	203	6,433*	•
Shared program/storage memory	•	•	•	•	•	•
Alpha program labels						•
Single-character program labels		5	5	6	56	‡
Numeric program labels		10	20	10	100	‡
Program review (single- and backstep)	•	•	•	•	•	•
Insert/delete editing	•	•	•	•	•	•
GO TO	•	•	•	•	•	•
Levels of subroutines		4	7	4	6	6
Conditional tests	2	8	12	8	10	Unlimited
Flags	•	2	10	6	56	106
Pause						•
Indexed looping (DSE, ISG)		•	•	•	•	•B
Indirect control of: Data storage/recall		•	•	•	•	•B
Storage register arithmetic		•	•	•	•	•B
Branching		•	•	•	•	•B
Looping		•	•	•	•	•B
Display format		•	•	•	•	•B
Flags		•	•	•	•	•B
Integer/fraction truncation	•	•	•	•	•	•B
Alpha string manipulation						•B
<b>Dedicated Input/Output Devices</b>						
Card Reader					P	P
Printer/Plotter					P	P
Optical wand					P	P
<b>HP-IL Peripherals</b>						
Digital Cassette Drive					P	P
Thermal Printer/Plotter					P	P
Impact Printer (80-column)					P	P
ThinkJet Printer					P	P

**Symbols**  
 • Built-in feature or function.  
 + To be used with the HP-41C only.  
 \* The HP-41CV has 319 registers or 2,233 bytes built in, (expandable to 6,454 bytes).  
 The HP-41CX has 443 registers or 3,105 bytes of main and extended memory built in (expandable to 6,454 bytes).  
 The HP-71 is limited only by available memory.  
 ‡ With the HP-71, any BASIC program can be labeled with up to eight alpha characters.

	Calculators					Handheld Computer
	Financial	Scientific	Computer Science	Advanced		
	HP-12C	HP-11C	HP-15C	HP-16C	HP-41CV/CX	HP-71B
<b>HP-IL Interfaces:</b>						
HP-IB						P
RS-232C						P
Series 80						P
<b>General Arithmetic Features</b>						
+ , - , X , / , √x , 1/x , CHS	•	•	•	•	•	•
Ln x , e <sup>x</sup>	•	•	•	•	•	•
y <sup>x</sup> , Log x , 10 <sup>x</sup> , x <sup>2</sup> , x	•	•	•	•	•	•
Absolute value						•
Storage register arithmetic	•	•	•		•	•
<b>Business Features</b>						
Maximum number of dedicated financial registers	5					
Solves for:						
Number of periods (n), compound interest (i), present value (PV), payment (PMT), future value (FV)	•	S	S		S	S
Simple interest	•	S			S	S
Amortization (accumulated interest/remaining balance)	•	S			S	S
Net present value (NPV) and internal rate of return (IRR)	•		S		S	S
Beginning/end of period selection	•	S	S		S	S
Calendar functions	•				S	•
Clock						•
Bond:						
Yield-to-maturity	•				S	
Price	•				S	
Depreciation (SL, DB, SOYD)	•	S			S	
<b>Scientific Features</b>						
Solve (root finder)		S	•		S	S
Integrate (numerical integration)		S	•		S	S
Math Exceptions			•		S	•
Matrix operations			•		S	S
Complex functions		S	•		S	S
Bit manipulation				•	S	S
Boolean operators (NOT, OR, AND, XOR)				•	S	S
Complement modes (1's, 2's, unsigned)				•	S	S
Number base arithmetic (binary, octal decimal, hexadecimal)				•	S	S
Metric conversions					S	S
Trigonometric functions: Modes (degrees, radians, grads)		•	•		•	•
Sin, Sin <sup>-1</sup> , Cos, Cos <sup>-1</sup>		•	•		•	•
Tan, Tan <sup>-1</sup>		•	•		•	•
Hyperbolics and inverses		•	•		S	S
Rectangular ↔ polar coordinates		•	•		•	•
Decimal angle ↔ angle in degrees (hrs)/min/sec.		•	•		•	•
Degrees ↔ radians		•	•		•	•
Fixed and scientific notation		•	•	•F	•	•
Engineering notation		•	•		•	•
Automatic under/over flow into scientific	•	•	•	•F	•	•
<b>Statistical Functions</b>						
Percent	•	•	•		•	•
Percent change	•	•	•		•	•
Percent total	•	•	•		•	•
Mean/standard deviation (1- or 2-variable; up to 15 variables on HP-71)	•	•	•		•	•
n, Σx, Σx <sup>2</sup> , Σy, Σy <sup>2</sup> , Σxy	•	•	•		•	•
Weighted mean	•	•	•		S	•
Linear regression or estimate	•	•	•		S	•
Correlation coefficient	•	•	•		S	•
Normal distribution	S	S	S		S	S
Factorial function	•	•	•		S	S
Gamma function	•	•	•		S	S
Random number generator	S	•	•		S	•
IEEE Floating-Point math standard				S		•

**B** BASIC.  
**D** Ten digits are used in computation when in Floating-Point Decimal Mode. Word size is user-specifiable in other modes, up to 64 bits.  
**F** Using Floating-Point Decimal Mode.  
**P** Peripheral available.  
**R** 16-bit registers.  
**S** Available in software form.

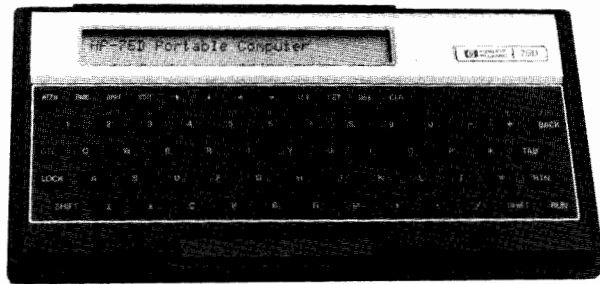

HP-75D



### HP-75D Handheld Computer

The HP-75D is ideal as a remote data collection and information processing tool whether operated from the keyboard or used with a bar code wand. It has an 8-bit CMOS Series 80 personal computer CPU with built-in HP-IL and Digital Bar Code Wand interfaces.

The HP-75D is a fully-integrated, battery-powered computer weighing only 26 ounces and measuring 10 x 5 x 1.25 inches. Its information handling capability and accuracy compares favorably with what you would expect of larger desktop computers.

Data collected with the HP-75D can be processed at remote sites or transferred to another computer using the portable HP 82168A Acoustic Coupler or the HP 82718A Expansion Pod. The HP-75D can communicate with other HP computers and peripherals also, using the HP 82164A HP-IL/RS-232C or HP 82169A HP-IL/HP-IB Interfaces.

Special built-in programming features mean the HP-75D can be easily customized to meet your specific needs. Keys can be completely redefined. HP's Custom Products program is available when you want customized software modules, magnetic cards, or keyboard overlays.

The built-in 48K-byte ROM BASIC operating system has 167 system commands, including 41 numeric functions. Multiple file structure allows any number of files (up to available memory space) to be in memory at the same time. The built-in text file allows storage of text and basic files.

The HP-75D offers a maximum of 24K bytes of RAM, with 16K bytes built-in and an optional 8K-byte memory module (HP 82700A). Three ports hold up to 96K bytes of applications ROM modules. Continuous Memory assures that data and programs will be saved even when the computer is turned off. A typewriter-like keyboard allows for fast data entry, and more than 190 key combinations can be redefined. Simple keystrokes call up a "hidden" numeric keypad for quick input of numeric data.

Built-in Digital Bar Code Wand and HP-IL interfaces provide the key to the HP-75D's conversion into a full-fledged, versatile system. The HP-75D becomes a single integrated data communications package when used with the HP 82718A Expansion Pod (which has built-in 3 of 9 Code and Code 11 software, 300 baud modem, and electronic disc). For five more bar code decoders, slip the HP 82725A Bar Code Reader Module into one of the ports on the HP-75D. (The HP 92267A/B Digital Bar Code Wand is required to read bar code.)

With HP-IL, it's easy to connect up to 30 devices for mass-storage on cassettes, printing, plotting, measurement and access to larger systems. HP-IL interface converters also make it possible to connect the HP-75D to HP-IB, RS-232C, and GPIO devices, and to HP Series 80 personal computers. Three rechargeable nickel-cadmium batteries permit two to three weeks of normal use between charges, or 20 to 30 hours of continuous use.

A built-in appointment function provides personal scheduling, audio alarm, and message options. TIME mode calls up the system clock and allows the execution of time- and date-dependent programs.

A built-in card reader allows the use of small, inexpensive magnetic cards for storage of programs, text files, data files and keyboard redefinitions, up to a capacity of 1.3K bytes per card.

The liquid-crystal display acts as a 32-character window on a 96-character line. View the entire line by scrolling. The 256-character set includes both upper- and lowercase ASCII characters with true descenders, as well as several special characters.

The HP-75 comes complete with Owner's Manual, Reference Manual, Owner's Pac, Keyboard Overlay Kit, field case, rechargeable battery pack, recharger/AC adapter, HP-IL cables, and card holder.

**Size:** 12.7 x 25.4 x 3.2 cm ( 5 x 10 x 1.25 in)

**Weight:** 737.1 g (26 oz)

### Ordering Information

HP 12C  
HP-11C  
HP-15C  
HP-16C  
HP-41CV  
HP-41CX  
HP-71B  
HP-75D

### Enhancements and HP-IL Peripherals

#### HP-41:

##### HP 82180A Extended Functions/Memory Module

This module (built into the HP-41CX) increases the HP-41 programming function set by adding such functions as programmable SIZE and ASSIGN, plus string functions. It also provides functions for accessing extended memory and 868 bytes of solid-state mass storage.

##### HP 82181A Extended Memory Module

This module provides an additional 238 data registers, or 1,666 bytes, of solid-state mass storage to the HP-41. Up to two HP 82181As may be used in the HP-41. (The HP 82180A Module is required when using the HP 82181A with the HP-41CV.)

##### HP 82182A Time Module

The Time Module expands the HP-41CV with time information and time-controlled operations. (The HP-41CX has the same capabilities plus five more built-in.) With this module, the HP-41 can become a time-scheduled system controller, an alarm clock, an appointment reminder, a calendar, a timer, even an advanced stopwatch.

##### HP 82183A Extended I/O Module

Provides easy-to-use I/O functions which enhance HP-41 control of the HP-IL loop. This 4K-byte module provides 59 functions beyond those provided by the HP 82160A HP-IL Module. These functions enhance mass storage, character manipulation, HP-IL control and advanced control of the HP-41 and devices on the HP-IL loop.

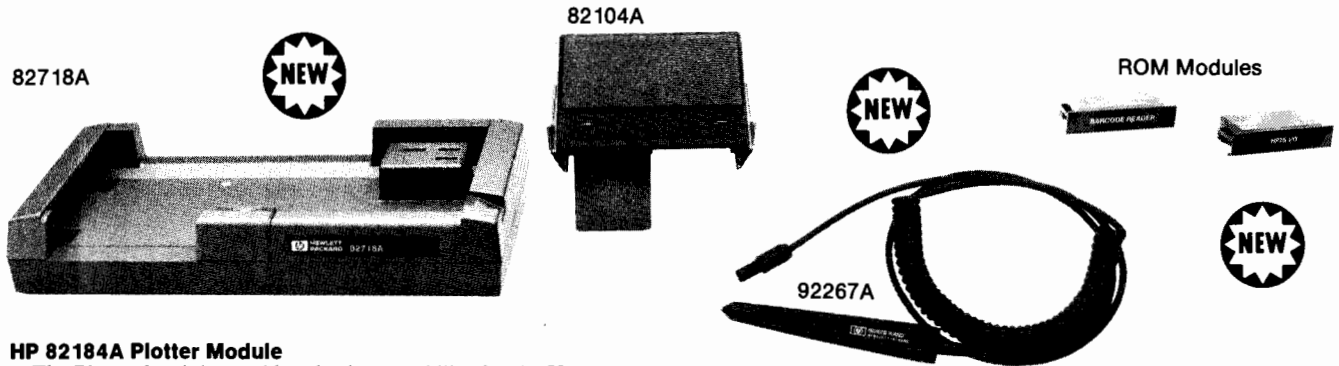

#### HP 82184A Plotter Module

The Plotter Module provides plotting capability for the HP-41 using the HP 7470A Plotter, Opt. 003 or HP 82162A Printer/Plotter. Plotting programs are included in the module for quick and easy generation of high-quality graphics. With the module, you can develop graphics programs as well as plot and print HP bar code.

#### HP 82160A HP-IL Interface Module

The HP-IL Interface Module plugs into any one of the four ports in the HP-41, connecting it with HP-IL peripherals and instruments. The module gives the HP-41 control of up to 30 devices on the loop. Three function sets are supplied by the HP-IL module: printer, mass storage, and general input/output (I/O).

**Size:** 2.8 x 1.2 x 0.4 cm (1.1 x 0.5 x 0.2 in)

**Cable length:** (two attached cables) 80 cm each (31 in. each)

**Data Transfer Rate:** 150 bytes per second (typical HP-41 transfer rates)

#### HP 82104A Card Reader

The HP-41 Card Reader allows programs and data to be saved on magnetic cards. Each card contains 32 registers, 16 per side. It adds over 30 card reader control functions to the HP-41, keeps track of cards as they are read, and prompts for the next card. A security feature permits a program to be run, but not reviewed or altered through normal operations. It also reads HP-67/97 program cards, making all necessary translations into HP-41 code.

#### HP 82143A Thermal Printer/Plotter

Portable, quiet, and battery-powered, the HP 82143A plugs directly into an I/O port in the HP-41. Provides numeric, upper- and lower-case alpha, double-wide characters, high-resolution plotting capabilities, and intensity control for optimum contrast and readability. Allows for user-defined special characters.

#### HP 82153A Optical Wand

Easily inputs data or programs into the HP-41. When passed across a printed page of HP bar code, the wand translates all programs and data into usable form and loads it into the HP-41. Most HP-41 software is available in HP bar code, including Users' Library programs and Solutions Books.

#### HP 00041-15042 Automatic Start and Cassette Duplication Module

The automatic start feature provides a means of writing "fool-proof" HP-41 programs. With the module installed, the HP-41 goes through a special sequence when it is turned on, which lets you write programs that automatically set status, configure memory, access peripherals, or provide prompts. The mass copy feature provides an easy-to-use means of duplicating programs and data. The information on one HP 82161A Digital Cassette Drive can be copied onto as many as 29 other cassettes simultaneously.

#### HP 00041-15043 HP-IL Development Module

This module makes it possible to add a second HP-41 to the HP-IL loop. In Scope mode, a second HP-41 can be used for displaying the mnemonics of HP-IL messages as they travel around the loop. Giving direct access to the HP-IL integrated circuit, the Development Module allows you to change the contents of any control register and poll certain status bits. Characters can be inserted at, or removed from, any position in the Alpha register.

#### HP-71:

##### HP 82420A 4K Memory Module

This module provides an additional 4K bytes of programmable memory. Up to four modules plug into front ports on the HP-71 for a maximum of 16K bytes of additional RAM.

##### HP 82401A HP-IL Interface

The HP-IL Interface allows direct connection to any HP-IL product, and to HP-IB, RS-232C, and GPIO devices using interface converters. This module facilitates simultaneous control of up to 30 devices on the loop including instruments and peripherals, and through secondary addressing, up to 930 devices. The 16K bytes of ROM in the Interface provide for printer, display, mass storage, and general input/output operations. Multiple HP-71s can be connected on the interface loop.

##### HP 82400A Card Reader

The card reader offers an inexpensive means of storage for programs and data. Cards can be encoded as a private file so that they may be copied and executed, but not viewed or edited. Automatic verification assures the accuracy of the information on the cards. Simple encoding protects cards from being overwritten.

#### HP-75:

##### HP 82700A 8K Memory Module

This module gives an additional 8K bytes of programmable memory. Plug it into the HP-75 for a maximum of 24K bytes of RAM.

##### HP 82718A Expansion Pod

Attach the HP 82718A Expansion Pod to your HP-75D for data communications capability in the form of a 300-baud, direct-connect modem and 32K or 64K bytes of electronic disc. Modem and electronic disc commands are built into the pod's 16K-byte ROM software. The direct-connect, serial, asynchronous, full-duplex modem is compatible with Bell 103/113 modems.

Electronic disc uses RAM to emulate a flexible disc as a high-speed disc drive, for fast data transfer and data file access. Electronic disc commands let you create, access and modify files, establish a hierarchical directory structure, and copy files into and out of the electronic disc. It's nonvolatile, so your information is retained, even when the computer is turned off.

The pod even has two industrial bar code decoders built in—3 of 9 Code and Code 11.

##### HP 82725A Bar Code Reader Module

The software that decodes scanned bar code comes packaged in this 8K-byte ROM module.

The module can decode 3-of-9 Code, Interleaved 2-of-5 Code, Industrial 2-of-5 Code, 2-of-7 Code, Code 11, Universal Product Code (UPC A or E), or European Article Number (EAN 8 or 13). (This module is not required to read 3-of-9 Code or Code 11, if you have the HP 82718A Expansion Pod.) Use the module with the HP 92267A or HP 92267B Bar Code Reader wand.

# COMPUTERS, PERIPHERALS & CALCULATORS

Personal Computation

Enhancements & HP-IL Peripherals

67



82168A



ThinkJet

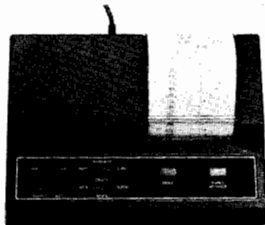

82143A



The HP-75D can process that data on the spot or send it to a text file, video monitor, or a host computer via modem and phone line. Text files can be sent to a host computer or stored on a digital cassette.

The module will reliably decode bar code that has a minimum element width of 0.0075 inch; and is read with a minimum scan speed of 3 inches per second (IPS) and a maximum scan speed of 30 IPS. A maximum string length of 42 characters can be decoded.

## HP 92267A/B Digital Bar Code Wands

These wands were designed for use with the HP 82725A Bar Code Reader Module. The HP 92267A is a high resolution (0.13 mm, or 0.005 in) wand that's recommended for reading high density labels which are generally produced on specialized printers. The medium resolution (0.19 mm, or 0.0075 in) HP 92267B is recommended for reading bar code labels produced on good quality dot matrix printers.

## HP 00075-15001 I/O ROM

The I/O ROM enhances the BASIC language capability of the HP-75D with HP-IL controller and advanced programming commands. It can be used with any HP-IL talker or listener device. The major I/O statements provided by the ROM are OUTPUT, ENTER, SENDIO, ENTIO\$, and SEND. Using these, and other I/O statements in BASIC programs, you can perform a wide variety of input/output tasks.

## HP-41, HP-71, and HP-75:

### HP 82161A Digital Cassette Drive

The Cassette Drive uses a digital-quality mini-cassette, capable of storing up to 128K bytes of information. Rewind time is under 30 seconds and read/write operations are executed at nine IPS, with search speed at 30 IPS. All tape movement is under microprocessor control, and buffer space provides temporary storage of directory information to help minimize access time and tape motion. The Cassette Drive can locate files when under program control. It also features STANDBY mode, enabling an HP-IL controller to turn the drive on or off remotely.

**Size:** 17.8 x 13.2 x 6.1 cm (7 x 5.2 x 2.4 in)

#### Data Format

Number of tracks: 2

Density: 335 bits per cm (850 bits per inch)

Format: 256 bytes/record (8 bits/bytes)

Formatted capacity: 512 records (131,072 bytes)

### HP 82162A Thermal Printer/Plotter

This HP-IL compatible printer/plotter provides numeric upper- and lowercase alpha, doublewide characters, and intensity control for optimum contrast and readability.

The chief enhancements of the HP 82162A over the HP 82143A dedicated Printer/Plotter are a 101-character buffer for enhanced graphics capabilities and a FORMAT function which automatically centers or justifies copy to the left and right margins.

The Printer/Plotter also supports STANDBY mode, so that any HP-IL controller on the loop can manage its power consumption.

**Size:** 17.8 x 13.2 x 6.1 cm (7 x 5.2 x 2.4 in)

**Cable length:** 86 cm (34 in)

#### Character Sets

96 standard ASCII

127 modified-expanded ASCII

### HP 2225B ThinkJet Personal Printer

ThinkJet prints bidirectionally at 150 characters per second to produce 80-column pages of graphics or text in the office or in the field. With sound pressure at under 50 decibels, printer noise need never interrupt your train of thought again.

An inexpensive, disposable cartridge holds the print head and ink reservoir, and can print about 500 pages before replacement. Ink is delivered to the paper on demand, and dries immediately.

The 11 x 12 dot-matrix format text mode has a logic-seeking feature to find the fastest print route. Bold mode won't slow printing speed. A ROMAN8 character set provides 216 printable characters to meet your multilingual printing needs. Print on single sheets or fanfold paper.

**Size:** 8.9 x 29.2 x 20.6 cm (3.5 x 11.5 x 8.1 in)

## Disc Drive, Printer, and Plotter Options

In addition to the peripherals described above, a disc drive, another printer, and a plotter which can be used with the HP-41, HP-71, and HP-75 are listed below. For a detailed description of each, refer to Disc Drives, Printers, and Plotters beginning on pages 59, 57, and 98. HP 9114A Disc Drive; HP 2671A/G Alphanumeric/Graphics Thermal Printer; HP 7470A Graphics Plotter.

## HP 82168A Acoustic Coupler (modem)

The Acoustic Coupler is a telephone interface device that provides remote communications capabilities for HP-41, HP-71 and HP-75 through HP-IL. With the coupler, you have access to "dial-up" computer systems through a telephone line. Data transmission rate is 300 baud, and it works anywhere a conventional (G-type) receiver is available.

The Extended I/O Module, HP-41 and the coupler are all that are necessary for HP-41 operation. The I/O ROM or Utilities Card (available in the HP-75 Solutions Book) is required for HP-75 operation. The Terminal Emulator program, available in the Acoustic Coupler Owner's Manual, is a convenient addition.

**Size:** 25.7 x 9.7 x 5.7 cm (10.1 x 3.8 x 2.2 in)

## Ordering Information

### HP-41:

HP 82180A Extended Functions/Memory Module

HP 82181A Extended Memory Module

HP 82182A Time Module

HP 82183A Extended I/O Module

HP 82184A Plotter Module

HP 82160A HP-IL Interface Module

HP 82104A Card Reader

HP 82143A Thermal Printer/Plotter

HP 82153A Optical Wand

HP 00041-15042 Automatic Start and Cassette Duplication Module

HP 00041-15043 HP-IL Development Module

### HP-71:

HP 82420A 4K Memory Module

HP 82401A HP-IL Interface

HP 82400A Card Reader

### HP-75:

HP 82700A 8K Memory Module

HP 82718A Expansion Pod

HP 82718A Opt. 064 Expansion Pod

HP 82725A Bar Code Reader Module

HP 92267A Digital Bar Code Wand

HP 92267B Digital Bar Code Wand

HP 00075-15001 I/O ROM

## HP-41, HP-71, and HP-75:

HP 9114A Disc Drive

HP 82161A Digital Cassette Drive

HP 82162A Thermal Printer/Plotter

HP 2225B ThinkJet Personal Printer

HP 2671A/G Alphanumeric/Graphics Thermal Printer

HP 7470A Opt. 003 Graphics Plotter

HP 82168A Acoustic Coupler

## HP-IL Instruments and Interfaces

### HP-41, HP-71, and HP-75:

#### Instrument Options

The listing below outlines the instruments which can be used with the HP-41, HP-71, and HP-75. For a detailed description of each, refer to the Instruments section, beginning on page 240.

HP 3468A Digital Multimeter; HP 3421A Data Acquisition/Control Unit; HP 5384A/HP 5385A Opt. 003 Frequency Counters; HP 5006A Signature Analyzer.

### HP 82164A HP-IL/RS-232C Interface

This device translates HP-IL signals into RS-232C signals and vice versa. It is designed to allow inter-connection of HP-IL systems with RS-232C devices. The interface provides bit-serial asynchronous data communication. Information can be sent and received (in true half- and full-duplex mode) in EIA RS-232C compatible voltage levels. Use it to interface HP-IL mainframes to computers, terminals, peripherals, and modems. Comes packaged with one HP-IL cable and an ac adapter.





82169A

**HP 82169A HP-IL/HP-IB Interface**

The HP-IL/HP-IB Interface permits linkage of HP-IL systems with HP-IB (IEEE 488, 1978) computers and lab equipment. Its key feature is its friendly, flexible two-mode operation. In Translator mode, a controller and devices to be controlled may exist on one or both sides of the interface. In Mailbox mode, controller systems exist on both sides of the interface. The interface responds to most HP-IL and HP-IB commands. Power is supplied by the accompanying ac adapter.

**HP 82165A HP-IL/GPIO Interface**

The GPIO Interface allows HP-IL to control equipment operating with parallel bus structures. This device contains I/O buffering and a built-in power supply that operates from an HP standard ac adapter, (included with the HP 82165A). Potential applications for the HP 82165A include interfacing to computers for data collection, interfacing to specialized devices in production or lab environments, and interfacing to devices such as printers with parallel interfaces.

**HP 82938A HP-IL/Series 80 Interface**

The HP 82938A Interface provides a communication link between the portable world of battery-operable products and the world of larger computers. Use an HP-41, HP-71, or HP-75 to gather data in the field, and then access an HP Series 80 personal computer to do more complex analyses. With the built-in graphics capabilities of an HP-85 or HP-86 Personal Computer, data can be displayed in easy-to-understand graphs and charts, or passed on to an even larger computer using Series 80 data communication products.

**HP 92198A Mountain Computer HP-IL 80-Column Video Interface (U.S.)**

Use this interface to display data and listings from an HP-41, HP-71, or HP-75/HP-IL system on a standard video monitor. Add an RF modulator and use it with a conventional TV set. View your electronic spreadsheet, word processing, and other applications in 24 row by 80 column format, or choose 20 rows by 40 columns. Characters also can be displayed in inverse video.

**HP 45643A Extended I/O Accessory**

The HP 45643A provides a communication link between The PORTABLE and the Touchscreen or Touchscreen MAX computers via the HP-IL interface. This powerful HP-IL link allows the transfer of up to two pages of text per second, with 500 words per page. Two ports are integral to the HP 45643A: two for HP-IL, and one for Centronics (parallel). Leverage the investment made in higher capability peripherals such as Winchester discs and letter-quality printers across several machines by using this accessory. Comes with instructions, plus software on a 3 1/2" disc.

**HP 82973A HP-IL Interface Card**

The HP 82973A provides a communication link between The PORTABLE and IBM PC/XT computers via HP-IL interfacing. Use it to transfer up to two pages, with 500 words each, of text per second. Take advantage of the convenience of a portable system including the HP 9114A Disc Drive and ThinkJet Printer, plus the power of a desktop system. Leverage the investment made in higher capability peripherals such as Winchester discs and letter-quality printers across several machines. Comes with instructions, plus software on a 5 1/4" disc.

**HP 82166C HP-IL Interface Kit**

The Interface Kit provides the necessary special components designed for incorporation into devices using the HP-IL Interface. Three components are key to implementing the HP-IL interface

standard: the HP-IL integrated circuit, the HP-IL transformer set, and the HP-IL panel receptacle. Included are complete component-level documentation, four complete sets of parts for prototype evaluation, and HP-IL development software for use on HP-41, HP-71, and HP-75 calculators and computers.

**Ordering Information****HP-41, HP-71, and HP-75:**

HP 3468A Digital Multimeter  
 HP 3421A Data Acquisition/Control Unit  
 HP 5006A Opt. 030 Signature Analyzer  
 HP 5384A/5385A Opt. 003 Frequency Counters  
 HP 45643A Extended I/O Accessory  
 HP 82164A HP-IL/RS-232C Interface  
 HP 82165A HP-IL/GPIO Interface  
 HP 82169A HP-IL/HP-IB Interface  
 HP 82938A HP-IL/Series 80 Interface  
 HP 82973A HP-IL Interface Card  
 HP 92198A Mountain Computer HP-IL 80-Column Video Interface (U.S. only)  
 HP 82166C HP-IL Interface Kit

**Accessories****Series 10, HP-41, HP-71, and HP-75:**

No matter what type of Hewlett-Packard calculator or computer you purchase, it is supported by a complete line of accessories and supplies. Such items as owner's manuals, programming pads, magnetic cards, thermal paper, battery packs, rechargers, and software manuals are readily available.

**Custom Products and Programming Development Aids**

HP Custom Products satisfy the growing need for specialization in portable computing products. Through customization, the powerful HP-41, HP-71, and HP-75 calculators and computers can be tailored to do complex and repetitious calculations or data acquisition tasks when and where needed. Proven Custom Products applications in banking, insurance, fuel savings, media buying, sales and service, and other areas provide the same results: increased performance and improved productivity.

Using customer- or third-party written programs, the HP-41, HP-71 or HP-75 can be customized using any of these options: Custom ROMs, Custom Magnetic Cards, and Custom Keyboard Overlays. The HP-41 also can be customized with Custom Keyboard Touchpads and Bar Code. When selecting one of these alternatives, consideration is given to the frequency of code alterations, desired program capacity, updating of variables in the data, required level of privacy, and initial investment. Bar code is supplied by an HP-approved independent vendor.

To make the customization process easy, the services of Independent Custom Consultants (ICCs) are provided. (A list of ICCs is available from your HP Sales Representative.) ICCs are application-oriented software houses with in-depth training on HP products. They convert software to finished Custom Products, and can write and field test software, package the system, write user's manuals, and more. To begin, choose and contact an ICC, who will provide the information you need to decide if Custom Products are right for you.

**HP-41:****HP-41CV or HP-41CX Opt. 001 Custom Calculator**

A custom HP-41CV or HP-41CX Option 001 with a blank keyboard eliminates unnecessary and possibly distracting nomenclature. This special option allows you to label those keys that precisely fit your application, minimizing potential error. Custom Keyboard Overlays and Custom Keyboard Touchpads label keys to provide the final professional touch.

**HP 82504A Custom Keyboard Touchpads**

Relabel the HP-41 keyboard with special functions assigned to each key. Available in a variety of background and printing colors.

**HP Bar Code**

Bar code is extremely cost efficient, and easy to use, duplicate,



and distribute. It also provides storage on paper which can be copied. Bar code can represent any operation that can be performed from the keyboard, and preserves special key assignments, programs, and data. You can even reproduce it using the HP 82184A Plotter Module.

#### **HP 82505 Software Development System**

The HP 82505 Software Development System (SDS) allows development of plug-in ROM software on HP-41 Advanced Calculators. The programs developed are converted to ROM image on the SDS. After field-testing and debugging is completed, copy the programs to a floppy disc. (This service can be performed by an ICC.) HP will manufacture ROM Modules from software contained on the disc. Contact an ICC for more information.

#### **HP-71:**

#### **HP 82440A Software Development Utility**

Allows development of HP-71 BASIC, FORTH, or assembly language source files using a personal computer. Then transfer the files to the HP-71. The HP-71 transfer programs are included in the Software Development Utility. Listings of typical programs for Series 80 and IBM PC computers, as well as instructions for setting up other PCs, are included. An HP-IL/HP-IB or HP-IL/RS-232C Interface is required.

#### **HP 82441A FORTH/Assembler**

The FORTH/Assembler ROM provides an extended software development environment for your HP-71. The FORTH operating system is a very effective language for instrument control applications because of its speed and versatility. HP-71 FORTH enhances the FORTH 1983 Standard word capability set with string manipulation words, floating point words, and HP-IL words. This implementation of FORTH allows the calling of routines from BASIC and vice versa.

An assembler, written in FORTH, provides the same command set as the assembler used to develop the HP-71 operating system. Use it to create FORTH primitives, HP-71 binary files, or language extension (LEX) files to extend the BASIC language.

Use the editor to create and edit text files for use as source files for BASIC, FORTH or assembly language programs, as well as non-programming related purposes.

A BASIC keyword in the FORTH ROM, <KEYBOARD IS>, lets you use any terminal device connected to your HP-71 through an interface as an external keyboard and display for the HP-71. (The keyword <DISPLAY IS> is provided in the HP-IL Interface, HP 82401A.)

#### **Plug-In Module Simulation Procedure**

Any Custom ROM Module developed for the HP-71 Handheld Computer can be simulated through one of the memory ports in the HP-71. By using the FORTH/Assembler ROM you can utilize the larger keyboard and display of the HP 150, Series 80, or other personal computers in software program development. See the HP-71B Plug-In Module Simulation Procedure (PMSP) sheet (available through an HP Sales Representative or Independent Custom Consultant) for further information.

#### **HP-71 Internal Design Specifications (IDS)**

##### **Documents**

#### **HP 00071-90068 Volume I: Detailed Design Description**

Provides details on the internal operation of the HP-71.

#### **HP 00071-90069 Volume II: Entry Point and Poll Interfaces**

Provides details on over 700 entry points into the operating system.

#### **HP 00071-90070 Volume III: Operating System Source Listings**

Provides details on source code listings.

#### **HP 82401-90023 HP-IL**

Provides details on HP-IL interface description, including entry points and source code listing.

#### **HP 00071-90071 Hardware Design Specification**

Provides details on hardware bus specifications.

#### **HP-75:**

#### **HP 82713A Plug-in Module Simulator**

The HP 82713A Plug-In Module Simulator (PMS) provides ROM simulation capability for an HP-75 Portable Computer. Store programs or files on the simulator on a permanent or temporary basis, or use it for software evaluations when developing a Custom ROM Module. A maximum of three simulators may be used at one time. A lithium battery ensures that the contents are retained when the simulator is unplugged.

#### **HP-41, HP-71, and HP-75 Custom ROM Modules:**

##### **HP-41: HP 82500A or B**

Provide 4K or 8K bytes of memory with each module, or nearly 21,000 program lines with up to four 8K modules.

##### **HP-71: HP 82486A, B, C, or D**

Provide 16K, 32K, 48K, or 64K bytes of program storage in a plug-in module. May be used in quantities of one to four for a maximum capacity of 256K ROM.

##### **HP-75: HP 82720A, B, C, or D**

Provide 8K, 16K, 24K, or 32K bytes of program storage in a plug-in module. May be used in quantities of one to three for a maximum capacity of 96K ROM.

#### **HP-41, HP-71, and HP-75 Custom Magnetic Cards**

##### **HP-41: HP 82502A**

Cards used with the HP-41 and HP-67/97 can be customized to load up to 225 bytes.

##### **HP-71 and HP-75: HP 82722A**

Cards used with the HP-71 or HP-75 can be customized to load up to 1.3K bytes.

#### **HP-41, HP-71, and HP-75 Custom Keyboard Overlays**

##### **HP-41: HP 82501A**

##### **HP-71: HP 82487A**

##### **HP-75: HP 82721A**

Relabel the HP-41, HP-71, or HP-75 keyboard with special user-defined functions assigned to each key. Available in a variety of background and printing colors.

#### **Ordering Information**

##### **HP-41:**

HP-41CV Opt. 001 Custom Calculator

HP-41CX Opt. 001 Custom Calculator

##### **HP-71:**

HP 82440A Software Development Utility

HP 82441A FORTH/Assembler ROM

HP 00071-90068 Volume I: Detailed

Design Description

HP 00071-90069 Volume II: Entry Point and Poll Interfaces

HP 00071-90070 Volume III: Operating System

Source Listings

HP 82401-90023 HP-IL

HP 00071-90071 Hardware Design Specification

##### **HP-75:**

HP 82713A Plug-in Module Simulator

NOTE: Prices for HP-41, HP-71, and HP-75 Custom Products vary. Therefore, they are not listed here. Please contact an ICC for this information.

#### **HP Users' Library**

The Users' Library is a source of programs which have been written and submitted by users of HP-41, HP-71, and HP-75 calculators and handheld computers. These programs cover applications ranging from business and finance to the physical sciences, and each of them has been thoroughly reviewed by the Library's technical staff. Documentation includes complete instructions, and individual program listings. (HP bar code is included for the HP-41 programs only.) Software is also available prerecorded on magnetic cards or on mini-cassettes for use with the HP-IL Digital Cassette Drive. Several programs may be stored on each cassette, since each one holds up to 128K bytes of information. The Users' Library also offers a custom cassette duplication service. As a subscriber to the Library, members will receive a complete list of programs, special discounts, contests, and special promotions. For more information on purchasing or contributing programs, contact the Users' Library, Dept. 39UL, 1000 N.E. Circle Blvd., Corvallis, OR 97330.



# COMPUTERS, PERIPHERALS & CALCULATORS

## Personal Computation

### Software

#### Ordering Information

One-Year Subscription (U.S. and Canada)  
 One-Year Subscription (Outside U.S. and Canada)  
 HP-41C, HP-41CV, HP-41CX programs (include documentation, and bar code)  
 HP-71B programs (include complete documentation)  
 HP-75 programs (include complete documentation)  
 HP 82176A Cassette Duplication Service (cassettes included)

#### Software

Hewlett-Packard offers a wide range of software packages as application pacs and solutions books. Each application pac comes with a comprehensive manual, a plug-in application module, and when applicable, prerecorded magnetic cards, a keyboard overlay, and quick reference card. Solutions books come with complete documentation. Magnetic cards and mini data cassettes are also available. Both application pacs and solutions books are available from dealers and HP Representatives.

#### Series 10:

00011-90009 HP-11C Solutions Handbook  
 00012-90021 HP-12C Leasing Applications Handbook  
 00012-90015 HP-12C Real Estate Applications Handbook  
 00012-90009 HP-12C Solutions Handbook  
 00012-90022 HP-12C Training Guide  
 00015-90011 HP-15C Advanced Functions Handbook

#### HP-41:

##### Application Pacs

00041-15018 Aviation (for pre-flight use)  
 00041-15024 Clinical Lab & Nuclear Medicine  
 00041-15006 Circuit Analysis  
 00041-15004 Financial Decisions  
 00041-15003 Mathematics  
 00041-15022 Games  
 00041-15023 Home Management  
 00041-15016 Real Estate  
 00041-15019 Thermal & Transport Science  
 00041-15039 Petroleum Fluids  
 00041-15026 Securities  
 00041-15001 Standard Applications  
 00041-15002 Statistics  
 00041-15027 Stress Analysis-Mechanical Engineering  
 00041-15021 Structural Analysis-Civil Engineering  
 00041-15005 Surveying  
 00041-15020 Machine Design  
 00041-15017 Navigation  
 00041-15042 Auto/Start Duplication ROM  
 00041-15043 HP-41 HP-IL Development Module

##### Solutions Books

Business:  
 00041-90094 Business Statistics/Marketing/Sales  
 00041-90096 Home Construction Estimating  
 00041-90086 Lending, Savings, & Leasing  
 00041-90136 Real Estate  
 00041-90137 Small Business

##### Engineering:

00041-90093 Antennas  
 00041-90100 Chemical Engineering  
 00041-90089 Civil Engineering  
 00041-90092 Control Systems  
 00041-90088 Electrical Engineering  
 00041-90139 Fluid Dynamics & Hydraulics  
 00041-90140 Heating, Ventilating & Air

##### Conditioning

00041-90090 Mechanical Engineering  
 00041-90138 Solar Engineering  
 00041-90441 Structural Design (cassette based)

##### Computation:

00041-90084 Geometry  
 00041-90083 High-Level Math  
 00041-90082 Test Statistics

##### Other:

00041-90145 Calendars  
 00041-90102 Chemistry  
 00041-90099 Games I  
 00041-90443 Games II  
 00041-90143 Optometry I (General)  
 00041-90144 Optometry II (Contact Lenses)  
 00041-90142 Physics  
 00041-90141 Surveying  
 00041-90525 1983 Taxes  
 00041-90395 Time Module Solutions I

#### HP-71:

##### Application Pacs

HP 82481A AC Steady State Circuit Analysis  
 HP 82484A Curve Fitting  
 HP 82482A Finance  
 HP 82441A FORTH/Assembler  
 HP 82480A Math  
 HP 82440A Software Development Utility (with mini-cassette)  
 HP 82483A Surveying  
 HP 82485A Text Editor

##### Solutions Books

00071-90065 Games  
 00071-90066 General Utilities  
 00071-90064 Math

#### HP-75:

##### Application Pacs

00075-15035 Data Communications  
 00075-15001 I/O ROM  
 00075-15015 Math  
 00075-15012 Surveying  
 00075-15019 Text Formatter  
 00075-15014 VisiCalc (R)

##### Solutions Books

00075-13008 Electronics  
 00075-13009 Finance  
 00075-13006 Games I  
 00075-13007 Games II  
 00075-13016 Graphics  
 00075-13013 I/O Utilities  
 00075-13015 Mass Media Duplication/Privacy  
 00075-13003 Math I  
 00075-13004 Math II  
 00075-13005 Math III  
 00075-13010 Real Estate  
 00075-13011 Statistics  
 00075-13012 Test Statistics

**For additional information or a demonstration of Hewlett-Packard professional calculators and handheld computers, visit your nearest HP dealer. For the location and number of the dealer nearest you, call toll-free 1-800-FOR-HPPC (1-800-367-4772).**



### Hewlett-Packard Interface Loop (HP-IL)

The Hewlett-Packard Interface Loop, HP-IL, is a bit-serial interface designed for low cost battery-operable systems. HP-IL allows HP-41 calculators and HP-71, HP-75, The PORTABLE, HP 150 and other computers to be used as system controllers, capable of transmitting and receiving data, and performing a wide variety of information management functions. In addition, HP-IL allows the HP-41, HP-71, and HP-75 to be used for instrument control.

In HP-IL systems, devices are connected by two-wire cables leading from the output port of one device to the input port of the next, until all devices form a closed loop. This loop structure provides a unique capability through: auto address assignment, device capability identification, power ON/OFF control, and error checking.

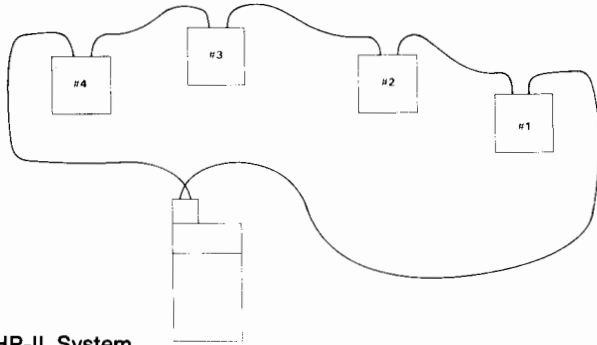

HP-IL System

#### Auto Address Assignment

In order to distinguish between devices on the loop, each device must have an address, a number from 1 to 30. An HP-41, HP-71, HP-75, or other mainframe, as the controller, uses the address to specify and control the devices on the loop. HP-IL enables the controller to assign addresses automatically, starting with the address 1 for the device next to the controller in the direction of the information transfer.

#### Device Capability Identification

Most HP-IL devices contain an accessory identification number that tells the system controller its device type, such as "printer" or "mass storage device". Upon execution of a PRINT command, the controller polls each device on the loop until it finds the device that responds with the appropriate accessory ID number for printers. Device identification frees the user from having to know the address of each device on the loop. This feature also allows software to be run and written without regard to system orientation, address switches or preassigned addresses, making HP-IL a truly user-friendly interface.

#### Power ON/OFF Control

Several HP-IL peripherals support STANDBY mode. Peripherals can be powered on or off, under program control, to conserve battery life. The ON/OFF feature enables the use of an HP-IL system for remote applications.

#### Automatic Error Checking

HP-IL allows for automatic error checking of any data being transmitted on the loop. Because each character must return to the device that originally sent it, the device compares the returning character with a copy of the one that was sent. If the two do not match, an error message is generated.

#### Hold-Until-Ready Protocol

HP-IL provides a simple means of coordinating the transfer of data. Some devices send and receive data at high rates while other devices work at a slower pace. In the HP-IL system, devices hold each piece of information until they are ready to receive another. When ready, they pass the information to the next device. By the time a piece of information makes a complete loop, all devices are ready to accept new information. This "hold-until-ready protocol" assures that fast and slow devices can operate in the same HP-IL system.

#### The Versatility of HP-IL

HP-IL is an ideal, low cost interface option for those applications requiring low power and maximum portability. HP-IL also provides a link between battery-powered devices and more powerful computational products. Through HP-IL interface converters, an HP-41 calculator, HP-71, HP-75, or other computer can pass information to desktop computers, modems, terminals, instruments and peripherals. Another HP-IL product, the Interface Kit, allows building an HP-IL interface into microprocessor-based products, making them into HP-IL devices.

#### HP-IB and HP-IL

HP-IL is not intended as a replacement for HP-IB, but rather as a low cost, low power alternative extending below the traditional scope of HP-IB in price and performance.

Although HP-IB and HP-IL serve the same basic function—interfacing controllers, instruments and peripherals—they differ in many respects.

1. Because of HP-IL's lower power consumption, it is usable with portable, battery-powered systems. Generally, HP-IB is not.
2. HP-IL system components will generally be low cost and have moderate performance; HP-IB system components are at the medium- to high-end of the performance spectrum and generally cost more.
3. HP-IL systems work at relatively low data rates compared to HP-IB, and relatively high data rates compared to RS-232C. For example, the HP-71 and The PORTABLE can maintain transmission speeds of 5K to 6K bytes per second (55,000 to 66,000 baud). HP-IL maximum data rate at 100 metre distances is 20K bytes per second.
4. HP-IL allows device separations of up to 100 metres with shielded, twisted pairs (10 metres with zip cord). HP-IB requires extender hardware for long distance connections.

#### The HP-IL Logo

Just as the HP-IB interface is designated by the HP-IB symbol, Hewlett-Packard identifies the HP-IL interface with its own symbol. Wherever this logo appears, it indicates that that mainframe, peripheral, instrument, etc., is HP-IL compatible.





# COMPUTERS, PERIPHERALS & CALCULATORS

## Hewlett-Packard Interface Loop

Low Cost Interface for Battery-Operable Systems

### HP-IL Products and Applications Summary

Model	Application	See Page
HP-41 Advanced Calculator (with HP 82160A HP-IL Interface Module)	Control: HP-IL bench/field controller Computation: Field data collection	64
HP-71 Handheld Computer (with HP 82401A HP-IL Interface)	Control: HP-IL bench/field controller Computation: Data acquisition, field analysis	64
HP-75 Handheld Computer (with HP-IL built-in)	Control: HP-IL bench/field controller Computation: Data acquisition, field analysis Remote transaction processing	68
Series 80 Personal Computers (with HP 82938A Interface)	HP-IL bench controller; field data analysis control	52
The PORTABLE (with HP-IL built-in)	Computation and field analysis Remote transaction processing Battery or AC operation	46
HP 82169A HP-IB Interface	Bench conversion from HP-IL to IEEE-488 computers, peripherals and instruments	68
HP 82164A RS-232C Interface	Bench conversion between HP-IL and RS-232C signals for terminals, modems, computers and peripherals	67
HP 82165A GPIO Interface	Bench conversion between HP-IL and parallel devices Digital data acquisition interface from HP-IL to most computers	68
HP 82938A Series 80 Interface	Bench conversion from HP-IL to Series 80 Personal Computers	68
HP 82166C HP-IL Interface Kit	Components that can be built into a device, providing HP-IL capability	68
HP 45643A Extended I/O Accessory	Bench conversion from HP-IL to the Touchscreen and Touchscreen MAX Driving HP-IL peripherals, including ThinkJet, plus parallel printers Allows communication between The PORTABLE and Touchscreen, and Touchscreen MAX	68
HP 82973A HP-IL Interface Card	Allows communication, using HP-IL, between The PORTABLE and the IBM PC/XT. Driving HP-IL peripherals	68
HP 82161A Digital Cassette Drive	Bench/field program storage Bench/field data storage Bench/field data logging Field data collection	67
HP-82162A Thermal Printer/Plotter	Bench/field hard copy Data logging Simple plotting Computational hard copy	67
ThinkJet Printer (HP-IL option)	Bench/field full-page, hard copy output Low noise environments High-resolution graphics and text Battery operation	57
HP 82905B Impact Printer Opt. 248,348,448	Bench 80-Column Printer utility hard-copy output (for program debugging, data output, and data presentations)	57
HP 2671A/G Alphanumeric/Graphics Printers Opt. 048	Bench full-page, hard-copy output Low noise environments High-resolution graphics and text	58
HP 7470A Graphics Plotter Opt. 003	Bench color graphics and charts Paper or transparency film output (for trend analysis, result comparison and information summaries)	98

Model	Application	See Page
HP 9114A 3 1/2" Flexible Disc Drive (with HP-IL built-in)	Bench/field program storage Bench/field data storage Bench/field data logging Bench/field data collection Bench/field data exchange with Series 80 and Series 200 personal computers Battery or AC operation	59
HP 82168A Acoustic Coupler (Modem)	Remote communications capability Telephone data access	67
HP 1630A/D/G Logic Analyzer	Bench logic design, development, and testing Digital diagnosis and debugging Timing analysis, state analysis, performance analysis, and interactive state/timing analysis	270
HP 3421A Data Acquisition/Control Unit	Bench/field automated measurement, channel selections and control Lab bench experimentation and control Portable experimentation and data collection	176
HP 3468A Digital Multimeter	Bench/field automated measurement Scientific experimentation Lab bench experimentation & trouble shooting Bench/field automated service & diagnostic tool	163
HP 4945A Transmission Impairment Measuring Set (TIMS)	Bench testing of voice grade data channels, program channels, and high speed digital channels Master/slave capability for end-to-end testing Automatic gain slope measurement Programmable sweep	115
HP 5006A Opt. 030 Signal Analyzer	Bench/field troubleshooting	243
HP 5384A/HP 5385A Opt. 003 Frequency Counters	Bench, systems, field automated measurement	298

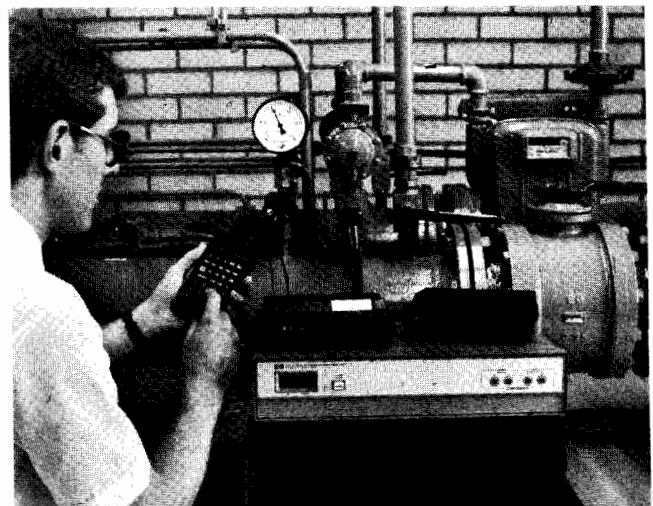



The HP 9000s are HP's family of 16- and 32-bit technical computers. Designed primarily for scientific and engineering tasks, they cover a wide spectrum of applications ranging from simple instrument control to sophisticated mathematical calculations to complete computer-aided design (CAD) and manufacturing (CAM). The HP 9000s are divided into two series - the Series 200 (16/32 bit) and Series 500 (32-bit).

The HP 9000s are a true 'family', with many things in common - common technology, operating systems, languages, peripherals and networking. There are also common applications; while each model is optimal for a specific task, it can also take on the functions of others, so there is an economy of overlap without going to an entirely new computer.

### HP 9000 Technology

Technology for the HP 9000 computer family was developed both within and without HP. The Motorola MC 68000 microprocessor, a 16-bit computer chip with a 32-bit internal data path, has been an industry standard for 16-bit computers for many years and is regarded as both inexpensive and reliable. It is available in 8 and 12.5 MHz versions, both of which have been implemented on the Series 200 computers.

The 32-bit chip was developed by HP as an answer to the demand in technical computing for increasing speed and accuracy while, at the same time, diminishing size. At its introduction in 1981, it ranked as the world's only 32-bit CPU on one chip, with over 450,000 transistors placed in an area about a quarter-of-an-inch square and an execution speed of 1 million instructions per second. From this same technology, called 'NMOS III', came random-access memory (RAM) chips containing over 600,000 individual transistors. The 32-bit chip and its sister RAM chips became the basis for the HP 9000 Series 500 computers.

### Series 200

The Series 200 computers are ideal for scientific and engineering applications requiring both high speed and data-handling capabilities, while remaining relatively low-cost. They can serve in stand-alone computer applications, as instrument controllers, or as full CAD/CAM systems when the computing capability of a mainframe or superminicomputer is not required.

While most Series 200 computers have the 8 MHz processor, a 12.5 MHz processor is available on the Model 220, Model 236, and Model 237 for more demanding applications. This higher performance hardware includes 16K bytes of cache memory and memory management hardware.

Some of the applications in which the Series 200 has proved successful include laboratory analysis, factory automation, mathematical modeling, and statistics, while on the 'high end' they have been used in computer-aided design (CAD) applications like electronic circuit design, printed circuit design and 2-D mechanical drafting.

The Series 200 machines can also be interfaced to a Series 500 machine as a 'front end' workstation to feed design data to the 32-bit machine for computation and then receive it back for graphic evaluation or additional rework.

Series 200 computers are available in a small 'personal' model, a low cost modular workstation, a modular rack-mount computer, a desktop workstation and a high-performance workstation.

### Series 500

Series 500, the 32-bit line of HP 9000 computers, are among the most powerful computers for their size ever built, having the full 32-bit data-addressing capability of larger mainframes and minicomputers. As powerful as they are, Series 500 computers can be made even more powerful by the simple addition of plug-in CPU cards, which can increase the power and speed up to 2.8 times.

Any computation-intensive application is the proving ground for a Series 500 machine - three dimensional modeling, finite element analysis, complex mathematical matrices, noise and stress analysis, and computer-aided design. As the 'high end' in a Series 200-500 coupling, they can form the computational basis for the most demanding tasks, while leaving the Series 200 machine to do the schematic capture or other relatively simpler tasks in the project.

The Series 500 machines are available as an integrated desktop workstation, a modular/rack computer, or a stand-alone console for multi-user environments.

### Languages and Operating Systems

HP 9000 computers have a full complement of programming languages to enhance their computational abilities.

HP BASIC is a highly enhanced version of standard BASIC that is simply and logically structured, yet immensely powerful. It has clear, high-level graphics commands, responsive instrument control, and easy, interactive program editing and debugging. On the Series 500, BASIC operates in a multi-programming environment. Besides being a powerful programming language, HP BASIC includes its own operating system, needing no other to run. It operates on the Series 200 and on the Model 520 of Series 500.

HP Pascal is a highly sophisticated tool for the advanced programmer. A compiled language, it offers extremely high speed and the ability to 'fine tune' the machine to a specific application. It has powerful and versatile programming structures and extensive debugging capabilities. Like HP BASIC, HP Pascal has its own operating system. It operates on all models of Series 200.

Besides BASIC and Pascal, HP provides the HP-UX operating system, HP's implementation of System III UNIX\* developed by Bell Laboratories, the system being chosen by increasing numbers of professionals. HP-UX is fully compatible with standard UNIX systems, providing access to a wide expanse of

software. HP-UX features a choice of languages - Pascal, FORTRAN 77, or C. In addition, HP-UX contains extensions to UNIX such as virtual memory+, multiple CPU support+, multi-tasking and single or multi-user capabilities, and a rich assortment of engineering tools. For complex problems involving several software programs, HP-UX also offers the ability to connect several programs together via a simple set of commands.

\*UNIX is a trademark of AT&T Bell Labs.  
+Series 500 machines only.

### Application Software

A rich assortment of application software is available for HP 9000 computers, both from HP and from third parties via the HP PLUS program.

Included are packs for office and project management, packs aimed at the scientist or engineer for analysis and design, and highly specialized packs for software and data base development. Both HP and HP PLUS offer the user more than 300 software packs, with the list growing constantly.

### Interfaces and Peripherals

Available with the Series 200 and Series 500 hardware are interfaces and peripherals that embrace a wide variety of computer applications. The most comprehensive is HP-IB (HP's implementation of IEEE Standard 408-1978), which insures compatibility between HP computers and peripherals. In addition, there is the Human Interface Link (HP-HIL) for daisy-chaining input devices, RS-232, GPIO, BCD, Asynchronous 8-Channel Multiplexer, Data Communications, Color Video, and others.

Peripherals for HP 9000 computers comprise one of the largest selections in the industry - mass storage devices, printers, drafting plotters, graphics tablets, digitizers, a mouse, terminals, and modems. In addition, the HP 9000 family is compatible with many of HP's selection of instruments.

### Networking

HP has made a major commitment to networking, with the eventual goal of communicating with all other HP computers and with popular models made by other manufacturers.

Current HP terminal emulators include HP, IBM, DEC, and Tektronix. The simplest all-HP network is Shared Resource Management, which allows several users to connect their computers to a common disc drive, printer, or plotter, thus cutting peripheral costs. A local area network (LAN 9000) allows up to 100 Series 500 computers to communicate with each other, with shared access to programs and files.

HP's strategy for networking, called HP AdvanceNet, will eventually link all major HP computers (HP 9000, 3000, 1000) with each other, with HP Personal Computers, and with computers made by other manufacturers. It is being implemented under IEEE Standard 802.3, whose purpose it is to facilitate data communication among all types of computers, so that their inherent potential may be fully realized.





# COMPUTERS, PERIPHERALS & CALCULATORS

## Technical Computers

### HP 9000 Series 200

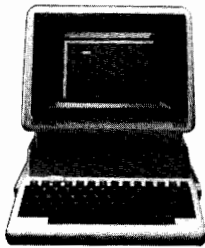

Model 216A

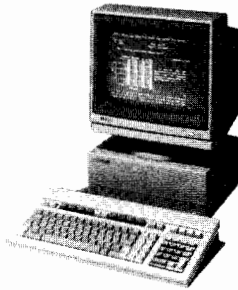

Model 217H

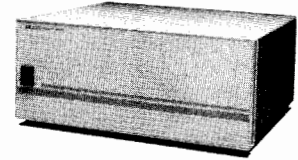

Model 220A



#### HP 9000 Series 200

The Series 200 is HP's line of technical workstations, based on the Motorola MC68000 family of micro-processors, with 16/32 bit architecture. For engineering or scientific calculations which require high speed and data-handling capabilities, Series 200 computers can provide cost-effective, reliable performance.

Series 200 Technical Computers include Models 216, 217, 220, 226, 236, and 237 (ordered as 9816, 9817, 9920, 9826, 9836, 9837).

#### Series 200 Base Systems

##### Model 216

The Model 216s are ideal for administrative project documentation or word processing tasks.

The Model 216A Personal Technical Computer has a 229mm (9-inch) monochrome CRT with 400 x 300 graphics, a detached keyboard, 128K byte internal RAM, and two backplane slots. It is compatible with BASIC, HPL, and Pascal. HP-IB and RS-232C interfaces are built in.

##### Model 217

The Model 217 is a capable, attractively-priced modular workstation with an MC68010 processor. The Model 217A Box Computer has built-in HP-IB and RS-232 interfaces, internal memory capacity up to 4M bytes, and six backplane slots. It offers the new HP Human Interface Link (HP-HIL) for daisy-chaining input devices such as the optional keyboard and mouse. The Model 217 is compatible with BASIC 3.0 and Pascal 3.0.

##### Model 220

The Model 220 Modular Computer is rack-mountable with separately available keyboards, monitors, and disc drives. It can serve in complex design and engineering problems and is compatible with HP instruments for all types of measurement, test, and control applications.

The Model 220A has 128K byte RAM, built-in HP-IB interface, and a 15 slot backplane, and is compatible with BASIC 3.0, Pascal 3.0, and SRM. The Model 220U has the 12.5 MHz processor and will support 3.07M byte internal RAM. It includes the HP-IB interface and eight backplane slots. It is compatible with BASIC 3.0, Pascal 3.0, SRM, and single or multi-user HP-UX.

##### Model 226

The Model 226 Technical Computer is equally at home in instrument/test control applications or computational assignments, and is ideal for CAT applications.

The Model 226A features a 178mm (7-inch) monochrome CRT with 400 x 300 graphics, 128K byte internal RAM, integrated 5/4-inch flexible disc drive, integrated keyboard, and HP-IB interface. It has an eight-slot backplane, can support up to 2.05M byte internal RAM, and is compatible with BASIC, HPL, Pascal, and SRM.

##### Model 236

The Model 236s are the most integrated of the Series 200s and have applications from electronic design to mechanical drafting to computerized graphics. The Model 236A/C (base systems) and Models 236S/CS (bundled systems) feature the 8MHz processor, while the Models 236U/CU (base systems) and Models 236T/CT (bundled systems) have the 12.5MHz processor.

The Model 236A Technical Computer features a 310mm (12-inch) monochrome CRT with 512 x 390 graphics, 128K byte internal RAM, two integrated 5/4-inch flexible disc drives, integrated keyboard, and HP-IB interface. It has an eight-slot backplane, supports up to 2.05M byte RAM, and is compatible with BASIC 3.0 and Pascal 3.0. The Model 236C includes the integrated keyboard, interface,

disc drives, backplane slots and RAM capacity of the Model 236A, but substitutes a 12-inch color CRT with 512 x 390 x 4 programmable map graphics and 4,096 color shades. It is compatible with BASIC 3.0 and Pascal 3.0.

The Model 236U has the 12.5MHz processor, and the same CRT, keyboard, disc drives, backplane slots, and interface as the Model 236A. It is compatible with BASIC, HPL, Pascal, and single or multi-user HP-UX. It will support up to 1.54M byte internal RAM. The Model 236CU also has the 12.5MHz processor, and features the same keyboard, color CRT, interface, backplane slots, and disc drives as the Model 236C. In addition to BASIC and Pascal, it is also compatible with single or multi-user HP-UX. It will also support 1.54M byte internal RAM.

#### Series 200 Bundled Systems

##### Model 216

The Model 216S includes the Model 216A base system, plus an additional 384K byte RAM (512K byte total). It includes BASIC, and is compatible with HPL and Pascal.

##### Model 217

The Model 217H includes the Model 217A base system, plus 512K byte RAM, the HP-HIL keyboard, and a 322mm (14-inch) monochrome monitor with alpha/graphics composite video interface cards. It is compatible with BASIC 3.0 and Pascal 3.0.

##### Model 220

The Model 220S includes the Model 220A base system plus a 2M HP-IB cable, rack mount kit, HP 98203A keyboard and 3M extension cord, HP 98204A Composite Video Card set, and an additional 512K byte RAM (640Kb total). It includes BASIC 3.0 and Pascal 3.0.

The Model 220T is based on the Model 220U base system, includes 1.02M byte RAM, and single or multi-user HP-UX. It also includes the HP 98204A keyboard, HP-IB interface, and Composite Video Card set. It has an 11-slot backplane and is compatible with BASIC, Pascal, and SRM.

##### Model 226

The Model 226S Computer includes the Model 226A base system, an additional 512K byte RAM (640Kb total), BASIC 3.0, Pascal 3.0, and SRM.

##### Model 236

The Model 236CS includes the Model 236C base color system, with an additional 512Kb RAM (640Kb total), BASIC 3.0, and Pascal 3.0. It has six backplane slots.

The Model 236S is based on the Model 236A, includes 512K byte additional RAM (640Kb total), BASIC 3.0, and Pascal 3.0. Six backplane slots are standard.

The Model 236T is based on the Model 236U, includes four backplane slots, 1.02M byte RAM, and single or multi-user HP-UX with FORTRAN 77, C, and HP Pascal Compilers, MC68000 Assembler, and Graphics/9000 DGL.

The Model 236CT is based on the Model 236CU base color system, and includes 1.02M byte RAM, single or multi-user HP-UX with C, FORTRAN 77, and HP Pascal Compilers, MC68000 Assembler, and Graphics/9000 DGL.

##### Model 237

The Model 237 is a high-performance graphics workstation featuring a high-resolution display and a 12.5 MHz processor. It provides the power and speed required by engineers and scientists involved in laboratory analysis, printed and integrated circuit board design, mathematical modeling, statistics, and 2-D mechanical drafting.



# COMPUTERS, PERIPHERALS & CALCULATORS

75

Technical Computers

HP 9000 Series 200 (cont)



Model 226A



Model 236C



Model 237H



The Model 237H features the 12.5 MHz processor with memory management hardware and cache memory, a 431mm (17-inch) monochrome display with 1024 x 768 resolution and bit-mapping capabilities, built-in HP-IB interface, optional floating point math hardware, the HP-HIL keyboard, mouse, and 512K byte RAM.

## Languages and Operating Systems

HP 98601A - ROM-based BASIC 2.0 Language System. Includes one system ROM board, BASIC 2.0 Language Manual Kit, and BASIC 2.0 Utilities Pack.

HP 98602A - ROM-based BASIC 2.0 plus extensions 2.1. Includes one ROM board, BASIC 2.0 with Extensions Manual kit and BASIC 2.0 Utilities Pack.

HP 98604A - ROM-based HPL 2.0 Language System. Includes one system ROM board, HPL 2.0 Language Manual kit, and HPL 2.0 Utilities. (Not available for Model 220 or Model 236C.)

HP 98613A - RAM-based BASIC 3.0 Language System. Includes system flexible disc and Language Extensions disc, BASIC 3.0 Language Manual kit, and BASIC 2.0 Utilities Pack.

HP 98614A - RAM-based HPL 2.0 Language System. Includes system flexible disc, HPL 2.0 Language Manual kit, and HPL 2.0 Utilities Pack. (Not available for Models 220 or 236C.)

HP 98615B - RAM-based Pascal 3.0 Language System. Includes system flexible disc set and Pascal 3.0 Language Manual kit.

HP 98670A - Single-user HP-UX Operating System.

HP 98680A - Multi-user HP-UX Operating System.

## Series 200 Interfaces

Interfaces for the Series 200 computers include:

HP 98622A - GPIO Interface. Provides 16 bits of latched input and output data for bidirectional information transfer, and permits interfacing to GPIO-compatible equipment.

HP 98623A - BCD Interface. Connects the Series 200 computers with bit-parallel, digit-parallel, binary-coded decimal devices for data input.

HP 98624A - HP-IB Interface. Allows communication with as many as 14 HP-IB compatible instruments.

HP 98644A - Serial Interface. Provides bit-serial communication between the Series 200 computers and asynchronous EIA RS-232C devices.

HP 98628A - Data Communications Interface. Provides both protocol management and electrical levels for asynchronous serial communications.

HP 98630A - Breadboard Card. Allows the user to customize his own interface cards. It provides the basic circuitry needed to interface to the Series 200 backplane.

HP 98640A - Analog to digital converter. Provides seven channels of 55,000-reading-per-second data acquisition.

HP 98255A - EPROM Card. Contains 16 sockets for EPROMs to allow up to 256Kb of storage using INTEL 27128A EPROMs or equivalent.

HP 98619A - Programmable Datacomm Interface. Provides broad capabilities that can be tailored to meet special datacomm and/or serial interfacing needs.

HP 9888A - Bus Expander. Provides a total of 16 additional card slots for Series 200 computers, with eight slots for either memory or I/O and eight slots for memory only.

## System Software

Numerous software packages are available for the Series 200 computers, including programs for computer-aided design, mechanical engineering, mathematics and statistics, and project and office management.

HP 98305 - Engineering Graphics System/200. A drafting system that allows you to create schematics of electronic designs, printed circuit board artwork, 2-D mechanical drawings, and other engineering drawings.

HP 98825 - AC Circuit Analysis/200. Calculates the frequency response of linear circuits. Magnitude, phase time, and impedance plots are available.

HP 98828 - Digital Filter Design - Includes both IIR and FIR digital filters, plus many other digital filter transformations.

HP 98826 - Linear Systems Analysis/200. Analyzes single-input/single-output linear systems using Root Locus, Nyquist, Step Response, Impulse Response, and Bode plots.

HP 98827 - Waveform Analysis. Signal analysis in the time and frequency domain, using either single or dual channels.

HP 98360 - HP DRAFT. A very fast, flexible, general-purpose drafting package with options for mechanical engineering drawings.

HP 98820A - Statistics Library. Contains Part I and Part II, including basic, general, and regression statistics, and an advanced library of general statistics.

HP 98821 - Numerical Analysis Library/200. Has seven main sections: root finders, numerical integration, ode solvers, eigen and fourier analysis, and interpolation.

HP 98810 - Visicalc®. An electronic worksheet for numerical data, text, and mathematical expressions.

HP 98818 - Forecasting/200. Allows time series data to be analyzed, smoothed, forecast, and plotted using a variety of statistical techniques.

HP 98815 - Graphics Presentation. Produces bar, line, and pie charts, and features four character fonts and seven color choices for paper or overhead slides.

HP 45481B - Context MBA™. Performs electronic spreadsheet, word processing, business graphics, telecommunications, and data management.

HP 98817 - Project Management. Analyzes project networks using CPM, PERT, and MPM techniques, with output in GANTT chart form.

HP 45614B - IBM 3278 Emulator Software. Provides IBM™ 3278 Model 2 terminal emulation when used with the 98695A interface.

HP 98790 - HP 2622 Emulator Software. Provides emulation of HP Model 2622 asynchronous block mode terminal.

HP 98791 - DEC™ VT100/HP 2622 Emulator Software. Provides emulation of Digital Equipment Corporation's VT100, and HP 2622 terminals.

HP 98792 - TEK™ 4010/HP 2622 Emulator Software. Provides emulation of Tektronix 4010 graphics terminal and HP 2622 terminal.

Visicalc® is a registered trademark of Visicorp.

Context MBA™ is a trademark of Context Management Systems.

DEC™ is a trademark of Digital Equipment Corporation.

TEK™ is a trademark of Tektronix Corporation.

IBM™ is a trademark of International Business Machines.



Model 520A

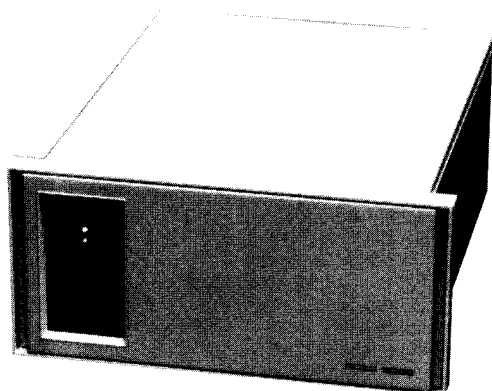

Model 530A

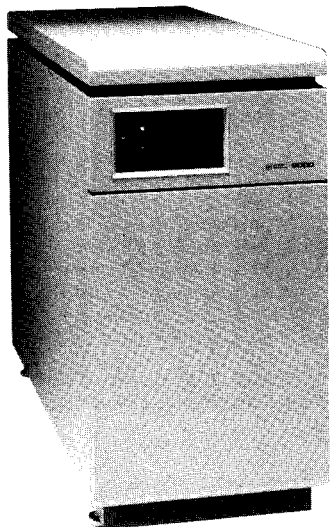

Model 540A



### HP 9000 Series 500

The HP 9000 Series 500 is HP's 32-bit computer line and is one of the most powerful computers for its size. For applications that require 32-bit 'number crunching' and speed, the Series 500 offers the alternative to a super mini-computer or mainframe. Three-dimensional modeling, finite element analysis, complex mathematical matrices, integrated/printed circuit design and analysis, mechanical drafting and design, noise and stress analysis, and software engineering are a few of the applications for which the Series 500 can be used.

The Series 500 computers are available as either an integrated workstation featuring graphics display on your choice of terminals, a keyboard, and mass storage (Model 520), or a component configuration (Models 530, 540) that permits selecting the peripherals that you need. The Series 500 computers include Models 520, 530, and 540 (ordered as 9020, 9030, and 9040)

### Series 500 Base Systems

#### Model 520

Model 520 is a compact workstation, suitable for desk or table-top use. With integrated mass storage and choice of CRT, the Model 520 is a 'mainframe on a desk' that can solve the entire range of engineering and scientific problems. All of the Model 520s feature an integrated keyboard, 12 slot memory/processor module, 512K byte RAM, a 4-slot backplane, and an integrated 5 $\frac{1}{4}$ -inch flexible disc drive. The Model 520s are compatible with BASIC or HP-UX (HP's UNIX\* operating system).

Model 520A features a 310mm (12-inch) standard color CRT with 512 x 390 graphics and 4,096 color shades. The Model 520B has a high performance 310mm (12-inch) monochrome CRT with 560 x 455 graphics. The Model 520C features a high-performance 330mm (13-inch) color CRT with 560 x 455 graphics and eight true colors with 4,913 dithered colors. Built-in options for Models 520A/B/C include additional CPUs, additional RAM, additional IOPs (for I/O expanders), 10M byte Winchester disc, 400 lpm thermal printer, and light pen.

#### Model 530

The Model 530A Box Computer is a compact, rack-mountable computer which can fit almost anywhere to serve as the heart of a sophisticated computational system. It features a 12-slot memory/processor module with one I/O processor, and a seven-slot backplane. 512K byte RAM are built in, as is a diagnostic display panel. It is compatible with single or multi-user HP-UX.

#### Model 540

The Model 540A is ideal for many project management procedures, such as planning, document preparation, and data entry, while still possessing all the power to handle the most demanding scientific and engineering problems. It has the same 12-slot processor module and built-in RAM as the Model 530, but in a roll-about cabinet ideal for placing in a 'furniture environment'. The Model 540A is compatible with single or multi-user HP-UX.

Built-in options for both the Model 530 and Model 540 include additional CPUs, RAM, and IOPs.

\*UNIX is a trademark of AT&T Bell Labs.



### Series 500 Bundled Systems

#### Model 520

The Models 520AS and 520AT are based on the Model 520A, include the standard color CRT, and are compatible with BASIC or HP-UX. The Model 520AS includes 512K byte additional RAM (1M byte total), the 97093A Winchester 10M byte fixed disc, integrated 97090A thermal printer, BASIC 3-D Graphics, and BASIC language system. It is compatible with single user HP-UX.

The Model 520AT has 1M byte additional RAM (1.5M byte total), integrated thermal printer, the 27100A HP-IB interface, single user HP-UX, FORTRAN 77, C, and Pascal Compilers, and Graphics/9000 DGL/AGP. It is compatible with the BASIC operating system.

#### Model 540

The Model 540AM is based on the Model 540A system, and includes 1M byte additional RAM (1.5M byte total), the 27100A HP-IB Interface, the 27130A 8-channel multiplexer, multi-user HP-UX, FORTRAN 77, C, and Pascal Compilers, and Graphics/9000 DGL/AGP. The Model 540AT includes the Model 540A base system, plus 1M byte additional RAM (1.5M byte total), the 27100A HP-IB interface, the 27128A RS-232 interface, single user HP-UX, FORTRAN 77, C, and Pascal Compilers, and Graphics/9000 DGL/AGP.

A complete line of peripherals is available for interfacing to the series 500 computers. For a list of supported peripherals, refer to the peripheral interfacing table on page 83.

### Languages and Operating Systems

HP 97050 - Single user BASIC for the Model 520. Multi-tasking using internal 10M byte disc as system disc.

HP 97070/80 - Single user/multi-user, multi-tasking HP-UX operating system for the Model 520.

HP 97071/81 - Single user/multi-user FORTRAN 77 Compiler. For HP-UX systems only, offering full implementation of the latest ANSI standard plus MIL-STD 1753 and other extensions.

HP 97072/82 - Single user/multi-user RJE Software. Allows for batch data transmission to another computer using IBM 2780/3780 binary synchronous protocol.

HP 97079/89 - Single user/multi-user, multi-tasking HP-UX operating system for Models 530 and 540.

HP 97086 - HP 1000 to 9000 Applications Migration. Used to transport programs from an HP 1000 RTE-6/VM system to an HP 9000 HP-UX system.

### Series 500 Interfaces

The following interfaces and memory enhancements are available for the Series 500 computers.

HP 2285A - Local Area Network - Consists of a self-contained Ethernet interfacing box, transceiver, HP-IB interface and software to provide an Ethernet switching interface between Series 500 computers.

HP 27110A - HP-IB Interface. Allows communication with as many as 31 HP-IB-compatible device addresses and 15 standard device loads.

HP 27112A - GPIO Interface. Provides 16 bits of latched input and output data for bidirectional information transfer, and permits interfacing to GPIO-compatible equipment.

HP 27116A - HP-CIO Service Extender. Extender card for out-of-card-page access to an operating HP-CIO Interface card.

HP 27122A - RJE Interface. Used by HP-UX 97077/87 software for batch data transmission to another computer using IBM 2780/3780 binary synchronous protocol.

HP 27123A - SRM Interface. Used by BASIC software for access to shared discs, printers, and plotters on Shared Resource Management.

HP 27128A - ASI Interface. Single channel asynchronous interface for linking to an RS-232C-compatible device.

HP 27130A - Eight-channel Multiplexer Interface. Supports up to eight RS-232C-compatible devices.

HP 97062A - RGB Interface. Color video interface used by BASIC 97052, HP-UX 97074/84, and Graphics software 97075/85 to display color graphics in an external CRT monitor.

HP 97060 - Graphics Processor. An intelligent external graphics processor offering full access to a 1,024 x 768 x 8 graphics display system.

### System Software

A variety of software packages are available for the Series 500, both in BASIC and HP-UX. The BASIC system provides the BASIC language and operating system, and allows access to the following software:

HP 97052 - BASIC 2-D/3-D Graphics. This package provides high performance graphics for the engineer or scientist and includes a comprehensive set of viewing and clipping functions.

HP 97056 - BASIC Asynchronous Terminal Emulator. The emulator package offers a simple, convenient method to link the Series 500 machines to a host computer.

HP 97053 - IMAGE/9000 DBMS. This package features two levels of data objects and data retrieval, and puts a user-friendly, interactive interface between the user and the data base.

HP 97058 - Shared Resource Management Software. The SRM software allows Series 500 computers and peripherals to be linked together in a local area network.

All Series 500 computers can be configured with the HP-UX operating system. The HP-UX system allows access to the following software:

HP 79300S/M - MUSE™ Word Processor - A technical word processor providing office-grade word processing for the scientist and engineer.

HP 98163/83 - HPSPICE Circuit Simulation - A general purpose circuit simulation program which is useful in the analysis and verification of electronic circuits.

HP 97074/84 - Graphics 9000/DGL - Fundamental device-independent graphics system.

HP 97075/85 - Graphics 9000/AGP - Advanced interactive graphics system consisting of a set of procedures called from an application program.

HP 97076/86 - HP-UX Async Communications Software - Provides a convenient method of linking Series 500 computers to other HP-UX systems, System III UNIX systems, and remote host computers.

HP 97077/87 - RJE Communications Software - Provides IBM 2780 or 3780 terminal emulation when used with the 27122A RJE interface.

Additional software packages are available through the HP PLUS program.



# COMPUTERS, PERIPHERALS & CALCULATORS

## Technical Computers HP 9000 Family Price Summary

### HP 9000 Series 200

- 9816A Model 216A Computer
- 9816S Model 216S Computer w/BASIC
- 9817A Model 217A Computer
- 9817H Model 217H Computer w/512Kb RAM, keyboard and terminal
- 9920A Model 220A Modular Computer
- 9920U Model 220U Modular Computer w/12.5MHz Processor
- 9920S Model 220S Modular Computer w/keyboard, BASIC, Pascal, 640Kb RAM
- 9920T Model 220T Modular Computer w/12.5MHz Processor, single-user HP-UX, keyboard
- Multi-user HP-UX
- 9826A Model 226A Computer
- 9826S Model 226S Computer w/640Kb RAM, BASIC, Pascal, SRM
- 9836A Model 236A Computer
- 9836C Model 236C Color Computer
- 9836U Model 236U Computer w/12.5MHz Processor
- 9836CU Model 236CU Color Computer w/12.5MHz Processor
- 9836CS Model 236CS Color Computer w/640Kb RAM, BASIC, Pascal
- 9836S Model 236S Computer w/640Kb RAM, BASIC, Pascal
- 9836T Model 236T Computer w/12.5MHz Processor, 1.02Mb RAM, single user HP-UX
- Multi-user HP-UX
- 9836CT Model 236CT Color Computer w/12.5MHz Processor, 1.02Mb RAM, single user HP-UX
- Multi-user HP-UX
- 9837H Model 237H Computer w/12.5MHz Processor, monitor, keyboard, 512Kb RAM, mouse

### Series 200 Operating Systems

- HP 98601A - ROM-based BASIC 2.0
- HP 98602A - ROM-based BASIC 2.0 w/extensions 2.1
- HP 98604A - ROM-based HPL 2.0
- HP 98613A - RAM-based BASIC 3.0
- HP 98614A - RAM-based HPL 2.0
- HP 98615B - Pascal 3.0
- HP 98670A - Single user HP-UX
- HP 98680A - Multi-user HP-UX

### Series 200 Interfaces

- HP 98620B - DMA Controller Card
- HP 98622A - GPIO Interface
- HP 98623A - BCD Interface
- HP 98624A - HP-IB Interface
- HP 98627A - RGB Color Interface
- HP 98628A - Data Communications Interface
- HP 98630A - Breadboard Card
- HP 98255A - EPROM Card
- HP 98259A - Magnetic Bubble Memory
- HP 98691A - Programmable Datacomm Interface
- HP 9888A - Bus Expander

### Series 200 System Software

- HP 98305 - HP EGS/200
- HP 98810 - Visicalc (R)
- HP 98815 - Graphics Presentation
- HP 98817 - Project Management
- HP 98820A - Statistics Library
- HP 98820B - Statistics Library Part I

- HP 98820C - Statistics Library Part II
- HP 98821 - Numerical Analysis Library/200
- HP 98825 - AC Circuit Analysis
- HP 98826 - Linear Systems Analysis
- HP 98827 - Waveform Analysis
- HP 98828 - Digital Filter Design
- HP 98360 - HP-DRAFT
- HP 97038JA - Context MBA™

### HP 9000 Series 500

- 9020A Model 520A Computer w/ standard color CRT
- 9020B Model 520B Computer w/ monochrome CRT
- 9020C Model 520C Computer w/ high performance color CRT
- 9020AS Model 520AS Computer w/ standard color CRT, 1Mb RAM, BASIC
- 9020AT Model 520AT Computer w/ standard color CRT, 1.5Mb RAM, single user HP-UX
- 9030A Model 530A Box Computer
- 9040A Model 540A Computer w/cabinet
- 9040AM Model 540AM Computer w/ cabinet, 1.5Mb RAM, multi-user HP-UX
- 9040AT Model 540AT Computer w/ cabinet, 1.5Mb RAM, single user HP-UX

### Series 500 Operating Systems

- HP 97050A - Single user BASIC for Model 520 (must specify medium)
- HP 97070 - Single user HP-UX for Model 520
- HP 97071 - Single user Fortran 77 Compiler for HP-UX systems
- HP 97072 - Single user Pascal Compiler for HP-UX systems
- HP 97079 - Single user HP-UX for Models 530, 540
- HP 97080 - Multi-user HP-UX for Model 520
- HP 97081 - Multi-user Fortran 77 Compiler for HP-UX systems
- HP 97082 - Multi-user HP Pascal Compiler for HP-UX systems
- HP 97089 - Multi-user HP-UX for Models 530, 540
- HP 97086 - HP 1000 to 9000 Applications Migration

### Series 500 Interfaces

- HP 2285A - Local Area Network Interface
- HP 27110A - HP-IB Interface
- HP 27112A - GPIO Interface
- HP 27116A - HP-CIO Service Extender
- HP 27122A - RJE Interface
- HP 27123A - SRM Interface
- HP 27128A - ASI Interface
- HP 27130A - 8-Channel Multiplexer Interface
- HP 97062A - RGB Interface

### Series 500 System Software

- HP 97074A/84A - Graphics 9000/DGL
- HP 97075A/85A - Graphics 9000/AGP
- HP 97052A - BASIC 3-D Graphics
- HP 97053A - IMAGE/QUERY 9000 DBMS
- HP 97056A - BASIC Asynch Terminal Emulator
- HP 97058A - Shared Resource Manager for BASIC systems
- HP 97076A - Asynch Datacomm for HP-UX systems
- HP 98163/83 - HPSPICE Circuit Simulation



HP 9915B



The HP 9915B is a modular computer that derived from the HP-85B desktop system but excludes keyboard, crt, tape drive and printer. This makes it ideal for integration into an automated system, omitting features not needed in a pre-programmed controller. Its optimal applications are in automated testing, measurement and control applications where durability is essential, eg. instrument control applications using a rack-mountable controller; machine control for presses, cutting, or sawing machines and transfer lines; test-bench control for chemical processes; nitrogen and exhaust analyses; product component control like quality control-goods, inward control and manufacturing supervision; data collection and control in labs and in environmental protection. In these applications, the HP 9915B can be used as a front end controller or host-controlled by an HP-1000 or other computers.

The HP 9915B is a viable alternative to custom-made microcomputer systems and board computers, which are expensive but difficult to engineer, program and develop.

The HP 9915B is an extended version of the earlier HP 9915A model. Software compatibility with the HP 9915A allows customers to switch over to the HP 9915B very easily.

### Efficient Program Development

Programs for the HP 9915B can be developed and debugged on the HP-85B and transferred to the HP 9915B via either EPROM, tape cartridge, or other Mass Storage devices. Applications can be running in about half the time it would take for a microcomputer or boardcomputer.

By using a Program Development Kit and other accessories the HP 9915B can also be used as its own development station.

For non-volatile storage and fast loading in industrial environments, the HP 9915B accepts 32K bytes of EPROM storage for application programs. Program development software is available that allows the designer to program EPROMS with commercially available PROM programmers.

- Run-Only Computer for test, measurement and computational applications in harsh environments.
- Intensive self-test function after power on.
- Rack-mountable for easy integration into a system.
- Custom operator interface - remote buttons and LEDs, keyboard and CRT control for operator convenience.
- Built-in EPROM board (max. 32K bytes), I/O ROM, Program Development ROM, and a Mass Storage/E-Disc ROM set
- Powerful BASIC language operating system. HP-85B compatible.
- Graphics capabilities.

32K Byte of user read/write memory and 32K byte of built-in Electronic Disc (E-Disc) read/write memory are available in the HP 9915B. The E-Disc memory can be expanded to up to 416K bytes by inserting memory modules into the I/O ports. The E-Disc is electronically accessed by a built-in Mass Storage/E-Disc ROM set and makes data transfer about 150 times faster than data transfer using tape.

### Flexible Design for Operator Interface

Offering a variety of operator interfaces, the HP 9915B can be tuned to the application as required. The program start button and eight (four shiftable) software-definable function keys will suffice for applications requiring minimal attention. For extensive operator interactions, the pushbuttons and LEDs can be remotely controlled and CRT displays, standard or custom keyboards can be added.

Since all of the HP-85's graphics capabilities are built into the HP 9915B, charts, histograms, block diagrams and other graphics may be easily displayed via an external CRT. CRT and keyboard are available as optional products.

### I/O Capabilities

The HP 9915B BASIC language includes a powerful set of statements to simplify I/O, providing the user with interrupt, bit manipulation, high speed transfer, software control of interface and easy data formatting. I/O drivers are built in and the following plug-in interfaces can be used: HP-IB (IEEE 488-1978); RS-232-C (serial); GPIO (8-bit/16-bit parallel); BCD (binary coded decimal); HP-IL (Interface Loop) and FDL (Factory Data Link).

### Additional Features

A complete line of peripherals is available for the HP 9915B including printers, plotters, and flexible- and winchester disc drives. HP multiprogrammers are available for analog input and output, digital input and output, stepper motor control, timing and counting.

### Ordering Information

**HP 9915B** Modular Computer with 32K RAM memory, 32K E-Disc memory, I/O ROM, Program Development ROM and Mass Storage/E-Disc ROM set.

**Opt.001** Built-in Tape Drive

**Opt.002** Operator Interface Capability (for commercial video monitors, keyboards and remote front panel control)

**HP 82908A** 64K E-Disc Memory Module

**HP 82909A** 128K E-Disc Memory Module

**HP 98150B** HP 9915B Opt.002 Program Development Kit Includes System Development Manuals, Accessory Keyboard, Tape Duplication and EPROM Programming Software Pack.

**HP 98155A** Keyboard

**HP 82912A** Monitor 9"

**HP 82913A** Monitor 12"



# COMPUTERS, PERIPHERALS & CALCULATORS

## Dedicated Multi-User Real-Time Computer Systems

### HP 1000 Systems

- Computer-aided manufacturing
- Computer-aided design
- Computer-aided test

### HP 1000 Systems — Real-Time Solutions for Manufacturing and Engineering

HP 1000 is a complete, compatible family of multi-user systems, interfaces, peripherals, and software uniquely qualified to satisfy your manufacturing productivity needs at every level. HP 1000 systems provide you with the power and versatility needed for real-time number crunching applications — from process monitoring and control to supervising a network of computers.

### A Choice of Processing Power Levels

HP 1000 systems offer a choice of three general levels of processing power, as summarized below.

Performance Level	HP 1000 Processor	Instructions per Second	Floating Point Operations per Second
1	A600+ E-Series	400,000 400,000	64,000 47,000
2	A700 F-Series	400,000 400,000	204,000* 183,000
3	A900	1,300,000	500,000

\*With hardware floating point processor, which is optional in Micro 27 system, standard in Model 27 system.

### Flexible, Versatile Micro/1000 or Rack-Mount Packaging

HP 1000 Computer Systems based on A600+, A700, and A900 processors are available in an economical Micro/1000 package that can be placed on a table or bench, installed in a space-saving vertical floor-mount that features roll-about convenience and portability, or rack mounted in a larger cabinet. In addition to its compactness and convenience, the Micro/1000 package can also incorporate integrated mass storage (a 14.5 megabyte mini Winchester disc and a 270 kilobyte microfloppy disc). For applications that need more card cage slots than the Micro/1000 package provides, A600+, A700, and A900 processors and E-Series and F-Series based systems are available in larger rack mounted configurations.

### Real Time Executive (RTE) Operating System-Based Compatibility

Compatibility of design throughout the HP 1000 family enables you to harness the precise level of power you need for a specific application and also gives you a clear growth path. Even after you've matched the proper combination of HP 1000 products to your initial needs, you remain free to choose an impressive number of options to keep pace with your growth. Or, if your needs change, you can smoothly reconfigure your HP 1000 to handle new applications. This compatibility extends through:

- HP 1000 Computers. The A600+, A700, A900, E-Series, and F-Series computers use the same basic instruction set, so you can change processors to fit your needs with little effect on software, peripherals, or operator training. Within the A-Series (A600+, A700, and A900), software will run on all three processors without change. You can use the full "supermini" capability of the A900 for developing programs to run on the highly cost-effective A600+ computer or the mid-range A700 computer.
- HP 1000 Systems Expansion. You can move up from the smallest memory-based system to the largest disc-based system at any time — all at once or in increments.

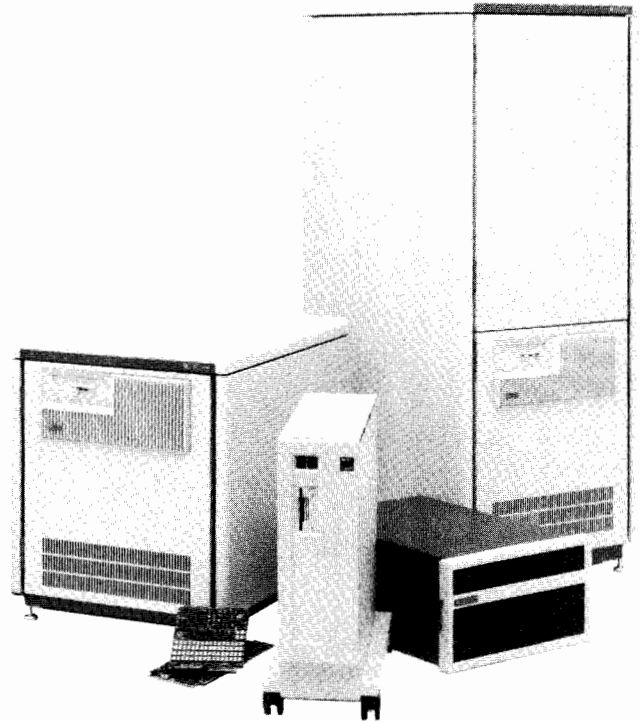

- RTE Operating System. HP's Real-Time Executive (RTE) operating system provides a solid, secure foundation of system services that are common across all of the supported HP 1000 computers. You can choose the RTE system and configuration that best suits your application and be confident that high-level language programs written and executed on one RTE system will execute on others as well with minimal modification (no change at all between A-Series computers).
- HP 1000 Software. HP 1000 software products for program development, data base management, graphics, and distributed systems networking are supported across the entire HP 1000 product line. In addition, software for process control, quality decision management, and programmable controller communications are supported in all A-Series computers. This universality of HP 1000 software helps you to tailor comprehensive, coherent solutions to your specific application needs. Further help is available from a growing array of HP 1000 software offered by third party suppliers under the HP PLUS software program.

### Eight HP 1000 System Models to Choose From

The HP 1000 family includes three A-Series systems with Micro/1000 packaging, three A-Series systems in rack cabinet, and E-Series and F-Series systems in rack cabinet. Each is based on a system processor unit that includes the computer, system console and disc interfaces, the system cabinet, and the RTE operating system. With a hard disc and optional software, each model can be used to develop programs in BASIC, FORTRAN 77, Pascal, and Macro/1000 Assembly language. All systems also support data base management, graphics, and distributed systems networking.

HP 1000 systems support sharable memory-resident data arrays up to 1.998 megabytes and virtual data arrays up to 128 megabytes in main memory and on disc. An enhancement package to RTE-A, called VC+, provides virtual code support for the development and execution of large programs — up to 7.75 megabytes — with automatic and transparent segmentation.

A wide choice of peripherals, I/O cards (including measurement and control cards, and an integral modem card), and software can be added to work together on your applications to maximize the value of your system investment. HP 1000 computers are well-suited to many application areas, but especially those listed on the following page.





## Plant Automation

HP's wide range of hardware and software supports automation of instruments and machines as well as monitoring and control of real-time processes. The HP 1000 can help improve productivity and reduce costs. For low point-count data acquisition, test and control applications, A-Series Measurement and Control Cards provide many analog interfacing functions without the need for an add-on peripheral device. For details, see page 188.

## Computer Networking

HP's DSN software makes it easy to connect HP 1000 systems and other systems across a city or a continent, sharing vital information throughout the network.

## Data Base Management

Informed management decisions flow easily and confidently from the timely, accurate information maintained in an Image/1000 data base.

## Interactive Graphics

Hewlett-Packard offers a complete line of graphics hardware and software — products for simplifying presentation of complex data or developing product designs. In addition to supporting the traditional graphic displays such as bar charts, pie charts, and histograms, Graphics/1000 software gives you the interactive, two and three dimensional capability needed for computer-aided drafting, mapping and design.

## Automated Test Systems

An HP Automated Test System can be configured from the HP 1000 E and F-Series computers and a wide range of electronic instruments to perform virtually any electronic test application. Whether you're testing microcircuits or aircraft engines, an ATS/1000 system can include all the hardware and software needed for fast, accurate, and thorough testing.

## Ordering Information

HP 1000 Micro 26 Sys Proc Unit\* w/512kb memory  
 HP 1000 Micro 27 Sys Proc Unit\* w/512kb memory  
 HP 1000 Micro 29 Sys Proc Unit\* w/768kb memory  
 HP 1000 Model 26 Sys Proc Unit\* w/512kb memory  
 HP 1000 Model 27 Sys Proc Unit\* w/512kb memory  
 HP 1000 Model 29 Sys Proc Unit\* w/768kb memory  
 HP 1000 Model 60 Sys Proc Unit\* w/256kb memory  
 HP 1000 Model 65 Sys Proc Unit\* w/256kb memory

\*Requires system console and system disc for operation.

## HP 1000 System Summary

	Micro 26	Micro 27	Micro 29	Model 26	Model 27	Model 29	Model 60	Model 65
Base system computer type	HP 2486A	HP 2487A	HP 2489A	HP 2196C/D	HP 2197C/D	HP 2199C/D	HP 2178C	HP 2179C
Memory cycle time	454 ns	500 ns	181 ns*	454 ns	500 ns	181 ns*	665 ns	420 ns
Operating system	RTE-A	RTE-A	RTE-A	RTE-A	RTE-A	RTE-A	RTE-6/VM	RTE-6/VM
Virtual Code+ available?	Yes	Yes	Yes	Yes	Yes	Yes	No	No
Recommended system console terminal	HP 262x	HP 262x	HP 262x	HP 262x	HP 262x	HP 262x	HP 262x	HP 262x
Maximum memory	4Mb Parity or 8Mb ECC	4Mb Parity or 8Mb ECC	6Mb ECC	4Mb Parity or 8Mb ECC	4Mb Parity or 8Mb ECC	24Mb ECC	2Mb Parity or ECC	2Mb Parity or ECC
Recommended system discs	HP 248xA, Opt 111, 14.5Mb fixed & 270kb microfloppy disc			HP 7908R (16.5Mb)	HP 7911R (28.1Mb)	HP 7914R (132.1Mb)	HP 7911R (28.1Mb)	HP 7911R (28.1Mb)
Alternative disc choices	HP 7908/7911/7912/7914/P/R/7933H/7935H  16.5Mb/28.1Mb/65.6Mb/132.1Mb/404Mb/ 404Mb			HP 7908R/7911R/7912R/7914R/ 7933H/7935H  16.5/28.1/65.6/132.1/404/404Mb			HP 7906M/MR/7908R/ 7911R/7912R/7914R/ 7920M/7925M/7933H/ 7935H 19.6/16.5/28.1/65.6/ 132.1/50/120/404/404 megabyte	
Flexible disc available?	Yes	Yes	Yes	Yes	Yes	Yes	Yes	Yes
H/W floating point?	No	Optional	Yes	No	Yes	Yes	No	Yes
Graphics/1000-II available?	Yes	Yes	Yes	Yes	Yes	Yes	Yes	Yes
HPSPICE Crt SimIn available?	No	No	No	No	No	No	No	Yes
PMC/1000 available?	Yes	Yes	Yes	Yes	Yes	Yes	No	No
QDM/1000 available?	No	No	No	Yes	Yes	Yes	No	No
Programmable controller interface available?	Yes	Yes	Yes	Yes	Yes	Yes	Yes	Yes
HP 2250 Meas & Cntrl Proc available	Yes	Yes	Yes	Yes	Yes	Yes	Yes	Yes
Meas & Cntrl I/F available?	Yes	Yes	Yes	Yes	Yes	Yes	No	No
Image/1000-II available?	Yes	Yes	Yes	Yes	Yes	Yes	Yes	Yes
DS/1000-IV communication w/HP 1000 & 3000 available?	Yes	Yes	Yes	Yes	Yes	Yes	Yes	Yes
Communication with IBM systems available?	Yes	Yes	Yes	Yes	Yes	Yes	Yes	Yes
Data Link support?	Yes	Yes	Yes	Yes	Yes	Yes	Yes	Yes
ATS/1000 Integration Services available?	No	No	No	No	No	No	Yes	Yes

\* Average effective access time, assuming 88% cache hit rate.



# COMPUTERS, PERIPHERALS & CALCULATORS

## HP1000 A-Series, E-Series, and F-Series Computers

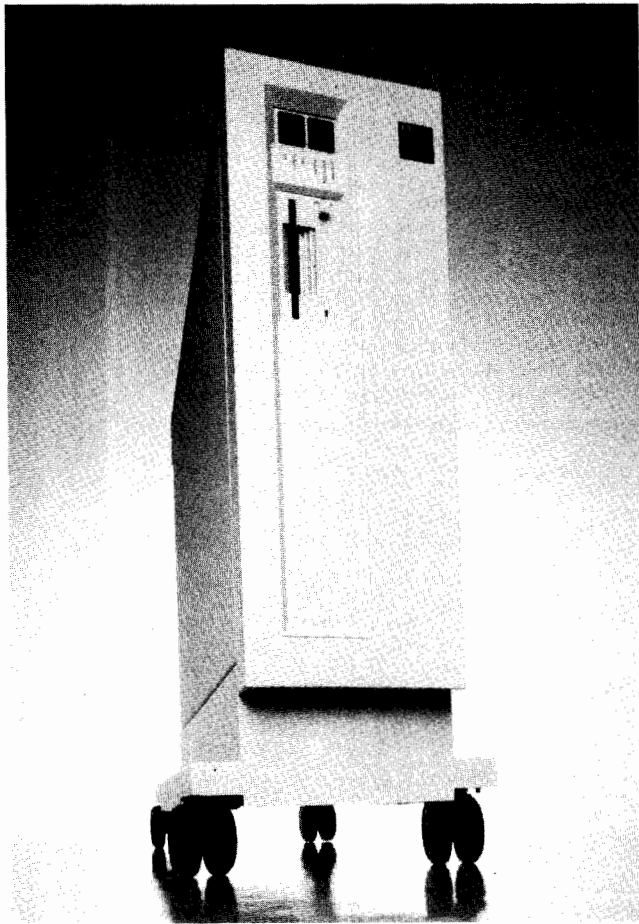

### HP 1000 A-Series

A-Series computers implement a distributed intelligence I/O design in which each I/O card has its own processor. This processor controls direct access transfers to/from memory with extra intelligence that supports chained multiblock transfers without interrupting the CPU. This leaves the CPU free to concentrate on arithmetic tasks with few interruptions and great efficiency.

The A600+ microcomputer offers 400,000 instructions per second execution speed and double precision floating point firmware for real-time operation. The A600+, price/performance leader of low-cost microcomputers, supports VC+ enhancements and is available as a two-board computer, box computer, system, or Micro/1000 system (shown above).

The A700 computer adds optional floating point hardware with scientific and vector instruction sets to the basic capability of the A600+ microcomputer for superior support of computer simulation, graphics, and other computation-intensive uses. The A700 is also microprogrammable, so it can be optimized for higher performance or user-customized applications. It is available as a system, Micro/1000 system (shown above), or box computer.

The A900 computer incorporates a pipeline implementation and a cache memory scheme, providing three times the performance of an

A700 computer. The A900's hardware floating point processor and scientific vector instruction sets are built-in, and 768k bytes of ECC memory is standard, assuring system integrity. The A900 is the ultimate computation machine designed to meet the most demanding needs of OEMs, system designers, software suppliers and end users. It is available as a system, Micro/1000 system (shown at left), or box computer.

### HP 1000 E-Series

The E-Series computer provides variable microcycle timing, microprogrammable block I/O, a microprocessor port, asynchronous memory, and large control store address space. E-Series computers are available in two models, HP 2109E and 2113E, with up to 2 Mbytes of mainframe memory and 9 or 14 I/O channels, expandable to 46 channels. (Also available as HP 2109EK board computer.)

### HP 1000 F-Series

For users who need faster than E-Series processing speed, HP offers the HP 2117F computer which features a hardware floating point processor that speeds calculations (2.2 to 6 times faster than E-Series) and a scientific instruction set for fast execution of trigonometric and logarithmic functions (compute sine in less than 48 microseconds). A fast FORTRAN processor, also standard in the HP 2117F, provides firmware microcode for over a dozen instructions—e.g., array address calculations, parameter passing, and other routines—that run 2 to 20 times faster than conventional software execution speed. An optional vector instruction set can be provided for fast matrix calculations. The HP 2117F computer features high performance 420 ns memory and is fully user-microprogrammable.

### Alternate Memory Systems

HP continues its lead in memory technology by being the first to offer 256k RAM memory: a 2 megabyte error correcting code (ECC) board for the A600+ and A700, and a 3 megabyte ECC memory board for the A900.

Parity checking memory is standard in HP 1000 memory systems for the A600+, A700, and E and F-Series. And, for very large systems in critical applications, Error Correcting Code (ECC), standard in the A900 and optional in the A600+, A700, and E and F-Series, detects and corrects all single-bit errors and detects all double-bit errors.

### Ordering Information

HP 2106BK A600+ Board Computer w/128 kb memory  
 HP 2156B A600+ Computer w/128 kb memory  
 HP 2137A A700 Computer w/128 kb memory  
 HP 2139A A900 Computer w/768 kb memory  
 HP 2113E E-Series Computer w/128 kb memory  
 HP 2117F F-Series Computer w/128 kb high perf memory  
 HP 12153A A700 Writable Control Store Card  
 HP 12156A A700 Floating Point Processor  
 HP 12157A A-Series Battery Backup System

Quantity discounts are available.

A complete list of HP 1000 computer accessories is available from your HP Sales Office.



This table shows peripherals that can be connected to many Hewlett-Packard technical computers. Information about EMI compliance and support of a specific system is available from a Hewlett-Packard sales office in your area.

### HP Technical Computer Interfacing Summary

Peripherals	Ref Page	9915 85B & 85B I/O 86B 87A 87XM	9020*		9030*	Series 200*				1000 Series		
			B	U	U	B	H	P	U	E,F	A	
2225A ThinkJet Printer	57	•				•						
2285A LAN	76			•	•							
2392A Terminal	87			•	•							
2563A/65A/66A Line Printer	95		•	•	•					•	•	
2565/66A A/Line Printers	95		•	•	•						•	•
2601A Daisywheel Printer	57	•	•	•	•	•					•	•
2602A Daisywheel Printer	57	•	•	•	•	•	•	•			•	•
2625A Dual System Terminal	89		•	•	•						•	•
2628A Word Processing Terminal	90		•	•	•						•	•
2623A Graphics Terminal	88		•	•	•						•	•
2624B Display Terminal	89			•	•						•	•
2626A Display Terminal	89			•	•						•	•
2627A Color Graphics Terminal	88			•	•						•	•
2671A/G Thermal Printer	58	•										
2673A Graphics Printer	58	•				•	•	•	•		•	•
2688A Laser Printer	57			•	•							
2932A Impact Printer	57	•	•		•						•	•
2933A Factory Data Printer	57	•	•		•						•	•
2934A Office Printer	57	•	•		•						•	•
37201A HP-IB Extender	679	•	•	•	•						•	•
37203A HP-IB Extender	678	•	•	•	•						•	•
37203L HP-IB Extender	678	•	•	•	•						•	•
37212A Modem	84	•	•	•	•						•	•
37213A/4A/5A/6A System Modem	84		•	•	•	•		•	•		•	•
37222A Modem	84			•	•						•	•
45610B HP 150 Multi-Function Terminal	43			•	•						•	•
45650B HP 150 PC w/9133 Disc	43				•						•	•
45660B HP 150 PC w/9133 Disc	43				•	•	•	•	•		•	•
7470A 2-Pen Plotter	98	•	•	•	•	•	•	•	•		•	•
7475A 6-Pen Plotter	98	•	•	•	•	•	•	•	•		•	•
7550A Graphics Plotter	100	•	•	•	•	•	•	•	•		•	•
7580B/85B/86B 8-Pen Plotter	102	•	•	•	•	•	•	•	•		•	•
7941A/45A Disc/Tape	91		•	•	•	•		•	•		•	•
7914P/R 132Mb CS/80 Disc/Tape	91		•	•	•	•		•	•		•	•
7914T/D Tape/Disc	91		•	•	•	•		•	•		•	•
7942A/46A Disc/Tape	91		•	•	•	•		•	•		•	•
7933H 404Mb Fixed Disc	92		•	•	•	•		•	•		•	•
7935H 404Mb Removable Disc	92		•	•	•	•		•	•		•	•
7970B/E 1/2" Tape Drive	93		•	•	•	•		•	•		•	•
7971A 1/2" Tape Drive	93		•	•	•	•		•	•		•	•
7974A 1/2" Tape Drive	93		•	•	•	•		•	•		•	•
7978A 1/2" Tape Drive	93		•	•	•	•		•	•		•	•
82906A Impact Printer	57	•			•	•	•	•	•		•	•
9111A Graphics Tablet	104	•	•	•	•	•	•	•	•		•	•
9121D/S 3-1/2" Flexible Dual Disc	59	•	•	•	•	•	•	•	•		•	•
9122D/S 3-1/2" Drive	59	•	•	•	•	•	•	•	•		•	•
9133D 15Mb Winchester	60		•	•	•	•		•	•		•	•
9134D 15Mb Winchester	60		•	•	•	•		•	•		•	•
9144A 1/4" Cartridge	93		•	•	•	•		•	•		•	•
97060A Graphics Processor	76		•	•	•	•		•	•		•	•
97060T Graphics Display System	76		•	•	•	•		•	•		•	•
9876A Thermal Line Printer	58		•	•	•	•		•	•		•	•
9895A 8" Flexible Disc	59		•	•	•	•	•	•	•		•	•

\* H=HPL, B=BASIC, P=Pascal, U=HP-UX



## Dial-Up Modems

Models 37213A/4A/5A/6A, 37222A, 37212A

- Auto-dial and auto-answer
- Automatic data-rate recognition and configuration
- Full duplex 1200 bps and 300 bps on dial-up lines

- Compatible with Bell 212A and CCITT V.22
- Central site, integral and stand-alone versions
- Local analog and remote digital loopback

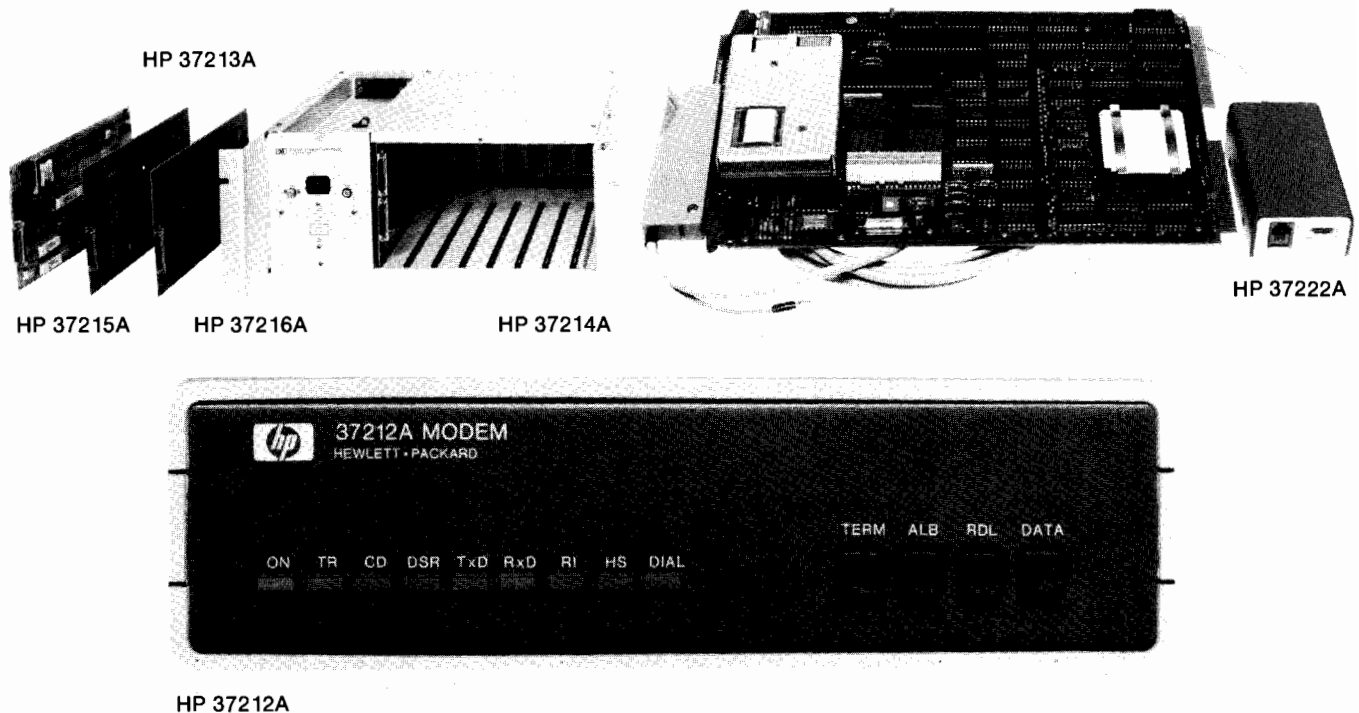

### Dial-Up Modem Family

The need for computers to communicate over long distances has increased rapidly over the last few years. The increased reliance on data communications has made it essential for modems to be able to operate completely unattended.

To facilitate this requirement, HP now provides a family of dial-up modems all of which are designed for full duplex operation over the Public Switched Telephone Network. The modems all conform to Bell-212A and CCITT V.22 standards for communication at 1200 bps or 300 bps.

### Automated Features

In order to benefit from completely unattended operation, all HP modems have auto-dial, auto-answer, and automatic data-rate recognition and configuration.

### Which Modem Should You Use

The HP 37212A is a stand-alone modem with integral power supply. Modem control lines are not required, hence this modem is ideal as a universal modem for use with any computer, terminal, or any other device which uses an RS-232C/V.24 interface.

The HP 37222A Integral Modem is a single plug-in card designed specifically for use with HP 1000 A/L-Series computers. It provides a very cost-effective solution for users who only require a few modems.

The HP 37213A/4A/5A/6A Systems Modem is designed specifically for use with HP 1000 A/L-Series and M/E/F-Series computers. The Systems Modem is based on a rack which will hold up to seven modem or other interface cards and is ideal for larger systems and for systems where the number of I/O slots in the computer is limited.

### HP 37212A Stand Alone Modem

The HP 37212A is an "intelligent" stand alone modem incorporating a microprocessor to provide modem control and auto-dial facilities for HP interactive display terminals, calculators and computers which do not support switched line modems via RS232C/V.24. The modem is fully Bell 212A compatible at 300 or 1200 bps and CCITT V.22 compatible at 1200 bps for use in some European countries. Either synchronous or asynchronous communication can be conducted. The Stand Alone Modem can support the same automatic functions as the other members of the dial-up modem family and additionally can be operated in leased line mode. Commands are passed from a terminal or computer through the RS232C/V.24 interface (using secondary TxD as an asynchronous command channel in the case of synchronous operation).

In addition to the commands available through the interface, the HP 37212A can also be operated in 'Dumb' mode, from the front panel. Non-volatile storage is provided for modem configuration and for 23 74-character strings which can be used for telephone numbers and log-on sequences. The strings can be linked together to provide completely automatic connection and log-on. A telephone is not required, but a second telephone connector is provided on the rear panel to allow one to be connected in parallel with the modem. The modem contains an integral power supply for ac operation, and also can operate from a dc supply where ac power is unavailable, e.g., telecoms and medical applications.



### **HP 37213A/4A/5A/6A Systems Modem**

The Systems Modem is designed for use with all HP 1000 Computers and communicates with the computer through an 8-channel multiplexer (HP 12040B in A/L-Series or HP 12792B in M/E/F-Series) and a single multiway cable.

### **HP 37214A Modem Interface Card Cage**

The Systems Modem is based on the HP 37214A Card Cage. This has space for up to seven modem or other interface cards in any combination. The eighth slot of the Card Cage is reserved for use by the integral controller and dialer which communicates with the user program by simulating an interactive display terminal. The controller and dialer provide the control signals, the pulse and DTMF dialing control, and loopback control for up to seven modem cards. Local analog loopback or remote digital loopback may be selected under program control to allow a user program to pass data and to check the integrity of the looped modem link. Also a local diagnostic terminal port enables monitoring of all the modem interface lines for diagnostic purposes.

### **HP 37213A Modem Card**

The HP 37213A is a single card modem. As with the HP 37215A/6A, it plugs into the HP 37214A Card Cage. It communicates with Bell 212A compatible modems at 1200 or 300 bps and with any CCITT V.22 (Alternatives A and B) compatible modem at 1200 bps. Asynchronous or synchronous communication is supported. The HP 37213A is also compatible with the Vadic 3450 Series Triple Modem. The Modem can perform both pulse and DTMF (tone) dialing under user program control. Two interfaces are provided, one for the 8-channel Multiplexer and one for an RS232C port for applications that either do not use a Multiplexer or require synchronous communication. Local analog or remote digital loopback may be performed under user program control.

### **HP 37215A Modem Interface Card**

For applications where a PTT supplied modem must be used or where a modem is already available, an HP 37215A Modem Interface Card may be used in place of an HP 37213A Modem Card. The

HP 37215A provides buffered RS232C and V.24/V.28 compatible lines for controlling all common switched line, full-duplex modems. Loopback of most external modems may be performed under user program control. The Modem Interface Card also provides auto-configuration of port speed with auto-answer modems. Auto-dialing is not possible when using external modems.

### **HP 37216A Terminal Interface Card**

The HP 37216A allows direct connection of local interactive display terminals to unused Multiplexer ports. With the Terminal Interface Card, one local terminal can be connected to one port of the 8-channel Multiplexer via a standard 25-pin D-type connector.

### **HP 37222A Integral Modem**

The HP 37222A Integral Modem offers virtually identical functions to the HP 37213A/4A Systems Modem. However, it is a completely self-contained modem built into an A-Series interface card. Designed for use in HP 1000 A/L-Series Computers, this card plugs directly into the computer. This modem is the first of its kind (from Hewlett-Packard) to offer its users a direct connection from the CPU to an external phone line. The HP 37222A is software-compatible with the HP 37213A/4A Systems Modem, so applications software developed for use with the HP 37213A/4A may be used with the HP 37222A.

The Modem is compatible with Bell 212A type modems and CCITT V.22 (Alternative B) type modems but, unlike the Systems Modem, will only support asynchronous communications. All other functions offered by the HP 37213A/4A Systems Modem are also supported by the HP 37222A Integral Modem. HP 1000 M/E/F-Series Computers must use the HP 37213A/4A Systems Modem.

### **Ordering Information**

HP 37213A Modem Card  
 HP 37214A Modem Interface Card Cage  
 HP 37215A Modem Interface Card  
 HP 37216A Terminal Interface Card  
 HP 37222A Integral Modem  
 HP 37212A Stand Alone Modem



# COMPUTERS, PERIPHERALS & CALCULATORS

## Business Oriented Computer Systems

HP 3000, HP 250



HP 3000 BUSINESS COMPUTER SERIES 68



HP 250 BUSINESS COMPUTER

### HP 250 Small Business Computer System

Designed for small businesses that need an easy-to-use yet comprehensive computer solution, the HP 250 system is a good choice for first time users. Friendly and reliable, the HP 250 is working hard for over 7,000 companies around the world. No system operator is required and minimal system training is necessary. Productivity and user acceptance begin immediately.

The HP 250 supports from 16.5Mb to 275Mb of mass storage and from 256Kb to 896Kb of main memory. Up to 11 tasks of 64Kb can be configured. Task-to-task communication is possible, as is job streaming. The HP 250 supports up to 10 workstations and a wide variety of printers, data entry devices, plotters and more.

Comprehensive application solutions are available on the HP 250 for accounting, manufacturing, inventory control, order processing, decision support graphics, and text processing.

### HP 3000 Business Computers

The HP 3000 family ranges from the cabinet-sized Series 37 office computer to the Series 68 distributed mainframe. All four models share the same multiprogramming executive operating system (MPE) featuring cache memory, the same high-level languages, a variety of peripherals, and the ability to interchange software without modification. General-purpose capabilities include simultaneous transaction processing, data communication, on-line program development, and batch operations in COBOL, RPG, BASIC, FORTRAN, Pascal, and SPL/3000.

The four models in the HP 3000 family include the Series 37, 42, 48, and 68. The entry-level Series 37 is a compact system for as few as two users or as many as 28, and offers 512Kb of main memory. The Series 42 provides a very cost-effective solution for up to 92 terminals and 3Mb of memory. Where greater expandability is required, the Series 48 offers you a system with up to 152 terminals and 4Mb of memory. The most powerful HP 3000 computer, the Series 68, features up to 8Mb of memory, the ability to support up to 400 terminals, and 24 data communications lines.

All smaller HP 3000 models can be upgraded to the Series 68 without software conversion. The HP 3000s provide a complete data base management and inquiry facility, IMAGE/QUERY, as well as VPLUS/3000, a data entry/forms generation system. HP 3000 computers may be interconnected via a network that can also integrate them with HP 1000 computers, HP touchscreen personal computers, and the HP 9000 engineering workstations, as well as IBM mainframes.

### Office System Tools

Software packages are available for the HP 3000 computer to make it especially productive in an automated office. These office software products bring the information processing and communications capabilities of the HP 3000 directly to managers, business professionals, and support personnel.

HP Word sets new standards for ease of use in word processing for secretaries and support staff.

HP DeskManager is a multi-function software solution for electronic mail, personal filing, time management, and simplified word processing.

INFORM/3000 lets you quickly retrieve and combine information from various data bases to create reports.

DSG/3000 is a sophisticated interactive system for creating charts, graphs, production plans, and other graphic output.

HP Draw designs and produces overhead slides and high quality presentation aids.

HP EasyChart lets you quickly produce pie charts, bar charts, and line graphs.

With HP ListKeeper you can create, edit, find, sort, and print your own personal information lists.

### Application Software Solutions

Hewlett-Packard offers application software products for manufacturing on the HP 3000 computer. These products include HP Materials Management/3000, HP Production Management/3000, HP Maintenance Management, Financial Accounting, SFD/3000, HP Pay, and Semiconductor Productivity Network software.

HP Materials Management/3000 helps you manage the materials planning and control function of a manufacturing operation. It is available with or without lot control.

HP Production Management/3000 is an interactive application system for managing manufacturing production planning and control.

HP Maintenance Management provides the tools to better manage your maintenance tasks, including work order control, preventive maintenance scheduling, and spare parts inventory.

HP Pay automates your company's payroll function.

Financial Accounting is applicable to manufacturing as well as the complete range of other business/financial tasks.

SFD/3000 integrates inventory distribution control, order processing, and other functions for distributors.

Semiconductor Productivity Network is an integrated set of application software products to help semiconductor manufacturers improve productivity.



# COMPUTERS, PERIPHERALS & CALCULATORS

Interactive Terminals  
Model 2392A

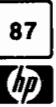

- Compact size
- High resolution display
- Block/Forms Mode
- Up to 4 pages of memory (up to 4 additional pages optional)
- Smooth scrolling
- Integral tilt and swivel
- Optional printer port
- Optional ANSI compatibility



Model 2392A

## Introduction

Hewlett-Packard's family of interactive display terminals offer a complete spectrum of features optimized to suit a variety of applications on HP computer systems and software packages. The applications include program development, data entry, word processing, electronic mail and graphics.

The HP 2392A is a new low cost, high performance display terminal designed for a full range of applications from data entry to program development. The HP 2392A takes up just over a cubic foot of space, while providing a full 12 inch diagonal CRT. Careful attention to ergonomics in the HP 2392A has resulted in a terminal that maximizes ease of use. At the same time, the HP 2392A is packed with features like extended memory, smooth scrolling, and high speed data communications.

The HP 2620 series of terminals offer a variety of sophisticated capabilities. The HP 2624B provides extended edit checks and a forms cache that make it ideally suited for data entry applications. For features like multiple user-defined workspaces and windowing—plus multipoint data communications, the HP 2626A offers an unparalleled array of functions. The HP 2623A gives the user low-cost, high quality monochrome graphics, while the HP 2627A offers color graphics. Graphics options are also available on the new HP 2625A and HP 2628A terminals. The HP 2625A is a unique terminal that can be connected simultaneously to an HP computer and an IBM mainframe, with both ports active at one time. The HP 2628A provides HPWORD word processing capability, as well as a number of other high performance features.

Terminal discounts for OEM's are available for the HP 2620 terminal series, as well as the HP 2392A terminal.

## HP 2392A Display Terminal

The HP 2392A is a compact, low cost, high performance terminal block mode terminal designed for a wide range of applications — from data entry to program development. Built-in ergonomic features like integral tilt and swivel, full 12-inch diagonal anti-glare screen in a display unit approximately a cubic foot in size, and a low-profile keyboard with adjustable stand provide maximum ease of use for the user. With the smooth scroll feature, users can easily view up to 4 pages of text or data (up to 8 optional). Forms mode, combined with the standard line drawing set, emulates existing paper forms on the screen to facilitate data entry. High speed datacomm (up to 19,200 bits per second) decreases system response time and cuts computer overhead.

An optional user-installable printer port offers a choice between an RS 232C serial or Centronics® - type parallel interface module.

Besides being compatible with HP computers and software, the HP 2392A, when equipped with the no-cost ANSI (American National Standards Institute) option, can communicate with ANSI "speaking" computer systems too—like DEC® computers.

## HP 2392A Display Terminal

DEC® is a registered trademark of Digital Equipment Corporation  
Centronics® is a registered trademark of Centronics Data Computer Corporation

# COMPUTERS, PERIPHERALS & CALCULATORS

## Interactive Display Terminals

Models 2623A, 2627A



- High Quality Display  
512 × 390 dot resolution  
TEKTRONIX® 4010 compatible (1024 × 780 dot resolution)
- Built-in Graphics Hardcopy (optional)
- HP 2622A Compatible
- HP 17623A Graphics Tablet Support

- High Quality Color Display
- Graphics Software Support
- Hardcopy and Video Interfaces
- HP 17623A Graphics Tablet Support

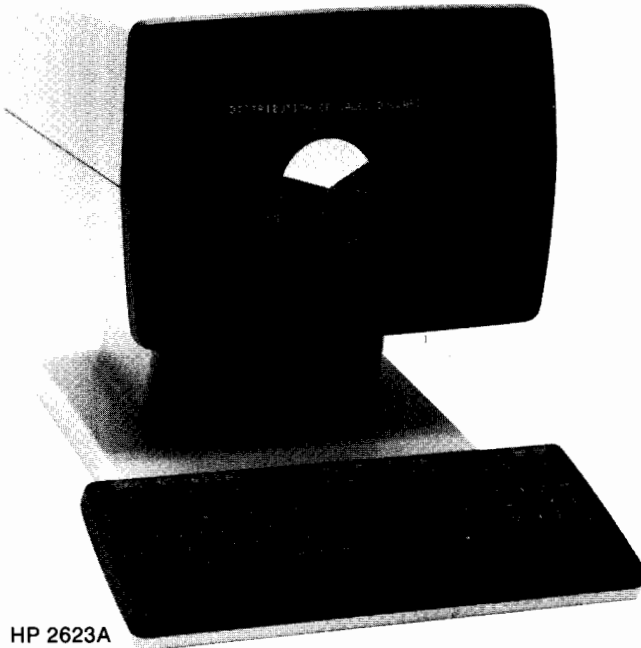

HP 2623A

### HP 2623A Graphics Terminal

The low cost HP 2623A is designed for the graphics user with an extensive on-line capability and system based software. The high quality display features 512 × 390 dot screen resolution and is ideally suited for many display graphics applications as well as some design applications. An optional built-in printer provides low cost graphic hardcopy in only 30 seconds by simply pressing a key.

The HP 2623A is supported on HP's Graphics 1000/II and Decision Support Graphics Software. The HP 2623A also works with other third party software such as TEKTRONIX®'s Plot 10 and is compatible with the TEKTRONIX® 4010 display terminal. In addition, the HP 2623A offers an ANSI software compatibility option which allows the HP 2623A to be used with host computers and application software that support this protocol.

The HP 2623A can generate vectors at 9600 baud and graphs can be quickly annotated locally in ASCII, or six other optionally available national languages, before obtaining a hardcopy.

All of the alphanumeric capabilities of the low cost block mode HP 2622A are available in the HP 2623A.

### HP 2623A Graphics Terminal



HP 2627A

### HP 2627A Color Graphics Terminal

The HP 2627A combines a high quality color raster display with fast vector graphics in a compact, low-price package. It's ideally suited to both business and technical display graphic applications where the addition of color enhances the comprehension of relationships and trends.

Eight basic colors are provided by the HP 2627A, plus hundreds of additional user-defined ones including colors that match HP plotter pens. With vector graphics and local polygonal area filling, it's easy to create precise shapes, symbols and typestyles quickly.

The HP 2627A not only provides color graphics, but also provides color alphanumerics. Up to eight color pairs (foreground/background) can be used on a per character basis to differentiate lines of text and identify critical fields. In addition, a full set of alphanumeric features are available with the HP 2627A to make it suitable for a wide range of non-graphic applications.

The HP 2627A is compatible with HP and major industry graphics software packages. TEKTRONIX® 4010 compatibility mode is offered on the HP 2627A, allowing it to be used with monochromatic PLOT 10 software.

In addition, the HP 2627A offers an ANSI software compatibility option which allows the TEKTRONIX® 4010 compatibility mode to operate in either HP or ANSI mode.

### HP 2627A Color Graphics Terminal

®TEKTRONIX is a registered trademark of Tektronix Corporation.

# COMPUTERS, PERIPHERALS & CALCULATORS

## Interactive Display Terminals

Models 2624B, 2625A

89



- High Resolution Display
- Advanced edit checks
- Local Forms Mode
- Block mode format
- Multipoint
- Terminal bypass mode

- IBM 3276 Compatibility
- Simultaneously-active dual system ports for HP and IBM
- Optional Graphics
- Optional word processing function



HP 2624B

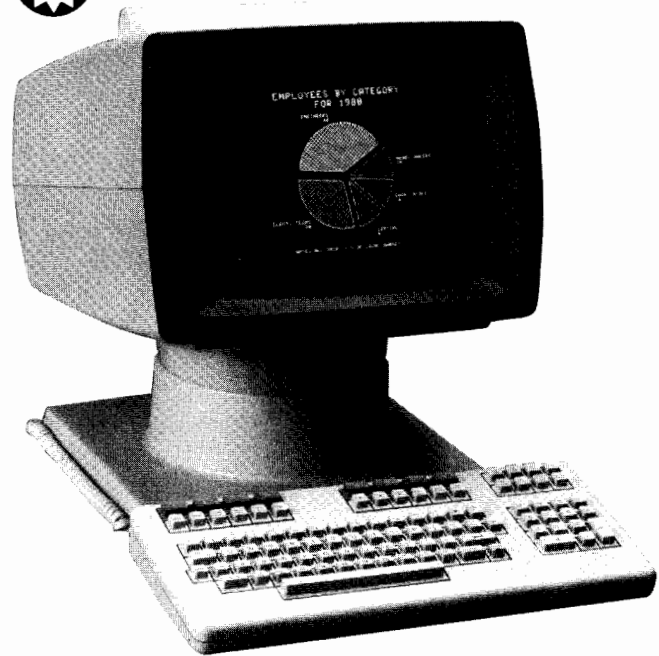

HP 2625A

### HP 2624B Data Entry Terminal

The HP 2624B represents the ultimate in a data entry terminal. Multiple forms can be downloaded from the system and stored in display memory for instant retrieval. This reduces the burden on the system and improves system response time while lowering transmission costs. The advanced edit checks which are supported by the HP 2624B improve data integrity and increase data throughput. In addition to protected, unprotected and transmit only fields, the HP 2624B provides the first level of data verification through field edit checks. The edit checks allow the terminal to detect many data entry errors and notify the user. By correcting errors at the terminal, system overhead is reduced. The checks include all characters, alphabetic, alphanumeric, numeric, integer, signed decimal and implied decimal. The preprocessing capabilities are justify, fills and implied decimal. Required and total fill fields provide entry control. These capabilities are an asset to applications that do not do data checking today and they reduce system overhead in programs where the computer previously performed all of the data verification.

The HP 2624B provides comprehensive point-to-point communications as well as multipoint communication so that multiple terminals can share an expensive communications line. In addition, an external printer connected to a HP 2624B can operate in terminal by-pass mode in multipoint. That is, the printer can be designated as a destination device and information can be sent directly from data comm. to the printer without disturbing the information on the screen or tying up the terminal display.

### HP 2624B Data Entry Terminal

### HP 2625A Dual System Display Terminal

The HP 2625A brings HP and IBM compatibility together in a single terminal. With the data entry features of the HP 2622A Block Mode Terminal on port 1, and IBM 3276 Display Station features on port 2, the HP 2625A offers convenience and cost savings to multiple system users.

Both ports remain active at all times, allowing tasks to run concurrently on both hosts. The HP 2625A also connects to non-HP systems supporting ASCII asynchronous point-to-point data communications in character mode.

Option 523 adds HP 2623A graphics features enhanced to provide polygonal area fill, rubberband line, and Tektronix 4014 compatibility. The graphics option allows the HP 2625A to run HP and other major industry software packages (see the HP 2623A product summary).

All the text editing features of the HP 2628A Word Processing Terminals can be added to the HP 2625A. Option 528 allows the HP 2625A to operate with HPWORD software on an HP 3000 system.

The HP 2625A also offers 19.2 kbps high-performance datacomm, smooth vertical scrolling, forms/format mode, and 11 national character sets. Configuration flexibility allows you to daisy-chain up to 32 terminals for both local and remote operations.

With IBM 3276 emulation, HP 2622A data entry, HP 2623A and Tektronix 4014 graphics, and HP 2628A word processing, the HP 2625A is actually five terminals in one.

### HP 2625A Dual System Display Terminal



# COMPUTERS, PERIPHERALS & CALCULATORS

## Interactive Display Terminals

Models 2626A, 2628A

- Multiple Workspaces
- Multiple Windows
- Dual Data Communications Ports
- Multipoint Data Communications
- Interactive Forms Design

- Complete word processing
- Optional graphics
- High speed data entry



HP 2626A

### HP 2626A Multi-Window Terminal

The HP 2626A is a high performance terminal which provides unique display capabilities and data communications flexibility. The HP 2626A display memory can be divided into four independent workspaces, and the display screen into four separate windows to examine and manipulate the contents of the workspaces. This capability amounts to four virtual terminals which may be changed from application to application or system to system.

Dual data communication ports can be linked to workspaces to display data from two different computers, or one port may be linked to a computer and the other used as an external RS232 serial printer port. Data may be communicated to the computer using block, line, line modify, or character modes in a point-to-point or multipoint environment.

The HP 2626A is ideally suited for program development or data entry particularly when taking advantage of the easy to use function key approach to forms design. The line length may be set from 80 to 160 characters so that 132 column reports as well as double width pages may be handled, with viewing via horizontal scrolling.

### HP 2626A Display Station



HP 2628A

### HP 2628A Word Processing Terminal

The HP 2628A combines HPWORD word processing, graphics, and data entry capability in one terminal.

For HP 300 system users with both word processing and data processing requirements, the HP 2628A is ideal. As a word processing terminal designed for use with HPWORD (Hewlett-Packard's word processing software for HP 3000 computer systems), the HP 2628A allows you to create, edit, and store documents. Keyboard overlays provide a full graphics and word processing keyboard, including syntactic keys (character, word, line, sentence, phrase and paragraph) for cursor positioning and editing functions such as delete, move and copy. Letter quality copies of the documents can be printed by an optional HP daisywheel printer attached to the terminal, or a selection of system printers.

Option 523 provides all the graphics capabilities of the popular HP 2623A Graphics Terminal, with enhanced features that include polygonal area fill, rubberband line, and Tektronix 4014 mode. Like the HP 2623A, the HP 2628A is compatible with HP and other major industry software packages (listed in this guide under the HP 2623A product summary). Tektronix 4014 compatibility allows the terminal to use PLOT 10 software as well.

When the HP 2628A is not being used as a word processing terminal on an HP 3000, it can perform all the data entry functions of the HP 2622A Block Mode Terminal. The HP 2628A's six pages of alphanumeric memory make it an ideal terminal for programmers, and VPLUS/3000 support allows HP block mode screen-oriented applications to be run.

In addition, the HP 2628A offers high-performance 19.2 kbps datacomm, smooth vertical scrolling, forms/format mode, optional integral thermal printer, plus 11 national character sets.

### HP 2628A Word Processing Terminal

# COMPUTERS, PERIPHERALS & CALCULATORS

## CS/80 DESKTOP DISC DRIVE FAMILY

models 7941A, 7945A, 7942A, 7946A

91



- Customer installable
- Convenient desktop package
- Quiet operation



HP 7941A

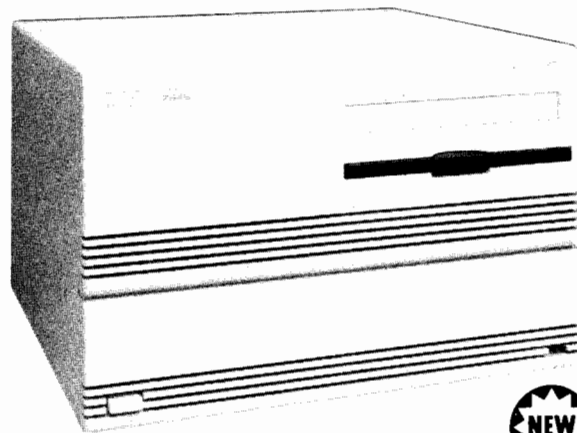

HP 7946A



### HP 7941A/45A and HP 7942A/46A

HP's newest additions to its disc drive line are four new products: two new discs and two new disc/tape subsystems. The HP 7941A and HP 7945A are 24- and 55-Mb disc drives, respectively. The HP 7942A and HP 7946A products feature the same 24 and 55 megabyte capacities but include a 1/4-inch cartridge tape drive integrated into a single unit. These products are designed and priced for the entry-level multi-user.

Both the disc products and the disc/tape products employ the same efficient command structure (CS/80) and HP-IB interface as the HP 7911, 7912, 7914, 7933, and 7935 mass storage products. This commonality in command structure allows you to mix and match a wide range of compatible mass storage solutions.

The disc and the disc/tape products are customer installable and contain extensive self-test capabilities resident in the controller. Both package designs provide quick access to all replaceable assemblies.

With acoustic emissions at 50dba, the disc and disc/tape products are quiet enough to operate unnoticed in an office environment.

The disc and disc/tape products are small enough to place on top of a desk, and both feature adapter kits to fit in 19-inch EIA rack enclosures or in HP's mobile mini-rack.

With a 30ms average disc seek time and a typical data transfer rate of one megabyte per minute for the tape drive, these disc and disc/tape products provide the performance needed for the entry-level multi-user system.

### Features

#### HP 7941A and HP 7945A Disc Drive

- Small stand-alone desktop cabinet (130mmx325mmx285mm) HxWxD
- Quiet operation; acoustic emissions 50dBA
- Customer installable
- Good performance with an average seek time of 30ms
- Fits in 19-inch EIA rack enclosure with an HP 19500A adapter kit

### Features

#### HP 7942A and HP 7946A Disc/Tape Drive

- Customer installable
- Good performance. The disc drives have an average seek time of 30ms. The tape drive can typically transfer data at one megabyte per minute.
- The tape drive has read-after-write capabilities and automatic error detection and correction for enhanced data reliability
- Small stand-alone desktop cabinet (208mmx325mmx285mm) HxWxD
- Quiet operation with acoustic emissions at 50dBA
- Fits in 19-inch EIA rack enclosure with an HP 19501A adapter kit

### Description

#### HP 7941A/7945A Disc Drives

The HP 7941A and HP 7945A are 24- and 55-Mb disc drives. Each of these products includes a fixed Winchester disc drive, intelligent HP-IB Command Set 80 controller and power supply — all in a compact desktop package.

### Description

#### HP 7942A/7946 Disc/Tape Drives

The HP 7942A and HP 7946A are mass storage systems combining either a 24-megabyte or a 55-megabyte fixed disc drive with a built-in 1/4-inch cartridge tape drive, intelligent HP-IB Command Set 80 Controller and power supply — all in a compact desktop package. A single controller integrates and controls the tape and disc drives.

### Operating Characteristics

#### Electromagnetic Emissions

Radiated and conducted interference:

- HP 7941A, 7942A, 7945A, 7946A - For U.S.A., designed to meet FCC Docket 20780 for Class B computing devices.
- HP 7941A, 7942A, 7945A, 7946A - For Europe, designed to meet VDE 0871 for Level B computing devices. FTZ licensed on some HP systems. Refer to your local sales representative for more information.

### Safety

The HP 7941A, 7942A, 7945A, 7946A meet all applicable safety standards of the following:

- IEC 380 and 435
- UL 114 and 478
- CSA C22.2 no. 154

### Ordering Information

HP 7941A (24Mb) disc

HP 7945A (55Mb) disc

HP 7942A (24Mb disc/tape cartridge)

HP 7946A (55Mb disc/tape cartridge)

Opt 015 Voltage selector set for 230V (For non-U.S. shipments)

Opt 550 Deletes one-metre HP-IB cable

HP 19500A Rack kit for mounting HP 7941A and HP 7945A in 19-inch EIA rack enclosures

HP 19501A Rack kit for mounting HP 7942A and HP 7946A in 19-inch EIA rack enclosures



# COMPUTERS, PERIPHERALS & CALCULATORS

## CS/80 Disc Drive Family

Models 7911, 7912, 7914, 7914ST, 7933, 7935

- Performance
- Reliability
- Serviceability

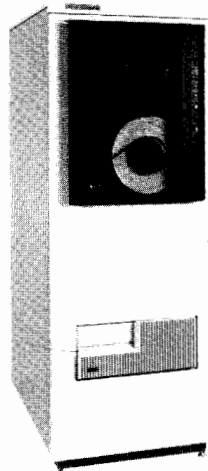

HP 7914ST

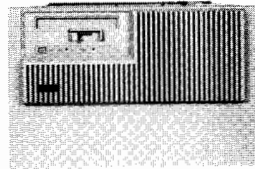

HP 7911R, 7912R, 7914R

- Integral self test and diagnostics
- Internal microprocessor controller

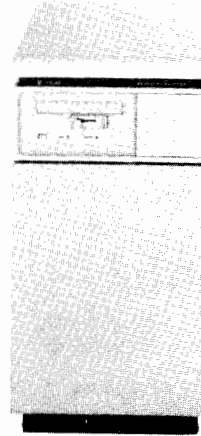

HP 7911P,  
7912P,  
7914P

HP 7933H,  
7935H

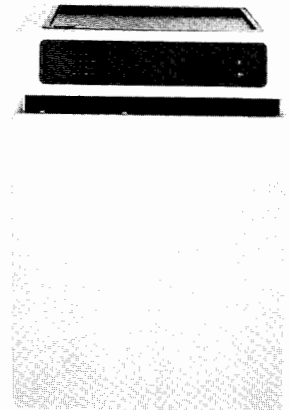

Creating new standards for efficiency and ease of use, Hewlett-Packard offers the HP 7911, 7912, 7914, 7933, and 7935 disc products. Whether you require an efficient entry level product or a larger, more powerful solution, these disc products are designed to satisfy your particular storage requirements.

To ensure flexibility in configuring mass storage needs, each disc product employs the same efficient command structure (CS/80) and the same interface standard (HP-IB), allowing you to mix and match a wide range of compatible storage solutions with little or no need for additional control hardware or software modification.

All of the CS/80 family disc products contain a sophisticated, internal controller which performs advanced, self-diagnostic routines to facilitate maintenance and servicing. These self-diagnostic capabilities, coupled with careful design and engineering, promote a highly reliable and serviceable disc drive which will provide greater system uptime and productivity.

### HP 7911, 7912, 7914 Disc/Tape Drives

These Disc/Tape Drives are a family of products designed to satisfy all peripheral storage requirements in a single compact package. Each product utilizes a unique integrated storage concept, featuring a reliable Winchester disc mechanism for mass storage, and a 1/4-inch cartridge tape drive for backup and user I/O.

The product line provides mass storage capacities from 28.1 to 132.1 Mbytes; they include the 7911 (28.1 Mbytes), 7912 (65.6 Mbytes), and 7914 (132.1 Mbytes).

### HP 7914ST Mass Storage Subsystem

The HP 7914ST is a complete mass storage subsystem offering 132 megabytes of winchester disc storage and an HP 7974A half-inch tape drive in a 1600mm high system cabinet. An option for a second 132-Mb disc drive in the same cabinet is also available.

### HP 7933H Disc Drive

The HP 7933H Disc Drive is a 404-MB fixed media device that provides high levels of performance, reliability, and serviceability. The performance of the HP 7933H promotes overall greater system efficiency. The advanced reliability and serviceability features are reflected by the exceptionally low maintenance costs of this product. A bundled package of three HP 7933H's is available as the HP 7933G at a reduced price.

### HP 7935H Disc Drive

The HP 7935H Disc Drive is a removable media device that provides 404 Mbytes of removable media for increased system flexibility and greater system uptime for private data volume configurations and

disc-to-disc backup/restore operations. This product is available in an HP 7935G package of three drives at a reduced price.

## Operating Characteristics

### Electromagnetic Emissions

The 7911, 7912, 7914, 7933, and 7935 are designed to meet FCC Docket 20780 for Class A computing devices. For Europe, they are designed to meet VDE 0871 for Level A computing devices and are FTZ licensed on some HP systems.

### Safety

The HP 7911, 7912, 7914, 7933, and 7935 meet all applicable safety standards of the following: CSA 22.2 No. 154, IEC 380 and 435, UL 114 and UL 478.

### Ordering Information

HP 7911P/R (28.1 Mbytes)

HP 7912P/R (65.6 Mbytes)

HP 7914P/R (132.1 Mbytes)

Opt 001: Dedicated tape controller (HP 7911, 7912, and 7914 on HP 3000 only)

Opt 015: 220-volt operation

Opt 140: Delete cartridge tape drive

HP 7914ST (132.1 Mbytes)

Opt 002: Adds cartridge tape drive and second controller (for HP 3000 only)

Opt 015: 220-volt operation

Opt 114: Adds second HP 7914R (less cartridge tape drive)

Opt 236: Configures HP 7970E with parallel interface (for HP 1000 E-and F-Series)

Opt 240: Adds cartridge tape drive to first HP 7914R

HP 7933H (404 Mbytes)

HP 7933G (1.212 Gbytes)

HP 7935H (404 Mbytes)

HP 7935G (1.2 Gbytes)

Standard Input Power: 208 volts

Opt 120: For 120-volt operation in U.S.A., Canada

Opt 220: For 220-volt operation in Canada

Opt 221: For 220-volt operation in continental Europe

Opt 222: For 220-volt operation in Switzerland

Opt 223: For 220-volt operation in Denmark

Opt 241: For 240-volt operation in United Kingdom

Opt 242: For 240-volt operation in Australia, New Zealand



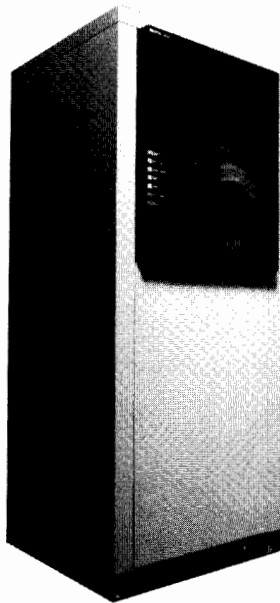

HP 7978A

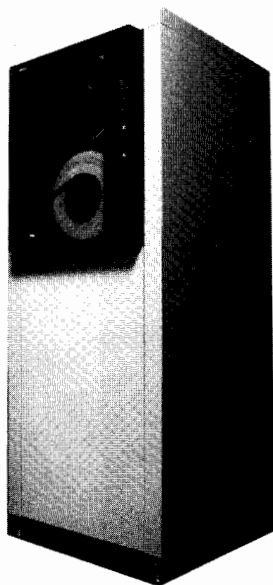

HP 7974A

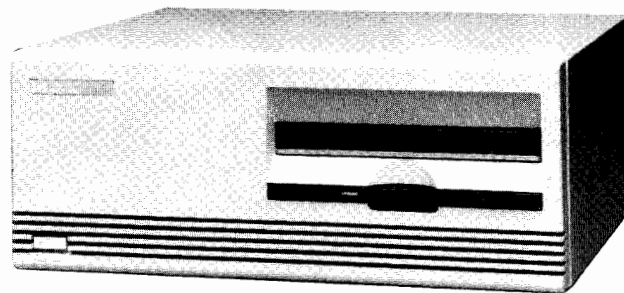

HP 9144A

The Hewlett-Packard family of tape drives provides a range of solutions to meet your format, capacity and performance needs. There are four key types of tape drive applications: 1) Backup for protection against equipment failure and operator error, 2) Archival storage for economical, long term data preservation, 3) Data exchange with other computers as well as software updates for the system, and 4) On-line mass storage for data logging and tape processing.

### High Performance System Backup

#### HP 7978A 1/2" Magnetic Tape Subsystem

The HP 7978A 1/2" Magnetic Tape Subsystem is the best solution for fast, reliable backup of systems with greater than 400-500 Mbytes of storage. The dual density recording format (6250 GCR/1600 PE cpi) packs up to 140 Mbytes on each 2400 foot reel for reduced media cost. The drive, offering low cost, streaming backup, features 75 ips read/write speed (250 ips rewind speed) and provides up to three times the transfer rate of the HP 7974A. Increased reliability, extensive front panel diagnostics and ease of repair mean lower cost of ownership. The drive is mounted in an upright cabinet and uses an HP-IB interface. The HP 7978A is supported on the HP 3000, Series 39,40/42,44/48,64/68. Future support is planned for the HP 1000-A Series.

### Midrange Solutions

#### HP 7974A 1/2" Magnetic Tape Subsystem

The HP 7974A is a midrange, low cost tape subsystem designed to operate in both the start/stop and streaming modes and is formatted with a 1600 (PE) cpi density. 800 (NRZI) cpi format can be added if dual density is needed. It is ideal to use as a dedicated drive for backup of systems with up to 400-500 Mbytes of storage and offers a good solution for transaction logging as well as data exchange and archival storage. The HP 7974A is a true start/stop tape drive operating at a tape speed of 50 ips with tension arm buffering. In the streaming mode, the drive operates at 100 ips enabling faster back-up (twice as fast as the HP 7970E). The HP 7974A uses an HP-IB interface and is mounted in an upright cabinet. It is supported by the HP 3000, 39,40/42,44/48,64/68 and the HP 1000-A Series.

#### HP 7970B/E 1/2" Magnetic Tape Subsystems

The HP 7970B/E tape drives offer cost effective support for midrange HP computer systems. They operate in the start-stop mode at 45 ips read/write speed (160 ips rewind speed) and use tension arms as physical tape buffers. Both the HP 7970B and HP 7970E

systems are available either in a lo-boy cabinet or without a cabinet for rack mounting. They are also available in an upright cabinet by ordering the HP 7971A described below.

The HP 7970B is especially valuable for data exchange between HP computers and other systems. It provides 800 characters per inch (cpi) density with NRZI format. The HP 7970B uses a parallel differential interface.

The medium speed and low cost of the HP 7970E make it suitable for backup of midrange systems which have up to 400-500 Mbytes of online storage, for data exchange and for transaction logging to protect real-time data base updates between system backups. Providing 1600 cpi density (PE), the drive is available with either a parallel or an HP-IB interface, which makes it useful for HP computers not supporting HP-IB peripherals and component OEM customers.

#### HP 7971A Upright Cabinet

The HP 7971A is an upright cabinet containing the HP 7970B and/or HP 7970E magnetic tape drives. One or two HP 7970B/E drives can be combined in one cabinet by ordering the HP 7971A with the appropriate option.

#### HP 9144A 1/4" Tape Cartridge Subsystem

The HP 9144A is a 1/4" Tape Subsystem designed for low cost, reliable backup of HP's midrange discs (up to 132 Mbytes) using 16 and 67 megabyte cartridges. Its compact, in-basket size saves valuable desktop space. Offering performance of up to 2 Mbytes/minute, it is a convenient backup alternative to multiple floppy discs at about one-third the cost of the faster half-inch tape drives. Compatible with existing cartridge subsystems built into the discs, the drive offers improved reliability and incorporates extensive error correction capabilities. The HP 9144A is designed for disc backup for the HP 9000, Series 200 and Series 500 and HP 1000-A Series and HP 3000.

#### Ordering Information

HP 7978A 1/2" Magnetic Tape Subsystem

HP 7974A 1/2" Magnetic Tape Subsystem (1600 cpi)

HP 7974A with NRZI option (1600/800 cpi)

HP 7970B 1/2" Magnetic Tape Subsystem

HP 7970E 1/2" Magnetic Tape Subsystem

HP 7971A Upright Cabinet for Tape Subsystem (price for single HP 7970E master drive; prices vary for other configurations)

HP 9144A 1/4" Tape Cartridge Subsystem



- High quality speech output
- Hardwire RS-232 peripheral
- Low cost
- RAM or EPROM based
- Over 1500 words and sounds available
- Dialog design tools available



HP 27201A

Welcome to the world of computer speech. HP's new speech output module makes speech synthesis a viable technology for a wide variety of computer-based applications. The HP 27201A Speech Output Module (SOM) offers you high quality speech, low price, and flexible configurability.

### Applications

The SOM is most useful for applications where prompting, warning, or error messages are required, or where a person is concentrating on or looking at something other than the computer.

In an office, you can benefit from the HP 27201A announcing receipt of electronic mail. In an electronic data processing center, the SOM can prompt you to load a magnetic tape or notify you that a printer is out of paper.

There are speech output applications in engineering environments. For example, in computer-aided design, a CRT filled with schematic information does not have to be overwritten with error messages. In computer-aided-test, a technician will not have to look at the screen for the results of a probe test; the SOM can advise pass or fail information.

Other prime applications include facilities monitoring, process control, graphics, inventory management, and computer-aided manufacturing.

### Easy to Use

The SOM is a small device that connects directly to a host computer or interconnects a host and another peripheral (such as a terminal, printer, or plotter). It communicates via a three-wire RS-232-C hardwired line at speeds up to 19,200 bits per second. An on-board microprocessor controls the HP 27201A by performing handshaking sequences with the host computer, interpreting HP 27201A commands and managing the flow of data. Vocabulary data can be downloaded from the host computer or resident on the HP 27201A in customer-supplied EPROM. EPROM-based vocabularies can in-

clude up to 200 words, while the downloaded vocabulary is limited only by host memory.

Software packages for the HP 1000 and HP 3000 computer systems include a word library of more than 1700 words and sounds, and an exerciser program to preview words and phrases and store them in files, all without writing a program.

### Ordering Information

**HP 27201A** Speech Output Module including: one 16K-bit RAM; HP 27201-60003 cable for connection to HP 262X terminals capable of supplying power (i.e., HP 262X with built-in printer); phone plug for attachment to user supplied speaker; hardware reference manual; monaural headphone

**Opt 001:** Adds five 16K-bit RAM

**Opt 002:** Substitutes HP 27201-60004 cable, which adds 115V ac power supply for HP 262X terminals with insufficient power for SOM

**Opt 003:** Substitutes HP 27201-60006 cable with 25-pin connectors for HP 264X terminals and general RS-232 hardware devices (includes 115V ac power supply)  
**HP 27203A** SOM Speech Library/1000 software for HP 1000 systems including a software reference manual (media option required)

**Opt 022:** Cartridge tape (Linus CS-80) compatible with HP 7908/11/12

**Opt 042:** 5.25 inch floppy disc

**Opt 051:** 1600 bpi magnetic tape

**HP 27205A** SOM Speech Library/3000 for HP 3000 systems including a software reference manual (contact HP for software distribution)

# COMPUTERS, PERIPHERALS & CALCULATORS

Line Printers, Laser Printers

Models 2563A, 2565A, 2566A, 2680A, 2686A, 2687A, 2688A

95



HP 2565/66A

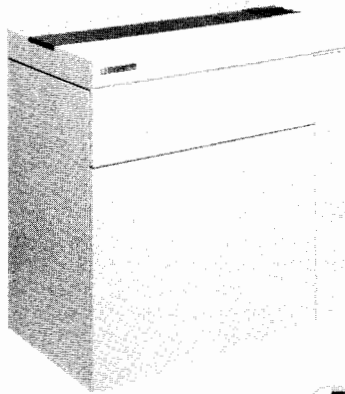

HP 2686A

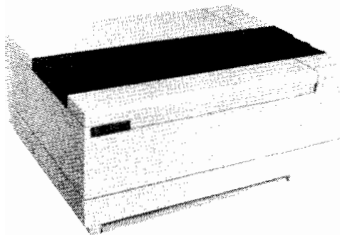

HP 2563A

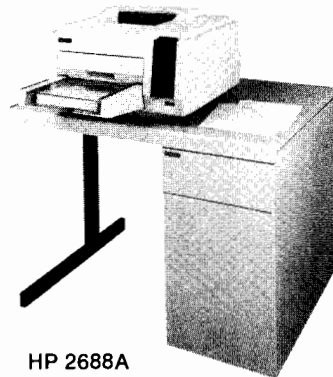

HP 2688A

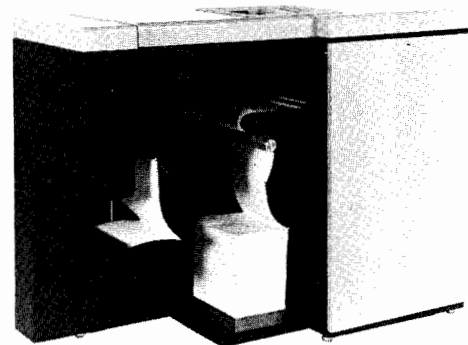

HP 2680A

## HP 2565A and HP 2566A

The HP 2565A and 2566A are moderately priced line matrix printers, printing at 600 and 900 lpm respectively in standard mode. The HP 2565A and 2566A offer many special user features such as graphics, bar code printing, multiple character sets, 16-channel vertical format control, high density printing, and compressed print.

### High Reliability

The HP 2565A and 2566A have greater than 95% commonality and have been designed with reliability as a primary criterion. The printing mechanism has few moving parts, operates with a minimum amount of friction and requires minimum maintenance.

### Printing Versatility

The HP 2565A and 2566A print crisp, clear dot matrix characters using line matrix technology. This provides flexibility to adjust character formation, allowing multiple languages, line draw and special characters to be printed by the HP 2565A and 2566A.

### Graphics Capability

The raster graphics mode is accessible to the user programmatically. The HP 2565A and 2566A have a dot placement which can be accessed by user written application programs or HP Software\* and provides the potential for a virtually unlimited array of graphics output.

\*Refer to the respective Graphics Software Package data sheet for the system under consideration to determine if the HP 2565A and 2566A are supported.

### User Convenience Features

The print mechanism on the HP 2565A and 2566A swings up to allow the operator access to the complete paper path, which allows easy loading and alignment of paper or forms in the printer. Power assisted horizontal positioning of the tractors increases the ease of forms loading and alignment.

## HP 2686A LaserJet Printer

The HP 2686A is a new low-cost, personal laser printer that provides letter quality text and graphics for workstation-based applications. The LaserJet printer incorporates an eight page-per-minute print engine with HP Formatter and RS-232 interface.

### Ideal for Word Processing Use

The HP 2686A features very quiet operation (< 55 dBA), multiple character fonts per page, multiple paper sizes up to legal size single sheet paper or envelopes, workstation on-demand printing, and compact, desktop size.

### Maintenance

The HP 2686A is easy to maintain and operate. The disposable cartridge containing the main electrophotographic components

makes the printer easy to service and very reliable. The HP 2686A requires no scheduled preventive maintenance.

### Character Font Flexibility

The standard character font for the HP 2686A is Courier 10 (Portrait and Landscape). There are additional optional fonts in plug-in cartridges, including both fixed pitch and proportionally spaced fonts; software selectable, this allows printing of multiple fonts on the same page.

The HP 2934A DUAL mode Printer can be found on page 58.

## HP 2563A

The HP 2563A is a reliable, medium speed, dot matrix line printer designed for use in most computer printing applications. Printing at 300 lines-per-minute in the standard mode and 150 lpm in the high density mode, the HP 2563A offers many user features such as graphics, bar code printing, multiple character sets, 16-channel vertical format control, compressed and double-size characters.

## HP 2687A and HP 2688A

The HP 2687A and 2688A page printers are medium speed, low to medium print volume laser electrophotographic printers. These printers are ideally suited for applications requiring high print quality such as letters, reports and documents. The maximum print speed of 12 pages-per-minute and their quiet operation make them excellent alternatives to daisywheel, impact matrix, thermal, or electrostatic printing technologies for many applications.

## HP 2680A

The HP 2680A Laser Printing System (LPS) combines the HP 2680A Laser Printer and several optional application packages. The printer operates at 45 pages-per-minute on plain 8.5-inch by 11-inch fanfold paper. It features continuous paper feed for paper handling reliability, non-contact fusing that is virtually maintenance free, and a data control system that is capable of handling variable size characters, electronic forms and multiple pages of print on one sheet of paper.

### Ordering Information

HP 2565A Line Matrix Printer  
HP 2566A Line Matrix Printer  
HP 2563A Dot Matrix Line Printer  
HP 2686A LaserJet Printer  
HP 2687A Page Printer  
HP 2688A Page Printer  
HP 2680A Laser Printer

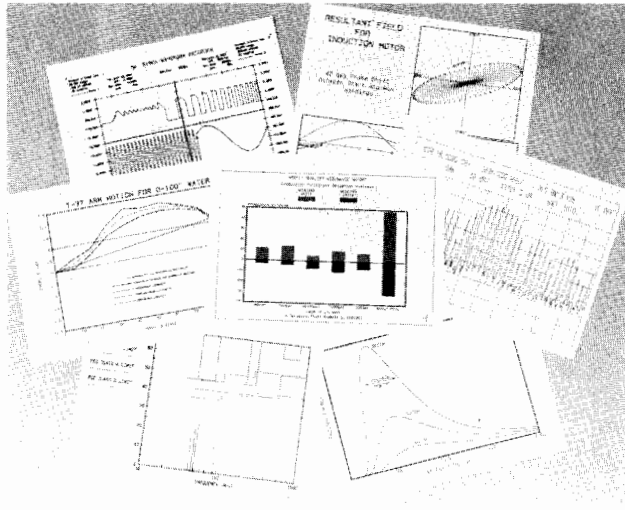

In fields as diverse as engineering, chemistry, medicine, finance, and marketing, the need for hardcopy graphics is growing. The reason is simple: graphics provide a comprehensive, easy-to-understand overview of numerical data.

### Plotters

Producing hardcopy graphics does not have to be difficult or expensive. Basically, there are two types of devices used to produce graphics—printers and plotters. Each have their own applications. Printers are raster devices which use closely spaced dots to create working-quality drawings generally in black and white. Plotters, on the other hand, are vector devices which produce colorful, visually perfect graphics with sharp lines and smooth curves.

With Hewlett-Packard plotters, you can quickly generate professional, hardcopy graphs and charts from design, measurement, and computational data. All HP plotters share several common features, and the same high-quality you expect from all Hewlett-Packard instruments.

### Data Display Graphics

Data analysis usually requires extrapolating trends over time, studying relationships between variables, making comparisons between entities, and looking for exceptions and variances. All these lend themselves to graphic portrayal.

By using graphics, you eliminate printouts with pertinent data buried in long listings of hundreds or even thousands of variables. Effective graphics can help you spot key ideas, trends, and relationships that might otherwise go unnoticed. In addition, graphics can improve communications at meetings, and make you appear more professional and better prepared. Reports can be shorter, and easier to understand.

### Design Graphics

Hardcopy graphics are a vital part of the computer-aided design and computer-assisted drafting fields. Tedious and time-consuming plans and schematics can be produced quickly and accurately using a plotter. HP drafting plotters create visually perfect drawings for applications in mechanical, electrical, and civil engineering, architecture, and drafting.

### Interfaces

There are three interfaces for connecting HP plotters with HP and non-HP computer systems: the HP-IB (IEEE-488-1978), the RS-232-C/CCITT V.24, and the HP-IL. (See the table on the opposite page for the interfaces available with each plotter.) These options make it easy to integrate an HP plotter into almost any computer system.

### HP-GL

Hewlett-Packard plotters understand HP-GL (Hewlett-Packard Graphics Language), a set of easy-to-understand mnemonic commands for controlling machine functions such as pen movement, character generation, and axis production. These internal commands simplify programming; for example, it often takes just one or two instructions to draw arcs or circles or define and fill a polygon.

### Plotting Media and Pen Choices

Each HP plotter uses chart paper and at least one additional medium: plots can be drawn on transparency film for overhead projection, on high-gloss presentation paper for reports or graphic hand-outs, or on vellum, double-matte polyester film, and tracing bond for engineering and drafting drawings.

HP makes three types of pens—fiber-tip, roller-ball, and liquid-ink drafting pens. The fiber-tip pens for both paper and transparency film come in two widths, a fine tip for grids, tick marks, and labels, and a wide tip for bold titles, heavy lines, and filled-in areas. For engineering and drafting media, refillable drafting pens come in six standard widths, roller-ball pens in one width and four colors.

### Intelligent Pen Control

All HP plotters change pens automatically under program control so no operator intervention is necessary. To produce graphics of consistently high quality, HP plotters precisely control pen movements through the use of sophisticated electronic circuitry. As pens descend, their motion is automatically damped to preserve pen tips. When pens are returned to their stalls after use, they are automatically capped so they stay fresh and last longer.

### Media Drive Mechanism

HP plotters are surprisingly compact because of Hewlett-Packard's micro-grip technology. Unlike flatbed plotters, which move a pen arm across the entire surface of the paper, HP plotters grip the paper, moving it back and forth along one axis, while the pen moves along the other axis. This low inertia mechanism allows HP to use smaller motors and lightweight components.

### Graphics Software

HP plotters are supported on most Hewlett-Packard computer systems, desktop computers, and intelligent terminals. In addition, many popular graphics application and integrated software packages support these plotters on HP and non-HP computer systems and personal computers.

HP also offers a graphics software package which allows simple adaptation of existing applications programs for use with an HP plotter. It can be used with any HP plotter with an RS-232-C/CCITT V.24 or HP-IB interface. The HP Industry Standard Plotting Package (HP-ISPP) is written entirely in ANSI Standard FORTRAN.

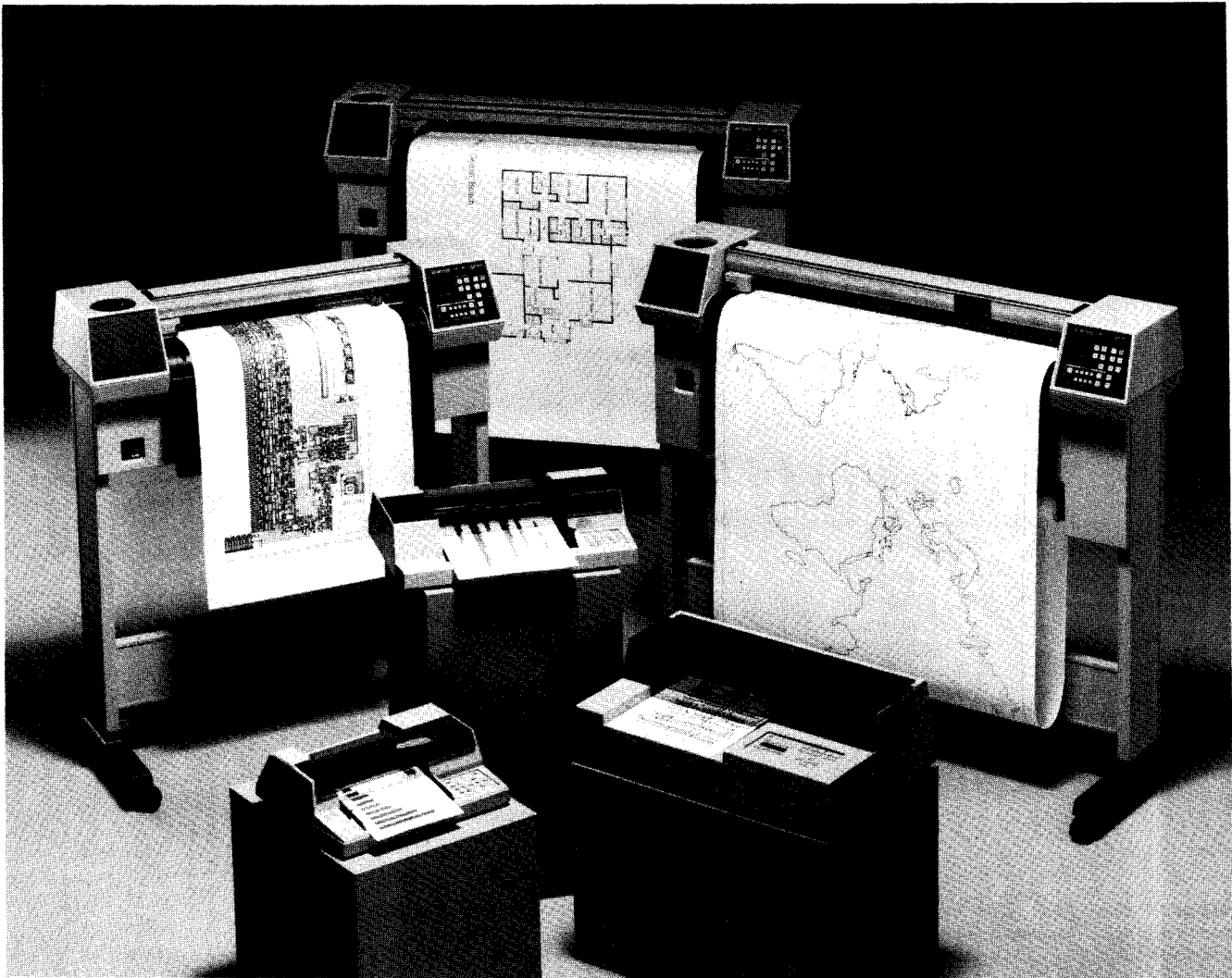

	HP 7470A	HP 7475A	HP 7550A	HP 7580B HP 7585B	HP 7586B
<b>Number of pens</b>	2 in individual pen stalls	6 in carousel	8 in carousel	8 in carousel	8 in carousel
<b>Pen types</b>	Paper, transparency	Paper, transparency	Paper, transparency, liquid-ink, roller-ball	Paper, liquid-ink roller-ball	Paper, liquid-ink roller-ball
<b>Media sizes</b>	A4/A	A4/A, A3/B	A4/A, A3/B	A4/A, A3/B, A2/C, A1/D, (A0/E HP 7585B only)	A4/A, A3/B, A2/C, A1/D, A0/E
<b>Media types</b>	Paper, transparency film	Paper, transparency film	Paper, transparency film, vellum, polyester film	Paper, vellum, tracing bond, polyester film	Paper, vellum, tracing bond, polyester film
<b>Media load methods</b>	Manual sheet loading for above media types	Manual sheet loading for above media types	Automatic sheet feed for paper, transparency film  Manual sheet loading for above media types	Manual sheet loading for above media types	Automatic roll feed for above media types except tracing bond  Manual sheet loading for above media types
<b>Interfaces</b>	RS-232-C/CCITT V.24 or (HP-IB) IEEE-488 or HP-IL	RS-232-C/CCITT V.24 or (HP-IB) IEEE-488	RS-232-C/CCITT V.24 and (HP-IB) IEEE-488	RS-232-C/CCITT V.24 and (HP-IB) IEEE-488	RS-232-C/CCITT V.24 and (HP-IB) IEEE-488
<b>Page</b>	98	98	100	102	102



# COMPUTERS, PERIPHERALS & CALCULATORS

## Graphics Plotters Models 7470A and 7475A

- Low cost, high performance
- Choice of six- or two-pen models
- Plot on paper
- Plot on HP overhead transparency film

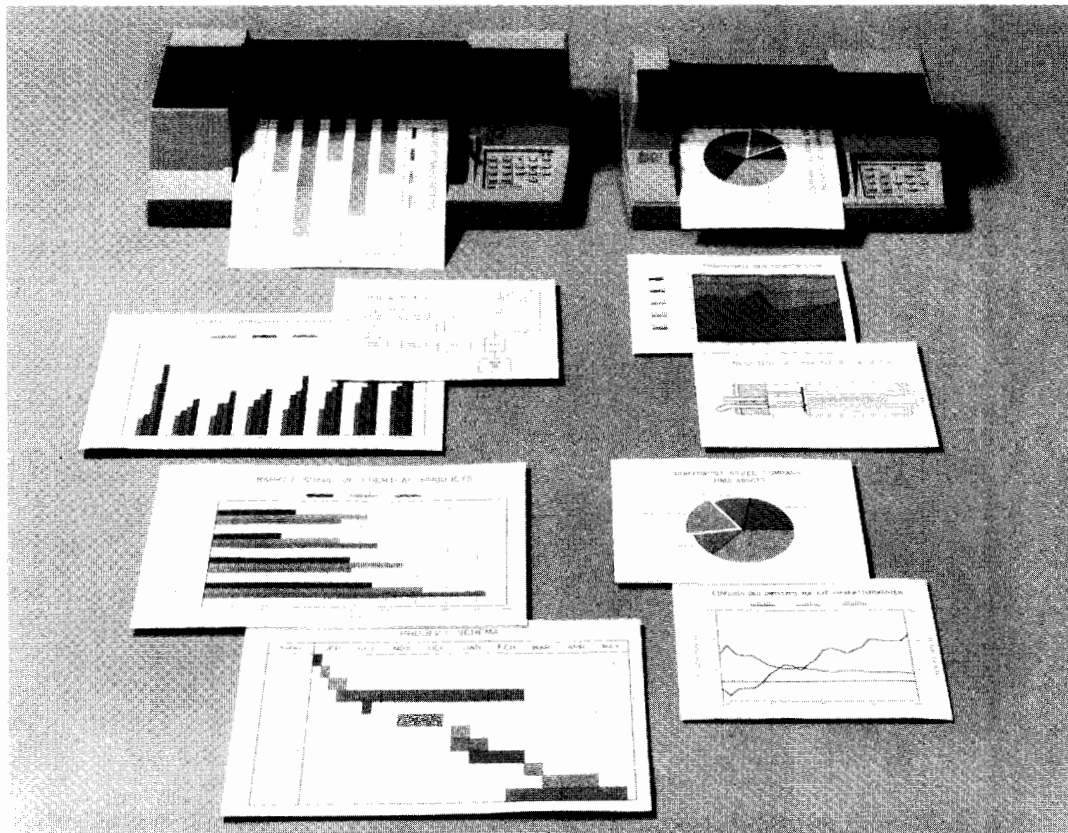

Hewlett-Packard's HP 7470A and 7475A graphics plotters provide the kind of graphics excellence you would expect to find only in much more expensive plotters. They feature the same high-quality components and innovative paper-moving technology which were introduced in HP's drafting plotters and which make it possible to offer high performance plotters at affordable prices. Refer to the table below for a quick comparison of the main features available in each plotter.

Features	HP 7475A	HP 7470A
<b>Media sizes</b>	Two ANSI sizes: A (8.5 x 11 in.) and B (11 x 17 in.) Two ISO sizes: A4 (210 x 297 mm) and A3 (297 x 420 mm)	One ANSI size: A (8.5 x 11 in.) One ISO size: A4 (210 x 297 mm)
<b>Pens</b>	Six fiber-tip; programmable pen selection; automatic capping	Two fiber-tip; programmable pen selection; automatic capping
<b>HP-GL instructions</b>	More than 50 instructions	More than 40 instructions
<b>Character sets</b>	19 sets, including ISO European standards and Katakana	Five sets
<b>Standard interfaces</b>	HP-IB (IEEE 488-1978) or RS-232-C (CCITT V.24)	HP-IB (IEEE 488-1978) or RS-232-C (CCITT V.24) or HP-IL
	Each plotter incorporates one permanent interface option.	
<b>Technology</b>	Both plotters use the same micro-grip drive for paper movement and have the same high resolution, repeatability, and velocity.	

### Computer Applications

The HP 7470A and 7475A provide hardcopy computer graphics for technical, scientific, and business applications. Colorful A4/A-size charts and graphs are ideal for reports and overhead transparencies. Use them for summarizing data, identifying trends, comparing results, and focusing on exceptions. The larger A3/B-size plots that can be drawn on the HP 7475A are particularly useful for time lines, PERT charts, schematics, engineering drawings, and other applications where you need to show visual detail.

### Measurement Applications

The HP 7470A and 7475A add hardcopy graphics capability to intelligent instruments and instrument systems with HP-IB (IEEE 488-1978). For most applications that use a display screen and an oscilloscope camera, these plotters can produce high-quality hardcopy of the screen for a cost that is substantially lower than camera film. Because they plot directly from measured data, they eliminate problems created by distortion from the screen. And plotter output provides better visual resolution than photographs. Many systems without screen displays can also have the benefits of HP 7470A or 7475A hardcopy graphics at very little additional cost.

### Easy to Use

When the HP 7475A or 7470A plotters are turned on, default conditions are automatically established for most plotting parameters. In many cases, it is only necessary to load the pens and plotting medium in order to start plotting.

Media and pen loading are also easy. A guide control lever makes media alignment perfect every time. The front panel can be used to select pens, to halt the program for exchanging pen colors, or to move the plot forward to "view" what you have plotted.

The front panel also allows easy access to the plotter's digitizing capability and scaling points. And, on the HP 7475A, push buttons can rotate plots 90 degrees or run a demonstration plot directly from the plotter.

### Intelligence Features

Intelligence features are built directly into these plotters to save you time by eliminating the need for software-generated characters and functions. Many HP-GL instructions (more than 50 in the HP 7475A; more than 40 in the HP 7470A) govern such tasks as labeling, pen movement, drawing arcs and circles, and selecting from a large variety of character sets. The HP 7475A has 19 character sets in-



cluding ISO European sets, Katakana, ASCII, and Roman 8 extensions; the HP 7470A has five internal character sets.

The HP 7475A's extra HP-GL instructions, which are used for filling rectangles and wedges for pie and bar charts, provide an enhancement especially designed for professional graphics.

**Writing Systems**

The HP 7470A has two built-in pen stalls which make two-color plotting easy. For plots with more than two colors, the program can be halted through program or front panel control; new pens can then be installed and plotting resumed. The HP 7475A's six-pen carousel allows you to store up to six different pen colors or a variety of colors and widths.

Several automatic features are included to protect the tip of the pen and increase pen life. When housed in the stall or carousel, the pen is capped to prevent premature drying. When a pendown command is given, the pen force is damped and the pen is gently lowered to the plotting surface.

**High-Quality Output**

The HP 7470A and 7475A have an addressable step size of 0.025

mm (0.001 in.). With this resolution, they can plot up to 1000 points in a 1-inch line. When commanded to return to the same point with no pen change, they achieve this repeatability within 0.1 mm (0.004 in.) Because of this outstanding resolution and repeatability, both plotters produce straight lines and smooth circles that have an artist-drawn appearance.

**Interface Options**

The HP 7475A and 7470A are easy to interface with most HP and non-HP computers. Both plotters offer the RS-232-C/CCITT V.24 or HP-IB (IEEE 488-1978) interface. With the RS-232-C option, a dual input/output cable is available for connecting the plotters with a terminal and computer. In addition, the HP 7470A offers a third interface option, HP-IL. This interface is used to connect the plotter with low-cost, portable HP systems.

**Graphics Software**

HP offers a full line of graphics software packages for use on most HP computer products. And software is also available for many non-HP computers. These packages make it easy for non-programmers to use the HP 7470A and 7475A plotters. Details are available from any HP sales and support office.

**Specifications**

	HP 7475A	HP 7470A
<b>Resolution</b>	Smallest addressable step size: 0.025 mm (0.001 in.)	
<b>Repeatability</b>	With a given pen: 0.1 mm (0.004 in.) From pen to pen: 0.2 mm (0.008 in.)	
<b>Pen velocity (each axis)</b>	Pen up, 50.8 cm/s (20 in./s); pen down, maximum — 38.1 cm/s (15 in./s), programmable — 1 to 38 cm/s in 1 cm/s increments	
<b>Acceleration</b>	Approximately 2 g's	
<b>Environmental range</b>	Operating, 0°C to 55°C Non-operating, -40°C to 75°C	
<b>Plotting area</b>	X-axis 258 mm (10.2 in.), A/B 275 mm (10.8 in.), A4/A3 Y-axis 198 mm (7.80 in.), A 192 mm (7.56 in.), A4 414 mm (16.3 in.), B 402 mm (15.8 in.), A3	191 mm (7.5 in.) A 191 mm (7.5 in.), A4 257 mm (10.2 in.), A 272 mm (10.7 in.), A4
<b>Interfaces</b>	HP-IB (IEEE 488-1978), implements the following HP-IB functions as defined in IEEE 488-1978: SH1, AH1, T2, TE0, LE0, SR1, RL0, DC1, DT0, L2, PP0, (listen only or address less than 7, otherwise PP2) RS-232-C/CCITT, asynchronous serial ASCII with switch selectable baud rates of 75, 110, 150, 200, 300, 600, 1200, 2400, 4800, 9600. External clock input capabilities with intermediate baud rates of up to 9600 baud. 1024 byte buffer.	Same as HP 7475A except 255 byte buffer. HP-IL, Hewlett-Packard Interface Loop for use with portable systems.
<b>Power Requirements</b>	<b>Source:</b> 100, 120, 200, 240 V~ -10%, +5% <b>Frequency:</b> 48-66 Hz <b>Consumption:</b> 35 W maximum	<b>Consumption:</b> 25 W maximum
<b>Size:</b>	Height 127 mm (5 in.) Width 568 mm (22.4 in.) Depth 367 mm (14.5 in.)	127 mm (5 in.) 432 mm (17 in.) 343 mm (13.5 in.)
<b>Weight:</b>	Net 7 kg (16.0 lb) Shipping Approx. 11 kg (25.0 lb)	6 kg (13.5 lb) Approx. 10 kg (22.0 lb)
<b>FCC</b>	FCC certified to conform to limits set for radio frequency interference when used with a Class B computing device.	

**Accessories Supplied**

**HP 7475A**

- HP 07475-90001 Interfacing and Programming Manual
- HP 07475-90002 Operation and Interconnection Manual
- HP 07475-90004 Reference Card

**HP 7470A**

- HP 07470-90001 Interfacing and Programming Manual
- HP 07470-90002 Operator's Manual
- HP 07470-90003 Interconnection Guide
- HP 07470-90004 Reference Card

Power cords and an assortment of pens and drawing media are also supplied with the plotters. The media size and the appropriate power cord are determined by plotter destination. The HP-IL cable (1/2-metre) is supplied with Option 003 only.

Note: Interface cables are not supplied with Option 001 and Option 002 plotters.

**Ordering Information**

**Options**

- 001 RS-232-C/CCITT V.24 (cable not included)
  - 002 HP-IB (IEEE 488-1978) (cable not included)
  - 003 HP-IL for 7470A only (cable included)
- Note: Option 001, 002, or 003 must be specified when ordering HP 7470A; Option 001 or 002 must be specified with HP 7475A.

**Interface Cables**

- HP 13242G Male-male, special RS-232-C cable for use with Option 001, HP 150 Personal Computer
- HP 17255B Male-female, special RS-232-C cable for use with Option 001, IBM Personal Computers
- HP 17355A Male-male standard cable for use with Option 001
- HP 17455A Eavesdrop cable for use with Option 001
- HP 10833A or HP 45529A or HP 31389A HP-IB 1-metre cable for use with Option 002
- HP 82167A HP-IL 1/2-metre cable (included with Option 003)

**Plotters**

- HP 7470A Two-pen Graphics Plotter
- HP 7475A Six-pen Graphics Plotter



# COMPUTERS, PERIPHERALS & CALCULATORS

## 8-pen Sheet Feed Plotter

Model 7550A

- Ideal for high-volume, shared environments
- Requires minimum operator supervision
- Uses drafting media, pens
- Automatic cut sheet feed
- 6 g acceleration, fast throughput
- Accepts A3/B- and A4/A-size media

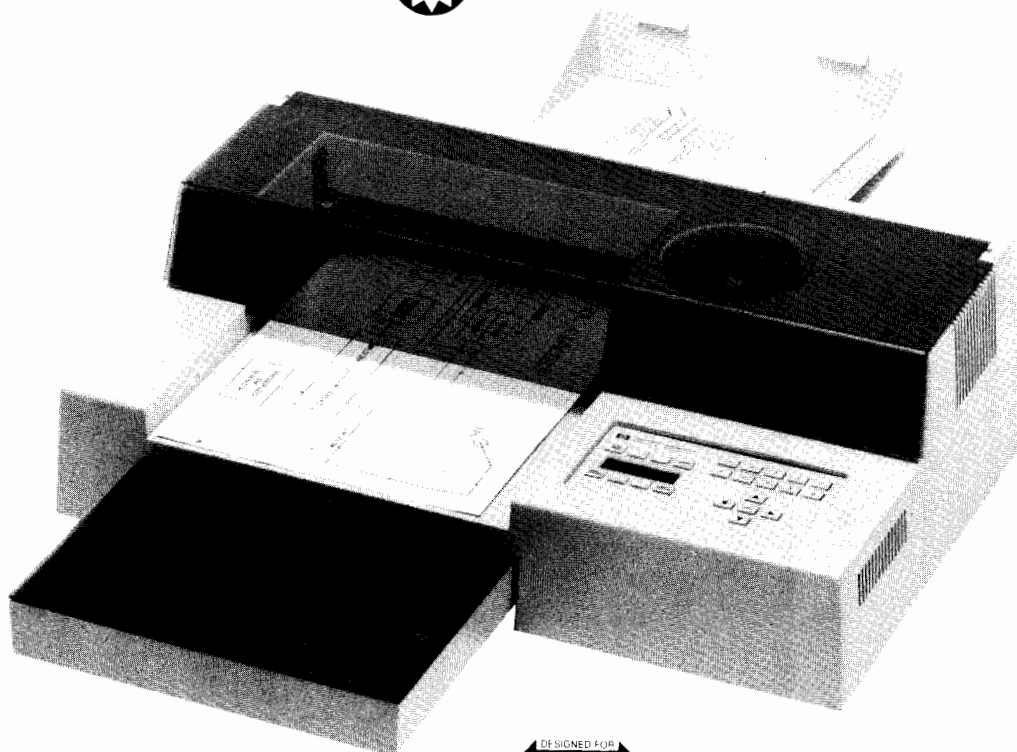

HP 7550A



Hewlett-Packard's new sheet feed 7550A plotter is an innovative graphics tool for business and technical users alike. Automatic cut sheet feed capability for paper and transparencies makes the HP 7550A ideal for unattended plotting or multiple color copies. With an unmatched 6 g of acceleration, the HP 7550A can produce quick graphs for problem-solving or decision making, or working drawings for drafting or design systems. And the HP 7550A meets Hewlett-Packard's high performance standards, so it creates professional-looking graphs for reports and presentations.

### Fast Throughput

The HP 7550A's fast acceleration and pen speed mean shorter plotting time. The HP 7550A draws in any direction at 80 cm/s (31.5 in./s) and letters at approximately 7-9 characters per second. It uses the powerful MC68000 16-bit microprocessor - the same one used in many personal computers. The HP 7550A is also equipped with a replot capability so it can produce up to 99 original color copies of most graphs without rerunning the program, freeing your computer to go on with other tasks.

### Minimum Operator Supervision

The HP 7550A eliminates manual paper handling of A3/B- and A4/A- size sheets of paper, and transparency film. The carousel allows eight pens to be loaded at once, and the plotter caps the pens when not in use to keep ink fresh. The HP 7550A automatically senses the type of carousel loaded, then sets the optimal pen type. It also senses what paper size is being used.

### High Quality Output

With an addressable resolution of 0.025 mm (0.001 in.) and mechanical resolution of 0.006 mm (0.00025 in.), the HP 7550A makes smooth arcs and draws lines that meet precisely. It also has a curved line generator which can be invoked when exceptionally smooth curves are required.

With 20 character sets, the HP 7550A is ideal for international business. Choices include Katakana and ISO European languages for Denmark, France, Germany, Italy, Norway, Portugal, Spain, Sweden, and the United Kingdom. The HP 7550A letters in two fonts: arc font with proportional spacing for maximum readability and stick font with fixed character spacing for speed.

### Features

The front-panel display and function keys guide users through each plotter setup, report plotter status, and give program messages. The HP 7550A rotates graphs 90 degrees for a choice of either horizontal or vertical formats, and aligns graphs to pre-printed forms and grids, all from the front panel.

The HP 7550A accepts standard A4/A- and A3/B-size paper, double-matte polyester film, vellum, and A4/A-size transparency film. Pen choices include liquid-ink, roller-ball, paper, and transparency pens. Because of its complete device control command set and dual interface - HP-IB (IEEE-488) and RS-232-C/CCITT V.24, the HP 7550A is adaptable to most system environments.



## Technical Applications

The drawing quality, media flexibility, automatic sheet feed and fast plotting time of the HP 7550A make it ideal for technical graphics applications in computer-aided design, computer-aided manufacturing, and research and development. The HP 7550A is supported by many technical graphics software packages; the HP 7550A can draw A3/B-size check plots and working drawings to help relieve overburdened drafting plotters, produce quick, problem-solving graphs or engineering analyses, and plot charts and graphs on transparency film for technical presentations. And the HP 7550A does it all quickly and easily.

## Business Applications

The HP 7550A is suited to business graphics users who appreciate the value of color hardcopy graphics, need quality graphics in quantity, and want a plotter that requires a minimum of operator supervision. Financial graphs, project schedules, forecasts and text charts are typical uses for a HP 7550A in a business environment. And both HP and non-HP graphics software packages make it easy for anyone to use the HP 7550A.

## Software

Software support is available for the HP 7550A on many HP computer systems, as well as HP and non-HP personal computers. In addition to HP's Industry Standard Plotting Package (see page 105, a variety of graphics packages for nonprogrammers is available. These software packages cover both business and technical applications. Complete information is available from any HP Sales and Support office.

## Specifications

**Media sizes:** accommodates ISO A4 (210 x 297 mm), ANSI A (8.5 x 11 in.), ISO A3 (297 x 420 mm), and ANSI B (11 x 17 in.)

**Maximum plotting area:** pen axis, 254 mm (9.97 in.) for A/B, 272 mm (10.65 in.) for A4/A3; paper axis, 411 mm (16.12 in.) for B, 399 mm (15.65 in.) for A3, 196 mm (7.68 in.) for A, 190 mm (7.45 in.) for A4.

**Resolution:** smallest addressable step size is 0.025 mm (0.001 in.); mechanical resolution is 0.006 mm (0.00025 in.)

**Repeatability:** with a given pen, 0.1 mm (0.004 in.)

**Pen Velocity:** pen down, maximum, 80 cm/s (31.5 in./s) in increments of 1 cm/s, from the front panel 10 to 80 cm/s (4 to 31.5 in./s) in increments of 5 cm/s; pen up 80 cm/s (31.5 in./s)

**Acceleration:** maximum approximately 6 g's; programmable from 1 to 6 g's in increments of 1 g.

**Pen force:** 15 to 66 grams

**Power requirements:** source, 100, 120, 220, 240 V, -10%, +5%; frequency, 48 - 66 Hz; consumption, 100 W maximum

**Interfaces:** HP-IB implements the following HP-IB functions as defined in IEEE 488-1978: SH1, AH1, T6, L3, SR1, RL0, DC1, DT0, C0, PP0, for listen only, PP1 for address greater than 7, and PP2 for address of 7 or less, device address front panel selectable, default value - 5; RS-232-C/CCITT V.24, asynchronous serial ASCII with front panel selectable baud rates of 75, 110, 150, 200, 300, 600, 1200, 2400, and 9600, default value - 2400

**Buffer size:** default, 1024 bytes; from the program expandable to 12K bytes

**Character sets:** 20 sets, each in two character fonts, including, the following ISO registered sets: International Reference Version (002); United Kingdom (004), U.S. ASCII (006), Swedish (010), Swedish

for Names (011), Katakana (013), JIS ASCII (014), Italian (015), Portuguese (016), Spanish (017), German (021), French (025), Norwegian (060), Norwegian II (061), plus HP 9825 character set, French/German, Scandinavian, Spanish/Latin America, Special Symbols, and Roman 8 Extensions

**Environmental range:** operating, 0°C to 55°C; nonoperating, -40°C to 75°C; automatic sheet feeder, operating with paper, 10 - 40°C and 0 - 80% RH, with transparency film, 15 - 35°C and 25 - 75% RH

**Size:** height, 215 mm (8.5 in.); width, 670 mm (26.4 in.); depth with A4/A loading tray/no catcher, 432 mm (17.0 in.), A4/A loading tray with catcher, 682 mm (26.8 in.), A3/B loading tray/no catcher, 635 mm (25.0 in.), A3/B loading tray with catcher, 896 mm (35.3 in.)

**Weight:** net approximately 17.3 kg (38.0 lb), shipping approximately 25.0 kg (55.0 lb)

**Pens:** 8 per carousel: fiber-tip, roller-ball, and liquid-ink

**Media:** chart paper, high-gloss paper, transparency film, vellum, double-matte polyester mylar film

## Accessories Supplies

	HP Part Number
Interfacing and Programming Manual	07550-90001
Operation and Interconnection Guide	07550-90002
Pocket Guide	07550-90003
A4/A Media Loading Tray	07550-60152
A4/A Paper Catcher	07550-40167
Pen carousel for fiber-tip transparency pens	07550-60050
Pen carousel for fiber-tip paper pens	07550-60051

A power cord and an assortment of fiber-tip pens, paper and transparency media are also supplied with the plotter. The media size and appropriate power cord are determined by destination. Drafting pens and drafting media are available; please refer to the Computer Users Catalog for a complete listing.

## Ordering Information

### Interface cables

**HP 31391A** Male-female RS-232-C/CCITT V.24 cable for use in remote modem environments; pins 1-25 wired end-to-end

**HP 17655A** Female-female RS-232-C/CCITT V.24 cable, adapted for use with IBM personal computer interface

**HP 17755A** Male-female RS-232-C/CCITT V.24 cable, adapted for use with HP 150 personal computer interface

**HP 17855A** RS-422-A adapter cable

**HP 10833A or 45529A** HP-IB 1-metre cable; RFI shielded

**HP 10833A or 45529B** HP-IB 2-metre cable; RFI shielded

## Accessories Available

**HP 17526A** A3-size Media Handling Kit, including media loading tray, media catcher, 50 sheets A3-size plotter paper

**HP 1755A** B-size Media Handling Kit, including media loading tray, media catcher, 50 sheets B-size plotter paper

## HP 7550A Graphics Plotter

**Eight-pen Drafting Plotters****Models 7580B, 7585B, 7586B**

- HP 7580B accepts sheets up to ISO A1 (ANSI D)
- HP 7585B, 7586B accept sheets up to ISO A0 (ANSI E)
- HP 7586B accepts rolls up to 919 mm (36.2 in.)
- Frame-to-frame long-axis plotting on HP 7586B
- HP-IB and RS-232-C/CCITT V.24 (switch selectable)
- Choice of pen, media combinations

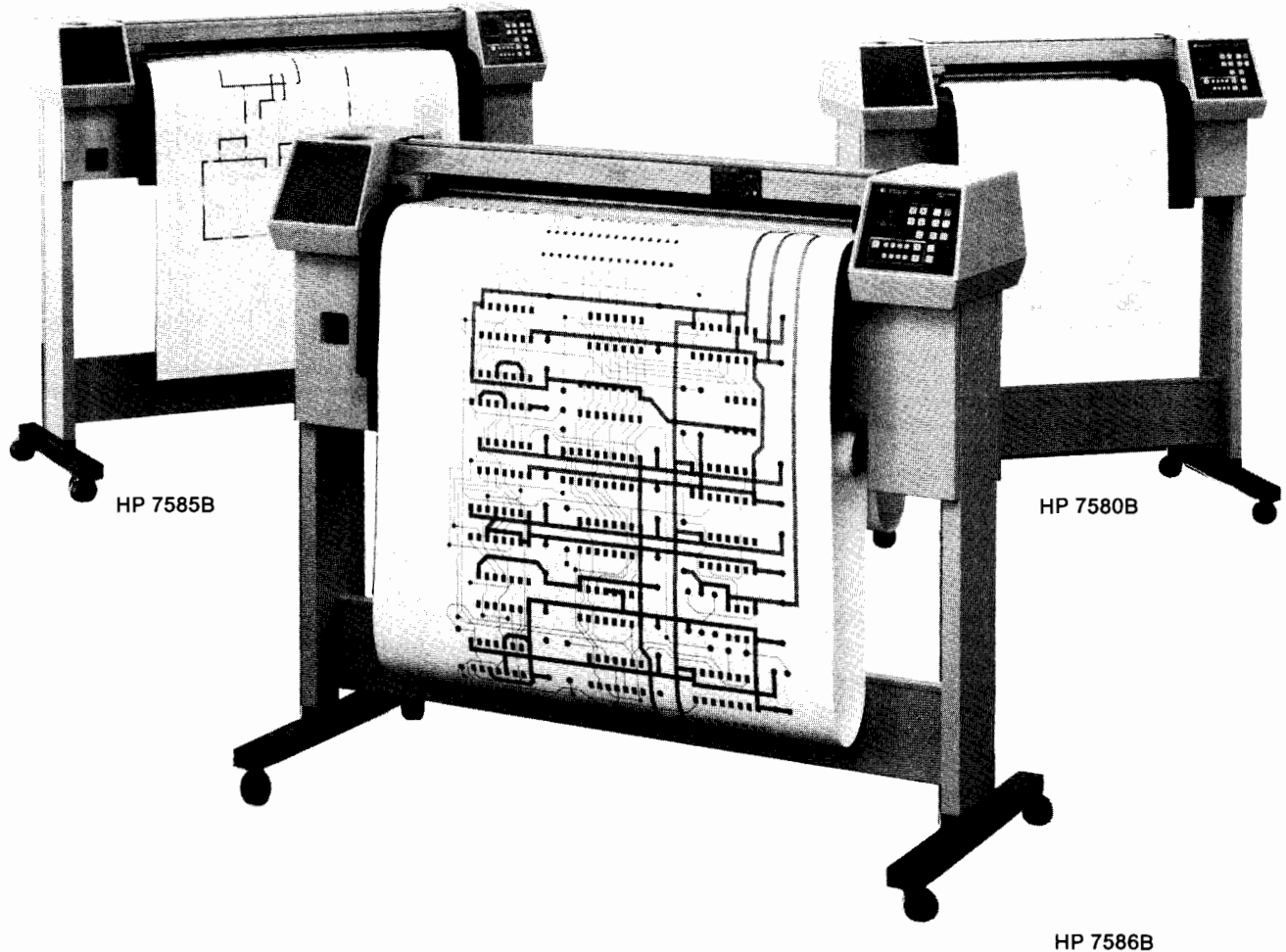

The HP 7580B, 7585B, and 7586B drafting plotters combine high-quality output and high throughput with features that make them exceptionally easy to use. The most important difference between these plotters is media size. The HP 7580B accepts sheets ranging from ISO A4 through A1 (ANSI A through D). The HP 7585B accepts sheets ranging from ISO A4 through A0 (ANSI A through E). The HP 7586B is a combined single-sheet and roll-feed plotter. It accepts sheets ranging from ISO A4 through A0 (ANSI A through E), plus it plots on rolls in standard widths up to 919 mm (36.2 in.) and lengths up to 46 m (150 ft).

All three drafting plotters draw on individual sheets of paper, vellum, double-matte polyester film, and tracing bond. The HP 7586B also draws on rolls of paper, vellum and polyester film. Users have a choice of roller-ball, fiber-tip, and liquid-ink drafting pens in various colors and line widths. When not in use, pens rest in an eight-pen carousel and are capped automatically.

**Applications**

The HP drafting plotters are suited for almost every application requiring plots that are visually perfect. Common uses in industry include computer-aided drafting; computer-aided design of printed circuit boards, integrated circuits, and mechanical parts; architectural or civil engineering design; and mapping applications.

**Roll Feed Available on HP 7586B**

The HP 7586B roll-feed plotter is designed for high volume, continuous feed, and long-axis plotting. With the HP 7586B, you can run large numbers of plots, then store them neatly on a roll or remove each plot as it is finished. The HP 7586B's frame-to-frame long-axis technique allows you to draw plots up to 46 m (150 ft). Long-axis plots are divided into sections and drawn one frame at a time. And the plotter automatically aligns each section to ensure the plot continues exactly where it left off.

**Advanced Pen Control and Writing Systems**

When a sheet is loaded, the HP drafting plotters automatically sense the sheet size and set the limits of pen motion. These plotters also sense which type of pen carousel has been loaded, and automatically choose the proper velocity, acceleration and pen force settings for the various ink and media combinations.

In addition, these plotters have an intelligent pen control system. On descent, pen motion is damped as the pen approaches the surface of the medium so that delicate pen tips are not damaged and pen bounce is minimized. Pens last longer and plotted lines are uniform from start to finish. Pen height above the surface is electronically controlled so the operator never needs to make mechanical adjustments, even when changing pens or media.



## High Quality Output

While the addressable resolution of the HP drafting plotters is excellent at 0.025 mm (0.001 in.), the pen and the drawing medium actually move on an even finer grid to create high quality lines. These movements are servo controlled with a mechanical resolution of 0.003 mm (0.00012 in.).

With HP drafting plotters, diagonal lines are the same quality as lines drawn parallel to the axes. A microprocessor keeps pen velocity and acceleration constant regardless of direction so lines are drawn with the same high quality in all directions.

In addition, these plotters offer quality labeling. Each has 21 character sets in three fonts to provide the user with a large range of annotation capabilities including mapping symbols, special centered symbols, and foreign language characters.

## High Throughput

At 60 cm/s maximum velocity and 4 g's of acceleration, HP drafting plotters are the fastest in their price range. When a slower speed is required to accommodate a drawing medium, throughput remains high because pen-up movements are always executed at maximum speed, and pen lift delays are kept to a minimum because the pen is lifted slightly on small moves (as when labeling) and to maximum height only on long moves.

## Pen Carousels

There are three different types of carousels - one for each type of pen. The plotter electronically senses the carousel type each time a new carousel is loaded and automatically selects the appropriate values for velocity, acceleration, and pen force. Users can select these values from the front panel controls or programmed plotter instructions.

## Simple, Powerful Command Set

Programming is easy using the Hewlett-Packard Graphics Language (HP-GL). The commands implemented on the plotters allow the user to draw lines, circles, arcs, to position labels, change character size, slant and direction, digitize, and more. They can rescale the plotting area in convenient user-defined units, rotate the plot 90 degrees, or "window" and plot only a portion of the original plot. Included in these commands are several area-fill instructions which make it easy to use patterns or solid coloring in wedges, rectangles, and polygons.

## Software Support

HP drafting plotters are supported on a number of Hewlett-Packard computer systems, desktop computers, and intelligent terminals. This support, consisting of high-level graphics programming instructions, enhances programmer productivity and ease of use. Several application software packages support the drafting plotters on HP computers.

For users of Industry Standard FORTRAN subroutines, a software package, HP-ISPP (Hewlett-Packard Industry Standard Plotting Package), is available. (See page 105)

## Specifications

### Media sizes

**HP 7580B** (sheets): minimum, 203 x 267 mm (8 x 10.5 in.); maximum, 622 x 1231.9 mm (24.5 in. x 48.5 in.); includes standard sizes A4/A, A3/B, A2/C, A1/D

**HP 7585B and 7586B** (sheets): minimum, 203 x 267 mm (8 x 10.5 in.); maximum 927 x 1231.9 mm (36.5 x 48.5 in.); includes standard sizes A4/A, A3/B, A2/C, A1/D, A0/E, excludes some nonstandard sizes between A3/B and A2/C

**HP 7586B** (rolls): width, 267 mm (10.5 in.) to 298 mm (11.75 in.) and 546 mm (21.5 in.) to 919 mm (36.2), length 46 meters (150 ft), roll core, inner diameter, 51 mm ± 1.6 mm (2.0 in.)

**Maximum Plotting Area:** Single sheets, drawing sheet less margins; roll media, roll width times frame length less margins; long-axis plotting, roll width less 30 mm (1.2 in.) margin times roll length.

**Frame Lengths for Roll Media:** Roll widths less than 298.5 mm (11.75 in.), 431.8 mm (17 in.); roll widths greater than 721.4 mm (28.4 in.), 1219.2 mm (48 in.); roll widths between 298.5 and 721.4 mm, 914.4 mm (36 in.)

**Margins:** Sheets, normal mode, three margins approx. 15 mm (.59 in.) each, fourth margin approx. 39 mm (1.5 in.); expand mode, three margins approx. 5 mm (.2 in.) each, fourth margin approx. 29 mm (1.1 in.)

Rolls, normal mode, 15 mm (.59) each side, expand mode, not recommended.

**Resolution:** smallest addressable move, 0.025 mm (0.0001 in.); mechanical resolution, 0.003 mm (0.00012 in.)

**Repeatability** (for a given pen): on paper, vellum, or 0.075 mm (0.003 in.) double-matte polyester film at 10-30°C: 0.10 mm (0.004 in.)

**Endpoint Accuracy:** on double-matte polyester film (3 mil) at 18-30°C, level floor: 0.1% of the move or 0.25 mm (0.0098 in.), whichever is greater.

**Pen velocity:** pen down, maximum: 60 cm/s (24 in./s) independent of vector direction; programmable: 1 to 60 cm/s in 1-cm increments (0.4 to 24 in./s); front panel selectable: 10 to 60 cm/s in 10-cm increments (4 to 24 in./s); front panel selectable: 10 to 60 cm/s in 10-cm increments (4 to 24 in./s). Pen up, 60 cm/s (24 in./s) independent of vector direction.

**Acceleration:** maximum, 4 g (39 m/s<sup>2</sup>, 129 ft/s<sup>2</sup>); programmable, 1 to 4 g in 1-g increments (9.7 to 39 m/s<sup>2</sup>, 32 to 128 ft/s<sup>2</sup>).

**Pen force:** programmable and front panel selectable: 10 to 66 grams in 8-gram increments.

**Power requirements:** source, 100, 120, 220, 240 V ~ -10%, +5%; frequency, 48-66 Hz single phase; consumption, 182 W max.

**Interfaces (selectable from a rear-panel switch):** HP-IB (IEEE 488-1978), implements the following HP-IB functions as defined in IEEE 488-1978: SH1, AH1, T6, L3, SR1, RL0, DC1, DT0, C0, PP0 for listen-only, PP1 for address greater than 7, and PP2 for address of 7 or less. For more on these codes, refer to the HP-IB section of this catalog.

RS-232-C/CCITT V.24, asynchronous serial ASCII with switch selectable baud rates of 50, 75, 110, 134.5, 150, 200, 300, 600, 1200, 1800, 2400, 3600, 4800, 7200 and 9600.

**Buffer Size:** 18,432 bytes

**Environmental Range:** operating: temperature, 0°C to 55°C, relative humidity, sheets, 5% to 95% (0°C to 40°C), rolls, 30% to 70% (10°C to 30°C); nonoperating: temperature, -40°C to 75°C

**Size:** HP 7580B, height, 1188 mm (46.8 in.), width, 1087 mm (42.8 in.), depth, 557 mm (21.9 in.)

HP 7585B and 7586B, height, 1188 mm (46.8 in.), width, 1392 mm (54.8 in.), depth, 557 mm (21.9 in.)

**Weight:** HP 7580B, net weight, 59.1 kg (130 lb), shipping weight, approx. 114 kg (250 lb)

HP 7585B, net weight, 70.4 kg (155 lb), shipping weight, approx. 131 kg (290 lb)

HP 7586B, net weight, 86.4 kg (190 lb), shipping weight, approx. 147.8 kg (325 lb)

**Pens:** 8 per carousel: fiber-tip, drafting, roller-ball.

**Media:** most standard paper, vellum, and double-matte polyester film, 3 or 4 mil thick.

## Accessories Supplied

Accessories Supplied	HP Part No.
Interfacing and Programming Manual	07580-90034
Operator's Manual	07580-90033
Programmer's Reference Card	07580-90035
3 Pen Carousels	
Drafting pen carousel	07580-60081
Roller ball carousel	07580-60082
Fiber tip carousel	07580-60035
Digitizing Sight	09872-60066
Male-to-male RS-232-C/CCITT V.24 cable	8120-3258

An assortment of pens and various drawing media and cleaning supplies are also provided with the plotter. Drafting media and other plotter supplies are available from Hewlett-Packard. Please refer to the HP Computer Users Catalog for a complete listing.

## Ordering Information

**HP 7580B** Drafting Plotter

**HP 7585B** Drafting Plotter

**HP 7586B** Drafting Plotter

### Options

<b>051</b> for use with HP 9000, Series 200 computers	N/C
<b>052</b> for use with HP Series 100 personal computers	N/C
<b>053</b> for use with HP 3000 computers	N/C
<b>058</b> for use with HP Series 80 personal computers	N/C
<b>059</b> for use with HP 9000, Series 500 computers	N/C
<b>060</b> for use with HP 1000 computers	N/C
<b>065</b> for use with non-HP computers	N/C

# COMPUTERS, PERIPHERALS & CALCULATORS

## Graphics Tablets

Models 9111A and 17623A

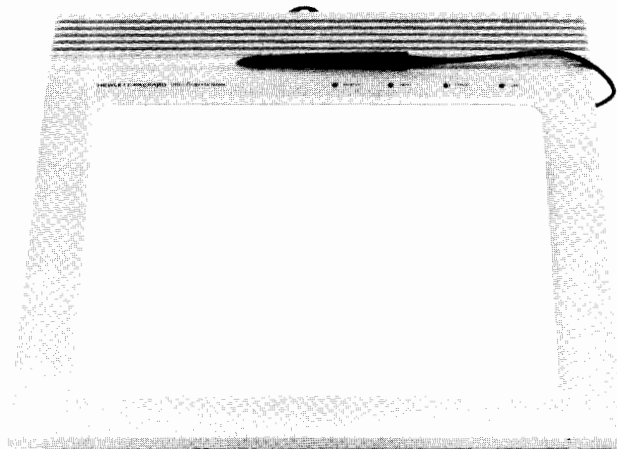

Hewlett-Packard's 9111A graphics tablet adds a new dimension to interactive graphics systems equipped with HP-IB (IEEE-488) interface. With this tablet's cursor moving capability, the user can bypass the keyboard and interact directly with the CRT display.

Twenty-seven HP-GL commands provide the user with precise control of all tablet functions. Sixteen softkeys can be programmed by the user. In addition, any portion of the active digitizing area can be defined as softkeys for increased menu selection capability.

The tablet is made of high quality durable materials; the platen's hard ceramic surface resists scratches and pits. The stylus is slim and lightweight with good tactile feedback on the switch position.

In addition to support on many general graphics packages for HP computer systems, several higher-level software programs that use the HP 9111A are available. The most extensive of these is the HP EGS/200 software for use with the HP 9000 Series 200 models 226 and 236 computers.

### Specifications

- Resolution:** 0.100 mm (0.00394 in.)
- Accuracy:** ±0.600 mm (0.0236 in.) at 20 °C for each measured point, change of 0.004 mm for each °C deviation from 20 °C
- Repeatability:** ± resolution unit
- Data rate:** programmable from 1 to 60 coordinate pairs per second, actual rate ±2 Hz from programmed rate
- Active digitizing area:** 218.5 x 300.8 mm (8.6" x 11.8"); can be extended to include the area occupied by the 16 softkeys
- Document material:** single sheet, electrically nonconductive, homogenous, less than 0.5 mm thick
- HP-IB interface functions\*:** SH1, AH1, T5, TE0, L4, LE0, SR1, RL0, PP2, DC1, DT0, C0
- Power requirements:** source: 100 V, 120 V, 220 V, 240 V, ±10%; frequency: 48 to 66 Hz; consumption: 100 V/200 mA max, 120 V/165 mA max, 220 V/90 mA max, 240 V/80 mA max, 25 W max
- Environmental range:** 0° to 55°C, 5% to 90% RH (40°C)
- Dimensions:** 440 L x 440 W x 85 mm H (17.3" x 17.3" x 3.4")
- Weight:** net, 5.8 kg (12.8 lb); shipping, 10.8 kg (23.8 lb)

\*For more on these codes, refer to the HP-IB section in this catalog.

### Ordering Information

Option	HP Computer	Description
026	HP 9000 Series 200 Model 226	Supplements to BASIC Language Reference and BASIC Programming Techniques manuals; BASIC extensions
036	HP 9000 Series 200 Model 236	Same as above
045	HP 9845B	System tutorial
059	HP 9000 Series 500	For purposes of documentation
085	HP-85	System tutorial and tools software
086	HP-86/87	9111A Graphics Tablet Programming Guide
100	HP 1000	For purposes of documentation
145	HP 9845C	Sample program

HP 9111A Graphics Tablet

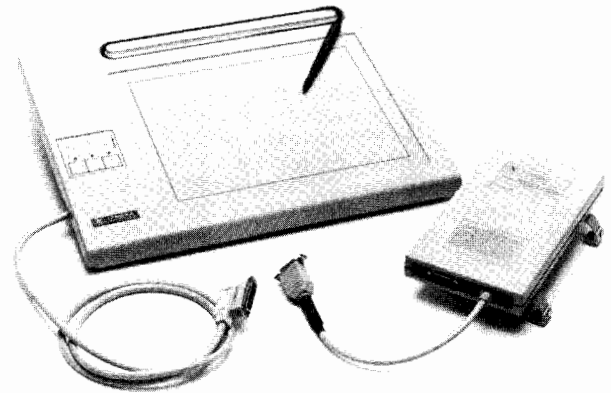

The HP 17623A graphics tablet is designed specifically for use with the HP 2623A monochromatic and HP 2627A color graphics terminals in an RS-232-C environment. It is connected directly to the terminal power supply for local cursor control. This direct tablet-to-display interaction minimizes host computer overhead making the tablet ideal for timeshare situations which require menu selection, digitizing, and cursor movement without time delay.

Coordinate data can be sent to the computer in ASCII format for easier programming or binary format to reduce data transfer time; synchronous and asynchronous transfer modes allow you to digitize one coordinate or send a stream of data each time the stylus is pressed.

### Graphics Software

You can develop your own software or use one of the packages available. The tablet is supported on the HP 1000 by GRAPHICS/1000-II DGL (HP 92841A) or GRAPHICS/1000-II AGP (HP 92842A); on the HP 3000 by HPDRAW (HP 33108A) or the HP 3000 Business Graphics Package, which includes HPDRAW (HP 32110A); and on the HP 9000 series by GRAPHICS/9000 DGL (HP 92074A or 92084A) or GRAPHICS/9000 AGP (HP 92075A or 92085A).

### Specifications

- Active digitizing area:** 295 x 225 mm (11.6 x 8.8 in.)
- Resolution:** (points within active digitizing area): fine—2048 x 1560, coarse—512 x 390 (matches CRT)
- Repeatability:** ± 1 resolution unit
- Cursor tracking rate (local):** 30 pts/s
- Coordinate transfer rate:** assumes asynchronous data transfer; depends on computer activity and data communication rate, e.g.,  
**ASCII @** 2400 BAUD-up to 15 pts/s  
                   @ 9600 BAUD-up to 60 pts/s  
**Binary @** 2400 BAUD-up to 34 pts/s  
                   @ 9600 BAUD-up to 60 pts/s

Heavy system activity can severely degrade these rates.

- Platen technology:** electrostatic
- Document material:** single sheet, electrically nonconductive, homogenous, less than 0.5 mm thick
- Environmental range:** 0° to 55°C, 5% to 80% RH (40°C), EMI meets VDE requirements with the HP 2627A and HP 2623A terminals on HP 1000, HP 3000, and HP 9000 series computers
- Power consumption:** 5 W max (supplied from the terminal)
- Dimensions:** 467 L x 367 W x 38 mm H (18.4 in. x 14.4 in. x 1.5 in.)
- Weight** (tablet and interface module): net, 3.62 kg (8.0 lb); shipping, 6.8 kg (15.0 lb)

### Accessories Supplied

- Operator's Manual
- Stylus Refills (2 Inkless, 3 Ink)
- Overlay (1)

HP Part No.  
17623-90001  
09111-68701  
4114-0962

### Ordering Information

HP 17623A Graphics Tablet



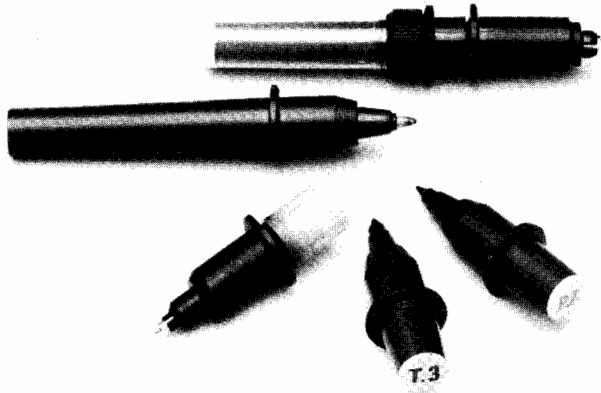

Hewlett-Packard's high quality supplies bring out the best in HP's graphics plotters. Even though paper and pens may at first seem unimportant, both affect the end result — your graphics. HP paper is smooth to help the pen make sharp, crisp lines and extend pen life, and the chemical reaction between HP papers and inks is continually tested to minimize color changes and fading.

For your convenience, HP offers a complete line of pens, drawing media, and accessories such as pen holders, digitizing sights, ink solvent, drafting pen tips, and cleaning aids. You can order supplies individually or in convenient kits. Either way, HP can supply everything you need for professional-looking, hardcopy graphics.

### Plotter Pens and Pen Holders

HP pens extend the capability of HP plotters because of the variety of pens available. All HP plotters use fiber-tip paper and transparency pens. The HP 7550 sheet-feed plotter and the drafting plotters also use roller-ball and liquid-ink drafting pens. You can choose from a spectrum of colors and a variety of tip widths for bold and fine lines.

To protect your pens from loss or damage, HP offers a sturdy 4-pen holder and 20-pen organizer. The pen holder (HP part number 07225-40054) can be placed next to your plotter for easy access to a selection of fiber-tip, roller-ball, or short-body drafting pens. The pen organizer (5061-5100), a compact and portable case made of smoke-colored plastic, is designed to keep pens neatly in place even if turned upside down.

### Drawing Media

HP's drawing media complement the performance of HP plotters. Plotter paper, tracing bond, vellum, polyester film, and overhead transparency film are all available in a range of standard sizes, both English and metric.

**Reports and Documentation:** Hewlett-Packard offers plotter paper in a range of sizes for a variety of applications. Paper is ideal for graphic hand-outs at a business meeting, a screen dump from a smart instrument, or graphs included in a report. A paper and pen kit is available for use with all HP plotters. This convenient kit contains all the supplies you need to create effective graphs on paper. It comes in both A4- and A-size and includes 20 fiber-tip pens in two line widths and 10 vivid colors and a sturdy pen holder. In addition to plain plot-

ter paper, HP now offers high gloss presentation paper to add a polished, professional look to your graphs.

**Presentations:** By preparing graphs and charts on overhead transparency film, you can make professional-looking presentations aids for a fraction of the cost charged by commercial graphics services. The same programs used to prepare plots on paper can be used to make overhead transparencies. Finished transparencies are colorful and virtually smear proof, so they can be used again and again. Overhead transparencies can enhance both business and technical presentations. Several transparency kits are available; each contains transparent sheets of plastic film and 16 fiber-tip pens in 2 tip widths.

**Drafting and Design:** Drafting and design graphics users can choose from a variety of media. In addition to plain paper, HP offers vellum, tracing bond and double-matte polyester film - all in a range of standard sizes. Polyester film, vellum, and chart paper also come in 914.4 mm (36 in.) and 609.6 mm (24 in.) rolls for use with the HP 7586B roll-feed drafting plotter.

### Ordering Information

It's easy to order plotter supplies and accessories from HP Sales and Support offices or through HP's direct telephone ordering service. The HP Computer User's Catalog (5953-2450), available from any HP Sales and Support Office, describes the complete range of supplies and accessories.

### Graphics Software

#### Software for HP Plotters: HP-ISPP

This software package minimizes the effort required to develop data plots on any of HP's plotters with RS-232-C/CCITT V.24 or HP-IB interfaces. It is written entirely in ANSI Standard FORTRAN (X3.9-1966); input and output to the plotter is accomplished through standard FORTRAN formatted read/write statements. The package is supplied in source language form on either magnetic tape or flexible diskette format depending on the option specified.

HP-ISPP can be easily installed on almost any ASCII-based computer system that offers the equivalent of 32,000 sixteen-bit words or more for user application program space. The system must provide a standard asynchronous terminal driver (or equivalent I/O communications software) capable of communicating with the plotter through FORTRAN read/write statements within a user-written application program.

The package contains 15 graphics subroutines which support the following HP-GL plotters: 7220C/T, 7470A, 7475A, 7550A, 7580A/B, 7585A/B, and 7586B.

#### HP-ISPP Features

- Provides absolute coordinate pen positioning from the origin (in centimetres or inches) and multiple pen selection
- Scales plots larger or smaller and changes plot origin
- Draws symbol strings at various angles and sizes
- Plots floating point numbers in FORTRAN 'F' format
- Draws and annotates axes
- Scales data to fit on a graph of a given size
- Connects a set of data points with straight lines
- Generates special characters at data points
- Permits plots to be stored on files
- Provides long-axis capability on the HP 7586B drafting plotter

### Ordering Information

**HP 17580B HP-ISPP Software** (specify media option from Table 1)

**Table 1**

No.	Media Options for HP-ISPP
001	800 BPI magnetic tape, 9-track, unlabeled, unblocked, 72 byte fixed-length records, ASCII character code
002	1600 BPI magnetic tape, 9-track, unlabeled, unblocked, 72 byte fixed-length records, ASCII character code
003	Flexible diskette, single-sided, single-density, compatible with Digital Equipment Corporation RX01 dual drive used under RT-11 operating system

# COMPUTERS, PERIPHERALS & CALCULATORS

## Computer Supplies and Accessories

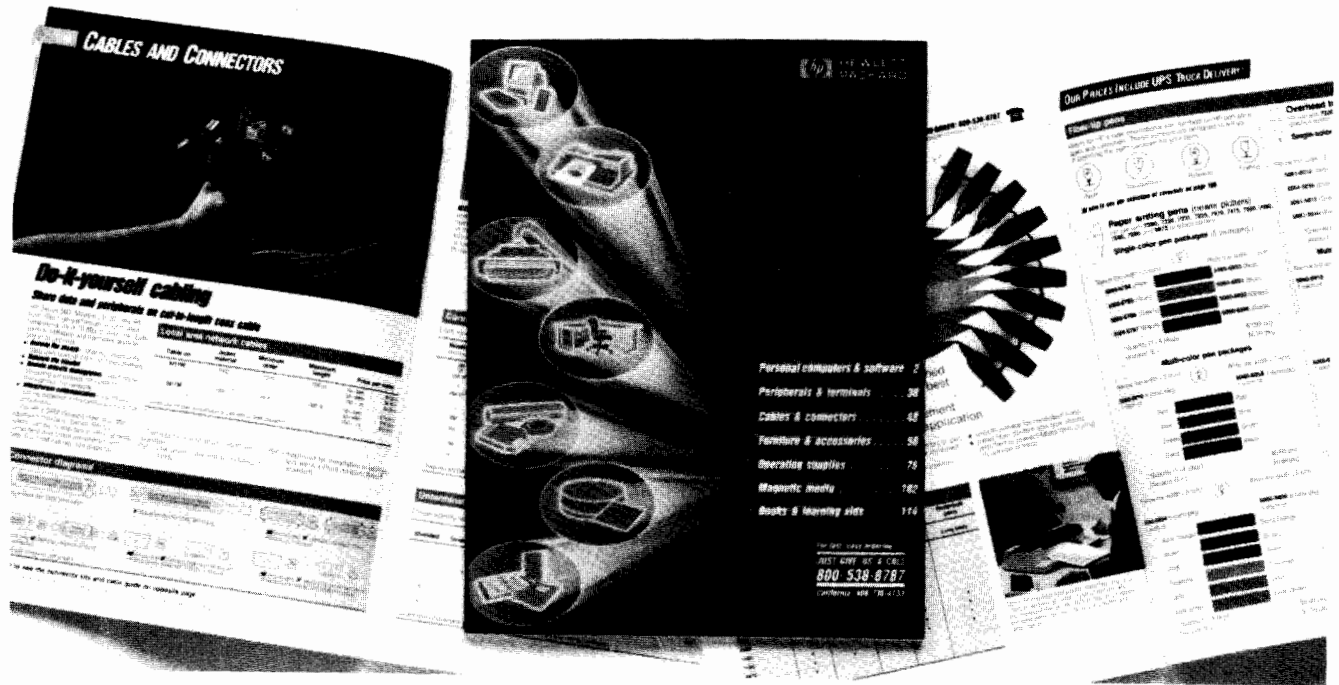

### Ask for a catalog today!

The biannual *Computer Users' Catalog* provides a fast, easy way for HP customers to shop for more than 1500 products. These products are HP manufactured, tested or approved to operate at maximum efficiency with HP equipment. Detailed descriptions, charts, full-color photographs and equipment guides provide you with all the information necessary to select the best products for your application.

Information is easily accessible. Individual products can be located within seconds by referring to one of three convenient indexes, or by flipping to the appropriate catalog section:

- Personal computers and software
- Peripherals and terminals
- Cables and connectors
- Furniture and accessories
- Operating supplies
- Magnetic media
- Books and learning aids

#### In the U.S.

Just give us a call at 800-738-8787 (in CA, AK, HI call 408-738-4133) and ask for a copy of our catalog, or contact your local HP Sales Office and request publication #5953-2450 (D).

#### Outside the U.S.

In the following countries, call the fast-order direct phone lines listed below and request the appropriate publication:

U.K.	:	#5953-2450UK
Germany	:	#5953-2450GE
France	:	#5953-2450FR
Italy	:	#5953-2450IT

In Japan request publication #9301-0761 from your local HP sales office.

In all other countries, ask your local HP sales office for publication #5953-2450

### The Fast, Convenient Way to Order Products

#### In the U.S.

Just call our Direct Phone Order Service any weekday during the following hours:

Call	Time Zone	Ordering Hours
800-538-8787 (in CA, AK, HI call 408-738-4133)	Eastern	9AM - 8PM
	Midwest	8AM - 7PM
	Rocky Mtn.	7AM - 6PM
	Pacific	6AM - 5PM

The following are just some of the advantages of calling in your catalog order:

- Immediate confirmation of availability, pricing and delivery
- Quantity discounts and telephone specials
- Next day shipment
- Expedited shipment available (upon request, at extra charge)
- Three convenient payment methods
  - net 30 for Direct Order Open Accounts
  - Visa, Master Charge or American Express for phone orders
  - Check, money order or credit card for mail orders.

#### Outside the U.S.

Special fast-order direct phone lines for computer supplies are now available in many countries (including those listed below). This phone service offers on-line price and availability information, as well as fast order processing.

Australia .....	(03) 8952645	Italy .....	(02) 92-36-91
	(03) 8952615		(06) 5-48-31
	(02) 8887712	The Netherlands .....	020-470639
	(02) 8871611	South Africa .....	802-5111
Belgium Luxembourg .....	(02) 7623200		53-7954
Canada			28-4178
Toronto local .....	416-671-8383	Sweden .....	08-7502027
Ontario .....	1-800-268-6982		08-7502028
Quebec .....	1-800-387-3417	Switzerland .....	(057) 312254
British Columbia .....	1-800-387-3154	United Kingdom .....	0734-697201
other provinces .....	1-800-387-3154	West Germany .....	07031-142829
France .....	(6) 928-3264		07031-223133

In those areas not yet served by direct order telephone lines, orders may be placed in the regular way through local HP sales offices.



- Assured lasting value for your HP computer products
- Broad range of services worldwide
- Up-to-date information for managers, operators and programmers



## HP Support Services for Maximum Value From Your Investment

Hewlett-Packard support services help you get the maximum value from your computer system by preventing many problems as well as by responding to them. Our wide variety of services, ranging from standardized service agreements to per-incident services, allows you to choose those which best meet your particular needs.

As a result of our continuing effort to provide the best support in the industry, we now have new Response Centers which furnish telephone assistance throughout the world. Designed to concentrate support resources for our customers, these centers help us deliver efficient, cost-effective support by resolving problems not requiring on-site assistance. Our local account teams are then available for those problems which do require on-site calls as well as for overall planning and evaluation of your operation.

This combination of local and centralized support brings you the advantages of personalized attention and sophisticated technology and allows you to achieve the maximum value from your HP computer system. Contact your local HP sales office to request more information on any of the services described or to order them.

## Software Support for Systems and Desktops

Assistance with the software running on your system can take many forms. We offer training courses, predefined and unstructured consulting assistance, and a variety of support agreements as well as assistance on a time and material basis.

## Software Support Agreements

Our software support agreements provide the initial and ongoing technical information your staff requires. The assistance provided can range from documentation updates to personalized technical assistance, depending upon the urgency and complexity of your needs. This broad range of offerings gives you the flexibility to adapt your selection of services to meet changing requirements during the ongoing operation of your computer system.

## Account Management Support

This service provides the expertise of an account-assigned support representative who gets to know you and your system. This in-depth knowledge of your situation allows our representative to make recommendations for managing your software with maximum effectiveness. It also contributes to prompt remedial actions when necessary.

Telephone access to the Response Center is an integral part of the service, providing you with an almost immediate response to urgent questions and a response within two hours to all others. If on-site assistance is needed to identify a problem or develop a workaround, it, too, is included in this level of support.

Additionally, you receive all support materials necessary to stay current with changes and improvements in HP software.

## Response Center Support

Response Center Support is an intermediate level of assistance which provides help from experienced professionals via the telephone. Teams of support engineers respond to your questions and duplicate any problems on a system just like yours. If on-site assistance is needed, it is available on a time and material basis.

Of course, all of the software support materials necessary to maintain your system at current levels are included as part of this service.

## Software Materials Subscription

Current documentation on software updates and the updated material itself are provided by mail through this service. This subscription is an integral part of both Account Management Support and Response Center Support, but it is also available separately. On-site assistance can be obtained on a time and material basis.

# COMPUTERS, PERIPHERALS & CALCULATORS



## Computer Support

### Software Support for Systems and Desktops (Cont.)

- Flexible options to suit your budget
- Expert instruction from the company that designed and built your system

#### Custom Support Plan\*

For additional assistance beyond the level provided by Account Management Support, we offer our Custom Support Plan. You work with your support representative to define the exact combination of services which meets your needs and specify their delivery in this annual agreement. For consulting, reviewing or coordinating on a regular basis, this plan allows you to plan all your software support needs in advance.

#### Support to Cover Multiple Systems

If you have several systems under a single System Manager, several optional services can be added to your support program to provide coverage for them at significant cost savings.

#### Time and Material Service

HP software support assistance is also available on a time and material basis for purchase as needed.

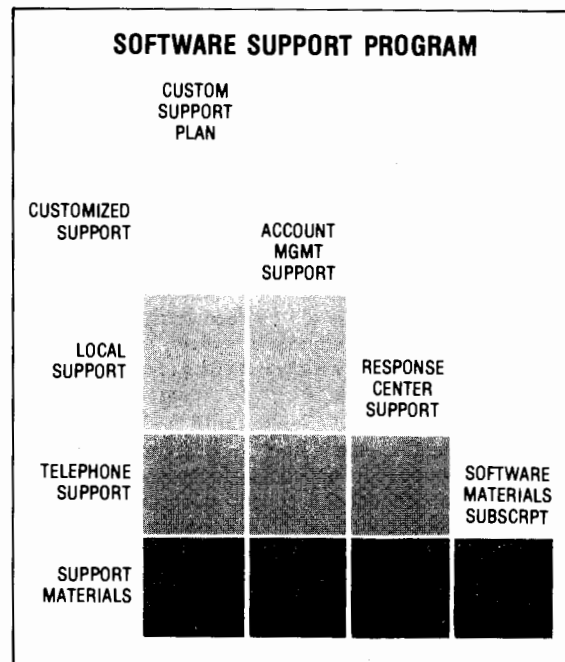

#### Training and Consulting

HP offers training courses at different levels for all of our systems. This instruction can improve your productivity and significantly reduce implementation time. Courses offer a balanced lecture/lab approach and are taught at over 40 training centers throughout the world. On-site and self-paced courses provide yet another alternative for many customers.

Consulting to customize a training course or troubleshoot a system can be purchased on a daily basis or as a standardized, predefined service with a fixed duration and price.

\*Check with your HP support representative for local availability.



- Flexible and comprehensive service plans
- Fixed monthly maintenance costs



### Hardware Maintenance Services

All Hewlett-Packard computer products can be covered by one of HP's maintenance agreement services to assure continuous operation and availability at a standard monthly charge. These services are provided by highly trained Customer Engineers and include travel, labor and parts. You can select from three different services, depending upon your requirements for response time, coverage hours, and cost.

All three services assign a specific Customer Engineer to your account. This person becomes familiar with your environment and takes personal responsibility for managing your system maintenance program. Preventive maintenance is performed on a regular basis, scheduled in advance, to maintain your system at its optimum performance specifications.

Remote diagnosis through HP's Tele-Support program is an integral part of all maintenance services for HP 3000 customers. The modem which provides this communication for rapid problem resolution and monitoring is provided with your system.

### Guaranteed Uptime Service\* (HP 3000 only)

This service is designed to provide 99% uptime for core elements of selected models of the HP 3000. It provides the CPU and up to two system-domain disc drives with on-site maintenance services and continuous, round-the-clock coverage. If your uptime percentage for a three-month period falls below 99%, you receive a credit equal to one month of service charges for the products covered.

### Standard System Maintenance Service

This agreement provides coverage from 8 a.m. to 9 p.m. every day of the standard workweek (excluding HP holidays). This coverage allows all scheduled maintenance services to be performed after normal working hours. Customers within 100 miles of a Support Responsible Office will receive an on-site visit within 4 hours. Extended coverage options can provide service up to 7 days a week, 24 hours per day.

### Basic System Maintenance Service

This service provides economical coverage from 8 a.m. to 5 p.m. during the normal workweek (excluding HP holidays). You will receive next-day response for on-site visits if you are located within 100 miles of a Support Responsible Office. Longer response times are offered beyond 100 miles. (Improved response time and After Coverage Hours service are also available at additional cost on a per-incident basis.) Desktop computers configured with system peripherals gain the account management and system support essential for these configurations. Desktops used in standalone situations can be covered under workstation services.

### System Installation Services

When you purchase an HP computer system, support services begin even before your system is installed. A Customer Engineer routinely provides site planning, site environmental survey, and installation services. This advance planning ensures the sustained, reliable operation of your system.

### Workstation Services

Refer to the Personal Computer section for information on maintenance services designed for terminals, personal computers, plotters and printers used with your system. While some of these products can be covered under your system maintenance agreement, it is usually more economical to obtain workstation coverage for them.

### Per-Incident Maintenance

Time and Material Service is available for HP computer systems not covered by a maintenance agreement. When you purchase this service, you receive a three-day response during coverage hours of 8 a.m. to 5 p.m., Monday through Friday, excluding HP holidays. You will be billed for all travel, parts and labor involved in the service call.

### Cooperative Support Services

Self-support is an expensive support solution. However, you may have the very large installed base of HP computer equipment and the technical expertise needed to make it cost-effective. If you meet these qualifications, HP has several services under the Cooperative Support Program to meet your needs.

Customer Maintenance Training is available for the HP 3000 series 40 and 44, the HP 1000, HP desktop computers, and selected peripherals associated with these products. A balance of theory and practical experience provides customers with the skills needed to troubleshoot, repair, and maintain these products to the major subassembly level.

Hardware Subscription Service furnishes current service information for products covered by Cooperative Support. It includes a monthly newsletter for prompt notification of changes to maintenance procedures, periodic bulletins for procedural changes not yet included in manual updates, service manual updates and revisions, and a quarterly newsletter for current schedules and other information on HP's maintenance training program.

Technical Assistance Service provides access to the HP Customer Engineering Organization through phone-in consulting. It also includes all the features of Hardware Subscription Service to keep you current on procedures and training schedules. In addition, this service provides an account-assigned Customer Engineer to ensure that you are making the most effective use of all HP hardware services.

The Assembly Exchange Program offers customers who perform their own maintenance a fast, economical method of exchanging defective assemblies for refurbished ones. The modular design of our products enables the easy removal of the defective assembly and the easy installation of its replacement. In addition, the refurbished assembly is automatically updated to the latest revision level.

### Warranty Services

After installation, HP provides on-site maintenance services for all hardware initially purchased with the system for a 90-day warranty period. If you purchase a maintenance agreement when your computer is installed, you will receive that level of service during the entire warranty period at no additional charge.

### HP Service Locations Worldwide

HP maintains computer sales and support offices in more than 30 countries around the world. Refer to the listing of addresses at the back of this catalog for specific information.

# COMPUTERS, PERIPHERALS & CALCULATORS



## Computer Support Hardware Maintenance Services (Cont.)

- Wide range of service offerings

### Service Selection Guide

SERVICE SUMMARY FEATURES	GUS	STANDARD	BASIC	ON-SITE PRODUCT	VOLUME REPAIR CENTER	PICKUP AND DELIVERY	FIELD REPAIR CENTER
Response time (or turnaround time)	4 Hours	4 Hours <sup>2</sup>	Next Day <sup>2</sup>	Next Day <sup>2</sup>	3 Days Average (scheduled weekly visit)	4 Days <sup>3</sup>	≥5 Days Total <sup>4</sup>
Coverage Hours	24 Hours/Day (7 Days/Week)	8 AM — 9 PM <sup>1</sup> (5-7 Days/Week)	8 AM — 5 PM (5 Days/Week)	8 AM — 5 PM (5 Days/Week)	8 AM — 5 PM —	8 AM — 5 PM	—
Relative Cost	1.6	1.0	0.8	0.6	0.3	0.4	0.3
Commercial Systems	Available only on new & current HP 3000 products Recommended only for critical applications						
Small Business Systems							
Technical Systems		Good for manufacturing systems needing multiple shift coverage					
Systems Workstations Personal Computers & Terminals		Recommended only on System Console			Recommended with purchase of spare units for backup		
Standalone Workstations Personal Computers		(Available on Series 100 & 200 only) Recommended only in critical applications					Recommended where Pickup and Delivery is not available
Standalone Workstations Desktop Computers			Available on desktops used with system peripherals (System agreement features requirements)	Available on desktops used only with workstation peripherals			

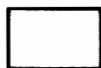

NOT AVAILABLE



NOT RECOMMENDED



RECOMMENDED

PRODUCT LIMITATIONS      RECOMMENDED USE SITUATIONS

<sup>1</sup>Extended hours are available

<sup>2</sup>Within 100 miles of a Primary SRO

<sup>3</sup>Within coverage zones specified. Call HP for coverage and availability.

<sup>4</sup>Total time varies according to your proximity to an FRC. Total time estimated here includes shipping time.



# DATA COMMUNICATIONS TEST EQUIPMENT

## General Information: Protocol Analysis



The growth of demands on datacomm systems is matched only by the burden of developing and maintaining them. Factors impeding datacomm support include:

- Increasingly multi-vendor systems
- ATT divestiture
- Shortage of skilled service personnel
- Exploding system complexity
- Less tolerance for system malfunction
- Proliferation of incompatible systems, standards, and equipment
- User demands for increased speed, reliability, and services

Maximizing system availability and utility requires increasingly sophisticated testing. As just one example, consider the wasted time and expense of calling in the wrong vendor for service when testing can assure you of calling the right one. Clearly, your network's performance can only be as good as your ability to measure and test. Hewlett-Packard has a proud history of contributions to the datacomm test industry. Table 1 lists some of our retiring instruments with suggested replacements. As your testing needs grow, we stand ready to help with equipment, systems, training, and support to develop and maintain your system, at any level, in any environment.

Any datacomm network can be divided into protocol (user level) links between computers, terminals, or other Data Terminal Equipment (DTE). Two DTEs communicate across a digital link such as RS-232/V.24, RS-449, or V.35. If the digital link is long, it may contain an analog path such as a telephone line. Guaranteeing transparency of the DTE-to-DTE link is the function of protocol.

Domain	New product	Old product
PROTOCOL TESTING	4951A Protocol Analyzer 4953A Protocol Analyzer 4955A Protocol Analyzer	1640B Serial Data Analyzer
DIGITAL TESTING	1645A Data Error Analyzer 4925B Bit Error Rate Test Set	4925A Bit Error Rate Test Set
ANALOG TESTING	4945A TIMS	4940A TIMS 4943A TIMS 4944A TIMS
	4935A TIMS	3551A TIMS (BELL) 3550B TIMS
	4936A TIMS	3552A TIMS (CCITT)



Because user interaction is with system protocol, the first section deals with protocol testing. Digital and analog testing are discussed in following sections. Test points in a typical system for the three domains of datacomm testing are shown in Figure 1.

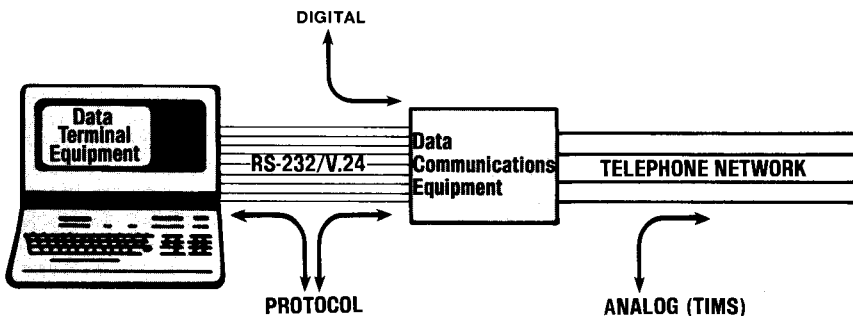

### Protocol Analysis

In datacommunications, protocol can be defined as "rules governing the exchange of information between two pieces of data processing equipment". Protocol may take the form of characters or bit fields separate from or added at the beginning or end or in the midst of user data, plus control lead changes. It is needed for message:

- Framing and Synchronization
- Error Detection and Recovery
- Sequence Control
- Acknowledgement
- Link Initialization and Disconnection
- Addressing and Routing

With low speed, simple datacomm networks an observer can watch data flow on a simple data monitor, visually searching for anomalies. This observer needs intimate knowledge of his network's protocol, as well as the capacity for inexhaustible attention to detail. Modern hi-speed, complex, multilevel protocols, and very complex networks, make real-time manual analysis (monitor mode) virtually impossible. A protocol analyzer can make complex automated testing easy, and provide many other more sophisticated capabilities.

Besides the monitor mode discussed above, a protocol analyzer offers two other fundamental modes of operation. These are data analysis mode and simulate mode. In data analysis mode, as in monitor mode, the analyzer is nonintrusively connected at the digital interface, and the system functions as though no analyzer were present. In analysis it can:

- store selected data for future use
- display only selected data
- trigger on selected events
- interpret advanced protocols
- count or time events
- verify protocol function
- evaluate system performance
- detect protocol incompatibilities

Simulation opens a whole new dimension of datacomm support. Besides the analysis tools mentioned above, the analyzer can now replace elements of the network under test. It can imitate the network to a DTE and exercise segments of the network without loading down the system or risking system failure because of malfunction in the tested segment. The analyzer can simulate a DTE into the network for system troubleshooting or certification.

Protocol analyzers can be used for:

- Troubleshooting
- System integration
- System installation
- Fault isolation
- Software and hardware development
- Network performance optimization

Different test applications and environments require different protocol analyzers. For field service, portability, ease of use, and remote capability would be key features. Speed, power, and large capture memory characterize needs of an EDP center. R&D and manufacturing require automation and programmability. In the fast changing world of protocol, versatility and power to add new capabilities are needed for any application.

# DATA COMMUNICATIONS TEST EQUIPMENT

## General Information: Protocol Analysis

### The Hewlett-Packard Protocol Analyzer Family

HP offers a family of three protocol analyzers to meet different application requirements. While maintaining family compatibility each analyzer is tailored for a different environment, with different features and characteristics. The HP 4951A, 4953A, and 4955A have common operating, setup, mass storage, remote transfer, and display characteristics. An overview of differences and similarities can be seen in the family chart at right. Family features are discussed on these two pages, with individual highlights on the following three pages.

### Ease of Use

Hewlett-Packard Protocol Analyzers use a softkey-driven menu interface to provide sophisticated testing capability without cryptic programming or long development times. With dynamic relabeling of the softkeys only choices appropriate to the setup and menu level are presented to the operator. No special programming skills or obscure code words need be learned. Complex tests can be written and run using only the softkeys. For example, to measure the time between Request To Send and Clear To Send leads going high, the softkey sequence would be WHEN, LEAD, RTS, ON GOTO BLOCK, 2, START, TIMER, 1, WHEN, LEAD, CTS, ON, GOTO BLOCK, 3, STOP, TIMER, 1. With each press of a softkey a new set of softkey labels appears. The HP 4953A and 4955A even provide softkey mnemonics for level 2 and 3 protocol triggers and send strings without reference to binary tables. Complete setups and monitor and simulate menus can be stored to tape for reuse or distribution.

All three analyzers have typewriter quality, full ASCII keyboards for easy entry of triggers or send strings. All keyboards fold against the fronts of the instruments to protect CRT, tape drives, and keyboard. There are no exposed cables to be damaged. HP 4953A and 4955A keyboards lock at any angle for operator convenience.

HP analyzers use high resolution CRTs, allowing sophisticated display of complex protocols to make even real-time analysis easy. Special displays are provided to make visual analysis of high level protocols or complex control lead handshaking quick, sure, and easy, on real-time, buffered, or taped data.

### Power

Besides the character traffic on a channel, HP protocol analyzers capture all lead activity and mark each event with a unique time stamp. This time stamp remains with the data in buffer or on tape. It is used for event-to-event timing measurements and to create timing diagram displays. The time and lead information also allows complete analysis of traffic at a later time, in another analyzer, or at a remote location. Relative time relationships are maintained without filling the buffer or tapes with idle line time.

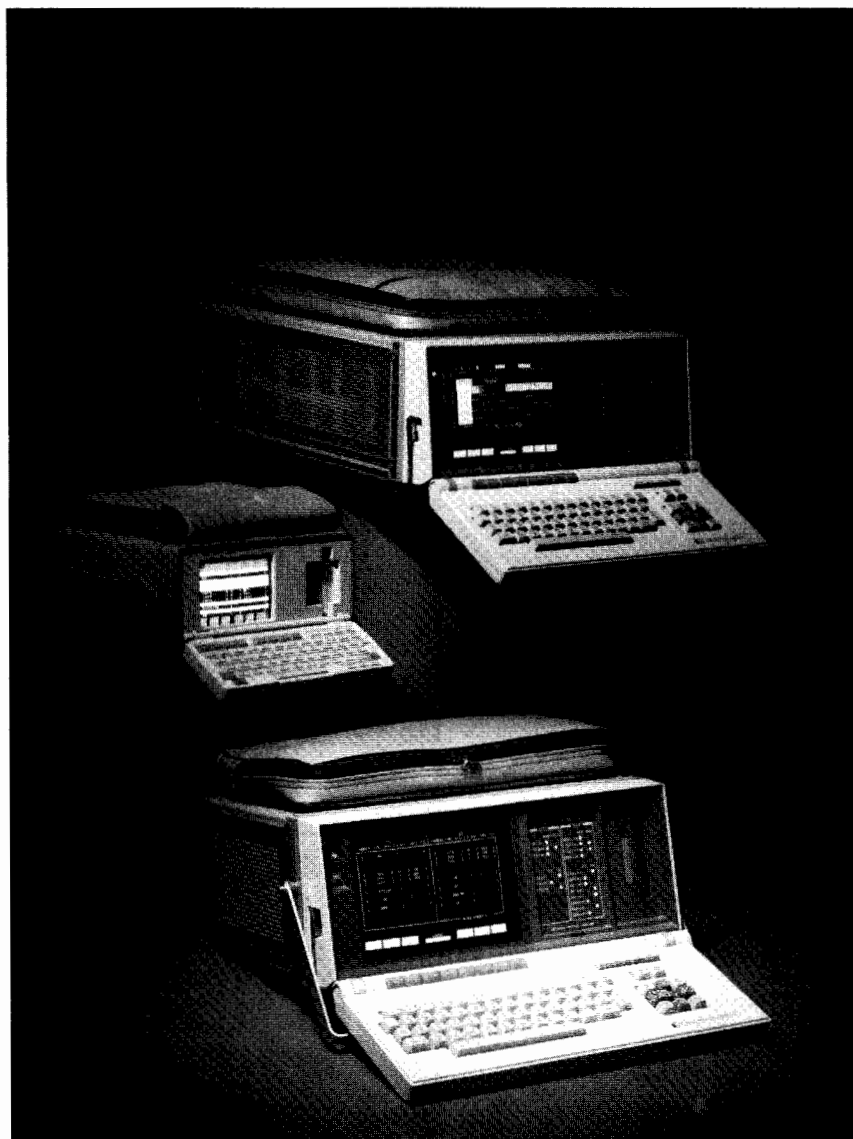

Sophisticated triggering allows the operator to program the analyzer to take a variety of actions in response to different system events. Character strings, lead transitions, errors, complicated protocol activity, or any event at the interface can trigger the analyzer to send a string, increment a counter, start a timer, start or stop tape or display, highlight, or take other actions. Triggering effectively automates protocol analysis.

Most common protocols are built into the HP family with specialized displays, instrument setup, and triggering mnemonics available as needed. User-defined character asynchronous/synchronous allows operation in most nonstandard protocols. Many protocols not inherent in the analyzers are available as application programs.

Besides powerful analysis abilities in nonintrusive monitor mode, all family members offer powerful simulate capability. Softkey/menu programming allows easy stimulus/response testing of network components without tying up other network resources. All the triggering and analysis capabilities are available while actively simulating networks or components. Simulation can be especially useful in isolating intermittent or infrequent troubles, or for testing a new application or device before system connection. The simulate menu specifies the analyzer as a DTE or DCE (see preceding page), transmitting in full or half duplex with user-defined or automatic control of control leads. Send strings may be entered from the keyboard or copied from buffer data.

## Protocol Analyzer Family Summary

	4951A	4953A	4955A
<b>Weight</b>	13 lbs (5.7kg)	34 lbs (15.5kg)	49 lbs (22kg)
<b>Size (HWD—inches)</b>	4.4x10.2x11.3 in	7.8x16.8x16.3 in	7.9x16.8x25.7 in
<b>(HWD—cm)</b>	11.2x25.9x28.6 cm	19.6x42.5x41.2 cm	19.6x42.5x65.4 cm
<b>Keyboard</b>	Full ASCII	locks in any position	locks in any position
	6 Softkeys	Full ASCII, 8 Softkey	Full ASCII, 8 Softkey
<b>Display</b>	5" diagonal	9 inch diagonal	9 inch diagonal
	16 lines	25 lines, 80 characters/line	25 lines, 80 characters/line
	32 char/line		
<b>Double Size</b>	No	Yes	Yes
<b>Printer Output</b>	Any ASCII RS-232C	Any ASCII RS-232C	HP-IB
		Graphics of HP2671G, 2673A	
<b>Lead Display</b>	LCD/LED on Pod	LEDs by CRT	SoftLEDs on CRT
<b>Remote</b>	Transfer data	menus, application programs via RS-232C	menus, application programs via RS-232C
		Total Remote RS-232C	Total Remote HP-IB
<b>Control/Monitor</b>	5 leads	15 leads	15 leads
<b>Data Capture</b>	32 Kbyte RAM	64 Kbyte	256 Kbyte RAM
<b>Buffer</b>	Continuous	256 Kbyte (opt)	
<b>Display Formats</b>	5 Built in	8 Built in	7 Built in
	Data & State, DTE, DCE, Frame & Packet	Data & State, DTE, DCE, Frame & Packet	DTE/DCE, Frame, Packet
<b>Application programs (more coming)</b>	SNA, JIS-7.8, X.21, DDCMP, BSC—X.25	JIS-8, SNA, X.21, BSC—X.25, Autoconfigure	DDCMP, SNA, BSC—X.25, Frame/Package, CCITT7, Remote, X.21, JIS-8, X.25 Emulation
<b>Tape Drive</b>	1 opt	1 standard	1 or 2
<b>Interfaces</b>		RS-232C/V.24, RS-449, V.35, MIL-188C, X.21	
<b>Data Codes</b>	IPARS	ASCII, EBCDIC, HEX, EBCD, Transcode, Baudot user defined	
<b>Protocols (firmware)</b>		BSC, HDLC, SDLC, CHAR ASYNC/SYNC, X.25, DDCMP, X.75	
<b>Protocols (software)</b>		X.21, BSC-X.25, SNA	DDCMP, CCITT#7
<b>Error Checking</b>		CRC-CCITT, CRC-16, CRC-12, CRC-6, LRC	
<b>Data Rates</b>	50bps - 19.2 Kbps		50 bps to 72kbps
<b>Programming</b>		Sortkey Monitor and Simulate Menus, BASIC	
<b>Triggering</b>		63 simultaneous triggers	
<b>Timers/Counters</b>		5 each	
<b>Send String</b>		1750 characters total	
<b>Autoconfigure</b>	255 chars/string	1350 chars/string	255 chars/string
<b>BERT</b>	Yes	Application Program	No
<b>Frame &amp; packet softkey mnemonics</b>	No	Yes	Yes
<b>Auto Increment</b>	No	Yes	Yes
<b>N(R), N(S), P(R), P(S)</b>	No	Yes	Yes
<b>Selective Store to tape</b>	No	Yes	Yes
<b>Other</b>	Battery Backup of Menus/Data	Softkey timing, Video Output, Autostart tapefile	HP-IB, Real-time Clock, External trigger



HP 4951A



HP 4953A

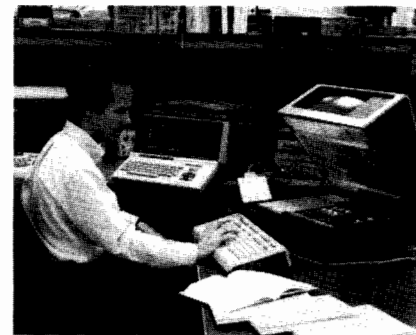

HP 4955A

### Application Programs

Application programs are HP-supplied machine language programs on tape that provide use in new protocols or applications. Some currently available programs are mentioned in the family chart and others are on the way. Application programs guarantee that your analyzer will not be obsoleted by changing technology or standards.

### Remote

All HP analyzers support the remote exchange of data, menus, and application programs. The HP 4953A provides a separate RS-232C/V.24 connector for total un-

attended remote control of up to 16 instruments. The HP 4951A and 4955A use the interface pod and require limited operator interaction. Remote capability gives field service personnel access to central site expertise and central site experts access to remote sites without qualified service personnel.

### Applications

Major applications involving protocol analyzers include field service; Electronic Data Processing center support; network component research, development, manufacture, installation and service; and general network

troubleshooting. With the new HP 4951A and 4953A joining the HP 4955A Hewlett-Packard is your source for total network test and support. The following three pages detail specific applications and operating characteristics for each analyzer. Besides test equipment, Hewlett-Packard provides the utmost in training and field support for datacomm users. Your local field engineer will be happy to provide information about the Datacomm Seminar, Protocol Seminar, or Customer Engineering services available in your area, as well as more detailed information or a demonstration of the Hewlett-Packard Protocol Family members meeting your needs.

## Protocol Analyzer

Model 4951A

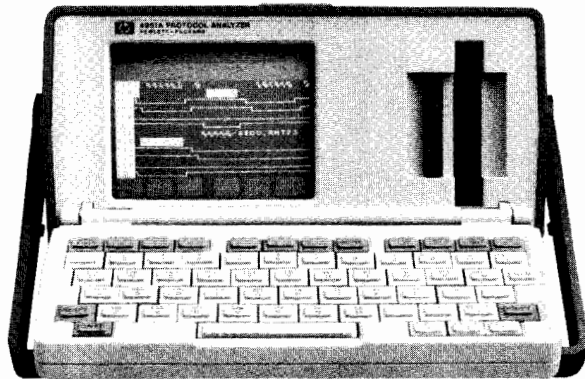

HP 4951A

### HP 4951A Protocol Analyzer

The HP 4951A Protocol Analyzer is the field service member of the protocol family. Its very small size, weight, and price combine with ease of use, power, and versatility to make an ideal installation and maintenance tool for any network. To the protocol family features it adds Bit Error Rate Testing (BERT), nonvolatile memory of data and menus, portability, and affordability. In BERT mode the HP 4951A measures bit errors, block errors, errored seconds, and percent error-free seconds, all simultaneously. Non-volatile memory and remote transfer capability provides the field technician access to central site expertise. The low price of the HP 4951A allows you to put high level testing ability in the hands of everyone who needs it. Portability and ease of use ensure that it will be used, and the testing power of the HP 4951A will ensure you of greater system uptime.

#### General Operating Characteristics

**Protocols:** X25, HDLC, SDLC (NRZI), BSC, and most character asynchronous or synchronous protocols.

**Data Transfer Rates (bps):** 50, 75, 100, 134.5, 150, 300, 600, 1200, 1800, 2000, 2400, 3200, 3600, 4800, 7200, 9600, 12000, 14400, 16000, 19200, teletext 1200/75, and EXTERNAL up to 19200 full duplex for all monitoring, simulation, triggering, and BERT tests.

The HP 4951A can capture a complete buffer full of data at line speeds up to 64 kbps (bit-oriented protocols only.)

**Clock Accuracy:** 0.005%.

**Data Codes:** ASCII, EBCDIC, Baudot, Six Bit Transcode, IPARS, and EBCD.

**Mass Storage Memory:** 32 Kbytes of RAM stores data characters, timing and lead status information.

Optional tape drive: 256 Kbytes. Store data, timing information, and menu configurations.

**Lead Status:** The status of five control leads are stored for each interface. They are RTS, CTS, DTR, DSR, and CD for RS-232C/V.24 and CS, RS, RR, TR, and DM for the RS-449 interface.

**Character Framing:** 5, 6, 7, or 8 information bits, plus parity. For asynchronous systems, select 1, 1.5, or 2 stop bits per character.

**Error Checking:** CRC-CCITT, CRC-16, CRC-12, CRC-6, LRC, and parity.

**Triggers:** 63 consisting of characters, errors, interface lead transitions or timer values. May be simultaneously active up to 19200 bits per second.

**Timers:** Five. Each timer has a maximum count of 65565 ms. Resolution 1 ms.

**Counters:** Five. Each counter may be incremented up to 9999.

**Keyboard:** Full ASCII keyboard with six softkeys and cursor control.

**Display:** 12.7 cm (5 in.) diagonal with 16 lines and 32 characters per line.

**Display Formats:** DTE data over DCE data, Data and Lead State. DTE data only, DCE data only, and Frame and Packet decode.

**Send Strings:** 255 characters per string maximum; 1750 characters total.

**Remote Capability:** Over the RS-232C/V.24 link, transfer data, setups and programs.

**Bit Error Rate Testing:** Simultaneously measure bit errors, block errors, errored seconds, and percent error free seconds. Block size: 63, 511, 1000, or 2047 bits.

Patterns: 63, 511, or 2047 bit pseudo random sequence.

Character framing: Select 5, 6, 7 or 8 bits per character and parity.

Inject error function: Inject single errors or bursts of errors.

**Additional Characteristics:** Auto-configuration of all setup parameters. Battery maintained RAM for all setups, data, and menus. Select bit order as LSB or MSB first and select the bit sense as inverted or normal.

**Self-Test:** Extensive self-test and functional verification routines will isolate failures to the functional component group. Built-in signature analysis permits fault isolation to the component level.

#### Interface Accessories

HP 18173A, HP 18174A, HP 18179A and HP 18180A.

Each interface is supplied with the appropriate 1.5-metre cable.

##### HP 18173A

**RS-232C/V.24 Interface:** Ten switches for line isolation. Twenty-five test points for monitoring, forcing, or cross-patching. One non-dedicated MARK/SPACE tristate monitor for user patching to any line. Nine hard-wired activity indicators: TD, RD, TC, RC, DTR, DSR, RTS, CTS, and CD.

##### HP 18174A

**RS-449 Interface:** Nine dedicated activity indicators: SD, RD, ST, RT, RS, CS, TR, DM, and RR.

##### HP 18179A

**RS-232C/V.24 Interface:** with a complete breakout box and tri-state LEDs. Ten tri-state LEDs monitor primary interface signals at the source. The 25 pin breakout box allows any interface to be interrupted.

**HP 18180A:** Combination RS-232C/V.24 and RS-449.

**HP 18173A:** weight, 0.6 kg (1.3 lb).

**HP 18174A:** weight, 0.6 kg (1.3 lb).

**HP 18180A:** weight, 0.7 kg (1.5 lb).

#### General Specifications

**Weight:** net, 5.7 kg (12.6 lb); shipping, 9.5 kg (21 lb).

**Size:** Height 11.2 cm, width 25.9 cm, depth 28.6 cm (4.4 x 10.2 x 11.3 in.)

**Temperature:** operating, 0°C to +55°C (+32 °F to +131 °F); \*\* storage, -40°C to +75°C (-40°F to +167°F).

\*\*Tape drive should only be operated from +5°C to +40°C (+41°F to +104°F).

**Altitude:** operating, 4600m (15000 ft); storage, 15300m (50000 ft).

**Power Requirements:** 110, 220 Vac, -15% to +15%; 48 to 66 Hz, single phase; less than 15 VA typical, less than 30 VA maximum.

#### Accessories

**HP 18173A:** RS-232C/V.24 Interface Pod

**HP 18174A:** RS-449 Interface Pod

**HP 18179A:** RS-232C/V.24 interface with complete breakout box.

**HP 18180A:** Combination RS-232C/V.24 and RS-449 Interface Pod

**HP 18172A:** Soft vinyl carrying case for extra pods

**HP 98200A:** Certified blank tape cartridges (set of five)

#### Ordering Information

**HP 4951A Protocol Analyzer**

(does not include interface pod)

**Option 001:** Integral tape drive

**Option 100:** Adds accessory HP 18173A

**Option 101:** Adds accessory HP 18174A

**Option 102:** Adds accessory HP 18180A

**Option 910:** Adds extra Operating and Service

Manuals

**Option 916:** Extra Operating Manual

# DATA COMMUNICATIONS TEST EQUIPMENT

Protocol Analyzer  
Model 4953A

115

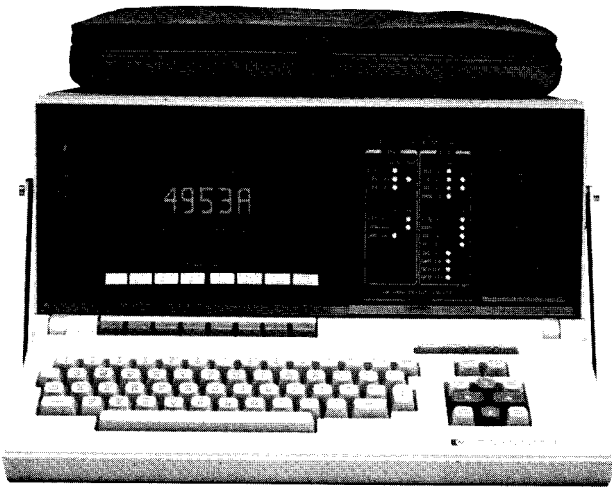

HP 4953A



## HP 4953A Protocol Analyzer

The HP 4953A is a powerful, high-speed, general-purpose protocol analyzer perfect for any protocol testing application. It combines portability, high level capability, total remote control, EDP center, remote site support, of any datacomm environment. The HP 4953A adds softkey driven cursor timing measurements without programming to the protocol family features, mnemonic labeled softkeys for easy set up of frame and packet tests, total remote operation, and tremendous future versatility. An RS-232C/V.24 connector (separate from analysis interface port) provides communication to a controller or up to 16 other HP protocol analyzers for remote site support with transfer of data and menus or unattended remote operation. For more information see the family summary on page 112.

### General Operating Characteristics

**Protocols:** X.25, X.75, HDLC, SDLC, BSC, DDCMP, and user-definable character asynchronous or synchronous protocols. SNA, X.21, BSC X.25 and others are available as application programs.

**Data Transfer Rates:** 50 bps to 72 kbps using the HP 4953A's internal clock or an externally supplied clock.

**Data Capture Speed:** bit oriented protocols to 256 Kbps.

**Data Transmission Modes:** synchronous, asynchronous, and synchronous NRZI.

**Capture Memory:** 64 Kbytes for storing data, timing, and interface lead status. Option 001 increases the capture memory to 256 Kbytes.

**Remote:** Total control of up to 16 remote instruments.

**Character Framing:** 5, 6, 7, or 8 information bits plus parity.

**Data Codes:** ASCII, EBCDIC, Baudot, EBCD, and Transcode are provided. The user may quickly define other data codes and store them to tape for future use.

**Error Checking:** CRC-CCITT, CRC-16, CRC-12, CRC-6, and LRC.

**Parity:** Odd, Even, None, and Ignore.

**Triggers:** 63 triggers, consisting of character strings, errors, or interface lead transitions. Bit and character masking, and "not" characters are supported. Trigger events can be selectively displayed and stored to tape.

**Tape Drive:** Cartridges store data, timing information, interface and lead status, menu configurations, custom data codes, and application programs. The entire contents of the buffer memory may be stored on a single data cartridge.

With Option 001, line data can be stored directly to tape at 48 kbps half duplex (display off) and 19.2 kbps full duplex (display on or off).

The standard memory supports 19.2 kbps half duplex and 9.6 kbps full duplex. Loading application programs will reduce the tape writing speed for the standard memory.

**Display:** A high resolution 23 cm (9 in.) diagonal, 25 line by 80 character display. Double size characters are selectable.

**Keyboard:** The full ASCII keyboard pivots and locks at any angle for convenient desk, bench, rack, or floor-standing operation.

**RS-232C/V.24:** For instrument control—separate from interface port. Direct hard-copy output of all normal sized displays to an HP 2671G or HP 2673A printer is standard. General-purpose RS-232C/V.24 ASCII printer support is a standard application program. Remote transfer of data, menus, setups, status, application programs, and remote menu execution via RS-232C/V.24 are all standard features.

### Timers and Counters (5 each)

**Timers:** 65 535 ms. max.; 1 ms resolution

**Counters:** up to 65 535 counts.

**Cursor Timing:** Direct display readout of the time between any two characters or lead transitions in the examine data menu.

Self test: Extensive self test and functional verification routines will isolate failures to the board assembly level. Built-in signature analysis permits fault isolation to the component level.

### Specifications

**Electromagnetic Compatibility:** type tested for compliance with VDE 0871 Level B, Radiated and Conducted.

### HP Class B Environmental Specifications

**Relative Humidity:** operating, 5 to 95% at 40°C; storage, 5 to 90% at 65°C.

**Temperature:** operating, 0°C to +55°C (+32°F to +131°F); storage, -40°C to +75°C (-40°F to +167°F)\*\*

\*\*Tape drive should only be operated from +5°C to +40°C (+41°F to +104°F).

**HP Class B Shock and Vibration Specifications:** IEC 348. ANSI 395, CSA Safety Standards.

**Altitude:** operating, 4 600m (15 000 ft); storage, 15 300m (50 000 ft).

**Primary Channel Clock Accuracy:** 0.005%.

**Dimensions (overall excluding pouch):** 41.2 cm L x 46.4 cm W x 19.6 cm H (16.25 x 18.25 x 7.75 in.); Rack height 17.8 cm (7 in.).

**Weight:** net, 15.5 kg (34 lb).

**Power Requirements:** 115/230 Vac + 10 -25%; 48 Hz to 66 Hz; single phase; 200 VA max.

### Ordering Information

\*HP 4953A Protocol Analyzer

**Option 001:** Extended Memory

**Option 003:** Katakana Character Set (JIS-8)

**Option 100:** adds HP 18135A

**Option 101:** adds HP 18136A

**Option 104:** adds HP 18137A

**Option 105:** adds HP 18138A

**Option 908:** Rack Mount

### Physical Interface Pods

HP 18135A RS-232C/V.24 Interface Pod

HP 18136A RS-449 Interface Pod

HP 18137A V.35 Interface Pod

HP 18139A MIL-188C Interface Pod

### Other Accessories

HP 18140A Breakout Box (for all interfaces)

HP 98200A Certified blank tape cartridges (set of 5)

### Applications Programs

HP 18153A SNA Decode

HP 18154A X.21 Decode

HP 18155A BSC.X.25 Decode

\*Does not include interface pods or service manual

# DATA COMMUNICATIONS TEST EQUIPMENT

## Protocol Analyzer

Model 4955A



### HP 4955A

#### HP 4955A Protocol Analyzer

The HP 4955A Protocol Analyzer is an excellent, high-level tool for R&D and manufacturing, as well as sophisticated network performance analysis. In addition to the capabilities of the protocol family it offers BASIC programming, HP-IB control, real-time clock, and dual tape drives. Troubleshooting is straightforward using the softkey menus, or via HP-IB and a controller, measurements and results can be collected automatically. The optional BASIC programming language can be used for very sophisticated analysis or for any of your unique dedicated applications. It uses many of the menu routines, maintaining softkey ease of use, while giving you the ability to write your own programs when needed. Display control allows proprietary or higher level protocols to be decoded and displayed, and statistical information to be presented in graphic format. For more details, please see the chart on page 112 or ask your Hewlett-Packard field engineer for a data sheet.

#### General Operating Characteristics

**Protocols:** X.25, HDLC, BSC, SDLC, user defined character synchronous/asynchronous.

Application software available supplies custom display formats to decode SNA, BSC framed X.25, DDCMP, X.21, and CCITT7.

**Data transfer rates:** 50 bps to 72 kbps using internal clock. HP 4955A can properly frame data at higher rates using an external clock.

**Data transmission modes:** synchronous, asynchronous, and synchronous NRZI.

**Capture memory:** 256K bytes for storing data, timing, and interface lead status.

**Character framing:** 5, 6, 7, or 8 information bits plus parity.

**Data codes:** ASCII, EBCDIC, Baudot, EBCD, IPARS. Selectric, and Transcode are provided. The user may quickly define other codes using the supplied application program, and store them to tape for future use.

**Error checking:** CRC-CCITT, CRC-16, CRC-12, CRC-6, and LRC.

**Parity:** Odd, Even, None, and Ignore.

**Triggers:** 63 - consisting of characters, errors, or interface lead transitions. External TTL pulse trigger-in and trigger-out ports are provided. Bit and character masking, and "not" characters are supported. Trigger events can be selectively displayed and stored to tape. Date and time are also stored for future reference.

**Timers and Counters** (5 of each)

**Timers:** 65535 ms max; 1 ms resolution and accuracy.

**Counters:** up to 10,000.

**Date and time clock:** battery backup.

**Dual tape drives:** cartridges store buffer data and timing information, menu configurations, custom data codes, application programs, and BASIC programs. The entire contents of the buffer memory may be stored on a single data cartridge.

BASIC programming language (Option 001): sample datacomm extensions to BASIC.

START/STOP (TIMER, TAPE, DISPLAY).

SEND . . .

HIGHLIGHT . . .

DECODE FRAME/PACKET

SET LEAD . . .

DISPLAY . . .

EMULATE (DTE/DCE).

**Display:** a 23 cm (9 in.) diagonal, 25 line by 80 character display. Double size characters are selectable.

**Keyboard:** the full ASCII keyboard pivots and locks at any angle for convenient desk, bench, rack, or floor standing operation.

#### HP-IB (IEEE-488-1978)

a. Direct hard copy output of any display to an HP 2671G or 2673A printer.

b. Remote operation using an HP-IB controller.

**Security:** inhibit simulation and data recording capability.

**Self test:** extensive self-test and functional verification routines isolate failures to the board assembly level. Built-in signature analysis permits fault isolation to the component level.

#### Specifications

**Electromagnetic compatibility:** type tested for compliance with VDE 0871 Level B, Radiated and Conducted.

**Primary channel clock accuracy:** 0.005%.

**Temperature:** operating, 0°C to +55°C (+32°F to +131°F)\*.  
storage, -40°C to +75°C (-40°F to +167°F).

\*Tape drives should only be operated from +5°C to +40°C (+41°F to +104°F).

**Altitude:** operating, 4600 m (15 000 ft).

storage, 15 300 m (50 000 ft).

**Dimensions** (overall, excluding pouch)

Length: 654 mm (25.7 in.)

Width: 436 mm (17.2 in.)

Height: 201 mm (7.9 in.)

Rack Height: 177 mm (6.97 in.)

**Weight:** net 22 kg (49 lb).

shipping 32 kg (70 lb).

**Power requirements:** 110, 220, Vac -15% to +15%; 48 to 66 Hz single phase; 250 VA max.

**HP-IB Interface Functions:** SH1, AH1, T2, L2, SR1, RL 1, PP0, DC1, DT0, C1, C2, C4, C27, and E2. For more on these codes, refer to the HP-IB section of this catalog.

#### Ordering Information

HP 4955A Protocol Analyzer (Includes HP 18135A)

**Option 001:** BASIC programming language

**Option 002:** Deletes HP 18135A

**Option 004:** Deletes second tape drive and pouch

**Option 908:** Rack mount kit (HP 5061-0078)

**Option 910:** Extra Operating Manual

#### Physical Interface Pods

HP 18135A RS-232C/V.24 Interface Pod

HP 18136A RS-449 Interface Pod

HP 18137A V.35 Interface Pod

HP 18138A X.21 Interface Kit (used with HP 18136A)

HP 18139A MIL-188C Interface Pod

#### Other Accessories

HP 18140A Breakout Box (for all interfaces)

HP 18141A Service Kit

HP 18142A BASIC Programming Language Field

Refit Kit

HP 98200A Certified blank tape cartridge (set of five)

Transit Case (HP 9211-2662)

One Day 4955A Training (+24A)



# DATA COMMUNICATIONS TEST EQUIPMENT

General Information: Data and Voice Testing

117



## Data Network Testing

There are a wide variety of tests that can be made on a data communications system. Depending on the point in the system at which the tests are made, quite different philosophies and techniques apply.

Protocol analysis is usually concerned with overall network performance, determined through monitoring or simulating network software (protocol and/or data). Digital testing involves measuring modem-channel-modem efficiency in terms such as Bit Error Rate (BER) and Block Error Rate (BLER). Analog testing measures the tariffed and other key parameters of the transmission line itself.

The interrelationships of these measurement philosophies are complicated and difficult to understand. For example, how is envelope delay distortion of the line related to the BER or the throughput of the system? Generally speaking, the three measurement philosophies are related in a hierarchical fashion. Nonintrusive network monitoring by protocol analyzers gives an indication of overall performance and can often isolate problems to the component or section. When monitoring is insufficient, such as during software debugging or systems integration, protocol analyzers also can be used to simulate network components such as front-end processors or terminals. Once sectionalized, BER testers are used to verify and quantify the link dysfunction, and analog measurements determine which tariffed parameter is out of specification should the telephone line be the problem.

Combined protocol, digital, and analog tests can be used synergistically to restore the network quickly and efficiently. Protocol Analysis has been previously described. The next sections detail the analog and digital testing.

## Digital Measurements

Data error analyzers are used to test the quality of both the modem and the transmission facility. They provide information about the modem and transmission line but no information about the DTE they replace.

The overall quality of the link is indicated by its BER. A good link will have an error rate better than  $1 \times 10^{-5}$  per bit. This measurement will include the effect of both transmission line impairments and the modem's ability to overcome them. Modems vary widely in their sensitivity to line impairments. Low speed (less than 300 bps) and adaptively equalized modems are less sensitive than high speed (more than 4800 bps) and non-adaptively equalized modems.

Since data communications systems transmit data and control information in blocks, these instruments also measure BLER and Percent Error Free Seconds (%EFS). BER, BLER and %EFS can be used together to examine the statistics of the error mechanism. If the BER and BLER or %EFS are both high, the impairment is random and probably due to noise. If the BER is high but the BLER or %EFS is low, the impairment is more sporadic. This happens when lines are switched, synchronization is temporarily lost or impulse noise is too high.

	Basic Testing				Conditioned Circuit Testing				Additional Testing for Complete Troubleshooting			Remote Automatic Testing	
	Up to 2400 bps		Up to 9600 bps and DDS		C & D Conditioning—BELL M1020 & M1040 Conditioning—CCITT				Return Loss	CGITT Crosstalk	HP-11B SYSTEMS	Master/Slave	
	Loss Continuity	Noise Loss vs. Freq.	Signal/Noise Ratio	Impulse Noise	Wideband Impulse Noise	P/AR	Envelope or Group Delay	Attenuation Distortion	NLD or Intermodulation Distortion	Phase Jitter	Amplitude Jitter	Hits Dropouts	
BELL Recommendations	3551A												
	4935A												
	4945A												
	3776B												
CCITT Recommendations	3552A												
	4936A												
	3770B												
	3776A												

Error rates are qualitative checks of the data communications system that can be made in a few minutes. If the system is bad, diagnostic measurements are provided to help isolate the problem. Dropouts, clock slips, error skew, jitter, and total peak distortion indicate some of the problems that can occur on a link. These measurements are made simultaneously with the error rate measurements and can be printed out in automatic, unattended mode if desired.

Catastrophic failures can usually be found with self-tests and loop-back switches built into the modem. Data error analyzers can find failures that are not illuminated by internal self-tests.

Modem dynamics are another source of data transmission problems. Modern modems have automatic equalization circuits to compensate for telephone line distortions. It is important to let the equalization process settle, particularly with switched carrier modems, so data is not transmitted too soon.

Measurements that verify modem dynamics are RTS-CTS delay and modem start up tests such as ping-pong.

## Analog Impairments Affect Performance

Analog impairments on the telephone line can significantly affect the efficiency of data communications. What the user notices is a slow down in transmission (because of frequent retransmission of blocks of data), garbled data or no data at all. These effects are a result of the line impairments so distorting

the modem signal that the receiving modem cannot make correct decisions. Data bits and blocks are received in error.

The various modem types are susceptible to each impairment in differing degrees. Low speed modems generally use robust modulation schemes and are mostly affected by problems of *continuity*, *loss*, *signal-to-noise ratio*, and *impulse noise*.

As modem speeds increase, the modulation scheme becomes more complex and so they are more susceptible to other impairments. Two approaches are taken to minimize these effects. One is to select and condition leased telephone lines to eliminate significant impairments. The impairments of concern are *bandwidth reduction*, *envelope (or Group) delay distortion*, *non-linear (Inter-modulation) distortion*, *return loss*, *phase jitter*, *hits*, and *dropouts*.

The other approach can address a limited number of these with varying degrees of success. Automatically adjusting equalization is built into the modem itself. This can take care of significant *signal/noise ratio reduction*, *bandwidth reduction*, and *envelope (or Group) delay distortion*, as well as some *phase jitter* and *return loss* problems. There is no significant protection against the other impairments and cases of severe or rapidly changing *envelope (or Group) delay distortion* or *bandwidth reduction* may not be adequately compensated for either.

Direct digital transmission is significantly more robust and basically affected by problems of *continuity*, *signal-to-noise ratio*, and *impulse noise*.



# DATA COMMUNICATIONS TEST EQUIPMENT

## Telephone Line Analyzer; Optional Data Line Analysis

Models 3770B, 3776A/B & Option 001

### HP 3770B

- Compatible with CCITT Recommendation 0.81
- Makes all the maintenance measurements listed in CCITT Recommendation M.1060
- Optional slaving facilities

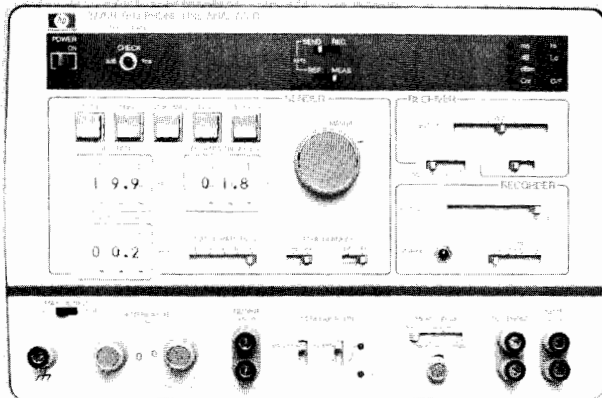

HP 3770B

### HP 3770B Telephone Line Analyzer

The HP 3770B is designed for audio data line characterization to CCITT standards. The HP 3770B makes, in one combined unit, all of the routine maintenance measurements listed in CCITT Recommendation M.1060 for high speed data lines.

The HP 3770B measures group delay, attenuation distortion, and absolute level in the frequency range 200 Hz to 20 kHz. It has automatic ranging, zeroing, and synchronization, with simultaneous LED read-out of measurement result and frequency. The sender and receiver are combined in a single, rugged, portable unit.

The HP 3770B also measures weighted noise, noise-with-tone and impulse noise. A crosstalk measurement is available as an option. Further, an optional slave facility for group delay and attenuation distortion measurements allows the measurement results for both directions of transmission on a 4-wire circuit to be displayed at one end of the circuit. The measurements in both directions can be controlled from one end of the circuit, leaving the slave unit unattended.

The HP 3770B has X-Y recorder outputs to enable a permanent swept record of the measurements to be made. A suitable portable X-Y recorder can be supplied as an option. Pre-printed graph paper showing CCITT limits for group delay and attenuation distortion measurements can also be supplied.

The instrument also has a built-in telephone facility to allow voice communication in a 2- or 4-wire mode over the line or lines under test. An integral loudspeaker allows the operator to monitor either the receiver input or sender output.

### HP 3776A/B Option 001

- CCITT and North American versions
- All measurements available at digital or analog interfaces
- Measurement sequence facility
- Direct output to printer or plotter

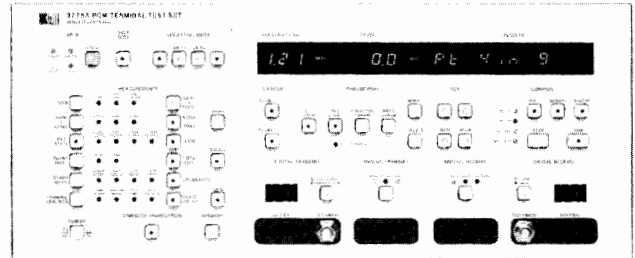

HP 3776A/B Option 001



### HP 3776A/B PCM Terminal Test Sets

In mixed analog/digital networks, the HP 3776A/B make PCM related measurements and with Option 001 the measurement set is extended to include measurements of the parameters affecting voice frequency (4 kHz) data transmission. These measurements can be made at any suitable analog or digital (PCM) access point in the network.

Data Measurements - available in all modes A-A, A-D, D-A, D-D.

- Frequency
- Group Delay Distortion (HP 3776A only)
- Envelope Delay Distortion
- Absolute Delay
- Phase Jitter (Choice of filters)
- Transient (measured simultaneously)
  - Amplitude/Gain Hits
  - Phase Hits
  - Interruptions/Dropouts
  - Impulse Noise (3-level)

The HP 3776A/B have pre-programmed measurement parameters that can be used immediately, but users can also create their own measurement parameters and store them in non-volatile memory; either set can be selected as required. A sequence of measurements can be created, using a controller, and downloaded into the HP 3776A/B. This sequence is also stored in non-volatile memory and can be run independently by the instrument at any time.

Results are always available via the LED display on the front panel; however, measurement parameters and results can also be output directly to a printer or plotter via HP-IB. In plot mode multipoint measurement results are presented in a graphical format and can also be shown in relation to the standard measurement mask, if this facility has been selected by the user.

Additional details on the HP 3776A/B can be found on page 129.

### Ordering Information

HP 3770B Telephone Analyzer

HP 3776A PCM Terminal Test Set + Option 001 - CCITT

HP 3776B PCM Terminal Test Set + Option 001 - North American

# DATA COMMUNICATIONS TEST EQUIPMENT

15 Hz to 50 kHz Selective Voltmeter

Model 3581C



- Voice grade testing
- Wideband data circuit testing
- Single frequency interference
- Spectrum analysis



HP 3581C

## Description

The HP 3581C Selective Voltmeter has found wide application in testing special service circuits in both inside and outside plant maintenance. The HP 3581C is used to do spectrum analysis, measure non-linear distortion (harmonic distortion) and to locate and measure unwanted spurious and induced tones. The unit can be operated from ac line or from optional internal batteries.

## Specifications

**Frequency range:** 15 Hz to 50 kHz.

**Display:** 5 digit LED readout. Resolution: 1 Hz. Accuracy:  $\pm 3.5$  Hz.

**Typical stability:**  $\pm 10$  Hz/h after 1 hour.  $\pm 5$  Hz/ $^{\circ}$ C.

**Automatic frequency control (AFC), hold-in range:**  $\pm 800$  Hz.

**Pull-in range:**  $> 5 \times$  bandwidth for 3 Hz to 100 Hz bandwidth;  $> 800$  Hz for 300 Hz bandwidth for full-scale signal.

**Lock frequency:** center of passband  $\pm 1$  Hz.

## Amplitude

### Instrument Range

**Linear:** 30 V to 100 nV full scale.

**Log:** +30 dBm or dBV to -150 dBm or dBV.

### Amplitude Accuracy\*

	Log	Linear
15 Hz-50 kHz, frequency response	$\pm 0.4$ dB	$\pm 4\%$
Switching between bandwidths	$\pm 0.5$ dB	$\pm 5\%$
Amplitude display	$\pm 2$ dB	$\pm 2\%$
Input attenuator	$\pm 0.3$ dB	$\pm 3\%$
Amplitude reference level, Most sensitive range	$\pm 1$ dB	$\pm 10\%$
All other ranges	$\pm 1$ dB	$\pm 3\%$

**Dynamic range:**  $> 80$  dB.

**Noise sidebands:** greater than 70 dB below CW signal. 10 bandwidths away from signal.

**IF feedthrough:** input level  $> 10$  V: -60 dB; input level  $< 10$  V: -70 dB.

**Spurious responses:**  $> 80$  dB below input reference level.

## Sweep

**Scan width:** 50 Hz to 50 kHz. These scans can be adjusted to cover a group of frequencies within the overall instrument range.

**Sweep error light:** this LED indicates a sweep that is too fast to capture full response.

\*Note: these specifications cover the full temperature frequency and amplitude range, and represent worst case. Accuracy is significantly better for measurements not at the extremes.

**External trigger:** a short to ground stops normal sweep. Opening the short then enables a sweep.

## Input

### Unbalanced (UNBAL)

**Impedance:** 1 M $\Omega$ /40 pF.

### Balanced/Bridged (BRDG)

**Impedance:** 10 k $\Omega$ .

**Frequency response:** 40 Hz-20 kHz,  $\pm 0.5$  dBm for signals  $< 20$  dBm.

### Balanced/Terminated (TERM)

**Impedance:** 600  $\Omega$ /900  $\Omega$  balanced.

**Frequency response:** same as balanced/bridging.

**Input connector:** accepts WECO 310 plug.

## Output Characteristics

**Tracking generator output** (also known as BFO or tracking oscillator output). Switchable on rear panel to restored output (HP 3581C acts as a narrow band amplifier).

**Range:** 0 to 2 V rms.

**Frequency response:**  $\pm 3\%$  15 Hz to 50 kHz.

**LO output:** 100 mV signal from 1 MHz to 1.5 MHz as input is tuned from 0 to 50 kHz.

**Output connector:** WECO 310, for connection to tracking generator output or restored output. In addition to monitoring restored output with headphones, an internal speaker also provides an audio indication of signal content.

**Restored output:** acts as a narrow band amplifier.

X-Y recorder analog outputs: 0 to +5V  $\pm 2.5\%$ .

## General

**Operating temperature range:** 0 $^{\circ}$ C to 55 $^{\circ}$ C.

**Humidity:** 95% relative, maximum at 40 $^{\circ}$ C.

**Power requirements:** 100 V, 120 V, 220 V, 240 V  $+5\%$  -10%, 10 VA typical, 48 Hz to 440 Hz.

**Size:** 412.8 mm H x 203.2 mm W x 285.8 mm D (16 $\frac{1}{4}$ " x 8" x 11 $\frac{1}{4}$ ").

**Weight:** 11.5 kg (23 lb); Option 001, 13.5 kg (30 lb).

**Accessory available:** HP 7090A Measurement Plotting System.

**Option 001: rechargeable battery:** used to make floating measurements; 12 hours to fully charge. Also includes front panel dust cover.

## Ordering Information

HP 3581C Selective Voltmeter

**Opt 001:** Battery Pack, dust cover

**Opt 003:** Rack Mount

# DATA COMMUNICATIONS TEST EQUIPMENT

## Transmission Impairment Measuring Sets (TIMS)

Models 4935A, 4936A

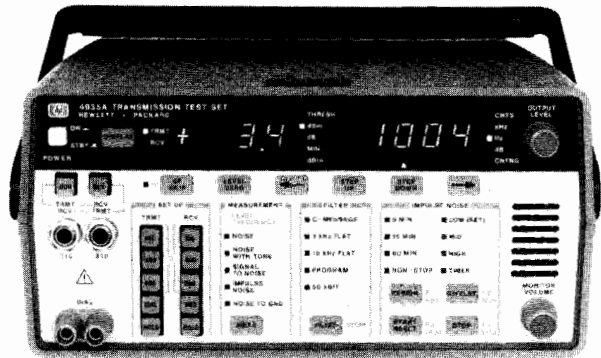

HP 4935A

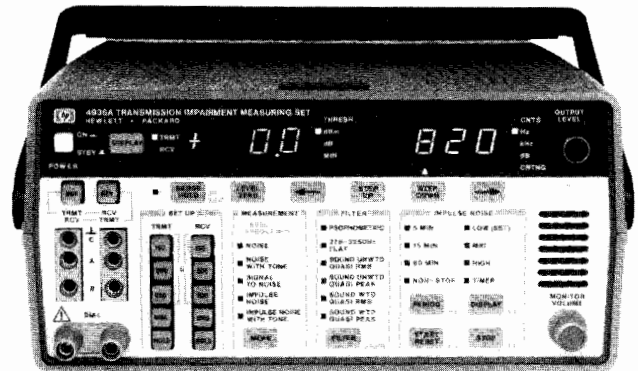

HP 4936A

### Product Description

#### Quality Circuits for Voice, Data or Program

The Hewlett-Packard 4935A and 4936A Transmission Impairment measuring Sets provide the basic analog tests to isolate faults and to qualify circuits for voice, data or broadcast transmission at frequencies up to 110 kHz. The HP 4935A is compatible with Bell standards and the HP 4936A is CCITT compatible. Both of these sets provide measurements of level versus frequency, noise and noise with tone using various noise filters, and three-level impulse noise. The HP 4935A performs the required test to qualify the local loop for Digital Dataphone Service up to 56 kbps. The Peak-to-Average-Ratio (P/AR) measurement option on the HP 4935A gives system users a powerful yet simple measure of the combined factors that effect the overall data transmission quality of the line. The P/AR measurement was developed by Bell Laboratories and is useful as a benchmark of a line's data transmission quality.

Telephone companies, PABX and other telecommunications equipment service people will find the HP 4935A and 4936A have the analog testing capability they need. Both instruments include standard dial and hold capabilities, independent transmit and receive impedances, level zero function, SF skip and complete unit annunciation.

#### Portable for Field Use

The HP 4935A and 4936A in their rugged polycarbonate cases weigh only 14 pounds with batteries, making them ideal for field applications.

#### Easy-to-Use Instruments Reduce Testing Time

Both the HP 4935A and 4936A are easy to use, allowing reduced training time, fewer operator errors and reduced testing times. The HP 4935A and 4936A guide you through the measurements by activating only the proper keys for each selection. Each selected function is indicated on its own LED and there is a beep when a key is pressed. Complete annunciation displays the selected measurement, proper units for each measurement, and error messages, if there is a problem with either the measurement or the instrument.

#### HP 4935S Transmission Test Set

The Hewlett-Packard 4935S Data Transmission Test Set combines the analog power of the HP 4935A TIMS with the digital testing capabilities of the HP 4925B Bit Error Rate Test Set (BERT) to give you a complete data service and installation tool in one portable package. The HP 4935S allows you to verify and troubleshoot most data links quickly and efficiently. Both analog transmission problems and modem problems can easily be isolated. The system weighs 17 pounds and is battery-powered, making it ideal for field installation and maintenance personnel.

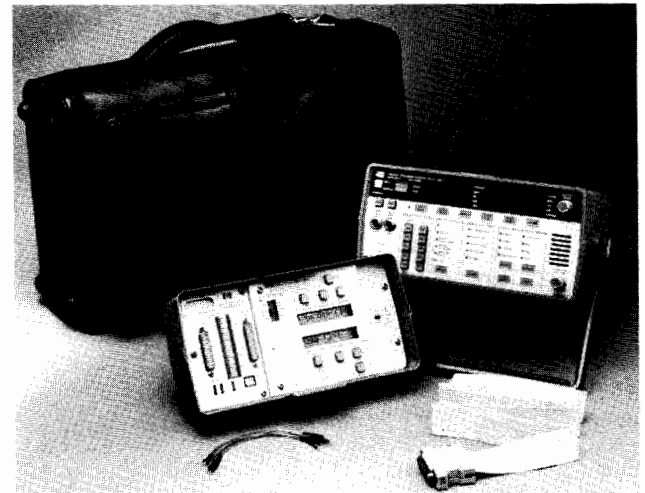

The HP 4935S includes the HP 4925B Option 001, the HP 4935A and a large carrying case.

#### HP 4925A Bit Error Rate Test Set

The HP 4925B Bit Error Rate Test Set (BERT) sits on the digital interface and measures the integrity of the data link to properly transmit and receive error-free data to 72 kbps. Digital testing allows you to perform bit error tests and data throughput analysis, and to test terminals, printers, and statistical multiplexers for proper operation.

#### More Than Just A Bert

In addition to the standard bit and block error test, the HP 4925B measures errored seconds, percent error-free seconds, timing delay, and parity errors. Increased flexibility is afforded by a complete breakout box.

The HP 4925B adds the ability to frame data for testing character-oriented systems such as statistical multiplexers. With it, you can also transmit the FOX message to printers and terminals. Three separate start-up tests—half-duplex ping-pong, local modem loopback, and remote Bell 208B—enable dynamic testing of modems.



## HP 4935A Specifications

### Level and Frequency

#### Transmitter

**Frequency range:** 20 Hz to 110 kHz.

**Resolution:**  $\pm 1$  Hz to 100 kHz.  
 $\pm 10$  Hz, 110 kHz.

**Level range:** -40 to +13 dBm.

**Level resolution:** 0.1 dB.

#### Receiver

**SF skip band:** 2600 Hz  $\pm 150$  Hz.

**Frequency range:** 20 Hz to 110 kHz.

**Resolution:**  $\pm 1$  Hz to 10 kHz.  
 $\pm 10$  Hz, to 110 kHz.

**Level range:** -60 to +13 dBm.

**Level accuracy:** from -40 to +13 dBm.

20-50 Hz  $\pm 1.0$  dB.

50-200 Hz  $\pm 0.5$  dB.

200 Hz-15 kHz  $\pm 0.2$  dB.

15 kHz-85 kHz 0.5 dB.

**Level resolution:** 0.1 dB.

### Noise Measurements

#### Range

**Message circuit noise:** 0 to 100 dBm.

**Noise with tone:** 10 to 100 dBm.

**Noise to ground:** 50 to 130 dBm.

**Detector:** quasi rms.

**Notch filter:** 50 dB rejection from 995 to 1025 Hz.

### 3 Level Impulse Noise

#### Threshold ranges @ 600 $\Omega$ :

**Low:** 30 to 109 dBm.

**Mid:** 4 dB above Low to 109 dBm.

**High:** 8 dB above Low to 109 dBm.

**Range of tone:** -40 to +13 dBm.

### Peak to Average Ratio

**Transmitted level range:** -40 to 0 dBm.

**Received level range:** -40 to +3 dBm.

**P/AR range:** 0 to 120 P/AR units

**Resolution:** 1P/AR unit.

### General

**Impedances:** 135 $\Omega$ , 600 $\Omega$ , 900 $\Omega$ .

**Filters:** C message  
3 kHz flat  
15 kHz flat  
Program  
50 kbit

## HP 4936A Specifications

### Level and Frequency

#### Transmitter

**Frequency range:** 20 Hz to 110 kHz.

**Resolution:**  $\pm 1$  Hz to 100 kHz.  
 $\pm 10$  Hz, 110 kHz.

**Level range:** -40 to +13 dBm.

**Level resolution:** 0.1 dB.

**Stored frequencies:** 404 Hz, 1004 Hz, 2804 Hz, 2713 Hz.

**Stored frequencies:** 300 Hz, 820 Hz\*, 2000 Hz, 3000 Hz.

\* 1020 Hz tone and notch available as option.

#### Receiver

**Tone blanking:** SF skips 2280 Hz  $\pm 150$  Hz.

**Frequency range:** 20 Hz to 110 kHz.

**Resolution:**  $\pm 1$  Hz to 10 kHz.

$\pm 10$  Hz, 110 kHz.

**Level range:** -70 to +13 dBm.

**Level accuracy:** from -40 to  $\pm 13$  dBm.

20-50 Hz:  $\pm 1.0$  dB.

50-100 Hz:  $\pm 0.5$  dB.

100 Hz-4 kHz:  $\pm 0.1$  dB.

4kHz-15 kHz:  $\pm 0.2$  dB.

15 kHz-85 kHz:  $\pm 0.5$  dB.

**Level resolution:** 0.1 dB.

### Noise Measurements

#### Range

**Noise:** -90 to +10 dBm.

**Noise with tone:** -80 to +10 dBm.

**Detector:** quasi rms.

quasi peak - monitored by analog outputs.

**Notch filter:** 50 dB rejection from 800-855 Hz\*.

\*With optional 1020Hz tone, notch is same as HP 4935A.

### 3 Level Impulse Noise

#### Threshold ranges @ 600 $\Omega$ :

**Low:** -60 to 16 dBm.

**Mid:** 3 db above Low to 16 dBm.

**High:** 6 dB above Low to 16 dBm.

**Range of tone:** -40 to +13 dBm.

### General

**Impedances:** 150 $\Omega$ , 600 $\Omega$ , 900 $\Omega$ .

**Filters:** Psophometric (P.53)

275-3250 Hz Flat (0.71 impulse noise)

Sound unweighted (J.16)

Sound weighted (J.16)

### Ordering Information

HP 4935A Transmission Impairment Measuring Set

**Option 001:** adds rechargeable battery pack

**Option 002:** adds P/AR measurement in place of noise-to-ground

**Option 003:** adds both battery pack and P/AR, deletes noise-to-ground

**Option 910:** adds extra HP 4935A Operating and Service Manual

HP 4936A Transmission Impairment Measuring Set

**Option 001:** includes 820 Hz tone with rechargeable battery pack

**Option 002:** 1020 Hz tone

**Option 003:** includes 1020 Hz tone with rechargeable battery pack

**Option 910:** adds extra HP 4936A Operating and Service Manual

HP 4935S Data Transmission Test Set

**Option 001:** adds rechargeable battery pack to HP 4935A

**Option 002:** adds P/AR measurement in place of noise-to-ground in HP 4935A

**Option 003:** adds both battery pack and P/AR to HP 4935A, deletes noise-to-ground

**Option 910:** adds extra HP 4935A and HP 4925B Operating and Service Manuals

### Accessories

HP 18132A 19 inch rack-mount adapter for HP 4935A

HP 18134A Soft vinyl carrying case for HP 4935A or HP 4935S

HP 18172A Soft vinyl carrying case for HP 4925B

HP 15513A 36-inch test cord with 310 male connector at both ends

HP 18161A Ladder Bracket



# DATA COMMUNICATIONS TEST EQUIPMENT

## Data Error Analyzer, Bit Error Rate Test Set

Models 1645A, 4925B

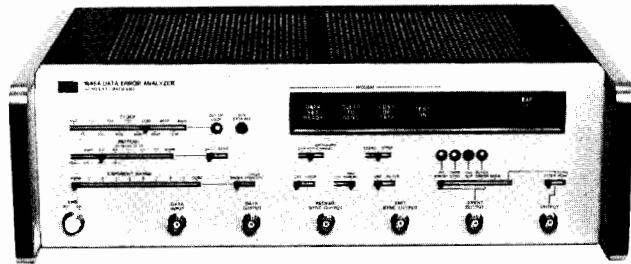

HP 1645A

### HP 1645A Description

Hewlett-Packard's Model 1645A Data Error Analyzer quickly isolates data communications link problems through six simultaneous measurements. During test, the HP 1645A can be left totally unattended because it automatically maintains synchronization even in the presence of dropouts. For added convenience, the HP 1645A can be equipped with a printer for hard-copy recordings of long tests.

Bit-error and block-error rate tests are autoranged and displayed directly on an LED readout; there is no need to perform any calculation. Additionally, the HP 1645A measures jitter or total peak distortion (the sum effect of jitter and bias), counts the number of times carrier loss or dropouts occur, measures data error skew, and counts the number of clock slips resulting from phase hits or modem synchronization problems.

With all these measurements made during the same test interval, you'll be able to determine more precisely where your problem is.

### HP 1645A Specifications

#### Transmitter and Receiver Bit Rate

**Asynchronous Modem Operation:** selectable 75, 150, 200, 300, 600, 1200, 1800, 2400, 3600, 4800, 7200, 9600 bps.

**Synchronous Modem Operation:** to 5 Mbps. (Modem supplies transmit and receive clocks.)

#### Indicators

Out of lock; received data inverted; bit error; carrier loss; clock slip; block error; data set ready (DSR); clear to send (CTS); loss of data; test on.

#### General

**Power:** 115 or 230 Vac, 48 to 440 Hz, 150 VA max.

**Dimensions:** 133 H x 425 W x 286 mm D (5.25" x 16.75" x 11.25").

**Weight:** net, 8.2 kg (18 lb); shipping, 10.9 kg (24 lb).

**Accessories Supplied:** one 3 m (10 ft) RS-232C interconnecting cable to connect the HP 1645A to the modem (HP P/N 01645-61605), one 2.3 m (7.5 ft) 3-wire power cord (HP P/N 8120-1378); one Operating and Service Manual.

#### Ordering Information

HP 1645A Data Error Analyzer

**Option 908:** Includes rack mounting kit

**Option 910:** Additional set of manuals

#### Interfaces

HP 10387A for Type 303 modems (with cable)

HP 10388A for CCITT V.35 (with cable)

HP 10389A Breakout Box (RS-232C) (with cable)

HP 18062B MIL-STD-188C Interface

HP 18063A RS-449 Interface (with cable)

#### Accessories

HP 10233A printer interconnecting cable connects HP 1645A to HP 5150A printer; 36-pin male connector on one end and 50-pin male connector on the other.

### HP 4925B Description

#### More than a BERT

The HP 4925B is more than just a bit error rate test set. In addition to the standard bit and block error tests, the HP 4925B measures errored seconds, percent error-free seconds, timing delay, and parity errors over both RS-232C/V.24 and V.35. Now complete data testing to 72 kbps is available making the HP 4925B ideally suited for complete DDS testing.

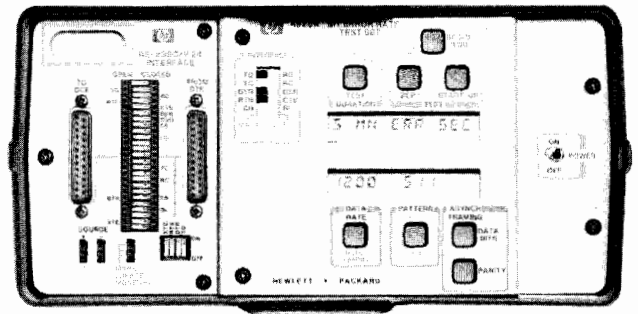

HP 4925B

Increased flexibility is afforded by a complete breakout box. You can manipulate and monitor individual signal lines on the RS-232C/V.24 interface or crosspatch any line from the DCE side of the interface to the DTE side of the interface.

In addition, the HP 4925B adds to its arsenal the ability to frame data for testing character-oriented systems. The HP 4925B also transmits the FOX message to terminals and printers. Three separate start-up tests enable dynamic testing of modems. This makes the unit extremely useful in isolating faults related to automatic equalization, receive carrier recovery, receive clock synchronization and initial recovery of received data. The start-up tests include an end-to-end, half-duplex ping-pong test, a local modem loopback test and a test specifically designed to use the remote testing capabilities of the Bell 208B modem.

Intended primarily for field service installation and maintenance, the HP 4925B weighs only three pounds with batteries. When ordered as option 001, which deletes the small vinyl carrying case, the HP 4925B will fit in place of the cover of either the HP 4935A or 4936A.

For operation with the V.35 interface, the HP 4925B is powered by a supplied AC power module accessory. This power module can also be used with the RS-232C/V.24 interface in fixed location or long term testing situations.

### HP 4925B Specifications

**Data rates:** 75, 110, 134.5, 150, 200, 300, 600, 1200, 1800, 2400, 3600, 4800, 7200, 9600, 14400, 19200 bps for asynchronous systems or externally timed synchronous. Up to 72 kbps for synchronous systems.

**Patterns:** 63, 511 or 2047 bit pseudo-random binary sequence, FOX message.

**Bit error testing:** simultaneous detection of bit errors, block errors, errored seconds and percent error-free seconds.

**Parity error analysis:** characters analyzed for odd or even parity errors.

**FOX message transmission:** use a 5-bit baudot code, 6-bit EBCDIC code, 7-bit ASCII code or 8-bit EBCDIC code.

**Character Oriented Network Testing**

Data levels: 5, 6, 7 or 8 bits per character.

Parity: odd, even or none.

**Detection and Annunciation of Dropouts and Clock Slips**

**RTS-CTS Delay Time**

**Resolution:** 1 ms.

**Accuracy:**  $\pm 4\%$  of reading.

**Maximum reading:** 999 ms.

**Start-up testing:** end-to-end test, loopback test, Bell 208B modem test.

**Power:** six 9-volt alkaline transistor batteries; battery life exceeds 50 hours of operation.

**Weight:** 1.5 kg (3 lb) with batteries.

**HP 18183A/Interface/breakout box (RS-232C/V.24):** hard-wired activity indicators for TD, RD, TC, RC, DTR, DSR, RTS, CTS, CD, RI; one nondedicated mark/space tristate activity monitor; individual line switches.

**HP 18184A V.35:** interface provides the physical level interface for data circuits operating to 72 kbps.

#### Ordering Information

HP 4925B Bit Error Rate Test Set

**Option 001:** deletes small vinyl carrying case HP 18172A (for connection to HP 4935A)

**Option 910:** adds extra HP 4925B Operating and Service Manual

**Option 101:** adds HP 18183A RS-232C/V.24 interface

**Option 102:** adds HP 18184A/V.35 interface and HP 18185A AC power module

#### Accessories

HP 18183A RS-232C/V.24 interface

HP 18184A V.35 interface

HP 18185A AC power module



# DATA COMMUNICATIONS TEST EQUIPMENT

Transmission Test Sets

Models 3551A & 3552A



- Attenuation distortion
- Loss
- Message circuit noise
- Noise-with-tone
- Noise-to-ground
- Single frequency interference

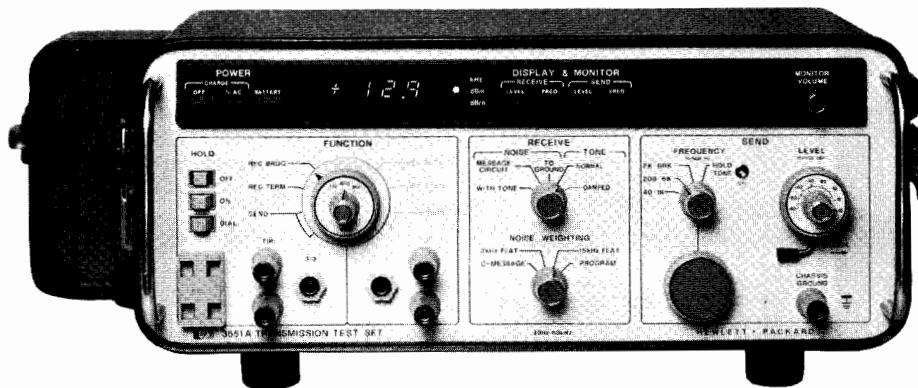

HP 3551A (North American)

## HP 3551A/3552A Description

The HP 3551A/3552A Transmission Test Sets are rugged, portable test sets ideally suited for measurements on voice, program and data circuits up to 50 kbps. The HP 3551A is designed for use with North American Bell Standards, while the HP 3552A is designed for the CCITT standards. Both test instruments contain tests capable of measuring tone level, noise or frequency while simultaneously sending tone. Both level and frequency are fully autoranging.

These test sets can measure both 2-wire and 4-wire balanced circuits. The test sets may be powered by either ac line or internal rechargeable batteries and are suited for both inside and outside plant maintenance.

For frequency measurements, a four digit autoranging frequency counter is provided. The readout features 1 Hz resolution from 40 Hz to 10 kHz and 10 Hz resolution from 10 kHz to 60 kHz.

A convenient set of clip-on dial terminals for connecting a line-man's handset are provided. This allows a line connection to be dialed up and then held in an off-hook condition while making either a receive measurement or transmitting a signal on the line.

Noise measurements are made with a quasi rms detector and displayed in dBm on the HP 3551A and dBm on the HP 3552A. Display rate is slowed to 2 per second to provide an analog feel of slowly changing noise levels. Both test sets have the capability of measuring noise-with-tone, message with circuit noise, and noise-to-ground. Four switch selectable weighting networks are provided: 3 kHz, 15 kHz Flat and Program for both models plus a C-message with the HP 3551A and a Psophometric with the HP 3552A.

## HP 3551A & 3552A Specifications

### Receiver

#### Level Measurements

**Frequency range:** 40 Hz to 60 kHz.

**Dynamic range:** +15 dBm to -70 dBm.

**Resolution:** 0.1 dB.

**Accuracy:** at 25°C ± 10°C, temperature coefficient: ±0.005 dB/°C beyond this range.

INPUT LEVEL (dBm)	FREQUENCY				
	40 Hz	100 Hz	1 kHz	16 kHz	20 kHz
+15	±0.5 dB	±0.1 dB	±0.2 dB	±0.3 dB	±0.3 dB
-30					
-70		±0.3 dB		±0.5 dB	

Receiver Accuracy Not Specified Below 500 Hz Or Below -65 dBm When Using 135 Ω Input.

### Transmitter HP 3551A & 3552A

**Frequency range:** 40 Hz to 60 kHz.

**Resolution:** 1 Hz (40 Hz to 10 kHz), 10 Hz (10 kHz to 60 kHz).  
**Level range:** +10 dBm to -60 dBm (40 Hz to 60 kHz). +6 dBm to -60 dBm. (1004 Hz fixed for HP 3551A; 800 Hz fixed for HP 3552A).

**Resolution:** 0.1 dB.

**Accuracy:** at 25°C ± 10°C, temperature coefficient: ±0.005 dB/°C beyond this range.

OUTPUT LEVEL (dBm)	FREQUENCY				
	40 Hz	100 Hz	1 kHz	4 kHz	60 kHz
+10	±0.5 dB		±0.2 dB		±0.5 dB
-30	±1 dB		±0.3 dB		±1 dB
-60					

Transmitter Accuracy Not Specified Below 500 Hz On 135 Ω or 150 Ω Output.

## HP 3551A Noise Measurements

### Dynamic Range

**Message circuit noise:** 0 dBm to +85 dBm.

**Noise-with-tone:** 10 dBm to +85 dBm.

**Noise-to-ground:** 40 dBm to +125 dBm.

**Resolution:** 1 dB.

**Detector type:** quasi rms responding.

## HP 3552A Noise Measurements

### Dynamic Range

**Message circuit noise:** -90 dBm to -5 dBm.

**Noise-with-tone:** -80 dBm to -5 dBm.

**Noise-to-ground:** -50 dBm to +35 dBm.

**Resolution:** 1 dB.

**Detector type:** quasi rms responding.

## General

**Balanced impedances:** 135 Ω, 600 Ω, 900 Ω (HP 3551A).

**Balanced impedances:** 150 Ω, 600 Ω, 900 Ω (HP 3552A).

**Hold circuit:** 20 milliamps constant current. <0.2 dB holding loss, resistive fuse protection.

**Input/output protection:** blocks 300 V dc.

**Maximum longitudinal voltage:** 200 V rms.

**Battery supply:** >4 hours continuous operation on internal rechargeable batteries at 25°C. Recharge in 12 hours.

**Power requirements:** 100 V, 120 V, 220 V, 240 V ± 10%; 48 Hz to 440 Hz; 15 VA.

**Temperature range:** 0°C to 55°C, operating; -20°C to +65°C, storage.

**Size:** 133 mm H x 343 mm W x 254 mm D (5.25" x 13.5" x 10").

**Weight:** net, 6.6 kg (14.5 lb); shipping, 7.3 kg (16 lb).

## Ordering Information

HP 3551A Transmission Test Set

HP 3552A Transmission Test Set (CCITT)

# DATA COMMUNICATIONS TEST EQUIPMENT

## Transmission Impairment Measuring Set (TIMS)

Model 4945A

- Compatible with North American standards
- Complete testing of:
  - Voice grade data channels
  - Program channels
  - High speed digital channels
- 110 kHz bandwidth
- Portable package for field use
- Versatile I/O for systems use
- Master/Slave capability for end-to-end testing
- Automatic gain slope measurement
- Programmable sweep

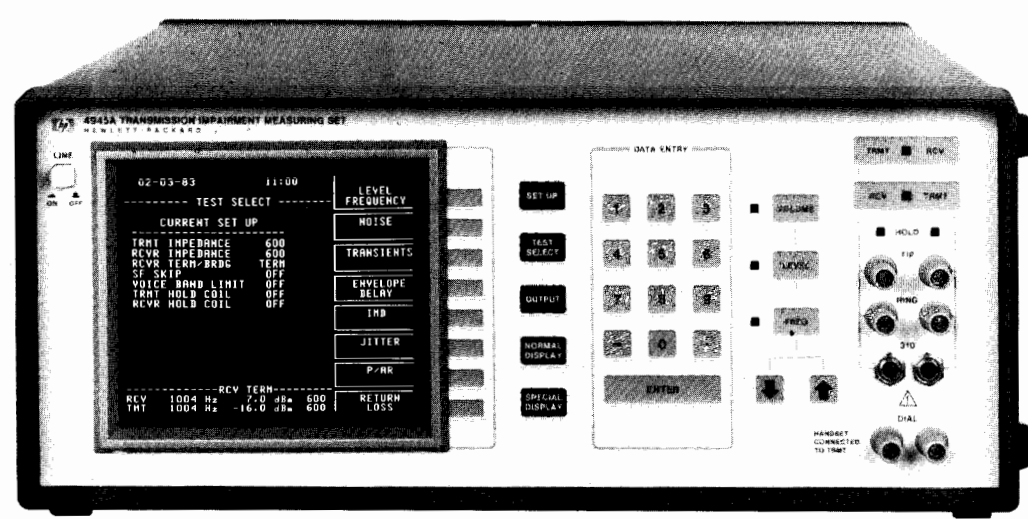

DESIGNED FOR  
**HP-IB**  
SYSTEMS  
RS-232



HP 4945A

### HP 4945A Product Description

The HP 4945A Transmission Impairment Measuring Set provides the complete set of measurements needed to quickly isolate faults and qualify circuits for voice, data or broadcast transmission up to 110 kHz. All measurements are compatible with current Bell standards including the ability to test local distribution loops for Dataphone Digital Service (DDS) to 56 kbps.

### Softkeys Guide the User

All set-up selections, measurement selections and results are presented on the CRT display. Softkeys are the key to making the HP 4945A extremely flexible while maintaining ease of operation. All appropriate choices for a particular measurement or configuration are present, thus eliminating guesswork or nonsense configurations. Through softkeys, you are never more than two key presses away from a parameter change.

### A Convenient Display

The CRT allows you to see more information than conventional segmented displays. All of the set-up conditions are presented in a logical, easy-to-understand format. The lower three status lines on the display always contain the important set-up information as well as the current level and frequency of both the transmitter and receiver. Some measurements, such as JITTER, have the "measure all" capability which allows simultaneous display of both amplitude and phase jitter in all three frequency bands (4-20 Hz, 20-300 Hz, 4-300 Hz). And don't worry about the CRT in the field environment. HP's experience and rigid testing standards assure you of a reliable product for field use.

### Complete Measurement Capability

The HP 4945A offers you all the measurements needed to install, troubleshoot, and maintain both voice and data circuits. These measurements are designed in accordance with Bell System Technical Reference 41009 and IEEE 743-1984. The list includes:

- |                               |                              |
|-------------------------------|------------------------------|
| <b>LOSS</b>                   | <b>3 LEVEL IMPULSE NOISE</b> |
| <b>ATTENUATION DISTORTION</b> | <b>GAIN HITS</b>             |
| <b>GAIN-SLOPE</b>             | <b>PHASE HITS</b>            |
| <b>MESSAGE CIRCUIT NOISE</b>  | <b>DROPOUTS</b>              |

- NOTCHED NOISE
- PEAK-TO-AVERAGE RATIO (P/AR)
- SIGNAL-TO-NOISE RATIO
- ENVELOPE DELAY
- NOISE-TO-GROUND
- 2-WIRE RETURN LOSS
- AMPLITUDE JITTER
- 4-WIRE RETURN LOSS
- PHASE JITTER
- INTERMODULATION DISTORTION

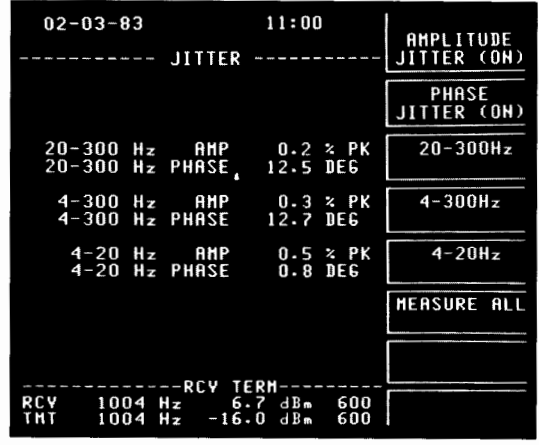

The CRT display provides more area for displaying useful data. Here, both phase and amplitude jitter in all three bands are simultaneously displayed along with the current receive and transmit status.

### Master/Slave Capability

Master/Slave saves time and money by allowing you to control the remote (Slave) TIMS from the local (Master) TIMS. This HP-pioneered and patented technique allows the Master unit to completely control and collect data from the remote Slave unit over the lines under test. Master/Slave greatly reduces the time, coordination, and highly-skilled manpower needed for performing end-to-end tests. The Master/Slave technique used on the HP 4945A is also backward-compatible with the HP 4943A and HP 4944A.

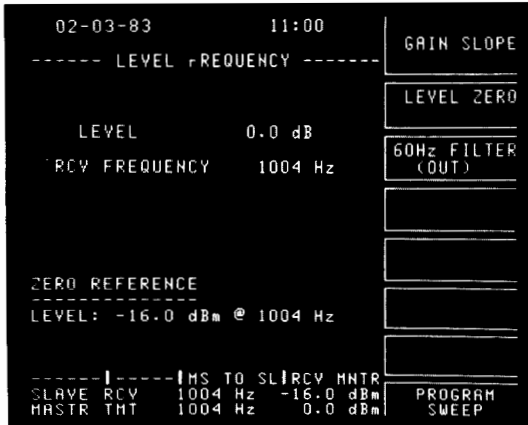

Master/Slave measurement results are displayed just like manual end-to-end results. The status lines indicate the direction of test (Master to Slave) and the current status of the Slave's receiver and Master's transmitter.

## Systems Capability

The HP 4945A can be controlled by a computer or controller over three different interfaces. For the larger systems, HP-IB provides the speed and versatility needed to tie together many test instruments in a customized system. For those faced with the problem of the HP 4945A being distant from the controller, RS-232C provides a low-cost solution for control. With the addition of inexpensive modems, an HP 4945A can be controlled over dial or leased lines. If portable data collection is a must, HP-IL provides a low-cost portable solution with a handheld calculator, such as the HP-41C or HP-71B acting as the controller.

In addition, the HP 4945A can output measurement results directly to a printer without the need for a controller. This gives you hardcopy results from any HP-IB, RS-232C, or HP-IL printer.

## Complete Self-Check and Calibration

Every time the HP 4945A is powered on, it executes a self-check which assures you that all the major blocks are functioning properly. There is also a built-in self-calibration mode. With the simple press of a softkey, the HP 4945A will calibrate itself, thus avoiding costly downtime and assuring you that the HP 4945A is operating at its peak performance. In addition, built-in self diagnostics quickly isolate and identify any problems thus reducing repair time and consequently downtime.

## Specifications

For detailed specifications ask your local HP Sales Office for an HP 4945A TIMS Data Brochure.

### General

**Impedances:** 135Ω, 600Ω, 900Ω, 1200Ω.

**Power:** 115/230 V ac + 11%–22%, 48 to 63 Hz, 150 W max.

**Dimensions:** 18.4 cm H x 45.1 cm W x 48.9 cm D (7.25" x 17.75" x 19.25").

**Weight:** 15 kg (33 lb).

**Interfaces Available:** HP-IB, RS-232C, HP-IL.

### Level and Frequency

#### Transmitter

**Frequency range:** 20 Hz to 110 kHz.

**Output level:** –60 dBm to +13 dBm; 600Ω, 900Ω, 1200Ω.  
–60 dBm to +5 dBm 135Ω.

#### Receiver

**Range:** –60 dBm to +13 dBm.

### Noise Measurements

**Transmitter:** 1004 Hz fixed or quiet termination.

### Receiver Range

**Message circuit noise:** 10 to 90 dBm

**Noise-with-tone:** 10 to 90 dBm

**Noise-to-ground:** 40 to 130 dBm

**Signal-to-noise ratio:** 10 to 45 dB

**Weighting filters:** C-message, 3 kHz Flat, Program, 15 kHz Flat, 50 kbit

**Notch filter:** 50 dB rejection from 995 to 1025 Hz.

### Peak to Average Ratio

#### Transmitter

**Signal spectrum:** Per BSTR 41009

**Range:** –40 to 0 dBm.

#### Receiver

**Level range:** –40 to 0 dBm.

**P/AR range:** 0 to 120 P/AR units.

### Jitter

#### Transmitter

See Noise Measurements.

#### Receiver

**Amplitude jitter:** 0 to 30% peak to peak

**Phase jitter:** 0 to 30 degrees peak to peak

**Bandwidths:** 20 to 300 Hz

4 to 300 Hz

4 to 20 Hz

### Transients

#### Transmitter

See Noise Measurements or Quiet Termination.

#### Receiver

**General: Count rate:** 7, 8, 100 counts per second.

**Count range:** 0 to 9,999.

**Timer:** 1 to 9,999 minutes or continuous.

**Phase hits:** thresholds: 5° to 45° in 5° steps.

**Gain hits threshold:** 2 to 10 dB in 1 dB steps.

**Drop outs:** threshold –12 dB.

#### Impulse Noise Range

**Low:** 30 to 110 dBm.

**Mid:** 2, 3, 4, or 6 dB above Low.

**High:** 2, 3, 4, or 6 dB above Mid.

### Envelope Delay

#### Transmitter

**Level range:** –40 to 0 dBm

**Modulation:** 83½ Hz

#### Receiver

**Level range:** –40 to +10 dBm

**Measurement range:** –3000 to 9000 microseconds.

### Return Loss

**Modes:** ERL, SRL-High, SRL-Low, Sine Wave

#### 2-Wire:

**Range:** 0 to 40 dB

Internal Hybrid 600Ω, 900Ω, in series with 2.16 μF capacitor, or external.

#### 4-Wire:

**Range:** 0 to 50 dB.

**Trans Hybrid Loss Compensation:** –10 to 30 dB.

## Ordering Information

### HP 4945A TIMS

#### Options

**101:** adds HP 18162A HP-IB Module

**102:** adds HP 18163A RS-232C Module

**103:** adds HP 18165A HP-IL Module

**104:** adds HP 18169A 19" Rack Mount

**105:** adds HP 18170A Soft Vinyl Carrying Case

#### Accessories

HP 18162A HP-IB Module

HP 18163A RS-232C Module

HP 18165A HP-IL Module

HP 18169A 19" Rack Mount

HP 18170A Soft Vinyl Carrying Case

HP 9211-2650 Hard Transit Case

\*The Non-Linear Distortion Technique is licensed under Hekimian Laboratories, Inc., USA Patent No. 3862380.

# DATA COMMUNICATIONS TEST EQUIPMENT

Transmission Impairment Measuring Set, Network Access Transmission Test Set

Models 4937A, 4938A



HP 4937A, 4938A

## HP 4937S Product Description

### A Transmission Test Set With Signaling

The HP 4937S Network Access Transmission Test Set provides transmission tests, supervisory signaling simulation, and network access capabilities for installation and maintenance of networks and PBXs. It is a field-service, portable test set designed for craft-level use. All the transmission measurements are compatible with current Bell standards.

### One Instrument for Installation/Maintenance of PBXs and Networks

The HP 4937S is an ideal field service test set for installation and maintenance of PBXs and networks. Traditionally, a technician needs three test sets for testing - a transmission test set, a return loss set and a signaling set. The HP 4937S combines all the analog measurements and signaling simulation in one portable test set. The HP 4937A contains a set of voiceband transmission tests - level/frequency measurement, noise, and 2- and 4-wire return loss measurements. It also has

the ability to seize and hold three types of loop circuits and three types of E/M lines. In addition, the HP 4937A simulates signaling both from the central office and from the PBX at the network interface (figure 1).

The HP 4938A provides additional network access and margin testing capabilities. It includes access to the 4-wire simplex leads, generating ringing signal, and providing access for loop current and ringing voltage measurement.

### Easy to Use and Reliable

The HP 4937S is designed for craft-level use with minimum training. Each measurement is annunciated as you go through the selection. You only have to connect the line under test to one instrument for signaling and making transmission tests. All results are shown clearly on the LED displays.

The instrument case is tough, durable, and is designed for rugged field use.

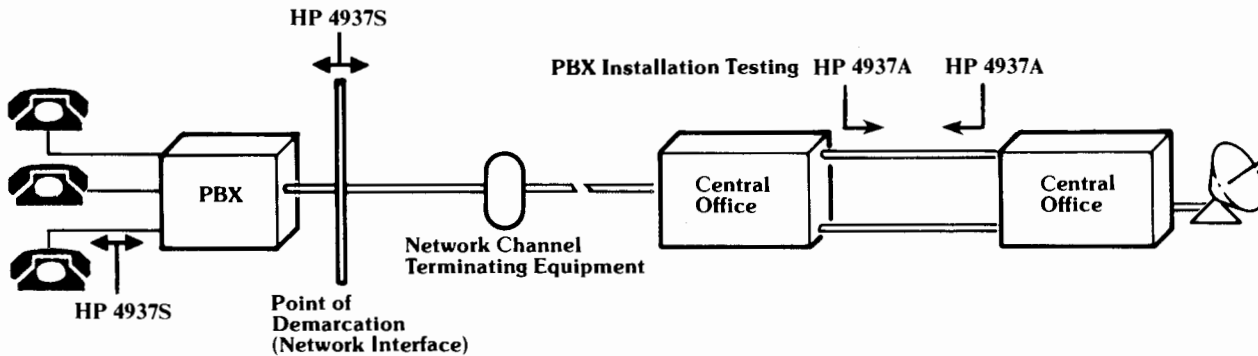

A Typical Voice PBX Network

## HP 4937A Specifications

### Level/Frequency

#### Transmitter

**Level:** -40 dBm to +13 dBm.

**Frequency:** 20 Hz to 9999 Hz.

#### Receiver

**Level:** -60 dBm to +13 dBm.

**Frequency:** 20 Hz to 9999 Hz.

### Noise

**Transmitter:** quiet terminated.

**Receiver Level:** 0 dBrn to 99 dBrn.

**Filters:** C-message, 3 Hz flat.

### Noise with Tone

**Transmitter Level:** -40 dBm to +13 dBm.

**Frequency:** 1004 Hz fixed tone.

**Receiver Level:** 10 dBrn to 99 dBrn.

**Filters:** C-message, 3 Hz flat.

**Notch Filter:** 50 dB rejection.

### Signal-to-Noise Ratio

**Transmitter Level:** -40 dBm to +13 dBm.

**Frequency:** 1004 Hz fixed tone.

**Receiver Level:** -40 dBm to +13 dBm.

**Ratio Range:** 10 dB to 45 dB.

**Filters:** C-message, 3 Hz flat.

**Notch Filter:** 50 dB rejection.

### Noise-to-Ground

**Transmitter:** quiet terminated.

**Receiver Level:** 50 dBrn to 99 dBrn.

**Filters:** C-message, 3 Hz flat.

### Return Loss

#### Return Loss, 2-Wire

**Impedance:** 600 and 900 ohms.

**Noise Spectra:** Echo return loss, singing return loss high, singing return loss low.

**Transmitter Level:** -26 dBm to -2 dBm.

**Receiver Range:** 0 to 40 dB.

#### Return Loss, 4-Wire

**Noise Spectra:** Echo return loss, singing return loss high, singing return loss low.

**Transmitter Level:** -26 dBm to -2 dBm.

**Receiver Range:** 0 to 50 dB.

**Transhybrid Loss Compensation:** -29.9 to +29.9 dB.

### Supervisory Signaling

**E/M Signaling:** Types I, II, III (both Originate and Terminate).

**Battery:** -48 Vdc current limited to 29 mA.

**Loop Signaling:** Loop start, Ground start, Loop Reverse Battery (both Originate and Terminate).

**Battery:** -48 Vdc current limited to 29 mA.

**Hold Circuit:** 2 each drawing 20 mA at a minimum voltage of 8.5 Vdc.

**WINK:** idle state, 100 ms; off-hook state, 200 ms.

### General

**Battery Supply (Optional):** Typically 5 hours of continuous operation at +25°C. Complete recharging in 14 hours with unit in STBY.

**Power Requirements:** 100V, 120V, 220V and 240 Vac +5%, -10%; 48-66 Hz.

**Temperature Range:** 0°C to 55°C, 0° to +40°C with batteries, operating; -40°C to +75°C, -20°C to +45°C with batteries, storage.

**Dimensions:** 27.9 cm W x 12.7 cm H x 38 cm L.

**Weight:** 5.3 kg, 7.6 kg with batteries.

## HP 4938A Specifications

### Ring Voltage Generator

**Output Level:** 86 Vrms superimposed on -48 Vdc.

**Frequencies:** 20 Hz and 30 Hz.

**Ring Trip Threshold:** 17 mA typical.

**Ring Termination:** REN-3 load, ring trip closure.

**Loop Signaling Network:** loop start, 430 ohms; ground start, 550 ohms to ground.

**4-Wire Network Access:** 2 dual center tapped simplex transformers.

**Battery Simulator:** 48 Vdc maximum current 100 mA.

### General

**Power Requirements:** 120V +5, -10%; 60 Hz only.

**Dimensions:** 9.1 cm H x 26.1 cm L x 12.6 cm D.

**Weight:** 1.5 kg.

### Ordering Information

HP 4937S Network Access Transmission Test Set

**Option 001:** Add rechargeable batteries.

**Option 002:** Replace 900 ohms with 150 ohms.

HP 4937A Transmission Impairment Measuring Set

**Option 001:** Add rechargeable batteries.

**Option 002:** Replace 900 ohms with 150 ohms.

**Option 910:** Extra operating and service manual.

HP 4938A Network Circuit Access Test Set

### Accessories

HP 18132A 19-inch rack mount adaptor for HP 4937A.

HP 15513A 36-inch test cord with 310 male connector at each end.

HP 18182A 60-inch test cord with 310 male connector and double alligator clips.

HP 18172A Small soft vinyl carrying case for HP 4938A.

HP 18190A Large soft vinyl carrying case for HP 4937S.



# TELECOMMUNICATIONS TEST EQUIPMENT

## Digital Communications Measurements

### Introduction

Digital networks have advanced rapidly from the early days when junction PCM systems were used to increase inter-exchange capacity between switching centers. Key to this has been the development of integrated digital switching and transmission systems and the impact of technology, particularly in the area of codecs and subscriber line interface circuits. This trend towards Integrated Digital Networks (IDNs) and Integrated Services Digital Networks (ISDNs) has resulted in new testing needs and increased emphasis on characterizing performance of PCM conversion equipment and digital transmission links.

### PCM Conversion Measurements

Today's IDNs are almost exclusively based on 64 kb/s PCM voice channels to one of two coding standards, CEPT A-law or Bell  $\mu$ -law, both of which are now standardized by the CCITT. These coding standards both use 8 kHz speech sampling and 8-bit PCM companding to achieve high quality digitized voice transmission through 64 kb/s circuit-switched digital exchanges. Circuits can also carry multiplexed low-speed or wideband high-speed data with the result that future networks will carry a mixture of voice and data services via digital transmission systems. Initially, the majority of data carried by IDNs will be "conventional" analog modulated data from modems at customers' premises which is then PCM encoded at the nearest serving exchange switching center. In addition to dial-up data circuits through digital switches, an increasing number of leased non-switched circuits are provided at least in part, if not completely, via PCM transmission systems between switching offices.

These developments have resulted in an increased demand for measurements in the PCM signal of parameters affecting both voice and data services. This is especially true for automatic remote test systems such as the checking of circuits provided via digital access and cross-connect systems. The key to testing these circuits is the ability to measure PCM voice and analog data transmission performance at both analog and digital access points i.e. in a mixed analog/

digital network. HP's 3776 PCM Terminal Test set can make both PCM voice and analog data measurements in both analog and digital domains.

The HP 3776 has also made significant advances in the field of PCM measuring technology by implementing most of the measurements using digital signal processing. This allows comprehensive measurement capability to be integrated into a smaller, lower cost, more portable package than previously possible. When coupled with HP's computational products, the HP 3776 becomes a powerful system component of automated remote access and test systems for monitoring and maintaining mixed analog/digital networks.

The HP 3779 Primary Multiplex Analyzer has a complementary focus. Its internal intelligence provides major benefits: an exceptionally friendly front panel, built-in automatic measurement sequencing with limit-testing, and channel scanner and printer control. The HP 3779 is therefore optimized for R&D, production test and commissioning of line cards and PCM multiplexers/channel banks.

### TDM Transmission Measurements

Digital transmission over cable, radio, satellite and, more recently, optical fibre is becoming an increasingly large proportion of inter-exchange and long haul transmission. As IDNs evolve and other services are added into the ISDN concept, transmission measurements have shifted from basic measures of bit error ratio and peak-peak jitter towards more thorough analysis of systems in terms of error performance or distribution with time. There is an increasing emphasis on evaluating "availability" of digital circuits. This requires more powerful analysis capability to be built into test instrumentation and the possibility of collecting large amounts of data for evaluation off-line in computers. HP is uniquely placed with advanced measuring and computational technology to provide measurement solutions for

these needs. A comprehensive range of error and jitter performance test equipment is now available covering bit rates from 1 kb/s to 170 Mb/s. Many special features are included for the three principal IDN digital transmission hierarchies now standardized by the CCITT.

The latest and most powerful instrument is the HP 3764A Digital Transmission Analyzer which is specifically designed for error and jitter performance measurements on 140 Mb/s links. Built-in analysis of availability and error distribution with real time are provided together with a choice of printer or cassette data capture media. An option of the instrument provides error performance testing and interfacing at the four standard bit rates of the CEPT digital hierarchy. Full HP-IB control also makes this instrument a powerful tool in automated production testing or digital network maintenance.

### Jitter and Digital Networks

The increasing interest in and significance of timing jitter in digital networks has made this parameter of key importance in PCM/TDM measurements. This phenomenon has not been well understood until relatively recently, but is now recognized to be a major source of errors and other transmission impairments. HP offers a comprehensive range of jitter testing capability based on the HP 3785 Jitter Generator & Receiver for bit rates up to 50 Mb/s, and the HP 3764A Digital Transmission Analyzer for 140 Mb/s. Ease-of-use features such as built-in jitter tolerance mask sweeping and full HP-IB control make these instruments powerful tools in production test and field trial situations. A loop timing measurement in the HP 3776 PCM Terminal Test Set provides a quick field check of the most common causes of digital switching machine malfunction when working to loop-timed PCM multiplexers/channel banks.

Read on for a more detailed look at the comprehensive range of HP products for digital communications applications.

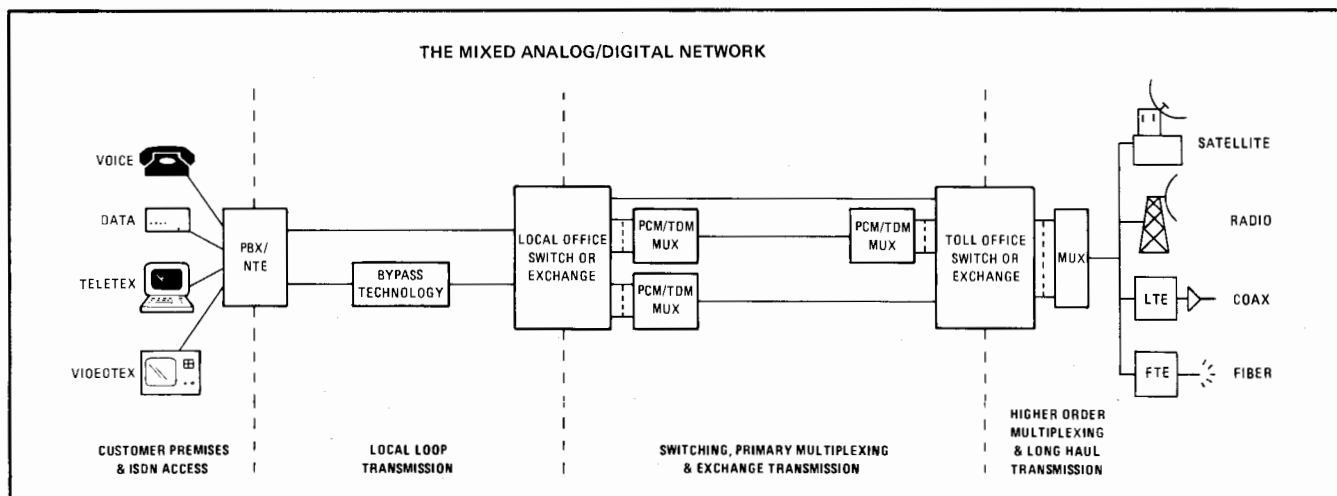



# TELECOMMUNICATIONS TEST EQUIPMENT

## PCM Terminal Test Set

Models 3776A, 3776B



- Analog and digital interfacing in CEPT/Bell/Japanese/CCITT networks
- Provides voice, PCM and data measurements in one instrument
- Direct output to printer or plotter

- Simple measurement sequencing
- Full A-A, A-D, D-A, D-D measurement modes
- Built-in self test and measurement checking
- Optional Data Parameter Measurement

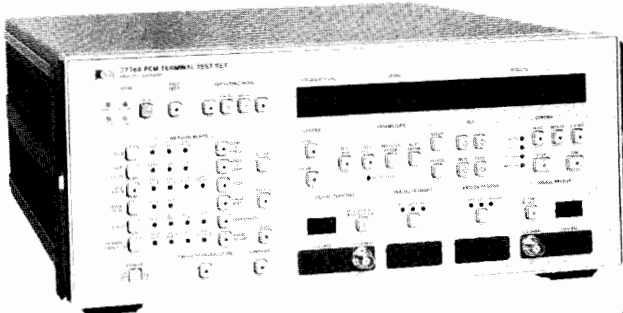

HP 3776A

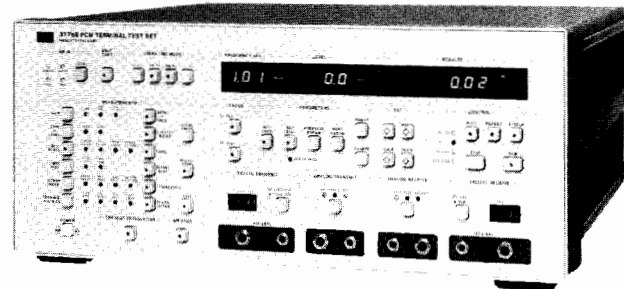

HP 3776B



The 3776A/B PCM Terminal Test Sets interface directly at the analog and digital level in mixed analog/digital networks. The HP 3776A is designed for CEPT/CCITT compatible networks while the HP 3776B is suitable for North American/Japanese/CCITT networks. Used in installation, commissioning and maintenance, the HP 3776A/B ensure optimum performance for each section (e.g., PCM channel bank, digital switching system or transmultiplexer) of the network.

### One Instrument for Voice and Data Services

The HP 3776A/B provide comprehensive voice, PCM and data measurements for testing 4 kHz bandwidth analog and digital channels. They replace the collection of independent analog and digital test equipment previously used in a mixed system environment with one compact instrument. Facilities included are:

- Voice and PCM measurements in A-A, A-D, D-A or D-D modes
- Framing and signaling bits setting and monitoring
- Data measurements - on analog and digital circuits.

A summary of the measurements available is shown below:

Standard Measurements	A-A	A-D	D-A	D-D
Gain	•	•	•	•
Digital mW gain	•	•	•	•
Level (including harmonic distortion)	•	•	•	•
Gain vs level (using tone)	•	•	•	•
Gain vs level (using noise - HP 3776A)	•	•	•	•
Gain vs level (using sync 2 kHz)	•	•	•	•
Gain vs frequency	•	•	•	•
Idle state (choice of filters)	•	•	•	•
Coder offset and peak codes	•	•	•	•
Noise with tone	•	•	•	•
Quantizing distortion (using tone)	•	•	•	•
Quantizing distortion (using noise - HP 3776A)	•	•	•	•
Intermodulation (using two tones)	•	•	•	•
Intermodulation (using four tones - HP 3776B)*	•	•	•	•
Digital Tx/Rx	•	•	•	•
Return loss 4W (ERL - HP 3776B)	•	•	•	•
Loop timing check	•	•	•	•

\*The non-linear distortion technique is licensed under Hekimian Laboratories, Inc., US Patent no. 3862380.

Optional Data Measurements	A-A	A-D	D-A	D-D
Frequency	•	•	•	•
Group delay distortion (HP 3776A)	•	•	•	•
Envelope delay distortion	•	•	•	•
Absolute delay	•	•	•	•
Phase jitter (choice of filters)	•	•	•	•
Transients (measured simultaneously):	•	•	•	•
Amplitude/gain hits				
Phase hits				
Interruption/dropouts				
Impulse noise (3 levels)				

### Isolate Problems Quickly and Minimize Downtime

The HP 3776A/B provide convenient features to help reduce measurement set-up time. Hence more time can be spent isolating problems and restoring service with minimum downtime. These features are:

- Pre-programmed default measurement parameters
- User-modified measurement parameters held in non-volatile memory
- Measurement sequences can be downloaded from a controller to the HP 3776A/B and run independently.

### Results Management

Measurement parameters and results are output directly to a printer or plotter via the HP-IB. Printed results are in a systematic, tabular format for easy analysis. In plot mode, multipoint measurement results are presented in a neat graphical format. Performance discrepancies can be spotted easily.

### Features for Tomorrow's Networks

The HP 3776A/B have been designed keeping in mind the needs of tomorrow. Unique facilities provided for future use are:  
 HP 3776A - Selection of 30 or 31 voice channel testing  
 HP 3776B - Bell extended superframe (ESF) format & B8ZS line coding.

### Specifications Summary

Full information and specifications are contained in the HP 3776A/B Data Sheet and HP 3776A/B Specifications Booklet.

**Supply voltages:** 115/240V ac +10%, -22%

**Power consumption:** 85W nominal

**Size:** 178 H x 425 W x 440 mm D (7 x 16.75 x 17.25 in.)

**Weight:** 15 kg (33 lb)

**Temperature range:** operating 0° to 55°C  
storage -40° to 75°C

### HP 3776A Options

**001** - Adds data measurements.

**002** - Replaces digital interface BNC connectors with 75 ohm Siemens 1.6/5.6 mm coaxial.

### HP 3776B Options

**001** - Adds data measurements.

**002** - Japanese measurement and connector requirements

**004** - Interface connectors on standard instrument replaced by Trompeter triaxial type BJ77 located on rear panel.

### Common Options

**801** - Front panel cover (not available with front handle & rack flange options 907, 908, 909)

**910** - Extra set of manuals

### Ordering Information

**3776A** PCM Terminal Test Set

**3776B** PCM Terminal Test Set

Transit Case HP 9211-2650: see page 690



# TELECOMMUNICATIONS TEST EQUIPMENT

## Primary Multiplex Analyzer; HP-IB Controlled Channel Selector

Models 3779C, 3779D, 3777A

### HP 3779C/D

- Comprehensive PCM measurements.
- User-level keyboard programming.
- Direct control of printer and HP 3777As.

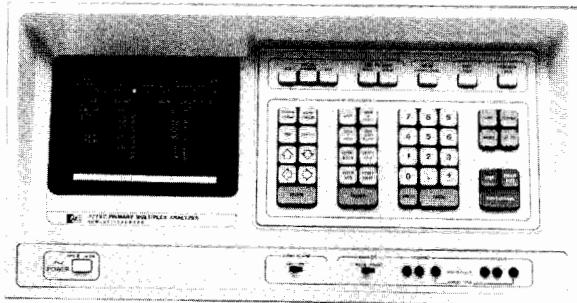

HP 3779C



### HP 3779C/D Primary Multiplex Analyzer

The HP 3779C/D Primary Multiplex Analyzer (PMA) is an intelligent instrument for fast, comprehensive testing of PCM products.

Model 3779C tests voice channels to CEPT recommendations. The digital options test PCM equipment conforming to CCITT Rec. G.711 and G.732, i.e., 30 channels/32 time slots encoded using the A-law and multiplexed into a 2048 kb/s stream. A single channel TTL-compatible interface is available for codec and digital line card testing where clock and sync signals are separate from the PCM data.

Model 3779D tests voice channels to Bell recommendations. Digital options 001 and 003 test PCM equipment conforming to BSTR Pub 43801 and CCITT Rec. G.711 and G.733, i.e., 24 channels/24 time slots encoded using the u-law and multiplexed into a 1544 kb/s stream. A single channel TTL-compatible interface is also available on all options and is used exclusively on option 002 for u-law systems operating at 2048 kb/s.

The standard HP 3779C/D provides A-A and E-E (end-to-end) measurements. A-D, D-A and D-D capability is optional.

Measurements	A-A	A-D	D-A	D-D
Gain	•	•	•	•
High accuracy gain	•			
Digital mW gain			•	
Gain vs frequency	•	•	•	•
Gain vs level using noise (3779C only)	•	•	•	•
Gain vs level using tone	•	•	•	•
Gain vs level using sync 2 kHz			•	
Coder offset		•		
Peak codes		•		
ICN weighted, 3 kHz flat & selective)	•	•	•	•
Noise with tone	•	•	•	•
Quantizing distortion using tone	•	•	•	•
Quantizing distortion using noise (3779C only)	•	•	•	•
Intelligible crosstalk	•	•	•	•
Intermodulation using two tones	•	•	•	•
Intermodulation using four tones (3779D only)+	•	•	•	•
Discrimination against out-of-band inputs	•	•	•	•
Spurious out-of-band outputs			•	•
Spurious in-band outputs			•	•
Return loss using swept tone (Tx & Rx)	•	•	•	•
Impedance balance (Tx & Rx)	•	•	•	•
Signal balance	•			•
E&M Signalling distortion	•			•
Tx-Rx	•	•	•	

+ The Non-Linear Distortion technique is licenced under Hekimian Laboratories Inc, US Patent No. 3862380.

### HP 3777A

- DC to 110 kHz.
- High quality relays.
- 2-wire/4-wire balanced switching.

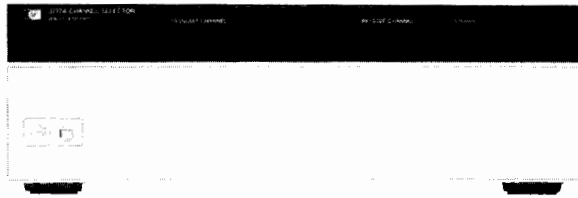

HP 3777A



Although measurement execution software is built-in, test values can be easily modified from the front panel. When selected, a measurement can be executed immediately or assembled with other measurements into a test sequence (stored in non volatile memory). Pass/fail conditions give simple but powerful control over the measurement process, e.g. branch, print on fail, etc.

By itself, the PMA can control a printer and HP 3777A Channel Selectors. However, when required, it can be readily subordinated to another HP-IB controller.

For details of a transit case accessory (Model 15514A) suitable for the HP 3779C/D, refer to page 135.

### HP 3779C Options

**001:** provides A-D, D-A, and D-D hardware and software; 2048 kb/s PCM interfaces are ternary rectangular with 75 ohm BNC connectors

**002:** as Option 001 except PCM and clock connectors are 75 ohm Siemens 1.6/5.6 mm

**003:** as Option 002 except PCM and co-directional clock connectors are 120 ohm Siemens 3-pin

### HP 3779D Options

**001:** provides A-D, D-A, and D-D hardware and software; 1544 kb/s PCM interfaces are bipolar rectangular with 100 ohm balanced WECO connectors

**002:** provides A-D, D-A, and D-D hardware and software for u-law systems operating at 2048 kb/s; digital connections are via single channel interfaces only

**003:** as Option 001 except PCM and clock connectors are BNC 75 ohm

### Ordering Information

HP 3779C Primary Multiplex Analyzer (CEPT)

HP 3779D Primary Multiplex Analyzer (Bell)

### HP 3777A Channel Selector

The HP 3777A is a 4-pole access switch for telecoms applications. It may be configured as a single 4-wire switch or as two, independent, 2-wire switches. Channel capacity is arranged by adding standard modules. Unselected channels are quiet terminated.

### HP 3777A Options

No. of Channels	Connectors	
	Siemens 3-pin	WECO 310
6	Opt H07	Opt H16
12	Opt 002	Opt 003
18	Opt H13	Opt H17
24	Opt H14	Opt 001
30	Std	Opt H05

### HP 3777A Channel Selector

# TELECOMMUNICATIONS TEST EQUIPMENT

1 kb/s/50 Mb/s PCM/TDM Error Measuring Set for Field Use

Model 3780A

131



- Binary and code error measurements
- Internal crystal clocks and clock recovery
- Clock frequency offset generation and measurement
- Ternary coded and binary interfaces
- PRBS and WORD pattern generation and detection
- Printer and recorder outputs

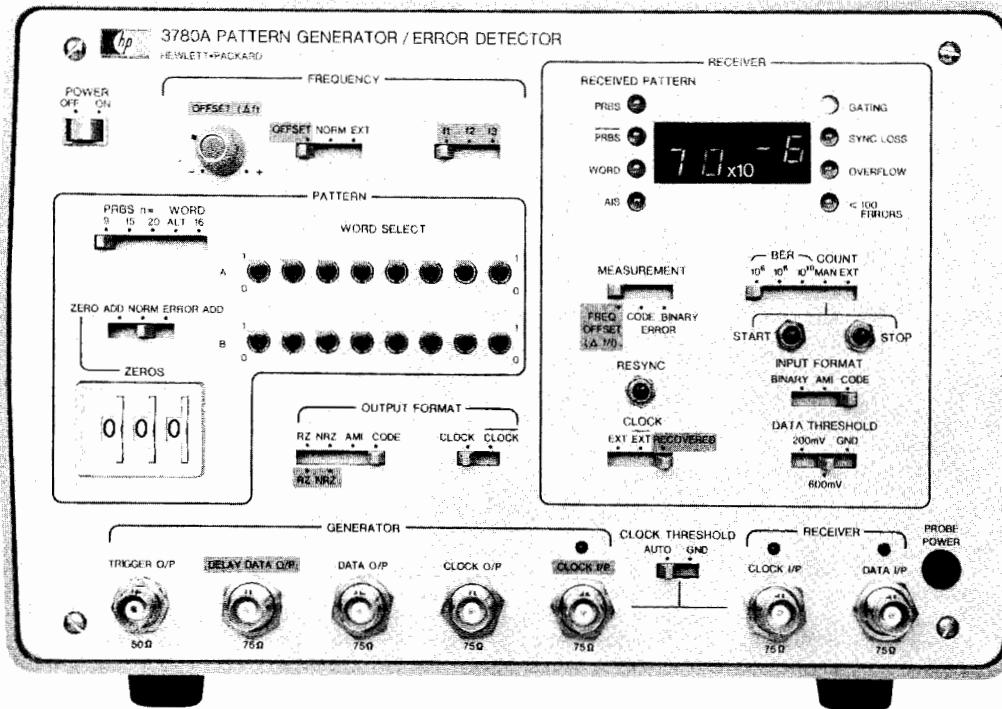

HP 3780A  
Option 001

The HP 3780A Pattern Generator/Error Detector is a comprehensive error measuring set in one portable package. The instrument measures Binary Errors and Code Errors in digital transmission equipment operating at bit rates between 1 kb/s and 50 Mb/s. Frequency offset generation and measurement are also provided at the standard bit rates used in PCM/TDM transmission.

Binary errors are detected by stimulating the system with a test pattern and comparing the output bit-by-bit with a separate internally generated, error-free pattern. Code errors on interface or line coded information are detected during decoding into binary data. The errors can be counted over a chosen gating period and displayed directly as bit error ratio (BER) or total error count (COUNT).

Error measurements can be made with PRBS or WORD patterns and the receiver has automatic pattern recognition and synchronization. Alternatively, the reference pattern can be preset by the pattern switch which allows detection of systematic pattern errors. Zero add facilities allow investigation of regenerator clock recovery performance. This capability can be extended by the optional addition of programmable word and alternating word generation.

The clock frequency in the pattern generator can be offset and measured in the receiver. The offset is displayed as a fraction of the nominal crystal centre frequency. In addition, the offset of external clocks applied to the generator can be measured provided that the frequency is within 25 kHz of one of the installed crystal frequencies.

BER or COUNT results can be displayed directly by LED's on the front panel or monitored via a BCD printer and strip chart recorder. This makes the HP 3780A ideally suited for unattended long-term measurements. Monitoring, display, and recording of the Alarm Indication Signal (AIS) is now included.

The HP 3780A has been designed principally for use in field trials, commissioning, and maintenance of digital transmission terminal and link equipment. A new option has been added which provides  $2^{23}-1$  pattern capability and automatic equalization for in-station cabling for 2, 8 and 34 Mb/s systems.

## Specifications

### Measurements

**Binary errors:** closed loop bit-by-bit detection on any pattern produced by generator, excluding added zeros or alternating words.

**Code errors:** violations of coding rule detected on any pattern with AMI, HDB3, or HDB2 coding (optionally AMI, B6ZS, or B3ZS).

**Frequency offset:** measurement of fractional offset of generator clock output from installed crystal rates.

### Options

#### Word/Connector Options

**001:** all words replaced by a 16-bit front panel programmable word

**002:** Siemens 1.6 mm connectors

**003:** combination of 001 and 002

#### Frequency Offset Option

**099:** frequency offset—measurement only; frequency offset generation deleted

#### Frequency/Codec Options

**Std:** internal clock frequencies of 2048, 8448, and 1536 kHz; HDB3/HDB2 codec.

**100:** internal clock frequencies of 2048, 8448, and 34368 kHz; HDB3/HDB2 codec.

**101:** internal clock frequencies of 1544, 6312, and 44736 kHz; B6ZS/B3ZS codec.

**102:** internal clock frequencies of 1544, 6312, and 3152 kHz; B6ZS/B3ZS codec.

**103:** internal clock frequencies of 2048, 8448, and 34368 kHz;  $2^{23}-1$  pattern replaces  $2^9-1$ ; HDB3 codec.

**104:** as option 103 but with Siemens 1.6 mm connectors

## HP 3780A Pattern Generator/Error Detector



# TELECOMMUNICATIONS TEST EQUIPMENT

## Dedicated PCM/TDM Error Measuring Sets

### Models 3781A, 3782A, 3781B, 3782B

#### HP 3781A/B

- Versatile selection of test patterns
- Internal jitter modulation
- Additional delayed data output

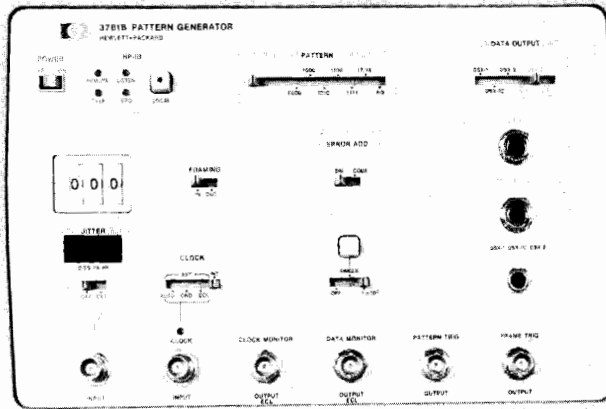

HP 3781B



#### HP 3782A/B

- Binary and code error measurements
- Error ratio, error count, error seconds and error-free seconds displayed
- Powerful error distribution analysis

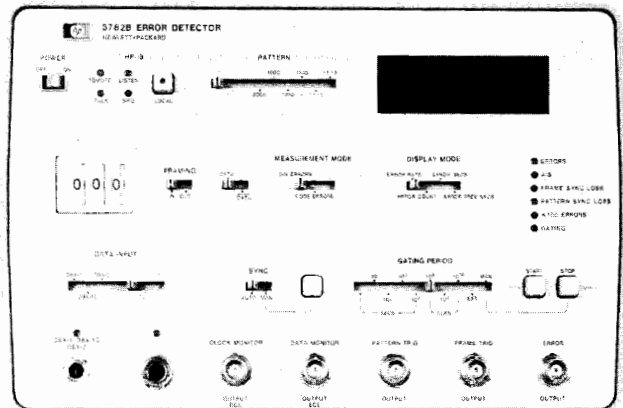

HP 3782B

The HP 3781A Pattern Generator and HP 3782A Error Detector form a high performance error measuring system which complements the existing HP 3780A Pattern Generator/Error Detector. Designed to conform with CEPT and CCITT standards, the HP 3781A/3782A provide four bit rates (up to 50 Mb/s) of the digital hierarchy in one compact system. Applications of the system are in R&D, field trial and production testing, especially where an automatic and remote measurement capability via the HP-IB is required.

In the HP 3781A, binary or code errors can be injected as single shot or at  $10^{-3}$  or  $10^{-5}$  rates into a wide range of PRBS and 16-bit WORD test patterns coded in AMI or HDB3. The test patterns provided include standard  $2^9-1$ ,  $2^{15}-1$ , and  $2^{23}-1$  bit PRBS to CCITT Recommendations, fully programmable 16-bit WORD, and two 8-bit WORDS which may be alternated under the control of an external signal. Zero substitution (up to 120 zeros) for PRBS patterns is included to examine, for example, the clock recovery performance of regenerators. 75  $\Omega$  unbalanced and 120  $\Omega$  balanced pseudo-ternary outputs and binary TTL monitor outputs are provided. A jitter modulation input facility is provided for simple oscillator connection, with direct LED display of pk-pk bits of jitter. This can be used to measure the input jitter tolerance of digital transmission equipment. A second data output with 12 bits delay provides adequate simulation of an independent sequence for thorough testing of 4 $\phi$ PSK digital radio systems. As an option, four extra data outputs coded in AMI or HDB3 can be included on the rear panel for driving adjacent radio channels.

The HP 3782A detects binary or code errors which can be displayed in the form of error ratio, error count, error seconds, and error-free seconds over a wide choice of gating periods. All four results are computed simultaneously over the same gating period. For ease of use there is a built-in automatic check for compatibility of switch position combinations. An error code flashes on the display if incompatibility is detected. When the monitor mode is used, the HP 3782A can be used for in-service monitoring of digital transmission links.

Measurement results are available on the HP-IB and a rear panel result threshold switch allows pre-selection of an error threshold above which results will be printed. This provides useful data reduction and a first order error distribution analysis. With a built-in real-time clock, results can be output with time, if required.

The HP 3781B Pattern Generator and HP 3782B Error Detector form a dedicated error measurement system for testing and evaluating the performance of Bell digital transmission terminal and link equipment, up to and including the DS-3 level in the digital hierarchy. The HP 3781B/3782B can be used in production testing, field installation, and maintenance of the Bell digital transmission system, including PCM/TDM transmission over cable, radio, satellite, and fibre optic links. The principal application is at the DS-3 level in the Bell digital hierarchy.

The HP 3781B/3782B are designed to interface at Bell System standard cross connect points with appropriate ternary coding and interface voltage levels at each hierarchical level. Interfacing at the DS-1C and DS-2 levels is limited to T1-C and T2 line systems. At the DS-3 level, a choice of four data formats is available. Alternatively, binary ECL interfaces can be used.

The HP 3781B Pattern Generator provides a selection of standard  $2^9-1$ ,  $2^{15}-1$ , and  $2^{20}-1$  bit PRBS and fixed WORD test patterns with a choice of single error or 1 in  $10^5$  error simulation on the digital data stream for normal measurements and troubleshooting. A pattern of 17 ones/15 zeros and zero substitution (up to 999 zeros) for PRBS patterns are included to examine phase sensitive circuitry such as clock recovery of regenerators. A jitter modulation input facility is provided for simple oscillator connection, with direct LED display of pk-pk bits of jitter. This can be used to measure the input jitter tolerance of digital transmission equipment. A second DS-3 output channel with 22 bits delay provides adequate simulation of an independent sequence for thorough testing of 4 $\phi$  PSK digital radio systems. As an optional extra, four DSX-3 BNC outputs on the rear panel can be included for driving adjacent radio channels.

The HP 3782B Error Detector detects any binary or code errors generated by the system under test. At the DS-3 level, it can perform in-service or out-of-service measurements of parity errors within the digital transmission system. The HP 3782B can measure simultaneously error rate, error count, error seconds, and error free seconds over a single gating period. When the DS-3 MON facility is used, in-service measurements (eg parity errors) of live traffic are possible. For ease of use, there is a built-in automatic check for compatibility of switch position combinations. An error code flashes on the display if incompatibility is detected. Hard copies of results can be obtained on a printer via HP-IB control, either in the "talk-only" or "addressable" modes. In addition, a preselectable error rate threshold and a real time clock allows selection for printing results which exceed a defined threshold (with local time, if required).

**Ordering Information**  
 HP 3781A Pattern Generator  
 HP 3782A Error Detector

**Ordering Information**  
 HP 3781B Pattern Generator  
 HP 3782B Error Detector

# TELECOMMUNICATIONS TEST EQUIPMENT

Dedicated 150 Mb/s PCM/TDM Error Detection System

Models 3762A/3763A, 3764A



## HP 3762A/3763A

- Binary bit-by-bit error detection
- Coded and binary operation
- Variable clock frequency offsets

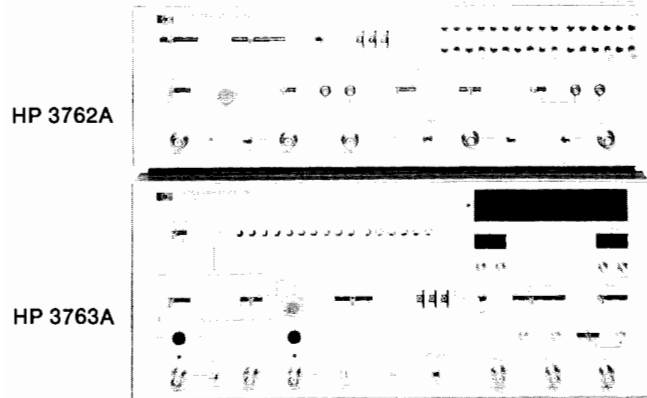

## HP 3764A

- Full 140 Mb/s error measurement
- Jitter generation and measurement at 140 Mb/s
- Portable single-unit construction

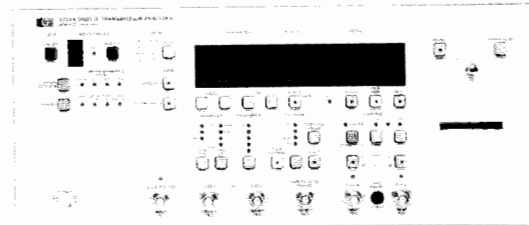

HP 3764A



## HP 3762A Data Generator/3763A Error Detector

The HP 3762A Data Generator and HP 3763A Error Detector comprise a dedicated error rate measurement system for evaluating high-speed digital transmission equipment. Basically, there are two versions of the system available. One features CMI and binary data formats and is specifically intended for use in field commissioning and maintenance of digital radio (terrestrial microwave and TDMA satellite) systems. The other version, with CMI and ternary (HDB3 and B3ZS) data formats, is designed for digital multiplex and digital cable systems. Burst gating inputs allow the HP 3762A/3763A to be used in TDMA applications

### Specifications Summary

#### HP 3762A Data Generator

**Internal clock:** two crystal clocks in the range 30 to 150 MHz; crystals fitted in standard unit are 139.264 and 141.040 MHz; offset continuously variable up to  $\pm 60$  ppm.

**External clock input:** 1 kHz to 150 MHz; 75 ohm.

**Patterns:**  $2^{10}-1$ ,  $2^{15}-1$ , and  $2^{23}-1$  PRBS; two 10- or 16-bit programmable words; two 1010 . . . repetitive patterns; two 8-bit words alternated by an external signal; PRBS patterns can be gated off for 1 to 999 clock periods after trigger pulse (zero substitution); error add facilities.

#### HP 3763A Error Detector

**Data input:** CMI, NRZ, or RZ formats; 75 ohm; DATA or  $\overline{\text{DATA}}$ ; 12 dB fixed equalization at 70 MHz on CMI inputs with clock recovery.

**External clock:** as 3762A.

**Patterns:** all the patterns of the HP 3762A, including zero substitution, but excluding alternating words.

**Count:** totalizes errors over a selected gating period; internal period can be  $10^6$ ,  $10^8$ ,  $10^{10}$  clock periods or 1 min to 24 h, repetitive or single shot, manual start/stop or external (ECL) control; result displayed as ABCD.

**Measurement gating input:** gates error and clock inputs to error counter, providing a measurement "window"; 50 ohm; ECL levels.

**Frequency offset measurement:** measures deviation of received bit rate from nominal rate; result displayed as  $\pm \text{BCD} \times 10^{-6}$ .

**Printer output** (rear panel): 8-4-2-1 BCD, 10-column output of result plus local time, if required, and flags; TTL print command pulse.

**Recorder output** (rear panel): constant current drive output of BER or COUNT result, with flags.

### Ordering Information

HP 3762A Data Generator  
HP 3763A Error Detector

## HP 3764A Digital Transmission Analyzer

The HP 3764A Digital Transmission Analyzer is Hewlett-Packard's new product for analyzing the error performance of high speed digital transmission systems. Three versions of the HP 3764A are produced, each being designed to fulfill different operating requirements. This flexible approach allows the HP 3764A to provide substantial benefits in a wide range of applications, from design and development to commissioning and maintenance.

- Standard HP 3764A — this is a dedicated 140 Mb/s digital transmission analyzer with pattern generation, error detection and error analysis capabilities. The error analysis provision includes error performance measurements for testing the proposed Integrated Services Digital Networks (ISDN).
- Multiple frequency version — option 001 instruments provide the standard HP 3764A's measurement capability at the four main CEPT bit-rates of 2, 8, 34 and 140 Mb/s. This reduces the number of test sets required in multiple frequency environments.
- Jitter version — in addition to the standard HP 3764A's measurement capability option 002 instruments also provide jitter generation and timing jitter measurement at 140 Mb/s. This offers a cost-effective solution to 140 Mb/s testing requirements.

### Specifications Summary

#### Generator Section

**Clocks:** internal clock 139.264 MHz; offset clocks + and - 15 ppm; external clock 1 kHz to 170 MHz.

**Data outputs:** CMI format at 139.264 Mb/s; Binary RZ or NRZ from 1 kb/s to 170 Mb/s, ECL levels, 75 ohm unbalanced.

**Patterns:** PRBS  $2^{23}-1$ ; WORD, 1 to 16-bit fully programmable; ALT WORD, two 1 to 8-bit programmable words, crossover rate controlled by external signal; AIS, "all ones" pattern.

#### Receiver Section

**Recovered clock:** 139.264  $\pm 3$  Mb/s.

**Binary clock:** 1 kHz to 170 MHz.

**Data inputs:** 75 ohm Terminated mode; Monitor mode; Binary, RZ or NRZ, ECL levels; External Error, ECL levels.

#### Measurements Performed

**Error performance:** % Availability, % ER  $\leq N$ , % EFS.

**Errors:** Error Ratio, Error Count, Error Seconds, Error Free Seconds.

#### Options

(Select one option only)

**001:** four internal frequencies.

**002:** jitter generation and measurement at 140 Mb/s.

## HP 3764A Digital Transmission Analyzer



# TELECOMMUNICATIONS TEST EQUIPMENT

## Dedicated PCM/TDM Jitter Generator and Receiver

Models 3785A, 3785B

- Jitter generation and measurement on data and clock
- Jitter specifications designed to CCITT recommendation 0.171
- Transient-free sweeping of internal CCITT defined jitter tolerance masks

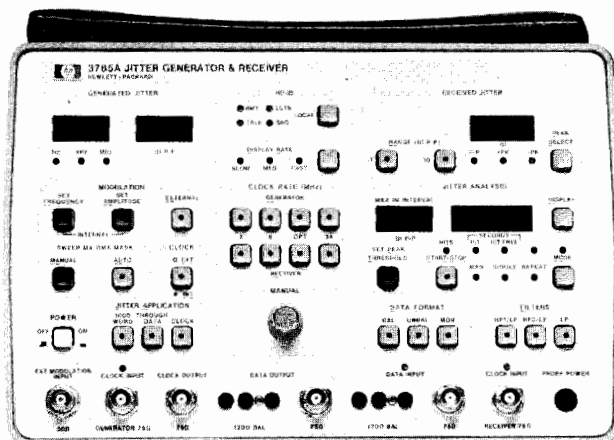

HP 3785A (2048, 8448, 34368 and, optionally, 25776 kHz)  
CEPT

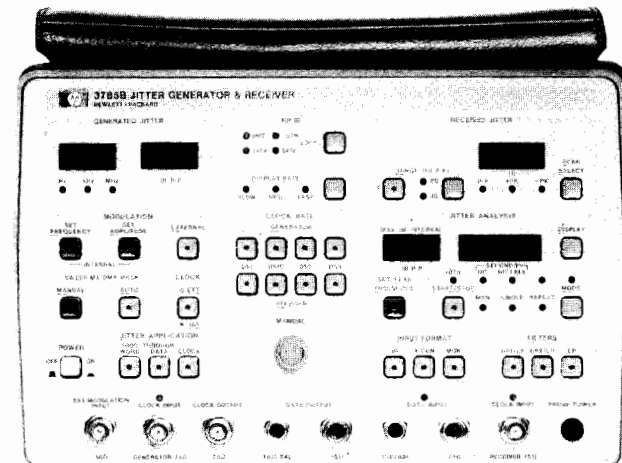

HP 3785B (DS-1, DS-1C, DS-2 and DS-3)  
Bell



The HP 3785A/B Jitter Generator and Receiver is a dedicated jitter measurement system for testing and evaluating the performance of CEPT or Bell digital transmission terminal and link equipment up to and including the third level (34368 kb/s or DS-3) in the digital hierarchy. The HP 3785A/B can be used in production testing, field installation and maintenance of the CEPT or Bell digital transmission system including PCM/TDM transmission over cable, radio, satellite, and fiber optic links. The principal application is thorough testing to current CCITT Recommendations at each level in the digital hierarchy.

In addition to providing a comprehensive measurement capability which includes in-service jitter measurements, the microprocessor-controlled Jitter Generator and Receiver is easy to use with ergonomic layout of switches and connectors on the front panel. The instrument is designed to interface fully with the HP-IB, allowing bus-controlled operation and automatic measurement sequencing.

The Jitter Generator may be used to phase modulate an internally provided crystal clock, an externally applied clock (at a nominal digital hierarchy bit rate) or an externally applied data stream. Sinusoidal modulation is provided by an internal synthesizer whose amplitude and frequency can be set manually or swept, transient-free, through a CCITT shaped jitter tolerance mask programmed into the instrument. Alternatively, external modulating signals can be applied. The amplitude of generated jitter in unit intervals (U.I.) pk-pk and the frequency of internal modulation are in accordance with CCITT Recommendation 0.171 and are displayed on the front panel.

The modulated clock output can be applied to an external pattern generator such as the HP 3780A, 3762A, 3781A or 3782B. For jitter transfer function measurements, the CCITT standard 1000 repetitive pattern is provided within the HP 3785A/B. In addition, for demultiplexer jitter transfer function, jitter can be applied to an externally applied data stream which has the necessary framing and justification digits. Consult the data sheet for full technical specifications.

Consult the data sheet for full technical specifications.

### Measurements

The Jitter Receiver offers six types of measurement:

- Absolute jitter amplitude in U.I. pk-pk
- Jitter peak, positive or negative
- Jitter hit count of the number of times received jitter exceeds a user-defined hit threshold in U.I. pk

- Single portable unit for up to 4 internal bit rates
- Built-in measurement filters to CCITT recommendations
- Comprehensive jitter analysis against real-time and jitter amplitude

- Jitter hit seconds count of the number of seconds in which one or more jitter hits occur
- Jitter hit-free seconds count of the number of seconds which are free of jitter hits
- Maximum absolute jitter amplitude in U.I. pk-pk is held during the jitter analysis gating period

Simultaneous measurement of all six parameters is possible with result display selection. In addition, the Receiver has a built-in interval timer and real-time clock to allow measurements of jitter distribution against time to be made.

The measurements can be made on clock or data inputs with or without internal filtering. Two high pass filters and one low pass filter as specified by CCITT are provided for each of the four bit rates. In addition, external filters can be connected between the demodulated jitter output and the measuring circuitry input. The demodulated jitter output can also be used to measure rms jitter amplitude on an external voltmeter or to display jitter spectrum on an external analyzer.

The clock reference for the jitter measurements can be internally derived from the applied data or clock via a narrow band phase-locked loop or externally derived from an applied reference.

The data input allows out-of-service or in-service measurements. The MON facility for in-service measurements has built-in additional gain to compensate for the flat loss at the protected monitor points.

### HP-IB Operation

The capabilities of the HP 3785A/B can be enhanced by using the HP-IB to provide remote operation and automatic sequencing of results.

The HP-IB facility offers several principal features:

- Remote control of front panel switches and pushbuttons using programming codes
- Control codes which are set to default values on power-on and can be user-defined with the controller
- The ability to transfer all desired switch positions and masks onto a tape memory and reloaded back onto the instrument at a later time
- Output of the result data to a printer (eg HP 5150A Thermal Printer) or storage memory

### Ordering Information

HP 3785A Jitter Generator and Receiver (CEPT)  
HP 3785B Jitter Generator and Receiver (Bell)



# TELECOMMUNICATIONS TEST EQUIPMENT

## PCM/TDM Accessories

135



Models 15507A, 15508B, 15508C, 15509A, 15509B, 15510A, 15511A, 15512A, 15513A, 15514A, 15515B, 15518A/B/C



HP 15518A/B/C



HP 15509A



HP 15509B

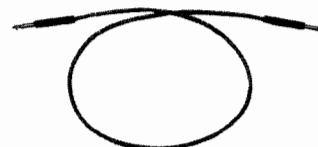

HP 15513A

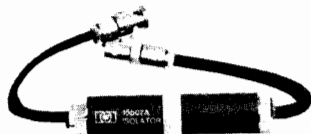

HP 15507A



HP 15510A

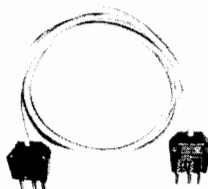

HP 15511A

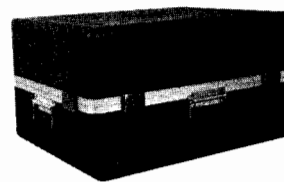

HP 15514A



HP 15508B



HP 15508C

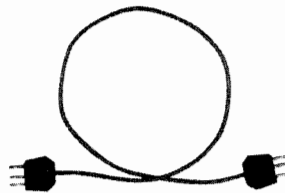

HP 15512A

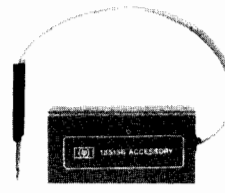

HP 15515B

### HP 15507A Isolator

This unit provides isolation from longitudinal voltages which may appear on test connections to digital transmission equipment. It can also be used when the ground potential of the test equipment is different from that of the transmission equipment.

### HP 15508B Converter (75 $\Omega$ unbal—110 $\Omega$ bal)

This unit provides a nominal 110  $\Omega$  balanced interface conversion from 75  $\Omega$  unbalanced interfaces on digital test equipment. This is required at the 1544 kb/s DS-1, 3152 kb/s DS-1C, and 6312 kb/s DS-2 levels of North American digital transmission systems.

### HP 15508C Converter (75 $\Omega$ unbal—120 $\Omega$ bal)

The HP 15508C provides a nominal 120  $\Omega$  balanced interface conversion from 75  $\Omega$  unbalanced interfaces on digital test equipment. This may be required at the 2048 kb/s primary multiplex levels of European digital transmission systems.

### HP 15509A Amplifier

This unit is designed to provide sufficient gain on a digital signal appearing at a standard digital equipment protected monitor point to trigger the Error Detector input. This is required to monitor in-service systems for code violations. Power for the HP 15509A is supplied from the error detector front panel PROBE POWER socket.

### HP 15509B Amplifier

The HP 15509B is similar to the HP 15509A except that it is intended for operation at the DSX-1, DSX-1C, and DSX-2 monitor points of North American digital transmission systems.

### HP 15510A 75 $\Omega$ Cable Accessory

The HP 15510A is designed to provide a protected monitor point to the HP 15509A input. This allows the Error Detector to monitor in-service systems (75  $\Omega$ ) for code violations when the system monitor point is unprotected.

### HP 15511A 120 $\Omega$ Cable Accessory

The HP 15511A is designed to provide a protected monitor point to the HP 15508C input and, subsequently, the HP 15509A input. This allows the Error Detector to monitor in-service systems (120  $\Omega$ ) for code violations when the system monitor point is unprotected.

### HP 15512A Cable

The HP 15512A is a 1 m length of 600  $\Omega$  balanced cable with a 3-pin audio connector (Siemens type) at each end.

### HP 15513A Cable

The HP 15513A is a 1 m length of 600  $\Omega$  balanced cable with a WECO 310 jack plug at each end.

### HP 15514A Transit Case

The HP 15514A is a transit case with moulded foam inserts for transporting the HP 3779 Primary Multiplex Analyzer.

### HP 15515B Loop Holding Unit

Model 15515B is a loop holding unit which provides 24 mA loop holding current sinking. It is supplied with WECO connectors.

### 15518A/B/C Loop Holding Accessory

Models 15518A/B/C are loop holding accessories designed to satisfy the requirements of CCITT/Bell/Japanese networks requirements and work with a HP 3776A/3776B/3776B Opt 002 respectively.

### Ordering Information

HP 15507A Isolator  
HP 15508B Converter (75  $\Omega$  unbal—110  $\Omega$  bal)  
HP 15508C Converter (75  $\Omega$  unbal—120  $\Omega$  bal)  
HP 15509A Amplifier  
HP 15509B Amplifier  
HP 15510A 75  $\Omega$  Cable Accessory  
HP 15511A 120  $\Omega$  Cable Accessory  
HP 15512A Cable  
HP 15513A Cable  
HP 15514A Transit Case  
HP 15515B Loop Holding Unit  
HP 15518A/B/C Loop Holding Accessory



# TELECOMMUNICATIONS TEST EQUIPMENT

## General Information: Radio and FDM Carrier System Testing

### FDM System Measurements

Frequency Division Multiplex (FDM) systems are the traditional method of transmitting a number of telecommunications channels over a single wideband transmission medium such as coaxial cable or microwave radio, each channel being allocated a unique part of the frequency spectrum. In narrow satellite or radio channels there might be only 12 or 24 telephone channels, whereas in a high capacity 12 MHz or 18 MHz system 2700 or 3600 channels can be transmitted simultaneously.

Hewlett-Packard supplies a comprehensive range of manual and automatic test-equipment, summarized in the table below, for FDM baseband, microwave radio and satellite systems.

### FDM Measurements

The HP 3586A/B Selective Level Meter (SLM) and its companion Synthesizer/Level Generator the HP 3336A/B are specifically designed for manual measurements in manufacture, installation and maintenance. Both instruments incorporate synthesizer tuning for stability and resolution and provide absolute level accuracy of  $\pm 0.2$  dB (SLM) and  $\pm 0.15$  dB (Generator). The HP 3586A/3336A combination is optimized for testing to CCITT standards and the HP 3586B/3336B to Bell or North American standards.

Both HP 3586A/B and HP 3336A/B are HP-IB programmable and can be combined into a low-cost system with the HP-85F Personal Computer. This system, the HP 3046A/B, is simple to use and enables automatic multiple measurements and sequences to be set up using the stored FDM plans. Up to four test points can be accessed by means of an HP 3755A Access Switch Controller and HP 3754A Access Switch.

The HP 3746A SLMS, developed from the HP 3586A/B, has been optimized for FDM maintenance measurements, particularly in automatic network monitoring

systems. Its built-in "intelligence" enables high speed scans of FDM signals using the internally stored FDM plans and limits which check for unacceptable levels. Group power measurements and hot-tone search provide rapid detection of high level signals (see Application Note AN 323). The HP 3746A has a built in access switch controller (similar to the facilities of the HP 3755A Access Switch Controller) to provide low-cost system integration with the HP 3754A, 3756A and 3757A Access Switches. The internal real-time clock allows limit violations to be logged on an external printer with the time of occurrence. All these facilities are available from the keyboard or programmable from a system controller.

The performance objectives for present day networks, and customer expectations, particularly business customers and data users, demand rapid fault location and analysis of system degradation. Hewlett-Packard offers two automatic monitoring systems designed round the HP 3746A SLMS: the HP 37050S system based on the HP 1000 A-Series Computer, and the HP 37051S based on the HP 9816S Personal Technical Computer. The HP 37051S is a low-cost measurement system for smaller networks providing control of up to six remote measurement subsystems, each with up to 45 access points. The software on the HP 9816S stores database information on the test points and allows a surveillance routine to be run continuously using sequence files. These can be interrupted at any time for demand measurements.

The computer-based HP 37050S system has all of these features and in addition can control up to 16 remote subsystems per computer and provides comprehensive data reduction and results reporting — for the larger system this is essential. The computer utilizes powerful Real-Time Executive (RTE) Operating System Software, so (unlike the HP 37051S) can provide simultaneous measurements at multiple sites and can support several users at local or remote terminals. The HP 37050S can be readily extended to cover a very large network

by linking computers using DS/1000-IV Network Software.

### Analog Radio Measurements

Radio measurements divide into two categories, qualitative baseband measurements and analytical IF and RF transmission measurements. IF transmission measurements, including group delay, amplitude flatness, differential gain and linearity, are used mainly for troubleshooting. The Hewlett-Packard Microwave Link Analyzers (MLAs) are equipped to make the full range of these measurements at 70 MHz (HP 3710A, 3702B) and 70/140 MHz IF (HP 3711A, 3712A). They are well established products with a very good reputation for reliability and accuracy essential for examining individual sections of the radio. Interpretation of MLA measurements and the relationship to white-noise testing is covered in Hewlett-Packard Application Note AN175-1, "Differential Phase and Gain at Work".

These MLA transmission measurements can be readily extended to RF interfaces using the high-performance HP 3730B Down Converter, and the HP 8620C Up Converter Simulator. In both these instruments the different microwave bands are covered by a range of plug-ins.

Baseband qualitative measurements such as white noise (NPR) testing can be carried out at IF interfaces using the HP 3717A 70 MHz Modulator/Demodulator. This is a compact, high-performance unit incorporating selected pre- and de-emphasis networks to CCIR and Bell standards.

### Digital Radio Measurements

In common with other digital transmission systems, the overall performance measurement for digital radio is the bit-error-ratio (BER) performance (see page 9.1). To check the radio fade-margin, the carrier to noise ratio (C/N) is artificially degraded by adding noise and the BER is measured to plot the classical BER vs. C/N curve. The new HP 3708A Noise and Interference Test Set has been designed for this application and the test can be automated using the HP 3708S system operating on the HP 9816S Personal Technical Computer. Transmission impairments such as amplitude response and group-delay in the IF and RF sections can be evaluated with the HP Microwave Link Analyzers in the same way as analog radio.

		MAINTENANCE/ MONITORING	INSTALLATION	MANUFACTURE
FDM Measurements	Manual	HP 3586A/B, 3746A	HP 3586A/B, 3336A/B	HP 3586A/B, 3336A/B
	Automatic	HP 3046A/B, 3746A	HP 3046A/B, 3746A 3336A/B	HP 3046A/B
	Surveillance	HP 37050S, 37051S	—	—

# TELECOMMUNICATIONS TEST EQUIPMENT

## Selective Level Measuring Set, HP-IB CRT Display

Models 3746A, 37461A

137



- Fast, accurate measurements on frequency division multiplex (FDM) systems
- Selective filters for pilot, channel and (optionally) group power and weighted noise measurements
- Automatic tuning to stored frequency plans with comparison of measured level to stored limits

- Built-in access switch controller, real-time clock and frequency counter
- HP-IB controller for external printer, frequency synthesizer and companion display unit
- Versatile, efficient remote system device in computer-controlled HP-IB systems

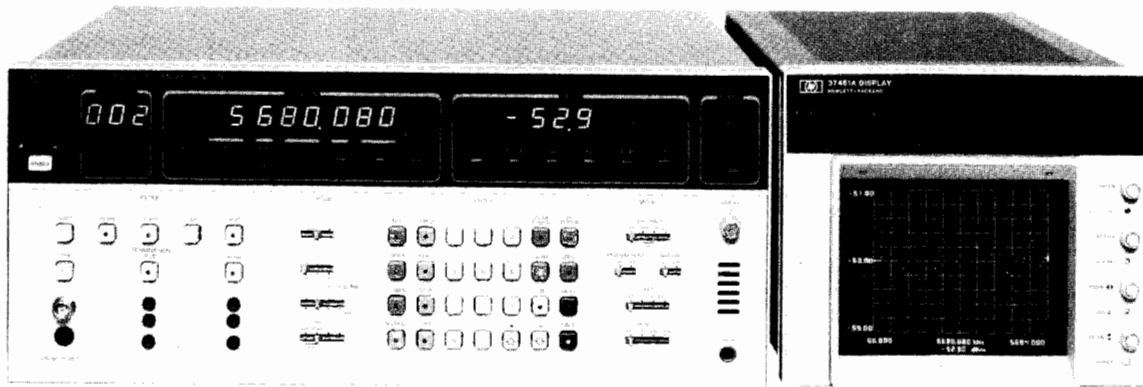

HP 3746A



HP 37461A

### HP 3746A Selective Level Measuring Set (50 Hz to 32 MHz)

The HP 3746A Selective Level Measuring Set (SLMS) is designed to make fast, accurate selective level measurements. A built-in frequency synthesizer gives accurate, stable tuning to the precise frequency at which the measurement is to be made. The HP 3746A can be tuned over its frequency range (50 Hz to 32 MHz) with a resolution of 1 Hz.

The SLMS measures true rms power between +20 dBm and -120 dBm with 1 dB, 0.1 dB, or 0.01 dB resolution. Fully auto-ranging attenuators and amplifiers simplify operation further by eliminating the need to set attenuators and add meter readings. Measurement results are automatically displayed to the selected resolution, in dBm or dB relative terms, on an LED display. The absolute accuracy of the measurement over wide level and temperature ranges is  $< \pm 0.25$  dB.

Many benefits are derived from the purpose designed filters contained in the SLMS. The 38 Hz pilot filter has a flat top over 22 Hz, necessary for automatic tuning, and achieves high out-of-band rejection so that, for example, carrier leak can be measured on active systems. The channel filter is a flat-topped 3.1 kHz filter which can be used for measuring all signals in the voice channel and provides high out-of-band rejection. Optional weighted filters are available to make either true 'C'-message or CCITT psophometrically weighted noise measurements. These options also provide the following voice channel impairment measurements: single level impulse noise, phase jitter and noise-with-tone measurement. A 48 kHz filter for group power measurements is available by option to facilitate fast location of high level signals on a multiplex.

The HP 3746A is internally controlled by a microprocessor which provides many ease-of-use and time-saving features. As well as tuning exactly to an entered frequency, the SLMS can refer to CCITT or Bell multiplex frequency plans in its memory and automatically tune to the correct frequency at any level in the multiplex. Other frequency plans, as used for example on submarine cable or satellite links, can be installed to special order. Also, up to 145 unrelated frequencies can be stored in non-volatile memory and the SLMS programmed to scan through these frequencies. The comprehensive FDM plan and frequency storage capability of the SLMS eliminates the need for the operator to refer to FDM plan charts and tables. The SLMS can automatically step through pilots and supervisory tones, channels, group powers, carrier leaks, etc. across the baseband of a multiplex—comparing levels with pre-determined alarm limits and providing a print-out of limit violations on a separate printer. 250 pilot measurements can be made in about 2 minutes and 2700 channel powers can be measured in about 5 minutes.

Control of test point selection is provided by means of a built-in Access Switch Controller. This performs a function similar to the HP 3755A Switch Controller: control of HP 3754A, 3756A, or 3757A Switches to select 1 from a possible 1000 RF outputs. A 3-digit display on the SLMS front panel indicates the selected port. Another useful feature is the SLMS's integral Real-time Clock which can display time or date and holds the correct time even when the SLMS is switched off. If a printer is connected to the HP 3746A via the HP-IB, the SLMS can be configured to output measurement results to the printer together with the date and time at which each measurement is made.

The HP 3746A is fully programmable via the HP-IB, and can itself assume the role of system controller. In this mode, selectable by a rear panel switch, the SLMS can control a tracking Frequency Synthesizer (HP models 3330B, 3335A, 3336A/B are compatible), a 20- or 80-column Printer (for example, HP 5150A or 2631B), and a HP 37461A CRT Display. It is thus possible to assemble a self-contained test station for network maintenance and surveillance.

#### HP 3746A Options

- 001: Siemens series 1.6/5.6 mm 75  $\Omega$  connectors
- 005: WECO 477B/223A (equivalent) connectors
- 011: 48 kHz group filter
- 012: tracking generator
- 014: high stability frequency reference
- 015: channel impairments—CCITT
- 016: channel impairments—North America
- 907: front handle kit
- 908: rack flange kit
- 909: rack and handle kit
- 910: extra set of manuals

#### HP 3746A Selective Level Measuring Set

#### HP 37461A Display

The HP 37461A Display is a CRT-based display unit with integral processor and HP-IB interface. Under control of the HP 3746A SLMS, a graticule with labelled frequency and level axes is displayed and up to 256 measurement results can be plotted. This type of visual presentation enables speedy assessment of overall traffic loading, identification of spurious signals and detection of high level users.

#### HP 37461A Options

- 907: front handle kit
- 908: rack flange kit
- 910: extra set of manuals

#### HP 37461A Display

# TELECOMMUNICATIONS TEST EQUIPMENT

## Access/Distribution Switches and Controller, SLMS Accessories

Models 3754A, 3755A, 3756A, 3757A, 15580A, 15581B, 15582A, 15589A

- Select 1 from a possible 10 RF inputs/outputs
- Cascade up to 111 Switches to allow selection from 1000 inputs/outputs
- Mix different Switches for the most cost-effective solution
- Switches controllable from HP 3755A Switch Controller or HP 3746A SLMS
- Remote input selection using HP-IB (HP 3755A or 3746A)
- 75  $\Omega$  termination of unselected ports



HP 3754A

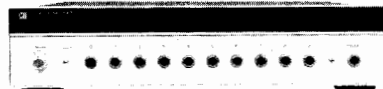

HP 3756A



HP 3757A

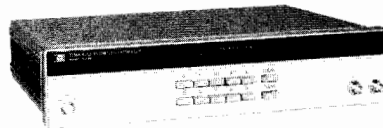

HP 3755A

The HP 3754A, 3756A and 3757A Switches and the 3755A Controller have been developed to meet the requirements of four main areas.

1. Frequency Division Multiplex (FDM) system surveillance and maintenance—the Switch arrangement is used in conjunction with a Selective Level Measuring Set (SLMS), such as the HP 3746A, to monitor pilot and traffic levels at various points in the multiplex. The HP 3746A SLMS can control the Access Switches directly without needing the HP 3755A Controller.
2. Production testing—where automatic selection or distribution of RF signals is required.
3. IF access and distribution—70 MHz IF signals can be switched using the HP 3756A for connection to the HP 3717A 70 MHz Modulator/Demodulator.
4. Access and distribution of digital communications signals up to 34 Mb/s (CEPT) or 44.7 Mb/s (DS-3).

### HP 3754A 25 MHz Access Switch

The HP 3754A 25 MHz Access Switch is an ac-coupled, uni-directional, ten-input switch with a frequency range from 10 kHz to 25 MHz. The HP 3754A incorporates a virtual-ground amplifier—giving an insertion loss of  $< \pm 0.1$  dB from 50 kHz to 20 MHz and high isolation across the whole frequency range. The isolation between any unselected input and the output is  $> 85$  dB and the isolation between any two inputs is  $> 90$  dB. In addition, pre-set gains of 1, 2 and 3 dB are internally selectable to compensate for losses in cables and equalizers.

### HP 3756A 90 MHz Bi-directional Switch

The HP 3756A 90 MHz Switch is a dc-coupled, bi-directional, ten-way switch with a frequency range from dc to 90 MHz. The HP 3756A offers isolation of  $> 80$  dB between channels, and  $> 75$  dB between unselected input and output ports. It has an insertion loss of 1 dB with a flatness of  $< \pm 0.2$  dB and  $> 28$  dB return loss.

### HP 3757A 8.5 MHz Access Switch

The HP 3757A 8.5 MHz Access Switch is a low-cost, ac-coupled, uni-directional, ten-input switch with a frequency range of 10 kHz to 8.5 MHz. An option provides expanded frequency range from 200 Hz to 8.5 MHz. The HP 3757A has an insertion loss  $< 0.1$  dB from 10 kHz to 4 MHz and isolation of  $> 95$  dB between channels. In addition, pre-set gains of 1, 2 and 3 dB are internally selectable to compensate for losses in cables and equalizers. (The HP 3757A is powered from a  $\pm 15$  V dc supply.)

### HP 3755A Switch Controller

The HP 3755A Switch Controller has a small, easy-to-operate keyboard with a 3-digit LED display to denote the input or output select-

ed. Each Switch (HP 3754A, 3756A or 3757A) is given a 1-digit code, to select the required port from up to 1,000.

The HP 3755A Switch Controller can be remotely controlled over the Hewlett-Packard Interface Bus (HP-IB) by a desk-top computer. If the HP 3746A is used as Switch controller, similar principles apply.

### Active and Passive Probes

Models HP 15580A and 15581B High-Impedance Probes are used with the SLMS for bridging measurements. The HP 15580A is an "active" device powered from the SLMS having an insertion loss of 0 dB. Model HP 15581B is a passive probe having an insertion loss of 20 dB. The HP 15581B can also inject signals from a Level Generator at points where a high impedance source is required.

### Specifications

Parameter	HP 15580A	HP 15581B
Frequency Range	20 kHz to 25 MHz	10 kHz to 25 MHz
Insertion Loss	0 dB $\pm 0.2$ dB (50 kHz to 20 MHz)	20 dB $\pm 0.2$ dB (50 kHz to 20 MHz)
Tapping Loss (in 75 $\Omega$ system)	$< 0.15$ dB (50 kHz to 20 MHz)	$< 0.25$ dB (50 kHz to 20 MHz)

### Return Loss Kit

Model HP 15582A Return Loss Kit, with a suitable Level Generator, allows the SLMS to make return loss measurements from 10 kHz to 25 MHz.

### Instrument Cart

HP Model 15589A is suitable for transporting the SLMS and its auxiliary equipment.

### Ordering Information

HP 3754A 25 MHz Access Switch  
 HP 3755A Switch Controller  
 HP 3756A 90 MHz Bi-directional Switch  
 HP 3757A 8.5 MHz Access Switch  
 HP 15580A Active Probe  
 HP 15581B Passive Probe  
 HP 15582A Return Loss Kit  
 HP 15589A Instrument Cart

# TELECOMMUNICATIONS TEST EQUIPMENT

## FDM Network Monitoring Systems

Models 37050S, 37051S

139



- Automated FDM network monitoring
- Multiple remote SLMS control
- Integral CCITT and Bell FDM plans

- Flexible configurations
- Fast, accurate measurements
- Concise result presentation

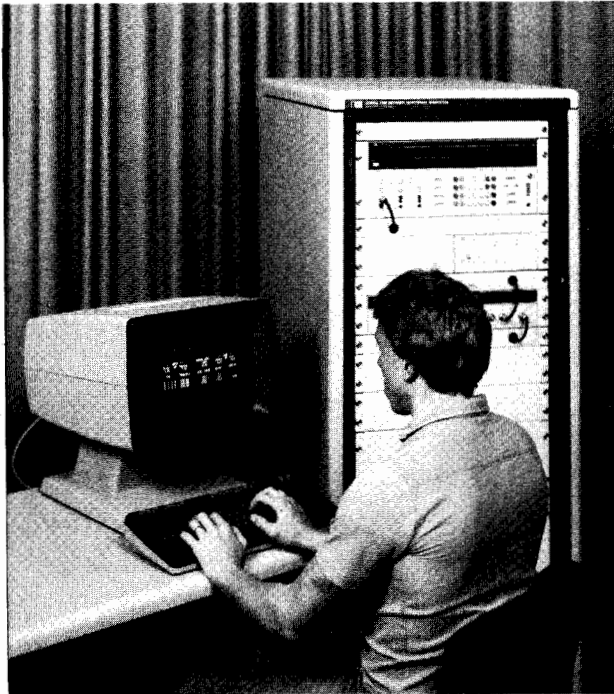

### HP 37050S FDM Network Monitoring System

The HP 37050S is a flexible, automatic measurement system for use in the commissioning, monitoring, fault-finding and maintenance of FDM transmission networks.

The System operates under the direct control of an HP1000 A-Series Computer system which gathers measurement data concurrently from remote SLMS-based instrument subsystems. Up to 16 remote subsystems can be continuously monitoring network performance. Specialized result modes are provided that reduce the mass of data available to only that which is really relevant.

A number of User Terminals (VDU/keyboards) can be added to the HP 37050S to provide direct on-demand control of all measurements (e.g. for on-the-spot investigations of problems highlighted during automatic monitoring).

HP's Distributed Systems Network Software, DS/1000-IV, can be incorporated to allow two or more computer systems to be linked together. This facility enables an HP 37050S system to be expanded beyond 16 SLMSs.

### HP 37016A FDM Network Monitoring Software

The HP 37016A Software is the power behind the HP 37050S and is used to control all the operations of the FDM Network Monitoring System. The software includes measurement programs and functional tests for verifying that the instruments at the remote sites function correctly.

### HP 37051S FDM Measurement System

The HP 37051S is the ideal answer for the operator of a small FDM network who wishes to make measurements quickly at several remote, possibly unmanned, FDM installations and present the information obtained at one central location.

This system operates under the control of an HP 9816S Personal Technical Computer that provides sequential control of up to 6 remote SLMSs. Surveillance sequences can be created in which all the SLMSs are controlled in succession. User initiated measurements, temporarily interrupting any surveillance sequence, can be made to investigate a problem highlighted by surveillance.

HP 37051S operators retain the ability to later expand their monitoring system to the HP 37050S as their networks grow or needs change.

### HP 37014B FDM Measurement Software

The HP 37014B Software controls the HP 37051S system providing measurement programs and also functional tests for verifying that the instruments at the remote sites function correctly.

Table 1. Monitoring Systems Summary

	HP 37050S	HP 37051S
Automated measurements (continuous and time-scheduled)	YES	YES
Measurements on-demand	YES	YES
Result storage capability	YES	YES
Maximum number of supported SLMSs per controller	16 (simultaneously)	6 (sequentially)
Maximum number of test points per SLMS	999	45
User Terminals	YES	NO

### HP 37050S

The HP 37050S and 37051S provide the ability to monitor continually both Bell and CCITT Frequency Division Multiplex (FDM) networks.

These systems allow faults or deteriorations within an FDM network to be isolated and rectified in the shortest possible time. The HP 37050S has been designed to meet the demands of large, high capacity FDM networks, whereas the HP 37051S provides a low-cost solution for small FDM networks.

### System Structure

Both systems use the extensive measurement capability and built-in intelligence (including FDM plans) of the HP 3746A Selective Level Measuring Set (SLMS). Expandable access switching arrangements using HP 3754A (25 MHz) or HP 3757A (8.5 MHz) switches enable each SLMS to monitor at a number of test points.

Both systems employ specialized software packages to control their operation and provide data base information, measurement routines and dedicated control software (e.g. time-scheduling routines).

### Data Base Assistance

The HP 37050S and 37051S both incorporate a system data base to simplify system operation. Information detailing the required measurements and the test points at which they should be performed (e.g. test level, gain parameters) need only be entered once initially. This information is available to both the computer or manually initiated automatic measurements.

### Comprehensive Measurements

Measurements supported by the systems include:

- Pilots
- Carrier Leaks
- Noise (Intersupergroup Slot, Channel)
- Power (Broadband, Channel, Group, Supergroup)
- Tones (Test, Signaling)
- Fast High Level Searches (FDM, Spectrum)
- Channel Impairments (Phase Jitter, Impulse Noise, Noise with Tone) — HP 37050S only

### Support Services

Full training programs for the HP 37050S and 37051S are available. All the individual components that make up these Systems (excluding data links) are designed and manufactured by Hewlett-Packard and are backed up by HP's worldwide support.



# TELECOMMUNICATIONS TEST EQUIPMENT

## Microwave Radio Noise and Interference Measurement System

Models 3708A, 3708S

### HP 3708A

- Highly accurate wideband noise source covers all common microwave link IFs
- Tracking mode maintains constant C/N ratio under carrier fading conditions
- Broadband interference facility, with or without noise injection, stresses the radio deterministically

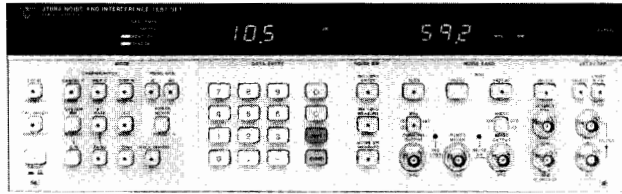

HP 3708A



### HP 3708A Noise and Interference Test Set

The HP 3708A Noise and Interference Test Set offers an accurate, yet simple, method of simulating microwave radio fade conditions. Designed for operation in the IF section of a digital or FM microwave radio, HP 3708A will add calibrated levels of white noise and/or interference signals to the radio IF carrier. A built-in power meter and microprocessor control enables the radio IF carrier power to be sampled by the HP 3708A at the point of noise injection and the noise density adjusted automatically to maintain a constant carrier to noise ratio even in the presence of receiver carrier level variations. A simple, yet powerful interference test facility is also included in the HP 3708A, allowing an external broadband signal to be mixed with the radio IF carrier along with/instead of the injected noise. Additional capability provided within the instrument includes

- True RMS IF power meter
- High stability 0 dBm reference tone
- Direct noise bandwidth measurement.

### HP 3708A Specifications Summary

#### Noise Generation

**Outputs:** "Noise only" or "noise + carrier (+ auxiliary interferer if desired)".

**Absolute accuracy of noise power:**  $\pm 0.25$  dB in range +6 to  $-10$  dBm at  $23 \pm 3^\circ\text{C}$ .

**Accuracy of carrier to noise power ratio:**  $\pm 0.35$  dB over range: C = +1 to  $-5$  dBm, C/N = 10 to 30 dB.

**Maximum noise power output:** +6 dBm "noise only" output. 0 dBm "noise + carrier" output.

**Band-limiting filters:** four fixed internal filters plus external filter facility with range 10 - 200 MHz.

#### Interference Signal Inputs

**Auxiliary Interferer** (i.e., in addition to Noise Injection)

**Input:** Broadband (10 to 200 MHz) fixed loss path (typically 15 dB) to IF output.

**Interferer Only** (i.e., Instead of Noise Injection)

**Input:** Broadband (10 to 200 MHz), acceptable signal level typically  $-30$  dBm. Injection level determined by HP 3708A.

**Accuracy of C/I power ratio:**  $\pm 0.35$  dB in range C = +1 to  $-5$  dBm, C/I = 10 to 30 dB,  $23 \pm 3^\circ\text{C}$  for 70, 140 MHz ( $\pm 10$  MHz) interferer.

#### Power Measurement

**Absolute Accuracy:**  $\pm 0.05$  dB at 0 dBm  $23 \pm 3^\circ\text{C}$ , 70/140 MHz after calibration using internal reference tone.

**Resolution:** 0.01 dB.

#### Options

**Std:** Signal connectors impedance, 75 ohms nominal unbalanced to GND. Reference tone oscillator frequency is 70/140 MHz.

**001:** Signal connectors impedance, 50 ohms nominal unbalanced to GND.

**Special Options:** Reference tone oscillator frequencies, other than the standard values, are available on a special order basis.

### HP 3708A Noise and Interference Test Set

### HP 3708S

- Data base recall and editing of system setup parameters and measurement results
- Extensive graphics capability facilitates operation and measurement interpretation
- Complete range of Hewlett-Packard HP-IB compatible bit error ratio test sets supported

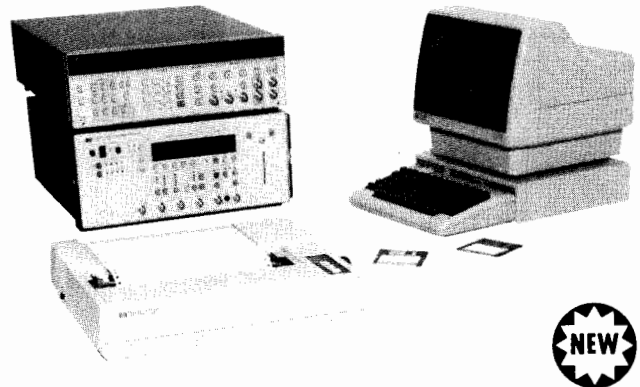

### HP 3708S Noise and Interference Measurement System

The HP 3708S system enables computer-controlled automatic measurements to be made of microwave radio performance under simulated flat-fade conditions. The measurements are centered around an HP 3708A Noise and Interference Test Set to simulate flat fade (and/or interference) conditions with additional pattern generator and error detector to provide and monitor a known test pattern. All instruments are controlled by a single HP 9816S desktop computer via the HP-IB interface including extra configurable peripherals such as printer and pen plotter. The system is capable of performing BER versus C/N measurements both in the tracking and non-tracking of the HP 3708A, with the optional presence of interfering signals. Measurements of BER vs. Carrier/Interference ratio's are also supported. Versions of the HP 3708S system software (HP 3708) exist to support all current Hewlett-Packard bit error ratio test sets with HP-IB capability. The HP 3708S system is intended for production and maintenance where speed of testing, hard copy results and ease of use are all important factors.

### HP 3708S System Configuration Summary

The HP 3708S system configuration basically consists of the following (plus miscellaneous accessories):

#### Controller

**HP 9816S** Desktop computer (includes 512 kbytes of standard RAM, RAM-based BASIC and internal HP-IB interface).

Plus: **HP 98624A** HP-IB plug-in module.

**HP 9121D** dual 3.5 in. disc drive.

#### Noise and Interference Test Set

**HP 3708A** Noise and Interference Test Set.

#### Bit-Error-Ratio Testers

**HP 3781A/3782A** Pattern Generator and Error Detector.

**HP 3781B/3782B** Pattern Generator and Error Detector.

**HP 3764A** Digital Transmission Analyzer.

#### Hard Copy Peripherals

**HP 82906A** Printer.

**HP 7470A** Plotter.

#### System Software

**HP 37080A** for use with HP 3781A/3782A.

**HP 37080B** for use with HP 3781B/3782B.

**HP 37080C** for use with HP 3764A.



# TELECOMMUNICATIONS TEST EQUIPMENT

## Selective Level Meter and Synthesizer

Models 3586A/B & 3336A/B

141

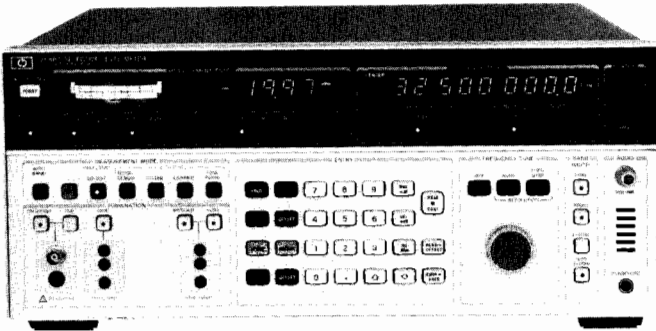

HP 3586A Selective Level Meter (CCITT)



### General

The HP 3586A/B Selective Level Meters and HP 3336A/B Tracking Synthesizers offer the high performance necessary to meet the demanding requirements in the design, manufacture, commissioning and maintenance of Frequency Division Multiplex (FDM) systems. The HP 3586 and HP 3336 "A" models meet CCITT requirements, and the "B" models meet North American (Bell) standards. Both are fully programmable over the HP Interface Bus. The HP 3586A & B Selective Level Meter provides a unique combination of features, including wideband power and optional telephone impairment measurement of impulse noise, phase jitter, noise with tone, and signal-to-noise with tone ratio. The HP 3586A & B's wide frequency coverage to 32.5 MHz allows measurements to be made at both voice channel and carrier frequencies. Microprocessor control adds many ease-of-use features such as amplitude offset measurements of tone and noise level in units of dBmO, dBmCO, or dBpWO. Convenience features include simultaneous analog and digital level displays, precise frequency setting with HP's fractional N synthesized local oscillator, accurate frequency counter and tone measurements with automatic channel alignment for 800 Hz (CCITT) or 1004 Hz (Bell) test tone or carrier frequency reference.

The HP 3336 A/B Synthesizer/Level Generator is an excellent precision tracking signal source for the HP 3586A and B Selective Level Meter. When the Selective Level Meter and Synthesizer are in the tracking mode, the frequency of the synthesizer is automatically set to the frequency of the SLM. Frequency coverage is 10 Hz to 20.9 MHz, making the HP 3336 A and B useful for telephone circuit loop testing on most FDM systems, transfer function and distortion measurements in telecommunications manufacturing.

### Carrier Frequency and Voice Channel

The HP 3586A & B can make both carrier frequency measurements to 32.5 MHz and voice channel measurements from 50 Hz to 100 kHz.

You can measure tone levels, idle channel noise or weighted noise at voice channel, then compare at carrier frequency.

### Transmission Impairments

The Transmission Impairments capability permits phase jitter, weighted noise, noise-with-tone, signal-to-noise-with-tone ratio, and single level impulse noise measurements. The HP 3586A's capability to make these transmission impairment measurements at both FDM voice channel and carrier frequencies is unique.

### Frequency and Amplitude Precision

The HP 3336 A/B provides frequency resolution of one microhertz (.000001 Hz) up to 100 kHz and one millihertz (.001 Hz) to 20.9 MHz. Level accuracy is  $\pm 1.5$  dB at full output over the full frequency range with  $\pm 1.2$  dB optional. Harmonic levels are more than 60 dB down up to 1 MHz and more than 50 dB down up to 20.9 MHz, performance not previously available in a synthesizer.

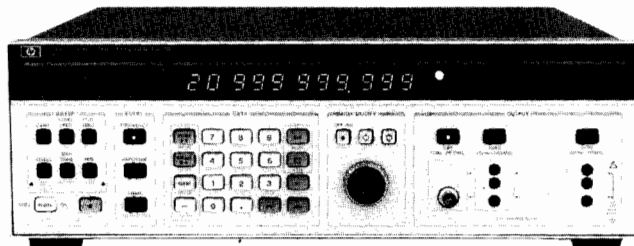

HP 3336A Synthesizer/Level Generator (CCITT)

### FDM Testing

The flexible output section allows different connectors to be provided either by option or special request. Frequency entry is accomplished by keyboard or analog control for manual tuning or frequency stepping of any digit.

The Amplitude Blanking feature allows testing of operational FDM systems without disturbing adjacent channels while the frequency is changed. The output is blanked to less than  $-85$  dBm until the next desired frequency is reached.

### General Purpose Features

The HP 3336 A/B Synthesizer provides wide band sweep capability—sweep the full frequency range (or as little as two microhertz), log or linear, single or continuous. Single phase lock loop design means the sweep is phase continuous and you can modulate with AM to 50 kHz or PM to 5 kHz. Ten storage registers can be used to keep different test settings available for repetitive test. All necessary functions on the HP 3336 A/B can be remotely programmed by HP-IB control for automatic testing.

### Designed-In Serviceability

The HP 3586 A/B Selective Level Meter and the HP 3336 A/B Synthesizer/Level Generator have been designed for reliable operation and excellent accessibility with many useful service features.

### North American (Bell) and CCITT Requirements

The HP 3586A & B Selective Level Meter and HP 3336 A & B Synthesizer/Level Generator are designed to meet most world-wide connector and impedance requirements for both carrier and voice channel measurements. Special or regional connectors can be provided by option or special request.

### Input Configuration

#### CCITT Requirements

HP 3586A SLM	75 $\Omega$ /10 k $\Omega$ Unbalanced 150 $\Omega$ , 600 $\Omega$ /10 k $\Omega$ Balanced
HP 3336A Synthesizer	75 $\Omega$ Unbalanced 150 $\Omega$ , 600 $\Omega$ Balanced

#### North American (Bell) Requirements

HP 3586B SLM	75 $\Omega$ /10 k $\Omega$ Unbalanced 124 $\Omega$ , 135 $\Omega$ , 600 $\Omega$ /10 k $\Omega$ Balanced
HP 3336B Synthesizer	75 $\Omega$ Unbalanced 124 $\Omega$ , 135 $\Omega$ , 600 $\Omega$ Balanced

### Fully Programmable

HP-IB control is standard, allowing automatic operation to be controlled by a desktop calculator such as the HP Model 85B, HP 9816A, Series 200, or by a main frame computer, such as the HP 1000. FDM tests such as surveillance can be made from a remote location to reduce maintenance costs and increase troubleshooting efficiency. See page 144 for information on HP 3046 A/B selective level measuring system.

### High Impedance Accessory Probes

Models HP 15580A and HP 15581B unbalanced high impedance probes and model HP 15576A balanced high impedance probe are available for use with the HP 3586A/B to facilitate bridging measurements.



# TELECOMMUNICATIONS TEST EQUIPMENT

## Selective Level Meter and Synthesizer

Models 3586A/B & 3336A/B (con't)

### Frequency

Signal Input	HP 3586A	HP 3586B
75 $\Omega$ Unbalanced	50 Hz to 32.5 MHz	
124 $\Omega$ Balanced		4 kHz to 10 MHz
135 $\Omega$ Balanced		4 kHz to 1 MHz
150 $\Omega$ Balanced	4 kHz to 1 MHz	
600 $\Omega$ Balanced	50 Hz to 108 kHz	

The 124  $\Omega$ , 135  $\Omega$ , 150  $\Omega$  and 600  $\Omega$  inputs are usable over wider frequency ranges, but are not specified in under and overrange operation.

**Frequency resolution:** 0.1 Hz.

**Center frequency accuracy:**  $\pm 1 \times 10^{-5}$ /year ( $\pm 2 \times 10^{-7}$ /year with option 004).

**Counter accuracy:**  $\pm 1.0$  Hz in addition to center frequency accuracy for signals within the 60 dB bandwidth of the IF filter chosen or greater than  $-100$  dBm (largest signal measured).

**Frequency display:** 9 digit LED.

### Selectivity

**3 dB Bandwidth,  $\pm 10\%$**

HP 3586 (CCITT)	HP 3586B (N. American)
20 Hz	20 Hz
400 Hz	400 Hz
3100 Hz	3100 Hz
Psophometric Noise Weighting	C-Message Noise Weighting

**Adjacent channel rejection:** 75 dB minimum at  $\pm 2850$  Hz, 3100 Hz BW.

**Passband flatness:**  $\pm 0.3$  dB.

### Amplitude

**Measurement range:**  $+20$  to  $-130$  dBm.

**Amplitude resolution:** .01 dB.

**Level accuracy:** 10 dB autorange, low distortion mode, after calibration. 20 Hz and 400 Hz BW below  $-80$  dBm.

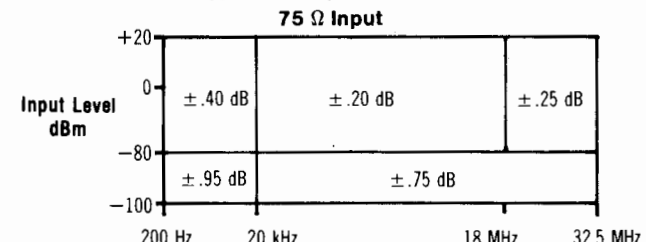

124  $\Omega$  Input (HP 3586B):  $\pm 0.6$  dB, 4 kHz to 10 kHz;  $\pm .35$  dB, 50 kHz to 5 MHz;  $\pm .50$  dB, 10 kHz to 50 kHz, and 5 MHz to 10 MHz for  $+20$  to  $-80$  dBm.

135  $\Omega$ /150  $\Omega$  input (HP 3586A or B):  $\pm 0.6$  dB, 4 kHz to 10 kHz;  $\pm .35$  dB 50 kHz to 1 MHz,  $\pm .50$  dB 10 kHz to 50 kHz for  $+20$  to  $-80$  dBm.

600  $\Omega$  Input (3586 A/B):  $\pm .35$  dB 200 Hz to 108 kHz for  $+20$  to  $-80$  dBm.

**Level accuracy: 100 dB range (after calibration):** add correction to 10 dB auto-range accuracy for dB below full scale. (Not required when in 10 dB autorange).

dB Below Full Scale	Accuracy Correction
0 to $-20$ dB	$\pm .25$ dB
$-20$ to $-40$ dB	$\pm .50$ dB
$-40$ to $-80$ dB	$\pm 2.0$ dB

### Dynamic Range

#### Spurious Responses

**Image rejection (100-132 MHz):**  $-80$  dBc.

**IF rejection:** 15625 Hz,  $-80$  dBc; 50 MHz,  $-60$  dBc.

**Non-harmonic spurious signals:**  $> 1600$  Hz offset,  $-80$  dBc; 300 Hz to 1600 Hz offset,  $-75$  dBc.

### Distortion

**Harmonic distortion:**  $-70$  dB below full scale ( $> 4$  kHz on 75  $\Omega$  and 600  $\Omega$  inputs), low distortion mode.

**Intermodulation distortion:** 60 dB below full scale, 200 Hz to 50 kHz offset; 70 dB below full scale, 50 kHz to 1 MHz offset.

**Wideband power accuracy:** after calibration, 100 dB range, averaging on,  $-45$  to  $+20$  dBm.

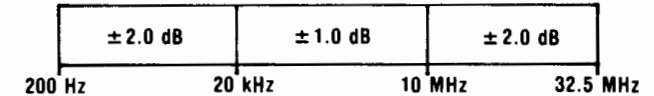

### Noise Floor (full scale setting $-35$ to $-120$ dBm)

Frequency	Bandwidth	Noise Level
100 kHz to 32.5 MHz	3100, 1740, 2000 Hz	$-116$ dBm
	20 Hz, 400 Hz	$-120$ dBm
10 kHz to 100 kHz	All	$-105$ dBm

The noise floor for full scale settings of  $-30$  to  $+24$  dBm will be 80 dB below full scale for  $> 100$  kHz, or 60 dB below full scale for  $< 100$  kHz.

### Signal Inputs

HP Model	Impedance	Frequency	Mating Connector
3586A	75 ohms unbalanced	50 Hz to 32.5 MHz	BNC
	150 ohms balanced	4 kHz to 1 MHz	Siemens 3-prong
	600 ohms balanced	50 Hz to 108 kHz	9 Rel 6 AC
3586B	75 ohms unbalanced	50 Hz to 32.5 MHz	WECO 439/440A
	124 ohms balanced	4 kHz to 10 MHz	WECO 443A
	135 ohms balanced	4 kHz to 1 MHz	WECO 241A
	600 ohms balanced	50 Hz to 108 kHz	WECO 310

### Connector Options

**Opt 001 (HP 3586A):** 75 ohms mates with Siemens 1.6/5.6 mm coaxial.

**Opt 001 (HP 3586B):** 75 ohms mates with WECO 358A. 124 ohms mates with WECO 372A.

(Contact local sales office for other special connectors.)

**Return loss:**  $-30$  dB (50/75  $\Omega$ );  $-25$  dB (600  $\Omega$ ).

### Balance

Input	Frequency	Balance
124 $\Omega$	10 kHz to 10 MHz	$-36$ dB
135 $\Omega$ or 150 $\Omega$	10 kHz to 1 MHz	$-36$ dB
600 $\Omega$	50 Hz to 108 kHz	$-40$ dB

### Demodulated Audio Output

Output Level: 0 dBm into a 600  $\Omega$  load, adjustable.

Output Connector: mates with WECO 347A.

**HP-IB Interface Functions:** SH1, AH1, T6, TE0, L4, LE0, SR1, RL1, PPI, DC1, DT1, C1, C3, C28.

### Additional Options

#### HP 3586A (CCITT)

**Opt 001:** 75  $\Omega$  input connector option. Siemens 1.6/5.6 mm coaxial connector replaces BNC.

**Opt 004:** High Stability Frequency reference 10 MHz oven stabilized reference oscillator improves frequency stability to  $\pm 2 \times 10^{-7}$ /year.

#### HP 3586B (N. American)

**Opt 001:** 75  $\Omega$  and 124  $\Omega$  input connector option. Changes 75  $\Omega$  input connector to mate with WECO 358A and 124  $\Omega$  input to mate with WECO 372A.

**Opt 004:** High Stability Frequency reference. Same as Opt 004-HP 3586A.

### Auxiliary Signal Inputs/Outputs

**Tracking generator:** 0 dBm rear panel tracking output.

**External reference input:** 1 MHz, 10 MHz or sub-harmonic input.

**Reference output:** 10 MHz,  $+8$  dBm output.

# TELECOMMUNICATIONS TEST EQUIPMENT

## Selective Level Meter/Synthesizer

Models 3586A/B and 3336A/B (cont.)

143



**Probe power:** front panel dc output for HP active high impedance accessory probes.

**HP-IB Interface Functions:** rear panel interface meeting IEEE 488-1978 for remote operation. Used for tracking synthesizer interface. SH1, AH1, T6, L3, SR1, RL1, PP0, DC1, C0, E1.

**Additional outputs:** rear panel demodulated audio; phase jitter meter.

### General

#### Operating Environment

**Temperature:** 0° to 55°C.  
**Relative humidity:** 95%, 0° to 40°C.  
**Altitude:** ≤15,000 ft; ≤4600 metres.

#### Storage Environment

**Temperature:** -40°C to 75°C.  
**Altitude:** ≤50,000 ft; ≤15,240 metres.  
**Power:** 100/120/220/240 V, +5%, -10% 48 to 66 Hz, 150 VA.  
**Weight:** 23 kg (50 lb) net; 30 kg (65 lb) shipping.  
**Size:** 177 mm H x 425.5 mm W x 466.7 mm D (7" x 16.75" x 18.38").

### HP 3336 A & B Abbreviated Specifications

(See data sheet or manual for complete specifications)

#### Frequency

##### Frequency Range of Signal Outputs

Signal Output	HP 3336A	HP 3336B
75 Ω Unbalanced	10 Hz to 20.999 999 999 MHz	
124 Ω Balanced		10 kHz to 10.999 999 999 MHz
135 Ω Balanced		10 kHz to 2.099 999 999 MHz
150 Ω Balanced	10 kHz to 2.099 999 999 MHz	
600 Ω Balanced	200 Hz to 109.999 999 kHz	

All balanced outputs are usable over wider frequency ranges but are not specified in under and overrange operation.

**Resolution:** 1 μHz for frequencies < 100 kHz, 1 mHz for frequencies ≥ 100 kHz.

**Aging rate (instruments without option 004):** ±5 x 10<sup>-6</sup>/year (20° to 30°C).

**Warm-up time:** 30 minutes.

#### Amplitude

**Range:** 75 and 600 Ω outputs: -72.99 to +7.00 dBm.

124, 135 and 150 Ω outputs: -78.23 to +1.76 dBm.

**Level accuracy, 20° to 30°C**

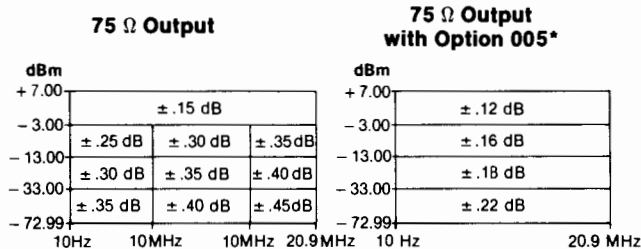

\*high accuracy attenuator

124 Ω output: 50 kHz to 10.9 MHz ±.15 dB -8.23 to 1.76 dBm, ±0.3 dB -18.23 to -8.24 dBm, ±.35 dB -38.23 to -18.24 dBm ±.4 dB -78.23 to -38.24 dBm.

135 Ω/150 Ω output: 10 kHz to 2.09 MHz, ±.17 dB -8.23 to +1.76 dBm, ±.32 dB -18.23 to -8.24 dBm, ±.37 dB -38.23 to -18.24 dBm, ±.42 dB -78.23 to -38.24 dBm.

600 Ω output: 200 Hz to 109.9 kHz, ±.30 dB -3.00 to +7.00 dBm/±.40 dB -13.00 to 2.99 dBm, ±.45 dB -33.00 to -12.99 dBm ±.50 dB -72.99 to -32.99 dBm.

1. Add ±.03 dB for 0° to 55°C operation.

2. Warm-up time is 30 minutes.

**Amplitude blanking:** <-85 dBm output during blanking

#### Spectral Purity

**Phase noise:** <-72 dB, HP 3336A and HP 3336B, for a 3 kHz band, 2 kHz either side of a 20 MHz carrier.

**Harmonic level:** -35 dB, 10 Hz to 30 Hz; -50 dB, 30 Hz to 50 Hz; -60 dB, 50 Hz to 1 MHz; -55 dB, 1 MHz to 5 MHz; -50 dB, 5 MHz to 20 MHz.

**Spurious:** all non-harmonically related signals will be more than 70 dB below the fundamental or -115 dBm with option 005 except 150 or 600 Ω, whichever is greater.

#### Phase Offset

**Range:** ±719.9° with respect to arbitrary starting phase or assigned zero phase.

**Resolution:** 0.1°.

**Increment accuracy:** ±0.2°.

**Ambient stability:** ±1.0 degree of phase per degree C.

#### Frequency Sweep

**Sweep time:** linear sweep, 0.01 s to 99.99 s; single log sweep, 2 s to 99.99 s; continuous log sweep, 0.1 s to 99.99 s.

**Maximum sweep width:** specified frequency range of selected output.

**Minimum sweep width:** log sweep, 1 decade; linear sweep, minimum sweepwidth (Hz) = 0.1 (Hz/s) x sweep time(s).

**Phase continuity:** sweep is phase continuous over full frequency range.

**Sweep flatness:** ±0.15 dB, fast leveling, 10 kHz to 20 MHz, 0.03 s sweep time; ±0.15 dB, normal leveling, 50 Hz to 1 MHz, 0.5 s sweep time.

**Amplitude modulation:** modulation depth, 0 to 100%. Modulation frequency range, 50 Hz to 50 kHz.

**Phase modulation:** range, 0 to ±850°. Linearity, ±0.5% from best fit straight line. Modulation frequency range, dc to 5 kHz.

**External leveling:** input from an external voltage source to regulate the signal amplitude at a remote point.

**HP-IB Interface Functions:** rear panel interface meeting IEEE 488-1978 for remote operation. Used for tracking synthesizer interface. SH1, AH1, T6, L3, SR1, RL1, PP0, DC1, C0, E1.

#### Options

##### Option 001, HP 3336A/B Synthesizer/Level Generator

1.6/5.6 mm 75Ω input, (HP 3336A). 75Ω mates with WECO 358A, (HP 3336B). 124Ω connector mates with WECO 372A, (HP 3336B).

##### Option 004, High Stability Frequency Reference

**Aging rate:** ±5 x 10<sup>-8</sup>/week after 72 hours continuous operation ±1 x 10<sup>-7</sup>/month after 15 days continuous operation.

**Ambient stability:** ±5 x 10<sup>-7</sup> maximum, 0° to 55°C.

**Option 005, high accuracy attenuator:** improves level accuracy and spurious level. See main specifications.

#### General

##### Operating Environment

**Temperature:** 0° to 55°C.  
**Relative humidity:** ≤85%, 0° to 40°C.  
**Altitude:** ≤15,000 ft., ≤4600 metres.

##### Storage Environment

**Temperature:** -50° to +65°C.  
**Altitude:** ≤50,000 ft., ≤15,240 metres.  
**Power requirements:** 100/120/220/240 V, +5%, -10%, 48 to 66 Hz, 60 VA, (100 VA with all options), 10 VA standby.

**Size:** 132.6 mm high x 425.5 mm wide x 425.5 mm deep (5¼" x 16¾" x 16¾").

**Weight:** Net wt., 10 kg (22 lb). Shipping wt., 15.5 kg (34 lb).

#### Ordering Information

##### HP 3586A Selective Level Meter (CCITT)

**Opt 001:** 1.6/5.6 mm 75 Ω Connector  
**Opt 004:** High Stability Frequency Reference

##### HP 3586B Selective Level Meter (N. American)

**Opt 001:** 75 Ω Connector mates with WECO 358A and 124 Ω Connector mates with WECO 372A  
**Opt 004:** Same as HP 3586A

##### HP 3336A Synthesizer/Level Generator (CCITT)

**Opt 001:** 1.6/5.6 mm 75 Ω Connector  
**Opt 004:** High Stability Frequency Reference  
**Opt 005:** High Precision Attenuator

##### HP 3336B Synthesizer/Level Generator (N. American)

**Opt 001:** 75 Ω WECO 358A, 124 Ω WECO 372A  
**Opt 004, 005:** Same as HP 3336A



- Low cost FDM surveillance
- Stored CCITT or Bell FDM plans
- Synthesizer frequency accuracy
- 0.2 dB amplitude accuracy
- Voice channel impairments
- Plotting and storage of data



HP 3046B



## Introduction

The HP 3046A/B systems are designed to automate measurements made on Frequency Division Multiplex (FDM) systems. These include tests such as pilot levels, carrier leaks and slot noise. The system, with all of its measurement power, requires no computer background to operate. Surveillance programs are configured simply by making choices from a series of measurement menus. The HP 3046A is designed for CCITT applications, while the HP 3046B meets North American (Bell) requirements.

This system is ideal for automating surveillance and routine maintenance on a local basis for small to medium capacity systems. Hewlett-Packard also provides automatic test equipment for large capacity FDM systems, using a distributed approach. See page 85-9.14 for a description of these automatic test systems. With a distributed system, remote selective level meters (SLMs) can be monitored from a central computer. With a local system such as the HP 3046A/B, each SLM computer is independent, making installation and operation easier, and the system more mobile.

## System Configuration

A standard HP 3046A/B consists of an HP 3586A/B Selective Level Meter with Transmission Impairments and two copies of the appropriate system software, contained on data cartridges. An HP-85 desktop computer is also required and may be ordered as part of the system. A minimum controller configuration includes the HP-85B, a 82936A ROM Drawer, an 00085-15004 Matrix ROM and the 82937A HP-IB interface.

System software consists of FDM surveillance programs with stored CCITT (HP 3046A) or Bell (HP 3046B) plans, and system test software. The system test software can be used to verify proper

system operation and to help identify the faulty component in case of a failure.

For applications requiring a precision signal source, an HP 3336A/B Synthesizer/Level Generator can be added to the system. A 0 dBm tracking source is standard with the HP 3586A/B.

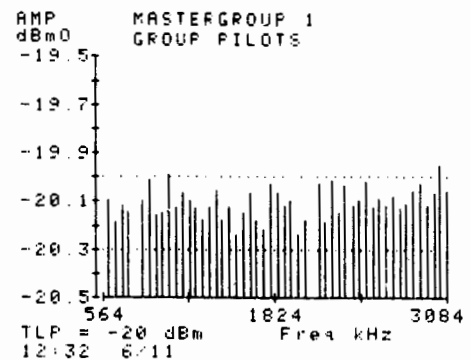

## Tabular and Graphic Outputs

An automatic system will collect large amounts of data in a short time, making effective presentation of the results vital. In addition to a variety of tabular listing formats, the Selective Level Measuring

# TELECOMMUNICATIONS TEST EQUIPMENT

## Selective Level Measuring System

Model 3046A/B (cont.)

145



(SLM) System provides graphics—the ability to plot measured results. A plot of hundreds of data points can be analyzed in seconds, providing real insight into the condition of the system. With only a tabular listing, interpretation of hundreds of data points is difficult if not impossible. An active marker is provided to read the amplitude of any point on the graph to 0.01 dB resolution and to list FDM number and frequency.

### Storage of Tests and Data

Tests are performed with an automatic system in much the same way they are done manually. First, the measurement parameters (frequency, bandwidth, etc.) are set, and then the measurement is made. The SLM System provides for storage of test parameters on the computer's built-in tape. With this feature often used test set-ups can simply be recalled from tape rather than having to be re-entered each time the test is run. In addition, a program can be stored in a file that will load and run when power to the computer is cycled. In this way a complicated series of tests can be run simply by turning the computer off and then on.

The system can also store measured data for future reference. Short term storage is automatic and has a capacity of 600 readings. This means that measured data can be retrieved any time after a test has been run. If an overnight test were run with only errors printed, this feature would allow printing or plotting of all the data in the morning.

Permanent storage on tape is also provided. This storage allows comparison of today's readings with those taken weeks or months earlier (limit is 600 readings). Data stored includes test limits, TLP, and the time of day and date when the measurement was made.

### Timed Measurements

Every printout of test results includes time from turn on or time of day, and the date. The system also provides for delayed start of test and/or repetition of the test at timed intervals. This makes it easy to run a test at night or over a weekend and monitor system performance over time.

### Provision for Custom Plans

An "array sweep" is available for testing of non-standard FDM plans. Each of four arrays has a capacity of 100 custom frequencies. Carrier tests can be performed at each test frequency, tested against limits and plotted or printed. Once an array of custom frequencies and the test at each is entered, it can be stored on tape for easy access.

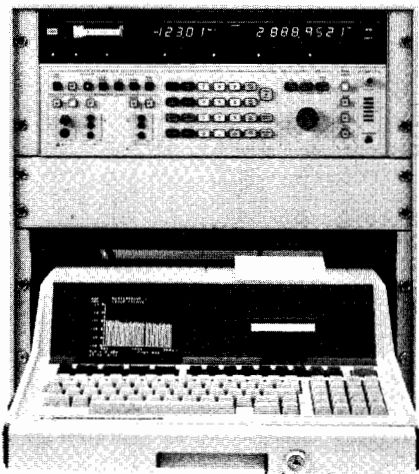

Option 400 cabinet with locking drawer

### Recommended Accessories

**Disk drive:** A disk drive, such as the HP 82901M or HP 9121D provides much faster access to programs and data. This is highly recommended if the level of system interaction is expected to be high. These drives interface the system via HP-IB (HP-IB cable not supplied; ROM included with HP 85B computer only.)

**Access switch:** An access switch and switch controller can be added to the system with simple program modifications. The recommended controller is the HP 3755A, with several compatible switches available.

### General

#### System Specifications

System accuracy specifications are identical to those of the HP 3586A/B and HP 3336A/B; see pages 142 and 143.

**Measurement speed:** 0.5 seconds/reading with no range change; 1.3 seconds/reading with range change; 3.3 seconds/reading with range change and Auto-cal.

### System Performance

#### FDM Carrier Tests

##### Pilots

**HP 3046A (CCITT):** Group, Supergroup, Mastergroup, Super-mastergroup, and Hypergroup.

**HP 3046B (North American):** Group, Supergroup and Mastergroup pilots. Non-standard pilots can also be measured.

**Carrier leaks:** Channel, Group and Supergroup.

**Test tones:** 1010 Hz or 800 Hz (HP 3046A) or 1004 Hz (HP 3046B) and custom tones.

**Signalling tones:** 2600 Hz (HP 3046B)

##### Channel Noise and Slot Noise

**HP 3046A:** Flat or Psophometric weighting

**HP 3046B:** Flat or C-Message weighting

#### Other Tests

##### Transmission Impairments

###### Phase Jitter

**Weighted Noise** with 3100 Hz channel filter

**Noise with Tone** (notched noise)

**Impulse noise** can be measured and graphed over any period of time up to 90 minutes

**Spot frequency:** in the spot frequency mode, the HP 3046 can measure and print the level at a single frequency. The point to be measured can be defined by frequency or FDM number. Wide band power can also be measured and printed out in this mode.

**System verification:** the system verification program verifies operation of the HP 3586A/B and the HP 3336A/B, and can be used to locate the source of a hardware failure.

#### Physical Parameters

**Temperature:** 5 to 40°C

**Relative humidity:** 95%, 0 to 40°C

**Altitude:** ≤4600 metres, 15,000 feet

### Ordering Information

**HP 3046S** Selective Level Measuring System

By ordering the system instrumentation and controller under this model number, total system compatibility is insured.

**HP 3046A** SLM System Instrumentation and Software (CCITT)

**HP 3046B** SLM System Instrumentation and Software (Bell)

**001:** Special Connector (HP 3586A/B Option 001)

**004:** High Stability Frequency Reference (HP 3586A/B Option 004)

**100:** Add HP 3336A/B Synthesizer/Level Generator

**101:** Special Connector (HP 3336A/B Option 001)

**104:** High Stability Frequency Reference

(HP 3336A/B Option 004)

**105:** High Accuracy Attenuator (HP 3336A/B Option 005)

**400:** Locking Cabinet for Standard System

**450:** Locking Cabinet for System with Synthesizer

**480:** 220 V Operation

**HP 85B** Controller configurations are priced beginning at  
Consult the HP 3046S System Configuration Guide for further details.



# TELECOMMUNICATIONS TEST EQUIPMENT

## 70 MHz Modulator/Demodulator

Model 3717A

- Up to 5 pre-/de-emphasis networks
- Video and telephony inputs and outputs
- Service channel provided
- Built-in 15 dB open-ended attenuator
- Optional HP-IB control
- Optional balanced BB input and output

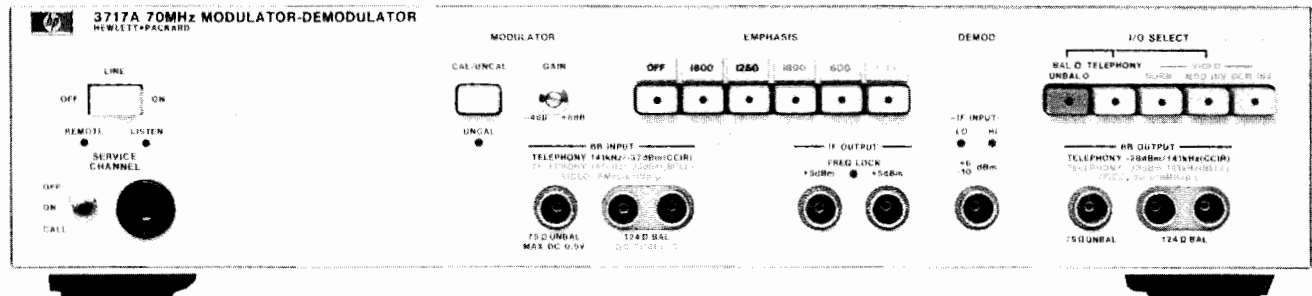

The HP 3717A 70 MHz Modulator/Demodulator can be used in microwave radio link systems to enable BB qualitative measurements to be made at non-demodulating repeater stations.

Standard measurement practice for the alignment and maintenance of microwave radio links involves two specific categories of tests, i.e. swept response measurements and BB qualitative measurements. Normal practice is to align a microwave radio initially by using swept response techniques such as those provided by an MLA. After these measurements have been completed successfully, qualitative measurements such as white noise loading, TV waveform testing, and BB frequency response are performed at the BB terminals of the microwave radio to verify operational performance.

However, the optimum swept response does not always produce the best possible qualitative figure. When this happens it may be necessary to isolate the faulty section by performing qualitative measurements from BB terminal stations to IF repeater stations, or vice versa. To do this, a high quality wideband test modulator or demodulator is required. The HP 3717A provides this capability.

### Specifications Summary

#### Back-to-Back Performance (telephony)

##### BB Frequency Response (with or without emphasis)

50 Hz to 10 MHz:  $\pm 0.2$  dB.

50 Hz to 20 MHz:  $\pm 3$  dB.

##### Noise Loading Performance

At manual loading for all slots, 70 to 7600 kHz (1800 channels with emphasis):  $\leq 25$  pWOp (57 dB NPR).

Thermal: mod/demod is thermally dominated and will typically tolerate a 6 dB overload with no degradation.

##### Spurious Response

300 kHz to 10 MHz:  $\leq -72$  dBm0.

#### Back-to-Back Performance (video)

##### BB Frequency Response

5 Hz to 10 MHz:  $\pm 0.2$  dB.

Square wave tilt (50 Hz):  $< 1.0\%$ .

Diff. Gain (4.43 MHz)\*:  $\leq 0.7\%$ .

Diff. Phase (4.43 MHz)\*:  $\leq 0.7^\circ$ .

\*Measured on an HP Microwave Link Analyzer with a test tone of 4.43 MHz.

### Options

#### Connector Options—Select Any One.

Std: BNC

003: Siemens small.

004: commercial equivalent of WECO 477B balanced input.

**Emphasis networks**—up to five may be installed and should be specified with every order. Other emphasis networks are available to special order.

#### CCIR

011: 24 channel emphasis.

012: 60 channel emphasis.

013: 120 channel emphasis.

014: 300 channel emphasis.

015: 600 channel emphasis.

016: 960 channel emphasis.

017: 1260 channel emphasis.

018: 1800 channel emphasis.

021: 525 line emphasis.

022: 625 line emphasis.

023: 819 line emphasis.

#### Bell

031: Bell 600 channel emphasis.

032: Bell 900 channel emphasis.

033: Bell 1200 channel emphasis.

034: Bell 1500 channel emphasis.

035: Bell 1800 channel emphasis.

#### Miscellaneous options

006: deletes Modulator section.

007: deletes Demodulator section.

100: HP-IB.

136: Combination of options 003 and 006.

137: Combination of options 003 and 007.

146: Combination of options 004 and 006.

147: Combination of options 004 and 007.

**HP 3717A 70 MHz Modulator/Demodulator**



# TELECOMMUNICATIONS TEST EQUIPMENT

## Microwave Link Analyzers and Accessories

Models 3711A/3712A, 3710A/3702B, 3743A, 3750A

147



- Test analog and digital radios
- Isolate and characterize causes of intermodulation distortion in wideband FM microwave radios



- Baseband and IF interfaces
- 70/140 MHz or 70 MHz only IF capability
- Selectable combinations of BB test tones

70/140 MHz IF MLA System

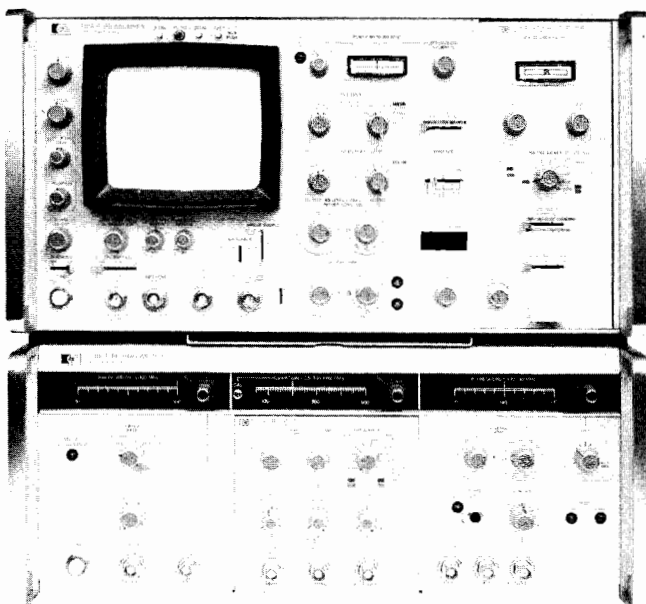

HP 3711A IF/BB Transmitter  
HP 3791B BB Transmitter (Plug-in)  
HP 3712A IF/BB Receiver  
HP 3793B Diff. Phase Detector (Plug-in)

70 MHz IF MLA System

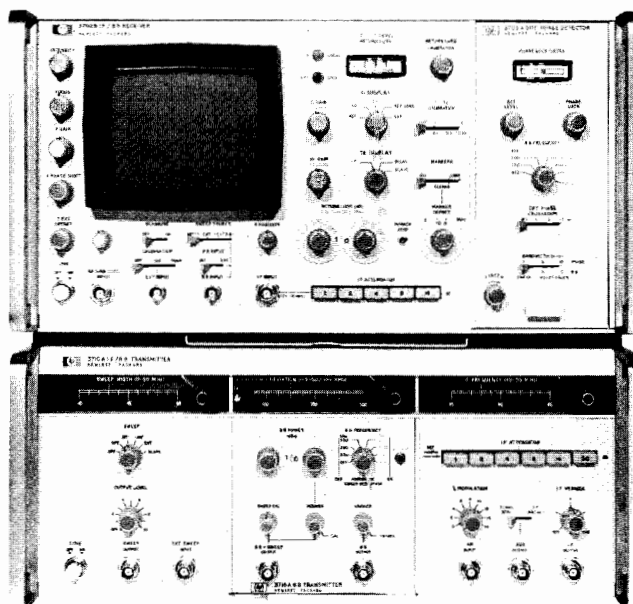

HP 3710A IF/BB Transmitter  
HP 3716A BB Transmitter (Plug-in)  
HP 3702B IF/BB Receiver  
HP 3705A Group Delay Detector (Plug-in)

Two versions of the Microwave Link Analyzer (MLA) are available: the 70 MHz IF HP 3710A/3702B System, and the dual 70/140 MHz IF HP 3711A/3712A System. For microwave radio stations employing both 70 and 140 MHz intermediate frequencies, the dual IF MLA is an economical way of providing a complete range of dedicated measurements at both IF's.

The HP 3710A/3702B and HP 3711A/3712A MLA's isolate and characterize causes of intermodulation distortion in wideband microwave radios. They have applications in both analog and digital radio systems. Measurements performed by the MLA's include:

- BB power, gain, and loss
- IF power, gain, and loss
- modulator/demodulator deviation sensitivity
- modulator/demodulator linearity
- modulator/demodulator group delay
- swept IF amplitude response
- swept IF group delay
- swept IF return loss
- BB and IF differential gain (HF linearity)
- BB and IF differential phase (HF group delay)
- BB return loss

When used with the HP 8620C/86200 Series RF Sweeper system (equipped with the MLA interface option) and the HP 3730B RF Down Converter, the swept measurements of the basic MLA's can be extended to RF. Pages 149 and 150 give further details about this RF instrumentation (HP 3730B and 8620C).

Apart from the dual 70/140 MHz IF capability, with the full range of measurements available at both frequencies, the HP 3711A/3712A MLA has many other refinements over earlier systems. These include an improved marker system, an IF input frequency counter, improved input sensitivity at  $-19$  dBm, a slope control, a 16 dB dynamic display range, and X-Y Recorder facilities.

Another major contribution is the provision of an interface for the HP 8501A Storage-Normalizer. Use of this instrument with the HP 3711A/3712A MLA provides digital averaging and normalizing facilities. Further, measurement limit masks and adjustment instructions can be displayed on the MLA screen when a desk-top computing controller is used with the Storage-Normalizer.

A series of options are available with the MLA's, including:

- test-tone frequencies
- connectors
- balanced 124  $\Omega$  baseband impedance
- sweep frequencies
- variable phase output of sweep signal

# TELECOMMUNICATIONS TEST EQUIPMENT



## Microwave Link Analyzers and accessories

Models 3711A/3712A, 3710A/3702B, 3743A, 3750A (cont)

### Options (HP 3711A/3712A and 3710A/3702B MLA's)

To compile a suitable MLA System for your application, select *one* of the following combinations:

**70/140 MHz IF**— HP 3711A/3791B/3712A/3793B.

**70 MHz IF with Low- and High-Frequency Test-Tones**

HP 3710A/3716A/3702B/3705A.

### Connector Options

(HP 3711A/3791B/3712A/3710A/3716A/3702B only)

Option	BNC	Siemens Large	Siemens Small	WECO 477B	WECO 560A
Std	•				
002		•			
003			•		
004				•	
005*					•

\* Available with 3711A/3791B/3712A only.

### Test-Tone (BB) Options

(HP 3791B/3793B/3716A/3705A)

HP 3791B/ 3793B/ 3716A/ 3705A	Test-tone Frequencies											
	83.333 250 & 500 kHz	92.593 277.778 & 555.556 kHz	55.556 92.593 & 277.778 kHz	2.4 MHz	3.50 MHz	3.58 MHz	4.43 MHz	4.50 MHz	5.60 MHz	8.20 MHz	12.39 MHz	
Options	•	•	•	•	•	•	•	•	•	•	•	
Std	•	•	•	•	•	•	•	•	•	•	•	
010		•	•	•	•	•	•	•	•	•	•	
011		•	•	•	•	•	•	•	•	•	•	
012		•	•	•	•	•	•	•	•	•	•	
013	•			•	•	•	•	•	•	•	•	
014	•			•	•	•	•	•	•	•	•	
016	•			•	•	•	•	•	•	•	•	
018	•			•	•	•	•	•	•	•	•	
019	•			•	•	•	•	•	•	•	•	
021*		•	•	•	•	•	•	•	•	•	•	
022	•			•	•	•	•	•	•	•	•	
210*			•	•	•	•	•	•	•	•	•	
211*			•	•	•	•	•	•	•	•	•	
212*			•	•	•	•	•	•	•	•	•	
221*			•	•	•	•	•	•	•	•	•	

\* Available with 3791B/3793B only.

### Sweep Frequency Options (HP 3711A/3710A only)

Option	70 Hz	LINE	Opt			
			70 Hz	50 Hz	100 Hz	18 Hz
Std	•	•	•			
006	•	•		•		
007	•	•			•	
015	•	•				•

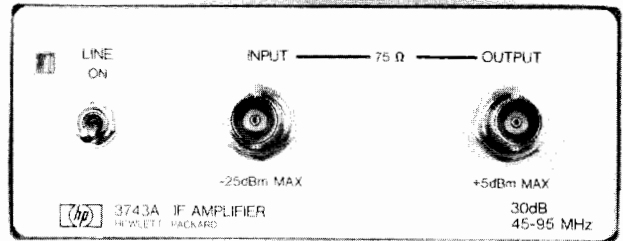

HP 3743A IF Amplifier

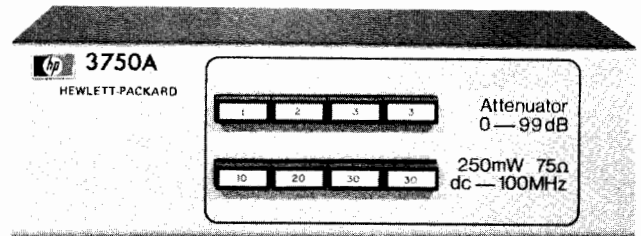

HP 3750A Attenuator

### Miscellaneous Options

- 008** (HP 3711A/3710A only) Variable phase sweep output.
- 015** (HP 3793B/3705A only) Additional phase detector bandwidths of 90 and 180 Hz—must be used with 18 Hz sweep rate on HP 3711A or 3710A IF/BB Transmitter.
- 020** (HP 3712A only) CRT graticule illumination.
- 908** (HP 3711A/3712A/3710A/3702B only) Rack mounting kit.
- 910** Extra manuals.

### HP 3743A IF Amplifier

- Improve MLA IF input sensitivity to -40 dBm.
- Frequency range 45 to 95 MHz.
- Group delay < 0.3 ns.
- Amplitude flatness < 0.2 dB.
- Return loss > 26 dB (75 Ω).
- Noise figure ≤ 8 dB.

### HP 3750A Attenuator

- Impedance 75 Ω.
- Attenuation range 0 to 99 dB, in 1 dB steps.
- Frequency range dc to 100 MHz.

### Ordering Information

**70/140 MHz system** (HP 3711A/3791B/3712A/3793B)

**70 MHz system with low- and high-frequency test-tones** (HP 3710A/3716A/3702B/3705A)

HP 3743A IF Amplifier

HP 3750A Attenuator



- RF to IF frequency conversion
- 1.7 to 14.5 GHz frequency range

- Extends test capability of MLA's to RF
- 70 or 140 MHz IF output

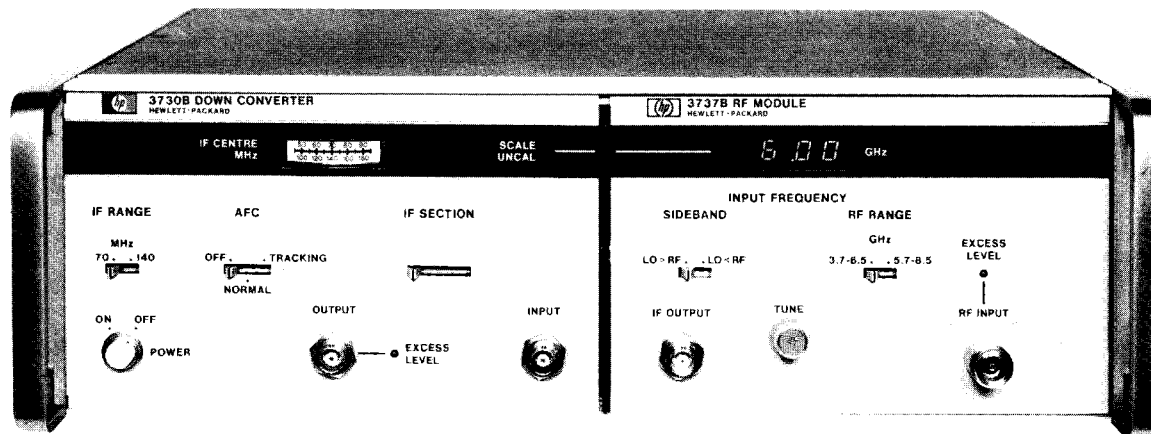

HP 3730B Option 010 Down Converter mainframe with HP 3737B RF Module plug-in

The HP 3730B Down Converter and plug-ins provide RF to IF conversion and RF test capabilities for Microwave Link Analyzers (MLA's). The 0.7 to 14.5 GHz RF range is accommodated by a series of local oscillator plug-ins, allowing easy tuning to the desired operating frequency.

The HP 3730B has dual IF capability which allows the Down Converter to interface with single 70 MHz IF (eg HP 3710A/3702B) or dual 70/140 MHz IF (eg HP 3711A/3712A) MLA's, or with wide-band demodulators (eg HP 3717A) when white noise loading.

A tracking AFC and recovered sweep facility causes the local oscillator in the HP 3730B to track the incoming swept RF signal, thus almost eliminating the swept component of the IF signal. This feature is particularly useful in wideband applications. It allows the Down Converter to be used in conjunction with an Up Converter and a conventional MLA to perform RF to RF measurements over bandwidths of up to 250 MHz.

The tracking AFC facility also has advantages when operating over conventional measurement bandwidths of a Microwave Link Analyzer. Because of the effective sweep compression of the IF signal, the residual distortions of both the Down Converter and Microwave Link Analyzer receiver are reduced considerably.

Provision has been made for incorporating an isolator in the RF input of the Down Converter. The standard RF input circuit of the HP 3730B is broadband. However, for some measurement applications, introducing a narrow band isolator can provide substantial benefits, eg improved input return loss, reduced L.O. leakage, improved noise figure and increased input sensitivity

On a microwave radio route containing a number of repeater stations, the local oscillator can be positioned above or below the carrier frequency and this can vary from repeater station to repeater station. This can cause difficulties when comparing MLA responses between stations due to frequency axis inversion of the swept response. Selecting upper or lower sideband operation on the HP 3730B overcomes this.

Lengthy runs of RF cable between the Down Converter and the RF test point can generate ripple responses which can mask the true measurement response. To avoid this problem, it is possible to remove the Down Converter plug-in and mount this directly onto a waveguide test point. The plug-in is then supplied with its power and mainframe control signals via an umbilical cable (HP 15609A). The plug-in's IF output is connected to either the HP 3730B or the measurement system, eg an MLA, via a cable of suitable length. This reduces the possibility of erroneous measurements as only IF signals are transmitted from the test point.

Option 010 of the HP 3730B incorporates an additional IF section, comprising a 25 dB fixed gain amplifier and a 30 dB stepped attenuator, to ensure that the IF signal level is sufficient to drive most MLA's when operating at RF input levels below -12 dBm. Note that no degradation of the residual performance specifications occurs when this option is fitted.

## Specifications

### HP 3730B + 3736B/7B/8B/9B

#### Residual Performance

	50 MHz Sweep Width at 70 MHz centre frequency	100 MHz Sweep Width at 140 MHz centre frequency
Amplitude Response	0.2 dB	0.3 dB
Group Delay	0.2 ns	0.3 ns
Diff Gain (5.6 MHz test tone)	0.3%	0.5%
Diff Phase (5.6 MHz test tone)	0.3°	0.5°

The residual specifications quoted are measured using the FM Sweep Input to reduce the residual contributions of the RF test source, and using storage normalizer techniques to remove MLA receiver contributions. Further improvements in the residual performance can be obtained by utilising the HP 3730B's unique tracking AFC facility.

**Min RF input level:** -15 dBm, typically (-40 dBm when Opt 010 is fitted), for correct operation of MLA; however, min input level dependent on input sensitivity of MLA and RF-IF gain conversion of Down Converter (HP 3710A/3702B MLA—min input sensitivity -10 dBm; HP 3711A/3712A MLA—min input sensitivity -19 dBm).

**Size:** 141 mm H x 425 mm W x 467 mm D (5.5 x 16.75 x 18.38 in.)

**Power supply:** 100, 120, 220, or 240V ac, +5 -10%; 48 to 66 Hz; consumption 100 VA max, including plug-in.

**Weight:** 11.9 kg (26 lb) net, including plug-in.

**Temperature range:** 0 to 55°C, operating.

#### Options

**010:** 25 dB fixed gain amplifier, with 30 dB (10 dB step) attenuator.

#### Accessories

**HP 15600A** Isolator: 3.7 to 4.2 GHz.

**HP 15601A** Isolator: 5.9 to 6.5 GHz.

**HP 15602A** Isolator: 7.1 to 8.5 GHz.

**HP 15603A** Isolator: 10.7 to 11.7 GHz.

**HP 15609A** Remote Extender Cable: 3 metre umbilical cable.

#### Ordering Information

**HP 3730B** Down Converter

**HP 3736B** RF Module 1.7 to 4.2 GHz

**HP 3737B** RF Module 3.7 to 8.5 GHz

**HP 3738B** RF Module 5.9 to 11.7 GHz

**HP 3739B** RF Module 10.7 to 14.5 GHz



# TELECOMMUNICATIONS TEST EQUIPMENT

## RF Sweeper MLA Upconverter Simulation

Models 8350, 8620C, 86200 Series RF Plug-Ins

- MLA upconverter simulator options 0.5 to 18.0 GHz
- Use with MLA or as a general purpose sweeper
- Swept and CW RF source
- Test digital & analog microwave radio systems & components

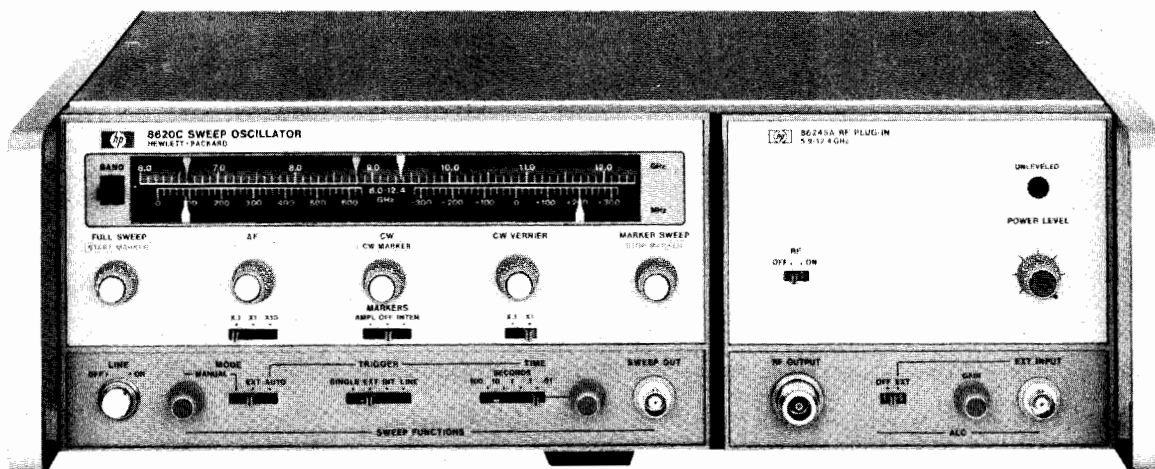

HP 8620C/86245A

### Description

The HP 8620C Sweep Oscillator and HP 86200 Series of RF plug-ins provide a high performance, solid state source for Microwave Radio System tests via MLA Upconverter Simulation Options. These permit accurate RF-to-BB, RF-to-IF and RF-to-RF distortion measurements to be made with the HP 3700 Series MLA Systems. The plug-ins can also be used as standard sweeper plug-ins, with the only basic difference being modified FM circuitry. The RF-to-RF measurements must be made in conjunction with the HP 3730B RF Down Converter. This allows group delay, linearity, differential gain and phase measurements to be made on RF devices and components within the Microwave Radio System. The HP 8350 Sweep Oscillator Mainframe is also compatible with the HP 86200 series MLA option plug-ins through the use of the HP 11869A Adapter (see page 486).

### Specifications

The HP 8620C/86200 Series MLA Upconverter Simulation Plug-ins are optimized for group delay, linearity, and differential gain and

phase over the specified frequency range. All plug-ins can be used with MLA sweep widths of 100 MHz (200 MHz with Option H42) or less. The following specifications supplement the standard HP 8620C system specifications (covered on pages 488-493).

### Complementary Equipment

HP 8350 Sweeper Mainframe

HP 11869A Adapter

HP 8620C Sweeper Mainframe (required)

To properly interface the HP 8620C/86200 Series plug-in to the item under test, the following are recommended for optimal performance:

HP 784C Directional Detector (1.7 – 12.4 GHz)

**Flatness over any 30 MHz:**  $< \pm 0.1$  dB

**Equivalent source match:** typically  $\leq 1.5$

HP 11675B Leveling Cable Assembly (1.7 – 12.4 GHz)

**Group delay:**  $\leq 0.25$  ns p-p (with 1.25 SWR at each end)

### MLA Upconverter Simulation Plug-in Specifications (25°C)

HP Model Number <sup>1</sup>	MLA Option Number	MLA Freq. Range (GHz)	Group Delay (ns) p-p	Linearity (%)	Diff. Gain (%)	Diff. Phase (°)	FM Sens. (MHz/V)
			@277.7 kHz		@5.6 MHz <sup>2</sup>		
			Across Any 30 MHz BW				
86222A/B	H80	0.5–2.4	<3	<2.5	<2.5	<3	N/S
86235A	008	1.7–4.3	<2	<2.0	<2.0	<2	+20
86240C	—	3.6–8.6	<1	<0.5	<0.5	<1	+20
86242D	008	5.9–9.0	<1	<0.5	<0.5	<1	+20
86245A	008	5.9–12.4	<1	<0.5	<0.5	<1	+20
86250D	008	8.0–12.4	<1	<0.5	<0.5	<1	+20
86260A	H82	12.0–18.0	<3	<2.5	<2.5	<3	N/S

<sup>1</sup>Internal leveling is standard on all HP 86200 series plug-ins.

<sup>2</sup>Except HP 86222A/B & 86260A which are tested @ 2.4 MHz.

For applications requiring better distortion specifications, HP also offers plug-in systems which include a leveling cable and directional coupler. These systems are available in the following bands: 5.8–6.5 GHz, 7.0–8.6 GHz, 10.7–11.7 GHz, and 12.2–12.7 GHz. The system specifications are as follows:

**Group delay @ 500 kHz:**  $< 0.5$  ns p-p

**Linearity @ 500 kHz:**  $< 0.25\%$

**Flatness:**  $< \pm 0.1$  dB

For more information consult your local HP Field Engineer.

The options shown after each plug-in provide the special MLA interface capability. Refer to pages 488-493 for details on other RF Sweeper plug-in specifications and options.

# TELECOMMUNICATIONS TEST EQUIPMENT

Remote Access and Test System

Model 37100S

151



- Remote testing of private voice-frequency circuits finds faults fast
- Access to any circuit without moving from the keyboard
- Modular design means system is now even more suitable for all sizes of installation
- New, lower-cost version for small installations
- User-friendly software means no special keyboard skills are required



The HP 37100S Remote Access and Test System provides the hardware and support for nationwide testing and troubleshooting of private voice-frequency lines. Circuits can be accessed and tests carried out at remote sites under control from a central site. Any number of remote sites may be accessed, allowing fast fault isolation to a particular section of the network. This greatly reduces the time taken to restore a faulty circuit.

The HP 37100S is modular at all levels, providing solutions all the way from large telephone companies with many lines to the smaller systems required by end-users. The system is designed with expansion in mind: additional circuits, extra test features, more test personnel - all are easily accommodated.

## Remote Site Configurations

Five types of module have been designed by HP and these provide the basic building blocks of any HP 37100S system.

### Access Module (AM) - 19 inch rack (HP 37150A)

The circuits to be tested are cabled to the AMs which are situated at remote sites or offices. This allows testing between any two points on the network. Each AM accommodates up to 96 4-wire circuits via its 4 Access Cards and AMs can be chained together to a maximum of 15 (1440 4-wire circuits).

The connectors for the AM cards have a make-before-break action, allowing cards to be removed or replaced without breaking the continuity of any circuits.

### Test and Measurement Unit (TMU) — 19 inch rack (HP 37160A)

Up to 4 TMUs can be connected to a chain of AMs. The following features are provided:

- Multimeter measurements - dc/ac voltage and current, resistance and capacitance
- Variable level and frequency signal source
- Flat or weighted level measurements

- Selective level measurements
- Pair selection, splitting and termination
- Crossover, loopback, top-ring and/or pair reversal
- Audio talk/monitor with automatic gain
- Signaling
- ERL, SRL
- P/AR
- Test Desk
- External equipment connection

As features are provided on separate cards, only those that are required need be specified - others can be added later.

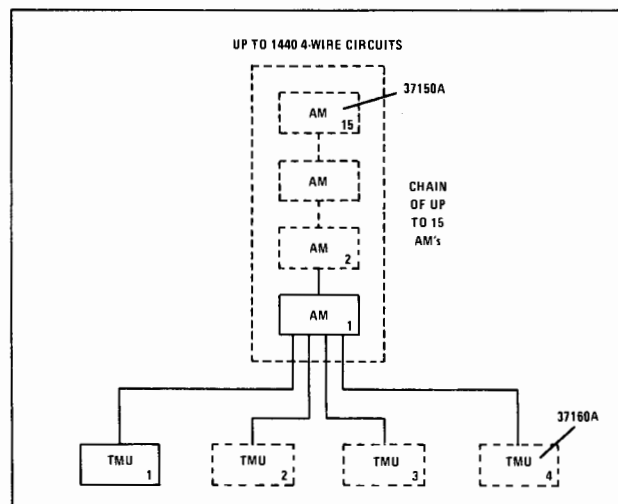



# TELECOMMUNICATIONS TEST EQUIPMENT

## Remote Access and Test System

Model 37100S (cont.)

### Chain Selector (CS) - 19 inch rack (HP 37180A)

If more than one chain of 15 AMs (1440 4-wire circuits) is required at any remote site, then Chain Selectors are interfaced between the TMUs and AMs. This allows up to 60 TMUs to be connected to up to 30 chains of AMs (a total of 43,200 4-wire circuits).

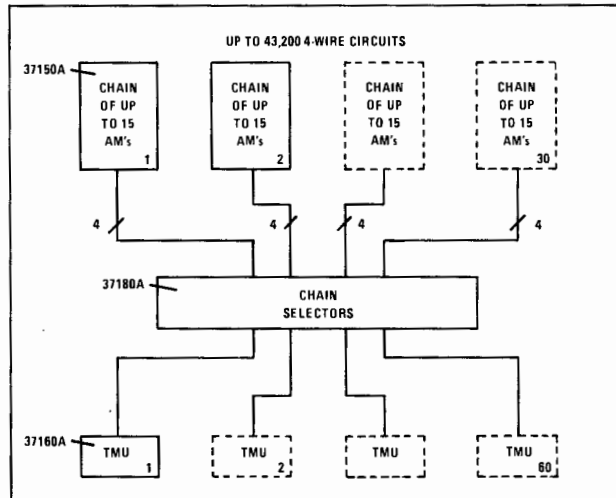

### New - Combined TMU and AM - 23 inch rack (HP 37140A)

- By increasing the width of the card cage and omitting some optional features, access and test is provided in one module. This leads to significant cost savings, particularly for small installations.
- Provides the full range of TMU features and measurements plus accessing for up to 96 4-wire circuits.
- Fully compatible with existing HP 37100S hardware and software, and uses the same cards.

### New - Dual AM - 23 inch rack (HP 37130A)

- Each module accommodates up to 192 4-wire circuits via 8 Access Cards.
- Fully compatible with HP 37150A AM, and both types can be intermixed if required.

The HP 37130A Dual AM can be configured for either single or dual bus operation. In either case, primary blockage is higher than with the four-bus HP 37150A AM.

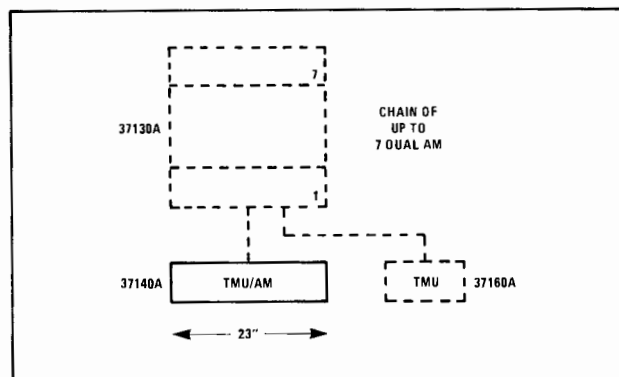

- Single bus configuration - ideal for small stations of 24 to 288 4-wire circuits.
- Dual bus configuration - suitable for intermediate stations of up to 1440 4-wire circuits (can be further expanded using CS).

## Central Site Configuration

### System Control

There are two different ways of driving the system:

#### Computer Mode

The majority of users will drive the system in computer mode for most of the time. This allows Centralized Remote Access and Test with all of its inherent benefits. User-friendly soft keys and screen graphics combine to provide a technician with the tools needed for fast troubleshooting. Even at the remote sites, a terminal can be attached to a TMU and provides the same power as a terminal at the central site. This means that any circuit at any site connected to the system can be accessed via this terminal. Also, data base updating is feasible at each remote site and circuit records can be modified as soon as changes occur.

An HP 1000 A-Series Computer is used in the HP 37100S.

#### Local Mode

There will be occasions when users will not choose to drive the system through the computer. For example, during commissioning of new circuits and when a computer link has still to be established.

In these cases, Local Mode provides access and test via a terminal connected to a TMU at any remote site. All of the powerful access and test features still apply in this mode but circuits can only be accessed at the remote site where the technician is working.

#### Distributed System

Very large Systems with many accesspoints can have more than one central site, each with its own computer. These computers communicate with each other over HP's Distributed Systems Network. This allows access to any circuit on the network from any terminal.

#### Technician/Machine Interface

The 37100S uses 8 soft keys (programmable function keys) on the terminal to make the technician/machine interface extremely friendly. The technician is asked to make one of 8 choices. On pressing a soft key to indicate a choice, the labels on the screen change. The same 8 soft keys can then be used to make different choices. The technician is guided through a test sequence - the only inputs from the rest of the keyboard are concerned with numeric values and the circuit access points.

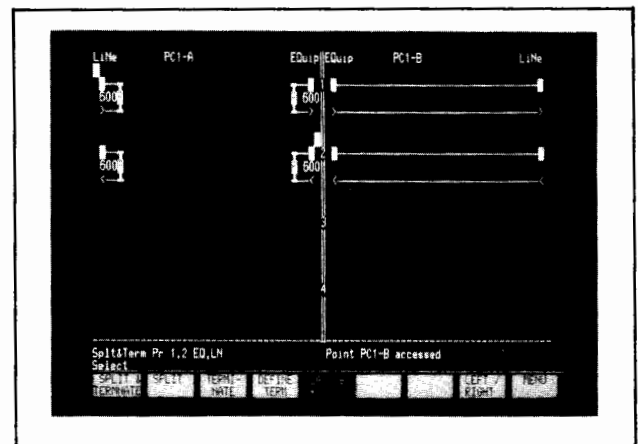

#### Screen graphics

Full details of the specifications of individual cards and the system in general are contained in the HP 37100S data sheet.





DVM's have historically been optimized for either a systems environment where speed is important or for bench applications where high accuracy, high resolution and low noise are paramount. HP offers both systems and bench dmm's with speed and accuracy trade-offs provided by the multislope A/D technique introduced in the HP 3456A. The HP 3456A is the high accuracy, high speed dmm equipped with HP-IB for test system applications. The HP 3468A/B and 3478A are a family of lower cost dmm's with  $3\frac{1}{2}$  to  $5\frac{1}{2}$  digit resolution and a full five functions. The HP 3478A is completely programmable via HP-IB and the HP 3468A/B are completely programmable via HP-IL. The HP 3468A dmm comes in a streamlined case with handle suited to portable applications and the new HP 3468B is in a rack and stack case for convenient bench use.

The new family of lower cost dmm's have a new electronic calibration that eliminates potentiometer adjustments. Calibration constants are stored in non-volatile memory and kept alive by a lithium battery capable of retaining the calibration constants for more than 10 years.

A new, low cost interface for peripheral and instrumentation is found in the HP 3468A/B. It is called HP-IL, the Hewlett-Packard Interface Loop. The new interface offers a low power, multidrop serial interface

which allows interfacing between handheld calculators like the HP 41C/CV and the series 80 Personal Computers and the HP 3468A/B DMMs. All of this computational power can be applied to automate measurements on the bench or in a production environment.

With the power of a programmable calculator and the HP 3468A/B, software can easily be developed to analyze and store data for a customer's specific application. For example, if a customer needs to measure temperature, he can use the HP 41C/CV to linearize the transducer device and display the results in degrees C or F right on the display of the HP 3468A/B. With a simple HP 41C/CV program, the HP 3468A/B can display in dBm referenced to any impedance for audio and telecommunication applications. For applications such as resistor tolerance or performance testing of a device, the HP 3468A/B can easily be programmed to provide the measurements necessary for tolerance testing.

For HP-IB systems the new HP 3478A DMM offers high system performance at low cost bench prices. The HP 3478A measures dc volts, true rms ac volts, 2 and 4 wire ohms, and current with  $3\frac{1}{2}$ ,  $4\frac{1}{2}$ , or  $5\frac{1}{2}$  digit resolution. It measures dc voltage from 30 mV full scale with 100 nanovolt sensitivity up to 300

volts. This wide dynamic range allows detection of low level signals or higher voltages and reduces the amount of signal conditioning necessary. The HP 3478A has a 300 kHz bandwidth and 4:1 crest factor to give customers confidence in true rms ac voltage measurements. Either 2-wire or 4-wire ohms measurements can be selected with a maximum range of 30 Mohms down to a 100 microhm sensitivity on the 30 ohm range. 4-wire ohms can be used for reducing errors caused by cable resistance and relay scanners in a customer's system or the 2-wire ohms can be used for convenience. Both .3 A and 3 A ranges of dc and true rms ac current are provided, completing the function capability of the HP 3478A.

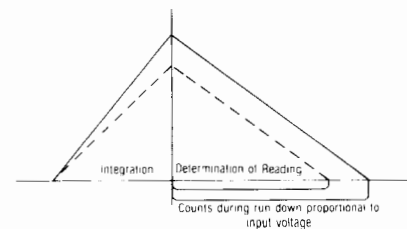
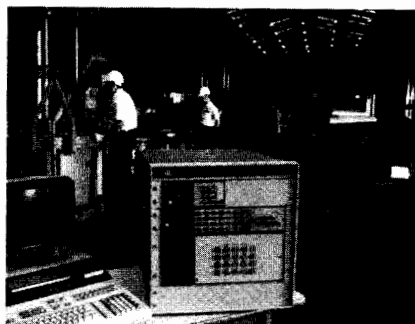

Figure 1. The classical dual-slope integration technique is limited in speed to how fast the zero crossing can be detected accurately. In addition, the final reading is not known until rundown has been completed. Note that the voltage remaining in the integrator's capacitor is proportional to input level.



### HP IC Technology Lowers the Cost of Multi-slope A/D Conversion

The A/D conversion technique pioneered by the HP 3456A has been refined with monolithic clip technology on the HP 3468A/B and 3478A to give high performance at very low cost. In addition, the reduced number of parts in the new multi-meters means reduced

service problems and lower cost of ownership. The basic design contributions of the multi-slope technique are:

1. Speed
2. Elimination of high speed logic in the zero comparator.
3. Keeping the run-up slopes steep to effectively extend the range of the comparator.
4. Completion of the A/D conversion during the measurement.
5. Conversion of the gain errors and timing errors into offset errors where they can be subtracted out.

In summary, the design emphasis of the HP 3468A/B and 3478A lets the customer match his DMM needs to the performance level required. Either extremely high performance in resolution, speed, and accuracy with the HP 3456A or low cost for automated bench use with the HP 3468A/B &

3478A. The DMM Selection Chart below can help in the selection of the DVM for a bench or system application.

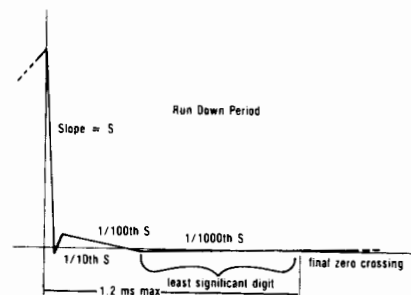

Figure 2. The Multi-slope II technique used in the 3456A Digital Voltmeter employs a four-slope rundown to successively establish the value of the four least significant digits in the final reading. Note that the final zero crossing which determines the least significant digits is done with the shallowest slope.

## BENCH DVM'S

DVM's	Features	dc Volts				Basic Accuracy	Bandwidth	Resistance			Current		General		
		Max. Input	Rdgs/Sec	Ranges	Sensitivity			Ranges	Sensitivity	Open Circuit Voltage	ac	dc	Ranging	Over-range	Other
HP 3435A 3½ digit p. 165	<ul style="list-style-type: none"> <li>Accuracy</li> <li>10 milli Ω</li> </ul>	1200 V	4.7	100 mV to 1200 V	100 μV	±(.1% Rdg. + 1 count)	100 kHz	10 Ω to 10 MΩ	10 milli Ω	< 5 V	Yes	Yes	Auto/Manual	100%	Battery Power Opt 002
HP 3466A 4½ digit p. 162	<ul style="list-style-type: none"> <li>Autorange</li> <li>True RMS</li> <li>1 μV sensitivity</li> </ul>	1200V	4.7	10 mV to 1200 V	1 μV	±(.03% Rdg. + 1 count)	100 kHz True rms	10 Ω to 10 MΩ	1 milli Ω	< 5 V	Yes True rms	Yes	Auto/Manual	100%	Battery Power Trms/ac or dc
HP 3468A/B 3½-5½ digit p. 163	<ul style="list-style-type: none"> <li>HP-IL</li> <li>5 Functions</li> <li>Low Cost</li> </ul>	300 V	32 (3.7 with 5½ digit)	.3 V to 300 V	1 μV	±(.0035% Rdg. + 2 counts)	300 kHz True rms	300 Ω to 30 MΩ	1 mΩ	<6.5 V	Yes True rms	Yes	Auto/Manual	N/A	Battery-Option 001 HP-IL

## SYSTEM DVM'S

DVM's	Features	dc Volts				Basic Accuracy	Bandwidth	Resistance			Current		General		
		Max. Input	Rdgs/Sec	Ranges	Sensitivity			Ranges	Sensitivity	Open Circuit Voltage	ac	dc	Ranging	Over-range	Other
HP 3437A 3½ digit p. 161	<ul style="list-style-type: none"> <li>HP-IB</li> <li>High speed Sample/Hold</li> </ul>	20 V	5700	100 mV to 10 V	100 μV	±(.03% Rdg. + 2 counts)							Manual	100%	HP-IB Int. timer Sample/Hold Hold
HP 3455A 5½, 6½ digit p. 160	<ul style="list-style-type: none"> <li>HP-IB</li> <li>AutoCal</li> </ul>	1000 V	24	100 mV to 1000 V	1 μV	±(.002% Rdg. + 1 count)	1 MHz True rms	100 Ω to 10 MΩ	1 milli Ω	< 5 V			Auto/Manual	50%	HP-IB, guarded, 4 terminals, Math
HP 3456A 3½, 4½, 5½, 6½ digit p. 157	<ul style="list-style-type: none"> <li>High Performance</li> <li>Selective integration time</li> </ul>	1000 V	330 (48 with 6½ digits)	100 mV to 1000 V	100 nV	±(.0008% Rdg. + 2 counts)	250 kHz True rms	100 Ω to 1 GΩ	100 μΩ	< 9.5 V			Auto/Manual	20%	HP-IB, guarded, Statistics, Pass/Fail, Offset, % error
HP 3478A 3½-5½ digit p. 155	<ul style="list-style-type: none"> <li>HP-IB</li> <li>5 Function</li> <li>Low Cost</li> </ul>	300 V	71 (4.4 with 5½ digits)	30 mV to 300 V	100 nV	±(.0034% Rdg. + 2 counts)	300 kHz True rms	30 Ω to 30 MΩ	100 μΩ	<6.5 V	Yes True rms	Yes	Auto/Manual	N/A	HP-IB, 4 Wire Ω, Full 5 Functions
HP 3497A 3½, 4½, 5½ digit p. 182	<ul style="list-style-type: none"> <li>Selectable # of digits</li> <li>Built-in memory</li> </ul>	120 V	300 (50 with 5½ digits)	0.1 V to 100 V	1 μV	±(.002% Rdg. + 1 count)		Program. current source for ohms					Auto/Manual	20%	HP-IB, Guarded Built-in mem. Program. current source

# VOLTMETERS, DIGITAL & ANALOG

Low Cost 3½ to 5½ Digit HP-IB Multimeter

Model 3478A

155



- 5 measurement functions
- Up to 71 readings/s

- Electronic calibration
- 100 nanovolt resolution

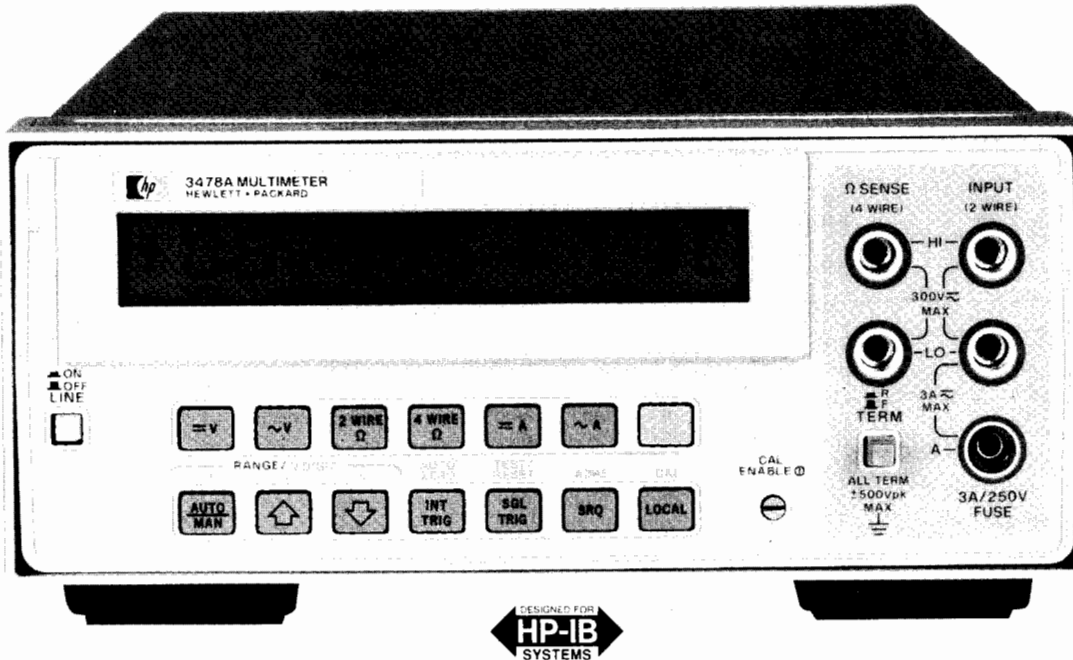

HP 3478A



## Description

The HP 3478A provides a low cost, completely HP-IB programmable solution for system measurements. Selectable 3½ to 5½ digit resolution and 5 autoranging functions offer flexibility in automated testing. The HP 3478A can measure DCV, true RMS ACV, 2- and 4-wire ohms, and dc and ac current. Simple, fast electronic calibration eliminates all adjustments to provide a lower cost of ownership.

## Performance

Selectable speed and resolution provide the right capability for your measurement. The HP 3478A can perform production tests or acquire experimental data at 71 readings/s with 3½ digit resolution, or take 33 readings/s with 130 dB of noise rejection using 4½ digits. The 5½ digit mode offers 100 nVdc and 100 μΩ resolution for precise measurements. True RMS with 300 kHz bandwidth and 4:1 crest factor provides reliable measurements of ac signals. Fast autoranging makes the first reading useful and accurate.

## Designed for Systems

Switchable front/rear inputs permit flexible system connections. The Voltmeter Complete output and External Trigger input allow synchronization of the HP 3478A with a scanner for fast multiplexed measurements without the delay of software commands. The test program can automatically present messages or results on the alphanumeric liquid crystal display. The operator can then respond by pressing the HP 3478A's SRQ key to interrupt the controller and start the next test. Built-in self-test capability assures proper operation.

## Electronic Calibration

Complete calibration of the HP 3478A is accomplished without any internal adjustment or removing the instrument's covers. The simple and fast electronic calibration procedure lowers the cost of ownership. You only need to connect standards to the HP 3478A and store calibration constants in the HP 3478A's non-volatile memory. Calibration can be done manually from the front panel or automatically using HP-IB.

## Specifications

### DC Voltage

#### Input Characteristics

Range	Maximum Reading (5½ digit)	Resolution		
		5½ digit	4½ digit	3½ digit
30 mV	±30.3099 mV	100 nV	1 μV	10 μV
300 mV	±303.099 mV	1 μV	10 μV	100 μV
3 V	±3.03099 V	10 μV	100 μV	1 mV
30 V	±30.3099 V	100 μV	1 mV	10 mV
300 V	±303.099 V	1 mV	10 mV	100 mV

**Input resistance:** 30 mV, 300 mV, 3 V ranges: >10<sup>10</sup> Ω  
30 V, 300 V ranges: 10 MΩ ±1%

**Maximum input voltage** (non-destructive): Hi to Lo: 303 Vrms or 450 V peak; Hi or Lo to Earth Ground: ±500 V peak

**Measurement accuracy:** ±(% of reading + number of counts). Auto zero ON.

### 5½ Digit Mode

Range	T <sub>Cal</sub> * ±1°C	T <sub>Cal</sub> * ±5°C	
	24 Hour	90 Day	1 Year
30 mV	0.027 + 35	0.03 + 41	0.04 + 41
300 mV	0.005 + 4	0.0074 + 5	0.02 + 5
3 V	0.0034 + 2	0.0059 + 2	0.019 + 2
30 V	0.005 + 3	0.0074 + 3	0.02 + 3
300 V	0.0055 + 2	0.0076 + 2	0.02 + 2

\*T<sub>Cal</sub> is the temperature of the environment where the HP 3478A was calibrated. Calibration should be performed with the temperature of the environment between 20°C and 30°C.

**4½ and 3½ digit mode:** accuracy is the same as 5½ digit mode for % of reading; use 1 count for number of counts on all ranges except 30 mV, use 4 counts.



# VOLTMETERS, DIGITAL & ANALOG

**Temperature coefficient:** 0° to 55°C, 5½ digits, auto zero ON. ±(% of reading + number of counts)/°C

Range	Temperature Coefficient
30 mV	0.0028 + 5.0
300 mV	0.0005 + 0.5
3 V	0.0004 + 0.05
30 V	0.0006 + 0.5
300 V	0.0004 + 0.05

**Noise rejection:** in dB with 1 kΩ imbalance in Lo lead. AC rejection for 50, 60 Hz ± 0.1%. Auto zero ON.

Display	AC NMR	AC ECMR	DC CMR
5½ digits	80	150	140
4½ digits	59	130	140
3½ digits	0	70	140

**Maximum Reading Rates** (readings/s.)

Line Frequency	Auto Zero	Resolution		
		3½ digits	4½ digits	5½ digits
60 Hz	Off	71	33	4.4
	On	53	20	2.3
50 Hz	Off	67	30	3.7
	On	50	17	1.9

**AC Voltage** (true rms)  
**Input Characteristics**

Range	Maximum Reading (5½ Digit)	Resolution		
		5½ Digit	4½ Digit	3½ Digit
300 mV	303.099 mV	1 µV	10 µV	100 µV
3 V	3.03099 V	10 µV	100 µV	1 mV
30 V	30.3099 V	100 µV	1 mV	10 mV
300 V	303.009 V	1 mV	10 mV	100 mV

**Input impedance:** 1 MΩ ± 1% shunted by <60 pF

**Maximum Input Voltage** (non-destructive):

Hi to Lo: 303 Vrms or 450 V peak

Hi or Lo to Earth Ground: ±500 V peak

**Measurement accuracy:** ±(% of reading + number of counts). Auto zero ON. 5½ digit display. Accuracy is specified for sinewave inputs only, >10% full scale.

**1 Year, T<sub>Cal</sub>\* ±5°C**

Frequency	Ranges		
	300 mV	3 V, 30 V	300 V
20-50 Hz	1.14 + 163	1.14 + 102	1.18 + 102
50-100 Hz	0.46 + 163	0.46 + 103	0.5 + 102
100 Hz-20 kHz	0.29 + 163	0.26 + 102	0.33 + 102
20-50 kHz	0.56 + 247	0.41 + 180	0.55 + 180
50-100 kHz	1.74 + 882	1.05 + 825	1.26 + 825
100-300 kHz	10.1 + 3720 (30 V range only)		

**Crest factor:** >4:1 at full scale

**Common mode rejection:** with 1 kΩ imbalance in Lo lead, >70 dB, at 60 Hz

**Maximum reading rates:** 3½ or 4½ digits, 1.4 readings/s; 5½ digits, 1.0 readings/s. First reading is correct within 70 counts of final value when triggered coincident with step input. Add 0.6 second for each range change.

**Resistance** (2-wire Ω, 4-wire Ω)  
**Input Characteristics**

Range	Maximum Reading (5½ Digit)	Resolution		
		5½ Digit	4½ Digit	3½ Digit
30 Ω	30.3099 Ω	100 µΩ	1 mΩ	10 mΩ
300 Ω	303.099 Ω	1 mΩ	10 mΩ	100 mΩ
3 kΩ	3.03099 kΩ	10 mΩ	100 mΩ	1 Ω
30 kΩ	30.3099 kΩ	100 mΩ	1 Ω	10 Ω
300 kΩ	303.099 kΩ	1 Ω	10 Ω	100 Ω
3 MΩ	3.03099 MΩ	10 Ω	100 Ω	1 kΩ
30 MΩ	30.3099 MΩ	100 Ω	1 kΩ	10 kΩ

**Input protection** (non destructive): Hi to Lo: ±350 V peak; Hi or Lo to Earth Ground: ±500 V peak.

**Measurement accuracy:** ±(% of reading + number of counts). Auto zero ON. 5½ digit display. 4-wire ohms.

Range	T <sub>Cal</sub> * ±1°C	T <sub>Cal</sub> * ±5°C	
	24 Hour	90 Day	1 Year
30 Ω	0.023 + 35	0.027 + 41	0.034 + 41
300 Ω	0.0045 + 4	0.012 + 5	0.017 + 5
3 k-300 kΩ	0.0035 + 2	0.011 + 2	0.016 + 2
3 MΩ	0.0052 + 2	0.011 + 2	0.016 + 2
30 MΩ	0.036 + 2	0.066 + 2	0.078 + 2

**Current Through Unknown**

Range	30 Ω	300 Ω	3 kΩ	30 kΩ	300 kΩ	3 MΩ	30 MΩ
Current	1 mA	1 mA	1 mA	100 µA	10 µA	1 µA	100 nA

**DC Current**  
**Input Characteristics**

Range	Maximum Reading (5½ Digit)	Resolution		
		5½ Digit	4½ Digit	3½ Digit
300 mA	± 303.099 mA	1 µA	10 µA	100 µA
3 A	± 3.03099 A	10 µA	100 µA	1 mA

**Maximum input** (non-destructive): 3 A from <250 V source: fuse protected.

**Measurement accuracy:** ±(% of reading + number of counts). Auto zero ON. 5½ digit display.

Range	T <sub>Cal</sub> * ±5°C	
	90 Days	1 Year
300 mA	0.11 + 40	0.15 + 40
3 A (<1 A)	0.14 + 6	0.17 + 6
3 A (>1 A)	1.0 + 30	1.0 + 30

**Maximum burden at full scale:** 1 V (3 A range), 0.1 V (0.3 A range)

**AC Current** (true rms responding)  
**Input Characteristics**

Range	Maximum Reading (5½ Digit)	Resolution		
		5½ Digit	4½ Digit	3½ Digit
300 mA	303.099 mA	1 µA	10 µA	100 µA
3 A	3.03099 A	10 µA	100 µA	1 mA

**Maximum input:** (non-destructive): 3 A from <250 V source; fuse protected.

**Measurement accuracy:** ±(% of reading + number of counts). Auto zero ON. 5½ digit display. Accuracy is specified for sinewave inputs only, >10% of full scale.

**1 Year, T<sub>Cal</sub>\* ±5°C**

Frequency	Ranges	
	300 mA	3 A
20-50 Hz	1.54 + 163	2.24 + 163
50-1 kHz	0.81 + 163	1.50 + 163
1 k-10 kHz	0.72 + 163	1.42 + 163
10 k-20 kHz	0.86 + 163	1.56 + 163

**Maximum burden at full scale:** 1 V (3A range)

**General**

**Operating temperature:** 0 to 55°C

**Humidity range:** 95% R.H., 0 to 40°C

**Power:** ac line 48 to 440 Hz; 86 to 250 V, 25 VA max.

**Size:** 102 mm H x 215 mm W x 356 mm D (4" x 8" x 14"); 3½ in. H without feet.

**Weight:** 3 kg (6.5 lb)

**HP-IB Interface Functions:** SH1, AH1, T5, TE0, L4, LE0, SR1, RL1, PP0, DC1, DT1, C0

**Ordering Information**

Choose one N/C power option:

**Opt 315:** 100 V, 50 Hz; **Opt 335:** 220 V, 50 Hz

**Opt 316:** 100 V, 60 Hz; **Opt 336:** 220 V, 60 Hz

**Opt 325:** 120 V, 50 Hz; **Opt 345:** 240 V, 50 Hz

**Opt 326:** 120 V, 60 Hz; **Opt 346:** 240 V, 60 Hz

**Opt 907:** Front Handle Kit (HP P/N 5061-0088)

**Opt 908:** Rack Mount Kit (HP P/N 5061-0072)

**Opt 910:** Extra Manuals

**HP 3478A Multimeter**

# VOLTMETERS, DIGITAL & ANALOG

## 3 1/2 to 6 1/2 Digit DVM for Bench/System Applications

### Model 3456A

157



- Up to 330 rdgs/s.
- 100 nanovolt resolution
- Transfer standard performance

- 100 micro-ohm to 1.0 gigaohm measurement capability
- Offset compensated ohms (OC  $\Omega$ )
- Fast ac

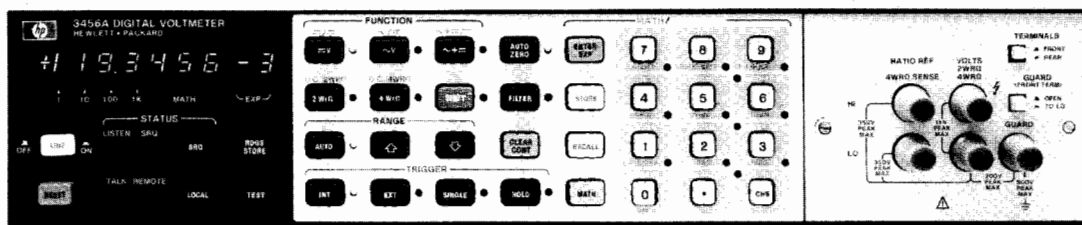

HP 3456A



### Description

This microprocessor-based, fully guarded, integrating Digital Multimeter is designed for bench or systems. The HP Model 3456A measures dc, true RMS ac voltage and resistance.

Five full scale dc ranges from 0.1 volt to 1000 volts are provided. Measurement speed and accuracy can be enhanced for a specific application, using the HP 3456A's selectable integration time (up to 100 power line cycles) and settling time. An operator can select up to 330 readings/second for high speed bursts or one reading every fifteen minutes for periodic measurements. Resolution of 100 nanovolts at 48 readings/second (6 1/2 digits) to 10 microvolt resolution at 330 readings per second (3 1/2 or 4 1/2 digits) can be selected.

Because the HP 3456A uses an integration technique with features such as "Program Memory" and "Reading Store", the operator can obtain the fastest possible reading rate with the most noise rejection. The first reading is correct, every time. The HP 3456A built-in memory is divided into two parts (Program and Reading Store). This feature lets the operator choose the length of program and the number of readings to be stored. For example, one could store an instrument command string 8 bytes long in program memory with room for 348 stored readings. The size of the HP 3456A memory is 1400 bytes long.

Transfer standard performance is assured with the HP 3456A. With good repeatability and 100 nanovolt sensitivity, accuracy on the ten volt range is  $\pm 0.0008\% + 2$  counts over a 24-hour period at  $23^\circ\text{C} \pm 1^\circ\text{C}$ .

Four full-scale, true TRMS ac voltage ranges are provided, with reading speeds up to 12 per second speed over a 20 Hz to 250 kHz frequency range with 1 microvolt resolution (6 digits). Best accuracy is 0.05%. Crest factor is greater than seven at full scale.

### Offset Compensated Ohms

A technique called Offset Compensated Ohms is incorporated in the HP 3456A. The DMM compensates for any resistance inaccuracies that may be caused from thermally produced offset voltages in the circuit under test. In the ohms function, the instrument first measures the voltage drop across the circuit under test. The voltage measured is stored in the DMM. Simultaneously, the DMM supplies a fixed current through the circuit under test and measures the voltage drop. Since the thermal error first stored in the DMM's memory, it is automatically eliminated from the measurement.

The measurement range is from 1 m $\Omega$  to 1.2 G $\Omega$ , using either 2 or 4 wire connections.

### System DMM

Standard on the HP 3456A is an isolated HP-IB (IEEE-488) I/O for systems operation. The front panel indicators on the HP 3456A display range, function and HP-IB status during remote operation. Also on the front panel is a SRQ (Service Request) button

which can be used to flag or interrupt a computer. With the HP 3456A's program memory and reading storage capability, system programmers and operators can use only one desktop or minicomputer to control numerous test stations, each containing a HP 3456A. By depressing the HP 3456A numerical entry keys and SRQ, the computer can be instructed to transfer a measurement sequence to the HP 3456A. The HP 3456A can take measurements and store them while a computer continues its operation as before the SRQ interrupt.

Another system feature of the HP 3456A is its hardware scanner advance capability for scanned or multiplexed system applications. As soon as the HP 3456A's measurement cycle is complete, a TTL signal is available to trigger an HP 3495A Scanner or HP 3497A Data Acquisition/Control Unit to advance to their next channel. Up to 330 channels can be scanned per second without computer interaction.

### Bench DMM

With a 2 ppm stability, the HP 3456A is a true transfer standard offering either 100 nanovolt sensitivity or 0.001% accuracy. Other standard features include fast autorange and easy-to-use math functions. The user can scale, limit test, null and make measurements in percent error, dB and dBm, as well as themistor compensation in degrees F and C. A statistics function key (STAT) enables the operator to improve the HP 3456A's sensitivity, resolution and accuracy by averaging. Averaging reduces random noise fluctuations and improves sensitivity by a factor of the square root of the number of measurements. For example, for low level signals after 100 measurements, the actual sensitivity of the HP 3456A is approximately 10 nanovolts instead of 100 nanovolts. In addition, STAT enables the operator to recall the maximum (upper), minimum (lower), and variance.

Calibration of the HP 3456A is fast and convenient since all routine adjustments are accessible from a concealed door in the front panel. Should service be necessary, built-in diagnostics and PC Board modules make the HP 3456A easy to service.

### Specifications

#### DC Voltage

#### Input Characteristics

RANGE	MAXIMUM READING		RESOLUTION			INPUT RESISTANCE	MAXIMUM INPUT VOLTAGE
	5 1/2 digit	6 1/2 digit	5 1/2 digit	4 1/2 digit			
0.1 V	.119999 V	100 nV	1 $\mu\text{V}$	10 $\mu\text{V}$		$>10^{10} \Omega$	$\pm 1000$ V peak
1.0 V	1.19999 V	1 $\mu\text{V}$	10 $\mu\text{V}$	100 $\mu\text{V}$		$>10^{10} \Omega$	
10.0 V	11.9999 V	10 $\mu\text{V}$	100 $\mu\text{V}$	1 mV		$>10^{10} \Omega$	
100.0 V	119.999 V	100 $\mu\text{V}$	1 mV	10 mV	10 M $\Omega \pm 5\%$		
1000.0 V	1000.00 V	1 mV	10 mV	100 mV	10 M $\Omega \pm 5\%$		

Guard to chassis:  $\pm 500$  V peak

Guard to low:  $\pm 200$  V peak



**Measurement accuracy:** ± (% of reading + number of counts). Auto-zero on and filter off.

RANGE	24 hour: 23°C ±1°C		90 days: 23°C ±5°C	
	6½ digit (≥10 PLC)	6½ digit (1 PLC)	6½ digit (≥10 PLC)	6½ digit (1 PLC)
0.1 V	.0022 + 24	0.0024 + 32	0.0034 + 24	0.0035 + 32
1.0 V	0.0009 + 4	0.0012 + 5	0.0024 + 4	0.0025 + 5
10.0 V	0.0008 + 2	0.0011 + 3	0.0023 + 2	0.0024 + 3
100.0 V	0.0011 + 3	0.0014 + 4	0.0026 + 3	0.0027 + 4
1000.0 V <sup>1</sup>	0.0011 + 2	0.0013 + 3	0.0024 + 2	0.0025 + 3

<sup>1</sup>Add .012  $\left(\frac{\text{Input Voltage}}{1000}\right)^2$  % to % of reading.

**Temperature coefficient:** ± (% of reading + number of counts/°C)

RANGE	5½ Digit Display				
	0.1V	1.0V	10.0V	100.0V	1000.0V
Temp Coef.	0.0002 +0.2	0.0002 +0.2	.0002 +0.02	0.0002 +0.02	0.0002 +0.02

For 6½ digits, multiply counts by 10. For 4½ digits, multiply counts by .1

**Auto-zero OFF:** (5½ digit). For a stable environment ±1°C, add 10 counts for 0.1 V range, 1 count for 1 V and 100 V ranges, and .1 count for 10 V and 1000 V ranges. For 6½ digits, multiply counts by 10. For 4½ digits, multiply counts for .1.

**Filter ON:** rejection is >60 dB at 50 Hz. Add 2 μV to uncertainty for .1 V, 1.0 V and 10 V range and 200 μV for 100 V and 1000 V range.

**Response Time**

**Filter OFF:** for preprogrammed settling times (0.0 seconds), error is <0.0005% of input voltage step.

**Filter ON:** for preprogrammed settling times (.65 seconds), error is <.01% of input voltage step.

**NOISE REJECTION (dB) (1 kΩ unbalance in Lo)**

	AC <sup>1</sup> NMR	AC <sup>1</sup> ECMR	DC ECMR
	.01 PLC or .1 PLC	0	90
≥1 PLC	60	150	140
≥1 PLC with filter	120	160	140

<sup>1</sup>For 50, 60 Hz (depending on option) ±.09%

**Resistance (2 WΩ, 4 WΩ, 2 WOCΩ, 4 WOCΩ)  
Input Characteristics**

RANGE	MAXIMUM READING (5½ digit)	6½ digit	RESOLUTION 5½ digit	4½ digit	CURRENT THROUGH UNKNOWN	MAXIMUM VALID READING VOLTAGE	MAXIMUM OPEN CIRCUIT VOLTAGE
100 Ω	119.999 Ω	100 μΩ	1 mΩ	10 mΩ	1 mA	12 V	5.5 V
1 kΩ	1199.99 Ω	1 mΩ	10 mΩ	100 mΩ	1 mA	1.2 V	5.5 V
10 kΩ	11.9999 kΩ	10 mΩ	100 mΩ	1 Ω	100 μA	1.2 V	5.5 V
100 kΩ	119.999 kΩ	100 mΩ	1 Ω	10 Ω	50 μA	6 V	9.5 V
1 MΩ	1199.99 kΩ	1 Ω	10 Ω	100 Ω	5 μA	6 V	9.5 V
10 MΩ	11.9999 MΩ	10 Ω	100 Ω	1 kΩ	500 nA	6 V	9.5 V
100 MΩ	119.999 MΩ	100 Ω	1 kΩ	10 kΩ	<500 nA <sup>1</sup>	5 V	5.5 V
1 GΩ	1000.00 MΩ	1 kΩ	10 kΩ	100 kΩ	<500 nA <sup>1</sup>	5 V	5.5 V

<sup>1</sup>Ohms source is a 500 nA current source in parallel with a 10 MΩ resistance.

**Non-destructive overload:** 350 V peak

**Measurement accuracy:** ± (% of reading + number of counts). Auto-zero on, filter off, and 4-wire ohms.

RANGE	24 hour: 23°C ±1°C		90 days: 23°C ±5°C	
	6½ digit (≥10 PLC)	6½ digit (1 PLC)	6½ digit (≥10 PLC)	6½ digit (1 PLC)
100 Ω	0.003 + 24	0.003 + 32	0.004 + 24	0.004 + 32
1 kΩ	0.002 + 4	0.003 + 5	0.003 + 4	0.004 + 5
10 kΩ	0.002 + 4	0.003 + 5	0.003 + 4	0.004 + 5
100 kΩ	0.002 + 2	0.003 + 3	0.003 + 2	0.004 + 3
1 MΩ	0.006 + 2	0.006 + 3	0.007 + 2	0.007 + 3
10 MΩ	0.041 + 2	0.041 + 3	0.042 + 2	0.042 + 3
100 MΩ	1.3 + 1	1.3 + 1	1.8 + 1	1.8 + 1
1 GΩ	11 + 1	11 + 1	16 + 1	16 + 1

**AC RMS Voltage (ac, ac + dc)  
Input Characteristics**

RANGE	MAXIMUM READING (5½ digit)	6½ digit	RESOLUTION 5½ digit	4½ digit	INPUT IMPEDANCE	MAXIMUM INPUT VOLTAGE
1.0 V	1.19999 V	1 μV	10 μV	100 μV	1 MΩ ±.5% shunted by <90 pF	±1000 V peak (700 V rms) 10 <sup>6</sup> VHZ
10.0 V	11.9999 V	10 μV	100 μV	1 mV		
100.00 V	119.999 V	100 μV	1 mV	10 mV		
1000.0 V	700.00 V	1 mV	10 mV	100 mV		

**Measurement accuracy:** ±(% of reading + number of counts). Auto-zero on, >1% of scale, and dc component <10% of ac component.

90 days: 23°C ± 5°C

Filter OFF	FREQUENCY IN Hz				
	10 to 30	400-20k 30-20k	20k to 50k 20k to 50k	50k to 100k 50k to 100k	<sup>1</sup> 100k to 250k <sup>1</sup> 100k to 250k
6½ digit (≥1 PLC) <sup>2</sup>	.47 + 450	.07 + 730	.17 + 1700	.55 + 2900	5.0 + 6500
5½ digit (.1 PLC)	.48 + 90	.08 + 73	.18 + 173	.56 + 293	5.0 + 653
4½ digit (.01 PLC)	.56 + 10	.13 + 9	.23 + 9	.61 + 31	5.1 + 67

<sup>1</sup>Frequencies > 100 kHz are specified for 1.0 V and 10 V ranges only.

<sup>2</sup>Integration Time in Power Line Cycles (PLC). For 5½ digits, multiply counts by 0.1. For 4½ digits, multiply counts by 0.01.

**Guard to chassis:** ±500 V peak

**Guard to low:** ±200 V peak

**Temperature coefficient:** ±(% of reading + number of counts)/°C. (5½ digit) ±(.008 + 6)/°C for DC component <10% ac component. Otherwise add ±(.008 + 12)/°C. For 6½ digit, multiply counts by 10. For 4½ digit, multiply counts by .1.

**DC component > 10% of ac component:** (5½ digit) Add ±(.5% of Reading + 50 counts) to accuracy. For 6½ digit, multiply counts by 10. For 4½ digit, multiply counts by .1. For signals with no ac component, use the 1 kHz ac spec.

**Crest factor:** >7:1 at full scale.

**Common mode rejection (1 kΩ Lo unbalance):** >90dB dc to 60 Hz.

**Auto-zero OFF:** for stable environment ±1°C no accuracy change. **Response time:** for preprogrammed settling times, error is <.1% of input voltage step.

**Filter OFF:** 0.06 seconds

**Filter ON:** .80 seconds

**2-Wire ohms accuracy:** Same as 4-wire ohms except add a maximum of .2 ohm offset.

**Auto-zero OFF accuracy:** (5½ digit). For a stable environment ±1°C, add 10 counts for 100 Ω range, 1 count for 1 kΩ and 10 kΩ range, and .2 counts for ≥100 kΩ range. Changes in lead resistance are not corrected in 4-wire ohms. For 4½ digit, multiply counts by .1. For 6½ digit, multiply counts by 10.



# VOLTMETERS, DIGITAL & ANALOG

## 3 1/2 to 6 1/2 Digital DVM for Bench/System Applications

### Model 3456A (cont.)

159



**Offset compensated ohms accuracy:** same as 2-wire and 4-wire except maximum reading may be reduced by 9% for large offset voltages.

**Response time:** with preprogrammed settling time and <200 pF of capacitance, first reading is in specification.

**Filter is not operational in ohms.**

**Temperature coefficient:** (5 1/2 digits)  $\pm$ (% of Reading + Number of Counts)/°C

RANGE	1 k $\Omega$					
	100 $\Omega$	100 k $\Omega$	1 M $\Omega$	10 M $\Omega$	100 M $\Omega$	1 G $\Omega$
Temp Coef.	.0004 +2	.0004 +.02	.0004 +.004	.0010 +.004	.16 +0	1.6 +0

4 1/2 digit: multiply counts by 0.1; 6 1/2 digit: multiply counts by 10.

### Ratio

**Type:** dc/dc, ac/dc, or (ac + dc)/dc

**Method:** 4-wire with Volts Lo input common

$$\text{Ratio} = \frac{\text{Signal Voltage}}{\text{Ref. Hi Voltage} - \text{Ref. Lo Voltage}}$$

**Signal measurement:** Same as dc Volts, ac Volts, or ac + dc Volts

**Reference measurement:** automatically selects .1 V, 1 V, or 10 V dc. Volts range and a 0.0 ms. settling time. Filter is off.

### Maximum Reference Voltages

Ref. Hi:  $\pm$ 12 V

Ref. Lo:  $\pm$ 9% of Ref. Hi

Ref. Hi-Ref. Lo:  $\pm$ 11.9999 V

Protection:  $\pm$ 340 V peak

**Accuracy:** total % signal error + total % reference error (same as .1 V, 1 V, or 10 V DC volts)

### Reading Rate

Reading rates are with autorange, math, display and filter off. Output is to internal memory using internal trigger and packed mode. Packed output in place of internal memory adds 0.35 ms; ASCII output adds 2.3 ms per reading.

**Rates vs. integration time and auto-zero:** dc volts and 100  $\Omega$  thru 10 k $\Omega$  ranges with preprogrammed settling times ( $-0.0$  s.). Also, ac or ac + dc volts and 100 k $\Omega$  thru 10 k $\Omega$  ranges with 0.0 s delay.

INTEGRATION TIME IN POWER LINE CYCLES (PLC)	RATES (rdgs/second)			
	Auto Zero OFF		Auto Zero ON	
	60 Hz	50 Hz	60 Hz	50 Hz
0.01 (4 1/2 digit)	330	290	210	180
0.10 (5 1/2 digit)	210	180	120	100
1.00 (6 1/2 digit)	48	40	25	20
10.00 (6 1/2 digit)	5.8	4.8	2.9	2.4
100.00 (6 1/2 digit)	.57	.47	.29	.24

### Memory

**Reading store:** can store up to 350 readings.

can be recalled from HP-IB interface or front panel

**Program memory:** can execute an internal program which controls instrument configuration and measurement sequence. Program is input from the HP-IB interface with up to 1400 ASCII characters.

**Memory size:** total size is 1400 bytes. Memory used is 1 byte per ASCII character + 4 bytes per reading stored.

### Math Functions

**General:** math function specifications do not include error in X (instrument reading) or in entered values (R, L, U, Y, Z). Range of values input or output is  $0.000000 \times 10^{-9}$  to  $\pm 1999999 \times 10^9$ . Out of range values send "OL" to display and  $\pm 1999999 \times 10^9$  to HP-IB.

**Pass/fail:** displays "HI" for values > upper limit (U), "LO" for values < lower limit (L), and X for values between the limits, with no introduced error. SRQ mask can be programmed to respond to out-of-limit conditions.

**Maximum execution time:** 20 ms

### Statistics

$$\text{Mean (M)} = X_1 + \frac{1}{C} \sum_{i=1}^C (X_i - X_1)$$

$$\text{Variance (V)} = \frac{\sum_{i=1}^C (X_i - X_1)^2 - \frac{1}{C} \left[ \sum_{i=1}^C (X_i - X_1) \right]^2}{C - 1}$$

Maximum (U) and Minimum (L) are the most positive and negative instrument readings, respectively. X is displayed during calculation of statistics.

$X_1$  is the first reading taken after enabling statistics and is stored in the Z register. The number of readings taken (C) is stored in the count register.

**Maximum execution time:** 50 ms

**Null:**  $X - X_1$  ( $X_1$  is the first valid reading taken after enabling null and is stored in the Z register).

**Maximum execution time:** 15 ms

### dBm(R):

$$10 \log \left| \frac{x^2/R}{1 \text{ mW}} \right| \quad R \text{ is the user-entered impedance.}$$

**Output range:**  $-280$  to  $+340$  dBm

**Maximum execution time:** 150 ms

**Thermistor (F):** converts resistance of thermistor HP0837-0164, YSI 44007, Omega UUA35J3, and Fenwal UUA35J1 to temperature in °F.

**Output range:**  $-112^\circ$  to  $302^\circ$  F

**Maximum execution time:** 150 ms

**Scale:**  $(X - Z)/Y$

**Maximum execution time:** 60 ms

$$\text{dB: } 20 \log \frac{X}{Y}$$

**Output range:**  $-620$  to  $+620$  dB

**Maximum execution time:** 100 ms

**% Error:**  $100 \times (X - Y)/Y$

**Maximum execution time:** 60 ms

### General

**Operating temperature:** 0 to 50°C

**Warmup time:** one hour to meet all specifications

**Humidity range:** 95% R.H., 0 to 40°C

**Storage temperature:**  $-40$  to  $+75^\circ$  C

**Power:** 100/120/240 V  $\pm$ 5%,  $-10\%$ , 48 Hz to 66 Hz line operation, 60 VA; 220 V  $\pm$ 10%, 48 Hz to 66 Hz line operation, 60 VA.

**Size:** 88.9 mm H x 425.5 mm W x 527.1 mm D (3 1/2" x 16 3/4" x 20 3/4")

**Weight:** net, 10.49 kg (23.13 lb.); shipping, 13.35 kg (29.38 lb.)

### Ordering Information

**HP 10833A:** 1 Meter (39.37 in.) HP-IB Cable

**HP 10833B:** 2 Meter (78.74 in.) HP-IB Cable

**HP 10833C:** 4 Meter (157.48 in.) HP-IB Cable

**HP 10833D:** 0.5 Meter (19.69 in.) HP-IB Cable

**03456-90001:** Operating information supplement (one furnished with HP 3456A)

**HP 11002A:** Test Leads, dual banana to probe and alligator

**HP 34111A:** High Voltage Probe, 40 kV

**Opt 050:** Noise rejection for 50 Hz

**Opt 060:** Noise rejection for 60 Hz

**Opt 907:** Front handle kit, P/N 5061-0088

**Opt 908:** Rack flange kit, P/N 5061-0074

**Opt 909:** Rack flange and front handle kit, HP P/N 5061-0075

**Opt 910:** Extra operating & service manual

**HP 3456A Digital Voltmeter**

# VOLTMETERS, DIGITAL & ANALOG

5 1/2 / 6 1/2 -Digit DVM with Auto Cal



Model 3455A

- DCV/ACV/Ohms
- Removable calibration reference

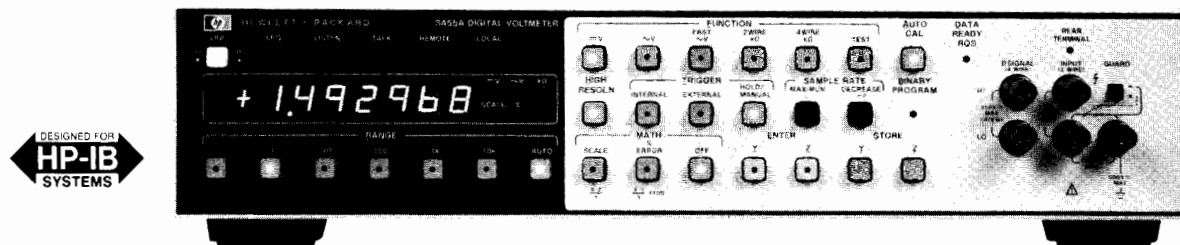

## Description

Hewlett-Packard's 3455A Digital Voltmeter is a microprocessor controlled 5 1/2- or 6 1/2-digit integrating voltmeter for bench or systems applications. The standard instrument measures dc volts, ac volts, and resistance. HP-IB and auto or manual ranging are also standard.

## Measuring Speed

The HP 3455A is fully guarded and has greater than 60 dB normal mode noise rejection at reading rates of up to 24 readings per second on all dc ranges. Ohms reading rates are up to 12 readings/second and an ac fast mode gives reading rates of up to 13 readings/second at frequencies above 300 Hz. (Readings/second given for 60 Hz operation and high resolution off.)

## Performance

DC measurements can be made with up to 1 μV sensitivity. Ohms measurements are made with either a 2-wire and 4-wire mode. The High Resolution (6 1/2-digit) mode gives dc and ohms measurements with greater than 1 part per million resolution. The standard true rms converter gives ac measurements from 30 Hz to 1 MHz. Complex signals with crest factors of up to 7:1 at full scale can be measured.

## Serviceability

Routine maintenance and calibration has been simplified with the removable reference assembly. Calibration of dc and ohms functions can be done by replacing the reference assembly with a recently calibrated one. Extra reference assemblies are available as HP 11177A.

## Specifications

### DC Voltage-Maximum Display

Range	Hi Resolution OFF	Hi Resolution ON
0.1	±0.149999 V	—
1	±1.49999 V	±1.499999 V
10	±14.9999 V	±14.99999 V
100	±149.999 V	±149.9999 V
1000	±1000.00 V	±1000.000 V

### Accuracy ± (% of reading + counts)

24 hrs: 23°C ± 1°C		
Range	High Resolution Off	High Resolution On
0.1 V	0.004 + 4	—
1 V	0.003 + 1	0.003 + 4
10 V	0.002 + 1	0.002 + 3
100 & 1000 V	0.004 + 1	0.004 + 3
90 days: 23°C ± 5°C		
Range	High Resolution Off	High Resolution On
0.1 V	0.007 + 4	—
1 V	0.006 + 1	0.006 + 4
10 V	0.005 + 1	0.005 + 3
100 & 1000 V	0.007 + 1	0.007 + 3

**Input resistance:** 0.1 V through 10 V range: > 10<sup>10</sup> ohms. 100 V and 1000 V range: 10 megohm ± 0.1% with Auto Cal. "off."

**Maximum Input Voltage: High to low input terminals:** ±1000 V peak; **Guard to chassis:** ±500 V peak; **Guard to low terminal:** ±200 V peak.

**NMR at 50 or 60 Hz ± 0.1%:** > 60 dB.

**ECMR with 1 kΩ Unbalance in Lo at DC:** > 160dB;

### AC Voltage (rms converter)

Ranges:	Maximum display:
1.00000 V	1.49999 V
10.0000 V	14.9999 V
100.000 V	149.999 V
1000.00 V	1000.00 V

## Input Impedance

**Front terminals:** 2 MΩ ± 1% shunted by less than 105 pf.

**Rear terminals:** 2 MΩ ± 1% shunted by less than 90 pf.

## Maximum Input Voltage

**High to low terminals:** ±1400 volts peak; 10<sup>7</sup> VHz max.

**Guard to chassis:** ±500 V peak; **Guard to low terminal:** ±200 V peak.

**Crest factor:** 7:1 at full scale.

## Performance (rms converter)

**Accuracy:** [± % of reading + counts] (ac coupled)

Fast ACV	300 Hz to 20 kHz	20 kHz to 100 kHz	100 kHz to 250 kHz	250 kHz to 500 kHz	500 kHz to 1 MHz	
	30 Hz to 20 kHz					
90 days	23°C ± 5°C	0.05 + 50	0.50 + 100	2.00 + 250	5.00 + 500	6.00 + 3100

## Ohms

Range	Maximum Display	
	High Resolution Off	High Resolution On
0.100000 kΩ	0.149999 kΩ	—
1.00000 kΩ	1.49999 kΩ	1.499999 kΩ
10.0000 kΩ	14.9999 kΩ	14.99999 kΩ
100.000 kΩ	149.999 kΩ	149.9999 kΩ
1000.00 kΩ	1499.99 kΩ	1499.999 kΩ
10000.0 kΩ	14999.9 kΩ	14999.99 kΩ

### Accuracy ± (% of reading + counts) 4-wire kΩ

24 hours: 23°C ± 1°C		
Range	High Resolution Off	High Resolution On
0.1 kΩ	0.003 + 4	—
1 kΩ	0.003 + 1	0.0025 + 4
10 kΩ	0.005 + 2	0.0045 + 4
100 kΩ	0.002 + 2	0.0020 + 5
1000 kΩ	0.012 + 5	0.0120 + 4
10,000 kΩ	0.10 + 5	0.1000 + 4
90 days: 23°C ± 5°C		
Range	High Resolution Off	High Resolution On
0.1 kΩ	0.005 + 5	—
1 kΩ	0.005 + 1	0.0035 + 5
10 kΩ	0.007 + 2	0.0060 + 5
100 kΩ	0.004 + 2	0.0035 + 6
1000 kΩ	0.014 + 5	0.0135 + 5
10,000 kΩ	0.100 + 5	0.1000 + 5

### Maximum Reading Rates for Remote Operations. (Rdgs/s)

Function	High Resolution ON		High Resolution OFF	
	50 Hz	60 Hz	50 Hz	60 Hz
DCV	5	6	22	24
Ohms	2.5	3	11	12
ACV (rms)			1.1	1.3
Fast ACV (rms)			12	13

## General

**Power:** 100 V, 120 V, 240 V +5% -10%, 48-400 Hz; < 60 VA.

**Size:** 88.9 H x 425.5 W x 527.1 mm D (3.5" x 16.75" x 20.75").

**Weight:** net, 9.38 kg (20.7 lb); shipping, 11.8 kg (26 lb).

## Options

**001:** Average converter

**HP 3455A Digital Voltmeter**

# VOLTMETERS, DIGITAL & ANALOG

## High Speed 3½ Digit System Voltmeter

161



Model 3437A

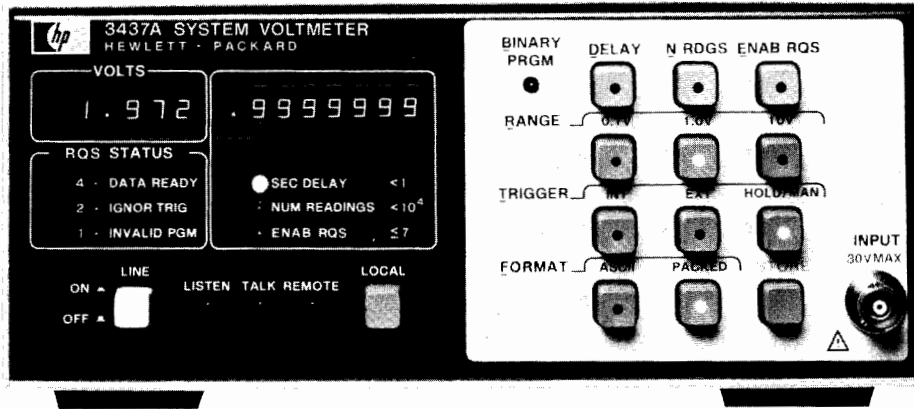

### Description

The Hewlett-Packard 3437A System Voltmeter is designed for systems. It is a 3½-digit, high-speed dc voltmeter with sample and hold. The standard unit measures dc volts, provides trigger delay, burst reading capability and Hewlett-Packard Interface Bus (HP-IB).

There are three dc floating input ranges: 0.1V, 1.0V and 10.0V full scale with a maximum display of "1998." Sample and Hold allow the HP 3437A to be an instantaneous reading voltmeter. The trigger delay can be set from 0.1µs to 1.0 second and the number of readings can be set from 0 to 9999 readings.

### Typical Operation

**Example:** set Delay to 1 ms and Number of Readings is set to 1000. The HP 3437A will now take 1000 readings spaced 1 ms apart from one trigger.

### Data Output

All front panel switches are programmable from the HP-IB. Two data output formats are available: (1) ASCII output (Serial ASCII characters) and (2) packed output (two 8-bit bytes on the HP-IB to send the complete reading).

### Applications

**Waveform analysis**—The HP 3437A can be used to analyze a wide variety of waveforms. The delay and burst reading capability allows frequency, positive or negative peak values, RMS value and harmonic distortion to be measured. The accuracy of these measurements is comparable to more traditional measurement techniques.

**Transient signal analysis**—The HP 3437A is capable of measuring transient signals because of the wide bandwidth input (>1 MHz), high measuring speed and sample-and-hold.

**Fast AC measurements**—Sinusoidal signals of known frequency can be measured in less than one cycle of the signal. Very low frequency measurements can be made more quickly than with conventional techniques.

**High speed scanning:** multiple input measurement applications can be satisfied with the HP 3437A and the HP 3497A Data Acquisition/Control Unit. Reading rates of up to 4800 channels/second can be attained.

### Data-Sheeted Systems

The HP 3437A is a component of the HP 3054A Automatic Data Acquisition and Control System. The HP 3054A includes the HP 3437A for high speed measurements, the HP 3456A Digital Voltmeter for high accuracy measurements and the HP 3497A Data Acquisition/Control Unit for multiplexing and control outputs. The HP 3054A includes an extensive software package to support the HP 3437A when used for thermocouple measurements, high speed scanning, and waveform digitization.

## Specifications

### DC Volts

Ranges	Max. Display	Overload Reading
10 V	±19.98	±99.99
1 V	±1.998	±9.999
0.1V	±.1998	±.9999

**Ranging:** manual or remote.

### Performance

**Static Accuracy (90 days, 23°C ±5°C)**

**10 V range:** ±(0.05% of reading +1.6 counts).

**Static Accuracy (1 year, 23°C +5°C) V range:**

**10 V range:** ±(0.05% of reading +2 counts).

**Static accuracy temperature coefficient (0°C–50°C):**  
±(0.002% reading +0.05 counts) / °C.

### Input Characteristics

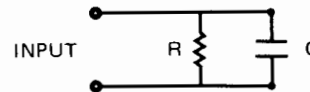

**10 V range:** R = 1 MΩ ±20%; C < 75 pF.

**Maximum input voltage high to low on all ranges:** < ±30 V peak.

**Maximum voltage low to chassis:** ±42 V peak.

**Number of readings (N readings):** 0 to 9,999.

Readings are not internally stored.

For N = 0 the HP 3437A operates in delay mode only.

**Maximum reading rate (remote, N Rdgs. > 1, and a zero delay listener)**

**ASCII:** 3600 readings/s.

**Packed:** 5700 readings/s.

### Delay

**N Rdgs. = 0 or 1**

**DELAY (setting):** 0 to 0.999 999 9 sec. in 0.1 µs steps.

**N Rdgs. > 1 (remote and a zero delay listener)**

**ASCII:** 0.0002778 s ≤ DELAY ≤ 0.9999999 s.

**PACKED:** 0.0001754 s ≤ DELAY ≤ 0.9999999 s.

Minimum delay is a function of listener delay related by:

**ASCII:** 277.8 µs + listener delay.

**PACKED:** 175.4 µs + listener delay.

**Accuracy (EXT. TRIG to DELAY OUT, 0°C to 50°C)**

**Delay offset:** 100 ns ±25 ns (with <150 pF cable capacitance)

**Delay accuracy:** ±0.008% DELAY Setting + Delay offset.

**Delay repeatability (jitter) for N Rdgs = 0 or 1**

DELAY of 0 or 0.1 µs: 2 ns

DELAY of 0.2 µs to 50 ms: 10 ns + 0.0002% DELAY setting.

DELAY of >50 ms: ±110 ns.

**Input Bandwidth (3 dB)**

**1 V and 10 V range:** 1.0 MHz.

### Settling Time

**10 V range:** 10 V range with 10 V step input:

Reading settles to within 30 mV of final value in 7.5 µs or to within 200 mV of final value in 700 ns.

### General

**Operating temperature:** 0 to 55°C.

**Storage temperature:** -40°C to 75°C.

**Humidity range:** <95% R.H., 0°C to 40°C.

**Power:** 100 V, 120 V, 220 V, 240 V +5%, -10%, 48 Hz to 440 Hz line operation, <42 VA.

**Size:** 88.9 mm H x 212.7 mm W x 527.1 mm D (3½" x 8⅜" x 20¾").

**Weight:** net, 5.6 kg (12 lb 4 oz). Shipping, 7.6 kg (16 lb 12 oz).

**HP-IB Interface Functions:** SH1, AH1, T5, L4, SR1, RL1, PP0, DC1, DT1, C0, E1

**HP 3437A System Voltmeter**



# VOLTMETERS, DIGITAL & ANALOG

## 4 1/2 Digit Autoranging DMM

### HP Model 3466A



HP 3466A

### Description

The HP 3466A is a 4 1/2 digit Multimeter with autoranging volts and ohms. Functional capability includes ACV, DCV, (ac + dc) V, ACI, DCI, (ac + dc) I,  $\Omega$ , and diode test. AC measurements are true rms with selectable ac or dc coupling. Available with rechargeable batteries or ac power only, it has 1  $\mu$ V dc and 1 m $\Omega$  sensitivity with zero adjustment on lowest ranges to compensate for external offsets.

### Specifications

#### DC Voltmeter

Voltage Range	Maximum Display
20 mV	$\pm 19.999$ mV
200 mV	$\pm 199.99$ mV
2 V	$\pm 1.9999$ V
20 V	$\pm 19.999$ V
200 V	$\pm 199.99$ V
1200 V	$\pm 1199.9$ V

**Maximum input:**  $\pm 1200$  V maximum dc and peak ac.

**Accuracy: (1 yr., 18 to 28°C)**

Range	$\pm$ (% of reading + # of counts)
20 mV	(.05 + 3)
200 mV	(.04 + 2)
2 V $\rightarrow$ 200 V	(.03 + 1)
1200 V, <700 V input	(.035 + 1)
1200 V, >700 V input	(.055 + 1)

**Input resistance:** 10 meg  $\Omega \pm 0.5\%$  all ranges.

**Input type:** floating, 500 V maximum common to ground.

#### AC Voltmeter

**AC converter:** true-rms responding, true-rms calibrated

Range	Maximum Display
200 mV	199.99 mV
2 V	1.9999 V
20 V	19.999 V
200 V	199.99 V
1200 V	1199.9 V

**Maximum input:** (ac + dc):  $\pm 1200$  V dc;  $\pm 1700$  V (dc + peak ac), ac:  $\pm 600$  V dc; 1700 V (peak ac + dc),  $10^7$  V  $\cdot$  Hz.

**Crest factor:** 4:1 at full scale.

**Accuracy** (with display of  $\geq 10\%$  of range): 1 yr., 18 to 28°C sinusoid waveform.

**AC TRMS: (20 Hz to 100 kHz)**

Frequency Range	$\pm$ (% of reading + # of counts)
20 Hz to 30 Hz	(2 + 50)
30 Hz to 50 Hz	(1 + 30)
50 Hz to 10 kHz	(0.3 + 20)
10 kHz to 20 kHz	(1 + 40)
20 kHz to 100 kHz	(2 + 150)

**DC + AC TRMS:** dc + (20 Hz to 100 kHz).

### Ohmmeter

Ohms Range	Maximum Display	Current Through Unknown	Accuracy: 1 yr., 18 to 28°C $\pm$ (% of reading + # of counts)
20 $\Omega$	19.999 $\Omega$	5 mA	.08 + 2
200 $\Omega$	199.99 $\Omega$	5 mA	.08 + 2
2 k $\Omega$	1.9999 k $\Omega$	1 mA	.03 + 1
20 k $\Omega$	19.999 k $\Omega$	100 $\mu$ A	.03 + 1
200 k $\Omega$	199.99 k $\Omega$	10 $\mu$ A	.03 + 1
2000 k $\Omega$	1999.9 k $\Omega$	1 $\mu$ A	.04 + 1
20 M $\Omega$	19.999 M $\Omega$	100 nA	.15 + 1

**Input protection:** 250 V rms or 350 V (dc + peak ac).

### DC Current and True RMS AC Current

Current Range	Maximum Display
200 $\mu$ A	$\pm 199.99$ $\mu$ A
2 mA	$\pm 1.9999$ mA
20 mA	$\pm 19.999$ mA
200 mA	$\pm 199.99$ mA
2000 mA	$\pm 1999.9$ mA

**Maximum input:** 2 A rms from < 250 V source (fuse protected).

**DC Current Accuracy (1 yr., 18 to 28°C):**

Range	$\pm$ (% reading + # of counts)
200 $\mu$ A through 20 mA	(.07 + 2)
200 mA	(0.15 + 2)
2000 mA	(0.5 + 2)

**AC current accuracy:** (with display  $\geq 10\%$  of range) 1 yr., 18°C to 28°C, sinusoid waveform.

**AC TRMS:** 20 Hz to 10 kHz.

Range	Frequency	$\pm$ (% of reading + # of counts)
200 $\mu$ A–200 mA	20 Hz–30 Hz	2 + 50
	30 Hz–10 kHz	0.9 + 35
2000 mA	20 Hz–30 Hz	2 + 50
	30 Hz–10 kHz	1.2 + 20

**(DC + AC) TRMS:** dc + (20 Hz to 10 kHz).

### Diode Test

**Function:**  $\rightarrow+$  (k $\Omega$ ). **Range:**  $\rightarrow+$  (2k $\Omega$ ).

**Current source:** 1 mA  $\pm 1.5\%$ .

**Humidity:** 95% RH at +40°C.

**Power:** ac line; 48–440 Hz; 86–250 V.

**Battery:** rechargeable lead-acid; 8 hours maximum continuous operation with full charge. Recharge time: 16 hours operating, 12 hours non-operating.

**Size:** HP 3466A: 98.4 mm H x 238.1 mm W x 276.2 mm D (3.88" x 9.38" x 10.88").

**Weight:** HP 3466A, 2.9 kg (6.31 lb); HP 3466A Opt 001, 2 kg (4.41 lb).

### Ordering Information

**HP 3466A Digital Multimeter.** Standard configuration in a streamlined portable case with handle, ac line power, batteries and charger, and test leads.

**HP 3466A Opt. 001,** streamlined portable case, ac line power only.

**HP 3466A Opt. 002,** rack and stack case, ac line power only. (Rack mount kit not included.)

All orders must include one of the power options: 86–106 V Opt. 100; 190–233 V Opt. 210; 104–127 V Opt. 115; 208–250 V Opt. 230.

# VOLTMETERS, DIGITAL & ANALOG

5 1/2 to 3 1/2 Digit, HP-IL

HP Model 3468A/B

163



- Five functions
- Electronic calibration
- 5 1/2 to 3 1/2 digits

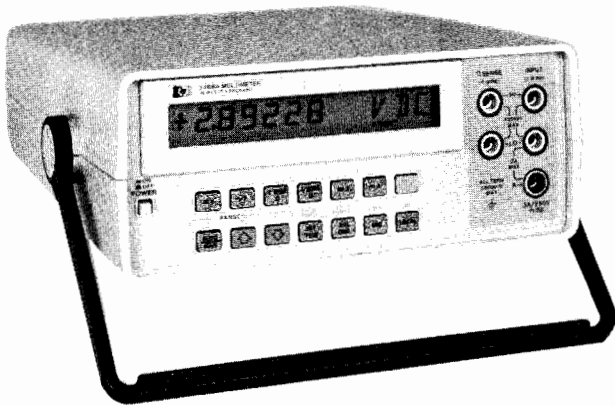

HP 3468A

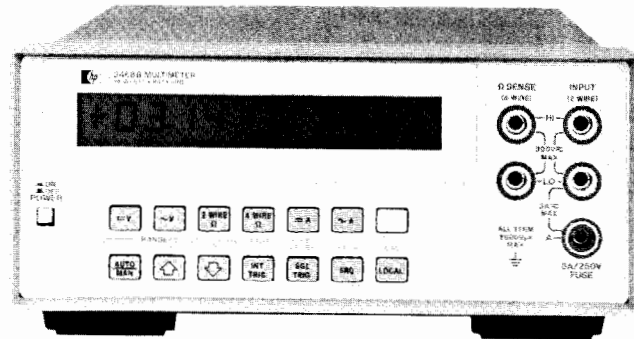

HP 3468B



## Description

The HP Models 3468A/B are autoranging 5 1/2 to 3 1/2 digit DMMs, with the five functions of dc volts, true RMS ac volts, 2- and 4-wire ohms, dc current and true RMS ac current. They are low-cost, highly reliable DMMs which can be completely calibrated electronically, either manually from the front panel or remotely in an automatic calibration system. Remote calibration is made possible by the built-in HP-IL (Hewlett-Packard Interface Loop) interface which provides complete programmability of functions, ranges and modifiers.

The HP 3468A comes in a streamlined portable package with a handle for convenient carrying, whereas the HP 3468B comes in a plastic system case for easy rack mounting. Both are available with a rechargeable battery and battery charging circuitry for portable measurements.

## High Performance

The HP 3468A/B have 5 functions with selectable 5 1/2, 4 1/2 or 3 1/2 digit resolution. DC and true RMS ac voltage measurements are provided from 0.3 volt full scale range with 1  $\mu$ V sensitivity up to 300 volts. The bandwidth of the true RMS ac converter is from 20 Hz to 100 kHz on all ranges and up to 300 kHz on the 30 V range. Either 2 or 4-wire ohms measurements can be selected with a maximum range of 30 M $\Omega$ . Both dc and true RMS ac current capability is provided up to 3 A. All functions on the HP 3468A/B incorporate a fast autoranging. The HP 3468A/B use an integrating analog to digital conversion technique for high noise rejection. The selectable 3 1/2, 4 1/2 or 5 1/2 digits of resolution allows flexibility for choosing speed or noise rejection.

## Electronic Calibration

Complete calibration of the HP 3468A/B is done electronically, either manually from the front panel or remotely in an automatic calibration system. There are no internal adjustments necessary. Complete calibration of all functions is done without removal of the instrument's covers, thus saving valuable time and reducing cost. The calibration procedure for the HP 3468A/B involves connecting a calibration standard to the input, then pressing three keystrokes to store one calibration constant in CMOS RAM for each range and function. When the HP 3468A/B make a measurement, each reading is corrected according to the calibration constants that have been stored.

The internal CMOS RAM used in the HP 3468A/B is powered by a lithium battery to create a non-volatile memory capable of holding the calibration constants for more than ten years.

## HP-IL

The HP Models 3468A/B are fully programmable with HP-IL, a two-wire serial interface, and the HP-41C/CV handheld calculators or the more powerful HP Series 80 computers. HP-IL provides automatic measurements and adds computational power to these bench DMMs.

## Battery

The optional battery pack includes a rechargeable battery and the battery charger circuitry for up to five hours of continuous measurements.

## DC Voltage

### Input Characteristics

Range	Maximum Reading (5 1/2 digit)	Resolution		
		5 1/2 digit	4 1/2 digit	3 1/2 digit
0.3 V	$\pm 0.301000$ V	1 $\mu$ V	10 $\mu$ V	100 $\mu$ V
3 V	$\pm 3.01000$ V	10 $\mu$ V	100 $\mu$ V	1 mV
30 V	$\pm 30.1000$ V	100 $\mu$ V	1 mV	10 mV
300 V	$\pm 301.000$ V	1 mV	10 mV	100 mV

**Input resistance:** 0.3 V, 3 V ranges:  $> 10^{10} \Omega$   
30 V, 300 V ranges: 10 M $\Omega \pm 1\%$

**Maximum Input Voltage** (non-destructive)

Hi to Lo: 301 Vrms or 450 V peak

Hi or Lo to Earth Ground:  $\pm 500$  V peak

**Measurement accuracy:**  $\pm$ (% of reading + number of counts). Auto zero ON. 5 1/2 digits.

Range	TCal $\pm 1^\circ\text{C}$ 24 Hour	TCal $\pm 5^\circ\text{C}$	
		90 Day	1 Year
0.3 V	0.005 + 4	0.009 + 5	0.02 + 5
3 V	0.0035 + 2	0.007 + 2	0.018 + 2
30 V	0.005 + 3	0.009 + 3	0.02 + 3
300 V	0.0055 + 2	0.009 + 2	0.02 + 2

\*TCal is the temperature of the environment where the 3468A/B was calibrated. Calibration should be performed with the temperature of the environment between 20°C and 30°C.



# VOLTMETERS, DIGITAL & ANALOG

## 5½ to 3½ Digit, HP-IL

### HP Model 3468A/B

**Temperature coefficient:** 0°C to 55°C, 5½ digits, auto zero ON.  
± (% of reading + number of counts)/°C.

Range	Temperature Coefficient
0.3 V, 30 V	0.0008 + 0.5
3 V, 300 V	0.0007 + .05

**Noise rejection:** in dB, with 1 kΩ imbalance in Lo lead. AC rejection for 50, 60 Hz ±0.1%. Auto zero ON.

Display	AC NMR	AC ECMR	DC CMR
5½ digits	80	150	140
4½ digits	59	130	140
3½ digits	0	70	140

**Maximum reading rate with HP-85:** 32 readings/second.

**Maximum reading rate with HP-41CV:** 2 readings/second.

## Resistance (2-wire Ω, 4-wire Ω)

### Input Characteristics

Range	Maximum Reading (5½ digit)	Resolution		
		5½ digit	4½ digit	3½ digit
300 Ω	301.000 Ω	1 mΩ	10 mΩ	100 mΩ
3 kΩ	3.01000 kΩ	10 mΩ	100 mΩ	1 Ω
30 kΩ	30.1000 kΩ	100 mΩ	1 Ω	10 Ω
300 kΩ	301.000 kΩ	1 Ω	10 Ω	100 Ω
3 MΩ	3.01000 MΩ	10 Ω	100 Ω	1 kΩ
30 MΩ	30.1000 MΩ	100 Ω	1 kΩ	10 kΩ

**Input protection (non-destructive):** ± 350 V peak.

**Measurement accuracy:** ±(% of reading + number of counts). Auto zero ON. 5½ digit display. 4-wire ohms.

Range	T <sub>Cal</sub> ±1°C 24 Hour	T <sub>Cal</sub> ±5°C	
		90 Day	1 Year
300 Ω	0.004 + 4	0.012 + 4	0.017 + 5
3 kΩ-300 kΩ	0.004 + 2	0.011 + 2	0.016 + 2
3 MΩ	0.005 + 2	0.011 + 2	0.016 + 2
30 MΩ	0.036 + 2	0.066 + 2	0.078 + 2

## Current Through Unknown

Range	300 Ω	3 kΩ	30 kΩ	300 kΩ	3 MΩ	30 MΩ
Current	1 mA	1 mA	100 μA	10 μA	1 μA	100 nA

**Maximum open circuit voltage:** 6.5 V

## AC Voltage (true RMS responding)

### Input Characteristics

Range	Maximum Reading (5½ digit)	Resolution		
		5½ digit	4½ digit	3½ digit
0.3 V	0.301000 V	1 μV	10 μV	100 μV
3 V	3.01000 V	10 μV	100 μV	1 mV
30 V	30.1000 V	100 μV	1 mV	10 mV
300 V	301.000 V	1 mV	10 mV	100 mV

**Input impedance:** 1 MΩ ±1% shunted by <60 pF.

**Maximum input voltage (non-destructive):** 301 Vrms or 450 V peak.

**Measurement accuracy:** ±(% of reading + number of counts) Auto zero ON. 5½ digit display. Accuracy is specified for sinewave inputs only, >10% of full scale.

### 1 Year, T<sub>Cal</sub> ±5°C

Frequency	Ranges		
	0.3V	3 V, 30 V	300 V
20-50 Hz	1.14 + 163	1.14 + 102	1.18 + 102
50-100 Hz	0.46 + 163	0.46 + 103	0.5 + 102
100 Hz-20 kHz	0.29 + 163	0.26 + 102	0.33 + 102
20-50 kHz	0.56 + 247	0.41 + 180	0.55 + 180
50-100 kHz	1.74 + 882	1.05 + 825	1.26 + 825
100 k-300 kHz	10.1 + 3720 (30 V range only)		

**Crest factor:** >4:1 at full scale.

## DC Current

### Input Characteristics

Range	Maximum Reading (5½ digit)	Resolution		
		5½ digit	4½ digit	3½ digit
3 A	± 3.01000 A	10 μA	100 μA	1 mA

**Maximum input (non-destructive):** 3 A from <250 V source; fuse protected.

**Measurement accuracy:** ±(% of reading + number of counts). Auto zero ON. 5½ digit display.

Range	T <sub>Cal</sub> ±5°C	
	90 Days	1 Year
3 A, <1 A input	0.14 + 6	0.17 + 6
3 A, >1 A input	1.0 + 30	1.0 + 30

## AC Current (true RMS responding)

### Input Characteristics

Range	Maximum Reading (5½ digit)	Resolution		
		5½ digit	4½ digit	3½ digit
3 A	0.301000 A	1 μA	10 μA	100 μA
3 A	3.01000 A	10 μA	100 μA	1 mA

**Maximum input (non-destructive):** 3 A from <250 V source; fuse protected.

**Measurement accuracy:** ±(% of reading + number of counts). Auto zero ON. 5½ digit display. Accuracy specified for sinewave inputs only, >10% of full scale.

### 1 Year, T<sub>Cal</sub> ±5°C

Frequency	Ranges	
	0.3 A	3 A
20-50 Hz	1.77 + 163	2.5 + 163
50-1 kHz	1.1 + 163	1.8 + 163
1 k-10 kHz	1.0 + 163	1.7 + 163
10 k-20 kHz	1.14 + 163	1.84 + 163

## General Information

**Operating temperature:** 0 to 55°C

**Humidity range:** 95% R.H., 0 to 40°C

**Power:** AC line 48 to 440 Hz, 86 to 250 V, (see configuration)

**Battery:** (Opt 001) Rechargeable lead-acid; minimum continuous operation for 5 hours at 25°C; recharge time is 16 hours with HP 3468A/B opt and 36 hours with HP 3468A/B on.

**Size:** HP 3468A: 98.4 mm H x 238.1 mm W x 276.2 mm D (3.88 in. H x 9.38 in. W x 10.88 in. D). 3468B: 89 mm H x 213 mm W x 275 mm D (without feet), 3.5 in. H x 8.38 in. W x 10.83 in. D.

**Weight:** HP 3468A/B—2.1 kg (4.63 lb); HP 3468A/B with Opt 001—3.1 kg (6.83 lb).

**Configuration:** order one power and frequency option at no charge from below.

**Opt 315:** 100 V, 50 Hz; **Opt 335:** 220 V, 50 Hz

**Opt 316:** 100 V, 60 Hz; **Opt 336:** 220 V, 60 Hz

**Opt 325:** 120 V, 50 Hz; **Opt 345:** 240 V, 50 Hz

**Opt 326:** 120 V, 60 Hz; **Opt 346:** 240 V, 60 Hz

### Ordering Information

HP 3468A DMM in Streamlined Portable Case with HP-IL and test probes.

HP 3468B DMM in Rack and Stack Case with HP-IL and test probes.

### Options and Accessories.

HP 3468A/B Option 001, add Rechargeable Battery Pack

HP 3468A/B Option 541, add HP-41CV Handheld Computer and HP 82160A HP-IL Interface Module

HP 3468A/B Option 561, add HP 82161A Digital Cassette Drive

HP 3468A/B Option 562, add HP 82162A Thermal Printer/Plotter

HP 3468B Option 401, add Side Handle Kit

(HP P/N 5061-1171)

HP 3468B Option 907, add Front Handle Kit

(HP P/N 5061-1170)

HP 3468B Option 908, add Rack Mount Kit for a

Single Instrument (HP P/N 5060-0173)

HP P/N 5061-0174 Rack Mount Kit for rack mounting

two instruments side-by-side



# VOLTMETERS, DIGITAL & ANALOG

3 1/2 Digit, High Accuracy DMM

Model 3435A



HP 3435A

## Description

The HP 3435A is a 3 1/2 digit multimeter providing five functions of ACV, DCV, ACI, DCI and  $\Omega$ . It is available with rechargeable batteries or ac line power only. The HP 34112A Touch-Hold probe provides "eyes-on" probing of ac and dc voltages by holding the HP 3435A display using a button on the probe. The HP 3435A case is rugged with a detent position carrying handle which is used also as a tilt stand.

## Specifications

### DC Voltmeter

<b>Ranges:</b> 200 mV	<b>Maximum display:</b> $\pm 199.9$ mV
2 V	$\pm 1.999$ V
20 V	$\pm 19.99$ V
200 V	$\pm 199.9$ V
1200 V	$\pm 1199$ V

**Maximum input:** 1200 V (dc + peak ac)

**Accuracy:** 1 year, 15 to 30°C.

Range	Specifications
200 mV	$\pm(0.1\%$ of reading + 2 counts)
2 V to 1200 V	$\pm(0.1\%$ of reading + 1 count)

**Temperature coefficient:** (0 to 15°C and 30 to 55°C)  $\pm(0.015\%$  of reading + 0.1 count)/°C.

**Input resistance:** 10 M $\Omega$   $\pm 1\%$ .

**Input type:** floating, 500 V maximum common to ground.

**Normal mode rejection:** >40 dB at 50 Hz/60 Hz  $\pm 0.1\%$ .

**Response time:** <0.7 second to within 1 count of final value on one range. Add 1 second for each range change.

**Effective common mode rejection:** (1 k $\Omega$  unbalance) >120 dB at 50/60 Hz  $\pm 0.1\%$ .

### AC Voltmeter

**AC converter:** avg. responding rms calibrated.

<b>Ranges:</b> 200 mV	<b>Maximum display:</b> 199.9 mV
2 V	1.999 V
20 V	19.99 V
200 V	199.9 V
1200 V	1199 V

**Maximum input:** 1700 V (dc + peak ac), 10<sup>7</sup> volt-Hz max.

**Accuracy:** (with display of  $\geq 20$  counts) 1 year, 15 to 30°C.

Range	Specification
30 Hz-50 Hz	$\pm(1.5\%$ of reading + 3 counts)
50 Hz-20 kHz	$\pm(0.3\%$ of reading + 3 counts)
20 kHz-100 kHz	$\pm(1.5\%$ of reading + 10 counts)

**Temperature coefficient:** (0 to 15°C and 30 to 55°C)  $\pm(0.04\%$  of reading + 0.2 count)/°C.

**Input impedance:** resistance: 5 M $\Omega$ . Shunt capacitance: <50 pF.

## Ohmmeter

Ranges	Maximum Display	Current Through Unknown
20 $\Omega$	19.99 $\Omega$	5 mA
200 $\Omega$	199.9 $\Omega$	5 mA
2 k $\Omega$	1.999 k $\Omega$	500 $\mu$ A
20 k $\Omega$	19.99 k $\Omega$	50 $\mu$ A
200 k $\Omega$	199.9 k $\Omega$	5 $\mu$ A
2000 k $\Omega$	1999 k $\Omega$	500 nA
20 M $\Omega$	19.99 M $\Omega$	50 nA

**Input protection:** 250 V rms.

**Accuracy:** 1 year, 15 to 30°C.

Range	Specifications
20 $\Omega$	$\pm(0.5\%$ of reading + 12 counts)
200 $\Omega$ -2000 k $\Omega$	$\pm(0.2\%$ of reading + 2 counts)
20 M $\Omega$	$\pm(0.8\%$ of reading + 2 counts)

**Temperature coefficient:** (0 to 15°C and 30 to 55°C)

Range	Specifications
20 $\Omega$ -2000 k $\Omega$	$\pm(0.04\%$ of reading + 0.2 count)/°C
20 M $\Omega$	$\pm(0.18\%$ of reading + 0.2 count)/°C

## DC Current and AC Current

<b>Ranges:</b> 200 $\mu$ A	<b>Maximum display:</b> $\pm 199.9$ $\mu$ A
2 mA	$\pm 1.999$ mA
20 mA	$\pm 19.99$ mA
200 mA	$\pm 199.9$ mA
2000 mA	$\pm 1999$ mA

**Maximum input:** current: 2 A (fuse protected). Voltage: 250 V.

**DC current accuracy:** 1 year, 15 to 30°C.

Range	Specifications
200 $\mu$ A to 200 mA	$\pm(0.3\%$ of reading + 2 counts)
2000 mA	$\pm(0.6\%$ of reading + 2 counts)

**AC current accuracy:** (with display of  $\geq 20$  counts)—1 year, 15 to 30°C.

Current Range	Frequency of Input Signal	
	30 Hz	50 Hz
2000 mA	$\pm(2\%$ of reading + 5 counts)	$\pm(1.2\%$ of reading + 5 counts)
200 mA To 200 $\mu$ A	$\pm(1.7\%$ of reading + 5 counts)	$\pm(0.9\%$ of reading + 5 counts)

## General

**Reading rate:** 2.4 - 4.7/s depending on input level.

**Ranging:** automatic or manual on ACV, DCV and ohms. Manual only on ac & dc current.

**Operating temperature:** 0 to 55°C.

**Humidity:** 95% RH, +15 to +40°C.

**Power:** ac line: 48-440 Hz; 86-250 V (see ordering information). Battery: rechargeable lead-acid; 10 hours minimum continuous operation with full charge. Recharge time: 16 hours operating, 12 hours nonoperating.

**Size:** HP 3435A: 23.91 cm W x 9.84 cm H x 27.62 cm D (9.4" x 3.9" x 10.9").

**Weight:** HP 3435A: 2.41 kg (5.3 lb); HP 3435A Opt 001: 1.84 kg (4.1 lb).

## Ordering Information

**HP 3435A** streamlined portable case with handle, ac line power. Batteries and charger included.

**HP 3435A Opt. 001**, streamlined portable case, ac line power only.

**HP 3435A Opt. 002**, Rack and Stack case, ac line power only. (Rack mount kit not included.)

All orders must include one of the power options: 86-106 V Opt. 100; 190-233 V Opt. 210; 104-127 V Opt. 115; 208-250 V Opt. 230.



# VOLTMETERS, DIGITAL & ANALOG

## Voltmeter Accessories

Probes, Dividers, Carrying Cases

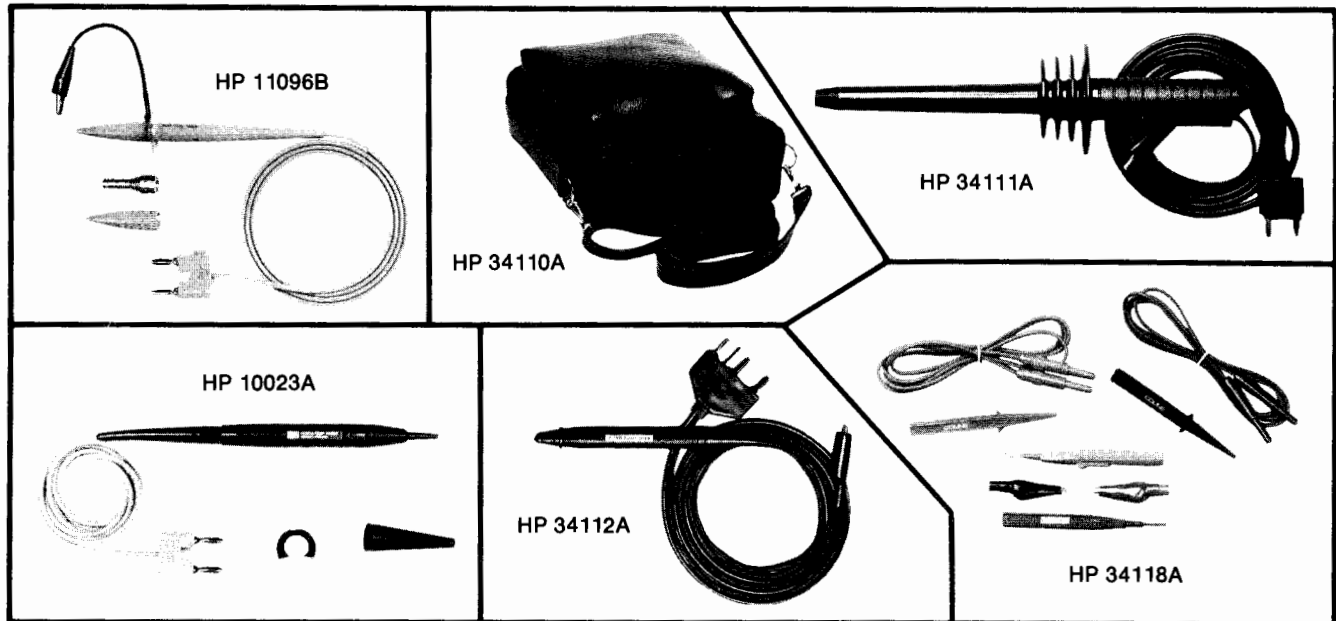

### HP 10023A Temperature Probe

The HP Model 10023A Temperature Probe provides the fast, accurate temperature measurements needed in a wide variety of thermal design, diagnostic, and testing applications. Surface temperature measurements are read directly in degrees Celsius on general purpose digital multimeters having an input impedance of  $\geq 10$  megohms. A pencil-like probe tip easily accesses small components and a press-to-read switch makes measurements easy.

The probe is a self-contained temperature-to-voltage transducer with a forward-biased diode chip providing calibrated linear output of 1 mV/°C. The entire electronics assembly, including integrated circuits and battery is packaged in the probe barrel.

A standard dual banana plug output connector provides universal connection to digital voltmeters.

### HP 10023A Specifications

#### Electrical

**Measurement range:**  $-55^{\circ}\text{C}$  to  $+150^{\circ}\text{C}$ .

**Output:** 1 mV/°C.

**Short term repeatability:**  $\pm 0.3^{\circ}\text{C}$  (minimum of 48 hrs).

**Accuracy:**  $\pm 2^{\circ}\text{C}$  from  $0^{\circ}\text{C}$  to  $100^{\circ}\text{C}$ , decreasing linearly to  $+2^{\circ}\text{C}$ ,  $-4^{\circ}\text{C}$  at  $-55^{\circ}\text{C}$  and  $+4^{\circ}\text{C}$ ,  $-2^{\circ}\text{C}$  at  $+150^{\circ}\text{C}$ .

**Maximum voltage at tip:** 600 V (dc + peak ac).

**Tip capacitance to ground:** approx 0.5 pF.

**Thermal response:**  $< 3$  s to settle within  $2^{\circ}\text{C}$  of final reading (liquid measurement) for a  $100^{\circ}\text{C}$  temperature change.

**DMM input R:**  $\geq 10$  M $\Omega$

#### General

**Operating environment (probe tip to approx. 13 mm (0.5 in) from probe tip):** temperature,  $-55^{\circ}\text{C}$  to  $+150^{\circ}\text{C}$ ; altitude, to 4600 m (15 000 ft); vibration, vibrated in three planes for 15 min each with 0.38 mm (0.015 in) excursion, 10 to 55 Hz.

**Operating environment (probe body):** temperature,  $0^{\circ}\text{C}$  to  $60^{\circ}\text{C}$  (battery limitation); humidity (non-condensing), to 95% relative humidity at  $+40^{\circ}\text{C}$ , altitude and vibration same as those for probe tip.

**Overall length:** approx 1.4 m (53 in).

**Weight:** net, 85 g (3 oz); shipping, 312 g (11 oz).

**Battery life:** approx 50 hr (varies with ambient temperature).

**Accessories supplied:** one replacement battery (HP 1420-0256), one sliding lock collar (HP 10023-23201), and one probe tip cover (HP 00547-40005).

### Ordering Information

HP 10023A Temperature Probe

HP P/N 10023-60001 Replacement tip, includes pre-calibrated tip and matching compensation network

HP 11096B High Frequency Probe

### HP 11096B High Frequency Probe

Converts dc voltmeter with 10 M $\Omega$  input to high-frequency ac voltmeter. Works with any dc voltmeter with 10 M $\Omega$  input impedance.

### HP 11096B Specifications

**Voltage range:** 0.25 to 30 Vrms.

**Transfer Accuracy (when used with 10 M $\Omega$   $\pm$  10% dc voltmeter):**

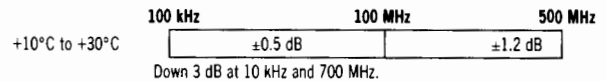

**Response:** peak responding. Calibrated to read rms value of sine wave.

**Input impedance:** 4 M $\Omega$  shunted by 2 pF.

**Maximum input:** 30 V rms ac; 200 V dc.

**Accessories furnished:** high-frequency adapter; straight tip; hook tip; ground lead.

### HP 34110A Soft Vinyl Carrying Case

Carrying case for  $\frac{1}{2}$  rack size instruments. Inside dimensions of 25.4 cm x 22.9 cm x 10.2 cm or 10 in D x 9 in W x 4 in T. Zipper flip top lid and zippered accessory pouch. Has shoulder carrying strap.

### HP 34111A DC Hi-Voltage Probe

1000:1 divider will accept up to 40 kV. Input Z =  $10^9$   $\Omega$ . Divider accuracy meets specifications when connected to 10 M $\Omega$  input resistance instrument.

#### Division Ratio Accuracy

0–20 kV	$< 4\%$	Divider has interchangeable hook and pointed tip.
30–40 kV	$< 4\%$	
20–30 kV	$< 2\%$	

### HP 34112A Touch-Hold Probe

Allows user to hold DMM display by depressing button on probe body. Both ac and dc voltage up to 1200 V max. dc or ac RMS may be measured and held. Usable on the HP 3435A, HP 3438A, HP 3465A/B, and HP 3466A.

### Ordering Information

HP 34110A Carrying Case for  $\frac{1}{2}$  Rack Size Instruments

HP 34111A DC Hi-Voltage Probe

HP 34112A Touch-Hold Probe

HP 34118A Test Lead Kit



### Selecting An Analog Voltmeter

Analog voltmeters are used for many applications from general purpose bench or field use to special needs of true rms ac detection.

For measurements involving dc applications, select the instrument with the broadest capability meeting your requirements. For ac measurements involving sine waves with only modest amounts of distortion (<10%), the average-responding voltmeter can perform over a bandwidth extending to several megahertz. For high-frequency measurements (>10 MHz), the peak-responding voltmeter with the diode-probe input is the most economical choice. Peak-responding circuits are acceptable if inaccuracies caused by distortion in the input waveform can be tolerated. For measurements where it is important to determine the effective power of waveforms that depart from a true sinusoidal form, the true rms-responding voltmeter is the appropriate choice.

Some analog voltmeters offer multiple functions such as dc and ac voltage plus resistance measurements.

### Analog Voltmeter Accuracy

Before we can discuss meter accuracy, we must have a familiarity with the various meter scales available. Many instruments have meter scales marked in both volts and decibel (dB) units. It should be noted that dB and

voltage are complements of each other. That is, if a voltage scale is made linear, the dB scale on the same meter face will be logarithmic or nonlinear. Likewise, if the dB scale is made linear, the voltage scale becomes nonlinear. The term "linear-log scale" is applied to an instrument that has a linear dB scale and, therefore, a nonlinear voltage scale. Several different types of meter faces are illustrated in Figure 1.

Analog meters usually have nonlinearities and/or offsets present in the attenuators and amplifiers. The meter movement itself can have nonlinearities even with individually calibrated meter scales. Nonlinearities cause percent of reading errors, and offsets cause percent of full scale errors.

Looking at instrument specification sheets, accuracy specifications are usually expressed in one of three ways: 1. percent of the full-scale value, 2. percent of the reading, 3. (percent of reading + percent of full-scale). The first is probably the most commonly used accuracy specification. The second (percent of reading) is more commonly applied to meters having a logarithmic scale. The last method has been used more recently to obtain a tighter accuracy specification on a linear-scale instrument.

Hewlett-Packard uses the two-part accuracy specification to take advantage of the upper-scale accuracy and yet maintain a reasonable specification for the lower portion of the scale.

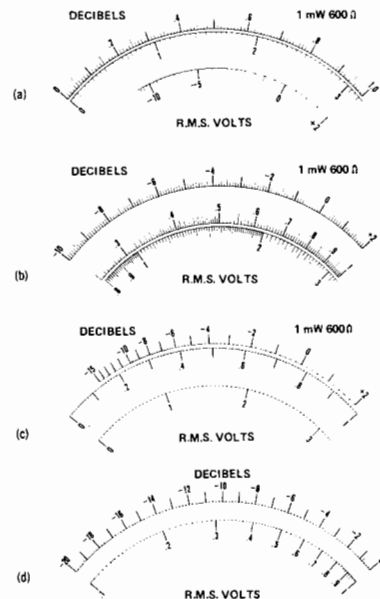

Figure 1. Four different types of meter scales available. (a) Linear 0-3 V and 0-10 V scales plus a dB scale. (b) Linear dB scale plus non-linear (logarithmic) voltage scales. (c) dB scale placed on larger arc for greater resolution. (d) Linear -20 to 0 dB scale useful for acoustical and communications applications.

### Analog Voltmeter Selection Chart

Model	AC VOLTMETERS	Voltage Range	Frequency Range; Typical Accuracy	Page
HP 3400A	RMS VOLTMETER provides rms readings of complex signals. Has dc output for driving DVM's or recorders	1 mV to 300 V (12 ranges)	10 Hz to 10 MHz ±1% to ±5%	168
HP 400E HP 400 EL	HIGH ACCURACY AC VOLTMETER has dc output (±0.5%) for driving recorder	1 mV to 300 V; -60 dB to +50 dB	10 Hz to 10 MHz ±1% ±5%	169
HP 400F HP 400 FL	FAST-RESPONSE AC VOLTMETER 100 kHz low-pass filter ac amplifier	100 μV to 300 V; -80 dB to +50 dB	20 Hz to 4 MHz; ±1% to ±4%	169
HP 400GL	HIGH ACCURACY dB VOLTMETER 20 dB log scale (0 dB = 1 V)	-80 dB to +60 dB (8 ranges)	20 Hz to 4 MHz; ±0.2 dB to 0.4 dB	169
HP 3406A	SAMPLING RF VOLTMETER provides true rms measurements when used with HP 3400A. Many accessories	1 mV to 3 V (8 ranges)	10 kHz to >1.2 GHz ±3% to ±13%	171
Model	MULTI-FUNCTION METERS	Voltage Range (Accuracy)	Resistance Range (Accuracy)	Page
HP 427A	BATTERY-OPERATED MULTI-FUNCTION METER has 10 MΩ dc input impedance and 10 MΩ/20 pF ac input impedance	dc: ±100 mV to 1000 V (±2%) 9 ranges ac: 10 mV to 300 V 10 Hz to 1 MHz (±2%) 10 ranges	10 Ω to 10 MΩ mid-scale ±5%; from 0.3 to 3 on the meter scale (7 ranges)	170
HP 410C	VERSATILE VOLTMETER has 100 MΩ dc input impedance and 10 MΩ/1.5 pF ac impedance	dc: ±15 mV to ±1500 V (±2%) 11 ranges ac: 0.5 V to 300 V 20 Hz to >700 MHz (±3% at 400 Hz) 7 ranges	10 Ω to 10 MΩ (center scale) 0 to midscale: ±5% or ±2% of midscale (whichever is greater) 11 ranges current: dc: ±1.5 μA to ±150 mA (±3%)	170
Model	CURRENT METERS	Current Range	Frequency Range	Page
HP 428B	dc MILLIAMMETER with clip-on probe eliminates direct connection	1 mA to 10 A FS (9 ranges)	dc to 400 Hz	171



# VOLTMETERS, DIGITAL & ANALOG

## 10 Hz to 10 MHz True RMS Voltmeter

HP Model 3400A

- 10 MHz bandwidth
- High crest factor for accurate pulse measurements
- Stable, linear dc output

- 1 mV full-scale sensitivity
- 10 M $\Omega$  input impedance
- Taut-band individually calibrated meter

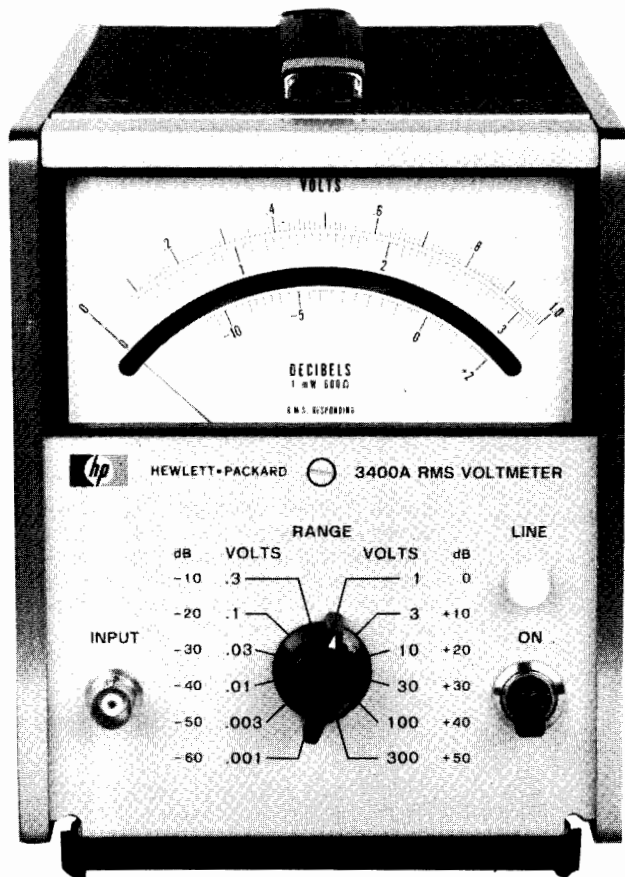

HP 3400A

### Description

The Hewlett-Packard Model 3400A is a true root-mean-square (rms) voltmeter, providing a meter indication proportional to the dc heating power of the input waveform.

Six-decade frequency coverage makes the HP 3400A extremely flexible for all audio and most RF measurements and permits the measurement of broadband noise and fast-rise pulses.

Pulses or other non-sinusoids with crest factors (ratio of peak to rms) up to 10:1 can be measured full scale. Crest factor is inversely proportional to meter deflection, permitting up to 100:1 crest factor at 10% of full scale.

Permanent plots of measured data and higher resolution measurements can be obtained by connecting an X-Y plotter, strip chart recorder or digital voltmeter to the convenient rear-panel dc output. The dc output provides a linear 0 to 1 volt drive proportional to meter deflection.

### Specifications

**Voltage range:** 1 mV to 300 V full scale, 12 ranges.

**dB range:** -72 to +52 dBm (0 dBm = 1 mW into 600 $\Omega$ ).

**Frequency range:** 10 Hz to 10 MHz.

**Response:** responds to rms value (heating value) of the input signal for all waveforms.

**Meter accuracy:** % of full scale (20°C to 30°C)\*

10Hz	50Hz	1MHz	2MHz	3MHz	10MHz
±5%	±1%	±2%	±3%	±5%	

**AC-to-DC converter accuracy:** % of full scale (20°C to 30°C)\*

10Hz	50Hz	1MHz	2MHz	3MHz	10MHz
±5%	±0.75%	±2%	±3%	±5%	

\* TC: ±0.1% from 0°C to 20°C and 30°C to 55 °C.

**Crest factor:** (ratio of peak to rms amplitude of input signal): 10 to 1 at full scale (except where limited by maximum input) inversely proportional to meter deflection (e.g., 20 to 1 at half-scale, 100 to 1 at tenth scale).

**Maximum continuous input voltage:** 500 V ac peak at 1 kHz on all ranges; 600 V dc on all ranges.

**Input impedance:** from 0.001 V to 0.3 V range: 10 M $\Omega$  shunted by <50 pF. From 1.0 V to 300 V range: 10 M $\Omega$  shunted by <20 pF. ac coupled input.

**Response time:** for a step function, <6 s to final value.

**AC overload:** 30 dB above full scale or 800 V p, whichever is less, on each range.

**Output:** negative 1 V dc into open circuit at full-scale deflection, proportional to meter deflection from 10–100% of full scale. 1 mA maximum; nominal source impedance is 1000 $\Omega$ . Output noise <1 mV rms.

**Power:** 115 or 230 V ±10%, 48 to 66 Hz, 15 VA max.

**Size:** 159 H (without removable feet) x 130 W x 279 mm D (6.25" x 5.1" x 11"); 1/3 module.

**Weight:** net, 3.3 kg (7.3 lb). Shipping, 4.5 kg (10 lb).

**Accessories furnished:** 10110A Adapter, BNC to dual banana jack.

### Accessories Available

**HP 11170A** Cable, 12 in., male BNC connectors

**HP 11170B** Cable, 24 in., male BNC connectors

**HP 11170C** Cable, 48 in., male BNC connectors

**HP 11002A** Test lead, dual banana plug to alligator clips

**HP 11003A** Test Leads, dual banana plug to probe and alligator clip

**HP 11076A** Carrying Case

### Ordering Information

**HP 3400A** Opt 001 spreads out the dB scale by making it the top scale of the meter.

Rear terminals in parallel with front panel terminals and linear log scale uppermost on the meter face are available on special order.

### HP 3400A RMS Voltmeter

# VOLTMETERS, DIGITAL & ANALOG

## AC Voltmeter, 10 Hz to 10 MHz

HP Models 400E, EL, F, FL, GL

169

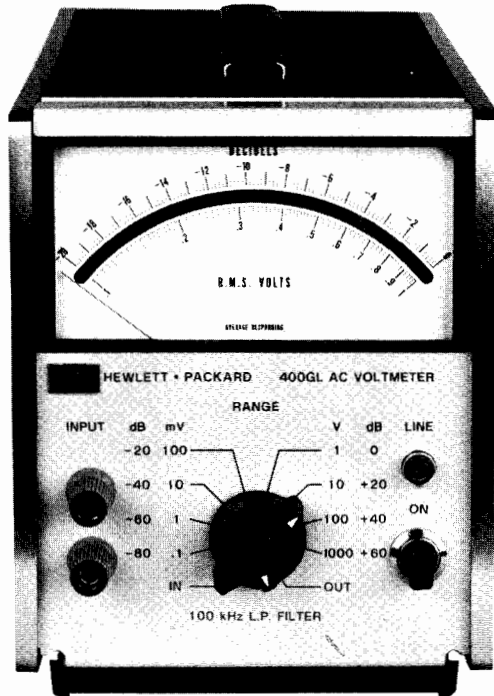

HP 400GL



HP 400F

### Specifications

	HP 400E/EL*	HP 400F/FL*	HP 400 GL
Voltage range	1 mV to 300 V F.S. 12 ranges	100 $\mu$ V to 300 V F.S. 14 ranges	-80 dB to +60 dB F. S. 8 ranges
Frequency range	10 Hz-10 MHz	20 Hz-4MHz	20 Hz-4 MHz
Input impedance	10 M $\Omega$ on all ranges <25 pF to <12 pF depending on ranges	10 M $\Omega$ on all ranges <30 pF to <15 pF depending on ranges	10 M $\Omega$ on all ranges <30 pF to <15 pF depending on ranges
Accuracy*	<p><math>\pm</math>(% reading + % range)</p> <p><b>3 mV-300 V ranges</b></p> <p>10 Hz-40 Hz: <math>\pm(2.5 + 2.5)</math></p> <p>40 Hz-2 MHz: <math>\pm(1 + 0)</math></p> <p>2 MHz-4 MHz: <math>\pm(1.5 + 1.5)</math></p> <p><b>4 MHz-10 MHz</b></p> <p>3 mV range: <math>\pm(2.5 + 2.5)</math></p> <p>10 mV-3V range: <math>\pm(3.0 + 2.0)</math> for 4 MHz to 6 MHz <math>\pm(3.75 + 3.75)</math> for 6 MHz to 10 MHz</p> <p>10 V-30 V: <math>\pm(3.5 + 3.5)</math></p> <p><b>1 mV range</b></p> <p>10 Hz-40 Hz: <math>\pm(2.5 + 2.5)</math></p> <p>40 Hz-500 kHz: <math>\pm(1 + 0)</math></p> <p>500 kHz-4 MHz: <math>\pm(2.5 + 2.5)</math></p>	<p>(% reading + % range) (% reading)</p> <p><b>300 <math>\mu</math>V-300 V ranges</b></p> <p><b>F</b> <b>FL</b></p> <p>20 Hz-40 Hz: <math>\pm(2 + 2)</math> <math>\pm 4</math></p> <p>40 Hz-100 Hz: <math>\pm(1 + 1)</math> <math>\pm 2</math></p> <p>100 Hz-1 MHz: <math>\pm(\frac{1}{2} + \frac{1}{2})</math> <math>\pm 1</math></p> <p>1 MHz-2 MHz: <math>\pm(1 + 1)</math> <math>\pm 2</math></p> <p>2 MHz-4 MHz: <math>\pm(2 + 2)</math> <math>\pm 4</math></p> <p><b>100 <math>\mu</math>V range</b></p> <p>30 Hz-60 Hz: <math>\pm(2 + 2)</math> <math>\pm 4</math></p> <p>60 Hz-100 kHz: <math>\pm(1 + 1)</math> <math>\pm 2</math></p> <p>100 kHz-500 kHz: <math>\pm(1 + 1)</math> <math>\pm 2</math></p> <p><math>\pm(1 + (+0, -7))</math> <math>+1, -8</math></p>	<p><b>+60 dB range</b></p> <p>20 Hz-40 kHz: <math>\pm 0.4</math> dB</p> <p>40 kHz-100 kHz: <math>\pm 0.2</math> dB</p> <p><b>-60 dB thru +40 dB ranges</b></p> <p>20 Hz-40 Hz: <math>\pm 0.4</math> dB</p> <p>40 Hz-500 kHz: <math>\pm 0.2</math> dB</p> <p>500 kHz-2 MHz: <math>\pm 0.4</math> dB</p> <p>2 MHz-4 MHz: <math>+0.2, -0.8</math> dB</p> <p><b>-80 dB range</b></p> <p>30 Hz-60 Hz: <math>\pm 0.4</math> dB</p> <p>60 Hz-100 kHz: <math>\pm 0.2</math> dB</p> <p>100 kHz-500 kHz: <math>+0.2, -0.8</math> dB</p>
Recovery		<2 s for 80 dB overload	
Overload		**500 V rms ac, 300 V dc	**1200 V rms max. input; 1000 V dc max. input
Calibration		Responds to average value of input; calibrated in rms value of sine wave. Scale -10 to +2 dB between ranges, 100 divisions on 0 to 1 scale. The dB scale reads -10 to +2 dB; 10 dB between ranges.	Responds to average value of input; calibrated in rms value of sine wave. Linear -20 to 0 dB scale, 100 divisions. 20 dB per range. Log voltage scale.
Weight		Net, 2.7 kg (6 lb). Shipping, 4.1 kg (9 lb)	
Size		159 mm H (without removable feet) x 130 mm W x 297 mm D (6.25" x 5.13" x 11")	
Power		AC: 115 or 230 V $\pm 10\%$ , 48 to 440 Hz, 6 VA max. DC: External batteries; + and - voltages between 35 V and 55 V	

\* NOTE: HP 400 EL same as HP 400E, and HP 400FL same as HP 400F, except for calibration. Linear dB scale -10 dB to +2 dB, 10 dB between ranges. Log voltage scales 0.3 to 1 and 0.8 to 3, 120 divisions from -10 dB +2 dB. HP 400 FL accuracy is % of reading in dB only.

\*\* AC overload voltage decreases with increasing frequency.

# VOLTMETERS, DIGITAL & ANALOG

## General Purpose, Multi-Function Meters



### HP Models 410C, 427A

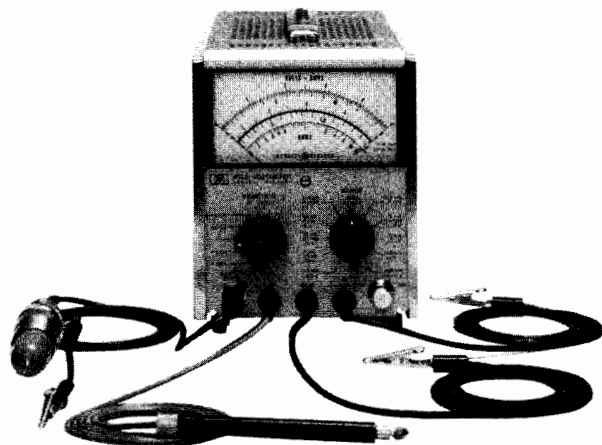

HP 410C with HP 11036A

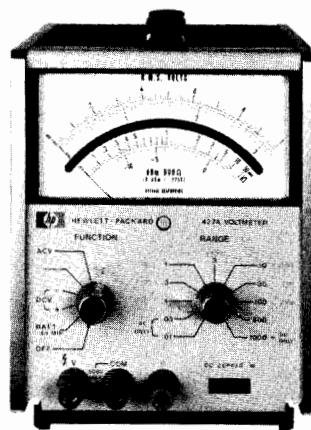

HP 427A

### Description

HP's model 410C can be used for both dc current and voltage measurements as well as resistance measurements. With the supplied HP 11036A Plug-in Probe, ac voltages can also be measured.

### Description

HP's model 427A is a portable multi-function meter valuable for measuring both ac and dc voltages and resistance. It will operate for more than 300 continuous hours on its internal battery. Option 001 provides both ac line and battery operation.

### Specifications

		HP 410C	HP 427A										
DC Voltmeter	Voltage Range Accuracy Input Resistance	±15 mV to ±1500 V F.S. 11 ranges ±2% of F.S. on any range 100 MΩ ±1% on 500 mV range and above, 10 MΩ ±3% on 150 mV range and below	±100 mV to ±1000 V F.S. 9 ranges ±25% of F.S. on any range 10 MΩ										
AC Voltmeter	Voltage Range Frequency	0.5 V to 300 V F.S. 7 ranges 20 Hz to 700 Hz	10 mV to 300 V F.S. 10 ranges 10 Hz to 1 MHz (> 500 MHz with HP 11096B High Frequency Probe) responds to average value, calibrated in rms										
	Response Accuracy	AC probe responds to positive peak-above average value, calibrated in rms ±3% of F.S. at 400 Hz for sinusoidal voltages from 0.5V-300V rms	<table border="1"> <thead> <tr> <th rowspan="2">Frequency</th> <th colspan="2">Range</th> </tr> <tr> <th>0.01V to 30V</th> <th>100V to 300V</th> </tr> </thead> <tbody> <tr> <td>10 Hz to 100 kHz</td> <td>2% of range</td> <td>2% of range</td> </tr> <tr> <td>100 kHz to 1 MHz</td> <td></td> <td></td> </tr> </tbody> </table>	Frequency	Range		0.01V to 30V	100V to 300V	10 Hz to 100 kHz	2% of range	2% of range	100 kHz to 1 MHz	
Frequency	Range												
	0.01V to 30V	100V to 300V											
10 Hz to 100 kHz	2% of range	2% of range											
100 kHz to 1 MHz													
Ohmmeter	Resistance Range	10Ω to 10MΩ center scale, 7 ranges	10Ω to 10mΩ center scale, 7 ranges										
	Accuracy	zero to midscale: ±5% of reading or ±2% of midscale, whichever is greater; ±7% from midscale to scale value of 2; ±8% from scale value of 2 to 3; ±9% from scale value of 3 to 5; ±10% from scale value of 5 to 10	±5% of reading (from 0.3 to 3 on scale)										
DC Ammeter	Current Range Accuracy	±1.5μA to ±150 mA F.S. 11 ranges ±3% of F.S. on any range	Not applicable										
Amplifier		Maximum voltage gain of 100; output proportional to meter indication; 1.5 Vdc F.S.	Not applicable										
Weight		Net, 3.6 kg (8 lb); shipping, 6.35 kg (14 lb)	Net, 2.4 kg (5.3 lb); shipping, 32 kg (7 lb)										
Size		159 mm H x 130 mm W x 280 mm D (6 1/2" x 5 1/8" x 11")	159 mm H x 130 mm W x 203 mm D (6 1/2" x 5 1/8" x 8")										
Power		115 V or 230 V ±10%, 48 Hz to 440 Hz, 15 VA (24 VA with HP 11036A AC Probe)	> 300 hr operation on 22.5 V battery; Option 001: battery or ac line operation, rear panel selectable, 115 V to 230 V ±20%, 48 to 440 Hz, 0.7 VA										
Accessories		Detachable power cord, HP 11036A AC Probe furnished standard	Refer to data sheet for available accessories										
Ordering Information		HP 410C Voltmeter Option 002 (less ac probe)	HP 427A Voltmeter Option 001 (ac power supply and battery)										



# VOLTMETERS, DIGITAL & ANALOG

Special Purpose Meters

Models 428B, 3406A

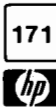

HP 428B

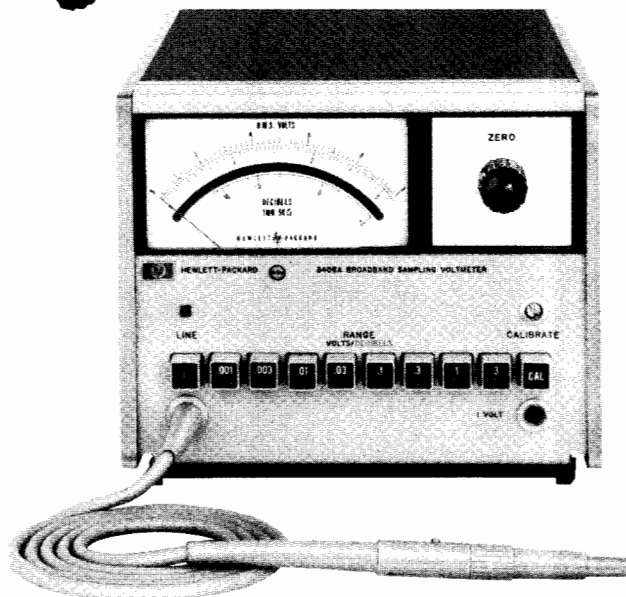

HP 3406A

## Description

HP model 428B Clip-On Millammeter measures direct current without interrupting your measured circuit or producing loading errors. DC current is measured by utilizing a clip-on transducer that converts the magnetic field around the conductor to an ac voltage proportional to dc current. This voltage is detected and displayed as direct current. Since no contact is made to the circuit, complete dc isolation is ensured.

Low frequency currents up to 400 Hz can also be measured by connecting an oscilloscope or voltmeter to the front panel output.

## Specifications

**DC current range:** 1 mA to 10 A full scale, nine ranges.

**Accuracy:**  $\pm 3\%$  of full scale  $\pm 0.15$  mA, from 0°C to 55°C (when instrument is calibrated to probe).

**Output:** variable linear output level with switch position for calibrated 1 V into open circuit (corresponds to full scale deflection).

**Frequency Range:** dc to 400 Hz (3 dB point).

**Power:** 115 or 230 V  $\pm 10\%$ , 48 to 440 Hz, 71 W.

**Probe insulation:** 300 V maximum.

**Probe tip size:**  $\approx 0.5$  in. (12.7 mm) by 0.66 in. (16.67 mm) aperture diameter 0.16 in. (3.97 mm).

**Size:** cabinet, 292 H x 191 W x 368 mm D (11.5" x 7.5" x 14.5").

**Weight:** net, 8.6 kg (17 lb); shipping, 10.9 kg (24 lb).

## Accessories Available

**HP 3529A Magnetometer Probe:** this probe measures magnetic field strength and direction. The component of magnetic field sensed is parallel to the cylindrical axis of the probe.

**Range:** 1 mG to 10 G full scale, nine ranges. 1 mG = 1 mA conversion factor.

**Accuracy:**  $\pm 3\%$  of full scale (0°C to +55°C) after calibration.

**Frequency Range:** dc to 80 Hz (3 dB point).

**Weight:** net, 0.45 kg (1 lb); shipping, 0.91 kg (2 lb).

## Ordering Information

HP 428B Analog Millammeter

HP 3529A Magnetometer Probe

## Description

The HP model 3406A RF Voltmeter employs sampling techniques to achieve an extremely high bandwidth (10 kHz to 1.2 GHz) with high input impedance. Signals as small as 50  $\mu$ V can be resolved. Accessory probe tips enable the use of the HP 3406A in applications such as receivers, amplifiers and coaxial transmission lines.

## Specifications

**Voltage range:** 1 mV to 3 V full scale in 8 ranges; decibels from -50 to +20 dBm (0 dBm = 1 mW into 50  $\Omega$ ); average-responding instrument calibrated to rms value of sine wave.

**Frequency range:** 10 kHz to 1.2 GHz; useful sensitivity from 1 kHz to beyond 2 GHz.

**Full-Scale Accuracy (%) with appropriate accessory (after probe is properly calibrated)**

10 kHz	20 kHz	25 kHz	100 kHz	100 MHz	700 MHz	1 GHz	1.2 GHz
$\pm 13$	$\pm 8$	$\pm 5$	$\pm 3$	$\pm 5$	$\pm 8$	$\pm 8$	$\pm 13$

## Sample Hold Output

Provides ac signal whose unclamped portion has statistics that are narrowly distributed about the statistics of the input, inverted in sign (operating into  $> 200$  k $\Omega$  load with  $< 1000$  pF). Output is 0.316 V at f.s. on any range.

## Meter

**Meter scales:** linear voltage, 0 to 1 and 0 to 3; decibel, -12 to +3. Individually calibrated taut-band meter.

## General

**DC recorder output:** adjustable from 0 to 1.2 mA into 1000 ohms at full scale, proportional to meter deflection.

**Power:** 115V  $\pm 10\%$ , 48-440 Hz; 230V  $\pm 10\%$ , 48-66 Hz; 25 VA max.

**Size:** 159 mm H (without removable feet), x 197 mm W x 279 mm D (6.25" x 7.75" x 11");  $\frac{1}{2}$  module.

**Weight:** net, 5.4 kg (12 lb); shipping, 6.8 kg (15 lb).

**Accessories:** refer to data sheet.

## Ordering Information

HP 3406A RF Voltmeter

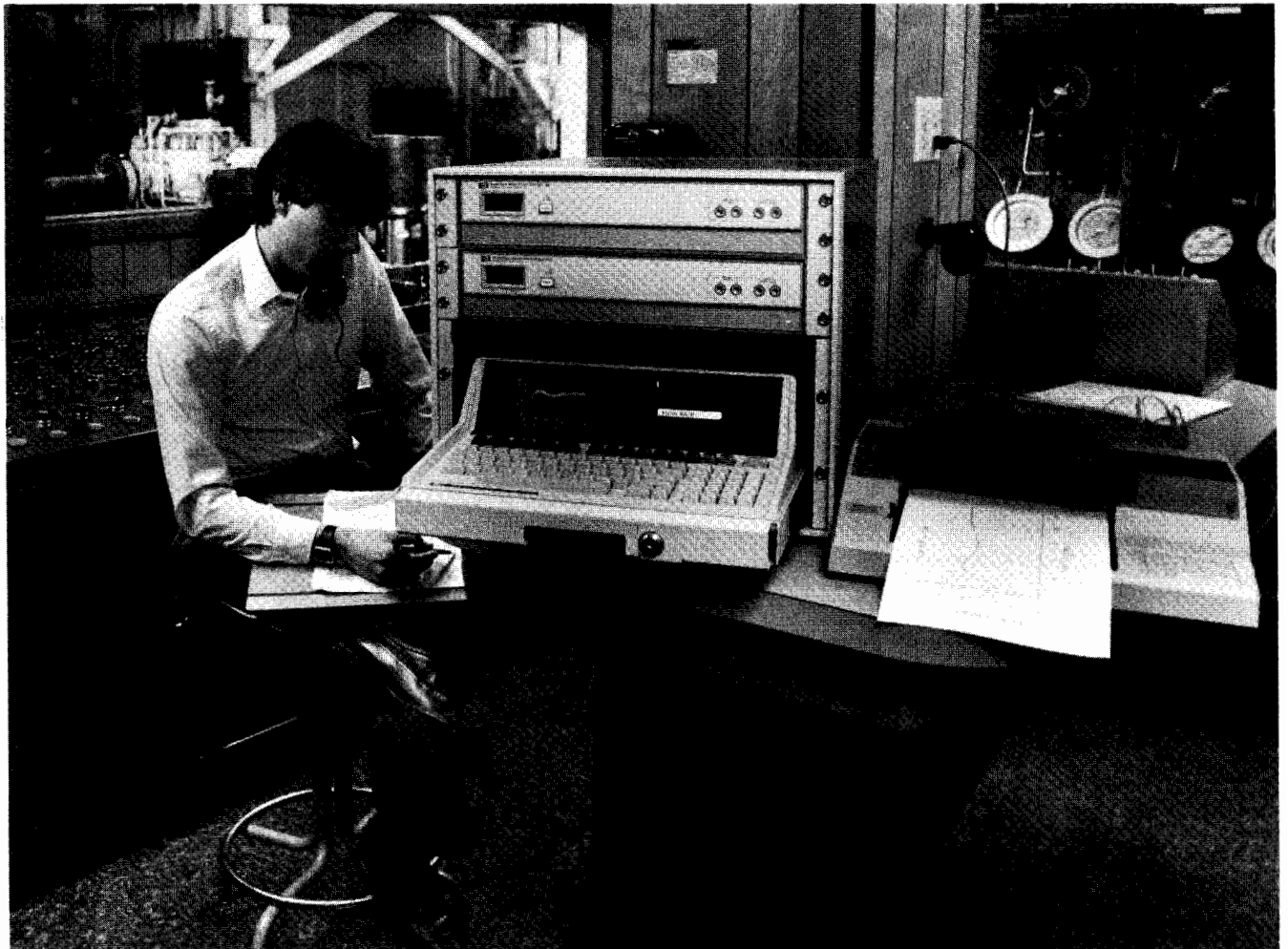

HP 3056DL with HP 7470A

Hewlett-Packard's automatic data acquisition and control equipment serves an ever-growing role as the world's industry strives to increase its productivity. More and more industries are discovering that automation is the key to remaining competitive and profitable. This section outlines some of the points that should be considered when evaluating automation solutions.

Industrial automation applications can be organized into three ideal categories: **Test**, **Measurement**, and **Control**.

### Test

The approach to industrial automation described as **Test** represents a situation where a product or device is being checked to its design standards. The variables to be measured and the requirements for accuracy and precision are well known. As an example of the **Test** philosophy, consider battery testing. A definite set of variables are measured (output voltage, voltage under load, output current charge capacity, etc.). Expected values and allowable tolerances for all inputs are known in a test application.

### Measurement

A measurement approach to industrial automation includes applications that evaluate or research a device, design or phenomenon. Unlike the **Test** approach, the measurement model is not known; in fact, the quantities may not be understood. **Measurement** is the gathering of the data to construct a model of the unknown. As an example, scientists are researching ways to maximize food production by optimizing plant watering methods. These scientists might adopt a **Measurement** philosophy by attempting to characterize the response of crops to various watering strategies. Quantities they might need to measure include plant weight, growth, leaf temperature, etc. It is very likely that as they develop a model of how a plant reacts to different watering strategies they will want to measure other things, i.e., they will seek to improve their model.

### Control

A **Control** type of application is similar to a **Test** application in that the model or process is well understood. A **Control** system

makes a series of events take place, measures them and takes corrective action. Consider the sequence of events in a metal casting and curing operation. Because the parts may be used in aircraft, careful control and documentation of the process will be needed. For example, the controls on the curing oven will be set according to the particular part being produced. In addition, to comply with the documentation requirements the temperature of the curing oven must be recorded. To insure against costly rework or scrap, the control operation needs to sense other critical events and to take appropriate action.

The three classes of industrial automation described above are ideal and any real world application would probably be a composite of all three. However, they emphasize certain requirements that will help in recognizing what equipment is best suited to fit a specific automation application. The following sections analyze test, measurement and control applications in regard to instrument and computer features.

**Accuracy**

High accuracy, wide dynamic range and good resolution are the requirements for measurement applications. In these situations the input signal is frequently small and high accuracy is needed to aid in developing the most accurate model possible. In contrast, in control and production test applications the input is well characterized and therefore the demands of accuracy and resolution may not be as stringent.

**Comparison of Analog Measurement Performance**

	Sensitivity	Resolution	Accuracy
HP 3421A	1 $\mu$ V	1 part in 300,000	.01%
HP 3497A	1 $\mu$ V	1 part in 120,000	.007%
HP 3054A/C	100nV	1 part in 1,200,000	.0035%
HP 6940B	10 $\mu$ V	12 bit	.20%
	50 $\mu$ V	12 bit	.15%
HP 6942A	50 $\mu$ V	12 bit	.15%
HP 6944A	50 $\mu$ V	12 bit	.15%
HP 2250	1.56 $\mu$ V	14 bit	.1%

**Measurement Speed**

Maximizing measurement speed is often a characteristic of test and control applications where throughput and production efficiency are of great concern. As a general rule there is a trade-off between speed and accuracy—the longer something is measured, the more accurately it is measured. Or conversely, the faster an input is measured, the less accurate the measurement.

**Comparison of Analog Measurement Speed**

	Resolution	Maximum Readings/Second
HP 3421A	1 part in 300,000	4
	1 part in 30,000	22
	1 part in 3,000	35
HP 3497A	1 part in 120,000	50
	1 part in 12,000	200
	1 part in 1,200	300
HP 3054A/C	1 part in 1,200,000	48
	1 part in 120,000	210
	1 part in 12,000	330
	1 part in 2,000	4,800
HP 6940B	12 bit	7 (integrating converter)
	12 bit	20,000
HP 6942A	12 bit	33,000
	12 bit	500,000
HP 6944A	12 bit	33,000
	12 bit	500,000
HP 2250	14 bit	50,000

**Control Features**

The Hewlett-Packard products considered in this section have capability to sense digital inputs, count pulse trains, close relays and provide programmable voltage and current outputs. Consider each product in regard to your particular application.

Instrument	Digital Input/Interrupt	Actuator Output	Programmable Voltage & Current	Counter Input	Timer	Pulse Train Output
HP 3421A	x	x	—	x	—	—
HP 3497A	x	x	x	x	x	—
HP 3054A/C	x	x	x	x	x	—
HP 6940B	x	x	x	x	x	x
HP 6942A	x	x	x	x	x	x
HP 6944A	x	x	x	x	x	x
HP 2250	x	x	x	x	x	x

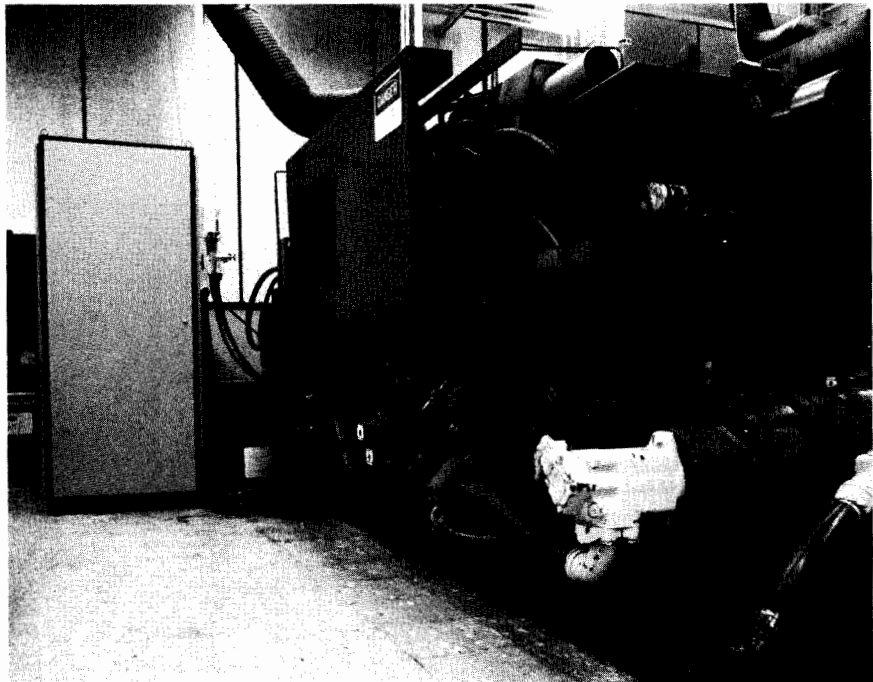

HP 2250

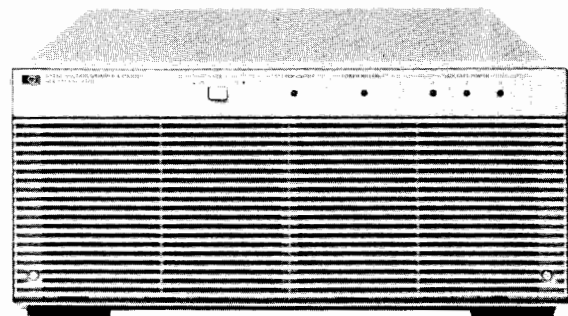

HP 6942A

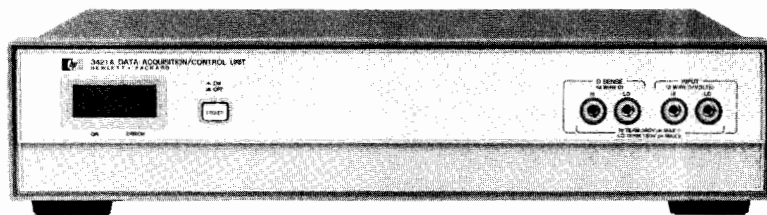

HP 3421A

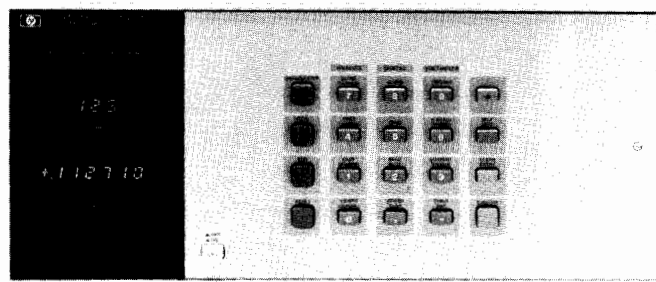

HP 3497A



### Instrument Intelligence

Applications differ in how much they will require instruments to do independently of a computer.

**Measurement** applications are usually closely coupled to the computer and place few demands on the instrument. **Test** and **control** applications may have higher instrument intelligence requirements. In **Test** applications the instrument may operate stand alone from the computer and only report exceptions to the test limits. In **Control** applications it may be desirable for the instrument to operate separately from the computer to protect against computer or I/O link failure. Some products rely on powerful microprocessors that can operate independently of the main computer. Other products utilize dedicated card handshaking to provide additional capability.

	Relative Rating of Standalone Product Intelligence (doesn't include computer)	Reading Storage	Program Storage
HP 3421A	Low	Yes	No
HP 3497A	Low	Yes	No
HP 3054A/C	Low	Yes	No
HP 6940B	Low	No	No
HP 6942A	Moderate	Yes	Yes
HP 6944A	Low	Yes	No
HP 2250	High	Yes	Yes

### Environment

Consideration of the operating environment is a very important step in choosing a measurement, test or control system. Any application can require that a test, measurement or control system operate in hot, dusty and corrosive environments. In addition, the electrical environment should also be considered in regard to the amount of electrical noise (both common and normal mode) present in the area.

All Hewlett-Packard instruments are designed to operate in moderately harsh environments and the HP 2250 Measurement and Control Processor is available in a NEMA-12 rated enclosure for industrial installations.

HP 6944A

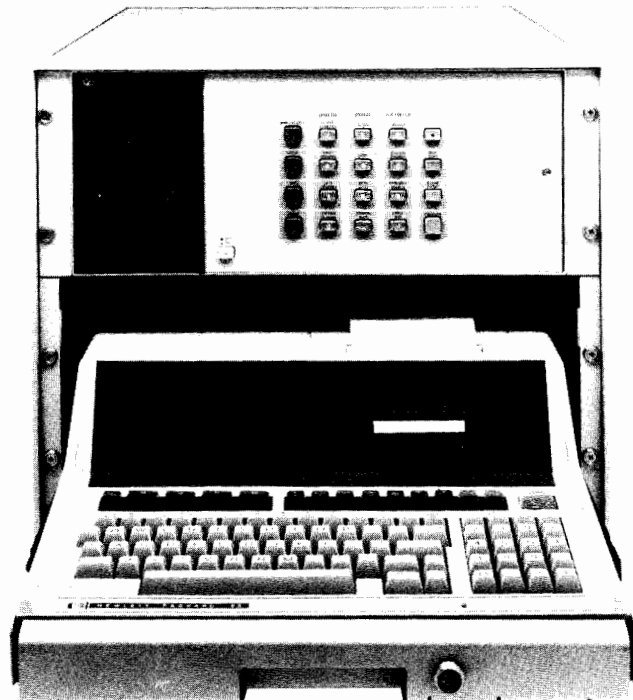
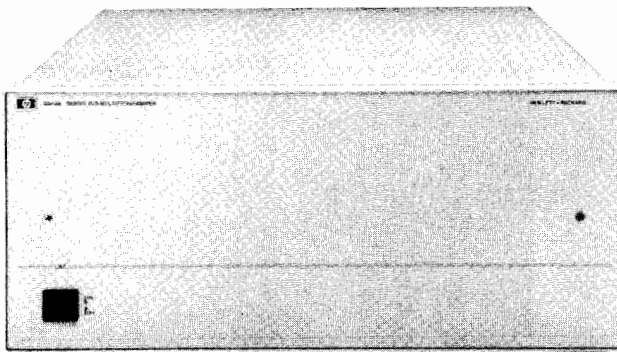

HP 3054DL

### Integrated Systems

In addition to providing the individual instruments and computers needed for automation, Hewlett-Packard also provides **SYSTEMS** that combine instruments, computers, and software with rack mounting and integration. Systems range from the HP 3054DL Data Logger, which provides an easy-to-use software package for the first time user, to the HP 3054A/C systems that provide utility subprograms you can use to build your own program. Systems have the advantage of providing a more complete solution and allowing users to concentrate more on automation tasks.

Base Instrument	System
HP 3421A	HP 3056DL Data Logger
HP 3497A	HP 3054DL Data Logger
HP 3497A/3456A	HP 3054C Automatic Data Acquisition/Control System
HP 3497A/3456A/HP 3437A	HP 3054A Automatic Data Acquisition/Control System
HP 6940B	Software Available
HP 6942A	HP 6901S Measurement and Analysis System
HP 6944A	Software Available
HP 2250	Software Available

Customized system integration is also available using the ATS/1000 system integration service. This service combines customer specified measurement and control equipment with HP 1000 computers. Integration ranges from simple racking and cabling to installation of the system and writing of software.

For further information on these products, please refer to the following catalog pages. Separate technical brochures are also available on each product.

Automation Hardware	Catalog Page	Technical Brochure #
HP 3421A	176	5953-6975
HP 3497A	182	5953-6911
HP 3054A	188	5952-8897
HP 3054C	181	5952-8865
HP 3054DL	180	5952-8862
HP 3056DL	175	5953-6975
HP 6940B	192	5952-4077
HP 6942A	192	5952-4092
HP 6944A	199	5952-4110
HP 2250	186	5953-6976

- Up to 60 channels
- Graphics
- Data stored on tape
- Menu and subroutine software

- Adaptive data logging
- User definable functions
- Choose from 18 separate functions

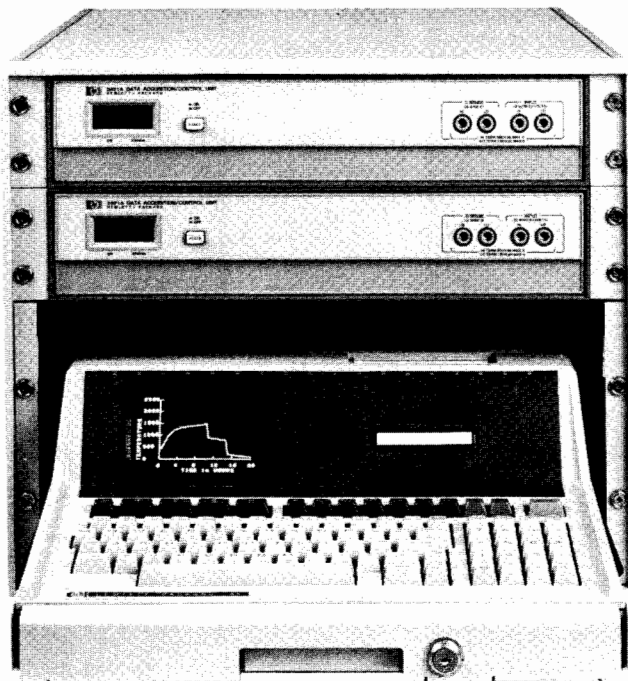

HP 3056DL



## Description

The HP 3056DL Data Logger merges the measurement capabilities of up to two HP 3421A Data Acquisition/Control Units with the programming versatility of the HP-85B computer. It comes in an attractive locking cabinet with two dedicated software packages and all necessary cables.

## The Hardware

Each HP 3421A Data Acquisition/Control Unit used in the HP 3056DL Data Logger has the accuracy and resolution for critical applications. The basic accuracy is .01%, with a 5½ digit A/D Converter, a sensitivity of one microvolt, signal conditioning for thermocouples, DCV, ACV, Ohms, and Frequency. Each has a scanning capacity of up to 30 channels as well as 30-reading storage buffer. The HP 3421A assures you of precise transducer measurements at a surprisingly low price.

The HP-85B Personal Computer communicates with the HP 3421A via either HP-IL or HP-IB. The HP-85B has the data logging features you need all in a single integrated package: keyboard, magnetic tape drive, graphics printer and CRT.

## The Software

Two levels of software come with each HP 3056DL Data Logger. The HP 3056DL Menu Software is ideal for the first-time user, yet powerful enough for an expert.

For the BASIC programmer, there are measurement subroutines in the HP 3056DL software. Integrate these subroutines into your own programming material to get the optimum speed and efficiency from the data logger.

## User Definable Functions

There are no less than 17 separate functions to choose from:

- DCV
- 2-Wire Ohms
- Thermocouples: J, K, T, E, R, S
- 2-Wire RTD
- ACV
- 4-Wire Ohms
- 4-Wire RTD
- Digital Read
- Frequency
- 2.2K Thermistor
- Actuate
- 4-20 mA

Each function is selected simply by pressing the appropriate key on the HP-85B computer.

When the 17 available functions are not adequate, you can generate your own linearization equation:  $mX+B$ , a 5th order polynomial, or even a BASIC subroutine that you write yourself.

## Adaptive Data Logging

When a specified channel exceeds its measurement limits, you can instruct the system to print, display a warning, or jump to a completely different measurement routine. For instance, you can scan slowly while the process you are monitoring is stable, and then adapt the scanning rate when an out-of-limit condition occurs. This "adaptive scanning" philosophy makes efficient use of data storage space and computer time.

## Ordering Information

**HP 3056S** includes the HP 3056DL Data Logger plus the HP 85B Controller.

### Input Assembly Options

- 020:** 8 Channel Multiplexer/2 Channel Actuator Assembly
- 021:** 9 Channel Multiplexer/1 Channel Actuator Assembly
- 022:** 10 Channel Multiplexer Assembly
- 040:** Breadboard Assembly, connector block
- 050:** Digital Assembly, connector block

### Power Line Options

**315-346:** Options for 100 V/50 Hz through 240 V/60 Hz

### Systems Options

- 201\*:** add HP-IB interface to the HP 3421A (allows the use of EITHER HP-IB or HP-IL)
- 202\*:** two HP 3421As (both HP-IL) for up to 60 channel capacity
- 203\*:** two HP 3421As (both HP-IB) for up to 60 channel capacity
- 400:** delete 16 in. cabinet, locking drawer
- 541:** add HP-41CV, HP 44468A Data Acquisition Pac for HP-41CV, HP 82160A HP-IL Module and HP 82182A Time Module
- 561:** add HP 82161A HP-IL Digital Cassette Drive
- 562:** add HP 82162A HP-IL Printer/Plotter
- 910:** extra set of HP 3056DL manuals, pre-recorded tape cartridge

### Computer

Order the HP-85B. To operate the HP 3056DL software, you must have all items (HP-85B, ROM drawer, HP-IB or HP-IL, Advanced Programming ROM).

- HP-85B** Computer with CRT, keyboard, tape drive graphics, 32K memory, I/O ROM, mass storage ROM
- HP 82936A** ROM Drawer
- HP 82937A** HP-IB Interface
- HP 82938A** HP-IL Interface
- HP 00085-15005** Advanced Programming ROM

### HP 3056DL Data Logger

Includes one HP 3421A Data Acquisition/Control Unit with 5½ digit DVM, VDC, VAC, Ω, Counter, 30-reading storage, HP-IL Interface, sliding drawer and cabinet, software levels 1 and 2. Computer is ordered separately or as part of the HP 3056S.

\* Select no more than one



# DATA ACQUISITION, CONTROL & TEST

## Data Acquisition/Control Unit

Model 3421A

- Up to 30 differential channels, 56 single-ended channels
- Electronic calibration for repeatable answers
- Built-in 5½ digit A/D converter with 1  $\mu$ V sensitivity
- HP-IL (standard) and HP-IB (optional) with rear panel switch
- Optional 12 volt battery power
- "Sleep mode" for extended battery life in remote locations
- Front terminals for convenient DCV, ACV, 2 & 4-wire ohms, frequency and temperature
- Display shows channels closed, digital states and self-test conditions

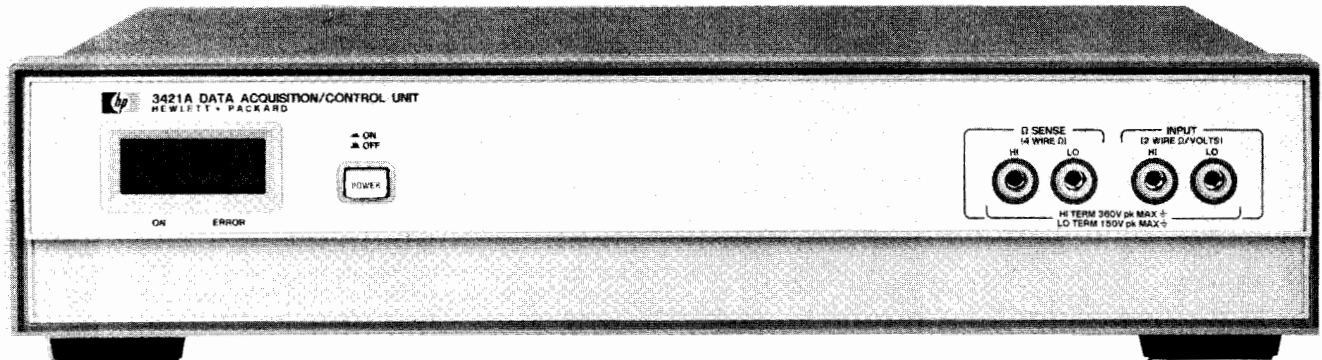

HP 3421A



### Description

The HP 3421A Data Acquisition/Control Unit is the system that beats the high cost of data logging. Use it for that small data acquisition project with the assurance that it will quickly pay its own way.

The HP 3421A scans up to 30 channels, measuring DCV, ACV, 2- and 4-wire Ohms, Frequency, and Temperature. It also reads and writes digital information and stores up to 30 analog readings. The standard HP 3421A comes with an HP-IL interface for battery-powered flexibility or HP-IB for more computational power.

Up to three of the following assemblies may be added to the HP 3421A mainframe:

- 10-channel analog multiplexer/actuator assembly with thermocouple compensation
- 8-bit input/8 bit output digital assembly
- Breadboard assembly for custom circuitry

### Measurement Integrity

With its 5½, 4½, 3½ digit A/D converter, the HP 3421A can resolve 1  $\mu$ V out of 300 mV to monitor thermocouples, strain gage bridges and other low-level transducers. Or it can read higher level signals by auto-ranging up to 300 volts dc.

### System Versatility

Each HP 3421A can scan up to 30 differential channels or 56 single-ended channels of analog information. The HP 3421A is battery-powered with latching relays that will not change state when the ac line power is removed. Battery power gives the HP 3421A its own uninterruptible power supply.

All functions are remotely programmable via either HP-IL or HP-IB. Use HP-IL with the HP 41CV handheld calculator as a self-contained battery-powered data logger, or use HP-IB with the HP 85B Personal Computer for more programming performance.

### Special HP 41C/CV ROM

To make the HP 3421A more convenient for benchtop or field use, a Data Acquisition Pac (HP 44468A) is available for the HP-41C/CV handheld computers. Using the HP-IL I/O, this Pac gives the HP 3421A an operational front panel from the computer's keyboard using "soft" keys defined by a keyboard overlay and special ROM. It also includes a data logger program complete with special keyboard overlay to allow the user to enter beginning-and-ending

scan sequence, to define the functions to be measured, to automatically compensate for the most common types of thermocouples and to simplify storage of data. Prompting is done on the HP-41 handheld computer's LCD display. The HP-41C/CV can be equipped with an HP 82182A Time Module which allows the operator to specify at what time scanning sequences are to take place and at what interval measurements are to be made.

### The HP 41CV System

Combine the HP 41CV, the HP 3421A, the HP 82161A Digital Tape Drive, and the HP 82162A Printer/Plotter to make a portable low-cost data logger. The HP 44468A Data Acquisition Pac makes programming easy. It contains a HP-41CV Control ROM for the HP 3421A as well as two special HP-41CV keyboards. Each keyboard is dedicated to providing fast, simple function programming with the HP-41CV.

### The HP 85B System (The HP 3056DL)

The HP 3421A can also be combined with the HP-85B Personal Computer for even easier and more powerful data logging. Dedicated software enhances the system with Menu programming, Subroutine programming, instrument panel emulation and graphic analysis. It makes data logging as easy as answering a few questions on the CRT display.

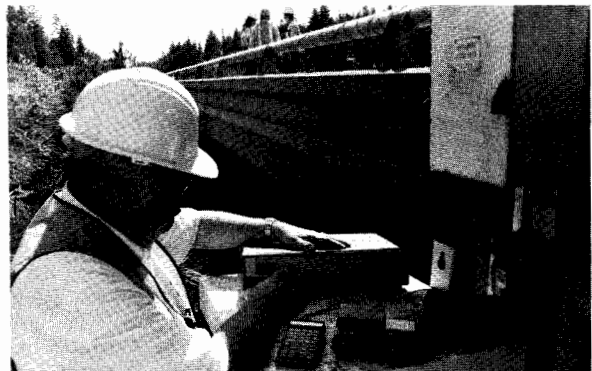



Use thermocouples with the HP 3421A to measure the temperature of a bridge section to tell the best time to resurface the roadbed. Or use the dc voltage function to monitor the galvanic effect that causes steel reinforcing rods to corrode inside the concrete.

The HP-41CV handheld calculator can turn on the HP 3421A Data Acquisition/Control Unit, trigger it to scan a list of 30 channels, instruct the digital cassette to store all 30 readings on tape and then power down the entire system until the next time interval passes.

The HP 3421A is not limited to portable applications. It is equally useful in laboratory situations, where its 0.01% accuracy, 1 microvolt sensitivity and 5½ digit resolution assure you of reliable answers.

Digital inputs, actuator outputs and a breadboard assembly give the laboratory designer a great deal of instrument flexibility while HP-IB compatibility adds the option of a more powerful instrument controller.

## HP 3421A Mainframe Specifications

The HP 3421A mainframe comes with:

- A 5½, 4½, and 3½ digit integrating A/D converter
- Thermocouple compensation
- Type T thermocouple linearization built in
- HP-IL
- 30-reading storage buffer
- LCD 30 channel display with power and error indicators
- Electronic calibration
- Rechargeable battery
- High level command set

All specifications apply for relative humidity less than 85% at 30 degrees C.

### DC Voltage

**Ranges:** 300 mV, 3 V, 30 V, 300 V, Autorange

**Basic accuracy:** ±(.009% reading + 3 counts); 5½ digits

**Reading rates:** 2 to 35 readings/second

### Resistance

**Ranges:** 300 Ω, 3 kΩ, 30 kΩ, 300 kΩ, 3 MΩ, 30 MΩ; Autorange

**Basic accuracy:** ±(.012% reading + 3 counts); 5½ digits

**Reading rates:** 2 to 35 readings/second

### AC Voltage

**Ranges:** 3 V, 30 V, (300 V with HP 44469A divider)

**Converter type:** averaging

**Resolution:** 3½ or 4½ digits

**Basic accuracy:** 4½ digits: ±(0.5% reading + 60 counts), 45 Hz to 500 Hz; ±(1% reading + 60 counts), 30 Hz to 1 kHz

### Counter

The counter is part of the mainframe circuit, and is multiplexed through the channel relays.

**Resolution:** 65,535 counts

**Frequency:** 1 Hz to 10 kHz

**Modes:** frequency, totalize

### Thermocouple Thermometer

Type T thermocouple linearization is built in. For other thermocouple types, the reference junction temperature is available on each multiplexer assembly.

### Option 020, 021, 022 Multiplexer/Actuator Assemblies

The configuration of multiplexer and actuators depends on the option you order. Option 020 has 8 multiplexer/2 actuator channels; Option 021 has 9 multiplexer/1 actuator channels; Option 022 has 10 multiplexer channels. The actuators are capable of switching 252 Vac. One HP 3421A mainframe can hold up to 3 assemblies.

### Option 040 Breadboard Assembly

The breadboard assembly is convenient for constructing custom circuitry. It comes complete with a manual describing the circuit that enables the HP 3421A to communicate directly with an 8-bit microprocessor.

### Option 050 Digital I/O Assembly

Option 050 has 8 isolated input lines and 8 isolated output lines for both monitoring and controlling external digital devices.

### Option 201 HP-IB

The Option 201 adds an HP-IB interface to the HP 3421A. Interface functions: SH1, AH1, T6, TE0, LE0, L4, SR1, RL0, PP0, DC1, DT1, C0. For more on these codes, see the HP-IB section of this catalog.

### Option 212 12 Volt Power Assembly

The 12 volt assembly provides the necessary isolation and voltage regulation to allow use of a 12 volt automotive battery as a power supply. This option also provides connectors to charge the HP-41CV controller, the HP 82161A Cassette Drive and the HP 82162A Printer/Plotter. The system will operate in an automotive environment such as from a cigarette lighter with the engine running or off. Option 212 cannot be ordered if Option 201 has been specified.

## Ordering Information

### Input and I/O Assembly Options

**020:** 8 Channel Multiplexer/2 Channel Actuator Assembly

**021:** 9 Channel Multiplexer/1 Channel Actuator Assembly

**022:** 10 Channel Multiplexer Assembly

**040:** Breadboard Assembly with connector block

**050:** 8 bit in, 8 bit out Digital I/O Assembly with connector block

**201:** add HP-IB interface. Allows use of EITHER an HP-IB or HP-IL controller

**212:** add 12 volt power assembly. Cannot be added if opt 201 is specified

### HP 3421A/41CV System Options

**541:** Add HP-41CV for HP 3421A control. This option includes the HP-41CV handheld calculator, HP 44468A Data Acquisition Pac with HP 3421A/41CV Control ROM, HP 82160A HP-IL Interface Module for HP-41CV, and an HP 82182A Time Module

**561:** Add HP 82161A Digital Cassette Drive (HP-IL)

**562:** Add HP 82162A Printer/Plotter (HP-IL)

### Power and Frequency Options

**315-346:** Line power options from 100 V/50 Hz-240 V/60 Hz

### Rack Mount and Manual Options

**401:** Side Handle Kit

**907:** Front Handle Kit

**908:** Rack Mount Kit

**909:** Rack Mount with Handle

**910:** Extra Manuals

### Field Installation Kits\*

**HP 44462A:** 8-Channel Multiplexer/2 Channel Actuator Assembly with thermocouple compensation, connector block

**HP 44463A:** extra connector block for above

**HP 44464A:** Breadboard Assembly with connector block

**HP 44465A:** 8 bit in, 8 bit out digital I/O assembly with connector block

**HP 44466A:** Extra connector block for digital or breadboard assembly

**HP 44468A:** Data Acquisition Pac for HP-41CV

**HP 44469A:** Seven 10:1 dividers for measuring 300 Vac

### Accessories

**HP 11341A/B:** HP 3421A Carrying Case (Hardshell). Holds HP 3421A, Options 561, 562 and either the HP-41CV or the HP-75D

**HP 11340A:** 20-metre HP-IL cable

**HP 11340B:** 50-metre HP-IL cable

**HP 11340C:** 100-metre HP-IL cable

## HP 3421A Data Acquisition/Control Unit

\* Field installation is recommended to be performed only by service trained personnel.

# DATA ACQUISITION, CONTROL & TEST

Automatic Data Acquisition/Control System

HP Model 3054S/HP Model 3054A

- Improve productivity in research and manufacturing
- Low cost data acquisition
- Precision transducer measurements and analysis
- 1000 analog channels and 1360 digital points
- Control functions for closed-loop applications

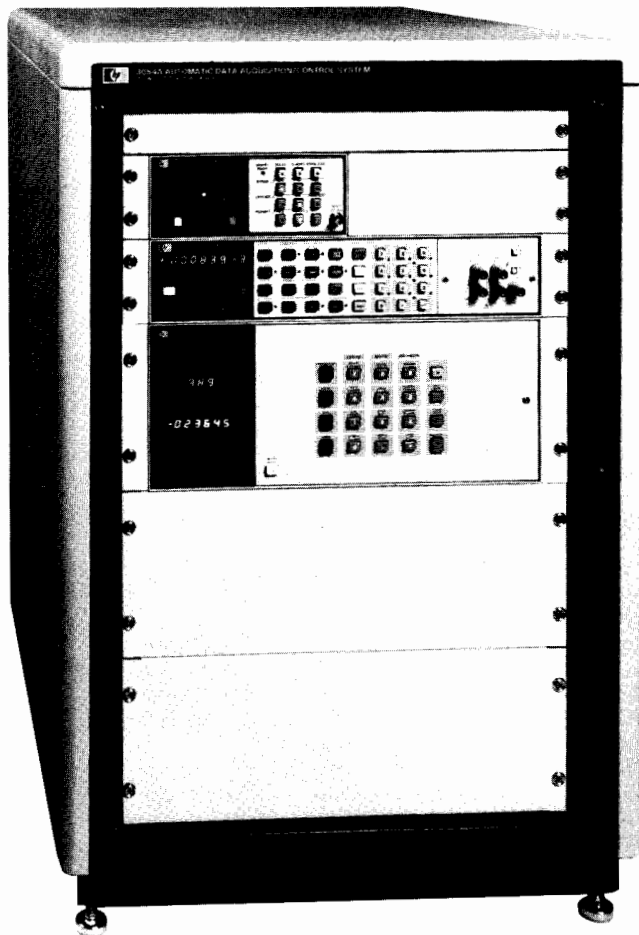

HP 3054S/A



## Description

The HP 3054S/A is a computer-based automatic data acquisition and control system. The HP 3054S/A combines speed, precision and a variety of control functions with full computation and analysis capabilities. The HP 3054S/A offers flexibility, convenience, and performance to solve many data acquisition applications.

The system has the flexibility to make a wide variety of measurements, including outputs of thermocouples, strain gages, RTDs, flow meters, and other transducers. The HP 3054S/A also has digital inputs and outputs, voltage and current D/A converters for precision closed-loop control.

The HP 3054S/A offers the convenience of using instrumentation that is designed as a system. To help the user get started fast, the measuring system is rack-mounted and pretested. System specifications represent the summation of all instrument errors. An Introductory User's Guide is part of the system documentation package which enables the user to quickly learn how to use the system for his or her application.

The HP 3054S/A system performs by combining speed, accuracy and computational power. Measurement rates, from 4800 readings/second (60 Hz operation) to 48 readings/second, are possible with resolutions from 3½ digits to 6½ digits. DC measurements of low level transducers can be made with 100 nanovolt resolution with greater than 150 dB of noise rejection. An HP desktop computer or mini-computer will automate the system, store data, linearize transducers, and provide computation and analysis.



HP 9826A

The HP 3054S/A system is a powerful yet economical system for transducer measurements. By adding a graphics plotter, system measurements can be plotted for analysis, documentation, and presentation. Recommended plotters include the 6-pen HP 7475A, and the 2-pen HP 7470A.

## System Configuration

The HP 3054A system includes an HP 3497A Data Acquisition/Control Unit, an HP 3456A Digital Voltmeter and an HP 3437A System Voltmeter. The HP 3054S system includes an entire HP 3054A plus a desktop computer (HP 85B, HP Series 200 or HP 7825B) and selected peripherals.

**The HP 3497A Data Acquisition/Control Unit** is the instrument that provides the analog multiplexing, digital monitoring, and control functions using plug-in assemblies. The 20 Channel Reed Relay Assembly provides low level guarded switching with  $<2 \mu\text{V}$  of thermal offset. An isothermal connector is provided as an option to this assembly for thermocouple compensation. An FET multiplexer assembly provides fast scanning and high reliability. Digital input and output assemblies are available for monitoring and control. And you get specialized measurement and control using the Reciprocal Counter Assembly and the programmable D/A Converter Assemblies. Up to five of these optional plug-in assemblies can be contained in the HP 3497A mainframe. Expansion to more than five assemblies is provided by the HP 3498A Extender. Each HP 3498A can hold ten more assemblies. A total of thirteen extenders can be supported by one HP 3497A mainframe, giving a maximum of 1000 analog channels and 1360 digital channels.

System timing is accomplished through the non-volatile real time clock in the HP 3497A.

The optional DVM assembly for the HP 3497A has  $1 \mu\text{V}$  sensitivity, 5½ digit resolution, integration, and guarding—capability previously available only on stand-alone system DVMs. (Refer to page 182)

**The HP 3456A Digital Voltmeter** is a 3½ to 6½ digit integrating voltmeter with high accuracy, 100 nanovolt sensitivity, and speed to 330 readings/second. Its dc and true rms ac voltage and resistance measurement capability reduce the amount of signal conditioning necessary. The HP 3456A can detect 100 nanovolt changes in 100 mV signals at speeds of 48 readings/second. This capability is necessary for measuring thermocouples with the HP 3054S/A system to better than 0.01°C resolution. Common mode rejection of 140 dB makes the HP 3054S/A system particularly suited for repeatable low level measurements in the presence of noise.



The built-in memory of the HP 3456A can store both readings and sequences of measurement commands. The HP 3456A can store internally up to 350 readings or up to 1400 ASCII programming characters or combinations of both readings and programming characters.

**The HP 3437A System Voltmeter** is a high speed 3½ digit dc voltmeter that provides precisely timed sample and hold readings. Use it to analyze repetitive signals up to 1 MHz or transients down to 1 ms. in a fraction of the time required by conventional means. Use it with Option 030 FET Multiplexer Assembly to scan sequential channels at up to 4800 channels per second (60 Hz operation).

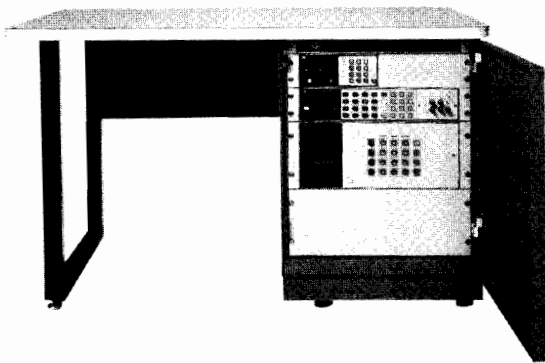

The variety of cabinet options with the HP 3054S/A can be configured to fit a wide range of applications.

## Power and Performance in Desktop Computers

A choice of computers with the HP 3054S/A provides a wide range of capability and performance for automating data acquisition applications. The desktop computers supported with the HP 3054S/A are the HP 85B, HP Series 200 and HP 9825B. The computers automate the system by controlling the instruments and gathering the data over HP-IB. All of these computers offer easy interaction to greatly simplify the writing and editing of programs. The friendly languages of the computers and the HP 3054S/A software package make it easy to get started. The presentation of data is very versatile when using a computer and external peripherals. Transducer data can be converted to engineering units, statistical analyses of the data can be performed, and graphical representations of the data can be produced. The individual capabilities of each computer—such as speed, memory size, and output devices—should be considered for the different data acquisition applications.

## Software and Documentation

The system software is an integral part of the HP 3054S/A Automatic Data Acquisition/Control System. Specially written software and documentation packages are supplied for each of the computers. This complete software package greatly simplifies programming and enables the user to get started fast.

The complete software and documentation package supplied with the HP 3054S/A includes:

- operational verification programs
- system sub-programming routines
- typical application programs

The system verification/diagnostic programs can be used to verify that the system is in operating condition at the time of installation. The programming of the HP 3054S/A is most effectively accomplished by combining the system sub-program with other system operations. Sample application programs are also provided for assistance in developing functional software.

## Racks and Cabinets

Other cabinets may be chosen besides the standard 30" rack for the HP 3054S/A. A 16" case is offered as a compact and portable package for the HP 3054S/A. A desk provides rack space for the instrument and a table top for software development. The 56" cabinet provides space for additional equipment and future expansion.

For more information on the HP 3054S/A, contact your nearest HP Sales Office.

## System Options

### Input Assemblies for the HP 3497A

- 010:** 20 Channel, Low Thermal Relay Multiplexer Assembly
- 020:** Relay Multiplexer Assembly with Thermocouple Compensation
- 030:** 20 Channel FET Multiplexer Assembly
- 050:** 16 Channel, Isolated, Digital Input/Interrupt Assembly
- 060:** Reciprocal Counter Assembly
- 070:** 10 Channel, 120Ω Strain Gage/Bridge Assembly
- 071:** 10 Channel, 350Ω Strain Gage/Bridge Assembly

### Output Assemblies for the HP 3497A

- 110:** 16 Channel Actuator/Digital Output Assembly
- 115:** 8 Channel High Voltage Actuator
- 120:** ±10V Dual D/A Converter Assembly
- 130:** 0 to 20 mA or 4 to 20 mA Dual D/A Converter Assembly
- 140:** Breadboard card for custom designs
- 230:** U.S. Clock Format for the HP 3497A (month:day:hour:minute:second)
- 231:** European Clock Format for the HP 3497A (day:month:hour:minute:second)

**260:** Delete Keyboard and Display on HP 3497A

**261:** Delete HP 3437A SVM and HP-IB cable

**262:** Delete HP 3456A DVM and HP-IB cable

**280:** Add 5½ digit DVM and current source for the HP 3497A. NOTE: Only one DVM may be deleted from system, unless optional HP 3497A DVM assembly is added.

**298:** Add HP 3498A Extender and connecting cables

### Cabinet Options for HP 3054A

**400:** Delete 30" cabinet; rack-mounting hardware supplied

**416:** Add 16" combining case with power strip; delete 30" cabinet

**456:** Add 56" cabinet with fan and power strip; delete 30" cabinet

**490:** Add HP 44530A systems desk with fan, power strip, and 23" rack space; delete 30" cabinet

**495:** Field wiring termination panel; fits 30" (standard) and 56" (opt 456) cabinets only

**496:** Add locking drawer, 8" high, for 85A

**498:** Add locking drawer, 18" high

### Software and Documentation Options for HP 3054A

**841:** Complete HP 3054S System Documentation—85B

**842:** Complete HP 3054S System Documentation—HP 9825B

**800:** Complete HP 3054S System Documentation—Series 200 (BASIC) on 3½" flexible disc

**801:** Complete HP 3054S System Documentation—Series 200 (BASIC) on 5¼" flexible disc

**804:** Complete HP 3054S System Documentation—HP 9826A (HPL)

### Basic HP 3054A System



# DATA ACQUISITION, CONTROL & TEST

## Data Loggers

HP Model 3054S/HP Model 3054DL

- 5½ Digit measurement
- Graphics

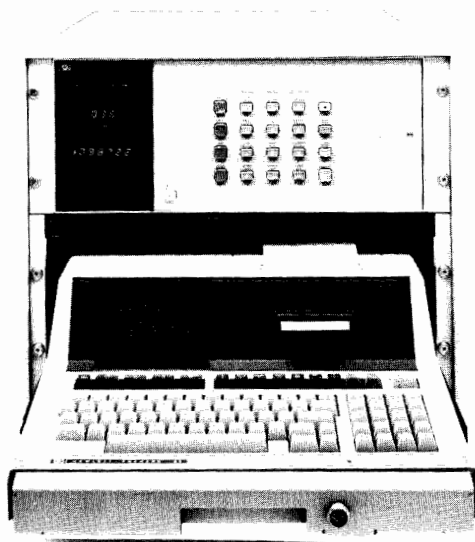

## Description

The HP 3054DL consists of a precise measurement unit housed inside an attractive locking cabinet. When you add the computational capability of the 85B scientific computer, the combination becomes more than just a data logger—it becomes a complete scientific measurement station with data and program storage, graphics and excellent measurement performance the HP 3054S.

**The measurement unit** contains a 5½ digit digital voltmeter with a dc current source for ohms measurements as well as a 5-slot mainframe for optional plug-in assemblies. Each slot accepts either a counter, a low-thermal multiplexer, a thermocouple multiplexer, a digital input card or a digital output (alarm relay) card. Advanced noise-rejection techniques such as Multi-Slope Integration and Tree Switching compliment the 1 microvolt sensitivity of the voltmeter.

**The HP 85B computer** is not only a system controller, it is a full function BASIC language scientific computer with data analysis capabilities, graphics CRT and printer, and a built-in tape cartridge for both data and program storage.

**Temperature measurements**, whether made with thermocouples, RTD's or thermistors, are all specified in terms of total system accuracy. The thermocouple reference junction is located on the connector block and is read automatically via the data logger software.

**Resistance** can be measured in a 4-wire configuration to eliminate the effects of lead wire resistance.

**The reciprocal counter** accepts logic-level inputs and can operate in either a period measurement mode or a totalize mode.

**Digital inputs and digital (alarm relay) outputs** are available for monitoring switch positions and controlling external devices.

### Graduated software

The program, or "software" that instructs the measurement unit is stored on a magnetic tape cartridge in the HP 85B computer. This software flexibility allows you to choose any one of the three programming methods that fits your need best:

Level 1: Menu entry . . . no programming language required

Level 2: Line entry . . . no computer language required . . . just enter data logger information

Level 3: Subroutine . . . enter a short BASIC program that uses prewritten subprograms.

- Data analysis
- Graduated software

**Graphic presentation** is the key to understanding the data. From the graphic display to the program flexibility to the precise measurement capability, the 3054S is the complete data logger.

### HP 3054S/DL Specifications

The following specifications include all contact resistances, contact voltages and DVM errors. Accuracy specifications apply when the HP 3054S is in an ambient environment of 23°C ± 5°, <85% R.H. Temperature coefficients are applied when the ambient temperature is 0 to 18°C or 28 to 50°C.

#### DC voltmeter (use option 010 or 020)

**Ranging:** auto or fixed range

**A/D technique:** integrating

**Maximum input voltage:** hi to lo: ±120 V peak

**Lo to guard:** ±170 V peak

**Any terminal to chassis:** ±170 V peak

Range	Maximum Reading	Resolution	Accuracy (90 days) (%Rdg. + Counts)	Temperature Coefficient (%Rdg. + Counts)/°C	Z <sub>in</sub>
.1 V	.119999	1 μV	.007 + 5	.00025 + .15	>10 <sup>10</sup>
1 V	1.19999	10 μV	.006 + 2	.0002 + .02	>10 <sup>10</sup>
10 V	11.9999	100 μV	.006 + 1	.0002 + .01	>10 <sup>10</sup>
100 V	119.999	1 mV	.006 + 1	.00025 + .03	10 MΩ ±0.5%

For >90 days, add 10 ppm/month to accuracy

**Normal mode rejection:** 60 dB (50 or 60 Hz ± .1%)

**Effective common mode rejection**

**AC:** 150 dB (50 or 60 Hz ±.1%)

**DC:** 104 dB (100 channels)

**Ohmmeter (use option 010 or 020)**

**Type:** 2-wire or 4-wire

**Current source:** floating

Range	Maximum Reading	1 Count Resolution	Current Through Unknown	Accuracy (90 days) (%Rdg. + Counts)	Temperature Coefficient (%Rdg. + Counts)/°C
100 Ω	119.999	1 mΩ	1 mA	.032 + 5	.0028 + .15
1 kΩ	1.19999	10 mΩ	100 μA	.032 + 5	.0028 + .15
10 kΩ	11.9999	100 mΩ	10 μA	.032 + 5	.0028 + .15
100 kΩ	119.999	1 Ω	10 μA	.031 + 2	.0027 + .02

For >90 days, add 20 ppm/month to basic accuracy

Note: the HP 3054S system includes the entire HP 3054DL (with selected options) plus certain system peripherals.

### Options

**Option # (choose up to 5 total option cards—HP 3054DL capacity is 5 slots)**

**010:** 20 channel guarded input relay card

**020:** 19 channel guarded input relay card with thermocouple compensation. Measures JKERS thermocouples or dc volts

**050:** 16 channel optically isolated digital input

**060:** Frequency counter, totalizer

**110:** 16 channel digital output actuator relay card

**115:** 8 channel high voltage actuator

**230:** Clock format: Mo:Day: Hr:Min:Sec

**231:** Clock format: Day:Mo: Hr:Min:Sec

**260:** Delete scanner display and controls

**400:** Delete locking cabinet with sliding drawer

**841:** Add Level 3 software for custom data acquisition programs

**910:** Extra set of Level 1 & 2 software (one set comes with HP 3054DL at no charge)

**Computer** (order both items to complete the 3054S)

**HP 85B:** Personal Computer with integrated screen, tape and printer. Built-in I/O ROM included. Must order HP 82937A HP-IB I/O Card separately.

**HP 82937A:** HP-IB Interface for use with Series 80 personal computer.

**HP 3054DL:** Includes 5½ digit DVM, current source, real time clock, HP-IB interface, sliding drawer and cabinet, software Levels 1 & 2, and pre-initialized data tape

# DATA ACQUISITION, CONTROL & TEST

Automatic Data Acquisition/Control System

HP Model 3054C

181



- Precise measurement and analysis
- Execute multiple programs simultaneously
- Communicate to other computers in a distributed network

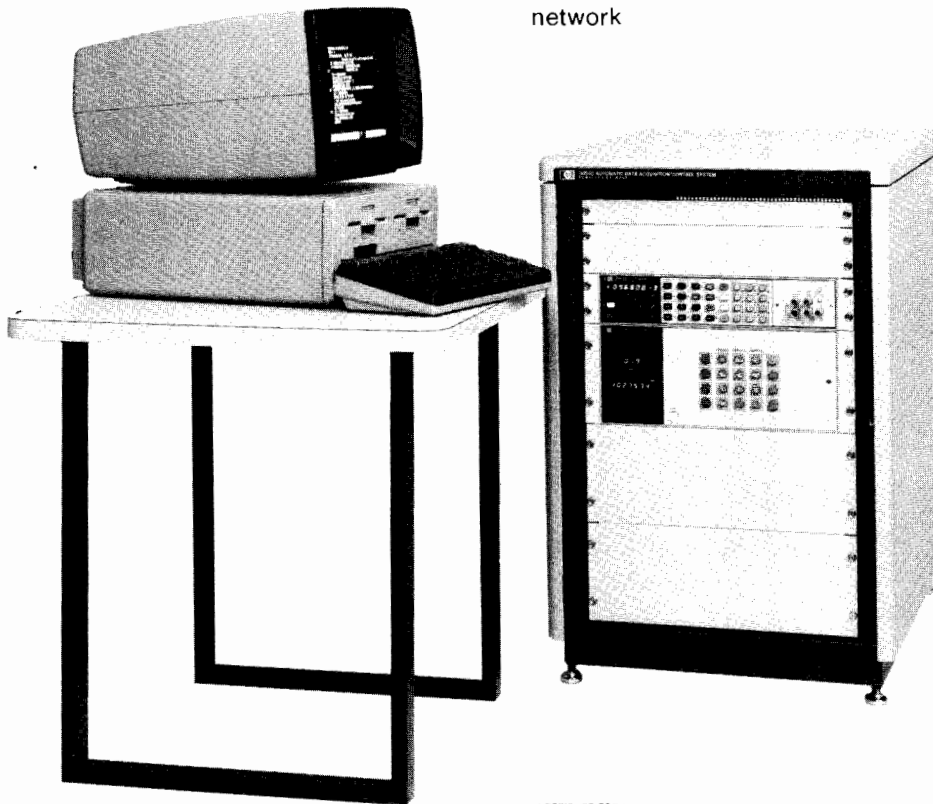

HP 3054C



## Description

The HP 3054C Automatic Data Acquisition/Control System combines precise instrumentation with the power and versatility of HP 1000 computers. The HP 3054C is similar to the HP 3054A system except that the HP 3054C supports software compatible with the HP 1000 series of computers. The HP 1000 series of computers give you increased analysis capabilities and can be used to create multitasking, distributed data acquisition and control networks. Distributed systems allow you to control instruments with one computer while another computer in the network analyzes or processes the data. The multitasking capability of the HP 1000 allows any computer in the network to simultaneously control instruments with one program while another program performs other, possibly unrelated, tasks.

## Instrumentation

The HP 3054C consists of a HP 3497A Data Acquisition/Control Unit and a HP 3456A Digital Voltmeter. The HP 3497A is a card cage instrument that can be custom configured to meet your needs. Assemblies are available for A/D conversion, multiplexing, strain gage/bridge completion, digital inputs/interrupts, counting, actuator outputs, and voltage and current D/A outputs. The HP 3456A is a very precise voltmeter and has the resolution and noise rejection required for measuring low levels in a noisy system environment.

## Computers

The HP 3054C software package is compatible with the HP 1000A, L, E, and F series of computers. These computers allow you to configure or expand your system as needed. The L series of computers offers the lowest cost solution for controlling the HP 3054C. The HP 1000 A series offers significantly more computing power at slightly more cost. The HP 1000 E and F series provides more versatility and the easiest program development. The HP 1000 A, E, and F series computers are recommended as host computers in a distributed system.

## Software

The HP 3054C software package consists of over 35 subroutines that can be used as building blocks to create a useful measurement program. The subroutines allow the user to write sophisticated programs without knowing instrument programming codes. Included in the HP 3054C software package are linearization programs for most thermocouples, 120 and 350 ohm strain gages, thermistors and RTDs. The routines include error trapping to locate and identify system problems.

## System Configuration

The HP 3054C consists of the following. The computer, other computer peripherals and computer operating systems are ordered separately.

### HP 3054C

#### Instruments

HP 3497A Data Acquisition/Control Unit

HP 3456A Digital Voltmeter

#### Software and Documentation

HP 3054C Software package consisting of measurement, conversion, utility and HELP routines.

#### Rack/Integration

30" rack (shown) is standard. Other racks are available. Integration includes HP-IB cables, instrument connecting cables and test assemblies.

#### Verification/Installation

The HP 3054C is installed and tested with the HP 1000 computer at the customer's site.

## Ordering Information

**Basic HP 3054C Automatic Data Acquisition/  
Control System**



# DATA ACQUISITION, CONTROL & TEST

## Data Acquisition/Control Unit

### HP Model 3497A

- Relay multiplexing
- DVM
- FET multiplexer
- Real time clock
- Bridge completion
- Digital inputs/outputs
- Counter
- Programmable D/As
- Optional RS-232C interface

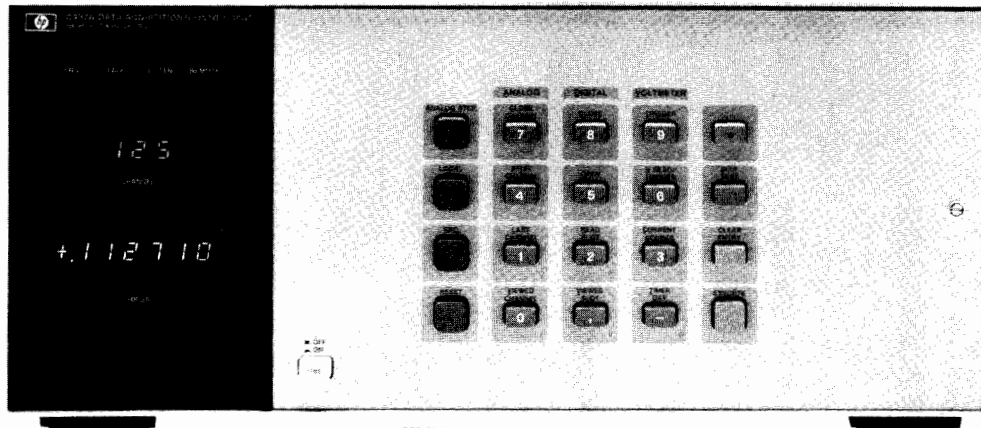

HP 3497A

### Description

The HP 3497A Data Acquisition/Control Unit combines the capabilities of several instruments and is a basic building block of an automatic data acquisition and control system. The HP 3497A will be used in an HP-IB automated system and can be viewed as a precision measurement and control computer peripheral.

The HP 3497A has been designed to be a very versatile and very powerful instrument. A basic HP 3497A consists of a mainframe that includes a front panel keyboard and display, a non-volatile real time clock, and an HP-IB interface. Available as an option is a 5½ digit integrating digital voltmeter and current source that occupies a dedicated slot in the HP 3497A chassis. Capability is added to the HP 3497A by using any combination of plug-in assemblies. Available plug-in assemblies are:

- Relay Multiplexers with or without thermocouple compensation
- FET Multiplexer
- Digital Input/Interrupt
- Counters
- Strain gage/bridge completion
- Actuators
- Programmable voltage and current D/As
- Breadboard Assembly

Up to 5 assemblies can be added to a HP 3497A and the HP 3498A Extender chassis can hold up to 10 more plug-in assemblies.

### High Performance

The HP 3497A DVM can resolve 1 microvolt signals and is ideal for the precise measurement of the outputs of thermocouples, strain gauges and other transducers. Included on the DVM is a programmable current source that allows four-terminal resistance measurements. The multiplexer assemblies switch 3 wires (Hi, Lo, and Guard) and add less than 2 microvolts of thermal offset to the measured signal.

### Flexible Hardware Configuration

The HP 3497A card cage can hold 5 of any combination of the plug-in assemblies. This allows the multiplexing of up to 100 3-wire inputs to the DVM in a single HP 3497A or a single HP 3497A might contain 60 multiplexer channels, 16 digital inputs, 16 actuator outputs, and a DVM. By using the HP 3498A Extender, up to 1000 analog channels and 1360 digital channels can be controlled, all at a single bus address.

### Ease of Use

The HP 3497A keyboard and display make the HP 3497A very easy to use and makes debugging of a HP 3497A based system easy. The calibration adjustments for the HP 3497A DVM are located behind a

hinged front panel; this allows complete calibration of the DVM without removing it from the test rack. Connections to all of the HP 3497A assemblies are made using screw terminals, thereby eliminating the need for soldering.

### Automatic Data Acquisition and Control Systems

The HP 3497A is an integral part of the HP 3054A/C Automatic Data Acquisition and Control Systems. The HP 3054A consists of a HP 3456A Digital Voltmeter for high accuracy measurements, a HP 3437A Systems Voltmeter for high speed measurements and an HP 3497A for multiplexing, digital I/O and control. The HP 3054A includes software compatible with the HP 85 and Series 200 computers. The HP 3054C is similar to the HP 3054A but it does not include the 3437A and the software is compatible with the HP 1000 series of computers. The HP 3497A is also a part of the HP 3054 DL data logger.

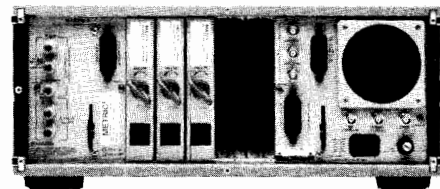

### Real Time Clock

The HP 3497A mainframe includes a quartz-referenced, non-volatile, real-time clock. In addition to providing timing data, the clock can measure elapsed time, interrupt at a presettable time, and output a programmable pulse train.

### Clock Format

Month:Day:Hours:Minutes:Seconds (U.S. Format)

Day:Month:Hours:Minutes:Seconds (European Format)

Modes	Max. Time	Resolution	Accuracy
Real Time Mode:	1 year	1 second	±(.005% of time + .1 s)
Elapsed Time Mode:	10 <sup>6</sup> seconds	1 second	±(.005% of time + .1 s)
Time Alarm Mode:	24 hours	1 second	±(.005% of time + .1 s)
Time Interval Mode:	24 hours	1 second	±(.005% of time + .1 s)
Timer Output Mode:	1 second	100 μs	±.02% of time



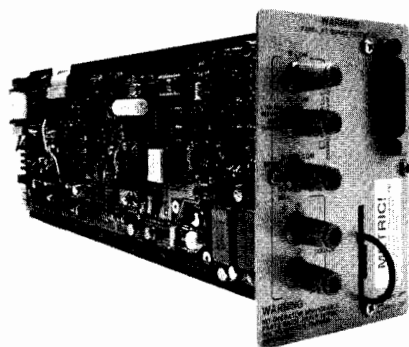

### Option 001—5½ Digit DVM and Current Source

The HP 3497A DVM assembly is a systems quality, 5½ digit, 1 microvolt sensitive dc voltmeter. The DVM is fully guarded and uses an integrating A/D conversion technique; this yields excellent common and normal mode noise rejection.

Included on the DVM assembly is a three level programmable current source. The current source, when used simultaneously with the DVM, can be used to make high accuracy four terminal resistance measurements with 1 milliohm resolution. Maximum speed is 300 readings per second in 3½ digit mode.

### Voltmeter Specifications

Range	Max. Display	5½ Digit Resolution	Accuracy 90 Days, 23°C ± 5°C 5½ Digits	Input Z
.10 V	±1.19999	1 μV	±(.007% RDG + 3 counts)	10 <sup>9</sup> Ω
1.0 V	±1.19999	10 μV	±(.006% RDG + 1 count)	10 <sup>9</sup> Ω
10.0 V	±11.9999	100 μV	±(.006% RDG + 1 count)	10 <sup>9</sup> Ω
100.0 V	±119.999	1 mV	±(.006% RDG + 1 count)	10 <sup>9</sup> Ω

### Maximum Input Voltage

- High to low: 120 V peak
- Low to guard: 170 V peak
- Guard to chassis: 170 V peak

### Current Source

Accuracy: 90 days

Range	23°C ± 5°C
10 μA	2.5 nA
100 μA	25.0 nA
1 mA	250 nA

- Compliance: >+15 volts
- Isolation voltage: 170 volts peak

### General Information

Maximum Reading Rate: (readings/second)

Auto Zero	60 Hz Operation Digits Displayed			50 Hz Operation Digits Displayed		
	5½	4½	3½	5½	4½	3½
ON	25	100	150	20	83	125
OFF	50	200	300	40	166	250

- Delay: 0 to 99.9999 seconds in 100 μs steps
- Buffer size: packed format: 100 readings; ASCII format: 60 readings
- Number of readings per trigger: 1 to 999
- Measurement Speeds

For the HP 3497A DVM and the relay multiplexer, speeds are given for measurements on random channels (using software channel selection) and sequential channels (using external hardware increment). Speeds include I/O times to the indicated computers.

### 60 Hz Operation (50 Hz operation)

	Number of Digits Selected	Computer			
		85	9826*	1000L	1000E,F
Sequential Channels using external increment	5½ digits	39 ( 33)	39	39 (25)	30 (25)
	4½ digits	97 ( 88)	103	108 (79)	88 (79)
	3½ digits	112 (107)	123	127 (99)	107 (99)
Random Channels using software	5½ digits	13 ( 11)	27	21 (16)	22 (16)
	4½ digits	14 ( 11)	51	31 (28)	35 (30)
	3½ digits	14 ( 11)	55	33 (29)	35 (32)

\*9826 speeds for BASIC operating system

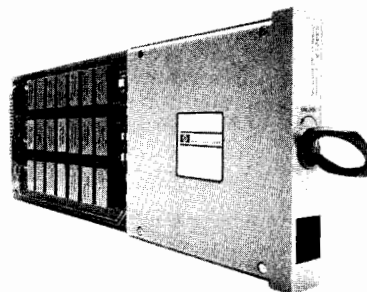

### Option 010—20 Channel Relay Multiplexer

This assembly uses reed relays to multiplex signals to the DVM or other instruments. Each assembly switches 20 channels, each channel consists of HI, Lo, and Guard lines. Two channels may be closed per assembly and relays may be closed in a random sequence or incremented between programmable limits. The low thermal offset of the relays make it suitable for measuring the outputs of strain gage and other transducers. Each channel can be configured with a filter or current shunt for additional flexibility.

### Input Characteristics

- Maximum input voltage: <170 V peak between any two input terminals
- Maximum current: 50 mA per channel non-inductive
- Maximum power: 1 VA per channel
- Thermal offset: direct switched, <1 μV differential; tree switched, <2 μV differential

### Closed Channel Resistance

- In series: 100 Ω ±10% in High, Lo and Guard
- Relays contacts only: <1 Ω per contact
- Open channel isolation: >10<sup>10</sup> Ω (Hi to Lo, 40°C, <60% R.H.)
- Maximum switch rate: 475/second (using hardware increment)
- Rated switch life at 1 VA: 10<sup>7</sup> operations
- All Relays are Break-Before-Make

### Option 020—Relay Multiplexer with Thermocouple Compensation

The option 020 assembly uses the same relay multiplexer as option 010 but incorporates a special isothermal connector block to allow thermocouple compensation. Two types of compensation (selectable by the user) are available. A temperature-dependent voltage is generated for software compensation; this voltage is then used in a computer program to compensate the thermocouple voltage. Hardware compensation involves inserting a voltage in the measurement circuit that automatically compensates the thermocouple voltage.

### Reference Junction Compensation Comparison

	Software	Hardware
Compatible Thermocouples	Any mixture	One of the following types: B,E,J,K,R,S,T
Measurement channels available per assembly	19	20
Reference junction compensation accuracy (23° C ± 5° C)	0.1°C	



# DATA ACQUISITION, CONTROL & TEST

## Data Acquisition/Control Unit (cont.)

Model 3497A

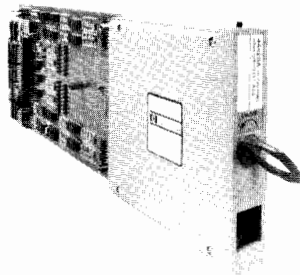

### Option 030—20 Channel FET Multiplexer Assembly

The option 030 assembly is used to multiplex input signals to a DVM in a manner similar to option 010. The option 030 assembly provides high speed, low level multiplexing. Maximum signal levels are 12 volts peak between any high, low or guard input and any other guard input, guard common or chassis ground.

**Maximum sequential scanning rate:** 4800 readings/s (at 60 Hz) using an HP 3437A Voltmeter and HP Series 200 computer; 4000 readings/s at 50 Hz power.

**Bias currents:** sourced by either high or low to guard

0-28°C		28-55°C
Channel closed:	±300 nA	Current doubles
Channel open:	± 15 nA	every 15°C
From each deselected FET assembly:	± 15 nA	above 28°C

**Differential offset voltage:** includes effects of bias currents and series resistance. Does not include effects of voltmeter bias and noise currents.

0-28°C	28-55°C
±1.4 mV	Add ±140 μV/°C for each degree above 28°C
±0.15 mV per deselected FET assembly	Add ±15 μV/°C above 28°C for each selected FET assembly

**Series resistance for each input:** intrinsic resistance of the FET switch (when ON) plus series protection resistor.

	0-55°C
High, low	5500 Ohms
Guard	3500 Ohms

**Maximum current:** ±1 mA per channel

### Option 050—16 Channel Isolated Digital Input/Interrupt

The option 050 assembly can sense up to 16 channels of digital data. The first 8 channels can also be used as interrupt lines to detect transient signals. The assembly can accept a wide range of input levels and all functions and masks are fully programmable. A five-volt supply is provided for driving external contact closures and open collector outputs.

#### Input Signal Characteristics

Input Level	Low Voltage Maximum	High Voltage Minimum	Maximum Input Voltage Between High & Low Terminals	Minimum Input Current
5 V	0.8 V	2.4 V	30 V	400 μA
12 V	3.0 V	7.0 V	42 V	1 mA
24 V	6.0 V	13.0 V	42 V	2 mA

**Maximum voltage:** ±170 V peak between any terminal and chassis

**Logic polarity:** positive true (negative true is jumper selectable)

#### Interrupt Mode (bits 0-7)

**Minimum pulse width:** 100 microseconds

**Triggering:** each interrupt line is individually programmable for positive or negative edge triggering.

**Masking:** each interrupt line may be enabled or disabled using a programmable mask.

### Option 060—100 kHz Reciprocal Counter

This option can be used to measure mechanical and low frequency electronic signals. The counter can measure the period of signals up to 100 kHz and the pulse width of signals down to 18 μs. The counter can also count up or down from a programmable start point. It can accept a wide variety of input signals including CMOS, open collector TTL and passive contact closures.

#### Input Signal Characteristics Input Levels

Input Level Range	V(Lo) (Maximum)		V(Hi) (Minimum)	
	Isolated	Non-iso	Isolated	Non-iso
5 V	1.0 V	1.0 V	4.2 V	4.2 V
12 V	1.8 V	2.7 V	10.3 V	8.0 V
24 V	2.6 V	6.0 V	18.4 V	16.5 V

(5 V level is standard, 12 and 24 volt levels are jumper selectable. Other voltages can be accepted using customer supplied resistors.)

**Input circuit:** switch selection of optically isolated or non-isolated input. Non-isolated input has 19.5 kΩ minimum input impedance.

**Maximum isolation voltage:** 170 V peak between any terminal and ground. Isolated mode only.

#### Period Mode

**Maximum input frequency:** 100 kHz

**Minimum on time:** 5 μs

**Minimum off time:** 5 μs

#### Range Characteristics

Range	Least Significant Digit (LSD)	
	HP-IB	Display
9999.999 s	1 ms	10 ms
99.99999 s	10 μs	100 μs
0.9999999 s	100 ns	1 μs
.09999999 s	10 ns	1 μs

**Accuracy:** ±(.01% of reading + 2 LSDs + Trigger Error)

#### Pulse Width

**Minimum start to stop time:** (pulse width): 18 μs

**Minimum stop to start time:** 18 μs

#### Range Characteristics

Range	Least Significant Digit (LSD)	
	HP-IB	Display
9999.999 s	1 ms	10 ms
99.99999 s	10 μs	100 μs
0.9999999 s	1 μs	1 μs
.09999999 s	1 μs	1 μs

**Accuracy:** ±(0.1% of reading + Trigger Error + (2 LSDs or 18 μs, whichever is greater)).

#### Totalize/Down Count Mode

**Maximum input frequency:** 100 kHz

**Minimum pulse width:** 5 μs

**Range:** 0 to 999,999

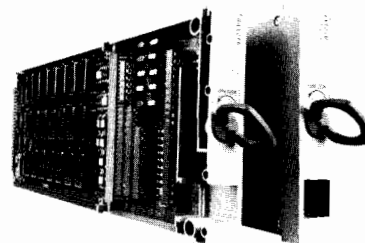

### Option 070—120 Ohm Strain Gage/Bridge Completion Assembly

### Option 071—350 Ohm Strain Gage/Bridge Completion Assembly

The option 070/071 assemblies may be used to provide bridge completion for measuring strain gages, RTDs pressure sensors and load cells. Each card uses an internal shared half bridge and can complete 10 channels of ¼ and ½ and full bridges in any combination. When used with a +5 V excitation supply (such as the HP 6214A) and the HP 3497A DVM, the assembly provides 0.1 µE sensitivity with 1 µE accuracy. Provisions are made for shunt calibration and checking gage leakage and lead resistance.

**Specifications**

Bridge Type	Sensitivity (excitation voltage at 5 volts)		Accuracy	
	HP 3497A DVM	HP 3456A DVM	Range at Best Resolution	90 Day 23°C ± 5°C
¼	.4 µE	.04 µE	42400 µE	25 µE
½	.2 µE	.02 µE	21200 µE	5 µE
Full	.1 µE	.01 µE	9500 µE	1 µE

**Excitation Supply Requirements**

**V max:** 5.4 Vdc; **I (out):** 250 mA per 10 channels (120 ohm gages)

**Option 110—16 Channel Actuator**

**Option 115—8 Channel High Voltage Actuator**

Option 110 consists of 16 mercury wetted form C (single pole-double throw) relays. Each relay can be individually closed and can switch 1A at 100V. The actuator assembly can be used to switch test fixture power or to actuate alarm bells. This flexibility of this assembly allows it to be used as a digital output or matrix switch.

Option 115 is an 8 channel high voltage actuator assembly that can switch voltages up to 252 Vrms and currents up to 2 amperes. The Option 115 assembly is ideal for switching power line voltages to small motors, alarm bells and lights, motor starters and solenoids.

**Option 110 and 115 Specifications**

	Option 110	Option 115
Switch Form	C	A
Contact Type	Mercury Wetted	Dry
Number of channels	16	8
Maximum Voltage	100 V Peak	252 Vrms 48 Vdc
Maximum Current	1 A	2 Arms or dc
Maximum Power	100 VA	500 VA ac 60 VA dc

**Option 120—Dual Voltage D/A**

**Option 130—Dual Current D/A**

Option 120 consists of two 0 to ±10 V programmable voltage sources. These sources can be used to provide a programmable test stimulus or to control voltage programmed devices like power supplies and VCOs.

Option 130 consists of two 0 to 20 mA or 4 to 20 mA programmable current sources. These sources, especially when using the 4 to 20 mA range, can be used as transmitters in industrial current loops and can drive up to 600 ohms of total loop resistance.

**Option 120 Specifications**

- Output:** 13 bits including polarity
- Least significant bit:** 2.5 mV
- Output range:** -10.2375 V to +10.2375 V
- 90 day accuracy:** ±.070% of programmed value ±4.0 mV
- Maximum output current:** 15 mA (output within specifications)

**Option 130 Specifications**

- Output:** 12 bits
- Least significant bit:** 5 µA (0 to 20 mA range)  
4 µA (4 to 20 mA range)
- Output range:** 0 to 20.475 mA or 4 to 20.380 mA (each source jumper selectable)
- 90 day accuracy:** ±0.07% of programmed value ±10.0 µA
- Compliance voltage:** 12.0 volts

**Option 140 Breadboard Card**

Option 140 is a breadboard card compatible with the HP 3497A cardage. Using this card, HP 3497A users can construct special purpose assemblies that communicate with the HP 3497A backplane.

**Option 232—RS232C Interface**

Option 232 to the HP 3497A deletes the standard HP-IB interface and adds an RS232C (CCITT/V.24) compatible interface. The option 232 interface is also compatible with the new RS423 (CCITT/V.10) version of the RS449 interface.

The option 232 interface allows you to remotely locate the 3497A. HP technical brochure part number 5952-8884 contains additional information on HP 3497A option 232.

**Option 298—HP 3498A Extender**

The HP 3498A Extender chassis allows low cost expansion of HP 3497A-based systems. Each HP 3498A can hold up to ten HP 3497A plug-in assemblies. Use of one or more HP 3498As requires a HP 3497A (for control); all required connecting cables are supplied with the HP 3498A.

**Number of slots per HP 3498A:** 10

**Maximum number of added analog multiplexer channels** (options 010, 020): 900 channels (45 assemblies)

**Maximum number of added non-analog acquisition assemblies** (options 050, 060, 110, 120, 130): 85 assemblies

**Maximum number of HP 3498As per HP 3497A:** 13

**General**

**HP-IB Interface functions:** SH1, AH1, T5, L4, SR1, RL1, PP0, DC1, DT1, C0, E1

**Size** (HP 3497A or HP 3498A): 190.5 mm H x 428.6 mm W x 520.7 mm D (7½" x 16⅞" x 20½")

**Net weight:** HP 3497A, 20.4 kg (45 lb) and 3498A, 20.4 kg (45 lb) with assemblies in all slots.

**Shipping weight:** HP 3497A and HP 3498A maximum with assemblies in all slots are 26.3 kg (58 lb.)

Operating temperature: 0°C to 55°C

Non-operating temperature: -40°C to 75°C

Humidity: to 95% at 40°C except as noted

Operating power: switch selection of 110, 120, 220 and 240 volts ±10%, 48-66 Hz, 150 VA 3497A and 3498A.

**Ordering Information**

Each HP 3497A can hold one DVM assembly (Opt 001) and up to 5 plug-in assemblies. Each HP 3498A (Opt 298) can hold 10 additional plug-ins. To order plug-ins without a mainframe, order as 444XXX Field Installation Kits as shown below.

**Required on Every Order:**

- A Clock Format (Option 230 or 231)
- A Power Line Frequency and Voltage (Options 315 through 346)

**Opt 001 or 44420A:** 5½ Digit DVM and Current Source

**Opt 010 or 44421A:** 20 Channel Relay Multiplexer Assembly

**Opt 020 or 44422A:** Relay Multiplexer Assembly with thermo-couple compensation

**Opt 030 or 44423A:** 20 channel FET Multiplexer Assembly

**Opt 050 or 44425A:** 16 channel Isolated Digital Input/Interrupt Assembly

**Opt 060 or 44426A:** 100 kHz Reciprocal Counter

**Opt 070 or 44427A:** 120 Ohm Strain Gage/Bridge Completion Assembly

**Opt 071 or 44427B:** 350 Ohm Strain Gage/Bridge Completion Assembly

**Opt 110 or 44428A:** 16 Channel Actuator/Digital Output Assembly

**Opt 115 or 44431A:** 8 Channel High Voltage Actuator Assembly

**Opt 120 or 44429A:** Dual Output Voltage DAC Assembly

**Opt 130 or 44430A:** Dual Output Current DAC Assembly

**Opt 140 or 44432A:** Breadboard Card

**Opt 230:** Clock Format (Month:Day:Hours:Min:Second)

**Opt 231:** Clock Format (Day:Month:Hours:Min:Second)

**Opt 232:** Delete HP-IB Interface, add RS232C Interface

**Opt 260:** Delete Keyboard and Display

**Opt 298:** Add HP 3498A Extender & connecting cables

**HP 3497A Data Acquisition/Control Unit**

# DATA ACQUISITION, CONTROL & TEST

## Measurement and Control Processor

Model 2250

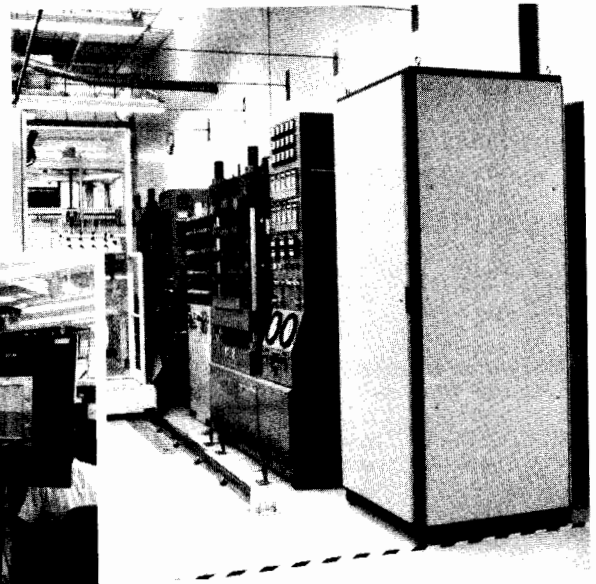
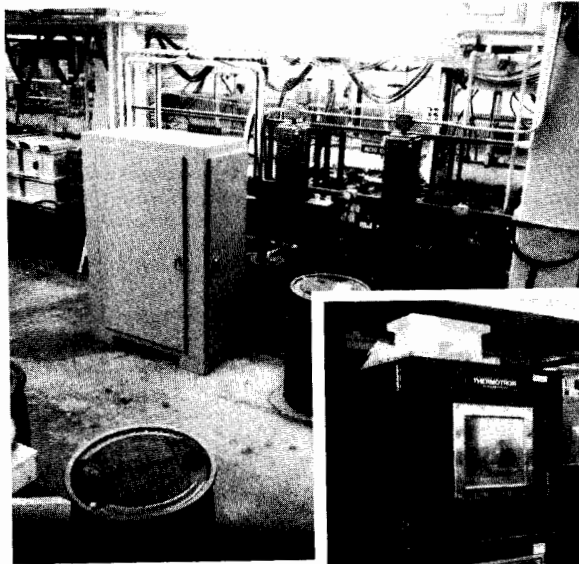

### System Description

The HP 2250 Measurement and Control System provides a powerful solution to today's demanding laboratory and industrial automation applications. The HP 2250's modular hardware structure gives you the versatility of selecting only the product you need for a cost-effective solution to your specific automation problem—yet you have the flexibility to expand your capabilities as your automation needs grow.

The HP 2250 operates in conjunction with a host HP 1000 or HP 200 series computer via the HP-IB, Hewlett-Packard Interface Bus, our implementation of IEEE Standards 488-1978. A single HP-IB cable connection is all that is required to link your computer to the HP 2250, creating a high-performance automation system. For those applications that require the HP 2250 to be remotely located, a coaxial cable or fiber optic HP-IB extender is available to extend the computer/HP 2250 link up to 1000 metres.

The HP 2250 has a built-in LSI microcomputer and MCL/50 firmware, a software command set consisting of over 100 applications oriented mnemonic commands that can be used in many combinations to optimize measurement and control operations. MCL/50 Measurement and Control language software is easy to learn and use, allowing users to program their applications and control all HP 2250 function cards without intervention from the host computer. This decoupled operation facilitates a simpler and faster implementation of your automation solution and results in more predictable and repeatable performance.

Measurement and control applications exist in many different environments, and the modular HP 2250 hardware is designed with the flexibility to meet the diverse requirements of these applications. A comprehensive set of high performance analog and digital function cards are available to interface to the broad range of sensors and actuators commonly found in laboratory and industrial environments today. Additionally, most function cards include provisions for on-board signal conditioning modules that permit accurate and reliable interfacing in demanding industrial applications. Also provided are convenient industrialized field wiring assemblies accommodating up to 10 AWG wire.

### System Features

- High-performance analog measurement capability includes:
  - 14 bit resolution
  - accuracy specified from 0 to 40° C
  - 50,000 samples per second average throughput to disc\*
  - isolated voltage and current outputs
  - paced sampling.
- Wide range of function cards are available with 45 separate plug-on signal conditioning modules.
- Digital output relay is modularized to allow individual relay replacement.
- HP MCL/50 high level command set enables task multiplexing and computer decoupled operation.
- Solid-state output relay digital design is ruggedized to enable mechanical relay replacement in most operations.
- Fully integrated systems or components available separately for custom cabinet installations.

### HP 2250A Industrial Measurement and Control System

The HP 2250A is a complete measurement and control system in an industrialized enclosure. This system is designed for applications ranging from local machine to large process control in industrial environments. Field wiring and the electronic assemblies are accessed through separate doors and all doors are lockable.

The HP 2250A contains one HP 2104B Processor Unit and up to two HP 2251B Measurement and Control Units. The HP 2104B provides local intelligence for computer-decoupled operation and MCL/50 command interpretation and execution. The HP 2104B communicates with the function cards in the HP 2251B over a dedicated high speed bus. Each HP 2251B contains slots for up to 8 I/O cards.

### Features

- Integrated measurement and control system in an industrialized NEMA-12 rated enclosure
- Removable metal access plates for field wiring conduit installation.
- Capacity for up to 16 I/O function cards.
- Floor standing.
- Separate lockable compartments for electronics and field wiring.
- Convenient and well labeled field wiring interface.

\*For High level signals, not using HP-IB extenders.

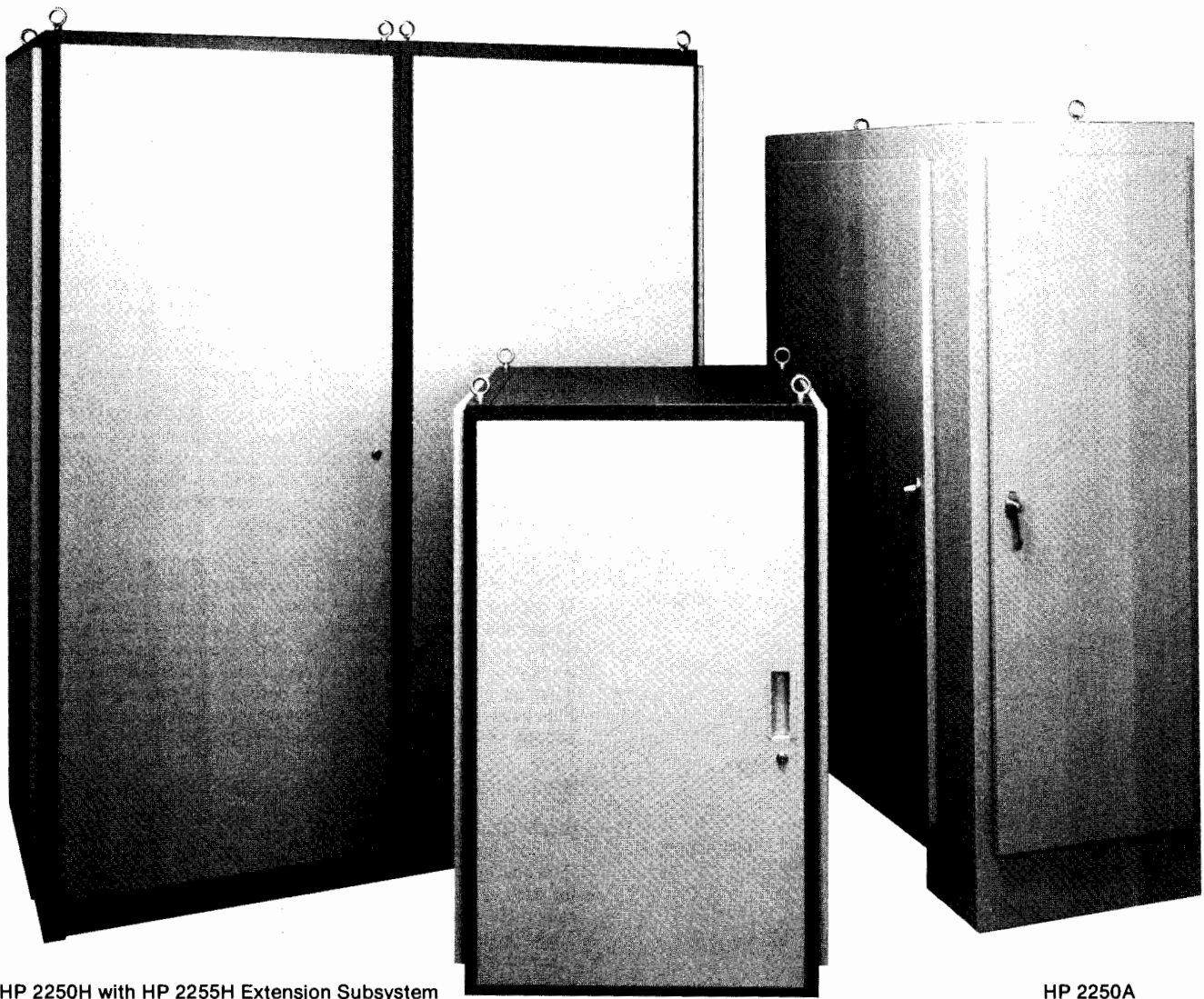

HP 2250H with HP 2255H Extension Subsystem

HP 2250L

HP 2250A

## HP 2250H Measurement and Control System

The HP 2250H is a complete measurement and control system in an upright cabinet. This system is appropriate for high point count applications in laboratory and less harsh industrial environments.

The HP 2250H contains one HP 2104B and up to two HP 2251B's just like the HP 2250A. However, as many as three HP 2255H expansion subsystems can be easily attached to one HP 2250H to provide a total of eight HP 2251Bs. This allows up to 64 I/O function cards to be controlled from one HP 2104B. In a maximal configuration as many as 1920 analog input points or 2048 digital I/O points are available in one system.

### Features

- Integrated measurement and control system in an upright cabinet.
- Capacity for up to 16 I/O function cards.
- HP 2255H expansion subsystems allowing 64 I/O function card capacity.
- Convenient and well labeled field wiring interface.

## HP 2250L Mobile Measurement and Control System

The HP 2250L is a complete measurement and control system in a small mobile cabinet. This system is designed for small laboratory or industrial applications and temporary data acquisition and control projects that require frequent movement of equipment.

The HP 2250L contains one HP 2104B and one HP 2251B, which provides capacity for up to 8 I/O function cards. A maximal configuration of this system could provide up to 240 analog input points or 256 digital I/O points.

### Features

- Integrated measurement and control system in a small mobile cabinet.

- Capacity for up to 8 I/O function cards.
- Convenient and well labeled field wiring interface.

### Ordering Information

The HP 2250S is an ordering convenience that simplifies purchasing an HP 2250 system with an HP Series 200 desktop computer. Contact your local Hewlett-Packard sales office for details.

**HP 2250A** Industrial Measurement and Control System

**HP 2250H** Measurement and Control System

**HP 2255H** Measurement and Control Subsystem

**HP 2250L** Mobile Measurement and Control System

**HP 2104B** Processor Unit

**HP 2251B** Measurement and Control Unit

**HP 25501B** 16-Channel High Speed ADC Input Card

**HP 25502B** 32-Channel High Level FET Multiplexer Input Card

**HP 25503B** 32-Channel Low Level FET Multiplexer Input Card

**HP 25503C** 32-Channel Low Level FET Multiplexer with Thermocouple Reference Connector

**HP 25504B** 16-Channel Relay Multiplexer Input Card

**HP 25504C** 16-Channel Relay Multiplexer with Thermocouple Reference Connector

**HP 25510B** 4-Channel Voltage/Current DAC Output Card

**HP 25511B** 32-Channel Digital Input Card

**HP 25512B** 4-Channel Counter Input Card

**HP 25513B** 32-Channel Digital Output Card

**HP 25514B** 16-Channel Digital Relay Output Card

**HP 25515B** 4-Channel Pulse Output Card

**HP 25516B** 16-Channel In/16-Channel Out Digital Multi-function Card





# DATA ACQUISITION, CONTROL & TEST

## A-Series Measurement & Control Cards

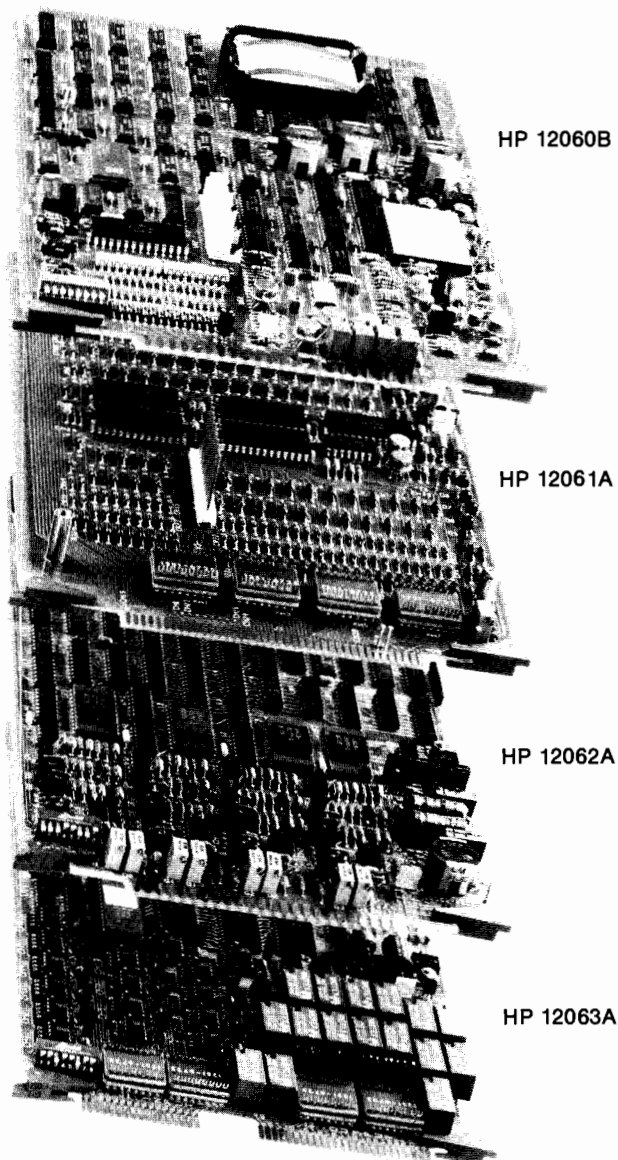

HP 12060B

HP 12061A

HP 12062A

HP 12063A

### Description

The HP 12060B, 12061A, 12062A, and 12063A are plug-in cards for HP 1000 A-Series Computers. They provide low cost, high performance, analog and digital I/O for use in distributed measurement and control applications. The A-series product in which these cards are used must have a 25 kHz power supply. Hood connectors with each card allow users to build cables for connection to their applications.

### 12060B 8 Channel Analog Input Card

The HP 12060B is capable of acquiring up to 55,000 readings per second with 12-bit resolution. Auto scanning or single-channel sampling is possible to 55 kHz. Provisions for external pacing/trigging of sampling and scanning is provided. The HP 12060B includes four programmable full scale ranges from plus or minus 1.28 V to plus or minus 10.24 V. Maximum resolution is 0.625 mV on the 1.28 V range. A separate "zero reference" on the card allows the user to measure actual offset due to temperature drift, and correct readings on all channels for higher accuracy. The card has 8 differential channels.

### HP 12061A 32 Channel Analog Input Expansion Card

The HP 12061A provides 32 additional differential inputs for the HP 12060B card. The HP 12061A card fastens directly onto the HP 12060B card, creating a two-board unit that occupies two I/O slots in an HP 1000 A-series computer. Programming information is passed from the HP 12060B directly to the HP 12061A; analog signals on the additional 32 channels are in turn passed back to the HP 12060B for digitizing. The HP 12061A includes removable plug-in headers so the user can add current sense resistors for current loop measurements. These headers allow the board to be adapted to the specific application without soldering components directly on the board and are easily removable for repair purposes.

### HP 12062A 4 Channel Analog Output Card

The HP 12062A Analog Output Card provides 4 independent bipolar voltage outputs. Remote sensing per channel provides accurate output voltages to compensate for long distances of field wiring. Undedicated digital outputs may be used in pen up/down control, CRT display, or X-Y plotters. DMA compatibility provides fast analog updates on a per-channel basis or between channels. Programmable time delay between DMA updates provides signal reconstruction capability with a full power bandwidth of 20 kHz.

### HP 12063A 32 Channel Digital Multifunction Card

#### Input Characteristics

The HP 12063B provides 16 fully isolated digital inputs via voltage threshold opto-couplers. Input voltage levels are selectable by the user for each channel by installing the appropriately valued resistors on removable plug-in headers (8 resistors per header = 8 channels). These headers allow the board to be adapted to the specific application without soldering components directly on the board, and are easily removed for repair purposes. Plug-in opto-couplers (supplied) allow user selection of ac or dc coupling for each channel by merely installing the opto-coupler in the ac position or dc position. For ac coupling, a plug-on jumper is provided for each channel to select 60 Hz ac filtering of the rectified input if desired.

#### Event Detection

In addition to status, any input may be user programmed to function as an interrupt to be generated on the rising edge or falling edge of the input or both (whichever occurs first). This capability is easily activated by the user via loading the appropriate pattern into the three registers. The on-card microprocessor takes over to cause the interrupt to be generated when that event occurs. User programming is required to service the interrupt.

#### Debounce Delay

The same microprocessor also provides the user-programmable debounce delay up to 246 ms on any input when monitoring contact closures and may be used in both status mode and event sense mode.

#### Output Characteristics

Sixteen form C (SPDT) relay outputs are provided on the same card. Both the normally open (NO) and normally closed (NC) contacts are available to users. Two removable headers allow for arc suppression devices to be added by the user for each channel without soldering directly to the board. Each header handles 8 output channels. Plug-on jumpers select the arc suppression across the NO or NC contacts. An on-card isolated power supply derived from the 25 kHz ac supply in the A-Series processor provides coil power for the relays. This technique minimizes any coupling of relay contact noise in the computer itself.

#### Ordering Information

HP 12060B 8 Channel Analog/Digital Converter  
 HP 12061A 32 Channel Analog Input Expansion  
 HP 12062A 4 Channel Digital/Analog Converter  
 HP 12063A 32 Channel Digital Multifunction Card



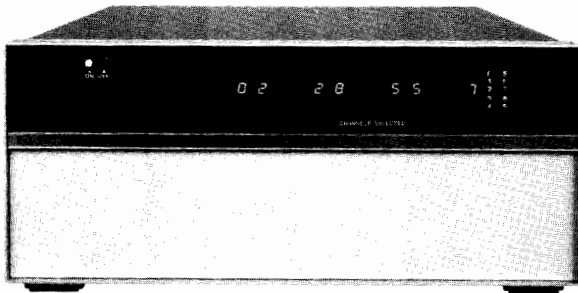

HP 3495A

## Description

### General

The HP 3495A Scanner switches analog input signals to an appropriate measuring device (voltmeter). It can also control external devices with relay actuator closures. Ideal for many data logging and data acquisition applications, the scanner can be used for sequential or random scanning. Any Hewlett-Packard Interface Bus (HP-IB) compatible controller can be used to operate the Scanner. Any combination of four relay assemblies (discussed below) can be used per scanner mainframe. More than four assemblies requires additional scanner mainframes.

Five optional relay assemblies are available with the scanner, four low thermal assemblies and one actuator assembly.

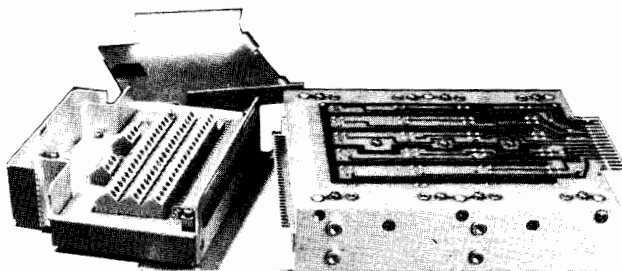

Option 004

### Low Thermal Relay Multiplexer Assemblies

These assemblies are used to multiplex signals into a common detector, often a digital voltmeter. Typical applications are the multiplexing of low level dc voltages and resistances like the outputs of thermocouples, thermistors, strain gages and other transducers. Options 001 and 004 have 10 and 20 channels respectively. Options 003 and 005 have 9 and 19 channels respectively, an isothermal connector block and a thermistor to sense the temperature of the isothermal block. This gives options 003 and 005 thermocouple compensation capability.

### Multiplexer Comparison

	Option 001	Option 003	Option 004/005
Number of Channels	10	9	20/19
Voltage Maximum	230 V peak	42 V peak	42 V peak
Current Maximum	200 mA	200 mA	40 mA
Thermal Offset	<2 $\mu$ V	<2 $\mu$ V	<1 $\mu$ V
Isolation	>10 <sup>10</sup> ohms	>10 <sup>7</sup> ohms	>10 <sup>7</sup> ohms
Switching Time	10 ms max.	10 ms max.	10 ms max. 1 ms max. using HP 3495A high speed controller

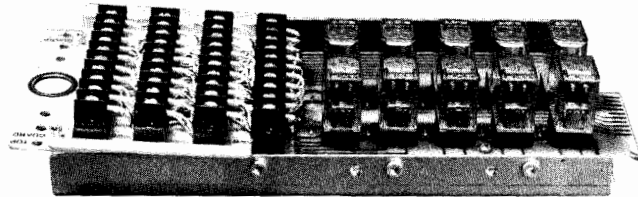

Option 002

### Relay Actuator Assembly

**Applications:** process control, actuate visual or audio indicators, control high current relays, up to 2 x 5 x 2 matrix switching.

**Ten Channel Relay Actuator Assembly:** This relay actuator assembly provides ten independently-programmable, 2-wire closures for controlling high current relays, distributing low current dc or ac voltages, or external control function. Each two-pole relay can switch currents up to 2 A rms. Any combination of channels on this assembly may be closed or opened simultaneously.

**Maximum contact ratings:** voltage: 100V rms; Current: 2 A rms; Maximum input voltage: 230V peak; Thermal offset: < 30  $\mu$ V differential EMF; Switching time: 40 ms max. (Caution: For use in circuits fused at 2 amperes or less and less than 200 VA).

### General

**Operating temperature:** 0°C to +55°C

**Humidity range:** 95% R.H., 0°C to +40°C

**Power:** 100/120/220/240 +5%, -10%

48 to 66 Hz line operation, <100 VA

**Size:** 190.5 H x 428.6 W x 520.7 mm D (7.5" x 16.87" x 20.5")

**Weight:** depends on options. Net: 18 kg (39.6 lb) maximum with four relay assemblies. Shipping: 22 kg (48.4 lb) maximum.

### Option

**001:** Ten Channel Low Thermal Relay Assembly

**002:** Ten Channel Relay Actuator Assembly

**003:** Nine Channel Reference Assembly With Thermocouple Compensation

**004:** Twenty Channel Low Thermal Relay Assembly

**005:** Nineteen Channel Reference Assembly With Thermocouple Compensation

**100:** High Speed Control Board

### Field Installation Kits

**HP 44401A** Ten Channel Low Thermal Relay Assembly

**HP 44402A** Ten Channel Relay Actuator Assembly

**HP 44403A** Nine Channel Reference Assembly With Thermocouple Compensation

**HP 44404A** Twenty Channel Low Thermal Relay Assembly

**HP 44405A** Nineteen Channel Reference Assembly With Thermocouple Compensation

**HP 44413A** High Speed Control Board

In addition, options 001 or 004 can be field modified to include thermocouple compensation by ordering the appropriate terminal connectors.

### Additional Terminal Connectors for

Ten Channel Low Thermal Relay Assembly, HP 03495-64101

Ten Channel Relay Actuator Assembly, HP 03495-64104

Nine Channel Thermocouple Reference Assembly, HP 03495-64103

Twenty Channel Low Thermal Relay Assembly, HP 03495A-64114

Nineteen Channel Thermocouple Reference Assembly, HP 03495-64115

### HP 3495A Scanner



# DATA ACQUISITION, CONTROL & TEST

Low Cost, Versatile HP-IB Switching

Model 3488A

- DC—300 MHz signal switching
- Matrix, multiplexer, & general purpose relays
- Digital I/O control & actuation
- Up to 50 channels
- 40 configuration storage registers
- 6 switch & control modules

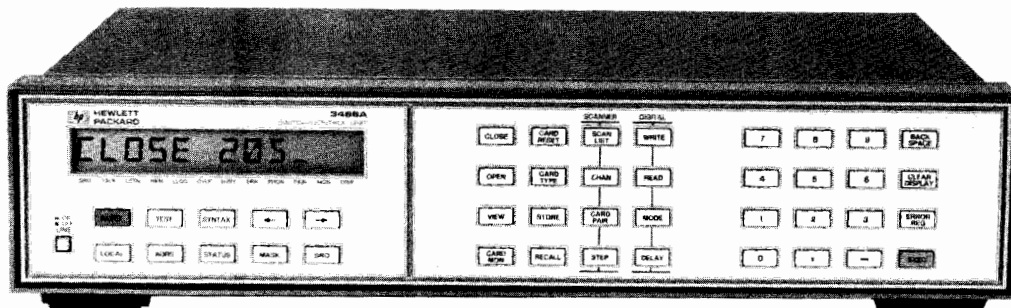

HP 3488A



## Description

The HP 3488A Switch/Control Unit brings versatile, HP-IB programmable switching to tests requiring multi-channel measurements. The HP 3488A provides signal switching with the integrity and isolation needed for high performance test systems in production. It also offers a flexible, low cost interconnection solution for automating experiments on the bench and for development testing in the lab. The HP 3488A is designed to hold any combination of up to 5 of the following optional switch and control modules:

- 10 Channel Relay Multiplexer
- 10 Channel General Purpose Relay
- Dual 4 Channel VHF Switch
- 4 x 4 Matrix Switch
- 16 Bit Digital Input/Output
- Breadboard

## Flexible Switching

The HP 3488A offers an economical approach to switching flexibility through plug-in modules. The user can select the right combination of switching functions to meet both performance and budget requirements. Testing is simplified by having one solution for connections of low level DVM inputs, high level dc and ac power, and VHF signals to 300 MHz. Additional devices such as microwave relays and programmable attenuators are easily controlled with digital I/O functions. Custom circuitry can also be implemented on breadboard modules.

## Versatile Performance

The HP 3488A can store up to 40 complete switch configurations for convenient recall in automated test programs. Switch operation can be with multiple relay closures or with selectable channels in a break-before-make mode. Break-before-make closures and recallable complete switch configurations can be combined in a programmable scan list. The HP 3488A uses removable screw terminal connectors that provide easily interchangeable wiring configurations for each test. Built-in self-test capability assures proper operation.

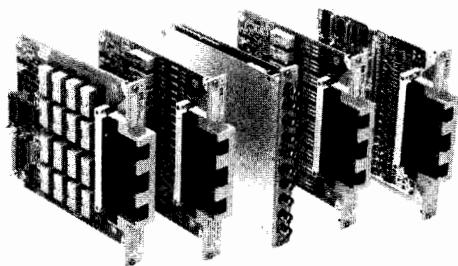

## Multiplexer (option 010)

Option 010 is a 10 channel multiplexer for scanning or multiple signal connections. Channels switch 2 wires (Hi & Lo) with 2PST relays for DVM inputs and other signals up to 250 V and 2A. This module can also be used to multiplex signals to other switching functions such as the matrix module.

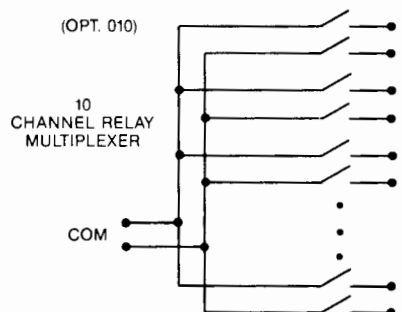

## General Purpose Relays (option 011)

This module consists of 10 SPST independent relays for general signal switching and control of external devices. The quality connections provided make this module ideal for switching signals when multiplexing isn't required or for supplying switchable power to the device under test.

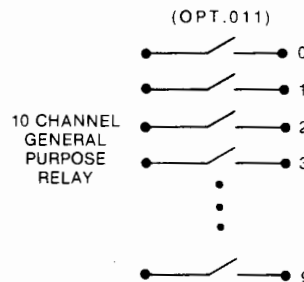

## Matrix Switch (option 013)

Option 013 offers highly flexible switching with a 4 x 4, 2 wire matrix. Any combination of 4 input channels may be connected to any combination of 4 output channels. Each cross point or node in the matrix uses a 2PST relay to switch 2 lines (Hi & Lo) at a time. Multiple 4 x 4 modules can be connected to form larger matrices. Multiplexers can be used in conjunction with this module to effectively expand the number of inputs and outputs of the matrix.



(OPT. 013)

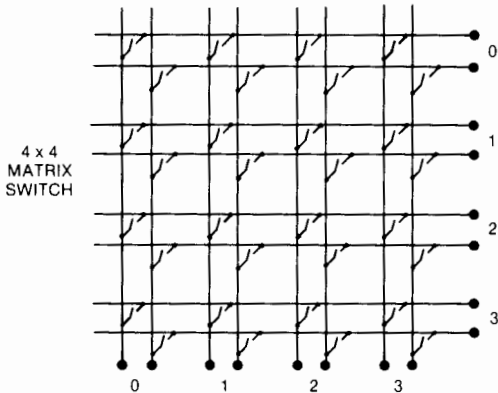

### VHF Switch (option 012)

The VHF module provides broadband switching capability for high frequency and pulse signals. The 2 independent groups of bidirectional 1 x 4 switches can be used for signals from dc to 300 MHz. All channels have 50 ohm characteristic impedance and are break-before-make within a group of 4 channels. Each group is isolated from the other and from ground to prevent ground loops. Excellent isolation makes this module ideal for high frequency signal analyzer measurements requiring a large dynamic range.

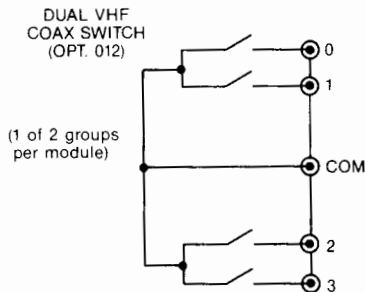

### Digital I/O (option 014)

This module offers 16 very flexible bidirectional I/O lines and 4 TTL compatible handshake lines for sensing and control of external devices. The digital inputs can be used to sense contact closures to ground. Each channel provides current sinks for remote switching of external relays such as the HP 33311 series of coaxial switches.

### Breadboard (option 015)

The breadboard module provides a convenient way to implement custom circuits and special functions that interface directly with the HP 3488A's backplane control signals.

### Specifications for Option 010 Multiplexer, Option 011 General Purpose Relay, and Option 013 Matrix Switch Modules

#### Input Characteristics

**Maximum voltage (terminal-terminal or terminal-chassis):** 250 V dc, 250 Vac rms, 350 Vac peak

**Maximum current:** 2A dc, 2A ac rms

**Maximum power:** 60 W dc, 500 VA ac

**Thermal offset:** < 3  $\mu$ V

#### DC Isolation (40°C, 60% RH)

**Channel-channel, open channel:** > 10<sup>11</sup>  $\Omega$

### AC Isolation/Performance

(50 $\Omega$ termination)	100 kHz	1 MHz	10 MHz
Insertion Loss (dB)	<0.30	<0.35	<0.90
Crosstalk (dB)	<-73	<-53	<-33

### Specifications For Option 012 VHF Switch Module

#### Input Characteristics

##### Maximum Voltage

Center-center: 250 Vdc, 30 Vac rms, 42 Vac Peak  
Low-chassis, low-low: 42 V dc

**Maximum current (per channel):** 30 mA dc, 300 mA ac rms

**Thermal offset:** <15  $\mu$ V per channel

**Characteristic impedance:** 50  $\Omega$

### AC Isolation/Performance

	30 MHz	100 MHz	300 MHz
Crosstalk (dB)			
Chan-Chan	<-100	<-85	<-65
Group-Group	<-85		<-50
Insertion Loss (dB)	<0.5	<0.75	<1.25
VSWR	<1.06	<1.12	<1.43

All channels break-before-make within a group of 4 channels.

### Specifications for Option 014 Digital I/O Module

#### I/O Lines

**Maximum voltage** = +30 Vdc (line-chassis)

**Output characteristics:** V (high)  $\geq$  2.4 V; V (low)  $\leq$  0.4V

**I (low) maximum** = 125 mA @ V (low)  $\leq$  1.25 V; fused at 250 mA.

**Input characteristics:** V (high)  $\geq$  2 V; V (low)  $\leq$  0.8 V

**External increment:** advances HP 3488A to next programmed configuration on falling edge of TTL pulse.

**Channel closed:** indicates completion of new configuration; TTL pulse.

### General Specifications

#### Environmental

Temperature: 0 to 55°C; humidity: 95%, 0 to 40°C

**Power:** 86-132 V or 195-250 V, switch selectable; 48 to 440 Hz; 18 VA.

**Size:** 89 mm H (without feet) x 425 mm W x 292 mm D (3.5" x 16.75" x 11.5"). Allow 76 mm (3") additional depth for wiring.

**Weight:** net: 8.5 kg (18.5 lb). Shipping: 16 kg (36.5 lb).

**Connectors** (all modules except option 012/HP 44472A VHF switch): Removable screw terminal connector. Each terminal accepts 18-26 gauge (16-40 mils) wire, with strain relief for wiring. Option 012/HP 44472A VHF Switch: BNC connectors.

### Ordering and Configuration Information

#### Options

(Switch Modules-includes terminal connectors)

**010:** 10 Channel Relay Multiplexer Module

**011:** 10 Channel General Purpose Relay Module

**012:** Dual 4 Channel VHF Switch Module

**013:** 4x4 Matrix Switch Module

**014:** 16 Bit Digital Input/Output Module

**015:** Breadboard Module

#### Rack Mounting and Manuals

**401:** Side Handle Kit (HP P/N 5061-1171)

**907:** Front Handle Kit (HP P/N 5061-1170)

**908:** Rack Flange Kit (HP P/N 5061-1168)

**909:** Rack Flange with Handles (HP P/N 5061-1169)

**910:** Extra Operating & Service Manuals

**HP 3488A Switch/Control Unit**



# DATA ACQUISITION, CONTROL & TEST

## Multiprogrammer: Versatile Basic Building Block for System Integration.

Models 6940B, 6942A, and 6944A

- Isolated power supplies for analog functions
- Mainframe extenders for increased I/O capacity
- Broad range of I/O instrumentation cards

- Easy-to-use, menu-driven software
- Large range of user/application documentation

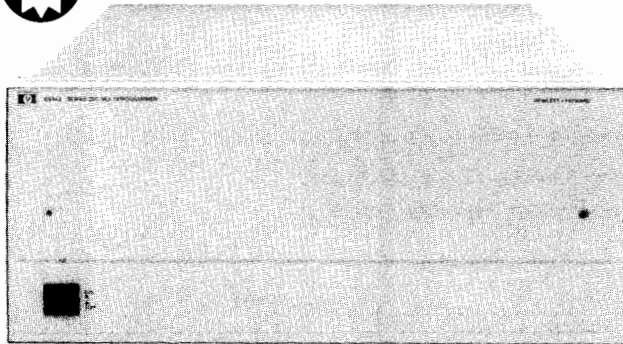

HP 6944A

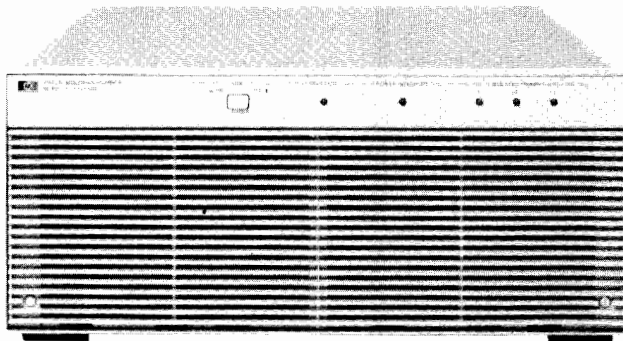

HP 6942A

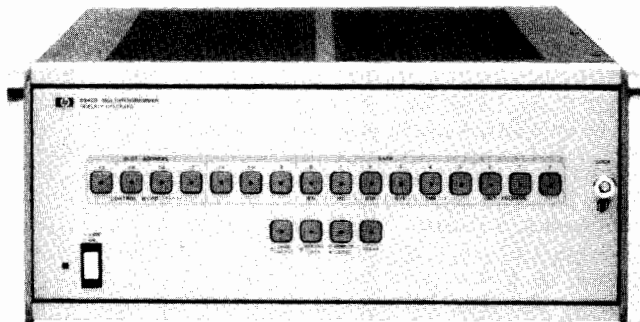

HP 6940B

### Introduction

Hewlett-Packard Multiprogrammer products provide solutions for a variety of data acquisition, control and test applications. The application flexibility is due to the architectural features of these products. The plug-in Multiprogrammer I/O cards allow card-to-card communication, isolated inputs and external triggering and provide a wide range of functions. The HP 6940B coupled with the Multiprogrammer Series I I/O cards offers low-cost solutions when operated on the GP-IO Bus. The HP 6942A Multiprogrammer and the Series II I/O cards are a medium-performance, medium-speed, HP-IB solution. For applications requiring a higher level of performance and more speed, the HP 6944A Series 200 Multiprogrammer should be considered for use with the Series II I/O cards.

The I/O cards have many benefits. Multiple-card configurations can be established that provide instrument-like functions. For example: high-speed scanning and multiple simultaneous-buffered analog-to-digital converters. Other features provide precise crystal-controlled timing or pacing of I/O operations. This allows the modular construction of instrumentation functions such as frequency measurement, time interval measurement and programmable pulse generation. The card-to-card communication feature allows the I/O operation of the Multiprogrammer to operate independently of the computer. The computer is then free to perform other tasks until it receives an interrupt from the Multiprogrammer. If the application requires the process to control data acquisition, it can be accomplished via the external trigger feature. This feature allows the process to time or pace operations independently of the computer. In addition, I/O data can be stored in the Multiprogrammer's plug-in memory system, allowing high-speed operation of other tasks the computer must perform.

### HP 6944A Features

- Data transfer rate of 180,000 readings/second
- Dedicated interface (HP 98633A) to HP Series 200 computers
- Direct to disc at 180K words/second
- HP 14751A CAT programming package
- HP Multiprogrammer Series II I/O cards

### HP 6942A Features

- Data transfer rate 18,000 readings/second
- HP-IB interface
- HP 14750A CAT programming package
- HP Multiprogrammer Series II I/O cards

### HP 6940B Features

- Front panel control
- GP-IO or optional HP-IB interfacing
- Data transfer rate 20,000 readings/second
- HP multiprogrammer Series I I/O cards
- Temperature measurement capability

# DATA ACQUISITION, CONTROL & TEST

## Multiprogrammer: Measurement & Analysis System

Model 6901S

193

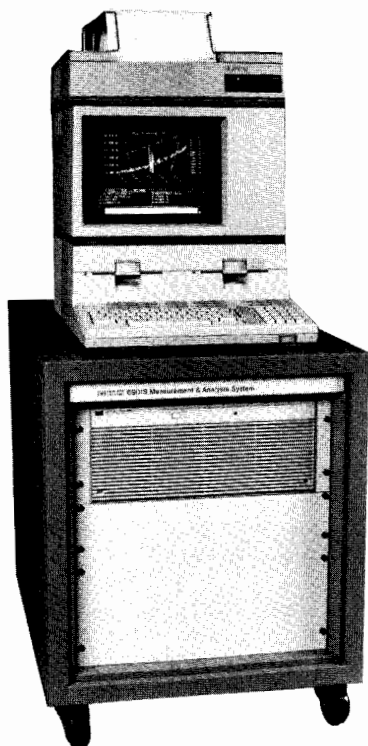

HP 6901S

### Description

Hewlett-Packard's 6901S Measurement and Analysis System is a fully integrated, high speed scanning system for measuring multiple channels of voltage, current or resistance. It's a complete, ready-to-use solution which improves productivity by allowing a user to begin making measurements immediately. It also retains the flexibility to be customized for individual applications.

### Easy to Use

A comprehensive software package makes the HP 6901S easy to use—for many applications, no software writing is required. Friendliness is enhanced via the use of descriptive menus. Sequencing of menus is controlled by the HP 6901S general-purpose mainline program.

The system comes fully assembled in a desk-height rack which provides a convenient work surface for any of the HP Series 200 Computers. User connections are easily made with a screwdriver to a factory-wired termination panel in the rear of the rack.

### Hardware Features

The standard HP 6901S will scan 1 to 64 single-ended, analog channels at up to 25,000 channels per second, or up to 100 scans per second with programmable limit checking. (A scan is one complete pass through every channel.) By adding additional scanning cards, the standard system can scan up to 256 channels, or up to 768 channels with user-supplied termination panels. Options for double-ended and 4-wire scanning are also available.

As shipped, the HP 6901S will measure signals in the  $\pm 10.23$  volt range with 12-bit resolution.  $\pm 1.023$  volt and  $\pm 102.3$  millivolt ranges are switch selectable.

### Software Features

The HP 6901S software includes one burst and three continuous scanning modes:

- Burst mode is used for applications requiring high speed scanning for up to 4096 readings.
- Limit mode is used to look at data before and after the occurrence of an out-of-limit condition on any channel. Both high and low limits are programmable for each channel.
- Strip chart mode produces a continuous hard copy record to indicate long term change.
- Running statistics mode outputs a statistical summary of long-term tests.

The HP 6901S graphics utilities support the following types of outputs: multichannel plotting, histogram plotting, cumulative distribution plotting, and tabular listings. Interactive graphics are provided within each plotting utility for extracting and analyzing the important information from the plots. The system also supports the HP

2671G Graphics Printer and three HP graphics plotters for hard copies and overhead transparencies.

Four of the HP Series 200 Computers can be specified with the HP 6901S. These are the Model 16S, 26S, 36S and 36CS computers.

### Easy to Customize

Both the HP 6901S hardware and software can be easily customized for the customer with special needs. The standard system software makes use of many separate utilities, all of which are available to the user. Each one is written in BASIC and can be accessed by the user by modifying the mainline program.

The HP 6901S is also easily customized by users with special hardware needs. By using the HP 14750A CAT Programming Package, included with the system, a variety of HP Multiprogrammer Series II I/O Cards can be added to the system. This family of 24 cards, described on pages 196 and 197, performs many functions. This type of customization makes the HP 6901S a partially integrated solution to a broad range of automatic test, data acquisition, and control needs.

### Specifications

#### Maximum Scanning Rates (single-ended only)

**Burst mode:** 25 kHz (channels/second),  $\pm 10$  V,  $\pm 1$  V ranges; 14 kHz,  $\pm 100$  mV range. Buffer Size: 4096 words

**Limit mode:** 100 Hz (scans/second) with limit checking on up to 30 channels.

**Strip chart mode:** 1 Hz (scans/second) for any 8 channels.

**Running statistics mode:** 5 scans/second average for up to 16 channels with no more than 400 milliseconds between successive readings on any one channel.

**Minimum Out-of-Limit Condition Duration of an Input Signal In Limit mode:** 10 ms for 100 Hz scanning rate.

**Slots available for Multiprogrammer cards:** 16 (the standard system uses five of these.) Up to seven HP 6943A Multiprogrammer Extenders can be added external to the rack.

**Operating temperature range (HP 6901S):** 10–40°C.

**Dimensions (HP 6901A):** 725 mm high x 600 mm wide x 900 mm deep, (28.6 in high x 23.7 in wide x 35.6 in deep).

**Power (HP 6901A):** 100/120/220/240 Vac (selectable), +5%, –10%, 47 to 63 Hz, 600 VA.

**Weight (HP 6901A):** net, 81.7 kg (180 lb); shipping, 107 kg (235 lbs)

### Ordering Information

**Step 1:** Specify the HP 6901S  
HP 6901S Measurement & Analysis System

**Step 2:** Order two RAM Boards and one Computer  
Two HP 98256A 256 kbyte RAM boards @ \$1,060  
HP 9836CS Computer  
HP 9836S Computer  
HP 9826S Computer  
HP 9816S Computer, Option 630  
HP 9888A Bus Expander (required for HP 9816S only)  
HP 9121D 3½-in Dual Flexible Disc Drives (HP 9816S only)  
HP 10833A HP-IB Cable; 1 m (3.3 ft) (HP 9816S only)  
HP 98612A BASIC Extensions 2.0, Option 630 (HP 9816S only)

**Step 3:** Specify HP 6901A with one media option  
HP 6901A Scanning Subsystem  
Opt 630: 3½-in flexible discs  
Opt 655: 5¼-in flexible discs for HP 9826/9836

**Step 4:** Options 1, 2, or 3 may be ordered as alternatives to the 64 channel FET scanner. Order as many expansion options as required.

Opt 001: Substitute 16-Channel FET  
Opt 002: Substitute 16-Channel Double Ended Relay  
Opt 003: Substitute 16-Channel 4-wire Ohms Scanner  
Opt 004: Add 16 FET Channels  
Opt 005: Add 64 FET Channels  
Opt 006: Add 16 Double Ended Relay Channels (may only be ordered with opt. 002 or 003)  
Opt 007: Add 16 4-Wire Ohms Scanning Channels (may only be ordered with opt. 003)  
Opt 008: Right to copy software (deletes SW)

**Step 5:** Select peripherals required for hard copy (HP 2671G Printer, and HP 9872C, 9872T, 7470A Plotters)



# DATA ACQUISITION, CONTROL & TEST

## Multiprogrammer: Versatile Building Block Approach to Systems

Model 6944A

- Data transfer rate 180,000 readings/second
- Dedicated interface (HP 98633A) to HP Series 200 Computers



HP 6944A

### Description

The HP 6944A Series 200 Multiprogrammer is a high-speed data acquisition and control system designed exclusively for use with HP Series 200 computers. The HP 6944A capitalizes on the HP Series 200 computer architecture by using the dedicated HP 98633A Multiprogrammer Interface and the HP 98620B DMA Controller to achieve high-speed data transfers.

The powerful HP Multiprogrammer Series II I/O cards provide a broad variety of I/O functions for the HP 6944A. These cards allow the user to configure the HP 6944A to implement many instrumentation functions such as high-speed scanning, analog waveform synthesis, limit checking and transient analysis.

The HP 6944A is programmed exclusively with the HP 14751A Computer Aided Test Programming Package. This software package effectively couples the flexible hardware architecture of the HP 6944A with the BASIC language system of the HP Series 200 Computers. The friendliness of this system is such that the system programmer only needs to be able to program in BASIC. The control statements are english-like and closely linked to the application by a list of "Names" supplied by the user. An easy-to-use, menu-driven configuration process correlates the user-assigned "Names" to the system's I/O functions automatically from the BASIC program. The software, through the same menu-driven process, then leads the system programmer through the hardware configuration. The net result is fast program development, self documenting, and the ability to maintain different configuration files on one disc.

### Features

The primary features of the HP 6944A evolve around the architecture of the HP 6944A, HP Series 200 Computers, and the Multiprogrammer Series II I/O cards.

The key feature of the HP 6944A is high-speed data transfer. With the HP 6944A, HP 6975A 500 kHz A/D, HP 69791A/92A High-Speed Memory I/O System, and the HP 98620B DMA Controller Card, data may be transferred to an HP Series 200 Computer at rates of 180,000 readings/second. Without the HP 98620B DMA Controller Card, transfer rates of nine kilowords/second are achieved.

A second key feature of the HP 6944A is its ability to unburden the HP Series 200 Computer from controlling each I/O task of the HP 6944A. This allows the HP Series 200 Computer time to perform numerical analysis or manage other instruments during these time periods.

- Direct-to-disc transfer rate of 180,000 words/second
- HP 14751A CAT programming package
- HP Multiprogrammer Series II I/O cards

### HP 6944A Specifications

**Plug in I/O card positions:** Maximum of 15 plug-in output or input cards per mainframe. Removable rear cover provides access to card slots.

**Computer interface:** The HP 6944A is connected to an HP Series 200 Computer via the HP 98633A Multiprogrammer Interface Card and HP 14704A, B or C cable.

**Extender units:** Up to eight HP 6944A Series 200 Multiprogrammers can be "linked" to the Series 200 via one HP 98633A Multiprogrammer Interface Card by using HP 14704A, B or C Interface Cables.

**Maximum length of a link:** A link of up to eight HP 6944A Series 200 Multiprogrammers can be nine metres long, maximum. This maximum length is the sum of the lengths of all the HP 14704A, B or C Interface Cables in the link.

**Power supplies:** All necessary power supplies for up to 16 I/O cards are built into each HP 6944A frame. Three  $\pm 18$  V supplies are isolated from each other and from ground, and are available for powering isolated I/O card circuits.

**Cooling:** Built-in forced air cooling draws air in through the side vents and exhausts air through the rear cover.

**Operating temperature range:** 0 degrees C to +55 degrees C.

**Power:** 100/120/220/240 Vac (switch, selectable), +5% to -10%, 47 to 63 Hz, 650 VA.

**Dimensions:** 177.0 mm high x 425.5 mm wide x 597.0 mm deep (7.0 in high x 16.25 in wide x 23.5 in deep).

**Weight** (without I/O cards): Net, 21 kg (46 lb); shipping, 28.6 kg (63 lb).

### Ordering Information

#### Step 1: Select the necessary quantity of HP 6944As.

HP 6944A Series 200 Multiprogrammer

Option 908: rack mount kit

Option 910: extra operating and service manual

#### Step 2: Select the HP Series 200 Multiprogrammer Interface Card for HP 6944A.

HP 98633A Multiprogrammer Interface Card

#### Step 3: Select number and lengths of cables required for connecting HP 98633A Interface to first frame.

An additional cable is needed for each HP 6944A frame used as an extender.

HP 14704A Multiprogrammer Interface Cable,  
1 m (3.3 ft)

HP 14704B Multiprogrammer Interface Cable,  
2 m (6.6 ft)

HP 14704C Multiprogrammer Interface Cable,  
4 m (13.2 ft)

#### Step 4: Select HP 14751A to receive necessary CAT software and documentation (mandatory).

Select the option appropriate for the system controller.

HP 14751A Computer Aided Test Programming Package

Option 630: software provided on 3 1/2" flexible discs

Option 655: software provided on 5 1/4" flexible discs

Option 910: extra set of documentation

HP 14751R: right to reproduce HP 14751A CAT programming package (documentation provided)



# DATA ACQUISITION, CONTROL & TEST

## Multiprogrammer: Versatile Automatic Test, Data Acquisition and Control

Model 6942A

195



- Action-oriented instructions
- Isolated analog inputs and outputs
- Built-in self test

- Overlapped input and output
- Internal or external pacing
- Easy to configure

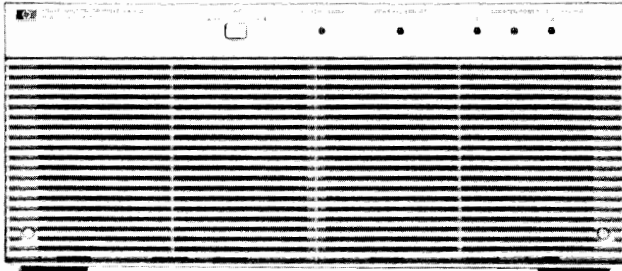

HP 6942A



### The Multiprogrammer Performs Operations in Parallel

With this one instrument you can control several processes at once. And, while you are controlling the processes, the Multiprogrammer can also be watching for interrupt conditions. The internal microprocessor manages all the parallel operations and monitors the alarm lines; when the operations have completed or if an alarm condition occurs, the Multiprogrammer interrupts the controller.

### How does the HP 6942A Connect With Your Controller?

The HP 6942A Multiprogrammer interfaces with your controller (desktop or minicomputer) using the HP-IB, Hewlett-Packard's implementation of IEEE Standard 488 and the identical ANSI Standard MCI.1. Data and status readback make use of the extended bus addressing features of the HP-IB.

### Programming Flexibility

Mnemonic, action-oriented instructions make the HP 6942A Multiprogrammer simple to learn and use. For instance, the output instruction "OP" works with all output cards. When you send an instruction, the internal microprocessor checks which type of card you are addressing and automatically converts the data to the proper format for that card. You select the units with which you want to program each card. Whether you want to use volts, millivolts, amps, degrees, feet, or any other units, the Multiprogrammer does the converting for you.

### Mainframe Memory Unburdens The Controller

The mainframe memory of the HP 6942A will accept up to 76 instructions from the controller at one time. This leaves your controller free for other processing activities while the Multiprogrammer works on the I/O operations. This mainframe memory may also be used to collect up to 1440 data readings and hold them until the controller is free to take them. (For even more data storage, up to 1 Meg words of data may be stored using the HP 69741A and HP 69792A Memory System Cards.

### Real Time Clock

Built-in real-time clock gives you time-of-day readings and pacing of measurements. The clock detects which power line frequency you are using, 50 Hz, or 60 Hz, and automatically synchronizes itself to this frequency. The range of the clock is 65,534 days, with resolution to a tenth of a second.

### Computers and Documentation

The HP 6942A can be operated with a wide variety of computers, including the HP Series 80, Series 200, Series 1000, 9825, and 9845 computers. Documentation packages are available for all of these computers. Each one contains a User's Guide with programming examples, a utility program tape or flexible disc, operating and service manuals, and a binder to hold this material. One no-charge documentation option must be specified to select the documentation appropriate for your computer.

### Accessories

**HP 14700A extender kit:** this kit contains the transmission boards which go into the master mainframe (HP 6942A) and the last extender mainframe in the chain.

**HP 14701A intermediate extender kit:** when more than two mainframes are in a chain, the card in this kit must be used in each intermediate extender mainframe.

**HP 14702A chaining cable:** this is the cable which chains together the master and extender mainframes. One cable is required for each extender mainframe. Length: 1.5 m (5 ft).

**HP 14703A card edge connector:** extra connectors for the I/O cards may be ordered in addition to the one supplied with each I/O card.

### HP 6942A/6943A Specifications

**Plug-in I/O card positions:** maximum of 16 plug-in output or input cards per mainframe. Removable rear cover provides access to card slots.

**Computer interface (HP 6942A only):** the Multiprogrammer is connected to a controller via the Hewlett-Packard Interface Bus (HP-IB), Hewlett-Packard's implementation of IEEE Std. 488.

**Real time clock (HP 6942A only):** the built-in real time clock is automatically synchronized with the 50/60 Hz ac power line frequency. The clock is read and set with data in the form of days, hours, minutes and seconds with a resolution of 0.1 second.

**Extender interface kits (HP 6943A only):** each HP 6943A Extender requires one HP 14700A or 14701A Interface Kit and one HP 14702A Chaining Cable for operation with the HP 6942A.

**Maximum number of mainframes per chain:** up to seven HP 6943A Multiprogrammer Extenders may be placed in a chain with one HP 6942A Multiprogrammer.

**Maximum chain length:** a chain of mainframes can be up to 152 meters (500 feet) long. This maximum length is the sum of the lengths of all HP 14702A Chaining Cables used in one chain.

**Power supplies:** all power supplies for up to 16 I/O cards are built-in including three  $\pm 18$  V supplies isolated from each other and from the ground.

**Cooling:** built-in forced air cooling draws air in through the front panel and exhausts air through the ventilated rear cover.

**Front panel indicators:** five light emitting diodes on the front panel indicate power supply and self-test status.

**Operating temperature range:** 0°C to 55°C.

**Power:** 100/120/220/240 Vac (selectable), +5%, -10%, 47 to 63 Hz, 600 VA.

**Dimensions:** 177.0 mm high x 425.5 mm wide x 597.0 mm deep, (6.969 in. high x 16.250 in. wide x 23.500 in. deep).

**Weight (without I/O cards):** net, 20 kg (45 lb); shipping, 27 kg (60 lb).

**Accessories furnished:** PC board Extender Card (HP Part No. 5060-2792).

### Ordering Information

**Opt 010-386:** One Set Documentation/Software

**Opt 410-786:** Extra Documentation/Software

**Opt 908:** Rack Flange Kit

**Opt 910:** Extra Manual

**HP 14700A** Extender Interface Kit

**HP 14701A** Extender Interface Kit

**HP 14702A** Chaining Cable

**HP 14703A** Spare Card Connector

**HP 14711A** Field Service Kit

**HP 6942A Multiprogrammer**

**HP 6943A Multiprogrammer Extender**



# DATA ACQUISITION, CONTROL & TEST

## Multiprogrammer Series II I/O Cards

Models 69700A-69793A

### Multiprogrammer Series II I/O Cards for the HP 6944A/S, 6942A/S and 6901S

For a complete description of the Multiprogrammer Series II I/O Cards, ask for publication 5952-4090.

	Functions	Applications	Cards Used
STIMULUS	<p>Programmable DC Voltage and Current</p>	The output voltage (up to 250V) and current (up to 1000A) of forty different HP power supplies can be programmed to provide bias in automatic test systems or control of electromechanical process equipment.	Resistance Output, HP 69700A-69706A; Power Supply Control, HP 69709A.
	<p>Digital-to-Analog Conversion</p>	Twelve-bit voltage DAC's provide outputs for strip chart, x-y, and analog tape recorders as well as control of analog programmable instruments and stimulus of units under test. Control process equipment with 4-20 mA output.	Voltage DAC, HP 69720A; Current DAC, HP 69721A.
	<p>Analog Waveform Synthesis</p>	The Memory card can continually supply pre-loaded data to the D/A card at rates of up to 100 kHz. Special waveforms may be loaded into the Memory card from the computer and used as stimuli for test and processes. The analog output is isolated from digital ground.	Memory card, HP 69790B; 69791A, 69792A Voltage DAC, HP 69720A; or Current DAC, HP 69721A.
MEASUREMENT	<p>Voltage, Current, and Resistance Measurements</p>	A/D converters may be used to measure voltages from $\pm 50\mu\text{V}$ to $\pm 100\text{ V}$ in the presence of 250 V of common-mode noise. Connecting a resistor across the input permits current measurements for 4-20 mA current loops used in process control. Combine the A/D with the current DAC for resistance measurements.	High Speed ADC, HP 69751A, HP 69759A
	<p>Frequency Measurements</p>	The Pulse Counter card accumulates counts over a precise time interval when a Timer card is connected to the enable line of the Counter. The program divides the count by the time interval to measure frequencies from 1 MHz to less than 0.001 Hz.	Counter, HP 69775A; Timer HP 69736A.
	<p>Pulse Counting Preset Up/Down</p>	The Counter may be preset to any value within the count range of 0 to 65,535 and can cause an interrupt when it rolls over. The Counter may be enabled and disabled by pulses or levels. The computer may read the count without disturbing the counting process.	Counter, HP 69775A.
	<p>Offline Analog Acquisition</p>	Differential or single-ended signals may be digitized at rates up to 500 kHz by the A/D, and stored in the Memory system. Each Memory system can store up to one megawords. The digitizing process can take place independent of other Multiprogrammer activity.	High Speed ADC, 69751A; Memory cards, 69790B, 69791A/69792B.
	<p>Scanner Systems</p>	Analog measurements from up to 960 channels may be acquired at 25,000 readings per second depending upon the scanner system configuration. Random access to any channel, as well as continuous scanning, are easily accomplished. (See Application Note AN316-3.)	Cards used: Scan Control, HP 69750A; FET Scanners, 69752A or 69755A; Relay Scanner, HP 69754A; High Speed ADC HP 69751A; Memory card HP 69790B, or 69791A/92A
	<p>Digital Output and Switching</p>	Sixteen-bits of data in TTL, open collector, or SPST relay-contact form provide digital control of instruments and indicators. AC power, up to 6, can be switched to 12 loads with a HP 69731B, and HP 14570A AC Power Controller.	Digital Output, HP 69731B; Relay Output, HP 69730A; AC Power Controller, HP 14570A.
CONTROL	<p>Digital Input</p>	Digital input cards accept 16-bits of data from digital measuring instruments, push-buttons, switches, relays, and other digital devices in the form of logic levels or contact closures. Digital data sources with more than 16-bits of data use several digital input cards.	Digital Input, HP 69771A; Isolated Digital Input, HP 69770A.
	<p>Stepping Motor Control</p>	The Stepping Motor card can produce from 1 to 32767 pulses at either of two outputs (CW or CCW) to control motor translators. Output pulses are also used for pulse-train update of supervisory control stations. The pulse rate (motor speed) is also programmable.	Pulse Train/Stepping Motor, HP 69735A.
	<p>Time and Frequency Reference</p>	Crystal controlled timing pulses, programmable from 1 $\mu\text{s}$ to 18 hours, may be used as a time-base reference for control, measurement, and data acquisition. Period, duty cycle, and number of pulses are all programmable.	Timer, HP 69736A or Pulse Train, HP 69735A.
	<p>Level Detecting</p>	When signals cross preset levels, the Digital Input card can trigger the interrupt card to interrupt the computer. The alarm trigger levels can be programmed with the D/A or fixed with resistors.	Digital Input HP 69771A; Interrupt card, HP 69776A.
ALARM	<p>Event Sensing</p>	A digital word may be used to trigger quick computer response with the interrupt card. The computer responds to the interrupt with a software routine. The interrupt may also cause immediate local response by triggering a preloaded output card.	Interrupt card, HP 69776A.

**HP 69752A 64 Channel FET Scanner Card**

Scans 64 single-ended channels ( $\pm 10.24$  V input signal range) at up to 25,000 readings per second. Cards cascable to 960 channels in a single mainframe.

**HP 69755A 16 Channel FET Scanner Card**

Same as 69752A, except scans 16 channels.

**HP 69754A 32 Channel Relay Scanner Card**

Scans 32 single-ended (16 double-ended) channels with a  $\pm 100$  V input signal range at speeds up to 1000 readings per second (625 readings double-ended). Switches currents up to 50 mA.

**HP 69750A Scan Control/Pacer Card**

Provides all pacing and control functions for the scanner cards listed above. One required for each group of scanner cards (maximum of 15 cards—see data sheet for further clarification).

**HP 69709A Power Supply Control Card**

Used for full system control of 6024A and 6012A Autoranging Power Supplies.

**HP 14728A Buffered A/D Cable**

Used to connect 69751A and 69790B in a buffered A/D configuration.

**HP 69700A-69706A Resistance output cards:** the output of each of these cards is a programmable resistance value. Twelve mercury wetted relay contacts close across binary weighted precision resistors in a series string. The cards are designed to program the voltage or current output of an HP power supply with option 040.

**HP 69720A D/A voltage converter card:** provides a high speed, bipolar output voltage programmable from  $-10.240$  V to  $+10.235$  V up to 5 mA load current.

**HP 69721A D/A current converter card:** provides a bipolar  $-20.480$  mA to  $+20.475$  mA current output.

**HP 69730A Relay output card:** provides sixteen independent, normally open, mercury wetted relay contacts. Contacts rated at 100 Vdc; or 1 Amp; and 28 VA.

**HP 69731B Digital output card:** provides sixteen TTL or CMOS compatible outputs, or sixteen 100 mA open-collector switches.

**HP 69735A Pulse train output/stepping motor control card:** generates up to 32767 pulses at a programmable frequency.

**HP 69736A Timer/pacer card:** outputs a programmable pulse from one microsecond to eighteen hours or a programmable square wave.

**HP 69751A A/D converter card:** this card measures bipolar dc voltages in one of four ranges,  $\pm 100$  mV,  $\pm 1$  V,  $\pm 10$  V, or  $\pm 100$  V, with 12 bit resolution at up to 33,000 readings per second.

**HP 69770A Isolated digital input card:** breaks the path of potential ground loops with an optically coupled isolator in each of the sixteen digital input lines.

**HP 69771A Digital input/analog comparator card:** monitors up to sixteen contact closures, switches, TTL signals, CMOS signals, or analog signals. The switching threshold can be set to any value between  $\pm 9.5$  volts by a screwdriver-adjustable potentiometer on the card or may be externally programmed.

**HP 69775A Counter/totalizer card:** counts contact closures, TTL or CMOS logic level pulses, or analog waveform transitions in the range of 0 to 65,535.

**HP 69776A Interrupt card:** compares up to sixteen logic level or contact closure inputs with a sixteen-bit reference word and interrupts for =,  $\neq$ , <, > conditions.

**HP 69790B Memory card** (occupies 2 I/O slots): provides 4096 16-bit words for use with the DAC cards or the ADC cards or for other input/output tasks that need to run independent of other Multiprogrammer or computer tasks. Several Memory cards may be used to implement truly simultaneous operations.

**HP 69793A Breadboard card:** the generalized grid area on this card may be used for mounting custom circuits.

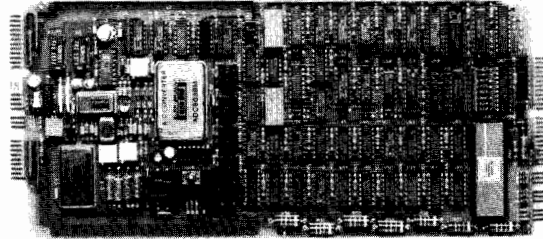
**HP 69759A - 500 kHz A/D**

The HP 69759A 500 - kHz A/D converter measures bipolar voltages in four programmable ranges,  $\pm 100$  V,  $\pm 10$  V,  $\pm 1$  V, and  $\pm 100$  mV. The digitized values may be read directly by the controller or transferred into HP 69791A and HP 69792A memory buffer cards available for the Multiprogrammer system. Use of memory buffers permits simultaneous digitization of as many as 40 independent signal channels at rates up to 500 kHz per channel. Scanning subsystems designed specifically to work with the HP 69759A card provide additional measurement flexibility and permit expansion up to 7168 channels. Timebase and triggering functions may be added using other Multiprogrammer cards to form a complete analog measurement system that is precisely tailored to the requirements of the specific application.

Application Note 316-5, Data Capture, describes several ways that the HP 69759A can be used with other Multiprogrammer cards to solve several different applications. These descriptions include cable diagrams and program listings for both the HP 14751A and the HP 6942A native instructions.

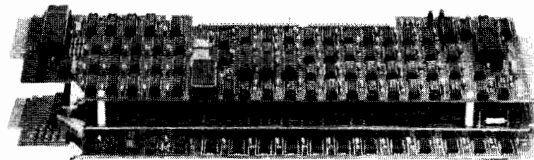
**HP 69759A****HP 69791A/92 - Memory System**

The HP 69791A and HP 69792A Memory Cards form a buffer used to perform input and output tasks without intervention from the controller. A memory card buffer can be used for inputs or outputs, or both. Data can be acquired at up to 760 kilowords/second or sent at up to 400 kilowords/second.

A memory card buffer has one HP 69791A Memory Card and up to five HP 69792A Memory Expansion Cards for a maximum memory size of 1M (1,048,576 16-bit words). The HP 69791A holds 64k (65,536 16-bit words) and the HP 69792A holds 192k (196,608 16-bit words). The memory card buffer functions as a single memory, regardless of how many HP 69792As are added.

The memory card subsystem can be used with the HP 69751A or HP 69759A A/D cards to input digitized analog measurements. Up to eight HP 69759A A/D Cards can be multiplexed into a single HP 69791A/69792A memory buffer. The A/Ds can be triggered by the same timebase for truly simultaneous readings which are then stored in sequential memory locations. This reduces memory costs and the number of mainframe slots required.

**HP 69791A**  
**HP 69792A**



# DATA ACQUISITION, CONTROL & TEST

## Multiprogrammer: Computer Aided Test System

Models 6942S/14750A and 6944S/14751A

- Easy to use menu entry
- Faster software development
- Improved HP 6942A performance

### Description

The new HP 6944S and the HP 6942S are easy to use computer-aided test systems that improve productivity by enabling you to implement your testing requirements more quickly. This is achieved through the use of two new software packages. The HP 14750A is a powerful CAT programming package which replaces the standard two-letter mnemonics of the HP 6942A Multiprogrammer. The HP 14751A is the standard programming language for the new HP 6944A Series 200 Multiprogrammers.

These systems are friendly and easy to use. Mnemonic-type language is not needed to program the HP 6944A. In addition, the HP 14750A will increase the performance speed of the HP 6942A. These CAT programming packages support all of the Multiprogrammer Series II I/O cards and several multiple-card functions. (Support for the HP 69759A and HP 69791A using the HP 14750A is currently under development. For further details, see your HP field engineer.) The HP 6942S and HP 6944S systems consist of: the desired Multiprogrammer mainframe, the appropriate CAT programming package.

### CAT Programming Package

The CAT programming package is a comprehensive collection of software routines that provide the ATE system designer with a high-performance linkage between the BASIC language and Multiprogrammer hardware. Both friendliness and higher performance are combined in the software through an architecture which optimizes total system performance.

Friendliness is achieved by replacing traditional "computer language" statements with test-oriented commands. Communication with all supported instrumentation is via "functional names", chosen by the user, which have a close relationship with the function performed. For example, in the menu below, the name "value", is used to program a HP 69720A Voltage D/A Converter. This lets you program in terms that are familiar to you resulting in programs which are virtually self-documenting. Friendliness is further enhanced by convenient menu entries, which make it easy to enter all function names and parameters.

The CAT programming package reduces the amount of software written by the user thus speeding program development. Productivity is improved by shortening test development time. To create test software, the user enters functional names and other data into a series of menus. Then a program is written in HP-enhanced BASIC to handle all sequencing, computational, and decision-making operations. Whenever a stimulus, acquisition or control function is desired, the BASIC program is instructed to call a routine from the CAT programming package.

### Features

Some of the CAT programming package features are highlighted in a menu below. The timeout feature can generate an error if an operation has not completed in a specified time. Since the error can be trapped like any other BASIC error, corrective action can be programmed to occur automatically. Limit-checking prevents out of range values from being executed, and data conversion permits programming with user specified units. Initial values can also be specified and, at run time, sent to all instrumentation with a single command.

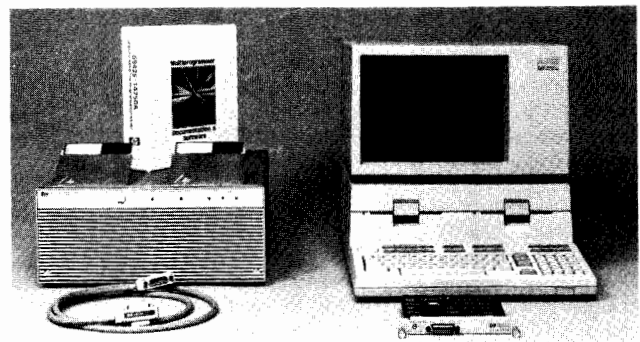
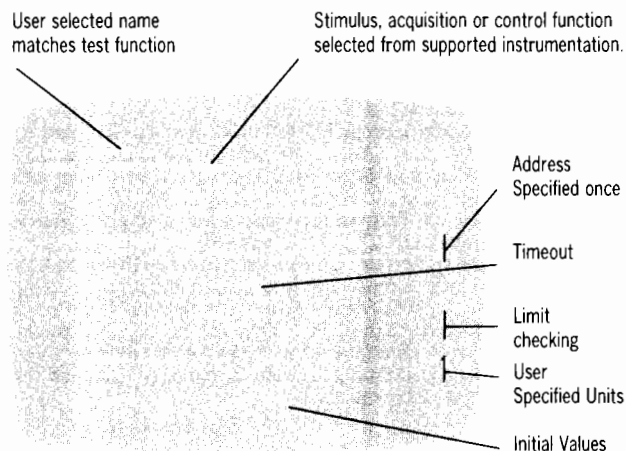

### Multiprogrammer Series II I/O Cards

The CAT programming package supports the Multiprogrammer Series II I/O card functions, described on pages 196 and 197, and four popular multiple-card functions. These include combinations such as using a high-speed scanner, A/D, and memory card together. In addition, the HP 3478A 5 1/2-digit Multimeter is supported for applications requiring high-accuracy and high-resolution measurements.

### HP 6942A Multiprogrammer

The Multiprogrammer is a high-performance mainframe that provides the necessary interface for up to sixteen plug-in cards. Optional HP 6943A Multiprogrammer Extenders can be added to a system to further expand its capabilities. Up to seven Extenders, each holding up to sixteen plug-in cards, can be chained to one mainframe.

### HP 6944A Series 200 Multiprogrammer

The new HP 6944A Series 200 Multiprogrammer is a high-speed mainframe that provides the necessary interface for up to sixteen plug-in cards. The HP 98633A Multiprogrammer interface must be used to operate the HP 6944A. Up to eight HP 6944A Multiprogrammers may be operated from one HP 98633A Multiprogrammer interface.

### System Performance Specifications

Note: Specified times are for the HP 9826 and HP 9836 configurations. Actual times for the HP 9816 may be slightly slower.

Mainframe Interface	HP 6942A	HP 6944A
CAT Programming Package	HP 98624A	HP 98633A
	HP 14750A	HP 14751A
Single Data Point Input	1.9 ms	1.5 ms
Single Data Point Output	2.1 ms	1.4 ms
Scaling to User Units	add 0.35 ms	add 0.35 ms
Interrupt Response Time	13.7 ms	13.7 ms
Maximum Block Transfer Input	12,500	180,000*
Maximum Block Transfer Output	18,000	30,000
*HP 98620A DMA controller required.		

### Product Selection Guides

To order the HP 6942S or HP 6944S, it is recommended that the appropriate technical data sheet be used in conjunction with the Multiprogrammer Series II I/O card technical data sheet.

Title	Data Sheet Number
HP 6942S Computer Aided Test System	5952-4092
HP 6944S HP Series 200 Multiprogrammer System	5952-4110
Multiprogrammer Series II I/O Cards	5952-4090

### Ordering Information

HP 14750A Computer Aided Test Programming Package

Opt 630 3 1/2" Flexible Discs

Opt 655 5 1/4" Flexible Discs for 9826/9836

Opt 910 Extra Set of Documentation

HP 14750R Right to Reproduce HP 14750A CAT

Programming Package (Interface and Documentation provided)

HP 14751A Computer Aided Test Programming Package

Opt 630 3 1/2" Flexible Discs

Opt 655 5 1/4" Flexible Discs for 9826/9836

Opt 910 Extra Set of Documentation

HP 14751R Right to Reproduce HP 14751A CAT

Programming Package (Documentation provided)

# DATA ACQUISITION, CONTROL & TEST

## Multiprogrammer: Versatile Building Block Approach to Systems

Model 6940B

199



- Front panel control
- GPIO or HP-IB
- Data transfer rate 20,000 readings/second

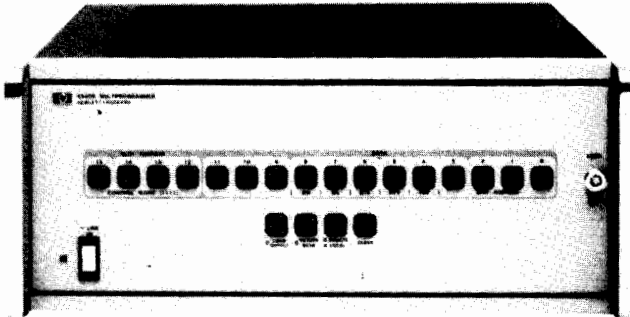

HP 6940B

### Description

The HP 6940B Multiprogrammer is a low-cost, medium-speed data acquisition and control system designed to be used with controllers or computers via the GP-IB, a 16-bit parallel interface bus. The HP 6940B is supported by a full complement of I/O cards. These I/O cards provide a broad range of instrumentation functions for acquisition, stimulus, measurement and control.

The HP 6940B is programmed by a set of word formats and octal coding. There are three word formats: a control word that selects the operating mode, a data word used to select and control output cards, and an address word to select and control an input card.

The HP 6940B may also be used as an HP-IB product. This requires an HP 59500A Multiprogrammer Interface Kit. This kit provides conversion of the HP-IB format to 16-bit parallel format.

### Features

A full-feature, front-panel switch register permits manual programming of all Multiprogrammer output, input and control functions. Fault isolation or manual system checkout of the computer, multiprogrammer or external devices is accomplished from the front panel.

Another feature of the HP 6940B is isolation of analog cards. Isolation from system ground is provided on analog cards. The HP 6940B has four isolated bias power supplies available to independently power the output circuitry of up to four groups of cards.

The HP 6940B Multiprogrammer has the capability of growing to meet the user's needs. Up to 15 HP 6941B extenders can be added to the system, allowing up to 240 I/O slots to be programmed from a single computer interface. The HP 6941B Multiprogrammer Extender has a blank front panel and all interfacing is provided in the HP 6940B Multiprogrammer.

### Specifications

**Plug-in I/O card position:** Maximum of 15 plug-in input or output cards per mainframe.

**Computer Interface:** Can be interfaced using the GP-IO, which requires an I/O slot of the computer and a GP-IO interface card. An HP 59500A Multiprogrammer Interface Kit is required for use on the HP-IB.

**Extender Units:** Up to 15 HP 6941B extenders can be chained together to create 240 programmable I/O slots. Extenders may be separated from one another by up to 30 metres.

**Data transfer rate:** 20,000 readings/second using the GP-IO interface.

**Cooling:** Natural convection

**Operating temperature range:** 0 to +55 degrees Celsius.

**Power:** 100/120/220/240 Vac (selectable), +5%, -10%, 48 to 440 Hz, 230 watts.

**Dimensions:** 172.2 mm high x 425.4 mm wide x 539.8 mm deep (6.78 in high x 16.75 in wide x 21.25 in deep).

**Weight (without I/O cards):** 15.9 kg (35.0 lb) net, 19.5 kg (43.0 lb) shipping.

- Temperature measurement capability
- Multiprogrammer Series I I/O cards

### Ordering Information

#### Step 1 - Select controller

Controller	ROM HP P/N	Description
HP-85B		HP-IB: Option 085 GP-IO: Option 185
HP-86B	00087-15003*	HP-IB: Option 085 GP-IO: Option 185
HP-87XM	00087-15003*	HP-IB: Option 085 GP-IO: Option 185
HP 9826A	N/A	BASIC: Option 026 HPL: Option 126
HP 9836A	N/A	Option 036
HP 1000	N/A	Option 010

\*Requires HP 8936A ROM drawer.

#### Step 2 - Select interface

Interface	GP-IO	HP-IB
HP-85B	HP 6940B Opt 185	HP 59500A and HP-85B Opt 007
HP-86B*	HP 6940B Opt 185	HP 59500A
HP-87XM*	HP 6940B Opt 185	HP 59500A
HP 9826A	HP 98622A Opt 003	HP 59500A, includes 2-metre HP-IB cable
HP 9836A	HP 98622A Opt 003	HP 59500A
HP 1000A	HP 14550B	HP 59500A and HP 59310B

\*When ordering an HP-86B or HP-87XM and using HP-IB interface, an HP-IB cable must be ordered.

#### Step 3 - Determine I/O card set

Select I/O functions from Series I I/O cards (See page 200).

#### Step 4 - Select number of mainframes

HP 6940B - holds up to 15 I/O cards plus one

HP 69351C voltage regulator card.

**Option 10:** HP-1000

**Option 85:** HP-85B HP-IB

**Option 185:** HP-85B GP-IO

**Option 026:** HP 9826A BASIC

**Option 126:** HP 9826A HPL

**Option 036:** HP 9836A BASIC

**Option 136:** HP 9836A HPL

**Option 908:** Rack Mount Hardware for HP 6941B Extender, additional 15 I/O slots

**Option 908:** Rack Mounting Hardware HP 14541A Extender Cable; one for each HP 6941B

#### Step 5 - Determine accessories

HP 59500A Multiprogrammer Interface; required for each HP 6940B on the HP-IB

### Accessories

HP 14540A Main Input Cable Assembly, 3.6 m (12 ft)

HP 14541A Chaining Cable, HP 6940B to HP 6941B

HP 14550B Multiprogrammer Interface Kit for the HP 1000

HP 14551A Service Kit for the HP 6940B

HP 14555A Connector Kit for Series I Multiprogrammer I/O cards

HP 14556A Software Library for the HP 9826A

HP 14557A Power Supply Interconnect Cable for the HP 69520A Programming Card

HP 14558A Termination Panel; with 40 dual-screw terminals

HP 14560A Cable Assembly for Series I I/O cards; 15 conductors

HP 14561A Cable Assembly for Series I I/O cards; 30 conductors

HP 14562A Cable Assembly for Series I analog I/O cards; two shielded conductors





# DATA ACQUISITION, CONTROL & TEST

## Multiprogrammer: Series I/O Cards for HP 6940B and 6941B

### Power Supply Programming

#### HP 69500A-69513A Resistance

##### Programming Cards

HP 69500A is supplied without resistors. The HP 69501A-69506A are single output, 12-bit resolution cards designed to program a single HP power supply equipped with Option 040. The HP 69510A-69513A are dual-output cards with six-bit resolution designed to program the current output of HP power supplies equipped with Option 040.

Provides full system control of HP 6023A, 6024A and HP 6011A, 6012A autoranging power supplies. Requires HP 14557A interconnect cable.

### Temperature Measurement

#### HP 69423A Low Level A/D and Scanner Card

Six channels of thermocouples or other low-level dc sources in the range of  $\pm 20$  mV can be measured with resolution of  $5 \mu\text{V}$ . A seventh channel is used to read the temperature of the isothermal input terminal block. An HP 69351C Voltage Regulator Card is required to provide the regulated isolated bias voltage to the HP 69423A. One HP 69351C will support up to four analog input cards.

### Analog Input

#### HP 69336B High Speed Scanner Card

This card features a FET multiplexer with 16 single-ended voltage input channels that can be scanned at 20,000 channels/second. Input voltage range is  $\pm 10.24$  volts with 100 V isolation from data common. Several cards can be cascaded to provide up to 224 channels.

#### HP 69422A High Speed A/D Card

The High Speed A/D Card measures bipolar dc voltages in one of four ranges,  $\pm 100$  mV,  $\pm 1$  V,  $\pm 10$  V, and  $\pm 100$  V. The three lower ranges are switch selectable. The  $\pm 100$  V input range is connected to an on-board divide-by-ten attenuator. Data conversion rate is 33,000 readings/second.

### Analog Output

#### HP 69321B D/A Voltage Converter Card

This model provides a high-speed (33 kHz), bipolar output voltage ( $\pm 10.24$  volts at 5 mA) that is the analog of the digital input data. Dual-rank storage, a feature that allows all D/A cards in a system to change their outputs simultaneously, is provided on the HP 69321B.

#### HP 69322A Quad D/A Voltage Converter Card

This D/A card provides four individually programmable, bipolar output voltages ( $-10.24$  V to  $+10.22$  V at 5 mA, 16 kHz maximum) that are the analog of the digital data input. Two of the 12 data-bits address the DACs, and the remaining ten data-bits provide the digital input data.

#### HP 69370A D/A Current Converter Card

This model provides a high-speed (33 kHz), constant-current output (0 to 20.475 mA at up to 10.5 V) that is the analog of the digital data input. Dual-rank storage, a feature that allows all D/A models in the system to change their outputs simultaneously, is provided on the HP 69370A.

#### HP 69351C Voltage Regulator Card

The Voltage Regulator Card provides four regulated, isolated bias supplies for the analog models and is inserted into the voltage regulator slot of the HP 6940B and HP 6941B. The HP 69351C is required for proper operation of the analog input and output models. It will support up to four of these models.

### Digital Input

#### HP 69430A Isolated Digital Input Card

This card employs photoisolators to provide up to 100 V RMS isolation between the 12 data lines and chassis ground. The model is designed to monitor only circuits that are active. This model may be ordered with any of three different logic options. One of these options must be specified when ordering this model:

- Option 069:** negative-true TTL logic levels
- Option 073:** positive-true TTL logic levels
- Option 088:** positive-true Hi level =  $\pm 12$  to 25 V.

#### HP 69431A Digital Input Card

The Digital Input Card provides 12 data lines that can be used to monitor contact closure or logic levels referenced to ac earth ground. Gate/flag circuitry provides the HP 69431A with the interface to the computer interrupt system. An option must be specified when ordering this model.

- Option 069:** negative-true TTL logic levels
- Option 073:** positive-true TTL logic levels
- Option 070:** positive-true Hi level = 6 to 14 volts

### Digital Output

#### HP 69331B Digital Output Card

This model is a general-purpose, 12-bit card with power-on preset, system enable/disable, and gate/flag capabilities. The output lines are jumper selectable for TTL or  $+12$  volt logic levels. The HP 69331B digital output is shipped with TTL logic level configuration.

#### HP 69332A Open Collector Output Card

This card is similar to the HP 69331B except it can switch up to 30 volts dc and currents up to 40 mA. The HP 69332A open collector output card is designed to drive lamps and relay coils utilizing an external dc power source. The outputs of the HP 69332A may be random at power-on.

#### HP 69433A Relay Output with Readback Card

The relay card provides 12 independent SPST, mercury-wetted, normally-open contact pairs. The HP 69433A also allows the computer to examine the status of the relay coil drive circuits, before and after the contacts are changed. No external handshaking is available with this product.

### Functional

#### HP 69335A Stepping Motor Control Card

This model can be programmed to generate from 0 to 2047 square-wave pulses at either of two output terminals. The user may also configure the card to generate 0 to 4095 square-wave pulses. An 11-bit binary data word specifies the total steps and Bit-12 specifies direction of rotation.

#### HP 69435A Pulse Counter Card

This card will count pulses, up or down, with a maximum square-wave input frequency of 200 kHz. Carry and borrow pulses are generated so that the HP 69435A may be cascaded for greater counting capabilities.

#### HP 69602A Timer/Pacer Card

The Timer/Pacer Card provides a full programmable, crystal-controlled time base that can be used to pace Multiprogrammer I/O operations or generate accurate one-shot pulses. The HP 69602A coupled with the HP 69435A can satisfy requirement for frequency measurement (maximum of 200 kHz). Time interval measurement (10  $\mu\text{s}$  to 34 minutes) and time of day (2.8 minutes to 1084 years).

### Interrupt

#### HP 69434A Event Sense Card

The Event Sense Card monitors up to 12 external contact closures and interrupts the computer when one or more contacts change state with respect to the 12 reference bits stored on the card. Jumpers allow for reconfiguration to provide four logical arguments: equal to, not equal to, greater than, or less than.

#### HP 69436A Process Interrupt Card

This card provides an interrupt to the computer when any one or more of the 12 data lines being monitored change state. The HP 69436A has TTL and open collector compatible edge detectors and can detect any logic transition lasting 100 nanoseconds or longer.

### Breadboard

#### HP 69280A Breadboard Card

The Breadboard Card provides a generalized grid pattern for mounting custom circuitry. The HP 69280A plugs into the HP 6940B and HP 6941B, allowing access to the data lines and power supply lines of the Multiprogrammer backplanes.

#### HP 69380A Breadboard Output Card

This breadboard card is similar to the HP 69280A and has output storage buffer circuits that allow the Multiprogrammer backplane output data to drive external or custom circuits. A large portion of the printed circuit board has a plated grid and general-purpose circuit pattern.

#### HP 69480A Breadboard Input Card

The Breadboard Input Card is identical to the HP 69380A, except the on-board logic is the input buffer gates for driving the Multiprogrammer backplane.



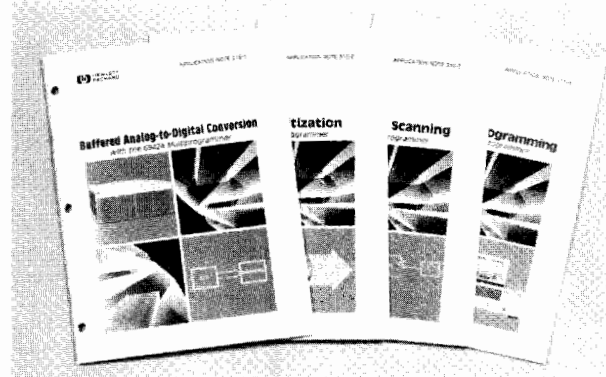
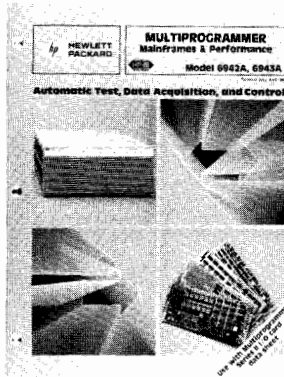
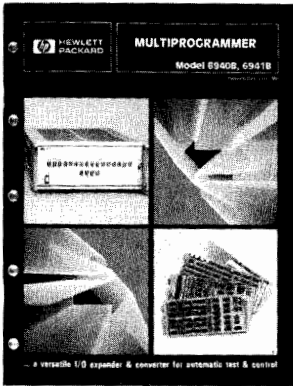

### Technical Data

In addition to a broad range of products for integration of data acquisition, control and test systems, Hewlett-Packard provides a selection of technical literature as further support of the Multiprogrammer products. These technical brochures provide detailed operating specifications of the Multiprogrammer product family and are extremely helpful in configuring the best Multiprogrammer package for your application. Other literature available are Product Notes describing a specific product application and Application Notes.

This technical literature will provide information to help you choose the right Multiprogrammer products for your application. The Product Notes augment the Operating and Service Manuals and provide additional information on product configurations and actual applications. The Application Notes are more specific "how to" information aimed at a specific application and product configuration.

This technical literature is provided at no charge upon request. Ask your local Hewlett-Packard field engineer, or use the card at the rear of this catalog.

Publication Title	Publication Number
Multiprogrammer Model 6940B, 6941B	5952-4077
Multiprogrammer Mainframes & Performance Models 6942A, 6943A	5952-4089
Multiprogrammer Series II I/O Cards Models 69700A-69793A	5952-4090
Measurement & Analysis System Model 6901S	5952-4093
Computer Aided Test System Models 6942S, 147501A	5952-4092
HP Series 200 Multiprogrammer System Models 6944S, 6944A, 14751A	5952-4110 5952-4110

### Product Notes

A series of product notes is available for the Multiprogrammers. The first two, 6940B-1 and 6940B-2, are product oriented, and describe how to use particular Multiprogrammer cards. The others are product "Application Stories" which describe how Multiprogrammer customers have implemented specific applications.

#### 6940B-1 Scanning with the 6940B Multiprogrammer

Describes use of the HP 69336B FET scanning card for high-speed data acquisition.

#### 6940B-2 Power Supply Control

Describes use of the HP 69520A power supply programming card to control HP autoranging power supplies.

#### 6940B-3 Subassembly Testing

Details Ford Motor Company's use of a building block approach to increase the flexibility of Ford's systems testing while reducing cost and design times.

#### 6940B-4 Automating Manual Equipment

Describes the implementation of the HP 6940B in a radiation monitoring system.

#### 6940B-5 Basic Research

Describes the interfacing of an HP 6940B and HP 9845A to a scanning electron beam microscope.

#### 6940B-6 Product Evaluation

Describes the use by BF Goodrich of the HP 6940B to test the true effectiveness of tires for the different ice, snow, soil and load conditions.

#### 6942A-1 Production Line Testing

Describes Solitron Devices Inc. use of the HP 6942A for hybrid device testing.

#### 6942A-2 Heavy Industry

Describes Northwest Culvert Company's use of the HP 6942A to control metal pipe production and improve process control.

#### 6942A-3 Instrument Control

Describes the use of an HP 6942A to control RF test equipment in an automatic modem test system.

#### 6942A-4 Research and Development

Describes the use of an HP 6942A as control and data acquisition system for a heavy oil pump development test rig.

#### 6942A-5 Materials Evaluation

Describes the use of an HP 6942A to automate the measurement of fluid viscosities.

#### 14750A-1 Burn-In

Describes the use of an HP 14570A AC power controller in testing for equipment reliability with AC power cycling.

### Application Notes

A new series of application notes introduces a beginner to computer aided test, and makes it easier for any user to implement the most common HP 6942A Multiprogrammer configurations. Each of the notes contains a comprehensive study of an application, and includes theory, wiring information, and software listings for the basic functions. Information on advanced techniques is also provided. Although the programming information is oriented toward the HP 9826A and HP 9836A computers, the concepts are discussed in a general way that allows application to other computers. Copies of these application notes are available through your local HP sales office.

#### AN316-0 Introduction to Computer Aided Test

This introductory note is designed to take a computer aided test novice through the steps of evaluating, planning, and implementing a sample computer aided test system.

#### AN316-1 Buffered Analog-to-Digital Conversion

A buffered A/D allows the HP 6942A to acquire data rapidly, and store it without computer intervention. Additional buffered A/D's can be used to make measurements simultaneously from many channels. This note describes how to configure the HP 69751A A/D converter and the HP 69790B memory card with the HP 14728A cable for this application.

#### AN316-2 Waveform Digitization

The HP 6942A can also function as a logic analyzer for analog signals. It can store a pre-determined block of voltage readings occurring before, during or after an external event. This capability makes the HP 6942A useful for digitizing transients, and recording events with long propagation delays.

#### AN316-3 High-Speed FET Scanning

High speed data acquisition from many channels is easily accomplished with the Multiprogrammer scanner system consisting of an HP 69750A or HP 69755A scanner cards. This note covers sequential and random access scanning methods.

#### AN316-4 Power Supply Programming

Full system control of a power supply, including output voltage and current readback, is possible with a single Multiprogrammer card. The HP 69709A power supply control card is designed for control of HP 6023, HP 6024A, HP 6011, and HP 6012A power supplies equipped with Option 002.



# DATA ACQUISITION, CONTROL & TEST

## Multiprogrammer Accessories and Training

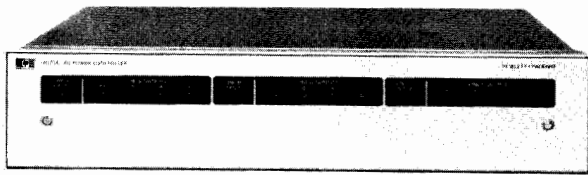

### HP 14570A AC Power Controller

The HP 14570A is a high-reliability and low-EMI alternative to relays or conventional solid-state switches for controlling AC power. Up to 12 AC loads can be switched under computer control. Both 115 and 230 Vac loads of up to six amps can be controlled from a single unit. Primary uses include switching AC power to instruments, power supplies, motors, and devices under test. It is also useful for burn-in, power cycling, and process control applications.

#### Feature Summary

- 12 AC power switches
- Switches up to 6 amps rms
- Low-noise
- Handles inductive loads
- True zero-crossing switching
- Short-circuit protection
- 115 and 230 volt AC outputs
- Rated for 2 million operations
- Quick-disconnect AC plugs
- Designed to meet UL, IEC & CSA
- 6940B, 6942A or TTL Control
- AC line filtering

#### Specifications

**Line voltage:** 115 or 230 Vac, +15%, -22%

**Line frequency:** 47 to 63 Hz

**Isolation voltage:** 1500 Vac rms

**Maximum current (rms):** up to 6 Amps per switch (at any lagging power factor\*), with each group of four switches limited to 15 Amps.

\* Loads with a leading power factor, such as power-factor correction capacitors, should not be switched with the HP 14570A.

**Maximum current (peak):** 100 Amps per switch for less than 1 ms (non-repetitive). 20 Amps per switch continuously, subject to rms limitations.

**Minimum load current:** 20mA

**Off-state leakage:** 2 mA through the external load

**Maximum switching rate:** 0.5 Hz

**Turn-On delay:** 6 to 30 ms. Turns on at zero voltage.

**Turn-Off delay:** 14 to 34 ms. Turns off at zero current.

**Input characteristics:** 1 k $\Omega$  pull-up resistors to +5 V

Logic-High Level (Off) = 3.5 to 5.25 V

Logic-Low Level (On) = -0.5 to 1.50 V

**Required drive:** negative-true, open collector; 5 mA maximum current sink at logic-low level

**Dimensions:** 80 mm x 425 mm x 425 mm (3 1/2" x 16 3/4" x 16 3/4")

**Weight:** 9.5 kg (21 lbs)

#### HP 14570A Options

**040:** HP 69331B card & cable for use with HP 6940B

**042:** HP 69731B card & cable for use with HP 6942A

**050:** Unterminated cable for use with other sources

**HP 14570A AC Power Controller**

#### Training

**HP 50004A:** HP 6942A Multiprogrammer User's Course

#### Description

This three-day introduction to the Multiprogrammer teaches a person how to use the HP 6942A to make measurements and perform stimulus/response or control for automation applications. An overview of the HP-85 Personal Computer is followed by lectures, discussions, and lab exercises which provide experience in programming the HP 6942A in the BASIC language. Experience is gained in using the memory card, real time clock, and data formatting/conversion capabilities of the Multiprogrammer.

At least one-third of the class time is devoted to hands-on lab exercises using the HP-85 controller. You will write practice programs which are readily adaptable to other HP-IB\* controllers and using the information gained, you will improve your Multiprogrammer application skills.

The HP 50004A HP 6942A Multiprogrammer User's Course is offered at HP training centers around the world. Please contact your local HP Sales Office for dates, locations, and enrollment information. Lodging and meals are the responsibility of the student.

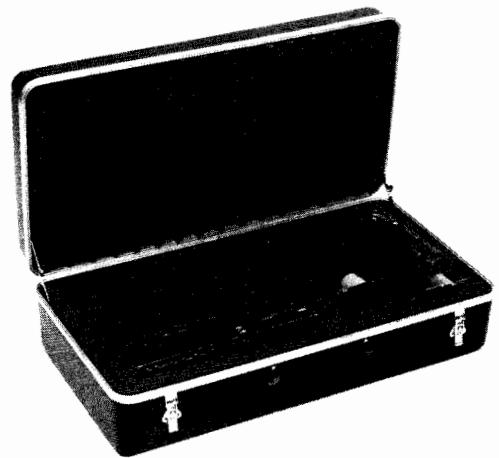

### HP 6944A, HP 6942A, and HP 6940B Service Kits

The **HP 14711D Field Service Kit** is a service aid for the HP 6944A Series 200 Multiprogrammer. It provides customers with the parts needed to minimize down time.

The Model 14711D contains pre-tested HP 6944A mainframe printed circuit assemblies in a lightweight case. A two meter transmission cable is included along with space for small parts and software discs.

Defective boards, which are replaced by boards from the HP 14711D, can be sent to the local HP Service Center for repair.

The **HP 14711A Field Service Kit** is a service aid for the HP 6942A Multiprogrammer. It provides board exchange capability for users with a need for the shortest possible downtime.

The 14711A case contains seven pretested mainframe PC assemblies which can replace defective PC assemblies in the HP 6942A. Twelve additional slots can be filled by the user with spare I/O cards.

Troubleshooting information needed to isolate a malfunctioning mainframe PC assembly can be found in the *HP 6942A Installation and Assembly Level Service Manual* (HP P/N 06942-90006). Interpretation of errors reported by defective I/O cards can be found in Appendix B of the *HP 6942A User's Guide*.

Defective boards, which are replaced by boards from the 14711A, can be sent to the local HP Service Center for repair.

The **HP 14551A Multiprogrammer Service Kit** for the Hewlett-Packard Model 6940A/B Multiprogrammer subsystems is designed to be used with an HP computer in the HP 1000 series, a HP 9825A desktop computer, or by the HP 6940B operating alone in the LOCAL mode.

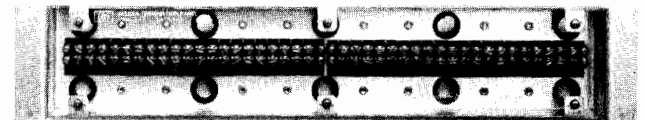

### HP 14558A Termination Panel

The HP 14558A Termination Panel is an accessory for Multiprogrammer systems to facilitate field wiring to the I/O cards. The HP 14558A allows the user to bring the edge connections of the Multiprogrammer I/O cards out to a screw-terminal barrier strip. The field wiring may be brought to this rack-mounted barrier strip to complete the connection. This is an alternative to soldering the field wiring directly to the card edge connectors which are supplied with the I/O cards.

#### Specifications

**Terminals:** Two 20-position barrier blocks provide a total of 40 pairs of #6 screw terminals at 0.38-inch (9.5 mm) center-to-center spacing. Terminals accept #6 crimped terminations up to 0.31 inches (7.9 mm) wide and are equipped with rising surface clamp screws that also accept unterminated wire up to #14 AWG.

**Current Rating:** 20A

**Voltage Rating:** 250 volts dc or ac

**Net Weight:** 0.8 kg (2 lbs)

**Dimensions:** 88 mm high x 482.6 mm wide x 36.6 mm deep (3.47 in high x 19.00 in wide x 1.44 in deep)

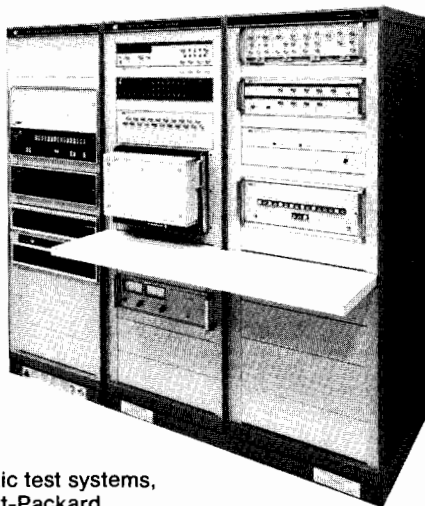

Customized automatic test systems,  
integrated by Hewlett-Packard

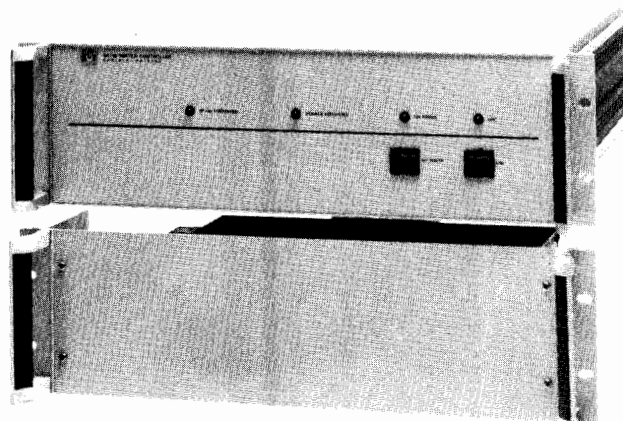

HP 9411B Switch Controller



#### Switches for Automatic Test

HP-IB switch products used in HP automatic test systems are available individually for HP 1000 system users who manufacture their systems in-house or those who have complex switching requirements in their HP 1000-based automated test systems. These switches provide a commercially-available solution for connecting the system to the unit-under-test (UUT). Three types of switching units are available, all controlled by a single HP 9411B Switch Controller that provides micro-processor control of multiple switch mainframes.

#### ATS/1000 Integration Services

Previously, when building an automatic test system, users had only two choices: purchase an already-assembled "turn-key" system or purchase computers and instruments separately and assemble them on their own. As a result of our experience with more than 1000 HP automatic test system installations worldwide, HP offers two categories of system-building assistance, called ATS/1000 Integration Services.

An automatic test system can be purchased at various levels of completion, depending on how much assistance the user desires. At the lowest level, called Racking and Cabling Service, HP consolidates the equipment, designs cabinet layout and power distribution, then installs the equipment in cabinets. The user assumes responsibility for software configuration and testing.

With the highest level of service, Configuration/System Test, the user receives a fully-integrated, fully-installed system, ready for developing application programs. HP consolidates the equipment, installs it in cabinets, configures the operating software, and checks out the system on-site.

Integration service prices vary, depending on the complexity and size of the system. A typical system that contains \$100,000 of instrumentation typically requires \$30,000 to \$40,000 of integration services to be fully configured and tested.

#### Ordering Information

HP 93283A ATS Racking and Cabling Service

HP 93284A ATS Configuration/System Test Service

- **HP 9411B Switch Controller**  
The HP 9411B is for use on HP 1000 Computer Systems and is controlled via the HP-IB. It provides control logic and relay power for the switch mainframes. It performs comprehensive self-test and fault isolation of all signal relays in the HP 9412A and 9414A switch cards.
- **HP 9412A Modular Switch**  
Provides high-density, multi-function switching of signals up to 10 MHz. A built-in 1768-pin (34 x 52) matrix interface panel improves signal performance and eliminates "spider web" cabling. The HP 9412A accommodates five types of switch cards in any combination up to a total of 25 cards.
- **HP 9413A VHF Switch**  
Provides modular, flexible high-frequency switching of pulse and video signals up to 500 MHz. The HP 9413A accommodates up to 12 coaxial switch modules.
- **HP 9414A Matrix Switch**  
Provides maximum flexibility for switching signals up to 10 MHz. Designed for high-density, high-performance switching, the HP 9414A allows any UUT pin to be switched to any instrument in the system. The 16-input matrix can be configured in 30-pin increments (UUT pins) up to 120 pins. A distribution bus allows several instruments to share four of the 16 matrix inputs, thus minimizing switching requirements.

## General Information



C, R, L, D, Q,  $\theta$  and ICs

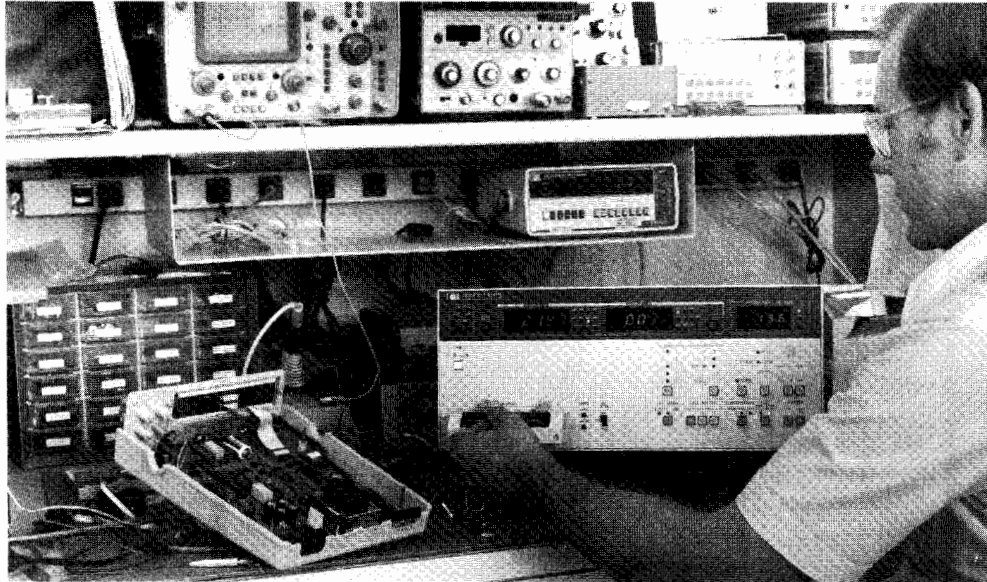

Instrument	Frequency				Q or 1/D		C in farads, L in henries or R in ohms**						Basic Accuracy			Page		
	1 DC Hz	1 kHz	1 MHz	1 GHz	10 <sup>0</sup>	10 <sup>1</sup>	10 <sup>-15</sup>	10 <sup>-12</sup>	10 <sup>-9</sup>	10 <sup>-6</sup>	10 <sup>-3</sup>	10 <sup>0</sup>	10 <sup>3</sup>	0.1%	1%		10%	
Multi-frequency LCR Meter HP 4274A		•	•							C			R					206
Multi-frequency LCR Meter HP 4275A		•	•							C			R					206
LCZ Meter HP 4276A		•	•							C		L	Z					210
LCZ Meter HP 4277A		•	•							C		L	Z					210
RF Impedance Analyzer HP 4191A					10 <sup>-3</sup>					C		L	R, Z					214
LF Impedance Analyzer HP 4192A		•	•							C		L	Z, R					216
Vector IZI Meter HP 4193A			•										Z					218
Digital LCR Meter HP 4261A		•	•							C		L	R					220
Digital LCR Meter HP 4262A		•	•							C			R					220
1 MHz C Meter/C-V Plotter HP 4280A			•							C								222
Q Meter HP 4342A										C		L						224
Milliohm Meter HP 4328A													R					225
High Resistance Meter HP 4329A*										10 <sup>6</sup>			R					225
pA Meter/DC Voltage Source HP 4140B*		•								C		I						226
Semiconductor Parameter Analyzer HP 4145A*		•										I						228
Semiconductor/Component Test System HP 4061A		•	•							C		I						230
Semiconductor Parametric Test System HP 4062A		•	•							C		I						232
Semiconductor Parameter Analysis System HP 4063A		•	•							C		I						234
Digital IC Tester HP 5045A/5046A	Functional and dc parameter measurements on TTL, CMOS, ECL, HTL, and DTL logic families.																236	

\*I in amperes, V in volts; (V is test voltage).

\*\*Maximum resolution to full scale

## Impedance |Z|, $\theta$ , C, R, L, D & Q

Hewlett Packard's family of component measurement instruments covers the impedance range from less than one milliohm to greater than  $10^{16}$  ohms. Instruments range from the traditional manual null measurement technique to the completely automatic, microprocessor-controlled, systems-oriented type.

The basic characteristics of each instrument are summarized in the selection guide on the preceding page.

## Impedance Considerations

Impedance measuring instruments can be categorized, according to the technique used, into the bridge, voltage/current and Q methods. In the bridge technique, circuit conditioning required to achieve a balance or null condition is detected and processed to indicate the measured value. The voltage/current method essentially uses Ohm's Law, in that, a constant voltage or current is applied to the unknown and the converse current or voltage is indicative of the unknown value. The Q method utilizes unique characteristics of the series resonant circuit to determine Q, and indirectly L, C and R.

## New Generation Component Measurements

Many of these measurements have been not practical, very difficult, or very costly to make with earlier instruments that were designed to make measurements only under relatively limited test conditions. However, Hewlett-Packard now offers a new generation of instruments to change the measuring concept of evaluating electronic components, devices and circuits—that is, "testing and evaluating under actual working conditions."

The addition of the HP 4274A and HP 4275A will allow the user to test components under actual operating conditions. Both instruments feature variable test signal levels, ten spot frequencies, self test capability, digital offset to compensate for test leads and fixtures, and vector/phase angle measurements.

The HP 4276A and HP 4277A LCZ Meters are recent additions to HP's line-up of component measuring instruments. Both instruments are capable of high speed LCZ measurements under real-world frequency conditions and both have an optional comparator for fully automatic bin sorting. These features, along with  $4\frac{1}{2}$  digit resolution and a basic measurement accuracy of 0.1%, make the HP 4276A and HP 4277A ideal for either production line or R & D applications.

Impedance analysis and network analysis can be performed accurately and efficiently using the HP 4191A RF Impedance Analyzer and the HP 4192A LF Impedance Analyzer.

In the frequency range of 1 MHz to 1000 MHz, the HP 4191A measures 14 parameters including |Z|, |Y|,  $\theta$ , R, X, G, B, L, C, D and Q, reflection coefficient | $\Gamma$ |, | $\Gamma_x$ | and | $\Gamma_y$ |, plus deviation  $\Delta$  and  $\Delta\%$  for all parameters. The HP 4192A measures the same parameters as the HP 4191A - except | $\Gamma$ |, | $\Gamma_x$ |, and | $\Gamma_y$ |—plus Gain, Phase and Group Delay in the frequency range of 5 Hz to 13 MHz.

Both HP 4191A and HP 4192A have built-in frequency synthesizers and dc bias sources, including internal sweep of both frequency and bias voltage. Basic measuring accuracy for the HP 4191A (1 MHz to 1000

MHz) is 1%. Basic accuracy for the HP 4192A (5 Hz to 13 MHz) is 0.3%.

HP's 4193A enables in-circuit measurements of impedance magnitude and phase. The HP 4193A features a built-in, 4-digit synthesizer, sweepable from 400 kHz to 110 MHz. HP 4193A also offers in-circuit and component impedance evaluation at actual operating frequencies.

## Semiconductor Measurements

HP's 4280A 1 MHz C Meter/C-V Plotter is a convenient and economical instrument for C-V (Capacitance vs. Voltage)/C-t (Capacitance vs. Time) characteristics evaluation of semiconductor devices. The HP 4280A combines the capabilities of a capacitance/conductance meter with a pulse generator, dc voltage staircase generator and computer. It performs very reliable semiconductor capacitance and conductance measurements by applying internal error compensation which compensates for residual impedances in the test set-up.

Very high speed C-t measurements are featured in the HP 4280A. Resolution up to 10 milliseconds can be achieved without external equipment. Resolution up to 10 microseconds can be achieved when the HP 4280A controls an external pulse generator like the HP 8112A. Such high speed testing helps analyze semiconductor imperfections over a wide range of trap levels. This makes the HP 4280A a valuable tool in semiconductor process evaluation and for new semiconductor device development and process control.

The HP 4140B pA Meter/dc Voltage Source is a highly accurate test instrument designed for basic dc characteristics measurements such as leakage current, current-voltage characteristics, quasi-static C-V measurements and other measurements especially required by the semiconductor industry for new device development and for improvement of production yields.

The HP 4140B makes measurements on electric components and equipment and is ideal for measuring leakage current or insulation resistance in order to improve product reliability.

The HP 4140B consists of a very stable picoampere meter with a synchronized, dual programmable dc voltage supply— $V_A$  and  $V_B$  ( $V_A$  includes staircase capability and ramp voltage generation).

HP's 4145A Semiconductor Parameter Analyzer provides complete dc characterization of semiconductor devices and materials. It is a fully automatic, high performance, programmable test instrument designed to measure, analyze, and graphically display a wide range of semiconductor dc characteristics, such as  $h_{FE}$ ,  $g_m$ , and  $V_{th}$ .

Device stimulus and parameter measurements are performed by four programmable stimulus/measurement units (SMU), providing automatic, high speed measurements and eliminating instability resulting from connection changes at the DUT. The HP 4145A also has two voltage sources and two voltage monitors for measurement applications which require more than the four SMUs.

Measurement results are displayed on a built-in, 6-inch CRT and can be dumped directly on to an external digital printer/plotter. A built-in flexible disc drive allows storage of measurement set-ups and measurement results.

## Integration into HP-IB System

Adding the HP-IB option to a component measuring instrument enables the instrument to be incorporated into an HP-IB system. This permits high speed measurement of many components along with arithmetic processing of measurement data and greatly increases the efficiency of production line testing of discrete components, of quality assurance tests, or of laboratory evaluations.

HP 4061A Semiconductor/Component Test System is a dedicated HP-IB system that performs efficient, automatic evaluation of the fundamental characteristics of semiconductor and electronic components. The HP 4061A is useful for new component/material development, quality control, and in the early stages of semiconductor manufacture, for monitoring and controlling the wafer process.

HP's 4062A is a parametric test system for semiconductor wafer processing. It provides a wide range of parametric measurements on the basic elements of any LSI circuit including resistors, capacitors, diodes, transistors and FETs. Automatic measurement of simple parameters, such as current, voltage and capacitance is performed at wafer level through 48-channel Switching Matrix in order to characterize the wafer and monitor the wafer process. Utilizing a specialized desktop computer and data reduction technique, the HP 4062A can determine process deficiencies, enhance throughput and improve yield.

Intended for semiconductor R and D applications, the new HP 4063A Semiconductor Parameter Analysis System measures and analyzes the dc and capacitance characteristics of semiconductor devices and materials through a six-channel switching matrix. Main applications are new materials and device development, and process development for new devices.

Picoampere-range measurements with 1fA resolution, low voltage measurements down to  $10\mu V$ , C-V/C-t measurements, and temperature measurements are standard capabilities of the HP 4063A.

Powerful yet friendly system control software is furnished with the HP 4063A to ensure easy programming—from device measurement to analysis of measurement results.

## Summary

To assist in the selection of an impedance meter suitable for your needs, the following guidelines may be used:

- (1) Choose an instrument capable of measuring your device under frequency, signal level, and dc bias conditions identical to those of the intended application.
- (2) Consider the environmental parameters (lead resistance and inductance, stray capacitance, temperature variations, ...) that will affect your measurement and choose a measurement technique that will tend to counteract them.
- (3) Then select the instrument with the broadest measurement capability within accuracy and cost constraints.

Hewlett-Packard's impedance measuring instruments have been used in numerous diverse applications. If you have an unusual application or need assistance, contact your nearest Hewlett-Packard sales office for information.





## Multi-Frequency LCR Meters

Models 4274A & 4275A

- Test frequencies – 100 Hz to 100 kHz
- Test signal level – 1 mV to 5 Vrms
- High resolution – 5½ digit: D=0.00001
- Measure L/C – D/Q/ESR/G;  $|Z| - \theta$ , R-X/B/L/C;  $\Delta$ LCRZ,  $\Delta\%$
- 0.1% basic accuracy

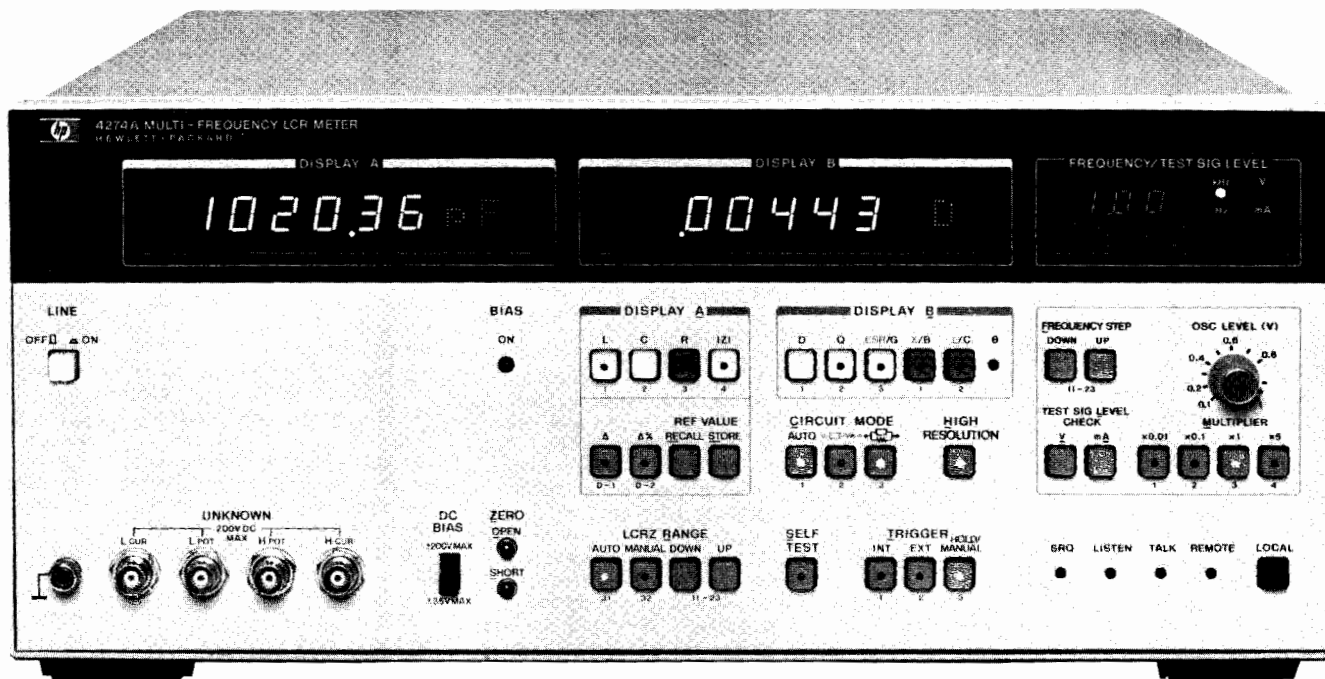

HP 4274A



### Description

The HP 4274A and HP 4275A Multi-frequency LCR Meters are recent additions to Hewlett-Packard's new generation of microprocessor-based impedance measuring instrumentation. Both instruments offer a new measuring concept for the evaluation of LCR components, complex components, electronic circuits "tested under actual working conditions", and semiconductor materials. A measurement under conditions similar to the intended use contributes to the improvements in quality and reliability of electronic components, devices and circuits.

### Multi-Frequency Capability

To insure the high reliability in circuits and devices, it is most important that they be tested and evaluated at test signals similar to those of actual operating conditions.

The HP 4274A covers the wide frequency range of 100 Hz to 100 kHz in 11 spot frequencies and the HP 4275A has 10 spot frequencies from 10 kHz to 10 MHz, in 1-2-4 step sequence with 1-3-5 as an option. This feature produces the frequency characteristics of components or devices. In addition, two optional special frequencies (for example, 455 kHz and 10.7 MHz) are available within the frequency range of each instrument. This wide frequency range selection offers evaluation of circuit design with a continuously variable test signal over the range of 1 mV to 5 Vrms (to 1 Vrms for the HP 4275A), and with internal dc bias optionally available with 1 mV maximum resolution. The test voltage or current values can be monitored on the 3-digit display for accurately setting the actual conditions under which the device-under-test will operate.

### Multi-Parameter Measurements

The HP 4274A and HP 4275A measure equivalent series resistance (ESR), impedance ( $|Z|$ ), phase angle ( $\theta$ ), reactance (X), susceptance (B), and conductance (G), in addition to the conventional L,C,R,D and Q parameters in certain combinations with a dual 5½ digit display, and an HP-IB standard for systems integration.

This wide selection of 11 parameters provides for more accurate evaluation of electronic materials or components with high measurement speed for most needed combined parameters; for example, the C-G measurement of semiconductors, an R-X measurement in circuit design, or the C-ESR or  $|Z| - \theta$  measurement of tantalum capacitors.

In addition, a deviation measurement capability ( $\Delta, \Delta\%$ ) for the L,C,R, and  $|Z|$  functions displays the difference between the actual value and a stored reference, either as a difference value or in percent. Deviation applications include, for example, a temperature dependence measurement of devices in environmental tests.

### Reliable Measurements with 5½ Digit Resolution

The HP 4274A and HP 4275A measure only the value of the component and/or device under test, with 5½ resolution and 0.1% basic accuracy by reducing the possibility of errors due to self or mutual inductance, stray capacitance and/or residual inductance in the test leads or test fixture used. This measurement is obtained by a state-of-the-art four terminal pair configuration and a built-in automatic ZERO-offset capability to compensate for these errors.



- Test frequencies – 10 kHz to 10 MHz
- Test signal level – 1 mV to 1 Vrms
- 0.1% basic accuracy
- High resolution – 5½ digit; D=0.00001
- Measure L/C – D/Q/ESR/G;  $|Z| - \theta$ , R-X/B/L/C;  $\Delta$ LCRZ,  $\Delta\%$

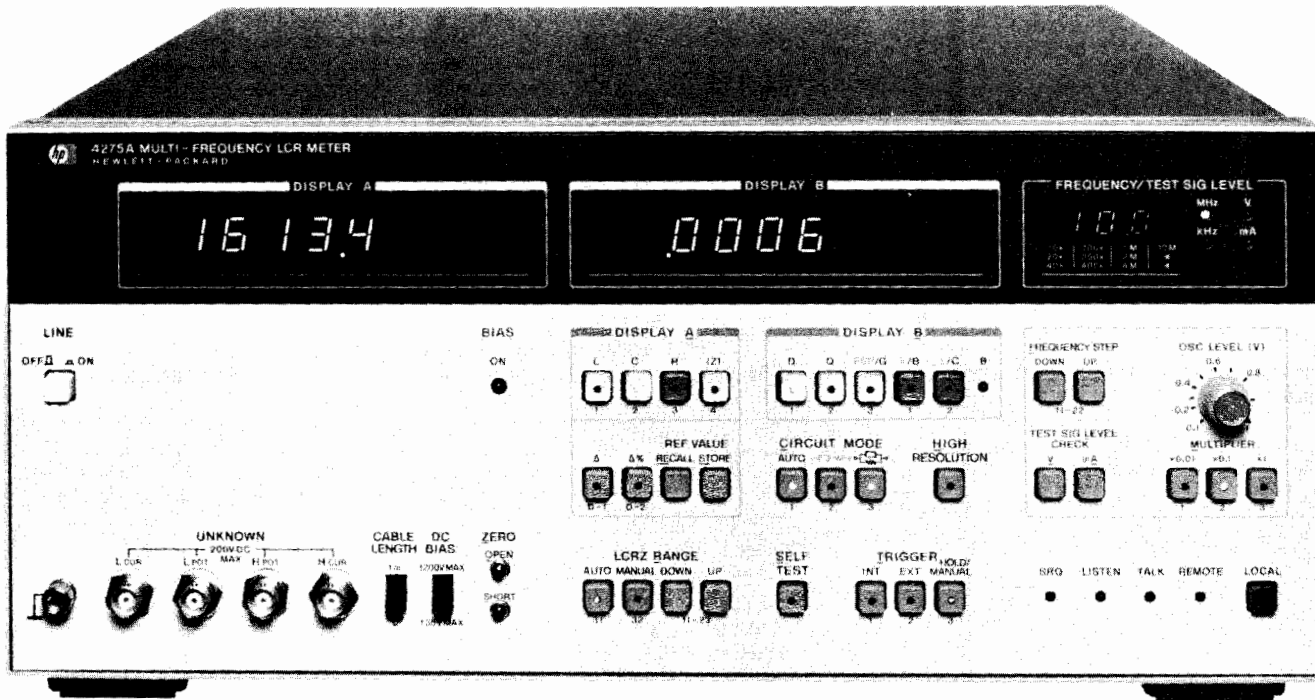

HP 4275A



The fast measurement speed, high resolution, and high accuracy can make major contributions for the component manufacturer and user who is concerned about reducing his costs, improving quality, and throughput efficiency. In these areas, the HP 4274A and the HP 4275A are ideal for D-measurements of film capacitors or insulation material (with the high resolution of 0.00001), the C-G measurements of semiconductors (with maximum resolutions of 0.01 fF, 0.01 nS, respectively), and for the low impedance measurement of aluminum electrolytic capacitors (with a maximum resolution of 0.001 m $\Omega$ ).

#### Automatic Semiconductor and Component Measurements with HP-IB

Integrating the HP 4274A and the HP 4275A into an HP-IB controlled system is an excellent method for improving efficiency and cost savings both in the laboratory and on the production line. These automatic measurement systems are assembled by connecting the HP-IB cables between the instruments to be utilized for a specific task.

A system built around the HP 4274A and/or HP 4275A allows the user to obtain useful data for many diverse applications. For example, the evaluation of semiconductors based on the frequency dependence of its C-V characteristics that requires a wide range and fast measurement speeds is easily accomplished with these instruments. The four-terminal pair input configuration and the automatic zero offset capability insures that the measured data is accurate, even in a systems environment.

#### Sample Applications

##### Semiconductor Measurements

The evaluation of a semiconductor can be done with a C-V or G-V measurement with the multi-spot frequencies featured in the HP

4274A and HP 4275A, (with C resolution of 0.01 fF and G resolution of 0.01 nS), their two programmable bias sources (maximum resolution 1 mV) and their continuously variable test signal levels (from 1 mVrms).

Of significant use is the evaluation of the doping process and the measurement of the characteristics of MOS or bipolar semiconductor materials which employ a C or G measurement with varying dc bias voltage.

A sample plot of a semiconductor measurement is shown in the figure below. Such measurements at high speed can offer high reliability and high throughput efficiency in the semiconductor manufacturing processes.

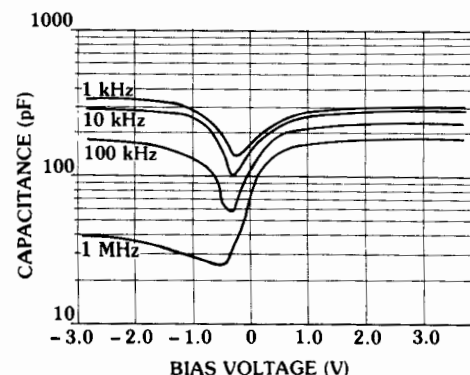

# COMPONENT & SEMICONDUCTOR MEASUREMENT

## Multi-Frequency LCR Meters

Models 4274A & 4275A (cont.)

### Common Specifications (HP 4274A & HP 4275A)

#### Parameters Measured

L: inductance C: capacitance	Q: =1/D ESR: equivalent series resistance	θ: phase angle Δ: deviation for L, C, R, Z, Δ%: % of deviation Test frequency Test signal level (voltage or current)
R: resistance Z: impedance D: dissipation factor	G: conductance X: reactance B: susceptance	

#### Parameter Combinations

Display A	Display B	
L	D / Q / ESR	D / Q / G
C		
R	X / L	B / C
Z	θ	

#### Measurement Frequencies, Test Signal Levels, and Full Scale Range

MODEL	HP 4274A	HP 4275A
Measurement frequencies	100 Hz-100 kHz, 11 spots (100 Hz, 120 Hz, 200 Hz, 400 Hz, 1 kHz, 2 kHz, 4 kHz, 10 kHz, 20 kHz, 40 kHz, 100 kHz; ±0.01%)	10 kHz-10 MHz, 10 spots (10 kHz, 20 kHz, 40 kHz, 100 kHz, 200 kHz, 400 kHz, 1 MHz, 2 MHz, 4 MHz, 10 MHz; ±0.01%)
Test signal levels	4-ranges (1 mVrms-5 Vrms) continuously variable	3-ranges (1 mVrms-1 Vrms) continuously variable
Full scale range	L: 100.00 nH - 1000.0 H C: 1.0000 pF - 1.00 F R,  Z , ESR, & X: 100.00 mΩ - 10.000 MΩ D: 0.00001 - 9.9999 Q (1/D): 0.01 - 9900 G & B: 1.0000 μS - 100.00 S θ: 0 - ±180°	L: 100.00 nH - 10.00 H C: 1.0000 pF - 100.00 μF R,  Z , ESR, & X: 1.0000 Ω - 10.000 MΩ D: 0.00001 - 9.9999 Q: 0.01 - 9900 G & B: 1.0000 μS - 10.00 S θ: 0 - ±180°

**Accuracy (HP 4274A only):** typical C-D, L-D, R-X and |Z|-θ measurement accuracy values are given below.

**Displays:** dual 5½-digit and single 3-digit; maximum display 199999 (full scale and overrange in high resolution mode), and 4½-digit; maximum display 19999 in normal mode. (Number of digits depends on measurement frequency, test level, and range).

**Circuit modes:** series equivalent circuit and parallel equivalent circuit. Automatic selection available in AUTO mode.

**Deviation measurement:** difference between recallable stored reference and displayed is deviation value (count or percent).

Display range: -199999 to +199999 counts in AUTO range. -199999 to +199999 counts in MANUAL range (the sample should be measurable at the selected range).

Percent display range: -199.99% to +199.99%

**Ranging:** AUTO or MANUAL (UP/DOWN).

**Trigger:** internal, external or manual.

**Measurement terminals:** four-terminal pair with guard.

**Auto zero adjustment:** automatic normalization of the readout offset due to residuals of the test fixture by pushbutton operation.

**Normalization range:** C < 20 pF, L < 2000 nH, R < 0.5 Ω, G < 5 μS.

**Self test:** automatic operational verification check indicates pass or fail condition.

**HP-IB data output and remote control:** standard.

**Memory back-up for storing measurement conditions:** standard.

**Range:** full scale range, accuracy: % of reading + counts (D: accuracy: % of reading + absolute D value + count).

FREQUENCY RANGE	C-D/Q	L-D/Q	R-X	Z -θ
		D-range: 0.00001-9.9999 Q-range: 0.01-9900 (=1/D) (C & D accuracies apply only when C: full scale and D: ≤ 0.1)	D-range: 0.00001-9.9999 Q-range: 0.01-9900 (=1/D) (L & D accuracies apply only when L: full scale and D: ≤ 0.1)	(R accuracies apply only when R: full scale) (X accuracies apply only when R: 1/10 of full scale and X: full scale)
100 Hz 120 Hz	C: 1000 pF-1000 mF, 0.1% + 3 D: 0.33% + 0.0008 + 1	L: 100 μH-10 kH, 0.1% + 3 D: 0.33% + 0.0013 + 1	R: 100 mΩ-10 MΩ, 0.1% + 3 X: 100 mΩ-10 MΩ, 0.1% + 13	Z : 100 mΩ-10 MΩ, 0.1% + 3 θ: ±0.1°
200 Hz	C: 1000 pF-1000 mF, 0.1% + 2 D: 0.32% + 0.0007 + 1	L: 100 μH-10 kH, 0.1% + 3 D: 0.32% + 0.0012 + 1	R: 100 mΩ-10 MΩ, 0.1% + 3 X: 100 mΩ-10 MΩ, 0.1% + 13	Z : 100 mΩ-10 MΩ, 0.1% + 3 θ: ±0.1°
400 Hz	C: 100 pF-100 mF, 0.14% + 1 D: 0.34% + 0.0013 + 1	L: 100 μH-10 kH, 0.1% + 3 D: 0.31% + 0.0011 + 1	R: 100 mΩ-10 MΩ, 0.1% + 3 X: 100 mΩ-10 MΩ, 0.1% + 13	Z : 100 mΩ-10 MΩ, 0.1% + 3 θ: ±0.1°
1 kHz	C: 100 pF-100 mF, 0.1% + 3 D: 0.33% + 0.0008 + 1	L: 10 μH-1000 H, 0.1% + 3 D: 0.33% + 0.0013 + 1	R: 100 mΩ-10 MΩ, 0.1% + 3 X: 100 mΩ-10 MΩ, 0.1% + 13	Z : 100 mΩ-10 MΩ, 0.1% + 3 θ: ±0.1°
2 kHz	C: 100 pF-100 mF, 0.1% + 2 D: 0.32% + 0.0007 + 1	L: 10 μH-1000 H, 0.1% + 3 D: 0.32% + 0.0012 + 1	R: 100 mΩ-10 MΩ, 0.1% + 3 X: 100 mΩ-10 MΩ, 0.1% + 13	Z : 100 mΩ-10 MΩ, 0.1% + 3 θ: ±0.1°
4 kHz	C: 10 pF-10 mF, 0.14% + 1 D: 0.34% + 0.0013 + 1	L: 10 μH-1000 H, 0.1% + 3 D: 0.31% + 0.0011 + 1	R: 100 mΩ-10 MΩ, 0.1% + 3 X: 100 mΩ-10 MΩ, 0.1% + 13	Z : 100 mΩ-10 MΩ, 0.1% + 3 θ: ±0.1°
10 kHz	C: 10 pF-10 mF, 0.1% + 3 D: 0.33% + 0.0008 + 1	L: 1 μH-100 H, 0.1% + 3 D: 0.33% + 0.0013 + 1	R: 100 mΩ-10 MΩ, 0.1% + 3 X: 100 mΩ-10 MΩ, 0.1% + 13	Z : 100 mΩ-10 MΩ, 0.1% + 3 θ: ±0.1°
20 kHz	C: 10 pF-10 mF, 0.1% + 2 D: 0.32% + 0.0007 + 1	L: 1 μH-100 H, 0.1% + 3 D: 0.32% + 0.0012 + 1	R: 100 mΩ-10 MΩ, 0.1% + 3 X: 100 mΩ-10 MΩ, 0.1% + 13	Z : 100 mΩ-10 MΩ, 0.1% + 3 θ: ±0.1°
40 kHz	C: 1 pF-1000 μF, 0.14% + 1 D: 0.34% + 0.0013 + 1	L: 1 μH-100 H, 0.1% + 3 D: 0.31% + 0.0011 + 1	R: 100 mΩ-10 MΩ, 0.1% + 3 X: 100 mΩ-10 MΩ, 0.1% + 13	Z : 100 mΩ-10 MΩ, 0.1% + 3 θ: ±0.1°
100 kHz	C: 1 pF-1000 μF, 0.1% + 3 D: 0.33% + 0.0008 + 1	L: 100 nH-10 H, 0.1% + 3 D: 0.33% + 0.0013 + 1	R: 100 mΩ-10 MΩ, 0.1% + 3 X: 100 mΩ-10 MΩ, 0.1% + 13	Z : 100 mΩ-10 MΩ, 0.1% + 3 θ: ±0.1°

(Conditions: Warm-up time ≥ 30 minutes, environment temperature: 23°C ± 5°C). Refer to technical data sheet for accuracy details.



**Accuracy (HP 4725A only):** typical C-D, L-D, R-X and  $|Z|-\theta$  measurement accuracy values are given below.

**Range:** full scale range, accuracy: % of reading + counts (D accuracy: % of reading + absolute D value + count).

Frequency Range	C - D/Q	L - D/Q	R - X	$ Z  - \theta$
	D-range: 0.00001 - 9.9999 Q-range: 0.01-9900 (= 1/D) (C & D accuracies apply only when C: full scale and D: $<0.1$ )	D-range: 0.00001 - 9.9999 Q-range: 0.01 = 9900 (= 1/D) (L & D accuracies apply only when L: full scale and D: $<0.1$ )	(R accuracies apply only when R: full scale) (X accuracies apply only when R: 1/10 of full scale and X: full scale)	$\theta$ -range: $-180.00^\circ - +180.00^\circ$ (Z & $\theta$ accuracies apply only when Z: full scale)
10 kHz	C: 10 pF - 100 $\mu$ F, 0.1% + 3 D: 0.33% + 0.008 + 1	L: 10 $\mu$ H - 100H, 0.1% + 3 D: 0.33% + 0.0013 + 1	R: 1000 m $\Omega$ - 10 M $\Omega$ , 0.1% + 3 X: 1000 m $\Omega$ - 10 M $\Omega$ , 0.1% + 13	$ Z $ : 1000 M $\Omega$ - 10 m $\Omega$ , 0.1% + 3 $\theta$ : $\pm 0.1^\circ$
20 kHz	C: 10 pF - 100 $\mu$ F, 0.1% + 2 D: 0.32% + 0.0007 + 1	L: 10 $\mu$ H - 100 H, 0.1% + 3 D: 0.32% + 0.0012 + 1	R: 1000 m $\Omega$ - 10 M $\Omega$ , 0.1% + 3 X: 1000 m $\Omega$ - 10 M $\Omega$ , 0.1% + 13	$ Z $ : 1000 M $\Omega$ - 10 m $\Omega$ , 0.1% + 3 $\theta$ : $\pm 0.1^\circ$
40 kHz	C: 1 pF - 10 $\mu$ F, 0.14% + 1 D: 0.34% + 0.0009 + 1	L: 10 $\mu$ H - 100 H, 0.1% + 3 D: 0.31% + 0.0011 + 1	R: 1000 m $\Omega$ - 10 M $\Omega$ , 0.1% + 3 X: 1000 m $\Omega$ - 10 M $\Omega$ , 0.1% + 13	$ Z $ : 1000 M $\Omega$ - 10 m $\Omega$ , 0.1% + 3 $\theta$ : $\pm 0.1^\circ$
100 kHz	C: 1 pF - 10 $\mu$ F, 0.1% + 3 D: 0.33% + 0.0008 + 1	L: 1 $\mu$ H - 10 H, 0.1% + 3 D: 0.33% + 0.0013 + 1	R: 1000 m $\Omega$ - 10 M $\Omega$ , 0.1% + 3 X: 1000 m $\Omega$ - 10 M $\Omega$ , 0.1% + 13	$ Z $ : 1000 M $\Omega$ - 10 m $\Omega$ , 0.1% + 3 $\theta$ : $\pm 0.1^\circ$
200 kHz	C: 10 pF - 10 $\mu$ F, 0.14% + 2 D: 0.32% + 0.0007 + 1	L: 1 $\mu$ H - 1000 mH, 0.2% + 3 D: 0.53% + 0.0023 + 1	R: 1000 m $\Omega$ - 1 M $\Omega$ , 0.2% + 3 X: 1000 m $\Omega$ - 1 M $\Omega$ , 0.2% + 13	$ Z $ : 1000 M $\Omega$ - 1 m $\Omega$ , 0.2% + 3 $\theta$ : $\pm 0.1^\circ$
400 kHz	C: 1 pF - 1000 nF, 0.14% + 1 D: 0.34% + 0.0009 + 1	L: 1 $\mu$ H - 1000 mH, 0.2% + 3 D: 0.51% + 0.0021 + 1	R: 1000 m $\Omega$ - 1 M $\Omega$ , 0.2% + 3 X: 1000 m $\Omega$ - 1 M $\Omega$ , 0.2% + 13	$ Z $ : 1000 M $\Omega$ - 1 m $\Omega$ , 0.2% + 3 $\theta$ : $\pm 0.1^\circ$
1 MHz	C: 1 pF - 1000 nF, 0.1% + 3 D: 0.33% + 0.0008 + 1	L: 100 nH - 100 mH, 0.2% + 3 D: 0.55% + 0.0025 + 1	R: 1000 m $\Omega$ - 1 M $\Omega$ , 0.2% + 3 X: 1000 m $\Omega$ - 1 M $\Omega$ , 0.2% + 13	$ Z $ : 1000 M $\Omega$ - 1 m $\Omega$ , 0.2% + 3 $\theta$ : $\pm 0.1^\circ$
2 MHz	C: 10 pF - 100 nF, 0.3% + 3 D: 0.55% + 0.0025 + 1	L: 1 $\mu$ H - 10 mH, 0.5% + 5 D: 1.0% + 0.0033 + 1	R: 10 $\Omega$ - 100 k $\Omega$ , 0.5% + 5 X: 10 $\Omega$ - 100 k $\Omega$ , 0.5% + 15	$ Z $ : 10 $\Omega$ - 100 k $\Omega$ , 0.5% + 5 $\theta$ : $\pm 0.2^\circ$
4 MHz	C: 1 pF - 10 nF, 1% + 20 + 0.002 pF D: 3.3% + 0.01 + 1	L: 1 $\mu$ H - 10 mH, 1% + 5 D: 2.0% + 0.0063 + 1	R: 10 $\Omega$ - 100 k $\Omega$ , 2% + 7 X: 10 $\Omega$ - 100 k $\Omega$ , 2% + 105	$ Z $ : 10 $\Omega$ - 100 k $\Omega$ , 2% + 7 $\theta$ : $\pm 0.8^\circ$
10 MHz	C: 1 pF - 10 nF, 2% + 20 + 0.002 pF D: 4% + 0.011 + 1	L: 100 nH - 1 mH, 2% + 7 D: 3.1% + 0.002 + 1	R: 10 $\Omega$ - 100 k $\Omega$ , 2% + 7 X: 10 $\Omega$ - 100 k $\Omega$ , 2% + 105	$ Z $ : 10 $\Omega$ - 100 k $\Omega$ , 2% + 7 $\theta$ : $\pm 0.8^\circ$

(Conditions: Warm-up time  $\geq$  30 minutes, environment temperature:  $23^\circ\text{C} \pm 5^\circ\text{C}$ ). Refer to technical data sheet for accuracy details.

## General Information

### Test Signal Level Monitor

Model	Range		Accuracy
	Voltage	Current	
HP 4274A	0.001 V - 5.00 Vrms	0.001 mA - 100 mArms	$\pm$ (3% of reading + 1 count)
HP 4275A	0.001 V - 1.00 Vrms	0.001 mA - 10.0 mArms	$\pm$ (3% of reading + 1 count) at $< 1$ MHz  $\pm$ (10% of reading + 2 counts) at $\geq 1$ MHz

**Measurement time:** (typical) 140-180 ms ( $> 1$  kHz); 140-210 ms  $\leq 1$  kHz (measurement time depends on range, sample value and off-set adjustment value).

**Z -  $\theta$  measurement time:** 170-210 ms  $> 1$  kHz; 170-240 ms  $\leq 1$  kHz.

**High resolution mode:** approximately 8 times the normal measurement time.

**Auto ranging time:** 100 ms - 300 ms per range change.

## Options

**Opt 001:** 0 to  $\pm 35$  internal dc bias

Range	Steps	Accuracy
$\pm$ (.000 - .999) V	1 mV	$\pm$ (0.5% of reading + 2 mV)
$\pm$ (1.00 - 9.99)	10 mV	$\pm$ (0.5% of reading + 4 mV)
$\pm$ (10.0 - 35.0)	0.1 V	$\pm$ (0.5% of reading + 20 mV)

**Control:** HP 16023B dc Bias Controller or remote control with HP-IB

**Opt 002:** 0 -  $\pm 99.9$  V internal dc bias (for C  $\leq 0.1$   $\mu$ F)

**Range:**  $\pm$  (00.0 - 99.9) V, 0.1 V steps

**Accuracy:**  $\pm$  (2% of reading + 40 mV)

**Control:** same as Opt 001

**External dc bias:**  $\pm 200$  V maximum.

**Bias monitor:** rear panel BNC connector monitors internal or external input bias.

**Opt 004:** frequency steps in 1-3-5 sequence.

## Special Options

One or two arbitrary test frequencies for each instrument are available.

### Selectable Frequency Range

**HP 4274A:** 100 Hz to 100 kHz to  $\pm 0.1\%$ . If two frequencies are added, at least one frequency must satisfy the following equation:  $f = 1200/N$  kHz where N is an integer from 12 to 12000.

**HP 4275A:** 10 kHz to 10.7 MHz  $\pm 0.1\%$ .

The following special test frequencies are among those which are available:

Option number	Frequency	Option number	Frequency
F01	15.7 kHz	F14	25.2 kHz
F02	32.8 kHz	F15	79.6 kHz
F03	455 kHz	F16	252 kHz
F04	3.58 MHz	F17	796 kHz
F05	4.19 MHz	F18	2.52 MHz
F06	10.7 MHz	F19	7.96 MHz
F11	15.75 KHz	F21	15.625 kHz
F13	62.5 kHz	F25	63.16 kHz

## Accessories

**HP 16047A:** Direct coupled test fixture. Furnished accessory with the HP 4274A and HP 4275A.

**HP 16023B:** dc Bias Controller, for control of dc bias Opt 001 or 002 Internal Bias Supply. Control range 0 to  $\pm 99.9$  V by setting thumbwheel switch.

**HP 16034B:** Test Fixture for chip components

**HP 16047B:** Test Fixture with safety cover

**HP 16047C:** Test Fixture for high frequencies

**HP 16048A:** Test leads, BNC

**HP 16048B:** Test leads, RF miniature

**HP 16048C:** Test leads with alligator clips

## Options

**Opt 001:** 0 to  $\pm 35$  internal dc bias, max resolution; 1 mV steps

**Opt 002:** 0 to  $\pm 99.9$  V internal dc bias, resolution: 100 mV steps.

**Opt 004:** Frequency steps in 1-3-5 sequence

**Opt F01-F25:** Special test frequencies (each)

## Ordering Information

**HP 4274A** 100 Hz - 100 kHz Multi-Frequency LCR Meter

**HP 4275A** 10 kHz - 10 MHz Multi-Frequency LCR Meter



## Model 4276A

- 3-digit frequency setting: 100 Hz to 20 kHz (801 spots)
- High speed measurements (1 kHz): 95 ms/meas (4-digit display resolution); 60 ms/meas (3-digit display resolution)
- Measure L/C-D/Q/ESR/G,  $|Z| - \theta$ , high speed L/C
- 10-bin component sorting-comparator
- 0.1% basic accuracy over impedance range of 100 m $\Omega$  to 10 M $\Omega$

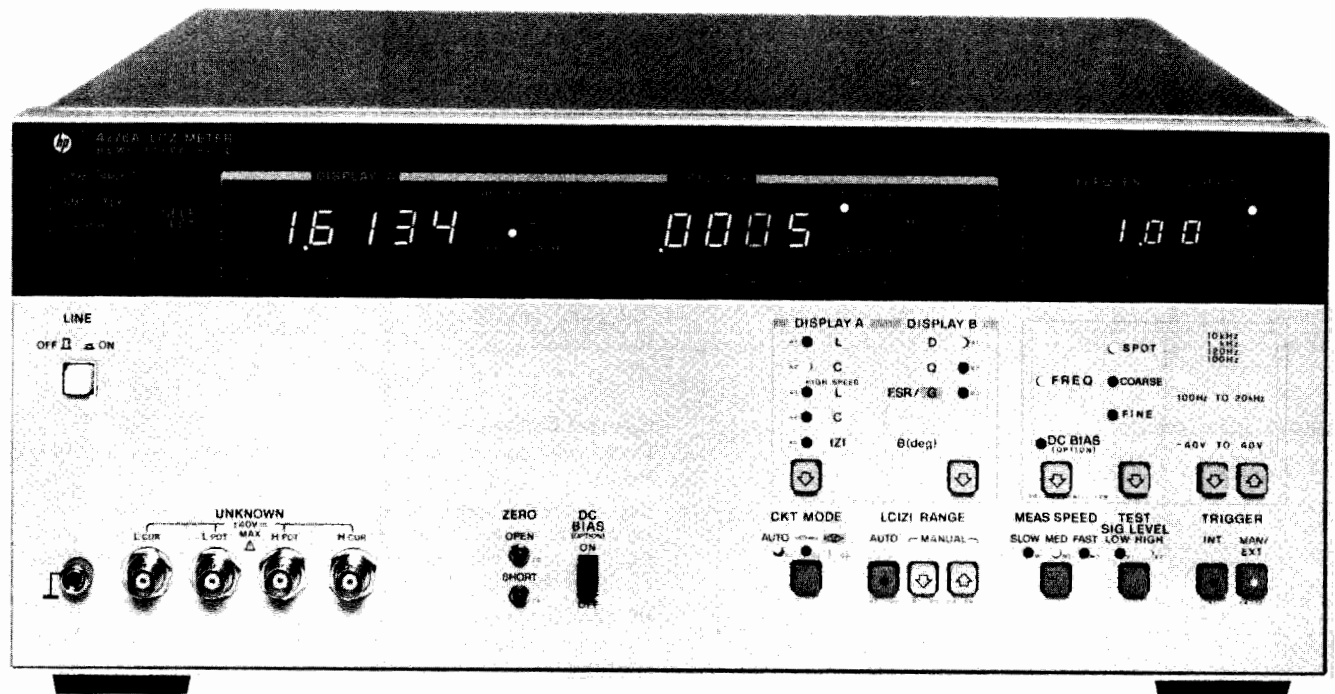

HP 4276A



## Description

HP's 4276A and 4277A LCZ Meters are general purpose impedance measuring instruments designed to measure circuit components such as capacitors and inductors using frequency and dc bias conditions identical to those of the intended application. Both HP 4276A and HP 4277A feature variable test frequency (100 Hz – 20 kHz and 10 kHz – 1 MHz respectively), optional dc bias variable from 0 to  $\pm 40$  V, multiple parameters (L • C • |Z| • D • Q • ESR • G •  $\theta$ ) with fully automatic high speed measurements, and 4½ digit resolution. The HP 4276A has an impedance range of 100 m $\Omega$  to 10 M $\Omega$  and the HP 4277A 10  $\Omega$  to 1 M $\Omega$ .

Both instruments are ideal for production line, quality control, and circuit design applications, and are versatile enough for stand-alone use or systems use under HP-IB control (standard). An optional comparator for 10-bin sorting with measurement time of less than 100 ms make the HP 4276A/4277A a good choice for production line testing of discrete components.

## Variable Test Parameters: Frequency, Bias, Signal Level

HP's 4276A and 4277A offer variable test frequency, optional internal dc bias, and selectable test signal level (HIGH and LOW). This makes it possible to measure components under conditions almost identical to those of the intended circuit.

The HP 4276A (100 Hz to 20 kHz) and the HP 4277A (10 kHz to

1 MHz) provide 801 and 701 test frequencies, respectively. Test frequencies of both instruments are linearly spaced along a logarithmic scale. The most commonly used test frequencies for production line measurements—100 Hz, 120 Hz, 1 kHz and 1 MHz, all of which are specified in MIL/IEC standards are included. Frequency setting resolution is 3 digits.

Both instruments feature selectable test signal levels—1 V/50 mV (Cp) (HP 4276A) and 1 V/20 mV (Cp) (HP 4277A)—and both can be equipped with an optional internal dc bias source that is variable from 0 to  $\pm 40$  V in 10 mV (0 to 10 V) or 100 mV (10 to 40 V) steps. Thus, bias conditions that suit the measurement and the DUT can be selected, an important consideration for semiconductor C/V measurements.

The features described above satisfy most impedance measurement requirements for component development and circuit design. HP-IB enhances these features.

## High Speed Measurements

The HP 4276A and HP 4277A provide high speed measurements with 3½ to 4½ digits resolution. The time required for a C-D measurement, for example, is 95 ms (4-digit) or 60 ms (3-digit) at 1 kHz, and 70 ms (4-digit) or 60 ms (3-digit) at 1 MHz. Even at 120 Hz, a measurement time of 170 ms (4-digit) or 150 ms (3-digit) is possible. Also, when the instrument is set to high speed L or high speed C measurement mode, measurement time is 45 ms (4-digit) or 35 ms (3-digit) at 1 kHz (if D is less than 0.002), and 40 ms (4-digit) or 30 ms (3-digit) at 1 MHz (if D is less than 0.01).

**Model 4277A**

- 3-digit frequency setting: 10 kHz to 1 MHz (701 spots)
- High speed measurements (1 MHz): 70 ms/meas (4-digit display resolution); 60 ms/meas (3-digit display resolution)

- Measures L/C-D/Q/ESR/G,  $|Z| - \theta$ , high speed L/C
- 10-bin component sorting-comparator (optional)
- 0.1% basic accuracy over impedance range of 10  $\Omega$  to 1 M $\Omega$

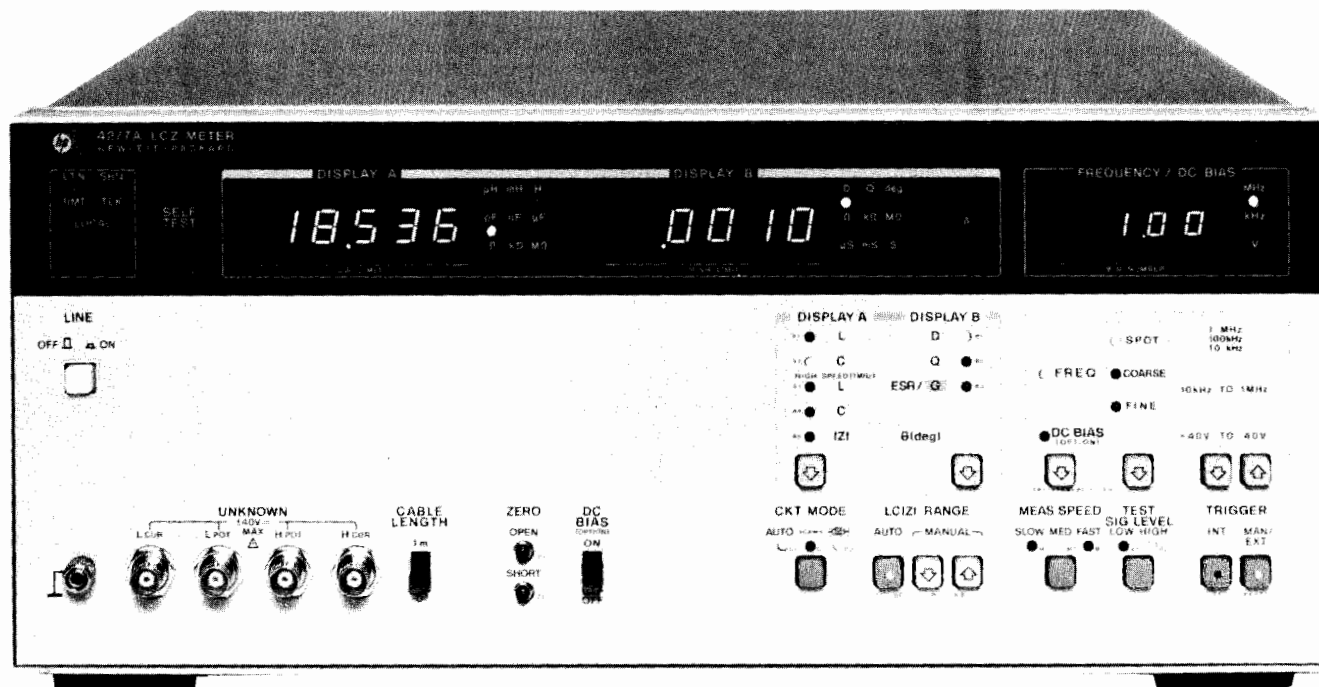

HP 4277A



Such high speeds considerably improve the efficiency and increase the throughput of high volume measurements such as outgoing inspection on the production line and incoming inspection by component end users. If an HP-IB system is configured, measurement efficiency is further improved because HP-IB is capable of packed binary data output format, which can be processed much faster than the usual ASCII format. Even when the HP-IB capability is not used, the HP 4276A/4277A can increase production line throughput if the optional comparator is used.

**Optional Ten-Bin Component Sorting**

A 10-bin comparator (option 002) is available. Nine sets of bin limits (high and low) can be input for L, C or  $|Z|$ . Also, high and low limits for D, Q, ESR, or G can be set to provide go/no-go testing.

Multiple bin sorting is especially beneficial on the production line and in incoming inspection. Test costs can be significantly reduced using the HP 4276A/4277A's high speed measuring capability. When the optional handler interface is used for automatic component sorting, measurement efficiency is better than that when using HP-IB. This is because time for data handshake is not needed.

Output data from the handler interface is at TTL or open collector level, which improves system noise immunity. Particularly,

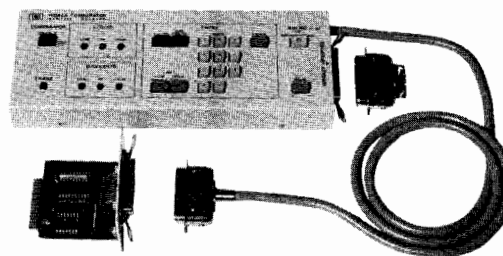

Option 002 Comparator

three lines—external trigger and measurement complete signals—are photo-isolated, so a reliable sorting system free from noise can be constructed.

Measurement reliability is improved by other comparator features such as front panel lock-out and auto zeroing of fixture residuals.

Plus, all comparator functions can be HP-IB controlled. So a fully automatic component sorting system can be constructed for use in outgoing/incoming inspection.

**Specifications** (Refer to data sheet for complete specifications) (Common to HP 4276A and HP 4277A)

**Parameters measured:** C-D•Q•ESR•G  
L-D•Q•ESR•G  
high speed L, high speed C  
 $|z| - \theta$  and  $\Delta$ (deviation for any parameter)

**Display:** 4½ digits (max), maximum display 19999

# COMPONENT & SEMICONDUCTOR MEASUREMENT

## LCZ Meters



### Models 4276A & 4277A (cont.)

**Measurement circuit modes:** Auto, Parallel, and Series  
**Frequency control modes:** SPOT (100 Hz, 120 Hz, 1 kHz, 10 kHz, 100 kHz, 1 MHz), COARSE (10 freq./decade), and FINE (max. freq. resolution).

**Test Signal Level** (unknown terminal open)

	HIGH	LOW
HP 4276A	1 Vrms ± 10%*	50 mV ± 20%*(Cp only)
HP 4277A	1 Vrms ± 10%	20 mV ± 15%

\*at 1 kHz only

**Output impedance:** 100 Ω

**Ranging modes:** Auto and Manual (up-down)

**Trigger:** Internal, External or Manual

**Measurement terminals:** 5-terminal (HP 4276A)  
 4-terminal pair (HP 4277A)

**Measurement speed modes:** FAST, MED, and SLOW

**Offset adjustments:** front panel OPEN and SHORT adjustments to compensate for residual impedance and stray admittance of the test fixture.

**Test frequencies:** HP 4276A - 100 Hz to 20 kHz ± 0.01% (801 points)

HP 4277A - 10 kHz to 1 MHz ± 0.01% (701 points)

### Step Frequency

Test Frequency	Step Frequency
100 Hz-200 Hz	1 Hz
202 Hz-500 Hz	2 Hz
505 Hz-1 kHz	5 Hz
1.01 kHz-2 kHz	10 Hz
2.02 kHz-5 kHz	20 Hz
5.05 kHz-10 kHz	50 Hz
10.1 kHz-20 kHz	100 Hz
20.2 kHz-50 kHz	200 Hz
50.5 kHz-100 kHz	500 Hz
101 kHz-200 kHz	1 kHz
202 kHz-500 kHz	2 kHz
505 kHz-1 MHz	5 kHz

### Compensation Frequencies

**HP 4276A:** 100, 200, 500, 1k, 2k, 5k, 10k, 16k, 20 kHz

**HP 4277A:** 10k, 20.2k, 50.5k, 100k, 202k, 505k, 700k, 900k, 1 MHz  
 Compensation at other frequencies is automatically done using second degree interpolation.

### Offset Ranges

	HP 4276A	HP 4277A
OPEN	C ≤ 20 pF G ≤ 0.2 μS	C ≤ 20 pF G ≤ 2 μS
SHORT	Z  ≤ 2 Ω	L ≤ 2 μH R ≤ 2 Ω

### HP-IB Interface

**Remote control:** all front panel control settings and HP 16064A (comparator) settings can be controlled using HP-IB.

**Data output:** parameter measured, equivalent circuit, display status, measured values and decision output of comparator.

**Output format:** ASCII and packed binary.

**Self test:** checks HP 4276A/4277A's basic operation.

**Measurement accuracy and range:** specified at the front panel unknown connectors when all of the following conditions are satisfied:

- (1) warmup time ≥ 30 min.
- (2) test signal level is set to HIGH (1 Vrms)
- (3) measurement speed mode: MED or SLOW
- (4) ambient temperature is 23°C ± 5°C
- (5) cable length switch is set to Om (HP 4277A)
- (6) OPEN and SHORT adjustments have been made
- (7)  $D \leq 0.1$  (L-D-Q, C-D-Q, and |Z| - θ measurements)  
 $D \leq 0.002$  (HP 4276A) high speed L/C measurement  
 $D \leq 0.01$  (HP 4277A)

Accuracies given in Tables 1 through 6 are read as ±(% of reading + number of counts) for L, C, and |Z|, and ±(number of degrees + number of counts) of θ.

**C-D/C-Q (1/D) measurement accuracy:** accuracies for C measurements are given in Table 1 (frequencies other than 100, 120, 1k, and 1 MHz) and Table 2 (100, 120, 1k and 1 MHz only). The HP 4277A's C accuracies in the tables are for the full scale value of each C range.

**High Speed C Measurements** can be made under the following conditions

	Test Frequency	Measurement Range	D
HP 4276A	All frequencies	All ranges except for the two highest ranges at each frequency	≤ 0.002
HP 4277A	1 MHz	1 pF - 10 nF	≤ 0.01

(Refer to the HP 4276A/4277A data sheet for complete accuracy specifications, including D/Q accuracies)

**L-D/L-Q (1/D) Measurement:** accuracies for L measurements are given in Table 3 (for frequencies other than 1k, 10k, 100k, and 1 MHz) and Table 4 (for 1k, 10k, 100k, and 1 MHz). The HP 4276A's L accuracies given in the tables are for the full scale value of each L range.

**High Speed L Measurement** can be made under the following conditions

	Test Frequency	Measurement Range	D
HP 4276A	All frequencies	All ranges except for the two highest ranges at each frequency	≤ 0.002
HP 4277A	1 MHz	1 μH - 100 μH	≤ 0.01

(Refer to the HP 4276A/4277A data sheet for complete accuracy specifications, including D/Q accuracies)

**|Z| - θ Measurement:** accuracies for |Z| / θ measurements are given in Table 5 (HP 4276A) and Table 6 (HP 4277A). Accuracies given in the tables are for the full scale value of each |Z| range.

### DC Bias

**Internal dc bias (opt.): 0 to ±40 V**

Bias Voltage	Voltage Step	Accuracy (at 23 ± 5°C)
-40.0 to -10.0 V	0.1 V	±(1% of reading + 35 mV)
-9.99 to -0.01 V	0.01 V	±(1% of reading + 10 mV)
0.00 to 9.99 V	0.01 V	±(0.3% of reading + 10 mV)
10.0 to 40.0 V	0.1 V	±(0.5% of reading + 35 mV)

**Output resistance:** 1020 Ω ± 10% (HP 4276A)

1040 Ω ± 10% (HP 4277A)

**Control:** front panel or via HP-IB

**External dc bias via rear panel:** 0 to ± 40 V

**Continuous Memory** (approx. two weeks)

**Memory contents:** all front panel key settings, excluding BIAS, offset values, reference for deviation and comparator limit data.

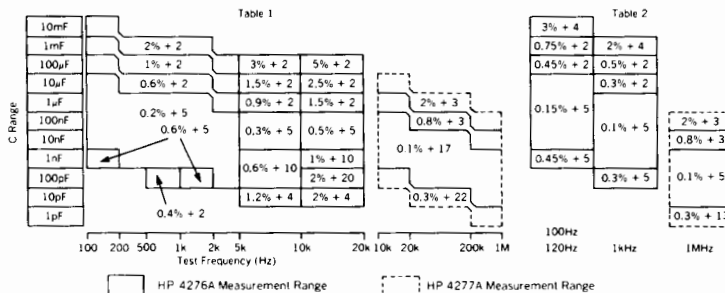



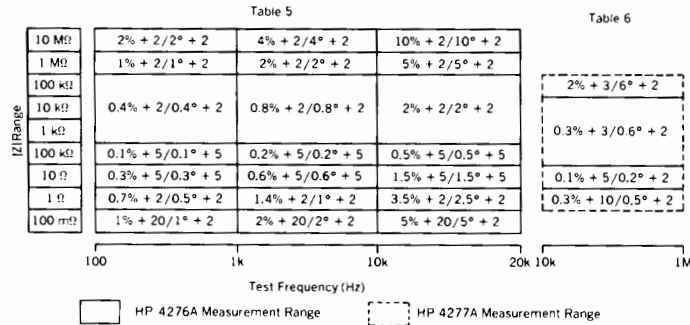
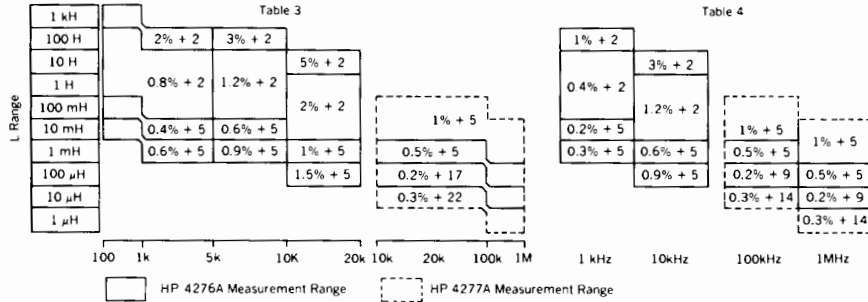

**General Measurement Time (Typical)**

**HP 4276A** (circuit mode set to AUTO, and test signal level set to HIGH)

**Capacitance measurement:** applicable to all ranges except for highest range when measuring low loss capacitors of full scale value.

**Inductance measurement:** applicable to all ranges except for lowest range when measuring low loss inductors of full scale value.

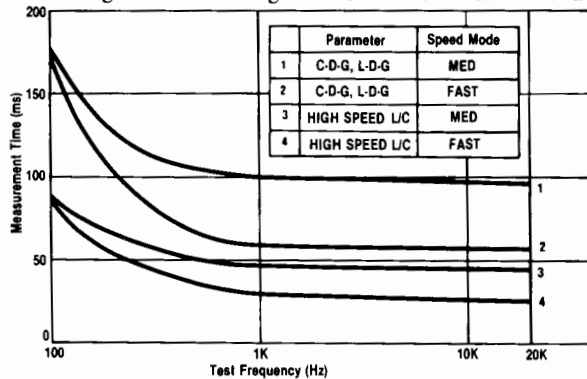

**HP 4277A** (circuit mode set to AUTO)

**Capacitance measurement:** applicable to parallel C ranges when measuring low loss capacitors of full scale value.

**Inductance measurement:** applicable to series L ranges when measuring low loss inductors of full scale value.

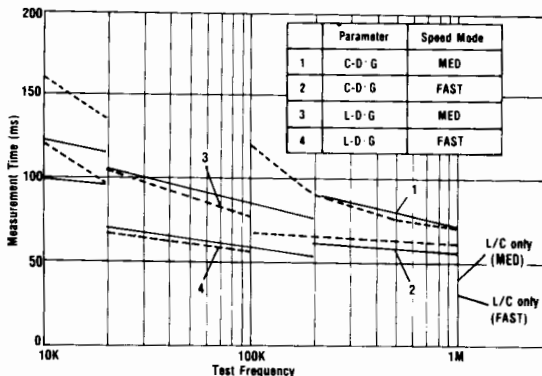

**Operating temperature and humidity:** 0° to 55°C, ≤ 95% RH at 40°C.

**Power requirements:** 100/120/220 Vac ±10%, 240 V + 5% - 10%; 48 to 66 Hz.

**Power consumption:** 65 VA max (HP 4276A); 75 VA max (HP 4277A).

**Size:** 188 mm H x 426 mm W x 422 mm D (7 7/8" x 16 3/4" x 16 2/3").

**Weight:** approx. 8.5 kg (18.7 lb).

**Options**

**Opt 001:** Internal dc bias, 0 to ±40 V, max resolution 10 mV/100 mV.

**Opt 002:** 10-bin sorting for L/C/|Z| and go/no-go testing for D/Q, interchangeable with component handler, usable only with HP 4276A/4277A.

**Limit data input:** high and low limits using comparator numerical keys or HP-IB

**Limit setting range:** 00000 to 19999

**Decision output:** BIN number, LED (high/in/low), or HP-IB

**Handler interface** (negative true)

**Output signal** (open collector or TTL)

**Decision outputs:** BIN number, high/in/low

**Index:** analog measurement complete, photo isolated

**Measurement complete:** full measurement complete, photo isolated

**Input signal** (open collector or TTL)

**External trigger:** photo isolated

**Accessories**

**Furnished accessories:** HP 16047A Direct Coupled Test Fixture

**Accessories Available**

**HP 16034B:** Tweezer Type Test Fixture for Chip Components

**HP 16047C:** Test Fixture

**HP 16048A:** Test Leads, BNC (1m)

**HP 16048B:** Test Leads, RF Miniature (1m)

**HP 16048C:** Test Leads, with Alligator chips (1m)

**HP 16048D:** Test Leads, BNC (2m)

**HP 16064A:** Retrofit Kit for Comparator (HP 4276A/HP 4277A, Opt 002)

**HP 16065A:** External DC Bias Test Fixture (≤200 V)

**Options**

**001:** Internal DC Bias

**002:** Comparator

**Ordering Information**

**HP 4276A** LCZ Meter

**HP 4277A** LCZ Meter



# COMPONENT & SEMICONDUCTOR MEASUREMENT

## RF Impedance Analyzer

Model 4191A

- 1-1000 MHz variable test frequency with sweep capability
- Direct reading of  $|Z| - \theta$ ,  $|Y| - \theta$ ,  $|\Gamma| - \theta$ ;  
 $L \cdot C - R \cdot G \cdot D \cdot Q$   
 $R - X, G - B, \Gamma_x - \Gamma_y$
- High resolution—4½ digit max
- Wide measuring range—1 m $\Omega$  – 100 k $\Omega$  ( $|Z|$ )
- Versatile, easy-to-use test fixtures

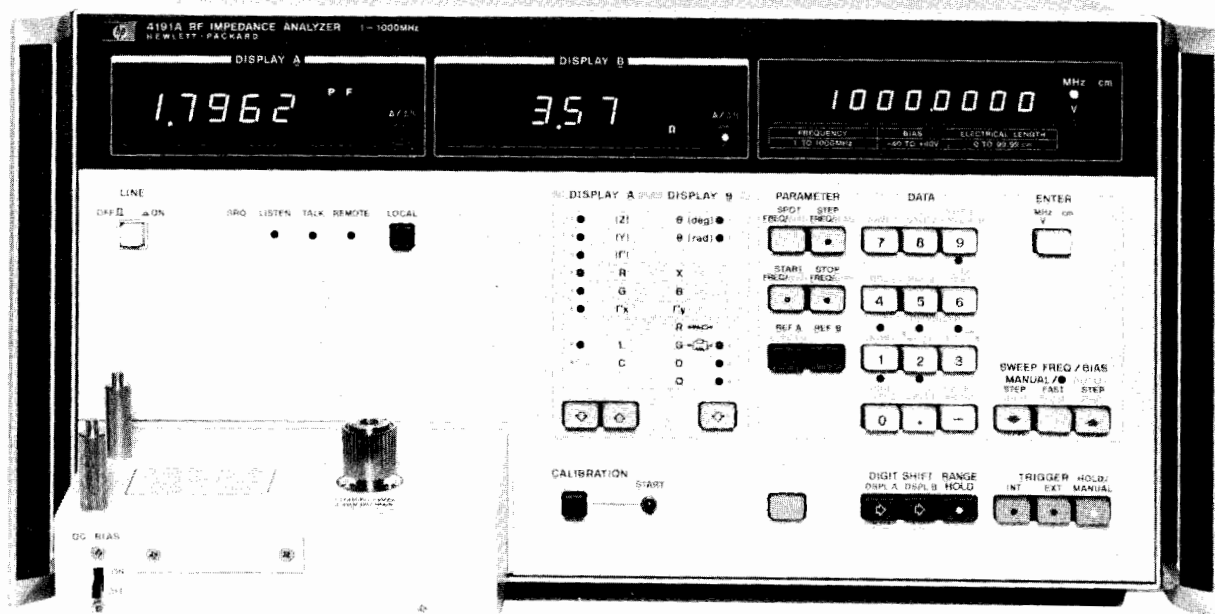

HP 4191A (Shown with Opt 907 Handles)

### Description

The HP 4191A RF Impedance Analyzer measures 14 parameters with a maximum resolution of 4½ digits. The internal synthesizer provides variable frequencies from 1 MHz through 1000 MHz covering the UHF, VHF and video bands with automatic sweep capability. An internal dc bias supply with auto sweep function covers the voltage range of  $\pm 40$  V in 10 mV steps.

The HP 4191A permits reliable measurements over a wide measuring range. Its outstanding repeatability, frequency response and accuracy are made possible by unique error correction capability and specially designed test fixtures. These features allow the HP 4191A to be used in evaluation of electronic materials, components and circuitry.

The internal synthesizer provides a maximum resolution of 100 Hz (Opt 002) with an accuracy of 3 ppm, allowing small changes in the resonant frequency of the device under test to be easily detected. The swept frequency capability aids in the analysis of frequency characteristics of the device.

Two complete front panel settings (parameter selection and the sweep control) can be stored in a non-volatile memory and recalled at any time with a single key operation. This, together with the standard HP-IB interface, makes the HP 4191A extremely efficient either as a stand-alone or systems instrument.

These unique features permit very wide applications in: (1) semiconductor testing such as surface state evaluation at high frequencies (C-V/G-V and conductance  $G/\omega$ ) characteristics), (2) resonator, filter, and magnetic and dielectric materials testing, (3) evaluation of LCR components such as high frequency chip and leaded components, and (4) testing of communications related components such as cables, connectors, etc.

### Specifications

**Parameter measured:**  $|Z| - \theta$ ,  $|Y| - \theta$ ,  $|\Gamma| - \theta$

$R - X, G - B, \Gamma_x - \Gamma_y$

$L - R \cdot G \cdot D \cdot Q, C - R \cdot G \cdot D \cdot Q$

**Display:** 4½ digit, max display 19999 counts

**Deviation Measurement** (deviation from stored reference)

$\Delta$ : -19999 to +19999 counts

$\Delta\%$ : -1999.9 to +1999.9%

**Measuring Signal** ( $23 \pm 5^\circ\text{C}$ )

**Frequency range:** 1 MHz to 1000 MHz

**Frequency step:** Standard: 100 kHz, 1-500 MHz  
200 kHz, 500-1000 MHz

Opt 002: 100 Hz, 1-500 MHz

200 Hz, 500-1000 MHz

**Frequency accuracy:**  $\pm 3$  ppm

**Signal level (into 50 $\Omega$ ):**  $-20 \pm 3$  dBm

**Frequency control:** spot and swept

### Measuring Mode

**Spot measurement:** at specific frequency (or dc bias)

**Swept measurement:** manual or automatic sweep from start to stop frequency (or dc bias) at step frequency (or dc bias) rate in linear or logarithmic form.

### Auto Calibration

Automatic error compensation referenced to connected terminations (0  $\Omega$ , 50  $\Omega$ , 0 S)

**Calibration frequency:** 51 frequencies including start and stop frequencies.

**Electrical length compensation:** automatic compensation for electrical length of test fixtures.



**Compensating range:** 0 to 99.99 cm.

**DC Bias**

**Internal dc Bias**

- Voltage range:** -40 to +40 V, 10 mV step
- Setting accuracy:** 0.1% of setting +10 mV
- Bias control:** spot and swept

**External dc Bias**

- Voltage range:** -40 to +40 V
- Max allowable current:** 100 mA

**Key status memory:** 2 sets of measuring conditions can be stored and recalled at any time. These conditions are kept in storage even when LINE is turned off.

**Ranging:** Auto/Range hold

**Trigger:** Internal, External or Manual

**Self-test:** automatic internal program test

**HP-IB data output and remote control:** standard

**Measuring Range, Resolution and Accuracy**

Specified at APC-7 UNKNOWN connector for reflect coefficient measurement at measuring frequency and ambient temperature (0 - 55°C) where calibration is performed after the warm-up time of 40 minutes. Refer to General Information for temperature coefficient and typical measuring range/resolution and accuracies of other measuring parameters (see data sheet for detailed specifications).

**$\Gamma$  -  $\Theta/\Gamma_x$  -  $\Gamma_y$  Measurement**

**Measuring Range**

- $\Gamma$ ,  $\Gamma_x$ ,  $\Gamma_y$ : 0.0001 to 1.0000
- $\Theta$ : 0° to ±180.00° (0 to ±π rad.)
- $\Gamma$ ,  $\Gamma_x$ ,  $\Gamma_y$  resolution: 0.0001

$\Gamma$ ,  $\Gamma_x$ ,  $\Gamma_y$  accuracy (see graph below)

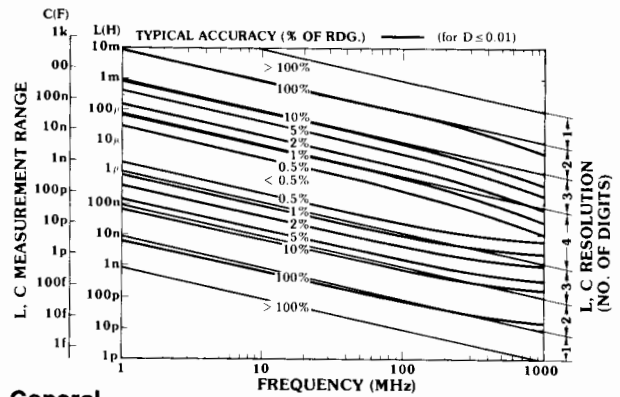
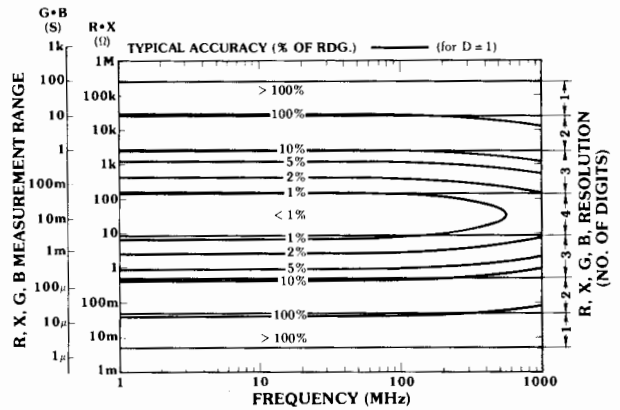
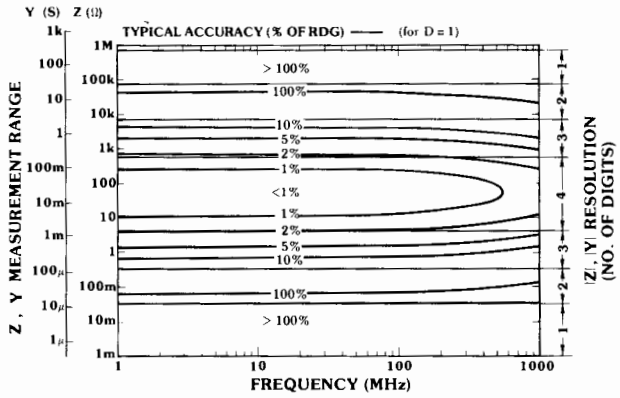
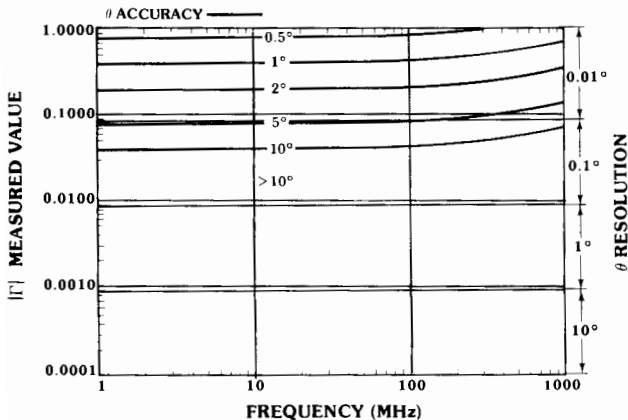
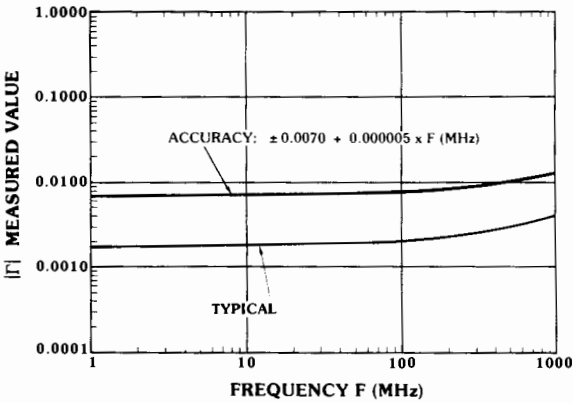

**General**

**Temperature coefficient for  $\Gamma$ ,  $\Gamma_x$ , and  $\Gamma_y$ :** 0.0001/°C (23 ± 5°C)

**Measuring time:** <800 ms or <250 ms (high speed mode)

**Frequency switching time:** ≤ 200 ms

**Temperature:** 0 - 55°C, < 95% RH

**Power:** 100, 120, 220 V ± 10%, 240 V + 5% - 10%, 48 - 66 Hz, 150 VA max.

**Size:** 425.5 mm W x 230 H x 574 mm D (16.75" x 9" x 22.6").

**Weight:** approx. 24 kg (52.8 lb)

**Accessories furnished:** accessory case (with reference terminations included).

**Accessories Available**

- HP 16091A Coaxial Fixture Set
- HP 16092A Spring Clip Fixture
- HP 16093A Binding Post Fixture
- HP 16093B Binding Post Fixture
- HP 16094A Probe Fixture

**Options**

- 002: 100 Hz/200 Hz resolution synthesizer
- 004: Recorder Outputs

**HP 4191A RF Impedance Analyzer**



# COMPONENT & SEMICONDUCTOR MEASUREMENT

## LF Impedance Analyzer (5 Hz to 13 MHz)

Model 4192A

- 5 Hz to 13 MHz variable measuring frequency
- Gain-phase measurement: amplitude, phase, group delay
- Floating or grounded devices
- Impedance measurement:  $|Z| \cdot |Y| \cdot \theta \cdot R \cdot X \cdot G \cdot B \cdot L \cdot C \cdot D \cdot Q \cdot \Delta \cdot \Delta\%$
- Standard HP-IB

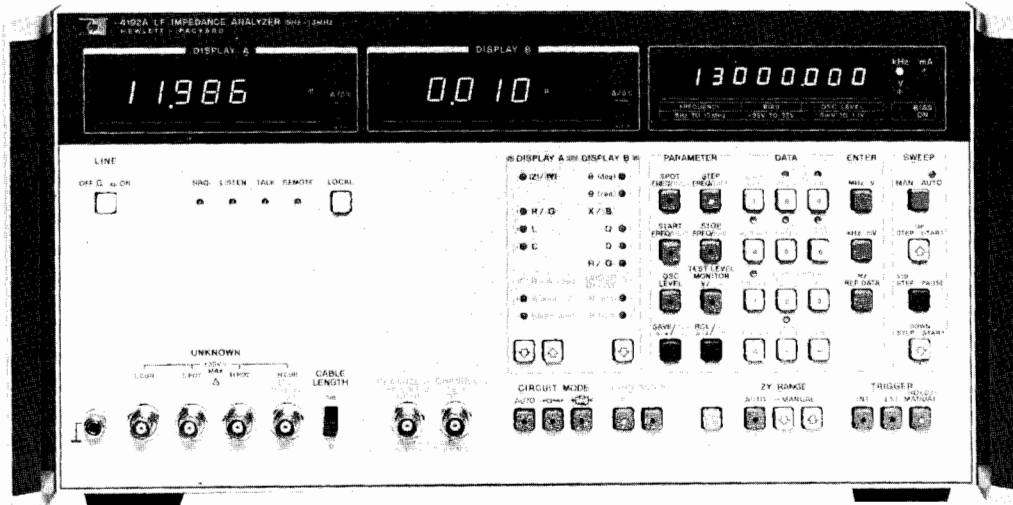

HP 4192A (shown with Opt. 907 handles)



### Description

The HP 4192A LF Impedance Analyzer performs both network analysis and impedance analysis on devices such as telecommunication filters, audio/video electronic circuits, and basic electronic components. Both floating and grounded devices can be tested.

### Automatic Swept Frequency Measurement of All Impedance Parameters

The HP 4192A can measure 11 impedance parameters ( $|Z|$ ,  $|Y|$ ,  $\theta$ ,  $R$ ,  $X$ ,  $G$ ,  $B$ ,  $L$ ,  $C$ ,  $D$ ,  $Q$ ) over a wide range  $|Z|$ : 0.1 m $\Omega$  to 1 M $\Omega$ ;  $|Y|$ : 1 nS to 10 S.

The built-in frequency synthesizer can be set from 5 Hz to 13 MHz with a maximum resolution of 1 mHz. This feature allows accurate characterization of high Q devices such as crystals. Test signal level is variable from 5 mV to 1.1 V with 1 mV resolution. Also, an internal dc bias voltage source provides  $\pm 35$  V at 10 mV increments. Thus, the HP 4192A can evaluate components and entire circuits near actual operating conditions.

### Specifications (complete specifications on data sheet)

#### Measuring signal (23 $\pm 5^\circ$ C)

**Frequency range:** 5 Hz to 13 MHz

**Frequency step:** 0.001 Hz (5 Hz to 10 kHz), 0.01 Hz (10 kHz to 100 kHz), 0.1 Hz (100 kHz to 1 MHz), 1 Hz (1 MHz to 13 MHz).

**Frequency accuracy:**  $\pm 50$  ppm

**OSC level:** 5 mV to 1.1 Vrms variable into 50  $\Omega$  (amplitude-phase measurement) or open circuit (impedance measurement).

**OSC level step:** 1 mV (5 mV to 100 mV), 5 mV (100 mV to 1.1 V).

**OCS level accuracy:** 5 Hz to 1 MHz:  $\pm(5 + 10/f)\%$  of setting  $\pm 2$  mV where f is in Hz. 1 MHz to 13 MHz:  $\pm(4 + 1.5 \times F)\%$  of setting  $\pm 2$  mV where F is in MHz.

**Level monitor** (impedance measurement): current through or voltage across sample can be monitored

**Control:** spot and sweep via front panel or HP-IB

#### Measuring Mode

**Spot measurement:** at specific frequency (or dc bias)

**Swept measurement:** manual or automatic sweep from START to STOP frequency (or dc bias) at selected STEP frequency (or dc bias) rate

**Sweep mode:** linear or logarithmic (frequency only)

**Recorder outputs:** output dc voltage proportional to each measured value, and frequency or dc bias.

**Maximum output voltage:**  $\pm 1$  V

**Output voltage accuracy:**  $\pm 0.5\%$  of voltage  $\pm 20$  mV

**Key status memory:** 5 sets of measuring conditions can be stored and recalled at any time.

**HP-IB data output and remote control:** standard

**Self-test:** automatic introspective testing

**Trigger:** internal, external or manual

### Amplitude—Phase Measurement

**Parameter measured:** relative amplitude B-A (dB) and phase  $\theta$  (degrees or radians), B-A and group delay, absolute amplitude A (dBm or dBV) or B (dBm or dBV), and deviation ( $\Delta$ ,  $\Delta\%$ ) of all parameters

**Reference amplitude:** 0 dBV = 1 Vrms, 0 dBm = 1 mW (with 50  $\Omega$  termination)

**OSC output resistance:** 50  $\Omega$

**Channels A and B:** input impedance: 1 M $\Omega \pm 2\%$ , shunt capacitance: 25 pF  $\pm 5$  pF

### Display Range and Resolution

**B-A:** 0 to  $\pm 100$  dB\*, 0.001 dB (0 to  $\pm 20$  dB), 0.01 dB ( $\pm 20$  to  $\pm 100$  dB)

$\theta$ : 0 to  $\pm 180^\circ$ , 0.01 $^\circ$

**Group delay:** 0.1 ns to 19 s, max. resolution 4 $\frac{1}{2}$  digits

**A or B:**  $+0.8$  to  $-100$  dBV\*, 0.001 dB ( $> -20$  dB), 0.01 dB ( $\leq -20$  dB),  $+13.8$  to  $-87$  dBm, 0.001 dB ( $> -20$  dBm), 0.01 dB ( $\leq -20$  dBm)

**Measuring accuracy (23  $\pm 5^\circ$ C):** specified at BNC unknown terminals after 30 minute warmup (test speed: normal or average)

**B-A (relative amplitude) and  $\theta$  (phase) Measurement**

Determined by sum of channel A and B accuracies given below (accuracy of each channel changes according to absolute input level)

\*Accuracy of relative and absolute gain measurements is specified from 0 dB to  $\pm 80$  dB.

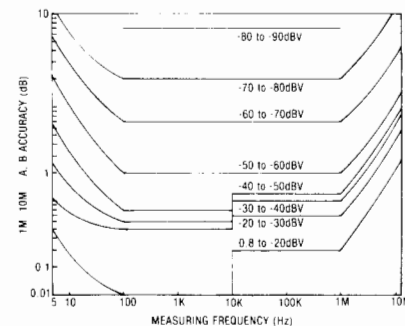

FIGURE 1: GAIN MEASUREMENT ACCURACY

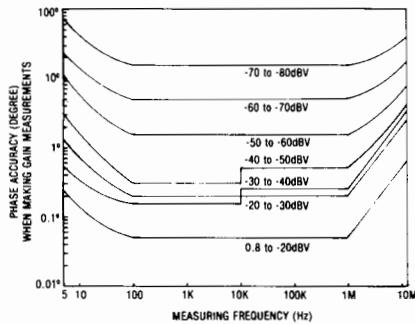

FIGURE 2: PHASE ACCURACY WHEN MAKING GAIN MEASUREMENTS

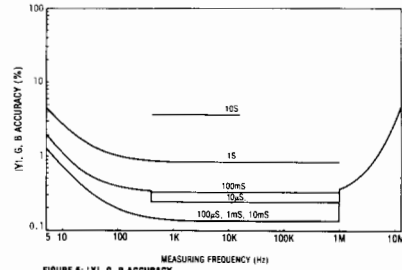

FIGURE 5: |Y|, G, B ACCURACY

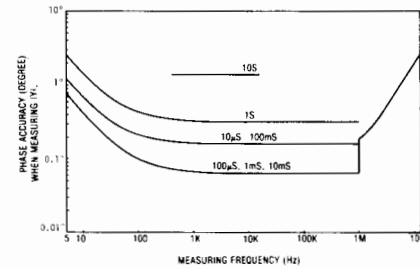

FIGURE 6: PHASE ACCURACY WHEN MEASURING |Y|

## Impedance Measurement

**Parameter measured:**  $|Z| - \theta$ ,  $|Y| - \theta$ ,  $R - X$ ,  $G - B$ ,  $L - D \cdot Q \cdot R \cdot G$ ,  $C - D \cdot Q \cdot R \cdot G$  and deviation ( $\Delta$ ,  $\Delta\%$ ) of all parameters

**Display:** 4½ digits, max. display 12999 counts, 19999 for L & C.

**Circuit mode:** series equivalent circuit (—□—) and parallel equivalent circuit (—□—). Automatic selection available.

**Auto ZERO adjustment:** automatic normalization of the readout offset due to residuals of the test fixture by pushbutton operation (at spot frequency)

**Measuring range and accuracy (23 ± 5°C):** specified at BNC unknown terminals after 30 minute warmup when OSC level is more than 0.1 V and when auto ZERO adjust is performed (test speed: normal or average). Accuracy given below is only valid when the measured value is equal to full scale of each range.

**$|Z| - \theta$ ,  $R - X$  measurement:** range:  $|Z|$ ,  $R$ ,  $X$ : 0.1 mΩ to 1.2999 MΩ;  $\theta$ : -180.00° to +180.00°. Accuracy:  $R$  accuracy ( $D \geq 10$ );  $X$  accuracy ( $D < 1$ )

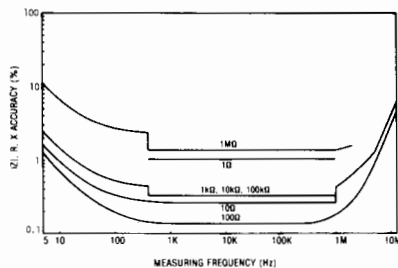

FIGURE 3: |Z|, R, X ACCURACY

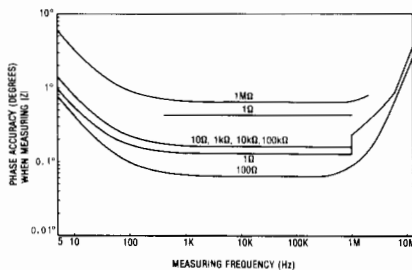

FIGURE 4: PHASE ACCURACY WHEN MEASURING |Z|

**$|Y| - \theta$ ,  $G - B$  measurement:** range:  $|Y|$ ,  $G$ ,  $B$ : 1 nS to 12.999 S;  $\theta$ : -180.00° to +180.00°. Accuracy:  $G$  accuracy ( $D > 1$ );  $B$  accuracy ( $D \leq 0.1$ ).

**$L - D \cdot Q$ ,  $C - D \cdot Q$  measurement:** (automatically calculated from measured  $Z/Y$  values)

Parameter	Measuring Range*	Basic Accuracy
L	0.01 nH to 1000 H	0.27%
C	0.1fF to 199** mF	0.15%
D(1/Q)	0.0001 to 19.999	0.001 (C-measurement) 0.003 (L-measurement)

\*Varies with measuring frequency except for D(1/Q)

\*\*Accuracy of C ranges over 100 mF is not specified.

**Internal dc bias:** standard (impedance measurement only)

**Voltage range:** -35 V to +35 V, 10 mV step

**Setting accuracy (23 ± 5°C):** 0.5% of setting + 5 mV

**Bias control:** spot and swept, using front panel controls or HP-IB

## General

### Measuring Time (high speed mode)

**B-A and  $\theta$ , A or B:** 88 to 127 ms ( $\geq 400$  Hz)

**Impedance parameters:** 58 to 91 ms ( $\geq 1$  kHz)

### Test Level Monitor Range (impedance measurement)

**Voltage:** 5 mV to 1.1 V

**Current:** 1  $\mu$ A to 11 mA

**Operating temperature:** 0 to 55°C,  $\leq 95\%$  RH at 40°C

**Power:** 100, 120, 220 V  $\pm 10\%$ , 240 V + 5% to -10%, 48 to 66 Hz, 150 VA max.

**Size:** 425.5 mm W x 235 mm H x 615 mm D (16.75" x 9" x 22.6")

**Weight:** approx. 19 kg (41.9 lb)

**Furnished accessories and parts:** HP 16047A test fixture, 50  $\Omega$  feed thru terminations (2 ea.), power splitter, BNC cables (2 ea.), BNC adapter

## Accessories available

HP 16095A Probe Fixture

HP 16096A 2-port Component Test Fixture

HP 16097A Accessory Kit

HP 16047C 2-terminal Test Fixture

HP 16048B Test Leads (miniature connector)

HP 16048C Test Leads with alligator clip

HP 4274A/4275A's test fixtures/leads are usable with HP 4192A

## HP 4192A LF Impedance Analyzer

# COMPONENT & SEMICONDUCTOR MEASUREMENT

## Vector Impedance Meter (400 kHz to 110 MHz)



Model 4193A

- 400 kHz to 110 MHz spot or swept frequency
- Measure impedance magnitude (10 mΩ to 100 kΩ) and phase (−180.0° to +180.0°)
- Test components in-circuit and out-of-circuit
- Fixtures include low-grounded probe, spring clip fixture and binding post fixture
- Standard HP-IB and analog outputs

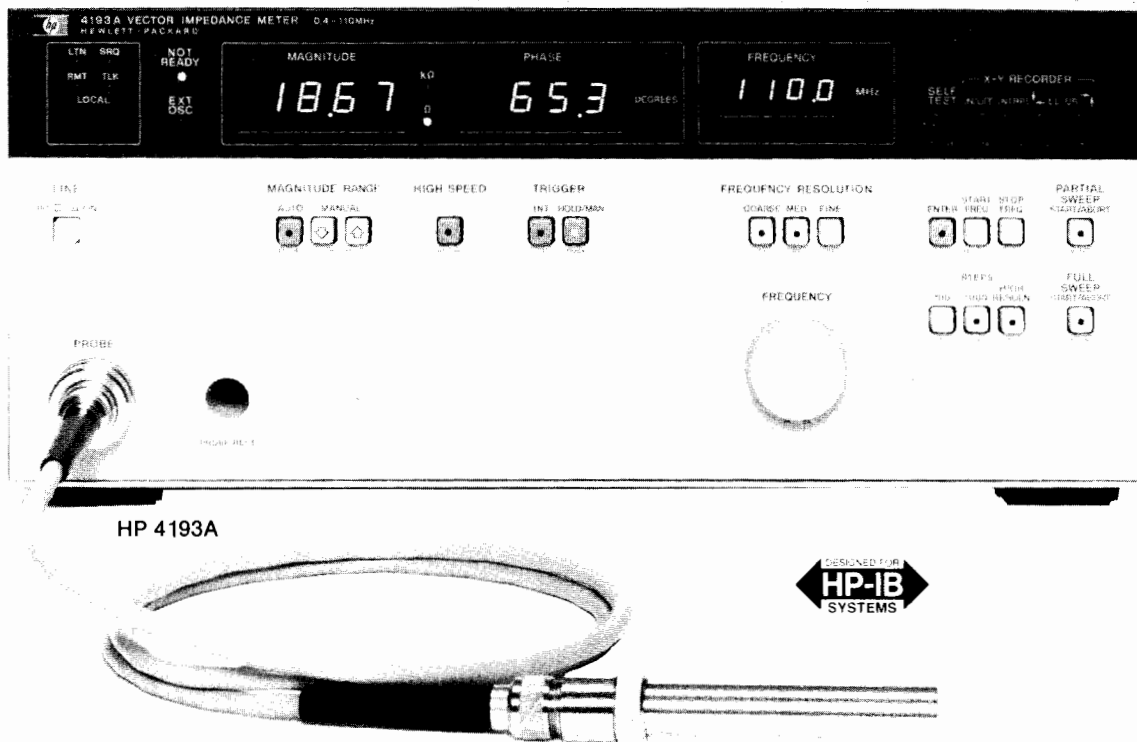

### Description

The HP 4193A Vector Impedance Meter measures impedance magnitude and phase. An internal oscillator provides test signals from 400 kHz to 110.0 MHz. The test signal is constant current between 10 μA and 100 μA, depending on  $|Z|$  range.

### Reliable and Accurate Impedance Measurement

The HP 4193A can measure and display impedance magnitudes from 10 mΩ to 100 kΩ. Impedance phase is displayed from +180.0° to −180.0°. Accuracy is as good as 3.0% of reading (magnitude) and 3.2° (phase).

Also, the HP 4193A's 3½ digit resolution makes it easy to see small changes in measurement results during adjustment procedures, for example.

### Frequency Sweep for Complex Component Testing

When testing complex components like ceramic resonators, it is useful (1) to sweep frequency to get the big picture and (2) identify critical impedance points such as the series resonant point. This requires both swept measurement and measurements at individual "spot" frequencies. The HP 4193A can do both.

The HP 4193A can be tuned to any individual frequency from 400 kHz to 110.0 MHz with maximum resolution of 1 kHz. If greater frequency resolution is required, it can be provided by connecting an external synthesized source such as the HP 3335A or HP 8656A to the HP 4193A EXT OSC input.

Flexible internal frequency sweep is an exciting HP 4193A feature. Frequency can be swept linearly over any portion of the HP 4193A frequency range—or swept logarithmically over the entire 400 kHz to 110.0 MHz range.

### Test In-Circuit and Out-of-Circuit Components

Several test fixtures help adapt the HP 4193A to your device under test. For example, the handy L-ground probe is useful for in-circuit

testing. The HP 16099A Test Fixture Adapter and three associated fixtures help connect to out-of-circuit devices of various sizes and shapes.

### Easy to Use—Both Manually and Under HP-IB Control

The HP 4193A front panel is amazingly simple. In just a few minutes you can become an expert operator. This is a big time saver over most other impedance meters which are usually much more difficult to operate. Plus, the HP 4193A has standard HP-IB, making it a good choice for automated testing in R&D, incoming inspection, production and product assurance.

### Specifications

#### Test Signal Output Specifications

Test signal is output from the furnished low-ground probe.

**Frequency range:** 400 kHz to 110.0 MHz

#### Frequency Resolution

**400 kHz to 9.999 MHz:** 1 kHz resolution

**10.00 MHz to 99.99 MHz:** 10 kHz resolution

**100.0 MHz to 110.0 MHz:** 100 kHz resolution

**Frequency accuracy:** ±0.01% of setting after calibration.

**Frequency stability:** ±100 ppm per month (0 to 55 °C)

#### Frequency Control

**Spot:** spot frequency is set using coarse, medium and fine controls  
**Full sweep:** logarithmic sweep at 43 points over full range of 400 kHz to 110 MHz

**Partial sweep:** linear sweep from selected START to STOP frequency. Number of steps is selected as 100, 1000 or "HIGH RESOLN". When "HIGH RESOLN" steps are selected, the operator must also select "coarse", "medium" or "fine" resolution.



**EXT OSC:** increase frequency resolution by connecting an external frequency synthesizer such as the HP 3335A or HP 8656A.

**Input signal level:** 0 dBm to +5 dBm

**Input impedance:** 50 ohms ±10%

**Frequency range:** 400 kHz to 110 MHz

**Test level:** constant current source

Z  Range	Current in μA ±20%	Voltage <sup>1</sup> Across DUT in μVrms
10 Ω	100	1
100 Ω	100	10
1 kΩ	100	100
10 kΩ	50	500
100 kΩ	10	1000

<sup>1</sup>Voltage across DUT depends on |Z| of DUT. The voltage shown is across a |Z| of full scale value. For example, 1 Vrms would appear across |Z| of 10 Ω on the 10 Ω range.

**Impedance Measurement Specifications**

**Input configuration:** low-grounded probe (furnished)

**Residual Impedance of Probe** (at probe tip)

**Resistance:** <0.55 Ω

**Inductance:** <(4.9 + 10/f) nH where f is measuring frequency in MHz

**Capacitance:** <0.11 pF

**Digital display of impedance:** 3½ digits

**|Z|:** 0 to 1999 counts (0 to 120 counts on 100 kΩ range)

**θ:** -1800 to +1800 counts (-180 to +180 counts on 100 kΩ range)

**Measurement trigger:** internal, external, and manual

**Measurement range control:** auto, hold, and manual

**Measurement Range**

**|Z|:** Five decade ranges: 10 Ω, 100 Ω, 1 kΩ, 10 kΩ, 100 kΩ

**minimum |Z| (sensitivity):** 10 mΩ

**maximum |Z|:** 120 kΩ

**θ:** One range: -180.0° to +180.0°

**Recorder output:** dc voltage proportional to measured |Z|, θ and measurement frequency.

**Output voltage:** accuracy specification for all recorder output voltages is ±(1% + 20 mVdc)

**|Z|:** 0 Vdc (0000 display counts) to +1 Vdc (1999 display counts)

**θ:** -1 Vdc (-180.0°) to +1 Vdc (+180.0°)

**Frequency**

**Full sweep:** 0 Vdc (400 kHz) to +1 Vdc (110 MHz), log sweep

**Partial sweep:** 0 Vdc (START frequency) to +1 Vdc (STOP frequency), linear sweep

**HP-IB remote control and data output:** standard

**Self-test:** standard

**General Information**

**Test Signal Output**

**Frequency settling time:** 5 ms to 400 ms. Best case is when (Δf/f)% is less than 10% (below 10 MHz) and less than 1% (above 10 MHz).

**Signal Purity**

**Spurious:** -60 dBc (dBc is dB below carrier)

**Harmonics:** -30 dBc

**Residual FM:** measured in a 100 Hz band centered on the carrier

**400 kHz to 1 MHz:** 40 Hz p-pFM

**1 MHz to 110 MHz:** 100 Hz p-pFM

**Impedance Measurement**

**Measuring speed:** assumes range is fixed; recorder output is OFF

**HI SPEED:** approximately 150 ms per measurement

**NORMAL:** approximately 1 s per measurement

**Ranging time:** approximately 400 ms per range plus one measuring interval (e.g., 1 s in normal mode)

**Temperature coefficient at 23°C ± 5°C**

**|Z|:** 2 mΩ/°C

**θ:** 0.02°/°C

**|Z| and θ Measurement Accuracy: in the Table below, "f" is in MHz**

Range	Accuracy	Measuring Frequency in Megahertz		
		4	1	10
10 Ω Range	Z  Accuracy	±[(5.7 + 0.56/f)% rdg + 9 counts]	±(6.3% rdg + 6 counts)	±[(4.5 + 0.18f)% rdg + 4 counts]
	θ Accuracy	±(1.7 + 1.8/f + $\frac{35}{ Z  \text{ counts}}$ ) deg	±(3.3 + 0.20f + $\frac{35}{ Z  \text{ counts}}$ ) deg	
100 Ω Range	Z  Accuracy	±[(2.4 + 0.56/f)% rdg + 4 counts]	±(3.0% rdg + 4 counts)	±[(2.6 + 0.037f)% rdg + 4 counts]
	θ Accuracy	±(1.5 + 1.9/f + $\frac{35}{ Z  \text{ counts}}$ ) deg	±(3.3 + 0.035f + $\frac{35}{ Z  \text{ counts}}$ ) deg	
1 kΩ Range	Z  Accuracy	±[(3.2 + 0.56/f)% rdg + 4 counts]	±(3.7% rdg + 4 counts)	±[(2.7 + 0.11f)% rdg + 4 counts]
	θ Accuracy	±(1.6 + 1.8/f + $\frac{35}{ Z  \text{ counts}}$ ) deg	±(3.3 + 0.11f + $\frac{35}{ Z  \text{ counts}}$ ) deg	
10 kΩ Range	Z  Accuracy	±[(2.9 + 0.56/f)% rdg + 4 counts]	±[(3.2% + 0.29f)% rdg + 4 counts]	±[(0.74 + .53f)% rdg + 4 counts]
	θ Accuracy	±(2.1 + 1.9/f + $\frac{35}{ Z  \text{ counts}}$ ) deg	±(3.1 + 0.53f + $\frac{35}{ Z  \text{ counts}}$ ) deg	±(8.3 + 0.01f + $\frac{35}{ Z  \text{ counts}}$ ) deg
100 kΩ Range	Z  Accuracy	±[(3.3 + 0.56/f)% rdg + 4 counts]		
	θ Accuracy	±(3.0 + 1.9/f + $\frac{35}{ Z  \text{ counts}}$ ) deg		Not specified

**Guideline for Use of the |Z| and θ Accuracy Table**

- "f" is in MHz.
- "rdg" is display reading, for example, 50.0 ohms.
- "counts" is display counts in the |Z| display.
- "deg" is degrees of arc.

**Example:** calculate the |Z| and θ accuracy for a device which gives HP 4193A readings of |Z| = 50.0 Ω and θ = -45.0°. Assume an 0.9 MHz test frequency 100 Ω range, and normal measuring mode.

$|Z| = 50.0 \Omega \pm [(2.4 + \frac{0.56}{0.9}) \% \text{ of rdg} + 4 \text{ counts}]$

$|Z| = 50.0 \Omega \pm [(2.4 + \frac{0.56}{0.9}) * \frac{50.0 \Omega}{100\%} + 0.4 \Omega]$

$|Z| = 50.0 \Omega \pm 1.91 \Omega$

$\theta = -45.0^\circ \pm (1.5 + \frac{1.9}{0.9} + \frac{35}{500}) \text{ deg}$

$\theta = -45.0^\circ \pm (1.5 + \frac{1.9}{0.9} + \frac{35}{500}) \text{ deg}$

$\theta = -45.0^\circ \pm 3.68^\circ$

**Operating temperature/humidity:** 0 to 55°C, 95% RH @ 40°C. Note that measurement error in 0°C to 55°C temperature range is typically double the error in the 23°C ± 5°C range.

**Power:** 100/120/220 V ±10%, 240 V -10% to +5%, 48 to 66 Hz, 150 VA max

**Size:** 426 mm W x 178 mm H x 498 mm D, (16.75" x 7" x 19.6").

**Weight:** 18 kg (40 lb)

**Accessories furnished:** low-ground probe kit includes probe, spare pins, spare clips, BNC adapter, component mounting adapter, probe socket and accessory case.

**Accessories Available**

**HP 16099A** Test Fixture Adapter (used with HP 16092A and HP 16093A/B)

**HP 16092A** Spring Clip Fixture (used with HP 16099A)

**HP 16093A** Binding Post Fixture (used with HP 16099A)

**HP 16093B** Binding Post Fixture (used with HP 16099A)

**HP 4193A Vector Impedance Meter**

# COMPONENT & SEMICONDUCTOR MEASUREMENT

## Digital LCR Meters

Models 4261A and 4262A

- Automatic balancing, ranging & circuit mode selection
- Test frequencies: HP 4261A, 120 (100) Hz and 1 kHz  
HP 4262A, 120 (100) Hz, 1 kHz and 10 kHz
- Versatile accessories and options
- High reliability

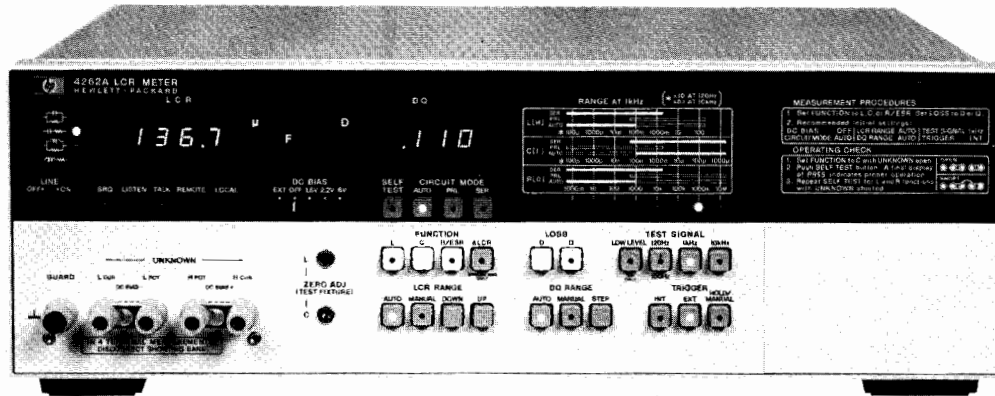

HP 4262A



HP 4261A

## Description

The HP 4261A and HP 4262A are 3½ digit LCR meters that meet today's requirements for component measurements. Both instruments feature fully automatic operation over wide measuring ranges. Simply select the measuring functions and one of the test frequencies, then insert the device to be measured. The instrument does the rest—automatically selecting the proper measuring range and equivalent circuit mode. The HP 4261A and HP 4262A basic features are summarized in the table below.

	HP 4261A	HP 4262A
<b>Test Frequency</b>	120 (100) Hz, 1 kHz	120 (100) Hz, 1 kHz, 10 kHz
<b>Signal Level</b>	1 V, 50 mV (Cp)	1 V, 50 mV (Cp)
<b>Parameters Measured</b>	C-D L-D R	C-D • Q L-D • Q R (ESR) Δ (Deviation)
<b>HP-IB</b>	No	Yes (opt.)
<b>Digital Comparison</b>	No	Yes (opt.)
<b>BCD Output</b>	Yes (opt.)	Yes (opt.)

In addition to automatic measurements, the HP 4261A and HP 4262A provide high accuracy (0.2% reading), internal dc bias, and series and parallel equivalent circuit modes.

These relatively low cost and easy-to-use LCR meters are capable of a wide range of applications—measuring electrolytic/ceramic capacitors, filter coils, pulse transformers, internal resistance of dry cells and semiconductor junction capacitance, as well as ordinary LCR components. Extended features of these reliable instruments include optionally available HP-IB (HP 4262A) and BCD (HP 4261A) data output capabilities and a comparator option which is convenient for production line applications.

**Specifications** (refer to data sheet for complete specifications) Measurement ranges and accuracies: see table on next page. Accuracy applies over a temperature range of 23°C ±5°C (at 0° to 55°C, error doubles). 10 kHz and Q specifications are given only for the HP 4262A.

	HP 4261A	HP 4262A
<b>Parameters measured</b>	L-D, C-D R	L-D • Q, C-D • Q R (ESR), Δ LCR
<b>Display</b>	3½ digits max. display 1900	3½ digits max. display 1999
<b>Test frequency</b>	120 (100) Hz, 1 kHz ±3%	120 (100) Hz, 1 kHz 10 kHz ±3%
<b>Test signal level (typical)</b>	1 V, 50 mV (Cp mode only)	
<b>DC bias</b>	Int	1.5 V, 2.2 V, 6 V ±5%, selectable
	Ext	0 to +30 V
<b>Equivalent circuit modes</b>	auto, parallel, series	
<b>Ranging modes</b>	LCR	auto, manual
	DQ	D only — fixed
<b>Trigger</b>	internal, external, manual	
<b>Measuring terminal</b>	5-terminal configuration	

**Deviation measurement (HP 4262A):** displays the difference between a stored value (that is, measured value when Δ LCR switch is depressed) and subsequent measured data.

**Offset adjustments (HP 4262A):** front panel adjustments to compensate for stray capacitance and residual inductance of the test fixture.

**C:** 0 to 10 pF      **L:** 0 to 1 μH

**Self-test (HP 4262A):** automatically checks the HP 4262A's basic functions.

### General

**Measuring time (typical):** for a 1000 count measurement on a low loss component on a fixed range:

**1 kHz, 10 kHz:** C/L 220-260 ms, R 120-160 ms

**120 (100) Hz:** C/L 900 ms, R 700 ms

### Ranging Time

**1 kHz, 10 kHz:** 180 ms/range step

**120 (100) Hz:** 670 ms/range step

**Reading rate:** INT (internal trigger) approximately 30 ms between end of measurement cycle and start of the next cycle. EXT (external trigger) measuring cycle is initiated by a remote trigger input.

**C-D/C-Q Measurement**

Range	C	120 (100) Hz	1000 pF	10.00 nF	100.0 nF	1000 nF	10.00 μF	100.0 μF	1000 μF	10.00 mF	
		1 kHz	100.0 pF	1000 pF	10.00 nF	100.0 nF	100.0 nF	1000 nF	10.00 μF	100.0 μF	1000 μF
	D	0.001 to 1.900 (HP 4261A), 0.001 to 19.9 (HP 4262A)									
	Q <sup>±1</sup>	0.050 to 1000 (4 ranges, HP 4262A)									
C Accuracy <sup>±2</sup>		0.2% + 1 <sup>±3</sup>									
		At 120 (100) Hz, 1 kHz					0.3% + 2				
		At 10 kHz					0.5% + 2				
D (1/Q) Accuracy <sup>±2</sup>		0.2% + (2 + 200/Cx)					At 120 (100) Hz, 1 kHz				
		0.5% + (2 + 200/Cx)					At 10 kHz				
		At 120 (100) Hz, 1 kHz					0.3% + (2 + Cx/500)			1% + (5 + $\frac{Cx}{500}$ )	
		At 10 kHz					0.5% + (2 + Cx/500)			1% + (5 + $\frac{Cx}{500}$ )	

<sup>±1</sup>Calculated as the reciprocal of D.  
<sup>±2</sup>±(% of reading + number of counts), Cx is capacitance readout in counts. Accuracies in this table apply when D < 1.900.  
<sup>±3</sup>Add 0.2 pF for HP 4261A.  
<sup>±4</sup>(5% + 2 counts) at 1 kHz.

**L-D/L-Q Measurement**

Range	L	120 (100) Hz	1000 μF	10.00 mH	100.0 mH	1000 mH	10.00 H	100.0 H	1000 H	
		1 kHz	100.0 μH	1000 μH	10.00 mH	100.0 mH	100.0 mH	1000 mH	10.00 H	100.0 H
	D	0.001 to 1.900 (HP 4261A), 0.001 to 19.9 (HP 4262A)								
	Q <sup>±1</sup>	0.050 to 1000 (4 ranges, HP 4262A)								
L Accuracy <sup>±2</sup>		At 120 (100) Hz, 1 kHz			0.3% + 2			1% + 2		
		At 10 kHz						1% + 2		
		0.2% + 2 <sup>±3</sup>			0.2% + 2			At 120 (100) Hz, 1 kHz		
D (1/Q) Accuracy <sup>±2</sup>		At 120 (100) Hz, 1 kHz			0.3% + (3 + Lx/500)			1% + (3 + Lx/500)		
		At 10 kHz			0.5% + (3 + Lx/500)			1% + (3 + Lx/500)		
		0.2% + (3 + 200/Lx)						At 120 (100) Hz, 1 kHz		
		0.5% + (3 + 200/Lx)						At 10 kHz		

<sup>±1</sup>Calculated as the reciprocal of D.  
<sup>±2</sup>±(% of reading + number of counts), Lx is inductance readout in counts. Accuracies in this table apply when test signal level is 1 V and D < 1.900.  
<sup>±3</sup>Add 0.2 μH for HP 4261A.

**R (ESR)<sup>±1</sup> Measurement**

Range	120 (100) Hz	1000 mΩ	10.00 Ω	100.0 Ω	1000 Ω	10.00 kΩ	100.0 kΩ	1000 kΩ	10.00 MΩ	
Accuracy <sup>±2</sup>		0.2% + 1					0.3% + 2 <sup>±3</sup>			

<sup>±1</sup>ESR measuring range is from 1 mΩ to 19 kΩ (typical). These values vary depending on the series capacitance or inductance value of the device under test.  
<sup>±2</sup>±(% of reading + number of counts).  
<sup>±3</sup>±(5% + 2 counts) on 10.00 MΩ range at 10 kHz.

	HP 4261A	HP 4262A
Operating temperature and humidity	0°C to 55°C ≤95% RH at 40°C	
Power requirements	100/120/220/240 V ± 10% 48-66 Hz	100/120/220 V ± 10%, 240 V + 5% -10%, 48-66 Hz
Power consumption	<25 VA	
Size	132.6 H x 213 W x 427 mm D (5 • 1/4" x 8 • 3/8" x 16 • 3/4")	147 H x 426 W x 345 mm D (5 • 3/4" x 16 • 3/4" x 13 • 3/4")
Weight (approx.)	7.5 kg (16.51 lb)	8 kg (17.51 lb)

**Options Available**

Option	HP 4261A <sup>±1</sup>	HP 4262A <sup>±2</sup>
001	BCD data output (L/C/R and D simultaneously)	BCD data output
002	BCD data output (L/D, C/D, R alternately)	—
003	BCD remote control	—
004	—	Digital comparator
101	—	HP-IB

<sup>±1</sup>Options 001 and 002 are mutually exclusive.  
<sup>±2</sup>Option combinations 101/001 and 101/004 cannot be ordered.

**Accessories available:** **HP 16061A:** test fixture, direct couple, 5-terminal; **HP 16062A:** test leads with alligator clips, 4-terminal (for low impedance measurements); **HP 16063A:** test leads with alligator clips, 3-terminal (for high impedance measurements).

**Ordering Information (4261A)**

- HP 16061A Test Fixture, Radial/Axial lead devices
- HP 16062A Test Leads, 3-wire
- HP 16063A Test Leads, 4-wire
- Opt 001: BCD Output (Simultaneous)
- Opt 002: BCD Output (Alternately)
- Opt 003: BCD Remote Control
- Opt 010: 100 Hz Test Frequency
- Opt 910: Extra Manual
- HP 4261A Digital LCR Meter

**Ordering Information (HP 4262A)**

- Opt 001: BCD Output
- Opt 004: Digital Comparator
- Opt 010: 100 Hz Test Frequency
- Opt 101: HP-IB Interface
- Opt 907: Front Handle Kit
- Opt 908: Rack Flange Kit
- Opt 909: Rack/Handle Kit
- Opt 910: Extra Manual
- HP 16061A Test Fixture for Radial/Axial Lead Devices
- HP 16062A Test Cables, 3-wire
- HP 16063A Test Cables, 4-wire

**HP 4262A Digital LCR Meter**



# COMPONENT & SEMICONDUCTOR MEASUREMENT

## 1 MHz C Meter/C-V Plotter

Model 4280A

- Built-in sweepable dc bias source and timer for C-V (Capacitance-Voltage)/C-t (Capacitance-Time) measurements
- High speed C-t measurements with minimum measurement interval of 10 ms (10  $\mu$ s if an external pulse generator is used)
- Basic C measurement accuracy: 0.1%
- Test lead extension up to 5 m
- 5½-digit display resolution (option) for C measurement

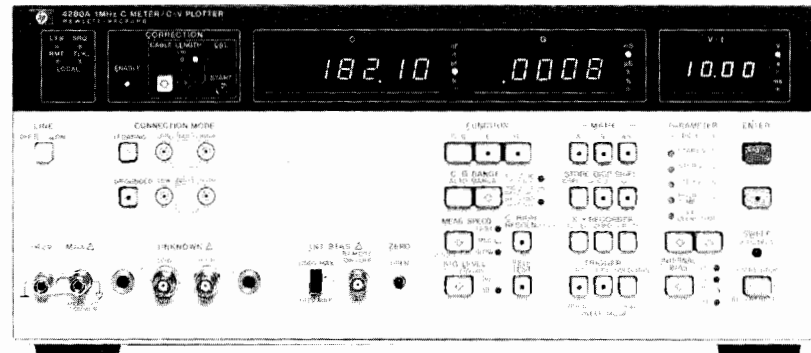

HP 4280A



### Description

HP's 4280A 1 MHz C Meter/C-V Plotter measures the capacitance and conductance of semiconductor devices and materials as functions of applied voltage (C-V) or time (C-t). The HP 4280A consists of a precision 1 MHz C-G meter, a programmable dc bias source that can be swept in staircase fashion, and accurate timing control.

### C-V and C-t Measurements

The HP 4280's internal dc bias source has a range of 0 V to  $\pm 100$  V with 1 mV resolution on the most sensitive range. Various measurement parameters for C-V and C-t measurements—hold time (bias pulse width) and delay time (measurement interval)—can be manually set from the front panel. Or these parameters can be set under program control via the HP-IB. Settable range for C-t measurement interval is 10 ms to 32s with a best case resolution of 10  $\mu$ s. If an external pulse generator is used, however, measurement intervals as short as 10  $\mu$ s can be set. Up to 9999 readings can be set for a C-t measurement. These capabilities make it possible for the HP 4280A to measure the C-t characteristics of virtually any device.

### High Speed C-t Measurement

A special sampling integration technique employed in the HP 4280A provides measurement intervals as short as 10  $\mu$ s using an external pulse generator, such as the HP 8112A or HP 8160A, to provide the bias pulse. Short measurement interval makes the HP 4280A applicable to Deep Level Transient Spectroscopy (DLTS) measurements, which are commonly used to analyze the physical characteristics of semiconductors.

### Precision, High Resolution Measurements

The HP 4280A measures capacitances up to 1.900 nF, over three ranges, with 0.001 pF resolution on the most sensitive range. Conductance up to 12 mS can be measured with a maximum resolution of 10  $\mu$ S.

C and G measurements are made at 1 MHz. AC signal level is selectable between 10 mVrms or 30 mVrms, suitable for semiconductor measurements. Basic measurement accuracy is 0.1%. Maximum display resolution is 4½ digits. With Option 001, however, display resolution for capacitance is 5½ digits.

The accuracy and resolution of the HP 4280A satisfy the stringent requirements of laboratory and R and D measurements, which require the detection of minute changes in device characteristics.

### Probed Measurements On Wafers

HP's 4280A has an automatic error correction function that makes

it possible to use test leads up to 5 m long (HP P/N 8120-4195). The HP 4280A can measure either floating or grounded devices. Thus, the HP 4280A can be connected to a wafer prober and still provide stable, accurate C and G measurements.

### Easy, Low Cost Systemization

HP-IB is standard on the HP 4280A. So, a process evaluation system or a lab automation system capable of evaluating the physical characteristics of semiconductor devices can be easily constructed.

The HP 4280A is equipped with analog outputs to allow users to plot device characteristics on an X-Y recorder or large screen display.

### Specifications (refer to data sheet to complete specifications)

Measurement functions: C, C-V and C-t

Function		Available Internal dc Bias Function
Basic Function	Selection	
C	C only C-G only	OFF, $\equiv$ (DC)
C-V	C-V G-V C & G-V	
C-t	C-t G-t C & G-t	

### C Measurement

#### Test Signal

Frequency: 1 MHz  $\pm 0.01\%$

OSC level: 30 mVrms or 10 mVrms  $\pm 10\%$

Measurement terminals: two-terminal-pair configuration (High, Low and Guard).

Connection mode: sets connection configuration between DUT (floating/grounded) and measurement circuit.

#### Ranging: auto or manual

#### Error Compensation

Cable length: 0 m, 1 m or 0-5 m. The standard cable (HP P/N 8120-4195) up to 5 m can be internally compensated.

Zero open: compensate stray capacitance and conductance at the test fixture.

External error compensation: compensate errors by external computer to eliminate other error factors not listed above.

Measurement speed: FAST, MED or SLOW

Trigger: Internal, External or Hold/Manual

Internal dc bias mode: OFF or  $\equiv$  (DC)



### Measurement Range/Resolution/Accuracy

Range <sup>1</sup>	Resolution <sup>2</sup>	Max. Display <sup>3</sup>	Accuracy <sup>4</sup> ±(% of rdg + counts)	
			OSC: 30 mV	OSC: 10 mV
10 pF/100 μS	0.001 pF 0.01 μS	19.000 pF 120.00 μS	±(0.1% + 5) ±(0.2% + 5)	±(0.2% + 5) ±(0.3% + 5)
100 pF/1 mS	0.01 pF 0.1 μS	190.00 pF 1.2000 mS	±(0.1% + 3) ±(0.2% + 3)	±(0.2% + 3) ±(0.3% + 3)
1 nF/10 mS <sup>5</sup>	0.1 pF 0.001 mS	1.9000 nF 12.000 mS	±(0.1% + 3) ±(1.2% + 3)	±(0.2% + 3) ±(1.2% + 3)

<sup>1</sup> 100 pF/1 mS and 1 nF/10 mS ranges only in grounded measurement.

<sup>2</sup> When measurement speed is set to FAST (10 mV/30 mV) or MED (10 mV), resolution and Max. display become 1 digit less (3½ digit display).

<sup>3</sup> Approx. 50 pF at 100 pF/1 mS range and 1.76 nF at 1 nF/10 mS range in grounded measurement. Error correction to offset residuals will reduce maximum value which can be measured.

<sup>4</sup> Accuracy is specified at UNKNOWN terminals and at the end of HP 16082A Test Leads (1 m) after warm-up ≥30 min., at temperature 23°C ±5°C, zero open calibration is performed, and CORRECTION is enabled. Front panel settings are C-G, FLOATING and 0 m or 1 m (CABLE LENGTH). Some errors will be added at other settings (refer to data sheet). C accuracy is specified when D < 0.05 and G accuracy is specified when counts of C < 1/100 of range. Error double at 0°C-55°C.

<sup>5</sup> Add 0.1% of rdg for C and 0.2% of rdg for G when HP 16082A is used.

### C-V Measurement

**Function:** measures C-V, G-V or C & G-V characteristics using internal staircase bias.

**Measurement speed:** FAST, MED or SLOW

### C-t Measurement

**Function:** measures C-t, G-t or C & G-t characteristics using internal and/or external pulse bias source.

**Internal measurement mode:** Burst or Sampling Mode automatically selected.

**Burst mode:** apply one pulse then make repetitive measurement with specified time interval between measurements.

**Sampling mode:** repeated pulse with single samples between pulses. Delay between application of measure voltage and sample can be specified.

**Measurement speed:** FAST or MED

### DC Bias Source

**Output Mode:** , , , (DC) or OFF

**Output Voltage Range/Resolution/Accuracy**

Voltage Range	Resolution	Accuracy* ±(% of setting + volts)
±1.999 V	1 mV	±(0.2% + 0.01 V)
±19.99 V	10 mV	±(0.1% + 0.02 V)
±100.0 V	100 mV	±(0.1% + 0.1 V)

\*at 23°C ±5°C, at 0°C -55°C error doubles

**Staircase Sweep Parameter Settings (C-V Basic Function Only)**

**Start/stop voltage:** 0 V-±100 V (max. 1 mV resolution)

**Step voltage:** 0 V-200 V (max. 1 mV resolution)

**Hold/step delay time (th/td):** 3 ms-650s (max. 1 ms resolution)

**Pulse Bias Parameter Settings (C-t basic function only)**

**DC/pulse/measurement voltage:** 0 V-±100 V (max. 1 mV resolution)

**Number of readings:** 1-9999

**Hold time (th):** max. 10 μs resolution

**Internal bias:** 10 ms-32 s

**Ext bias slow:** 50 μs-32 s

**Ext bias fast:** 10 μs-32 s

**Delay time (td):** 10 μs-32 s (max. 10 μs resolution)

### Burst Mode

Function	Meas. Speed	Block Mode	Non Block Mode	
			Data Format	
			Binary	ASCII
C-t G-t	FAST	10 ms-32 s	20 ms-32 s	150 ms-32 s
	MED			
C & G-t	FAST	50 ms-32 s		200 ms-32 s
	MED		100 ms-32 s	250 ms-32 s

### Sampling Mode

**Ext bias slow:** 200 μs-5 s

**Ext bias fast:** 10 μs-5 s

**Math functions:** displays measured C/G values as differential values (Δ), % ratio (%) or differential % (Δ%) of the reference value.

### Other

**HP-IB:** not just IEEE-488, but the hardware, documentation and support that delivers the shortest path to a measurement system.

**Data output format:** ASCII or Binary

**Block mode output:** can make C-V/t characteristics measurement and store measured data (C-V/t or G-V/t Function: 680 data, C & G-V/t Function: 400 data) into the internal data buffer. Then, packed data can be output.

### Recorder Output

**Output voltage:** ±10 V for C, G and V/t data

**Accuracy:** ±(% of output voltage + V)

**C or G:** ±(0.5% + 20 mV)

**V or t:** ±(0.15% + 40 mV)

**Self test:** verifies normal measurement operations (not including calibration)

### Options

**Option 001:** High Resolution Offset Capacitance Measurement

**Function:** increase C measurement resolutions by one digit with offset reference value.

**C offset range:** 0 pF-1023 pF (1 pF increment). C offset value can be set by measured data or numeric key.

### General Specifications

**Operating temperature range:** 0°C to 55°C; 95% RH at 40°C

**Power requirements:** 100/120/220 V ±10%, 240 V + 5% - 10%; 48 to 66 Hz; 140 V A max.

**Dimensions:** 426 mm W x 177 mm H x 498 mm D (16.5" x 7" x 19.5")

**Weight:** 15.3 kg (33.7 lb)

### Accessories Furnished

**HP 16080A:** Direct Coupled Test Fixture

**Reference Data** (reference data are typical values given for information purpose)

**C/G measurement time:** A (+B) (+C) (+D)

	Meas. Speed	Display Parameter		
		C	G	C-G
A (Net Meas. Time)	FAST	10 ms		30 ms
	MED	40 ms	35 ms	70 ms
	SLOW	270 ms	220 ms	400 ms
B (Internal Error Compensation Time)		30 ms		60 ms
C (MATH Function Time)		10 ms		20 ms
D (Display Output Time)		10 ms		20 ms

**Residual L-R compensation:** error compensation for residual L-R (max. 19 μH/190 Ω) is available using an external controller.

**Internal DC Characteristics of High and Low Unknown Terminals (Without DC Bias)**

**Maximum offset voltage:** ±1 mV

**Maximum allowable current:** 100 mA

### Internal DC Bias

**Settling time (99.9% of final value):** 0.05 × voltage swing (V) + 1.7 (ms)

**Maximum output current:** ±6 mA

**Hold time/step delay time/th/td:** 0.02% (basic accuracy)

**Response time of the EXT SLOW bias circuit (99.9% of final value):** 100 μs

### Option 001

**C offset accuracy:** ±(0.2% of reference value + 0.5 pF) can be compensated by CORRECTION ENABLE key.

### Ordering Information

**Opt 001 C-High Resolution** (not field installable)

**HP 16081A Test Leads,** 2 m double shielded, BNC

**HP 16082A Test Leads,** 1 m, BNC

**HP 16083A Pulse Bias Noise Clipper**

**HP 4280A 1 MHz C Meter/C-V Plotter**

## Q Meter

Model 4342A



- Frequency range: 22 kHz to 70 MHz
- Q range: 5 to 1000

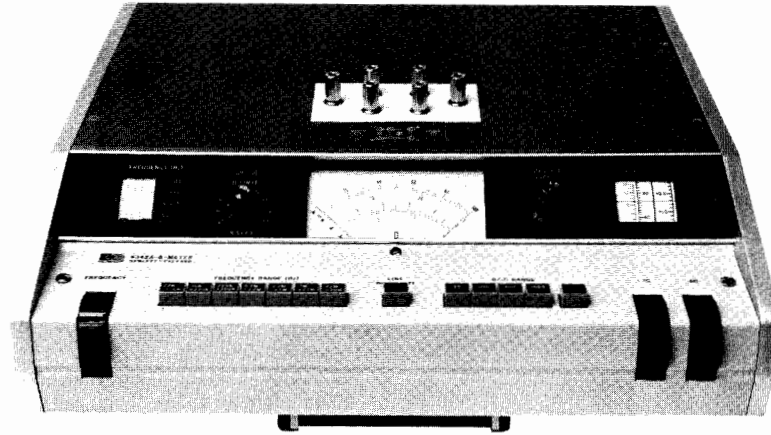

HP 4342A

### Description

The direct-reading expanded scale of the HP 4342A permits measurement of Q from 5 to 1000 and readings of very small changes in Q resulting from variation in test parameters. The HP 4342A is solid state with the elimination of specially matched, fragile thermocouple components.

The HP 4342A will measure dissipation factor and dielectric constant of insulating materials. The Q meter can measure coefficient of coupling, mutual inductance, and frequency response of transformers. RF resistance, reactance, and Q of resistors and capacitors can also be determined.

Pushbutton operation of frequency range and Q/ $\Delta$ Q range selection provides straightforward measurement. Automatic indication of meter scales, frequency dials and frequency multipliers are featured, adding to simplicity and reading speed.

### Specifications

#### RF Characteristics

**RF range:** 22 kHz to 70 MHz in 7 bands: 22 to 70 kHz, 70 to 220 kHz, 220 to 700 kHz, 700 to 2200 kHz, 2.2 to 7 MHz, 7 to 22 MHz, 22 to 70 MHz.

**HP 4342A Opt 001:** 10 kHz to 32 MHz in 7 bands: 10 to 32 kHz, 32 to 100 kHz, 100 to 320 kHz, 320 to 1000 kHz, 1 to 3.2 MHz, 3.2 to 10 MHz, 10 to 32 MHz.

**RF accuracy:**  $\pm 1.5\%$  from 22 kHz to 22 MHz;  $\pm 2\%$  from 22 MHz to 70 MHz;  $\pm 1\%$  at "L" point on frequency dial.

**HP 4342A Opt 001:**  $\pm 1.5\%$  from 10 kHz to 10 MHz;  $\pm 2\%$  from 10 MHz to 32 MHz;  $\pm 1\%$  at "L" point on frequency dial.

**RF increments:** approximately 1% resolution.

#### Q Measurement Characteristics

**Q range:** 5 to 1000 in 4 ranges: 5 to 30, 20 to 100, 50 to 300, 200 to 1000.

**Q accuracy:** % of indicated value: (at 25°C)

Q Freq.	HP 4342A & HP 4342A Opt. 001 22 kHz-30MHz	HP 4342A 30 MHz-70 MHz
5-300	$\pm 7$	$\pm 10$
300-600	$\pm 10$	$\pm 15$
600-1000	$\pm 15$	$\pm 20$

**Q increments:** upper scale, 1 from 20 to 100; lower scale, 0.5 from 5 to 30.

**$\Delta$ Q range:** 0 to 100 in 4 ranges: 0 to 3, 0 to 10, 0 to 30, 0 to 100.

**$\Delta$ Q accuracy:**  $\pm 10\%$  of full scale.

**$\Delta$ Q increments:** upper scale, 0.1 from 0 to 10; lower scale, 0.05 from 0 to 3.

#### Inductance Measurement Characteristics

**L range:** 0.09  $\mu$ H to 1.2 H, direct reading at 7 specific frequencies.

**L accuracy:**  $\pm 3\%$  after substitution of residuals (approx. 10 nH).

#### Resonating Capacitor Characteristics

**Capacitor range:** main dial, 25 to 470 pF, vernier dial,  $-5$  to  $+5$  pF.

**Capacitor accuracy:** main dial,  $\pm 1\%$  or 1 pF, whichever is greater; vernier dial,  $\pm 0.1$  pF.

**Capacitor increments:** main dial, 1 pF from 25 to 30 pF, 2 pF from 30 to 200 pF, 5 pF from 200 to 470 pF; vernier dial, 0.1 pF.

#### General

##### Rear Panel Outputs

**Frequency monitor:** 170 mV rms min. into 50  $\Omega$ .

**Q analog output:** 0 to 1 V  $\pm 50$  mV dc after 15 minutes warmup, proportional to meter deflection. Output impedance approximately 1 k $\Omega$ .

**Over limit signal output:** contact closure at the rear panel. Relay contact capacity 0.5 A/15 VA.

**Over limit display time:** selectable, 1 s or continuously on, after limit exceeded.

**Temperature range:** 0°C to 50°C.

**Power:** 115 or 230 V  $\pm 10\%$ , 50-400 Hz, approximately 40 VA.

**Size:** 138 mm H x 425 mm W x 414 mm D (5 $\frac{1}{16}$ " x 16 $\frac{3}{4}$ " x 16 $\frac{1}{16}$ ").

**Weight:** net, 14 kg (31 lb); shipping, 18.45 kg (41 lb).

##### Accessories Available

**HP 16014A series loss test adaptor:** designed for measuring low-value inductors and resistors and high-value capacitors.

**HP 16451A Dielectric Test Adapter:** designed for measuring the dielectric constant, capacitance and dissipation factor of insulating materials.

**HP 16462A Auxiliary Capacitor:** designed to extend the Q and L measurement capability of the HP 4342A Q Meter. It is especially useful for measuring small inductors at low frequencies.

**HP 16470A Reference Inductors:** A range of 20 inductors (any of which can be supplied separately) which can be used with the HP 4342A Q Meter when measuring the RF characteristics of capacitors, resistors, or insulating materials.

**HP 16470B Stable Inductors:** A set of 4 inductors (any of which are separately available) which can be used to compensate indicated Q values and/or instrumental variation in the maintenance of the HP 4342A Q Meter. They are usable over a range of 800 kHz to 50 MHz with excellent long-term temperature stability.

##### Options and Accessories

**Opt 001:** Frequency Range (10 kHz - 32 MHz)

**Opt 910:** Extra Manual

**HP 16014A Series Loss Test Adaptor**

**HP 16451A Dielectric Test Adapter**

**HP 16462A Auxiliary Capacitor**

**HP 16470A Reference Inductors, set of 20**

**HP 16470B Stable Inductors, set of 4**

**HP 16470C Complete set of 24 Inductors (HP 16470A**

**+ HP 16470B)**

**HP 4342A Q Meter**



# COMPONENT & SEMICONDUCTOR MEASUREMENT

## Milliohmmeter/High Resistance Meter

Model 4328A/4329A

225



- 20  $\mu\Omega$  resolution on 1 m $\Omega$  range
- Four terminal measurement
- Low test voltage



- Wide range: 500 k $\Omega$  to  $2 \times 10^{16} \Omega$
- Selectable test voltages: 10 V to 1000 V

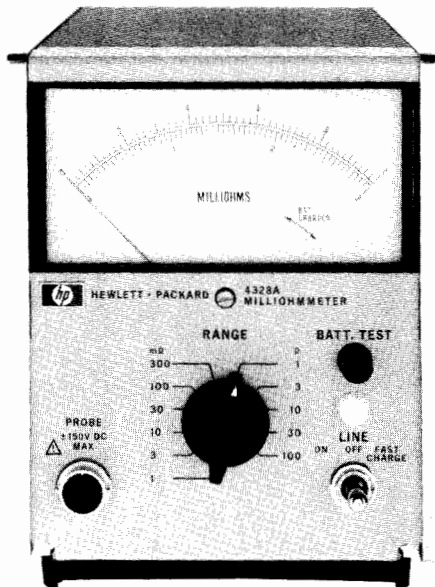

HP 4328A

### Description

HP's 4328A Milliohmmeter is a high sensitivity portable instrument for measurement of low resistances. The 1 m $\Omega$  to 100  $\Omega$  measuring range and 20  $\mu\Omega$  resolution make the HP 4328A ideal for measuring the contact resistance of switches, relays, and connectors and the resistivity of conductors and semiconductors. Series reactances of up to twice the full scale resistance will not affect the accuracy. The maximum voltage across a sample, with the instrument at the proper range, is less than 200  $\mu\text{V}$  peak. Even at incorrect range settings, the voltage across the sample will not exceed 20 mV peak.

The special probes that allow four-terminal measurement in two probes are furnished with the HP 4328A.

The basic HP 4328A is line operated but Opt 001 permits operation from rechargeable batteries for 15 continuous hours.

### Specifications

**Range:** 0.001 to 100 ohms full scale in a 1, 3 sequence.

**Accuracy:**  $\pm 2\%$  of full scale. No additional error is caused by series reactance of samples up to two times full scale.

**Measuring frequency:** 1000 Hz  $\pm 100$  Hz.

**Voltage across sample:** 200  $\mu\text{V}$  peak at full scale.

**Maximum voltage across sample:** 20 mV peak.

**Superimposed dc:** 150 V dc maximum (external source).

**Recorder output:** 0.1 V dc output at full scale, output resistance approx. 1 k $\Omega$ .

**Applied current (mA):** constant by range, 150/(full scale value in milliohms).

### General

**Power requirements:** 115/230 V  $\pm 10\%$ , 50 to 60 Hz, 1.5 VA.

**Weight:** 3.2 kg (7 lb).

**Size:** 155 mm H x 130 mm W x 280 mm D (6 $\frac{1}{2}$ " x 5 $\frac{1}{8}$ " x 11").

**Accessories furnished:** HP 16005A Probe, HP 16006A Probe, HP 16007A/B Test Leads and HP 16143A Probe Cable.

### Ordering Information

HP 4328A Milliohmmeter

Opt 001: Rechargeable battery operation

Opt 910: extra manual



HP 4329A

### Description

The HP 4329A is a solid-state insulation resistance meter designed for easy, accurate and direct readings of the very high resistance values typically found in synthetic resins, porcelain, insulating oils and similar materials. It is also useful for measurements in electrical components such as capacitors, transformers, switches and cables. Seven fully regulated dc test voltages (between 10 and 1000 Vdc) are provided as test sources.

The HP 4329A is instantly convertible from ungrounded-to-grounded-sample operation via a simple relocation of the front panel ground strap from "guard" to "+" position.

The HP 4329A also has a current measurement capability. Minute currents as low as 0.05 pA can be readily measured.

The HP 16008A Resistivity Cell, designed for use with the HP 4329A, can safely, rapidly and conveniently measure the volume and surface resistivity of sheet insulation materials (maximum sample size: 125 mm W x 125 mm D x 7 mm H).

### Specifications

#### Resistance Measurement

**Range:** 500 k $\Omega$  to  $2 \times 10^{16} \Omega$ . (Depends on the test voltage).

**Accuracy:** total accuracy is determined by test voltage and range used. At low resistance end of each scale, accuracy is  $\pm 3\%$ , near center scale  $\pm 5\%$ , and near the specified upper limit on the meter scale (a quarter of full scale), accuracy is  $\pm 10\%$ . Accuracy is not specified above these limits. On all voltage ranges, if multiplier is set to Rmax., an additional  $\pm 3\%$  is included.

**Test voltages:** 10 V, 25 V, 50 V, 100 V, 250 V, 500 V and 1000 V  $\pm 3\%$ .

#### Current Measurement

**Range:**  $5 \times 10^{-14}$  to  $2 \times 10^{-5}$  A in 8 ranges.

**Accuracy:**  $\pm 5\%$  of full scale deflection (there can be an additional  $\pm 3\%$  error at the top decade).

#### General

**Recorder output:** 0 to 100 mV dc, proportional to meter deflection; 1 k $\Omega$  output resistance.

**Power:** 115/230 V  $\pm 10\%$ , 50-60 Hz, approximately 3 VA.

**Size:** 155 mm H x 198 mm W x 204 mm D (6 $\frac{1}{2}$ " x 7 $\frac{7}{32}$ " x 8 $\frac{25}{32}$ ").

**Weight:** 3.5 kg (7.7 lb).

**Accessory furnished:** HP 16117A Low Noise Test Leads.

**Accessory available:** HP 16008A Resistivity Cell.

### Ordering Information

HP 16008A Resistivity cell

HP 4329A High resistance meter

Opt 910: extra manual



# COMPONENT & SEMICONDUCTOR MEASUREMENT

## pA Meter/DC Voltage Source

Model 4140B

- 3 basic semiconductor measurements: I, I-V and quasi-static C-V
- Two programmable voltage sources
- Basic accuracy: 0.5%
- High resolution:  $0.001 \times 10^{-12}$
- HP-IB standard

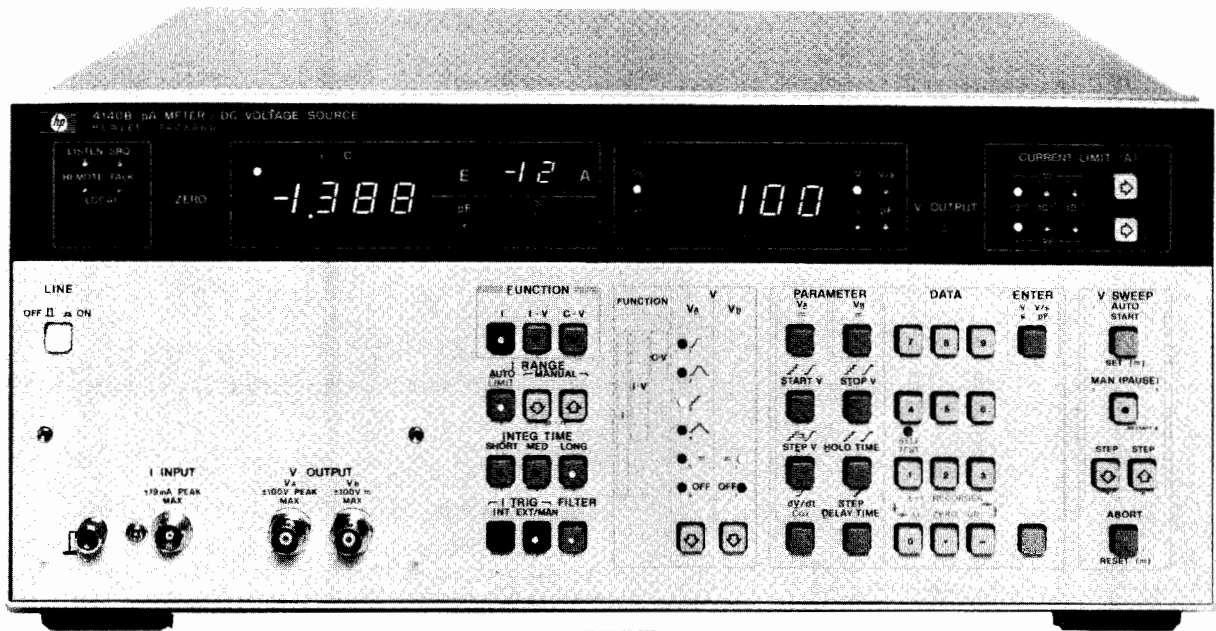

HP 4140B



### Description

The HP 4140B pA Meter/DC Voltage Source is another in Hewlett-Packard's new generation of Component Measurement instrumentation. It consists of an extremely stable picoampere meter and two programmable dc voltage sources, one of which operates as a ramp and staircase generator as well as a dc source. These features make the HP 4140B ideal for making dc characteristic measurements such as leakage current, current-voltage characteristics and quasi-static C-V measurements required by the semiconductor industry for new product development and for improving production yields. It is equally useful in measurements of electronic components and materials to determine leakage currents or insulation resistances.

The HP 4140B can contribute to the development, production and quality control of semiconductor devices and to the improvement in the reliability of electronic components and equipment.

### Stable pA Measurements

Stable picoampere measurements can be made with the HP 4140B with a maximum resolution of  $10^{-15}$ A. This is made possible by a new measurement technique in conjunction with an offset current capability, low noise test leads, and an electrostatic and light shielded test fixture. These features provide both stable and fast picoampere measurements.

This measurement technique is very useful in making small leakage current measurements and determining dc parameters of semiconductor devices or measuring the insulation resistance and leakage current for dielectric absorption measurements necessary in the analysis of capacitors or insulation materials.

### Synchronized I-V Measurements

The HP 4140B makes automatic, synchronized current-voltage measurements that have required a large instrumentation system in the past.

The two voltage sources in the HP 4140B operate over a range of  $-100$  V to  $+100$  V with a maximum resolution of 10 mV. One operates only as a stable dc source while the other generates a staircase voltage, a precise ramp or a stable dc level.

By adding precise, programmable timing capability, we can now make fast, accurate I-V and C-V measurements. Device stabilization times, (time between the applied voltage and the subsequent current

measurement) can now be programmed from the front panel of the HP 4140B or via the HP-IB bus.

### Quasi-Static C-V Measurements

Automatic quasi-static C-V measurements are easily accomplished by the ramp voltage capability of the HP 4140B. This measurement is highly significant in evaluating basic semiconductor characteristics.

The HP 4140B operates over a capacitance range of 0.1 pF to 1999 pF with a dc voltage ramp rate of 1 mV/s to 1 V/s in 1 mV/s increments. Capacitance, which is calculated from the measured current divided by the ramp rate, can also be provided as a percent of the capacitance of the oxide film ( $C_{ox}$ ) over a range of 0.0 to 199.9%. By providing the output voltage at each capacitance measurement point, we have the dc (quasi-static) C-V characteristics of the device under test.

### HP-IB Capability

Interfacing the HP 4140B to an HP-IB system improves measurement efficiency and takes advantage of its high speed (approx 5 ms) measurement rate. Such a system will minimize measurement time of dc parameters of semiconductors and the insulation resistance and leakage current of electric components and materials. This allows rapid feedback to production for fast evaluation of a new device in the development stage.

### Specifications

**Measurement functions:** I, I-V and C-V

**Voltage sources:** two separate sources ( $V_A$  and  $V_B$ )

$V_A$ :  $\pm 100$  V programmable source/function generator

$V_B$ :  $\pm 100$  V programmable dc voltage source

**Measurement Function/Source Selection**

Function	$V_A$	$V_B$
I		
I-V		
C-V		

**Voltage sweep:** auto or manual (pause)

#### Current Measurements

**Displays:** current, 3½ digits with 2 character annunciator. Voltage, 3½ digits.

**Measurement range:**  $\pm 1.000 \times 10^{-12} \text{A}$  to  $1.000 \times 10^{-2} \text{A}$  full scale in 11 ranges.

**Overrange capability:** 99.9% on all ranges.

**Range selection:** auto (lowest current range is selectable) and manual

#### Measurement Accuracy/Integration Time

Range	Accuracy* ± (% of rdg. + counts)	Integration Time** (ms)		
		Short	Medium	Long
$10^{-2} - 10^{-9}$	0.5 + 2	20	80	320
$10^{-10}$	2 + 2			
$10^{-11}$	5 + 3	80	320	1280
$10^{-12}$	5 + 8	160	640	2560

\* Accuracy for long integration time.  $23^\circ\text{C} \pm 5^\circ\text{C}$ , humidity  $\leq 70\%$ . For short and medium integration time, see reference data section.

\*\* Integration times specified at 50 Hz. For 60 Hz operation, multiple time by  $\frac{5}{4}$ .

**Zero offset:** cancels leakage current of test leads or test fixtures.

**Offset range:** 0 to  $\pm 100 \times 10^{-15} \text{A}$ .

**Trigger:** INT, EXT and HOLD/MAN

**Input terminal:** triaxial

#### Capacitance-Voltage (C-V) Measurement

**Measurement ranges:** 0.0 pF – 100.0 pF and 200 pF – 1000 pF full scale in two ranges; 99.9% overrange

**Ranging:** auto

**%C:** capacitance change of device under test is displayed as a percent of the set value of the oxide capacitance ( $C_{ox} = 100\%$ )

**%C range:** 0.0% – 199.9%

**Cox setting ranges** (2 ranges): 0.1 pF – 199.9 pF and 200 pF – 1999 pF

**Capacitance calculation accuracy:** accuracy is dependent on accuracy of both the current measurement and ramp voltage.

**Zero offset:** cancels stray capacitances of test fixtures and test leads.

**Offset range:** 0 to 100 pF

**High speed I data output:** available with HP-IB interface only. Outputs current measurement data at 4 ms intervals (max rate).

#### DC Voltage Sources

##### Output Modes, $V_A$ and $V_B$

Function	$V_A$	$V_B$
I		--- (DC)
I-V		--- (DC)
C-V		(DC)

**Voltage ranges** ( $V_A$  and  $V_B$ ): 0 to  $\pm 10.00 \text{V}$  and 0 to  $\pm 100.0 \text{V}$  in 2 ranges, auto range only.

**Maximum current:** 10 mA, both sources.

**Voltage sweep:** auto and manual (pause), up/down step in manual (pause) mode. Sweep abort standard.

#### Operating Parameter Setting Ranges

**Start voltage and stop voltage:** 0 –  $\pm 10.00 \text{V}$ , 0.01 V steps; 0 –  $\pm 100.0 \text{V}$ , 0.1 V steps

**Step voltage:** 0 –  $\pm 10.00 \text{V}$ , 0.01 V steps; 0 –  $\pm 100.0 \text{V}$ , 0.1 V steps

**Hold time:** 0 – 199.9 seconds in 0.1 s increments; 0 – 1999 seconds in 1.0 s increments

**Step delay time:** 0 – 10.00 seconds in 0.01 s increments; 0 – 100.0 seconds in 0.1 s increments

**Ramp rate** (dV/dt): 0.001 V/s – 1.000 V/s in 0.001 V/s increments

#### Accuracy (at $23^\circ\text{C} \pm 5^\circ\text{C}$ )

**Output voltage:**  $\pm 10 \text{V}$ ,  $\pm(0.07\% + 11 \text{mV})$ ;  $\pm 100 \text{V}$ ,  $\pm(0.09\% + 110 \text{mV})$

**Ramp rate:** typically 0.5%, 0 –  $\pm 10 \text{V}$ ;  $< 5\%$ ,  $> 10 \text{V}$ .

**Current limit:** 100  $\mu\text{A}$ , 1 mA and 10 mA,  $\pm 10\%$  ( $V_A$  and  $V_B$ )

**Output terminals:** BNC; L-GND

## Reference Data

### Current Measurement

#### Current Measurement Accuracy\*

Range	Integration Time	
	Short	Medium
$10^{-2} - 10^{-8}$	0.5 + 3	0.5 + 2
$10^{-9}$	0.5 + 3	0.5 + 3
$10^{-10}$	2 + 4	2 + 3
$10^{-11}$	5 + 10	5 + 4
$10^{-12}$	5 + 20	5 + 10

\*  $\pm$  (% of rdg. + counts),  $23^\circ\text{C}$

**Current ranging times:** 21 ms to 3.8 s. (longer ranging time needed for large changes in input signal level, especially on lowest current ranges).

\*When FILTER is on, current ranging time increases 60 ms (50 Hz power line) or 50 ms (60 Hz power line)

**Warm-up time:**  $\geq 1$  hour

**Common mode rejection ratio:**  $\geq 120 \text{ dB}$  ( $\leq 2$  counts)

#### Analog Output I, C and $V_A$

**Accuracy:**  $\pm(0.5\% + 20 \text{mV})$

**Low pass filter:** 3 position: OFF, 0.22 s  $\pm 20\%$  and 1s  $\pm 20\%$  applied to both  $V_A$  and I/C data outputs

**Pen lift output:** TTL low level ( $\leq 0.8 \text{V}$ ) during sweep period in I-V and C-V functions

**Recorder output scaling:** pushbutton scaling of lower left and upper right limits of X-Y recorder

#### HP-IB Interface

**Remote controlled functions:** measurement function, current range, integration time, I data output trigger, voltage sweep controls, current limit,  $V_A$  and  $V_B$  voltages, zero (offset), self test and parameter settings (voltages, sweep/hold/delay times)

#### Data Output

Measured data (I, C and  $V_A$ ),

Voltage setting ( $V_A$  and  $V_B$ ),

Parameter settings

#### General Information

**Power:** 100, 120, 220, V  $\pm 10\%$ , 240 V  $+5\% - 10\%$ ; 48-66 Hz, 130 VA max

**Size:** 426 mm W x 177 mm H x 498 mm D (16.5" x 7" x 19.6")

**Weight:** 14.4 kg (31.7 lb)

#### Accessories Furnished

**HP 16053A test leads:** consists of one triaxial cable, two each BNC-BNC cables and one connection plate with mating female panel-mount connectors. Cables are one meter in length.

**HP 16055A test fixture:** for general device measurements. Provides electrostatic and light shielding for stable pA measurements.

#### Accessories Available

**HP 16054A connection selector:** provides a simple method to select appropriate connection of low lead for the pA meter section.

**HP 16056A current divider (10:1):** for use only on the 10 mA range to extend the measurement capability to 100 mA.

#### Ordering Information

##### Accessories

HP 16053A Test Leads (furnished)

HP 16054A Connection Selector

HP 16055A Test Fixture (furnished)

HP 16056A Current Divider (10:1)

##### Options

Opt 907 Front Handle Kit (HP P/N 5061-0090)

Opt 908 Rack Flange Kit (HP P/N 5061-0078)

Opt 909 Rack & Handle Kit (HP P/N 5061-0084)

Opt 910 Extra Manual

**HP 4140B pA Meter/DC Voltage Source**

## Semiconductor Parameter Analyzer

Model 4145A

- Fully automatic, high speed dc characterization of semiconductor devices and materials
- Four programmable stimulus/measurement units capable of high resolution, wide range sourcing and sensing ... I: 1 pA~100 mA, V: 1 mV~100 V
- Built-in graphics analysis functions
  - marker and cursor provide direct numeric readouts
  - line function for automatic calculation of line gradient and X,Y axes intercept values
- Built-in flexible disc drive for permanent storage of user programs and measurement results

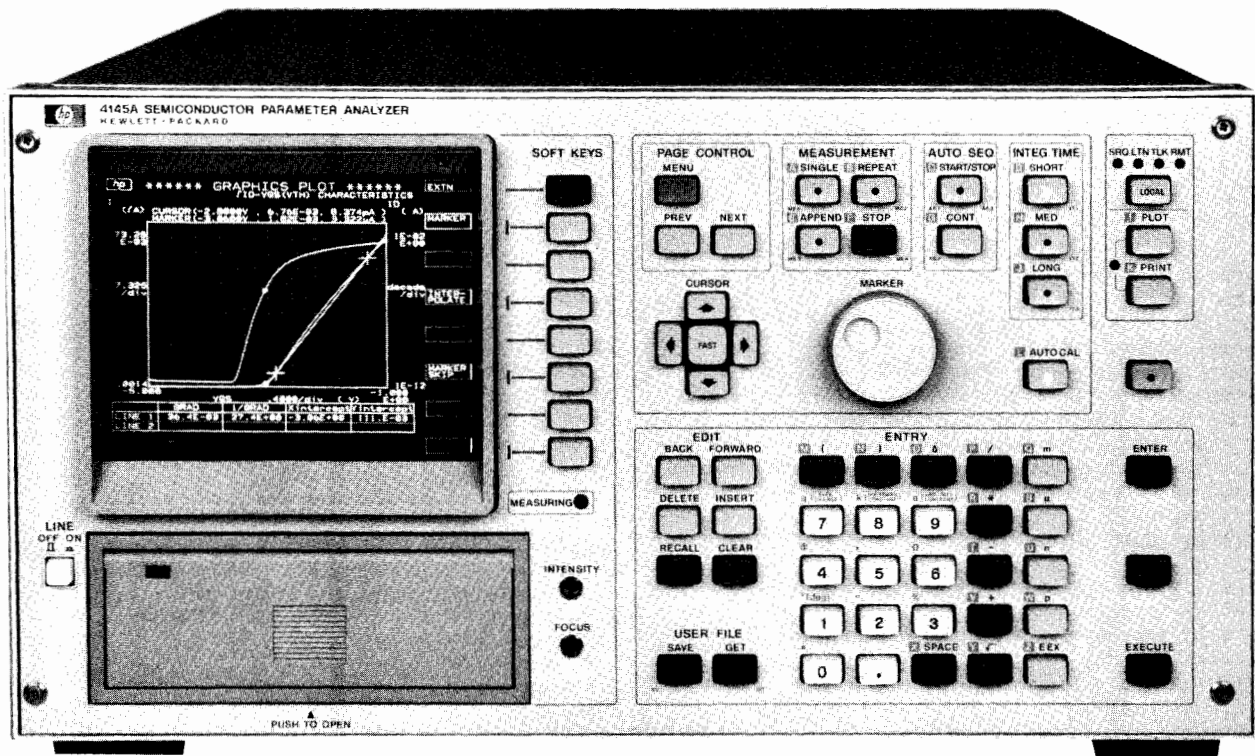

HP 4145A



### Description

Designed for production line and laboratory use, the HP 4145A is the electronics industry's first stand-alone instrument capable of complete dc characterization of semiconductor devices and materials. It stimulates voltage and current sensitive devices, measures the resulting current and voltage responses, and displays the results in a user-selectable format (graph, list, matrix or schmo) on a built-in CRT display. An on-board programmable calculator provides real-time calculation of voltage/current dependent parameters, such as the current gain ( $h_{FE}$ ) and transconductance ( $g_m$ ) of transistors, which also can be displayed on the CRT. A number of powerful graphic analysis tools—marker, cursor, line function, interpolation—enhance the HP 4145A's basic capabilities and provide fast, accurate analysis of semiconductor devices, leading to increased production yields and improved device quality.

Four built-in stimulus/measurement units (SMUs) are the heart of the HP 4145A. Each SMU can be independently programmed to function as either a voltage source/current monitor or a current source/voltage monitor. Thus, a bipolar transistor, for example, can be completely characterized in common-base, common-emitter, and common-collector configurations without changing connections—only changing the SMUs' operating modes is required. The HP 4145A is also equipped with two voltage sources and two voltage monitors for measurements on devices having more than four terminals, such as ICs.

The HP 4145A can be controlled from the front panel, via the HP-IB (standard), or by measurement setups stored on flexible discs.

Displayed information—measurement setups, auto-sequence programs, measurement results—can be dumped directly onto an external digital printer/plotter to obtain publication quality hard copies. Also, measurement results can be sent via the HP-IB to a computer for further processing.

### Auto Sequence Programs

Measurement programs stored on a HP 4145A flexible disc can be linked by an auto sequence program, making it possible to perform a series of measurements with just one keystroke.

### Four User-Selectable Display Formats to Suit the Evaluation

Measurement results can be displayed in one of four display formats: GRAPHICS, LIST, MATRIX or SCHMOO. After measurement has been made and the results displayed, the softkeys can be used to access various analysis functions for complete device evaluation. These functions include MARKER for numeric readout of measured value at any point along a plotted curve, CURSOR for numeric readout of value at any graphic point and for line positioning, STORE /RECALL for overlay comparisons, AUTO SCALE for optimum graphic scaling, and LINE FUNCTION for direct readout of line gradient and X-Y axes intercept values.

## Specifications

### Measurement

**Stimulus measurement unit (SMU):** four SMUs are built into the HP 4145A. Each SMU can be programmed to source voltage and monitor current, or conversely to source current and monitor voltage. Each SMU can also be programmed to COM mode. This sets voltage at 0 volts and current compliance at 100 mA.

**Output/measurement resolution:** voltage, 4½ digits; current, 4 digits

**Voltage measurement input resistance/current source output resistance:**  $\geq 10^{12} \Omega$

**Maximum capacitive load:** 1000 pF

### SMU Voltage Range, Resolution and Accuracy

Voltage Range	Resolution	Accuracy <sup>1,2</sup>	Max. Current
±20 V	1 mV	±(0.1% of reading + 0.05% of range + 0.4 Ω × I <sub>out</sub> *)	100 mA
± 40 V	2 mV		50 mA
± 100 V	5 mV		20 mA

\*I<sub>out</sub> is SMU output current in amps.

### SMU Current Range, Resolution and Accuracy

Current Range	Resolution	Accuracy <sup>1,2</sup>	Max. Voltage
± 100 mA	100 μA	±[0.3% + (0.1 + 0.2 × V <sub>out</sub> /100)%]	20 V (I > 50 mA) 40 V (20 mA < I ≤ 50 mA) 100 V (I ≤ 20 mA)
± 10 mA ± 1000 μA ± 100 μA ± 10 μA	10 μA 1 μA 100 nA 10 nA		100 V
± 1000 nA ± 100 nA	1 nA 100 pA	± [0.5% + (0.1 + 0.2 × V <sub>out</sub> /100)%]	
± 10 nA ± 1000 pA	10 pA 1 pA**	± [1% + (0.1 + 0.2 × V <sub>out</sub> /100)% + 5 pA]	

\*V<sub>out</sub> is SMU output voltage in volts.

\*\*50 fA resolution in current monitor mode.

- Accuracy specifications are given as ±% of reading or setting value ±% of range.
- Accuracy tolerances are specified at 25°C ± 5°C, after a 40 minute warm-up time, with AUTO CAL on, and specified at the rear panel connector terminals referenced to SMU common. Tolerances are doubled for the extended temperature range of 10°C to 40°C.

### SMU Voltage/Current Compliance

**Maximum voltage compliance:** 20 V, 40 V, or 100 V, depending on the output current range.

**Maximum current compliance:** 20 mA, 50 mA, or 100 mA, depending on the output voltage range.

**Compliance setting resolution:** same as current and voltage output/measurement resolution. Maximum current compliance resolution, however, is 50 pA.

**Compliance accuracy:** voltage compliance accuracy is the same as voltage output/measurement accuracy. Current compliance accuracy is current output/measurement accuracy ± (1% of range + 10 pA).

### Voltage/Current Sweep Characteristics

Output from up to three SMUs or voltage sources can be swept in one of three modes: VAR1, VAR2, or VAR1'.

**VAR1:** linear or logarithmic staircase sweep

**VAR2:** linear staircase sweep. Output from the VAR2 source is incremented after completion of each VAR1 sweep.

**VAR1':** output from the VAR1' source is synchronized with VAR1 but at levels proportional to a user-selectable ratio or offset relative to VAR1.

**Ratio:** ±0.01 to ±10

**Offset:** any value that will not cause VAR1' to exceed maximum allowable output.

**Hold time:** 0 to 650 seconds, ±(0.5% + 9 ms) with 10 ms resolution

**Delay time:** 0 to 6.5 seconds, ±(0.1% + 5 ms) with 1 ms resolution

### Voltage Sources (Vs) Characteristics

**Number of sources:** two

**Output resistance:**  $\leq 0.2 \Omega$

**Maximum capacitive load:** 1000 pF

### Voltage Output Range, Resolution and Accuracy

Output Voltage Range	Resolution	Accuracy	Max. Output Current
±20 V	1 mV	±(0.5% of setting + 10 mV)	10 mA

### Voltage Monitors (Vm) Characteristics

**Number of monitors:** two

**Input resistance:** 1 MΩ ± 1% shunted by 100 pF ± 10%

### Voltage Measurement Range, Resolution and Accuracy

Measurement Voltage Range	Resolution	Accuracy
± 2 V ±20 V	100 μV 1 mV	±(0.5% of reading + 10 mV) ±(0.2% of reading + 10 mV)

### Characteristics Common to SMUs, Voltage Sources & Voltage Monitors

**Maximum allowable terminal voltage:** 100 V peak across SMU and V<sub>m</sub> input terminals, or SMU and V<sub>S</sub> output terminals, or between those terminals and guard; and 42 V maximum from Common to Ground.

### Display

CRT size and screen resolution: 152.4 mm (6 inch) diagonal; 2048 x 2048 points.

**Display modes:** Graphics, Schmo, List, Matrix, and Time Domain

**External CRT analog output:** X, Y and Z outputs of 0 to 1 Vdc into 330 Ω (X and Y) and 240 Ω (Z).

### Analysis

**Calculation:** two user functions can be input and keyboard calculations can be done using the following 11 operators: +, -, \*, /, √, EXP, LOG, LN, \*\* (power), ABS (absolute) and Δ (differential).

### Constants Available on the Keyboard

**q:** Electron charge (1.602189 × 10<sup>-19</sup> coulomb)

**k:** Boltzmann's Constant (1.380662 × 10<sup>-23</sup> J/°K)

**e:** Dielectric constant of vacuum (8.854185 × 10<sup>-12</sup> F/m)

**Analysis functions:** overlay comparison with STORE/RECALL, Marker, Interpolate, Cursor, Auto scale, Zoom function (←→, →←, ↑↓, ↓↑), Line and Move Window.

### General Specifications

**Operating temperature range:** +10°C to +40°C; ≤70% RH at 40°C, permissible temperature change ≤1°C/5 min.

**Power requirements:** 100/120/220 V ± 10%; 240 V - 10% + 5%; 48 to 66 Hz; 270 VA max.

**Dimensions:** 426 mm W x 235 mm H x 612 mm D (16.75" x 9.06" x 24.1").

**Weight:** 27 kg (59 lb) approximately.

### Reference Data

**SMU measurement time:** measurement time = response time + ranging time + integration time.

### SMU Response Time

Current Range	Setup/Settling Time	SMU Wait Time
100 nA to 100 mA 1 nA and 10 nA	2.7 ms	0.2 ms 47.5 ms

**Ranging time:** varies from 4 ms to 74 ms

**Integration time:** SHORT, MED and LONG

	SHORT	MED	LONG
50 Hz	3.6 ms	20 ms	320 ms
60 Hz		16.7 ms	267 ms

### Accessories Furnished

HP 16058A Test Fixture

HP 16261A Software Disc Set

HP 04145-60001 Connector Plate

HP 04145-61622 Triaxial Cable (3m), 4 ea.

HP 04145-61630 BNC Cable (3m), 4 ea.

HP 04145-61623 Shorting Connector

### Ordering Information

HP 4145A Semiconductor Parameter Analyzer



# COMPONENT & SEMICONDUCTOR MEASUREMENT

## Semiconductor/Component Test System Model 4061A

- Ready to use—supplied with 7 turn-key application pacs
- Reliable impedance and current measurements with one probing
- Productivity improvement through accurate and fast measurement over wide range

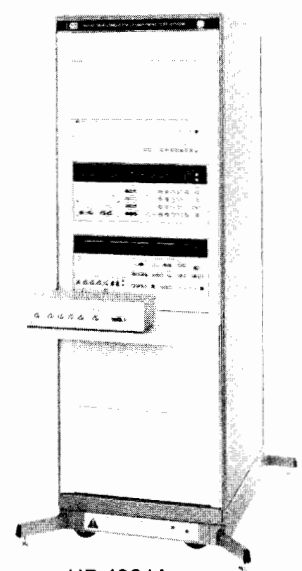

HP 4061A

### Description

The HP 4061A Semiconductor/Component Test System is a dedicated system for making efficient, automatic evaluation of the fundamental characteristics of semiconductor and electronic components required in R & D and production areas. This system employs reliable, accurate measurements and high speed data processing to perform more reliable evaluations with speed and less manpower. The HP 4061A is supplied with 7 sophisticated applications programs and is flexible in both software and hardware. Thus, the system can output measurement results in nearly any required data format.

The switching subsystem, designed especially for use with the HP 4061A, allows both impedance and current measurement without changing DUT connection. Using this new switching subsystem, and by making impedance measurements, the HP 4061A performs evaluation of Doping profile, Oxide capacitance, Flat band condition, Threshold voltage, Surface charge, and Minority carrier life time/surface generation velocity. The HP 4061A also measures leakage current and reverse/forward current-voltage characteristics. Surface state density evaluation, using both high (e.g., 1 MHz) and low frequency (Quasi-static) C-V measurements and data processing are also possible by making modifications to system software.

The system offers significant improvement in both yield and quality in production through fast and reliable measurements and evaluations. It is also a valuable evaluation tool for the development of new materials and devices. The HP 4061A provides the flexibility to meet the future measurement requirements of the electronics industry.

### System Configuration

- The HP 4061A consists of the following:
- HP 4140B pA Meter/DC Voltage Source
- HP 4275A Multi-frequency LCR Meter
- Switching Subsystem
- System controller can be chosen from HP 9000 Series 200 Model 226A/S, 236A/S or HP 9845B desktop computers
- HP 29402C 56-inch Rack Cabinet

### Impedance Measurement

The HP 4275A Multi-frequency LCR Meter offers excellent flexibility in measuring the impedance characteristics of semiconductors, LCR components and electronic materials. The HP 4275A's flexibility enables tests to be performed at test frequencies, test signal levels and dc bias voltage equivalent to, or very near actual operating

conditions. The HP 4275A offers up to 5½ digit resolution, wide measurement range (0.01 fF to 199.999 μF) basic accuracy of 0.1% over a 10 kHz to 10 MHz frequency range.

### Current Measurement

The HP 4140B pA Meter/dc Voltage Source offers stable current from 0.001 pA to 20 mA. Two programmable ±100 Vdc voltage sources are also built in. Fast, accurate I-V characterization of FETs and diodes are made easy using microprocessor timing control between the voltage sources and picoammeter. The HP 4140B also performs reliable quasi-static C-V measurement with high sensitivity and stability by using a highly linear ramp biasing technique.

### Switching Subsystem

The switching subsystem remotely changes DUT connection between the HP 4275A and HP 4140B. Thus, with one probing, the measurement cabling is automatically controlled and wide measurement range for both impedance measurements, up to 1 MHz, and current measurements down to 0.001 pA are guaranteed.

This switching subsystem includes an 8 bit data I/O function with 2 bit interrupt input for interface versatility. Non-HP-IB products such as IC probers, temperature controls, or component handlers can be interfaced through this 8 bit I/O. Of course, other HP-IB compatible products can be interfaced, allowing greater flexibility in both measurement and data processing.

### Controller

Standard controller for the HP 4061A can be selected from several desktop computers: HP 9000 Series 200 Model 226A/S, 236A/S and HP 9845B. The system controller provides 1) control functions via HP-IB interface and 2) complex data processing needed for evaluation of semiconductors and electronic components.

### System Software

System software consists of 7 turn-key application programs, 28 system subroutines, and 4 diagnostics. The application software is ready to use to perform basic semiconductor characterizations and component impedance evaluations. System subroutines are usable as major program subroutines to expand system measurement and data processing capabilities. The diagnostics isolate parts of the system not operating properly and can be used to verify system operation before making measurements.

### Furnished Application Software

Semiconductor high/low frequency C-V characteristics, I-V characteristics, C-t characteristics and Zerbst analysis, Impedance Frequency/Bias characteristics, Ideal C-V curve.

### Semiconductor Applications

#### C-V Characteristics

The HP 4061A measures the C-V characteristics of MIS structures. Both high frequency C-V (10 kHz to 1 MHz) and low frequency C-V (quasi-static) characteristics are easily measured. Using data from the C-V characteristics measurement, a doping profile is easily obtained.

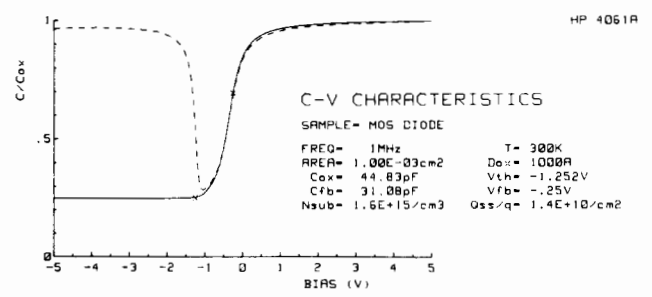

The HP 4061A performs the Zerbst analysis using the C-t measurement data. This analysis is an effective evaluation method for obtaining the semiconductor minority carrier generation characteristics.





## I-V and DC Characteristics

Total synchronization between the application of the voltage and the current measurement is automatically accomplished by the HP 4061A. This permits the accurate (0.5%) and high speed (35 ms on the 1 nA range) measurements necessary to measure small leakage currents in MOS structures, FETs, and diode static characteristics.

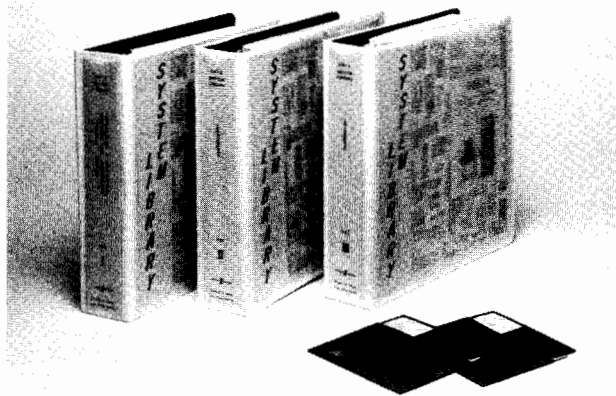
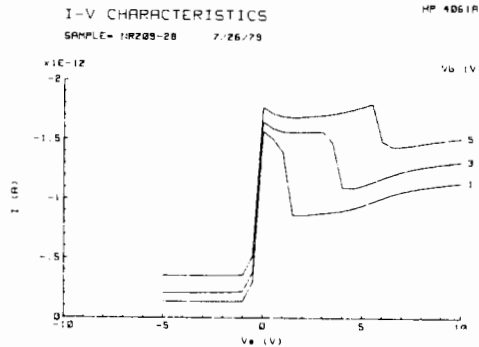

HP 4061A System Library

## Specifications

For detailed specifications on each of the instruments used in the HP 4061A, refer to the individual data sheets.

### Impedance Measuring Section (HP 4275A)

These specifications are for the HP 4275A connected directly to the device under test (DUT).

**Display:** 4½ digits; 5½ digits in high resolution mode

**Frequency:** 10 kHz to 10 MHz; 10 spot frequencies in a 1-2-4 step sequence.

**Oscillator level:** 1 mVrms to 1Vrms continuously variable into open circuit. Output impedance approximately 100 ohms.

**Measurement parameters:** C-D•Q•ESR•G, L-D•Q•ESR•G, R-X•B•L•C, |Z|—θ

#### Measurement Ranges

**C:** 0.01 fF to 199.99 μF

**L:** 1 pH to 19.999 H

**|Z|, R, X:** 0.01 mΩ to 19.999 MΩ

**G, B:** 0.01 nS to 19.999 S

**D:** 0.0001 to 9.9999

**Q:** 0.01 to 9900

**Basic accuracy:** ±0.1%

**Measurement time:** approximately 140 ms to 210 ms

**DC Bias (HP 4275A Option 001):** 0 to ±35 V, 1 mV maximum resolution.

### Current Measurement Section (HP 4140B)

These specifications are for the HP 4140B connected directly to the device-under-test.

**Measurement functions:** I, I-V, and C-V. Synchronized measurements of Current-Voltage (I-V) and Quasi-Static (C-V) are automatically performed.

## Current Measurement

**Display:** 3½ digit

**Range:** ±0.001 × 10<sup>-12</sup> A to 1.999 × 10<sup>-2</sup> A

**Basic accuracy:** ±0.5%

**Measurement time:** approximately 4 ms to 2.56 s

**DC voltage sources:** V<sub>A</sub> and V<sub>B</sub>

**Output mode:** V<sub>A</sub>;

Range: both sources, 0 to ±10 V in 10 mV steps, 0 to ±100 V in 100 mV steps; ramp rate, (V<sub>A</sub> only), 0.001 V/s to 1 V/s

## Capacitance-Voltage (C-V Measurement)

**Measurement ranges:** 0.0 pF to 199.9 pF and 200.0 pF to 1999 pF full scale in two ranges; 99.9% overrange.

## Switching Subsystem

The switching subsystem consists of a switch control module and switching module with interconnecting cables.

Function: Switches connection from DUT to either Multi-frequency LCR Meter or the pA Meter/DC Voltage source.

**System Measurement Range** (only deviations from individual instrument specifications are listed.)

### Impedance Measurements (HP 4275A)

**Frequency range:** 1 MHz

**Measurement parameters:** C-G

**Capacitance:** ≤200° pF (with D≤0.1)m

Accuracy: (accuracy of HP 4275A) × 1.5 + ΔC (at 25°C + 5°C).  
ΔC = 1.4 × 10<sup>-3</sup>Cxf<sup>2</sup> (pF) + 5 counts

**Conductance:** ≤12 mS (D≤0.1)

\*Accuracy: (accuracy of 4275A) × 1.5 + ΔG (at 25°C + 5°C)

ΔG = 6 × 10<sup>-3</sup>Cxf(S) + 5 counts

\*After 1 hour warmup and at DUT terminal of switching module  
f: frequency in MHz

Cx: Measured capacitance value in pF

At 5°C to 40°C, ΔC and ΔG doubles. Example: Assuming Cx = 1000 pF and f = 1 MHz, C = (1.4 × 10<sup>-3</sup> × 10<sup>3</sup> × (1)<sup>2</sup>) pF + 5 counts = 1.4 pF + 5 counts

### Current Measurements (HP 4140B)

**Accuracy:** (accuracy of HP 4140B) × 1.5 + 5 counts

After one-hour warmup and at DUT terminal of switching module

## Available Options

**Option 001:** ±100 V internal dc bias; HP 4275A internal bias is changed to ±100 V with 0.1 V resolution

**Option 002:** 1-3-5 frequency step; HP 4275A frequency steps are in a 1-3-5 sequence

**Option 026:** System library for HP 9826A/S controller is added

**Option 036:** System library for HP 9836A/S controller is added

**Option 045:** System library for HP 9845B option 175 controller added

**Option 046:** System library for HP 9845B option 275/280 controller added

## General Information

**Operating temperature:** 5°C to 40°C

**Relative humidity:** 70% at 40°C

**Power:** 100, 120, 220, and 240 V, +5% to 10%, 48 to 66 Hz, 520 VA

**Size:** 535 mm W x 1635 mm H x 770 mm D (21" x 64.4" x 30.3")

**Weight:** Approximately 125 kg (275 lbs).

## Ordering Information

**Option 001:** ±100 V dc Bias for HP 4275A

**Option 002:** 1-3-5 Frequency Steps for HP 4275A

**Option 026:** System library for HP 9826A/S controller

**Option 036:** System library for HP 9836A/S controller

**Option 045:** System library for HP 9845B option 175 controller

**Option 046:** System library for HP 9845B option 275/280 controller

## HP 4061A Semiconductor/Component Test System



# COMPONENT & SEMICONDUCTOR MEASUREMENT

## Semiconductor Parametric Test System

Model 4062A

- Probed wafer measurements with 1 pA resolution
- Easy to program
- Virtual front panel simplifies operation

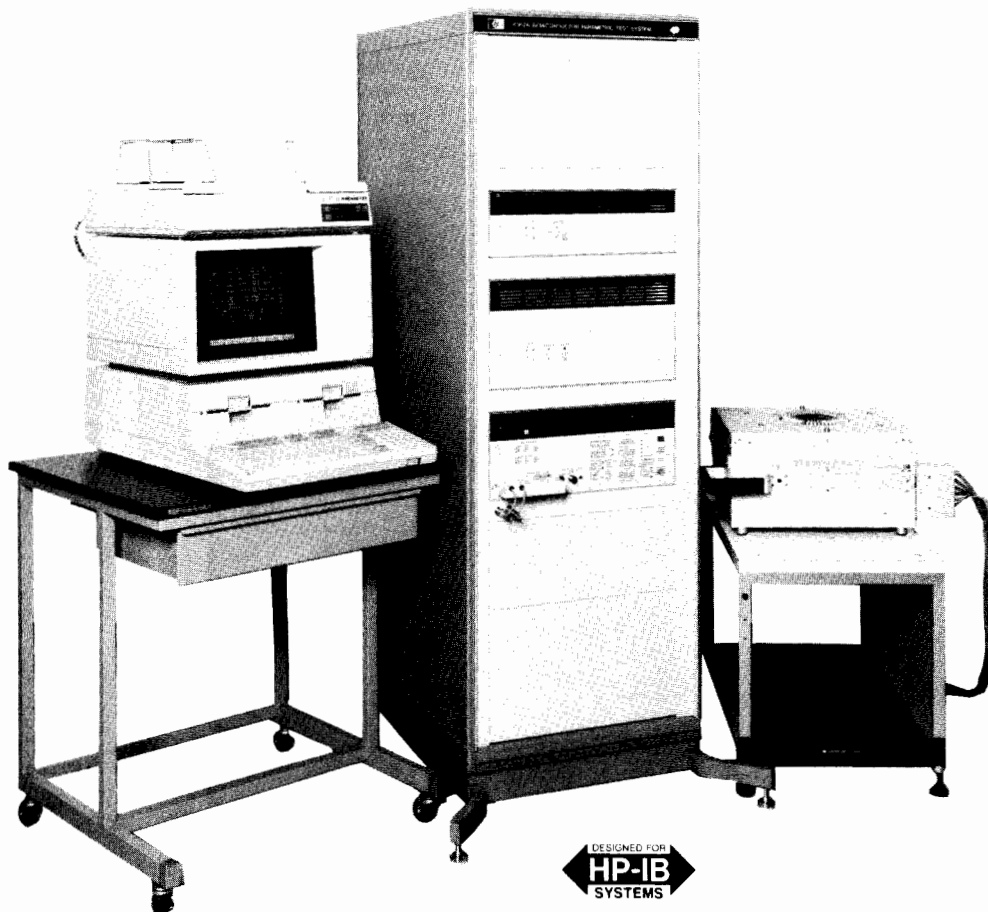

HP 4062A  
(System controller, printer and tables are not included in the HP 4062A)

### Description

The HP 4062A Semiconductor Parametric Test System is a fully automatic, computer-controlled system designed to measure the dc characteristics and the 1-MHz capacitance characteristics of semiconductor devices and materials. The system is ideally suited to semiconductor wafer process and design evaluation, new device research and development departments, and semiconductor manufacturing laboratories.

Specially designed system circuitry minimizes the effects of environmental noise and reduces leakage current to a negligible level, thereby enabling high resolution dc current measurements down to 1 pA.

Standard system hardware consists of three rack-mounted instruments and a switching matrix. The standard system is equipped with 48 measurement pins (max.) and 1 pA resolution is guaranteed for any pin configuration. (The switching matrix and switching matrix controller are available separately as the HP 4085M Switching Matrix, which is intended for use with the HP 4145A Semiconductor Parameter Analyzer. The necessary switching control software is included with the HP 4085M.)

Powerful system software furnished with the HP 4062A ensures measurement programming ease. Programming is greatly simplified with the aid of specially prepared commands and statements contained in the Utility Library.

By providing fast, accurate measurement of dc and 1 MHz parameters of discrete, packaged and wafer-stage semiconductor devices, the HP 4062A offers significant improvements in production yields.

### System Accuracy

The auto calibration feature of each system component ensures system measurement accuracy. The advanced design of the switching matrix effectively eliminates environmental noise as an error source while reducing leakage to a negligible level. Also, series resistance and residuals of test cables can be compensated for. System performance can be quickly verified with the system test module.

### Text Fixtures

The wide variety of HP 4062A test fixtures enables the testing of many types of devices. Five test fixtures are furnished, and devices of almost any conceivable configuration from 2 pins to 48 pins can be tested.

### Virtual Front Panel

The HP 4062A Virtual Front Panel (VFP) enables the user to set measurement conditions from the controller keyboard and to make real time measurements on the controller CRT.

The VFP allows the system to be operated just as if there were actual front panels for each system component. For example, when measuring threshold voltage of a MOSFET, pin assignment, drain, and gate voltages can be easily set from the keyboard of the controller. By using the rotary knob on the controller, the user can vary the voltage applied to the gate while monitoring drain current. When the appropriate drain current is obtained, threshold voltage has been reached. And all this is accomplished without a program.

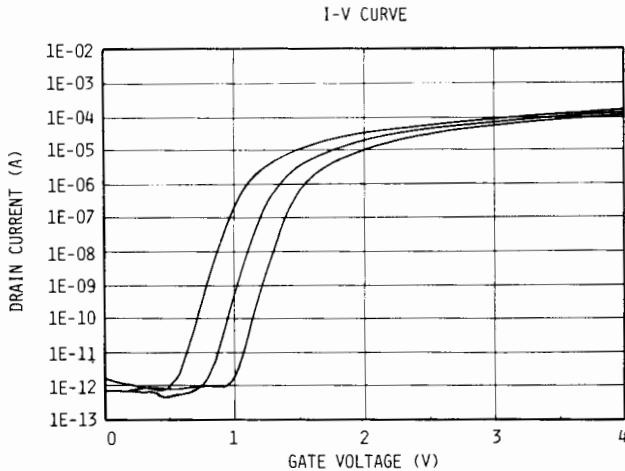

### System Software

Full automatic system operation, from measurement (e.g., I-V, C-V, and C-t) to wafer prober control to analysis (wafer mapping, histograms, etc.), can be performed with simple program statements contained in the Utility Library.

### Utility Libraries

#### Test Instruction Set

Setting/Monitor statements: prober control statements, sweep measurement statements

**Sweep Measurement Statements:** I-V Measurements, C • G - V Measurements, C • G - t Measurements

#### Parameter Measurement Library

Resistance Measurements (2 terminal/4 terminal), Breakdown Voltage Measurements, dc Current Gain Measurements Drain Current Measurements, Threshold Voltage Measurements (2 types), Lateral Diffusion Effect Measurements ( $\Delta L$  and  $\Delta W$ )

#### Characteristic Graph Library

Linear-Linear Graph (2 types), Linear-Log Graph

#### Wafer Prober Library

Probing Pattern Generator, Prober Control

#### Data Processing Library

Wafer Map, Histogram, Scatter Plot, Control Chart, Datafile Creation

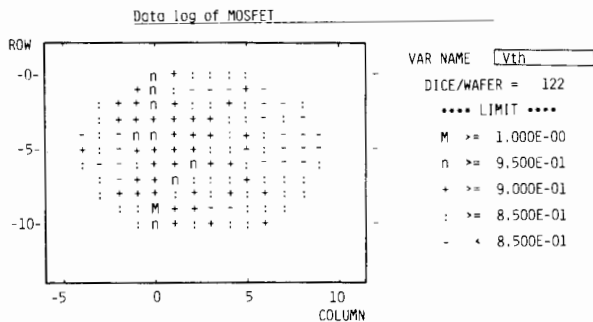

## Specifications

### Switching Matrix

**Number of pins** (to DUT): 48 pins (standard) with options for 12, 24 and 36 pins.

**Number of ports** (to instrument): 9 ports

High Resolution Source and Monitor Unit: 1 port

Source and Monitor Units: 3 ports

Ground: 1 port

C Measurement: 2 ports

Auxiliary: 2 ports

**Maximum allowable voltage between ports:** 220 VDC

**Maximum allowable current at pins:** 500 mA<sub>dc</sub>

**Maximum stray capacitance between pins:** 6 pF

### DC Source and Monitor Units

**High resolution source and monitor unit (SMU\*1):** 1 channel  
Output/Measurement Range: Current,  $\pm 1$  pA -  $\pm 100$  mA; Basic Accuracy, 0.3%; Voltage,  $\pm 1$  mV -  $\pm 100$  V, Basic Accuracy, 0.1%

**Source and monitor units (SMU\*2-4):** 3 channels  
Output/Measurement Range: Current,  $\pm 100$  pA -  $\pm 100$  mA; Basic Accuracy, 0.3%; Voltage,  $\pm 1$  mV -  $\pm 100$  V; Basic Accuracy, 0.1%

**Ground unit:** 1 channel

Output Voltage: 0V; Accuracy,  $\pm 2$  mV

**Voltage source (Vs):** 2 channels

Output Range:  $\pm 1$  mV -  $\pm 20$  V; Basic Accuracy, 0.5%

**Voltage monitor (Vm):** 2 channels

Measurement Range:  $\pm 100$   $\mu$ V -  $\pm 20$  V, Basic Accuracy, 0.2%

\* SMU 1-4: Each SMU can function either as a dc voltage source/current monitor or as a dc current source/voltage monitor.

### Capacitance-Conductance Measurements

**Test frequency:** 1 MHz  $\pm$  0.01%

**OSC level:** 30 mV<sub>rms</sub>  $\pm$  20% and 10 mV<sub>rms</sub>  $\pm$  20%

**Measurement range:** (Maximum resolution to full scale):

**C** 0.001 pF - 1.2 nF; basic accuracy, 0.5%

**G** 0.01  $\mu$ S - 12 mS; basic accuracy, 1.5%

**DC bias voltage for capacitance measurements:**  $\pm 100$  V

## General Specifications

**Operating temperature range:** 10°C - 40°C,  $\leq$ 70% RH at 40°C

**Permissible temperature change:**  $\leq$ 1°C/5 minutes

**Air cleanliness:** class 100,000 or higher clean room required

**Power requirements:** 100 V, 200 V: 10%; 120 V, 240V: +5% - 10%  
48 - 66 Hz, 510 VA max.

**Dimensions:** cabinet, 535 mm (W) x 1635 mm (H) x 770 mm (D);  
switching matrix, 406 mm (W) x 210 mm (H) x 380 mm (D)

**Weight:** cabinet with instruments, approximately 250 kg; switching matrix, approximately 22 kg

### HP 4062 Furnished Accessories

**HP 16066A:** Test Fixture Adapter

**HP 16067A:** 24 pins DIP Low Leakage Fixture

**HP 16068A:** 48 pin DIP Low Leakage Fixture

**HP 16069A:** Universal Low Leakage Fixture

**HP 16070A:** General Purpose Dip Fixture

**HP 16071A:** Universal Fixture

**HP 16072A:** Personality Board (for connecting probe card)

**HP 16075A:** Relay Test Adapter

**HP 16076A:** System Test Module

**HP 16077A:** Extension Cable Fixture

### System Controller

**Required Controller:** HP 9000 Series 200 Model 236A or 236C

**System Language:** BASIC 2.0 with BASIC Extensions 2.1

**Memory Size:**  $\geq$ 832 K byte

**Interface:** In addition to standard HP-IB, 2 HP-IB Interface Cards (HP 98624A) are required.

### Prober Interface

Automatic wafer probers used with the HP 4062A must be equipped with HP-IB capability. Hardware for mounting the switching matrix on the prober is also required. Contact the prober maker for details concerning necessary mounting hardware.

### Options

**001:** 12-pin System (delete 36 pins from std. HP 4062A)

**002:** 24-pin System (delete 24 pins from std. HP 4062A)

**003:** 36-pin System (delete 12 pins from std. HP 4062A)

**004:** Adds 1 pin (to augment the number of pins provided by options 001, 002 and 003)

**011:** Extra SMU Board (for maintenance purposes)

**102:** Deletes HP 4280A

**110:** Deletes Test Fixtures (HP 16066A thru 16071A)

**201:** Electroglas 1034X Control Software

**221:** Tokyo Seimitsu A-PM-3000/6000A Control Software

**NOTE:** Refer to HP 4062A data sheet for details

**HP 4062A Semiconductor Parametric Test System (does not include controller)**



- Picoampere-range current measurement with 1fA resolution through a wafer prober
- Deep Level Transient Spectroscopy (DLTS) measurements (optional) with 10 $\mu$ s resolution
- Fill-in-the-blanks type programming for simplified operation
- Data logging and Multi-format display of measurement results such as histograms, trend charts, scatter plots and 3D plots.

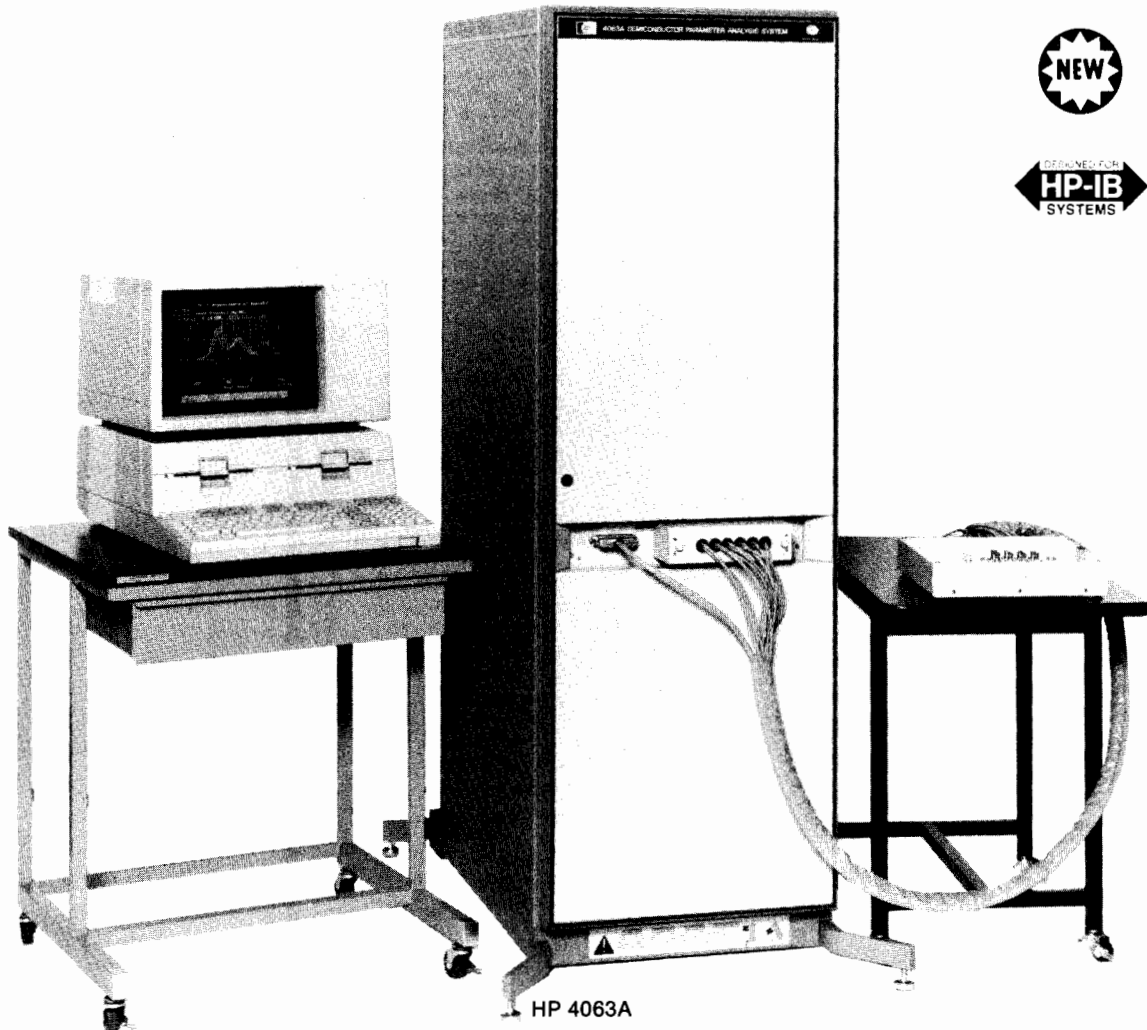

### Description

Intended for a wide range of semiconductor research and development applications, Hewlett-Packard's new 4063A Semiconductor Parameter Analysis System measures the dc characteristics and 1 MHz capacitance characteristics of semiconductor devices and materials. The HP 4063A also offers you an impressive array of data analysis and data logging capabilities as well as many standard data display formats of measurement results.

The special design of the system's six-channel switching matrix minimizes the effects of environmental noise and RFI, and virtually eliminates leakage current, the main source of error in low current measurements. This ensures 1 fA(dc) and 1 fF(ac) sensitivity through all measurement channels.

The HP 4063A's standard temperature measurement function enhances the system's versatility, making it possible to perform temperature-based measurements. This feature is especially useful for new device development applications, which require accurate temperature monitoring.

The extensive system control software furnished with the HP 4063A is designed to minimize training requirements and to make system programming and operation easy for first-time users.

With its high resolution, high accuracy, and simple programming and operation, the HP 4063A is ideally suited to new materials development, new device development, and new process development.

### High Resolution

In addition to its four built-in programmable source/monitor units (SMUs) that can be individually programmed to function as either voltage sources/current monitors or current sources/voltage monitors, the HP 4063A is equipped with a precision picoammeter and a high resolution voltage meter for dc parameter measurements. These two meters have 1 fA and 10-microvolt resolution, respectively, which makes it possible to measure such parameters as resistivity.

The system's 1 MHz C meter/C-V plotter measures capacitance down to 1 fF and conductance down to 0.01  $\mu$ S. Since the meter is equipped with a built-in dc-bias source (0 to  $\pm$  100V), pulse generator and timer, it can measure C and G as functions of applied dc voltage or time.



The optional DLTS measurement capability has 10-microsecond time interval resolution, making it possible to measure traps at very shallow energy levels.

### Easy to Operate

Setting up a measurement is simply a matter of filling in blanks on the various setup pages that appear on the system controller's CRT. Instructions are displayed as you progress through the set up process so that no special programming knowledge is required. Furthermore, a number of typical application programs are included in the furnished software to further simplify system operation. During these application programs, all phases of system operation—from measurement to analysis to data logging—are completely automatic.

### Easy to Program

System programming is made simple by a specially developed Pascal-based programming tool called Test Sequence Programming (TSP), which has its own editor, debugger, and intrinsics. To simplify the system programmer's job, we've included a subprogram library containing utility programs and intrinsics that implement a broad range of measurement functions. Programmers can link these subprograms into Pascal programs to significantly reduce the time normally required to write a measurement program. Additional user-written subprograms can be added to the subprogram library at any time.

### Display and Analysis

Measurement results can be displayed on the system's controller in a number of different formats, for example, XY graphs, 3D plots, wafer maps, histograms, and many others. Markers, linear regression, and averaging are a few of the computer-aided graphics analysis functions that are provided with the HP 4063A.

### Switching Matrix

The standard HP 4063A is equipped with a single switching matrix that is designed for operation over a wide measurement range, down to 1 fA for dc current measurements and down to 1 fF for capacitance measurements at 1 MHz. An optional second switching matrix can be added to equip the HP 4063A with up to twelve pins. Any of the system's thirteen measurement units can be automatically connected to a measurement pin, which in turn can be connected to a manual or automatic prober for wafer stage measurements, to one of the available test fixtures for package-device measurements, or to a cryostat for temperature-biased measurements.

### System Configuration

The HP 4063A consists of the following instruments: digital voltmeter, pA meter/dc voltage source, dc source/monitor, 1 MHz C meter/C-V plotter, switching matrix controller, switching matrix and 56-inch rack cabinet.

### Furnished Application Software

Included in HP 4063A software are MOSFET and bipolar transistor dc parameter measurements including temperature characteristics measurements and measurements using an automatic prober.

MOS diode capacitance measurements, including quasi-static C-V characteristics measurements and Schottky and pn junction capacitance measurements are also included in the HP 4063A software.

MOS diode and Schottky and pn junction DLTS measurements are optional.

#### < MOSFET DC Characteristics >

Sample = #29		
A) Leakage Current	$I_{dss}$	= 27 pA
B) Leakage Current	$I_{gss}$	= 85 fA
C) Threshold Voltage	$V_{th}$ (1)	= 1.49 V
D) Threshold Voltage	$V_{th}$ (2)	= 1.53 V
E) Threshold Voltage	$V_{th}$ (3)	= 0.72 V
F) Breakdown Voltage	$BV_{dss}$	= 6.721 V
G) Breakdown Voltage	$BV_{gss}$	= 18.62 V
H) Forward Transconductance	$G_m$	= 4.11 mS
I) Channel Conductance	$G_{ds}$	= 1.35 mS
J) On-Resistance	$R_{on}$	= 265.3 ohm

## Specifications

### Switching Matrix

**Number of DUT channels:** 6 (standard) or 12 (optional)

**Number of AUX terminals:** 2

**Connection method:** guarded Kelvin connection

**Maximum voltage between DUT Channels when switch is open:**  $\pm 200$  Vdc

**Maximum ground-referenced voltage at DUT Channel:**  $\pm 100$  Vdc

**Maximum current at DUT channel:** 500 mA

**Maximum allowable voltage:** 200 Vdc ( $\pm 100$  Vdc max from ground)

**Maximum allowable current:** 500 mA dc

### DC Measurements

**Source and Monitor:** 4 units

**Output Measurement Range:** current, 0 A to  $\pm 100$  mA, 0.3% basic accuracy, 1 pA max resolution; voltage, 0 to  $\pm 100$  V, 0.1% basic accuracy, 1 mV max resolution.

### Ground Unit

**Output Voltage:** 0V  $\pm 7$ mV

### Low Current Measurements

**Measurement Range:** 0A to  $\pm 19.99$  mA, 0.5% basic accuracy, 1 fA max resolution

### Voltage Source for Low Current Measurements

**Output Modes:**

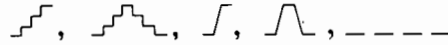

**Output Range:** 0 to  $\pm 100$  V, 10 mV max resolution,  
**Ramp Rate (dv/dt):** 1 mV/s to 1V/s

### High Resolution Voltage Measurements

**Measurement Range:** 0V to  $\pm 1000$  V, 0.0078% basic accuracy, 10  $\mu$ V max resolution

**Voltage Source:** 2 units

**Output Range:** 0V to  $\pm 20$  V, 0.5% basic accuracy, 1 mV max resolution

### Capacitance-Conductance Measurements

**Test Frequency:** 1 MHz  $\pm 0.01\%$

**OSC Level:** 30 mVrms  $\pm 30\%$  and 10 mVrms  $\pm 30\%$

**Measurement Range:**

**C:** to 1.2 nF, 0.35% basic accuracy, 1fF max resolution

**G:** to 11 mS, 0.55% basic accuracy, 10 mS max resolution

**dc Bias Source:** 0 to  $\pm 100$ V

### Temperature Measurements

**Available Thermocouples:** Type K, T, E, J, R, KP vs AU-0.07% Fe  
**Number of Thermocouple connection Terminals:** 3 (High, Low, Guard)

**Voltmeter for temperature measurements:** same as that for high resolution dc voltage measurements.

**Measurement Range:**  $-200$  °C to  $+400$  °C, 0.1 °C resolution

### General Specifications

**Operating Temperature Range:** 10 °C to 40 °C,  $\leq 70\%$  RH at 40°C

**Power Requirements:** 750 VA max (standard system)

**Dimensions:**  $\approx 535$ mm W x 1635mm H x 770mm D

Additional cabinet will be added for options 301, 302, or 311.

**Weight:** approximately 300 kg

### Accessories Furnished

**HP 16145A:** Interconnection Cable Set

**HP 16146A:** Measurement Cable

**HP 16147A:** Test Fixture

**HP 16148A:** Test Leads

**HP 16079A:** System Test Module

### System Controller

**Required Controller:** HP 9836A/S/C/CS Desktop Computer

### Accessory Available

**HP 16073A:** Personality Module

### Options

**050/060:** for 50/60 Hz power frequency

**100/120/220/240:** for 100/120/220/240 power voltage

**301:** DLTS

**302:** Current bias for DLTS

**311:** 12-channel configuration

**351:** Additional rack cabinet (for Opt. 301, 302)

**352:** Additional rack cabinet (for Opt. 311)

**501:** Eletrogas 1034X prober control software

**521:** TSK A-PM 3000/6000 prober control software

**611:** SI 5500 temperature controller control

software (for DLTS)

**801:** Extra SMU board

**910:** Extra system library

**Note:** Refer to the HP 4063A data sheet for details.

**HP 4063A Semiconductor Parameter Analysis System** (does not include controller)



# COMPONENT & SEMICONDUCTOR MEASUREMENT

## Digital IC Tester and Digital IC Test System

Models 5045A, 5046S

- Large program library
- Test ICs to 24 pins
- Print record of IC failures
- Modify existing device programs
- Generate one-of-a-kind device programs
- Characterize devices

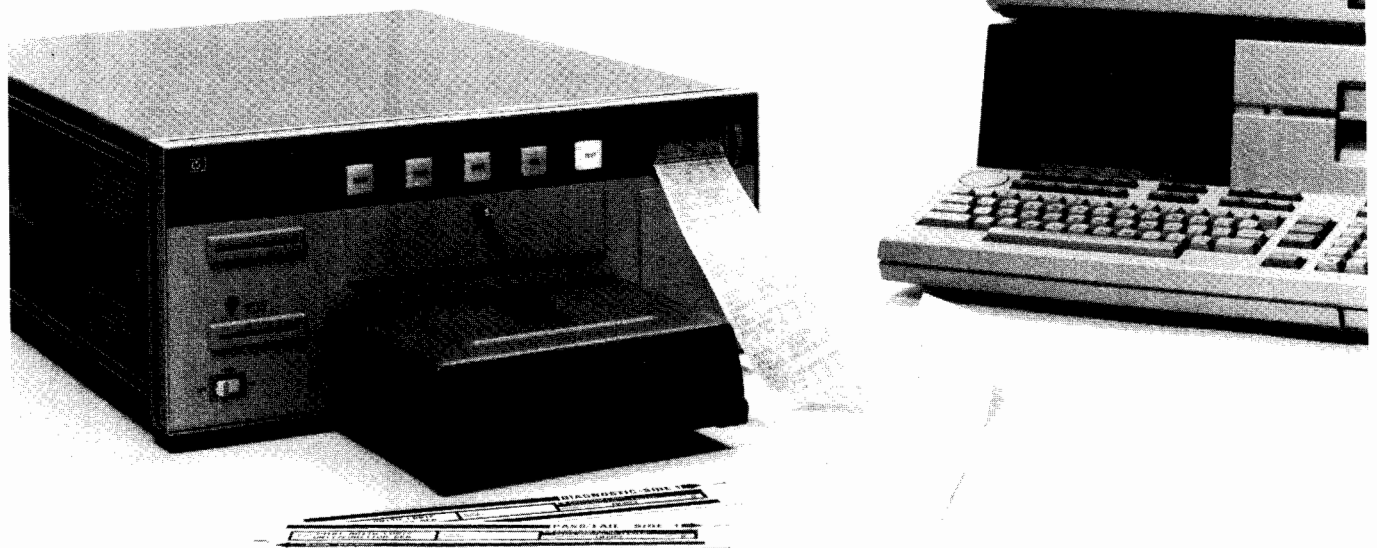

### HP 5045A Digital IC Tester

The HP 5045A Digital IC Tester is well suited for high volume incoming inspection of digital integrated circuits, simple enough to be used by an unskilled operator. To test a device, all that's required is a preprogrammed magnetic card. Insert the card into the front panel slot, and the tester is ready to provide complete dc parametric and functional verification. Test programs may be selected from an extensive list contained in our program catalog.

Permanent test results of individual IC failures are available on the standard thermal printer. Lot statistics are tabulated as testing proceeds, and are available from the printer. These are useful in documenting parts returned to manufacturers.

#### Test TTL (all versions), CMOS, ECL

Universal pin electronics permit each pin of the HP 5045A to act as a forced voltage or current driver for inputs, outputs, open circuit, and power supplies. This provides the flexibility and capability needed to test combinatorial and sequential circuits, from gates to RAMs. Devices with power supply voltages up to 15 volts ( $-7.5$  V to  $+7.5$  V) may be tested. As testing requirements expand, your HP 5045A may be easily and inexpensively updated by adding new program cards. The nominal cost of these cards means that your cost-of-ownership remains low while your testing ability is kept current.

### HP 5046S Digital IC Test System

The HP 5046S Digital IC Test System is a fully programmable system consisting of the HP 5045A IC Tester, HP Series 200 Controller and HP 2671G Printer. The System provides fast voltage and current test parameter changes with a few simple keystrokes. This ease of programming provides the ability to write or change IC test programs to meet your special testing needs. Evaluation and characterization capabilities are tailored to meet the needs of incoming QA departments as well as component evaluation.

#### Programming

You may apply the exact voltage and current you want for both the low and high states for any test. It's like having 24 programmable supplies available for a 24-pin IC. This capability is easily accessed using just a few lines of code. There are multiple programming methods to choose from, so you can apply just the right pattern for the device under test. You can key in all the 1's and 0's line-by-line, or write a short program block that automatically generates the device truth table. For ROMs, the system memorizes the output states of a known good device and automatically makes them part of the test program. Whether an input or output, test pattern coding is simple, direct, and provides a complete test for the device. Up to 16 separate detailed tests may be programmed to meet your exact testing requirements.





## DC Parametric and Functional Tests

The HP 5045A thoroughly tests devices both functionally and parametrically to ensure that defective components don't get loaded into your PC boards. Functional tests check the ability of the device to operate correctly, according to its truth table, as an appropriate input stimulus is applied. DC parametric tests check the voltage and current on devices' inputs and outputs under various conditions specified by the manufacturer. These tests eliminate almost all defective devices and avoid the expense of finding and replacing these bad circuits once they have been soldered into PC boards and perhaps become part of a complex system.

## Economical ROM Testing

To test the many different truth tables which may be programmed into ROMs of the same generic type, it is not necessary to buy a card for each one. A single card containing stimulus information for the generic ROM type is loaded into the HP 5045A and the unique truth table of a known good ROM is "memorized" by the HP 5045A. The complete program is then recorded on a blank card for further use. Duplicates of any card may be made from the original by programming the HP 5045A, pressing "write", and then inserting a blank card. ROMs up to 64K bits may be tested.

## Automatic IC Handlers

The HP 5045A is designed to work with automatic IC handlers needed for high volume testing. The Kelvin contacts, as well as the special circuits which generate the fast rise and fall times for testing digital circuits, are in a removable test head which can be placed within inches of the IC being tested. Problems caused by long cables between handler and tester (ringing, oscillation, slow rise/fall times) are eliminated.

HP, in cooperation with major automatic handler manufacturers, has designed custom interface kits for popular handlers. So interfacing the HP 5045A or HP 5046S and an automatic IC handler requires nothing more than plugging the two together.

## Printer Gives Permanent Copy of Test Results

A built-in thermal printer provides useful test information: A) It tells whether a program is loaded correctly and what program it is. B) It records the number of failed and passed IC's. C) It provides failure analysis information for each failed IC. In its failure analysis modes, the printer provides very detailed information; a special voltage/current printout, for example. This makes the printer a digital multimeter.

## Failure Statistics

Failure Statistics are valuable when making decisions on the relative acceptability of a group of devices. This information may be used as a vendor tracking tool. The HP 5045A and HP 5046S aid you in this determination by tabulating the number of devices that have PASSED and FAILED since the tester was programmed. General pass/fail statistics are available on the standard HP 5045A printer. Detailed lot statistics are available using the HP 5046S **FAILURE STATISTICS** program.

## Condensed Accessories

**HP 10844B/C:** programming interface retrofit kits contain all necessary parts, cables, interface board, and instructions to modify the HP 5045A for use in the HP 5046S Digital IC Test System.

**HP 10845A:** preprogrammed magnetic card for any device listed in the **IC PROGRAM CATALOG**; minimum order is 10 programs.

**HP 10846A:** book containing ten coupons, each redeemable for one IC program listed in the **IC PROGRAM CATALOG**. Coupons are mailed to factory, programs sent by return mail. Coupons expire after 2 years.

**HP 10847A:** service kit, allows fault isolation and rapid repair of the HP 5045A through board replacements, thereby reducing downtime. The kit includes: all CPU boards, two pin-drivers, card reader and interface, printer interface and solenoid, front panel control, diagnostic program card kit and accessories, and carrying case.

## Programming Tools

The HP 5046S system software is stored on one HP Series 200 Controller's disc. The programs are accessible using the special function keys on the desktop controller. The software package contains the following programs:

The **EDITOR** provides the capability to: 1) Enter IC test programs from the controller keyboard. 2) Read and store source programs from the disc. 3) Provide on-line editing to modify source programs.

The **COMPILER** provides the capability to: 1) Do syntax checking on source program statements. 2) Convert the source program into an object program. 3) Output the object program to the HP 5045A IC Tester.

The **DECOMPILER** provides the capability to: 1) Read an object program from the HP 5045A IC Tester. 2) Generate the corresponding source program.

The **PROGRAM ANALYZER** is used for error checking and debugging of source programs. It interrogates the HP 5045A processor as it executes a test program, then prints the following: 1) Listing of actual test sequence. 2) Programmed test parameters for each pin in each test. 3) The logical 1's and 0's for each pin in each test.

The **FAILURE STATISTICS** program provides the following: 1) Printout of failure by pin for each specific test failed. 2) Summary of failures and failure percentage for each test in the program.

The **FAILURE STATE MONITOR** program interacts with the HP 5045A while an IC is being tested. When a failure is encountered, it displays the state (vector) in which the IC failed.

The **DATA LOG** and **HISTOGRAM** programs provide detailed pin-by-pin voltage and current performance characteristics on IC devices. This provides the ability to carefully evaluate an IC's characteristics and design margins for usability in a company's products. Data is readily available on the HP 5046S system printer in a large, readable format.

The **STORE** and **RETRIEVE** functions provide the capability to store and retrieve up to 75 compiled programs on each floppy disc. This capability eliminates the need to load and store program cards manually for use with the HP 5045A.

## Ordering the Preprogrammed Magnetic Cards

The HP 5045A is programmed by prerecorded magnetic cards available from HP. These cards, covering the most common device types, are listed in our **IC PROGRAM CATALOG**. This catalog contains a wide variety of logic families and includes the majority of common device types. When additional programs are needed after the original purchase, they may be ordered through your local HP sales office or by mail with a prepaid coupon.

## Condensed Specifications

### Universal Pin Drivers

The same circuit drives or monitors each pin whether an input, output, power supply, clock, or open. Voltages and currents are individually programmable for each pin. No external fixtures required.

### VOLTAGE applied to the device under test:

Range	Accuracy
-7.5 V to <-1.875 V	±25 mV
-1.875 V to +1.875 V	±15 mV
>+1.875 V to +7.5 V	±25 mV

### CURRENT applied to the device under test:

Range	Accuracy
-200 mA to <-2.5 mA	±0.4 mA or ±6%*
-2.5 mA to +2.5 mA	±10 µA or ±6%*
>2.5 mA to 200 mA	±0.4 mA or ±6%*

\*whichever is greater

## Ordering Information

**HP 5045A** Digital IC Tester

**HP 5046S** Digital IC Test System



# COMPONENT & SEMICONDUCTOR MEASUREMENT

## Standard Capacitor Set and Decade Capacitor

Models 16380A, 16380B, 4440B

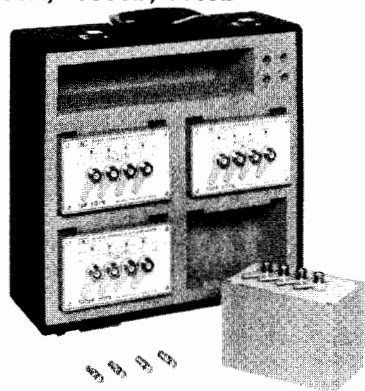

HP 16380A

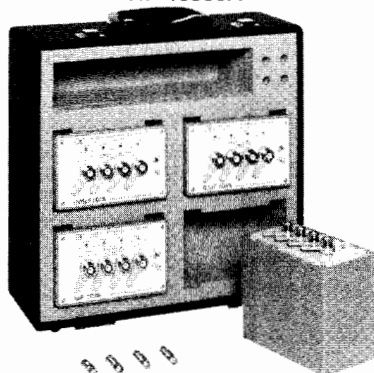

HP 16380B

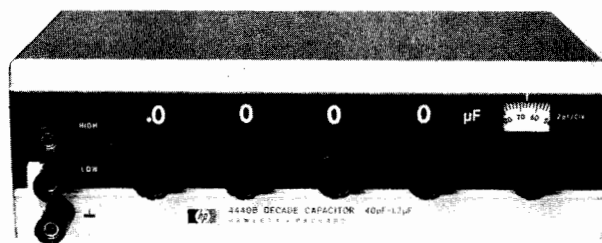

HP 4440B

### HP 16380A, HP 16380B Description

The HP 16380A and HP 16380B are precision standard capacitor sets that cover the range of 1 pF to 10 $\mu$ F in decade steps. The HP 16380A consists of four discrete air-dielectric capacitors with nominal values of 1 pF, 10 pF, 100 pF, and 1000 pF. Similarly, the HP 16380B consists of four discrete capacitors, but with solid dielectrics and with nominal values of 0.01 $\mu$ F, 0.1  $\mu$ F, 1  $\mu$ F, and 10  $\mu$ F.

Both the HP 16380A and HP 16380B are furnished with test certification of 0.01% calibration accuracy. One exception to this is the 10 $\mu$ F capacitor of the HP 16380B, which is certified at 0.05% calibration accuracy. Capacitance stability with respect to time varies from capacitor to capacitor but is specified in the range of  $\pm$ 50 to  $\pm$ 300 ppm/year.

The HP 16380A and HP 16380B both have the four-terminal pair configuration to allow direct connection to any of Hewlett-Packard's many four-terminal pair impedance measuring instruments. The HP 16380A/B can be easily adapted to two-, three-, and five-terminal configurations.

### HP 16380A, 16380B Specifications (valid at 1 kHz, 23 $\pm$ 5 $^{\circ}$ C)

#### HP 16380A

Capacitance	1 pF	10 pF	100 pF	1000 pF
Nominal Accuracy			$\pm$ 0.1%	
Calibration Accuracy			$\pm$ 0.01%	
Stability			<300 ppm/yr	
Dissipation Factor			<0.0001	
Dimensions	112 mm (H) x 142 mm (W) x 88 mm (D)			
Weight	8.0 kg (includes case)			

#### HP 16380B

Capacitance	0.01 $\mu$ F	0.1 $\mu$ F	1 $\mu$ F	10 $\mu$ F
Nominal Accuracy		$\pm$ 0.1%		$\pm$ 0.4%
Calibration Accuracy		$\pm$ 0.01%		$\pm$ 0.05%
Stability		<50 ppm/yr		<250 ppm/yr
Dissipation Factor	<0.0004	<0.0005	<0.0007	<0.003
Dimensions	117 mm (H)x142 mm(W)x88 mm(D)		143x142x88	
Weight	8.6 kg (includes case)			

### HP 4440B Description

The Hewlett-Packard 4440B Decade Capacitor is a high accuracy instrument providing usable capacitances from 40 pF to 1.2  $\mu$ F. Its 0.25% accuracy makes it an ideal aid for circuit design or as a working standard.

The use of silvered-mica capacitors in all four decades provides higher accuracy, lower dissipation factor and good temperature coefficient. An air capacitor vernier provides 100 pF (from 40 pF to 140 pF) with resolution of 1 pF. Capacitors are housed in a double shield in such a way that increased capacitance from two terminals to three terminals is held to 1 pF.

### 4440B Specifications

**Capacitance:** 40 pF to 1.2  $\mu$ F in steps of 100 pF with a 40 pF to 140 pF variable air capacitor providing continuous adjustment to better than 2 pF between steps.

**Direct reading accuracy:**  $\pm$ (0.25% + 3 pF) at 1 kHz for three-terminal connection.

**Resonant frequency:** typical values of the resonant frequency are 450 kHz at 1  $\mu$ F, 4 MHz at 0.01  $\mu$ F and 40 MHz at 100 pF

**Dissipation factor:** for C > 1000 pF, 0.001 max. at 1 kHz.  
for C < 999 pF, 0.005 max. at 1 kHz.

**Temperature coefficient:** < +70 ppm/ $^{\circ}$ C.

**Insulation resistance:** 5 G $\Omega$  minimum, after 5 minutes at 500 V dc.

**Maximum voltage:** 42 Vdc or 30 Vrms.

**Weight:** net, 2.5 kg (5 $\frac{1}{2}$  lb); shipping, 3.6 kg (8 lb).

**Size:** 76 mm H x 264 mm W x 152 mm D (3" x 11" x 6").

### Ordering Information

HP 16380A Standard Capacitor Set (1 pF, 10 pF, 100 pF, 1000 pF)

HP 16380B Standard Capacitor Set (0.01  $\mu$ F, 0.1  $\mu$ F, 1  $\mu$ F, 10  $\mu$ F)

HP 16380B Option 001 Delete 10  $\mu$ F capacitor

HP 4440B Decade Capacitor

# DIGITAL CIRCUIT TESTERS

Logic Troubleshooting System

Model 55005S

239



- Automated digital troubleshooting using signature analysis
- Automatic test construction and documentation generation
- Backtrace and signature matching troubleshooting modes
- No programming or device libraries required

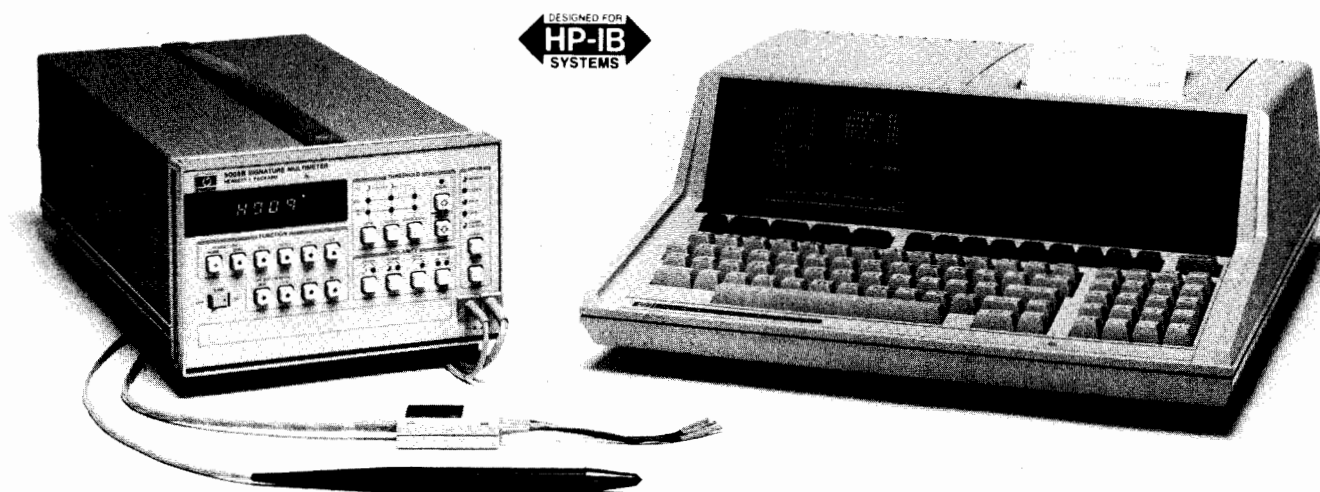

## HP 55005S Logic Troubleshooting System

### Description

The HP 55005S Logic Troubleshooting System represents a significant advance in automated digital test construction, documentation, and directed troubleshooting using Signature Analysis. It consists of an HP 85 Computer, HP 5005B Signature Multimeter, system software, optional flexible disc drive, and optional printer. These components together provide a significant productivity improvement when applied to troubleshooting digital products.

### Test Construction

Circuit characterization is greatly simplified by the HP 55005S's LEARN mode. All information necessary for troubleshooting a product is generated during the signature collection phase of LEARN mode. The operator only needs to know the device number, input/output status of each device pin, and the circuit connection points. Automatic signature collection, through the HP 5005B Signature Multimeter, and directed softkey inputs provide the data required to build a troubleshooting data base. This eliminates the requirement for device libraries or special programming.

Test construction utilizes the data base compiled in the LEARN mode. Signature and circuit connection information comprise the basic lists for backtrace and signature matching modes of troubleshooting. These lists are automatically generated by the HP 55005S software.

### Documentation

Troubleshooting a digitally based product requires sound documentation. The HP 55005S system generates a complete set of documentation for effective Signature Analysis troubleshooting. Three forms of printed documentation, or reports, can be generated by the HP 55005S system. Two of these reports, report-by-part and report-by-node, list the correct signatures for each respective circuit point. These reports comprise the basic documentation found in products designed for Signature Analysis troubleshooting. A third report, the troubleshooting tree, provides an innovative way to perform manual backtracing through a circuit. This troubleshooting tree provides a

means, by following through a set of special signature lists, to backtrace systematically through a circuit.

### Troubleshooting

Major improvements in troubleshooting productivity translate into recurring manufacturing and service savings. Two troubleshooting modes in the HP 55005S provide these productivity improvements for both highly skilled technicians and lower skill level personnel.

Higher skill level operators benefit from the HP 55005S's ability to indicate if a probed signature matches a correct signature existing in the unit under test's data base. This allows the operator to troubleshoot a product efficiently using knowledge of the circuit's operation, technical experience and intuition. Enhanced productivity results from this extension of the technician's efficiency.

A guided backtrace mode in the HP 55005S aids the lower skill level person in troubleshooting digital products. All probing and measuring is controlled by the software program. The operator repeatedly probes the circuit, as directed by the controller, until the HP 55005S system locates the faulty node. A full report printout of probing history, location of the faulty node, and circuit points connected to the bad node occurs upon locating the fault. This report can then assist a technician in repairing the circuit assembly.

### Configuration

Three system configurations (development, troubleshooting, and basic configuration) cover a variety of troubleshooting applications. Service support engineering, manufacturing, and field service organizations can select a system configuration which meets their exact needs. A full development system, for example, could support the troubleshooting procedure and documentation generation requirements found in a service support group. Manufacturing and field service would benefit from the cost savings and optimized performance available in the troubleshooting system configuration. Each system offers the flexibility to upgrade to higher performance configurations when the need arises.

# DIGITAL CIRCUIT TESTERS

Signature Multimeter, Combines Counter and Multimeter Functions with Signature Analysis

Model 5005A/B

- Digital and analog measurement capability optimized for digital troubleshooting
- Easy to use single probe measurement of logic signals, voltage, and frequency
- 25 MHz, multiple logic family signature analysis with qualified clocking mode
- Compact and portable (HP 5005A)

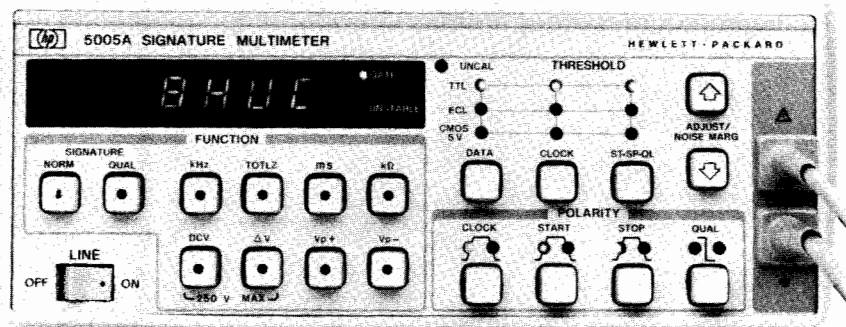

HP 5005A Signature Multimeter

## Description

Total checkout of a digital system often requires characterizing both digital data activity and analog signal parameters. A typical troubleshooting procedure may specify a digital multimeter for checking power supplies and circuit board integrity (shorts and opens), a universal counter to measure clock frequencies and time intervals between signals, and a means to verify the analog integrity of active digital signals. The HP 5005 Signature Multimeter offers, in a single instrument, a measurement set optimized for these types of digital troubleshooting applications.

Two versions, the HP 5005A for manual applications and the HP 5005B for automatic test system applications, share common performance capabilities. Their feature set includes:

- Field proven Signature Analysis (for multiple logic families).
- Digital multimeter (DC volts, resistance and differential voltage).
- Frequency counter (frequency, totalize, time interval).
- Voltage threshold (upper voltage peak, lower voltage peak).
- Multifunction probe.

## Signature Analysis

HP's patented Signature Analysis technique enables the HP 5005 to generate a compressed, four digit "fingerprint" or signature of the digital data stream at a logic node. Any fault associated with a device connected through the node will force a change in the data stream and, consequently, produce an erroneous signature. A more in-depth discussion of Signature Analysis can be found in the HP Application Note Series 222.

Specific features of the HP 5005 Signature Analyzer include:

- Multiple logic family compatibility—preset threshold levels for TTL, CMOS, and ECL or adjustable thresholds (+12.5 V to -12.5 V) assure coverage of a wide variety of logic device types.
- 25 MHz clock frequency—extends Signature Analysis to high speed circuits such as CRT controllers.
- Qualified signature mode—speeds fault isolation in complex products by windowing signature collection to specific modules or devices without requiring major test setup changes. This simplifies the engineering involvement in hardware and software testability and accelerates test procedure preparation.

## Digital Multimeter

Certain digital problems result from analog circuit failures: a low power supply voltage, an open or shorted circuit path, a faulty A/D or D/A converter. Each may contribute to a system failure. The HP 5005 contains a 4½ digit dc voltmeter, ohmmeter, and differential voltmeter, each with performance geared toward analog measurements necessary in digital troubleshooting.

The implementation of each multimeter function emphasizes simplicity and convenience. Automatic internal self calibration and auto-ranging maximize troubleshooting efficiency by eliminating unnecessary interaction with the instrument. Improvements in display interpretation also aid troubleshooting. The ohmmeter, for example, when measuring an open circuit, produces an "OPEN" indication on the display rather than the typical overload display.

## Frequency Counter

The counter within the HP 5005 provides totalize and frequency measurements to 50 MHz, and time interval measurements to 100 nanosecond resolution. Intended to extend the digital troubleshooting capabilities of the Signature Analysis (synchronous measurements), the counter functions provide the ability to characterize one-shots and timers through time interval measurement; test interrupt lines, reset lines, and asynchronous communication interfaces (RS-232) through totalize; and verify clock and clock driver circuitry through frequency measurement.

## Voltage Threshold

Logic level degradation is a common and troublesome malfunction in digital products. Isolating this failure typically requires displaying and interpreting the waveform. The HP 5005's peak voltage measurement mode provides a simple, direct method of measuring logic high and logic low voltage of active digital signals.

The peak voltage measurement mode allows the HP 5005 to characterize and display either the greatest (positive peak) or lowest (negative peak) voltage measured at the probe. Selection of either positive peak or negative peak mode displays the appropriate measured threshold for comparison against the specifications of the logic family.



- Complete HP-IB programmability of every function
- Measurement trigger switch in probe
- Rack and stack enclosure (HP 5005B)
- Programmable audible beeper

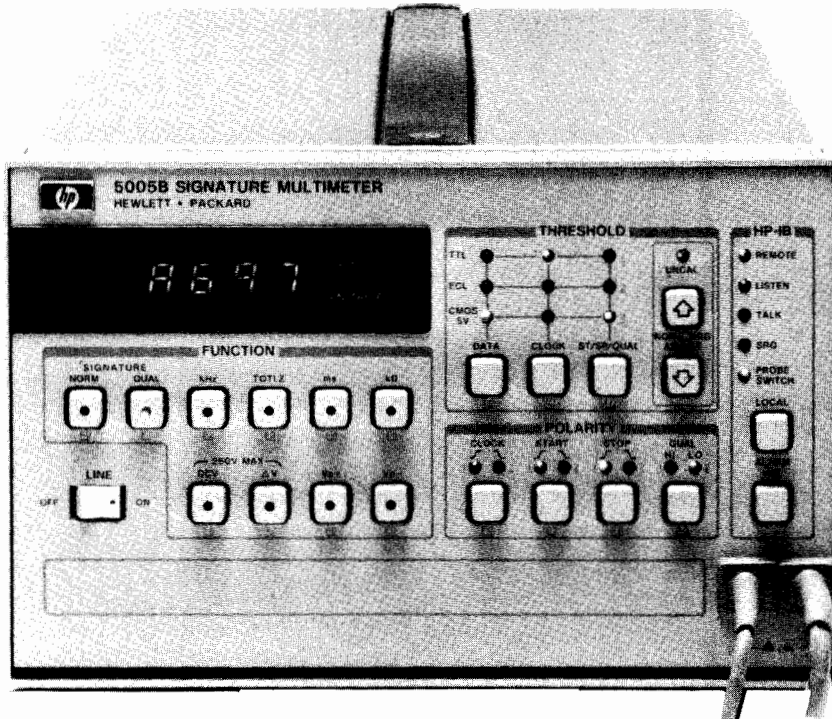

HP 5005B Programmable Signature Multimeter

## Multifunction Probe

Several measurement functions incorporated into a single instrument can provide optimal troubleshooting efficiency only when each function is easy to use. The operator, when troubleshooting, must be able to measure the analog signal parameters and digital functional characteristics of a node without requiring time consuming and error-prone probe or instrument setup changes. The HP 5005 multifunction probe solves this problem by providing automatic access to the Signature Analyzer, multimeter, and counter functions through a single probe. All signal multiplexing to the appropriate measurement function is accomplished inside the HP 5005.

This efficient probing scheme becomes particularly important in automatic applications. The HP 5005B takes advantage of the several functions available in the multifunction probe. A switch, located on the side of the probe, allows the operator to trigger automatic measurement. The instrument controller can then characterize both the analog parameters and functional digital operation of a circuit node while the operator probes the same point. This greater automatic measurement efficiency translates into increased troubleshooting productivity.

## HP-IB Programmability

Complete programmability makes the HP 5005B an ideal choice for automatic digital testing and troubleshooting. Every HP 5005B measurement and control function can be programmed through the HP-IB interface. This flexibility allows the automatic test system designer full access to the many measurement functions in the instrument.

Simplified programming enhances the automatic testing and troubleshooting productivity improvements inherent in the HP 5005B. Straightforward commands and data output formats aid in accelerating test program development. A measurement trigger switch located in the probe allows direct operator communication to the controller. Audible feedback, supplied by the beeper in the HP 5005B, can then indicate the completion of the measurement cycle. This closed-loop communication (controller-to-operator) aids in improving troubleshooting efficiency.

## Portability

The HP 5005A offers a compact portable solution for manual troubleshooting of digitally based products. Its compact package, complete measurement capabilities, and multifunction probe make it invaluable as a bench or field service tool. This complete measurement set, combined into a single instrument, insures you always having the necessary troubleshooting capabilities in hand.

The identical feature set between the HP 5005A and HP 5005B also simplifies going from automatic to manual troubleshooting procedures. Consistent front panel function key arrangements and performance specifications allow direct translation of test or troubleshooting procedures. Your investment in an automatic procedure provides an additional return when expanding into a manual troubleshooting environment.



# DIGITAL CIRCUIT TESTERS

Signature Multimeter, Combines Counter and Multimeter Function with Signature Analysis

Model 5005A/B (cont.)

## HP 5005A/B Specifications

### Signature

**Display:** 4 digits. Characters 0-9, ACFHPU.

**Fault detection accuracy:** 100% probability of detecting single-bit errors; 99.998% probability of detecting multiple-bit errors.

**Minimum gate length:** 1 clock cycle (1 data bit) between START and STOP.

**Maximum gate length:** no limit.

**Minimum timing between gates:** 1 clock cycle between STOP and START.

### Data Probe Timing

**Setup time:** 10 ns (data to be valid at least 10 ns before selected clock edge.)

**Hold time:** 0 ns (data to be held until occurrence of selected clock edge.)

### START, STOP, QUAL Timing

**Setup time:** 20 ns (signals to be valid at least 20 ns before selected clock edge.)

**Hold time:** 0 ns (signals to be held until occurrence of selected clock edge.)

### CLOCK Timing

**Maximum clock frequency:** 25 MHz.

**Minimum pulse width:** 15 ns in high or low state.

**Quality mode:** allows data clock qualification by an external signal. DATA probe input impedance  $\approx 50$  k $\Omega$  to the average value of "0" and "1" threshold settings ( $\pm 6$  V max); 15 pF.

START, STOP, CLOCK, QUAL input impedance  $\approx 100$  k $\Omega$ ; 15 pF.

**Front panel indicators:** flashing GATE light indicates detection of valid START, STOP, CLOCK conditions. Flashing UNSTABLE light indicates a difference between 2 successive signatures, and possible intermittent faults.

### Frequency

**Display:** 5 digits.

**Ranges:** 100 kHz, 1 MHz, 10 MHz, 50 MHz, autoranged.

**Resolution:** 1 LSD (1 Hz on 100 kHz range).

**Accuracy:**  $\pm 0.01\%$  of reading  $\pm 1$  count.

Minimum pulse width  $\approx 10$  ns in high or low state.

Gate time  $\approx 1$  s, fixed.

Input impedance  $\approx 50$  k $\Omega$  to the average value of "0" and "1" threshold settings ( $\pm 6$  V max); 15 pF.

### Totalizing

**Display:** 5 digits.

**Range:** 0-99,999 counts.

**Resolution:** 1 count.

Maximum input frequency  $\approx 50$  MHz, with a minimum pulse width of 10 ns, and minimum pulse separation of 10 ns.

Minimum START/STOP pulse width  $\approx 20$  ns.

DATA input impedance  $\approx 50$  k $\Omega$  to the average value of "0" and "1" threshold settings ( $\pm 6$  V max); 15 pF.

START, STOP input impedance  $\approx 100$  k $\Omega$ ; 15 pF.

### Time Interval

**Display:** 5 digits.

**Ranges:** 10 ms, 100 ms, 1 s, 10 s, 100 s, autoranged.

**Resolution:** 1 count (100 ns on 10 ms range).

Accuracy  $\pm 0.01\%$  of reading  $\pm 2$  counts.

Minimum START/STOP pulse width  $\approx 20$  ns.

START, STOP input impedance  $\approx 100$  k $\Omega$ ; 15 pF.

### Resistance

**Display:** 4 or 5 digits, depending on range.

**Ranges:** 30 k $\Omega$ , 300 k $\Omega$ , 1 M $\Omega$ , 3 M $\Omega$ , 10 M $\Omega$ , autoranged.

**Accuracy:** (at 15°C–30°C).

RANGE	FULL SCALE	ACCURACY	DISPLAY RESOLUTION
30 k $\Omega$	29,999 k $\Omega$	$\pm 1\%$ of reading $\pm 2$ $\Omega$	1 $\Omega$
300 k $\Omega$	299,99 k $\Omega$	$\pm 1\%$ of reading	10 $\Omega$
1 M $\Omega$	999.9 k $\Omega$	$\pm 1\%$ of reading	100 $\Omega$
3 M $\Omega$	2999. k $\Omega$	$\pm 10\%$ or reading	1 k $\Omega$
10 M $\Omega$	10000. k $\Omega$	$\pm 10\%$ of reading	10 k $\Omega$
Input impedance $\approx 20$ k $\Omega$ to $\pm 2$ V			

### DC Voltage

**Display:** 4½ digits.

**Ranges:**  $\pm 25$  V,  $\pm 250$  V, autoranged; referenced to earth ground.

**Accuracy:** (at 15°C–30°C).

RANGE	ACCURACY	RESOLUTION
25 V	$\pm 0.1\%$ of reading $\pm 2$ mV	1 mV
250 V (<100 V)	$\pm 0.25\%$ of reading $\pm 20$ mV	10 mV
250 V ( $\geq 100$ V)	$\pm 0.25\%$ of reading $\pm 20$ mV	100 mV

Input impedance  $\approx 10$  M $\Omega$ .

### Differential Voltage

**Reading:** reads input voltage present at the probe and displays difference between it and voltage at the time  $\Delta V$  key was depressed.

**Specifications:** same as for DCV, above. Voltage range is determined by larger of 2 compared voltages.

### Peak Voltage

**Display:** 3½ digits.

**Range:** 0– $\pm 12$  Vp.

**Resolution:** 50 mV.

**Accuracy:**  $\pm 2\%$  of reading  $\pm 5\%$  of p-p signal  $\pm 100$  mV.

Minimum peak duration  $\approx 10$  ns.

Maximum time between peaks  $\approx 50$  ms.

Input impedance  $\approx 100$  k $\Omega$ ; 15 pF.

### Signature Analyzer Logic Thresholds

Preset thresholds: TTL, ECL, CMOS.

**Adjustable thresholds:** each preset threshold can be adjusted.

**Range:**  $\pm 12.5$  V, in 50 mV steps.

**Accuracy:**  $\pm 2\%$  of setting,  $\pm 2$  V

Logic threshold circuitry is operative during NORM, QUAL, kHz, TOTLZ and ms measurements.

### General

**Data probe tip:** acts as high-speed logic probe in the NORM, QUAL, kHz and TOTLZ modes. Lamp indicates high, low, bad-level and pulsing states.

Minimum detected pulse width is 10 ns.

### Data Probe Protection

#### Continuous Overload

**DCV,  $\Delta V$ , k $\Omega$  modes only:**  $\pm 250$  V ac/dc.

**All other modes:**  $\pm 150$  V ac/dc, 20 V rms at input frequencies  $> 2$  MHz.

**Intermittent overload:**  $\pm 250$  V ac/dc, up to 1 min, for all modes.

#### Timing Pod Protection

**Continuous overload:**  $\pm 100$  V ac/dc, 20 V rms at input frequencies  $> 2$  MHz.

**Intermittent overload:**  $\pm 140$  V ac/dc, up to 1 min.

**Auxiliary power supply:** three rear-panel connectors supply 5 V at 0.7A total for accessories (HP 5005A only)

**Operating temperature:** 0°C to +55°C.

**Power:** selectable 100 V, 120 V, 220 V or 240 V ac line ( $+5\%$ – $-10\%$ ), HP 5005A–48-440 Hz, 35 VA maximum.

HP 5005B–48-66 Hz, 35 VA maximum.

**Weight:** HP 5005A–Net: 3.5 kg (8.0 lb.) Shipping: 10 kg (22.5 lb.).

HP 5005B–Net: 5.5 kg (12.0 lb.) Shipping: 8.7 kg (19 lb.).

**Size:** HP 5005A–90 mm H x 215 mm W x 410 mm D (3½" x 8½" x 16"), excluding handle.

HP 5005B–133 mm H x 212 mm W x 432 mm D (5¼" x 8¾" x 17"), excluding handle.

### Ordering Information

HP 5005A Signature Multimeter

HP 5005B Signature Multimeter

Option 910 Additional Manual



# DIGITAL CIRCUIT TESTERS

## Signature Analyzer, A Digital Troubleshooting Tool

Model 5006A

243



- Reduce warranty and service support costs
- Full at-speed testing of digital products

- Reduce comparisons to documentation with composite signature
- Compare signatures in groups with signature memory

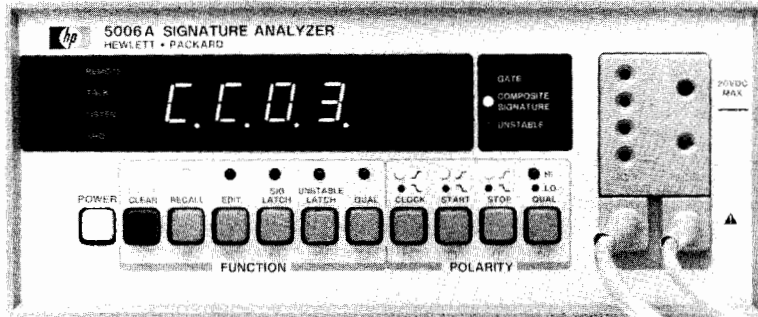

HP 5006A



### The Technique

Signature Analysis is a fast and accurate troubleshooting method for digital circuits. Fault finding is reduced to tracing signal flow and comparing measured signatures to those recorded on paper or in a computer. Troubleshoot with Signature Analysis by probing the circuit, reading the display and comparing to the known good signature. A signature is a cyclic redundancy code (CRC) used as an error detection check on blocks of data. Test patterns may be generated with in a circuit or stimulated externally.

### Programmability Means Efficiency

The HP 5006A is completely programmable using the optional HP-IL or HP-IB interfaces. Build a personal digital troubleshooting station to save time, improve productivity and reduce capital expenditures with HP-IL. Upgrade production test and troubleshooting systems to include digital troubleshooting by adding the HP-IB option.

Signatures compress the necessary troubleshooting information of a bit stream into 16 bits. Instead of entire bit streams, only signatures need be compared to detect bit errors in the unit under test.

### Time Savers

Composite signature and signature memory save time for the troubleshooter who does not have a computer-aided system. Composite signature is the binary sum of individual signatures. The HP 5006A computes it for any grouping of digital signals (i.e., bus or IC). Only one "composite" signature need be compared to documentation if all signals for that group are good.

Signatures are stored in the HP 5006A memory after the probe switch is pushed. The memory stores the last 32 signatures probed. Individual signatures can now be compared in groups instead of after each probe by reviewing the memory in the RECALL mode.

## HP 5006A Specifications

### General

**Display:** 4 digits. Characters 0-9, ACFHPU.

**Fault detection accuracy:** 100% probability of detecting single-bit errors; 99.998% probability of detecting multiple-bit errors.

**Composite signature:** maximum number of signatures: No limit. Sums all signatures, triggered by probe switch, following depression of CLEAR key, or power-up.

**Signature memory:** signatures recallable by probe switch: The last 32 signatures triggered by probe switch.

### Timing

**Clock:** maximum frequency: 25 MHz. Minimum clock time: 15 ns in high or low state.

**Probe:** setup time: 10 ns with 0.2V overdrive. (Data to be valid at least 10 ns before selected clock edge.) Hold time: 0 ns. (Data to be held after occurrence of selected clock edge.)

**Start, stop, qualifier:** setup time: 20 ns with 0.2V overdrive. (Data to be valid at least 20 ns before selected clock edge.) Hold time: 0 ns. (Data to be held until occurrence of selected clock edge.) Minimum gate length: 1 clock cycle (1 data bit) between START and STOP.

Maximum gate length: no limit.

Minimum timing between gates: 1 clock cycle between STOP and START.

### Input Impedance

**Probe:** 50k $\Omega$  to ground nominal.

**Pod:** 100k $\Omega$  to ground nominal.

### Overload Protection

**Probe:**  $\pm 150$ V continuous.

$\pm 250$ V intermittent.

250V ac for 1 minute.

**Pod:**  $\pm 20$ V continuous.

$\pm 140$ V intermittent.

$\pm 140$ V ac for 1 minute.

**CMOS sense:** 20V dc maximum.

### TTL Thresholds

**Probe:** Logic one: 2V + .2-.3. Logic zero: 0.8V +.3-.2

**Pod:** 1.4V  $\pm .6$

### CMOS Thresholds

**Logic one:** 70% of sensed voltage.

**Logic zero:** 30% of sensed voltage.

### Display and Indicators

**Signature:** four seven-segment digits with decimal point.

**Lamps:** Key Status: Recall, edit, signature latch, unstable latch, qualify mode, timing polarities. Programmable: Remote, talk, listen, SRQ. (Option 030 or 040). Status: Composite signature, gate, unstable.

**Probe:** logic levels indicated: High, low, open and pulsing. Minimum pulse width: 10 ns.

### Other

**Selectable power:** 115V +10%-25% ac line, 48-440 Hz.

230 V +10-15% ac line, 48-66 Hz. 25VA maximum.

**Operating environment:** temperature: 0-55°C. Humidity: 95% RH at +40°C. Altitude: 4600m (15,000 ft).

**Size:** 89 mm high x 216 wide 279 mm deep. (3-1/2 in. x 8-1/2 in. x 11 in.)

**Net weight:** 2.4 kg (5.3 lbs). Shipping weight: 4.1 kg (9 lbs)

### Options and Accessories

**Option 30:** HP-IL Interface

**Option 40:** HP-IB Interface

**Option 910:** Additional Manual

**HP 5060-0173** Half Rack Mount Kit

**HP 82167A** 0.5m HP-IL Cable

**HP 5006A** Signature Analyzer



# DIGITAL CIRCUIT TESTERS

## Microprocessor Exerciser, 6800, 6802, 6808, 8085 and Z-80 Support

### Model 5001A, B, C, and D

- External stimulus for signature analysis troubleshooting
- Over 50 preprogrammed tests
- Full I/O wraparound testing
- Unique memory overlay for preprogrammed tests

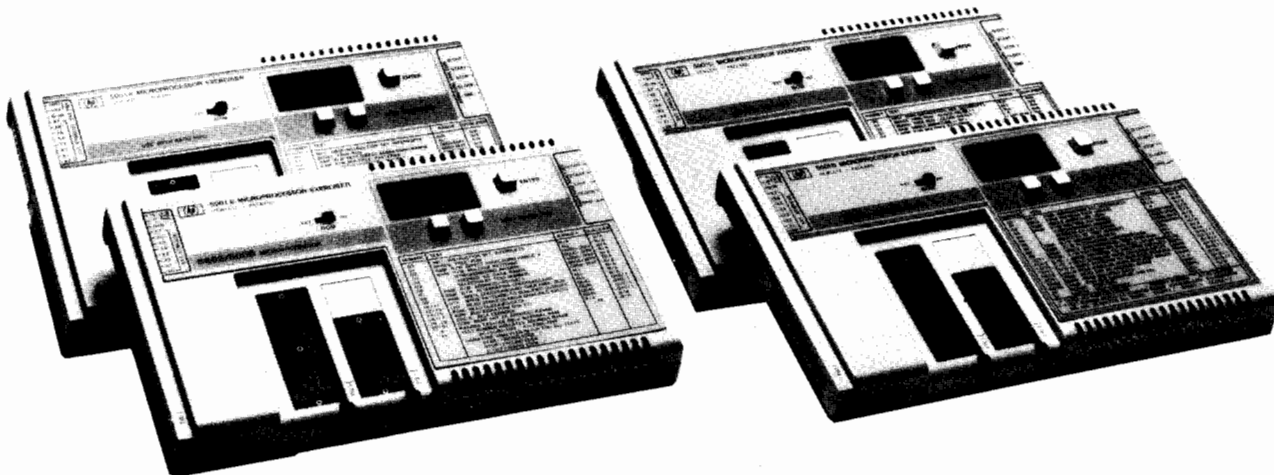

HP 5001 Microprocessor Family

## Description

The HP 5001 series of Microprocessor Exercisers offers a new alternative to add enhanced testability, in microprocessor-based products. Used in conjunction with a Signature Analyzer, the HP 5001 provides an external source of either preprogrammed or custom test stimulus to the microprocessor or input ports of a system. The operator simply removes the microprocessor from the system under test, connects the HP 5001 Microprocessor Exerciser, and utilizing the three button front panel, selects the test program to execute.

### Preprogrammed Test Stimuli

Front panel switches on the HP 5001 allow selection of over 50 preprogrammed tests which are stored in its ROM. These test stimuli include:

- A test of the microprocessor instruction set and interrupts.
- A free-run test for address and data bus integrity.
- ROM read tests.
- RAM read-write tests.
- Output port pattern tests.
- Input port pattern tests.

The HP 5001 utilizes the microprocessor of the product under test to repetitively execute preprogrammed stimuli.

### Custom Test Stimuli

The HP 5001 can be utilized to run custom programs for those portions of the product under test which require stimulus beyond that provided by the preprogrammed routines. It has a socket which allows instructions to be executed from a custom programmed ROM. The user writes stimulus programs, generates a PROM containing the appropriate microprocessor code and places it into the HP 5001 to execute up to 2 Kbytes of external stimulus. Typical custom tests could include:

- Configuration and stimulus for PIA's.
- Pattern stimuli for sequential logic outboard of output ports.
- Go/no go functional tests.

### Memory Overlay

A unique memory overlay scheme makes all preprogrammed tests and custom ROM programs independent of the system under test

memory map. A product may use its entire memory space without reserving ROM space for test programs. Additionally, this feature allows all programs to run independently of memory faults in the system under test.

### Single Signature Tests

Certain preprogrammed stimuli are designed to provide pass/fail information on the microprocessor, RAM and ROM through a single signature. For example, to save troubleshooting time a particular RAM test requires collecting only a single signature to verify a RAM rather than collecting signatures of all RAM pins.

### Qualified Stimuli

Some stimuli utilize a "qualify" line to optimize testing by dynamically modifying the effective address range of the preprogrammed test. For example, the output port tests call for the qualify line to be connected to the chip-enable pin of the port to be tested. The microprocessor searches its address field until that chip is enabled (and the qualify line asserted) then writes all possible patterns to that port, repetitively.

### Bus Signatures

The HP 5001 can read data from the product under test, as well as write patterns into it. Certain stimuli utilize this feature to read bus data, serialize it, and output a single bit stream. This "bus signature" saves time and reduces the potential errors in probing several separate points on a bus.

### Input Port Stimuli

The HP 5001 has eight output lines under microprocessor control. These can be used to stimulate input ports or circuitry within the product under test without requiring additional equipment, connectors, or fixtures. Reading the results into the HP 5001 allows full wrap-around testing of the product under test.

### SA Interface

A signature analyzer port on the HP 5001 allows quick and easy connection of START, STOP, CLOCK, and ground. Full control of these signals through either preprogrammed tests or through the custom test ROM saves time by reducing equipment setup changes.



- Support for the 6800, 6802, 6808, 8085 and Z-80 microprocessors
- External ROM socket for customer stimulus

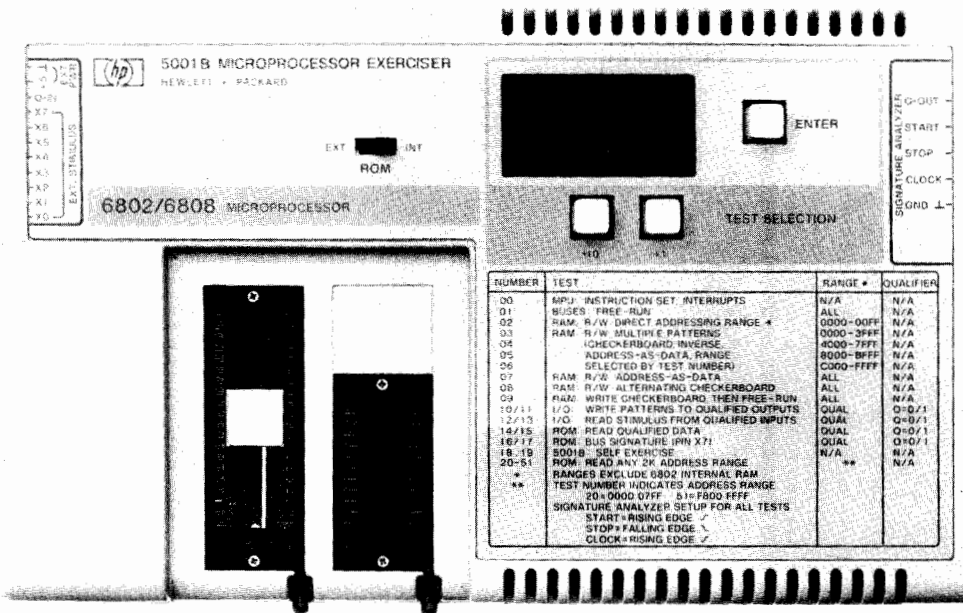

HP 5001B Microprocessor Exerciser (6802 and 6808)

## Specifications

HP Model Number	Micro-processor	Max Clock Frequency (fmax)		ROM Spec for fmax	
		External ROM	Internal ROM	t <sub>acc</sub>	t <sub>co</sub>
5001A	6800	2.0 MHz	1.5 MHz	250 ns	190 ns
5001B	6802; 6808	2.0 MHz	1.5 MHz	250 ns	190 ns
5001C	8085A	6.25 MHz	6.25 MHz	557 ns	256 ns
5001D	Z-80A	4.0	4.0 MHz	335 ns	245 ns

t<sub>acc</sub>-maximum address-to-output delay.  
 t<sub>co</sub>-maximum chip select-to-output delay.  
 External ROM type-Intel 2716 EPROM or equivalent.  
 Minimum clock rate-as specified by manufacturer.  
 HP 5001C Internal Crystal (switch selectable)-4 MHz.

## General Specifications

**Operating temperature:** 0-55°C.  
**Power requirements:** +5 V dc ±5%  
**HP 5001A:** 550 mA nominal.  
**HP 5001B:** 550 mA nominal.  
**HP 5001C:** 500 mA nominal.  
**HP 5001D:** 550 mA nominal.  
 Excluding the microprocessor and external custom ROM.  
**Shipping weight:** 1.36 kg (3 lb).  
**Dimensions:** 235 mm L x 140 mm W x 26 mm H (9¼" x 5½" x 1").

## Accessories and Options

Accessories include: microprocessor interface ribbon cable, external stimulus port cable, external power cable, 11 test point grabbers, protective carrying case, and operating and programming manual.

### Option 910: Extra Manual

**HP 5001A** Microprocessor Exerciser for 6800 Systems  
**HP 5001B** Microprocessor Exerciser for 6802/6808 Systems  
**HP 5001C** Microprocessor Exerciser for 8085 Systems  
**HP 5001D** Microprocessor Exerciser for Z-80 Systems

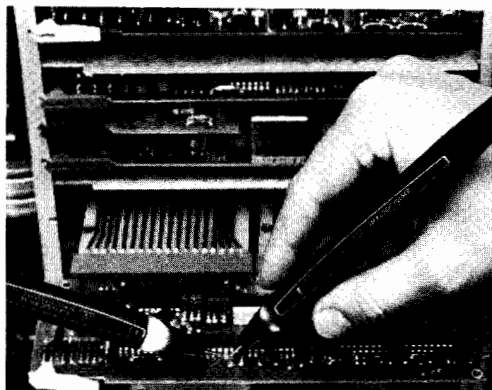

545A/546A

### Logic Probes

Logic Probes greatly simplify tracing logic levels and pulses in IC circuits to find nodes stuck HIGH or LOW, intermittent pulse activity, and normal pulse activity. That's because they instantly show whether the node probed is high, low, bad level, open circuited, or pulsing.

Logic Probes require a simple connection to the circuit under test's power supply, and they're ready to use. The strain-relieved power cord, and line-voltage protected tip insure long life and durability. High input impedance protects against circuit loading, not just in the HIGH state, but for logic LOWs as well.

### HP 545A TTL/CMOS Logic Probe

The HP 545A Logic Probe contains all the features built into other HP probes, plus switch-selectable, multi-family operation and built-in pulse memory. Employing straightforward one-lamp display the HP 545A operates from 3 to 18 volts in CMOS applications or from 4.5 to 15 V dc supplies in the TTL mode while maintaining standard TTL thresholds.

The probe's independent, built-in pulse memory and LED display help you capture hard to see, intermittent pulses. Just connect the probe tip to a circuit point, reset the memory, and wait for the probe to catch those hard to find glitches. The memory captures and retains a pulse until reset.

The hand-held HP 545A is light, rugged, overload protected, and very fast: 80 MHz in TTL, 40 MHz in CMOS. It also employs handy power supply connectors that enable you to easily hook up to supply voltage almost anywhere in the unit under test.

### ECL Logic Probe

The HP 10525E Logic Probe extends time-proven, cost-saving logic probe troubleshooting techniques to high-speed ECL logic. Its high speed circuitry stretches single shot phenomena so that single pulses as narrow as 5 nanoseconds may be observed.

The HP 10525E may be powered directly from any  $-5.2$  volt source and its high input impedance minimizes circuit loading.

**Accessories included:** BNC to alligator clips, ground clip.

### Accessories Available

HP 00545-60104 Tip Kit for HP 545A Probe, 546A  
Pulser  
HP 10525-60012 Tip Kit for HP 10525E Probe,

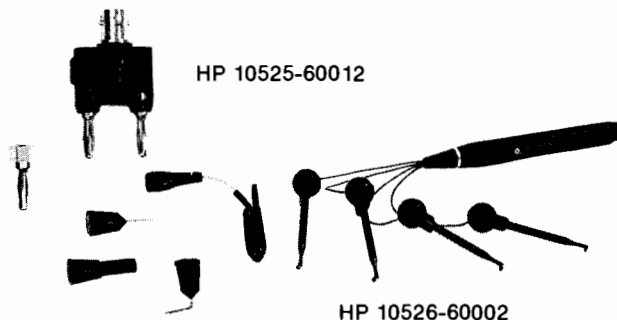

### HP 545A Probe Specifications

**Input current:**  $\leq 15 \mu\text{A}$  (source or sink).

**Input capacitance:**  $\leq 15 \text{ pF}$ .

#### Logic thresholds

\***TTL:** Logic one  $2.0 + 0.4$ ,  $-0.2 \text{ V}$ . Logic zero  $0.8 + 0.2$ ,  $-0.4 \text{ V}$ .

**CMOS:**  $3-10 \text{ V dc supply}$

Logic one:  $0.7 \times V_{\text{supply}} \pm 0.5 \text{ V dc}$ .

Logic zero:  $0.3 \times V_{\text{supply}} \pm 0.5 \text{ V dc}$ .

**CMOS:**  $\geq 10-18 \text{ V dc supply}$ .

Logic one:  $0.7 \times V_{\text{supply}} \pm 1.0 \text{ V dc}$ .

Logic zero:  $0.3 \times V_{\text{supply}} \pm 1.0 \text{ V dc}$ .

**Input minimum pulse width:** 10 ns using ground lead (typically 20 ns without ground lead).

**Input maximum pulse repetition frequency:**

TTL, 80 MHz. CMOS, 40 MHz.

**Input overload protection:**  $\pm 120 \text{ V}$  continuous (dc to 1 kHz);  $\pm 250$  for 15 seconds (dc to 1 kHz).

**Pulse memory:** indicates first entry into valid logic level; also indicates return to initial valid level from bad level for pulse  $\geq 1 \mu\text{s}$  wide.

#### Power Requirements

**TTL:** 4.5 to 15 V dc\*.

**CMOS:** 3 to 18 V dc.

**Maximum current:** 70 mA.

**Overload protection:**  $\pm 25 \text{ V dc}$  for one minute.

**Accessories included:** ground clip; BNC adapter.

\* $\pm 5 \pm 10\%$  V dc power supply; usable to  $+15 \text{ V dc}$  with slightly increased logic low threshold.

### HP 10525E ECL Probe Specifications

**Input impedance:** 12 k $\Omega$  in both the high and low state.

**Logic one threshold:**  $-1.1 \text{ V} \pm 0.1 \text{ V}$ .

**Logic zero threshold:**  $-1.5 \text{ V} \pm 0.1 \text{ V}$ .

**Input minimum pulse width:** 5 ns.

**Input maximum pulse repetition frequency:** 50 MHz (typically 100 MHz at 50% duty cycle).

**Input overload protection:**  $\pm 70$  volts continuous, 200 volts intermittent, 120 V ac for 30 seconds.

**Power requirements:**  $-5.2 \text{ V} \pm 10\%$  at 80 mA; supply overload protection for voltages from  $-7$  to  $+400$  volts.

### Ordering Information

HP 545A Logic Probe

HP 10525E Logic Probe

# DIGITAL CIRCUIT TESTERS

Logic Pulsers, Digital Current Tracer

Models 546A, 547A

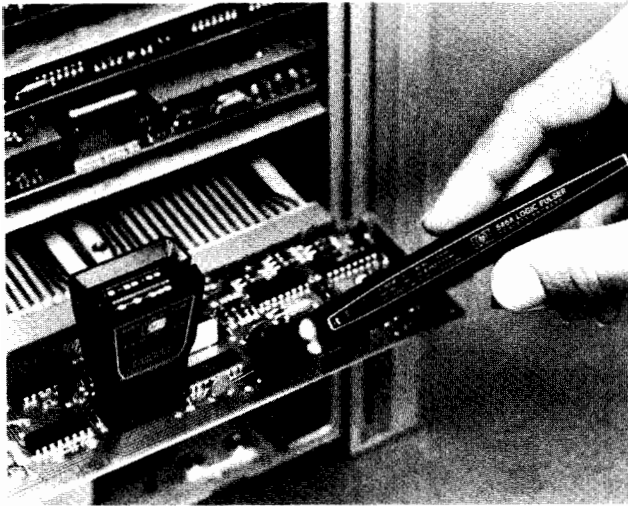

HP 548A/546A

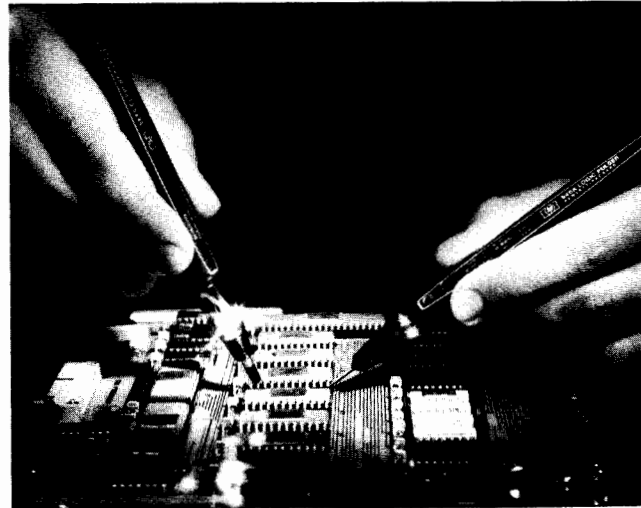

HP 547A/546A

## Logic Pulser

The Logic Pulser solves the problem of how to pulse IC's in digital circuits. Merely touch the Pulser to the circuit under test, press the pulse button and all circuits connected to the node (outputs as well as inputs) are briefly driven to their opposite state. No unsoldering of IC outputs is required. Pulse injection is automatic, high nodes are pulsed low and low nodes, high, each time the button is pressed.

Ability to source or sink up to 0.65 amperes insures sufficient current to override IC outputs in either the high or low state. Output pulse width is limited so the amount of energy delivered to the device under test is never excessive. Additionally, the Pulser output is three-state so that the circuit under test is unaffected until the Pulser is activated.

## HP 546A Logic Pulser

Automatic polarity pulse output, pulse width, and amplitude make for easy multi-family operation when you use the HP 546A Logic Pulser. But, the real surprise comes when you code in one of its six ROM-programmable output patterns (single pulses; pulse streams of either 1, 10, or 100 Hz; or bursts of 10 or 100 Hz; or bursts of 10 or 100 pulses). This feature allows you to continually pulse a circuit when necessary, or it also provides an easy means to put an exact number of pulses into counters and shift registers. Used with our multi-family IC Troubleshooters, the HP 546A acts as both a voltage and current source in digital troubleshooting applications.

## HP 546A Pulser Specifications

### Output

Family	Output Current	Pulse Width	Typical Output Voltage	
			HIGH	LOW
TTL/DTL	≤650 mA	≥0.5 μs	≥3 V dc	≤0.8 V dc
CMOS	≤100 mA	≥5.0 μs	≥(V <sub>supply</sub> - 1 V dc)	≤0.5 V dc

**Power supply requirements:** TTL; 4.5 to 5.5 V dc at 35 mA, CMOS; 3 to 18 V dc at 35 mA, protected to ±25 V dc for 1 min.

**Accessory included:** BNC adapter

## Digital Current Tracer

The HP 547A Current Tracer precisely locates low-impedance faults in digital circuits by locating current sources or sinks. For example, on a bad node the Tracer can verify that the driver is functioning and also show where the problem is by tracing current flow to the source or sink causing the node to be stuck. The Tracer is designed to troubleshoot circuits carrying fast rise-time current pulses. The Tracer senses the magnetic field generated by these signals in the circuit and displays transitions, single pulses, and pulse trains using a simple one-light indicator. Because it is not voltage sensitive, the Tracer operates on all logic families having current pulses exceeding 1 mA, including CMOS, where even lightly loaded outputs can have up to 2 to 3 mA of instantaneous charging current.

To use the Tracer, align the dot on its tip at a reference point, usually the output of a node driver. Set the sensitivity control to indicate the presence of ac current activity. As you probe from point to point or follow traces, the lamp will change intensity; when you find the fault the Tracer will indicate the same brightness found at the reference point.

## HP 547A Current Tracer Specifications

### Input

**Sensitivity:** 1 mA to 1 A.

**Frequency response:** light indicates single-step current transitions; single pulses ≥ 50 ns in width; pulse trains to 10 MHz (typically 20 MHz for current pulses ≥ 10 mA).

**Risetime:** light indicates current transitions with risetime ≤ 200 ns at 1 mA.

### Power Supply Requirements

**Voltage:** 4.5 to 18 V dc.

**Input current:** ≤ 75 mA.

**Maximum ripple:** ±500 mV above 5 V dc.

**Overvoltage protection:** ±25 V dc for one minute.

## Accessories Available

HP 00545-60104: Tip Kit for HP 546A Pulser, 545A Probe

HP 10526-60002: Multi-Pin Stimulus Kit

## Ordering Information

HP 546A Logic Pulser

HP 547A Digital Current Tracer



# DIGITAL CIRCUIT TESTERS

## Logic Clip, Logic Comparator

### Models 548A & 10529A



HP 548A

### Logic Clip

The Logic Clip is an extremely handy service and design tool which clips onto dual-in-line package (DIP) ICs, instantly displaying the states of up to 16 pins. Each of the clip's 16 LEDs independently follows level changes at its associated pin. Lit diodes are logic High, extinguished diodes are Low.

The Logic Clips's real value is in its ease of use. It has no controls to set, needs no power connections, and requires practically no explanation as to how it is used. The clip has its own gating logic for locating ground and  $V_{CC}$  pins and its buffered inputs reduce circuit loading.

The Logic Clip is much easier to use than either an oscilloscope or a voltmeter when you are interested in whether a circuit is in the high or low state, rather than its actual voltage. The Clip, in effect, is 16 binary voltmeters, and the user does not have to shift his eyes away from his circuit to make the readings.

The intuitive relationship of the input to the output—lighted diode corresponding a high logic state—greatly simplifies the troubleshooting procedure. The user is free to concentrate his attention on his circuits, rather than on measurement techniques. Also, timing relationships become especially apparent when clock rates can be slowed to about 1 pulse per second.

When used in conjunction with the Logic Pulser, the Logic Clip offers unparalleled analysis capability for troubleshooting sequential used to inject pulses between gates allowing it to supply signals to the IC under test absolutely independent of gates connected to the IC. All outputs may then be observed simultaneously on the Logic Clip. Deviations from expected results are immediately apparent as the Pulser steps the IC through its truth table.

### HP 548A Multi-Family Logic Clip

Fully automatic and protected to 30 V dc, and employing bright individual LEDs in its display, the HP 548A brings multi-family operation to the HP line of IC Troubleshooters. The Clip can be externally powered, if desired, using a simple power connector.

### HP 548A Specifications

**Input threshold:**  $(\geq 0.4 \pm 0.06 \times \text{Supply Voltage}) = \text{Logic High}$ .

**Input impedance:** 1 CMOS load per input.

**Input protection:** 30 V dc for 1 minute.

**Supply voltage:** 4-18 V dc across any two pins.

**Auxiliary supply input:** 4.5 to 20 V dc applied via connector. Supply must be  $\geq 1.5$  V dc more positive than any pin of IC under test.

**Supply current:**  $< 55$  mA.

### HP 548A Logic Clip

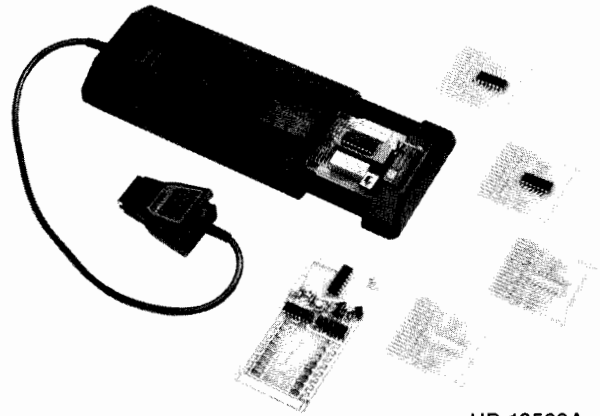

HP 10529A

### Logic Comparator

The HP 10529A Logic Comparator clips onto powered TTL or DTL ICs and detects functional failures by comparing the in-circuit test IC with a known good reference IC inserted in the Comparator. Outputs of the particular IC to be tested are selected via 16 miniature switches which tell the Comparator which pins of the reference IC are inputs and which are outputs. Any logic state difference between the test IC and reference IC is identified to the specific pin(s) on 14- or 16-pin dual in-line packages on the Comparator's display. A lighted LED corresponds to a logic difference. Intermittent errors as short as 300 nanoseconds (using the socket board) are detected, and the error indication on the Comparator's display is stretched for a visual indication. A failure on an input pin, such as an internal short, will appear as a failure on the IC driving the failed IC; thus a failure indication actually pinpoints a malfunctioning node. A test board is supplied to exercise all of the circuitry, test leads, and display elements to verify proper operation.

**HP 10541A:** twenty additional blank reference boards; identical to the 10 boards provided with the Logic Comparator.

**HP 10541B:** twenty preprogrammed reference boards. The 10541B includes the following ICs: 7400, 7402, 7404, 7408, 7410, 7420, 7430, 7440, 7451, 7454, 7473, 7474, 7475, 7476, 7483, 7486, 7490, 7493, 74121, 9601.

### HP 10529A Comparator Specifications

**Input threshold:** 1.4 V nominal (1.8 V nominal with socket board), TTL or DTL compatible.

**Test IC loading:** outputs driving Test IC inputs are loaded by 5 low-power TTL loads plus input of Reference IC. Test IC outputs are loaded by 2 low-power TTL loads.

**Input protection:** voltages  $< -1$  V or  $> 7$  V must be current limited to 10 mA.

**Supply voltage:** 5 V  $\pm 5\%$ , at 300 mA.

**Supply protection:** supply voltage must be limited to 7 V.

**Maximum current consumption:** 300 mA.

### Sensitivity

**Error sensitivity:** 200 ns with reference board or 300 ns with socket board. Errors greater than this are detected and stretched to at least 0.1 second.

**Delayed variation immunity:** 50 ns. Errors shorter than this value are considered spurious and ignored.

**Frequency range:** maximum operational frequency varies with duty cycle. An error existing for a full clock cycle will be detected if the cycle rate is less than 3 MHz.

**Accessories included:** 1 test board; 10 blank reference boards; 1 programmable socket board; 1 carrying case.

### Accessories Available

**HP 10541A:** Twenty Blank Reference Boards

**HP 10541B:** Twenty Pre-programmed Boards

### HP 10529A Logic Comparator



# DIGITAL CIRCUIT TESTERS

## Logic Troubleshooting Kits

Models 5011T, 5021A, 5022A, 5023A & 5024A

249



- Complete multi-family kits
- Stimulus-response capability
- In-circuit fault finding

- In-circuit analysis
- Dynamic and static testing
- Multi-pin testing



HP 5011T

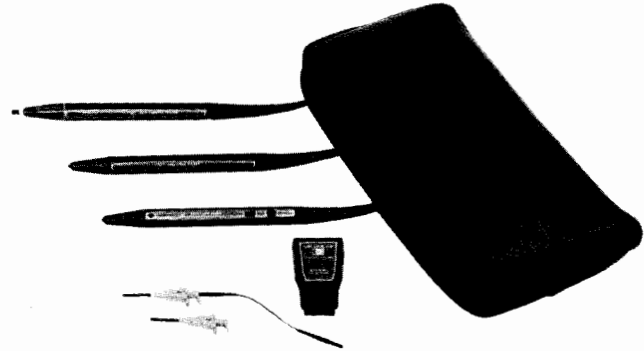

HP 5022A

FAULT	STIMULUS	RESPONSE	TEST METHOD
Shorted Node <sup>1</sup>	Pulser <sup>2</sup>	Current Tracer	<ul style="list-style-type: none"> <li>• Pulse shorted node</li> <li>• Follow current pulses to short</li> </ul>
Stuck Data Bus	Pulser <sup>2</sup>	Current Tracer	<ul style="list-style-type: none"> <li>• Pulse bus line(s)</li> <li>• Trace current to device holding the bus in a stuck condition</li> </ul>
Signal Line Short to Vcc or Ground	Pulser	Probe, Current Tracer	<ul style="list-style-type: none"> <li>• Pulse and probe test point simultaneously</li> <li>• Short to Vcc or Ground cannot be overridden by pulsing</li> <li>• Pulse test point, and follow current pulses to the short</li> </ul>
Supply to Ground Short	Pulser	Current Tracer	<ul style="list-style-type: none"> <li>• Remove power from circuit under test</li> <li>• Disconnect electrolytic bypass capacitors</li> <li>• Pulse across Vcc and ground using accessory connectors provided</li> <li>• Trace current to fault</li> </ul>
Internally Open IC	Pulser <sup>2</sup>	Probe	<ul style="list-style-type: none"> <li>• Pulse device input(s)</li> <li>• Probe output for response</li> </ul>
Solder Bridge	Pulser <sup>2</sup>	Current Tracer	<ul style="list-style-type: none"> <li>• Pulse suspect line(s)</li> <li>• Trace current pulses to the fault</li> <li>• Light goes out when solder bridge passed</li> </ul>
Sequential Logic Fault in Counter or Shift Register	Pulser	Clip	<ul style="list-style-type: none"> <li>• Circuit clock de-activated</li> <li>• Use Pulser to enter desired number of pulses</li> <li>• Place Clip on counter or shift register and verify device truth table</li> </ul>

1. A node is an interconnection between two or more IC's.

2. Use the Pulser to provide stimulus or use normal circuit signals, whichever is most convenient.

### Accessories Available

**HP 00545-60104:** Tip Kit for HP 545A Probe, and 546A Pulser

**HP 10525-60012:** Tip Kit for HP 10525E Probe

**HP 10526-60002:** Multi-pin Stimulus Kit for Logic Pulsers

**HP 10529-60006:** External Reference Kit for HP 10529A Comparator

**HP 10541A:** Twenty blank reference boards for HP 10529A Comparator

**HP 10541B:** Twenty pre-programmed reference boards for HP 10529A Comparator

Used individually, each of HP's IC Troubleshooters provide their own unique and important troubleshooting function. Together they become invaluable stimulus-response testing partners that help pinpoint faults and ensure fast non-destructive repair of digital circuits.

To help you take advantage of the usefulness of the IC Troubleshooters, HP has packaged them into kits which offer both ordering convenience, and cost savings. Also, applications information is available, such as AN 163-2, "New Techniques of Digital Troubleshooting", to help users derive maximum benefit from these instruments.

The table shows a series of typical node and gate faults and the combination of tools used to troubleshoot the circuit. As with all sophisticated measuring instruments, operator skill and circuit knowledge are key factors once the various clues or "bits" of information are obtained using the IC Troubleshooters.

To accomplish troubleshooting at the node and gate level, both stimulus (Pulser) and response (Probe, Tracer, Clip and Comparator) instruments are needed. Moreover, instruments with both voltage and current troubleshooting capability help isolate electrical faults where the precise physical location is hard to identify.

The HP 547A Current Tracer, the latest and most sophisticated of these troubleshooters, lets you "see" current flow on nodes and buses that otherwise appear stuck at one voltage level. Used with the HP 546A Pulser, stimulus-response testing is now also possible in the current domain.

### IC Troubleshooter Kits Ordering Information

Kit	H mm (in)	W mm (in)	D mm (in)	Net Wt kg (lbs, oz)	Ship Wt kg (lbs, oz)
HP 5011T	82.6 (3.25)	203 (8)	311 (12.25)	1.49 (3,5)	2.11 (4,11)
HP 5021A	64 (2.5)	146 (5.75)	298 (11.75)	0.51 (1,2)	0.62 (1,6)
HP 5022A	64 (2.5)	146 (5.75)	298 (11.75)	0.65 (1,7)	0.76 (1,11)
HP 5023A	225 (8.88)	200 (7.88)	337 (13.25)	1.63 (3,10)	2.19 (4,14)
HP 5024A	64 (2.5)	146 (5.75)	298 (11.75)	0.60 (1,5)	0.71 (1,9)

### IC Troubleshooter Kits Selection Guide

HP MODEL	545A TTL/CMOS Probe	546A TTL/CMOS Pulser	547A TTL/CMOS Current Tracer	548A TTL/CMOS Clip	10529A TTL Comparator
5011T Kit	X	X		X	X
5021A Kit	X	X		X	
5022A Kit	X	X	X	X	
5023A Kit	X	X	X	X	X
5024A Kit	X	X	X		

# DIGITAL CIRCUIT TESTERS

Digital Education Courses, Microprocessor Lab

Model 5035T, 5036A

- Complete introductory course in practical digital electronics.
- Covers hardware, software and troubleshooting in one course.

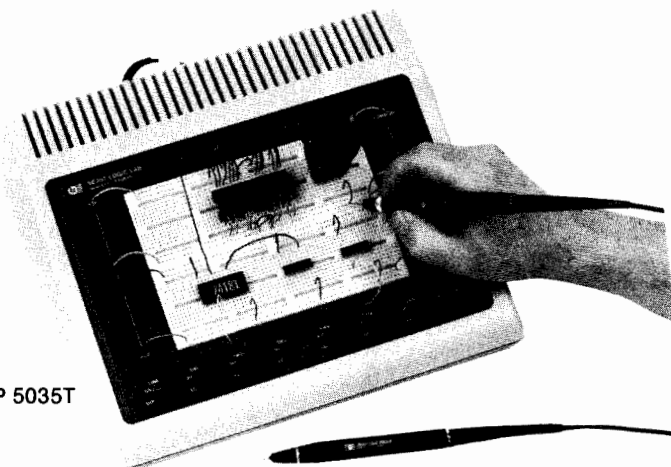

HP 5035T

## HP 5035T Complete Logic Lab

Learn logic . . . the practical way. The HP 5035T Logic Lab combines theory and lab so you'll learn digital logic quickly, enjoyably, and memorably. Start by building simple circuits and work up to a complete digital clock. Logic labs have been adopted by schools, industrial firms and individuals who want to keep up with the changing world of electronics, and enjoy doing it.

### HP 5035T Lab Includes

**Mainframe** with removable breadboard (see below)

#### "Practical Digital Electronics"—An Introductory Course

- Complete textbook
- 26 Experiment Workbook

#### TTL/DTL Test Instruments

- HP 545A Logic Probe
- HP 546A Logic Pulser
- HP 548A Logic Clip

#### Wire and Component Kit

- 32 TTL, MSI, LSI ICs
- 285 Pre-stripped Wires
- 4 Large LED Numerical Displays
- IC Remover

### Logic Lab Mainframe

The Logic Lab Mainframe brings convenience and flexibility to breadboarding by allowing solderless connection of new circuit ideas. Fully self-contained, the mainframe has a 5-volt 1-amp power supply, two clocks, four LED indicators, six data switches, two 5-volt BNC connectors, and a handy removable breadboard. To use it, just connect circuits using standard 24-gauge wire, then power up either one or several breadboards to verify new circuit ideas quickly and easily before incurring PC board layout and rework charges.

### Accessories Available

**HP 1258-0121:** Additional breadboard assembly

**HP 1540-0258:** Heavy duty, padded vinyl carrying case

**HP 05035-60006:** Wire interconnect kit

**HP 10656A:** Set of 10 "Practical Digital Electronics", An Introductory Course—Text and Lab Workbook

**HP 10657A:** Additional component and wire kit

## HP 5035T Complete Logic Lab

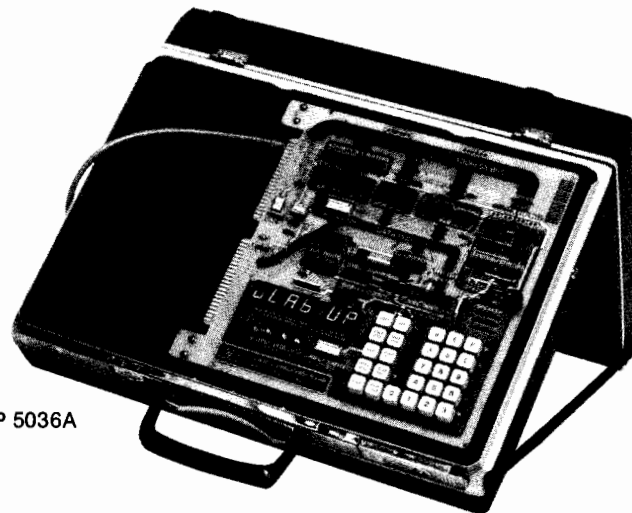

HP 5036A

## HP 5036A Microprocessor Lab

### Staying Current with Technology

The microprocessor presents a repair problem due to its complexity, and because it is used in so many diverse products. Little imagination is required to anticipate field repair problems with microprocessor-based products like traffic controllers, typesetters, POS terminals, medical instrumentation, etc.

There are scientists and engineers who can contribute to solving this problem by learning about both the hardware and software in microprocessor systems, and there is a virtual army of technicians who need to learn to troubleshoot them. The HP 5036A Microprocessor Lab provides both the hardware and software basics and vital troubleshooting information needed to solve the microprocessor puzzle.

The HP 5036A course book, *Practical Microprocessors*, covers both hardware and software in detail in separate chapters containing summaries, hands-on experiments and quizzes. Once these chapters are completed, the course builds up to a series of troubleshooting experiments employing recommended troubleshooting instruments that challenge the user and reinforce microprocessor operating concepts. The book also contains information on the use of oscilloscopes, signature analyzers, logic analyzers, and logic probes for troubleshooting microprocessor-based products.

### HP 5036A Major Features

- Color PC board graphics illustrate system block diagrams to enhance learning.
- Multiple-experiment troubleshooting chapter highlights IC Troubleshooters such as HP 545A Probe, 546A Pulser, 547A Current Tracer and HP Signature Analyzers.
- Plug-in jumpers create real hardware faults that allow realistic troubleshooting practice.
- Complete resident software.
- Dual 5-volt power supplies, plus edge connectors for expandability.
- LED monitors on all data, address, status and output lines.

### Recommended Accessories for Troubleshooting Experiments

**HP 5024A** Logic Troubleshooting Kit

**HP 5006A** Signature Analyzer

**HP 5036A Microprocessor Lab** and Power Supply mounted in briefcase, plus *Practical Microprocessors* text and lab book, in English (German, French and Italian editions are available in those countries).

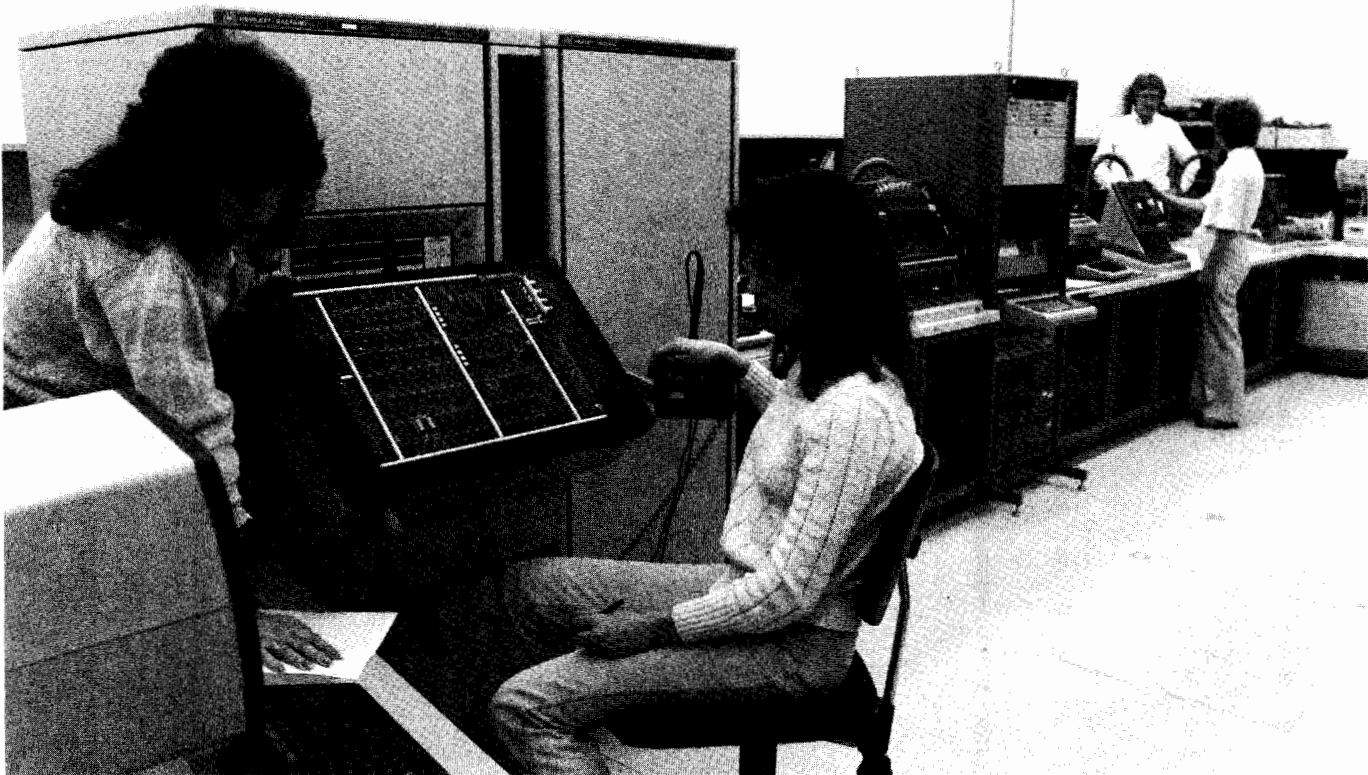

Technological advances and increased worldwide competition are placing new demands on production managers to cut costs, increase productivity and improve product quality. Automatic test equipment has become a key factor in achieving these goals. The implementation of a cost effective ATE solution requires careful assessment of the particular production environment in which it will be used.

### Fault Identification

The cost of finding a fault or failure in electronic equipment increases by a factor of ten at each stage of the production process. A fault detected at board test could cost \$5—at final assembly the cost could exceed \$50. If this defective unit reached your customer, it could cost \$500 or more. While the economic costs are high, the intangible costs can be even greater. Defects at the board level could cause bottlenecks, disrupting the smooth flow of boards through production process. Failures that remain undetected until final test can lead to late deliveries and nonlinear shipments. If this same failure reached the field, it could undermine customer goodwill and your company's reputation for quality.

Since the cost of fault identification increases dramatically at each step in production, you must catch faults as early as possible. Extensive incoming inspection of parts is not necessarily the answer. Your real goal is high turn-on rates in final test. To achieve this goal requires boards that are defect free. High yield PC boards are a function of good parts and good processes.

A number of problems can occur during

the PC board assembly process that cannot be eliminated at incoming inspection. Typical problems are open traces, solder splashes, wrong or misloaded parts, poor solder joints, and parts damaged during the assembly process. If board level testing is omitted, these process faults would lead to unacceptably low turn-on rates in final test. Even with a good board yield of 60%, a simple product with only five boards would fail 90% of the time. Clearly, the best place for thorough testing is at the board level because it is the first opportunity to locate faults across the entire fault spectrum.

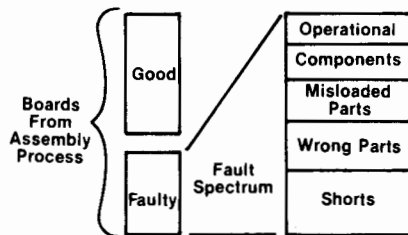

### The Board Test Advantage

Automatic board test equipment will save you money by increasing productivity and improving product quality. Productivity is increased by replacing labor-intensive manual testing with computer-aided testing. Component level diagnostics provided by ATE reduces rework costs. As production through-

put increases, so does your plant capacity.

ATE will also help to achieve your quality goals. Higher quality products will lower warranty costs and preserve customer goodwill. Automatic testing provides critical feedback necessary to diagnose quality problems in your production process and correct them. This allows you to build quality into your product, not test it in.

Your production operation is unique. To determine if ATE will make sense in your application, you must compare the total cost of ownership with the savings accrued by using ATE. Return on investment calculations often show that the test equipment will pay for itself in a year or less.

### Choosing a Circuit Board Tester

There are no simple answers to selecting an automatic board test system. You must consider such factors as: production yield, test yield, process induced fault spectrum, production volume, board type, and anticipated new products. If ATE makes sense, you must then consider the level of support you will require from the ATE vendor.

Three general types of loaded board testers are presently being used in the electronics industry. They are in-circuit, functional and combination in-circuit/functional testers. The in-circuit test system locates faults by checking components and circuitry without energizing the entire board. Functional testers isolate faults by exercising the board in a manner that simulates its use in the final product. Combinational testers perform in-circuit evaluation before powering the board for functional testing.

# CIRCUIT TEST SYSTEMS

## Production Testing of Electronic Printed Circuit Board Assemblies (cont.)

### In-circuit Board Testers

In-circuit testers access all nodes on the PC board through a bed-of-nails fixture. Spring loaded pins contact the internal points on the loaded board. Components can be isolated using an electrical guarding technique and then tested for value, placement, and component type. In-circuit testers are well suited for detecting manufacturing and workmanship-related faults which can account for up to 80% of all faults.

Program generation on an in-circuit tester is simple and straightforward. Most of these test systems have automatic program generators that automatically develop the in-circuit portion of the test plan. Since the tests are component level only, the actual function of the PC board is irrelevant. The tester steps through the test plan from component to component and evaluates specific characteristics of each device. This technique provides excellent diagnostic resolution at the component level.

### Functional Board Testers

Functional test systems emulate the electrical environment of the board under test. Stimulus sources act as input signals to the circuit, while detectors measure the output and compare it with the expected response. The primary goal of the functional test system is to verify the dynamic performance of the complete circuit under test. Most dedicated functional test systems are stimulator-based and provide a fast go/no go indication on the board under test. Since all tests are performed at the board-edge connector, fault isolation is more difficult and time consuming than with the bed-of-nails fixture used for in-circuit testing.

### Combinational Test Systems

Individually, in-circuit and functional testers have advantages and disadvantages. Combining these measurement techniques provides a complementary approach to board testing. The spectrum of faults not covered by in-circuit testing is usually covered by functional test capability.

Advances in test technology have led to the development of test systems that perform both in-circuit and functional testing. They combine the best of both techniques into a single system. Test systems that blend in-circuit and functional test capability can not only check for shorts and component errors, but can also verify the dynamic performance of the circuit under test.

These combined test systems are ideal for boards that have nodes that can be accessed with a bed-of-nails fixture, whether analog, digital or hybrid. Test capabilities of these systems can include analog in-circuit, analog functional, digital in-circuit, digital functional, and shorts testing.

### Advanced Analog In-circuit Testing

All HP in-circuit testers use advanced techniques that allow component isolation in even the most difficult circuit configurations. For example, a 0.01  $\mu\text{F}$  capacitor can be measured to an accuracy of 4% even when in parallel with a 1000 ohm resistor. This is made possible by our 6-wire guarding and phase synchronous detection. Added features

such as remote sensing, extended guarding, and extra digit greatly expand the precision measurement capabilities of HP's board test systems.

### Extended Guarding

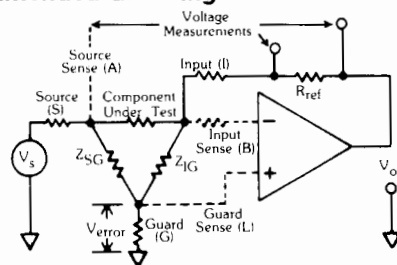

### Analog Functional Testing

Functional testing enhances in-circuit test results and can significantly increase board test system yields. Each HP board test system with in-circuit capability also has standard sources and detectors to provide functional testing. Optional instrumentation can easily be added via the HP-IB interface. Active analog functional testing finds faults not detected with in-circuit testing and allows tuning and circuit adjustments by system operators.

### Digital In-circuit Testing

Digital in-circuit testing electrically isolates each IC on the board while it is tested. This technique requires that the test system take control of the chip's inputs by overdriving the outputs of "upstream" devices. Overdriving without careful analysis of these digital tests can potentially cause failure during testing or latent failures due to device degradation.

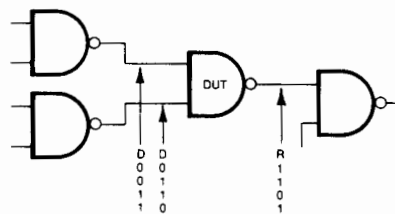

After over three years research, HP determined that to minimize the potential for device damage, each individual IC test should be analyzed. This is due to the variety of configurations in which a device can be used. HP's "Safeguard In-circuit" analysis software looks at each test as it is created. It considers device parameters such as package type, power dissipation, and overdrive voltages and currents to minimize the damage potential. To further reduce the potential for device damage, two driver edge speeds are available to reduce voltage overshoot. If the chance of excessive temperature rise exists, a cooldown time is automatically imposed. After all these precautions are taken, if the potential for damage still exists, the programmer receives a warning message.

### Digital Functional Testing

There are basically two forms of digital functional testing: high speed digital functional testing and static pattern testing.

HSDFT tests the circuit "at speed", emulating the dynamic operation of the circuit under test. Signature Analysis is an HSDFT test method consisting of a high speed digital stimulus and a synchronous measurement technique. Long data strings are compressed into a four character hexadecimal string called a signature. These DUT signatures are then compared to those learned from a known good board.

Static pattern testing consists of applying a test pattern at the input of a printed circuit board and measuring the response at the output. If the tester has access to internal circuit nodes, the output of each individual device can be tested.

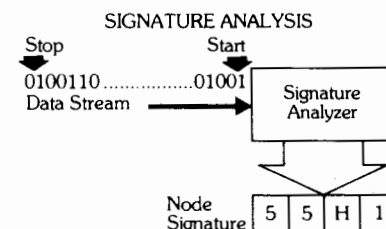

Test systems can access the board under test in several ways. The first is via the board-edge connector. Used primarily with the static pattern test technique, this method gives a fast go/no go indication for the circuit under test. Component level fault isolation, if available, is usually through the use of a program-directed probing technique. A second method uses a bed-of-nails fixture to access every circuit node, providing simple component level diagnostics. The same is true for the combined edge connector/bed-of-nails fixturing method.

Test patterns for functional test systems can be generated manually or by a simulator. Manual generation is usually limited to simple circuits. The output of computer aided design (CAD) systems can be used to simplify the manual process. The two basic types of simulators used to generate functional test patterns are those that are an integral part of the functional tester and the off-line simulator. Simulator outputs are generally required for comprehensive testing of large, complex digital circuits.

### HP's Testing Techniques

Since each production process is unique, your specific process may require several of the measurement capabilities listed above. HP's Circuit Test product line offers a wide range of board test systems, each providing at least two of these testing techniques. Analog in-circuit and functional testing capabilities are available in the HP 3061A, HP 3062A and HP 3065H board test systems. The HP 3062A provides static pattern and high speed digital functional testing. Digital in-circuit testing with "Safeguard In-circuit" analysis is provided on the HP 3065H. The DTS-70 is a simulator-based digital functional tester with analog functional testing capability.



### Maintaining Control of the Manufacturing Process

Automatic testing in the production test area is not the total solution to productivity or product quality. There must be an overall strategy for linking computer-aided solutions throughout the entire manufacturing facility. The HP Manufacturer's Productivity Network (MPN) is an integrated strategy for providing products and services that link the four major areas in a facility. They include operations, administration, engineering and production. Timely communication among these areas is essential if control of the manufacturing facility is to be maintained.

The HP Q-STAR network (Quality Systems for Test, Analysis and Repair) is a significant addition to the HP MPN in the production test area. It provides productivity and product quality enhancements in the test area with multiple links to other MPN quadrants. HP Q-STAR was developed on the premise that a network is more than a hardware link. It must also provide applications software to form a framework for using board test data to improve product quality as well as provide feedback to improve the manufacturing process.

HP Q-STAR resides on the HP 3065 Board Test System and takes advantage of its unique cluster architecture that allows users to access common peripherals and data bases. Several new application packages have been added to enhance the standard HP 3065 software. These include paperless repair, CAD-HP 3065 interfacing, and test reporting using Statistical Quality Control (SQC) methods.

### Paperless Repair/Reporting

Paperless repair/reporting with bar code reader capability automates the data flow between the test and repair areas and provides board tracking through the test/repair cycle. Failure information by board serial number can be stored for retrieval by repair operators using a terminal keyboard or a bar code reader. This test/repair data can be used to identify "looping" boards and result in increased

productivity in the repair process. The same data base can be analyzed and provide timely feedback to improve the production process. PPR is a standard feature on the HP 3065 Board Test System.

### Test Statistics Reporting

Analysis of data obtained in the test/repair loop is the job of HP Q-STATS, another standard feature of the HP 3065. The statistical analysis turns raw data into usable information required by programmers, test engineers and managers. For example, producibility reports provide a statistical measure of the quality and repeatability of a test. This is a clear indication of how well the test will perform in the production process.

HP Q-STATS provides production management information in several different formats based on Statistical Quality control concepts. Tabular reports highlight production parameters such as yield, volume of boards tested, and average wait, test and repair times. Pareto charts provide more detailed information such as board failures by component designator. These reports can be used as they are, or can be easily tailored to meet user format requirements.

### CAD-ATE Interfacing

In every in-circuit board test system, a description of the circuitry, or topology of the board to be tested, must be entered into the test system before a test plan can be generated. Computer Aided Design (CAD) systems are widely used in the design of the boards and contain much of the data required by the test system. Standard CAD outputs such as netlists and parts lists can be formatted and used instead of manually entering each component and interconnect. Once the topology information is in the test system, component values and tolerances must be entered manually. At this point, most in-circuit test systems have an automatic program generator that generates the basic test plan.

HP provides a unique solution for extracting data from the CAD systems for use on the HP 3065 Board Test System. Instead of relying on a CAD vendor to supply a post-processor to format the CAD files, the standard outputs are read into the HP 3065 and reformatted there. Using a software package called HP CAD-VANTAGE, board test data can be extracted from custom CAD systems as well as commercial systems.

After the transferred data is formatted in the HP 3065, it is entered into the forms entry package. Parameters such as component values, tolerances and failure messages can then be entered into this menu-driven package. Once the data is complete, the HP 3065's program generator, IPG-II, automatically generates a complete in-circuit test for the board in a fraction of the time required using the manual entry mode. In addition, the board description may be transferred to other HP board testers for test program generation on those systems.

### Linked Solutions

These applications require supported links to be useful. The HP 3065 provides high speed links for networking a number of test clusters together to share files and resources. A single "copy" command can transfer remote files as well as local files over HP's proven Distributed Systems (DS) link.

For links beyond the HP 3065 environment, HP has provided a number of new software capabilities. HP 3062 Data Link Utilities enables an HP 3065 to communicate with HP 3061/2 systems over the HP-IB (IEEE-488) interface. The Q-STAR environment is open to a wide variety of computer systems used in Computer Aided Manufacturing (CAM). New software provides access to the HP 3065's RS-232 ports for custom communications with virtually any computer system via hardwired or modem links.

Standard HP 3065 software also uses ISO's HDLC packet switched protocol, BYSYNC communication or standard ASCII record transfers to link to HP 1000, 3000 and desktop computers. Modem interfaces allow remote communications and support for the X.25 international packet switched standard provides true global network capability for the HP 3065 Board Test Family.

### Is ATE the Answer?

Can automatic board test equipment save you money? Again, there are no simple answers. Chances are that it can if any of the following conditions exist in your plant: high PC volume, complex boards, backlogs in production test, low turn-on in final assembly, high in-process inventory and high warranty costs. HP's sales representatives can help you characterize your production operation by comparing the cost of testing or not testing at each level of the process. They are available to help you answer your ATE questions.





# CIRCUIT TEST SYSTEMS

## In-Circuit/Functional Test Systems

### Model 3061A/3062A



### Description

Two new board testers, the HP 3061A and HP 3062A, have been added to Hewlett-Packard's expanding line of circuit test systems. These test systems combine excellent in-circuit fault isolation with functional testing capability to maximize PC board yields. Both the HP 3061A and HP 3062A incorporate advanced measurement and interface technology based on years of experience within HP and field proven in the HP 3060A.

The HP 3061A Board Test System has been optimized for analog PC board testing. It combines advanced analog in-circuit and analog functional test capabilities with high speed shorts/opens testing.

The HP 3062A Board Test System adds both digital static and digital functional testing to analog testing capabilities of the HP 3061A. You can choose the system that is right for your specific production test needs.

### Selecting a Board Tester

Which quality problem does your board test area encounter most often? Is it workmanship? Shorted or open circuits? Failed components? Misloaded components? Functional failures? Hewlett-Packard board test systems are designed to solve the problems of shorts/opens, component or functional failures. High test yields mean lower test and repair costs.

HP board test software minimizes your test development investment. Using the program development tools decreases the time required to generate board test programs. The software is also structured so programmers can develop board test programs on programming stations anywhere in your facility. 'Off-line' programming stations allow programmers to develop programs without affecting production flow.

### System Controllers

A board test system controller must offer your programmers high-level software and a user interface which is friendly and flexible for production testing. HP selected its own Series 200 Desktop Computers for this important function. The HP Series 200 Computers are the result of more than 10 years of system controller design experience. They offer advanced edit features for programming efficiency and simple system

expansion via the flexible I/O structure. With the power of the Series 200 controller, your programmers will be able to write effective board test programs.

You may select from four system controllers, the HP Model 36, HP Model 26, HP Model 20, or HP Model 16. Software written on one model is directly compatible with the others. The HP Model 26 and 36 computers have built-in floppy disc drives for convenient programming. Additional hard disc drives can be added. The HP Model 16's low cost and small physical size makes it an ideal controller for dedicated test applications. The HP Model 20 Box Computer is rack mounted and offers a low cost alternative to the HP Model 26 and 36. It has a 15-slot card cage for additional interfaces and memory expansion.

### Advanced Analog In-circuit Testing

The HP 3061A/3062A advanced analog in-circuit testing finds faults over a wide variety of components, measurement values, and tolerances. Advanced six-wire guarding methods make accurate measurements possible, even in cases of severe parallel shunting. (HP pioneered this technique in the mid 70's.) Programmers may select a variety of guarding methods to optimize throughput and accuracy for specific production requirements.

This test technique assures you of consistent measurement results from board-to-board and between systems. For example, you can off-load analog testing from one tester to another during peak production periods and get the same test results. HP analog in-circuit testing techniques mean flexible, consistent, and accurate measurements from your testers.

### Analog Functional Testing for Higher Yields

Analog functional testing enhances the results of in-circuit testing and significantly increases PC board yields. Yields of 85-90% using analog in-circuit test methods may be increased to 95-98% with the addition of functional testing. The standard HP 3061A/3062A gives the user a wide range of measurement test tools for full functional testing. If additional functional test capability is required, HP-IB instrumentation from Hewlett-Packard may be easily added for your specific functional test needs.



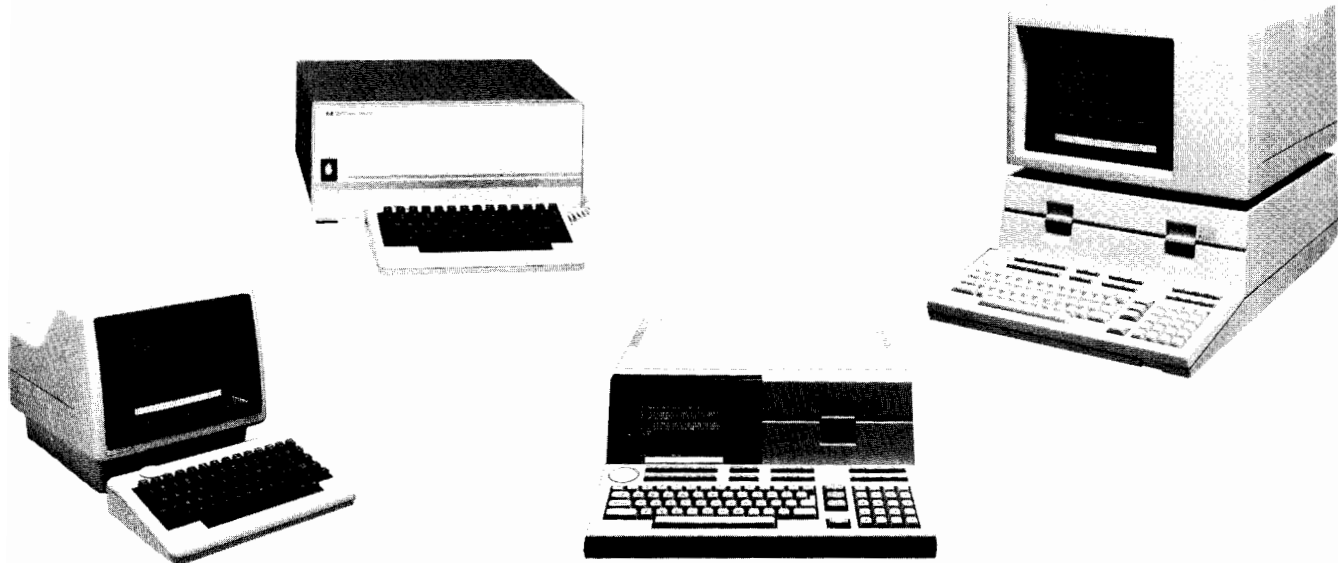

HP Series 200 controllers for HP 3061A/3062A board test systems

### Digital Functional Testing

The HP 3062A tests digital PC boards containing a wide range of logic devices including microprocessors. The testing of microprocessor-based circuits with bus-structured devices, large memories, and dynamic memory devices often presents difficult test problems. Functional testing of your microprocessor boards is reduced to a manageable task using Signature Analysis (SA).

Digital Static Pattern Testing tests circuits of medium complexity. This technique stimulates digital circuits and compares the measured response to an expected response. Using advanced analog testing and static pattern testing, hybrid circuits such as A to D's and phase lock loops can be thoroughly tested.

### Software For Your Programmers

Your programmer will reduce test development times through the use of HP's high-level languages and automatic program generator. The system software includes Board Test Language (BTL200), In-circuit Program Generator (IPG200), Digital Functional Test Development Package (DFT200), Data Logging routines and Fixture Verification programs.

The system Board Test Language (BTL200) controls complex system functions. These functions include setup, measurement, response, and data evaluation. It is structured to work efficiently with the system hardware, reducing the amount of time it takes to execute a test. Your programmer needs to know only simple high-level component test statements to write a program.

Using on-line editing and immediate execution capabilities, various test configurations can be quickly evaluated. With BTL200's high-level statements, your programmer can write board test programs which will increase throughput on your production line.

IPG200 automatically generates the analog in-circuit test program. Your programmer needs to enter only the circuit description with component values and test tolerances. IPG200 will automatically analyze parallel paths and select optimum guarding locations. When the program is complete, a measurement analysis of each component, the test program, and fixture documentation is printed out. Using the final test program and fixture documentation, your programmer can begin building the test fixture. Fixture verification software will help check fixture construction for errors.

The DFT200 software development package aids the user in entering and debugging programs using the Signature Analysis (SA) technique. DFT200 combines stimulus and SA measurement routines into a final efficient test program. This means faster program execution and high PC board throughput.

### Systems Designed For Your Changing Needs

The dynamic nature of the electronics industry requires the selection of a flexible board test system for your production area. HP board test systems, with their standard HP-IB capability and modu-

lar design concept, give you the necessary flexibility. As your testing requirements expand, additional measurement capability can be added to the basic system to increase the test capability.

### Production Test Strategy

ATE is used in all areas of the manufacturing process to reduce production costs. You may think of other reasons for buying ATE, but the major benefits are lower production costs, higher yields, and increased productivity for your production area.

There are many steps in the production process where testing may be done. When and how to test depends on factors such as PC board volume and complexity, production yield, and the desired level of fault isolation. Based on actual testing reports, it's easier to find faults at the PC board level than anywhere else in the production process. This makes a strong case for concentrating the testing effort at the PC Board level.

### Quality Through Data Analysis

Board test systems find faults and give you the opportunity to repair them before they reach customers. But is finding a fault and repairing it the ultimate goal for your board test area? The use of statistical methods to analyze recorded failure data and eliminate problems in your manufacturing process is the real key to increasing productivity.

HP 3061A/3062A Test Systems accumulate data required for statistical evaluations of your production process. HP-supplied programs can analyze the data or you can write your own data analysis programs easily using HPL statements. Analysis of your failure information will isolate problems in your manufacturing process.

### HP Support

Qualified systems engineers are located near your facility to provide you with applications and programming support. Customer Engineers support your system on a worldwide basis through the use of locally-placed system service kits. But, that's still not the whole story. Complete user training courses are taught for each system. To enhance the learning process, these training courses are offered at 14 Hewlett-Packard training locations throughout the world.

### Installation

HP will install your system and verify proper operation to insure that you have a quick start-up.

### Documentation

HP board test systems are supplied with complete documentation. This documentation is used for training, future applications and service reference.

### Ordering Information

**HP 3061A Board Test System**  
(depending on configuration)

**HP 3062A Board Test System**  
(depending on configuration)

# CIRCUIT TEST SYSTEMS

## Board Test Family

Model 3065

- High throughput
- Low programming costs

- Multiple test stations
- Multiple programming stations



### Description

The HP 3065 Board Test Family is the result of years of experience in automatic testing and advanced computer technology. It combines high speed digital in-circuit testing with our proven 6-wire analog in-circuit and analog functional measurement capabilities. In addition, the HP 3065's distributed intelligence architecture allows a single system controller to support multiple test stations, multiple programming stations and a variety of peripherals without sacrificing high throughput in production test.

The HP 3065's family concept and modular design allows configurations to meet today's testing requirements and still provides flexibility for future expansion. A basic HP 3065 test system consists of a system controller and a test station which includes an equipment bay, a measurement bay and a work station with terminal and strip printer.

### System Controller

The HP 3065C System Controller includes a high speed minicomputer that serves as a test station controller for production testing and a test development center for program generation. It is configured exclusively for the board test environment, requiring the user to interact only with the board test software, not with the computer's operating system.

A single HP 3065 controller supports up to three test stations plus three programming stations simultaneously. If less than three test stations are required, programming stations may be added. The HP 3065C can be used exclusively for a test development center, supporting a total of six programming stations.

### Analog/Digital Test Station

The HP 3065H Analog/Digital Test Station provides state-of-the-art in-circuit testing to isolate both component and process induced faults on PC board assemblies.

Digital test speeds are enhanced by making the test station a part of the distributed control structure. The test station uses a bit-slice computer as a local controller. RAM-behind-the-pins stores complex test patterns to be applied by the controller to SSI, MSI and LSI/VLSI

devices. Pattern application rates are programmable up to 2.5 MHz on all pins. The HP 3065H's 1056 digital node capability allows it to test large digital boards with over 200 ICs.

Advanced testing techniques provide shorts testing at greater than 200 nodes per second. Failure messages report all common devices connected to the failing node to aid in speeding up the repair process. Digital in-circuit testing uses the HP 3065 device library of over 3500 part numbers to decrease digital test development times. The in-circuit program generator, IPG-II, automatically modifies each library test to match the topology of the device on the board. Custom IC tests are easily generated using the high level Vector Control Language of the HP 3065 system.

The HP 3065H also includes analog in-circuit and analog functional testing capability. It can be configured with up to 1056 digital or 1408 analog nodes for testing large analog, digital or hybrid boards.

Analog in-circuit provides 6-wire guarding, phase synchronous detection as well as enhanced and extra digit measurement modes for measuring a wide range of components and component values. Analog functional measurements can be made with internal sources and detectors or a variety of external instrumentation via the HP-IB interface. Functional tests are programmed by simple BT BASIC commands.

### Throughput

Digital throughput is usually incorrectly equated to test pattern application rates. In reality, actual test times are a very small portion of the total time required to test a digital device. With test vectors being applied at MHz rates, it takes less than 50 microseconds for most IC tests. Conventional testers incur overhead times of 50 to 750 milliseconds reading data from the disc, downloading test data to the hardware, reading the received data, and comparing the results with the expected pattern. In most cases, overhead varies with IC complexity. The HP 3065's digital throughput of 30-45 ICs per second is virtually independent of device complexity.

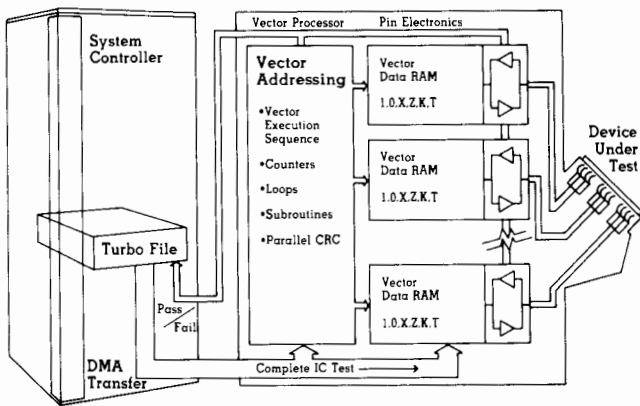

The HP 3065's architecture downloads an entire digital test from the system controller to the test station electronics in one DMA transfer. A Vector Processor microcomputer in each HP 3065H test station sequences test vectors stored in the RAM behind the pins.

### Distributed Intelligence Architecture

The HP 3065 uses efficient software and a distributed intelligence hardware design to minimize overhead times. Each test station has its own bit-slice microcomputer, the Vector Processor, plus RAM and control electronics to provide MHz test vector rates on all digital pins.

The HP 3065C System Controller reads multiple device tests into a "turbo" file in its memory during a single disc access. Then using Direct Memory Access (DMA), the system controller downloads complete device tests from the "turbo" file to the test station one at a time. Test sequence information is loaded into the Vector Processor memory and unique test vectors are loaded into the RAM behind the pins.

### Vector Processor

The Vector Processor controls the real-time digital test execution for each test station. Using a pipeline architecture, the Vector Processor eliminates overhead time between test vector applications. As tests are executed, pin electronics supporting each test pin makes a pass/fail decision in hardware by comparing the received data with the expected pattern. The instant a failure is detected, a fail bit is returned to the Vector Processor. The system controller detects this failure and immediately initiates the DMA transfer of the next complete device test.

### Pin Electronics

Each bi-directional test pin is supported by local RAM. This RAM is used to store only unique test vectors required to test a device. Each of these vectors may be applied as many times as necessary by the Vector Processor to completely test the DUT. The RAM also supports the HP 3065's K (keep the previous state) and T (toggle the previous state) vector states in addition to the traditional 1, 0, X and Z. This derivative mode and the unique vector storage give the HP 3065 an equivalent of 4k random vector storage and almost unlimited algorithmic vector capability. Using these techniques, data compression of 150:1 and greater can be achieved.

By reducing the amount of data that must be transferred and minimizing or eliminating overhead times inherent in the test process, the typical HP 3065 overhead time averages less than 30 milliseconds. This gives the HP 3065 a digital throughput rate of 30-45 ICs per second.

### Lower Test Development Costs

Test development costs can be the major on-going cost of owning a board test system. The HP 3065 helps control these costs by providing a unique software environment to increase programmer productivity and reduce test development costs. From data entry to test execution, the HP 3065 is easy to use.

### Automatic Program Generation

Since Computer Aided Design (CAD) systems often contain board topology information, the HP 3065 can link to these systems to

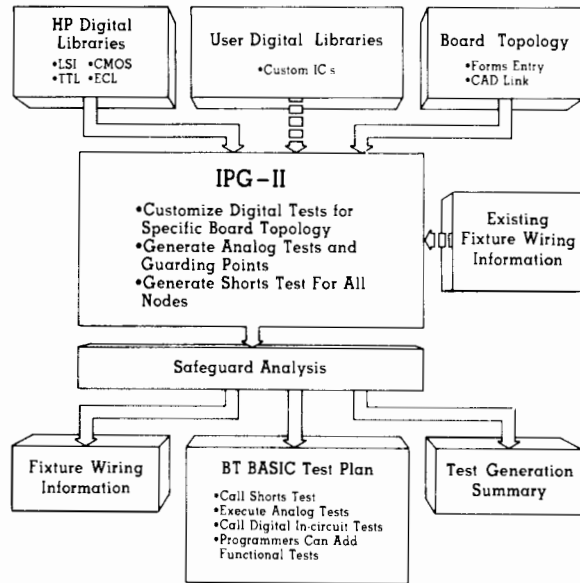

IPG-II is HP's second generation in-circuit program generator. Requiring only a board topology as input, IPG-II uses digital libraries and the circuit description to generate the entire in-circuit test plan.

retrieve this data. Non-technical personnel can add to CAD data using the HP 3065 forms entry package. If CAD system data is not available, the entire circuit description can be entered easily into the fill-in-the-blank forms package.

Once the circuit description is entered, the HP 3065's In-circuit Program Generator (IPG-II) creates an in-circuit test plan for all analog and digital components—automatically. Tests for all analog components are automatically generated, including guarding required to eliminate the effects of the surrounding circuitry. Digital IC tests are selected from the HP 3065's library of more than 3500 part numbers and automatically modified to reflect specific applications of digital devices on the board under test.

IPG-II easily accommodates engineering changes after the board is in production. In addition to entering the production changes, the existing fixture wiring information can be entered. IPG-II will use this data to produce a new wirelist to minimize fixture rewiring.

The outputs of IPG-II are fixture wiring information and a test plan that calls the shorts tests, executes the analog test, and calls the digital IC tests. A test generation summary is also provided. On a digital board with over 200 ICs and 100 analog components, IPG-II produced a test plan with 90% working tests without debug. This translates to faster test turn-on and lower test costs.

### Screen Editing

The HP 3065's screen editor is patterned after word processor systems and is interactive and user friendly. Information displayed on the screen is the actual content of the file, eliminating the need for system users to learn a large number of display commands. Dedicated editing keys on the terminal keyboard provide screen scrolling and character or line insertion and deletion. High-level commands such as "find", "move" and "change" simplify the editing of files.

The HP 3065 provides line-by-line syntax checking. Any attempt to enter incorrect syntax produces a self-explanatory error message to the screen. A blinking cursor indicates the position of the error to speed error correction.

Softkeys support each phase of test development and allow users to execute the most commonly used functions rapidly. These keys are automatically programmed by the system and displayed on the CRT screen. These softkeys provide such functions as command recall, fixture control and data entry throughout the test development process.

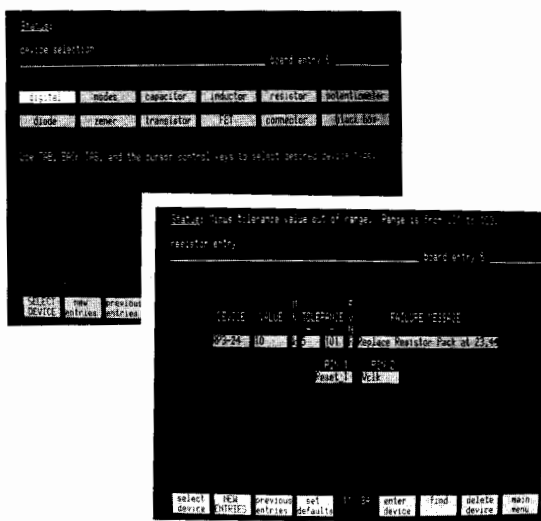

With fill-in-the-blank forms and softkey command execution, the HP 3065 simplifies user interaction for fast test turn-on. All entries are checked for correct syntax before they are accepted by the system. Syntax errors are written to the screen in an easily readable format.

### System Programming Languages

The HP 3065 system uses Board Test BASIC, consisting of familiar BASIC commands with additional high-level statements to simplify test development and modification. Because it is BASIC, users rapidly grasp the fundamental concepts of the language and can concentrate on advanced programming techniques. In-circuit tests are written in BT BASIC and test components with a single command. The system does the actual programming of the hardware, relieving programmers of having to learn cryptic programming codes. The programmer still has the option of optimizing the test for a particular component. Built-in features such as long variable names, conversion routines, looping and subroutines make the programmer's task much easier.

Custom IC tests are developed using the HP 3065 Vector Control Language (VCL). VCL provides powerful tools for developing proprietary device tests, or for custom devices not in the digital library. The language is flexible yet friendly, with screen editing and syntax checking built in. Since the standard library tests are written in VCL and are self-documenting, they can be used as examples when programming custom devices. All features such as counters, subroutines and parallel CRC are available to the programmer as well.

### "Safeguard In-circuit" Analysis

Digital in-circuit testing electrically isolates a device on a PC board while it is being tested. This technique requires that the test system takes control of the chip's inputs by overdriving the outputs of "upstream" devices. Overdriving these devices without careful analysis can potentially cause device damage or degradation. HP spent three years researching the causes of device damage and found the major causes to be overdrive current, excess temperature rise and voltage overshoot. It was determined that the circuit configuration as well as the device parameters contribute to potential IC damage.

HP's "Safeguard In-circuit" analysis package automatically evaluates all digital tests to minimize the potential for device damage or degradation. The analysis considers device parameters such as package type, device family, power dissipation, and voltage/current handling capabilities as well as circuit topology. It then selects minimum levels necessary to overdrive logic states, yet maintain adequate noise

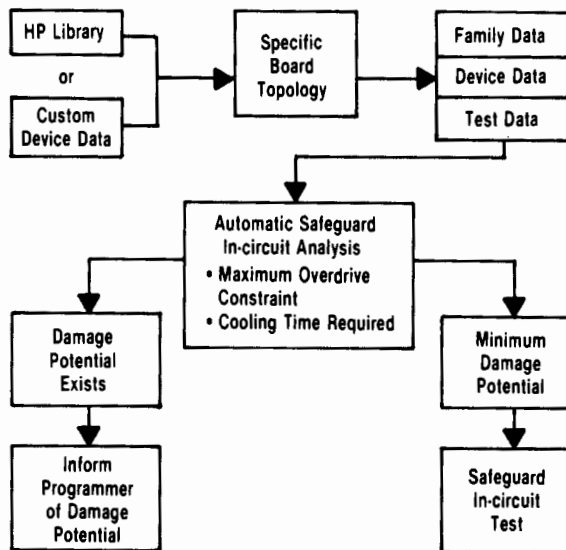

The HP 3065's Safeguard In-circuit analysis package automatically evaluates each digital test as it is created. Whenever the potential for damage is identified, the programmer is notified and test execution is prohibited.

margins. It also selects the appropriate edge speed to minimize overshoot; fast edge for fast TTL and ECL logic families, slow edge for CMOS to prevent latchup.

If cumulative heating is a problem, "Safeguard In-circuit" imposes a cooldown time between tests. This is particularly important during debug since it may be necessary to loop on a test or series of tests. The cooldown period occurs during the overhead time, therefore it has minimal effect on digital throughput.

### Networking for Productivity

HP brings the Manufacturer's Productivity Network into your test department. With the introduction of the new Q-STAR network (Quality Systems for Test, Analysis and Repair), the HP 3065 has the multi-link capability to become an integral part of your facility networking plans. HP Q-STAR provides productivity and quality enhancements within the test department with multiple links to the other MPN quadrants. More than just a hardware link, Q-STAR provides application software to improve production testing as well as timely feedback to improve the manufacturing process.

HP Q-STAR takes advantage of the unique cluster architecture of the HP 3065 Board Test System that allows users to access common peripherals and data bases. Application packages include paperless repair, statistical test reporting (Q-STATS) and interfacing to CAD Systems (CAD-VANTAGE). HP's MPN, in conjunction with Q-STAR, provide the strategy and the tools to help you maximize control of your manufacturing facility.

### Support

HP offers a complete solution to your application, hardware and software support needs. Application software services are available to get you up and running fast or help out during peak load periods. This is the fastest way to get your test system into productive use. Preventive maintenance and periodic adjustments will keep it operating at peak efficiency.

Our software support services give your programmers the most current revision of the HP 3065 software and can provide worldwide programming assistance when needed. HP can help design a support package that best meets your specific requirements.

### HP 3065 Board Test Family

Price depends on system configuration

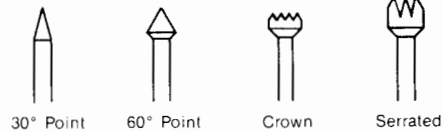
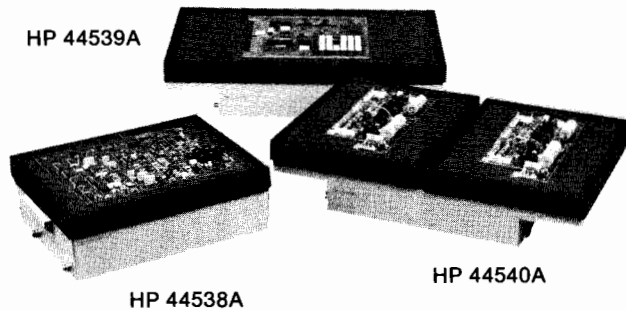

## Fixturing Products

### Description

The vacuum-actuated test fixtures have a dual vacuum plate design that creates a guided probe system. The spring probes are equipped to allow wire-wrap interconnections, and are easily replaceable. A patch panel interfaces the probes to HP 306X Board Test Systems' relay matrix. The entire lightweight fixture is enclosed by a molded plastic case, eliminating the possibility of accidental damage or contamination. An optional extender and breadboard kit allows you to add your own custom test circuitry to the fixture.

### Performance

Special attention has been paid to the design of the fixturing products to ensure performance. The patch panel is made of a material that exhibits very high isolation resistance. This means leakage currents are kept low and will not significantly affect in-circuit measurements. In addition, the spring probes exhibit low series resistance and can handle up to three amperes of current.

Attention has been paid not only to electrical performance but to mechanical performance as well. For example, the fixture has been designed to significantly reduce vacuum requirements. Low leakage probe sockets together with an improved vacuum seal made of durable thermoplastic rubber help achieve an air-tight construction. The improved vacuum seal serves to muffle the acoustic noise level for smooth, quiet operation.

The fixture kits are designed for ease of assembly and modification. No adhesives are required at any point in the assembly process. The test head is hinged and can be locked in either the down position or the up position for easy access to wiring. Once assembly is completed, a fixture verification software package aids you in debugging the initial construction and is also useful for repairing and troubleshooting the kits already in production.

### Test Fixture Available in Three Sizes

There is a kit for relatively small boards up to a size of 25.4 x 33 cm (10" x 13"). For larger boards, a kit that will accommodate sizes up to 33 x 55.9 cm (13" x 22") is available. In addition, a dual fixture kit is also available which allows you to increase your throughput by testing boards in tandem. Each side of the dual fixture will accept a small size PC board. All three of the fixturing products are fully compatible with HP 306X Board Test Systems, and are available as either options or accessories.

### Fixture Construction Kit Parts

#### Probes

Four probe styles are available, each with two different ranges of spring tension. The probes can be ordered with sixty degree single-point tip (HP 44561L and 44561H), star or crown-point tip (HP 44563L and 44563H), serrated multi-point tip (HP 44562L and 44562H) and spear point tip (HP 44564L and 44564H). The high force (8 oz. spring tension) probes are recommended except for high pin density applications. In these applications, low force (4 oz. spring tension) probes should be used. Each option contains 100 probes.

#### Sockets

HP sockets (HP 44574A) are specially designed for low air leakage and reliability. The sockets have 0.54" diameter barrel which accepts most standard probes.

#### Patch Panel Plugs

Six patch panel plugs are available to meet your specific fixture building needs. Single (HP 44589S and 44589SW) and dual plug (HP 44590D and 44590DW) versions are available pre-wired and with wirewrap posts or posts only. The pre-wired 5-plug (HP 44592A) is used for HP 3065 systems digital nodes. It features twisted pair wires for quick and easy wiring of 4 digital nodes. HP 44591A DUT PWR Pin plugs are required for HP 3065 digital pulser power requirements. These plugs are specially designed to fit the HP 3065 system scanner board.

#### Extenders

Height extenders are available for the standard fixture (HP 44560S) and for the large or dual fixture (HP 44560D). These extenders add 7.6 cm (3") of vertical height. A 12.7 cm x 17.8 cm (5" x 7") breadboard is available for either extender.

**Assembly tool kit**—HP 44572A option 003 contains the hardware and tools needed to assemble HP test fixtures. One tool kit is needed for each assembly station.

**Spare parts kit**—HP 44573A contains spare parts for constructing or modifying an HP test fixture.

#### Ordering Information

- HP 44538A Standard Test Fixture Kit
- HP 44539A Large Test Fixture Kit
- HP 44540A Dual Test Fixture Kit
- HP 44560S Standard Extender
- HP 44560SA Standard Extender Angled to 45°
- HP 44560D Large/Dual Extender
- HP 44560A Large/Dual Extender, Angled to 45°
- HP 44572A Assembly Tool Kit
- HP 44573A Spare Parts Kit
- Option 001 Fixture Verification Software Package

#### Probes

- HP 44561L LF Single (60°) point 100 per bag
- HP 44561H HF Single (60°) point 100 per bag
- HP 44562L LF Serrated Head 100 per bag
- HP 44562H HF Serrated Head 100 per bag
- HP 44563L LF Star 100 per bag
- HP 44563H HF Star 100 per bag
- HP 44564L LF Spear (30°) point 100 per bag
- HP 44564H HF Spear (30°) point 100 per bag

#### Sockets

- HP 44574A Socket (.054" dia. barrel)

#### Patch Panel Plugs

- HP 44589S Single Plug w/wirewrap tail
- HP 44589SW Single Plug pre-wired
- HP 44590D Dual Plug w/wirewrap tail
- HP 44590DW Dual Plug pre-wired
- HP 44591A HP 3065 DUT Power Pin Kit
- HP 44592A HP 3065 Dr/Rv 5-plug



# LOGIC ANALYZERS & DEVELOPMENT SYSTEMS

## Software Development and Real-Time Analysis



### Introduction

Hewlett-Packard logic analyzers and HP 64000 Logic Development System are a family of instruments that support the entire cycle of design, production, testing, troubleshooting, and maintenance of logic products. Analyzers and the modular development system add to productivity by providing effective tools to accomplish the many tasks in developing digital products. Additional benefits of the logic analyzers and development system are convenience and ease of use; users can focus their attention on design and analysis tasks rather than on the tools.

### Improved Productivity with Appropriate Tools

Value of design aids and support tools is a function of the degree to which they serve either of two purposes: (1) provide a necessary function not available otherwise, or (2) make it possible to do a task quicker or more effectively. As logic-based products become more complex, the instruments needed to create and test them become correspondingly more complex.

Appropriate development tools can have a direct impact on total development time. A product that goes to market sooner may have a longer life cycle, and, consequently, generate additional revenue. Selecting the right instruments is a very important step, and it becomes much simpler by beginning at the end: first, determine what is to be accomplished with the instruments. Feature sets

should be compiled only after analyzing the application environment. By first defining measurement needs, the user assures that there will be adequate measurement power and design aids to support present and future development programs.

### Design and Development

Model 64000 Logic Development System provides advanced software development, real-time emulation, software analysis, and hardware analysis. These functions may be used separately, combined, or interactively to support all phases of developing microprocessor-based products. A flexible system, the HP 64000 System, can be configured to suit a broad range of application environments. It can be an integrated cluster of up to six stations sharing a high-performance hard disc and printer. For larger design teams, one or more clusters can be integrated with a central computer through a high-speed link. With dual flexible-disc drives, an HP 64000 development station can also operate as a stand-alone instrument. Complete sets of design aids and tools are available for many popular microprocessors, including processor-specific emulators, assembler/linkers, preprocessors, inverse assemblers, Pascal compilers, and C compilers. Software performance analysis with comprehensive, global views of executing programs speed code optimization and program debugging. In any setup, directed-syntax softkeys

support quicker learning for new users and faster response for experienced users.

### Logic Analysis

Hewlett-Packard logic analyzers are powerful measurement tools for today's complex digital systems. They are essential during the critical phase of integrating hardware and software. Costly design errors can be avoided by optimizing code and fine-tuning total product performance before production. When the digital products are in production or operation, a logic analyzer is the troubleshooting tool that quickly isolates problems to decrease downtime. Hewlett-Packard logic analysis instruments offer a variety of measurement tools for a wide span of applications. The sophisticated HP 64000 subsystems may be assembled modularly to provide software performance analysis, state analysis, timing analysis, or emulation bus monitoring. Model 1630 Logic Analyzer is suitable for benchtop applications. The analyzer can be used directly with specific microprocessor families, and the HP 1630 Logic Analyzer is also valuable for troubleshooting general digital circuits.

Application environments for logic development systems and analyzers can be divided into two major categories: team applications and benchtop applications.



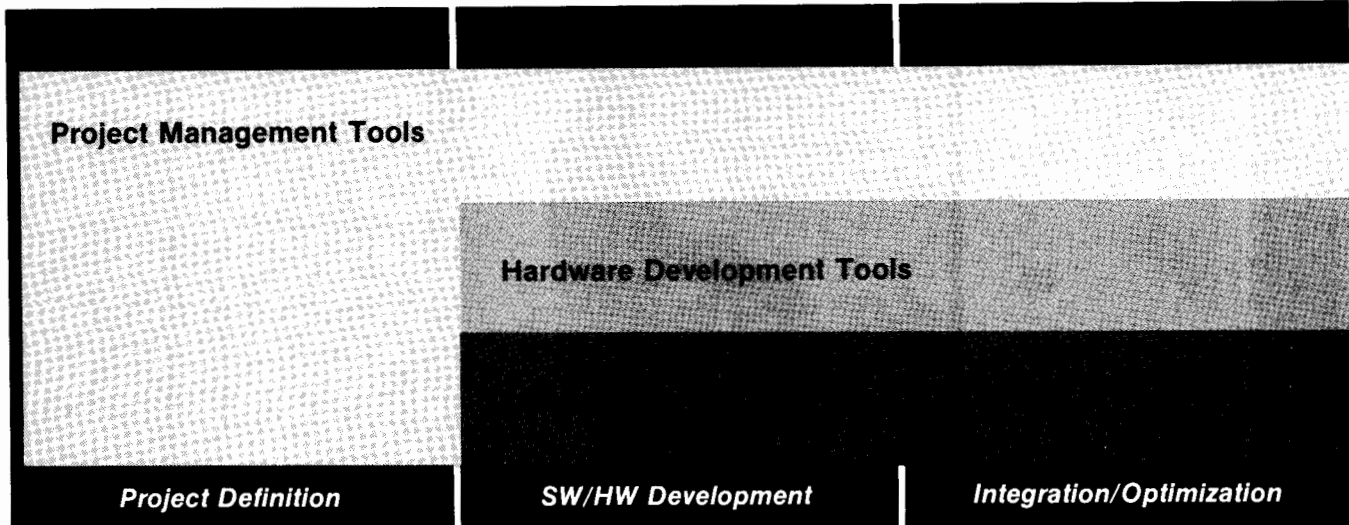

The development cycle for microprocessor-based and logic products integrates several diverse design tasks. Appropriate design aids and development tools reduce development time while supporting improved designs, resulting in better products that go to market sooner.

## Team Approaches

Marketing pressures together with the complexity of new logic products often dictate a team approach to design and development. The desired result is a compressing of the total development time.

Major milestones in developing a logic product are the same whether the product is created by a team or by an individual. The tasks include setting design criteria, designing and implementing hardware, writing and debugging software, integrating hardware and software, optimizing execution, and documenting all processes for subsequent use by quality control, production, and service. Hewlett-Packard's answer to team development for microprocessor-based and other logic products is the HP 64000 Logic Development System.

## Setting Design Criteria

The initial step is defining what the product is to be. Microprocessor products sufficiently complex to warrant a team effort must be defined in some detail before beginning any programming or circuit design. In an HP 64000 cluster or computer-based system, all of the designers share a common data base. Design criteria are entered in a file available to all members of the design team, and as additions and amendments are made, earlier versions are stored or discarded. The final, agreed-upon paper design remains available throughout the entire project, avoiding duplicated efforts, misunderstandings that can result in incompatible components, and costly oversights. If changes to the guidelines occur during the project, message functions keep all members informed of the latest amendments.

## Developing Software and Hardware

Typically, the development task is divided between a hardware team and a software team, and then further divided between the members of each team. In an HP 64000 system cluster, emulation, development, and analysis functions can be conducted simultaneously at different development stations on the same system.

For the software developer, the HP 64000 offers two avenues for creating code, either directly on a development station or using the software tools resident on an associated computer. The editor functions on the HP 64000 system are easy to use, offering the convenience of the syntax-driven softkeys. Programs may be written in high-level languages, such as C or Pascal, compiled, and linked with other code modules compiled from other high-level languages or assembly code. Assembly language may be used for tighter, more efficient code for frequently called routines without losing the speed and ease gained by high-level languages for the greater share of the program.

Emulators serve both hardware and software engineers. A universal development system, the HP 64000 system offers processor-specific emulators for over 25 popular 8-bit and 16-bit microprocessors. Other processors may be supported by designing and implementing custom-made emulators using the user-definable emulator kit. A ROM emulator adds another form of emulation. When software modules are completed, they can be executed on an emulator even if no target system hardware exists. As hardware units are completed, they can be combined with the emulator performing the functions of the missing hardware. Each emulator has a real-time run mode. Emulators are valuable for exercising software and checking timing relationships, handshake signals, and conformance to electrical specifications as new hardware modules are completed and added to the prototype.

## Optimizing System Flow

Performance analysis measurements are effective for locating bottlenecks and inefficient program flow. As statistical overviews of total program execution, these measurements are valuable when code is rewritten to create a smoother flow or a better fit within the design parameters for memory space and execution times. The HP 64310A Software Performance Analyzer has six measurements to characterize usage, duration, and interactions in the target system. The Performance

Analyzer is operated with an HP 64000 emulator, so optimizing can begin with the very first stages of product development.

## Integrating Hardware and Software

As modules of the microprocessor-based product are completed, hardware and software are combined and run together. During integration, there is a need to verify that all modules perform as expected and that the hardware and software execute well together. Logic analysis is the major means of detecting problem sources during integration, and evaluating the solutions.

### Hardware Analysis

Model 64600S Hardware Analyzer offers real-time, transparent timing analysis for 8 or 16 input lines. Four measurement modes (wide sample at 200 MHz, fast sample at 400 MHz, glitch capture, and dual threshold) provide the measurements for checking timing relationships and locating marginal execution. In setting up timing measurements, the inputs may be specified by input bits or with labels. The labels are user defined for specified bit sets for easier interpretation while analyzing the timing displays. Softkeys, labels, a choice of modes, and flexible triggering conditions make it easy to pinpoint precisely the critical program flow to be monitored.

Current HP 64600S timing analyzers include an enhanced feature set with post-processing capabilities. Complete timing traces may be stored and recalled for additional analysis and statistical calculations. With postprocessing, the designer can perform more extensive analysis on timing measurements.

### Software Analysis

Model 64620S Logic State/Software Analyzer subsystem is assembled modularly. With a choice of 20 to 120 channels in 20-channel or 40-channel increments, the software analyzer can be configured to accommodate target systems of varying complexity, including multiprocessor systems. Setting up measurements is simple with softkeys. Parameters for defining mea-



# LOGIC ANALYZERS & DEVELOPMENT SYSTEMS

## Software Development and Real-Time Analysis

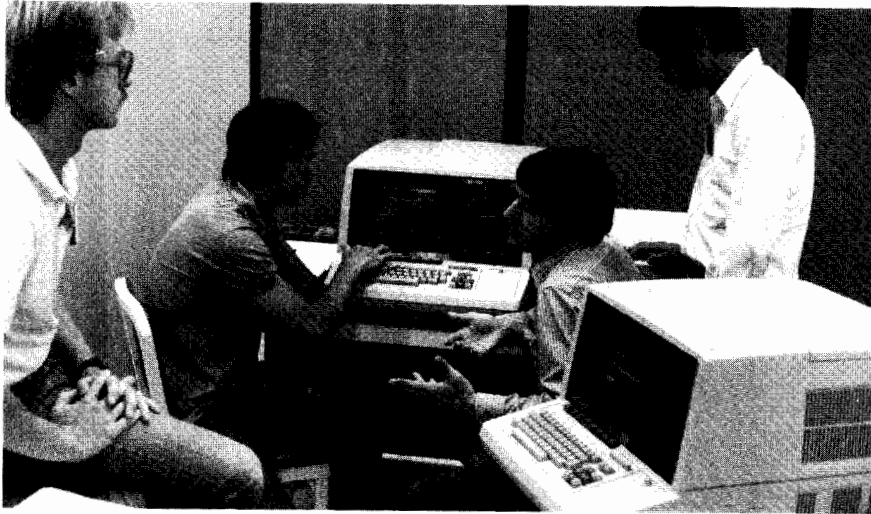

An integrated set of modular development tools are well-suited to applications that require teams of designers. A common database enhances a smooth integration of all the components.

Measurements may include labels from the symbol table, user-defined labels, and direct or referenced addresses. Resource sharing in the software analyzer is distributed across the trigger, qualify, and store functions. A trigger sequence as deep as 15 terms may be used, or up to three windows can be defined for observing complex state flow. The overview function provides histograms and graphs for basic performance analysis. As many as eight events (addresses, symbols, or ranges) can be compared for relative frequency of occurrence or elapsed time.

Trace displays may be in high-level source statements, assembly code, or numeric code. A convenient display when programming in high-level languages shows each source line followed by the assembly-level code generated by the statement. Current HP 64620S software analyzers support a number of features that simplify analysis in high-level languages.

### Interactive Subsystems

Any combination of analysis or emulation subsystems in an HP 64000 System may be linked for interactive modes using the Intermodule Bus (IMB). The IMB supports cross-arming and cross-triggering between analysis subsystems.

For multiprocessor applications, the interactions between processors can be investigated early in hardware development by using emulator analyzers in cross-arming modes. Two timing analyzers can monitor relationships between peripheral control lines and the CPU I/O. Two state analyzers double the combinations of trigger, store, count, sequence, and enable parameters. A powerful combination for the integration stage is a linked Hardware Analyzer and Software Analyzer. With both measurements available simultaneously, it is simple to determine whether some code module fails under unique execution conditions, or that a portion of the circuits are operating marginally and failing intermittently.

The greatest advantage realized with the IMB is the freedom to move smoothly from

one function to another. For example, if hardware analysis uncovers a marginal signal, a few keystrokes can activate the emulator analyzer to check the impact of that signal on the code modules related to the signal. When an inefficient subroutine is identified with the Software Performance Analyzer, the Software Analyzer can be armed to trigger on the first address in the subroutine to take a closer look at activity, step by step. HP 64000 directed-syntax softkeys make it relatively simple to move between functions in the development station; the IMB makes it possible to change to another subsystem contingent on specified events in the first subsystem.

### Computer Aided Development

For larger design programs, combining the development system with a computer accommodates larger design teams. Computer/development system networks are particularly well-suited for software development programs. It supplies an answer to the rapidly growing demands for more software in less time.

Software design plays an increasingly greater role in microprocessor-based products. Hardware offers more modular functions at ever lower prices, and more memory is available for the products, also at lower cost. These factors result in products that require more firmware and software. A much larger portion of the development costs and efforts, far more than half, is now consumed in preparing the software.

Adding a computer to the HP 65000 development system increases the programs that can be used for more efficient project management and programming. Economical computer workstations can be used for software development, while the HP 64000 development stations are still accessible for the development and integration tools of emulation and logic analysis. Typically, computers that are compatible with the high-speed link to the development system support more than

six stations, a decided advantage when the project requires a team of more than ten or twelve designers.

Computer/development system networks are the solution when the development team to be coordinated spans a large physical environment, whether they are housed in labs across a building or across the country. Via the computer, the HP 64000 system development tools may be used in a remote mode, too.

There are also design applications when a separate HP 64000 cluster is the best configuration. The distributed processing network responds quickly because of the computing power available in each of the development stations. A very friendly editor and high-level language compilers simplify programming, and all of the design aids and tools are right at hand.

### Documentation Trail

No product is complete without documentation. At the far end of the microprocessor product development, the customer needs some written instructions on the care and use of the product. But long before that, a written history tracking the product from the very first design specifications avoids misunderstandings and misinterpretations during the development phases that follow the first prototype: production, testing, quality control, marketing, manual writing, service. On an HP 64000 Logic Development System, a design team can initiate a separate file for documentation while in the process of defining the product criteria. Keeping the file updated is convenient, because text is entered from the same keyboard used for all the other HP 64000 functions. In this way, documentation required for production will be completed when the prototype is finished. When a computer is combined with the development system, product history and a message center can be stored on computer memory and accessed from any system station.



Benchtop logic analyzers provide state, timing and performance analysis for troubleshooting and optimizing digital systems in the laboratory and at remote sites.

## Benchtop Applications

Not every project related to a digital product requires a team of designers. Many applications for logic instruments involve a single technical person, or several people who need the instruments only occasionally. For these uses, a benchtop instrument or a stand-alone unit is the best solution. Servicing products in remote locations is best accomplished with a portable analyzer. Modifying an earlier design in part is often a project assigned to a single engineer. A separate, stand-alone development station in production gives the manufacturing area access to the common data base used in the original development of the microprocessor product. Despite the growing need for instrument systems to support team projects, there remains a large number of applications that are better suited to stand-alone instruments and benchtop logic analyzers.

## Design, Debug and Troubleshooting

When phrases like "cost effective," "productivity improvement," and "benefit analysis" have real meaning to the engineers in the lab, as well as accounting people, it is important to take note of the powerful measurement sets available in benchtop analyzers. Logic analyzers are well established tools for designing and troubleshooting general logic circuits and microprocessor buses and control lines.

Logic analyzers provide windows on target system activity, nonintrusive, real-time views of activity on system buses and control lines. Hewlett-Packard has two lines of benchtop logic analyzers. HP 1630A/D/G Logic Analyzers offer state, timing, and performance analysis plus interactive state/timing analysis. All three analyzers have an excellent performance/price ratio, and a broad selection of peripherals tailor the HP 1630 analyzer for a variety of application environments.

The second line is modular, beginning with an HP 64000 development station. Logic analysis subsystems are added as needed to suit the application. Four analysis systems are available for timing, state, software performance, and high-level software analysis. Interactive configurations for the analyzers and any of the emulation subsystems create even larger measurement systems.

Benchtop logic analyzers complement the development system. Once the design is largely completed, a stand-alone logic analyzer can be used for the final fine-tuning, freeing the development system for the next design project. Logic analyzers are also important troubleshooting and testing instruments away from the design lab, in production, quality control, and service.

## One-Station Projects

Dual flexible-disc drives make an HP 64000 system development station an independent "system" for designing and troubleshooting microprocessor-based designs. As the product evolves, the development station can be reconfigured by changing the subsystems residing in the station to suit the design phase. When only one engineer is assigned to a design, the dual flexible-disc drives give him or her the advantages of the HP 64000 design aids.

## External Controllers

The HP 1630 Logic Analyzer includes both HP-IB and HP-IL interfaces, and it can be used with a variety of desktop computers for automated applications.

A station from the HP 64000 system may be used as a terminal to a computer via an RS-232 link, assuming a compatible communication protocol can be established. Files are downloaded to the HP 64000 system to take advantage of the emulation and analysis subsystems. In the other direction, data can be uploaded to the computer to take advantage of the computer's utilities for more extensive statistical analysis. The station can also serve as an input terminal.

## Beyond Development

Applications for logic analyzers and the development system are not restricted to the laboratory and R&D settings. There are many uses for logic instruments in production and in the field.

## Production

Production conforms to a different set of constraints and pressures than those in a lab. Speed, automation, and efficiency are paramount concerns. The HP 64000 system is at home in production, too; common data base and convenient, friendly development stations smooth the transition from prototype to production. Logic analyzers with HP-IB interfaces are combined with external controllers as part of automated testing and monitoring systems. Off-line, logic analyzers are used for troubleshooting.

## Inspection and Quality Control

Inspection and quality control departments make judgments about a product's performance against two sets of criteria: (1) the specifications established by the design team, and (2) the standards imposed by the marketplace. Ideally, the standards desired by the end user are a subset of the standards set by the designers; but, in either case, the work of inspection and QC is easier and more effective when they have a full history of the product from the teams that developed it. For products developed on the Logic Development System, this history is present on the common data base.

Logic analyzers are important tools in verifying performance of any logic products. Nonintrusive, real-time monitoring allows inspection and quality control people to do more than just accept or reject end products. Cost savings result when rejected products can be classified by failure type and degree, since many products can be made acceptable with only minor fixes. A strong inspection and quality control program also uncovers production line problems early, avoiding costly, high rejection rates, or the even more costly failures at customer sites.

## Field Testing

Service personnel often have the responsibility of generating tests and troubleshooting algorithms that are eventually used in the field. Service people also benefit from the documentation and information stored in the HP 64000 system data base. In the field, portable logic analyzers perform the tests and execute the algorithms that developed along with the product. Analyzers may be used as stand-alone units, or linked to a central controller or HP 64000 system.

## Updating Products

It is often practical, and sometimes necessary, to redesign existing products around new components. On one hand, there is the advantage of having all of the basic problems defined and solved. On the other hand, there are the disadvantages of being bound by the constraints of the earlier design. Sometimes, the update is simply a matter of exchanging the old component with a new one. But, when simple swapping is not adequate, the redesign team needs the same design aids and tools required for the original design.

# LOGIC ANALYZERS & DEVELOPMENT SYSTEMS

## Logic Development System

Model 64000



HP 64000 Logic Development System

## Introduction

Model 64000 Logic Development System is a universal development system that supports design and development of microprocessor-based products. Powerful measurement subsystems for all phases of development can produce significant savings in the time and effort invested in creating new products. Primary functions available with an HP 64000 System are software development, system integration, and analysis. A wide selection of design support tools are offered for most popular microprocessor families. Processor-specific subunits include emulators, assembler/linkers, Pascal compilers, C compilers, and preprocessors for logic analysis. The HP 64000 System is not limited to applications for supported microprocessors; user-definable products are the means of tailoring the Development System for additional microprocessors and general digital designs.

With the flexibility possible through the broad base of support tools, the HP 64000 System facilitates all phases of microprocessor-based product development, resulting in better products that go to market sooner. Measurement power provided by the various subsystems are all accessed from the development station keyboard and implemented with directed-syntax softkeys. New HP 64000 System users become proficient quickly.

Each HP 64000 System is configured to meet current needs. For moderate-sized design teams, the system can be set up in a cluster of up to six development stations sharing a hard-disc memory and a high-speed printer. For larger teams with many software designers, a high-speed link can network an HP 64000 System with a central computer. A single station with flexible-disc drives can be operated independently as a very sophisticated logic analyzer or emulator for use in the lab or field. Any development station can also serve as an instrumentation peripheral for a computer via an RS-232 link.

The Development System is a continually evolving set of compatible design aids and instruments. A continuing growth to keep pace with the needs of the digital domain industry is possible because of the sound foundation of the HP 64000 System architecture.

## System Architecture

The fundamental unit of an HP 64000 System is the Development Station. Flexibility of the system architecture exists across two dimensions: within stations and between stations.

Within the station, the multiple bus structure is a key architectural feature. The operating system and station CPU communicate with the option-card slots via the development station bus. This bus carries address, data, and control signals from the host CPU and supplies power to all option cards. Cards which comprise a distinct subsystem, e.g., an emulation subsystem, communicate via separate high-speed subsystem buses. Another bus, the intermodule bus (IMB) is the link for interactive analysis modes. Since buses are not shared, the host system does not intrude on emulation or analysis operations to conduct "housekeeping" tasks, allowing real-time run modes and multitasking for the subsystems.

Functions for each development station are defined by the subsystems installed in the station. Subsystems reside on cards, and a single subsystem may require from one to five cards. Operating software is stored on the mass storage device used for the configuration, and stations sharing common memory can all access the stored software. For example, in a cluster arrangement, all stations in the cluster can use any of the assemblers and compilers stored on the cluster's mass storage device.

Between stations, there are four basic arrangements. A system cluster, with hard disc, printer, and development stations, operates as a distributed processing network. Distributed processing takes advantage of the powerful host CPU resident in each development station, maintaining a high level of responsiveness even when extra stations are added, up to a total of six per cluster. For larger design programs with major software development demands, uniting the development system with an HP 9000 or other compatible computer via a high-speed link adds extra stations and extra capabilities. Typically, the tools for writing software are housed in the computer, and object code and symbol tables are passed to development stations to take advantage of the simulation, integration, and optimization tools of the HP 64000 System. The special development aids can be accessed directly on a development station or remotely from a computer workstation.



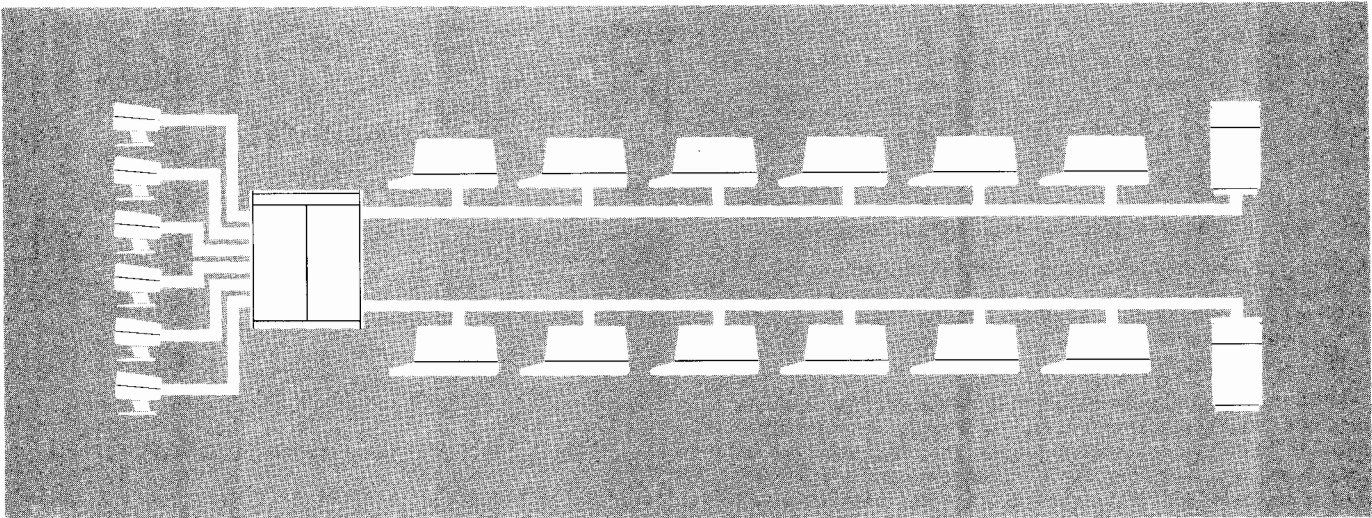

A modular system, the HP 64000 Logic Development System can be configured for a variety of application environments. A development station can be used as a stand-alone benchtop instrument, up to six stations with a hard disc and printer can form a cluster, or one or more clusters together with computer terminals can be networked with a central computer to accommodate large design teams.

A third possibility is setting up a single development station as a benchtop instrument. A fourth basic setup with an RS-232 link defines a development station as a terminal for a host computer and an independent analysis/emulation instrument.

New products for the HP 64000 System are compatible with existing HP 64000 Systems that are maintained or updated to current status with Software Subscription Service. As applications change, the user can reconfigure an HP 64000 System to meet the new needs. On-going compatibility allows users to take advantage of enhancements and new subsystems as they become available.

Versatility of the HP 64000 Logic Development System architecture supports tailored combinations of design and development tools for today's applications while leaving open the options for tomorrow's tools. The HP 64000 System is a long-term investment that keeps pace with changing industry needs.

### Development Stations

Development stations are the user's interface to the Logic Development System. There are two stations, Model 64100A Development Station and the smaller, transportable Model 64110A Development Station. In use, the two stations are functionally the same, with an ASCII keyboard and eight syntax-driven softkeys to operate the installed subsystems. Each station contains:

- High-performance, 16-bit host processor
- Resident ROM and RAM memories for HP 64000 station CPU
- Card cage with five or ten slots for subsystem option cards
- RS-232-C (V.24) interface to access other clusters or computers

Model 64100A Development Station has ten slots to accommodate subsystem cards. An optional PROM programmer can be installed directly in the station, to the right of the keyboard; specific interfaces are available for most of the commonly used PROMs. Local mass storage can be added with Option 041 Dual Flexible Disc Drives. At least one station in an HP 64000 System cluster must have local mass storage as a means of entering operating software for the system and any subsystems. Local mass storage frees the station for stand-alone applications, and it also provides a convenient, economical means of storing and transferring work in progress.

Dual, flexible disc drives are standard for Model 64110A Development Stations. The transportable HP 64110A station has adjustable legs and a hinged keyboard, which makes it a logical choice for field and stand-alone uses. HP 64110A development station has five option card slots.

### Software Development

As hardware components for microprocessor-based products become more complex and powerful, the task of creating software to control the hardware elements becomes increasingly important, in both magnitude and impact. The Logic Development System offers the tools and convenience valued by software designers:

- Directed-syntax softkeys for quick entry of measurement setups
- Sophisticated, easy-to-use editor
- Assemblers for 8-bit and 16-bit microprocessors
- Pascal and C compilers for high-level language programming
- Linkers to combine code modules from any compatible source.

Software development tools of the HP 64000 System make good programming practices easy. For example, when an error is found, a programmer can amend the code segment at the source code level with a few keystrokes, avoiding the problem of the code "patch" that fails to be entered in the main body of the program.

Entering and editing code or text is simple with a sophisticated, screen-oriented HP 64000 editor function. When a high-speed link combines one or more development system clusters with a computer, software may be written on computer terminals as well. Assembler/linkers, C compilers, and Pascal compilers are available for a broad selection of popular microprocessor families. These software development tools are available in several media, as appropriate for the host system, i.e., the HP 64000 System or the central computer. Compilers and assemblers operating on the computer produce object code and symbol tables that are compatible with the HP 64000 System; this simplified transfers when using the system for simulation, emulation, analysis, and optimization.

High-level languages are often preferred for increased programmer efficiency and the transportability of code from one microprocessor system to another. Either Pascal or C may be the best choice, depending on the application. At some point in a program, it may be more convenient to use assembly-level code, to conserve code space, to achieve a faster response, or to implement a special feature of the microprocessor. Segments from any of the sources become relocatable modules that are arranged and combined by means of the linker. High-speed linking frees the software designer to program at any level, using the most effective language or utility for each module.

Software development flows quickly because the HP 64000 System is well adapted to the software designer's needs. The designer can concentrate on the design task rather than on any constraints of the design tools.



# LOGIC ANALYZERS & DEVELOPMENT SYSTEMS

## Logic Development System

### Model 64000 (cont.)

#### Emulation

Emulation is a valuable design tool throughout most of the steps of creating microprocessor-based products. Emulation has become a standard technique for evaluating and debugging both hardware and software. An emulator should conform to the characteristics, operating modes, and specifications of the processor it supports.

Emulation allows the designer to check software execution even before user-system hardware exists. Features of HP 64000 emulation subsystems meet the needs of hardware and software engineers:

- Real-time emulation mode without inserted wait states
- Run-time controls for single cycling and register display
- Mapping memory blocks to emulation or target memory
- Simulated I/O using HP 64000 System resources
- High-speed emulation memory

Software modules can be evaluated as they are developed, rather than after both hardware and software are totally complete. Since much of the debugging is done as modules are added, there are far fewer problems in integrating hardware and software. The HP 64000 System emulators add one more dimension of user friendliness—all emulation commands are entered with directed-syntax softkeys from the development station keyboard.

The Logic Development System offers emulation subsystems for a variety of 8-bit and 16-bit microprocessors. Presently, emulators are available for the following processors:

NSC800	6802	68B09	8049
Z80	6803	68B09E	8051
Z8001	6805	68000	8080
Z8002	6805R/U/P	68010	8085
6800	6808	8031	8086
68A00	6809	8035	8088
68B00	6809E	8039	80186
6801	68A09	8048	80188

For microprocessors that are not presently supported with a dedicated HP 64000 System emulator, a custom emulator can be developed using Model 64274S User-Definable Emulator as a base. For ROM-based systems, there is a ROM Emulator, Model 64272S, to provide a controlled environment for software execution and analysis. Both user-defined emulators are powerful alternative tools for applications not served by processor-specific HP 64000 System emulators.

Emulation subsystems for the HP 64000 System consist of a control card and an emulator pod assembly. Memory for the emulator, ordered separately, requires at least two slots in the development station card cage, one for the control card and a second slot for the memory card. Emulation memory is implemented with high-speed static RAM; up to 1 Mbyte of emulation memory may be installed in increments of 32, 64, or 128 kbytes.

The emulation processor is run from two memories: emulation memory and target system memory. Memory is assigned to either memory by blocks of memory address space, but the processor runs as if only one memory existed. Blocks of memory addresses may be designated as RAM, ROM, or illegal. As code modules are completed, they can be tested on the emulator in combination with existing target system hardware.

One of the important advantages of an emulator is the control over the microprocessor during the development phase. The microprocessor can be run, halted, or single-stepped from the development station keyboard. During emulation, it is possible to examine the contents of the microprocessor memory and registers, modify the contents, and then continue the emulation run.

An emulation bus analyzer should be added to the subsystem to monitor activity on the emulator bus. Model 64302A analyzer provides real-time traces of address, data, and status/control signals. Displays may be in the microprocessor mnemonics or in an appropriate numerical base.

For multiprocessor applications, emulators may be used interactively with the Intermodule Bus (IMB). The IMB links emulation bus analyzers for cross-arming modes, and the IMB can also establish larger measurement systems for interactive emulators, timing analyzers, and/or state analyzers. When emulation and analysis subsystems reside in separate stations, an IMB extender (HP 64303A) is available for cross-station measurement systems.

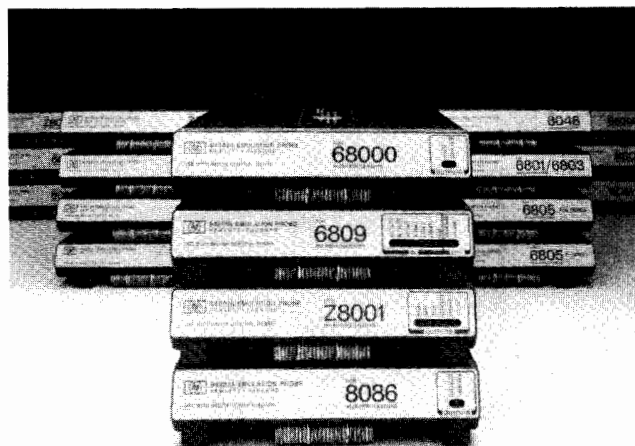

A broad selection of emulator subsystems ensures that there is HP 64000 System support for any of the most popular microprocessors. When a new design requires a different microprocessor, a new emulation subsystem can be installed readily.

#### Analysis

Analysis and system integration are major functions when designing and developing superior microprocessor-based products. The HP 64000 System offers five analysis subsystems to meet measurement needs for troubleshooting, debugging, and optimizing target systems. The HP 64302A Emulation Bus Analyzer is a basic real-time analyzer used with an emulation subsystem. As well as providing the displays and triggering conditions for the emulator, the HP 64302A analyzer is the emulator's access point for interactive emulation/analysis; in addition, it supports the High-Level Software Analyzer (HP 64330) for analysis in high-level programming languages of C and Pascal. HP 64310A Software Performance Analyzer is also used with an emulator, providing overview measurements that aid in system-level evaluations. For complex problem solving, HP 64600S Logic Timing/Hardware Analyzer and HP 64620S Logic State/Software Analyzer are high performance analyzers that may be used separately or interactively.

#### High-Level Software Analysis

The HP 64330 High-Level Software Analyzer offers a measurement set that relates directly to code written in C or Pascal for a target microprocessor. Measurements are arranged in a hierarchy, from a global measurement showing execution sequence and nesting levels to a detailed measurement that traces the actual values of up to ten variables, plus source lines that assigned the values.

- Measurement definitions and displays compatible with high-level programming languages
- Four analysis modes from general to specific views for quick, efficient focusing of troubleshooting efforts
- Direct control over target system operation

Software designers who are accustomed to high-level languages can do debugging and troubleshooting using the same concepts and labels they use in writing code.

Analysis with the High-level Software Analyzer does not require a detailed knowledge of the operation of the target microprocessor. Listings of actual system execution can be compared directly to the written programs.

HP 64330 analyzer uses the HP 64302A Emulation Bus Analyzer input to generate the measurements. Through the close tie to the emulator, the High-level Software Analyzer provides controls over the target system execution. There is a load function to enter programs into the emulator for execution. Up to 16 breakpoints can be defined to halt the program at predetermined points. A modify function and run function complete the control set.



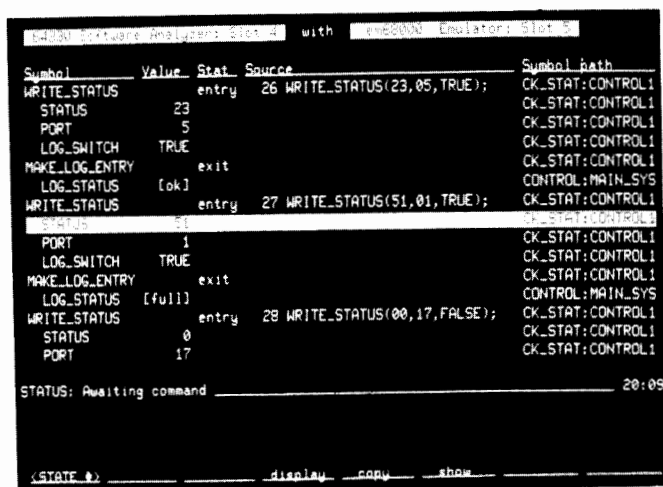

When programs are written in C or Pascal programming languages, the HP 64330 High-level Software Analyzer offers analysis in the same language. A hierarchy of measurements streamline troubleshooting, from a global view of module execution down to the detail of variable values.

### Software Performance Analysis

Model 64310A Software Performance Analyzer provides overview measurements to aid in evaluating total system effectiveness of programs operating in real time. Global measurements let software designers determine where system resources are being used, in terms of execution times, memory usage, and interaction traffic. Software performance measurements aid in determining where to focus optimization efforts for maximum effect on system performance.

- Histogram displays for quick comparisons of software activity
- Tabular displays with continually updated means and standard deviations on current measurement
- Measurement modes of memory and program activity
- Measurement modes of event duration
- Measurement modes of intermodule linkages

Model 64310A analyzer is used with any of the processor-specific emulators for either 8-bit or 16-bit microprocessors. Up to three Software Performance Analyzers may be installed in a single station and they may be operated interactively through the intermodule bus (IMB). Each analyzer occupies one card slot. Software performance analysis is a powerful analytical tool once reserved for large main-frame computers, and now available for developing microprocessor products.

### Logic State Analysis

Model 64620S Logic State/Software Analyzer offers real-time, transparent software analysis for microprocessor systems. A modular system, the Software Analyzer can be configured for 20 to 120 input channels. The HP 64620S analyzer supports analysis at all levels of complexity for microprocessor systems.

- Multiple trigger parameters using symbols, ranges, NOT, and "don't care" terms as well as file names and line numbers
- Selective data storage for edited state listings
- Powerful 15-level sequencer that may also be used to form one or two measurement windows
- Extensive symbolic tracing for quick setups and easy interpretation
- Real-time, nonintrusive analysis feature set supports debug for high-level programming languages
- Two software performance overview modes for code optimization
- Processor-specific interfaces and inverse assembly for easy hook-ups and state listings in the microprocessor mnemonics

An extensive feature set accommodates analysis of code written in high-level languages. An analyzer trace may contain source line numbers, high-level instructions together with comment fields, and

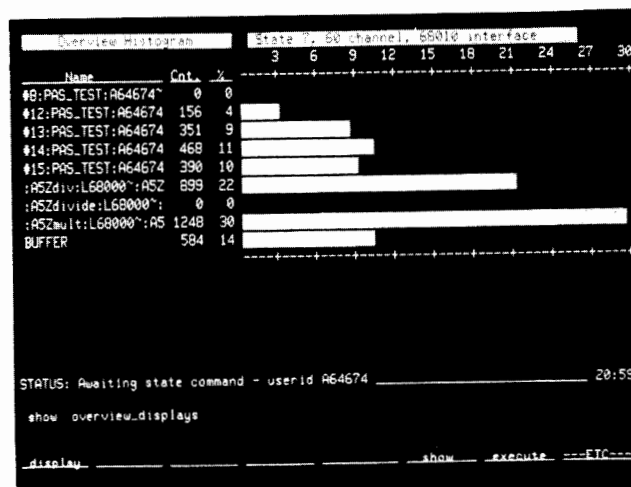

HP 64310A Software Performance Analyzer brings performance analysis measurements to design applications for microprocessor-based products. Six measurements quickly characterize total system performance, allowing the software designer to allocate available resources optimally.

assembly language lines. A listing of system activity in terms of high-level source lines together with the assembly-level language generated by the source lines resembles an expanded listing; this measurement is particularly useful when modifying code for quicker execution or more efficient use of program memory. When the HP 64620S analyzer includes the overview measurement capabilities, code modules that run too long or take too many lines of code can be quickly identified, rewritten, and tested again. Measurements may be specified by symbol names rather than address ranges or line numbers.

Preprocessors and inverse assemblers are available for a variety of microprocessors. Displays are automatically formatted and state listings are translated into the microprocessor mnemonics for convenient measurements. Refer to page 274 for a description of the interfaces available for specific microprocessors.

The HP 64620S Software Analyzer subsystem is composed of a control card, one to three data acquisition cards, and general purpose probes or dedicated interfaces. There are two types of data acquisition cards: a card with 40 input channels and a card with 20 input channels and the overview circuits. The analyzer collects and stores data at data transfer rates up to 10 MHz. Analyzer memory is 256 states deep, with a 4096-state memory for the overview function.

Flexible triggering, a major strength of the Software Analyzer, is implemented with shared resources between trigger, store, and count functions. Trigger parameters may include values, ranges, "don't care" terms, NOT terms, file names, symbols, and line numbers. Events stored may include all states, or may be limited to only states of a specified type or within a defined range. Event or time interval counts can be made between stored states or from the trigger point to each stored state.

A sequencer may be used in conjunction with the trigger, store, and count functions. When the sequencer enables the trigger function, conditions specified for the sequencer must be met before the analyzer initiates a search for other triggering conditions. A basic sequence specification may have up to 15 sequence terms. Restart terms may be used with one or more of the sequence terms to define a state that reinitiates the search for a portion or all of the sequence.

At the highest level of analyzer control, the master enable condition enables or disables all other analyzer functions. The master enable may be a specific event, a sequence, or a stimulus from another analyzer across the intermodule bus.

Symbolic tracing is based on the symbol table created by the linker. Other user-defined labels may be added as needed. Symbols are alphanumeric names assigned to absolute addresses, ranges, or procedure names. All entries in the symbol table become part of a softkey set, saving time in setting up measurements.



# LOGIC ANALYZERS & DEVELOPMENT SYSTEMS

## Logic Development System

### Model 64000 (cont.)

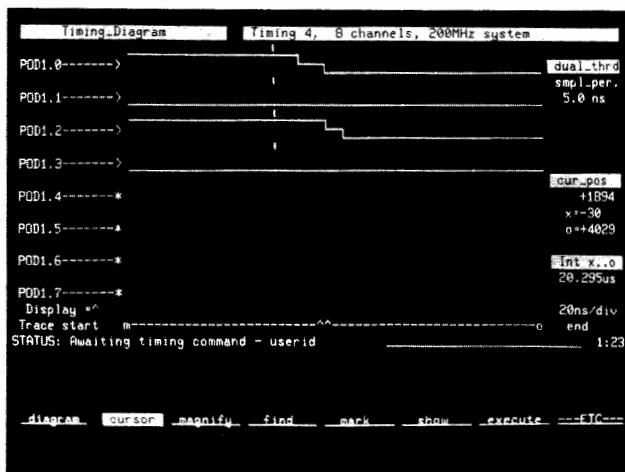

Dual threshold mode for the HP 64600S Hardware Analyzer has a three-level waveform that shows when the signal voltage is above, below, or between defined voltage levels.

### Logic Timing Analysis

Model 64600S Logic Timing/Hardware Analyzer with 8 or 16 input channels provides very sophisticated timing analysis measurements for asynchronous system activity. Traditionally, timing analyzers were considered tools for hardware engineers, but the HP 64600S analyzer with softkey operation and plug-in connectors makes the timing measurements accessible to a wider range of designers and troubleshooters. The HP 64600S Hardware Analyzer offers powerful analysis that is easy to use.

- Four measurement modes to suit a variety of applications
  - Wide sample mode to 200 MHz for typical measurements
  - Fast sample mode to 400 MHz for more detailed timing analysis
  - Glitch mode to locate intrusive glitches as narrow as 3 ns
  - Dual threshold mode to check for marginal signals
- Versatile triggering to locate the trace quickly and accurately
- User-defined labels for easy identification of displayed signals
- Memory depth of 4060 samples in standard mode, 8140 samples in fast sample mode
- Postprocessing functions for extended analysis capability

Model 64600S analyzer aids in quickly resolving timing problems in multichannel logic systems.

Each measurement mode provides a different view of the system under test. Wide sample mode is the most frequently used mode for standard timing analysis measurements from 2 Hz to 200 MHz. Fast sample mode captures asynchronous events at rates up to 400 MHz, and stores them in a memory 8140 samples deep. In glitch capture mode, a separate glitch detection circuit is activated whenever a signal crosses threshold two or more times in the same sample period resulting in completely asynchronous glitch monitoring. Dual threshold mode displays are three-level waveforms that show when the signal is above, below, or between threshold levels. This mode identifies marginal signals and slow transitions which are frequent causes for intermittent hardware problems.

Labels for single input lines or groups of lines identify the input source for easier interpretation of the display. Once defined, these user labels are added to the softkey set, making measurement setups and analysis much more convenient.

Speed, memory, and measurement modes give the Hardware Analyzer its power, but the finesse is a function of the versatile triggering parameters. Patterns, Boolean NOT conditions or a glitch on one or more lines can serve as trigger conditions. Transition triggering establishes a trigger point as a set of signals enter or leave a defined state. Time interval specifications can be defined for patterns, and the analyzer is triggered if the pattern persists longer than the defined time or if it does not persist long enough. When 16 channels are available, a trigger on inputs of one probe pod can arm the analyzer to search for another trigger specification on the second probe pod, a sequential trigger.

The capability of storing and retrieving timing measurements quickly and simply is an enabling function for other postprocessing functions. Find and mark functions can locate and indicate the occurrence of a specified pattern across the entire 4000 or 8000 sample measurement. All occurrences of a marked time interval can be measured and the mean calculated automatically. New measurements may be compared to a stored measurement for automatic testing processes. Timing displays can be translated directly into state listings, together with the marked conditions and time interval measurements. In a two-step process, the analyzer can collect traces from one set of trigger specifications, pass the trace to the postprocessing functions where a second set of trigger specifications determines whether the trace is stored or discarded. Postprocessing functions are implemented by the HP 64600S Hardware Analyzer operating software.

### Development System-Computer Network

HP 64000 Logic Development System can be integrated with a central computer. High-speed links form development system-computer networks that can support more software development terminals while retaining the powerful set of HP 64000 System design, development, integration and analysis aids. Assembler/linkers and compilers are available for the host computer that are also appropriate for the development system.

High-speed links and compatible software synthesis support are available for HP 9000 Series 500 and 200 computers with HP-UX operating systems (pp. 7.36-7.41); HP-UX is Hewlett-Packard's enhancement of the UNIX\* operating system. Comparable support is also offered for Digital Equipment Corporation VAX 11/700 series computers with VMS® operating systems.

Adding a general purpose computer enlarges the common data base available to all members of the design and development facility, in content as well as size. For example, the computer is a resource for a broad selection of utilities and applications programs that can be used directly to supplement analysis and to support very complex project management schemes; it also serves as central storage for subroutines and modules to be used in target system software for function-level programming.

When a development system-computer network is practical because of the magnitude of the application environment, there are added economies of size. By linking computers, remote sites can be tied to a central location; the larger common database does not infringe on the autonomy of each project and each design team. Computer terminals can be dedicated to software synthesis tasks, leaving the development stations open for the special design tools of emulation and analysis. Several designers can use the powerful HP 64000 System measurement set, either at a development station or in remote mode from the computer terminals. Combining a computer with the HP 64000 System is a major cost advantage for organizations that have a large software investment in existing computer-based development tools.

The development system-computer link adds a new environment for the logic development system. HP 64000 System configurations can begin with a single benchtop station and grow to serve an entire group of development laboratories.

\*UNIX is a trademark of AT&T Bell Laboratories.



Model 64000 Logic Development System offers total support for all phases of developing microprocessor-based products.

## Summary

Model 64000 Logic Development System is a complete system for developing microprocessor-based products. From the very first outlines for design specifications, through delivery to the customer, through modifications and updates, the HP 64000 System provides a common data base accessible by everyone associated with the product. Engineers and technicians working with the new product don't have to guess what should happen on the basis of out-of-date listings, inaccurate after-the-fact flowcharts, and scanty notes. They know. Final code and complete documentation can be passed on with the product as it moves to completion. Since there is a common user interface for all processes, there is no need to adapt to a new instrument for each major development phase. As an implementation of the "electronic workbench" the HP 64000 System supports microprocessor products through all phases of design, development, production, test, and redesign.

The HP 64000 System offers full microprocessor support: emulators, assemblers, C compilers, Pascal compilers, tailored for a wide selection of 8-bit and 16-bit processors. For debugging, integrating, and optimizing, five analyzers provide real-time, nonintrusive measurements to quickly locate problems and bottlenecks. The HP 64000 System is an integrated set of compatible tools that support microprocessor development from conception through obsolescence.

As a universal system, the HP 64000 System frees the user to select the optimum processor for each new product. With a dedicated development system, a processor is chosen first, and then support instruments are chosen to match the processor; economy may dictate that the same processors be used for subsequent products, forcing the designer to fit later applications to existing support equipment. Tooling up for a new microprocessor project with the HP 64000 System solution is a moderate add-on expense because the fundamental support already exists in the development stations, hard disc or flexible disc drives, and printer. With the universal HP 64000, it becomes practical to consider two or more processors, and even make comparisons through some breadboarding phases, before selecting the processor that best suits the application. Multiprocessor applications become feasible, even when the microprocessors come from different vendors. When a microprocessor is not supported by any of the HP 64000 development aids, user-defined kits are available to create new processor-specific emulators, assemblers, and inverse assemblers.

The HP 64000 is a friendly system, friendly in many dimensions. New users become proficient in little time, typically less than a day, and experienced users progress quickly to take full advantage of the

advanced applications of the HP 64000 System. Details of routine tasks are performed by the system, not the user. Yet, none of the functions are hidden; the display status line always describes current system activity, and error messages and commands are fully spelled out. Softkeys as implemented in the system are virtually self-explanatory; frequent references to manuals to decipher a code are eliminated. With softkeys, typing is used to create new code and text, and not for entering commands. Directed syntax displays the possible choices for the next command and avoids the inconvenience of entering a command string in the wrong sequence. Model 64000 Logic Development System encourages users to practice sound design and development techniques.

Open-ended architecture and modular structure add another dimension of flexibility. An HP 64000 System can be purchased in functional units and enhanced across time. A small cluster of several development stations, hard disc, and printer provides a solid basis for design and development tools. Assemblers, compilers, emulators, and analyzers can be added as they are needed. The HP 64000 Logic Development System can be configured to meet the needs of the application environment. A single station can serve as a high-performance benchtop instrument – several clusters can be networked with a central computer to serve an entire design laboratory. There is a broad range of HP 64000 System configurations. Select the one that best meets your design and development requirements, to help your designers and engineers work more productively.

## Selecting a Logic Development System

Model 64000 Logic Development System is complex and dynamic family of microprocessor support tools. Consequently, it is recommended that an HP Instrument Sales Representative be contacted for suggested system configuration and applications. Prices for selected components are listed below.

### Ordering Information

**HP 64100A** Development Station

**Opt 041** Dual Flexible Disc Drives

**HP 64110A** Development Station with Flexible Disc Drives

**HP 64156S** 32k byte Emulation Memory Subsystem

**HP 642XXS** Emulation Subsystem, 8-bit  $\mu$ P

**HP 642XXS** Emulation Subsystem, 16-bit  $\mu$ P

**HP 64302A** Internal 48-channel Logic Analyzer for Emulator Bus

**HP 64310A** Software Performance Analyzer

**HP 64500S** PROM Programmer

**Opt XXX** PROM-specific Interface

**HP 64600S** Logic Timing/Hardware Analysis Subsystem, 8 channels

**Opt 010** 16 channels

**HP 64620S** Logic State/Software Analyzer Subsystem, 20 channels and overview

**Opt 010** 40 channels

**Opt 011** 60 channels and overview

**Opt 012** 80 channels

**Opt 013** 100 channels and overview

**Opt 014** 120 channels

**HP 64650A** General Purpose Preprocessor

**HP 646XXA** Processor-specific Interfaces for

**HP 64650A**

**HP 64330X** High-Level Software Analyzer

**HP 648XXA** Pascal Compiler, 8-bit  $\mu$ P

**HP 648XXA** Pascal Compiler (16-bit  $\mu$ P) or C Compiler

**HP 648XXA** Assembler/Linker, 8-bit  $\mu$ P

**HP 648XXA** Assembler/Linker, 16-bit  $\mu$ P

**HP 64851A** User-Defined Assembler

**HP 64856A** User-Defined Inverse Assembler

# LOGIC ANALYZERS & DEVELOPMENT SYSTEMS

## State, Timing & Performance Analysis

### Model 1630A/D/G

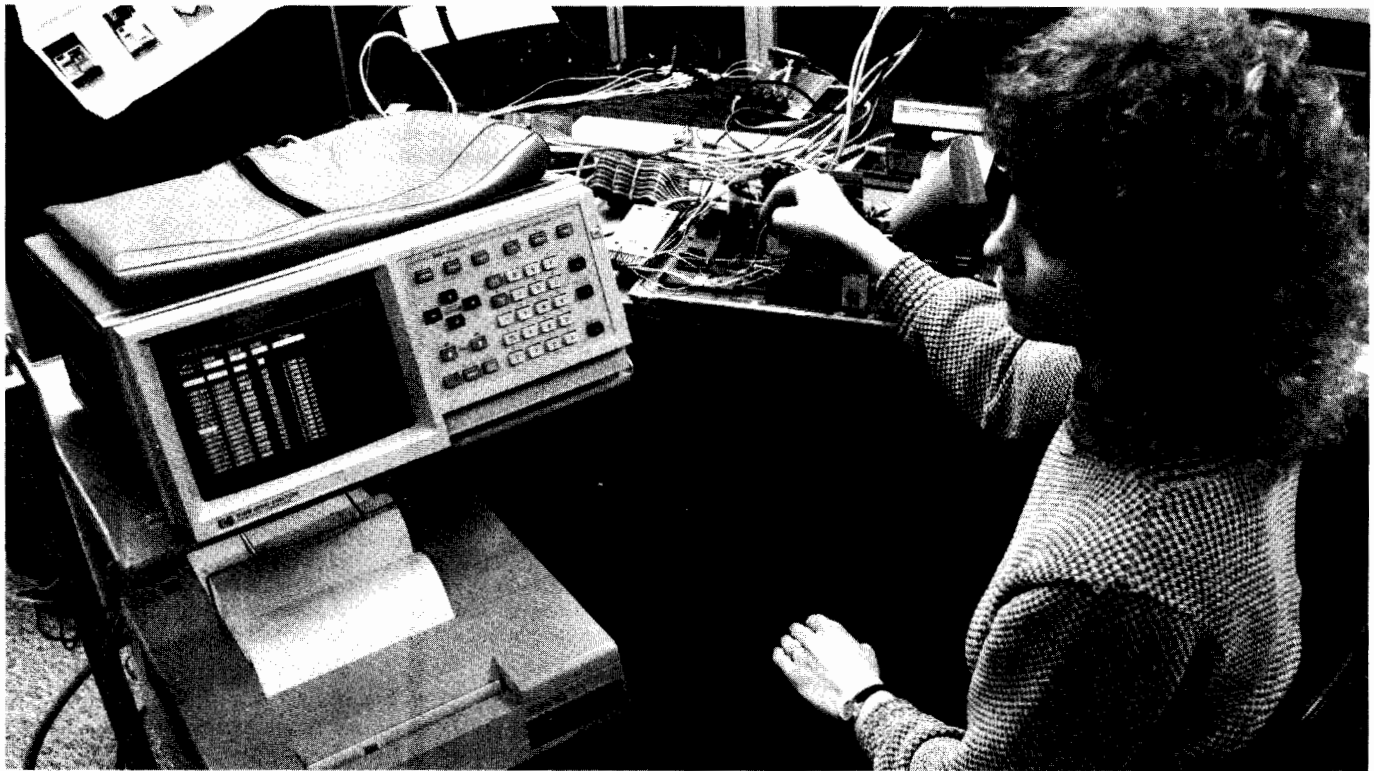

HP's 1630 logic analyzer . . . the one tool for every phase of digital-product development now has 65 channels, making it ideal for applications involving 16-bit microprocessors.

### HP 1630 Series Description

#### Powerful

- Timing, state, and software performance analysis all in one low-cost instrument.
- Trigger measurements on combinations of glitches, edges, and patterns so you can quickly track down hard-to-find problems.

#### Versatile

- Each instrument within the family can be upgraded, providing a range of price/performance solutions.
- Preprocessors, disassemblers, and down-loadable programs tailor the HP 1630 for a variety of microprocessors.
- Built-in HP-IB and HP-IL interfaces allow for both manual and automatic testing applications and for sending data to an external printer.

#### Easy to Use

- A menu architecture guides you through each step in the measurement process. All choices are clearly shown, and prompt and error messages help eliminate setup guesswork.
- Data can be displayed in eight different formats, including microprocessor mnemonics, relocatable addresses, and user-defined labels.

HP 1630A State	HP 1630A Timing	HP 1630D State	HP 1630D Timing	HP 1630G State	HP 1630G Timing
35	—	43	—	65	—
—	8	—	16	—	8
27	8	35	8	57	8
—	—	27	16	—	—

Combining four logic analysis functions in one benchtop instrument, the HP 1630A/D/G may be your single most important tool for digital-product design, development, and testing.

- Timing analysis at 100 MHz to check hardware and status signals.
- State analysis at 25 MHz to trace program and software flow.

- Performance analysis to optimize code.
  - Interactive state/timing analysis to integrate circuits and code.
- Flexibility, high performance, and reliability make the HP 1630-series logic analyzers an excellent value.

### Timing Analysis

- 8 or 16 (HP 1630D) input channels monitor signal-line activity.
- 100 MHz speed for functional measurements with 10 ns resolution.
- Sophisticated, flexible triggering modes including glitch triggering and pattern-edge triggering.
- Labels for quicker setups and easier interpretation.
- Two cursors and automatic readings for interval measurements.

Timing analysis is the province of the hardware engineer. Functional relationships of signals on the status lines are critical to system operation. With the 100 MHz internal clock, the HP 1630 timing analyzer performs many first-level parametric measurements.

A first consideration in selecting a logic timing analyzer is finesse of the triggering conditions. The capability to place the timing trace at a point of interest results in more efficient analysis. Timing trigger conditions for the HP 1630 allow you to place a monitoring window where you want it. Trigger points may be specified by a pattern, a positive or negative edge (signal-line transition), a glitch occurring on any specified channel, a pattern and edges, or a pattern and glitches. The trigger point can be placed at the beginning, center or end of a trace, and a pattern duration specification defines how long a pattern must persist to be recognized as valid. A time delay to 9999 seconds can be inserted between the trigger point and the trace. Flexibility in triggering conditions assures that your measurements will be taken where and when you need them.

The waveforms of the timing display let you compare the activity on up to 16 status lines. Two cursors can be moved anywhere on the timing display, and the time interval between the two cursors is displayed automatically on the upper right corner of the screen. If you want to check a time interval to be sure timing parameters of your system are being met, you can move the two cursors together, keeping a constant time interval, while you compare successive transitions of related status lines. Magnification of the display from one to forty times and an adjustable sample period from every 10 ns to 500 ms let you make time measurements at any level of accuracy.

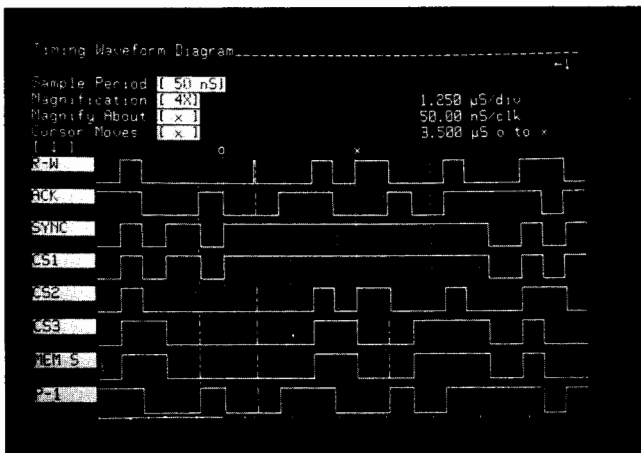

Timing waveform displays represent real-time activity at rates up to 100 MHz on up to 16 input channels. User-definable labels identify each input. Glitches are uniquely displayed as dashed lines. A direct readout of the time between the x and o cursors is displayed in the upper right corner.

You can alter the timing display for your convenience. You can name each line with labels up to five characters long. With labels indicating the function of each line being monitored, you avoid the bother, and the possible errors, of recalling the probing scheme when you run a measurement. Timing lines can be arranged in any order, and you can delete the timing lines that are not needed for the measurement in progress.

The timing waveform measurement can be translated directly into a numeric state listing with the LIST key. Labels can be defined for monitored lines, individually or in groups. Elapsed time from the trigger point is also shown for each sample state on the timing list. Numeric bases are typically binary, octal, or hexadecimal, assigned by label group, but you may select decimal base or assign ASCII mnemonics for values of sets of six or more bits.

Measurement power of the HP 1630 timing analysis function is a consequence of the basic feature set, with 100 MHz sampling speed, 1024-bit deep memory, and 16-channel width of the HP 1630D. But the value of the HP 1630 in actual application is the versatility and ease with which the analyzer can be configured to fit each analysis situation, to obtain accurate measurements that answer timing analysis questions directly.

### State Analysis

- 35 (HP 1630A), 43 (HP 1630D), or (HP 1630G) channels to trace state flow nonintrusively.
- Speed to 25 MHz to accommodate data transfer rates in microprocessor and other digital systems.
- Four trigger/qualifier resources to initiate state flow measurements and to edit the information to be stored.
- 1024-word memory to support broad-sweep measurements.
- User-defined labels to match input lines to processor system functions.
- Edit (HP 1630A/D) and Full (HP 1630G) compare mode to check measurement against known data.
- Mark/show selected states to edit state listing quickly.
- Three clocks for demultiplexed address and data signals.
- Low-cost peripheral adds extra memory and inverse assembly for trace lists in the microprocessor mnemonics.

As the components for digital systems become more complex and perform more functions that are transparent from the user's viewpoint, software becomes more critical to the smooth operation of a digital system. A major tool for software debugging and system integration is the state analyzer. State analysis with the HP 1630 lets you view real-time state flow nonintrusively.

State analysis with the HP 1630 is supported by a solid foundation of basic features: 35 (HP 1630A), 43 (HP 1630D), or 65 (HP 1630G) channels, 25 MHz speed, and 1024-bit deep memory for each channel. Width, speed, and depth ensure that the HP 1630 is suitable for a broad spectrum of measurement applications. Beyond that, the software analyst needs features that support flexible definitions of where, when, and how the measurement is made.



State listings may be translated into the mnemonics of the target microprocessor with the probe interface. Inverse assembly makes it easier to compare the state measurement to the source code listing, without the need to translate from a hexadecimal listing. State flow is monitored nonintrusively at rates to 25 MHz.

In state analysis, you can define up to four resource terms to set parameters for triggering, storing, and restarting the measurement. Resource terms may be used to define a sequence to be found before triggering and capturing a state listing trace. One or more resource terms may be used to define the conditions under which a search for a trigger point is terminated and a new search is initiated. Resource terms can also be used to qualify the states that are to be stored in the analyzer memory, such as storing only reads to memory. With the four resource terms, you can place a window on state flow, and "edit" the information to include only the data you need for analysis.

Labels can be assigned to groups of input lines for the state analysis mode, also. A total of eight labels may be assigned, each label name with up to five alphanumeric characters. Labels are the means of grouping the input lines, with the added convenience of mnemonics that are meaningful for your applications, such as ADDR, DATA, RD\_WR, etc. Once a label is assigned to a set of bits, that set of bits is treated as a single variable.

Further identifiers can be defined for a label set. Module names can be specified for up to eight contiguous address ranges or 16 contiguous ranges. Status names can also be defined for any label group of four or fewer bits. By using the HP 1630G's non-volatile memory and an interface, inverse assembly translates the state listings into the mnemonics for the microprocessor being used. Interfaces are available for many popular microprocessors.

Two alternative forms of the standard state listing offer other views of the collected data. From one to sixteen of the state inputs can be translated into a state waveform display. For a global view, the state listing can be transformed into a graph display. Typically, the graph is based on the addresses, plotting the magnitude of the address against the order of occurrence. A graph of system activity highlights inappropriate looping and any activity occurring in an illegal memory area.

Comparing new measurements with previous measurements is implemented with key events; with the HP 1630A/D you select and mark up to sixteen events anywhere in the 1024-event standard listing, modify them as necessary, and they will be compared to the comparable events in subsequent listings. The HP 1630G's full compare mode allows you to acquire a full sample of 1024 states and store it in memory. A new sample can then be acquired and compared to the reference, with any differences between the two samples indicated. The compare mode is well-suited for automated testing with an HP-IB or HP-IL controller.

### Interactive State and Timing Analysis

- Correlate synchronous and asynchronous measurements.
- Resolve hardware/software problems.
- HP 1630A has 27 state channels and 8 timing channels in the interactive mode.





# LOGIC ANALYZERS & DEVELOPMENT SYSTEMS

## State, Timing & Performance Analysis

Model 1630A/D/G (cont.)

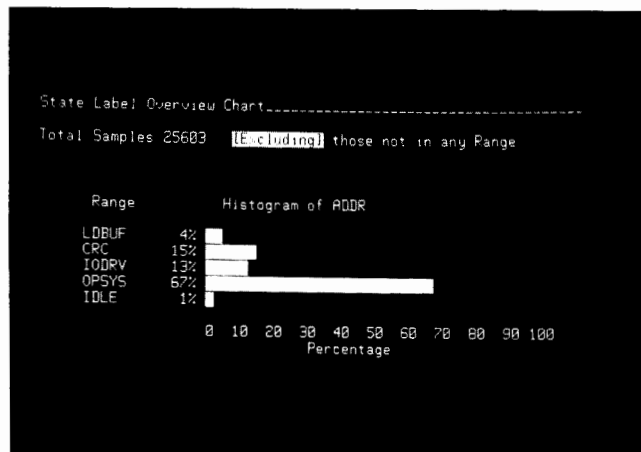

Histograms may be generated by event frequency or elapsed time for an overview of system flow. Up to eight label ranges or time intervals may be specified to analyze the impact of selected code modules on the total program execution. These modes support performance measurements to locate bottlenecks and inefficiencies.

- HP 1630D has either 27 state and 16 timing channels or 35 state and 8 timing channels in interactive mode.
- State and timing analysis functions retain full feature sets in any mode.

When the HP 1630 analyzer is used for interactive state/timing measurements, both analysis units continue to collect data simultaneously. Either function can arm the other function. For example, you can define a triggering condition for the timing analyzer, and set it to arm the state analyzer to trigger on any state. This, in essence, sets a timing trigger condition to initiate a state measurement. By tying the two functions together, you can relate a state flow problem to the occurrence of a glitch on a status line, or seek out a timing problem in a particular part of program activity.

Since hardware and software are usually designed in separate phases and often by different people, the interactive measurement modes are most valuable when integrating the two subsets to create the final product. Software/hardware analysis quickly pinpoints problem sources, and you avoid multiplying your troubleshooting efforts.

### Software Performance Analysis

Meeting system throughput requirements often requires a global look at overall system activity. With the HP 1630's versatile software performance analysis mode, you can view selected portions of code and measure time or occurrence distribution. This lets you:

- Spot bottlenecks in operating software.
- Determine best- and worst-case conditions as a function of data variables.
- Establish benchmarks of modules or entire programs.
- Graph memory activity as a function of occurrence to indicate infinite loops, erroneous jumps, and activity in forbidden areas.

Design engineers can use performance analysis throughout most of the development cycle, monitoring execution time of individual modules and ensuring that they meet specifications. However, performance analysis is primarily used in areas where improvement will be most effective.

Performance analysis is simple with the HP 1630. No extra controllers and interfaces are needed—they're all in the HP 1630. There are five performance analysis measurements that show you quickly, graphically, and globally where the program spends time and uses memory space. All of the HP 1630's performance-analysis measurement results are in histogram form.

Time Histograms (HP 1630A/D/G): suppose you have a functioning system, but the data transfer rate through an I/O port is slower than expected. In the performance analysis mode, the HP 1630 can start a measurement when the I/O driver outputs a byte of data and can stop it when the hardware is ready to output the next byte. The

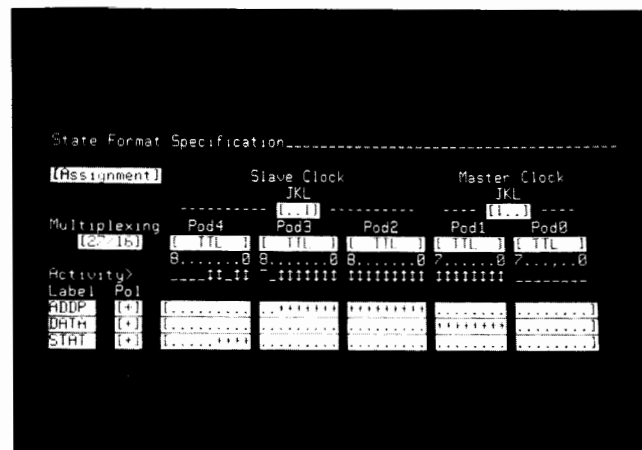

The state format specification defines the conditions for making state or performance measurements. A choice of either or both edges of three clocks and a master clock allow demultiplexing when needed. Up to eight user-defined labels may be assigned to designated groups of input bits for easier interpretation.

resulting histogram shows the time distribution of many executions. In addition, the HP 1630G can count either all acquired states or only the instructions in the histogram. This eliminates confusion if the program generates in-line code or if memory blocks are interspersed between sections of the program.

Label Histograms (HP 1630A/D/G): to see where activity is concentrated during I/O transfers, labels can be assigned to address ranges that correspond to various software modules that constitute the routine. The HP 1630 can then be set to make repetitive measurements and produce a histogram that shows the relative amount of activity in each module.

Time-positional Histograms (HP 1630G): this measurement allows you to measure the number of times a state occurs per unit of time. It is used to understand the behavior of a system under a time-varying load. Applications include measuring calls to an operating system or peripheral per unit of time, or monitoring a floating-point or array processor.

Linkage Histograms (HP 1630G): this measures the relative frequency with which a set of state pairs occurs. Each pair consists of two states, where an occurrence is defined as the first state followed immediately by the second state with no intervening states. For example, the linkage measurement could be used to measure the relative number of times that an I/O routine is called from various parts of the main program.

### Peripherals and Preprocessors

HP-IB and HP-IL interfaces are standard in all HP 1630 logic analyzers. The HP 1630 accommodates a variety of peripheral instruments for a number of applications. HP-IB printers and printer/plotters can provide hardcopy for documentation and post-processing analysis. Any HP-IB external controller or the handheld HP 41C can be programmed to operate the analyzer remotely and as an automated test instrument.

Ten-channel state and eight-channel timing pods offer a variety of connection methods. The general-purpose probes, with miniature probe tips, let you connect a single channel to any point on the board, individually. Alternatively, you can remove the probe lead for push-pin hookup to a wire-wrap or test pin. With the probe leads removed, the pod can be aligned directly into a standard 11-pin connector.

In today's complex microprocessor products, connecting a logic analyzer to test points can be frustrating and time-consuming. HP has paid special attention to this interface, and offers a family of preprocessors that tailors the HP 1630 to today's popular 8-bit and 16-bit microprocessors. Preprocessor interface modules simplify connection to the system under test by providing easy probe connection and circuitry to format inputs properly in terms of buses, control lines, and status lines.





## HP 1630A/D/G Specifications

### Memory

**Data acquisition:** 1024 words.

**Compare:** 16 words, HP 1630A/D; 16 or 1024 words, HP 1630G.

**Memory search:** all patterns within a label set may be marked or separately displayed.

### State Analysis Mode

#### Clocks

**Clock edges:** for each of three ORed clocks, select either or both edges; separate edges of one clock may be selected for multiplexed modes.

**Repetition rate, single phase:** 25 MHz for single edge of single clock; 20 MHz for any combinations of ORed clocks and edges.

**Repetition rate, multiplexed:** master clock must follow slave clock by at least 10 ns and precede next slave clock by at least 50 ns.

**Pulse width:**  $\geq 10$  ns at threshold.

**Setup time:**  $\geq 20$  ns.

**Hold time:** zero.

#### Data Indexing

**Resources:** four terms, including the Boolean NOT of each term, ALL patterns or NO pattern; terms may be used as often as needed.

**Trigger:** up to four resource terms in sequence; final sequence term may use up to four ORed resource terms.

**Restart:** up to four ORed terms to reinitiate sequence search.

**Store qualifiers:** up to four ORed resource terms; may be separately defined for each term in the trigger sequence.

**Occurrence:** to 9999; applies to final sequence term only.

**Compare:** width of analyzer by 16 words; trace until "equal to" or "not equal to" with each compare word matched to all 1024 words in memory; compare words may contain "don't care" terms.

**Full compare (HP 1630G only):** the compare file is the full 1024 states of memory.

### Timing Analysis Mode

#### Clock

**Range:** 10 ns to 500 ms in 1, 2, 5 sequence.

**Accuracy:**  $\pm 0.01\%$ .

**Glitch:** min detectable glitch, 5 ns width at threshold; with glitch detection on, number of timing channels is halved.

#### Data Indexing

**Asynchronous pattern:** 20 ns to 1 ms in 1, 2, 5 sequence with accuracy  $\pm 20\%$  or 15 ns, whichever is greater; glitch or edge ANDed with asynchronous pattern.

**Maximum time delay:** approx  $2^{18}$  times the sample period, to 9999 s max.

**Cursors:** time between dual cursors (x and o) displayed to accuracy of one sample period.

**Expansion:** X1 to X40 in 1, 2, 4 sequence; standard display shows entire 1k memory at X1.

### Interactive State/Timing Analysis Mode

**Arming:** the full data-indexing capabilities of either the state or timing analysis mode can be used to arm the other analysis mode.

### Software Performance Analysis and Overview Modes

**XY Chart:** all 1024 events/samples for any label group can be displayed as a chart of order of occurrence by magnitude; max and min vertical limits are user-specified.

**Time interval histogram:** measures time between start and stop events defined for up to eight time ranges.

**Time range:** min size, 1  $\mu$ s.

**Display:** histogram; min, max, average, and last time reading; total elapsed time; number of samples.

**Resolution:** for four-bit label group, 250 ns or 0.1% of reading, whichever is greater.

**State histogram:** sampled occurrence count of events in a label group for up to eight total user-defined ranges or values.

**Max count:**  $2^{63} - 1$ .

**Resolution:**  $\pm 0.01\%$ .

**Time-positional histogram (HP 1630G only):** shows the number of occurrences of an event over time. A time unit is defined, and the analyzer counts the occurrences of a specified event in that time unit. The measurement can be repeated for up to 1023 equal-sized time units.

**Typical accuracy of first time unit:**  $-250$  ns to  $+500$  ns,  $\pm 0.01\%$  of specified width.

**Typical accuracy of subsequent time units:**  $\pm 0.01\%$  of specified width.

**Linkage histogram (HP 1630G only):** shows up to eight module links. A link is defined as a specific state followed immediately by another specific state with no intervening states. Store qualification can be used to acquire states selectively. The measurement can be started on completion of a sequence of up to three resource terms, with restart and occurrence capabilities such as state data indexing.

**Max number of definable events:** 8.

**Max number of definable links:** 8.

**Max count:**  $2^{63} - 1$ .

### Probe Inputs

**RC:** 100 k $\Omega$   $\pm 2\%$  shunted by approx 5 pF at probe body.

**Min swing:** 600 mV peak-to-peak.

**Min input overdrive:** 250 mV or 30% of input amplitude, whichever is greater.

**Max voltage:**  $\pm 40$  V, peak.

**Threshold range:**  $-9.9$  to  $+9.9$  V in 0.1 V increments.

**Accuracy:**  $2.5\% \pm 120$  mV.

**Dynamic range:**  $\pm 10$  V around threshold.

### General

#### Labels

**Input channel:** up to eight labels for state channels and up to 16 labels for timing channels; each label up to five characters. Bits may be used for more than one label, and need not be contiguous.

**User field:** user-defined labels for specified patterns for label groups of four or fewer bits.

**Relocatable field:** up to 16 starting locations within a label group.

#### Rear-Panel Outputs

**HP-IB:** connector and 8-position switch with 5 positions to determine address and 2 positions to set "talk-only" for hardcopy or system controller modes.

**HP-IL:** rear-panel port.

**BNC:** TTL output, high  $\geq 2$  V into 50  $\Omega$ , low  $\leq 0.4$  V into 50  $\Omega$ ; one of seven possible signals entered in menu from keyboard.

#### Operating Environment

**Temperature:**  $0^\circ$  to  $55^\circ$  C ( $+32^\circ$  to  $130^\circ$  F).

**Humidity:** up to 95% at  $40^\circ$  C.

**Altitude:** to 4600 m (15 000 ft).

**Vibration:** vibrated in three planes for 15 min each with 0.3 mm excursions, 5 to 55 Hz.

**Power:** 115/230 Vac,  $-22\%$  to  $+10\%$ ; 275 W max; 48 to 66 Hz.

**Size:** 189 H  $\times$  426 W  $\times$  430 mm D (7.5  $\times$  16.8  $\times$  17.6 in).

**Weight:** HP 1630A 12.6 kg (28 lb) net, 17 kg (38 lb) shipping; HP 1630D 13.2 kg (29 lb) net, 17.7 kg (39 lb) shipping; HP 1630G 13.6 kg (30 lb) net, 18.1 kg (40 lb) shipping.

**Accessories supplied:** three HP 10271A state probes; one HP 10272A state and timing probe for HP 1630A/G, two HP 10272A state and timing probes for HP 1630D; one HP 82167A HP-IL cable; (HP 1630A/D only); one 2.3 m (7.5 ft) power cord; one Operating Manual.

### Ordering Information

HP 1630A Logic Analyzer (35 channel)

HP 1630D Logic Analyzer (43 channel)

HP 1630G Logic Analyzer (65 channel)



# LOGIC ANALYZERS & DEVELOPMENT SYSTEMS

## Preprocessors and Interfaces

Models 64650A and 10269A/B

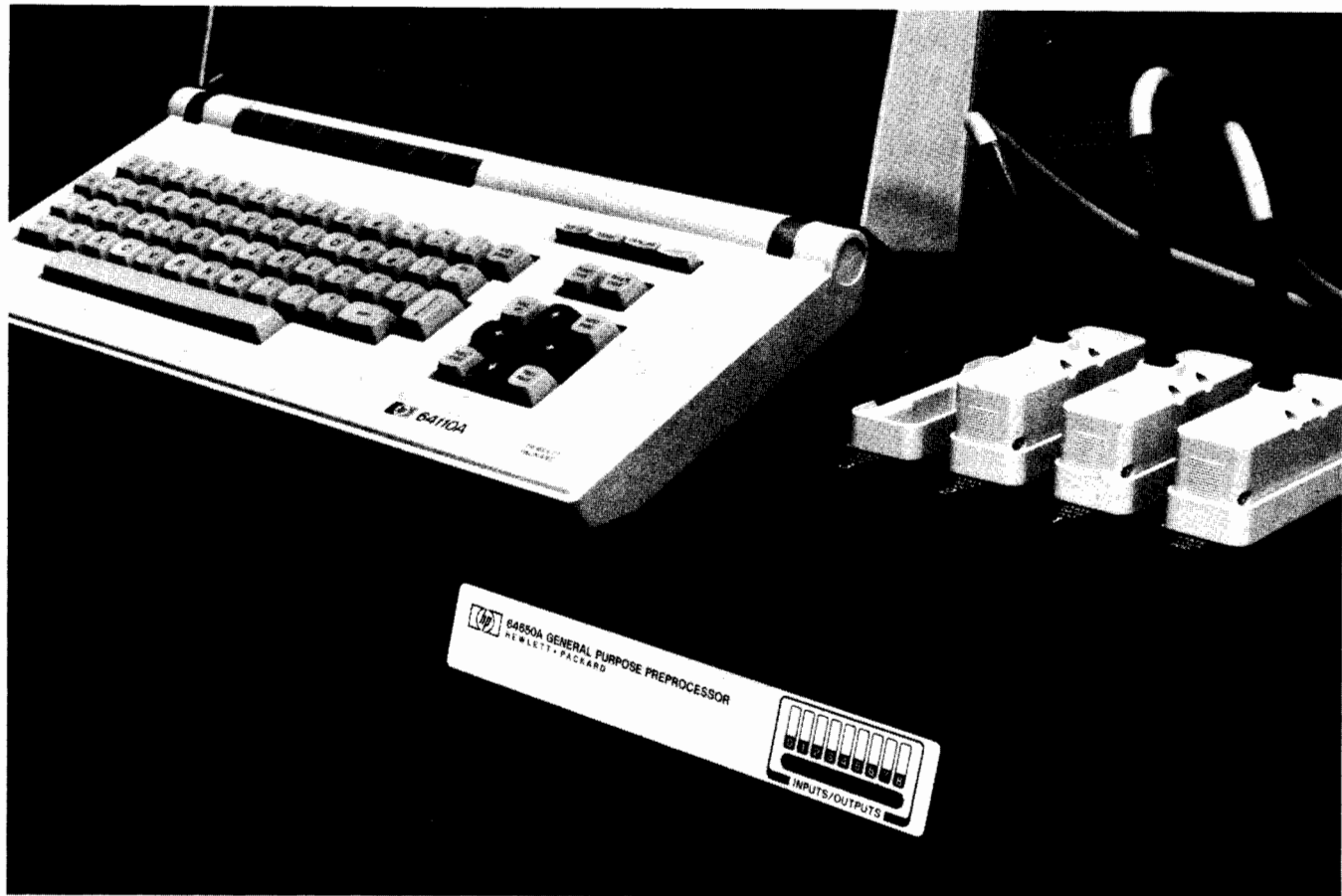

HP 64650A General Purpose Preprocessor

### Preprocessors and Interfaces

Preprocessors and interface modules tailor the HP 64620S Logic State/Software Analyzer and HP 1630A/D/G Logic Analyzer for use with specific microprocessor systems. Preprocessors provide quick, convenient connections between target microprocessor systems and logic analyzers. Inverse assemblers translate collected state events into the microprocessor mnemonics for easy reading and analysis. The interface software automatically sets formats for the logic analyzer to match inputs from the processor under test.

Model 64650A General Purpose Processor for a 60-channel HP 64620S Software Analyzer replaces three HP 64635S data probes and one HP 64636A clock probe. The comparable preprocessor unit for HP 1630A/D Logic Analyzer is HP 10269A 5-probe Interface, and for HP 1630G Logic Analyzer, the HP 10269B 9-probe Interface is used. Control software and the inverse assemblers are included with the interface modules that are installed in the Preprocessor/Probe Interface units; interface circuits are carried on the interface module boards. The interface modules also include the cables and

probes for connection to the target systems, with the probes replacing the target microprocessors. Both processor-specific and user-definable modules are available.

General-purpose, wire-wrapping interface modules include the hardware, chip sockets and interface boards to create unique interfaces for microprocessors and minicomputer buses. For the HP 64620S Software Analyzer, a matching inverse assembler may be written using the Inverse Assembly Language software, HP 64856A.

### Minicomputer Interfaces

Three interfaces access bus signals on minicomputers: HP 10275A PDP-11 Unibus<sup>®1</sup> Interface, HP 10276A LSI-11 Q-Bus<sup>®1</sup> Interface, and HP 52126A Intel MULTIBUS<sup>®2</sup> Interface. Active circuits on the interface ensure that bus-loading specifications are not exceeded and generate a clock signal for a logic analyzer. Minicomputer interface boards plug directly into the minicomputer.

Switches on each interface board are used to qualify information routed to the preprocessor by selected activity type. Any combination of monitored activities may be selected for a measurement.

Computer Activity	HP 10275A	HP 10276A	HP 52126A
Reads	X	X	X
Writes	X	X	X
Interrupt vectors	X	X	
DMA transfers	X	X	
Refresh activity		X	
I/O transfers			X

Minicomputer bus activity may be monitored directly from the minicomputer interface boards using individual logic analyzer probe leads. In general, it is more convenient to take advantage of the general-purpose interfaces for the preprocessor probe interfaces. Bus signal routing can be defined on the preprocessor general-purpose interface board.

<sup>1</sup>Registered, Digital Equipment Corporation

<sup>2</sup>Registered, Intel Corporation

Microprocessor	HP 64620S Software Analyzer	HP 1630A/D Logic Analyzer	HP 1630G Logic Analyzer
	HP 64650A Interface Model No.	HP 10269A Interface Model No.	HP 10269B Interface Model No.
8086/8088	HP 64653A	HP 10305C	HP 10305B
8085	HP 64655A	HP 10304C	HP 10304B
80286	HP 64657A	HP 10312C	HP 10312B
80186/80188	HP 64658A	HP 10306C	HP 10306B
6809/6809E	HP 64671A	HP 10308C	HP 10308B
6800/6802	HP 64672B	HP 10307C	HP 10307B
68008	HP 64673A	HP 10310C	HP 10310B
68000/68010	HP 64674A	HP 10311C	HP 10311B
Z8001	HP 64680A	HP 10301C	HP 10301B
Z8002	HP 64681A	HP 10302C	HP 10302B
Z80	HP 64683A	HP 10300C	HP 10300B
NSC800	HP 64690A	HP 10303C	HP 10303B
General purpose	HP 646451B	HP 10320C	HP 10320B

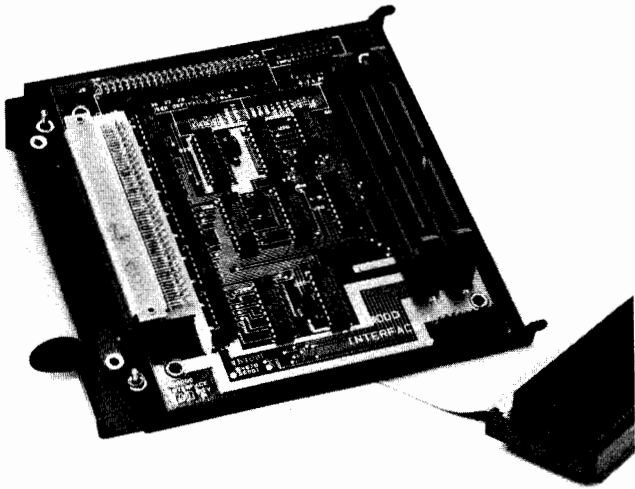

Interface Board

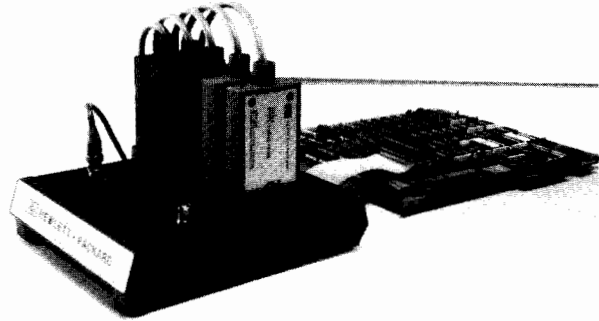

HP 10269A

### Interface Software

Each preprocessor or interface module that is dedicated to a specific microprocessor family includes the appropriate operating software and inverse assembler. The software, including the inverse assemblers, is supplied on the medium suitable for the logic analyzer. Interface software for HP 1630A/D Logic Analyzers is on mini data cassettes; for HP 1630G Logic Analyzer, on 3½-inch microfloppy disc; and for HP 64620S Software Analyzer, on 5¼-inch flexible disc.

### HP 64650A Specifications

**Channel width:** 60 channels.

**Qualified clock rate:** 10 MHz.

#### Input

**RC:** 100 kΩ shunted by < 20 pF at interface module connector.

**Maximum:** ±40 V.

**Dynamic range:** threshold ±10 Vdc in 0.1 V increments.

**Minimum single swing:** 600 mV.

**Minimum clock pulse width:** > 20 ns.

#### Setup and Hold Times

**Clock qualifier setup time:** 20 ns min.

**Clock qualifier hold time:** zero.

**Data setup time:** 37 ns min; clocked by preprocessor, 23 ns min.

**Data hold time:** zero; when clocked by the preprocessor, 7 ns min.

#### Power

**Consumption:** 0.8 A max at +5 V; 2.5 V max at -5.2 V.

**Available for interface module:** 1.0 A max at +5 V.

**Note:** all power supplied by the software analyzer subsystem.

#### Environmental

**Temperature:** operating, 0° to 55° C (+32° to +131° F); nonoperating, -40° to +75° C (-40° to +167° F).

**Altitude:** operating, 4600 m (15 000 ft); nonoperating, 15300 m (50 000 ft).

**Humidity:** operating, to 90% noncondensing.

### HP 10269A/B Specifications

**Channel width:** HP 10269A, 5 probe sockets, 43 data channels, and 3 clock channels; HP 10269B, 9 probe sockets, 65 data channels, and 3 clock channels.

**Qualified clock rate:** 25 MHz max.

#### Input

**Impedance:** 100 kΩ < 20 pF at interface module connector.

**Maximum:** ±40 Vdc.

**Dynamic range:** threshold ±10 V in 0.1 V increments.

**Minimum clock pulse width:** 10 ns.

#### Setup and Hold Times

**Setup time:** 20 ns min.

**Hold time:** zero.

#### Power

**Power available for interface module:** 1.0 A max at +5 Vdc, supplied by HP 1630 Logic Analyzer.

#### Environmental

**Temperature:** operating, 0° to +55° C (+32° to +131° F); nonoperating, -40° to +75° C (-40° to +167° F).

**Humidity:** to 90% at +40° C, noncondensing.

**Altitude:** operating, 4600 m (15 000 ft); nonoperating, 15 300 m (50 000 ft).

### Ordering Information

**HP 10269A** 5-probe Interface for HP 1630A/D Logic Analyzer

**HP 10269B** 9-probe Interface for HP 1630G Logic Analyzer

**Note:** HP 103XXB Preprocessors are used with HP 1630G Logic Analyzer; HP 103XXC Preprocessors are used with HP 1630A/D Logic Analyzers. An inverse assembler is included with each HP 103XX Preprocessor that is dedicated to a specific microprocessor.

**HP 10300B/C** Z80 Preprocessor

**HP 10301B/C** Z8001 Preprocessor

**HP 10302B/C** Z8002 Preprocessor

**HP 10303B/C** NSC800 Preprocessor

**HP 10304B/C** 8085 Preprocessor

**HP 10305B/C** 8086/8088 Preprocessor

**HP 10306B/C** 80186 Preprocessor

**HP 10307B/C** 6800/6802 Preprocessor

**HP 10308B/C** 6809/6809E Preprocessor

**HP 10310B/C** 68008 Preprocessor

**HP 10311B/C** 68000/68000 Preprocessor

**HP 10312B/C** 80286 Preprocessor

**HP 10320A** User-definable Interface Module

**HP 10321A** Microprocessor Interface Kit (10320A)

**HP 10322A** 40-pin Dual-in-line Connector (10320A)

**HP 10323A** 48-pin Dual-in-line Connector (10320A)

**HP 10324A** 64-pin Dual-in-line Connector (10320A)

**HP 64650A** General Purpose Preprocessor

**HP 64651B** Wire-wrapping Interface Module

**Opt 001** Microprocessor Interface Kit for HP 64651B

**Opt 010** 40-pin Cable and Connector for HP 64651B

**Opt 011** 48-pin Cable and Connector for HP 64651B

**Opt 012** 64-pin Cable and Connector for HP 64651B

**Note:** An inverse assembler is included with each HP 646XXA Interface Module that is dedicated to a specific microprocessor.

**HP 64653A** 8086/8088 Interface Module

**HP 64655A** 8085 Interface Module

**HP 64657A** 80286 Interface Module

**HP 64658A** 80186/80188 Interface Module

**HP 64671A** 6809/6809E Interface Module

**HP 64672B** 6800/6802 Interface Module

**HP 64673A** 68008 Interface Module

**HP 64674A** 68000/68010 Interface Module

**HP 64680A** Z8001 Interface Module

**HP 64681A** Z8002 Interface Module

**HP 64683A** Z80 Interface Module

**HP 64690A** NSC800 Interface Module

**HP 64856A** User-defined Inverse Assembler

**HP 10275A** PDP-11 Unibus Interface board

**HP 10276A** LSI-11 Q-Bus Interface board

**HP 52126A** Intel MULTIBUS Interface board

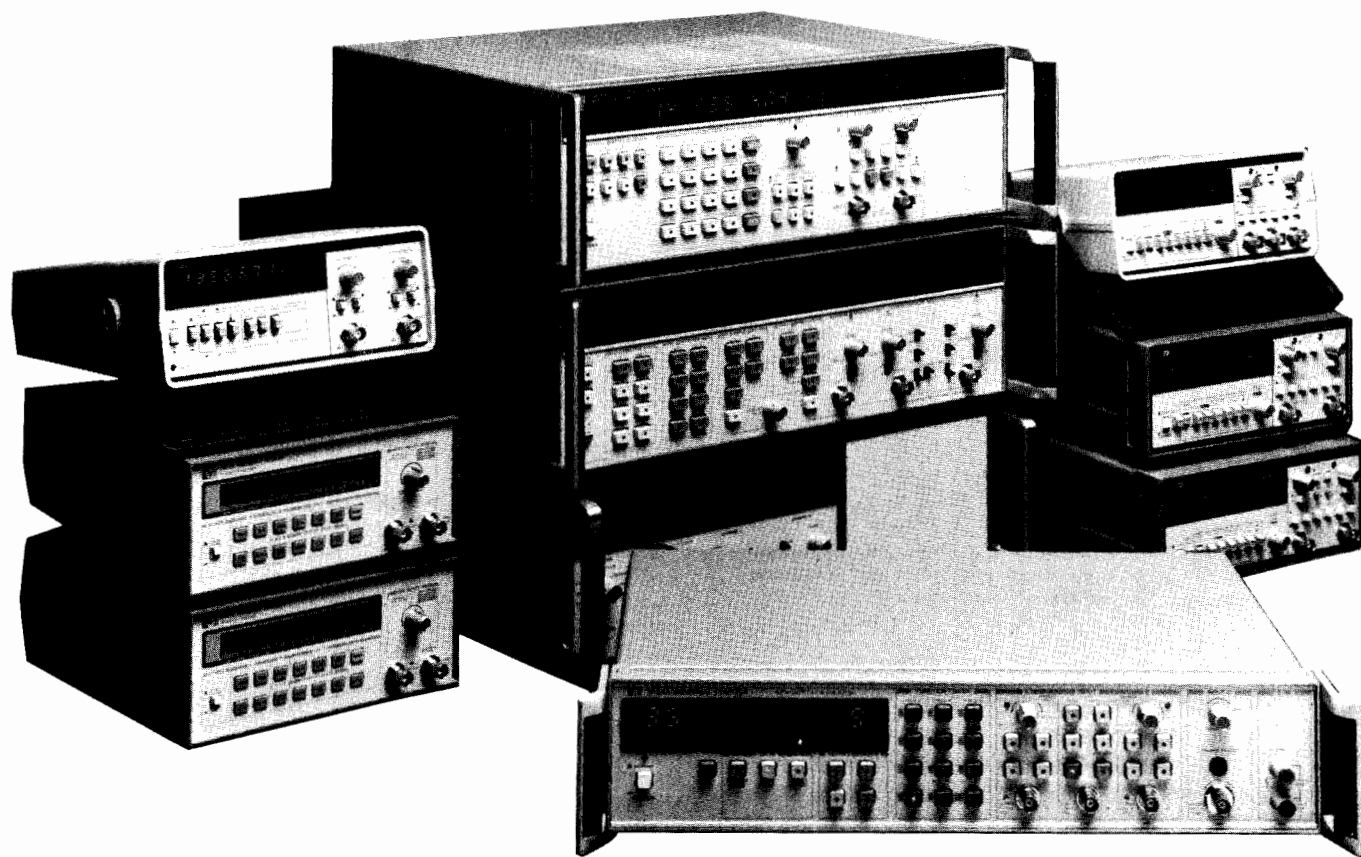

## Introduction

HP introduced its first digital electronic counter in 1952. That product, the HP 524A, could measure frequencies to 10 MHz and time intervals as short as 100 ns. Thirty years later HP counters measure frequencies as high as 40 GHz and time intervals as short as 20 picoseconds, the time it takes light to travel six millimetres.

Applications for counters exist throughout the electronics industry, in all phases of engineering, production and service. Today's counters make a variety of measurements, which are summarized below.

## Frequency

In this fundamental measurement, the counter totalizes cycles of the unknown signal for a precisely known length of time. Using high speed custom ECL parts, counters today measure frequency to 500 MHz directly and to 40 GHz with down conversion. Measurement quality is closely linked to the timebase and HP counters feature a variety of high stability oscillators to match the requirements of the application.

## Period

The inverse of frequency measurement is available on most products to provide high resolution measurement of low frequency.

## Totalize

This measurement is similar to frequency except that the user controls the time interval

over which the measurement takes place. Applications for totalize range from mechanical systems to high speed electronics R & D. The ability of the HP 5345A to totalize at a 500 MHz rate represents the current state of the art for this measurement.

## Ratio

Some counters have the ability to compute and display the ratio of two input frequencies. The major application is the measurement of harmonically related signals.

## Scaled Output

A divide by N version of the input signal is available at the timebase output of the HP 5328B for specialized applications.

## Time Interval

The importance of the digital techniques throughout the electronics industry makes high resolution measurement of time interval increasingly useful. Seven HP counters make time interval measurements including the HP 5370B which uses phase locked vernier interpolation to measure time interval as short as 20 picoseconds. Time interval averaging, a technique pioneered by HP, improves the resolution of measurements made on repetitive signals over the single shot resolution of the counter. Another product, the HP 5363B Time Interval Probe, aids time interval measurements by expanding the dynamic range of trigger levels and reducing uncertainties caused by trigger level errors.

## Pulse Parameters

HP's newest counter, the HP 5334A, has complete pulse characterization capability which includes peak amplitude measurement, a feature not previously available in counters. Along with peak amplitude, the HP 5334A can also measure pulse width and rise/fall times. On the HP 5335A counter the measurement hardware is combined with the power of a microprocessor to make complex measurements easier and faster. At the touch of few keys, the HP 5335A automatically measures phase, slew rate, duty cycle, rise/fall times, and computes statistics.

## Reciprocal Counting

All newer HP counters measure frequency by counting the internal clock for a known number of periods of the input signal and computing frequency. This technique, known as reciprocal counting, makes the resolution of the measured frequency proportional to the frequency of the timebase rather than the one Hertz in one second resolution of conventional counters. Reciprocal counting is necessary for high resolution low frequency measurements. In keeping with HP's commitment to advanced measurement technology, the capability of frequency counting was extended with the introduction of interpolator-enhanced reciprocal counting with the HP 5335A. This technique allows, not only HP 5335A, but also the newest counters, the HP 5334A, 5384A and 5385A, to obtain 9-digit per second low frequency resolution at low cost.



## Categories of Frequency Counters

While counters can potentially offer all of the capabilities described above, they essentially fall into three categories, frequency counters, universal counters, and microwave counters.

Frequency counters offer basic frequency measurement. They are designed for people with specific applications and the wide variety of products in this area insure that one is available to economically match most applications. The newest additions to this category, the HP 5384A and 5385A, also offer full systems compatibility with either HP-IB or HP-IL.

Universal counters provide time interval measurement capability in addition to the other measurements found in frequency counters. The HP 5314A is the most economical of HP universal counters and features 100 MHz frequency and 100 nanosecond time interval. At the other extreme the HP 5370B measures time intervals of 20 picoseconds single shot. In between, the HP 5315A/B, 5316A, 5328B, 5334A, 5335A, and 5345A offer a range of capabilities that is more fully described in the comparison chart below.

HP microwave counters make high accuracy frequency measurements at frequencies up to 40 GHz. The HP 5343A automatically measures frequencies to 26.5GHz with one

Hertz resolution and wideband FM tolerance. For pulsed RF or CW microwave applications, the HP 5355A plug-in for the HP 5345A is a complete solution to 40GHz.

The HP 5344S Microwave Source Synthesizer is a recent addition to the HP Microwave Counter family. When used with microwave sweepers such as the HP 8350B, the HP 5344S greatly improves frequency accuracy for network measurements.

Most HP counters are compatible with the HP Interface Bus, Hewlett-Packard's implementation of IEEE-488, when equipped with the HP-IB option. In fact, all newer HP counters (the HP 5316A, 5334A, 5335A, 5370B, 5384A and 5385A) come equipped with HP-IB standard. This makes them ideal for applications requiring a large number of time or frequency measurements, frequent changes of the front panel settings or automatic data reduction storage and output.

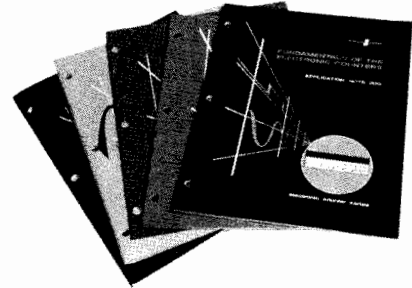

The 200 series of application notes, shown above, explains in detail the operation and application of HP's frequency counters.

- Topics include:
- Fundamentals of Electronic Counters 200
  - Fundamentals of Microwave Counters 200-1
  - Fundamentals of Quartz Oscillators 200-2
  - Fundamentals of Time Interval Measurements 200-3
  - Understanding Counter Specifications 200-4
- These notes are available from all HP sales offices.

## HP-IL

The HP 5384A and 5385A counters provide frequency and period measurement capability for low cost HP-IL systems. HP-IL is HP's new two-wire serial interface that allows remote instrument control via HP-41C/CV handheld calculators or the more powerful HP 80 series computers.

## Counter Selection Guide

	HP Model	Counting Technique <sup>1</sup>	Digits	Sensitivity	Frequency	Single Shot Time Interval	HP-IB Interface Functions <sup>2</sup>											Other Features <sup>3</sup>	Page	
							SH	AH	T	L	SL	RL	PP	DC	DT	C	E			
Frequency	5381A	CO	7	25 mV	80 MHz	—														299
	5382A	CO	8	25 mV	225 MHz	—														299
	5383A	CO	9	25 mV	520 MHz	—														299
	5384A	RE	11	15 mV	225 MHz	—	1	1	5	4	1	1	0	1	1	0	1		HP-IL <sup>4</sup>	298
	5385A	RE	11	15 mV	1000 MHz	—	1	1	5	4	1	1	0	1	1	0	1		HP-IL <sup>4</sup>	298
Universal	5314A	CO	7	25 mV	100 MHz	100 ns													P,R,T	297
	5315A	RE	8	10 mV	100 MHz	100 ns													P,R,T	294
	5315B	RE	8	10 mV	100 MHz	100 ns													P,R,T,X <sup>5</sup>	294
	5316A	RE	8	10 mV	100 MHz	100 ns													P,R,T,X <sup>4</sup>	294
	5328B	CO	8	25 mV	100 MHz	100 ns	1	1	1	2	1	1	0	1	1	0	1		P,R,T,X <sup>4</sup>	293
	5334A	RE	9	35 mV	100 MHz	2 ns	1	1	5	4	1	1	0	1	1	0	1,2		P,R,T,X <sup>4,6</sup>	288
	5335A	RE	12	25 mV	200 MHz	2 ns	1	1	5	4	1	1	0	1	1	0	1		P,R,T,X <sup>6,7</sup>	290
	5345A	RE	11	25 mV	500 MHz	2 ns	1	1	1	2	1	2	0	1	0	0	1		P,R,T,X	282
5370B	RE	12	20 mV	100 MHz	20 ps	1	1	1	2	1	1	0	1	1	0	1		P,Stats <sup>4</sup>	286	
Microwave	5340A	TO	8	-35 dBm	18 GHz	—	1	1	1	2	1	2	0	1	1	0	1		X	281
	5342A	HH	11	-25 dBm	18 GHz	—	1	1	1	2	1	1	0	1	1	0	1		Ampl, D to A <sup>8</sup>	278
	5343A	HH	11	-33 dBm	26.5 GHz	—	1	1	1	2	1	1	0	1	1	0	1		D to A, X <sup>9</sup>	278
	5344S	HH	11	-25 dBm	18 GHz	—	1	1	1	2	1	1	0	1	1	1	1		Ampl, D to A, X <sup>8</sup>	280
	5355A	HH	11	-15 dBm	1.6 GHz	—	0	1	0	2	0	1	0	1	1	0	1		P,R,T	284
	5356A	HH	11	-20 dBm	18 GHz	—													P,R,T	284
	5356B	HH	11	-20 dBm	26.5 GHz	—													P,R,T	284
	5356C	HH	11	-20 dBm	40 GHz	—													P,R,T	284

<sup>1</sup>CO - Conventional, RE - Reciprocal, TO - Transfer Oscillator, HH - Harmonic Heterodyne.

<sup>2</sup>For more information on these codes, refer to the Hewlett-Packard Interface Bus section of this catalog.

<sup>3</sup>P - Period, R - Ratio, T - Totalize, X - Extended Frequency Option.

<sup>4</sup>HP-IB Standard.

<sup>5</sup>Offset and/or Normalize Option.

<sup>6</sup>Pulse Characteristics.

<sup>7</sup>Phase



# ELECTRONIC COUNTERS

## Automatic Microwave Counters

Models 5342A & 5343A

- Microprocessor controlled
- Automatic measurement to 18 GHz/26.5 GHz
- Wide FM tolerance

- Simultaneous display of input level
- High sensitivity
- Automatic or manual operation



HP 5342A

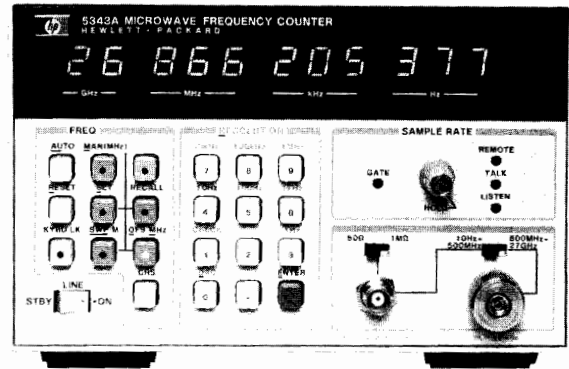

HP 5343A



### Description

The HP 5342A and HP 5343A Microwave Counters provide Automatic Frequency Measurement up to 18 or 26.5 GHz in highly portable packages. The HP 5342A extends to 24 GHz optionally.

The powerful and versatile microprocessor controlled keyboards can accomplish offset tasks as a standard feature as well as providing user interactive diagnostic information. The eleven-digit display is sectionalized for easy readout to one hertz resolution.

Both units utilize the Harmonic Heterodyne down conversion technique which combines the best performance features of the Heterodyne Converter and Transfer Oscillator Techniques. Now Wide FM Tolerance is achievable along with high input sensitivity and automatic amplitude discrimination. This allows the counter to automatically measure the largest signal present within the counters' spectrum while ignoring all others.

### Amplitude Measurements (option 002) (HP 5342A only)

Option 002 adds the ability to measure the input level of the incident sinewave signal. The instrument then displays this level in dBm. The eleven-digit LED display simultaneously presents frequency to 1 MHz resolution and amplitude to 0.1 dBm resolution. An added benefit from Option 002 is that dynamic range is extended so that frequency measurements to +22 dBm are accomplished. This extended dynamic range is also available without the amplitude measurement capability by ordering Option 003 (HP 5342A only).

### FM Tolerance

The ability to measure a carrier frequency while being frequency modulated has broad appeal in the communications industry and elsewhere. The HP 5342A can tolerate 50 MHz peak-to-peak worst case FM in the wide mode, or the normal mode with accompanying faster acquisition time can be selected which gives 20 MHz peak-to-peak worst case FM. The HP 5343A offers a selection of three (3) acquisition times including a 200 ms "fast" acquisition time with 6 MHz peak-to-peak worst case FM tolerance.

### Offset Functions

The power and versatility of the microprocessor controlled keyboard allows the user to perform offset functions by means of a few key strokes. Frequency values to 1 Hz resolution can be added to or subtracted from the measured frequency for IF offset application and also for monitoring variances about a given frequency. The HP 5343A also offers an  $m \times \pm b$  mode for receiver testing where the measured local oscillator can be multiplied by the appropriate harmonic number. Adding the IF as an offset has the counter displaying the received frequency.

With Option 002 installed (HP 5342A) this offset capability can be applied to the amplitude measurements. These offset values can be recalled to the display at any time for reviewing.

### Digital-to-Analog Converter (option 004)

The ability to convert any three consecutive displayed digits (frequency or amplitude) into an analog voltage output on the rear panel is added by Option 004. This makes the monitoring of microwave oscillator frequency drift easy to make with only a strip chart recorder.

### Microwave Limiter (option 006)

High input level protection is available with Option 006. It provides built-in microwave limiter protection for CW input signals up to +39 dBm (8 watts). This option is very useful for high input level environments where expensive input circuitry of the counter could be damaged.

### HP Interface Bus For Systems Use (option 011)

The full power of HP-IB (IEEE 488) is brought to fruition with the addition of Option 011. Front and rear panel controls can now be remotely programmed and measurement results can be outputted to HP-IB-compatible instruments, calculators, or computers. This interface also can select a given frequency in the manual mode and reduce acquisition time to typically less than 80 ms.

### HP 5342A Specifications

#### Signal Input

##### Input 1

**Frequency range:** HP 5342A: 500 MHz to 18 GHz

HP 5343A: 500 MHz to 26.5 GHz

**Sensitivity:** HP 5342A: 500 MHz to 12.4 GHz: -25 dBm  
12.4 GHz to 18 GHz: -20 dBm

HP 5343A: 500 MHz to 12.4 GHz: -33 dBm  
12.4 GHz to 18 GHz: -28 dBm  
18.0 GHz to 26.5 GHz: -23 dBm

**Maximum input:** +7 dBm (See OPT 002, 003 for higher levels)

**Impedance:** 50 ohms, nominal

**Connector:** HP 5342A: Precision Type N female  
HP 5343A: APC 3.5 male with collar

**Damage level:** +25 dBm, peak (See OPT 006 for +39 dBm -protection)

**Coupling:** dc to load, ac to instrument.

**SWR:** < 2:1, 500 MHz-10 GHz

< 3:1, 10 GHz-18 GHz/26.5 GHz





**FM tolerance:** switch selectable (rear panel)

**Wide:** 50 MHz p-p worst case

**Normal:** 20 MHz p-p worst case

**Narrow:** (HP 5343A only) 6 MHz p-p worst case

For Modulation Rates from dc to 10 MHz.

**AM tolerance:** any modulation index provided the minimum signal level is not less than the sensitivity specification.

**Automatic amplitude discrimination:** automatically measures the largest of all signals present, providing that signal is 6 dB above any signal within 500 MHz; 20 dB above any signal, 500 MHz–18 GHz/26.5.

#### Modes of Operation

**Automatic:** counter automatically acquires and displays highest level signal within sensitivity range.

**Manual:** center frequency entered to within  $\pm 40$  MHz of true value.

#### Acquisition Time

##### Automatic Mode

Narrow FM 200 ms worst case (HP 5343A only)

Normal FM 530 ms worst case

Wide FM 2.4 s worst case

**Manual mode:** 80 ms after frequency entered

#### Input 2

**Frequency range:** 10 Hz to 520 MHz direct count.

**Sensitivity:** 50  $\Omega$ : 10 Hz to 520 MHz: 25 mV rms. 1 M  $\Omega$ : 10 Hz to 25 MHz: 50 mV rms.

**Impedance:** selectable 1 M $\Omega$ , <50 pF or 50  $\Omega$  nominal.

**Coupling:** ac.

**Connector:** type BNC female.

**Maximum input 50  $\Omega$ :** 3.5 V rms (+24 dBm) or 5 V DC, fuse protected

**1 M $\Omega$ :** 200 V DC + 5 V rms

#### Time Base

**Crystal frequency:** 10 MHz.

#### Stability

**Aging rate:**  $< 1 \times 10^{-7}$ /month

**Temperature:**  $< \pm 1 \times 10^{-6}$  over the range 0°C to 50°C

**Short term:**  $< 1 \times 10^{-9}$  for 1 second averaging time.

**Line variation:**  $< \pm 1 \times 10^{-7}$  for 10% change from nominal.

**Output frequency:** 10 MHz,  $\geq 2.4$  V square wave (TTL compatible) 1.5 p-p V into 50  $\Omega$  available from rear panel BNC.

**External time base:** requires 10 MHz, 3.0 V p-p sine wave or square wave into 1 k $\Omega$  via rear panel BNC connector. Switch selects either internal or external time base.

#### Optional Time Base (option 001)

**Crystal frequency:** 10 MHz.

#### Stability

**Aging rate:**  $< 5 \times 10^{-10}$ /day after 24-hour warmup

**Temperature:**  $< 7 \times 10^{-9}$  over the range 0°C to 50°C

**Short term:**  $< 1 \times 10^{-10}$  for 1 second averaging time

**Line variation:**  $< 1 \times 10^{-10}$  for 10% change from nominal

**Warm-up:**  $< 5 \times 10^{-9}$  of final value 20 minutes after turn-on, at 25°C.

#### Amplitude Measurement (opt 002) (HP 5342A only)

##### Input 1

**Frequency range:** 500 MHz–18 GHz.

**Dynamic range (frequency and level)**

–22 dBm to +22 dBm 500 MHz to 12.4 GHz

–15 dBm to +22 dBm 12.4 GHz to 18 GHz

**Maximum operating level:** +22 dBm

**Damage level:** +25 dBm, peak

**Resolution:** 0.1 dBm

**Accuracy:**  $\pm 1.5$  dB (excluding mismatch uncertainty).

**SWR:** <2:1 (amplitude measurement).

<5:1 (frequency measurement).

**Measurement time:** 100 ms + frequency measurement time.

**Display:** simultaneously displays frequency to 1 MHz resolution and level. (Option 011 provides full frequency resolution on HP-IB).

##### Input 2 (50 $\Omega$ impedance only)

**Frequency range:** 10 MHz–520 MHz.

**Dynamic range (frequency and level):** –17 dBm to +20 dBm

**Damage level:** +24 dBm.

**Accuracy:**  $\pm 1.5$  dB (excluding mismatch uncertainty).

**SWR:** <1.8:1.

**Measurement time:** 100 ms + frequency measurement time.

**Display:** simultaneously displays frequency and input level.

#### Extended Dynamic Range (opt 003) (HP 5342A only)

**Frequency range:** 500 MHz to 18 GHz.

**Sensitivity:** 500 MHz to 12.4 GHz: –22 dBm

12.4 GHz to 18 GHz: –15 dBm

**Maximum operating level:** +22 dBm

**Dynamic range:** 500 MHz to 12.4 GHz: 44 dB

12.4 GHz to 18 GHz: 37 dB

**Damage level:** +25 dBm, peak

**SWR:** <5:1

#### Microwave Limiter (option 006)

##### Input 1

**Frequency range:** HP 5342A: 500 MHz – 18 GHz

HP 5343A: 500 MHz – 26.5 GHz

**Sensitivity:** HP 5342A: 500 MHz – 12.4 GHz: –21 dBm

12.4 GHz – 18 GHz: –15 dBm

HP 5343A: 500 MHz – 12.4 GHz: –30 dBm

12.4 GHz – 18 GHz: –24 dBm

18 GHz – 26.5 GHz: –18 dBm

**Maximum operating level:** +7 dBm

**Damage level:** 500 MHz – 6 GHz: +39 dBm (8W)

6 GHz – 18 GHz: +36 dBm (4W)

(HP 5343A only) 18 GHz – 26.5 GHz: +34.8 dBm (3W)

**SWR:** 2.5:1, 500 MHz – 10 GHz

3.5:1, 10 GHz – 18 GHz/26.5 GHz

**Note:** Option 006 is incompatible with Option 002, Option 003, and Option 005 for HP 5342A. Please consult factory special to combine Options 005 and 006.

#### General

**Accuracy:**  $\pm 1$  count  $\pm$  time base error.

**Resolution:** front panel push buttons select 1 Hz to 1 MHz

**Display:** 11 digit LED display, sectionalized to read GHz, MHz, kHz, and Hz.

**Self-check:** selected from front panel pushbuttons displays 75 MHz for resolution chosen.

**Frequency offset:** selected from front panel pushbuttons. Displayed frequency is offset by entered value to 1 Hz resolution.

**Frequency multiply:** (HP 5343A only) (mx  $\pm$  b) measured data is multiplied by any integer up to 99. Offset can then be added or subtracted. Front panel selectable.

**Totalize (HP 5343A only):** input 2 can totalize at rates up to 520 MHz. Readout on the fly is controlled by front panel or HP-IB.

**Sample rate:** variable from less than 20 ms between measurements to HOLD which holds display indefinitely.

**IF out:** rear panel BNC connector provides 25 MHz to 125 MHz output of down-converted microwave signal.

**Power requirements:** 100/120/220/240 V rms, +5%, –10%, 48–66 Hz; 100 VA max.

**Weight:** net 9.1 kg (20 lb.). Shipping 12.7 kg (28 lb.).

**Size:** 133 mm H x 213 W x 498 mm D (5.25" x 8.38" x 19.6").

#### Options and Accessories

**001:** High Stability Time Base

**002:** Amplitude Measurement (HP 5342A Only)

**003:** Extended Dynamic Range (HP 5342A Only)

**004:** Digital-To-Analog Converter

**005:** Frequency Extension to 24 GHz (HP 5342A Only)

**006:** Limiter Input Protection (+39 dBm)

**011:** Digital Input/Output (HP-IB) (Cable Not Incl)

**908:** Rack Mounting Adapter Kit

**HP K70-59992A:** Rack Mounting Adapter Kit With Slot for access to front connectors from rear.

**HP 10842A:** Extender Board Kit

**HP 5342A Frequency Counter**

**HP 5343A Frequency Counter**

# ELECTRONIC COUNTERS

## Microwave Source Synchronizer

Model 5344S



- Convenient CW lock
- High performance microwave counter

- Narrow band locked sweeps
- Wideband lock and roll

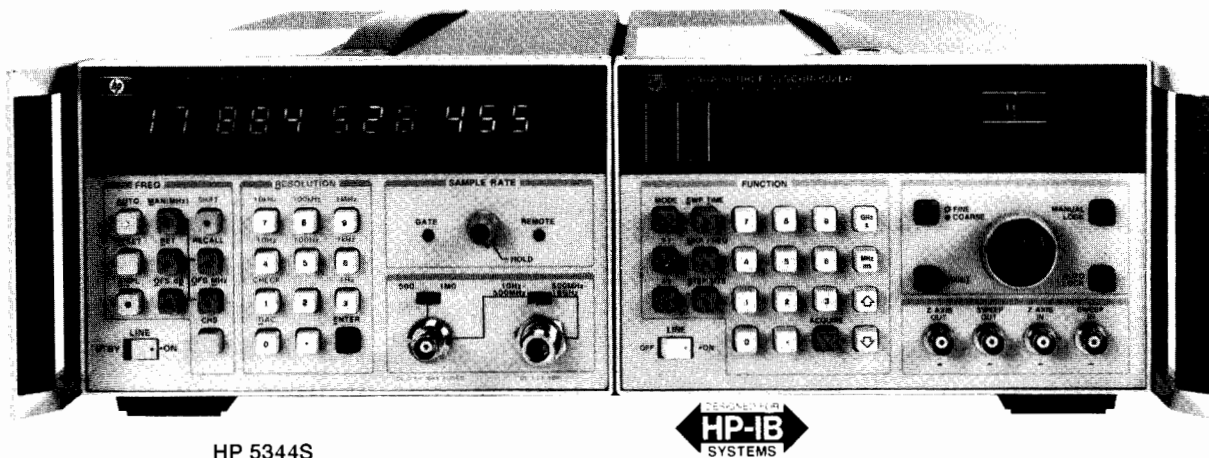

HP 5344S



### Description

The HP 5344S Microwave Source Synchronizer phase locks your microwave signal to a high stability quartz oscillator in the HP 5344S. This greatly increases the frequency accuracy and repeatability of the microwave source in CW or swept operation. The long-term frequency stability ( $5 \times 10^{-10}/\text{day}$ ) of your source now becomes comparable to that of a microwave synthesizer but at a much lower cost. The HP 5344S is a full rack system consisting of the HP 5344A Source Synchronizer and the HP 5342A 18 GHz Microwave Counter with an Option 001 High Stability Timebase and Option 011 HP-IB Interface (HP's implementation of IEEE Standard 488). These two half rack instruments are mechanically and electrically integrated at the factory.

For applications requiring direct phase locked frequencies up to 26.5 GHz, the HP 5344S Option 043 is available which replaces the HP 5342A with the HP 5343A 26.5 GHz Microwave Counter.

### HP 5344S Specifications

#### Lock Input

**Frequency coverage:** 500 MHz–18 GHz  
500 MHz–26.5 GHz (HP 5344S Option 043)

**Resolution:** 1 Hz

**Long-term stability:** equal to timebase in counter

Minimum Lock Level	Standard (HP 5342A)	Option 043 (HP 5343A)
500 MHz–12.4 GHz	–22 dBm	–30 dBm
12.4 GHz–18.0 GHz	–19 dBm	–25 dBm
18.0 GHz–26.5 GHz	—	–20 dBm

**Lock time (typical):** dependent on source. Typical times with HP 8350B/83592A source

Manual Lock: 900 ms Apply to CW or LOCK/ROLL modes.  
Auto Lock: 1.5 s For CF/ $\Delta$ F or START/STOP add 300 ms.

Option 043: all lock times reduced by 400 ms

**Accuracy (CW):** equal to counter accuracy

#### Capture Range (manual mode)

**CW or LOCK/ROLL (start frequency):**  $\pm 25$  MHz for sources with FM sensitivity greater than or equal to 5 MHz/V. Five volts  $\times$  FM sensitivity for sources less than 5 MHz/V sensitivity.

**FM output connector:** rear panel BNC female

**FM output drive:**  $\pm 10$  V in series with 250 ohms

**Polarity:** automatic selection

### Operating Modes

**CW: Manual Lock**—Source is manually tuned to within capture range of desired frequency

**Auto Lock**—Source is tuned automatically by the HP 5344S via the HP-IB to bring it into lock.

**CW/ $\Delta$ F sweep (manual lock or auto lock):** performs a phase continuous locked sweep from  $CF - \frac{1}{2}\Delta F$  to  $CF + \frac{1}{2}\Delta F$  in a sweep time defined by the user. Sweeps up to 40 MHz are available.

**START/STOP sweep (manual lock or auto lock):** performs a phase continuous locked sweep from START frequency to STOP frequency over a sweep time defined by the user. Sweeps up to 40 MHz are available.

#### Accuracy—CF/ $\Delta$ F and START/STOP modes

**Start or Stop Frequencies:** 1 kHz typical

**Linearity:**  $\pm 0.05\%$  of sweep with respect to Sweep Out voltage (typical)

**Resolution:** 1 Hz for CF/ $\Delta$ F, START, and STOP frequencies

**Sweep time:** available in CF/ $\Delta$ F and START/STOP modes. Continuously adjustable from 10 ms to 100 s.

**Marker frequencies:** available in CF/ $\Delta$ F and START/STOP modes. Up to four frequency markers are settable across the sweep band.

**LOCK/ROLL (manual lock or auto lock):** sweep is phase-locked by the HP 5344S to a precise start frequency and then control is transferred to the sweeper to complete the sweep. The source determines sweep time, marker frequencies, and stop frequency.

### General

**Microwave counter specifications:** refer to HP 5342A or 5343A data.

**Operating temperature:** 0°C to 50°C

**Power requirements:** 100/120/220/240 V rms, +5%, –10% 48–66 Hz; 125 VA max (HP 5344A) plus 100 VA max (HP 5342A)

**Size:** 133 mm H x 426 mm W x 498 mm D ( $5\frac{1}{4}$ " x  $16\frac{3}{4}$ " x  $19\frac{3}{8}$ " )

**Weight:** net, 18.7 kg (41 lb); shipping, 25.9 kg (57 lb)

**Front handles:** supplied with the instrument.

### Ordering Information

**Option 043:** 26.5 GHz operation (HP 5343A microwave counter replaces the HP 5342A in the system)

**Option 142:** Deletes HP 5342A microwave counter

**Option 908:** Rack mounting flange kit for use upon removal of supplied front handles

**Option 913:** Rack mounting flange kit for use with supplied front handles

**HP 5344S Microwave Source Synchronizer (18 GHz)**

# ELECTRONIC COUNTERS

## Automatic Microwave Counter

Model 5340A

281



- Single input 10 Hz to 18 GHz
- Automatic amplitude discrimination
- High sensitivity -35 dBm

- Optional extension to 23 GHz
- High AM and FM tolerance
- Exceptional reliability



HP 5340A



The HP 5340A Frequency Counter provides an easily used, versatile instrument for the direct measurement of frequencies from 10 Hz through 18 GHz via a single input connector. Utilizing microwave samplers incorporated in advanced phase-lock loops, this counter excels in many important specification parameters. It is therefore suited to a wide range of applications.

The exceptional sensitivity of this instrument enhances measurement in the microwave field, where signals are commonly low level and many times are connected via directional couplers or lossy devices. Wide tolerance of AM, FM, and residual noise insure accurate measurement of microwave carrier frequencies despite the presence of these deviations. Automatic amplitude discrimination allows the HP 5340A to choose the largest signal in a spectrum (250 MHz to 18 GHz) and measure only that signal's frequency, ignoring all others.

Access to the HP Interface Bus via Option 011 provides a particularly flexible system interface. The ability to program octave range via this input allows reduction of acquisition time to typically less than 40 ms. AN 181-1 describes the use of a calculator-controlled measurement system built around the HP Interface Bus for microwave component testing.

### HP 5340A Specifications

#### Signal Input

##### Input 1

**Range:** 10 Hz to 18 GHz.

**Symmetry:** sinewave or squarewave input (40% duty factor, worst case).

**Sensitivity:** -30 dBm, 10 Hz to 500 MHz; -35 dBm, 500 MHz to 10 GHz; -25 dBm, 10 to 18 GHz.

**Dynamic range:** 37 dB, 10 Hz to 500 MHz; 42 dB, 500 MHz to 10 GHz; 32 dB, 10 GHz to 18 GHz.

**Impedance:** 50  $\Omega$ .

**VSWR:** <2:1, 10 Hz-12.4 GHz; <3:1, 12.4-18 GHz.

**Connector:** precision Type N.

**Coupling:** dc to load, ac to instrument.

**Damage level:** +30 dBm.

Total power (ac + dc) not to exceed 1 watt. See Option 006 for up to +39 dBm protection.

**Acquisition time:** <150 ms mean typical.

##### Input 2

**Range:** 10 Hz-250 MHz direct count.

**Sensitivity:** 50 mV rms, 150 mV p-p pulses to 0.1% duty factor; minimum pulse width 2 ns.

**Impedance:** 1 M $\Omega$  shunted by <25 pF.

**Connector:** type BNC female.

**Coupling:** ac

**Maximum input:** 200 V rms, 10 Hz to 100 Hz; 20 V rms, 100 Hz to 100 kHz; 2 V rms, 100 kHz to 250 MHz.

**Automatic amplitude discrimination:** automatically selects the strongest of all signals present (within 250 MHz to 18 GHz phase-lock range), providing signal level is: 6 dB above any signal within 200 MHz; 10 dB above any signal within 500 MHz; 20 dB above any signal, 250 MHz-18 GHz.

**Maximum AM modulation:** any modulation index as long as the minimum voltage of the signal is not less than the sensitivity specification.

#### Time Base

**Crystal frequency:** 10 MHz.

#### Stability

**Aging rate:** <3  $\times 10^{-7}$  per month.

**Short term:** <5  $\times 10^{-10}$  rms for 1 second averaging time.

**Temperature:** < $\pm 2 \times 10^{-6}$  over the range of 0°C to 50°C.

**Line variation:** < $\pm 1 \times 10^{-7}$  for 10% line variation from nominal.

**Output frequency:** 10 MHz,  $\geq 2.4$  V square wave (TTL compatible) available from rear panel BNC.

**External time base:** requires 10 MHz approximately 1.5 V p-p sine wave or square wave into 1 k $\Omega$  via rear panel BNC. Switch selects either internal or external time base.

**Optional time base (opt 001) aging rate:** <5  $\times 10^{-10}$  per day after 24 hour warm-up for less than 24 hour off-time.

#### General

**Accuracy:**  $\pm 1$  count  $\pm$  time base error.

**Resolution:** front panel switch selects 1 MHz, 100 kHz, 10 kHz, 1 kHz, 100 Hz, 10 Hz, or 1 Hz.

**Display:** eight digit LED with positioned decimal point and appropriate measurement units of kHz, MHz, or GHz.

**Self check:** counts and displays 10 MHz for resolution chosen.

**Sample rate:** controls time between measurements. Continuously adjustable from 50 ms typical to 5 seconds. HOLD position holds display indefinitely. RESET button resets display to zero and activates a new measurement.

**Operating temperature:** 0°C to 50°C.

**Power:** 115 V or 230 V +5%, -10%, 48-66 Hz, 100 VA.

**Weight:** net, 11.3 kg (25 lb). Shipping, 14.1 kg (31 lb).

**Size:** 88.2 H x 425 W x 467 mm D (3.47" x 16.75" x 18.39").

#### Options

**001:** High Stability Time Base

**002:** Rear Panel Connectors

**005:** Frequency Extension to 23 GHz

**006:** Limiter Input Protection (+39 dBm)

**011:** Remote Programming-Digital Output (HP-IB)

**908:** Rack Flange Kit

### HP 5340A Frequency Counter

**282** **ELECTRONIC COUNTERS**  
**500 MHz Plug-In Counter**  
**Model 5345A**

- DC to 500 MHz direct counting
- 2 ns single shot T.I. resolution
- Averaging to 2 ps resolution

- 25 mV sensitivity to 500 MHz
- Plug-in measurements to 40 GHz
- Full HP-IB programming optional

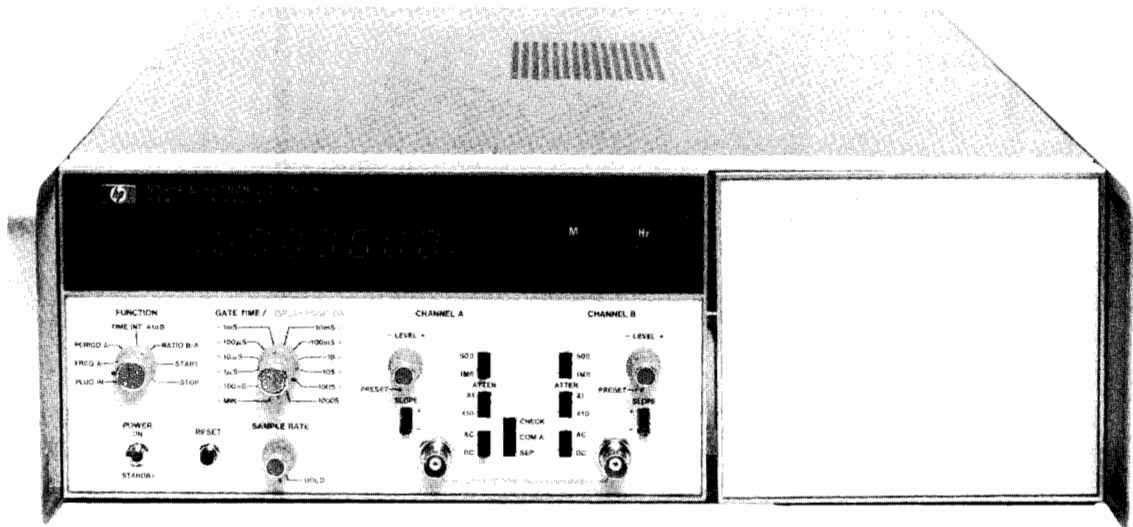

The HP 5345A Electronic Counter represents one of the most advanced general purpose instruments in the Hewlett-Packard Counter Product Line. Utilizing monolithic bipolar integrated circuit technology especially designed and manufactured at Hewlett-Packard, this instrument provides unsurpassed power, versatility and flexibility in frequency and time measurements. The HP 5355A plug-in (p. 283) extends the capability and frequency range of the HP 5345A main-frame.

**Input Signal Conditioning**

The fully optimized front end includes switchable 50 Ω/1MΩ input impedance, dc/ac coupling, and slope selection. The sensitive wide-band amplifiers assure measurements on even the lowest level sinusoidal and digital signals. Also featured is an extremely wide linear operating range of -2 to +2 Vdc.

Frequency measurements are made direct from dc to 500 MHz. Using the reciprocal technique, 9 digits of resolution occur in a one second gate time over the entire frequency range. This means a 1 MHz input can be resolved to  $2 \times 10^{-9}$  (= 0.002 Hz) in one second.

This high resolution in a short period of time can be traded for greater measurement speeds. Using a 100 μs gate with a resolution of  $2 \times 10^{-5}$  the measurement can now be made 5000 times a second. Up to 9000 readings a second can be output to the Interface Bus using the computer dump mode.

**Measurement Speed**

Mode of Operation	Readings per Second
Normal Operation (Max sample rate)	10
Externally armed	500
Externally gated	500
Computer dump	9,000

**Time Interval**

Single-shot time interval resolution is 2 ns. Time interval averaging on repetitive inputs can improve resolution to 2 ps. Due to a modulated clock technique, true averaging occurs under all conditions. Also helpful in time interval applications is knowing where triggering on the input signal occurs. This can be determined by simply measuring the dc trigger levels at rear panel BNCs.

**External Gating Capability**

Via the rear panel gate control input, the operator can determine at what point in real time and for how long the measurement is to be made. The major application is in the measurement of pulsed RF signals, using frequency averaging to improve resolution (see Figure 1).

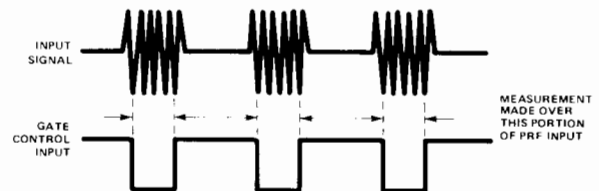

Figure 1. Frequency Averaging to Increase Resolution

External gating can also provide more versatility in time interval and totalize modes. For example, this capability allows the user to select only the desired portion of an input pulse train for a totalize measurement, as in figure 2. Time Interval measurements, such as those in figure 3, can also be made.

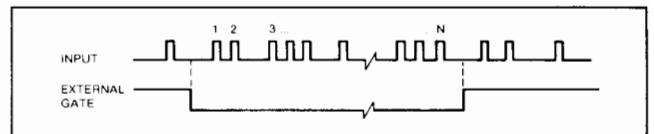

Figure 2. Selecting a Portion of a Pulse Train

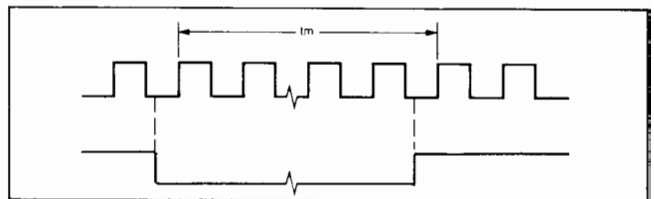

Figure 3. Using EXT GATE to Measure Tm



### Ratio/A±B Modes

Ratio and A±B functions are included, being extremely useful for comparison between reference and test signals applied to the two mainframe inputs. Typical applications include bit error rate and synthesizer testing. Allowing high speed measurements, the frequency or bit rate of either channel can vary from dc to 500 MHz.

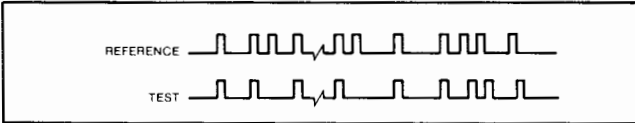

Figure 4. Comparison Measurements

In A-B mode, any difference between the total number of events accumulated in each channel is indicated by the HP 5345A display after the measurement is completed. In A+B mode, all transitions of a 1 gigabit NRZ signal can be measured by setting the "A" trigger slope to "+" and the "B" slope to "-".

### Hewlett-Packard Interface Bus

Option 011 provides HP-IB control for all measurement functions, sample rate, gating and display position commands. Adding complete systems programmability, option 012 also includes remote slope and trigger level control.

## HP 5345A Condensed Specifications

### Frequency/Period Measurements

**Range:** 0.00005 Hz to 500 MHz.

**Accuracy:**  $\pm 2 \times 10^{-9}$  gate time  $\pm$  trigger error  $\pm$  time base error.

**Gate time:** 1000 seconds to 100 nanoseconds in decade steps; < 50 ns in MIN position.

### Time Interval/Time Interval Average

**Range:** 10 ns to 20,000 s.

**Minimum dead time:** 10 ns

**Trigger pulse width:** 1 ns minimum width input at minimum voltage input.

### Accuracy

**Time interval:**  $\pm$  trigger error  $\pm$  2 ns  $\pm$  time base error.

### Time Interval Averaging

$$\frac{\text{trigger error} \pm 2 \text{ ns}}{\sqrt{\text{intervals averaged}}} \pm 0.7 \text{ ns} \pm \text{time base accuracy}$$

Not affected by harmonics of clock frequency.

### Resolution

**Time interval:** 2 ns.

### Time Interval Average

$$\pm \frac{2 \text{ ns}}{\sqrt{\text{intervals averaged}}} \pm 2 \text{ picoseconds.}$$

### Ratio B/A

**Range:** both channels accept dc to 500 MHz.

**Accuracy:**  $\pm$  LSD  $\pm$  trigger error.

### Start/Stop

**Range:** both inputs dc to 500 MHz.

**Modes:** A, A±B determined by rear panel switch.

### Scaling

**Range:** dc to 500 MHz.

**Scaling factor:** selectable by GATE TIME setting. Scaling factor equals GATE TIME setting/10<sup>-9</sup> seconds.

**Input:** input signal through channel A.

**Output:** output frequency equals input frequency divided by scaling factor.

### Input Channels A and B

**Range:** 0 to 500 MHz dc coupled 50 Ω and 1 MΩ; 4 MHz to 500 MHz ac coupled, 50 Ω; 200 Hz to 500 MHz ac coupled, 1 MΩ.

**Impedance:** selectable, 1 MΩ shunted by less than 45 pF or 50 Ω (nominal).

**Sensitivity:** X1, 25 mV rms sine wave and 75 mV peak-to-peak pulse. X10, 300 mV rms sine wave and 900 mV peak-to-peak pulse.

**Dynamic range:** 50 Ω & 1 MΩ: 25 mV to 300 mV rms sine wave (X1); 300 mV to 2.0 V rms (X10).

**Trigger level:** adjustable over  $\pm 2.0$  V dc.

**Output:** rear panel BNC connectors bring out CHAN A TRIG LEVEL and CHAN B TRIG LEVEL for convenient DVM monitoring.

### Common Input

**Range:** ac coupled 50 Ω, 4 MHz to 400 MHz; ac coupled 1 MΩ, 300 Hz to 400 MHz.

**Impedance:** 50 Ω remains 50 Ω; 1 MΩ becomes 500 kΩ shunted by < 80 pF.

**Sensitivity:** 50 Ω: 50 mV rms; 1 MΩ: No change.

**Dynamic range:** 50 Ω: 50 mV to 600 mV rms (X1); 600 mV to 4 V rms (X10); 1 MΩ: No change.

### Time Base

#### Standard High Stability Oven

**Frequency:** 10 MHz

**Aging rate:**  $< 5 \times 10^{-10}$  per day.

**Short term:**  $< 1 \times 10^{-11}$  for 1 second average.

**Temperature:**  $< 7 \times 10^{-9}$ , 0°C to 55°C.

#### Opt 001

**Frequency:** 10 MHz

**Aging rate:**  $< 3 \times 10^{-7}$  per month.

**Short term:**  $< 2 \times 10^{-9}$  rms for 1 second

**Temperature:**  $< 2 \times 10^{-6}$ , 25°C to 35°C.

$< 5 \times 10^{-6}$ , 0°C to 55°C.

**Line voltage:**  $< 1 \times 10^{-8}$ ,  $\pm 10\%$  from nominal.

**External frequency standard input:** input voltage  $> 1.0$  V rms into 1 kΩ required from source of 1, 2, 2.5, 5 or 10 MHz  $\pm 5 \times 10^{-8}$  ( $\pm 5 \times 10^{-6}$  for opt. 001).

**Frequency standard output:**  $> 1$  V rms into 50 Ω at 10.0 MHz sine wave.

### General

**Display:** 11 digit LED display and sign. Annunciator displays ksec to nsec, k to n,  $\mu$ Hz to GHz. Decimal point is positioned with DISPLAY POSITION control or positioned after the first, second or third most significant digit if DISPLAY POSITION is in AUTO. Leading zeros are suppressed.

**Overflow:** asterisk is illuminated when display is overflowed.

**Sample rate:** continuously variable from  $< 0.1$  s to  $> 5$  s with front panel control. In HOLD position the last reading is maintained until the counter is reset.

**External arm input:** counter can be armed by a  $-1.0$  V signal applied to the rear panel 50 Ω input.

**External gate input:** same conditions as for EXT ARM.

**Gate output:**  $> 1$  volt into 50 Ω.

**Operating temperature:** 0°C to 55°C.

**Power requirements:** 100/120/220/240 V rms  $\pm 5\%$   $-10\%$  48 to 66 Hz, maximum power 250 VA.

**Weight:** 17 kg (37 lb).

**Size:** 132.6 H x 425 W x 495 mmD (5.22" x 16.75" x 19.5").

### HP 10590A Plug-In Adapter

The HP 10590A allows the user to interface any of the obsolete HP 5245 series of plug-ins (except the HP 5264A) to the HP 5345A counter.

### Options and Accessories

**001:** Room Temperature Time Base

**010:** HP-IB Talk Only

**011:** HP-IB includes remote programming

**012:** HP-IB similar to OPT 011, but also includes slope and trigger level controls

**908:** Rack Flange Kit, HP 5060-8740

**HP 10595A Board Extender Kit:** For troubleshooting

**HP K13-59992A:** State machine tester to aid troubleshooting the arithmetic processor

**HP K15-59992A:** Standby power unit: Plug-in maintains oscillator operation without line voltage

### Ordering Information

**HP 10590A Plug-In Adapter**

**HP 5345A Plug-In Counter**

# ELECTRONIC COUNTERS

## Automatic Frequency Converter Plug-In for Model 5345A

### Models 5355A & 5356A/B/C

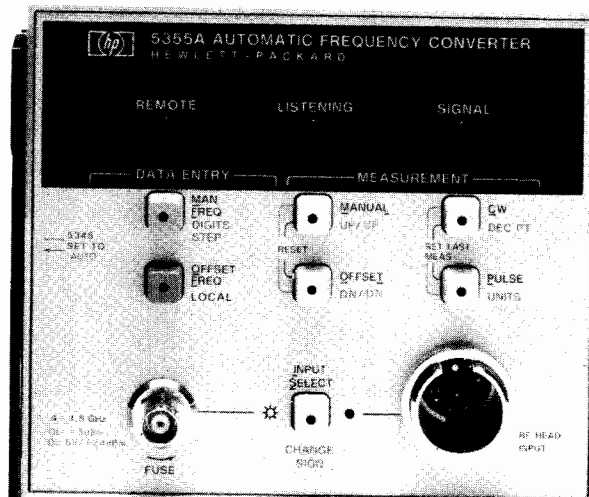

HP 5355A

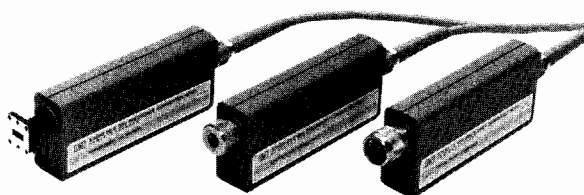

HP 5356A/B/C

The HP 5355A automatic frequency converter plug in, together with the HP 5356A, 5356B, or 5356C frequency converter head, provides pulsed and CW frequency measurement capability to 18/26.5/40 GHz for the HP 5345A counter. A 0.4–1.5 GHz preselected input offers pulsed and CW measurement for the lower microwave range even without one of the heads. The HP 5355A's internal microprocessor controls the measurement algorithm, computes the input microwave frequency, and displays it on the eleven digit HP 5345A display.

Superior pulsed RF performance is provided with selectable resolution to 100 Hz and better, with accuracy to 3 kHz. Internal pulse detection circuitry sets the counters gate for maximum resolution for any pulse width down to 75 ns. External gating allows samples as small as 20 ns for performing dynamic frequency profiling of "CHIRPS" and other FM on the RF burst. This is also an excellent CW microwave counter, providing 1 Hz resolution in 1 second. Automatic amplitude discrimination and 60 MHz FM tolerance allows this counter to correctly measure carrier frequencies in the most difficult transmitted signals.

Microprocessor control provides automatic operation and diagnostic routines for quick easy failure isolation. The front panel keyboard provides user definable offsets including an  $m \times \pm b$  offset mode for receiver testing, where the local oscillator can be measured directly then multiplied by the appropriate harmonic number. Offsetting this by the receiver's IF allows the counter to conveniently display the tuned receiver frequency.

### Ordering Information

**HP 5355A** Automatic Frequency Converter Plug-In (HP-IB Standard)

**HP 5356A** 18 GHz Frequency Converter Head

**Option 001** High Pass Filter

**Option 006** Limiter Input Protection (+39 dBm)

**HP 5356B** 26.5 GHz Frequency Converter Head

**Option 001** 18–26.5 GHz Waveguide Input

**Option 006** Limiter Input Protection (+39 dBm)

**HP 5356C** 40 GHz Frequency Converter Head

**Option 001** 26.5–40 GHz Waveguide Input

- Fully automatic to 40 GHz
- Pulsed RF or CW measurement
- 60 ns minimum pulse width
- User definable offsets from front panel

### Specifications

#### Input Specifications (pulse and CW mode)

	HP 5356A	HP 5356B	HP 5356C
<b>Frequency Range</b>	1.5–18 GHz	1.5–26.5 GHz	1.5–40 GHz
<b>Sensitivity:</b>			
1.5–12.4 GHz	-20 dBm	-20 dBm	-25 dBm
12.4–18 GHz	-15 dBm	-15 dBm	-20 dBm
18–26.5 GHz	—	-15 dBm	-20 dBm
26.5–34 GHz	—	—	-15 dBm
34–40 GHz	—	—	-10 dBm
<b>Maximum Input</b>			
1.5–12.4 GHz	+5 dBm	+5 dBm	+5 dBm
12.4–18 GHz	+5 dBm	+5 dBm	+15 dBm
18–26.5 GHz	—	+5 dBm	+15 dBm
26.5–40 GHz	—	—	+15 dBm
<b>Damage Level*</b>	+25 dBm peak	+25 dBm peak	+25 dBm peak
<b>Impedance</b>	50 $\Omega$ nominal	50 $\Omega$ nominal	50 $\Omega$ nominal
<b>SWR:</b>			
1.5–10 GHz	<2:1 typical	<2:1 typical	<2:1 typical
10–18 GHz	<3:1 typical	<3:1 typical	<3:1 typical
18–26.5 GHz	—	<3:1 typical	<3:1 typical
26.5–34 GHz	—	—	<3:1 typical
34–40 GHz	—	—	<5:1 typical
<b>Connector</b>	N Male	SMA Male	APC 3.5 Male

\* see Option 006 for higher damage protection.

#### CW Mode

	HP 5356A/B/C Auto Mode	HP 5356A/B/C Man Mode
<b>FM Tolerance</b>	15 MHz p-p (60 MHz p-p in special FM mode) rate: dc -10 MHz	80 MHz p-p rate: dc -10 MHz
<b>AM Tolerance</b>	Any modulation index provided the minimum signal level is greater than the counter sensitivity.	
<b>Multiple Signal Discrimination</b>	Automatic Amplitude Discrimination (AAD). Automatically measures largest signal provided signal is 8 dB (typical) greater than any signal within 500 MHz and 20 dB (typical) greater than any signal over the full frequency range of the head.	
<b>Acquisition Time</b>	HP 5356A/B = 400 ms; HP 5356C = 1.4 s	15 ms
<b>LSD Displayed</b>	1 Hz $\div$ HP 5345A Gate Time	
<b>Resolution</b>	$\pm 2 \times$ LSD $\pm 10^{-10}$ rms x FREQ	
<b>Accuracy</b>	$\pm 2 \times$ LSD $\pm 1 \times 10^{-10}$ rms x FREQ $\pm$ time base error x FREQ	

#### Pulse Mode

	HP 5356A/B/C Input Auto Mode	HP 5356A/B/C Input Man Mode
<b>FM Tolerance</b>	50 MHz p-p Chirp	80 MHz p-p Chirp
<b>Acquisition Time</b>	HP 5356A/B/C Input Man Mode: 0 HP 5356A/B Input Auto Mode: $100 \mu\text{s} \div (\text{EXT GATE WIDTH} \times \text{PRF}) + 650 \text{ ms}$ for EXT GATE $\leq 100 \mu\text{s}$ $(2 \div \text{PRF}) + 650 \text{ ms}$ for EXT GATE $> 100 \mu\text{s}$ HP 5356C Input Auto Mode: $(8 \div \text{PRF}) + 1.55\text{s} + 100 \mu\text{s} \div (\text{EXT GATE WIDTH} \times \text{PRF})$ for EXT GATE $\leq 100 \text{ s}$ . $(10 \div \text{PRF}) + 1.55 \text{ s}$ for EXT GATE $> 100 \mu\text{s}$ .	
<b>Pulse Width Min:</b>	100 ns	75 ns
<b>Max:</b>	20 ms	20 ms
<b>Pulse Repetition Frequency Min:</b>	50 Hz	50 Hz
<b>Max:</b>	2 MHz	2 MHz
<b>Minimum ON/OFF RATIO</b>	25 dB typical	
<b>Maximum Video Feed-Through</b>	15 mV p-p typical for rf burst rise and fall times $> 10 \text{ ns}$	
<b>Minimum EXT GATE WIDTH</b>	20 ns	
<b>LSD Displayed</b>	1 Hz $\div$ HP 5345A GATE TIME	
<b>Resolution</b>	$\pm 2 \times$ LSD $\pm$ rms jitter*	
<b>Accuracy</b>	$\pm 2 \times$ LSD $\pm$ rms jitter* $\pm \frac{.04}{\text{EXT GATE WIDTH}} \pm 3 \text{ kHz}$ $\pm$ Time base error X FREQ	

\* rms jitter =  $100 \text{ Hz rms} + 1 \div \sqrt{(\text{HP 5345A GATE TIME})(\text{EXT GATE WIDTH})}$

For EXT GATE signals generated by the HP 5355A, the EXT GATE WIDTH equals the input PULSE WIDTH minus 30 ns (typical) for the HP 5356A/B/C input and equals input PULSE width minus 65 ns (typical) for the HP 5355A 0.4–1.5 GHz input.



- Precise trigger level setting
- Wide input dynamic range



HP 5363B



### HP 5363B Time Interval Probes

#### Enhanced Counter Measurements

The HP 5363B provides the necessary input signal conditioning to allow a universal counter to make highly accurate and repeatable time interval measurements. Counters such as the HP 5345A, 5370B, 5335A, 5334A, and 5328B when teamed up with the HP 5363B can now make more accurate rise time, fall time, slew rate, propagation delay, and other complex measurements.

#### Wide Dynamic Range, Fine Trigger Level Setability

Greatly improved dynamic range allows the trigger point to be selected in 10 mV increments from -9.99 V to +9.99 V.

#### Minimized Circuit Loading

High impedance, low capacitance active probes minimize circuit loading and pulse distortion. Each probe contains two measurement channels, start and stop, so timing measurements on one waveform are possible. As example, the input/output rise (propagation delay) of a device can be measured between the probes.

#### Eliminate Systematic Timing Errors

Delays through probes, cables and inherent differential delays between a counter's input channels limit the absolute accuracy of time interval measurements.

A calibration procedure using the HP 5363B can equalize such systematic delays to set the counter to read 0.0 ns. This is possible with counters that can measure down to 0 ns like the HP 5370B, 5334A, and HP 5335A. For counters with a minimum time interval specification (HP 5345A and 5328B have 10 ns minimum capability), the HP 5363B can add a fixed offset of 10 ns to permit measurements of zero time interval.

#### Condensed Specifications

- Operating range:** ±10 V
- Minimum input voltage:** ±100 mV about trigger point
- Damage level:** ±30 V
- Voltage resolution:** 10 mV
- Impedance:** 1 M ohm shunted by <20 pF
- Effective bandwidth:** 350 MHz (1 ns rise time)
- Minimum pulse width:** 5 ns at ±100 mV about trigger point
- Output to counter:** separate start/stop outputs; -0.5 V to +0.5 V into 50 ohm, slew rate through zero volts exceeds 0.25 V/ns
- Delay compensation range:** 2 ns adjustable about 0 ns or 10 ns
- Power:** 100, 120, 220, 240 Vac (+5-10%), 48-440 Hz; 40 VA max
- Weight:** net 3.0 kg (6.5 lb). Shipping 5.5 kg (12 lb)
- Dimensions:** 88.1 H x 212 W x 295 mm D (3.5" x 8.4" x 11.6").

$$\pm 1 \text{ ns} \pm \frac{\text{START TLA} + \text{START NTE}}{\text{START slew rate}} \pm \frac{\text{STOP TLA} + \text{STOP NTE}}{\text{STOP slew rate}}$$

where TLA denotes trigger accuracy and NTE denotes noise trigger error.

**Noise trigger error:**  $\sqrt{(125 \mu\text{V})^2 + e_n^2}$  volts where 125  $\mu\text{V}$  is the typical input noise on the HP 5363B and  $e_n$  is the input signal noise for a 350 MHz bandwidth.

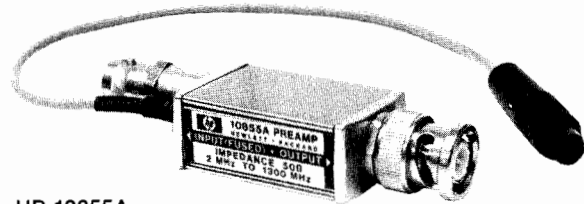

HP 10855A

### HP 10855A 2-1300 MHz Preamp

The HP 10855A Preamp provides a minimum of 22 dB gain from 2 MHz to 1300 MHz to enhance measurements of very low-level signals. The ±1.5 dB flat response reduces distortion in non-sinusoidal waveforms. The HP 10855A operates conveniently with a variety of HP measuring instruments having probe power outlets, or will work with the HP 1122A Probe Power Supply. The HP 5334A/5335A Option 030 and HP 5328B Option 031 counters all measure frequency to 1300 MHz and are compatible for use with the HP 10855A.

#### HP 10855A Specifications

- Frequency range:** 2 MHz-1300 MHz
- Gain (minimum):** 22 dB; 24 dB typical
- Gain flatness across full frequency range:** ±1.5 dB
- Noise figure:** <8.5 dB typical
- Output power for 1 dB gain compression:** 0 dBm
- Harmonic distortion:** -30 dB for -15 dBm output, typical
- Output for <-66 dB harmonic distortion:** -25 dBm, typical
- VSWR:** input and output, <2.2
- Impedance:** 50  $\Omega$  nominal
- Reverse isolation:** >45 dB
- Maximum input:** 3.5 V rms (+24 dBm), fuse protected

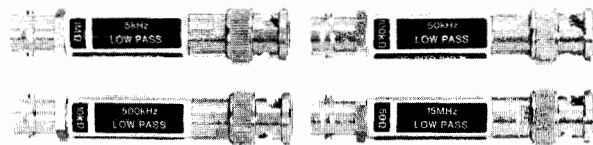

HP 10856A

### HP 10856A Low Pass Filter Kit

The four low pass filters of the HP 10856A filter kit are recommended for use with any HP frequency counter to reduce high frequency noise or unwanted signals that cause frequency or period measurement errors. Further applications for the kit include reducing noise (trace fuzz) in oscilloscope and spectrum analyzer displays.

#### HP 10856A Specifications

Cut Off Frequency (NOMINAL)	5 KHz	50 KHz	500 KHz	15 MHz
Input Impedance (NOMINAL)	1 M $\Omega$	100 k $\Omega$	10 k $\Omega$	50 $\Omega$
Signal Rejection, 100 MHz to 500 MHz	>40 dB	>40 dB	>40 dB	>20 dB

**Roll-off:** 20 dB per decade.

**Attenuation:** × 2, reduces signal voltage by a factor of 2.

**Output impedance:** for use with 1 M $\Omega$  input instruments.

#### Accessories Available

HP 10821A Probe Accessory Kit including 2 of each of the following: HP 10229A Hook Tip; HP 10218A BNC to Probe Adapter; HP 10100C 50 ohm Feedthrough termination; HP 1250-0655 BNC Tee to Probe Adapter; and HP 8710-0661 HP Probe tips (extra).

#### HP 5363B Time Interval Probes

#### HP 10855A 2-1300 MHz Preamp

#### HP 10856A Low Pass Filter Kit

# ELECTRONIC COUNTERS

## Universal Time Interval Counter

Model 5370B



- 20 ps single shot time interval counter
- Statistics
- Automatic calibration of systematic errors
- Positive or negative time intervals
- Frequency and period to 100 MHz

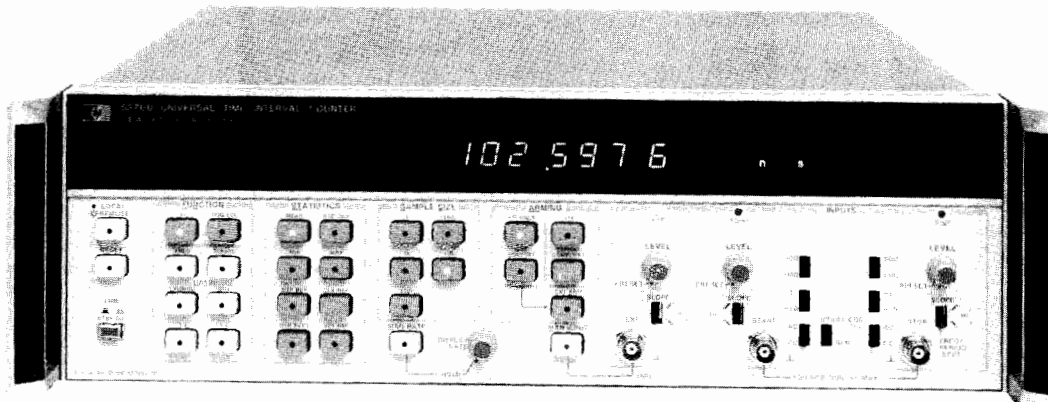

HP 5370B



The HP 5370B Universal Time Interval Counter is designed for easy, very accurate testing of components, radar and laser ranging, and nuclear systems, as well as having applications in digital communications, IC testing, and calibration. Its microprocessor-based design adds features such as statistics that let the user characterize jitter. Positive or negative time interval measurements, useful for differential measurements, and display of trigger levels are also among the features found on the HP 5370B.

In addition to having a measurement scheme which resolves single-shot time interval measurements to  $\pm 20$ ps, this counter specs a full 4V pp dynamic range with  $-2$  volts to  $+2$  volts trigger level range. Other standard features found on the instrument include automatic computation of statistical data on pulse trains and easy operation, and the instrument will also measure waveform period and frequency to 100 MHz with up to 11 digits in 1 second of measurement time.

All major front panel controls including trigger levels are programmable by means of the Hewlett-Packard Interface Bus (HP-IB), which is another standard feature of this instrument.

### Functions

**TI:** time interval function measures time difference from the START to the STOP channel. In the  $\pm$ TI mode, the counter will measure the time from the first event in either channel to the first event in the other channel. The microprocessor affixes a negative sign to the display if the stop channel event occurred first.

The negative time feature allows applications like differential phase measurement between two waveforms to be continuously monitored even though the phase changes from a positive to a negative drift. Statistical functions are available in both TI modes.

**Trig Lvl:** measures the trigger levels of START and STOP channels and displays both levels simultaneously with 10 mV resolution. Additional equipment like an oscilloscope or DVM is not required.

**Freq:** measures the frequency of the STOP channel signal by taking the reciprocal of a period average. Both timed gates and single period gates are available. In the single period mode, resolution may be improved by using a larger sample size. Statistics are available in the single period mode.

The exceptionally high resolution (11-12 digits per second) of the HP 5370B makes the instrument ideal for directly measuring the drift of oscillators and other applications requiring exceptionally high frequency resolution.

**Period:** measures the period average of STOP channel events. Statistics are available in the single period mode.

### Statistics

Statistical functions allow much more complete characterization of time intervals. In addition to the mean, both the max and min within a selected sample size are available and also the standard deviation. In many cases, these parameters are of more interest than the mean. For example, in a digital communications system, the limits of pulse jitter as described by the max and min could be of primary interest. For a normal distribution of jitter, the standard deviation gives the rms jitter directly.

**Sample size:** push-button selectable to 1,100, 1k, 10k, and 100k samples.

**Mean:** displays the mean estimate which is the average for the selected sample size.

**Std dev:** displays a standard deviation estimate for the selected sample size.

**Min:** displays the minimum time interval measured within the selected sample size.

**Max:** displays the maximum time interval measured within the selected sample size.

### Arming

Extremely flexible arming greatly extends the usefulness of the HP 5370B into new applications. "Hold-off" features allow complex pulse trains to be measured by preventing "stop channel" arming until the removal of an external "gating" signal. An example could be the measurement of time from a radar or laser send pulse to the return pulse, where depending on the range of the object, several return pulses may occur before the return pulse of interest.

Other methods of arming allow the counter to be externally gated by an input waveform which very precisely controls both measurement duration and the time position at which the measurement occurs. Applications are in the frequency profiling of VCO's, pulsed rf bursts, or sweep linearity investigations.

The following modes of arming are available:

#### +TI

Internally armed – no hold-off

Externally armed – no hold-off

Externally armed – external hold-off

#### $\pm$ TI

External arming

Internal arming



## Programming

Major controls are programmable via the HP-IB, making the HP 5370B a versatile, hi-performance unit for systems applications.

## Data Output Rate

- 1) HP-IB: 10-20 readings per second.  
Dead time between measurements within a sample is 330  $\mu$ s.
- 2) Fast Binary: >5 k readings per second.  
Dead time between measurements is 165  $\mu$ s.

## Condensed Specifications

**Sensitivity:** 100 mV p-p, 35 mV rms sine wave  $\times$  attenuator setting.

**Impedance:** selectable 1 M $\Omega$ /45 pF or 50  $\Omega$  nominal.

**Trigger level:** -2 V to +2 V, adjustable; 10 mV displayed resolution.

**Trigger slope:** independent selection of + or - slope.

**Attenuators:**  $\div 1$  and  $\div 10$  nominal.

### Dynamic Range (preset)

- 50  $\Omega$   $\div 1$ : 100 mV to 4 V p-p pulse;  $\div 10$ : 1 V to 7 V p-p pulse  
 1 M $\Omega$   $\div 1$ : 100 mV to 4 V p-p pulse;  $\div 10$ : 1 V to 10 V p-p pulse  
 Dynamic range for rms sine wave is one-third of the above values.

### Signal Operating Range

- 50  $\Omega$   $\div 1$ : -4 V to +4 V;  $\div 10$ : -7 V to 7 V  
 1 M $\Omega$   $\div 1$ : -4 V to +4 V;  $\div 10$ : -25 V to 10 V

**Coupling:** ac or dc switch selectable.

**Minimum pulse width:** 5 ns

### Maximum Input

- 50  $\Omega$   $\div 1$ :  $\pm 7$  V dc  
 7 V rms below 5 MHz  
 3.5 V rms (+24 dBm) above 5 MHz  
 $\div 10$ :  $\pm 7$  V dc, 7 V rms (+30 dBm)  
 1 M $\Omega$   $\div 1$ :  $\pm 350$  V dc  
 250 V rms to 20 kHz decreasing to 3.5 V rms  
 above 5 MHz  
 $\div 10$ :  $\pm 350$  V dc  
 250 V rms to 20 kHz decreasing to 35 V rms  
 above 5 MHz

### Common Input

All specifications are the same as for separate operation with the following differences:

**Impedance:** 1 M $\Omega$  becomes 500 k $\Omega$  shunted by <80 pF. 50  $\Omega$  same as in separate.

### Sensitivity (preset)

- 50  $\Omega$   $\div 1$ : 200 mV p-p, 70 mV rms;  $\div 10$ : 2 V p-p, 700 mV rms  
 1 M $\Omega$ : same as in separate

### Dynamic Range (preset)

- 50  $\Omega$   $\div 1$ : 200 mV to 5 V p-p pulse;  $\div 10$ : 2 V to 5 V p-p pulse  
 1 M $\Omega$ : same as in separate

### Maximum Input

- 50  $\Omega$   $\pm 5$  V dc or 5 V rms  
 1 M $\Omega$  same as in separate

**Attenuators:** becomes  $\div 2$  and  $\div 20$  for 50  $\Omega$

## Time Interval Measurements

### Time Interval Range

- $\pm$  **Mode:** -10 seconds to +10 seconds including 0 seconds  
 + **Only mode:** 10 ns to 10 seconds

**Sample size. (N):** 1, 100, 1000, 10,000, 100,000  
 1 to 16777215 via HP-IB

**Statistics:** Mean, Standard Deviation, Maximum, Minimum. Time between measurements 330  $\mu$ s; minimum rise time 1 ns

**Least significant digit displayed:** 20 ps /  $\sqrt{N}$

### Resolution

$(\pm 100 \text{ ps rms} \pm \text{Start Trigger Error} \pm \text{Stop Trigger Error}) \div \sqrt{N}$

**Accuracy:**  $\pm$  Resolution  $\pm$  Time Base Error  $\times$  Time Interval  
 $\pm$  Trigger Level Timing Error  $\pm$  1 ns Systematic

**Trigger Error =**

$$\frac{\sqrt{(150 \mu\text{V})^2 + e_n^2}}{\text{Input voltage slew rate (V/s) at trigger point}} \text{ seconds rms}$$

Input voltage slew rate (V/s) at trigger point

where 150  $\mu$ V is the typical rms input amplifier noise on the HP 5370B and  $e_n$  is the rms noise of the input signal for a 500 MHz bandwidth.

**Trigger Level Timing Error =**

$$25 \text{ mV} \div \text{input voltage slew rate (V/s) at trigger point}$$

## Frequency Measurements

**Frequency range:** 0.1 Hz to 100 MHz

### Timed Gates

**Internal gate time:** 1 period, 0.01, 0.1, 1 seconds

**Least significant digit displayed:**  $\frac{20 \text{ ps}}{\text{Gate Time}} \times \text{FREQ}$

### Resolution

$$\pm \frac{100 \text{ ps}}{\text{Gate Time}} \times \text{FREQ} \pm 1.4 \frac{\text{Trigger Error}}{\text{Gate Time}} \times \text{FREQ}$$

**Accuracy:**  $\pm$  Resolution  $\pm$  (Time Base Error)  $\times$  FREQ  
 $\pm$  (100 ps Systematic  $\div$  Gate Time)  $\times$  FREQ

**Statistics:** Mean

### Sample Mode (single period)

**Sample size:** same as Time Interval

**Least significant digit displayed:** 20 ps /  $\sqrt{N} \times \text{FREQ}$

### Resolution

$$\pm \frac{100 \text{ ps}}{\text{Gate Time}} \times \text{FREQ} \pm 1.4 \frac{\text{Trigger Error}}{\text{Period} \sqrt{N}} \times \text{FREQ}$$

**Accuracy:**  $\pm$  Resolution  $\pm$  (Time Base Error)  $\times$  FREQ  
 $\pm$  (100 ps Systematic  $\div$  Period)  $\times$  FREQ

**Statistics:** Mean, Standard Deviation, Maximum, Minimum.

### External Gate

**Gate input:** 20 ns to 10 seconds

Resolution and accuracy estimates may be made with the same specifications as Timed Gates above.

## Period Measurements

**Period range:** 10 ns to 10 seconds

### Timed Gates

**Internal gate time:** 1 period, 0.01, 0.1, 1 seconds

**Least significant digit displayed:**  $\frac{20 \text{ ps}}{\text{Gate Time}} \times \text{PERIOD}$

### Resolution

$$\pm \frac{100 \text{ ps}}{\text{Gate Time}} \times \text{PERIOD} \pm 1.4 \frac{\text{Trigger Error}}{\text{Gate Time}} \times \text{PERIOD}$$

**Accuracy:**  $\pm$  Resolution  $\pm$  Time Base Error  $\times$  PERIOD  
 $\pm$  (100 ps Systematic  $\div$  Gate Time)  $\times$  PERIOD

### Sample Mode (single period)

**Sample size (N):** same as Time Interval.

**Least significant digit displayed:** 20 ps /  $\sqrt{N}$

**Resolution:**  $\pm 100 \text{ ps} / \sqrt{N} \pm 1.4 \text{ Trigger Error} / \sqrt{N}$

**Accuracy:**  $\pm$  Resolution  $\pm$  Time Base Error  $\times$  PERIOD  
 $\pm 100 \text{ ps Systematic}$

**Statistics:** Mean, Standard Deviation, Maximum, Minimum.

### External Gate

**Gate input:** 20 ns to 10 seconds

Resolution and accuracy estimates may be made with the same specifications as timed measurements above.

## Time Base

### High Stability Oven Oscillator

**Frequency:** 10 MHz

**Aging:**  $< 5 \times 10^{-10}$  per day

**Temperature:**  $< 2.5 \times 10^{-9}$ , 0 $^\circ$  C to 50 $^\circ$  C

### General

**Display:** 16 digits, suppressed leading zeros.

**Size:** 133 H  $\times$  426 W  $\times$  521 mm D (5.25"  $\times$  16.75"  $\times$  20.5").

**Weight:** 14.55 kg (32 lbs.)

**Power requirements:** 100, 120, 220, or 240 V ac  $\pm 5\%$  -10%, 48 to 66 Hz, less than 250 VA.

**Front handles:** supplied with instrument.

## Ordering Information

**Option 908:** Rack Flange Kit for use without handles

**Option 913:** Rack Flange Kit for use with supplied front handles

**HP 10870A:** Service Kit Accessory

**HP 5370B Universal Time Interval Counter**



# ELECTRONIC COUNTERS

## 100 MHz Universal Counters

### Model 5334A

- Two matched 100 MHz channels; optional 1.3 GHz channel C
- 9 digits per second resolution over the entire frequency range in one second
- 2 ns single shot time interval resolution
- Automatic rise/fall time, pulse width and peak amplitude measurements
- Store/recall of up to 10 front panel setups
- Complete HP-IB programmability including trigger levels

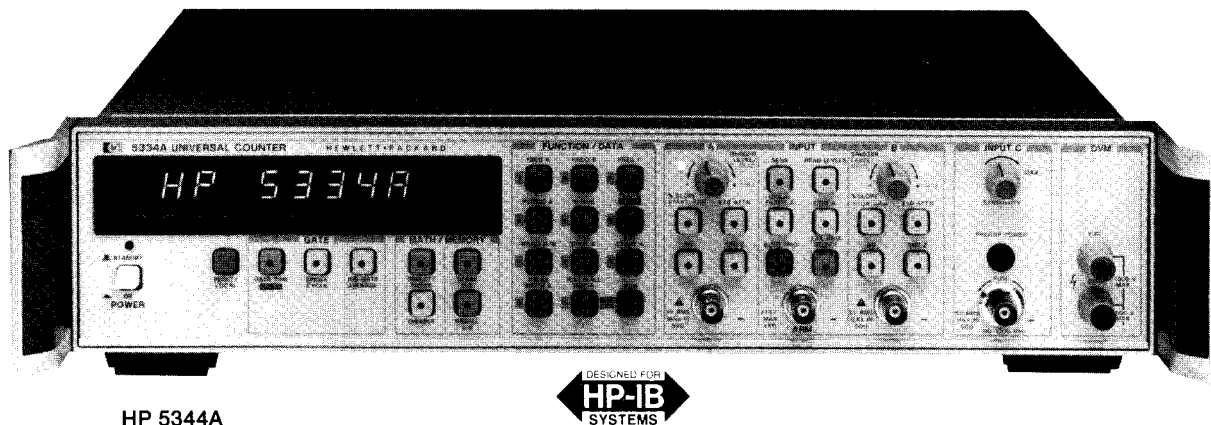

HP 5334A

The HP 5334A is a two-channel, 100 MHz Universal Counter with 9 digits in one second resolution and 2 ns single shot time interval resolution. Frequency, period, rise time, fall time, pulse width and peak amplitude may be measured automatically—all at the touch of a button. Options include a high-stability oven oscillator, a  $\pm 1000$  V DVM and a 1.3 GHz C-Channel.

#### Fully Programmable

Complete HP-IB capability standard is a first for counters in this class, opening up new possibilities for ATE applications. All front panel controls are programmable including input signal conditioning and trigger levels. Optional rear terminal inputs simplify cabling in rack-mounted systems.

#### Peak Amplitudes

The peak amplitude function adds a new dimension to universal counter applications. For any waveshape up to 20 MHz, the HP 5334A measures not only time and frequency, but also the maximum and minimum peak amplitudes of Channel A or B input signals. Often this function reduces the need for additional test equipment and gives a more complete picture of the input signal.

#### Input Signal Conditioning

In addition to automatic capability, independent selection of input signal conditioning provides flexibility for any application. Accurate triggering is ensured by selection of trigger slope, coupling, input impedance, attenuation, low pass filter, and variable sensitivity. Variable sensitivity may be used to widen the hysteresis band for measurements on noisy input signals.

#### Triggering Alternatives

The HP 5334A offers four alternatives for trigger level selection. Auto Trigger offers maximum convenience. The maximum and minimum peaks of the input signal are found automatically, and the optimum trigger point calculated. Auto Attenuator is enabled with Auto Trigger, ensuring correct counting by selecting the X10 attenuator when the input signal amplitude is greater than the input signal operating range.

The trigger levels may also be set manually over the range of  $-5.10$  V to  $+5.10$  V ( $-51.0$  V to  $+51.0$  V in X10 attenuation). Read Levels may be used to display the current trigger level control settings. -Storing trigger levels from the front panel and programming trigger levels over HP-IB complete the alternatives for reliable and accurate -triggering.

#### Store/Recall

Up to ten instrument setups including trigger levels may be stored in a nonvolatile memory and conveniently recalled. Sequencing through several complicated setups requires much less time and results in repeatable, exact measurement setups.

#### Math

Math functions let you view results in measurement units of your choice such as velocity, flow, or ppm. Normalize divides the measured value by a constant. Offset adds or subtracts the measured value by a constant.

#### External Arming

Synchronize a measurement to a real time event or events. Start arm is used alone to enable the start of a measurement, stop arm to enable the stop of a measurement. External gating is accomplished by arming both the start and stop of a measurement. This capability facilitates applications such as measuring the frequency within a pulsed RF signal and averaging for increased resolution, selecting a specific time interval within a pulse train, and selecting a portion of a pulse train to totalize.

The arm input and slope selection are conveniently located on the front panel and are programmable over HP-IB. The trigger level at which the arm signal will arm a measurement may be selected from  $-4$  V to  $+4$  V via a rear panel control.

#### Condensed Specifications

##### Input Characteristics (channels A and B)

##### Range

**DC coupled:** 0 to 100 MHz.

**AC coupled:** 1 M $\Omega$ , 30 Hz to 100 MHz. 50 $\Omega$ , 1 MHz to 100 MHz.

##### Sensitivity

15 mV rms sine wave to 20 MHz. 35 mV rms sine wave to 100 MHz.

100 mV peak-to-peak at a minimum pulse width of 5 ns.

Sensitivity can be continuously varied to 150 mV rms, (NOMINAL) using the TRIGGER LEVEL/SENS control in sensitivity mode. (Trigger levels set to 0 V NOMINAL.)

##### Dynamic Range (X1)

45 mV to 5 V peak-to-peak, to 20 MHz.

100 mV to 2.5 V peak-to-peak, to 100 MHz.

**Signal operating range, dc:**  $\pm 5$  V DC (X ATTN).

##### Trigger Level Range

**Manual (auto trigger off):** continuously adjustable over  $\pm 5.1$  V, displayed in 20 mV steps. In X10,  $\pm 51$  V displayed in 200 mV steps.

**Preset:** 0 V NOMINAL in Sensitivity Mode.

**Auto Trigger****DC coupled:** 100 Hz to 100 MHz.**AC coupled:** 1 M $\Omega$ , 100 Hz to 100 MHz, 50 $\Omega$ , 1 MHz to 100 MHz.**Coupling:** ac or dc, switch selectable.**Trigger slope:** independent selection of + or - slope.**Impedance:** 1 M $\Omega$  NOMINAL shunted by <60 pf or 50  $\Omega$  NOMINAL, switch selectable.**Attenuator****Manual:** X1 or X10 NOMINAL, switch selectable.**Auto:** attenuator automatically switched when in Auto Trigger.**Low pass filter:** 100 kHz NOMINAL, switchable in or out of Channel A.**External Arm****Minimum width:** 50 ns.**Maximum transition time:** 1  $\mu$ s.**Sensitivity:** 500 mV peak-to-peak.**Signal operating range:** -5 Vdc to +5 Vdc.**Slope:** independent selection of START and STOP ARM slopes: +, -, or OFF.**Frequency A and Frequency B****Range:** .001 Hz to 100 MHz.**LSD:** (4ns/Gate Time) X FREQ.**Resolution**

$$\pm \text{LSD} \pm \frac{(1.4 \times \text{Trigger Error} + 1 \text{ ns rms})}{\text{Gate Time}} \times \text{FREQ.}$$

**Accuracy:**  $\pm$  Resolution  $\pm$  Time Base Error  $\times$  FREQ.**Period A****Range:** 10 ns to 10<sup>3</sup> s.**LSD:** (4 ns/Gate Time)  $\times$  PER.**Resolution**

$$\pm \text{LSD} \pm \frac{(1.4 \times \text{Trigger Error} + 1 \text{ ns rms})}{\text{Gate Time}} \times \text{PER.}$$

**Accuracy:**  $\pm$  Resolution  $\pm$  Time Base Error  $\times$  PER.**Time Interval A to B****Range:** -1 ns to 10<sup>3</sup> seconds.**LSD:** 1 ns (100 ps using 100 GATE AVERAGE).**Resolution:**  $\pm$  LSD  $\pm$  Start Trigger Error  $\pm$  Stop Trigger Error  $\pm$  1 ns rms.**Accuracy:**  $\pm$  Resolution  $\pm$  (Time Base Error  $\times$  TI)  $\pm$  Trigger Level Timing Error  $\pm$  Trigger Level Setting Error  $\pm$  2 ns.**Time Interval Delay**

Used with Time Interval A to B, a selectable delay can be inserted between START (Channel A trigger) and STOP (Channel B trigger). Electrical inputs during delay are ignored. Delay Range is 1 ms to 99.999 s (1 ms steps).

**Ratio A/B****Range:** .001 Hz to 100 MHz both channels.**LSD:** 4  $\times$  RATIO/(FREQ A  $\times$  Gate Time).**Resolution and Accuracy**

$$\pm \text{LSD} \pm (\text{B Trigger Error}/\text{Gate Time}) \times \text{RATIO.}$$

**Totalize A****Range:** 0 to 10<sup>12</sup> -1.**LSD:** 1 count of input signal.**Resolution and accuracy:**  $\pm$  LSD.**Pulse Width A****Range:** 5 ns to 10 ms.**LSD:** 1 ns (100 ps using 100 GATE AVERAGE).**Resolution:**  $\pm$  LSD  $\pm$  Start Trigger Error  $\pm$  Stop Trigger Error  $\pm$  1 ns rms.**Rise/Fall Time A****Range:** 30 ns to 10 ms.**Minimum amplitude:** 500 mV peak-to-peak.**Dynamic range:** 500 mV to 40 V peak-to-peak.**LSD:** 1 ns (100 ps using 100 GATE AVERAGE).**Resolution:**  $\pm$  LSD  $\pm$  Start Trigger Error  $\pm$  Stop Trigger Error  $\pm$  1 ns rms.**Read Peak Amplitudes**

Maximum and minimum peaks of Channel A or Channel B input are displayed.

**Frequency range:** DC, 100 Hz to 20 MHz.**Dynamic range:** 0 V to 40 V peak-to-peak.**Resolution:**  $\times$ 1: 20 mV.  $\times$ 10: 200 mV.**Time Base****Standard Crystal****Frequency:** 10 MHz.**Aging rate:**  $<3 \times 10^{-7}$  per month.**Temperature:**  $<5 \times 10^{-6}$ , 0 $^\circ$  to 50 $^\circ$ C.**Line voltage:**  $<1 \times 10^{-7}$  for 10 % change.**External input:** rear panel BNC accepts 10 MHz, 500 mV to 5 V rms.**Time base output:** 10 MHz, >500 mV rms sine wave into 50 $\Omega$  via rear panel.**Gate time range:** 1 ms to 99.999 seconds in 1 ms increments.**Math****Display** = (Measurement/Normalize) + Offset.**Entry range:**  $\pm 1 \times 10^{-10}$  to  $\pm 9.9999999999 \times 10^9$ .**Single cycle:** when enabled, one measurement is taken with each push of RESET key.**100 gate average:** 100 gates accumulated and average displayed. This adds an additional digit of resolution.**Gate output:** rear panel BNC drives TTL levels into 1 k $\Omega$ .**Hewlett-Packard Interface Bus****Programmable controls:** all front panel controls and functions, except Option 030 Channel C sensitivity and power on/stby switch.**Trigger level:** set Channel A or B from -5.1 V to +5.1 V in 20 mV steps ( $\times$  ATTN).**Other:** Initialize, Transmit Error, High-Speed Output, Transmit Calibration Data, Device ID, and SRQ Mask.**Data Output****Normal operation:** format: 19 characters plus CR and LF. Rate: Ten readings/second.**High speed output mode:** format: 8 bytes of count data and Interpolator Start and Stop counts. Rate: 150 readings/second.**Options****Option 010 High Stability Time Base (Oven)****Frequency:** 10 MHz.**Aging rate:**  $<5 \times 10^{-10}$ /day after 24-hour warm up.**Short term:**  $<5 \times 10^{-10}$  rms for a 1-second average.**Temperature:**  $<7 \times 10^{-9}$ , 0 to 50 $^\circ$ C.**Line voltage:**  $<5 \times 10^{-10}$  for 10% change (2 minutes after change).**Warm up:** within  $5 \times 10^{-9}$  of final value in 20 minutes.**Option 020 DC Digital Voltmeter****Range:** 4 digits, autoranging, and autopolarity in  $\pm 10$  V,  $\pm 100$  V,  $\pm 1000$  V ranges.**Sensitivity and LSD:** 100  $\mu$ V for  $\pm 1$  V reading. 1 mV for  $\pm 10$  V reading. 10 mV for  $\pm 100$  V reading. 100 mV for  $\pm 1000$  V reading.**Input type:** floating pair.**Input resistance:** 10 M $\Omega$   $\pm 1\%$ .**Option 030 1300 MHz C Channel****Range:** 90 MHz to 1300 MHz.**Sensitivity:** 15 mV rms (-23.5 dBm) sine wave, 90 MHz to 1000 MHz. 75 mV rms (-9.5 dBm) sine wave, 1000 MHz to 1300 MHz.**Ordering Information****Option 010:** Oven Oscillator**Option 020:** DVM**Option 030:** Channel C**Option 050:** Both option 020 and 030, order instead of both options separately.**Option 060:** Rear Terminals

Channel A, B and ARM in parallel with front inputs.

Options 020 and 030 at rear panel only.

**Option 908:** Rack Mount Kit for use without front handles.**Option 913:** Rack Mount Kit for use with supplied front handles.**HP 5334A Universal Counter**



# ELECTRONIC COUNTERS

## 200 MHz Universal Counter

Model 5335A

- A high performance 200 MHz/2 ns Universal Counter
- Built-in automatic rise time, duty cycle, pulse width, slew rate and phase measurements
- Unique advanced automatic triggering capabilities
- HP-IB plus math and statistics functions standard



HP 5335A



### Remarkable Automatic Measurement Power

The HP 5335A is an advanced universal counter with automatic measurement power built in. Designed either for bench or systems applications, the counter has 16 front-panel measurement functions, plus four "phantom" functions, all automatically selected by push button or by HP-IB. These twenty functions, plus greatly expanded arming and triggering capability, make the HP 5335A a most powerful universal counter. In addition, math and statistics features, matched Channel A and B input amplifiers, and HP-IB are all included in the standard unit, making the HP 5335A easily the most advanced universal counter available at its price.

The HP 5335A has all the measurement functions normally found in a universal counter, plus it has automatic operation. Beyond these features, it possesses new measurements not previously included in this type of instrument.

### Pulse Characterization Measurements

Most HP universal counters provide you with a fairly complete measurement set. The HP 5335A possesses all these expected universal measurements, and does them better than ever before. But, beyond the expected measurement set, the HP 5335A has the ability to automatically measure waveform characteristics for various applications. Op amp characterization is one area where a number of measurements are needed to define the amplifier's performance. Using the HP 5335A and a signal source, rise and fall times, output slew rate, and propagation times can be measured with one test set-up. Also, duty cycle can be measured to see the distortion on a square wave through the amplifier due to different rising and falling slew rates. Lastly, phase measurements are also push-button selectable and automatically performed by the counter.

### Complete Triggering Capability

To get good measurement results, a counter must properly trigger on the input signal. The HP 5335A employs both manual and automatic trigger modes to quickly and easily set the right trigger points.

#### Manual Triggering

The counter has a  $\pm 5$  Vdc range to help reduce input attenuator use for most input signals, including TTL.

#### Automatic Triggering

Two auto trigger modes help you trigger automatically. Just press *auto trig* or select auto trig on the HP-IB and the counter automatically selects 10%-90% rise/fall time trigger points, 50% phase trigger points, or the preset value of your choice. Then it tracks the signal's dc offset continuously to stay on the right trigger point. Option 040 allows programmability of trigger levels via HP-IB.

### Trigger Level DVM

Built into the basic counter. Just press TRG LVL to see both input channel trigger levels displayed.

### A Full Set of Universal Measurement Functions

In addition to waveform characterization features, the HP 5335A has an extremely wide set of measurement functions covering frequency, time, events and volts. These functions let you characterize signals quicker and more thoroughly than ever before possible.

### Frequency

Frequency is the most common measurement performed by counters. The HP 5335A measures to 200 MHz in Channel A, 100 MHz in Channel B, and 1.3 GHz in its optional Channel C. Due to the counter's advanced design and reciprocal measurement technique, resolution is a constant 9 digits per second of gate time across its entire measurement range.

### Time

In a universal counter, a time interval measurement equates to a stopwatch measurement started and stopped by unique events. Precision is dependent on the counter's circuitry.

To ensure precision, the HP 5335A has matched custom input amplifiers to greatly reduce trigger errors that might be produced if the start and stop signals were amplified differently. Further, the counter employs an analog interpolation technique that turns its 10 MHz clock into the equivalent of a 1 GHz time base. The HP 5335A is thus able to resolve single shot time interval measurements to better than 2 nanoseconds (100 ps with averaging). This analog interpolation eliminates the need found in some counters for a phase-modulated (jittered) time base for time interval average measurements.

### Math and Statistics

Averaging techniques are often used to extend the resolution of a counter. For averaging, the HP 5335A provides sample sizes of  $N = 100$  or  $N = 1,000$ . Best of all, averaging can be employed for all measurements except phase. In addition to mean, and selection of sample size, the counter takes standard deviations of the current measurement for the sample size selected.

Math functions are another built-in feature that provide operator convenience. These functions let you convert the display into direct indications of parameters like flow, speed, pressure, and temperature. Additionally, the counter remembers the offset, scale, and normalize factors for each measurement function.





# ELECTRONIC COUNTERS

## 200 MHz Universal Counter

### Model 5335A (cont.)



## Condensed Specifications

### Input Characteristics (channel A and B)

#### Range

DC coupled, 0 to 100 MHz.

AC 1 M $\Omega$ , 30 Hz to 100 MHz.

AC 50  $\Omega$ , 200 kHz to 100 MHz.

NOTE: Channel A range 200 MHz when in Frequency A and Ratio modes.

#### Sensitivity (X1)

25 mV rms sinewave.

75 mV peak-to-peak pulse at minimum pulse width of 5 ns.

#### Dynamic Range (X1)

75 mV to 5 V peak-to-peak, to 100 MHz.

75 mV to 2.5 V peak-to-peak, >100 MHz.

#### Signal Operating Range (X1, DC)

-5 V dc to +5 V dc.

#### Trigger Level Range (X1)

##### Auto Trigger OFF

Preset: set to 0 V dc NOMINAL.

Adjustable: -5 V dc to +5 V dc.

##### Auto Trigger ON

Preset: set to nominal 50% point of input signal.

Adjustable: nominally between + and - peaks of input signal.

#### Auto Trigger (X1)

##### Range (50% duty cycle)

DC coupled, 30 Hz to 200 MHz.

AC 1 M $\Omega$ , 30 Hz to 200 MHz.

AC 50  $\Omega$ , 200 kHz to 200 MHz.

**Minimum signal:** 100 mV rms.

**Duty cycle range:** 10% to 90%.

**Response time:** 3 seconds, typical.

NOTE: Auto Trigger requires a repetitive signal.

Coupling: ac or dc, switchable.

**Impedance:** 1 M $\Omega$ , nominal, shunted by <35 pF or 50  $\Omega$  nominal, switchable. In COMMON A, 1 M $\Omega$  is shunted by <50 pF.

**Attenuator:** X1 or X10 nominal, switchable.

**Slope:** independent selection of + or - slope.

**Channel input:** SEPARATE or COMMON A, switchable.

#### Frequency A

**Range:** 0 to 200 MHz, prescaled by 2.

#### LSD Displayed

$\frac{1 \text{ ns}}{\text{Gate Time}} \times \text{FREQ.}$  (e.g. 9 digits in a second).

#### Resolution

$\pm (2 \times \text{LSD}) \pm 1.4 \times \frac{\text{Trigger Error}}{\text{Gate Time}} \times \text{FREQ.}$

**Accuracy:**  $\pm (\text{Resolution}) \pm (\text{Time Base Error}) \times \text{FREQ.}$

#### Period A

**Range:** 10 ns to  $10^7$  s.

#### LSD Displayed

$\frac{1 \text{ ns}}{\text{Gate Time}} \times \text{PER.}$  (e.g. 9 digits in a second).

**Period average:** user selects MEAN function, and n = 100, or n = 1,000.

#### Time Interval A $\rightarrow$ B

**Range:** 0 ns to  $10^7$  s.

**LSD displayed:** 1 ns (100 ps using MEAN).

**Resolution:**  $\pm (2 \times \text{LSD}) \pm (\text{START Trigger Error}) \pm (\text{STOP Trigger Error})$ .

**Accuracy:**  $\pm (\text{Resolution}) \pm (\text{Time Base Error}) \times \text{TI} \pm (\text{Trigger Level Error}) \pm (2 \text{ ns})$ .

**Gate mode:** MIN only.

**Time interval average:** user selects MEAN function, and n = 100, or n = 1,000.

#### Time Interval Delay (holdoff)

Front panel Gate Adjust control inserts a variable delay between START and enabling of STOP. Electrical inputs during delay are ignored. Delay ranges are same as gate time ranges (100  $\mu$ s, to 4 s NOMINAL) for gate modes of Fast, Norm, and Manual.

#### Inverse Time Interval A $\rightarrow$ B

**Range:**  $10^{-7}$  to  $10^9$  units/second

LSD Displayed, Resolution, and Accuracy are inverse of Time Interval A  $\rightarrow$  B specifications.

#### Rise and Fall Time A

**Range:** 20 ns to 10 ms transition with 50 Hz to 25 MHz repetition rates (50% duty cycle).

**Minimum pulse height:** 500 mV peak-to-peak.

**Minimum pulse width:** 20 ns.

**Duty cycle range:** 20% to 80%.

LSD Displayed and Resolution are same as Time Interval A  $\rightarrow$  B Specifications.

#### Pulse Width A

**Range:** 5 ns to  $10^7$  s.

**Trigger point range:** 40% to 60% of pulse height.

LSD Displayed and Resolution are same as Time Interval A  $\rightarrow$  B specifications.

#### Duty Cycle A

**Range:** 1% to 99%, 0 to 100 MHz.

**Trigger point range:** 40% to 60% of pulse height.

**LSD displayed:**  $\frac{1 \text{ ns}}{\text{PER}} \times 100\%$

NOTE: Constant duty cycle required during measurement.

#### Slew Rate A

**Range:** 50 V/s to  $10^8$  V/s slew rate with 50 Hz to 25 MHz repetition rates (50% duty cycle). Minimum Pulse Height, Width, and Duty Cycle Range are same as Rise and Fall Time A.

**Input mode:** automatically set to COMMON A with 10% and 90% trigger levels.

#### Ratio A/B

**Range:** Channel A, 0 to 200 MHz (prescaled by 2).  
Channel B, 0 to 100 MHz.

**LSD displayed:**  $\frac{\text{RATIO}}{\text{FREQ} \times \text{Gate Time}}$  where FREQ is higher frequency after prescaling.

#### Totalize A

**Range:** 0 to 100 MHz.

**LSD displayed:** 1 count of input

**HP-IB output:** at end of gate.

#### Manual

**Count reset:** via RESET key.

**HP-IB output:** totalize data on-the-fly sent if Cycle mode set to Single. Input frequency range in this mode is 0 to 50 Hz nominal.

#### Gated

**Count reset:** automatic after measurement.

#### Phase A Rel B

**Range:** -180 $^\circ$  to 360 $^\circ$ , Range Hold off, or 0 $^\circ$  to 360 $^\circ$ , Range Hold on, with signal repetition rates of 30 Hz to 1 MHz.

**Minimum signal:** 100 mV rms.

**LSD displayed:** 0.1 $^\circ$ .

#### Gate Time

**Range:** 100 ns to  $10^7$  s.

**LSD displayed:** up to three digits with Ext. Arm Enable OFF, 100 ns when ON. MIN Gate Mode display zero.



# ELECTRONIC COUNTERS

## 200 MHz Universal Counter

### Model 5335A (cont.)

#### Trigger Level

**Range:** X1, +5 to -5 volts; X10, +50 to -50 volts.

**Resolution:** X1, 10 mV; X10, 100 mV.

**Accuracy (X1):**  $\pm 20$  mV,  $\pm 0.5\%$  of reading.

#### Time Base

##### Standard Crystal

**Frequency:** 10 MHz.

**Aging rate:**  $< 3 \times 10^{-7}$ /month.

**Temperature:**  $< 4 \times 10^{-6}$ , 0 to 50°C.

**Line voltage:**  $< 1 \times 10^{-7}$  for 10% change.

**High stability crystal:** see Option 010.

**External time base input:** rear panel BNC accepts 5 or 10 MHz, 200 mV rms into 1 k $\Omega$ ; 5 V rms maximum.

**Time base out:** 10 MHz,  $> 1$  V p-p into 50  $\Omega$  via rear panel.

#### Statistics

**Sample size:** selectable between either  $n = 100$  or  $n = 1,000$  samples.

**Std. dev.:** displays a standard deviation of selected sample size.

**Mean:** displays mean estimate of selected sample size.

**Smooth:** performs a weighted running average and truncates unstable least significant digits from display.

#### Math

All measurement functions, with exception of GATE TIME and TRIG LVL, may be operated upon by Math functions. Offset, Normalize, and Scale may be used independently or together as follows:

$$\text{Display} = \frac{\text{Measurement} + \text{Offset}}{\text{Normalize}} \times \text{Scale}.$$

**Number value range:**  $\pm 1 \times 10^{-9}$  to  $\pm 9 \times 10^9$ .

**Last display:** causes value of previous display to Offset (negative value), Normalize, or Scale all subsequent measurements.

**Measurement t-1:** causes each new measurement to be Offset (negative value), Normalized, or Scaled by each immediately preceding measurement.

#### Hewlett-Packard Interface Bus

**Programmable controls:** all measurement functions, Math, Statistics, Reset, Range Hold, Ext. Arm Enable/Slope, Check, Gate Adj. (1 ms to 1 s), Gate Open/Close (gate times to 00), Gate Mode, Cycle, Preset, Slope, Common A, Auto Trigger.

**Special functions:** FREQ B, PULSE B, TIME B  $\rightarrow$  A, TOT A-B, LEARN, MIN, MAX, all internal diagnostic routines.

**HP-IB commands:** Trigger, Clear, Remote, Local, Local Lockout, Require Service.

**Data output:** fixed output format consisting of 19 characters plus CR and LF output is typically 8 ms.

**Option 040:** adds complete systems programmability; see column at right.

#### General

**Gate:** minimum, manual, or continuously variable (NORM/FAST) via Gate Adj. control.

**NORM:** 20 ms to 4 s NOMINAL.

**FAST:** 100  $\mu$ s to 20 ms NOMINAL.

**MIN:** minimum gate time. Actual time depends on function.

**MANUAL:** each press opens or closes gate.

**Cycle:** determines delay between measurements.

**NORM:** no more than 4 readings per second, nominal.

**MIN:** updates display as rapidly as possible (15 readings per second, depending on function).

**SINGLE:** one measurement taken with each press of button.

**Arming:** Ext. Arm Enable key allows rear panel input to determine Start and/or Stop point of a measurement. External gate defined by both Start and Stop armed. All measurements are armed except Manual Totalize, Phase, and Trigger Level.

**Start arm:** + or - slope of arm input signal starts measurement.

**Stop arm:** + or - slope of arm input signal stops measurement. When used, Start Arm must occur before Stop Arm.

**Ext. arm input:** rear panel BNC accepts TTL into 20 k $\Omega$ . Minimum Start To Stop Time: 200 ns.

**Trigger level out:** dc output into 1 M $\Omega$  via rear panel BNCs for Channel A and B; not adjusted for attenuators.

**Accuracy at dc (X1):**  $\pm 15$  mV  $\pm 0.5\%$  of TRIG LVL reading.

**Gate out:** TTL level into 50  $\Omega$ ; goes low when gate open; rear panel BNC.

**Range hold:** freezes decimal point and exponent of display.

**Reset:** starts a new measurement cycle when pressed.

**Check:** performs internal self test and lamp test.

**Display:** 12-digit LED display in engineering format; exponent range of +18 to -18.

**Operating temperature:** 0 to 50°C.

**Power requirements:** 100, 120, 220, 240 VAC (+5%, -10%), 48-66 Hz; 130 VA max.

**Weight:** net, 8.8 kg (19 lb. 8 oz.). Shipping, 13.6 kg (30 lb.)

**Dimensions:** 425.5 mm W x 132.6 mm H x 345.4 mm D (16 $\frac{3}{4}$ " x 5 $\frac{1}{4}$ " x 13 $\frac{1}{2}$ "), not including removable handles.

#### Options

##### Option 010: High Stability Time Base (oven)

**Frequency:** 10 MHz.

**Aging rate:**  $< 5 \times 10^{-10}$ /day after 24 hour warm up.

**Short term:**  $< 1 \times 10^{-10}$  rms for 1s average.

**Temperature:**  $< 7 \times 10^{-9}$ , 0 to 50°C.

**Line voltage:**  $< 1 \times 10^{-10}$  for 10% change.

**Warm-up:** within  $5 \times 10^{-9}$  of final value in 20 minutes.

##### Option 020: DC Digital Voltmeter

**Range:** 4 digits, autoranging, autopolarity, in  $\pm 10$ ,  $\pm 100$ ,  $\pm 1000$  V ranges.

**Sensitivity:** 100  $\mu$ V, 1 mV, 10 mV, 100 mV for  $\pm 1$  V,  $\pm 10$  V,  $\pm 100$  V,  $\pm 1000$  V readings.

**LSD displayed:** same as sensitivity.

**Input type:** floating pair.

**Input impedance:** 10 M $\Omega$   $\pm 1\%$ .

##### Option 030: 1.3 GHz C Channel

###### Input Characteristics

**Range:** 150 MHz to 1.3 GHz.

**Sensitivity:** 10 mV rms sinewave (-27 dBm) to 1 GHz. 100 mV rms sinewave (-7 dBm) to 1.3 GHz.

###### Frequency C

**Range:** 150 MHz to 1.3 GHz, prescaled by 20. LSD Displayed, Resolution, and Accuracy are same as Frequency A.

###### Ratio C/A

**Range:** channel A, 0 to 200 MHz.  
channel C, 150 to 1300 MHz.

##### Option 040: Complete Systems Programmability

Adds remote selection of low pass filter, ac/dc coupling, X1-X10 attenuation, dc trigger level and input impedance for both Channel A and B.

#### Definitions

**Duty cycle:** percentage of time a signal is high or low, depending on Slope A setting. Trigger point is high/low dividing point.

$$\text{DUTY CY} = \frac{\text{PULSE}}{\text{PER}} \times 100\%.$$

**Slew rate:** effective slope between 10% and 90% points of rising or falling signal depending on Slope A setting.

$$\text{SLEW} = \frac{V_B - V_A}{T_I}$$

**Phase:** angle, with respect to B signal, between 50% points of channel A and B signals, trigger slopes selected by Channel A and B slope switches.

$$\text{PHASE} = (T_{I1} + T_{I2}) \div \frac{2}{\text{PER}} \times 360^\circ$$

$T_{I1}$  is time between 50% points of A then B signals using slopes defined during Phase measurement.

$T_{I2}$  is time between 50% points of A then B signals using complement slopes to  $T_{I1}$ .

**Front handles:** supplied with instrument.

#### Ordering information

**Option 010:** Oven Oscillator

**Option 020:** DVM

**Option 030:** C Channel

**Option 040:** Expanded HP-IB Control

**Option 908:** Rack Flange Kit for use without handles

**Option 913:** Rack Flange Kit for use with supplied front handles

**5335A Universal Counter**

# ELECTRONIC COUNTERS

## 100 MHz Universal Counters

### Model 5328B

293



- 100 MHz and 1300 MHz
- 10 ns Time Interval
- T.I. Averaging to 10ps Resolution

- "Armed" Measurements
- DVM Option
- HP-IB Interface Standard

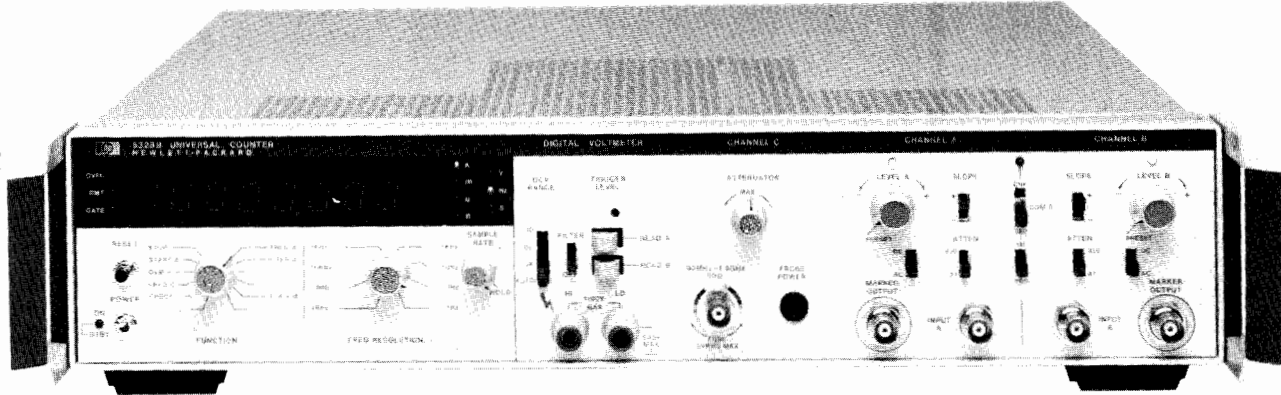

### Condensed Specifications

#### Input Characteristics

**Sensitivity:** 25 mV rms, to 40 MHz; 50 mV rms, 40 MHz-100 MHz.

**Attenuators (nominal):** X1, X10 switch selectable

#### Frequency A

**Range:** 0 to 100 MHz

#### Period A

**Range:** 100 ns to 10<sup>7</sup>s with resolution to 100 ns

#### Period Average A

**Range:** 100 ns to 10<sup>7</sup>s with resolution to 100 ps

#### Time Interval A → B

**Range:** 10 ns to 10<sup>7</sup>s with resolution to 10 ns

#### Time Interval Average A → B

**Range:** 0.1 ns to 1 s with resolution to 10 ps

**Minimum Dead Time:** 40 ns

#### Ratio B/A

**Range:** Channel A, 0 to 10 MHz; Channel B, 0 to 100 MHz

#### General

**Display:** 9 digit LED display, ninth digit used only with Channel C functions (FREQ. C, Ratio C/A, Events C, A → B).

**Blanking:** Suppresses display of unwanted zeros to left of most significant digit.

**Storage:** Holds reading between samples; can be overridden by rear panel switch.

**Sample Rate:** Variable from less than 2 ms between measurements to HOLD which holds display indefinitely.

**Gate output:** rear panel output

**Time base output:** Rear panel output: TTL levels.

**Check signal:** Place function switch in FREQ A and universal module in CHECK (CHK). Counter should display 100 MHz ± 1 count.

**Operating temperature:** 0° to 50°C.

**Power requirements:** 100/120/220/240V rms, +5%, -10% (switch selectable), 48-66 Hz; 150 VA max.

#### Time Base Oscillators

##### Standard Crystal Oscillator

**Frequency:** 10 MHz

**Aging rate:** < 3 x 10<sup>-7</sup>/month

**Temperature:** < 2.5 x 10<sup>-6</sup>, 0° to 50°C

**Line voltage:** < 1 x 10<sup>-7</sup> for 10% change

##### Option 010: Oven Oscillator

**Frequency:** 10 MHz

**Aging rate:** < 5 x 10<sup>-10</sup>/day after 24-hour warm-up

**Short term:** < 1 x 10<sup>-10</sup> rms/s

**Temperature:** < 7 x 10<sup>-9</sup>, 0° to 50°C

**Line voltage:** < 5 x 10<sup>-9</sup> for 10% variation

**Warm-Up:** Within 5 x 10<sup>-9</sup> of final value in 20 minutes

**Ext. freq. std. input:** 30 kHz to 10 MHz signal of amplitude > 1.0V rms into 1 kΩ. Maximum input: 5V p-p. The external frequency

standard must be 10 MHz for Period Avg., T.I. Avg., Period (N=1), and T.I. (N=1).

**Programmable functions:** Functions, resolution, sample rate (maximum or manual control), arming, display modes, measurement modes, output mode, and reset commands. Trigger level, trigger slope, input impedance, coupling, separate/common/check, invert A and B, Trigger level is programmable in 10 mV steps in x1; 100 mV in x 10. Trigger level accuracy under remote control in x1: ± 35 mV.

**HP-IB commands:** responds to the following bus commands (see HP-IB Users Guides for definitions) - Unlisten, Untalk, Local Lock-out, Selected Device Clear, and Group Execute Trigger.

**Service request (SRQ):** if enabled, indicates end of measurement

**Maximum data output rate:** 500 readings/s

#### Option 021: High Performance Digital Voltmeter

**Range:** ± 10, ± 100, ± 1000 Vdc and Autorange

**Sensitivity:** 10 μV, 100 μV, 1 mV, 10 mV, 100 mV for measurement times of 10 s, 1 s 0.1 s, 10 ms, 1 ms respectively

**Input type:** floating pair

**Impedance:** 10 MΩ nominal

**Maximum input:** hi to low: ± 1100 V all ranges; LO to chassis ground: ± 500 V

**Trigger level measurements:** 1 mV display resolution

#### Option 031: 1300 MHz C-Channel

##### Input Characteristics

**Sensitivity:** 20 mV rms sine wave (- 21 dBm)

**Input protection:** fused input

**Maximum input:** 5 Vrms, ± 5 Vdc

##### Frequency C

**Range:** 90 MHz to 1300 MHz, prescaled by 4 with resolution to 0.1 Hz.

##### Ratio C/A

**Range:** channel A, 0 to 10 MHz; channel C, 90 to 1300 MHz

**Attenuation:** continuously variable for optimum noise suppression

#### Options and Accessories

**010:** High Stability Time Base

**021:** High Performance DVM

**031:** 1300 MHz Channel C

**050:** DVM and Channel C

**908:** Rack Flange Kit for use without front handles

**913:** Rack Flange Kit for use with supplied front handles

**HP 10855A** Preamp

**HP 10856A** Filter Kit

**HP 5363B** Time Interval Probes

**HP 5328B** Universal Counter

**Front handles:** supplied with instrument



# ELECTRONIC COUNTERS

## Universal Counters

Models 5315A/B, 5316A

- Frequency, period, ratio, and totalize to 100 MHz
- Three versions: portable, rackable, or HP-IB
- 1 GHz capability available
- Uses reciprocal technique for full low-frequency resolution
- 100 ns time interval, 10 ps T.I. averaging
- Oven option for increased accuracy

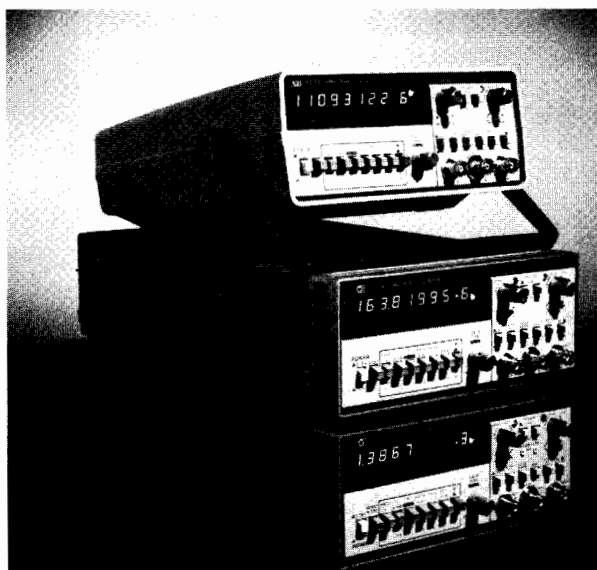

HP 5316A



### A Quiet Revolution in Capability . . .

HP's economical HP 5315A/B, and HP 5316A counters provide all the universal counter capability you've come to expect at much higher prices. That's because they use a unique custom circuit called the MRC (Multiple Register Counter) which packs counting and computing power into this popular counter series. To a user, the differences in operation from conventional direct models can be listed quickly: low frequency resolution is an outstanding 7 digits per second of gate time and reliability is extremely good due to the counter's low chip count. Also, the continuously adjustable gate time allows automatic selection of sample size for easy trade-offs between measurement time and resolution.

Much of the counter's performance is based on reciprocal counting techniques first pioneered in HP's high-performance HP 5360A computing counter, and the current HP 5345A Universal Counter. The use of these techniques coupled with HP's MRC and a microprocessor provides a quiet but powerful revolution in counter performance within the HP 5315A/B and HP 5316A. For example, this counter gives you its full 7-digits/second resolution over the range from 1 Hz to 100 MHz. This, simply stated, shows the power of the MRC and reciprocal counting.

### High Performance, Low Price

In addition to its economy, the MRC counter offers a full set of universal counter measurements, and there are very few limitations to this capability. Increased accuracy in low-cost portable and system counters is also available with the oven oscillator option through improved temperature stability and lower aging rates.

### Frequency to 100 MHz, C-Channel to 1.0 GHz

The MRC counter measures frequency to 100 MHz. Additionally the optional C-Channel measures to 1.0 GHz for both CW and pulsed RF signals as narrow as 60 ms. The C-Channel option is particularly useful in navigation and communications equipment testing due to this pulsed RF measurement feature.

### Time Interval to 100 ns, T.I. Averaging to 10 ps

The MRC counter provides three time measurement modes. Single-shot time interval allows measurements over a range of 100 ns to 100,000 seconds. This capability can be used to measure pulse width. Time interval averaging provides greater resolution for repetitive events. Finally, time interval delay avoids measurement of spurious signals by holding off the counter's trigger point by a precise, operator-selectable amount of time.

### A Full Set of Measurements

Besides the frequency and time functions mentioned above, the MRC counter has other measurement functions that make it a truly impressive value:

- Period A**—allows single period measurements via Channel A.
- Ratio A/B**—allows frequencies to 100 MHz into both Channel A and B
- A By B**—totalizes the A input between 2 events on B channel
- Totalize**—a manually gated totalize mode of operation

### Input Signal Conditioning Versatility

A full complement of input signal conditioning controls are provided for both channels. These include  $\pm$  slope,  $\pm 2.5$  Vdc trigger level, and ac/dc coupling. Other controls are a Separate/Common switch, and a 100 kHz low-pass filter for Channel A.

### A Choice of Three Models

The MRC counter is available in three different versions: **HP 5315A**: a portable, light-weight unit best suited for field applications. This unit has a convenient carrying handle and optional battery power is available for up to 4 hours continuous operation. Despite its high impact plastic case, the HP 5315A possesses low RFI/EMC characteristics, making it equally suitable for bench use.



**HP 5315B:** a rackable, stackable counter that is designed to meet the most demanding RFI/EMC specs, the HP 5315B is intended primarily for rack mount use.

**HP 5316A:** this model possesses all the characteristics of both the HP 5315A and HP 5315B, and it has HP-1B capability built-in as standard equipment. It has low RFI, it is rackable, and it is functionally identical to the HP 5315A/B. In addition to programmable measurement functions, the user can also select dc trigger level and  $\pm$  slope under HP-1B control. Channel A and B trigger levels are brought out to the front panel on this unit for easy measurement with a DVM.

## HP 5315A/B 5316A Condensed Specifications

### Input Characteristics (channel A and channel B)

**Range:** dc coupled 0 to 100 MHz.

ac coupled 30 Hz to 100 MHz.

**Sensitivity:** 10 mV rms sine wave to 10 MHz.

25 mV rms sine wave to 100 MHz.

75 mV peak-to-peak pulse at minimum pulse width of 5 ns.

Sensitivity can be varied continuously up to 500 mV rms *NOMINAL* by adjusting sensitivity control. In sensitivity mode, trigger level is automatically set to 0 V *NOMINAL*.

### Dynamic Range

30 mV to 5 V peak-to-peak, 0 to 10 MHz.

75 mV to 5 V peak-to-peak, 10 to 100 MHz.

**Coupling:** ac or dc, switchable.

**Filter:** low pass, switchable in or out of Channel A. 3 dB point of 100 kHz *NOMINAL*.

**Impedance:** 1 M $\Omega$  *NOMINAL* shunted by less than 40 pF.

**Signal operating range:** +2.5 Vdc to -2.5 Vdc.

**Attenuator:** X1 or X20 *NOMINAL*.

**Trigger level:** variable between +2.5 Vdc and -2.5 Vdc.

**Slope:** independent selection of + or - slope.

**Common input:** all specifications are the same for Common A except the following:

**Sensitivity:** 10 mV rms sine wave to 10 MHz; 25 mV rms sine wave to 50 MHz; 50 mV rms to 100 MHz; 150 mV peak-to-peak at a minimum pulse width of 5 ns.

**Dynamic range:** 30 mV to 5 V peak-to-peak to 10 MHz; 75 mV to 5 V peak-to-peak, 10-50 MHz; 150 mV to 5V peak-to-peak, 50-100 MHz.

**Impedance:** 500 k $\Omega$  *NOMINAL* shunted by less than 70 pF.

### Damage Level

ac & dc  $\times$  1:

dc to 2.4 kHz	250 V (dc + ac rms)
2.4 kHz to 100 kHz	$6 \times 10^5$ V rms Hz/FREQ
> 100 kHz	6 V rms

ac & dc  $\times$  20:

dc to 28 kHz	500 V (dc + ac peak)
28 kHz to 100 kHz	$1 \times 10^7$ V rms Hz/FREQ
> 100 kHz	100 V rms

### Frequency (channel A)

**Range:** .1 Hz to 100 MHz.

**LSD displayed:** 10 Hz to 1 n Hz depending upon gate time and input signal. At least 7 digits displayed per second of gate time.

### Period

**Range:** 10 ns to  $10^5$  s.

**LSD displayed:** 100 ns to 1 fs depending upon gate time and input signal. At least 7 digits displayed per second of gate time.

### Time Interval

**Range:** 100 ns to  $10^5$  s.

**LSD displayed:** 100 ns.

### Time Interval Average

**Range:** 0 ns to  $10^5$  s.

**LSD displayed:** 100 ns to 10 ps depending upon gate time and input signal.

**Number of intervals averaged (N):**  $N = \text{Gate Time} \times \text{FREQ.}$

**Minimum dead time (stop to start):** 200 ns.

### Time Interval Delay (holdoff)

Front panel gate time knob inserts a variable delay of *NOMINALLY* 500  $\mu$ s to 30 ms between START (Channel A) and enabling of STOP (Channel B). Electrical inputs during delay time are ignored. Delay time may be digitally measured by simultaneously pressing T.I. Averaging, T.I. Delay and blue key.

### Ratio

**Range:** 0.1 Hz to 100 MHz, both channels

**LSD:**  $\frac{2.5 \times \text{Period A}}{\text{Gate Time}} \times \text{Ratio.}$  (rounded to nearest decade)

### Totalize

#### Manual

Range: 0 to 100 MHz.

#### A gated by B

Totalizes input A between two events of B. Instrument must be reset to make new measurement. Gate opens on A slope, closes on B slope. Range: 0 to 100 MHz.

### General

#### Standard Time Base

**Frequency:** 10 MHz

**Aging rate:**  $< 3 \times 10^{-7}$ /mo.

**Temperature:**  $\pm 5 \times 10^{-6}$ , 0 $^\circ$  to 50 $^\circ$ C

**Line voltage:**  $< 1 \times 10^{-7}$  for a  $\pm 10\%$  variation.

**Check:** counts internal 10 MHz reference frequency over gate time range *NOMINALLY* 500  $\mu$ s to 30 ms.

**Error light:** LED warning light activated if logic error is found during instrument turn-on self-check.

**Display:** 8 digit LED display, with engineering units annunciator.

**Overflow:** only frequency and totalize measurements will overflow. In case of overflow, eight least significant digits will be displayed and front panel overflow LED will be actuated.

All other measurements which would theoretically cause a display of more than 8 digits will result in the display of the 8 most significant digits.

**Gate time:** continuously variable, *NOMINALLY* from 60 ms to 10 s or 1 period of the input, whichever is longer.

**Sample rate:** up to 7 readings per second *NOMINAL* except in time interval mode, where it is continuously variable *NOMINALLY* from 250 ms to 10 s via Gate Time Control.

**Operating temperature:** 0 $^\circ$  to 50 $^\circ$ C.

**Power requirements:** 100, 120, 220, 240 V (+5%, -10%) 48-66 Hz; 15 VA maximum or 30 VA maximum (HP 5316A).

**Weight:** net, 2.2 kg (4 lbs. 12 oz.). Shipping, 4.1 kg (9 lbs.).

**Dimensions:** 238 mm W x 98 mm H x 276 mm D (9 $\frac{3}{8}$ " x 3 $\frac{3}{8}$ " x 10 $\frac{7}{8}$ ").

### Additional HP 5315B Specifications

Rack and stack metal case with rear panel, switchable AC power line module. Specifications same as HP 5315A except as follows:

**Rack mount:** HP 5061-0072 recommended.

**Oscillator output:** 10 MHz, 50 mV pk-pk into 50  $\Omega$  load, on rear panel.

**External frequency standard input:** 10 MHz, 1 V RMS into 500  $\Omega$ , on rear panel.

**Dimensions:** 212 mm W x 88 mm H x 345 mm D (8 $\frac{3}{8}$ " x 3 $\frac{1}{2}$ " x 13 $\frac{3}{4}$ ").

**Weight:** net, 3.2 kg (7 lbs. 2 oz.). Shipping, 4.5 kg (10 lbs.).



# ELECTRONIC COUNTERS

## Universal Counters

Models 5315A/B, 5316A (cont.)

### Additional HP 5316A Specifications

Rack and stack metal case with rear panel, switchable ac power line module, Specifications same as HP 5315A except as follows:

**Rack mount kit:** HP 5061-0072 recommended.

**Oscillator output:** 10 MHz, 50 mV p-p into 50  $\Omega$  load on rear panel.

**External frequency standard input:** 1, 5, 10 MHz, 500 mV rms into 500  $\Omega$ , or rear panel.

**Trigger level output:**  $\pm 5\%$ ,  $\pm 15$  mV, over  $\pm 2.0$  VDC range at front panel connectors.

**Dimensions:** 212 mm W x 88 mm H x 415 mm D (8 3/8 x 3 1/2 x 1 1/2")

**Weight:** net, 3.9kg (8 lbs. 10 oz.). Shipping, 6.3kg (14 lbs.)

### Hewlett-Packard Interface Bus

**Programmable functions:** Frequency A, Frequency A Armed by B, Totalize, A Gated by B, Ratio A/B, Time Interval Average A $\rightarrow$ B, Time Int. Delay, Read Gate Time, Display Test, 10 MHz Check, Interface Test, Initialize, Reset, Wait State ON/OFF.

**Programmable controls:** Gate Time Command which sets long (60 ms to 10 s) or short (500  $\mu$ s to 30 ms) range; Trigger Level Commands which set Channel A and/or B slope ( $\pm$ ) and Channel A and/or B trigger from  $-2.50$  Vdc to  $+2.50$  Vdc in steps of .01V.

**Interface functions:** Group Execute Trigger, Device Clear, Selected Device Clear, Interface Clear, Local, Remote, Local Lockout, Read Status (serial poll enable), Request Service.

### Options

**Opt. 001:** High Stability Time Base (TCXO)

**Frequency:** 10 MHz.

**Aging rate:**  $< 1 \times 10^{-7}$ /mo.

**Temperature:**  $\pm 1 \times 10^{-6}$ ,  $0^\circ$  to  $40^\circ$ C.

**Line voltage:**  $< 1 \times 10^{-8}$  for  $\pm 10\%$  variation.

**Opt. 002:** battery (HP 5315A only)

**Type:** rechargeable lead-acid (sealed).

**Capacity:** TYPICALLY 4 hours of continuous operation at  $25^\circ$ C.

**Recharging time:** TYPICALLY 16 hours to 98% of full charge, instrument non-operating. Charging circuitry included with Option. Batteries not charged during instrument operation.

**Low voltage indicator:** instrument turns itself off automatically when low battery condition exists. *Discharge* LED flashes slowly when this happens. *Discharge* LED is on whenever battery is supplying power to instrument.

*Charge* LED indicates state of charge of battery during charging only and is on whenever battery is charged to 95% *NOMINAL* of capacity. *Charge* LED flashes when 90% *NOMINAL* of charge taken out is replaced. *Charge* LED is off if charge is less than 70% *NOMINAL* of capacity.

**Line failure protection:** instrument automatically switches to battery in case of line failure.

**Weight:** Opt. 002 adds 1.4 Kg (3 lbs.) to weight of instrument.

**Option 003:** C Channel

#### Input Characteristics

**Range:** 50 to 1000 MHz, prescaled by 10.

**Sensitivity:** 15 mV rms sinewave ( $-23.5$  dBm) to 650 MHz. 75 mV rms sinewave ( $-9.5$  dBm) to 1000 MHz.

Sensitivity can be decreased continuously by up to 20 dB *NOMINAL*, 50 to 500 MHz and 10 dB *NOMINAL*, 500 to 1000 MHz by adjusting sensitivity control. Trigger level is fixed at 0 V *NOMINAL*.

**Dynamic range:** 15 mV to 1 V rms (36 dB), 50 to 650 MHz. 75 mV to 1 V rms (20 dB), 650 to 1000 MHz.

**Signal operating range:**  $+5$  V dc to  $-5$  V dc.

**Coupling:** ac

**Impedance:** 50  $\Omega$  *NOMINAL* (VSWR,  $< 2.5$ :1 TYPICAL).

**Damage level:**  $\pm 8$  V (dc + ac peak), fuse protected. Fuse located in BNC connector.

**Frequency (channel C) Range:** 50 to 1000 MHz.

**LSD displayed:** 100 Hz to 1 Hz depending upon gate time. At least 7 digits per second of gate time.

**Option 004:** High Stability OVEN Time Base (HP 5315A only)

**Frequency:** 10 MHz

**Aging rate:**  $< 3 \times 10^{-8}$ /mo\*

**Temperature:**  $\pm 1 \times 10^{-7}$ ,  $0^\circ$  to  $50^\circ$ C.

**Line voltage:**  $< 1 \times 10^{-8}$ , for a 10% variation.

Oven will operate continuously off of a fully charged battery for  $> 24$  hours, typically, when in standby mode (no power applied, instrument OFF, and Freq. A button depressed).

(HP 5315B and HP 5316A)

**Frequency:** 10 MHz

**Aging rate:**  $< 3 \times 10^{-8}$ /mo.\*\*

**Temperature:**  $\pm 2 \times 10^{-8}$ ,  $0^\circ$  to  $50^\circ$ C

**Line voltage:**  $< 1 \times 10^{-9}$ , for a 10% variation.

### Ordering Information

		HP 5315A	HP 5315B	HP 5316A	Price
Option 001	TCXO Time Base	X	X	X	
Option 002	Battery Pack	X			
Option 003	C-Channel (1.0 GHz)	X	X	X	
Option 004	High Stability OVEN	X			
	Time Base		X	X	

All HP 5315A orders must include one (1) of these line power options:

**Option 100:** 90-105 VAC

**Option 120:** 108-126 VAC

**Option 220:** 198-231 VAC

**Option 240:** 216-252 VAC

**HP 5315A Universal Counter**

**HP 5315B Universal Counter**

**HP 5316A Universal Counter**

\* After 30 days continuous operation (ac power applied, in OFF or ON position).

\*\* After 30 days continuous operation.

$< 5 \times 10^{-9}$ /mo., after 7 days continuous operation.



# ELECTRONIC COUNTERS

Low Cost Universal

Model 5314A

297



- 100 MHz
- 100 ns time interval
- Portable

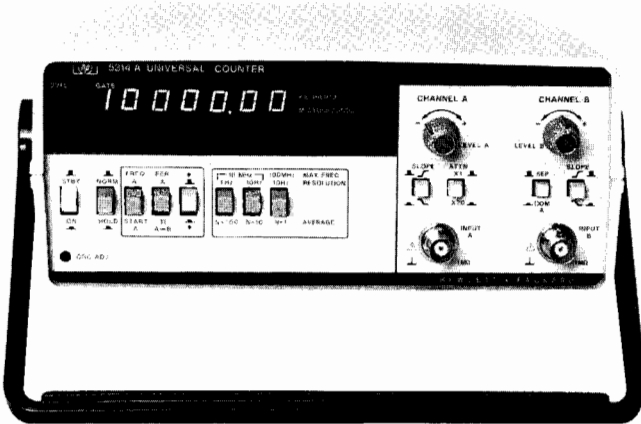

HP 5314A

The HP 5314A Universal Counter is the newest result of HP's continuing low cost counter product development effort. It combines excellent performance and traditional HP quality at a very attractive price. This counter is designed to deliver reliable, high quality operation in such areas as: Production Test, Frequency Monitoring, Education, Training, Service and Calibration. Additionally, the optional battery (option 002) makes the HP 5314A especially attractive for field and portable applications.

## Input Characteristics (channels A and B)

**Range:** CHANNEL A: 10 Hz to 10 MHz Direct.  
1 MHz to 100 MHz Prescaled.

CHANNEL B: 10 Hz to 2.5 MHz.

**Sensitivity:** CHANNEL A: 25 mV rms to 100 MHz.  
75 mV peak-to-peak at minimum pulse width of 5 ns (100 MHz range).

CHANNEL B: 25 mV rms to 2.5 MHz.  
75 mV peak-to-peak at minimum pulse width of 200 ns.

**Coupling:** ac

**Impedance:** 1 M $\Omega$  NOMINAL shunted by less than 30 pF.

**Attenuator:** X1 or X20 NOMINAL (A channel only).

**Trigger level:** continuously variable  $\pm$  350 mV times attenuator setting around average value of signal.

**Slope:** independent selection of + or - slope.

**Channel input:** selectable SEPARATE OR COMMON A.

**Dynamic range:** 75 mV p-p to 4 V p-p.

## Frequency

**Range:** 10 Hz to 10 MHz direct count.

10 Hz to 100 MHz prescaled by 10.

**Least significant digit (LSD) displayed:** direct count 0.1 Hz, 1 Hz, 10 Hz switch selectable. Prescaled 10 Hz, 100 Hz, 1 kHz switch selectable.

**Resolution:**  $\pm$  LSD.

**Accuracy:**  $\pm$  LSD  $\pm$  (time base error) x Freq.

## Period

**Range:** 10 Hz to 2.5 MHz.

**LSD displayed:**  $\frac{100 \text{ ns}}{N}$  for N=1 to 1000 in decade steps of N.

**Resolution:**  $\pm$  LSD  $\pm \frac{(1.4 \times \text{TRIGGER ERROR})}{N}$

**Accuracy:**  $\pm$  LSD  $\pm \frac{(1.4 \times \text{TRIGGER ERROR})}{N}$

$\pm$  (time base error) x Per.

## Time Interval

**Range:** 250 ns to 1 s.

**LSD displayed:** 100 ns.

**Resolution:**  $\pm$  LSD  $\pm$  START trigger error  $\pm$  STOP trigger error.

**Accuracy:**  $\pm$  LSD  $\pm$  START trigger error

$\pm$  STOP trigger error  $\pm$  (time base error) x TI.

External arming required for START/STOP channels.

## Ratio

**Range:** 10 Hz to 10 MHz CHANNEL A.

10 Hz to 2.5 MHz CHANNEL B.

**LSD displayed:** 1/N in decade steps of N for N = 1 to 1000.

**Resolution:**  $\pm$  LSD  $\pm$  (B trigger error x Frequency A)/N.

**Accuracy:**  $\pm$  LSD  $\pm$  (B trigger error x Frequency A)/N.

## Totalize

**Range:** 10 Hz to 10 MHz.

**Resolution:**  $\pm$  1 count of input.

Totalize controlled by front panel switch.

## General

**Check:** counts internal 10 MHz oscillator.

**Display:** 7 digit amber LED display with gate and overflow indication.

**Max sample rate:** 5 readings per second.

**Operating temperature:** 0 $^{\circ}$  to 50 $^{\circ}$ C.

**Power requirement:** 115, +10%, -25%; 230 V, +9%, -17%; 48-66 Hz; 10 VA max.

**Weight:** 2.0 kg (4.4 lb.).

**Dimension:** 238 mm W x 98 mm H x 276 mm D (9 $\frac{3}{8}$ " x 3 $\frac{7}{8}$ " x 10 $\frac{7}{8}$ ").

## Time Base

**Frequency:** 10 MHz.

**Aging rate:** < 3 parts in 10 $^7$  per month.

**Temperature:** <  $\pm$  10 parts in 10 $^6$ , 0 to 50 $^{\circ}$ C.

**Line voltage:** <  $\pm$  1 part in 10 $^7$  for  $\pm$  10% variation.

## Options

### Option 001 TCXO

**Frequency:** 10 MHz.

**Aging rate:** < 1 part in 10 $^7$  per month.

**Temperature:** <  $\pm$  1 part in 10 $^6$ , 0 to 40 $^{\circ}$ C.

**Line voltage:** <  $\pm$  1 part in 10 $^8$  for  $\pm$  10% variation.

### Option 002 Battery

**Type:** rechargeable lead-acid (sealed).

**Capacity:** typically 8 hours of continuous operation at 25 $^{\circ}$ C.

**Recharging time:** typically 16 hours to 98% of full charge, instrument non-operating. Charging circuitry included with option. Batteries not charged during instrument operation.

**Battery voltage sensor:** automatically shuts instrument off when low battery condition exists.

**Line failure protection:** instrument automatically switches to batteries in case of line failure.

**Weight:** option 002 adds typically 1.5 kg (3.3 lb.) to weight of instrument.

## Definitions

**Resolution:** smallest discernible change of measurement result due to a minimum change in the input.

**Accuracy:** deviation from the actual value as fixed by universally accepted standards of frequency and time.

**Trigger error:**

$$\frac{\sqrt{(80 \mu\text{V})^2 + e_n^2}}{\text{input slew rate at trigger point } (\mu\text{V/s})} \quad (\text{rms})$$

Where  $e_n$  is the RMS noise of the input for a 100 MHz bandwidth in CHANNEL A and 10 MHz bandwidth in CHANNEL B.

## Options

**001** High Stability Time Base

**002** Battery

All orders must include one (1) of these line power options:

**115:** 86-127 V

**230:** 190-250 V

**HP 5314A 100 MHz/100 ns Universal Counter**



# ELECTRONIC COUNTERS

## Low Cost Counters For Frequency Measurements

Models 5384A, 5385A

- Rackable
- Stackable
- Portable

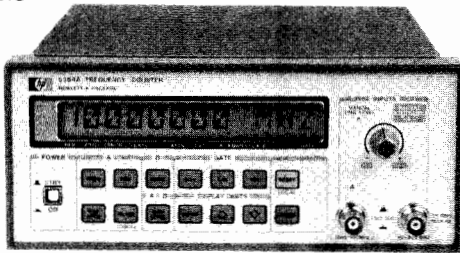

HP 5384A

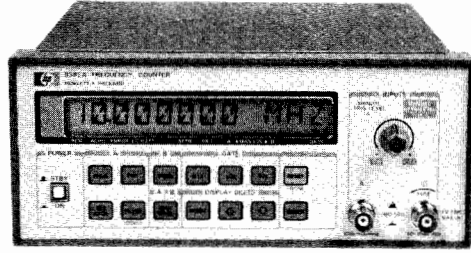

HP 5385A

### Description

The HP 5384A and HP 5385A are HP's lowest priced system counters. They provide outstanding measurement performance for bench, field, and system applications. The combination of wide frequency range, high resolution, high sensitivity, and HP-IB or HP-IL compatibility, puts the HP 5384A and HP 5385A in a class with instruments costing much more. The added feature of remote display extends the usefulness of these counters beyond that of simply making and displaying frequency measurements. User friendly messages, prompts, and measurement units can now be displayed.

### Condensed Specifications

**Input channel A (HP 5384A/85A):** 1M ohm // 25pF

**Range:** 10 Hz to 100 MHz

**Sensitivity:** 15 mVrms sine wave 50 Hz to 100 MHz  
25 mVrms sine wave 10 Hz to 50 Hz  
45 mV pk-pk 5ns minimum pulse width

**Dynamic range:** 45 mV to 4 V pk-pk  $\times$  attenuator setting

**Attenuator:** X1 or X20 nominal above 50 Hz input

**Low pass filter:** 100 kHz nominal 3 dB point

**Manual trigger level:** variable, -0.1 V to +0.1 V  $\times$  attenuator

**Damage level X1:** 10-200 Hz 350 V (DC + AC peak)  
0.2-420 kHz 170 V (DC + AC peak)  
0.42-10 MHz (5  $\times$  10<sup>7</sup> Vrms Hz)/FREQ  
> 10 MHz 5 Vrms

**X20:** < 1 MHz, Same as X1; > 1 MHz, 50 Vrms

**Input channel B (HP 5384A):** 50 ohm

**Range:** 50 to 225 MHz

**Sensitivity:** 10 mVrms 50 to 200 MHz; 15 mVrms 200 to 225 MHz

**Dynamic range:** 10 mV to 1 Vrms

**Manual attenuator:** variable, X1 to X5 (0 to 14dB) nominal

**Damage level:** 350 V dc + 5 Vrms ac

**Input channel B (HP 5385A):** 50 ohm, fused

**Range:** 90 to 1000 MHz

**Sensitivity:** 10 mVrms (-27 dBm) 100-1000 MHz  
15mVrms (-33dbm) 90-100 Mhz

**Dynamic range:** 10 mV to 7 Vrms (-27 to +30 dBm)

**Manual attenuator:** variable, X1 to X18 (0 to 25 db) nominal

**Damage level:** ac > 1 MHz +30 dBm (7 Vrms)  
ac < 1 MHz 2 Vrms, DC  $\pm$  5 V

### Frequency A and B

**Range channel A:** 10 Hz-100 MHz

**Range channel B:** (HP 5384A) 50 MHz-225 MHz,  
(HP 5385A) 90-1.0 GHz

**LSD displayed:** 10 Hz to 1 nHz

### Period A

**Range:** 10 ns to 0.1 s

**LSD displayed:** .001 fs to 10 ns

### Timebase: 10 MHz

#### Standard HP 5384A

**Aging rate:** < 3  $\times$  10<sup>-7</sup>/mo.

**Temperature:** < 5  $\times$  10<sup>-6</sup>, 0° to 50° C, ref. 25° C

**Line voltage:** < 1  $\times$  10<sup>-7</sup> for  $\pm$  10% variation.

#### TCXO (HP 5385A), Option 001 (HP 5384A)

**Aging rate:** < 1  $\times$  10<sup>-7</sup>/mo.

**Temperature:** < 2  $\times$  10<sup>-6</sup>, 0° to 40° C, ref. 25° C

**Line voltage:** < 5  $\times$  10<sup>-8</sup> for  $\pm$  10% variation.

### I/O Interface

#### HP-IB Standard, HP-IL Option 003

**Programmable functions:** Frequency A, Frequency B, Period A  
**Programmable controls:** ATTN A, FILTER A, MAN LEVEL A/B, Gate Time

**Display:** Normal, Increment, Decrement, Remote, Local

**Data output:** output will be maximum resolution/gate time

**Format:** 17 characters plus CR and LF

**Rate:** 4 readings/s maximum at 0.1 s gate

#### Oven Timebase (Option 004)

**Aging Rate:** < 3  $\times$  10<sup>-8</sup>/mo. after 30 days continuous operation.

**Temperature:** < 1  $\times$  10<sup>-7</sup>, 0° to 50° C, ref. 25° C.

**Line voltage:** < 2 $\times$ 10<sup>-8</sup> for  $\pm$  10% variation.

**Battery operation:** the instrument operates for 3 hours (typ.) with option 004. In STBY, the oven will operate continuously for 24 hours (typ.).

#### Battery Pack (Option 005)

**Battery type:** sealed lead-acid

**Capacity:** 4 hours(typ.) at 25° C without option 004.

**Recharge time:** 16 hours (typ.) in the standby mode.

**Battery low annunciator:** enabled 20 minutes prior to instrument shutdown nominally.

**Battery save switch (rear panel):** prevents discharge of internal battery by the oven timebase, option 004, during instrument standby (STBY).

**Line failure protection:** instrument automatically switches to battery in case of line failure.

**Weight:** option 005 adds 1.4 kg (3 lbs) to instrument weight.

### General

**Check:** 10 MHz self-test

**Gate times:** 0.1, 1, or 10 seconds (nominal).

**Display:** 12-digit alphanumeric liquid crystal.

**Display digits (variable):** frequency 3 to 11; period 3 to 8.

**Timebase output:** 10 MHz, 25 mV pk-pk (nom.) into 50 ohms.

**External timebase input:** 10 MHz, 0.5 Vrms into 500 ohms.

**Operating temperature:** 0° to 50° C

### Power Requirements

**AC:** selectable, 18 VA max. 115 V  $\pm$  10%, -25%

230 V  $\pm$  10%, -15% 48-66 Hz

115 V  $\pm$  10%, 380-420 Hz

**DC:** 9-15 V dc 1.0 A maximum

**Weight:** net, 2.2 kg. (4.8 lb). Shipping, 4.1 kg. (9 lb)

**Dimensions:** 238mm W x 98mm H x 276mm D (9 $\frac{3}{8}$  x 3 $\frac{7}{8}$  x 13 $\frac{1}{8}$  in.)

### Options and Accessories

**001** High Stability TCXO (HP 5384A)\*

**003** HP-IL I/O\*\*

**004** High Stability Ovenized Timebase

**005** Battery Pack

**910** Additional Operating/Service Manual

**HP-IL** Cable 1/2 Metre HP 82167A

**HP 5061-1171** Side Handle Kit

**HP 5060-0173** Rack Mount Kit (single)

**HP 5060-0174** Rack Mount Kit (dual)

**HP 34110A** Vinyl Carrying/Operating Case

\*TCXO timebase is standard with HP 5385A

\*\*Option 003 deletes the HP-IB I/O interface.

**HP 5384A Frequency Counter 225 MHz**

**HP 5385A Frequency Counter 1.0 GHz**

# ELECTRONIC COUNTERS

## Low Cost Counters for Frequency Measurements

Models 5381A, 5382A & 5383A

299

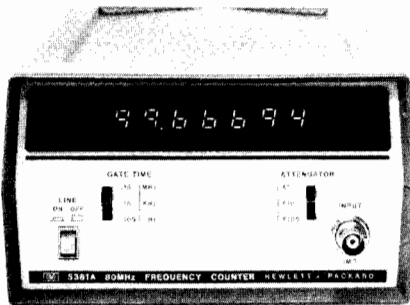

HP 5381A

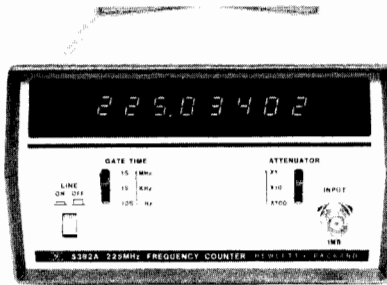

HP 5382A

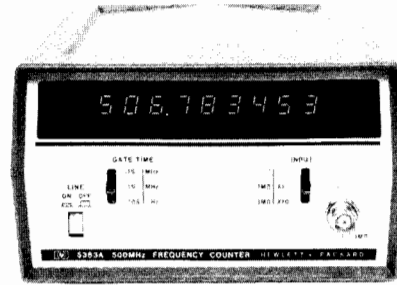

HP 5383A

## Description

### General

The HP 5381A, 5382A and 5383A are a logical result of HP's long-standing leadership in frequency counter development. Leadership in quality, technology and efficient production procedures allows HP to offer a superb price/performance combination in these three precision instruments. These counters are designed to deliver reliable, high quality operation in such diverse areas as: production line testing, service and calibration (two-way radio and test equipment), frequency monitoring, education and training.

### Resolution

The HP 5381A, 5382A and 5383A employ the direct counting technique and, with 7, 8 and 9 digits respectively, offer resolution of 10 Hz in 0.1 s., 1 Hz in 1 s and 0.1 Hz in 10 seconds.

## Condensed Specifications

### HP 5381A

**Frequency range:** 10 Hz to 80 MHz.

**Sensitivity:** 25 mV rms—30 Hz to 20 MHz.  
50 mV rms—10 Hz to 80 MHz.

**Input impedance:** 1 M $\Omega$ , <50 pF.

**Input attenuation:** X1, X10, X100.

**Accuracy:**  $\pm 1$  count  $\pm$ time base error.

**Resolution:** direct count; 1 Hz in 1 second.

**Gate times:** 0.1 second, 1 second, 10 seconds.

**Display:** 7 LED digits.

**Rear panel input:** sensitivity: TTL levels or 2.5 V rms.

**Ratio:** Rear Panel Input, 10 kHz to 2 MHz.

**External frequency standard:** Rear Panel Input, 1 MHz.

#### Time Base

**Frequency:** 1 MHz.

**Aging:** <0.3 ppm/month.

**Temperature:**  $\pm 10$  ppm  $0^{\circ}\text{C}$  to  $40^{\circ}\text{C}$ .

**Line voltage:**  $\pm 1$  ppm for 10% line change.

### HP 5382A

**Frequency range:** 10 Hz to 225 MHz.

**Sensitivity:** 25 mV rms—30 Hz to 10 MHz.  
50 mV rms—10 Hz to 225 MHz.

**Input impedance:** 1 M $\Omega$ , <40 pF.

**Input attenuation:** X1, X10, X100.

**Accuracy:**  $\pm 1$  count  $\pm$ time base error.

**Resolution:** direct count; 1 Hz in 1 second.

**Gate time:** 0.1 second, 1 second, 10 seconds.

**Display:** 8 LED digits, nonsignificant zero blanking.

**Rear panel input:** sensitivity: 250 mV rms.

**Ratio:** Rear Panel Input, 100 kHz to 10 MHz.

**External frequency standard:** Rear Panel Input, 10 MHz.

#### Time Base

**Frequency:** 10 MHz.

**Aging:** <0.3 ppm/month.

**Temperature:**  $\pm 2.5$  ppm  $0^{\circ}\text{C}$  to  $40^{\circ}\text{C}$ .

**Line voltage:**  $\pm 0.5$  ppm for 10% line change.

### HP 5383A

**Frequency range:** 10 Hz to 520 MHz.

#### Sensitivity:

**1 M $\Omega$ :** 25 mV rms—20 Hz to 10 MHz.

50 mV rms—10 Hz to 50 MHz.

**50  $\Omega$ :** 25 mV rms—20 Hz to 520 MHz.

**Input impedance:** selectable: 1 M $\Omega$ , <40 pF or 50  $\Omega$ .

**Input attenuation:** 1 M $\Omega$   $\times$  1,  $\times$  10; 50  $\Omega$   $\times$  1—fuse protected.

**Accuracy:**  $\pm 1$  count  $\pm$ time base error.

**Resolution:** direct count; 1 Hz in 1 second.

**Gate time:** 0.1 second, 1 second, 10 seconds.

**Display:** 9 LED digits, nonsignificant zero blanking.

**Display test:** RESET function (activated with GATE TIME switch) illuminates all segments of all digits.

**Rear panel input:** sensitivity: 250 mV rms.

**Ratio:** Rear Panel Input, 100 kHz to 10 MHz.

**External frequency standard:** Rear Panel Input, 10 MHz.

#### Time Base Output

**Frequency:** 10 MHz.

**Voltage:** 200 mV p-p into 50  $\Omega$  load.

**Control:** active with Rear Panel Internal/External switch in internal position.

#### Time Base

**Frequency:** 10 MHz.

**Aging:** <0.3 ppm/month.

**Temperature:**  $\pm 2.5$  ppm  $0^{\circ}\text{C}$  to  $40^{\circ}\text{C}$ .

**Line voltage:**  $\pm 0.5$  ppm for  $\pm 10\%$  line change.

### TCXO Option

**Opt 001:** (available for all models) Temperature Compensated Crystal Oscillator time base

**Frequency:** 10 MHz.

**Aging:** <0.1 ppm/month.

**Temperature:** <1 ppm  $0^{\circ}\text{C}$  to  $40^{\circ}\text{C}$ .

**Line voltage:**  $\pm 0.1$  ppm for  $\pm 10\%$  line change.

**Note:** time base output available for both HP 5382A and HP 5383A with Option 001.

### HP 5380 Family General Data

**Overflow:** LED lamp indicator when most significant digit overflows.

**Reset:** manual selection of reset occurs when GATE TIME switch is between three normal positions.

**Package:** rugged, high strength metal case.

**Operating temperature:**  $0^{\circ}\text{C}$  to  $40^{\circ}\text{C}$ .

**Power requirements:** 100, 120, 220, 240, V rms (+5%, -10%) 48-440 Hz; 30 VA maximum.

**Weight:** net, 2.2 kg (4 $\frac{1}{4}$  lb). Shipping, 2.8 kg (6 lb).

**Dimensions:** 98 H x 160 W x 248 mm D (3.5" x 6.25" x 9.75").

### Ordering Information

HP 5381A Frequency Counter

HP 5382A Frequency Counter

HP 5383A Frequency Counter

Opt 001: TCXO (all models)



# FREQUENCY & TIME STANDARDS

## General Information

Hewlett-Packard offers frequency standards and clocks which provide accurate frequency, time interval and timekeeping capabilities. Further, Hewlett-Packard standards provide means for comparing these quantities against national standards such as the National Bureau of Standards (NBS) and the U.S. Naval Observatory. Units of frequency or time cannot be kept in a vault for ready reference. They must be generated for each use, hence be regularly compared against recognized primary standards.

Frequency standards and clock systems manufactured by Hewlett-Packard are used for control and calibration at observatories, national centers for measurement standards, physical research laboratories, missile and satellite tracking stations, communication systems, radio navigation systems, manufacturing plants and radio monitoring and transmitting stations.

### Types of Frequency Standards

At the present time, three types of frequency standards are in common use. These are:

1. The cesium atomic beam controlled oscillator.
2. The rubidium gas cell controlled oscillator, and
3. The quartz crystal oscillator.

Hewlett-Packard manufactures all three types of frequency standards. Of these three standards, the first is a primary frequency standard and the last two are secondary frequency standards. The distinction between a primary standard and a secondary standard is that the primary standard does not require any other reference for calibration; whereas the secondary standard requires calibrations both during manufacturing and at intervals during use depending on the accuracy desired.

### Cesium Beam Frequency Standard

Cesium beam standards are in use wherever the goal is a very high accuracy primary frequency standard. In fact, the NBS frequency standard itself is of the cesium beam type. The cesium beam standard is an atomic resonance device which provides access to one of nature's invariant frequencies in accord with the principles of quantum mechanics. The cesium standard is a true primary standard and requires no other reference for calibration.

### Rubidium Frequency Standard

Rubidium frequency standards feature a high order of both short-term and long-term frequency stability. These are both important in certain fields such as deep-space communications, satellite ranging, and doppler radar.

Rubidium standards are similar to cesium beam standards in that an atomic resonant element prevents drift of a quartz oscillator through a frequency lock-loop. Yet the rubidium gas cell is dependent upon gas mixture and gas pressure in the cell. It must be calibrated and then it is subject to a small degree of drift. The drift is typically 100 times less than the best quartz crystal standard.

TABLE 1 Comparison of Frequency Standards

Standard	Principal construction feature	Principal advantage
Cesium Atomic Beam Resonator Controlled Oscillator.	Beam of free cesium atoms, spatially state selected, is subjected to a microwave signal at resonance frequency.	High intrinsic reproducibility and long-term stability. Designated as primary standard for definition of time interval.
Rubidium Gas Cell Resonator Controlled Oscillator.	Gas buffered resonance cell with optically pumped state selection.	Compact and light weight. High degree of short-term stability.
Quartz Crystal Oscillator.	Piezoelectrically active quartz crystal with electronic stabilization.	Very compact, light and rugged. Inexpensive.

### Quartz Crystal Oscillators

Quartz oscillators are used in virtually every frequency control application including atomic standards. The excellent short-term stability and spectral purity of the quartz oscillators used in Hewlett-Packard atomic standards contribute to the high quality of the output signal of these standards. For less demanding applications where some long-term drift can be tolerated, quartz oscillators are used as independent frequency sources.

### Frequency Standards and Clocks

Frequency standards and clocks have no fundamental differences—they are based upon dual aspects of the same phenomenon. Time and frequency are intangible quantities which can be measured only with respect to some physical quantity. The basic unit of time, the second, is defined as the duration of 9,192,631,770 periods of transition within the cesium atom. Conversely an unknown frequency is determined by counting the number of cycles over the period of a second. The Master Clock at the U.S. Naval Observatory, one of the world's most accurate clocks, is made of an ensemble of more than a dozen Hewlett-Packard cesium beam frequency standards. The USNO directly controls the distribution of precise time and time interval (frequency) from Naval radio stations, Loran-C (operated by U.S. Coast Guard), Omega and Satellite Navigation Systems. Hewlett-Packard portable cesium standards, "flying clocks," are used to periodically check the synchronization between these stations and the Master Clock.

Hewlett-Packard cesium beam standards are widely used to drive precision clocks because of the extremely good long-term stability and reliability of this primary standard. If a quartz oscillator or other secondary standard is used, it must be evaluated for rate of drift and be corrected periodically.

### Time Scale

The time interval of the atomic time scale is the International Second, defined in October 1967 by the Thirteenth General Conference of Weights and Measures. Since January 1972 the frequency offset between UTC and Atomic Time has been zero and the UTC time scale is kept in synchronism with the rotation of the earth to within  $\pm 0.9$  second by step-time adjustments of exactly 1 second, when needed (see Hewlett-Packard Application Note 52-2).

The U.S. National Bureau of Standards (NBS) and USNO provide the official basis for Standard Time for the United States. The UTC signal is broadcast from the NBS stations WWV and WWVB and by several other stations throughout the world. (See Hewlett-Packard Application Note 52-1, Fundamentals of Time and Frequency Standards, for a list of stations broadcasting time signals).

### Standby Power Supplies

Minimum down-time, important for any system, is vital to a time standard. Its worth depends directly on continuity of operation. Noninterrupted operation is also important to ultra-precise quartz oscillators.

Hewlett-Packard standby power supplies ensure continued operation despite line interruptions, and operate over a range of ac line voltage to supply regulated dc to operate frequency standards and frequency dividers and clocks. The batteries in the supplies assume the full load immediately when ac power fails.

### Hewlett-Packard Time and Frequency Standard

The Hewlett-Packard House Standard at the Santa Clara Division consists of an ensemble of five Hewlett-Packard Cesium Beam Standards each with the Option 004 High Performance Tube.

The standard is compared to the U.S. Naval Observatory Master Clock in Washington, D.C. by means of Loran C and TV Line 10 measurements through the USAS-TRATCOM satellite system. It is also compared with the U.S. National Bureau of Standards Frequency Standard (NBS FS) at Boulder, Colorado by means of Loran-C through the Naval Observatory. The frequency uncertainty of the standard is within a few parts in  $10^{13}$  with respect to the standards maintained by the NBS and the USNO.

Time is maintained relative to the Naval Observatory and the National Bureau of Standards master clocks to an accuracy of better than  $\pm 1.0$  microseconds. This accuracy is verified with flying clock trips from the Naval Observatory to both Hewlett-Packard Santa Clara Division and Hewlett-Packard Geneva. Both locations have been designated U.S. Naval Observatory Time Reference Stations.

# FREQUENCY & TIME STANDARDS

## Atomic Frequency Standards

Models 5061A, 5065A

301



- HP 5061A
- Improved accuracy  $\pm 6 \times 10^{-12}$
  - Primary standard
  - Proven reliability

- HP 5061A, Opt 004
- Accuracy  $\pm 4 \times 10^{-12}$
  - Settability  $\pm 1 \times 10^{-13}$
  - Time domain stability  $5 \times 10^{-12}$  (1 s avg)



### HP 5061A Cesium Beam Standard

The first Hewlett-Packard Cesium Beam Standard, the HP 5060A, was introduced in 1964. This was followed in 1967 with the improved HP 5061A and in 1973 with the high performance beam tube option for the HP 5061A. Since this time the accuracy and reliability of Hewlett-Packard cesium beam standards has been demonstrated and these standards have become the world-wide standard for frequency and time keeping. The HP 5061A has provision for an optional digital divider and reliable, easy-to-read LED clock (Option 001) and for a battery with ½ hour standby power capacity with automatic charging (Option 002).

**Reliability and warranty:** over 60 million operation hours have proven the performance and reliability of Hewlett-Packard cesium beam standards in various world-wide applications. The units have provided dependable microsecond accuracy in aircraft, ship and fixed environments.

A three-year warranty on the HP 5061A standard cesium beam tube is provided as a result of proven field reliability over an extended period. This warranty includes replacement of the cesium beam tube if it should fail within the warranty period. Typically, beam tube life has been in excess of five years.

### HP 5061A with Opt 004, High Performance Cesium Beam Tube

The Hewlett-Packard 5061A primary frequency standard with the Option 004 Cesium Beam Tube offers increased stability and accuracy in the instrument which has become the worldwide standard of frequency and time keeping since its introduction in 1967. Improvements in magnetic shielding, ruggedization and environmental performance permit improved performance and expansion of navigation and communication systems that have been made practical by the HP 5061A.

The design concept of the high performance beam tube includes unique HP designed dual beam optics with higher beam intensity to accomplish better short term stability and greater immunity to effects of shock and vibration. A 50 percent increase in resonance cavity length without change in the overall beam tube size contributes to better accuracy and settability because of the high Q of the narrower resonant line width. This tube retains the unique cesium standard feature of virtually no long term instability or aging.

The intrinsic accuracy is improved to  $\pm 4 \times 10^{-12}$  which provides an excellent reference standard without need of calibration. If desired, as in many timekeeping applications, two or more units may be calibrated to determine the difference in rate or may be adjusted to the same frequency. With the improved settability specifications of  $1 \times 10^{-13}$  small changes in frequency are accomplished rapidly and accurately. A provision for degaussing the tube without adversely affecting the instrument operation allows removal of any residual magnetic field in the tube. This is important in achieving the settability performance.

The short term stability specification is improved by a factor of ten with this tube. The  $5 \times 10^{-12}$  (1 s avg.) performance compares very favorably with that of rubidium type standards which are noted for their excellent short term stability. An important advantage from the better short term stability is the capability to make measurements to 1 sigma precision of  $1 \times 10^{-12}$  in about one minute compared to the two hours required previously. The HP 5061A with the Option 004 High Performance Tube has the same high reliability as the HP 5061A with the standard tube. The new high performance tube is warranted for one year, but is designed to have the same long life as the standard tube.

### HP 10638A Degausser

The HP 10638A Degausser is designed for use with the Option 004 High Performance Beam Tube to achieve settability of  $\pm 1 \times 10^{-13}$  and reproducibility of  $\pm 3 \times 10^{-12}$ . The degausser removes residual magnetic fields in the beam tube which slowly decay and cause a small frequency change. The degausser should be used when initially setting up the HP 5061A with Option 004 or after the instrument has been moved or adjusted.

### HP K34-59991A Broadband Linear Phase Comparator

The HP K34-59991A accurately compares the phase relationship of the output signals of two frequency standards having the same nominal frequency between 100kHz and 10MHz. The comparator output signal is suitable for driving a stripchart recorder, thus allowing long-term monitoring of the frequency standards' output differences. By using this comparator, very small frequency differences can be detected and adjustments can be made to the frequency standards to correct for timekeeping errors.

### HP E21-5061A Flying Clock

The HP E21-5061A consists of a HP 5061A Cesium Beam Standard with Option 001 LED Clock and HP 5089A Power Supply joined together to make one portable unit. The power supply, which can be operated from 11 to 30 V dc, 85 to 255 V ac, will provide approximately 7 hours standby power (from sealed immobilized electrolyte lead calcium batteries) for the HP 5061A Cesium Beam Standard.

This wide range of operating power capabilities enable the HP E21-5061A to operate on local power in virtually any country in the world. The seven hours standby capability make it possible to travel where there is no power available and, of course, allow the HP E21-5061A to conveniently be transported between power sources and operated in almost any air or surface vehicle as a "flying clock" (see Hewlett-Packard Journal, August 1966 and December 1967).

The Option 004 tube, because of the improved shielding, offers a significant increase in accuracy under the varying earth's magnetic field conditions experienced by flying clocks and is a desirable addition to the HP E21-5061A. In addition, the better short term stability permits more accurate and rapid comparison of standards. The Option 002 Battery may also be added to increase standby capability.



# FREQUENCY & TIME STANDARDS

## Atomic Frequency Standards

Models 5061A, 5065A (cont.)

- Compact, high reliability, proven performance
- Long term drift rate  $< 1 \times 10^{-11}$ /month
- Time domain stability  $< 5 \times 10^{-13}$  (100 s, avg)

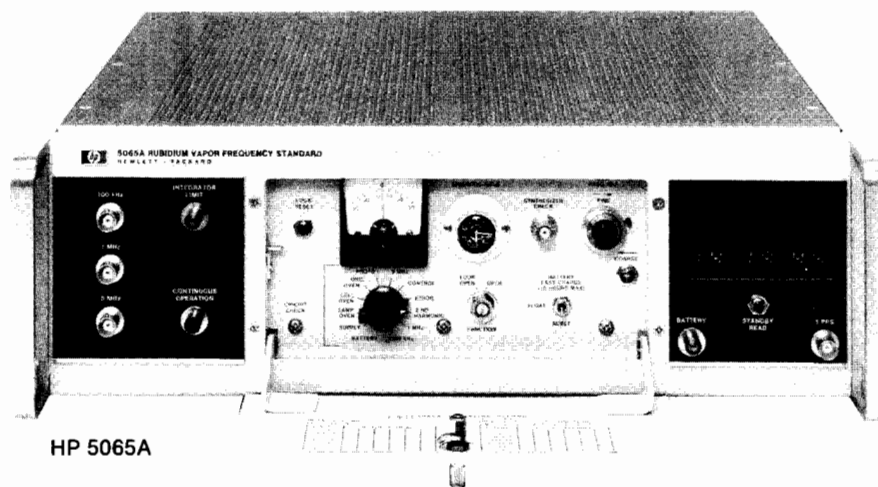

### HP 5065A Rubidium Frequency Standard

The HP 5065A is an atomic-type secondary frequency standard which uses a rubidium vapor resonance cell as the stabilizing element. As a result, it has long-term stability of better than  $1 \times 10^{-11}$  per month which exceeds that of high quality quartz oscillator frequency standards by 50 to 100 times. Furthermore, it has excellent short-term stability. These features contribute to its desirability as a coherent signal source, as a master oscillator for radio and radar systems where special requirements for stability and/or narrow bandwidth must be met, as a precision time keeper where the better performance of a cesium beam primary standard is not required, and as a house frequency standard for improved accuracy with fewer NBS calibrations compared to that required with quartz standards.

Front panel controls and circuit check meter of the HP 5065A are protected by a panel door. The magnetic field control provides fine frequency adjustment with which the frequency can be set to a precision of better than  $2 \times 10^{-12}$  without reference to a chart. The low noise quartz oscillator is phase-locked to the atomic frequency and provides the standard 5 MHz, 1 MHz, and 100 kHz outputs. The circuit check meter with selector switch monitors key voltages and currents for routine maintenance readings, calibration procedures, and fault finding.

The HP 5065A is designed for assured operation—to give the user confidence that the standard output signals are correct and locked to the atomic frequency. Logic within the unit maintains power to a “continuous” operation light on the front panel. If operation is interrupted, even momentarily, for any reason the light goes out and stays out until manually reset. An integrator limit light warns when the frequency correcting servo loop is approaching the limit of its dynamic range.

The HP 5065A is contained in a small-size package and is light-weight in comparison to a cesium beam standard. Additionally the rubidium resonance cell is much more frequency stable than quartz oscillators while subjected to shock and vibration, EMC, humidity, and magnetic field effects.

**Reliability and warranty:** the most significant module in the HP 5065A in terms of performance is the Rubidium Vapor Frequency Reference (RVFR). This temperature controlled, magnetically shielded unit includes the Rb gas cell and a photo sensitive detector

designed for maximum possible reliability. Field experience, including several million hours of operation, have demonstrated this reliability and the RVFR is now warranted for a period of three years. This increased warranty protects the owner in the event of random failure.

The Option 001 Digital Clock has an easy to read LED time-of-day display. The olive black upper panel provides a dark background around the readout for excellent contrast and readability. Initial clock setting is accomplished by means of pushbuttons easily accessible by removing the top cover. The LED display offers high reliability, freedom from errors due to mechanical shock, and performance over the full environmental range of the HP 5065A. A sync button on the digital divider permits automatic synchronization of this 1 PPS pulse to an external pulse. The clock 1 PPS is adjustable in decade steps from  $1 \mu\text{s}$  to 1 s, with respect to the synchronized reference, with 6 thumbwheel switches. A screwdriver adjustment allows fine continuous adjustment over a range of  $1 \mu\text{s}$ .

To conserve battery power, the display is not illuminated when ac power is not available. A STANDBY READ pushbutton below the display is used for readout when operating on the internal battery or external dc.

The Option 002 Standby Battery provides the HP 5065A with a minimum of 10 minutes standby power at  $25^\circ\text{C}$ . Switchover from line to battery is automatic so there is no interruption of operation if ac line power should fail. A front panel ac interruption light warns when ac power has failed or has been disconnected. Fast or float charging rates may be selected when ac power is available.

The Option 003 combines the Option 001 Clock and Option 002 Battery and should be specified if both Options 001 and 002 are required.

### HP E21- 5065A Portable Time Standard

HP E21- 5065A Portable Time Standard is a complete system for precision timekeeping and for transporting time from one location to another. It consists of the HP 5065A Rubidium Standard with digital clock and divider (Option 001) and the HP 5089A Power Supply with 6 or more hours standby capability. The component units are held together by side bars, and the interconnecting cables are protected by a back cover.



## Specifications

Instrument:	HP 5061A Option 004		HP 5061A		HP 5065A
Type of Standard:	Cesium		Cesium		Rubidium
Accuracy: maintained in magnetic field to 2 gauss and over temperature range of:	$\pm 7 \times 10^{-12}$ 0 to 50°C	$\pm 4 \times 10^{-12}$ $\pm 2.5^\circ\text{C}$ in range of 15 to 35°C	$\pm 1 \times 10^{-11}$ 0 to 50°C	$\pm 6 \times 10^{-12}$ $\pm 2.5^\circ\text{C}$ in range of 15 to 35°C	
Stability: Long Term: Short Term 5 MHz <sup>(2)</sup> :	Averaging time: 0.01				
	1	$\pm 3 \times 10^{-12(1)}$ $1.5 \times 10^{-10}$ $5 \times 10^{-12}$	$\pm 5 \times 10^{-12(1)}$ $1.5 \times 10^{-10}$ $5.6 \times 10^{-11}$		$\pm 1 \times 10^{-11}/\text{month}$ $1.5 \times 10^{-10}$ $5 \times 10^{-12}$
	10	$2.7 \times 10^{-12}$	$2.5 \times 10^{-11}$		$1.6 \times 10^{-12}$
	100	$8.5 \times 10^{-13}$	$8 \times 10^{-12}$		$5 \times 10^{-13}$
SSB Phase Noise Signal (1 Hz BW) Offset from signal:	Hz: $10^{-3}$	-28 dB	-8 dB		-25 dB
	$10^{-2}$	-48 dB	-28 dB		-52 dB
	$10^{-1}$	-68 dB	-48 dB		-72 dB
	0	-96 dB	-82 dB		-93 dB
	$10^1$	-120 dB	-120 dB		-120 dB
	$10^2$	-125 dB	-125 dB		-126 dB
	$10^3$	-140 dB	-140 dB		-140 dB
Reproducibility <sup>(4)</sup>	$\pm 3 \times 10^{-12(3)}$		$\pm 5 \times 10^{-12}$		
Settability (frequency) <sup>(5)</sup> :	$\pm 1 \times 10^{-13(3)}$		$\pm 7 \times 10^{-13}$		$\pm 2 \times 10^{-12}$
Warm-up:	At 25°C 30 Min.		At 25°C 45 Min.		At 25°C $1 \times 10^{-10}$ 1 hr. $5 \times 10^{-11}$ 4 hrs.
Sinusoidal Outputs: Output Voltage	5 MHz, 1 MHz, 100 kHz, Front & Rear BNC 1 V into 50 ohms				
Harmonic Distortion: (below rated output) Non-Harmonic related output: (below rated output) Under vibration or AC Mag Field: Signal-to-Phase Noise Ratio in 30 kHz noise BW (1 and 5 MHz):	>40 dB >80 dB >60 dB >87 dB		>40 dB >80 dB >60 dB >87 dB		>40 dB >80 dB >60 dB >87 dB
Environmental DC Magnetic Field Stability: AC Magnetic Field: 50, 60 and 400 Hz $\pm 10\%$ Temperature, operating with Option 001 or 002 Freq. change from 25°C:	$< \pm 2 \times 10^{-13}$ 2 Gauss Field $< 2 \times 10^{-12}$ for 2 Gauss peak 0 to 50°C $< 5 \times 10^{-12}$		$< \pm 2 \times 10^{-12}$ 2 Gauss Field $< 2 \times 10^{-12}$ for 2 Gauss peak 0 to 50°C $< 5 \times 10^{-12}$		$< \pm 5 \times 10^{-12}$ 1 Gauss Field $< 5 \times 10^{-12}$ for 1 Gauss peak 0 to 50°C $< 4 \times 10^{-11}$
Temperature, non-operating without options: with Option 001: with Option 002:	-40°C to 75°C -40°C to 75°C -40°C to 50°C		-40°C to 75°C -40°C to 75°C -40°C to 50°C		-40°C to 75°C -40°C to 75°C -40°C to 50°C
NOTES: (1) For life of beam tube. (2) Short-term stability for the HP 5061A with both standard and high performance tubes is given for the normal loop time constant. For improved short-term stability in controlled environments the long time constant may be used. (3) With HP 10638 Degausser. (4) Degree to which an oscillator will produce the same frequency from one occasion to another without recalibration. (5) Degree to which frequency can be set to agree with a reference frequency.					



# FREQUENCY & TIME STANDARDS

## Atomic Frequency Standards

Models 5061A, 5065A (cont.)

Instrument	HP 5061A Opt 004	HP 5061A	HP 5065A
Vibration: with isolators:	MIL-STD-167-1 MIL-T-21200	MIL-STD-167-1 MIL-T-21200	MIL-STD-167-1
Shock:	MIL-E-5400, Class 1 (30G)		
EMC:	1-MIL-T-21200, C.1		MIL-T-21200, C.1
General	MIL-STD-461, Notice 3, Class A		
Power: AC:	50, 60 or 400 Hz $\pm 10\%$ , 115/230 V $\pm 10\%$		
DC:	43 W 22 to 30 V 27 W	43 W 22 to 30 V 27 W	49 W 23 to 30 V 35 W
Option 001: add (AC/DC)	10/7.5 W	10/7.5 W	10/7.5 W
Option 002: add (AC/DC)	22/4.5 W	22/4.5 W	6/0 W
Option 010: add (AC/DC)			
Dimensions (H x W x D): mm:	221 x 425 x 416	221 x 425 x 416	133 x 425 x 416
inches:	8.7 x 16.7 x 16.4	8.7 x 16.7 x 16.4	5.2 x 16.7 x 16.4
Weight: (lb/kg)	70/31.8	67/30.5	34/15.4
Option 001: add (lb/kg)	2/0.9	2/0.9	2/0.9
Option 002: add (lb/kg)	5/2.3	5/2.3	3.5/1.6
Option 001, Clock			
1 PPS Outputs: Master:	Front & Rear BNC	Front & Rear BNC	Front & Rear BNC
Clock:	10 V peak into 50 $\Omega$ load		
Amplitude:			
Width:	20 $\mu$ s min	20 $\mu$ s min	20 $\mu$ s min
Rise Time:	<50 ns	<50 ns	<50 ns
Fall Time:	<50 ns	<50 ns	<2 $\mu$ s
Jitter, pulse-to-pulse:	<1 ns, rms	<1 ns, rms	<5 ns, rms
Synchronization:	Automatic, 100 ns $\pm$ 100 ns delay	Automatic, 100 ns $\pm$ 100 ns delay	Auto., 10 $\pm$ 1 $\mu$ s delay
Clock pulse adjustment range:	1 $\mu$ s to 1 s	1 $\mu$ s to 1 s	1 $\mu$ s to 1 s
Clock display:	Solid State Digital		
Option 002, Standby Power Supply Capacity at 25°C with Option 001 Clock:	30 Minutes	30 Minutes	10 Minutes
Recharge, Fast/Float:	Automatic, fast charge		Switch

### Ordering Information

HP 5061A Cesium Beam Frequency Standard

Opt 001: Clock

Opt 002: Standby Power Supply

Opt 003: Clock and Standby Power Supply

Opt 004: High Performance Beam Tube

Opt 908: Rack Flange Kit

HP E21-5061A Flying Clock

Consists of: HP 5061A with Opt 001 (not included in E21 price) and HP 5089A Standby Power Supply.

Weight: 64 kg (141 lb).

Size: 425 H x 405 W x 546 mm D (16.7" x 15.9" x 21.5") (includes handles).

HP 10638A Degausser

Weight: 1.2 kg (3 lb).

Size: 130 H x 77 W x 279 mm D (5.1" x 3" x 11").

HP 5065A Rubidium Frequency Standard

Opt 001: Clock

Opt 002: Standby Power Supply

Opt 003: Clock and Standby Power Supply

Opt 908: Rack Flange Kit

HP E21-5065A Portable Time Standard

Consists of: HP 5065A with Opt 001 (not included in E21 price) and HP 5089A Standby Power Supply.

Weight: 50 kg (110 lb).

Size: 425 H x 405 W x 546 mm D (16.7" x 15.9" x 21.5") (includes handles).

# FREQUENCY & TIME STANDARDS

Quartz Frequency Standard

Model 105B

305



- High spectral purity
- Well-buffered outputs
- Aging  $< 5 \times 10^{-10}$  per day

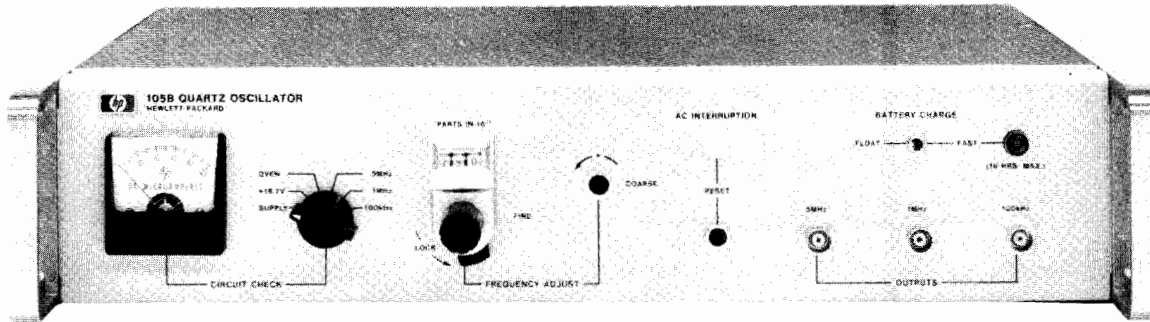

HP 105B

The HP 105B Quartz Oscillator provides state-of-the-art performance in precision frequency and time systems because of its excellent long and short term stability characteristics, spectrally pure output, unexcelled reliability, and ability to operate under a wide range of environmental conditions. The HP 105B fills a need for a small and economical yet highly stable precision quartz oscillator for frequency and time standards. The HP 105B can be operated from the ac line. It also has a built-in 8-hour standby battery for uninterrupted operation should line power fail. The 5 MHz, 1 MHz and 100 kHz buffered sinusoidal outputs have excellent short term stability (5 parts in  $10^{12}$  rms for 1 s averaging time) and aging rate ( $< 5$  parts in  $10^{10}$  per day).

The HP 105B features rapid warm-up. Typically, the oscillator will be within 5 parts in  $10^9$  of the final frequency in 15 minutes after an "off" period of 24 hours. The basis of these oscillators is an extremely stable "SC" cut quartz crystal developed by Hewlett-Packard. New technologies in the crystal mounting and packaging have resulted in a cleaner crystal which in turn has a lower aging rate. The crystal, oscillator and AGC circuit are all enclosed in a proportional oven which reduces the temperature effects on these components and circuits.

Particular care was taken to provide a spectrally pure 5 MHz output which, when multiplied high into the microwave region, provides signals with spectra only a few cycles wide. Spectra less than 1 Hz wide can be obtained in X-band (8.2 to 12.4 GHz). The stability and purity of the 5 MHz output make it suitable for doppler measurements, microwave spectroscopy, and similar applications where the reference frequency must be multiplied by a large factor.

## Specifications

**Outputs:** 5 MHz, 1 MHz, 100 kHz; 1 V rms into 50  $\Omega$  front and rear connectors.

**Clock output:** 1 MHz or 100 kHz; 0.5 V rms into 1 k $\Omega$ , rear connector. Normally supplied wired for 1 MHz output.

### Frequency Stability

**Aging rate:**  $< 5 \times 10^{-10}$  per 24 hours.

**Short-term stability:** for 5 MHz output only.

$\tau$ (sec)	$\sigma \Delta f/f(2,\tau)$
$10^{-2}$	$1.5 \times 10^{-10}$
$10^{-1}$	$1.5 \times 10^{-11}$
$10^0$	$5 \times 10^{-12}$

**Temperature:**  $< 2.5 \times 10^{-9}$  total change  $0^\circ\text{C}$  to  $50^\circ\text{C}$ .

**Load:**  $\pm 1 \times 10^{-10}$  open to short circuit, 50  $\Omega$  R, L or C load change.

**Supply voltage:**  $\pm 5 \times 10^{-11}$  for 22–30 V dc from 26 V dc reference and for 115/230 V  $\pm 10\%$ .

**Warm-up (at  $25^\circ\text{C}$ ):** to within  $5 \times 10^{-9}$  of final frequency in 15 min.

**Distortion (5 MHz, 1 MHz, 100 kHz) Below Rated Output**

**Harmonic:**  $> 40$  dB.

**Non-harmonic:**  $> 80$  dB.

**Frequency Adjustments**

**Fine:**  $\pm 5 \times 10^{-8}$  range with digital dial reading parts in  $10^{10}$ .

**Coarse:**  $1 \times 10^{-6}$  front panel screwdriver control.

**Phase locking:** external +5 V to –5 V allows  $> 2 \times 10^{-8}$  frequency control for locking to external source.

**Environmental**

**Temperature, operating:**  $0^\circ\text{C}$  to  $+50^\circ\text{C}$ .

**Temperature, storage:**  $-40^\circ\text{C}$  to  $+50^\circ\text{C}$  ( $+75^\circ\text{C}$  without standby battery).

**Altitude:** 15.24 km (50,000 ft.).

**Shock:** MIL-T-21200 (30 Gs).

**Vibration:** MIL-STD-167 and MIL-T-21200.

**Electromagnetic compatibility (EMC):** MIL-I-6181D.

**Standby supply capacity:** 6 hours at  $25^\circ\text{C}$  ambient temperatures.

**Power requirements:** 115/230 V  $\pm 10\%$ , 50–400 Hz at 18 W (70 W warm-up) Add 1 W for float charge and 12 W for fast charge. 22–30 V dc at 8 W (16 W warm-up).

**Size:** 88 H x 425 W x 286 mm D ( $3\frac{15}{32}$ " x  $16\frac{3}{4}$ " x  $11\frac{1}{4}$ ").

**Weight:** 105B—net, 11 kg (24 lb). Shipping, 14 kg (31 lb).

**Options**

**908:** Rack Flange Kit

**910:** Extra manual

**HP 105B Quartz Oscillator**



# FREQUENCY & TIME STANDARDS

## Distribution Amplifier

Model 5087A

- Versatile with 3 input and 12 output channels
- Low noise, high stability, and isolation

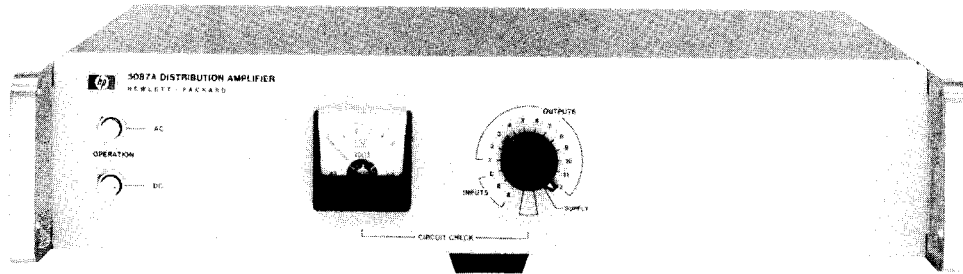

HP 5087A

The Hewlett-Packard 5087A Distribution Amplifier provides the isolation and flexibility required for distribution of the output of high quality frequency standards. Low distortion and excellent isolation make it ideal for providing multiple outputs from atomic or crystal frequency standards. The 3 input channels will accept 10 MHz, 5 MHz, 1 MHz or 100 kHz in any combination. The number of outputs for each channel is selectable up to a total of 12 outputs. The output levels are individually adjustable from 0 to 3 V rms. All input and output levels are monitored on a front panel meter.

The Distribution Amplifier features plug-in modular construction, short circuit isolation, exceptional phase stability, low noise and cross-talk, and uninterrupted switchover to standby dc in event of ac power failure.

The shielding around each input and output plug-in amplifier assures minimum noise and crosstalk. The tuned output amplifiers provide clean signals and high channel-to-channel isolation.

The instrument is designed for maximum versatility and can be supplied to meet a wide variety of special requirements. The standard configuration of input and output amplifiers is shown in Figure 1.

Several other commonly used configurations are also available and special combinations of the various input and output modules can be supplied. Input and output amplifiers can be added or the configuration easily changed at any time.

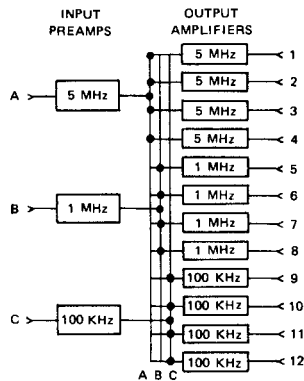

Figure 1. HP 5087A Distribution Amplifier with Option 031, Standard Configuration input and output amplifiers.

## Specifications

**Inputs:** (up to three, rear panel BNC).

**Frequencies:** 10 MHz, 5 MHz, 1 MHz or 100 kHz.

**Level:** 0.3 to 3.0 V rms, 50 ohms.

**Outputs:** (up to 12 rear panel BNC).

**Frequencies:** 10 MHz, 5 MHz, 1 MHz or 100 kHz.

**Level:** 0–3 V into 50 ohms (screwdriver adjustment).

**Harmonic distortion:** >40 dB below rated output.

**Non-harmonic distortion:** >80 dB below rated output

## Isolation

**Load** (open or short on any other channel)

**Amplitude change:** 0.1 percent.

**Phase change:** <0.1 ns at 5 or 10 MHz.

<0.5 ns at 1 MHz.

<5.0 ns at 100 kHz.

**Injected signal:** 1 V signal up to 50 MHz applied to any output except 10 MHz, will be down more than 60 dB in all other outputs; 10 MHz output channel will be down more than 50 dB.

**SSB phase noise (5 MHz):** >145 dB below signal in 1 Hz BW for frequencies > 1 kHz from carrier.

**Short term stability degradation (5 MHz):** <  $1 \times 10^{-12}$  in 10 kHz band. (1 s average).

## Environmental

**Temperature:** MIL-E-16400, Class 4.

**Operating:** 0–50°C; storage: –62° to +75°C.

**Stability:**

**Amplitude:** ±0.5 dB, 0° to 50°C.

**Phase:** <0.1 ns/°C., 5 and 10 MHz.

**EMC:** MIL-STD-461A.

**Humidity:** 95% at 40°C.

**Vibration:** MIL-STD-167.

**Altitude:** up to 30,000 ft.

**Shock:** MIL-T-21200, Class 1 and MIL-E-5400 (30 Gs).

## General

**Power:** 115 or 230 V ±10%, 48 to 440 Hz, 20 VA, max, or 22–30 V dc, 500 milliamperes, max.

**Dimensions:** 88 H x 425 W x 286 mm D (3.5" x 16.7" x 11.3").

**Weight:** typical, Opt 031–Net 7 kg (15 lb).

## Options

**Normal Configurations** (input and output amplifiers)

**031:** 5, 1 and 0.1 MHz inputs and 4 outputs at each frequency

**032:** Single 5 MHz input and 12 outputs

**033:** Single 10 MHz input and 12 outputs

**034:** Single 5 MHz input, 4 each outputs at 5, 1 and 0.1 MHz

## Special Configurations

**Input Preamplifiers** (up to 3 total)

**004:** Input Preamplifier (0.1 to 10 MHz)

**005:** 5 to 1 MHz Input Divider

**006:** 1 to 0.1 MHz Input Divider

**011:** 5 to 10 MHz Input Doubler

**013:** 10 to 5 MHz Input Divider

**014:** 10 to 1 MHz Input Divider

**Output Amplifiers** (up to 12 total)

**001:** 5 MHz Output Amplifier

**002:** 1 MHz Output Amplifier

**003:** 0.1 MHz Output Amplifier

**012:** 10 MHz Output Amplifier

**908:** Rack Flange Kit

## HP 5087A Distribution Amplifier Mainframe

# FREQUENCY & TIME STANDARDS

Standby Power Supply

Model 5089A

307



- 15 ampere-hour capacity
- Maintenance free lead-calcium batteries
- Used in "Flying Clocks"
- Automatic recharge

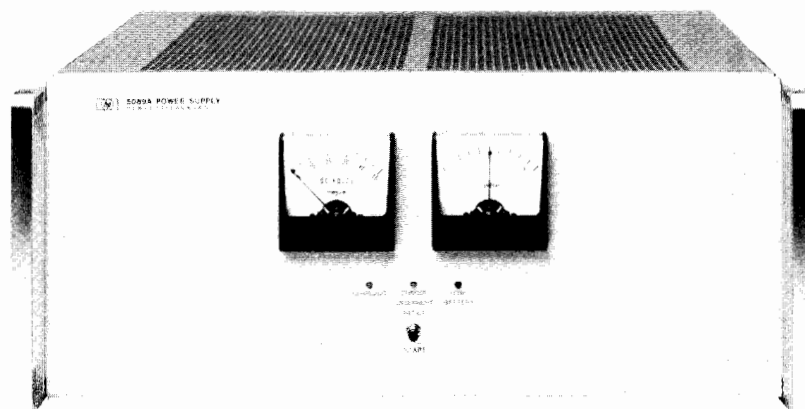

HP 5089A

## HP 5089A Standby Power Supply

The HP 5089A Standby Power Supply furnishes dc power to keep frequency or time standard systems operating during extended interruptions of ac line power. For applications where it is essential to maintain continuous operation and avoid loss of precise time, the use of a standby power supply is an absolute necessity. This unit is designed for use with the Hewlett-Packard Cesium Beam Standards, Rubidium Vapor Standards, Quartz Oscillators, and other equipment which will operate from 22 to 28 V dc. No switching is used in transferring power from line to battery operation and back again, thus assuring uninterrupted operation.

### Versatility

The HP 5089A is an extremely versatile unit. It was designed both as a portable power supply for the HP 5061A and HP 5056A "flying clocks", and as a standby supply for stationary applications.

### Portable Applications

Portable or "flying clock" applications require a power supply to operate from a wide range of power sources, along with the standby capability to maintain continuous operation where no external power is available. A special inverter permits operation from a 12V dc automobile battery. In addition, the 85 to 255 V ac, and 11 to 30 V dc capability enables the HP 5089A to operate from almost any power source in the world. The 15 ampere-hour standby batteries are the double sealed lead-calcium type, and thus are virtually spillproof. Mounting hardware is available to attach the HP 5089A to either the HP 5061A or the HP 5065A standards to make a portable frequency time standard package. These portable packages are available from Hewlett-Packard under HP E21-5061A and HP E21-5065A.

### Stationary Applications

Stationary applications require long periods of power supply operation in a float or standby mode. Then when an ac supply failure occurs the supply must provide full standby capability. The charging circuits inside the HP 5089A are designed to charge the batteries in such a way that they will provide both long, trouble-free, reliable operation, and full standby power. After use, when ac power is restored, the HP 5089A will fully recharge its batteries. The double sealed batteries will not leak nor require maintenance of any kind. Thus, the HP 5089A allows you to add standby capability to your system with very little increase in maintenance costs.

### Ease of Operation

In normal operation there is virtually no required operator intervention. The HP 5089A automatically maintains the batteries in a fully charged state, ready to supply standby power. Should regular line power fail, the HP 5089A will provide uninterrupted dc power (to the limit of its standby capacity) for your equipment. After normal operating power is restored, the HP 5089A will automatically recharge its batteries back to the standby level.

The HP 5089A tells you its operational status at a glance through three LED lamps: GREEN indicates the battery is being charged; YELLOW indicates there has been an ac line failure; a RED lamp lights when the battery is almost fully discharged. Two front-panel meters show battery voltage and charge/discharge current.

### Batteries

The HP 5089A utilizes the "immobilized electrolyte" technology in its maintenance-free lead-calcium batteries. The lead-calcium grid gives these batteries longer life with better reliability than conventionally designed batteries. The batteries are double sealed to provide virtually leakproof, and thus maintenance-free operation.

## HP 5089A Specifications

### Input Voltage

**AC charging:** 85V to 130V ac rms, 48 to 440 Hz, 300 VA max  
85V to 255V ac rms, 48 to 66 Hz, 300 VA max

**DC operation:** 11V to 30V dc, 110W max

**Output voltage:** 22V to 28V dc (nominal). 2A maximum.

**Standby capacity:** 15AH at +25°C when fully charged.

**Recharge:** complete recharge in 24 hours when operating from AC line.

**External low battery voltage alarm:** floating contact closure at rear panel barrier block for external visible or audible "low battery" warning. Contact rating is 30V dc at 2 amperes.

### Operating Environment

**Temperature:** 0°C to 50°C

**Humidity:** up to 95% at 40°C (with no internal condensation)

**Altitude:** 4,600 metres (15,000 feet)

### Storage Environment

**Temperature:** -40°C to +65°C

**Humidity:** up to 95% noncondensing

**Altitude:** 12,000 metres (40,000 feet)

**Dimensions:** 177mmH x 425mmW x 416mmD (7" x 16.7" x 16.4")

**Weight:** net weight 30.5kg (67 pounds)

### Accessories Supplied

HP 05061-6091: AC Power Input Cable Assembly  
HP 05089-60102: DC Power Input Cable Assembly  
HP 05089-60101: DC Output Cable Assembly  
HP 5060-0169: Extender Board Assy (Dual 25 Pin)

### Options Available

**Option 001:** Spare AI Board Assembly (HP 05089-60001)

**Option 908:** Rack Mounting Adapter Kit

**Option 910:** Extra Operating and Service Manual

**HP 5089A Standby Power Supply**

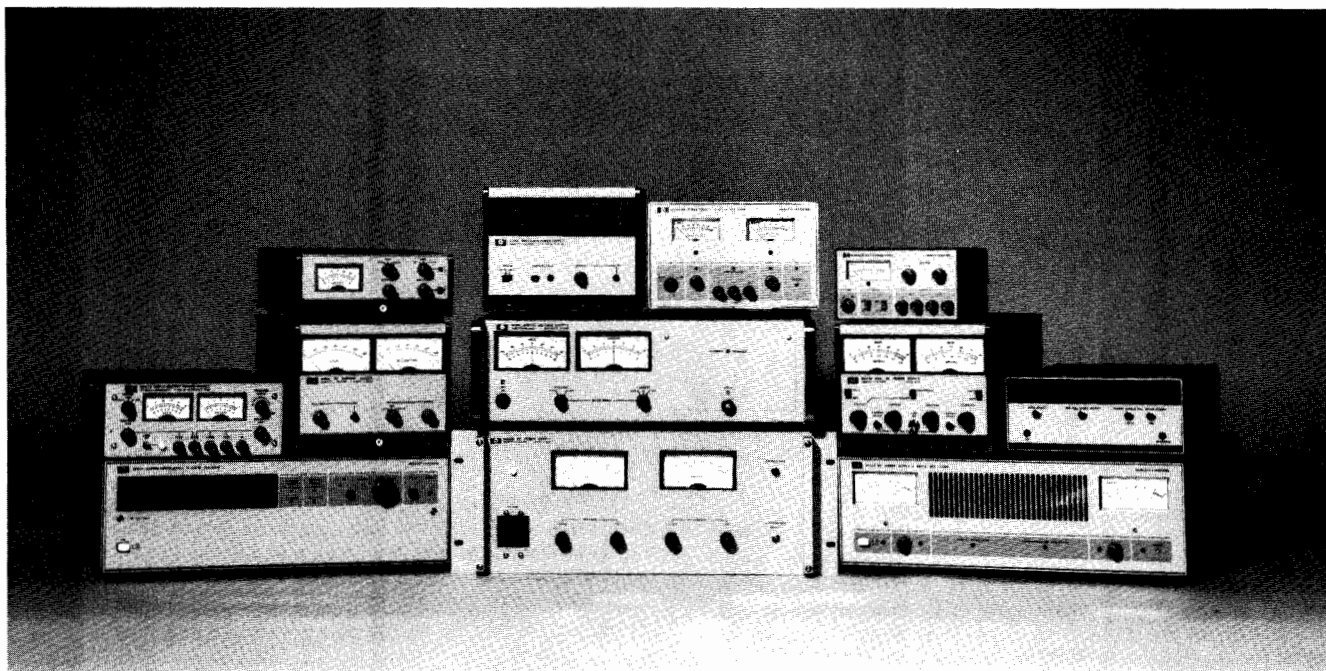

### Introduction

Hewlett-Packard's extensive variety of power supplies serve a wide range of applications. For circuit and device development, there are laboratory supplies. For industrial needs, there are high power units. The HP-IB power sources manufactured by Hewlett-Packard are used in automated systems, and OEM Modular Power Supplies are designed for incorporation into other products. Through technological innovations, Hewlett-Packard strives to offer advanced capabilities, high reliability, and good value in both system and bench power supply families.

### Regulation Techniques

The regulation technique used in a power supply defines its performance specifications, size, and efficiency. HP power supplies are designed using one of four proven regulation techniques: Series, SCR, SCR preregulator/series regulator, and switching.

**Series regulation:** this technique exhibits good regulation, low ripple and noise, and fast transient response. However, it is relatively inefficient. This results in greater power usage, large size, and more generated heat than the other methods. For this reason, series regulation is most useful for lower power units. These power supplies are used in laboratory and test applications, where stable, precise, dc power is needed.

**SCR regulation:** this technique is more efficient than series regulation, so the power supplies have lower power usage, smaller heat sinks, and less generated heat. However, the regulation (PARP ripple and noise) and transient response specifications are better with series regulation than with SCR regulation. Power supplies with SCR regulation are especially useful for high power industrial applications where fine regulation is not necessary and the lower cost/watt is important.

**SCR preregulation/series regulator:** this technique combines the best qualities of series and SCR regulation. As can be seen in the table, the operating specifications are much better than with SCR regulation. SCR preregulation does not detract from the excellent characteristic of series regulation, except for slower transient response. The efficiency is higher than that with series regulation, but not quite as high as with SCR regulation alone. These power supplies are used in laboratory and test applications similar to those of series regulated power supplies but at power levels greater than 75 watts.

**Switching regulation:** this technique provides high efficiency and operating specifications similar to series regulation (see table). These power supplies also tend to be small and lightweight.

### Example Power Supply Comparison for a 40 V, 25 A, 1000 Watt Application

Regulation Technique	HP Model Number	PARP (ripple and noise) rms/p-p	Load Effect	Load Transient Recovery	Typical Efficiency
Series with SCR preregulation	6268B 40 V @ 30 A	1 mV/5 mV	.01% + 200 $\mu$ V (4.2 mV at 40 V)	50 $\mu$ s, 10 mV	60%
Switching (autoranging)	6012A 60 V @ 50 A	5 mV/50 mV	.01% + 5 mV (9 mV at 40 V)	2 ms, 100 mV	75%
SCR	6434B 40 V @ 25 A	40 mV/500 mV	40 mV	200 ms, 200 mV	70%

### Selecting a Power Supply

The tables on the next few pages list the dc power supplies in this catalog in output voltage order. For manual power supply operation, simply find those power supplies that correspond to the appropriate voltage and current levels and turn to the listed page numbers for further information.

For operation in an automatic system, power supplies must be chosen which can be controlled by the method you intend to use in your system, following the information in the tables.

HP-IB control usually provides the greatest level of system capability. The HP 59501B (page 327) is a special, isolated DAC which is used to configure many models into HP-IB systems. The Multiprogrammer (page 192) is a computer-controllable instrument subsystem that can be configured to provide power supply programming and many other system functions, including digital inputs and outputs, A/Ds, DACs, and event sensing.

### New 1985 Power Supply Catalog

For more details concerning Hewlett-Packard power supplies, ask your HP sales representative for a *DC Power Supply Catalog*, or fill in the card at the back of this catalog.

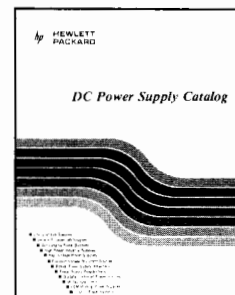



# POWER SUPPLIES

## Voltage Rating Index with remote control selection guide\*



Max. Volts (DC)	Max. Amperes (DC)	Type	HP Model	Page	GSA	Remote Control Methods*										Remote Readback Methods for Output Voltage Current and Status			
						for Output Voltage					for Output Current					Direct	Multiprogrammer*	HP-IB	
						Resistance	Voltage	HP 59501B*	Multiprogrammer*	HP-IB	Resistance	Voltage	HP 59501B*	Multiprogrammer*	HP-IB				
6	1	Triple Output (6, ±18 V)	6235A	314	•														
6	2.5	Triple Output (6, ±20 V)	6236B	314	•														
6.7	30	Autoranging	6023A	318		•	•	•	•		•	•	•	•		•	•		
6.7	30	HP-IB Autoranging	6033A	324		•	•	•		•	•	•		•				•	
7	120	Autoranging	6011A	318		•	•	•	•		•	•	•	•		•	•		
7	120	HP-IB Autoranging	6031A	324		•	•	•		•	•	•		•				•	
7.5	5	CV/CC	6281A	316	•	•	•	•	•		•	•	•	•					
8	1000	CV/CC	6464C	322	•	•	•	•	•		•	•	•	•					
±10	0.01	HP-IB DAC	59501B	327	•					•									
10	1	CV/CC	6214B	313	•														
10	10	CV/CC	6282A	316	•	•	•	•	•		•	•	•	•					
10	50	CV/CC	6259B	320	•	•	•	•	•		•	•	•	•					
10	100	CV/CC	6260B	320	•	•	•	•	•		•	•	•	•					
15	15.9	Autoranging	6023A	318		•	•	•	•		•	•	•	•		•	•		
15	15.9	HP-IB Autoranging	6033A	324		•	•	•		•	•	•		•				•	
15	71	Autoranging	6011A	318		•	•	•	•		•	•	•	•		•	•		
15	71	HP-IB Autoranging	6031A	324		•	•	•		•	•	•		•				•	
15	200	CV/CC	6453A	322	•	•	•	•			•	•	•						
16 or 18	600 or 500	CV/CC	6466C	322	•	•	•	•	•		•	•	•	•					
18	1	Triple Output (18, ±20 V)	6237B	314	•														
18	0.2	Triple Output (6, ±18 V)	6235A	314	•														
20	0.5	Triple Output (6, ±20 V)	6236B	314	•														
20	0.5	Triple Output (18, ±20 V)	6237B	314	•														
20	0.6	Dual Outut (20, 20 V)	6205C	314	•	•	•	•	•		•	•	•	•					
20	1.5	CV/CC	6200B	313	•	•	•	•			•	•	•						
±20	±2	Bipolar PSA	6825A	329	•	•	•	•			•	•	•						
20	2	Precision Voltage	6114A	330	•	•	•	•	•		•	•	•	•					
20	3	CV/CC	6284A	316	•	•	•	•	•		•	•	•	•					
20	3	Dual Output (20, 20 V)	6253A	316	•	•	•	•	•		•	•	•	•					
20	10	Autoranging	6023A	318		•	•	•	•		•	•	•	•		•	•		
20	10	HP-IB Autoranging	6033A	324		•	•	•		•	•	•		•				•	
20	10	Autoranging	6024A	318	•	•	•	•	•		•	•	•	•		•	•		

\* An option may be required to program with the specified method.



# POWER SUPPLIES

## Voltage Rating Index with remote control selection guide\* (Cont.)

Max. Volts (DC)	Max. Amperes (DC)	Type	HP Model	Page	GSA	Remote Control Methods*										Remote Readback Methods for Output Voltage Current and Status		
						for Output Voltage					for Output Current							
						Resistance	Voltage	HP 59501B*	Multiprogrammer*	HP-IB	Resistance	Voltage	HP 59501B*	Multiprogrammer*	HP-IB	Direct	Multiprogrammer*	HP-IB
20	10	CV/CC	6263B	320	•	•	•	•	•		•	•	•	•				
20	10	CV/CC	6286A	316	•	•	•	•			•	•	•					
20	20	CV/CC	6264B	320	•	•	•	•	•		•	•	•	•				
20	50	Autoranging	6011A	318		•	•	•	•		•	•	•	•		•	•	
20	50	HP-IB Autoranging	6031A	324		•	•	•		•	•	•	•		•		•	
20	50	Autoranging	6012B	318	•	•	•	•	•		•	•	•	•		•	•	
20	50	HP-IB Autoranging	6032A	324		•	•	•		•	•	•	•		•		•	
20	50	CV/CC	6261B	320	•	•	•	•	•		•	•	•	•				
25	0.2	Dual Output (25,25 V)	6234A	313	•													
25	0.4	CV/CC	6216B	313	•													
25	2	Dual Output (25, 25 V)	6227B	316	•	•	•	•	•		•	•	•	•				
30	1	CV/CL	6206B	313	•	•	•	•										
36	100	CV/CC	6456B	322	•	•	•	•			•	•	•					
36	300	CV/CC	6469C	322	•	•	•	•	•		•	•	•	•				
40	0.3	Dual Output (40, 40 V)	6205C	314	•	•	•	•	•		•	•	•	•				
40	0.75	CV/CC	6200B	313	•	•	•	•			•	•	•					
40	1	Precision Voltage	6114A	330	•	•	•	•	•		•	•	•	•				
40	1.5	CV/CC	6289A	316	•	•	•	•	•		•	•	•	•				
40	1.5	Dual Output (40,40 V)	6255A	316	•	•	•	•	•		•	•	•	•				
40	5	CV/CC	6266B	320	•	•	•	•	•		•	•	•	•				
40	5	CV/CC	6291A	316	•	•	•	•			•	•	•					
40	5.7	Autoranging	6024A	318	•	•	•	•	•		•	•	•	•		•	•	
40	10	CV/CC	6267B	320	•	•	•	•	•		•	•	•	•				
40	25	CV/CC	6434B	322	•	•	•	•			•							
40	30	Autoranging	6012B	318		•	•	•	•		•	•	•	•		•	•	
40	30	HP-IB Autoranging	6032A	324		•	•	•		•	•	•	•		•		•	
40	30	CV/CC	6268B	320	•	•	•	•	•		•	•	•	•				
40	50	CV/CC	6269B	320	•	•	•	•	•		•	•	•	•				
50	0.2	CV/CC	6218B	313	•													
50	0.5	Precision Current	6177C	331	•	•	•				•	•	•					
50	0.8	Precision Voltage	6115A	330	•	•	•	•	•		•	•	•	•				

\* An option may be required to program with the specified method.



Max. Volts (DC)	Max. Amperes (DC)	Type	HP Model	Page	GSA	Remote Control Methods*										Remote Readback Methods for Output Voltage Current and Status		
						for Output Voltage					for Output Current							
						Resistance	Voltage	HP 59501B*	Multi programmer*	HP-IB	Resistance	Voltage	HP 59501B*	Multi programmer*	HP-IB	Direct	Multi programmer*	HP-IB
50	1	Dual Output (50, 50 V)	6228B	316	•	•	•	•	•		•	•	•	•				
±50	±1	Bipolar PSA	6824A	329	•	•	•	•										
±50	±1	Bipolar PSA	6826A	329	•	•	•	•			•	•	•					
±50	±1	Precision Voltage**	6130C	328	•					•					•			
50	4	HP-IB Autoranging	6002A	326	•	•	•	•		•	•	•	•		•			
±50	±5	Precision Voltage**	6129C	328	•					•					•			
60	0.5	CV/CL	6206B	313	•	•	•	•										
60	1	CV/CC	6294A	316	•	•	•	•	•	•	•	•	•					
60	3.3	Autoranging	6024A	318	•	•	•	•	•	•	•	•	•		•	•		
60	15	CV/CC	6274B	320	•	•	•	•	•	•	•	•	•					
60	17.5	Autoranging	6012B	318	•	•	•	•	•	•	•	•	•		•	•		
60	17.5	HP-IB Autoranging	6032A	324		•	•	•		•	•	•	•		•			•
64	50	CV/CC	6459A	322	•	•	•	•		•	•	•	•					
64	150	CV/CC	6472C	322	•	•	•	•	•	•	•	•	•					
±100	±0.016	Precision Current**	6140A	328	•					•					•			
100	0.1	CV/CC	6212B	313	•													
100	0.25	Precision Current	6181C	331	•	•	•				•	•	•					
100	0.4	Precision Voltage	6115A	330	•	•	•	•	•		•	•	•	•				
±100	±0.5	Precision Voltage**	6131C	328	•					•					•			
±100	±0.5	Bipolar PSA	6827A	329	•	•	•	•			•	•	•					
100	0.75	CV/CC	6299A	316	•	•	•	•	•	•	•	•	•					
110	100	CV/CC	6475C	322	•	•	•	•			•	•	•					
120	2.5	CV/CC	6443B	322	•	•	•	•			•							
220	50	CV/CC	6477C	322	•	•	•	•			•	•	•					
300	0.1	Precision Current	6186C	331	•	•	•				•	•	•					
300	35	CV/CC	6479C	322	•	•	•	•			•	•	•					
320	0.1	CV/CC	6209B	313	•	•	•	•			•	•	•					
440	25	CV/CC	6483C	322	•	•	•	•			•	•	•					
500	20	CV/CC	6483C	322	•	•	•	•			•	•	•					
600	1.5	CV/CC	6448B	322	•	•	•	•			•							
600	15	CV/CC	6483C	322	•	•	•	•			•	•	•					

\* An option may be required to program with the specified method.

\*\*An HP 59301A ASCII to parallel converter is required to operate this source on the HP-IB.



# POWER SUPPLIES

## Power Supply Terms and Specification Definitions

### Power Supply Terms

**Ambient temperature:** the temperature of the air immediately surrounding the power supply.

**Auto-parallel operation:** a master-slave connection of the outputs of two or more supplies used for providing a current output greater than can be obtained from one supply.

**Autoranging power supply:** a power supply that can provide maximum rated power over a wide range of voltage and current without external intervention to change range.

**Auto-series operation:** a master-slave connection of the outputs of two or more supplies used for obtaining a voltage greater than can be obtained from one supply.

**Auto-tracking operation:** a master-slave connection of two or more supplies each of which has one of its output terminals in common with one of the output terminals of all of the other supplies.

**Complementary tracking:** a master-slave interconnection of two supplies in which the voltage of the slave is equal to or proportional to that of the master and of opposite polarity with respect to a common point.

**Compliance voltage:** the output voltage of a power supply operating in the constant-current mode.

**Constant-current (CC) power supply:** a power supply that stabilizes output current with respect to changes in influence quantities. Thus, for a change in load resistance, the output current remains constant while the output voltage changes by whatever amount necessary to accomplish this.

**Constant-voltage (CV) power supply:** a power supply that stabilizes output voltage with respect to changes in influence quantities. Thus, for a change in load resistance, the output voltage remains constant while the output current changes by whatever amount necessary to accomplish this.

**Constant-voltage/constant-current (CV/CC) power supply:** a power supply that operates as a constant voltage power supply or a constant-current power supply depending on load conditions. It acts as a constant-voltage source for comparatively large values of load resistance and as a constant-current source for comparatively small values of load resistance.

**Constant-voltage/current-limiting (CV/CL) power supply:** a power supply similar to a constant-voltage/constant-current supply except that at comparatively small values of load resistance, its output current is limited instead of being stabilized.

**Crowbar:** see overvoltage protection.

**Current limiting:** the action of limiting the output current of a constant-voltage supply to some predetermined maximum value (fixed or adjustable) and automatically restoring the output voltage to its normal value when the overload or short circuit is removed. There are three types of current limiting: 1) by constant-voltage/constant-current crossover, 2) by decreasing the output voltage as the current increases, 3) by decreasing both voltage and current as the load resistance decreases (referred to as foldback or cutback current limiting).

**Drift:** the maximum change of an output voltage or current during an 8-hour period following a 30-minute warmup, with all influence and control quantities maintained constant during the warm-up time and the period of drift measurement. Drift includes both periodic and random deviations over the bandwidth from zero frequency (dc) to a specified upper frequency limit (usually 20 Hz).

**Load effect:** formerly known as load regulation, load effect is the change in the steady-state value of the stabilized output voltage or current resulting from a full-load change in the load current of a constant-voltage supply or the load voltage of a constant-current supply, with all other influence quantities maintained constant.

**Load effect transient recovery time:** the time interval between a specified step change in the load current of a constant-voltage supply (usually a full-load or 5-ampere change, whichever is smaller) or in the load voltage of a constant-current supply and the instant when the stabilized output quantity returns to and stays within the specified transient recovery band.

**Master-slave operation:** a method of interconnecting two or more supplies such that one of them (the master) serves to control the others (the slaves). The outputs of the slave supplies always remain equal to or proportional to the output of the master. The outputs of

the master supply and of one or more slaves may be connected in series, in parallel, or with just their negative or positive output terminals in common. (See also complementary tracking.)

**Nominal value:** the value that exists "in name only," not the actual value. For example, in the case of a power supply with a calibrated output control, the nominal value is the value indicated by the control setting. For a supply with a fixed output, the nominal output is the output indicated on the nameplate. The nominal value of a 120-volt  $\pm$  10% line voltage is 120 volts.

**Output impedance:** the complex ratio of a sinusoidal voltage and sinusoidal current at the output terminals, the one being caused by the other and being of external origin.

**Overcurrent protection:** protection of the power supply and/or connected equipment against excessive output current.

**Overtemperature protection:** protection of the power supply or parts of it against temperatures exceeding specified values.

**Overvoltage protection:** protection of the power supply and/or connected equipment against excessive output voltage. Overvoltage protection is usually by means of a crowbar protection circuit, which rapidly places a low resistance shunt across the supply's output terminals to reduce output voltage to a low value if a predetermined voltage is exceeded. A supply equipped with an overvoltage crowbar must also be protected by a means of limiting or interrupting output current.

**PARD (acronym for periodic and random deviation):** the term PARD replaces the former term ripple and noise. PARD is the periodic and random deviation of a dc output voltage or current from its average value, over a specified bandwidth (20 Hz to 20 MHz) and with all influence and control quantities maintained constant.

**Programming speed:** the maximum time required for the programmed output voltage or current to change from a specified initial value (usually zero or maximum output) to a value within a specified tolerance band of a specified newly programmed value (for most models 99.9% or 0.1% of maximum output, respectively; 99% and 1% for the HP 6114A, 6115A, 6177C-6186C, and HP 6434B-6483C) following the onset of a step change in an analog programming signal, or the gating of a digital signal.

**Remote control:** also referred to as remote programming, remote control is the setting of the power supply voltage, current, or other function by means of an external control quantity such as a variable resistance, voltage, or current, or a digital signal.

**Remote sensing:** remote sensing, or remote error sensing, is a means by which a power supply monitors the stabilized voltage directly at the load using extra sensing leads. The resulting circuit action compensates for voltage drops in the load leads (up to a specified limit).

**Resolution:** for a bench supply, the smallest change in output voltage or current that can be obtained using the front panel controls. For a system supply, the smallest change that can be obtained using either the front panel controls or a computer.

**Reverse voltage protection:** protection of the power supply against reverse voltage applied at the output terminals.

**Slave operation:** see master-slave operation.

**Source effect:** formerly known as line regulation, source effect is the change in the steady-state value of the stabilized output voltage on current resulting from any change in the source voltage within its specified range, with all other influence quantities maintained constant. Source effect may be measured at any output voltage and current within rating.

**Temperature effect coefficient:** the maximum steady-state change in a power supply's output voltage or current per degree Celsius following a change in the ambient temperature within specified limits, with all other influence quantities maintained constant.

**Voltage limiting:** the action of limiting the output voltage of a constant-current supply to some predetermined maximum value (fixed or adjustable) and automatically restoring the output current to its normal value when the load conditions are restored to normal. There are two types of voltage limiting: 1) by constant-voltage/constant-current crossover, 2) by decreasing the output current as the voltage increases.

**Warm-up time:** the time interval after switching on a power supply until it complies with all performance specifications.

# POWER SUPPLIES

## Laboratory: Single & Multiple Output, 10W to 38W

### Models 6200B-6218B and 6234A-6237B

313



- HP 6212B-6218B . . . 10 watts output
- Compact, impact-resistant stackable case
- Short-circuit proof

- HP 6200B-6209B . . . 30 watts output
- Auto series, parallel, and tracking
- Remote sensing

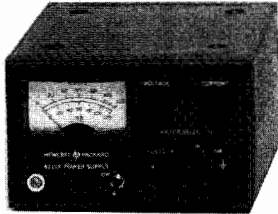

Single Output: HP 6212B-6218B

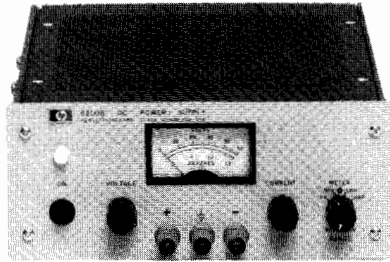

Single Output: HP 6200B-6209B

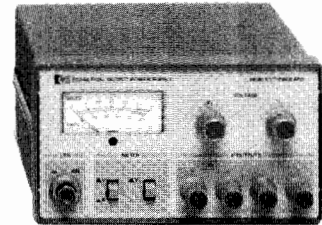

Dual Output: HP 6234A

## Description—Single Output Models

### Models 6212B-6218B

These popular low-cost CV/CC bench supplies are designed for general laboratory use and are equipped with front-panel mounted voltage and current controls, a combination volt/ammeter, and output binding posts. Output voltage and current are continuously variable, via coarse and fine controls from 0 to 15% above the maximum rated output. A switch selects either output voltage or current for display on the panel meter.

Load connections are made via three binding posts. Either the + or the - post may be grounded through an adjacent GND terminal or the supply may be operated floating at up to 300 volts above ground.

The supplies can also be operated as constant current sources with 500  $\mu$ A load regulation. All of these models can be connected in series or parallel.

The molded, impact-resistant case includes an interlocking feature for stacking several units vertically, thus minimizing bench space required for multiple supplies. Alternatively, up to three units can be mounted side by side in a 19" rack using Rack Mounting Kit HP 14521B. These supplies measure 86 H x 133 W x 368 mmD (3.40" x 5.25" x 8") and weigh 2 kg (4.4 lb).

### Models 6200B-6209B

This series of low-cost bench supplies includes five models covering an output voltage range from 0–7.5 V to 0–320 V. All models are equipped with ten-turn voltage and current controls, (except the HP 6206B, which does not have a current control), volt/ampere meter, meter function/range switch, and front and rear output terminals. In addition, on the dual-range models (HP 6200B and 6206B), an output range switch permits the selection of either a high or a low output voltage range.

The constant voltage/current limiting supply, HP 6206B, is short-circuit protected by a fixed current limiting circuit which is activated at approximately 110% of rated load current. The current-limit point can be reduced by changing the value of a single internal resistor. For the constant voltage/constant current supplies, ten-turn current controls allow the current-limit point to be set to any value within the current rating. Using these controls the CV/CC supplies can also be operated as constant-current sources.

Units may be bench operated or rack mounted individually or in pairs using accessory rack mounting hardware.

All models in this group of supplies measure 89 H x 216 W x 317 mm D (3.50" x 8.50" x 12.50") and weigh 4.5 kg (10 lb).

## Description—Dual Output Models

### Model 6234A

Model 6234A is a low-cost, dual-output bench power supply with two independently adjustable and isolated power sources in one compact unit. Both of the dc power sources are of the constant voltage/current limit type with each output voltage being adjustable continuously over a 0 to 25 V range. The maximum current available per output is 0.2 A and is limited automatically to prevent overload.

The HP 6234A offers considerable flexibility to the user with output voltages that can be arranged to provide identical or different voltages in any polarity combination with respect to 0 or other common positive or negative voltage points. The outputs can also be connected in series to provide up to 50 V at 0.2 A. Both sources are fully isolated to permit either of the output terminals to be grounded.

With pushbutton switches, users can select either voltage or current for each output to be monitored on the unit's meter. Other features include two multiple-turn controls for precise voltage setting, regulation to 0.01%, and ripple and noise of less than 200 microvolts rms.

With dimensions of only 93 mm high, 157 mm wide and 210 mm deep (3.64" x 6.17" x 8.25"), the HP 6234A supply takes up a minimum amount of bench space. Its weight is 2.3 kg (5 lb). The unit can be powered from a 115 V or an optional 230 V, 47-63 Hz ac input, (Option 028).

### Model 6205C

This low-cost bench supply is equipped with ten-turn output voltage controls, volt/ampere meter, meter function/range switch, and front and rear output terminals. In addition, an output range switch permits the selection of either a high or a low output voltage range.

Model 6205C combines the versatility of a dual power supply with the flexibility of auto-parallel and auto-series operation to extend the output ratings of this supply to 20 V/1.2 A, 40 V/0.6 A, and 80 V/0.3 A. In addition, using the supply's auto-tracking capability, opposite

# POWER SUPPLIES

Laboratory: Single & Multiple Output, 10W to 38W

Models 6200B-6218B and 6234A-6237B (cont.)

- Dual output to 24 watts
- Short-circuit proof
- Independent voltage controls

- Triple output to 38 watts
- Short circuit proof
- Tracking  $\pm 20$  volt outputs

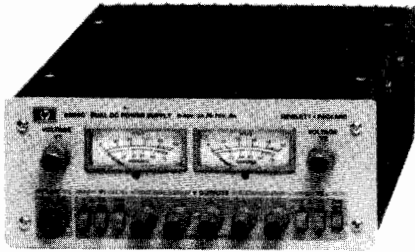

Dual Output: HP 6205C



Triple Output: HP 6235A

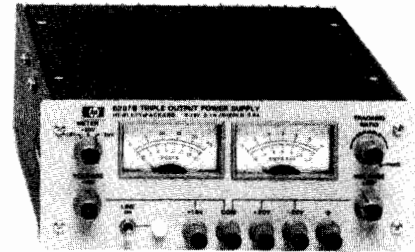

Triple Output: HP 6236B, 6237B

polarity voltages ( $\pm 20$  V,  $\pm 40$  V) can conveniently be obtained from this one supply.

This constant voltage/current limiting supply is short-circuit protected by a fixed current limiting circuit which is activated at approximately 110% of rated load current. The current-limit point can be reduced by changing the value of a single internal resistor. Units may be bench operated or rack mounted individually or in pairs using accessory rack mounting hardware.

## Description—Triple Output Models

### HP 6235A

This compact, low-cost, three-in-one power supply is a handy addition to the lab bench where single or multiple voltages are needed for designing and testing breadboards and prototypes. The HP 6235A delivers three adjustable dc output voltages: 0 to +6 V at 1 A, 0 to +18 V at 0.2 A, and 0 to -18 V at 0.2 A. A single 0 to 36 volt output at 0.2 A can also be obtained by connecting across the +18 V and -18 V terminals.

The controls, meter, and binding posts are conveniently arranged on the front panel. One voltage control simultaneously adjusts the +18 V and -18 V outputs, which track one another and can be used to power operational amplifiers and other circuits requiring balanced positive and negative voltages. The supply's dual outputs have added versatility with an adjustable tracking ratio control (TRACK) that can set the negative output to a lower voltage than the positive output. Once the tracking ratio control has established a voltage ratio between the positive and negative outputs, the ratio remains constant as the +18 V voltage control is adjusted. A third control sets the 0 to +6 V output voltage.

The supply is a constant voltage/current limit type with each output voltage continuously adjustable over its range, while the maximum current available is automatically limited to prevent over loading. The power supply's outputs share a common terminal and are isolated from chassis ground so that any output terminal can be grounded if desired. Each output voltage or current can be quickly selected and monitored with the push-button meter switches.

Model 6235A measures 89 H x 157 W x 210 mm D (3.5" x 6.17" x 8.25") and weighs 2.3 kg (5 lb).

### HP 6236B and 6237B

Microprocessors, digital and linear integrated circuits, and displays used in lab development frequently require triple output power supplies for operating prototypes. The HP 6236B and 6237B are valued additions to the design bench due to their multiple output voltages, small size, ease of operation and application-related performance.

These compact constant voltage/current limiting supplies combine 0 to  $\pm 20$  V tracking outputs rated at 0.5 A with a single output rated at 0 to +6 volts at up to 2.5 A in the HP 6236B, and 0 to +18 volts at 1 A in the HP 6237B.

Controls, meters, and binding posts are logically arranged on a neatly laid out front panel. One voltage control simultaneously adjusts the 20 V and -20 V outputs, which track within 1% to power operational amplifiers and circuits requiring balanced voltages. A tracking ratio control can disable the 1:1 tracking feature and set the negative output to a lower voltage than that of the positive output. Once the tracking ratio control has established a voltage ratio between the positive and negative outputs, the ratio remains constant as the  $\pm 20$  V voltage control varies both outputs. Another voltage control sets the 0 to +6 V (HP 6236B) or 0 to +18 V (HP 6237B) output.

All outputs are protected against overload and short-circuit damage by fixed current limiting circuits. For any overload condition, the +20 V and -20 V outputs in both models are limited to 0.55 A and the +18 V output in the HP 6237B is limited to 1.1 A. The overload protection circuit for the +6 V output in the HP 6236B has a current foldback characteristic that reduces the maximum available current from about 2.75 A at a 6 V terminal voltage to 1 A at zero volts (or short circuited). This foldback limiting characteristic maximizes the available current in the important 5 to 6-volt range while minimizing dissipation during overloads.

Another protective feature safeguards sensitive load circuitry by preventing an output voltage overshoot when the supply is turned on or off.

Separate dual-range panel meters allow both the voltage and current of any output to be monitored simultaneously. A three-position switch selects the output which the meters will monitor.

Both models measure only 89 H x 216 W x 319 mm D (3.5" x 8.5" x 12.5") and weigh 4.3 kg (9.5 lb).





## Specifications

RATINGS		PERFORMANCE							GENERAL	
DC Output		HP Model	Load Effect	Source Effect	PAR rms/p-p	Control Mode and Resolution	Remote Control Coefficients	Power 115 V ac ± 10%	Options	
Volts	Amps									
<b>SINGLE OUTPUT—10 WATTS</b>										
0-10	0-1	6214B	4 mV	4 mV	200 $\mu$ V/1 mV	CV/CC 5mV/75 $\mu$ A	**	48-440 Hz 0.3 A, 28 W	28	
0-25	0-0.4	6216B	4 mV	4 mV	200 $\mu$ V/1 mV	CV/CC 5mV/20 $\mu$ A	**	48-440 Hz 0.3 A, 28 W	28	
0-50	0-0.2	6218B	4 mV	4 mV	200 $\mu$ V/1 mV	CV/CC 10mV/10 $\mu$ A	**	48-440 Hz 0.3 A, 28 W	28	
0-100	0-0.1	6212B	8 mV	4 mV	200 $\mu$ V/1 mV	CV/CC 20mV/10 $\mu$ A	**	48-440 Hz 0.3 A, 28 W	28	
<b>SINGLE OUTPUT—UP TO 30 WATTS</b>										
0-7.5	0-3	6203B	5 mV	3 mV	200 $\mu$ V/1 mV	CV/CC 5 mV/2 mA	2000/V $\pm$ 1% 5000/A $\pm$ 10%	48-440 Hz 0.9 A, 70 W	11, 28	
Dual range 0-20 or 0-40	0-1.5 0-0.75	6200B	0.01% + 4 mV	0.01% + 4 mV	200 $\mu$ V/1 mV	CV/CC 10 mV/2 mA	2000/V $\pm$ 1% 0.5 k $\Omega$ /A $\pm$ 10% or 1 k $\Omega$ /A $\pm$ 10%	48-440 Hz 0.9 A, 70 W	11, 28	
Dual range 0-30 or 0-60	0-1 0-0.5	6206B	0.01% + 4 mV	0.01% + 4 mV	200 $\mu$ V/1 mV	CV/CL 10 mV/*	3000/V $\pm$ 1%	48-440 Hz 1 A, 66 W	11, 28	
0-160	0.2	6207B	0.02% + 2 mV	0.02% + 2 mV	500 $\mu$ V/40 mV	CV/CC 25 mV/500 $\mu$ A	3000/V $\pm$ 1% 75 k $\Omega$ /A $\pm$ 10%	48-63 Hz 1 A, 60 W	28	
0-320	0-0.1	6209B	0.02% + 2 mV	0.02% + 2 mV	1 mV/40 mV	CV/CC 40 mV/200 $\mu$ A	3000/V $\pm$ 1% 150 k $\Omega$ /A $\pm$ 10%	48-63 Hz 1 A, 60 W	28	
<b>DUAL OUTPUT—10 WATTS</b>										
Dual output 0-25 and 0-25	0.2 0.2	6234A	0.01% + 1 mV	0.01% + 1 mV	200 $\mu$ V/1 mV	CV/CL	**	104-127 Vac 47-63 Hz 0.26A, 35 W	28	
<b>DUAL OUTPUT—24 WATTS</b>										
Two dual ranges 0-20/0-40 and 0-20/0-40	0-0.6/0.3 0-0.6/0.3	6205C	0.01% + 4 mV	0.01% + 4 mV	200 $\mu$ V/1 mV	CV/CL 10 mV/*	2000/V $\pm$ 1%	48-440 Hz 0.5 A, 50 W	11, 28 40	
<b>TRIPLE OUTPUT—13 WATTS</b>										
Triple output 0 to 6 and 0 to 18 and 0 to -18	0-1 0-0.2 0-0.2	6235A	8 mV 10 mV 10 mV	8 mV 15 mV 15 mV	1 mV/5 mV 1 mV/5 mV 1 mV/5 mV	CV/CL	** ** **	47-63 Hz 0.26 A, 35 W	28	
<b>TRIPLE OUTPUT—35 WATTS*</b>										
Triple output 0 to +6 and 0 to +20 and 0 to -20	2.5 0.5 0.5	6236B	0.01% + 2 mV	0.01% + 2 mV	350 $\mu$ V/1.5 mV	CV/CL 70 mV/*	**	104-127 Vac 47-63 Hz 1.2 A, 112 W	100 120 220 240	
<b>TRIPLE OUTPUT—38 WATTS*</b>										
Triple Output 0 to +18 and 0 to +20 and 0 to -20	1 0.5 0.5	6237B	0.01% + 2 mV	0.01% + 2 mV	350 $\mu$ V/1.5 mV	CV/CL 70 mV/*	**	104-127 Vac 47-63 Hz 1.2 A, 112 W	100 120 220 240	

\*fixed current limit

\*\*remote control not available

\*ac input voltage option must be specified when ordering

## Option Descriptions

**011:** internal overvoltage protection crowbar. Protects delicate loads against power supply failure or operator error. Dual output models have dual crowbars.

HP 6200B, 6203B, 6206B  
HP 6205C

**028:** 230 Vac  $\pm$  10%, single phase input. Consists of reconnecting power transformer taps, and other components where necessary.

**040:** Multiprogrammer interface. Prepares HP 6205C power supplies for resistance programming by the HP 6940B or 6942A Multiprogrammer

**100:** 87-106 Vac, 47-63 Hz, single phase input

**120:** 104-127 Vac, 47-63 Hz, single phase input

**220:** 191-233 Vac, 47-63 Hz, single phase input

**240:** 208-250 Vac, 47-63 Hz, single phase input

**910:** one additional operating and service manual is shipped with each power supply

HP 6200B-6237B

## Accessories

**HP 14513A:** rack kit for one HP 6200-6209B, 6236B, or 6237B supply

**HP 14523A:** rack kit for two of the above power supplies

**HP 14521B:** rack kit for one, two or three HP 6212B-6218B power supplies

# POWER SUPPLIES

## General Purpose: 25–200 W Output

### Models 6227B–6299A

- Constant voltage/constant current operation
- Remote sensing and programming
- Auto-series, -parallel, & -tracking operation

- Front and rear output terminals
- Floating output—use as positive or negative source
- Bench or rack mounting

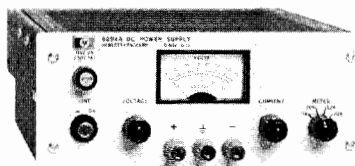

HP 6281A, 6284A, 6289A,  
6294A, 6299A

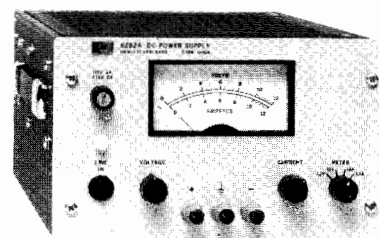

HP 6282A, 6286A,  
6291A, 6296A

## Description

### HP 6281A - 6299A Single Output

This series of medium-power constant voltage/constant current power supplies is available in two power ranges: 37–75 watts (packaged in 3½-inch high half-rack cases) and 100–200 watts (packaged in 5¼-inch high half-rack cases). All models except HP 6294A and 6299A have separate coarse and fine voltage and current controls that allow the voltage and current outputs to be varied from zero to the maximum rated values. The latter two models have ten-turn voltage controls. Crossover from constant voltage to constant current operation occurs automatically when the load current exceeds the value established by the current control settings. A four-position meter function switch selects either of two output voltage or output current ranges (X1, X0.1) for display on the panel meter.

The 37–75 watt models are of the series-regulated type. They have excellent regulation and ripple characteristics and include a special output-capacitor discharge circuit for improved programming speed. The 100–200 watt models employ a series-regulator/SCR-preregulator configuration to achieve the high efficiency necessary for a convection-cooled package of this size. They also have excellent regulation, low ripple and noise, and moderate programming speeds.

### HP 6253A and 6255A Dual Output

These versatile dual-output models each contain two identical, independently adjustable 60 watt power supplies in a full-rack width case. The regulator, voltage and current control, and metering circuits of each section of the supply are electrically identical to those of the individual 37–75 watt models described above.

By combining the versatility of a dual power supply with the flexibility of auto-series and auto-parallel operation, twice the maximum rated output voltage or current of each section can be obtained from the one supply. In addition, using the supply's auto-tracking capability, opposite-polarity voltages ( $\pm 20$  V for HP 6253A or  $\pm 40$  V for HP 6255A) are possible.

### HP 6227B and 6228B Dual Output

These versatile lab supplies each house two identical 50 W regulated power supplies. A convenient front panel switch selects either independent or tracking operation. In the track mode, the right supply tracks the left within  $0.2\% \pm 2$  mV. The tracking mode is especially useful for powering operational amplifiers, push-pull stages, deflection systems, or any application where plus and minus voltages must track with insignificant error. The independent mode permits operation of the two supplies individually, in auto-parallel or in auto-series.

## Specifications

RATINGS			PERFORMANCE							
DC Output		HP Model	Load Effect		Source Effect		PARD (rms/p-p)		Drift (stability)	
Volts	Amperes		Voltage	Current	Voltage	Current	Voltage	Current	Voltage	Current
0-7.5	0-5	6281A	5 mV	0.01% + 250 $\mu$ A	0.01% + 2 mV	0.01% + 250 $\mu$ A	200 $\mu$ V/1 mV	4 mA rms	0.1% + 2.5 mV	0.1% + 12.5 mA
0-10	0-10	6282A	0.01% + 1 mV	0.05% + 1 mA	0.01% + 1 mV	0.05% + 1 mA	500 $\mu$ V/25 mV	5 mA rms	0.1% + 2.5 mV	0.1% + 25 mA
0-20	0-3	6253A*	0.01% + 4 mV	0.01% + 250 $\mu$ A	0.02% + 2 mV	0.01% + 250 $\mu$ A	200 $\mu$ V/1 mV	2 mA rms	0.1% + 2.5 mV	0.1% + 7.5 mA
0-20	0-3	6284A	0.01% + 4 mV	0.01% + 250 $\mu$ A	0.01% + 2 mV	0.01% + 250 $\mu$ A	200 $\mu$ V/1 mV	2 mA rms	0.1% + 2.5 mV	0.1% + 7.5 mA
0-20	0-10	6286A	0.01% + 1 mV	0.05% + 1 mA	0.01% + 1 mV	0.05% + 1 mA	500 $\mu$ V/25 mV	5 mA rms	0.1% + 2.5 mV	0.1% + 25 mA
0-25	0-2	6227B*	0.01% + 1 mV	0.01% + 250 $\mu$ A	1 mV	100 $\mu$ A	250 $\mu$ V/4 mV	250 $\mu$ A/2 mA	0.2% + 2 mV	0.2% + 3 mA
0-40	0-1.5	6255A*	0.01% + 2 mV	0.01% + 250 $\mu$ A	0.01% + 2 mV	0.01% + 250 $\mu$ A	200 $\mu$ V/1 mV	500 $\mu$ A rms	0.1% + 2.5 mV	0.1% + 4 mA
0-40	0-1.5	6289A	0.01% + 2 mV	0.01% + 250 $\mu$ A	0.01% + 2 mV	0.01% + 250 $\mu$ A	200 $\mu$ V/1 mV	500 $\mu$ A rms	0.1% + 2.5 mV	0.1% + 4 mA
0-40	0-5	6291A	0.01% + 1 mV	0.05% + 1 mA	0.01% + 1 mV	0.05% + 1 mA	500 $\mu$ V/25 mV	3 mA rms	0.1% + 2.5 mV	0.1% + 12.5 mA
0-50	0-1	6228B*	0.01% + 1 mV	0.01% + 250 $\mu$ A	1 mV	100 $\mu$ A	250 $\mu$ V/4 mV	250 $\mu$ A/2 mA	0.2% + 2 mV	0.2% + 1.5 mA
0-60	0-1	6294A	0.01% + 2 mV	0.01% + 250 $\mu$ A	0.01% + 2 mV	0.01% + 250 $\mu$ A	200 $\mu$ V/1 mV	500 $\mu$ A rms	0.1% + 2.5 mV	0.1% + 2.5 mA
0-60	0-3	6296A	0.01% + 1 mV	0.05% + 1 mA	0.01% + 1 mV	0.05% + 1 mA	500 $\mu$ V/25 mV	3 mA rms	0.1% + 2.5 mV	0.1% + 7.5 mA
0-100	0-0.75	6299A	0.01% + 2 mV	0.01% + 250 $\mu$ A	0.01% + 2 mV	0.01% + 250 $\mu$ A	200 $\mu$ V/1 mV	500 $\mu$ A rms	0.1% + 2.5 mV	0.1% + 2 mA

\*Models 6227B, 6228B, 6253A, and 6255A contain two identical, independently-adjustable power supplies.

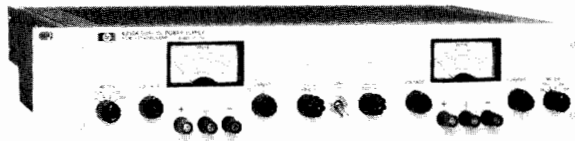

HP 6253A, 6255A

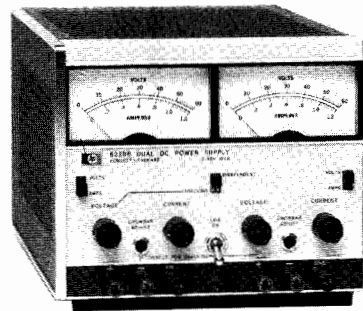

HP 6227B, 6228B

Each side of the dual supply can be operated as a constant voltage or constant current source, and each has its own crowbar for overvoltage protection. In the tracking mode, an overvoltage condition in either supply trips both crowbars. The power supply outputs are isolated up to 300 V from output to chassis or output to output.

**Specifications—General**

**Load effect transient recovery:** time, 50  $\mu$ s; level, 15 mV.  
**Meter accuracy:** 3% of full scale.  
**Power:** standard input voltage is 115 V ac  $\pm$  10%. Order Option 028 for 230 V ac  $\pm$  10% operation. Input power frequency, maximum input current, maximum power consumption are:  
 HP 6227B and 6228B, 48–63 Hz, 2.7 A, 260 W;  
 HP 6253A, 48–440 Hz, 2.6 A, 235 W; HP 6255A, 48–440 Hz, 2.6 A, 235 W; HP 6281A, 48–440 Hz, 1.3 A, 118 W; HP 6282A, 57–63 Hz, 3.5 A, 200 W; HP 6284A, 48–440 Hz, 1.5 A, 128 W; HP 6286A, 57–63 Hz, 5.5 A, 320 W; HP 6289A, 48–440 Hz, 1.3 A, 110 W; HP 6291A, 57–63 Hz, 5.5 A, 280 W; HP 6294A, 48–440 Hz, 1.3 A, 114 W; HP 6296A, 57–63 Hz, 4.5 A, 250 W; HP 6299A, 48–440 Hz, 1.5 A, 135 W.  
**Size:** 6227B, 6228B: 155 H x 197 W x 309.55 mm D (6<sup>3</sup>/<sub>32</sub>" x 7<sup>25</sup>/<sub>32</sub>" x 12<sup>7</sup>/<sub>16</sub>").  
 HP 6253A, 6255A: 87 H x 483 W x 403 mm D (3<sup>7</sup>/<sub>16</sub>" x 19" x 15<sup>7</sup>/<sub>8</sub>").  
 HP 6281A, 6284A, 6289A, 6294A, 6299A: 87 H x 209 W x 398 mm D (3<sup>7</sup>/<sub>16</sub>" x 8<sup>7</sup>/<sub>32</sub>" x 15<sup>7</sup>/<sub>8</sub>").  
 HP 6282A, 6286A, 6291A, 6296A: 131 H x 210 W x 435 mm D (5<sup>1</sup>/<sub>32</sub>" x 8<sup>1</sup>/<sub>4</sub>" x 17<sup>1</sup>/<sub>8</sub>").

**Option Descriptions**

**005:** 50 Hz ac input: optimizes power supplies that require adjustment/modification for 50 Hz operation.  
**010:** Chassis slides. Enable convenient access to rack-mounted power supply for maintenance.

**011:** Internal overvoltage protection crowbar. Protects sensitive loads against power supply failure or operator error. Monitors the output voltage and places a virtual short circuit (conducting SCR) across load after preset trip voltage is exceeded.

HP 6281A, 6284A, 6289A, 6294A, 6299A  
 HP 6282A, 6286A, 6291A, 6296A  
 HP 6253A, 6255A

**028:** 230 Vac  $\pm$  10%, single-phase input. Factory modification reconnects the multi-tap input power transformer for 230 V operation.

**040:** Interfacing for Multiprogrammer operation. Prepares standard HP power supplies for resistance programming by the HP 6940B or 6942A. Price per output.

**910:** one additional operating and service manual shipped with the power supply  
 HP 6253A, 6255A, 6227B, 6228B  
 HP 6281A, 6282A, 6284A, 6286A, 6289A, 6291A, 6294A, 6296A, 6299A

**Accessories**

**HP 14513A:** 3.5 in. high rack kit for one HP 6281A, 6284A, 6289A, 6294A, 6299A  
**HP 14523A:** 3.5 in. high rack kit for two above supplies  
**HP 14515A:** 5.25 in. high rack kit for one HP 6282A, 6286A, 6291A, 6296A  
**HP 14525A:** 5.25 in. high rack kit for two above supplies  
**HP 5060-8760:** blank filler panel for HP 6227B, 6228B  
**HP 5060-8762:** adapter frame for rack mounting one or two HP 6227B, 6228B

**Specifications, continued**

REMOTE CONTROL FEATURES								GENERAL				
Resistance Coefficient		Voltage Coefficient		Speed, UP*		Speed, DOWN*		Overvoltage		Weight		Options <sup>a</sup>
Voltage	Current	Voltage	Current	NL	FL	NL	FL	Range	Margin	Net	Shipping	
200 $\Omega$ /V $\pm$ 1%	200 $\Omega$ /A $\pm$ 10%	1 V/V $\pm$ 1%	0.2 V/A $\pm$ 10%	1 ms	2 ms	10 ms	6 ms	2.5–10 V	4% + 2 V	6.4 kg/14 lb	7.2 kg/16 lb	11, 28, 40
200 $\Omega$ /V $\pm$ 1%	100 $\Omega$ /A $\pm$ 10%	1 V/V $\pm$ 1%	100 mV/A $\pm$ 10%	70 ms	200 ms	9 s	40 ms	1–13 V	7% + 1 V	11.3 kg/25 lb	13.6 kg/30 lb	5, 11, 28, 40
200 $\Omega$ /V $\pm$ 1%	500 $\Omega$ /A $\pm$ 10%	1 V/V $\pm$ 1%	0.33 V/A $\pm$ 10%	30 ms	80 ms	400 ms	100 ms	2.5–23 V	4% + 2 V	12.7 kg/28 lb	17.7 kg/39 lb	10, 11, 28, 40
200 $\Omega$ /V $\pm$ 1%	500 $\Omega$ /A $\pm$ 10%	1 V/V $\pm$ 1%	0.33 V/A $\pm$ 10%	30 ms	80 ms	400 ms	100 ms	2.5–23 V	4% + 2 V	6.4 kg/14 lb	7.2 kg/16 lb	11, 28, 40
200 $\Omega$ /V $\pm$ 1%	100 $\Omega$ /A $\pm$ 10%	1 V/V $\pm$ 1%	100 mV/A $\pm$ 10%	150 ms	150 ms	9 s	70 ms	2–22 V	7% + 1 V	10.8 kg/26 lb	13.1 kg/29 lb	5, 11, 28
200 $\Omega$ /V $\pm$ 1%	500 $\Omega$ /A $\pm$ 10%	1 V/V $\pm$ 1%	5 V/A $\pm$ 10%	40 ms	200 ms	400 ms	75 ms	5–28 V	7% + 1.5 V	11 ka/24 lb	12.9 kg/28 lb	40
200 $\Omega$ /V $\pm$ 1%	500 $\Omega$ /A $\pm$ 10%	1 V/V $\pm$ 1%	0.66 V/A $\pm$ 10%	15 ms	45 ms	200 ms	40 ms	2.5–44 V	4% + 2 V	12.7 kg/28 lb	17.7 kg/39 lb	10, 11, 28, 40
200 $\Omega$ /V $\pm$ 1%	500 $\Omega$ /A $\pm$ 10%	1 V/V $\pm$ 1%	0.66 V/A $\pm$ 10%	15 ms	45 ms	200 ms	40 ms	2.5–44 V	4% + 2 V	6.4 kg/14 lb	7.2 kg/16 lb	11, 28, 40
200 $\Omega$ /V $\pm$ 1%	200 $\Omega$ /A $\pm$ 10%	1 V/V $\pm$ 1%	200 mV/A $\pm$ 10%	275 ms	275 ms	13 s	275 ms	6–43 V	7% + 1 V	11.3 kg/25 lb	12.7 kg/28 lb	5, 11, 28
200 $\Omega$ /V $\pm$ 1%	1 k $\Omega$ /A $\pm$ 10%	1 V/V $\pm$ 1%	1 V/A $\pm$ 10%	50 ms	350 ms	1 s	50 ms	5–55 V	7% + 1.5 V	11 ka/24 lb	12.9 kg/28 lb	40
300 $\Omega$ /V $\pm$ 1%	1 k $\Omega$ /A $\pm$ 10%	1 V/V $\pm$ 1%	1 V/A $\pm$ 10%	25 ms	80 ms	2 s	175 ms	5–65 V	4% + 2 V	5.9 kg/13 lb	6.8 kg/15 lb	11, 28, 40
300 $\Omega$ /V $\pm$ 1%	500 $\Omega$ /A $\pm$ 10%	1 V/V $\pm$ 1%	333 mV/A $\pm$ 10%	600 ms	600 ms	5 s	200 ms	9–66 V	7% + 1 V	11.3 kg/25 lb	12.7 kg/28 lb	5, 11, 28
300 $\Omega$ /V $\pm$ 1%	1 k $\Omega$ /A $\pm$ 10%	1 V/V $\pm$ 1%	1.3 V/A $\pm$ 10%	25 ms	200 ms	1.5 s	200 ms	20–106 V	4% + 2 V	5.9 kg/13 lb	6.8 kg/15 lb	11, 28, 40

\*UP = increasing output voltage. NL = No output load current. FL = Full rated output load current.

# POWER SUPPLIES

## Autoranging Power Supplies

Models 6011A, 6012B, 6023A, and 6024A



- Complete front panel control/display
- Constant voltage/constant current operation
- Remote programming and sensing

- Autoranging output
- High efficiency, compact, and light weight
- Ten-turn voltage and current controls

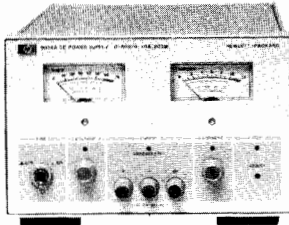

HP 6024A

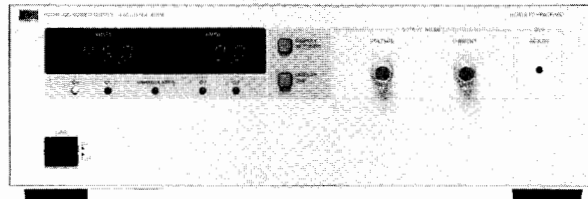

HP 6012B

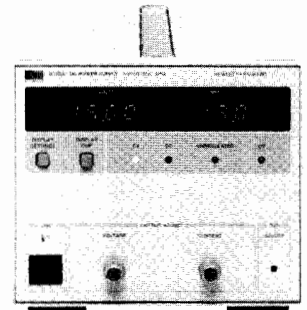

HP 6023A

### Description

#### HP Models 6011A, 6012B, and 6023A

This versatile family of dc power supplies provides laboratory grade performance along with many features to meet both laboratory and system needs.

Ten-turn front panel controls provide the means to precisely adjust the output voltage and current. The settings of these controls can be observed on the front panel meters by pressing the Display Settings button. This allows the current limit to be set when operating in the CV mode without shorting the output terminals and the voltage limit to be set when operating in the CC mode without opening the load leads.

Three and one-half digit front panel meters provide a convenient means for monitoring the output voltage and current. The accuracy of these meters allow them to replace external DVMs and monitor resistors in many applications that require monitoring of the power supply output.

The overvoltage protection (OVP) trip level can also be displayed on the front panel meters, allowing the trip level to be accurately adjusted without actually activating the OVP circuitry or disconnecting loads. In addition to the protection provided to the power supply and load by the OVP, these supplies also have protection against operating under excessive ac line or thermal conditions.

As autoranging power supplies, these units can operate at their maximum rated power over a wide and continuous range of voltage and current combinations. This often allows both present and future requirements to be satisfied with fewer supplies.

HP Model 6023A is stable when operating in the CC mode into inductive loads up to one henry. HP Models 6011A and 6012B are stable when operating in the CC mode into inductive loads up to 100 mH, and a special modification is available for these two models to assure stability with loads up to ten henries.

### System Features

The output voltage and current of these supplies can be remotely controlled with either 0-5 volt or 0-4000 ohm analog programming signals. The actual output levels can be monitored without complicated external circuitry by connecting DVMs to the buffered 0-5 volt monitor outputs. All programming and monitoring signals are referenced to the same common and are accessed through the rear panel barrier strip.

Either terminal may be grounded, or floated up to  $\pm 240$  volts from chassis ground.

If more output voltage or current is needed than a single unit can provide, auto-series or auto-parallel configurations can be used. Up to four 1000-watt units, or up to two 200-watt units can be connected in auto-parallel, and any combination can be used in auto-series providing up to 240 volts total. Remote sensing can be used to maintain the CV load effect specification at the load with up to 0.5 volt drop per load lead and sense wires that are less than 0.2 ohm per lead. Operation is possible with up to 2.0 volts per lead; however, load effect specification may be degraded. For more system control and monitoring capabilities, see Option 002.

### Specifications

Ratings						Regulation				10% Change Transient Recovery
Volts	Amperes	Output Power			HP Model	Load Effect		Source Effect		
		P <sub>1</sub> *	P <sub>2</sub> *	P <sub>3</sub> *		Voltage	Current	Voltage	Current	
0-20	0-30	200W	242W	200W	6023A	0.01% +2mV	0.01% +9mA	0.01% +1mV	0.01% +6mA	1ms / 50mV
0-20	0-120	1000W	1064W	840W	6011A	0.01% +3mV	0.01% +15mA	0.01% +2mV	0.01% +25mA	2ms / 100mV
0-60	0-10	200W	240W	200W	6024A	0.01% +3mV	0.01% +3mA	0.01% +5mV	0.01% +5mA	1ms / 75mV
0-60	0-50	1000W	1200W	1000W	6012B	0.01% +5mV	0.01% +10mA	0.01% +3mV	0.01% +10mA	2ms / 100mV

\*See Figure 1



**HP Model 6024A**

As an autoranging dc power supply, the HP 6024A can provide 200 watts over a wide and continuous range of voltage and current combinations, with maximums of 60 volts and 10 amperes. This provides greater flexibility than traditional power supplies that have only one maximum power point.

Ten-turn potentiometers provide precise control of the output voltage and current. The output levels can be observed on the separate front panel voltage and current meters. Terminals are available on both the front and rear panel for load connections.

The built-in OVP is adjustable from the front panel. Other protection features include over-temperature and high ac line detection.

The HP 6024A has many system oriented features. It can be remotely programmed with 0-5 volt or 0-2500 ohm analog signals. The output current can be easily monitored without an external shunt with the proportional 0-5 volt buffered monitor output. Remote sensing can be used to eliminate the effects of voltage drops in the load leads, and either terminal may be floated up to ±240 volts from chassis ground. Several units can be combined in auto-series, auto-parallel, and auto-tracking configurations, further increasing the HP 6024A's flexibility.

For more system features, see Option 002.

**General Specifications**

**Dimensions**

**HP 6011A and 6012B:** 132.6 mm H x 425.5 mm W x 516.4 mm D (5.2" x 16.75" x 20.33").

**HP 6023A:** 170.6 mm H x 208.8 mm W x 453.9 mm D (6.72" x 8.22" x 17.872").

**HP 6024A:** 133.4 mm H x 212.3 mm W x 415.33 D (5.25" x 8.36" x 16.35").

**Ordering Information**

**Option Descriptions**

**002:** provides extra programming and monitoring capabilities for system use. A card inserted into the power supply is accessible through a 37-pin connector on the rear panel. It provides easy access to the control and monitor signals available on standard units, as well as these additional features:

- OVP trip and reset
- power supply inhibit
- status bits indicating CV mode, CC mode, unregulated output, OVP tripped, overtemperature condition, and ac line drop-out
- remote programming via a 0-2 mA current sink
- bias supplies for your circuitry: +5 volts at 100 mA, +15 volts at 75 mA, and -15 volts at 75 mA.
- buffered 0-5 volt outputs representing both the output voltage and output current. (HP 6011A, 6012B, and 6023A provide this feature standard, but HP 6024A only provides a scaled 0-5 volt output to represent the output current, not the output voltage.)
- programmable remote/local for use when programming with a current sink.

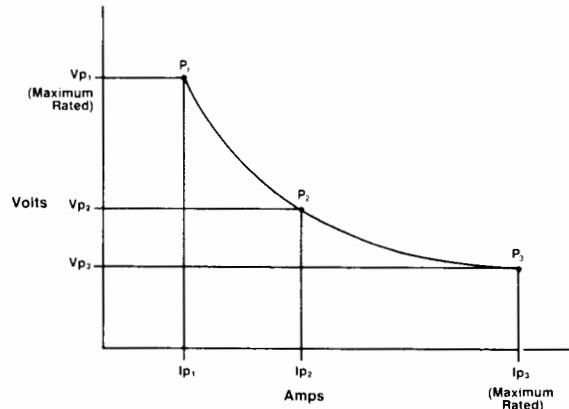

Fig. 1 - Generalized autoranging output characteristic curve

These features can all be taken advantage of with an HP 6940B or 6942A Multiprogrammer instrument sub-system configured with an HP 69520A or 69709A Power Supply Programming Card. The Multiprogrammer provides a cost-effective solution for controlling a group of power supplies, and also can provide many other digital and analog monitoring and control functions, all on the HP-IB. The voltage and current programming resolution available with either card is 1/1000th of full scale.

The features available with Option 002 can also be interfaced to your own external circuitry rather than an HP Multiprogrammer.

**100:** 87-106 Vac, 48-63 Hz. This option is for use in Japan only. The power supply output power is 75% of the output power available with the other line voltage options. It is available for HP 6024A only.

**120:** 104 to 127 Vac, 48-63 Hz.

**220:** 191 to 233 Vac, 48-63 Hz.

**240:** 208 to 250 Vac, 48-63 Hz.

**800:** Rack-mount kit for two units side by side. This applies to HP 6023A and 6024A only.

HP 6023A  
HP 6024A

**908:** Rack-mount kit for a single unit. A blank filler panel is supplied when ordered for half rack width units.

HP 6011A, 6012B  
HP 6023A  
HP 6024A

**910:** One extra operating and service manual shipped with each power supply.

PAR (rms/p-p) 20Hz-20MHz		Programming Response Time						General*					
		UP			DOWN			AC Input Current				Weight kg (lbs)	
		Settling Band	Full Load	No Load	Full Load	Light Load		100 Vac	120 Vac	220 Vac	240 Vac	Net	Shipping
Time	Load												
3 mV / 30 mV	15 mA / -	5 mV	100 ms	100 ms	200 ms	500 ms	50 Ω	-	6.5 A	3.8 A	3.6 A	8.6 (19)	10.5 (23)
8 mV / 50 mV	120 mA / -	30 mV	300 ms	300 ms	500 ms	1.5 sec	50 Ω	-	24 A	15 A	14 A	16.8 (37)	22.2 (49)
3 mV / 30 mV	5 mA / -	60 mV	200 ms	200 ms	300 ms	600 ms	Open	5.3 A	5.3 A	2.9 A	2.7 A	5.4 (12)	7.3 (16)
8 mV / 40 mV	25 mA / -	90 mV	300 ms	300 ms	2.0 sec	3.0 sec	100 Ω	-	24 A	15 A	14 A	15.9 (35)	21.3 (47)

\* An ac input option must be specified when ordering.

# POWER SUPPLIES

General Purpose: 120–2000 W Output

Models 6259B-6274B



- Built-in overvoltage protection
- Constant voltage/constant current operation
- Remote programming and sensing

- Remote sensing
- Auto-series, -parallel, and -tracking operation
- $\leq 50 \mu\text{s}$  load transient recovery

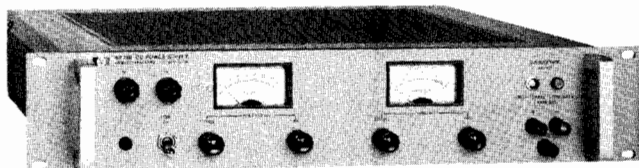

HP 6263B, 6266B, 6271B

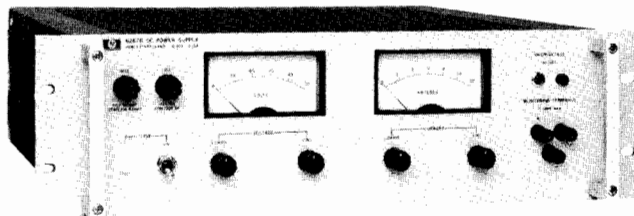

HP 6264B, 6267B

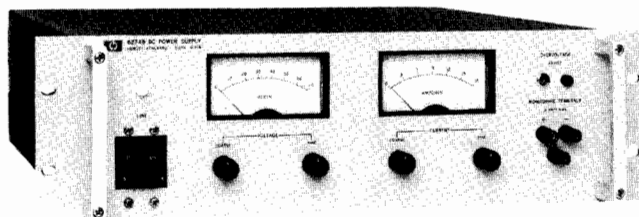

HP 6274B

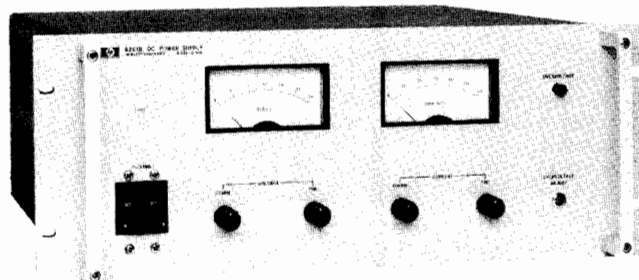

HP 6259B, 6260B, 6261B, 6268B, 6269B

## Description

### Models 6259B-6274B

This series of high-performance constant voltage/constant current supplies includes twelve models with output rating from 10 to 60 V. All models employ a transistor series-regulator/triac-preregulator circuit to achieve high efficiency, excellent regulation, low ripple and noise, and moderate programming speeds in a compact full-rack width package.

Separate coarse and fine voltage and current controls allow the voltage and current outputs to be varied from zero to the maximum rated value, crossover from constant voltage to constant current operation occurs automatically when the load current exceeds the value established by the current control settings.

Additional features include built-in overvoltage crowbar protection; remote error sensing; and auto-series, auto-parallel, and auto-tracking operation. The crowbar trip point adjustment and associated overvoltage indicator are conveniently located on the front panel.

## Specifications†

RATINGS			PERFORMANCE							
DC Output		HP Model	Load Effect		Source Effect		PARD (rms/p-p)		Drift (stability)	
Volts	Amperes		Voltage	Current	Voltage	Current	Voltage	Current	Voltage	Current
0-10	0-50	6259B	0.01% + 200 $\mu\text{V}$	0.02% + 1 mA	0.01% + 200 $\mu\text{V}$	0.02% + 1 mA	500 $\mu\text{V}/5 \text{ mV}$	25 mA rms	0.03% + 2 mV	0.03% + 10 mA
0-10	0-100	6260B	0.01% + 200 $\mu\text{V}$	0.02% + 2 mA	0.01% + 200 $\mu\text{V}$	0.02% + 2 mA	500 $\mu\text{V}/5 \text{ mV}$	50 mA rms	0.03% + 2 mV	0.03% + 20 mA
0-20	0-10	6263B	0.01% + 200 $\mu\text{V}$	0.02% + 500 $\mu\text{A}$	0.01% + 200 $\mu\text{V}$	0.02% + 500 $\mu\text{A}$	200 $\mu\text{V}/10 \text{ mV}$	3 mA rms	0.03% + 500 $\mu\text{V}$	0.03% + 6 mA
0-20	0-20	6264B	0.01% + 200 $\mu\text{V}$	0.02% + 500 $\mu\text{A}$	0.01% + 200 $\mu\text{V}$	0.02% + 500 $\mu\text{A}$	200 $\mu\text{V}/10 \text{ mV}$	5 mA rms	0.03% + 500 $\mu\text{V}$	0.03% + 6 mA
0-20	0-50	6261B	0.01% + 200 $\mu\text{V}$	0.02% + 1 mA	0.01% + 200 $\mu\text{V}$	0.02% + 1 mA	500 $\mu\text{V}/5 \text{ mV}$	25 mA rms	0.03% + 2 mV	0.03% + 10 mA
0-40	0-5	6266B	0.01% + 200 $\mu\text{V}$	0.02% + 500 $\mu\text{A}$	0.01% + 200 $\mu\text{V}$	0.02% + 500 $\mu\text{A}$	200 $\mu\text{V}/10 \text{ mV}$	3 mA rms	0.03% + 500 $\mu\text{V}$	0.03% + 3 mA
0-40	0-10	6267B	0.01% + 200 $\mu\text{V}$	0.02% + 500 $\mu\text{A}$	0.01% + 200 $\mu\text{V}$	0.02% + 500 $\mu\text{A}$	200 $\mu\text{V}/10 \text{ mV}$	3 mA rms	0.03% + 2 mV	0.03% + 3 mA
0-40	0-30	6268B	0.01% + 200 $\mu\text{V}$	0.02% + 2 mA	0.01% + 200 $\mu\text{V}$	0.02% + 2 mA	1 mV/5 mV	20 mA rms	0.03% + 2 mV	0.03% + 5 mA
0-40	0-50	6269B	0.01% + 200 $\mu\text{V}$	0.02% + 2 mA	0.01% + 200 $\mu\text{V}$	0.02% + 2 mA	1 mV/5 mV	25 mA rms	0.03% + 2 mV	0.03% + 10 mA
0-60	0-15	6274B	0.01% + 200 $\mu\text{V}$	0.02% + 500 $\mu\text{A}$	0.01% + 200 $\mu\text{V}$	0.02% + 500 $\mu\text{A}$	200 $\mu\text{V}/20 \text{ mV}$	5 mA rms	0.03% + 2 mV	0.03% + 5 mA

†Refer to page 312 for complete specification definitions.





Auto-series, auto-parallel, and auto-tracking connections should ordinarily include no more than three supplies. If a specific application requires the use of more than three supplies in any of the three connections, consult your local HP Field Engineer for additional information.

All dc output, ac input, sensing, control, and programming connections are made to rear-panel terminals. Either the positive or negative output terminal may be grounded or the supplies may be operated floating at up to 300 volts above ground. Models 6263B, 6264B, 6266B and 6267B are convection cooled. All other models in this series employ cooling fans. Models which output more than 200 watts are equipped with terminal blocks for ac input and are not shipped with line cords.

## Specification—General

**Load effect transient recovery:** time, 50  $\mu$ s; Level, 10 mV.

**Resolution:** voltage control, less than 0.02%; current control, less than 0.15%.

**Temperature coefficient per °C:** 0.01% of output plus 200  $\mu$ V.

**Temperature ratings:** operating, 0 to 55°C; storage, -40 to 75°C.

**Remote control programming:** these power supplies are capable of being programmed in constant voltage and constant current operation by using an external resistance or dc voltage with coefficients as shown in the table below.

Rear terminal wiring configurations for remote control operation are specified in the operating and service manual supplied with the power supply. For remote control programming procedures and timing considerations, contact your local HP field engineer.

**Power:** input voltage is 115 V ac or 230 V ac  $\pm$ 10%, 57-63 Hz. For other input voltage and frequency options available, see option listing below. Standard input voltage, maximum input current, and maximum power are:

HP 6259B, 230 V ac, 6 A, 850 W;  
 HP 6260B, 230 V ac, 12 A, 1600 W;  
 HP 6263B, 115 V ac, 4.5 A, 350 W;  
 HP 6266B, 115 V ac, 4 A, 325 W;  
 HP 6268B, 230 V ac, 12 A, 1600 W;  
 HP 6261B, 230 V ac, 12 A 1500 W;  
 HP 6264B, 115 V ac, 8 A, 600 W;  
 HP 6267B, 115 V ac, 8 A, 550 W;  
 HP 6269B, 230 V ac, 18 A, 2500 W;  
 HP 6274B, 115 V ac, 15 A, 1200 W;

**AC line connections:** three wire, five foot ac power cord included—HP 6263B and 6266B.

Three-terminal barrier strip provided on power supply for ac power connections—HP 6259B, 6260B, 6261B, 6264B, 6267B, 6268B, 6269B and 6274B.

## Size

HP 6263B, 6266B: 83.7 H x 483 W x 479.4 mm D (3.296" x 19" x 18.875").

HP 6264B, 6267B, 6274B: 127 H x 483 W x 479.4 mm D (5.00" x 19" x 18.875").

HP 6259B, 6260B, 6261B, 6268B, 6269B: 173 H x 483 W x 479.4 mm D; (6.812" x 19" x 18.875").

## Option Descriptions

**005:** 50 Hz ac input: optimizes power supplies that require adjustment/modification for 50 Hz operation.

**010:** chassis slides. For access to rack mounted power supplies: HP 6263B, 6264B, 6266B, 6267B, HP 6274B, 6259B, 6260B, 6261B, 6268B, 6269B

**016:** 115 Vac  $\pm$  10% single phase input. Consists of replacing power transformer and circuit breaker, and reconnecting bias transformer, RFI choke and fans.

**022:** voltage and current programming adjust. Allows the V and I programming coefficients and zero output to be conveniently adjusted to 0.1% accuracy via access holes in the rear panel. Consists of four potentiometers and resistors located inside the rear panel.

**026:** 115 Vac  $\pm$  10%, single phase input. Consists of replacing the input circuit breaker and reconnecting the power transformer, bias transformer, RFI choke, and fans.

**027:** 208 Vac,  $\pm$  10%, single phase input. Consists of reconnecting power transformer taps, and other components where necessary.

**028:** 230 Vac  $\pm$  10%, single phase input. Consists of reconnecting power transformer taps, and other components where necessary.

**040:** Multiprogrammer interface. Prepares standard HP power supplies for resistance programming by the HP 6942A or 6940B Multiprogrammers. This option includes Option 022, special calibration, and protection check-out procedures (where required).

**910:** one additional operating and service manual shipped with each power supply. HP 6259B-6274B

## Specifications, Continued

REMOTE CONTROL FEATURES								GENERAL				
Resistance Coeff.		Voltage Coeff.		Speed Up*		Speed Down*		Overvoltage		Weight		Options
Voltage	Current	Voltage	Current	NL	FL	NL	FL	Range	Margin	Net	Shipping	
200 $\Omega$ /V $\pm$ 1%	4 $\Omega$ /A $\pm$ 10%	1 V/V $\pm$ 1%	10 mV/A $\pm$ 10%	70 ms	70 ms	200 ms	100 ms	2-12 V	5% + 2V	31.3 kg/69 lb	35.3 kg/78 lb	5, 10, 22, 26, 27, 40
200 $\Omega$ /V $\pm$ 1%	2 $\Omega$ /A $\pm$ 10%	1 V/V $\pm$ 1%	5 mV/A $\pm$ 10%	70 ms	70 ms	200 ms	75 ms	2-12 V	5% + 2 V	43.9 kg/97 lb	48 kg/106 lb	5, 10, 16, 22, 27, 40
200 $\Omega$ /V $\pm$ 1%	100 $\Omega$ /A $\pm$ 10%	1 V/V $\pm$ 1%	50 mV/A $\pm$ 10%	150 ms	150 ms	7 s	350 ms	2-23 V	5% + 1 V	15.4 kg/34 lb	18.6 kg/41 lb	5, 10, 22, 27, 28, 40
200 $\Omega$ /V $\pm$ 1%	10 $\Omega$ /A $\pm$ 10%	1 V/V $\pm$ 1%	25 mV/A $\pm$ 10%	140 ms	140 ms	10 s	150 ms	2.5-23V	5% + 1 V	21.3 kg/47 lb	24.5 kg/54 lb	5, 10, 22, 27, 28, 40
200 $\Omega$ /V $\pm$ 1%	4 $\Omega$ /A $\pm$ 10%	1 V/V $\pm$ 1%	10 mV/A $\pm$ 10%	150 ms	150 ms	250 ms	250 ms	2-23 V	5% + 2 V	35.3 kg/78 lb	39.4 kg/87 lb	5, 10, 22, 26, 27, 40
200 $\Omega$ /V $\pm$ 1%	200 $\Omega$ /A $\pm$ 10%	1 V/V $\pm$ 1%	100 mV/A $\pm$ 10%	275 ms	275 ms	13 s	1.5 s	2.5-45 V	5% + 1 V	15.4 kg/34 lb	18.6 kg/41 lb	5, 10, 22, 27, 28, 40
200 $\Omega$ /V $\pm$ 1%	100 $\Omega$ /A $\pm$ 10%	1 V/V $\pm$ 1%	50 mV/A $\pm$ 10%	275 ms	275 ms	13 s	750 ms	2.5-45 V	5% + 1 V	17.7 kg/39 lb	20.8 kg/46 lb	5, 10, 22, 27, 28, 40
200 $\Omega$ /V $\pm$ 1%	6 $\Omega$ /A $\pm$ 10%	1 V/V $\pm$ 1%	16.7 mV/A $\pm$ 10%	300 ms	300 ms	1 s	650 ms	4-45 V	5% + 1 V	34.4 kg/76 lb	38.1 kg/84 lb	5, 10, 22, 26, 27, 40
200 $\Omega$ /V $\pm$ 1%	4 $\Omega$ /A $\pm$ 10%	1 V/V $\pm$ 1%	10 mV/A $\pm$ 10%	350 ms	350 ms	1 s	600 ms	4-45 V	5% + 1 V	40.3 kg/89 lb	44 kg/98 lb	5, 10, 22, 27, 40
300 $\Omega$ /V $\pm$ 1%	67 $\Omega$ /A $\pm$ 10%	1 V/V $\pm$ 1%	33.3 mV/A $\pm$ 10%	600 ms	600 ms	40 s	800 ms	6-66 V	5% + 1 V	21.7 kg/48 lb	24.5 kg/54 lb	5, 10, 22, 27, 28, 40

\*Up = increasing output voltage. NL = No output load current. FL = Full rated output load current



# POWER SUPPLIES

## General Purpose: 300—11,000 W Output

### Models 6434B—6483C

- Outstanding value—low cost/watt
- Up to 75% efficiency at full output
- Constant voltage/constant current operation

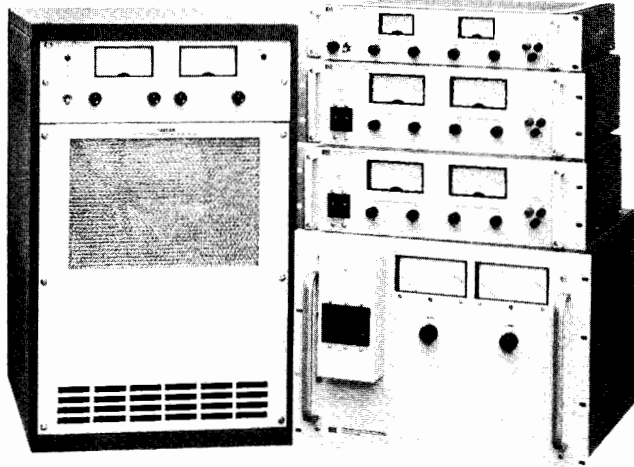

HP 6434B—6483C

## Description

This series of SCR-regulated power supplies is designed for medium to high-power applications requiring a fixed or variable dc source with moderate regulation and ripple. For supplies with better regulation, faster response time, and lower ripple, see models HP 6259B—6274B and 895A on page 320.

## Operating Features

All supplies in this series are of the constant voltage/constant current type. Large easy-to-read panel meters continuously monitor output voltage current.

Input and output power, remote sensing, remote programming, and auto-series, -parallel, and -tracking connections are made to bus bars and terminal blocks on the rear panel.

## Specifications†

RATINGS			PERFORMANCE						
DC Output		HP Model	Load Effect		Source Effect		PARD $\Delta$ rms/p-p	Temperature Coefficient	Drift
Volts‡	Amperes‡		Voltage	Current	Voltage	Current			
0-8	0-1000	6464C	0.05% + 5 mV	0.1% + 1 A	0.05% + 5 mV	0.1% + 1 A	80 mV/1 V	0.03% + 100 $\mu$ V	0.03% + 1 mV
0-15	0-200	6453A	0.2% + 10 mV††	1% or 2 A††	0.2% + 10 mV††	1% or 2 A††	150 mV rms	0.05% + 2 mV	0.25% + 10 mV
0-16 or 18	0-600 or 500*	6466C	0.05% + 5 mV	0.1% + 0.6 A	0.05% + 5 mV	0.1% + 0.6 A	180 mV/1 V	0.03% + 200 $\mu$ V	0.2% + 1 mV
0-36	0-100	6456B	0.2% + 10 mV††	1% or 1 A††	0.2% + 10 mV††	1% or 1 A††	180 mV rms	0.05% + 2 mV	0.25% + 10 mV
0-36	0-300	6469C	0.05% + 5 mV	0.1% + 0.3 A	0.05% + 5 mV	0.1% + 0.3 A	180 mV/1 V	0.03% + 400 $\mu$ V	0.15% + 1 mV
0-40	0-25	6434B	40 mV	200 mA	18 mV	200 mA	40 mV/500 mV	0.03% + 5 mV	0.1% + 20 mV
0-64	0-50	6459A	0.2% + 10 mV††	1% or 0.5 A††	0.2% + 10 mV††	1% or 0.5 A††	160 mV rms	0.05% + 2 mV	0.25% + 10 mV
0-64	0-150	6472C	0.05% + 100 mV	0.1% + 0.15 A	0.05% + 100 mV	0.1% + 0.15 A	160 mV/2 V	0.03% + 4 mV	0.15% + 16 mV
0-110	0-100	6475C	0.05% + 100 mV	0.1% + 0.1 A	0.05% + 100 mV	0.1% + 0.1 A	200 mV/2 V	0.03% + 5 mV	0.15% + 20 mV
0-120	0-2.5	6443B	120 mV	25 mA	60 mV	25 mA	240 mV/400 mV	0.03% + 20 mV	0.1% + 60 mV
0-220	0-50	6477C	0.05% + 100 mV	0.1% + 50 mA	0.05% + 100 mV	0.1% + 50 mA	330 mV/2 V	0.03% + 8 mV	0.15% + 35 mV
0-300	0-35	6479C	0.05% + 100 mV	0.1% + 35 mA	0.05% + 100 mV	0.1% + 35 mA	330 mV/3 V	0.03% + 11 mV	0.15% + 45 mV
0-440, 500 or 600	0-25, 20, 15*	6483C	0.05% + 100 mV	0.1% + 35 mA	0.5% + 100 mV	0.1% + 35 mA	600 mV/5 V	0.03% + 20 mV	0.15% + 80 mV
1-600	5 mA-1.5 A	6448B	1 V	40 mA	600 mV	15 mA	600 mV/2 V	0.03% + 100 mV	0.1% + 300 mV

† Refer to page 312 for complete specification definitions.

†† Specified for combined line and load regulation.

Δ For operation with a 50 Hz input (possible only with Option 005), the rms ripple and transient response specifications are increased by 50%.

\* The output current rating is given in the same order corresponding with the voltage rating.

## Protective Features

In addition to the overload protection inherent in constant voltage/constant current operation, there are many other built-in protective features included in these supplies. The features vary within the three model classifications as follows:

**HP 6434B—6448B:** (1) Reverse voltage protection. (2) Fused ac input.

**HP 6453A, 6456B, 6459A:** (1) AC line loss protection circuit monitors 3-phase input and cuts off SCR's and opens output bus if a phase drops out; operation resumes when ac input returns to normal. (2) 3-phase input circuit breaker. (3) Optional internal crowbar (Option 006) protects load from overvoltage condition.

**HP 6464C—6483C:** (1) High-temperature protection thermostat opens input to power transformer and lights front panel indicator if supply overheats. (2) Prolonged overload protection circuit is activated and lights front panel indicator if output current exceeds approximately 115% of maximum rating. (3) Optional internal crowbar (except on HP 6464C) protects load from overvoltage condition. (4) Turn-on circuit limits peak line current during start-up into low impedance loads. (5) Phase-balance circuit permits operation with line-to-line input voltage imbalance up to 8%. (6) Overcurrent and over-voltage circuits of master slave supplies used in auto-series, -parallel, or -tracking operation can be interlocked.

## Auto-Series, -Parallel, -Tracking Operation

Supplies may be connected in auto-series, or auto-tracking (except HP 6448B and 6483C, which cannot be connected in auto-series).

Up to three lower-power models (HP 6434B—6448B) may be connected in any of the above configurations. Higher-power model (HP 6453A/6483C) interconnection should ordinarily include no more than two supplies.

## Remote Programming

The voltage and current outputs of the supplies can be programmed by a remote resistance, or for most models, a remote voltage source. Programming speeds and coefficients are detailed in the specifications table.

## AC Power Requirements

The ac power requirements vary with the three model classifications (see option listings). When powered from a 50 Hz source (possible with option 005), the rms ripple and transient response specifications increase by 50%. The p-p ripple specification is unchanged by line frequency.

§ Under light loading conditions, power supply may not meet all published specifications. The graph on the next page defines the permissible operating regions for CV and CC modes of operation.

For operation with a 50 Hz input (possible only with Option 005), output current is linearly derated from 100% at 40°C to 80% at 50°C.

POWER SUPPLY OUTPUT RESTRICTIONS AS A FUNCTION OF LOADING

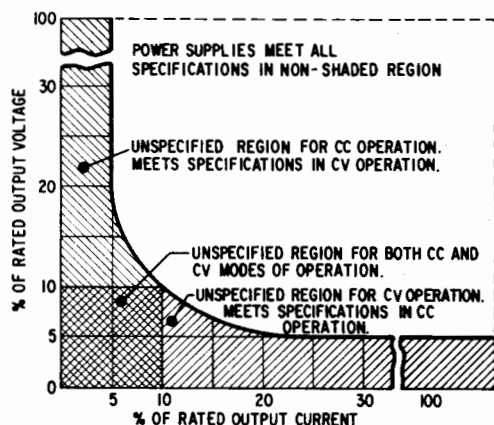

An ac input option must be specified when ordering.

**Line Cords**

Line cords are not supplied with models 6453A-6483C.

**Size**

- Model 6443B:** 89 H x 483 W x 445 mm D (3.5" x 19" x 17.5").
- Models 6434B, & 6448B:** 133 H x 483 W x 432 mm D (5.25" x 19" x 17").
- Models 6453A, 6456B, & 6459A:** 356 H x 483 W x 500 mm D (14" x 19" x 19.7").
- Models 6464C, 6466C, 6469C, 6472C, 6475C, 6477C, 6479C, & 6483C:** 705 H x 483 W x 715 mm D (27.75" x 19" x 28.12").

**Option Descriptions**

**HP 6434B-6448B**

- Std:** 115 V ac, ± 10%, single phase, 57-63 Hz
- 005:** realignment for 50 Hz operation
- 010:** chassis slides
- 027:** 208 V ac, ± 10%, single phase, 57-63 Hz
- 028:** 230 V ac, ± 10%, single phase, 57-63 Hz
- 910:** one extra operating and service manual shipped with each power supply

**HP 6453A, 6456B, 6459A**

An ac input option must be specified when ordering.

- AC input connections are by means of a 4-conductor connector at rear of unit. A matching Hubbell No. 7413G plug (HP part number 1251-1570) is furnished.
- 001:** 208 V ac, ± 10%, 3-phase, 15.5 A/phase, 57-63 Hz
- 002:** 230 V ac, ± 10%, 3-phase, 14 A/phase, 57-63 Hz
- 003:** 460 V ac, ± 10%, 3-phase, 7 A/phase, 57-63 Hz
- 005:** realignment for 50 Hz operation
- 006:** overvoltage protection crowbar

**HP 6453A, 6459A**

- HP 6456B**
- 010:** chassis slides
- 031:** 380 V ac, ± 10%, 3-phase, 8.5 A/phase, 57-63 Hz
- 032:** 400 V ac, ± 10%, 3-phase- 8.0 A/phase, 57-63 Hz
- 910:** one extra operating and service manual shipped with each power supply.

**HP 6464C-6483C**

An ac input option must be specified when ordering.

- AC input connections are by means of enclosed 4-wire terminal block
- 001:** 208 V ac, ± 10%, 3-phase, 55 A/phase, 57-63 Hz
- 002:** 230 V ac, ± 10%, 3-phase, 50 A/phase, 57-63 Hz
- 003:** 460 V ac, ± 10%, 3-phase, 25 A/phase, 57-63 Hz
- 005:** realignment for 50 Hz operation
- 006:** internal overvoltage protection crowbar

**HP 6477C, 6479C, 6483C**

- HP 6466C**
- HP 6469C**
- HP 6472C, 6475C**
- 023:** rack mounting attachments for standard 19" rack
- 031:** 380 V ac, ± 10%, 3-phase, 30 A/phase, 57-63 Hz
- 032:** 400 V ac, ± 10%, 3-phase, 28.5 A/phase, 57-63 Hz
- 040:** prepares power supply to be programmed with resistance by an HP 6940B or 6942A.
- 910:** one extra operating and service manual shipped with each power supply.

**Accessory**

- 14545A:** casters for HP 6464C-6483C—set of four

**Specifications, continued**

REMOTE CONTROL								GENERAL					
Resolution		Load Transient Recovery $\Delta$	Resistance Coefficient		Voltage Coefficient $\dagger$		Up		Down		Net Weight		Options
			Voltage	Current	Voltage	Current	NL	FL	NL	FL	Kg	lb	
8 mV	1 A	100 ms, 500 mV	200 $\Omega/V \pm 2\%$	1 $\Omega/A \pm 2\%$	1 V/V $\pm 1\%$	6.2 mV/A $\pm 7\%$	1.6 s	0.6 s	6 s	0.1 s	235	518	1, 2, 3, 5, 23, 31, 32, 40
65 mV	1 A	50 ms, 150 mV	200 $\Omega/V \pm 2\%$	1 $\Omega/A$	0.4 V/V	30 mV/A	1 s	0.5 s	20 s	0.2 s	108	238	1, 2, 3, 5, 6, 10, 31, 32
18 mV	0.5 A	100 ms, 500 mV	200 $\Omega/V \pm 2\%$	1.66 $\Omega/A \pm 2\%$	1 V/V $\pm 1\%$	10.3 mV/A $\pm 7\%$	1.6 s	0.6 s	15 s	0.2 s	226	500	1, 2, 3, 5, 6, 23, 31, 32, 40
90 mV	0.5 A	50 ms, 300 mV	200 $\Omega/V \pm 2\%$	2 $\Omega/A$	166 mV/V	60 mV/A	1 s	0.5 s	60 s	0.5 s	108	238	1, 2, 3, 5, 6, 10, 31, 32
36 mV	0.3 A	100 ms, 500 mV	200 $\Omega/V \pm 2\%$	3.33 $\Omega/A \pm 2\%$	1 V/V	20.6 mV/A $\pm 7\%$	1.6 s	3 s	20 s	0.5 s	226	500	1, 2, 3, 5, 6, 23, 31, 32, 40
10 mV	12.5 mA	200 ms, 200 mV	200 $\Omega/V \pm 2\%$	12 $\Omega/A$	1 V/V	**	0.3 s	1.2 s	75 s	1.2 s	30.4	67	5, 10, 27, 28
100 mV	0.25 A	50 ms, 600 mV	300 $\Omega/V \pm 2\%$	4 $\Omega/A$	94 mV/V	120 mV/A	1 s	0.5 s	45 s	0.7 s	108	238	1, 2, 3, 5, 6, 10, 31, 32
64 mV	0.15 mA	100 ms, 750 mV	300 $\Omega/V \pm 2\%$	6.7 $\Omega/A \pm 2\%$	1 V/V $\pm 3\%$	41.2 mV/A $\pm 7\%$	1.4 s	2.5 s	55 s	0.7 s	226	500	1, 2, 3, 5, 6, 23, 31, 32, 40
22 mV	0.1 A	100 ms, 1 V	300 $\Omega/V \pm 2\%$	10 $\Omega/A \pm 2\%$	1 V/V $\pm 3\%$	62 mV/A $\pm 7\%$	1.5 s	2 s	80 s	0.7 s	226	500	1, 2, 3, 5, 6, 23, 31, 32
30 mV	1.3 mA	200 ms, 600 mV	300 $\Omega/V \pm 2\%$	120 $\Omega/A$	1 V/V	**	0.5 s	2 s	210 s	2 s	14	31	5, 10, 27, 28
44 mV	50 mA	100 ms, 2 V	300 $\Omega/V \pm 2\%$	20 $\Omega/V \pm 2\%$	1 V/V $\pm 3\%$	124 mV/A $\pm 7\%$	1.5 s	2 s	95 s	1 s	226	500	1, 2, 3, 5, 6, 23, 31, 32
60 mV	35 mA	100 ms, 3 V	300 $\Omega/V \pm 2\%$	28.6 $\Omega/A \pm 2\%$	1 V/V $\pm 3\%$	177 mV/A $\pm 7\%$	1.5 s	2 s	75 s	1.6 s	226	500	1, 2, 3, 5, 6, 23, 31, 32
60 mV	25 mA	100 ms, 5 V	300 $\Omega/V \pm 2\%$	40 $\Omega/A \pm 2\%$	1 V/V $\pm 3\%$	0.25 V/A $\pm 7\%$	1.5 s	2 s	120 s	2 s	226	500	1, 2, 3, 5, 6, 23, 31, 32
60 mV	0.75 mA	200 ms, 3 V	300 $\Omega/V \pm 2\%$	600 $\Omega/A$	1 V/V	**	0.2 s	1 s	45 s	2 s	27.6	61	5, 10, 27, 28

$\Delta$ For operation with a 50 Hz input (possible only with Option 005), the rms ripple and transient response specifications are increased by 50%.

\*\* This feature is not available.

\* An ac input option must be specified when ordering these 3-phase models.

$\dagger$ Special Option J30 must be ordered with models 6434B-6448B and 6466C-6483C to be programmed with an HP 59501B Power Supply Programmer. Contact your local HP Field Engineer for ordering instructions.



# POWER SUPPLIES

## Autoranging System Power Supplies

Models 6031A, 6032A, 6033A, and 6038A

- HP-IB programming of voltage and current
- Readback of voltage, current and status
- Overvoltage and overcurrent protection

- Built-in self-test and diagnostics
- Up to 1200 watts output
- Full local control enable/disable

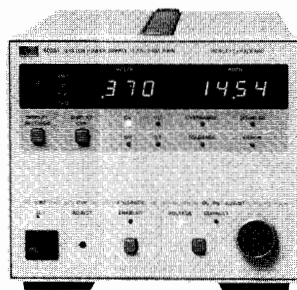

HP 6033A

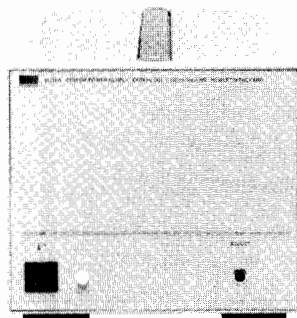

HP 6033A Opt 001

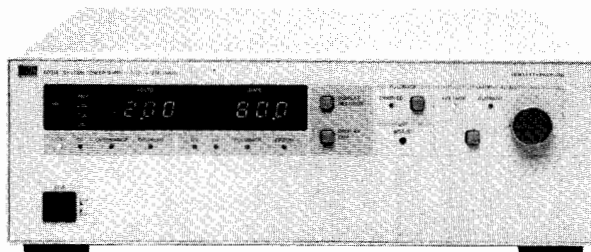

HP 6031A



### Description

These HP-IB CV/CC dc power supplies have many productivity-oriented features which make them easy to program, integrate into systems and use.

A conventional power supply subsystem capable of monitoring and controlling power supply voltage and current requires a variety of hardware in addition to the actual supply. These new power supplies, however, have built-in capabilities which eliminate the need for D/A programmers, DVMs, and associated auxiliary circuitry. Fewer instruments mean less rack space, easier calculation of system specifications, quicker configurations, higher system reliability, more rapid troubleshooting, and simpler software. As autoranging power supplies, these models can provide a wide and continuous range of voltage and current combinations at the maximum rated power. This often allows both present and future requirements to be satisfied with fewer supplies, also reducing the number of instruments in the system.

### Front Panel Control

Most of the extensive programmable instruction set can be simulated with front panel controls, thus facilitating design and debugging of system hardware and software. During system operation, if local control is not needed, the front panel controls can be disabled with a computer command. If operator interaction is required, a computer command can place limits on the output voltage and current available. Often, control and monitoring via the front panel is very useful during system development, but not needed afterwards. If the system is reproduced without further development, power supplies without front panel controls and meters (Option 001) can then be used. Ordering your power supplies with Option 001 significantly decreases the cost.

### Protection Features

Because of the delicate nature of most loads, these system power supplies provide several different types of protection. Since they are CV/CC supplies, both the output voltage and current will be automatically limited to the programmed values. If reaching a programmed value indicates an undesirable condition, the power supply can be instructed to automatically down-program to zero output. For example, if the programmed current limit is reached while testing a PC board assembly, it may indicate a shorted component. In this case, the FOLDBACK feature, if enabled, would be able to serve as an overcurrent protection circuit and down-program the power supply automatically. FOLDBACK can be enabled and reset over the HP-IB.

The built-in overvoltage protection circuit is adjustable with a front panel control. The set trip level can be displayed on the front panel meter and also can be read back over the HP-IB, thus making adjusting the level easy. The OVP circuit, once tripped, can be reset over the HP-IB.

Production procedures sometimes require the operator to adjust the output voltage or current of a power supply locally with the front panel controls. If this is done, programmed levels can be set to limit the available adjustment range to a safe margin.

Potentially harmful conditions, such as overtemperature and high or low ac input, will trigger the power supply to automatically down-program to zero output. When these conditions occur, or the FOLDBACK or OVP circuits trip, LEDs on the front panel light to indicate the failure. This status can also be read back to the computer over the HP-IB and can be used to generate interrupts.

### Specifications

Ratings						Regulation				Transient Recovery (10% load change) Time / Level
Volts	Amperes	Output Power			HP Model	Load Effect		Source Effect		
		P <sub>1</sub> *	P <sub>2</sub> *	P <sub>3</sub> *		Voltage	Current	Voltage	Current	
0-20	0-30	200W	242W	200W	6033A	0.01% +2mV	0.01% +9mA	0.01% +1mV	0.01% +6mA	1ms / 50mV
0-20	0-120	1000W	1060W	840W	6031A	0.01% +3mV	0.01% +15mA	0.01% +2mV	0.01% +25mA	2ms / 100mV
0-60	0-10	200W	240W	200W	6038A	0.01% +3mV	0.01% +5mA	0.01% +2mV	0.01% +2mA	1ms / 75mV
0-60	0-50	1000W	1200W	1000W	6032A	0.01% +5mV	0.01% +10mA	0.01% +3mV	0.01% +10mA	2ms / 100mV

\*See the generalized autoranging output characteristic curve.



**Programmable Features**

Below are the types of commands which can be sent to HP Models 6031A, 6032A, 6033A and 6038A, and the data which is available to be read back.

**Programmable Functions**

- Output Voltage
- Output Current
- Output Disable/Enable
- Soft Voltage Limit
- Soft Current Limit
- Group Trigger
- Foldback Mode
- Device Clear
- Interrupt Mask
- Interrupt Delay
- Preset Power Supply States
- Self-Test
- Local Lockout

**Readback Functions**

- Programmed Voltage
- Programmed Current
- Actual Voltage
- Actual Current
- OVP Trip Level
- Soft Voltage Limit
- Soft Current Limit
- Foldback Mode
- Present Status
- Accumulated Status
- Interrupt Mask
- Programming Error Codes
- Self Test Error Codes
- Output Disable/Enable
- Device ID

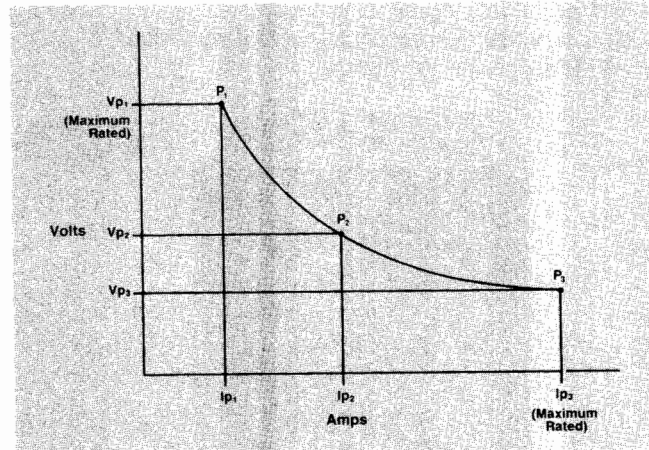

**System Configuration**

If your application requires more power than the output capability of a single unit, you can use an auto-series connection for greater output voltage or an auto-parallel connection for greater output current. Any combination of models is possible with two units used in auto-parallel or up to 240 volts total output for auto-series connections. In addition, up to four 1000 watt models may be connected in auto-parallel. For example, if you need 200 amperes at 6 volts, a cost-effective solution would be to use an HP 6031A as the master power supply and an HP 6011A as the slave in an auto-parallel configuration. See page 318 for more information about the HP 6011A, a non-HP-IB dc power supply.

Remote sensing can be used to maintain the CV load effect specification at the load with up to 0.5 volt drop per load lead, and sense wires which are less than 0.2 ohm per lead. Operation is possible with up to 2.0 volts drop per lead; however, the load effect specification may be degraded.

Either terminal may be grounded, or may be floated up to  $\pm 240$  volts from chassis ground.

Analog programming inputs and monitoring terminals are provided on the rear panel in addition to the HP-IB programming capabilities. Zero to full scale voltage or current can be programmed with either 0-5 volt voltage signals, or 0-4000 ohm resistance signals. The monitoring terminals present 0-5 volt buffered signals which are proportional to the output voltage and current.

HP models 6031A, 6032A, and 6038A are stable when operating in CC into inductive loads up to 100 mH, and the HP 6033A can handle up to 1 H. A special modification is available for HP Models 6031A and 6032A to ensure stable operation when operating into inductive loads up to 10 H.

**General Specifications**

HP-IB interface functions: SH1, T6, AH1, L4, SR1, RL1, PP1, DC1, DT1. For more on these codes, refer to the HP-IB section of this catalog.

Dimensions: HP 6033A and 6038A: 170.6 mm H x 208.8 mm W x 453.9 mm D (6.72" x 8.22" x 17.872")

HP 6031A and 6032A: 132.6 mm H x 425.5 mm W x 516.4 mm D (5.2" x 16.75" x 20.33")

**Specifications cont.**

PARD (rms/p-p) 20 Hz-20 MHz	Remote Control						General					
	Resolution		Accuracy				AC Input Current				Weight - kg (lbs)	
	Voltage	Current	Voltage	Current	Voltage	Current	100 Vac	120 Vac	220 Vac	240 Vac	Net	Shipping
3mV/30mV	15mA/-	5mV	7.5mA	0.035% +9mV	0.15% +20mA	6.0A	6.5A	3.8A	3.6A	9.6(21)	11.4(25)	
8mV/50mV	120mA/-	5mV	30mA	0.035% +15mV	0.25% +250mA	24A	24A	15A	14A	17.2(38)	22.7(50)	
3mV/30mV	5mA/-	15mV	2.5mA	0.035% +40mV	0.085% +10mA	6.0A	6.5A	3.8A	3.6A	9.6(21)	11.4(25)	
8mV/40mV	25mA/-	15mV	12.5mA	0.035% +40mV	0.2% +85mA	24A	24A	15A	14A	16.3(36)	21.8(48)	

Generalized autoranging output characteristic curve

**Option Descriptions**

- 001:** Front panel which has only line switch, line indicator, and OVP adjust.
- 100:** 87-106 Vac, 48-63 Hz. This option is for use in Japan only. The power supply output power is 75% of the output power available with the other line voltage options.
- 120:** 104-127 Vac, 48-63 Hz.
- 220:** 191-233 Vac, 48-63 Hz.
- 240:** 208-250 Vac, 48-63 Hz.
- 800:** Rack mount kit for two units side by side. This applies to HP 6033A and 6038A only.
- 908:** Rack mount kit for a single unit. A blank filler panel is supplied when this option is ordered with HP 6033A and 6038A.  
HP 6033A and 6038A  
HP 6031A and 6032A
- 910:** One extra operating and service manual shipped with each power supply.





# POWER SUPPLIES

## 200 Watt System Power Supply

### Model 6002A

- 200 watt autoranging dc output
- Constant-voltage/constant-current operation
- HP-IB programming option

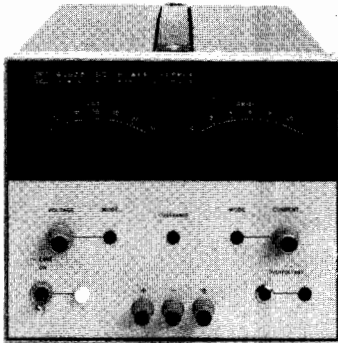

### Description

The HP 6002A dc power supply offers an exceptional combination of performance and flexibility. It employs a unique control concept which provides for an autoranging output with the performance characteristics of linear regulation. The HP 6002A is a 200 watt CV/CC power supply, which may be remotely programmed via the HP-IB when equipped with Option 001.

As an autoranging power supply, the HP 6002A can provide 200 watts over a wide range of voltage and currents without external intervention. This allows it to take the place of multiple conventional power supplies. For example, the HP 6002A can replace both a 50 volt, 4 ampere supply and a 20 volt, 10 ampere supply.

#### Autoranging Output Characteristic

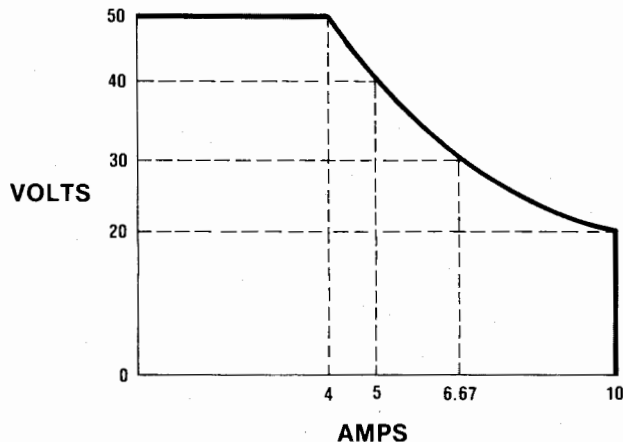

#### System Features/Remote Control

Analog programming of output voltages and current can be accomplished through the use of remotely controlled resistance or voltage applied to rear panel terminals. Additional control terminals are provided for remote load voltage sensing, auto-series or parallel operation, and for remotely activating the crowbar circuit. A pulse output from the crowbar terminal indicates the overvoltage circuit has been self-activated. A voltage step change appearing on terminal indicates a changeover to or from constant-current operation.

#### HP-IB Option

Digital programming via Option 001 permits control of output voltage or current by the Hewlett-Packard Interface Bus (HP-IB). Two programmable ranges allow better resolution below 10 volts or 2 amperes. The selection of HP-IB control of either voltage or current is done by rear panel switches. The IEEE 488 interface functions supported by the HP 6002A with Option 001 are basic listener (L2) and acceptor handshake (AH1). Complete explanation of these interface functions is available in the IEEE Std. 488-1978.

- Built-in overvoltage protection crowbar
- CV/CC operating status indicators
- Remote analog programming and sensing

### Specifications

**DC output:** voltage and current output can be adjusted over the ranges indicated by front panel controls, analog programming, or an optional HP-IB interface.

**Voltage:** 0-50 V. **Current:** 0-10 A.

Maximum 200 watts output from 20 V to 50 V.

**Load effect:** constant-voltage, 0.01% +1 mV. Constant-current, 0.01% +1 mA.

**Source effect:** CV, 0.01% +1 mV; CC, 0.01% +1 mA.

**PARD (ripple and noise):** rms/p-p, 20 Hz to 20 MHz; CV, 1 mV/10 mV; CC, 5 mA rms.

**Temperature coefficient:** CV, 0.02% +200  $\mu$ V/°C; CC 0.02% +5 mA/°C.

**Drift:** CV, 0.05% +1 mV/8 h; CC, 0.05% +5 mA/8 h.

**Load transient recovery:** 100  $\mu$ s for output voltage to recover within 15 mV of nominal voltage setting following a load current change of 50% to 100% or 100% to 50% of full load current.

**Response time:** maximum time for output voltage to change between 0 to 99.9% or 100% to 0.1% of maximum rated output voltage. Up Programming: no load, 100 ms; full load, 100 ms. Down Programming: no load, 400 ms; full load, 200 ms.

**Overvoltage protection:** trip voltage adjustable from 2.5 V to 60 V.

**DC output isolation:** 150 V dc.

**Power:** 100, 120, 220, or 240 V ac (-13%, +6%), 48-63 Hz.

**Temperature rating:** 0°C to 55°C operating, -40°C to +75°C storage. Supply is cooled by built-in fan.

**Size:** 180 H x 212 W x 422 mm D (6.97" x 8.36" x 16.6").

**Weight:** net, 14.5 kg (32 lb); shipping, 15.9 kg (35 lb).

#### HP-IB Option

**Programmable ranges:** high: 0-50 V or 0-10 A,  
low: 0-10 V or 0-2 A.

**Programming speed:** same as response time.

**Accuracy:** hi range: CV, 0.2% +25 mV; CC, 0.2% +25 mA.  
lo range: CV, 0.2% +10 mV; CC, 0.2% +25 mA.

**Resolution:** hi range: CV, 50 mV; CC, 10 mA. (12 bit)  
lo range: CV, 10 mV; CC, 2 mA. (12 bit)

**Isolation:** 250 volts dc from bus data lines to power supply.

#### Accessories

**HP 5061-0060:** rack mounting adapter kit for one HP 6002A

**HP 5061-0094:** cabinet lock-together kit to connect two HP 6002As

**HP 5061-0078:** rack flange kit to mount 2 locked HP 6002As

#### Options

**001:** HP-IB interface

**910:** one extra operating and service manual

**HP 6002A Autoranging DC Power Supply**



# POWER SUPPLIES

## Digital Programmable: HP-IB Programmer

### Model 59501B



- HP-IB power supply control
- HP-IB-to-power-supply isolation
- Programmable range

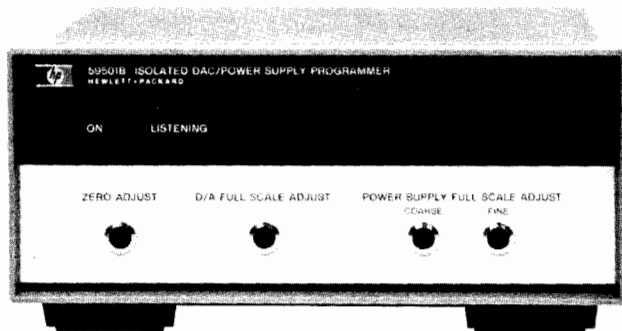

HP 59501B



### Description

The HP 59501B is an isolated digital-to-analog converter designed to provide a convenient interface between the Hewlett-Packard Interface Bus and HP power supplies. With the HP 59501B, a wide range of dc voltages and currents becomes automatically controllable via the HP-IB. With proper wiring, the built-in isolation devices protect other instrumentation on the HP-IB from damage that could be caused by power supply outputs. In addition, an internal control circuit holds the output level near zero until programmed data is received. A programmable High/Low range control improves resolution by ten-to-one.

Power supply control is accomplished through the HP 59501B's programmable output voltage and programming network (see below). By making the appropriate connections between the 59501B's rear terminals and the remote programming terminals on the supply, the output voltage (or current) of the supply can be programmed from zero to its full rated output. The HP 59501B front panel controls provide fast and easy calibration of power supply outputs. The Zero Adjust enables the user to correct for small offsets in power supply response to programmed inputs. The Power Supply Full Scale Adjust (part of programming network) enables the user to set the maximum output desired from the power supply when the HP 59501B is programmed to its maximum value. For example, this adjustment would normally be used to calibrate the maximum programmable output of a 320Vdc power supply to 320 volts. However, it could also be used to set the maximum to 200 volts.

The HP 59501B also can be used directly as a low level dc signal source. Unipolar and bipolar output modes are available with output voltages programmable from zero to 9.99 volts, or minus 10.0 to plus 9.98 volts. Output current up to 10 milliamperes is available and is automatically limited to protect the HP 59501B and user equipment. The HP 59501B produces a full scale voltage change in approximately 250  $\mu$ s from the time the digital data is received.

- Programmable 10-volt dc output
- Unipolar/bipolar operation
- Fast digital to analog conversion

### Specifications

#### Digital to Analog Converter

**DC output voltage:** programmable in high or low ranges within the voltage limits shown below. Output mode is unipolar or bipolar and is selected by a rear panel switch.

**Unipolar:** 0 to 9.99 V (low range, 0 to 9.999 V).

**Bipolar:** -10 to +9.98 V (low range, -1 to +0.998 V).

**DC output current:** 10 mA maximum.

**PARD (ripple and noise):** 2 mV rms/10 mV p-p.

**Resolution:** unipolar, 10 mV (low range, 1 mV). Bipolar, 20 mV (low range, 2 mV).

**Accuracy:** specified at 23°C  $\pm$ 5°C.

**Unipolar:** 0.1% +5 mV (low range, 0.1% +1 mV).

**Bipolar:** 0.1% +10 mV (low range, 0.1% +2 mV).

**Stability:** change in output over 8 hour interval under constant line, load, and ambient following a 30 minute warm-up. Stability is included in accuracy specification measurements over the temperature range indicated.

**Unipolar:** 0.04% + 0.5 mV (low range, 0.04% +0.1 mV).

**Bipolar:** 0.04% + 1 mV (low range, 0.04% +0.2 mV).

**Temperature coefficient:** unipolar, 0.01%/°C +0.5 mV/°C (low range, 0.1%/°C +0.1 mV/°C). Bipolar, 0.01%/°C +0.5 mV/°C (low range, 0.01%/°C +0.1 mV/°C).

**Zero adjust:** plus or minus 250 millivolts.

**D/A full scale adjust:** plus or minus 5%.

**Programming speed:** the time required for output to go from zero to 99% of programmed output change is 250  $\mu$ s (measured with resistive load connected to output terminals).

#### Power Supply Programming

**Programming network specifications:** in the following specifications, M represents the calibrated full scale value of the supply being programmed and P is the actual programmed output. The full scale value (M) can be any value within the supply's output range and is calibrated with the HP 59501B programmed to its maximum high range output.

**Accuracy:** specified at 23°C  $\pm$ 5°C.

**Unipolar:** 0.05% M +0.25% P (low range, 0.01% M + 0.25% P).

**Bipolar:** 0.1% M +0.25% P (low range, 0.02% M +0.25% P).

**Isolation:** 600 V dc between HP-IB data lines and output terminals.

**Temperature coefficient:** 0.005% M/°C + 0.015% P/°C (low range, 0.01% M/°C +0.015% P/°C).

**Programming resolution:** 0.1% M (low range, 0.01% M).

**Programming speed:** D/A programming speed plus the programming speed of the power supply.

#### General

**Temperature range:** operation, 0 to 55°C; storage, -40 to 75°C.

**Power:** 100, 120, 220, or 240 Vac (+6% -13%) 47-63 Hz, 10 VA (selectable on rear panel).

**Size:** 101.6 H x 212.9 W x 294.6 mm D (4" x 8.38" x 11.6").

**Weight:** net, 1.82 kg (4 lb); shipping, 2.27 kg (5 lb).

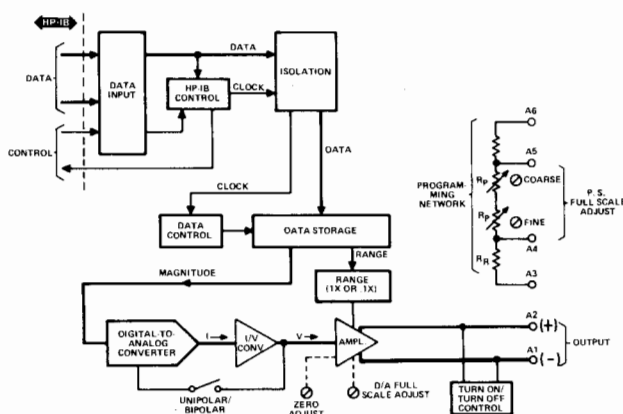

Several programming notes are available to assist in operating the HP 59501B Power Supply Programmer with the HP desktop computers. For more on free publications, see page 38.

#### Accessories

**HP 5060-0173:** rack mounting adapter kit for one HP 59501B

**HP 5060-0174:** rack mounting adapter kit to connect two HP 59501B's

#### Ordering Information

**HP 59501B** HP-IB Isolated D/A Power Supply Programmer



# POWER SUPPLIES

## Precision Bipolar System Supplies

Models 6129C-6131C & 6140A

- HP-IB compatible options P05 and J99 with HP 59301A
- Fast, accurate, high resolution programming
- Bipolar output

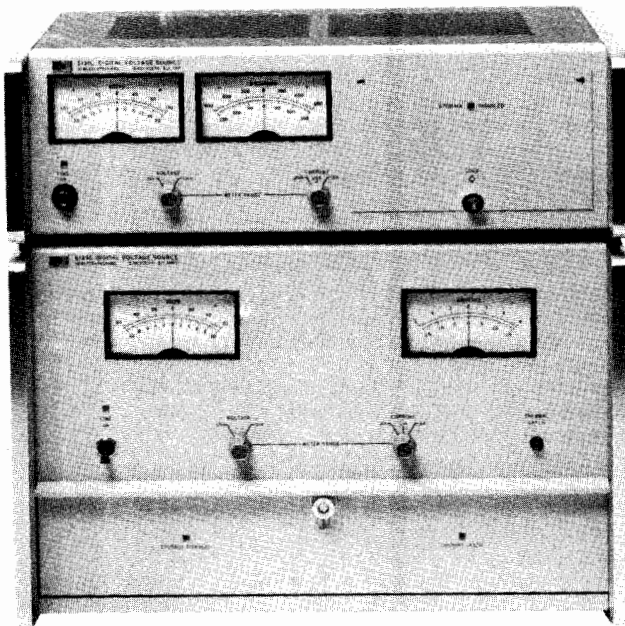

HP 6131C (top) & 6129C

### Description

The family of Precision Bipolar System Supplies consists of three voltage sources (HP 6129C, 6130C and 6131C) and one current source (HP 6140A). They provide easy, fast and accurate programming of their dc outputs, with many features oriented specifically towards efficient integration in automatic systems.

### HP-IB

These system power supplies, when ordered with either option P05 or J99, may be programmed on the HP-IB via the HP 59301A ASCII to parallel converter.

### Isolation

All digital inputs are completely isolated from the analog outputs.

### Programmable Current Limit (Voltage Source)

Valuable loads can be protected by a user programmable current latch. Output power goes to zero when the latch circuit is tripped. The reaction time to the latch can be adjusted, if desired, to avoid tripping when reprogramming with a capacitive load. There is also a fixed current limit at 110% of rated current output.

### Current Monitoring Terminals (Voltage Sources)

A voltage is available at the rear barrier strip which is proportional to the output current.

### Analog Input

An ac signal may be injected into the output amplifier to simulate various noise and ripple conditions.

### Precision Bipolar System Current Source

The HP 6140A Current Source has features which correspond to the voltage sources. It has a programmable voltage limit, voltage monitoring terminal, as well as isolation, HP-IB options, and analog input capabilities.

### Accessories Furnished

HP 1251-0086 50-contact rear plug.  
HP 5060-7948 Plug-in extender board for voltage source.  
HP 5060-7948/5060-7982. Two plug-in extender boards for current source.

- Current sink or source
- Programmable current latch (on voltage sources) or voltage limit (on current sources)
- Isolated output

### Specifications

	Binary Instruments Option J20 & P05		BCD Instruments Option J99	
	X1 Range	X10 Range	X1 Range	X10 Range
<b>HP 6129C</b>				
Output	±16.384 V, 5 A	±50.00 V, 5 A	±9.999 V, 5 A	±50.00 V, 5 A
Accuracy	1.5 mV	15 mV	1.5 mV	15 mV
Resolution	0.5 mV	5 mV	1 mV	10 mV
<b>HP 6130C</b>				
Output	±16.384 V, 1 A	±50.00 V, 1 A	±9.999 V, 1 A	±50.00 V, 1 A
Accuracy	1 mV	10 mV	1 mV	10 mV
Resolution	0.5 mV	5 mV	1 mV	10 mV
<b>HP 6131C</b>				
Output	±16.384 V, 0.5 A	±100.00 V, 0.5 A	±9.999 V, 0.5 A	±99.99 V, 0.5 A
Accuracy	1 mV	10 mV	1 mV	10 mV
Resolution	0.5 mV	5 mV	1 mV	10 mV
<b>HP 6140A</b>				
Output	±16.384 mA, 100 V	±163.84 mA, 100 V	±9.999 mA, 100 V	±99.99 mA, 100 V
Accuracy	1 μA ±0.01%	10 μA ±0.01%	10 μA ±0.01%	10 μA ±0.01%
Resolution	0.5 μA	5 μA	1 μA	10 μA

### Options

#### AC Power Option

**028:** transformer tap change for 230 V ac ±10%, single-phase input on HP 6130C and 6131C.  
(HP 6129C and 6140A are 115/230 switch selectable.)

#### Standard Interface Options\*

**P05:** 16 bit binary programming format with modifications to interface to the HP 59301A and be programmed on the HP-IB. In addition to power supply modifications, a cable to connect the supply to the HP 59301A and programming documentation are included.

**J99:** 4 digit BCD programming format, otherwise similar to Opt. P05. A cable, and programming documentation, are included.

**J20:** 16 bit binary interface for HP 12661A I/O programmer card for Hewlett-Packard computers.

#### Accessories Available

**HP 14533B:** Pocket programmer permits manual programming of all input functions by switch closure.

**HP 14534A:** Pocket programmer extension cable (3 ft).

**HP 14535A:** HP computer interface kit includes HP 12661A computer I/O card, HP 14539A cable, verification software and RTE Driver. Up to eight PBSS's may be controlled from one HP 14535A.

**HP 14536A:** Chaining cable connects an additional PBSS to the existing chain of PBSS's.

#### Ordering Information

An interface option must be ordered.

**HP 6129C:** Digital Voltage Source

**Opt 908:** Rack Flange Kit

**HP 6130C, 6131C:** Digital Voltage Source

**Opt 908:** Rack Flange Kit

**HP 6140A:** Digital Current Source

**Opt 908:** Rack Flange Kit

**Opt 910:** One extra operating and service manual shipped with each power supply

# POWER SUPPLIES

## Special Purpose: DC Power Supply/Amplifiers

### Models 6824A-6827A

329



- High speed remote programming
- Overload protection
- Wide-band response

- Bipolar voltage
- Current sink or source

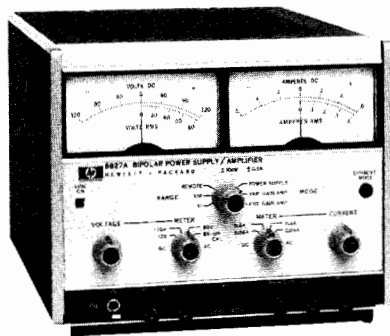

HP 6825A-6827A

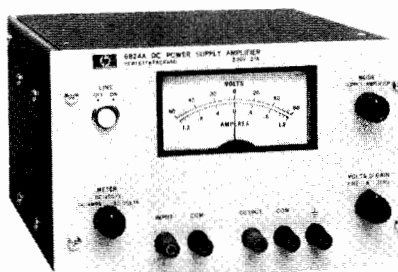

HP 6824A

### Description

The Power Supply/Amplifier is a general-purpose instrument useful in any laboratory engaged in research and development of electronic systems, circuitry, or components. The unit can be operated in one of two basic operating modes: power supply or amplifier. Terminals at the rear permit access to various internal control points to further expand the operational capabilities of the instrument. The resulting flexibility lends the Power Supply/Amplifier to an almost unlimited number of applications.

### Models 6825A Through 6827A

These models feature dual-range output and constant-voltage/constant-current operation. Output voltage and current as a dc supply, or gain as a power amplifier, are remotely controllable and are compatible with Hewlett-Packard Multiprogrammer Systems.

As a dc power supply, the unit can furnish a bipolar, constant-voltage or constant-current output. It can be remotely programmed with a resistance, voltage, or current and its high speed programming characteristics adapt it to a wide variety of laboratory and production testing applications. The supply can sink, as well as source, current permitting it to serve as a variable load device.

As a direct-coupled power amplifier, each unit offers a signal-to-noise ratio of approximately 80 dB at full output with low distortion and a frequency response up to 40 kHz in the fixed gain mode.

### Model 6824A

Although this model does not provide quite the level of performance and flexibility of Models 6825A through 6827A, it is lower in cost and is suitable for many applications.

As a power supply, this unit offers constant-voltage/current-limiting operation, remote programming, and auto-series, auto-parallel operation.

As a power amplifier, the unit exhibits a high signal-to-noise ratio with a 20 dB gain from dc to 10 kHz. It is useful in servo systems, as a pulse or oscillator amplifier, for motor control, and a variety of other applications.

### General Specifications

**Temperature:** operating, 0 to 55°C; storage, -40 to +75°C.

**Power:** HP 6824A, standard input voltage is 104-127 V ac, 48-63 Hz. Order Option 028 for 230 V ±10% operation. HP 6825A, 6826A, 6827A, switchable, 100, 120, 220, or 240 V ac, -13% +6%, 48-63 Hz, 150 W.

**Size:** HP 6824A, 131 H x 209 W x 303 mm D (5<sup>1</sup>/<sub>2</sub>" x 8<sup>3</sup>/<sub>2</sub>" x 11<sup>1</sup>/<sub>6</sub>"). HP 6825A, 6826A & 6827A, 155 H x 198 W x 316 mm D (6<sup>1</sup>/<sub>2</sub>" x 7<sup>2</sup>/<sub>32</sub>" x 12<sup>1</sup>/<sub>16</sub>").

**Weight:** HP 6824A, 7.7 kg (17 lb); 6825A, 6826A & 6827A, 8.2 kg (18 lb).

### Specifications

RATINGS			POWER SUPPLY PERFORMANCE						POWER AMPLIFIER PERFORMANCE						
DC Output		HP Model	PAR (rms/p-p)		Transient Recovery		Resolution		Voltage Gain		Frequency Response, +1, -3 dB		Distortion at full output		Options
Volts	Amperes		Voltage	Current	Time	Level	Voltage	Current	Fixed	Variable	Fixed Gain	Variable Gain	100 Hz	10 kHz	
-5 V to +5 V/ -20 V to +20 V	0-2.0 A Both Ranges	6825A	10/30 mV	5/15 mA	100 μs	20 mV	40 mV	6 mA	1X 4X	0-2X 0-8X	dc-40 kHz	dc-15 kHz	0.1% THD	0.5%	9
-5 V to +5 V/ -50 V to +50 V	0-1.0 A Both Ranges	6826A	6/35 mV	0.8/5 mA	100 μs	50 mV	100 mV	3 mA	1X 10X	0-2X 0-20X	dc-40 kHz	dc-15 kHz	0.1% THD	0.5%	9
-10 V to +10 V/ -100 V to +100 V	0-0.5 A Both Ranges	6827A	10/50 mV	0.4/5 mA	100 μs	100 mV	200 mV	1.5 mA	2X 20X	0-4X 0-40X	dc-30 kHz	dc-15 kHz	0.1% THD	1%	9
-50 V to +50 V	0-1.0 A	6824A	10 mV rms	--	100 μs	0.02% +5 mV	--	--	--	0-10X	--	dc-10 kHz	0.1% THD	--	9,28

### Options Descriptions

**028:** 230 V ac ± 10%, single phase input

**910:** one additional manual shipped with each power supply  
HP 6824A,  
HP 6825A, 6826A, 6827A

### Accessories

**HP 5060-8762:** adapter frame for rack mounting one or two HP 6825A-6827A units

**HP 5060-8760:** blank filler panel to be used with above units

**HP 14515A:** rack mounting kit for one HP 6824A

**HP 14525A:** rack mounting kit for two HP 6824As



# POWER SUPPLIES

## Special Purpose; Precision Voltage Sources

### Models 6114A and 6115A

- 0.025% output voltage accuracy
- Pushbutton voltage control
- Five minute warm-up



HP 6114A & 6115A

## Description

### HP Models 6114A and 6115A

These 40-watt precision power supplies are high-accuracy instruments designed for use as low-cost calibrators, working voltage standards, systems reference supplies, or high-performance lab supplies. They are ideal for applications where an accurate, highly stable, and easy-to-use source of dc voltage is required.

### Output Ratings

Both models feature automatic dual-range operation. For example, the HP 6114A can supply 0-20V at 0-2A, and 20-40V at 0-1A, without manual range switching. Automatic output current range cross-over occurs when the supply is providing greater than one-half of the maximum rated output voltage.

### Output Voltage Controls

Pushbutton voltage controls allow the output voltage to be set rapidly and accurately. The setting is displayed in large, easy-to-read numerals. A four-digit pushbutton switch increases or decreases the output voltage in unit steps, and the switches go directly from "9" to "0" without backing down. A fifth digit, set via a separate front-panel control, provides output voltage resolution of 200  $\mu$ V.

The output voltage accuracy is 0.025% (250 ppm) plus 1 mV — for example, at 40 volts output, the output voltage of Model 6114A is accurate within  $\pm 11$  mV. This accuracy is attained after only five minutes' warmup, thus making these supplies especially suitable as portable calibrators.

### Output Current Controls

A front-panel current control allows the maximum output current of these supplies to be set to any desired value within the maximum rating. Using this control, the supplies can be operated as constant-current sources with 0.01% current regulation. A current mode indicator (a light-emitting diode) immediately lights when the supply is operated in the gross current limit region or when the output current level established by the setting of the front-panel control is reached. When the indicator is lighted, the output voltage is uncalibrated, but the front panel voltmeter continues to indicate the output voltage with an accuracy of 2%. A ten-turn current control with a three-digit graduated dial provides 2 mA current resolution.

### Remote Programming

Models 6114A and 6115A are designed to be programmed with either the HP Multiprogrammer or the HP-IB Isolated D/A Power Supply Programmer. Interfacing for Multiprogrammer operation is included as a standard feature in these models; therefore, the addition of Option 040 is not required. See pages 192 and 327 for additional information on digital programming interfaces for power supplies. Both supplies can also be remote programmed by means of an external voltage or resistance.

The output capacitor can be disconnected to reduce current surges, thereby improving the performance of the supply as a constant-current source; this also increases the programming speed by approximately an order of magnitude. Note, however, that some capacitance

- May be used with HP-IB Power Supply Programmer
- Overvoltage and overcurrent indicators
- Built-in overvoltage crowbar

at the load may be required to maintain power supply stability under all loading conditions when the output capacitor is disconnected.

### Overvoltage Protection

A built-in overvoltage protection circuit (an SCR crowbar) monitors the output and reduces the output voltage and current to zero whenever a preset voltage limit (adjustable from the front panel) is exceeded. This feature provides a convenient method of limiting the maximum output voltage supplied to voltage-sensitive loads.

## Specifications

**DC Output:** voltage and current output can be adjusted over the range indicated by front-panel controls or analog programming.

**HP 6114A:** 0-20 volts, 0-2 amperes  
20-40 volts, 0-1 amperes

**HP 6115A:** 0- 50 volts, 0-0.8 amperes  
50-100 volts, 0-0.4 amperes

Both models feature automatic dual-range operation, which eliminates manual range switching.

**Load effect:** constant-voltage deviation, 0.0005% + 100  $\mu$ V. constant-current deviation, 0.01% + 500  $\mu$ A.

**Source effect:** over the rated input voltage range: constant-voltage, 0.0005% + 100  $\mu$ V; constant-current, 0.005% + 40  $\mu$ A.

**PARD (ripple and noise):** rms/p-p, 20 Hz to 20 MHz; CV 40  $\mu$ V/200  $\mu$ V, CC 200  $\mu$ A/1 mA.

**Temperature coefficient:** CV, 0.0001% + 15  $\mu$ V/ $^{\circ}$ C; CC, 0.02% + 50  $\mu$ A/ $^{\circ}$ C.

**Drift:** CV, 0.0015% + 15  $\mu$ V per 8 hours, 0.0075% + 30  $\mu$ V per 90 days.

**Output voltage accuracy:** output voltage accuracy obtained from front-panel controls at  $23 \pm 3^{\circ}$ C at any ac line voltage and load current within rating and following a five-minute warm-up: 0.025% + 1.0 mV.

**Resolution:** front-panel voltage control, 200  $\mu$ V; front-panel current control, 2 mA.

**Output impedance:** typical value is approximated by 0.05 m $\Omega$  in series with 3 mH.

**Load transient recovery time:** less than 50  $\mu$ s is required for output voltage (constant voltage operation) to recover within 50 mV of the nominal output level following a change in output current equal to the current rating of the supply.

**Remote programming speed:** up programming of voltage at full load: HP 6114A, 1.75s; HP 6115A, 4.5s. Down programming, no load: HP 6114A, 350 ms; HP 6115A, 500 ms.

**Overvoltage protection crowbar:** adjustable front-panel screwdriver control from 0.5 to 45 volts on the HP 6114A and 0.5 to 110 volts on the HP 6115A.

**Power:** 104-127 or 208-254 Vac (switchable), 48-440Hz, 150 VA max.

**Temperature rating:** operating, 0 to 50 $^{\circ}$ C; storage, -40 to +75 $^{\circ}$ C.

**Size:** 197 mm W x 165 mm H x 337mm D (7.75" x 6.5" x 13.25")

**Weight:** 7.7 kg (17 lb) net, 9.5 kg (21 lb) shipping.

### Accessories

**5060-8762:** adapter frame for rack mounting one or two 1/2 rack width units. This frame applies to HP 6114A, 6115A

**5060-8760:** blank filler panel. This 1/2 rack width panel applies to HP 6114A, 6115A

### Ordering Information

**HP 6114A** Precision Power Supply

**HP 6115A** Precision Power Supply

# POWER SUPPLIES

## Special Purpose: Precision Constant Current Sources

### Models 6177C, 6181C & 6186C

- Continuously variable voltage limit
- Output useful to micro-ampere region

- High output impedance—no output capacitor

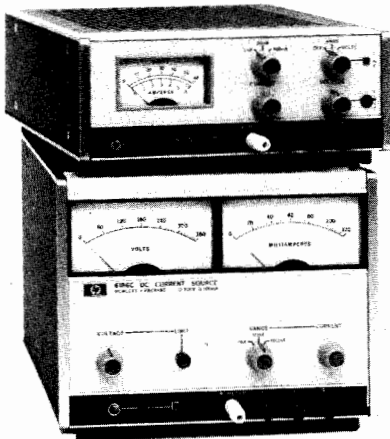

HP 6177C, 6181C

HP 6186C

### Description

These solid-state constant-current sources are ideal for semiconductor circuit development, component testing, and precision electroplating applications.

Their high-speed remote programming characteristics make these supplies useful in testing and sorting semiconductors, resistors, relays, meters, etc. The ability to superimpose ac modulation on the dc output permits the supplies to be used for measurement of dynamic or incremental impedance of circuit components.

### Specifications

**Load effect (load regulation):** less than 25 ppm of output + 5 ppm of range switch setting for a load change which causes the output

voltage to vary from zero to maximum.

**Source effect (line regulation):** less than 25 ppm of output + 5 ppm of range switch setting for any change in the line voltage between 104 and 127 V ac at any output current and voltage within rating.

**Load effect transient recovery:** less than 800  $\mu$ s for recovery to within 1% of nominal output current following a full load change in output voltage. (On HP 6186C, recovery time for 100 mA/10 mA/1 mA ranges is 1 ms/1.6 ms/4 ms, respectively.)

**Temperature coefficient:** output change per degree C is less than 75 ppm of output current + 5 ppm of range switch setting.

**Drift (stability):** less than 100 ppm of output current + 25 ppm of range switch setting. Stability is measured for eight hours after one hour warm-up under conditions of constant line, load, temperature, and output setting.

**Resolution:** 0.03% of range switch setting.

**Temperature rating:** operating 0, to 55°C; storage, -40 to +75°C.

### Accessories

**HP 5060-8764:** rack adapter for rack mounting one or two HP 6177C or 6181C supplies

**HP 5060-8762:** rack adapter for rack mounting one or two HP 6186C supplies

**HP 5060-8530:** filler panel for HP 6177C, 6181C

**HP 5060-8760:** filler panel for HP 6186C

### Options

**028:** 230 Vac  $\pm$ 10%, single-phase input.

**910:** one additional operating and service manual

### Ordering Information

**HP 6177C, 6181C** Constant Current Source

**HP 6186C** Constant Current Source

Model		HP 6177C	HP 6181C	HP 6186C	
Output Current ††		0-500 mA	0-250 mA	0-100 mA	
Voltage Compliance $\Delta$		0-50 V dc	0-100 V dc	0-300 V dc	
Output Ranges		A 0-5 mA	0-2.5 mA	0-1 mA	
		B 0-50 mA	0-25 mA	0-10 mA	
		C 0-500 mA	0-250 mA	0-100 mA	
AC Input		115V ac $\pm$ 10%, 48-63 Hz; 0.6 A, 55 W at 115 V ac For 230 V ac see Option 028	115 V ac $\pm$ 10%, 48-63 Hz; 0.6 A, 55 W at 115 V ac For 230 V ac see Option 028	115/230 V ac, 48-63 Hz; 0.9 A, 90 W at 115 V ac 115/230 V ac switch	
Constant Current	Voltage Control (accuracy: 0.5% of output current +.04% of range)	Range A 200 mV/mA	1 V/mA	10 V/mA	
		Range B 20 mV/mA	100 mV/mA	1 V/mA	
		Range C 2 mV/mA	10 mV/mA	100 mV/mA	
Remote Programming	Resistance Control (accuracy: 1% of output current +0.04% of range)	Range A 400 ohms/mA	2 k $\Omega$ /mA	10 k $\Omega$ /mA	
		Range B 40 ohms/mA	200 ohms/mA	1 k $\Omega$ /mA	
		Range C 4 ohms/mA	20 ohms/mA	100 $\Omega$ /mA	
Voltage Limit Remote Programming	Voltage Control (Accuracy: 20%)	1 V/V	1 V/V	1 V/V	
		Resistance Control	870 ohms/V	435 ohms/V	820 ohms/V
		Accuracy	25%	25%	15%
Typical Output Impedance (R in parallel with C)*		Range A R = 330 Meg, C = 500 pF	R = 1330 Meg, C = 10 pF	R = 10,000 Meg, C = 900 pF	
		Range B R = 33 Meg, C = 0.005 $\mu$ F	R = 133 Meg, C = 100 pF	R = 1,000 Meg, C = 700 pF	
		Range C R = 3.3 Meg, C = 0.05 $\mu$ F	R = 13.3 Meg, C = 1000 pF	R = 100 Meg, C = 1500 pF	
PAR (Ripple and Noise): rms/p-p (20 Hz to 20 MHz) with either output terminal grounded		Range A 1.6 $\mu$ A rms/40 $\mu$ A p-p	0.8 $\mu$ A rms/20 $\mu$ A p-p	0.2 $\mu$ A rms/5 $\mu$ A p-p	
		Range B 16 $\mu$ A rms/200 $\mu$ A p-p	8 $\mu$ A rms/100 $\mu$ A p-p	2 $\mu$ A rms/50 $\mu$ A p-p	
		Range C 160 $\mu$ A rms/1 mA p-p	80 $\mu$ A rms/500 $\mu$ A p-p	20 $\mu$ A rms/500 $\mu$ A p-p	
Programming Speed: from 0 to 99% of range switch setting with a resistive load ** (Output Current Modulation)		6 ms	6 ms	10 ms	
Dimensions:		7.75" (W) x 3.44" (H) x 12.38" (D) 197 mm (W) x 88 mm (H) x 315 mm (D)	7.75" (W) x 3.44" (H) x 12.38" (D) 197 mm (W) x 88 mm (H) x 315 mm (D)	7.75" (W) x 3.44" (H) x 12.38" (D) 197 mm (W) x 158 mm (H) x 315 mm (D)	
Weight: (Net/Shipping)		4.53 kg (10 lb)/5.9 kg (13 lb)	4.53 kg (10 lb)/5.9 kg (13 lb)	5.9 kg (13 lb)/7.7 kg (17 lb)	

\* This network is a simplified representation of a complex network. The formula  $Z = RX_c / \sqrt{R^2 + X_c^2}$  is used for frequencies up to 1 MHz by substituting the values given for R and C. Above 1 MHz, the output impedance is greater than the formula would indicate.

\*\* Output current can be modulated 100% up to 50 Hz; percent modulation decreases

linearly to 10% at 500 Hz.

†† For operation above 40°C the maximum output current must be reduced linearly to 80% of rating at 55°C (maximum temperature).

$\Delta$  Minimum voltage obtainable with voltage limit control is 0.5 V.



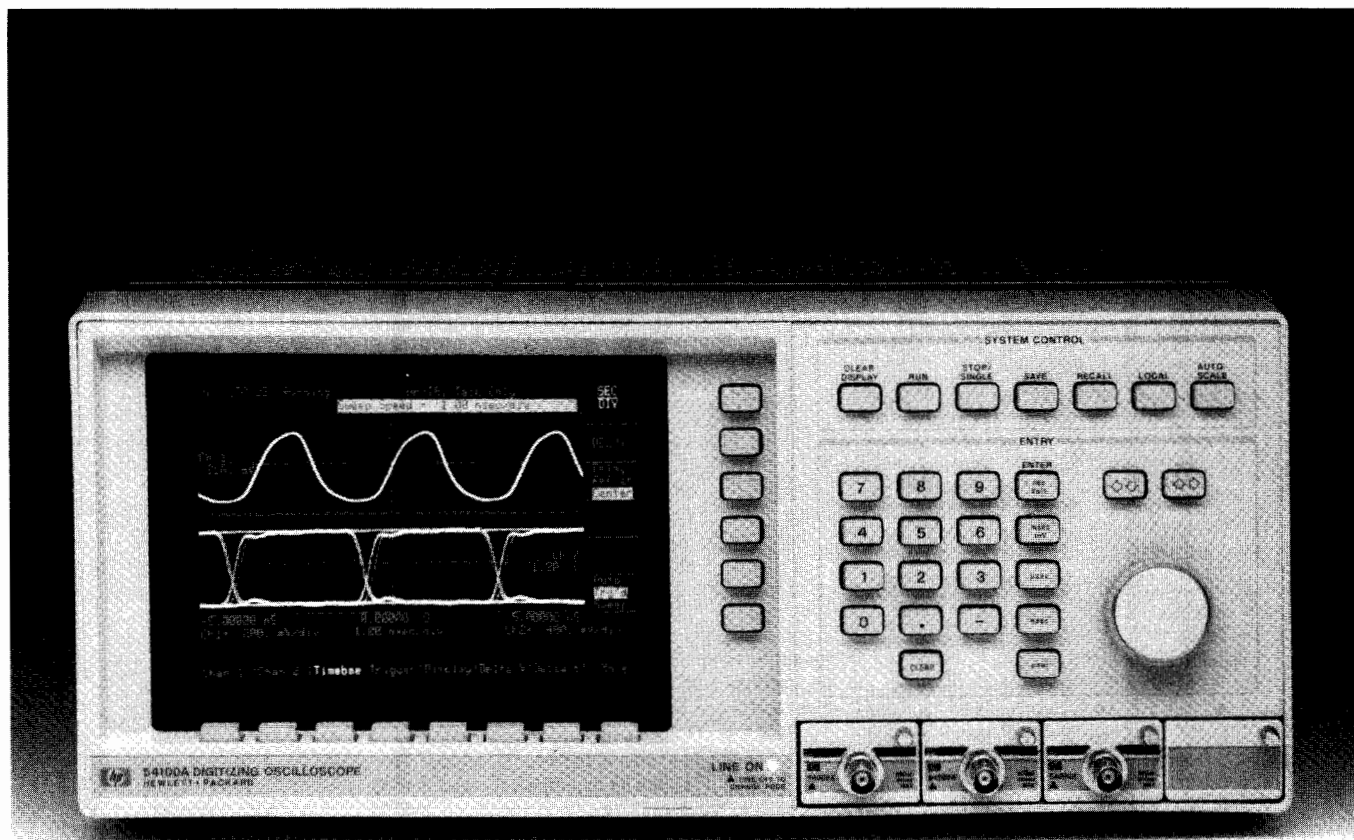

### Waveform Analyzers

Waveform analyzers are characterized by high resolution, deep memory, and computer processing, like FFTs (Fast Fourier Transforms) and time-domain analysis.

Applications for waveform analyzers are found where there is a need for computer-aided analysis and permanent storage of waveforms. Some examples are computer disc and video testing. Transducer-based signals from applications such as explosive and mechanical testing are also suitable for waveform analysis. Waveform recorder/generators help analog designers test circuits with signals captured from "real" sources.

Waveform analyzers digitize and store signals in a single-shot manner. This makes them ideal for recording transient events. A repetitive signal can be recorded in a single pass rather than only a few samples per cycle. This can save time in applications where throughput is an important consideration. Productivity can be increased with automatic measurements. Also, previously impossible measurements and multiple measurements can be made with a waveform recorder and a computer (i.e., waveform analyzer).

For more information on HP's waveform analyzers, including waveform recorders and waveform generation systems, please refer to page 334.

### Digitizing Oscilloscopes

Digitizing oscilloscopes are a relatively recent entry into the world of time-domain measurement instruments. Optimized for digital designers involved with high-speed logic design and the design of digital control logic, HP's digitizing oscilloscopes are easy to use both automatically and manually.

By providing the measurement performance and automatic features needed in today's digital design, digitizing oscilloscopes simplify the analog time-domain measurements that must be made on logic circuits.

Useful for the digital designer as well as in computer-aided test applications, HP's digitizing oscilloscopes provide digital storage capabilities, pre-trigger display, extensive logic triggering, ECL and TTL presets, configurable inputs, and automatic pulse parameter answers.

For more information on HP's digitizing oscilloscopes, please refer to page 340.

### Analog Oscilloscopes

Analog oscilloscopes are among the most general purpose tools of the electronics industry, providing measurement results in research and development labs, production, and service applications. Whether you need a general-purpose 100-MHz oscilloscope or a high frequency oscilloscope with picosecond accuracy, HP provides the oscilloscope that can solve your application problem.

HP's family of analog oscilloscopes provides a wide selection of quality instruments ranging in bandwidth from 100 MHz to 275 MHz, with both conventional and variable persistence storage CRTs available in each bandwidth category.

HP's three variable persistence/storage oscilloscopes offer extremely fast variable persistence and stored writing speeds, plus an auto-intensity circuit that minimizes concern over CRT damage during operation.

In addition to the standard time interval oscilloscopes available, HP also offers oscilloscopes that provide highly accurate time interval measurements plus convenient operation. For more information on HP's family of analog oscilloscopes, please refer to page 348.



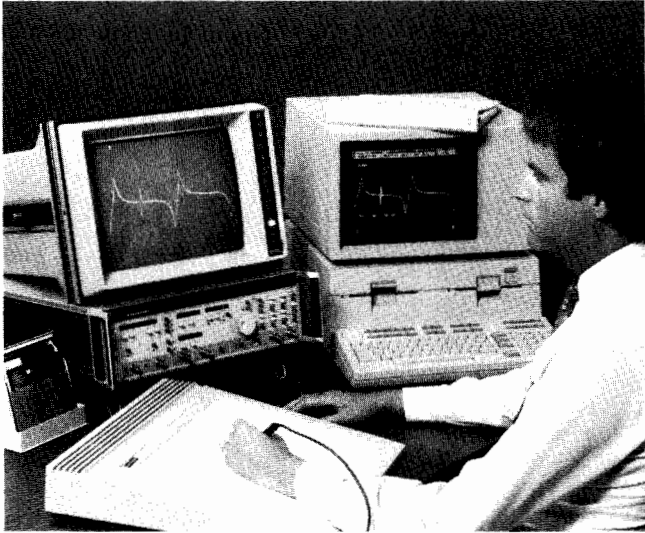

Draw, trace, or edit waveforms with friendly software and graphics tablet. Waveforms can also be generated by equation with this waveform generation system.

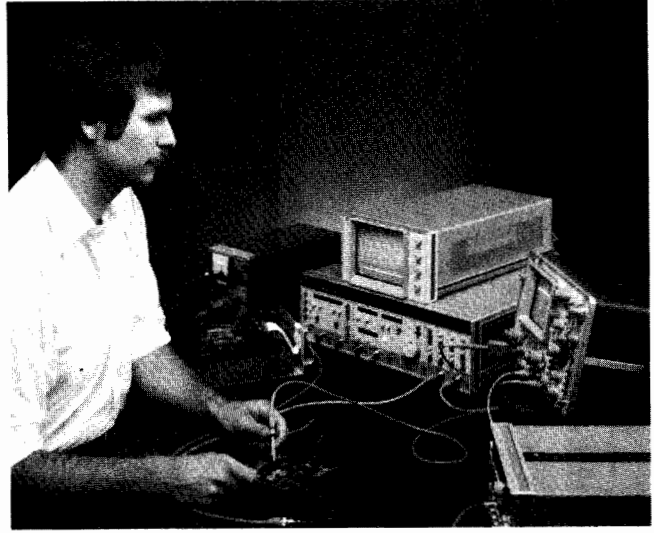

R&D engineers working on analog circuits are among the most likely candidates for a waveform analyzer.

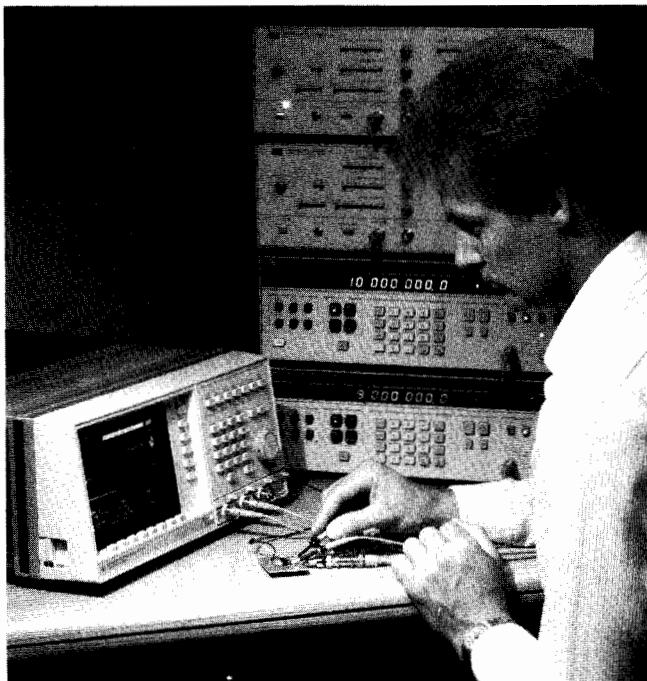

With their high bandwidth and digital storage capabilities, HP's digitizing oscilloscopes are useful in R&D labs working with high-speed logic.

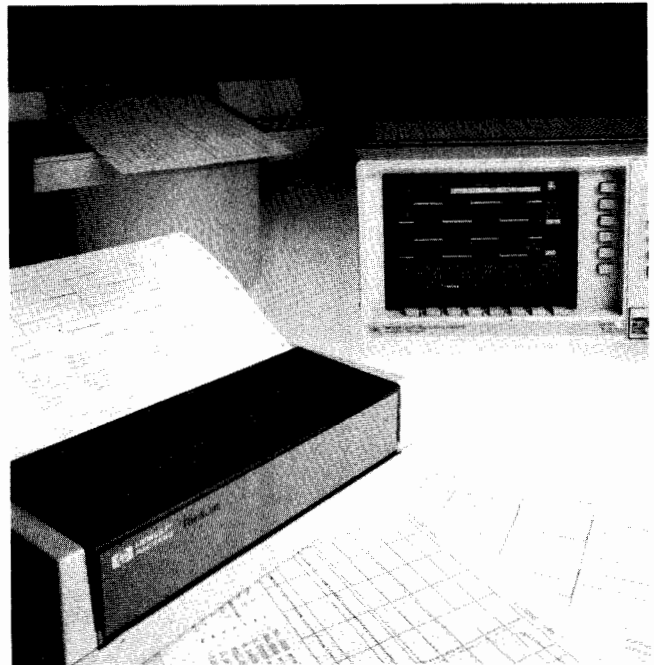

Digitizing oscilloscopes provide instant hardcopy output to HP printers and plotters.



# OSCILLOSCOPES & WAVEFORM ANALYZERS

## General Information - Waveform Analysis and Generation



STORAGE  
SCOPE

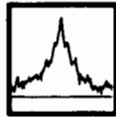

SPECTRUM  
ANALYZER



MODULATION  
ANALYZER

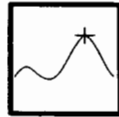

PEAK  
VOLTMETER

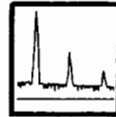

DISTORTION  
ANALYZER

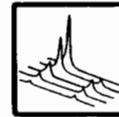

DYNAMIC  
SIGNAL  
ANALYZER



PHASE  
METER



TIME-  
INTERVAL  
COUNTER

Custom and Multiple measurements can be made with a Waveform Analyzer (Digitizing Oscilloscope + Computer). Time can be saved by displaying results in terms familiar to the user.

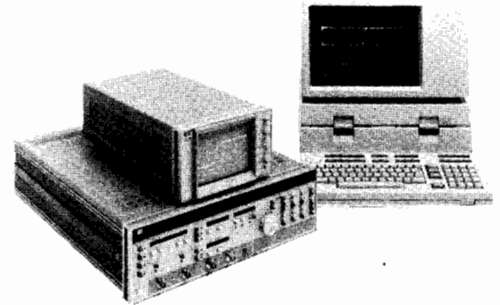
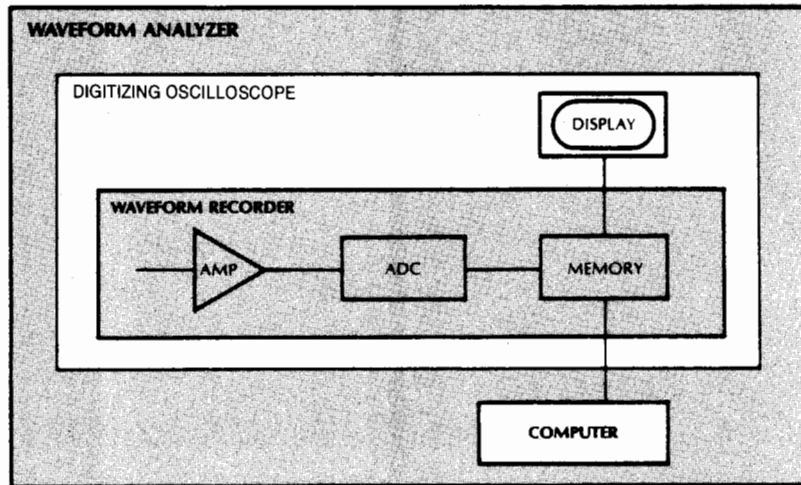

A fully integrated HP 5180S Waveform Measurement System consists of an HP 5180A Waveform Recorder, HP Series 200 Technical Computer and an XYZ display.

### Save the Cost of Dedicated Test Equipment

A waveform analyzer can save you the cost of hardware dedicated to specific tests. Once the signal is accurately digitized, all measurements can be made in the computer with software. Examples of common measurements include distortion, phase, frequency, time interval and peak volts. Also, more complicated analysis can be done: Fourier transforms, digital demodulation, and dynamic signal analysis.

### Replace Custom Test Setups

Replace inflexible custom test setups with an HP Waveform Analyzer. No need to buy or design special hardware. For example, all the tests necessary to evaluate floppy disc media and test drive electronics are performed with a Waveform Recorder and an HP Series 200 Technical Computer. Results can be tailored to the application. Answers can be displayed in familiar terms. Example software for disc testing is available from the Series 200 User Contributed Library and is documented in Application Note AN 313-9. See page 335.

### Make Previously Impossible Measurements!

A waveform analyzer is the perfect tool for fault capture and analysis because it can record the waveform before the trigger occurs. View the signal leading up to the detected fault with single-shot capture and pre-trigger features. For example, you can search a single disc sector for a dropout after the CRC check detects the error.

### High Fidelity Recording

Recording dynamic signals accurately is important because your measurement algorithm can only be as accurate as the data it uses. Consider a Fast Fourier transform routine available from the HP Series 200 User Contributed Library. Each additional effective bit of measurement resolution gives you 6 dB of additional dynamic range in the frequency domain. Whether you are analyzing signals or are storing and modifying them for replay later, an HP Waveform Recorder gives you confidence that your signal is digitized accurately. Product Note 5180A-2 describes the importance of dynamic performance.

### Accurately Digitize Single-Shot Waveforms

Infrequent or single-shot signals will not be missed when you use the HP 5180A and HP 5182A's highly accurate, variable sensitivity, digital trigger. The shape of steep attacks and decays is preserved by the dynamic performance of the analog-to-digital converter (ADC).

### Quickly Acquire Repetitive Signals

If your signal is truly repetitive, you can completely capture a single cycle instead of piecing together one or two samples per cycle (as with sampling oscilloscopes). This can greatly increase the throughput of your tests, whether on the production line or in the lab.

### Minimize Setup Time, Learning Time and Down-Time With HP Systems

Hewlett-Packard technical computers are designed to handle measurement instrument

control and have the power to perform numerical analysis needed for scientific and engineering problems.

Hewlett-Packard Systems are fully supported solutions. HP computers, measurement instruments, software, and interconnecting cables have all been tested together in the factory.

### HP Quality

Hewlett-Packard's attention to high standards of quality means more than just high fidelity recording and reliable operation. HP Waveform Recorders with digital trigger, excellent dynamic performance, flexible memory and fast computer I/O have been designed to give you confidence in your answers. For more details, please see the following pages.

### Capture Real Signals Once, Replay Them Single-shot or Repetitively

Now you can replay signals, right after you capture them. Create a library of captured signals for testing your circuits and systems. Playback a recording once, repetitively with no gaps, or with a delay between each replay.

You can turn single-shot transients into repetitive waveforms for testing or analysis. For example, you can replay a single-shot waveform repetitively and feed the signal into a spectrum analyzer.

Save money by not having to rerun expensive experiments to test your circuits or systems. Simply record the waveform and play it back whenever you need it. Eliminate the effects of wear on mechanical test set-ups. Record the signal once, replay the same signal every time.

# OSCILLOSCOPES & WAVEFORM ANALYZERS

## General Information-Waveform Generation

335

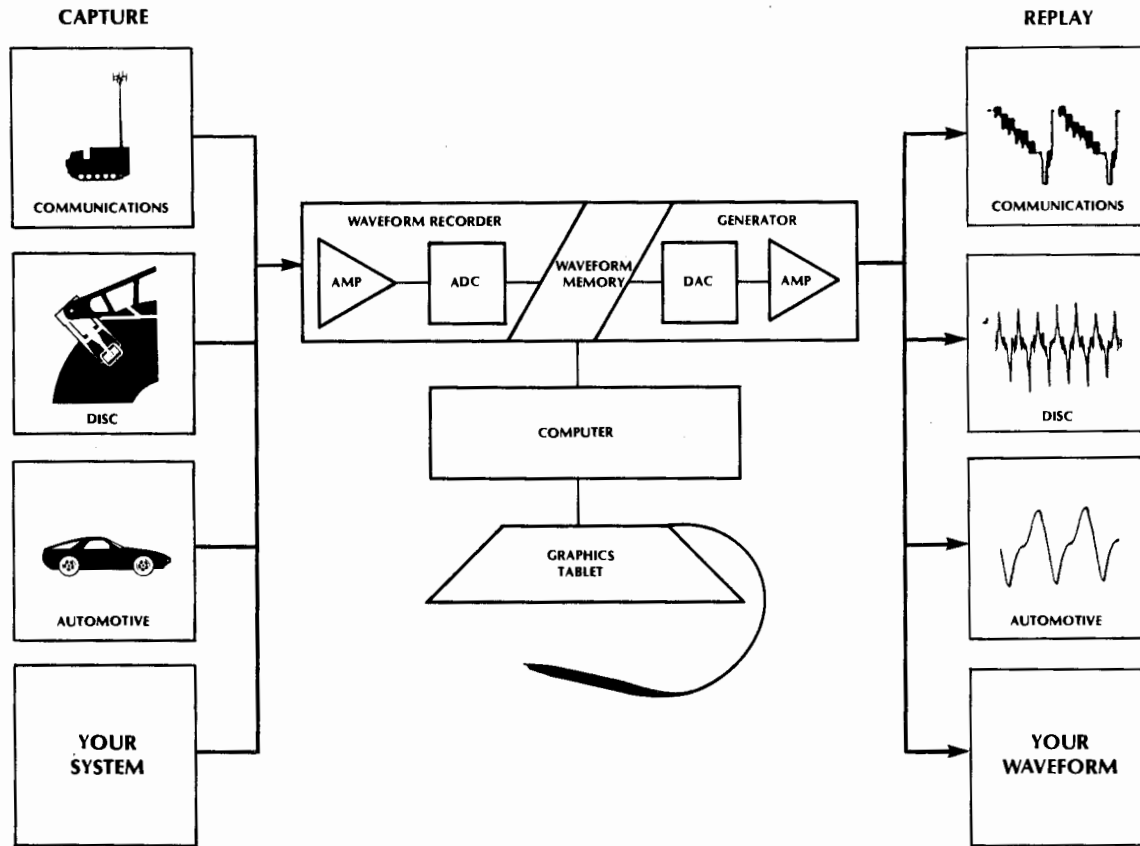

Replace expensive custom signal sources with an HP 5182S Waveform Generation System by capturing once and playing back any time. The HP 51820A Waveform Generation Software saves time modifying stored waveforms and generating arbitrary waveforms.

### Create Complex Waveforms Quickly with the HP 5182S System and HP 51820A Software

In minutes you can be testing the sensitivity of your circuit with waveforms you record from your circuit, waveforms you draw, or waveforms you calculate with an equation. The HP 51820A Waveform Generation Software is driven by only four SOFTKEY MENU'S. No programming is required.

**Write An Equation.** If you don't find your waveform in the library of standard waveforms included in the HP 51820A software, you can easily write your own. The software includes four SOFTKEYS for user-defined equations. Simply enter it in the form "Y=EQATION".

**Draw.** Pick up the graphics tablet pen and draw a waveform.

**Trace.** Tape a waveform from a magazine or journal to the graphics tablet and trace it. Now you are ready to try it in your circuit or analyze it.

### Quickly Modify Waveforms for "What If" Testing

What if the signal-to-noise ratio degrades 6dB? What if there is a glitch at the zero crossing? Now you don't need to build special test equipment or configure complicated setups to find out. Record the waveform, modify it with the HP 51820A, and immediately try it in your circuit.

**Add or Multiply Two Waveforms.** Generate random noise in the computer with an equation and add it to your waveform. Test the sensitivity of your receiver or detector by varying the gain of the noise from a SOFTKEY. Create an exponentially-damped waveform by multiplying it by a decaying exponential.

Modulate a waveform by multiplying the original one with one you draw, recall from disc or generate with an equation. No special hardware required. Differentiation or integration is possible by writing equations.

### Applications for Waveform Analysis and Generation

For more details, free copies of the application notes listed below are available from your local HP sales office.

**Floppy Disc Testing (AN 313-9).** See how a waveform recorder is used to test floppy disc media and disc drive electronics. Software is available from the Series 200 Technical computer contributed library. (Pub. 02-5952-7701).

**Sonar (A/N 313-6)** - The "Toggle timebase is used to capture both the source and the reflection of a sonar pulse in a single memory record. (Pub. 02-5952-7641).

**Direct Memory Access (AN 313-8)** - Shows how to transfer Waveform samples, to and from an HP 5180A or HP 5182A and an HP 9826A Computer, about ten times faster than HP-1B. (Pub. 05-5952-7710).

**Need More Information?** - Please read the following pages. Call your local sales office for other free Hewlett-Packard publications on Waveform Analysis.

### Other Literature Available for HP 5180A and HP 5182A

- HP 5180A/5182A Data Sheet (Pub. 02-5952-7722)
- AN313-1, Troubleshooting Microprocessor Systems (Pub. 02-5952-7634)
- AN 313-2, Using a Spectrum Analyzer Down Converter (Pub. 02-5952-313-2)
- AN 313-3, VCO Settling Time and Post Tuning Drift (Pub. 02-5952-7636)
- AN 313-4, Increasing Effective Sample Rate and Frequency Range (Pub. 02-5952-7636)
- AN 313-5, Power Supply Testing (Pub. 02-5952-7647)
- AN 313-7, Interconnecting HP 5180A's for Multiple Channel Recording (Pub. 02-5952-7670)
- Series 200 Technical Computers Exchange Lib. Software Cat. (Pub. 02-5952-7688)
- Prog. Note 5180/9826-1, Operating an HP 5180A with a 9826 Computer (Pub. 02-5952-7664)
- Prog. Note 5180/9825-1, Operating an HP 5180A with a 9825 Computer (Pub. 02-5952-7630)
- Prog. Note 5180/85-1, Operating an HP 5180A with an HP 85 Computer (Pub. 02-5952-7633)
- P/N 5182-1, HP 5180A and HP 5182A Operating Guide (Pub. 5952-7733)
- P/N 5180-2, Dynamic Performance Testing of ADC's (Pub. 02-5952-7629)
- P/N 5180-3, Subroutines for the HP 5180A & HP 9825A Controller (Pub. 02-5952-7643)
- HP Journal, November 1982 (Pub. 02-5952-8505).



# OSCILLOSCOPES & WAVEFORM ANALYZERS

## Waveform Recorder, 20 MHz, 10 Bits, 16K Word Memory

### Model 5180A

- 16K memory records up to 32 waveforms
- High quality samples
- Operates like a scope

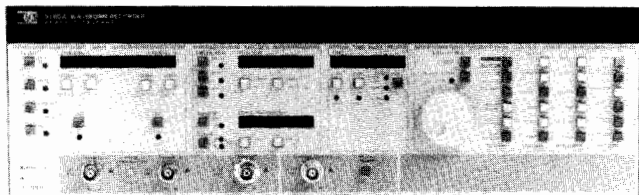

### High Quality Samples Every 50 Nanoseconds

Signal processing requires high quality input data. Hewlett-Packard's 5180A Waveform Recorder digitizes and stores single-shot or repetitive signals. Voltage waveforms are digitized at sampling rates up to 20 MHz (50 ns/sample). Each voltage sample is encoded into a 10-bit word and stored into the memory. These precise voltages (and times) can be read from the front panel with cursors.

Excellent dynamic performance (please read HP Product Note 5180-2) means the ADC does not break up for higher input frequencies. Therefore, your signal is accurately represented for analysis (and replay; see the next page for description of the HP 5182A Waveform Recorder/Generator).

**Accurately Digitize Transients** - The shape of fast attack and decay single-shot waveforms is preserved because the higher frequency components are accurately digitized. The digital trigger is precisely settable ensuring reliable triggering with no drift. Selectable hysteresis eliminates false triggering due to noise.

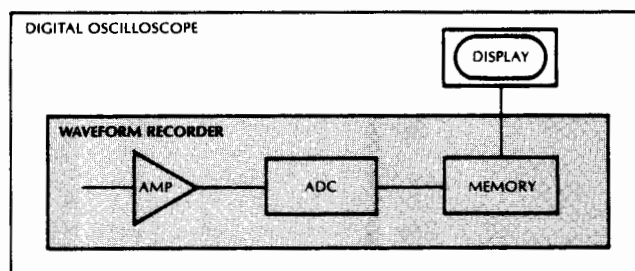

### View Single-shot or Repetitive Signals Quickly

The HP 5180A controls external XYZ displays and hardcopy devices to show the contents of memory records without the need for a computer. Zoom and Gain features expand displayed waveforms horizontally or vertically to look in detail at a selected portion of a waveform. Dual trace capability puts two waveforms on an external display for visual comparison. Digital plotters and printers are controlled by HP-IB. There are two methods of transferring data from the HP 5180A to a computer for analysis: HP-IB and DMA. Direct Memory Access (DMA) can transfer data at a rate up to 1 million words/second, depending on the computer.

The HP 5180A can begin recording a signal at one sampling rate and then switch to another. The switch point is selectable. Set one timebase at a faster sample rate to record more detail, and set the other at a slower rate to conserve memory space. Two transients may be recorded simultaneously using the HP 5180A's input CHOP mode.

The HP 5180A is fully programmable over HP-IB for automated operations.

- High speed repetitive signal acquisition
- Accurately digitize transient signals
- Quickly transfer waveform samples to computer

### Summary of HP 5180A Specifications\*

#### Channel A and B Inputs

**Input voltage range:**  $\pm 100$  mV to  $\pm 10$  V.

**Input offset voltage:**  $\pm$  selected Voltage Range.

**Amplifier bandwidth (-3 dB):** dc to 40 MHz (dc coupling).

10 Hz to 40 MHz (ac coupling).

**Input impedance (NOMINAL):** 1 M $\Omega$  || 40 pF (10 V range).

1 M $\Omega$  || 35 pF (other ranges).

**Damage level:**  $\pm 12$  V above 1 kHz.

#### Dynamic Performance

	Voltage Range	Input Signal	Test Frequency	
			1 MHz	10 MHz
DFT Spurious	$\pm 1$ V	2 Vp-p	$\leq -50$ dBc	$\leq -46$ dBc
Differential Nonlinearity	$\pm 1$ V	2.2 Vp-p	$\leq 3$ LSB	$\leq 4$ LSB
Missing Codes	$\pm 1$ V	2.2 Vp-p	None	None
Effective Bits	$\pm 1$ V	2 Vp-p	$\geq 7.8$ bits	$\geq 7.5$ bits
S/N Ratio	$\pm 1$ V	2 Vp-p	$\geq 48.6$ dB	$\geq 46.8$ dB

#### Triggering

**Internal trigger:** level and sensitivity selectable over input voltage range.

**External trigger:** level selectable over  $\pm 2.5$  V range.

**Trigger position:** -100% to +9999% of memory.

#### Timebase

**Internal timebase:** 20 MHz internal timebase allows sample rates between 50 ns and 50 ms in a 1-2-5 sequence.

**External timebase:** external timebase signals between 1 MHz and 20 MHz may be used. Internal divide ratio between 1 and  $10^6$  in a 1, 2, 5 sequence.

#### Memory

**Size:** 16,384 10-bit words.

**Segmentation:** memory may be divided into 1, 2, 4, 8, 16, or 32 equal-length records.

#### Outputs

**XYZ CRT monitor outputs:** X, Y deflection voltages (NOMINAL) -1 to 0V into 50  $\Omega$ . X requires 1 MHz bandwidth input; Y requires 5 MHz bandwidth input. Z voltage (NOMINAL) is 0 to 2 V into 1 k $\Omega$  (0 to 1V into 50  $\Omega$ ), selectable positive or negative going blanking pulse. Z requires 1.25 MHz bandwidth input.

**HP-IB:** all front panel function values selectable via HP-IB. Data I/O in ASCII or binary; maximum 3 Kbyte/second rate, depending on controller. "Talk only" to HP-GL plotters available even if no controller is used.

**DMA:** direct memory access allows fast parallel data transfer; maximum 1M word/second, depending on controller.

#### General

**Operating temperature:** 0°C to 55°C.

**Power requirements:** 100/120/220/240 volts +5%, -10%; 48 to 66 Hz. Max power dissipation 400 VA.

**Weight:** 22 kg (48 lb) net; 25 kg (53 lb) shipping.

**Size:** 142 mm H x 426 mm W x 574 mm D (5 $\frac{5}{8}$ " x 16 $\frac{3}{4}$ " x 23").

#### Accessories

HP 10871A Service Kit (for HP 5180A)

HP 10872A Parallel Interface (DMA Interface for use with HP 5180A and HP 9825/35/45 controller)

HP 10873A Rack Mount Kit (for HP 5180A)

HP 10874A Slide Mount Kit (for HP 5180A)

HP 10875A 4.8m DMA Cable

HP 10875B 1.0m DMA Cable

**Option 910: Additional Manual**

\*See HP 5180A Waveform Recorder Data Sheet for more information.

**HP 5180A Waveform Recorder**

# OSCILLOSCOPES & WAVEFORM ANALYZERS

Waveform Measurement System

Models 5180S, 51800A

337



- Automatic measurements
- Universal measurement solutions
- Modular software



- Increase test design productivity
- Choose standard measurements
- Add custom tests

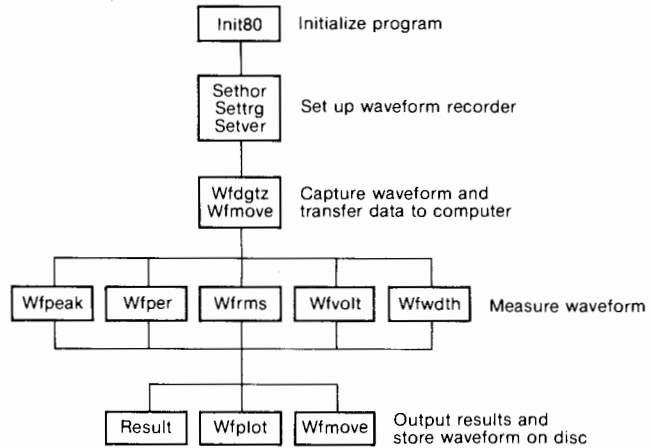
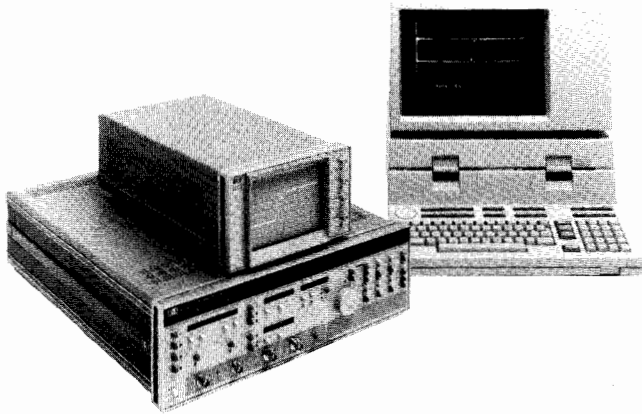

## Automatic Time Domain Measurements

Make time domain measurements on single-shot or repetitive waveforms with the HP Model 51800A Waveform Measurement Library. The library is a collection of programs designed to make measurements on signals captured by the HP 5180A Waveform Recorder and HP 5182A Waveform Recorder/Generator. Instruments are controlled by sub-programs. All you do is chain them together to make the measurements you need.

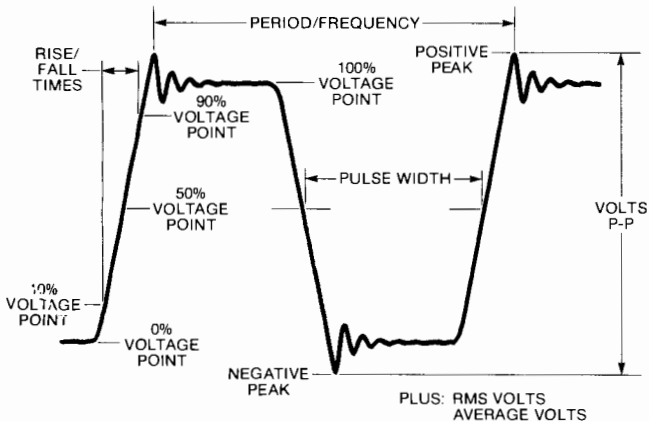

## Reduce Programming Time by Chaining Preprogrammed Subroutines From The HP 51800A Waveform Measurement Library

No programming is required to run the Measurement Program. Start taking measurements on repetitive waveforms the day the software arrives. Assemble your own program for infrequent and non-periodic waveforms from the library subprograms. For example, frequency is measured with one subprogram, while waveform comparisons are performed by another.

Since instrument control is done by subprograms, you can concentrate on the results you need, saving the time of learning how to program the instrument. Write your own program by chaining subroutines to make measurements, store waveforms on disc, print or plot results, and perform utility functions.

Three programs help you construct your own measurement programs faster. The example MAIN program includes everything a program needs to work with a waveform recorder and the library subprograms. The two other programs are an autoloader and comment stripper.

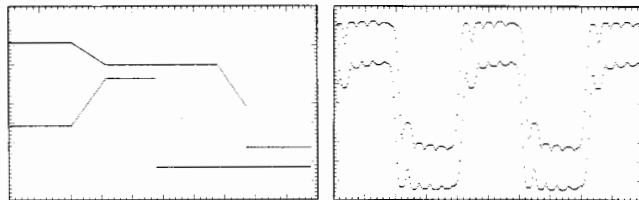

## Specify Arbitrary Test Limits

Set limits like those shown above from a set of endpoints that you input. Thus any arbitrary shape can be defined as the limit waveform.

You can also compare waveforms from units under test to the limits set by a known good signal. This saves time by not having to measure every parameter and allows the computer to make qualitative decisions.

## Ordering Information

HP 5180S Waveform Measurement System

To ensure coordination of shipments and compatibility of instruments, computers and software use the system model number when ordering the individual components, including peripherals such as printers and plotters. Obtain an HP 51800A Data Sheet and an HP 5180S Ordering Guide from your local sales office. See page 695.

HP 51800A Waveform Measurement Library

## Realize the Power of a Waveform Recorder by Interfacing it to an HP Series 200 Technical Computer

Because the signal has been digitized and stored, it can now be sent to a computer for analysis and then to a disc for permanent storage.

### Automate With HP-IB

All front-panel functions are remotely controllable with HP-IB including complete front-panel "teach" and "learn" strings.

HP-IB I/O Functions: SH1, AH1, T5, L3, SR1, RL1, PP0, DC1, DT1, C0, E1

### Transfer Data Fast With DMA

Waveform data can be sent to and from a computer about ten times faster than HP-IB using Direct Memory Access (DMA). As many as 100 records (1K word) per second can be sent to an HP 9826 Technical computer. For more information, call your local sales office (see page 695) for a free copy of Application Note A/N 313-8 on using DMA with an HP 9826 Technical Computer and HP 5180A Waveform Recorder.



# OSCILLOSCOPES & WAVEFORM ANALYZERS

## Waveform Recorder/Generator, 20 MHz, 10 Bits, 16K Word Memory

Model 5182A

- 16K Nonvolatile waveform memory
- Fully programmable via HP-IB
- Quickly transfer waveforms to/from computer
- Easily simulate complex, real signals
- Record single-shot, replay repetitively

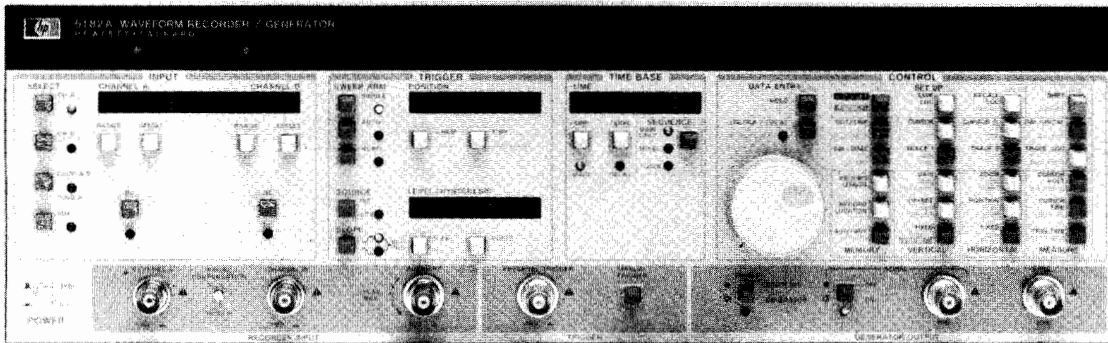

### Duplicate Infrequent Waveforms Whenever You Need Them

Get an "instant replay" of your single shot signal when you buy a HP 5182A Waveform Recorder/Generator. Also create repetitive signals by playing back a single recording over and over again with no time gap between replays.

Now you can test your circuits with the actual signal you record rather than a theoretical one. "What if" testing can be done by adding a computer to modify and store the waveforms. An HP Series 200 Technical Computer, HP 9111A Graphics Tablet and an HP 5182A form an HP 5182S Waveform Generation System.

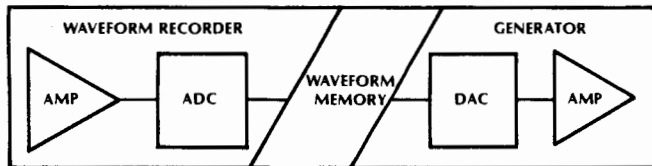

### A Waveform Recorder/Generator is a High Speed Digital "Tape" Recorder

The "tape" is silicon memory. At 20M samples per second, it can store 819  $\mu$ s, 819 seconds at 20 samples per second. This digitized waveform can be played back once or over and over again with no time gap. For example, you can accurately store 16 separate lines of video or a single sector of data from a floppy disc drive. The video signal can generate color bar patterns to test video circuits. The disc signal can be used to test read-recovery circuits.

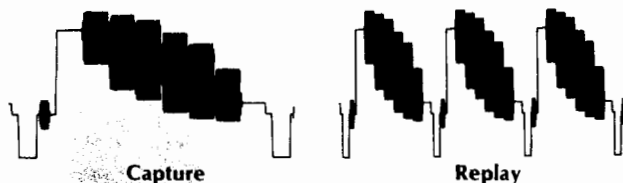

### Capture in the Field, Save, Replay on the Bench

Continuous (battery backed up) waveform memory allows you to record up to 32 waveforms on site. Remove the power and carry the HP 5182A back to the lab. Now you can play them back to test your circuits or for further analysis. Attach the HP 5182A to an HP Series 200 Technical Computer and you can store the waveforms on disc, process them further and modify them for "what if" testing.

Shown in the figure is one line of a TV color bar test pattern. Played back repetitively, this signal can be used as a video test signal.

### Simulate Expensive, Single-Shot Experiments

Some experiments can be very time consuming and expensive to repeat. For example, biomedical experiments, measurements of explosions, and propagation experiments such as radar and sonar. With the HP 5182A you can capture the signal accurately, when it occurs. Then, switch to generator mode, and you're ready to replay it, any time you need it.

A sync pulse is generated once per playback cycle for synchronizing other equipment.

### Specifications Generator Section

For recorder section, please see HP 5180A specifications on page 336.

#### Peak Output Voltage (for Full-Scale Waveform) Into 50 Ohms:

Range	Vernier Range		Vernier Step Size
	Min	Max	
5.12V	520 mV	5.12V	40 mV
512mV	52 mV	512 mV	4 mV
51.2mV	5.2 mV	51.2 mV	0.4 mV

**Max. output voltage into open circuit:** 10V (NOMINAL).

**Output Offset:** -5.12V to +5.11V in 10 mV steps into 50 ohms.

**AC Performance:** Noise: -65 dBc

**Harmonic Distortion (DC to 1MHz):** -48 dBc

**Spurious (Sample Rate Related):** -40 dBc TYPICAL

**Output Rise time:** 100ns max. (10% to 90%).

**Amplifier Bandwidth (-3dB):** 10MHz (NOMINAL)

**DC Performance** (10 bits resolution per sample)

**Differential Nonlinearity:** <1 LSB (Monotonic)

**Integral Nonlinearity:** <3 LSB

**Offset Accuracy:** 100mV (20-30°C)

**Absolute Accuracy:** 1% of p-p full scale range (20-30°C)

**Internal Trigger:** Output automatically triggered when armed.

**External Trigger:** Slope, level, hysteresis, width, impedance, coupling and maximum input same as for Recorder. (See page 336).

**Insertion Delay:** 250ns max.

#### Time Base Modes

**Main Only:** Available in Single, Auto, and Normal Sweep Arm modes.

**Mixed (Main, Delay):** Available in Single and Normal Sweep Arm modes.

**Memory Size:** 16384 10-bit words; Segmentation: 1,2,4,8,16 or 32 equal length blocks. Generation: Data may be generated from any memory block. Within any one block, a portion of the waveform may be generated by setting the starting point and stopping point. An even number of points is always output.

**Sync Output:** Voltage: 0 to -0.75V NOMINAL into 50 ohms, Pulse Width: One sample interval with the falling (first) edge active (or approximately 100  $\mu$ s when the sync pulse is past the stop position, and Sweep Arm is Single or Normal). Position: Settable from first point in the record to the last point. If the sync position is set outside the limits of the Start and Stop Position markers, the output record is extended to include the Sync Position by assigning a dc voltage (equal to the nearest Start/Stop Position marker) to the waveform between the Start/Stop Position marker and the sync position.



# OSCILLOSCOPES & WAVEFORM ANALYZERS

Waveform Generation System

Models 5182S, 51820A

339



- Save time storing and recalling waveforms
- Quickly modify and try waveforms

- Save time generating arbitrary waveforms
- No programming necessary

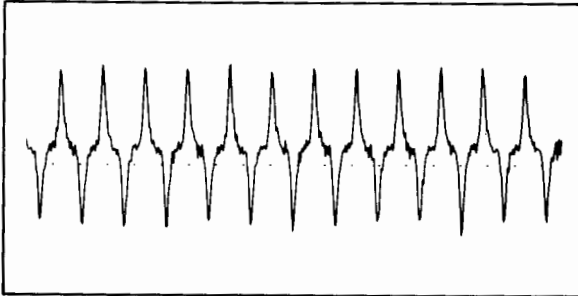

This signal was recorded from a floppy disc read head.

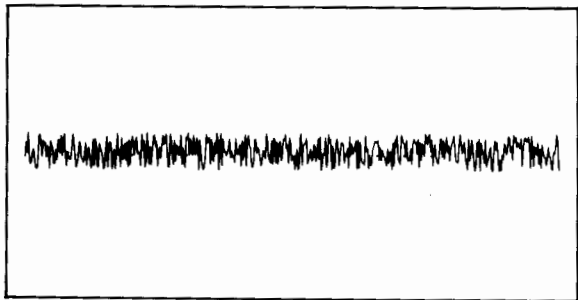

Combined with noise generated from built-in function . . .

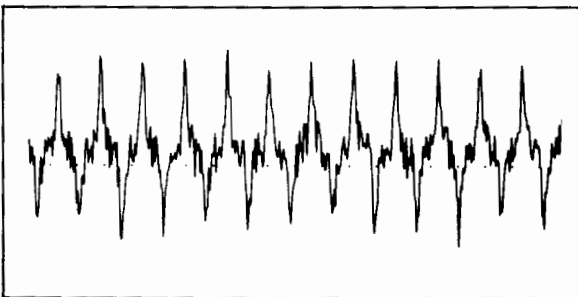

It is used to test the sensitivity of read recovery circuits.

## Save Time Generating Specialized Waveforms

The HP 51820A Software is a powerful set of tools for creating specialized waveforms. Modify captured waveforms or define new ones with the HP 9111A graphics tablet (part of the HP 5182S system). Simply press a SOFTKEY to send waveforms to the HP 5182A for replay or disc for storage. Since the HP 51820A is a complete package (no programming is required), you are productive immediately.

The software is driven by a main menu and three submenus: draw, process and I/O. Because it's only two levels deep, you won't get lost in multiple levels of menus.

### Waveform Capture, Modification and Playback

Modify waveforms you've captured and play them back into the device you are testing. Rather than waiting for a glitch to occur randomly, you can draw one and see the circuit response immediately.

Waveforms can also be modified by processing. Simple functions like offset and gain are built into the SOFTKEY MENU. There are also SOFTKEYS for adding or multiplying two waveforms together.

More complicated processing like calculus and convolution can be accomplished by modifying the user-equation subroutines. Four SOFTKEYS are reserved for your own equations. The Software comes with the equations programmed to generate sine waves, triangle waves, square waves and random noise.

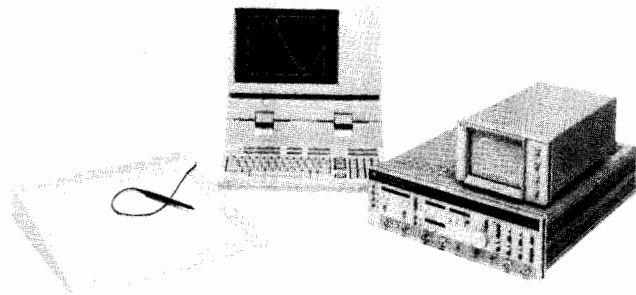

## Arbitrary Waveform Generation

There are three ways to create the waveforms you need. You can recall waveforms from the library, including sine waves, square waves, SIN (X)/X, Gaussian pulses, exponentials and more. You can calculate waveform samples with equations. Third, you can draw or trace waveforms with the graphics tablet. Choose the method that will get you the signal you need in the shortest time.

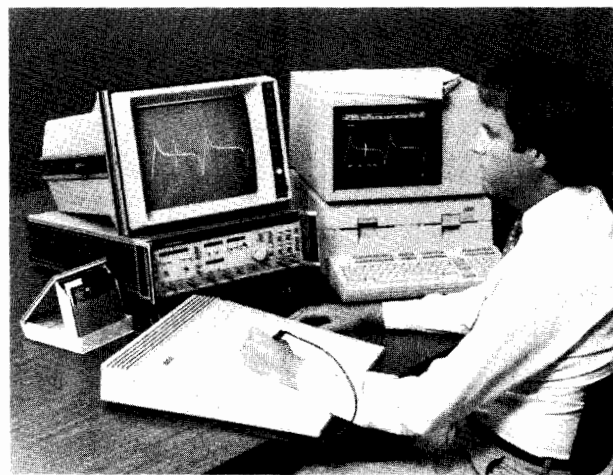

Draw, trace, or edit waveforms with friendly software and graphics tablet. Waveforms can also be generated by equations.

## Ordering Information

### HP 5182S Waveform Generation System

To ensure coordination of shipments and compatibility of instruments, computers and software, use the system model number when ordering individual components including peripherals such as printers and plotters. Obtain HP 51820A and HP 51800A Data Sheets and a HP 5182S Ordering Guide from your local sales office. See page 695.

### HP 51820A Waveform Generation Software



# OSCILLOSCOPES & WAVEFORM ANALYZERS

## Digitizing Oscilloscopes

Models 54100A/D, 54300A

- 1 GHz bandwidth
- Automatic pulse parameter and time interval measurements
- Digital storage
- Flexible probing solution
- Pre-trigger viewing
- Logic triggering capability

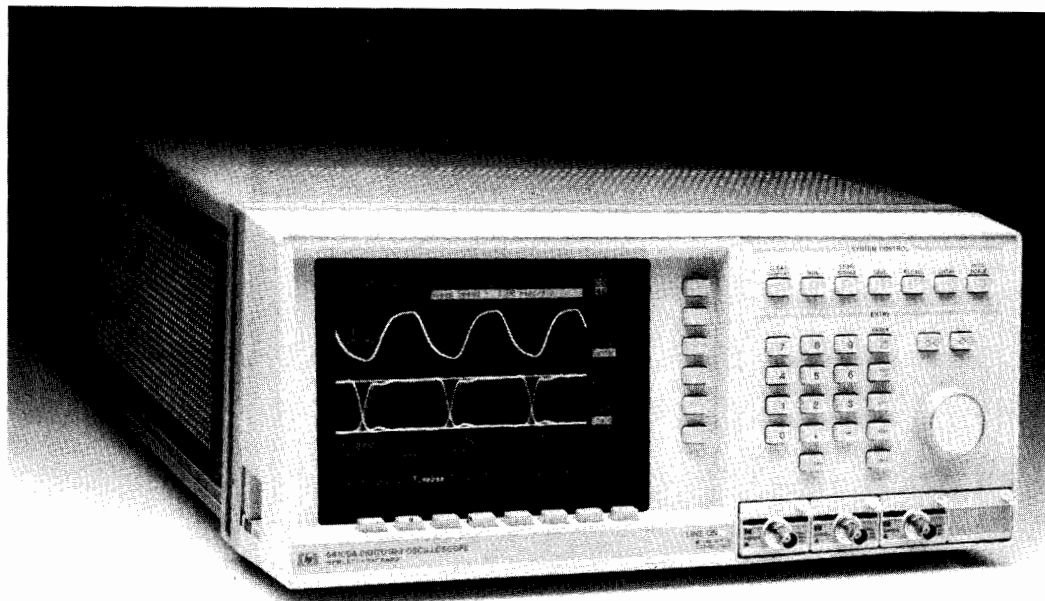

### The HP 54100A/D Description

In the HP 54100A/D Digitizing Oscilloscope, Hewlett-Packard combines a new oscilloscope architecture with state-of-the-art technologies, creating a general-purpose oscilloscope for engineers involved with digital design and test. The HP 54100A/D simplifies analog time-domain measurements on high-speed logic circuits: it can make the new measurements needed when working with the most recently developed logic families, and it can make standard measurements faster and more accurately than conventional oscilloscopes can.

#### Measurement Performance for High-Speed Logic Design

- 350 ps rise time.
- Stable triggering on pulses 1 ns wide.
- 100 ps/div time base.
- 40 megasample/sec digitizing rate.

#### Digital Storage

- Bright, stable display of low duty-cycle signals.
- Retain waveforms as long as desired for worst-case analysis.
- Fade-free, non-blooming display.
- Store as many waveforms as needed for comparison or reference.
- Make measurements after signal is acquired. This is especially useful on single-shot signals or infrequent error conditions.
- Waveform data available over the HP-IB.
- Signal averaging for noise rejection and increased resolution.

#### Automatic Measurements

- Automatic edge finders save time, eliminate uncertainty, and reduce operator error in time-interval measurements.
- Measure pulse parameters automatically, without a controller.
- Markers indicate where the measurement was made, providing confidence in measurement results.

#### Pre-trigger Display

- Find causes of events.
- Displayed time can be any time before or after the trigger, and is not limited to one screen width before the trigger. Time intervals

can be measured with a resolution of parts per million, before and after the trigger.

#### Stable, Precise, Accurate Time Base

- Stability of 0.1 parts per million allows you to measure small time increments over a large time range with minimal jitter.
- With 0.002% time base linearity, 50 ps aperture jitter, and 10 ps resolution, you can measure critical timing parameters in high-speed logic circuits confidently.
- Channel-to-channel skew calibration allows you to measure time intervals accurately at the probe tips.

#### Triggering on Complex Digital Waveforms

- Logic pattern triggering allows you to trigger on the complex events found in typical digital systems.
- Trigger holdoff can be specified by events or by time for stable triggering on long, complex sequences of events.
- Independent trigger threshold adjustments for each channel. No need to reset the trigger level each time you switch from one trigger source to another.

#### Easy-to-Use

- Pressing the Auto-Scale button automatically sets up the time base, sensitivity, offset, and trigger for a stable display over a wide range of input signals.
- Save up to ten front panel setups in non-volatile memory; simplify a sequence of repeated measurements quickly.
- Instant hardcopy with either a pen plotter or a graphics printer eliminates time-consuming, expensive photography.

#### Simplified Programming

- Simple, logical, structured programming mnemonics make programs easy to edit, easy to understand, and easy to modify for new applications.
- Measurement-oriented, English-like mnemonics.
- Complies with the recommendations of IEEE standard 728-1982, *Recommended Practice for Code and Format Conventions*.



### Configurable Inputs

- 50 ohm inputs and probes for a wide variety of environments, without the expense of amplifier plug-ins.
- 1 GHz active miniature probes for densely-packed, high-speed logic circuits.
- 1 megohm probes for circuits sensitive to resistive loading.
- 50 ohm BNC inputs for measurements where terminated lines are important.

### The HP 54100D - Extensive Logic Triggering

The HP 54100D adds the following triggering features to the basic capabilities of the HP 54100A.

#### Fourth Input

The HP 54100D has four inputs: two are vertical channels, and two are trigger inputs. The HP 54100A has three inputs; two vertical channels and one trigger input.

#### Pattern Trigger

In the HP 54100D's pattern trigger mode, each of the four inputs can be selected as high, low, or don't care. In the HP 54100A, the pattern selection is limited to the three inputs. The additional bit in the pattern specification extends the usefulness of pattern triggering to more complex data buses.

#### Time-Qualified Pattern

In addition to triggering on entering or exiting the specified pattern, the HP 54100D can be set to trigger when a specified pattern is present for less than or greater than a specified duration, from 10 ns to 5 seconds. Applications include glitch detection, triggering on timing violations, and capturing bus hangup conditions.

#### Pattern With Clock

The HP 54100D can be set to trigger on an edge of either polarity on any one of the four inputs, when a specified pattern exists at the other three inputs. This is useful when it is necessary to synchronize the display to a system clock and detect a system state.

#### Delayed Trigger

The HP 54100D can be set up to arm on an edge on any one of its four inputs, then trigger on an edge on any other input after a specified time or after a specified number of edges. The delay time can be varied from 20 ns to 5 seconds. The edge count can be set from 1 to 99999999. The delay-by-events mode is particularly useful in systems where the data rate fluctuates or jitters, as in a disc drive. You could use the delay-by-events mode to arm on the index pulse in a disc drive, then trigger on a data pulse anywhere around the track. This stabilizes the display on a particular pulse.

### Designed for the Digital Designer's Bench Save Time and Reduce Errors in Complex Measurement Setups

Automate a sequence of measurements on your design bench, without a controller, with the HP 54100A/D's save and recall keys, to save time and reduce errors. Step through a series of complex measurements by pressing only two keys for each new setup. Increase confidence in measurement correlation by not spending time between measurements changing setups.

### Locate and Measure Waveform Features Quickly and Accurately

The HP 54100A/D allows you to make precise time-interval measurements at specified voltage thresholds by pressing a button. Making a delay measurement between two signals is as simple as positioning voltage markers on each channel, then specifying the desired edge number and edge polarity for each channel.

#### Measure Pulse Parameters Automatically

The HP 54100A/D automatically locates and measures pulse features. Markers indicate where the measurement was made, so you are confident that the measurement was valid.

#### Store Multiple Waveforms for Comparison or Reference

With the HP 54100A/D, you can easily store waveforms by pressing a button. Because each waveform is stored exactly as it is displayed, many waveforms can be stored in each of the HP 54100A/D's two waveform storage memories. Stored waveforms are overlaid, facilitating precise visual comparisons between stored waveforms, or

from a stored waveform to a live waveform. The time and voltage markers can be used for quantitative measurements on stored waveforms.

#### Logic Family Presets

ECL and TTL presets scale the vertical gain, offset, and trigger levels for the selected logic family. This saves time in setting up for a measurement.

#### Document Results

Active as well as stored waveforms, setup conditions, and measurement results can be printed or plotted for instant, low-cost documentation. HP printers provide report-quality hardcopy for articles or printed reports at minimal cost, and without the delay of photographic reproduction.

#### Hold That Waveform!

When the input signal is removed, the display is retained on-screen. The display can also be frozen by pressing the Stop button. This is useful when it's difficult to hold the probe on a test point, or to see the oscilloscope screen and the test point simultaneously. You can also capture rapidly-changing or transient signals for viewing and analysis. You can use the markers to make measurements on the stored waveform; you can print or plot the captured waveform at leisure.

#### Automate Probing

Connect up to 16 probes to your circuit, then select any one or two at a time with the HP 54300A probe multiplexer. No need to move probes between measurements. You can be confident that all of your measurements were made under identical conditions because you didn't have to shut off power to the circuit under test, disturb test points by moving probes, or restart the test program. The time saved can be a significant portion of the time required to test a complex circuit with many measurements on each of several nodes.

You can cascade HP 54300A probe multiplexers to two levels for probing up to 128 points. You can store multiplexer setups in the HP 54300A's non-volatile memory in up to 100 lists of up to 100 steps each (3700 steps max), which you can then step through manually by pressing a button on the front panel or automatically under HP-IB control. This capability, together with the HP 54100A/D's save/recall feature, makes it easy to automate a series of measurements with or without a controller.

#### Your Computer: A Valuable Ally

Your desktop scientific or personal computer can be a powerful companion for making measurements with the HP 54100A/D digitizing oscilloscope and the HP 54300A probe multiplexer. Simple, English-like mnemonics and a logical, hierarchical structure make it easy to create and modify programs.

### For Computer-aided Test Applications Simplified Programming

Easily understood, English-like commands with a logical structure facilitate programming with minimum documentation, and they can simplify editing or modifying programs.

#### Save Setups in the HP 54100A/D's Memory

Speed up tests by storing setups in local memory. At execution time, simply recall the desired setups.

#### Data Or Measurements—Whichever You Need

Complete waveform data are available for analysis in a variety of formats. If you need to measure pulse parameters or time intervals, the HP 54100A/D can make these measurements automatically. This simplifies your program and reduces traffic on the HP-IB.

#### Select the Kind of Data You Need

- Program the HP 54100A/D to acquire the data in the format you need and transmit it as a binary block quickly and efficiently.
- Use the averaged data mode when the signal is noisy and you must analyze small reflections or perturbations.
- Select the envelope mode when you need to know the waveform's minimum and maximum values over a period of time; for example, when capturing soft errors that occur only once every million or more bits.
- Use the pixel format when you need to analyze every sample acquired on an eye pattern to detect random timing.



# OSCILLOSCOPES & WAVEFORM ANALYZERS

## Digitizing Oscilloscopes (Cont.)

### Models 54100A/D, 54300A (Cont.)

- Use the random data format for statistical analysis, such as histogramming.

#### Probe Multiplexing Complements the HP 54100A/D

The HP 54300A is a dual eight-to-one probe multiplexer that can be used with either the HP 54100A/D oscilloscope or other 50 ohm input HP instrumentation to provide a complete probing solution.

- Accepts all of the HP 54100A/D's input pods.
- You can store up to 100 sequences of up to 100 steps each (3700 steps max) in the HP 54300A's non-volatile memory. Then, step through them under computer control or from the front panel.
- Programmable over the HP-IB.
- Up to 16 pods in two groups of eight each.
- HP 54300As may be cascaded in two levels to provide up to 128 inputs.
- Connect all the probes to the circuit under test, then step through the tests desired. Save time, avoid turning power on and off repeatedly, and avoid restarting programs.

#### A Choice of Input Pods

**HP 54001A 1 GHz miniature active probe:** use the HP 54001A in applications such as high-speed logic measurements, where high bandwidth is essential and where capacitive probe loading dominates the probe's effect on the signal. At 1.5 metres, it provides excellent access to those hard-to-reach areas of a system rack or backplane. Its small tip diameter and low mass make it easy to get into crowded circuits without electrical degradation, by getting the probe close to the node you need to measure. The combined system rise time with the HP 54100A/D is less than 400 ps, for measurements on subnanosecond logic.

**HP 54003A (1 M) 1 megohm probe:** use this 1 megohm probe when resistive loading is critical, as in operational amplifier measurements. The probe can be removed from the pod to provide a 1 megohm, approximately 12 pF BNC input. This is useful where a coaxial connection is desired, in applications where bandwidth and capacitive load are not as critical as resistive loading (e.g., moderate bandwidth measurements in an automatic test system). Use the HP 10014A (1.1 M) 10 megohm input probe with the HP 54003A pod for measurements in extremely high resistance circuits.

**HP 54002A 50 ohm BNC input pod:** three of these pods are included with the HP 54100A, and four with the HP 54100D. Use a 50 ohm terminated system, with the HP 54002A pod at the oscilloscope input, to preserve signal fidelity and to minimize the effects of the measurement on the circuit under test. The HP 54002A can be used with the HP 10020A resistive divider probe kit. It may also be used with a variety of active oscilloscope probes that require a 50 ohm input.

## SPECIFICATIONS - HP 54100A/D

### Vertical (Voltage)

The following apply when the HP 54100A/D is used with the HP 54002A 50 ohm input pod.

**Bandwidth (-3 dB):** dc to 1 GHz; these specifications apply over ambient temperature range of +15° C to +35° C.

**Transition time (10% to 90%):** ≤350 ps

**Deflection factor (full-scale=8 divisions):** 10 mV/div to 1 V/div in 1-2-5 steps.

**DC accuracy, single voltage marker:** ±3% of full-scale ±2% of offset; when driven from a 50 ohm source.

**DC delta voltage accuracy using voltage markers on the same channel:** ±1% of full-scale ±3% of reading, when driven from a 50 ohm source.

### DC Offset

**Range:** ±1.5 × full-scale (referenced to center screen).

**Magnifier:** expands displayed signal vertically from 1 to 16 times; adjustable in 0.5% steps.

**Inputs:** two inputs, configurable with HP 54000-series pods.

### Horizontal (Time)

**Deflection Factor (full-scale is 10 divisions):** 100 ps/div to 1 sec/div.

### Delay (Time Offset)

**Pre-trigger range:** up to -200 ms or -10 divisions, whichever is greater.

**Post-trigger range:** up to +1 second or +10 divisions, whichever is greater.

### Time Base Accuracy

**Single-channel:** (100 ps ±2 × 10<sup>-5</sup> × delta T reading)

**Channel-to-channel:** (200 ps ±2 × 10<sup>-5</sup> × delta T reading)

**RMS Jitter:** (50 ps + 5 × 10<sup>-7</sup> × delay setting)

### Trigger

The following apply when the HP 54100A/D is used with the HP 54002A 50 ohm input pod.

Trigger Source	Vertical Channel 1 or 2	Trigger Input 3 (HP 54100D: Trigger Input 3 or 4)
Trigger level range	±2 × full-scale	±2 V
Trigger sensitivity dc to 100 MHz 100 to 500 MHz	0.12 × full-scale 0.24 × full-scale	40 mV 50 mV

**Trigger Source:** channel 1, channel 2, trigger 3 input (HP 54100D, trigger 4 input).

**Trigger 3 Input (HP 54100D, trigger 4 input):** configurable with HP 54000-series pods.

### Inputs

	HP 54002A	HP 54001A	HP 54003A
	50 Ω input	1 GHz miniature active probe	1 MΩ input, with 10:1 probe attached
Maximum input voltage	5 V rms	20 V peak	20 V peak
Coupling	dc	dc	dc
Input capacitance (nominal)	N/A	2 pF	8 pF
Input resistance (nominal)	50 Ω	10 kΩ	1 MΩ
Bandwidth (-3dB)	dc to 1 GHz	dc to 1 GHz	dc to 300 MHz
Transition time (10% to 90%)	≤350 ps	≤350 ps	≤1.2 ns
System bandwidth with HP 54100A/D (-3 dB)	dc to 1 GHz	dc to 700 MHz	dc to 300 MHz
System transition time with HP 54100A/D (10% to 90%)	≤350 ps	≤400 ps	≤1.2 ns
Division ratio	1:1	10:1 ±3%	10:1 ±3%

### Ordering Information

HP 54100A digitizing oscilloscope

HP 54100D digitizing oscilloscope

HP 54300A dual 8:1 probe multiplexer

### Accessories and Peripherals

#### Input pods

HP 54001A 1 GHz miniature active probe pod

HP 54002A 50 ohm BNC input pod

HP 54003A 1 megohm, 10:1 probe pod

# OSCILLOSCOPES & WAVEFORM ANALYZERS

Digitizing Oscilloscopes

Models 1980B, 1965A, 19860A, 1950A, 19800/19801

343



- Fully HP-IB programmable
- Digital waveform storage
- Gated universal counter
- Application software
- Front panel calibration
- Auto-scope automatically scales waveforms
- CRT test for operator instructions
- Two-channel expansion module



## The HP 1980 System Description

In the 1980 system, Hewlett-Packard has integrated many components that together provide complete waveform-measurement solutions.

HP's 1980 system combines a programmable oscilloscope, waveform digitizer, universal counter, and programmable analog comparators to provide versatile measurement capability. Combining these instruments into a single measurement system not only reduces your test system assembly time, but it also increases the quality of measurements and saves money by reducing the number of instruments you need to purchase. Linked together with HP's computers, software, and support, the HP 1980 system increases the productivity of developing, maintaining, and operating test systems.

## The HP 1980B Oscilloscope Measurement System

The HP 1980B Oscilloscope Measurement System is a fully HP-IB programmable, two-channel, 100 MHz oscilloscope. It features continuously-calibrated verniers, with 2 mV/div deflection factors and two independent 5 ns/div sweeps. Measurement capabilities can be expanded by adding internal options and plug-in expansion modules. In addition, the HP 1980 has these special features:

- The Auto-Scope function autoranges trigger levels, deflection factors, and sweep speeds to display input signals. It provides a one keystroke setup for most signals.
- Continuously calibrated verniers replace the standard 1-2-5 vernier sequence, providing exceptional versatility in viewing and measuring time-domain waveforms.
- Save/Recall registers can be used to save up to eight complete instrument states for recall in repetitive measurement procedures.
- Calibration can be performed on-site without removing covers and requires little or no test equipment. Internal reference signals are provided and complete, step-by-step instructions are displayed on the CRT.

## The HP 1950A Two-Channel Expansion Module

The HP 1950A adds two 100 MHz vertical channels to the HP 1980. It features continuously-calibrated variable deflection factors from 2 mV/div to 10 V/div and a delta voltage function.

## The HP 1980's Trigger Flag

Trigger Flag, a standard measurement feature of the HP 1980, accesses the HP 1980's trigger circuits and uses them as programmable analog trigger comparators to make static and dynamic tests. It can make a variety of measurements, including voltage and timing tolerance tests, random noise tests, envelope and burst measurements, and static-state testing.

## The HP 1965A Gated Universal Counter Expansion Module

The HP 1965A adds a fully-programmable, 100 MHz universal counter to the HP 1980 system. By merging oscilloscope and counter technologies, the HP 1965A makes counter measurements (i.e., frequency, period, time interval, and events) and automatic pulse-parameter measurements (i.e., rise/fall time, pulse width, duty cycle, propagation delay, and phase shift) with accuracy up to 500 picoseconds and  $\pm 10$  picosecond resolution. The HP 1965A simplifies measurements requiring complex gating or triggering by using the HP 1980's vertical signal conditioning, time bases, and trigger circuitry.

## The HP 19860A Digital Waveform Storage

Internally installed in the HP 1980, the HP 19860A adds digital waveform storage to the system. The HP 19860A can digitally store up to two waveforms with 10-bit vertical resolution over the entire 100 MHz bandwidth of the HP 1980. Waveforms are acquired in single-shot mode (sampling rate is 50 k-samples/second) or repetitive mode (100 MHz bandwidth). Additional flexibility is provided through programmable sample density and averaging.

## The Waveform Measurement Library

HP's HP 19800A/B and HP 19801A/B/C Waveform Measurement Library (i.e., Series-1980 application software) automates time-domain measurements. The software consists of first-day measurement capability, a flexible subprogram structure, and easy-to-use tools for developing specific application programs. Other HP software products can extend the system's measurement capabilities. For example, the Waveform Analysis Package when used with the Waveform Measurement Library can perform fast Fourier transforms on the waveform data captured by the HP 1980 system.





# OSCILLOSCOPES & WAVEFORM ANALYZERS

## Digitizing Oscilloscopes

Models 1980B, 1965A, 19860A, 1950A, 19800/19801

By performing waveform characterization and waveform comparison, this software provides an extremely versatile set of time-domain measurements. With the software package, the 1980 system can automatically characterize waveform parameters such as peak-to-peak voltage, rms voltage, frequency, pulse width, rise time, and fall time. Waveform comparison is a measurement technique that allows a computer to perform qualitative time-domain measurements. To perform a waveform comparison, the waveform must be compared to limits established for it. These limits can be derived from an ideal waveform generated by a computer or from a known "good" waveform. In this way, the computer, not the operator, can make the necessary judgments.

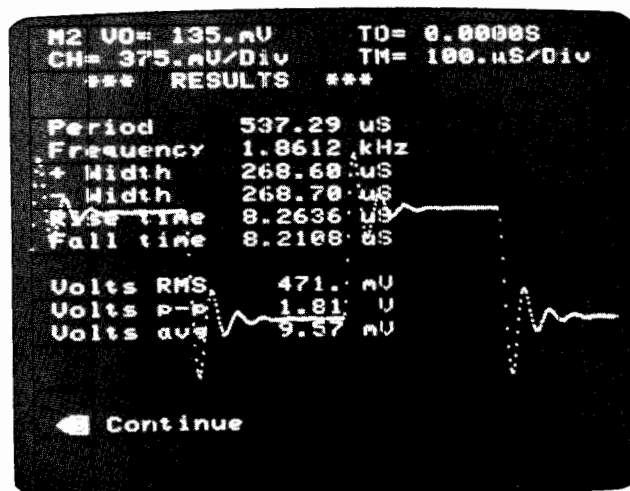

HP 19860A waveform characterization—the HP 19860A Digital Waveform Storage option and the HP Waveform Measurement Library can automatically characterize waveform parameters. This photo shows measurement results from the first-day Automatic Waveform Measurement Program. The program accounts for the ringing on the waveform when measuring parameters such as rise time and fall time. This program provides first-day measurement results without requiring any additional programming.

### HP 1980 System Accessories

HP provides several accessories for the HP 1980 system. The HP 19811A Plot/Sequence ROM memorizes up to 6 sequences of 25 keystrokes that are executed when enabled. Any key sequence can be initiated when you press a pushbutton on an HP 1008XA probe, send a command over HP-IB, or set a timer in the HP 1965A. Additionally, the HP 19811A can send waveforms stored by the HP 19860A to a plotter in stand-alone configurations. A complete line of testmobiles and miniature probes is also available.

### Improving Quality Through HP Automation

A test system based on the HP 1980 System and an HP computer can improve the quality of time-domain measurements. For example, the computer can automatically set up the HP 1980's front panel, eliminating operator errors. Measurements usually made by counting graticule lines can be made without operator intervention. In addition, the computer can make comparison measurements on waveforms, maintaining quality and reducing the required skill level of the operator. HP's Waveform Measurement Library is the software that accesses these capabilities to improve the quality of measurements.

## HP 1980 SYSTEM - CORE OF A TEST SYSTEM

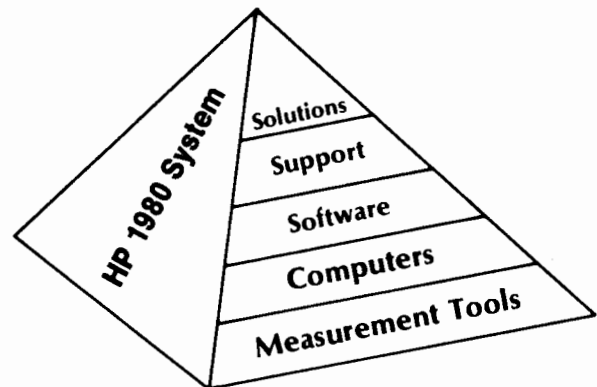

### The HP 1980—A Test System's Central Measurement Device

The various components of the HP 1980 system together provide a very extensive set of time-domain measurement capabilities. There are two main categories of measurements that the HP 1980 system can make—characterization and comparison. The system can characterize waveform parameters including peak-to-peak voltage, rms voltage, frequency, pulse width, rise time, and fall time. The system also performs waveform comparisons, a measurement technique that allows a waveform to be tested against specified tolerance limits. The HP 1980 system's flexible measurement capability can improve the quality of measurements in automatic, semiautomatic, and manual environments.

### Increasing Test System Throughput

The productivity of a test system can be evaluated by its measurement throughput. There are several steps associated with a measurement: after a waveform from a unit under test is connected to a test system, the instruments must be set up to view or store the waveform. Next, the measurement tools gather and transfer data to a computer for analysis. Together, these steps determine the throughput of a system. Because the HP 1980 and an HP computer provide automatic setup, acquisition, and analysis capabilities, they can increase the throughput of your test system.

The HP 1980 system is designed to increase measurement throughput of systems in automatic, semiautomatic, and manual environments. The HP 1980 system is ideal for automatic applications, because it provides full programmability, flexible measurement capability, and the application software needed to automate time-domain measurements. In semiautomatic applications, the HP 1980 system with an HP computer can increase throughput by automatically setting up its front panel and guiding an operator through a test procedure via text on the CRT. Manual applications can also benefit from features such as Auto-Scope and Save/Recall registers.

### HP's Complete Product Support

HP provides many services to help you be successful integrating the HP 1980 into a test system. In addition to product notes that discuss specific measurements, a Waveform Measurement Seminar is available that teaches you how to get the best results from the HP 1980 system. Also, HP's System Engineering Organization can provide consulting services and can help you to develop programs for your particular application.



## HP 1980B Specifications

### Operating Modes

Voltage vs time (V vs T); channel 1 vs 2 (1 vs 2); monitor mode for logic state display with HP Model 1607A (X-Y-Z).

### Vertical Display Modes (V vs T)

Channel 1; channel 2; channels 1 and 2 displayed on alternate sweeps (ALT); channels 1 and 2 displayed by switching between channels at approx 400 kHz rate with blanking during switching (CHOP); automatic selection of alternate for sweep speeds >1 ms/div and chop for sweep speeds ≤1 ms/div (AUTO-CHOP/ALT); channel 1 plus 2 algebraic addition (1 + 2), channel 1 and/or 2 may be inverted; and either main or delayed trigger signal.

### Vertical Amplifiers (2)

**Bandwidth:** 3 dB down from a 5 div reference signal (0° to +40°C).  
**DC-coupled:** dc to 100 MHz in 50 Ω and 1 MΩ input modes.

**AC-coupled:** <10 Hz to ≥100 MHz.

**Bandwidth limit:** limits upper bandwidth to approx 20 MHz.

**Input coupling:** ac, dc, 50 Ω (dc), ground. Ground position disconnects input connector and grounds amplifier input.

**Input RC:** ac or dc, 1 MΩ ±2% shunted by approx 16 pF; 50 Ω(dc), 50 Ω ±3%.

**Maximum input voltage:** 50 Ω, 5 V rms; 1 MΩ, ac or dc coupled, 250 V (dc + peak ac) at ≤1 kHz.

**Deflection factor:** range, 2 mV/div to 10 V/div; accuracy, ±3%; 3 digits of resolution.

**Vertical position:** range, baseline can be adjusted ±15 major div from center graticule line (possible 10 div off-screen); accuracy, ±(2% of reading + 0.3 major div).

**ΔV (channel 1 or 2):** range, ±15 times the deflection factor selected for that channel; accuracy, ±4% (for a Δ ≤ 10 major div).

### Channel 1 + 2

**Amplifier:** bandwidth and deflection factors are unchanged.

**Differential (channel 1-2 or channel 2-1):** CMRR is at least 20 dB from dc to 20 MHz with common mode signal amplitude equivalent to 10 div and one channel adjusted for optimum rejection.

**Trigger view:** displays internal or external trigger signal for either main or delayed sweep.

### Horizontal Display Modes (V vs T)

Main, main intensified, delayed, and dual. Dual simultaneously displays main intensified and delayed sweep.

### Main and Delayed Time Bases

**Range:** 5 ns/div to 1 s/div; 3 digits of resolution.

**Accuracy\***

Speed	Accuracy*
5 ns/div to 9.99 ns/div (center 8 div)	±3%
10 ns/div to 9.99 ms/div (first 10 div)	±3%
10 ms/div to 1 s/div (first 10 div)	±4%

\*Within ±10°C of the temperature at which the instrument was calibrated. For temperatures beyond the ±10°C range and within 0° to +55°C, add 1% and 2% from 0.5 s/div to 1 s/div.

### Sweep Delay

**Time delay:** range, 0 to 9.9999 s; resolution, displayed, 5 digits; HP-IB, 100 ps at any delay, possible 11 digits.

**Accuracy\***

Sweep Speed	Delay or Time Interval	
	<200 μs	≥200 μs
5 ns/div to 9.99 ns/div	±(2 ns + 0.1% of reading)	±(0.05% of reading)
≥10 ns/div	±(2 ns + 0.1% of reading + 1% of dly'd s/div × 10 div)	±(0.05% of reading + 1% of dly'd s/div × 10 div)

\*Within one hour of a delay self-calibration and in constant ambient temperature.

**Delay jitter:** 0.002% of delay time; at 10 MHz ±10 kHz, 0.01% of delay time.

**Time interval (ΔT):** in intensified, dual, or delayed horizontal display modes, a zero time reference can be set anywhere in the delay range and a ΔT measurement made from that point.

**Resolution, accuracy:** same as time delay.

**Frequency (1/ΔT):** calculates and displays reciprocal of time interval measurement; resolution, same as ΔT. As frequency increases, insignificant digits are truncated; accuracy, same as time delay.

**Digital delay:** range, 0 to 10<sup>8</sup> - 1 events; resolution, 1 event; maximum rep rate, 15 MHz with a 50% duty cycle.

### Triggering (main and delayed time bases)

#### Main Time Base

**Triggered:** specified level and slope generates a sweep.

**Auto-triggered:** baseline displayed in absence of a trigger signal; triggering is same as triggered above approx 10 Hz.

**Single:** sweep occurs once with same triggering as triggered mode.

#### Delayed Time Base

**Auto-sweep after delay:** delayed sweep starts at end of delay time.

**Triggered sweep after delay:** sweep can trigger after delay.

**Digital delay:** delayed sweep starts a specified number of events after start of main sweep.

**Sources:** selectable from channel 1, channel 2, enhancement module, or external. Line frequency triggering for main sweep only. Main and delayed independently selectable.

#### Internal Trigger Level

**Range:** ±20 major divisions from center horizontal graticule line.

**Resolution:** 0.02 major divisions; coarse or fine slew rates.

**Accuracy:** ±(3% of reading + 0.4 major div).

#### External Trigger Level

**Range:** ±1.2 V from ground reference; in ÷ 10, ±12 V.

**Resolution:** ÷ 1, 2 mV; ÷ 10, 20 mV; coarse or fine slew rates.

**Accuracy:** ±(3% of reading + 40 mV); ÷ 10, ±(3% of reading + 400 mV).

#### Line Trigger Level

**Range:** ±20 relative units.

**Resolution:** steps of 0.02; fine or coarse slew rates.

**Slope:** positive or negative slope within trigger signal range.

#### Sensitivity

**Internal:** <10 mV/div, at least 1.4 div from dc to 25 MHz increasing to 3 div at 100 MHz; ≥10 mV/div at least 0.7 div from dc to 25 MHz increasing to 1.5 div at 100 MHz.

**External:** ÷ 10, at least 500 mV p-p from dc to 25 MHz increasing to 1.2 V p-p at 100 MHz; ÷ 1, at least 50 mV p-p from dc to 25 MHz increasing to 120 mV p-p at 100 MHz.

**Coupling (internal and external):** ac, attenuates signals <10 Hz; dc, direct coupled; HF rej, attenuates signals above approx 35 kHz; LF rej, attenuates signals below approx 35 kHz.

#### External Trigger Inputs (main and delayed)

**Input RC:** ac or dc, 1 MΩ ±2% shunted by approx 15 pF; 50 Ω (dc), 50 Ω ±3%.

**Maximum input voltage:** 50 Ω (dc), 5 V rms; 1 MΩ, ac or dc coupled, 250 V (dc + peak ac) at ≤1 kHz.

### 1 vs 2 Operation

**Bandwidth:** Y-axis (channel 1), same as channel 1 in V vs. T; X-axis (channel 2), dc to 4 MHz.

**Phase difference:** ≤3° dc to 100 kHz.

**Deflection factors:** same as Vertical Amplifiers.

### Cathode-Ray Tube and Controls

**Type:** post-accelerator, approx 22 kV accelerating potential, aluminum P31 phosphor.

**Graticule:** 10 x 10 div internal graticule; 0.2 subdivision markings on major horizontal and vertical axes; 10 x 12 cm display area.

**Trace and character intensity:** adjustable in relative steps of 1 from 0 to 99.

### General

**Bus compatibility:** as defined in IEEE Std 488-1978 is SH1, AH1, T5, TE0, L3, LE0, SR1, RL1, PP0, DC0, DT1, C0, and E2.

**HP-IB interface functions:** SH1, AH1, T5, TE0, L3, LE0, SR1, RL1, PP0, DC0, DT1, C0, and E2. (See HP-IB section of this catalog.)



# OSCILLOSCOPES & WAVEFORM ANALYZERS

## Digitizing Oscilloscopes

Models 1980B, 1950A, 1965A, 19860A, 19800/19801

### HP 1980B Specifications (cont.)

**Power:** 100, 120, 220, 240 Vac, +5 to -10%; 48 to 440 Hz; 300 VA max with expansion module and plug-in ROMs, standard, 200 VA max.

**Weight:** net, approx 18.2 kg (40 lb). Shipping, approx 24.1 kg (53 lb).

**Dimensions:** (HP 1980A) 278 H x 213 W x 543 D mm (10.9 x 8.4 x 21.4 in); (HP 1980B) 143 H x 427 W x 543 D mm (5.6 x 16.8 x 21.4 in).

**Operating environment:** temperature, 0° to +55 °C; humidity, to 95% relative at +40°C; altitude, to 4 600 m (15 000 ft); vibration, vibrated in three planes for 15 min each with 0.38 mm (0.015 in) excursion, 10 to 55 Hz.

**Accessories furnished:** one blue light filter HP P/N 01980-02701; one 2.3 m (7.5 ft) power cord; one expansion module panel cover, HP P/N 01980-24106; two Operating/Programming Manuals; one service manual; one binder with divider tabs; two HP 10081A, 10:1 divider probes approx 2 m (6 ft) long.

### HP 1950A Specifications

#### Vertical Display Modes

Channels 3 and 4 independently selected; channel 3 vs 4; channel 3 + 4; either or both channels may be inverted.

#### Vertical Amplifiers

**Bandwidth:** same as HP 1980.

**Input RC:** same as HP 1980, channels 1 and 2.

**Deflection factors:** 2 mV/div to 10 V/div, ±3%, 3 digit resolution.

**ΔV (Channel 3 or 4):** same as HP 1980, channels 1 and 2.

#### General

**Operating environment:** same as HP 1980A/B.

**Weight:** net, approx 1.5 kg (3.3 lb). Shipping, 2.2 kg (4.8 lb).

**Power:** supplied by HP 1980.

**Accessories furnished:** one operating and service manual; two HP 10081A, 10:1 divider probes, approx 2 m (6.6 ft) long.

### HP 1965A Specifications

#### Frequency A

**Range:** 100 mHz to 100 MHz

**Note:** refer to Triggering for minimum pulse-width requirements.

**LSD Displayed:**  $\frac{10 \text{ ns}}{\text{sample time}} \times \text{frequency}$  (9 digits maximum)

#### Unarmed and Armed Modes

**Resolution:**  $\pm(2 \times \text{LSD}) \pm 1.4 \times \frac{\text{trigger error}}{\text{sample time}} \times \text{frequency}$

**Accuracy:**  $\pm$  resolution  $\pm$  time base error  $\times$  frequency

#### Gated Mode

**Resolution:**  $\pm$   $\frac{\text{period resolution}}{\text{period}} \times \text{frequency}$

**Accuracy:**  $\pm$   $\frac{\text{period accuracy}}{\text{period}} \times \text{frequency}$

\*\* Refer to period-gated mode specifications.

#### Period A

**Range:** 10 ns to 10 s

**LSD displayed:**  $\frac{10 \text{ ns}}{\text{sample time}} \text{ period}$  (9 digits maximum)

#### Unarmed and Armed Modes

**Resolution:**  $\pm(2 \times \text{LSD}) \pm 1.4 \times \frac{\text{trigger error}}{\text{sample time}} \times \text{period}$

**Accuracy:**  $\pm$  resolution  $\pm$  time base error  $\times$  period

#### Gated Mode

**Resolution:**  $\pm$   $\frac{10 \text{ ns} + (1.4 \times \text{trigger error})}{N \times \sqrt{\text{sample time}/(\text{period} \times N)}}$

**Accuracy:**  $\pm$  resolution  $\pm$  (time base error  $\times$  period)  $\pm \frac{4 \text{ ns}}{N}$

Where N is the number of cycles gated per sweep.

#### Time Interval A → B

**Range:**  $\pm$  -10 ps to  $\pm$  -10 s.

**LSD displayed:**  $\frac{10 \text{ ns}}{\sqrt{(\# \text{ of averages})}}$

Number of Averages	LSD
1	10 ns
100	1 ns
10 000	100 ps
1 000 000	10 ps

**Resolution:**  $\pm$  -LSD  $\pm$  -start trigger error/ $\sqrt{(\text{of averages})}$

$\pm$  -stop trigger error/ $\sqrt{(\text{of averages})}$

**Accuracy:**  $\pm$  -resolution  $\pm$  -time base error  $\times$  time interval  $\pm$  -trigger level timing error  $\pm$  -systematic error

#### RATIO A/B

**Range:** 10E-9 to 10E9

**Resolution:**  $\pm$  -  $\frac{\text{period B}}{\text{sample time}} \times \text{ratio} \pm$  -  $\frac{\text{trigger error}}{\text{sample time}} \times \text{ratio}$

**Accuracy:** same as Resolution

#### Events A (Gated)

**Range:** 0 to 1000 megabits

#### Events A During B

**Range:** 0 to 1000 megabits

**Minimum time between B pulses:** 75 ns

#### Totalize A

**Range A:** 0 to 1000 megabits

**LSD:** 1 count of input

**Resolution:**  $\pm$  -LSD

**Accuracy:** same as Resolution

#### Totalize A + B

**Range:** 0 to 2000 megabits

**LSD:** 1 count of input

**Resolution:**  $\pm$  -LSD

**Accuracy:** same as Resolution

#### Totalize A - B

**Range:** -1000 megabits to 1000 megabits

**Display:** continuous update for input repetition rates up to 5 MHz; beyond 5 MHz, display is updated when measurement is completed.

**LSD:** 1 count of input

**Resolution:**  $\pm$  -LSD

**Accuracy:** same as Resolution

#### Auto-Parameters

**Repetition rate:** 15 Hz to 20 MHz, such that period - time parameter  $>$  35 ns.

*Note: time parameter is parameter being measured, except the time parameter for duty cycle is pulse width, and time parameter for phase shift is propagation delay.*

**Maximum input undershoot + overshoot:** 10%

**Minimum peak-to-peak amplitude:** 3 divisions and 35 mV

**Resolution:**  $\pm$  -LSD  $\pm$  -start trigger error/ $\sqrt{(\# \text{ of averages})}$   $\pm$  -stop trigger error/ $\sqrt{(\# \text{ of averages})}$

**Time parameter accuracy:**  $\pm$  -resolution  $\pm$  - (time base error  $\times$  time interval)  $\pm$  -auto trigger error  $\pm$  -systematic error

*Note: systematic error for rise time, fall time, pulse width, and duty cycle is 1 ns. Systematic error for propagation delay and phase shift is 2 ns.*

**Auto-trigger error:**  $\pm$  -  $\frac{1\% \text{ of input p-p voltage}}{\text{slew rate at start trigger point}}$   
 $\pm$  -  $\frac{1\% \text{ of input p-p voltage}}{\text{slew rate at stop trigger point}}$

#### Time Base

Standard high stability, temperature-compensated crystal oscillator.

**Frequency:** 10 MHz

**Aging rate:**  $<$  1 part in 10E7 per month

**Short term:**  $<$  1 part in 10E9 rms for one-second average;  $<$  2 parts in 10E6, 0°C to 55°C

**External time base input:** front-panel BNC accepts 10 MHz 1 V rms to 10 V rms into 50 Ω. Time base selected to external via soft key selection.

#### Triggering

**Minimum  $\pm$  - pulse widths:** main = 5.0 ns (100 MHz maximum); delayed = 6.25 ns (80 MHz maximum)

#### Definitions

**Systematic error:** timing error due to propagation delays between start(A) and stop(B) trigger paths.

**Common source (main-to-main or delayed-to-delayed):** 500 ps

**Dual source with equal vertical sensitivities:** 1 ns

**Dual source with unequal vertical sensitivities:** 2 ns.



## HP 19860A Digital Waveform Storage Specifications

### Vertical

**Analog bandwidth:** dc to 100 MHz; ac coupled lower limit is <10 Hz; 3 dB down from a 5 div reference; 0° to 40°C.

**Acquisition window:**  $\geq \pm 4.5$  div from center horiz graticule line.

**Matching of data to CRT graticule lines:**<sup>1</sup>  $\pm 2\%$  of full scale.

### Matching of Digitized to Real Time Traces<sup>1</sup>

Sine Wave, Percent of Full-Scale		
10 Hz	1 kHz	1 MHz
$\pm 1.5\%$	$\pm 1.5\%$	$\pm 2.5\%$

Excludes first data point. In repetitive mode, trigger rep rate must be 1 Hz or faster. In single sweep mode, trigger must occur within 1 s of digitize command, otherwise exclude first five data points. Data for this specification is acquired using the Auto-Cal default mode of a full Auto-Cal.

**Absolute accuracy of data:**  $\pm$ (accuracy of vertical channel + matching of digitized trace to real-time trace + matching of data to graticule line).

**DC offset:** <0.2 div from real-time trace at time of data acquisition.  
<sup>1</sup>Full scale is ten divisions.

### RMS Noise<sup>2</sup>

Waveform Storage Mode	2 mV/div to 9.99 mV/div	10 mV/div to 10 V/div
Normal	0.75%	0.5%
8 Averages or Filtered	0.4%	0.25%

<sup>2</sup>Measured by grounding the vertical input, digitizing, and calculating the RMS value of the data.

### Horizontal

**Acquisition window:** main horizontal display mode (main s/div x 10 div); in intensified and delayed (delayed s/div x 10 div). In intensified and delayed, the acquisition window can be delayed 0 to 9.9999 s from main trigger point.

**Time offset from real-time trace:**  $-(\leq 30 \text{ ns})$ .

**Timing accuracy:**  $\pm(2 \text{ ns} + 0.2\%$  of the acquired time window).

**Jitter:** 0.002% of delay time + 1 ns; at 10 MHz  $\pm 10 \text{ kHz}$ , 0.01% of delay time + 1 ns.

### Operating Characteristics

**Repeatability of data:** approx 2% for waveforms acquired within 8 hours and within 20°C to 30°C. To optimize repeatability of waveform data, use either a minimum of 8 averages or filtered mode, for signals <100 Hz use dc or 50  $\Omega$  dc input coupling.

**Vertical resolution:** 10 bits, approx 0.1% of full scale.

**Auto-Cal:** pre-acquisition calibration of sampling efficiency that also sets offset and gain data correction factors. Offset and gain factors are used for post-acquisition data correction to match a digitized trace to a real time trace.

**Sample density:** selectable 1, 3, 6, 11, 21, 51, 101, 251, 501 points at any sweep speed.

**Minimum time between points:** repetitive, 100 ps, clocked by HP 1980 delay generator; single-shot, 19.8  $\mu\text{s}$ , clocked by HP 1980 processor clock.

**Acquisition mode:** repetitive, 999  $\mu\text{s}/\text{div}$  to 5 ns/div, two sweeps per point; single-shot, 1 s/div to 1 ms/div, one sweep per waveform.

**Averaging:** each sample point may be averaged 2, 4, 8, 16, 32, or 64 times in repetitive mode to reduce noise; N + 1 sweeps required per point, where N = number of averages.

**Filter:** approx 1 MHz low pass filter selectable in single-shot.

**Cursors:** start and stop cursors for memories (M1 and M2) to measure voltage from center graticule line, time from main trigger point, or  $\Delta V$  and  $\Delta T$  measurements on stored waveforms.

### General

**Operating environment:** same as HP 1980B.

**Weight:** net, 0.4 kg (13 oz). Shipping, 0.9 kg (2 lb).

## HP 19800A/B, 19801A/B/C Description

Series HP 1980 Application Software is available for HP Series 80 computers (HP 19801A/B/C) and HP Series 200 computers (HP 19800A/B). Application software is available for the HP Series 1000 computers through the HP Plus program; contact your local HP Sales Office for more details.

### Measurement Programs

**Automatic waveform measurement program:** automatically characterizes many different kinds of waveforms, displays measurement results, and can plot waveforms for permanent records. This program uses Trigger Flag and the HP 19860A Digital Waveform Storage.

**User-interactive waveform measurement program (HP 19800 only):** provides interactive menus allowing you to characterize waveform parameters, control waveform data bases, and obtain hardcopy output of results or waveforms. Measurements include pulse parameters and two-channel time intervals. This program uses Trigger Flag and the HP 19860A Digital Waveform Storage.

**Universal counter measurement program (HP 19800 only):** automatically characterizes waveform parameters using the HP 1965A. Trigger levels for rise time, fall time, and pulse width measurements are determined by digitally storing trigger view and determining top and base using a histogram.

**Gated time interval measurement program (HP 19800 only):** leads user through the process of making a gated time interval measurement with the HP 1965A. Measurement setups can be saved and recalled at a later time.

### Library Subprograms

1. The waveform characterization subprograms perform a wide range of parametric time-domain measurements by using the data captured by both the HP 19860A and Trigger Flag.

2. The waveform comparison subprograms perform limit test on waveform parameters to determine whether a given waveform is acceptable according to a specified set of tolerances.

3. The waveform setup subprograms reduce test times and eliminate operator setup errors by automatically setting up the HP 1980A/B. Within this group is a subprogram that automatically re-scales the waveform if there is insufficient information within the waveform data for the measurement.

4. The waveform data management subprograms control the HP 19860A and direct the movement of waveform data records. With these subprograms, permanent records of key waveforms can be made. Accessing these records eliminates needless repetition and simplifies the documentation of procedures and results.

5. The general utilities subprograms simplify the development of application programs. For example, they initialize the system, help debug programs being developed, manage instrument setup data, output results and plot waveforms onto HP graphics printers and plotters.

6. The HP 1965A subprograms set up and control the counter functions. They also perform statistical analysis on measurement results.

### Ordering Information

#### HP 1980S Oscilloscope Measurement System

Use the system model number when ordering a system mainframe with expansion modules, enhancements, and computer products. Any model number can also be ordered individually. Using the system model ensures coordination of shipments and compatibility of instruments, computers, and software

HP 1980B Oscilloscope Measurement System (rack)

HP 1950A 100 MHz Two-channel Expansion Module

HP 1965A 100 MHz Gated Universal Counter

HP 19811A Plot/Sequence ROM

HP 19860A Digital Waveform Storage

HP 19800A/B Waveform Measurement Library

HP 19801A/B/C Waveform Measurement Library

HP 1980A/B+24A Waveform Measurement System Training

HP 19807A Service Extender for expansion modules



# OSCILLOSCOPES & WAVEFORM ANALYZERS

## 100 MHz General Purpose, Large-Screen

### Models 1740A, 1745A, 1746A

- Laboratory-quality viewing plus portability
- Optional built-in DMM for increased accuracy & flexibility
- Dual channel, 5 mV/div to 100 MHz
- 3rd channel trigger view and selectable input impedance

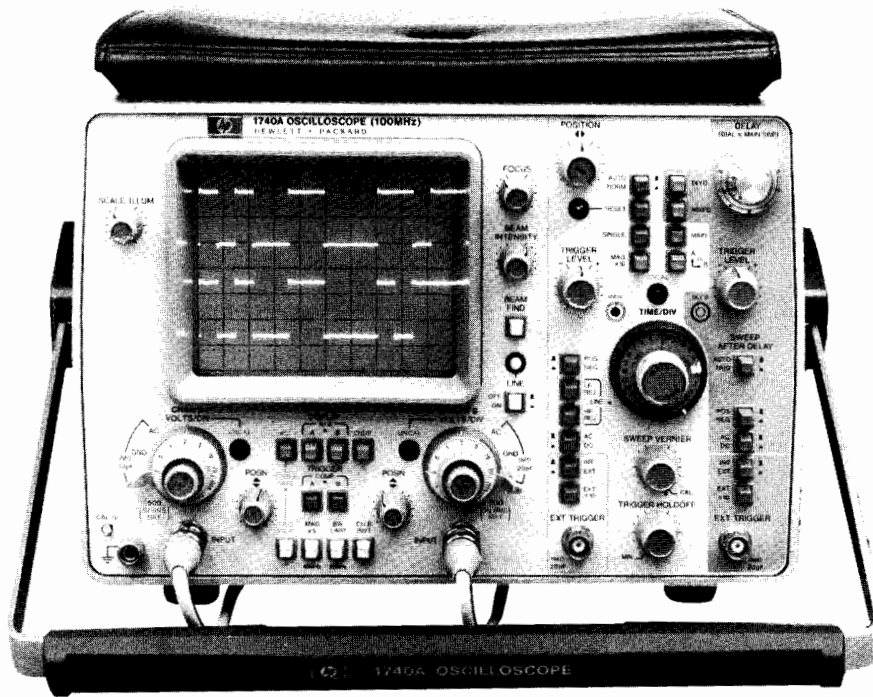

The CRT of the HP 1740A oscilloscope is reputed to have "the brightest, crispest trace in the industry."

### Description

The HP 1740-series of 100 MHz, dual-channel oscilloscopes have proven to be highly reliable measurement tools by passing the most complete testing program possible—years of use by satisfied customers. This reliable performance coupled with versatile measurement sets offer exceptional value for your time-interval and general-purpose oscilloscope needs over the long term.

The HP 1740s provide several measurement features that users have found to be particularly valuable. Both vertical channels provide 1 mV/div deflection factors with dc to 40 MHz bandwidth performance; the full 100 MHz performance is achieved with deflection factors of 5 mV/div to 20 V/div. Third channel trigger view, first offered in the HP 1740A, permits viewing the trigger signal plus simultaneous viewing and timing of the external trigger signal with both vertical channels. A X10 horizontal magnifier provides main and delayed sweep speeds to 5 ns/div, allowing full use of the 100 MHz bandwidth amplifiers. These amplifiers have a Gaussian roll-off characteristic for accurate pulse response.

In addition, the HP 1740s offer a TV/video sync option that allows a variety of measurements to be made on complex video waveforms. There is also an optional auto-ranging DMM with 3½ digit resolution for ac/dc voltage, ac/dc current, and resistance measurements.

### Individual Characteristics

#### HP 1740A

The HP 1740A, which is the basic building block of the HP 1740-series, is a highly reliable, general-purpose 100 MHz oscilloscope. In addition to the family characteristics of the HP 1740-series, the HP 1740A uses a single-marker delayed sweep for time interval measurements.

The HP 1740A's front panel is laid out in a clear logical manner and has a color coding scheme that simplifies operation. The blue buttons control the display functions, while all trigger function buttons are green. Other controls are light gray or white, and the delayed sweep functions are highlighted with a shaded background.

#### Reliable CRT

To the oscilloscope user, the most critical component in the instrument is the cathode ray tube (CRT). The 8 × 10 cm CRT used in the HP 1740A has been perfected to the point where it has been described as having "the brightest, crispest trace in the industry." Since the CRT is also the most expensive part of an oscilloscope, it is imperative that it be extremely reliable. With the HP 1740A, HP's CRT improvements have led to less than 1.4 failures per year per 1000 instruments—believed to be the best reliability record of any comparable CRT in industry.

#### HP 1745A/1746A

Both the HP 1745A and HP 1746A oscilloscopes add a large-screen CRT and a revised front panel to the time-tested instrument design of the HP 1740A. The new CRT offers a 43% larger viewing area while maintaining the same high standards of the HP 1740A trace quality. This provides more resolution for more accurate measurements, especially with multi-channel measurements that use third channel trigger view.

Voltage measurements are also simplified. The CRT graticule is 10 × 10 divisions, instead of the more traditional 8 × 10 divisions. Full-scale voltage display is ten times the deflection factor—greatly reducing the amount of mental arithmetic required of the user.

The HP 1745A and HP 1746A both offer a neutral gray contrast screen which is heat-treated with a proprietary anti-reflection coating. You obtain bright, sharp trace definition without annoying light reflections. In keeping with the new CRT's contrast screen color, the color coding of the controls has also been changed. The dark buttons control the display functions while all trigger functions are medium gray. Miscellaneous functions are light gray and all delayed sweep functions are highlighted with a lightly-shaded background.

The HP 1745A uses the familiar single-marker delayed sweep to perform time interval measurements. The HP 1746A adds HP's dual-marker delta time measurement capability for faster

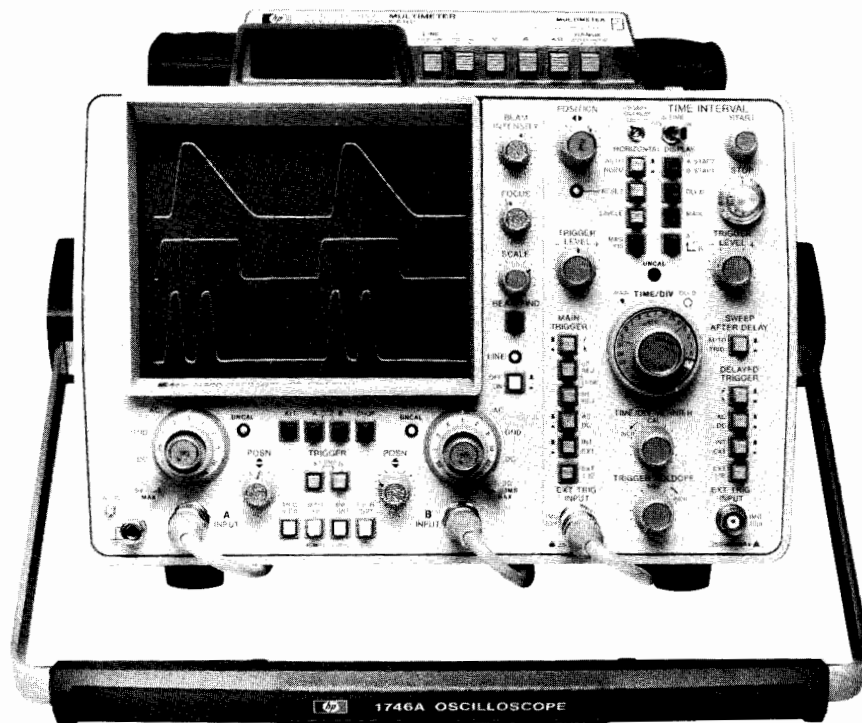

With a CRT screen 43% larger than the industry standard, the HP 1746A 100 MHz, time interval oscilloscope provides laboratory quality viewing in a portable package.

and more accurate timing measurements. When combined with the optional DMM, a direct readout of time interval measurements is provided on the LED display.

### Family Characteristics

#### Third Channel Trigger View

In many measurements, especially in digital applications, it is desirable to trigger the main sweep externally using a signal synchronous with the displayed waveforms. The third channel trigger view offers several measurement conveniences in timing applications:

1) The trigger threshold can be viewed relative to the trigger waveform for either an internal or external trigger source. Trigger threshold is the center horizontal graticule line and the trigger point is selected by positioning the trigger waveform vertically on the reference graticule line using the main sweep trigger level control. This also allows you to view the shape of the trigger waveform to verify that the correct signal is used as the trigger source and that the trigger threshold is not set to portions of a waveform containing irregularities and reflections.

2) With trigger view, three channels of information are displayed so that timing relationships can be analyzed. The displayed trigger signal has a specified delay of <3.5 ns relative to the two vertical channels.

#### Serviceability

Innovations in circuit design along with custom integrated hybrid circuits reduce calibration time because of a minimum of adjustments. Wire harnesses and interconnection cables between boards are reduced with an interface board which connects the main boards together. This interface board helps reduce service time and reassembly errors normally encountered with instruments containing many cables. These oscilloscopes do not require a fan or ventilating holes for convection cooling, reducing the amount of dust and dirt that can accumulate internally.

### Optional Measurement Capability

#### TV Sync Option

With this option you can trigger on composite video for analyzing fields, test signals, timing relationships, lines, or segments of lines. This capability is provided through a TV sync separator circuit that triggers the main sweep on the vertical interval of a composite video waveform and triggers the delayed sweep on individual horizontal lines.

#### Video Waveform Display

To aid in viewing specific portions of composite video waveforms, the TV sync option includes field select, TV line scan, and single line scan capabilities. Field selection is easily accomplished by pressing the field select button that automatically displays the alternate field in the frame. The TV line scan control allows you to position the intensified marker to the desired location for expansion. When switched to delayed sweep, individual lines are easily inspected and measured. For precise control of highly expanded line segments, single line scan lets you examine one line in detail.

The TV/Video Sync option is installed on the top cover and provides its own signal input with a 75 Ω termination to match most video systems. The input also provides a TV clamp that combines ac coupling and negative clamping to eliminate position shift due to varying levels for video information.

#### Optional Digital Multimeter

Adding an optional 3½ digit autoranging DMM improves the convenience of your basic measurement capabilities. With the optional DMM, you can make the five most common measurements: ac and dc voltage, ac and dc current, and resistance. The DMM has autoranging so that readings always have the same multiplier: voltage in volts, current in amperes, and resistance in kilohms.

In the HP 1746A, the optional DMM improves the accuracy and convenience of delta time measurements. A switch on the HP 1746A lets you select DMM operation or direct delta time readout.

# OSCILLOSCOPES & WAVEFORM ANALYZERS

## Variable Persistence/Storage

Models 1727A, 1744A, 1741A

- 2000 cm/ $\mu$ s variable persistence and stored writing speed (HP 1727A)
- Minimum blind time, auto intensity circuit
- 275 MHz bandwidth, 10 mV/div with 1 M $\Omega$  or 50  $\Omega$  input (HP 1727A)
- Time interval measurements and optional DMM (HP 1727A)

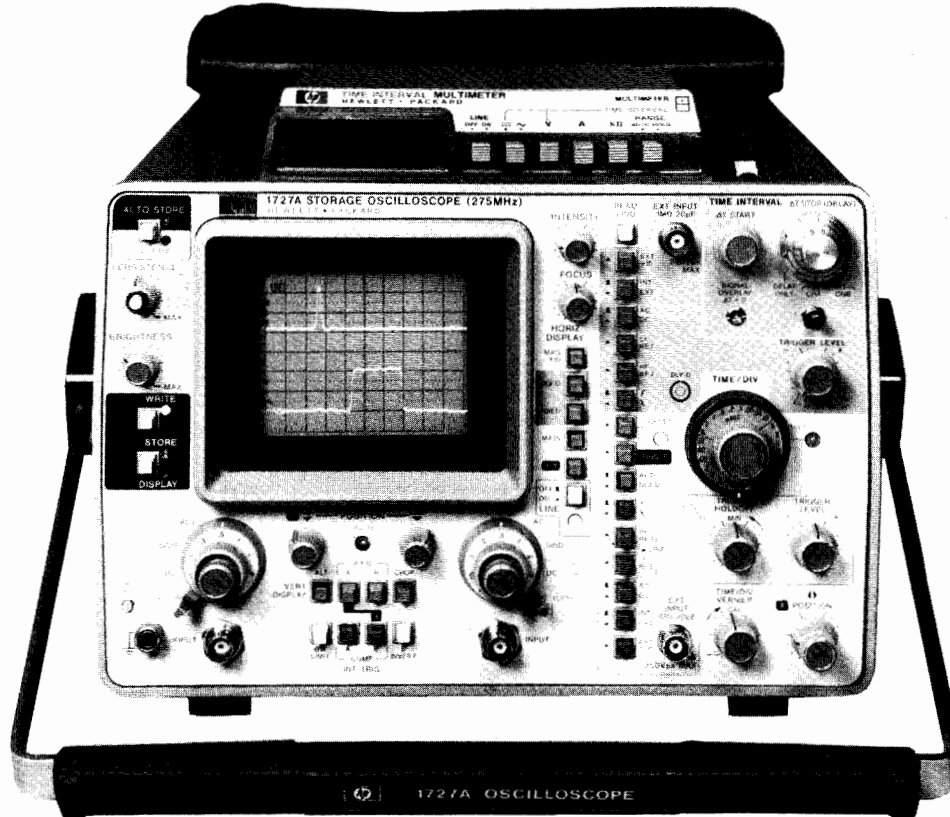

HP 1727A with opt 034

### Variable Persistence/Storage Oscilloscopes

Because many measurements involve signals that are difficult to display, Hewlett-Packard has incorporated variable persistence/storage capabilities into several of the HP 1700-series oscilloscopes. These oscilloscopes—the HP 1727A, HP 1744A, and HP 1741A—together offer a variety of performance capabilities and writing speeds to meet the wide range of measurements encountered daily.

HP's variable persistence CRTs have a "light-integrating" capability that enables these oscilloscopes to display results in bright, flicker-free, multiple sweep waveform displays. They have high, effective writing rates and produce highly visible presentations of low repetition rate signals.

### The HP 1727A Description

Hewlett-Packard's 275 MHz 1727A variable persistence/storage oscilloscope offers 2000 cm/ $\mu$ s writing speed in both the variable persistence and single-shot storage modes. The fast writing speed and high bandwidth make the HP 1727A ideal for viewing and analyzing narrow pulses in the physical sciences as well as glitches and noise pulses in digital environments. Signals with rise times as fast as 1.27 ns (4 div) can be captured and displayed in the single-shot mode.

Conveniently grouped variable persistence storage controls, front panel color coding, LED indicators, and automatic operating modes make the HP 1727A a very functional, high-speed storage oscilloscope. Additional features that provide exceptional versatility and ease of use include dual-marker time-interval measurements; an auto-intensity circuit to simplify the setup of a sharp, nonblooming trace; and selectable input impedance (1 M $\Omega$ /50  $\Omega$ ) for both general-purpose probing and high fidelity, high frequency signal capture with the built-in 50 ohm impedance matching.

### Expansion Storage

The HP 1727A's expansion storage CRT has a miniature storage mesh, about the size of a postage stamp, and an electronic lens system to present well-defined, sharp traces at the high writing speed of 2000 cm/ $\mu$ s in a variety of operating modes. The fast CRT writing speed is obtained over the full display quality area. Other convenience features include an automatic focus circuit that maintains a crisp display with changes in intensity, and an auto intensity circuit that minimizes blooming and reduces operator concern about CRT damage.

### Fast Writing Speed and High Bandwidth

The ability to write at 2000 cm/ $\mu$ s in the variable persistence mode makes the HP 1727A a general-purpose instrument. Using the variable persistence mode, the effective writing speed can be increased by integrating repetitive signals. With the HP 1727A, only two or three repetitions of a signal in a 10 second time period are needed to view any signal compatible with the vertical and horizontal specifications. For example, a 275 MHz sine wave with an amplitude of 8 divisions at a sweep speed of 1 ns/div has a maximum spot velocity of 5028 cm/ $\mu$ s and only requires about three repetitions for viewing.

The following table is a quick reference guide for determining the single-shot signals that can be captured by an HP 1727A.

Amp p-p	Sine Wave MHz	Observed Pulse Tr	Sweep Speed ns/div	Req Writing Speed cm/ $\mu$ s
4 div		1.27 ns	1	1952
4 div		1.27 ns	10	1816
3 div	275		1	2000
3 div	275		10	1867
4 div	200		1	1948
4 div	200		10	1811



- 1800 cm/ $\mu$ s variable persistence and stored writing rate (HP 1744A)
- 200 cm/ $\mu$ s variable persistence and stored writing rate (HP 1741A)
- Minimum blind time, auto-intensity circuit
- Dual channel, 5 mV/div to 100 MHz
- 3rd channel trigger view and selectable input impedance

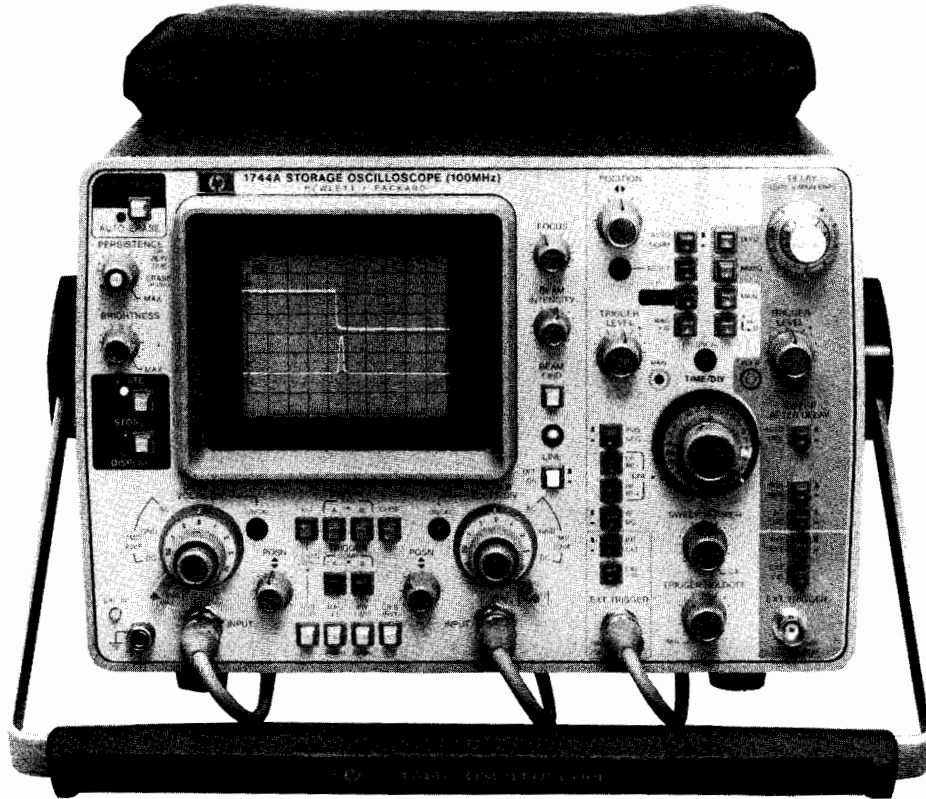

HP 1744A

### HP 1744A Description

The ability to capture signals at the maximum bandwidth of the HP 1744A vertical deflection system is achieved with expansion storage CRT technology. This fast writing speed is achieved by combining a miniature precision storage mesh with an electronic lens system that magnifies and projects the stored image. The extremely fast writing speeds provided by the expansion mesh technology are available in both variable persistence and storage modes. Operation is enhanced with an automatic focus circuit and maintains a crisp display with changes in intensity while an auto-intensity circuit helps to maintain a constant beam current to the storage surface over a wide range of sweep speeds.

### HP 1741A Description

The HP 1741A provides a "one oscilloscope" solution to the wide variety of measurements encountered daily. The versatility results from the many operating modes available—modes from minimum persistence, which approximates conventional operation, to continuous persistence settings and automatic storage. The adjustable persistence control provides the ability to match signal and persistence characteristics, resulting in excellent display characteristics over a wide range of conditions.

The HP 1741A provides a clear display of virtually any signal. However, it is especially useful in certain applications. Low repetition rate signals at fast sweep speeds produce very low light output on conventional CRTs and normally require the use of a viewing hood to obtain a viewable display. The variable persistence mode solves this problem by integrating several sweeps to amplify the light output, producing bright, clear traces. This "light-integrating" capability is also useful in eliminating flickering displays, which are the result of low repetition rates and slow sweep speed signals. These signals are annoying to view and even more difficult to measure; however, the display is improved by matching signal and persistence characteristics.

### HP 1741A, 1744A 1727A Operation

An auto-intensity circuit in all of these variable persistence/storage oscilloscopes simplifies operation. This circuit permits sharp, flicker-free, non-blooming traces to be obtained in the variable persistence mode under almost all operating conditions. There is a variety of settings available in the variable persistence mode. However, there is an easily set reference position that will provide a viewable trace: intensity—max, persistence—min, brightness—min. From this position, intensity can be decreased and persistence can be increased as necessary.

In addition to the variable persistence mode, storage LEDs provide positive identification of storage operating modes. The auto-erase mode periodically takes individual "snapshots" of an input signal. In this mode, persistence is internally set to maximum and the persistence control regulates how frequently a new "snapshot" is captured and displayed.

The auto-store mode makes single-shot events easy to capture and reduces the possibility of recording the wrong event by automatically switching to the normal trigger mode. The oscilloscope automatically switches from a "write" mode to a "store" mode after the sweep of the single-shot event for maximum trace retention time. A "store" LED indicates that the event is captured and one press of the Store/Display button displays the stored trace.

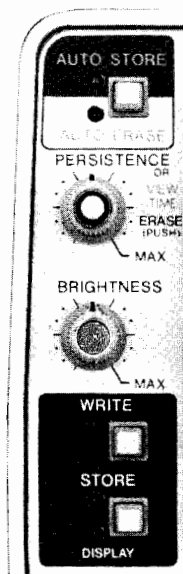



# OSCILLOSCOPES & WAVEFORM ANALYZERS

Time Interval, 275 MHz

Models 1725A, 1726A

- Time interval averaging to  $\pm 50$  ps (HP 1726A)
- 275 MHz bandwidth

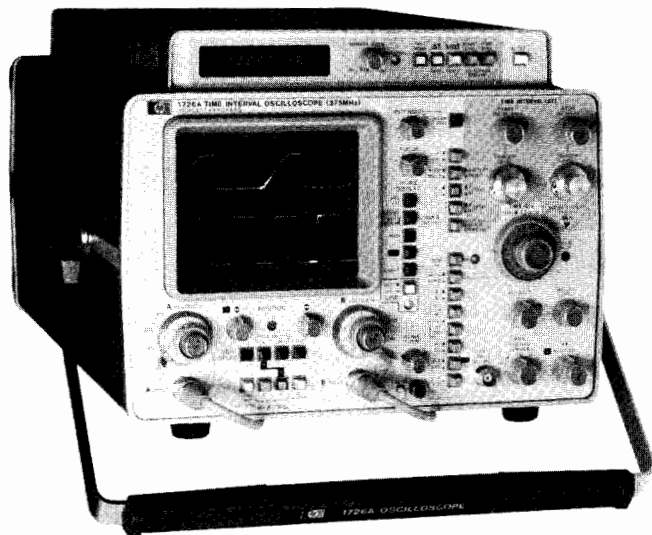

## HP 1726A Description

The HP 1726A provides precise time interval measurements by using a time interval averaging technique. In the HP 1726A, HP has eliminated the traditional oscilloscope horizontal sweep ramp as a reference for timing measurements and replaced it with a technique that measures time intervals by accumulating counts from a crystal oscillator. This allows these oscilloscopes to measure time intervals relative to the trigger event that synchronizes its waveform display, allowing them to make first pulse measurements. First pulse measurements are a class of measurements that are absolutely needed when solving many timing problems in today's fast circuits.

In addition to first pulse measurements, the crystal-referenced time base permits accurate timing measurements to be made with the oscilloscope's horizontal sweep vernier out of calibration. This extends the useful measurement range of every time base setting by a factor of three. This is important because accuracy is partially determined by the Main Time/Div setting. For example, the HP 1726A can measure time intervals as long as  $1.2 \mu\text{s}$  with  $\pm 10$  ps resolution.

## The HP 1726A—On the Leading Edge of Technology

The high bandwidth (275 MHz) of the 1726A enables it to make the stringent timing measurements that have resulted from advances in IC design, device characterization of custom ICs (e.g., bipolar and MOS processes), ECL circuits, and faster clock speeds in computers and other electronic systems. For example, characterizing a process, verifying system operation, or troubleshooting a new design all require the highly accurate and repeatable measurements that the HP 1726A can make.

## Fast, Confident Measurements

Combining a CRT with a marker system makes the measured interval easy to identify. Matched wideband pre-amplifiers allow pulse parameters such as overshoot and ringing to be examined, and the overlap mode permits precise measurements to be made from specific points on any displayed waveform. This measurement system eliminates uncertainty concerning the exact interval being measured, and it obsoletes the technique of externally gating a time interval counter with an oscilloscope.

## Precise Measurements ( $\pm 50$ ps)

Time interval averaging, which is automatically controlled through the main time/div switch, allows the HP 1726A to make precise measurements on virtually any repetitive signal that can be displayed on

- HP-IB data output (HP 1726A)
- First pulse measurements (HP 1726A)

an oscilloscope. A crystal-referenced time base combines with sophisticated triggering circuits to form the most accurate measurement system available today—up to 10 ps resolution and 50 ps accuracy.

## Repeatability and Convenience

Complex time interval measurements are highly repeatable and easy to make with the HP 1726A's triggered mode of operation. The triggered mode minimizes setup time, simplifies measurement procedures, and it allows highly repeatable measurements independent of the operator's skill level. The fast mode, which reduces the number of averages taken by a factor of ten, minimizes measurement time in all operating modes. In production and record-keeping applications, the HP 1726A's HP-IB interface outputs time interval information.

## Match Probe/Cable Propagation Delays

In many two-channel applications, small ( $\pm 200$  ps) differences in probe or cable propagation delays can significantly affect short time interval measurements. A front panel adjustment, Signal Overlap A=B, is designed to compensate for small ( $\pm 0.5$  ns) differential delays between probes or cables.

## Fast Mode

This front panel button reduces the number of averages required for a measurement by a factor of ten. It is primarily a convenience for quickly updating the time interval display. However, in low repetition rate applications, this mode is extremely useful. Reducing the number of averages affects the displayed resolution and/or the uncertainty in the least significant digit.

## Data Output Capability

A standard HP-IB interface on the HP 1726A can output data for production and record-keeping applications. Time interval measurements are easily output over HP-IB; and in the triggered mode, the start/stop trigger levels can be obtained.

## HP 1725A Description

The HP 1725A is a time interval oscilloscope with an optional DMM for direct readout of time, current, voltage, or resistance measurements. To simplify percentage measurements, its CRT graticule contains reference lines of 0%, and 100% amplitude that are 5 divisions apart as well as markings for 10%, 20%, 80%, and 90% amplitude for easy transition time measurements. The HP 1725A has a vertical deflection factor of 10 mV/div to 5 V/div over the full bandwidth. It offers a selectable 50 ohm or one megohm input for the high performance required in laboratory and field applications.

## Timing Measurements

The HP 1725A provides two methods for making timing measurements. One is a single-marker delayed sweep method, which uses the calibrated delay control to measure time relationships accurately. The second uses two intensified markers, which significantly improves accuracy while reducing the time needed to make a measurement. This second method, the delta time measurement technique, allows you to measure transition times, propagation delay, clock phasing, and other high speed digital timing measurements quickly and repeatably.

## Optional Digital Multimeter

Adding an optional multimeter to the HP 1725A improves the accuracy and convenience of time interval measurements as well as improving basic measurement capabilities. Through a switch on the oscilloscope, you can select direct time interval measurements or DMM operation. The DMM mode provides the five most common measurements—ac and dc voltage, ac and dc current, and resistance. The DMM also includes autopolarity, autozeroing, and autoranging used to make direct, convenient measurements.

# OSCILLOSCOPES & WAVEFORM ANALYZERS

## 100 MHz Specifications

Models 1740A, 1741A, 1744A, 1745A, 1746A

353



### Specifications

#### Vertical Display Modes

Channel A; channel B; A and B displayed alternately on successive sweeps (ALT); A and B displayed by switching between channels at  $\approx 250$  kHz rate with blanking during switching (CHOP); A plus B (algebraic addition); and trigger view.

**Vertical Amplifiers (2)** Bandwidth and rise time at all deflection factors from 0°C to +55°C.

**Bandwidth:** 3 dB down from 8 div reference signal; 3 dB down from 6 div reference signal for HP 1741A, HP 1744A; 3 dB down from 10 div reference signal for HP 1745A, HP 1746A.

**DC-coupled:** dc to 100 MHz in both 50  $\Omega$  and 1 M $\Omega$  input modes.

**AC-coupled:**  $\approx 10$  Hz to 100 MHz.

**Bandwidth limit:** limits upper bandwidth to  $\approx 20$  MHz.

**Rise time:**  $\leq 3.5$  ns measured from 10% to 90% points of a 6 div (5 div, HP 1744A, HP 1745A, HP 1746A) input step.

#### Deflection Factor

**Ranges:** 5 mV/div to 20 V/div (12 calibrated positions) in 1, 2, 5 sequence, attenuator accuracy  $\pm 3\%$ .

**Vernier:** extends deflection factor to  $\geq 50$  V/div.

**Polarity:** channel B may be inverted.

**Input coupling:** selectable ac or dc, 50  $\Omega$  (dc), or ground.

**Input RC (selectable):** ac or dc, 1 M $\Omega$   $\pm 2\%$  shunted by  $\approx 20$  pF; 50  $\Omega$ , 50  $\Omega$   $\pm 3\%$ , SWR  $\leq 1.4$  at 100 MHz.

**Maximum input:** ac or dc, 250 V (dc + peak ac) or 500 V p-p at  $\leq 1$  kHz; 50  $\Omega$ , 5 V rms.

#### A + B Operation

**Amplifier:** bandwidth and deflection factors are unchanged; channel B may be inverted for A-B operation.

**Differential (A-B) common mode:** CMR is at least 20 dB from dc to 20 MHz. Common mode signal amplitude equivalent to 8 div (6 div, HP 1744A; 10 div for HP 1745A, HP 1746A) with one vernier adjusted for optimum rejection.

#### Vertical Magnification (X5)

**Bandwidth:** 3 dB down from 8 div (6 div, HP 1744A; 10 div for HP 1745A, HP 1746A) reference signal.

**DC-coupled:** dc to  $\approx 40$  MHz; dc to  $\approx 30$  MHz for HP 1741A, HP 1744A.

**AC-coupled:**  $\approx 10$  Hz to 40 MHz;  $\approx 10$  Hz to 30 MHz for HP 1741A, HP 1744A.

**Rise time:**  $\leq 9$  ns,  $\leq 12$  ns for HP 1741A, HP 1744A (measured from 10% to 90% points of 8 div, 5 div HP 1744A, HP 1745A, HP 1746A input step).

**Deflection factor:** increases sensitivity of 5 and 10 mV settings by a factor of 5 with max sensitivity of 1 mV on channels A and B.

#### Trigger Source

Selectable from channel A, channel B, composite, or line frequency.

#### Trigger View

Displays internal or external trigger signal. In alternate or chop mode, channel A, channel B, and the trigger signals are displayed. In channel A or B mode, trigger view overrides that channel. Internal trigger signal amplitude approximates vertical signal amplitude. EXT trigger signal deflection factor is 100 mV/div or 1 V/div in EXT  $\div 10$ . Triggering point is approx. center screen. With identically timed signals to a vertical input and the EXT trigger input, trigger signal delay is  $\leq 3.5$  ns.

#### Horizontal Display Modes

Main,  $\Delta$ time with channel A or B start (HP 1746A), main intensified, mixed (except HP 1746A), delayed, mag X10, and A vs. B.

#### Main and Delayed Time Bases

##### Ranges

**Main:** 50 ns/div to 2 s/div (24 ranges) in 1, 2, 5 sequence.

**Delayed:** 50 ns/div to 20 ms/div (18 ranges) in 1, 2, 5 sequence.

##### Accuracy

Sweep Time/div	*Accuracy		Temp Range
	X1	X10	
50 ns to 20 ms	$\pm 3\%$	$\pm 4\%$	0°C to +15°C
	$\pm 2\%$	$\pm 3\%$	+15°C to +35°C
	$\pm 3\%$	$\pm 4\%$	+35°C to +55°C

\*Add 1% for 50 ms to 2 s ranges

**Main sweep vernier:** extends slowest sweep to at least 5 s/div.

**Magnifier (X10):** extends fastest sweep to 5 ns/div.

#### Calibrated Sweep Delay

**Delay time range:** 0.5 to 10X main time/div settings of 100 ns to 2 s (min delay 150 ns).

#### Differential Time Measurement Accuracy

(using one intensified marker and helical control)

Main Time Base Setting	Accuracy* (+15°C to +35°C)
100 ns/div to 20 ms/div	$\pm(0.5\%$ of reading $+0.1\%$ of fs)
50 ms/div to 2 s/div	$\pm(1\%$ of reading $+0.1\%$ of fs)

\*Add 1% for temperature from 0°C to +15°C and +35°C to +55°C.

**Delay jitter:**  $<0.002\%$  (1 part in 50 000) of max delay in each step from +15°C to +35°C;  $<0.005\%$  (1 part in 20 000) from 0°C to +15°C and +35°C to +50°C.

#### Differential Time Measurement Accuracy (HP 1746A)

(using  $\Delta$ time dual intensified markers)

Main Time Base Setting	Accuracy* (+15°C to +35°C)		
	Opt 034/035	External DVM***	Helical
100 ns** to 20 ms/div	$\pm(0.5\%$ of reading $+0.05\%$ of fs)	$\pm(0.5\%$ of reading $+0.05\%$ of fs)	$\pm(0.5\%$ of reading $+0.1\%$ of fs)
50 ms to 2 s/div	$\pm(1\%$ of reading $+0.1\%$ of fs)	$\pm(1\%$ of reading $+0.1\%$ of fs)	$\pm(1\%$ of reading $+0.1\%$ of fs)

\*Add 1% for temperatures from 0°C to +15°C and +35°C to +55°C.

\*\*On 100 ns/div range, specification applies after first cm of main sweep.

\*\*\*Add DVM accuracy.

#### Time Interval ( $\Delta$ Time) HP 1746A

**Function:** measures time interval between two events on channel A (A display); two events on channel B (B display); or two events starting from an event on either channel A or B and ending with an event on either channel A or B (alternate display).

**Time interval output voltage:** varies from 50 V to 100 mV full scale. Full scale output voltage can be determined by multiplying the number on the time/div dial by 10 V (e.g., 0.05 s, 0.05 ms, or 0.05  $\mu$ s per div gives 0.5 V output full-scale).

**Stability (0°C to +55°C):** short-term 0.005%. Temperature,  $\pm 0.03\%/^{\circ}$ C deviation from calibration temperature range.

#### Triggering

##### Main Sweep

**Normal:** sweep is triggered by internal or external signal.

**Automatic:** baseline displayed in absence of input signal. Above  $\approx 40$  Hz, triggering is same as normal.

**Single:** sweep occurs once with same triggering as Normal. Reset arms sweep and lights indicator (HP 1741A, HP 1744A). Single sweep is also initiated with erase; sweep is armed after the erase cycle.

**Internal:** dc to 25 MHz on signals  $\geq 0.3$  div vertical deflection, increasing to 1 div vertical deflection at 100 MHz in all display modes (required signal level is increased by 2 when in chop mode and by 5 when x5 vertical magnifier is used).

**External:** dc to 50 MHz on signals of 50 mV p-p or more, increasing to 100 mV p-p at 100 MHz (required signal level is increased by 2 when in chop mode).

##### Delayed Sweep (sweep after delay)

**Auto:** delayed sweep starts at end of delay period.

**Trig:** delayed sweep armed and triggerable at end of delay period.

**Internal:** same as main sweep.

**External:** same as main sweep.

**External input RC:**  $\approx 1$  M $\Omega$  shunted by  $\approx 20$  pF; max external input, 250 V (dc + peak ac) or 500 V p-p at  $\leq 1$  kHz.

**Level and slope:** internal, at any point on positive or negative slope of displayed waveform; external, continuously variable from +1 V to -1 V on either slope of trigger signal, +10 V to -10 V in  $\div 10$ .

**Coupling:** ac, dc, LF REJ, or HF REJ.

**Trigger holdoff (main sweep):** increases sweep holdoff, all ranges.

#### Calibrated Mixed Time Base (except HP 1746A)

Dual time base in which the main time base drives the first portion of sweep and the delayed time base completes the sweep at the faster delayed sweep. Also operates in single sweep mode. Accuracy, add 2% to main time base accuracy.



# OSCILLOSCOPES & WAVEFORM ANALYZERS

## 100 MHz Specifications

Models 1740A, 1741A, 1744A, 1745A, 1746A

### A vs B Operation

**Bandwidth:** channel A (Y-axis), same as channel A; channel B (X-axis), dc to 5 MHz.

**Deflection factor:** 5 mV/div to 20 V/div (12 cal positions) in 1, 2, 5 sequence; phase difference between channels,  $<3^\circ$ , dc to 100 kHz (75 kHz, HP 1743A).

### Cathode Ray Tube and Controls (HP 1740A)

**Type:** 12.7 cm (5 in) rectangular CRT, post accelerator,  $\approx 15$  kV accelerating potential, aluminized P31 phosphor.

**Graticule:**  $8 \times 10$  div (1 div = 1 cm) internal nonparallax graticule, 0.2 subdivision markings on major horizontal and vertical axes and markings for transition time measurements. Internal floodgun graticule illumination.

**Beam finder:** returns trace to CRT screen.

**Z-axis input (intensity modulation):** +4 V,  $\geq 50$  ns wide pulse blanks trace of any intensity, usable to  $\leq 10$  MHz for normal intensity. Input R,  $1 \text{ k}\Omega \pm 10\%$ . Max input  $\pm 20$  V (dc + peak ac).

**Rear panel controls:** astigmatism and trace align.

### Cathode Ray Tube and Controls (HP 1745A, HP 1746A)

**Type:** Hewlett-Packard, 15.6 cm (6.15 in) rectangular CRT, post accelerator, approximately 21 kV accelerating potential, aluminized P31 phosphor.

**Graticule:**  $10 \times 10$  div; 1 vertical div = 0.95 cm, 1 horizontal div = 1.2 cm; internal nonparallax graticule with 0.2 subdivision markings on major horizontal and vertical axes, markings for rise time measurements. Internal flood gun graticule illumination.

**Beam finder:** returns trace to CRT regardless of horizontal, vertical, or intensity settings.

**Z-axis input (intensity modulation):** +4 V,  $> 50$  ns width pulse blanks trace of any intensity, usable to  $\leq 10$  MHz for normal intensity; input R,  $1 \text{ k}\Omega \pm 10\%$ ; maximum input  $\pm 20$  V (dc + peak ac),  $\leq 1$  kHz.

**Rear panel controls:** astigmatism and trace align.

### Cathode Ray Tube and Controls (HP 1741A)

**Type:** 12.7 cm (5 in) rectangular CRT, post accelerator,  $\approx 7.5$  kV accelerating potential, aluminized P31 phosphor.

**Graticule:**  $8 \times 10$  div (1 div = 0.85 cm) internal, nonparallax graticule, 0.2 subdivision markings on major horizontal and vertical axes, with markings for transition time measurements. Graticule illumination is achieved with persistence control set to min.

**Beam finder:** returns trace to CRT screen.

**Z-axis input (intensity modulation):** same as HP 1740A.

**Operating modes:** write, store, display, auto-store, auto-erase, and conventional (rear panel control).

**Persistence:** variable,  $\approx 100$  ms to 1 min; conventional,  $\approx 40 \mu\text{s}$ .

**Writing speed, variable persistence and storage:**  $\geq 200$  cm/ $\mu\text{s}$  (235 div/ $\mu\text{s}$ ) over center  $7 \times 9$  div (with viewing hood).

**Storage time:** display mode, at least 10 s at  $22^\circ\text{C}$ ; store mode, at least 30 s at  $22^\circ\text{C}$ .

**Brightness:**  $\approx 170$  cd/ $\text{m}^2$  (50 fl) increasing to  $\approx 340$  cd/ $\text{m}^2$  (100 fl) depending on brightness control setting.

**Erase time:**  $\approx 300$  ms.

**Rear panel controls:** astigmatism, trace align, conventional push-button, and view time.

### Cathode Ray Tube and Controls (HP 1744A)

**Type:** 12.7 cm (5 in) rectangular CRT, post accelerator,  $\approx 10$  kV accelerating potential, aluminized P31 phosphor.

**Graticule:**  $8 \times 10$  div (1 div = 0.72 cm) internal graticule, 0.2 subdivision markings on major horizontal and vertical axes, with markings for transition time measurements. Graticule illumination is achieved with persistence control set to min.

**Beam finder, Z-axis input (intensity modulation):** see HP 1740A.

**Operating modes:** write, store, display, auto-store, and auto-erase.

**Writing speed, variable persistence and storage:**  $\geq 1800$  cm/ $\mu\text{s}$  (2500 div/ $\mu\text{s}$ ) over center  $6 \times 8$  div (with viewing hood).

**Storage time:** store mode, at least 30 s; view mode, at least 10 s; wait time, at least 60 s, at  $22^\circ\text{C}$ .

**Persistence:** variable (100 ms min).

**Erase time:**  $\approx 300$  ms.

**Rear panel controls:** astigmatism and trace align.

### General

**Rear panel outputs:** main and delayed gates, 0.8 V to  $\geq +2.5$  V; capable of supplying  $\approx 5$  mA.

### Amplitude Calibrator ( $0^\circ\text{C}$ to $+55^\circ\text{C}$ )

**Output Voltage:** 1 V p-p into  $\geq 1 \text{ M}\Omega$ , 0.1 V p-p into  $50 \Omega$ ; accuracy,  $\pm 1\%$ .

**Rise time:**  $\approx 0.1 \mu\text{s}$ .

**Frequency:**  $\approx 1.4$  kHz.

**Power:** 100, 120, 220, 240 V ac  $\pm 10\%$ ; 48 to 440 Hz; 100 VA max.

**Weight:** (HP 1740) net, 13 kg (28.6 lb); shipping, 15.7 kg (34.6 lb). (HP 1741, HP 1743, HP 1744), net 13.8 kg (30.5 lb); shipping, 17.7 kg (39 lb).

**Operating environment:** temperature  $0^\circ\text{C}$  to  $+55^\circ\text{C}$ ; humidity to 95% relative humidity at  $+40^\circ\text{C}$ ; altitude, to 4600 m (15000 ft); vibration, vibrated in three planes for 15 min each with 0.254 mm (0.010 in) excursion, 10 to 55 Hz.

**Size:** (HP 1740A, HP 1745A) 197 H x 335 W x 597 mm D (7.8 in x 13.2 in x 23.5 in) with handle, 492 mm D (19.4 in) without; (HP 1741A) 616 mm D (24.3 in) with handle, 552 mm D (21.7 in) without; (HP 1746A) 570 mm D (22.4 in) with handle, 502 mm D (19.8 in) without; (HP 1744A) 635 mm D (25 in) with handle; 511 mm D (20.1 in) without.

**Accessories furnished:** one blue light filter HP P/N 01740-02701, one front panel cover, one 2.3 m (7.5 ft) power cord, one vinyl accessory storage pouch, one Operators Guide and one Service Manual, two HP 10041A 10:1 divider probes  $\approx 2$  m (6.6 ft) long. The HP 1741A and HP 1744A also include one HP 10173A RFI filter and contrast screen, and one HP 10140A viewing hood.

### Options and Accessories

**001:** fixed power cord (U.S. only).

**002 (HP 1741A):** Triggered A vs B Mode; phase shift  $\leq 2^\circ$ , dc to 5 MHz; internal triggering on channel B.

**003:** Auto Camera (HP 1741A)

**005 (except HP 1743A, HP 1744):** TV sync

**034 (except HP 1743A, HP 1744A):** built-in DMM (60 Hz)

**035 (except HP 1743A, HP 1744A):** built-in DMM (50 Hz)

**091:** two 3 m (9.8 ft) HP 10042A 10:1 probes in lieu of 10041A probes

**096:** two 1.8 m (6 ft) HP 10006D 10:1 probes in lieu of 10041A probes.

**112:** includes HP 1112A Inverter Power Supply, a portable power source for HP 1700-series oscilloscopes.

**910:** extra set of product manuals.

**Multimeter kit:** HP P/N 01742-69501 (HP 1746A), 01741-69502 (HP 1741A), or 01740-69503 (HP 1740A, HP 1745A) adapts standard oscilloscope to an Option 034/035 with built-in LED readout. Kit includes a multimeter, top oscilloscope cover, vinyl storage pouch, and mounting hardware.

### Ordering Information

HP 1740A 100 MHz Oscilloscope

HP 1741A 100 MHz Storage Oscilloscope

HP 1744A 100 MHz Storage Oscilloscope

HP 1745A 100 MHz Large Screen Oscilloscope

HP 1746A 100 MHz Large Screen Oscilloscope

## Specifications

### Vertical Display Modes

Channel A; channel B; A and B displayed alternately on successive sweeps (ALT); A and B displayed by switching between channels at  $\approx 1$  MHz rate with blanking during switching (CHOP); A plus B (algebraic addition); X-Y (A vs. B).

### Vertical Amplifiers (2)

**Bandwidth:** 3 dB down from 6 div reference signal

**DC-coupled:** dc to 275 MHz, in both 50  $\Omega$  and high Z input modes.

**AC-coupled:** lower limit  $\approx 10$  Hz.

**Bandwidth limit:** limits upper bandwidth to  $\approx 20$  MHz.

**Rise time:** (HP 1725A, HP 1727A)  $< 1.3$  ns; (HP 1726A)  $< 1.27$  ns, measured from 10% to 90% points of a 5 div input step.

**Deflection factor:** ranges, 10 mV/div to 5 V/div (9 calibrated positions) in 1, 2, 5 sequence,  $\pm 2\%$  attenuator accuracy; vernier extends max deflection factor to  $\geq 12.5$  V/div.

**Polarity:** channel B may be inverted.

**Input coupling:** selectable, ac or dc, 50  $\Omega$  (dc) or ground.

**Input RC (selectable):** ac and dc, 1 M $\Omega$   $\pm 2\%$  shunted by  $\approx 11$  pF; 50 $\Omega$ , 50 $\Omega$   $\pm 2\%$ ; SWR  $\leq 1.3$  on 10, 20, and 50 mV ranges,  $< 1.15$  on all other ranges.

**Max input:** 1 M $\Omega$ ,  $\pm 250$  V (dc + pk ac) at  $\leq 1$  kHz; 50  $\Omega$ , 5 V rms.

**A+B operation:** amplifier, bandwidth and deflection factors are unchanged; channel B may be inverted for A-B operation; differential (A-B) Common Mode, CMR is  $\geq 40$  dB from dc to 5 MHz decreasing to 26 dB at 50 MHz. Common mode signal amplitude equivalent to 12 div with one vernier adjusted for optimum rejection.

### Vertical Output (rear panel)

**Amplitude:** one div of vertical deflection produces  $\approx 100$  mV output, dc to 50 MHz.

**Cascaded deflection factor:** 1 mV/div with both vertical channels set to 10 mV/div. Bandwidth, dc to 5 MHz (with bandwidth limit). Source resistance  $\approx 100\Omega$  (HP 1726A:  $\approx 50\Omega$ ); selection, trig source set to A selects channel A output, to B selects channel B output.

### Horizontal Display Modes

Main, main intensified (HP 1725A, HP 1726A), delayed, mixed, X-Y, and mag X10. The HP 1727A main intensified mode is automatically selected whenever the delayed time base is turned on.

### Main Time Base

#### Sweep

**Ranges:** 10 ns/div to 0.5 s/div (24 ranges) 1, 2, 5 sequence.

#### Accuracy

Main Sweep Time/Div	Accuracy (0°C to +55°C)	
	X1	X10
10 ns to 50 ns	$\pm 3\%$	$\pm 5\%$
100 ns to 20 ms	$\pm 2\%$	$\pm 3\%$
50 ms to 0.5s	$\pm 3\%$	$\pm 3\%$

**Vernier:** extends slowest sweep to at least 1.25 s/div.

**Magnifier:** extends fastest sweep to 1 ns/div.

#### Sweep Mode

**Normal:** sweep is triggered by internal or external signal.

**Automatic:** baseline displayed in absence of input signal. Triggering is same as normal above  $\approx 40$  Hz.

**Single:** in normal, sweep occurs once with same triggering as normal, reset arms sweep and lights indicators; in auto, sweep occurs once each time reset is pressed (HP 1727A). Erase pushbutton arms sweep, lights indicator, and performs the reset function immediately following the erase cycle.

### Triggering

**Source:** channel A, B, Comp, or line frequency.

**Internal:** dc to 100 MHz on signals causing  $\geq 0.5$  div vertical deflection, increasing to 1 div (1.5-HP 1726A) of vert deflection at 300 MHz (275 MHz, HP 1726A) in all display modes. Line freq. triggering selectable.

**External:** dc to 100 MHz on signals  $\geq 50$  mV p-p increasing to 100 mV p-p (150 mV p-p, HP 1726A) at 300 MHz (275 MHz, HP 1726A). Max input,  $\pm 250$  V (dc + peak ac) at  $\leq 1$  kHz. Input RC  $\approx 1$  M $\Omega$  shunted by  $\approx 15$  pF.

### Trigger Level and Slope

**Internal:** at any point on the vertical waveform displayed.

**External:** +1.0 V to -1.0 V (+10 V to -10 V in  $\div 10$  mode).

**Coupling:** ac, dc, LF REJ, or HF REJ.

**Trigger holdoff:** variable, to  $> 1$  sweep from 10 ns/div to 50 ms/div.

### Delayed Time Base

#### Sweep

**Ranges:** 10 ns/div to 20 ms/div (20 ranges) in 1, 2, 5 sequence.

**Accuracy:** same as main time base.

**Triggering (except HP 1726A)**

**Internal:** same as main time base, no line frequency triggering.

**Starts after delay:** sweep starts at end of delay period.

**Trigger:** with delayed trigger level control out of detent (starts after delay) delayed sweep is triggerable at end of delay period.

**Delay time range:** 0.5 to 10X main time/div settings of 20 ns to 0.5 s (min delay 50 ns).

External triggering, external input RC, maximum external input, trigger level and slope, and coupling are same as main time base.

**Triggering (with  $\Delta T$  off-HP 1726A)**

**Auto:** delayed sweep automatically starts at end of delay period.

**Trig:** delayed sweep is triggerable at end of delay period. Vary start (or delay) control to adjust the arming point of the delayed sweep trigger.

**Delayed trigger source:** channel A or channel B can be selected as a trigger source.

### Differential Time Accuracy (HP 1725A, HP 1727A)

Main Time Base Setting	Accuracy (+15°C to +35°C)
50 ns/div to 20 ms/div	$\pm(0.5\%$ of reading $+0.1\%$ of full scale)
20 ns/div	$\pm(1\%$ of reading $+0.2\%$ of full scale)
50 ms/div to 0.5 s/div	$\pm 3\%$

**Delay jitter:**  $< 0.005\%$  of max delay in each step.

**Stability (0°C to +55°C):** short term 0.005%. Temperature,  $\pm 0.03\%/^{\circ}\text{C}$  deviation from calibration temperature range.

### Time Interval ( $\Delta T$ -HP 1726A)

**Function:** measures the time interval between start and stop events on one or two channels, in all operating modes except X-Y.

**Overlap Mode:** the CRT is used as a visual comparator to measure time intervals between start and stop events. Time interval measurements are valid when start/stop delayed sweeps are overlapped or aligned on a vertical graticule (in  $\Delta T$  overlap with mag X10 if required). Known relationships between the delayed display and the stopping point for the counting process required for a time interval measurement enable the use of this technique.

**$\Delta T$  Overlap:** only the intensified portions (start/stop) of main sweep are displayed. With  $\Delta T$  off, the intensified single delayed sweep is displayed.

**Marker Width:** in main display, this control varies the width of the intensified start/stop markers. In  $\Delta T$  overlap display, the width (i.e., time window) of the displayed intensified region varies. With  $\Delta T$  off, this control is non-functional.

**Start (or Delay)/Stop ( $\Delta T$  Only):** controls position of the start/stop intensified markers. Markers move continuously in overlap mode, and they jump discretely (from trigger event to trigger event) in triggered mode. With  $\Delta T$  off, Start is the delay control for the single intensified marker.

**Delayed ( $\Delta T$  Overlap):** displays delayed sweep (i.e., the intensified



# OSCILLOSCOPES & WAVEFORM ANALYZERS

## 275 MHz Specifications

Models 1725A, 1726A, 1727A

portions of main sweep).

**ΔT:** activates time interval readout between start and stop events.

**1/ΔT:** displays reciprocal of ΔT measurement.

**Fast mode:** used in conjunction with ΔT or 1/ΔT; reduces number of averages by a factor of 10. Increases uncertainty of least significant digit displayed.

**Counting LED:** indicates a measurement in progress.

**Main time/div setting:** automatically determines the number of averages required for a measurement.

**Triggered mode:** measures time interval between start trigger point and stop trigger point. Start/stop trigger level controls adjust the desired trigger point when the corresponding button on the time interval module is engaged.

**Start/stop trigger level:** indicates through the LED readout the desired trigger point for start/stop events. These controls set the reference for the trigger point in the trigger chip. Actual trigger point will vary with slope, slew rate, and trigger voltage selected.

**Stop Lvl equals start Lvl:** automatically sets stop trigger level equal to start trigger level.

**Start/stop slope selection:** indicates positive or negative slope for start/stop trigger point.

### ΔT Accuracy (HP 1726A)

**Overlap mode:** there are three components of accuracy in this mode: 1) CRT screen resolution; 2) resolution of the time interval averaging process; and 3) uncertainty in the counting process. Table A summarizes accuracy in all operating conditions (Channel A, Channel B, ALT, CHOP, A+B, A-B).

Main Time/Div	Dly'd Time/Div	Accuracy†
20 ns	10 ns	±100 ps
50 ns	10 ns, 20 ns	±50 ps
0.1 μs, 0.2 μs, 0.5 μs	10 ns, 20 ns	±200 ps
0.1 μs, 0.2 μs, 0.5 μs	50 ns	±300 ps
0.2 μs, 0.5 μs	0.1 μs	±400 ps
0.5 μs	0.2 μs	±600 ps
1.0 μs, 2.0 μs	all	±2 ns
5.0 μs, 10.0 μs, 20 μs	all	±10 ns
50 μs, 1 ms, 0.2 ms	all	±100 ns
0.5 ms, 1.0 ms, 2.0 ms	all	±1 μs
5.0 ms, 10 ms, 20 ms	all	±10 μs
50 ms, 0.1 s, 0.2 s, 0.5 s	all	±100 μs

†Add ±50 ps if measurement is made relative to the first pulse. Accuracy is not specified if measurements are made relative to the last 0.5 divisions of main sweep.

**Triggered mode:** for accuracy greater than ±0.5 ns, all measurements should be verified with the overlap mode. Absolute accuracy on measurements made without overlap mode verification can be determined by adding ±300 ps to the accuracy specifications in Table A. A number of variables affect the accuracy of this mode. Accuracy is composed of: 1) "arm/walk" errors, which can be minimized by viewing triggered measurements in delayed (ΔT overlap) display; 2) trigger level vs trigger point errors (this error is minimized when time interval measurements are made at the same start/stop voltage on similar sloped edges); 3) counting process errors; 4) time interval averaging resolution; and 5) crystal time base accuracy of 0.001% of measurement.

### Time Interval (Δ time mode — HP 1725A, HP 1727A)

**Function:** measures time interval between two events on channel A (A display), on channel B (B display), or starting from an event on either A or B and ending with an event on either A or B (alt display).

**Time interval output voltage:** from 50 V to 100 mV full-scale.

**Accuracy:** time interval accuracy plus DVM accuracy.

Main Time Base Setting	Accuracy (+20°C to +30°C)
100 ns/div to 20 ms/div	±0.5% of reading ±0.05% of fs
50 ns/div*	±0.5% of reading ±0.1% of fs
20 ns/div*	±0.5% of reading ±0.2% of fs
50 ms/div to 0.5 s/div	±3%

### X-Y Operation

#### Bandwidth

Y-axis (channel A), same as channel A;

X-axis (channel B), dc to >1 MHz.

**Phase difference:** <3°, dc to 1 MHz (3 MHz, HP 1722B).

### Mixed Time Base

Dual time base in which the main time base drives the first portion of sweep and the delayed time base completes the sweep.

### Cathode-Ray Tube and Controls (HP 1725A, HP 1726A)

**Type:** post accelerator, ≈ 20.5 kV, aluminized P31 phosphor.

**Graticule:** 8 x 10 div internal graticule, 0.2 subdiv markings on major horiz and vert axes, 1 div = 1 cm. Internal floodgun illumination.

**Beam finder:** returns trace to CRT screen.

**Intensity modulation (Z-axis):** +8 V, ≥50 ns (HP 1726A: >(-2) V and >75 ns) width pulse blanks trace of any intensity, usable to 20 MHz for normal intensities. Input R, 1 kΩ ± 10%. Max input, ± 10 V (dc + peak ac).

**Auto-focus:** maintains beam focus with variations of intensity.

**Intensity limit:** limits beam current to simplify operation. Circuit response time ensures full writing speed.

### Cathode-Ray Tube and Controls (HP 1727A)

**Type:** post accelerator, ≈ 9.5 kV, aluminized P31 phosphor.

**Graticule:** 8 x 10 div internal graticule, 0.2 subdivision markings on major horiz and vert axes, 1 div = 0.72 cm.

**Beam finder:** returns trace to CRT screen.

**Intensity modulation (Z-axis):** +4V, ≥50 ns width pulse blanks trace of any intensity, usable to 20 MHz for normal intensities. Input R, 1 kΩ ± 10%. Max input, ± 20V (dc + peak ac).

**Operating modes:** write, store, display, auto-store, and auto-erase.

**Writing speed, variable persistence and storage:** ≥ 2000 cm/μs (2775 div/μs) over center 6 x 8 div (with viewing hood).

**Storage time (at 22°C):** display mode, at least 10 s; store mode, at least 30 s; wait time, at least 60 s.

**Persistence:** variable, ≥ 100 ms.

**Erase time:** ≈ 300 ms.

**Intensity limit:** limits beam current to simplify operation. Circuit response time ensures full writing speed.

**Auto-focus:** maintains beam focus with variations of intensity.

### General

**Rear panel controls:** astigmatism and trace align (both X and Y).

**Rear panel outputs:** main and delayed gates, -0.7 V to +1.3 V capable of supplying ≈ 3 mA; and vertical output.

**Calibrator:** type, 1 kHz ± 15% (±10%, HP 1722B) square wave; 3 V p-p ± 1%, <0.1 μs transition time.

**Power:** 100, 120, 220, and 240 Vac, -10% + 5%; 48 to 440 Hz; 110 VA max (HP 1726A: 160 VA max).

### Ordering Information

1725A 275 MHz Oscilloscope

1726A 275 MHz Time Interval Oscilloscope

1727A 275 MHz Storage Oscilloscope



# OSCILLOSCOPES & WAVEFORM ANALYZERS

Probes and Other Oscilloscope Accessories

Models 10017A, 10018A; 10020, 10040, 10080 Series

357



## Miniature Oscilloscope Probes

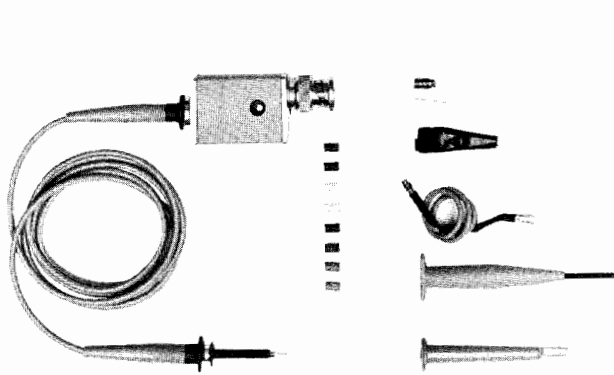

HP Models 10017A, 10018A, 10040A, 10041A, 10042A

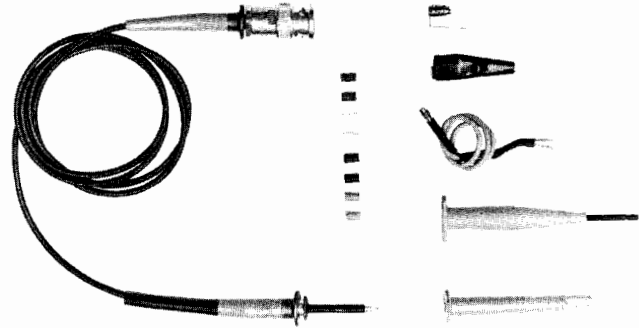

HP Models 10026A, 10027A

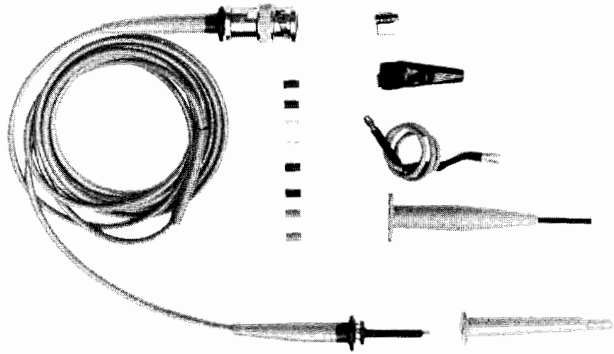

HP Models 10021A, 10022A

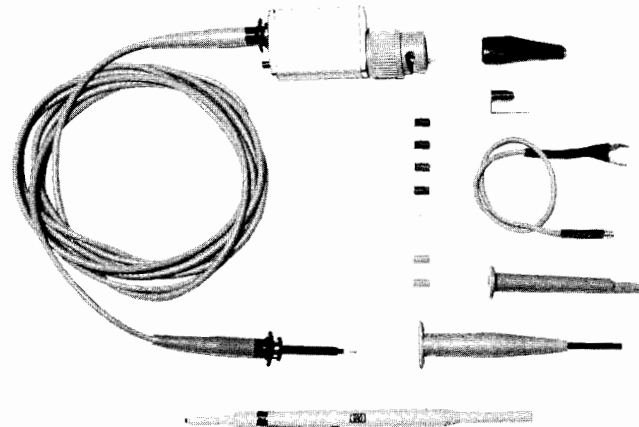

HP Models 10080A, 10081A, 10082A, 10083A, 10084A

*OSCILLOSCOPE/MINIATURE PROBE COMPATIBILITY AND PROBE CHARACTERISTICS*							
HP Oscilloscope/ Plug-in Model No. and Bandwidth	HP Probe Model No.	Approx Overall Length in Metres (ft)	Division Ratio	Input R	Shunt Capacitance	Compensates Oscilloscope Input	Max dc Volts
1725A/275 MHz 1727A/275 MHz	10017A	1 m (3.3)	10:1	1 MΩ	8 pF	9 to 14 pF	300
1725A 1727A	10018A	2 m (6.6)	10:1	1 MΩ	10 pF	9 to 14 pF	300
1740A, 1741A, 1744A, 1745A, 1746A 100 MHz	10040A	1 m (3.3)	10:1	1 MΩ	9 pF	20 to 30 pF	300
	10041A	2 m (6.6)	10:1	1 MΩ	12 pF	20 to 30 pF	300
	10042A	3 m (9.8)	10:1	1 MΩ	15 pF	20 to 30 pF	300
190 8/100 MHz 1950A/100 MHz	10080A**	1 m (3.3)	10:1	1 MΩ	9 pF	10 to 20 pF	300
	10081A**	2 m (6.6)	10:1	1 MΩ	12 pF	12 to 20 pF	300
	10082A**	3 m (10)	10:1	1 MΩ	14 pF	14 to 18 pF	300
	10083A**	1 m (3.3)	1:1		45 pF		300
	10084A**	2 m (6.6)	1:1		68 pF		300
All scopes with high Z inputs (may reduce bandwidth)	10021A	1 m (3.3)	1:1		36 pF		300
	10022A	2 m (6.6)	1:1		62 pF		300
All scopes with 50 Ω inputs and 54100A/D with a 50 Ω source impedance	10026A	1 m (3.3)	1:1	50 Ω			100
	10027A	2 m (6.6)	1:1	50 Ω			100

**Accessories supplied with each probe:** one retractable hook tip, one IC probe tip adapter, one alligator clip, one 20 cm (8 in) ground lead, eight color-coded indicator sleeves, one grounding spring, and one Operating Note.

\*These miniature probes may be used with other oscilloscopes and test instruments with the proper input capacitance with no noticeable bandwidth degradation. However, due to variations of input characteristics, the probes may require recalibration for optimum performance.

\*\*The HP 10080-series miniature probes include a Feature Enable pushbutton for exclusive use with the HP 1980 Oscilloscope Measurement System.



# OSCILLOSCOPES & WAVEFORM ANALYZERS

## Probes and Other Oscilloscope Accessories (Cont.)

Models 10001-10008, 10014A, 10016B, 1111B, 1111A, 1122A, 1124A.

### Standard probes

For measurements in standard circuits where miniature probes are not a requirement, Hewlett-Packard offers a wide selection of standard size probes.

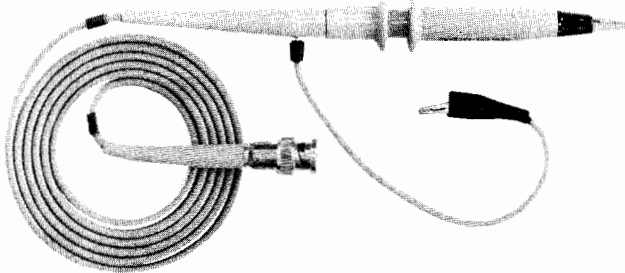

HP Models 10001A-10003A

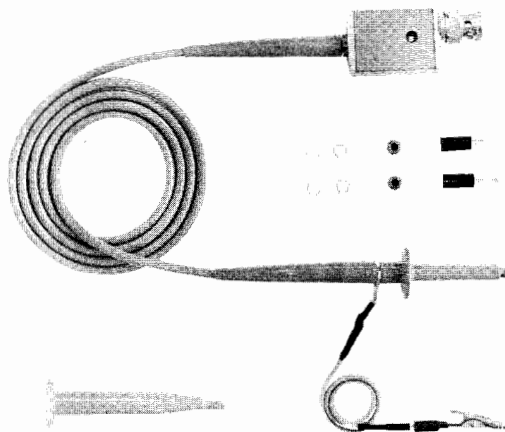

HP Models 10004D-10006D, 10014A, 10016B

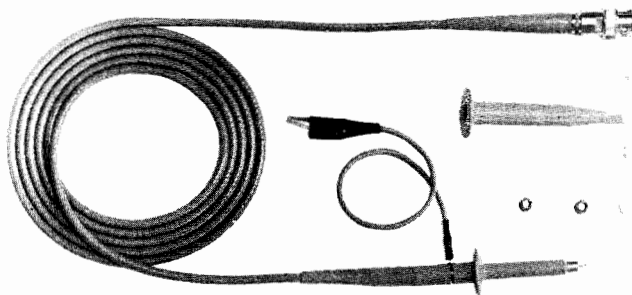

HP Models 10007B, 10008B

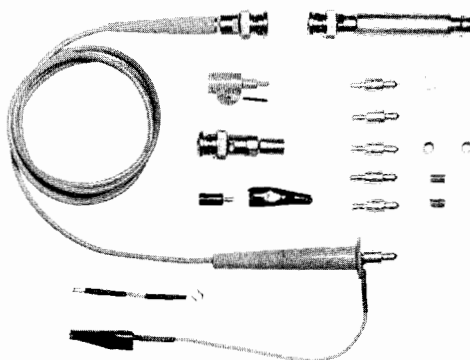

HP 10020A

### Standard Probe/Instrument Compatibility

Scope/ Plug-in	HP 1725A HP 1727A	HP 1740A thru 1744A
Probe		
10001A		L
10001B		L
10002A		L
10002B		L
10003A		L
10004D		X
10005D		L
10006D		X
10007B	L	L
10008B	L	L
10013A		
10014A	X	
10016B	X	
10020A	X	X
1120A	X	X
1124A	L	L

#### Notes:

X Indicates that probe will maintain the bandwidth of the instrument.

L Indicates that probe may limit the bandwidth of the instrument.

### Standard Divider Probe Characteristics

HP Model No.	Division Ratio	Resistance (M $\Omega$ )	Shunt Capacitance (pF)	Compensates Scope Input C (pF)	Max DC Volts	Overall Length m (ft)
10001A	10:1	10	10	15-55	600	1.5 (5)
10001B	10:1	10	20	15-45	600	3 (10)
10002A	50:1	9	2.5	15-55	1000	1.5 (5)
10002B	50:1	9	5	15-55	1000	3 (10)
10003A	10:1	10	10	15-55	600	1.3 (4)
10004D	10:1	10	10	20-30	500	1.1 (3.5)
10005D	10:1	10	17	20-30	500	3 (10)
10006D	10:1	10	14	20-30	500	1.8 (6)
10007B	1:1	—	40	—	600	1.1 (3.5)
10008B	1:1	—	60	—	600	1.8 (6)
10013A	10:1	10	13	24-45	500	1.8 (6)
10014A	10:1	10	10	9-13	500	1.1 (3.5)
10016B	10:1	10	14	9-13	500	1.8 (6)

### HP 10020A Resistive Dividers

Division Ratio	Input R* (ohms)	Division Accuracy	Max V** (rms)	Input C (pF)
1:1	50	—	6	—
5:1	250	$\pm 3\%$	9	<0.7
10:1	500	$\pm 3\%$	12	<0.7
20:1	1000	$\pm 3\%$	15	<0.7
50:1	2500	$\pm 3\%$	25	<0.7
100:1	5000	$\pm 3\%$	35	<0.7

\*When terminated in 50 ohms.

\*\* Limited by power dissipation of resistive element.

### HP 10020A Resistive Divider Probe Kit

Probe length (overall):  $\approx 1.2$  m (4 ft).

Weight: net, 0.45 kg (1 lb); shipping, 1.4 kg (3 lb).

Accessories supplied: blocking capacitor, BNC adapter tip, 6-32 adapter tip, alligator tip, probe handle, cable assy's 5.1 cm (2 in) & 15.2 cm (6 in) ground, spanner tip, insulating caps, colored sleeves.

### Ordering Information

HP 10020A Resistive Divider Probe Kit

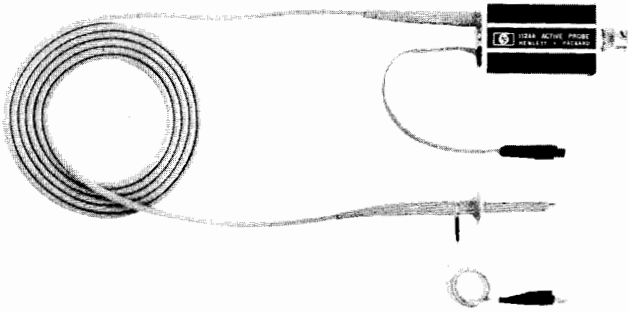

HP 1124A

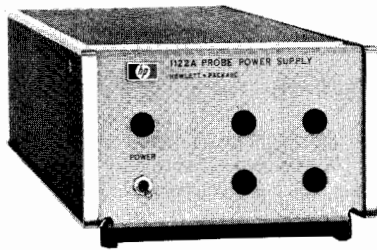

HP 1122A

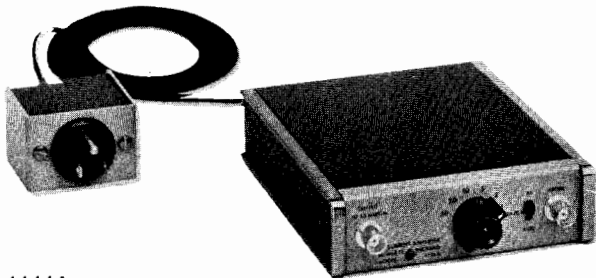

HP 1111A

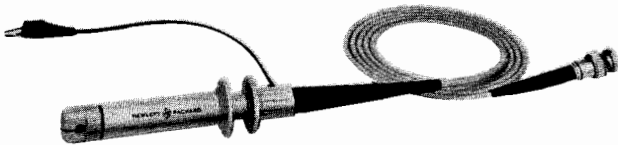

HP 1110B

### HP 1124A 100 MHz Active Probe

The HP 1124A Active Divider Probe provides high voltage, general-purpose probing capabilities for instruments having 50  $\Omega$  inputs without selectable high impedance inputs. This 10 M $\Omega$  10 pF probe allows direct measurements of 100 V, in the 100:1 division ratio mode, from dc to 100 MHz. In the 10:1 division ratio mode, input voltage range is  $\pm 10$  V. Power is supplied by instruments with probe power jacks or the HP 1122A probe power supply.

#### HP 1124A Specifications

(Measured when connected to a 50  $\Omega$  load.)

**Bandwidth:** (measured from a terminated 50  $\Omega$  source) dc-coupled,

dc to 100 MHz; ac-coupled, 2 Hz to 100 MHz.

**Pulse response:** (measured from a terminated 50  $\Omega$  source) transition time, <3.5 ns; perturbations, 5% p-p. Measured with pulse transition time of >2.5 ns.

**Attenuation ratio:** 10:1  $\pm 5\%$ ; 100:1  $\pm 5\%$ .

**Dynamic range:** X10,  $\pm 10$  V; X100,  $\pm 100$  V.

**Input RC:** 10 M $\Omega$  shunted by  $\approx 10$  pF.

#### Maximum Safe Input

**DC-coupled:** X10,  $\pm 300$  V (dc + peak ac)  $\leq 100$  MHz; X100,  $\pm 500$  V (dc + peak ac)  $\leq 100$  MHz.

**AC-coupled:** X10,  $\pm 300$  V (dc + peak ac)  $\leq 100$  MHz; dc component must not exceed  $\pm 200$  V; X100,  $\pm 500$  V (dc + peak ac)  $\leq 100$  MHz; dc component must not exceed  $\pm 200$  V.

**Accessories supplied:** one 20.3 cm (8 in) ground lead, one retractable hook tip, and two probe tip insulating caps.

**Power:** supplied by instruments with probe power jacks or the HP 1122A probe power supply.

**Weight:** net, 0.2 kg (5 oz); shipping, 0.91 kg (2 lb).

**Length:**  $\approx 1.5$  m (5 ft) overall.

**Available accessory:** HP 10131B 91.4 cm (36 in) extender cable (refer to HP 1122A Probe Power Supply). Required for use with HP 1700 oscilloscopes with probe power option.

### HP 1122A Probe Power Supply

The HP 1122A is a regulated power supply that provides all power requirements for simultaneous operation of up to four active probes.

#### HP 1122A Specifications

**Probe driving capability:** up to four HP active probes.

**Power output:**  $-12.6$  V and  $+15$  V,  $\pm 3\%$ .

**Power input:** 115 V or 230 V  $\pm 10\%$ , 48 to 440 Hz, 40 W (with four probes).

**Weight:** net, 2.7 kg (6 lb); shipping, 3.6 kg (8 lb).

**Accessories supplied:** four HP 10131B 91.4 cm (36 in) extender cables.

### HP 1111A AC Current Amplifier

**Deflection factor:** (with a 50 mV/div oscilloscope deflection factor) in X1, 1 mA/div to 50 mA/div; in X100, 100 mA/div to 5 A/div; 1, 2, 5 sequence in X1 or X100.

**Accuracy:** in X1,  $\pm 3\%$ ; in X100,  $\pm 4\%$ .

**Rise time:** 18 ns.

**Noise:** <100  $\mu$ A p-p, referenced to input signal.

**Maximum ac current:** above 700 Hz, 50 A p-p; below 700 Hz, decreases at 1.4 A/20 Hz.

**Output impedance:** 50  $\Omega$ .

**Size:** 38.1 H x 130.2 W x 152.4 mm D (1 1/2 in x 5 1/8 in x 6 in).

**Weight:** net,  $\approx 0.9$  kg (2 lb); shipping, 1.4 kg (3 lb).

**Power:** 115 or 230 V  $\pm 10\%$ , 50 to 440 Hz, 1.5 W.

### HP 1110B Current Probe

**Sensitivity:** without 100  $\Omega$  termination, 1 mV/mA; with 100  $\Omega$  termination, 0.5 mV/mA.

**Accuracy:**  $\pm 3\%$ .

#### Bandwidth

**Lower  $-3$  dB point:** without 100  $\Omega$  termination,  $\approx 1700$  Hz; with 100  $\Omega$  termination,  $\approx 850$  Hz.

**Upper  $-3$  dB point:** with 4 pF capacitive load,  $\approx 45$  MHz; with 30 pF capacitive load  $\approx 35$  MHz.

**Rise time:** with 4 pF capacitive load,  $\approx 7$  ns; with 30 pF capacitive load,  $\approx 9$  ns.

**Insertion impedance:**  $\approx 0.01$   $\Omega$  shunted by 1  $\mu$ H; capacitance to ground <3 pF.

**Maximum dc current:** 0.5 A.

**Maximum ac current:** 15 A p-p above 4 kHz; decreasing below 4 kHz at 3.8 A/kHz rate.

**Weight:** net, 0.5 kg (1 lb); shipping, 0.9 kg (2 lb).

**Dimensions:** probe aperture, 3.9 mm (3/16 in) diameter; overall length, 1.5 m (5 ft).

### Ordering Information

HP 1122A Probe Power Supply

HP 1124A 100 MHz Active Probe

HP 1111A Current Amplifier

HP 1110B Current Probe

# OSCILLOSCOPES & WAVEFORM ANALYZERS

## Probes and Other Oscilloscope Accessories (cont.)

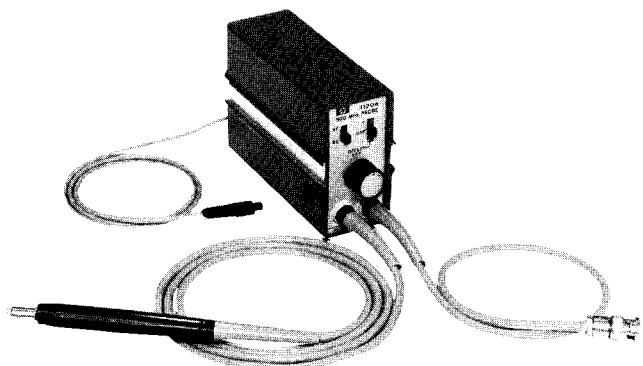

HP 1120A

### HP 1120A 500 MHz Active Probe

For probing high source impedances at high frequencies, the HP 1120A 1:1 active probe provides a probe tip impedance of 100 k $\Omega$  shunted by approximately 3 pF at 100 MHz. When used with the 10:1 or 100:1 divider tips, the shunt capacitance is <1 pF at 100 MHz. The 50  $\Omega$  output provides the optimum impedance match and measurement accuracy for oscilloscopes, spectrum analyzers, counters, and network analyzers with 50  $\Omega$  inputs. Power is supplied by instruments with probe power jacks or the HP 1122A probe power supply.

### HP 1120A Specifications

(measured with output connected to a 50  $\Omega$  load.)

**Bandwidth:** (measured from a terminated 50  $\Omega$  source) dc-coupled, dc to >500 MHz; ac-coupled, <1.5 kHz to >500 MHz.

**Pulse response:** (measured from a terminated 50  $\Omega$  source) transition time, <0.75 ns; perturbations, < $\pm$ 6% measured with 1 GHz sampler.

**Dynamic range:**  $\pm$ 0.5 V with  $\pm$ 5 V dc offset.

**Noise:**  $\approx$  2.5 mV (measured tangentially).

**Input RC:** 100 k $\Omega$ , shunt capacitance  $\approx$  3 pF at 100 MHz; with 10:1 or 100:1 dividers, shunt capacitance is <1 pF at 100 MHz.

**Maximum input:**  $\pm$ 80 V.

**Weight:** net, 1.8 kg (4 lb); shipping, 3.2 kg (7 lb).

**Power:** supplied by oscilloscopes with probe power jacks or an HP 1122A probe power supply.

**Length:** 1.2 m (4 ft) overall; with Option 001, 1.8 m (6 ft).

### Accessories Furnished

**HP 10241A 10:1 divider:** increases input R to  $\approx$  1 M $\Omega$  shunted by <1 pF at 100 MHz.

**HP 10242A bandwidth limiter:** reduces bandwidth to  $\approx$  27 MHz shunted by  $\approx$  6 pF and reduces gain <2%.

**HP 10243A 100:1 divider:** increases input R to  $\approx$  1 M $\Omega$  shunted by <1 pF at 100 MHz.

**Also included:** slip-on hook tip, 6.4 cm (2.5 in) ground lead, spare probe tips, a slip-on BNC probe adapter.

### HP 10034A Ground Lead Kit

The HP 10034A probe adapter kit consists of an assortment of 6-32 screw-on tips, and two ground lead cables that allow many methods of connecting the ground leads in a circuit. A 6-32 to slip-on adapter allows these tips to be used on HP 10004D-10006D, HP 10007B, HP 10008B, HP 10013A, HP 10014A, HP 10016B, and HP 1124A probes. The kit consists of one 15.2 cm (6 in) and one 30.5 cm (12 in) ground lead, one hook tip, one alligator tip, one pin tip, one tip for 0.6 mm (0.025 in) square pins, one banana tip, and one slip-on to 6-32 adapter.

### Ordering Information

HP 1120A 500 MHz Active Probe

HP 1120A Opt 001, 1.8 m (6 ft) length

HP 10221A 50  $\Omega$  Probing Tee

HP 10034A Ground Lead Kit

### HP 10035A Probe Tip Kit

The tips in this kit are designed to be used with probes that accept a 6-32 screw-on tip that include: HP 10001A/B, HP 10002A/B, and HP 10003A. A slip-on to 6-32 adapter allows these tips to be used with other probes with pin tips. The adapter is supplied with HP 10004D through HP 10006D, HP 10014A, HP 10016B, HP 10020A probes and HP 10034A ground lead kit. The HP 10035A probe tip kit contains a pincer jaw, banana tip, pin tip, and spring tip.

### HP 10036B Probe Tip Kit

The tips in this kit extend the usefulness of standard probes that accept slip-on tips, and the easy IC miniature probes. Included in the kit are two slip-on to 6-32 adapters and three bushing adapters that provide the flexibility to use the supplied tips with both types of probes. The adapters also allow use of other 6-32 probe tips with the probes. The HP 10036B includes an assortment of tips for the following: 2.0 mm (0.08 in) jack; 0.6 mm (0.025 in) and 1.14 mm (0.045 in) square pins; 1.0 mm-1.6 mm (0.040-0.062 in) diameter pin.

### HP 10037B Probe Tip Kit

The HP 10037B probe tip kit contains six 0.64 mm (0.025 in) square female (white) tips for standard probes that accept slip-on tips, and the easy IC miniature probes. Also included are six bushings that adapt HP miniature probes to the supplied tips.

### Miniature Probe Accessories

#### HP 10019A BNC to Square Pin Cable Assembly

The HP 10019A cable assembly is designed for connecting test equipment to 0.64 mm-0.76 mm (0.025 in-0.030 in) square pin signal nodes or to integrated circuits through the HP 10024A IC test clip. This adaptable cable assembly is primarily used as:

a) A signal pick-off device for applying circuit signals to the input of test equipment such as oscilloscopes and voltmeters. An application is checking voltages on computer back plane pins.

b) A signal insertion cable for inserting signals into suspected faulty circuits from power supplies, pulse generators, etc. Used in conjunction with the HP 10024A IC test clip, signals are easily inserted into the proper IC leads.

For applications requiring greater separation between the circuit nodes and the instrumentation, the HP 10019A may be extended by using a BNC to BNC adapter (HP P/N 1250-0080) and a 50  $\Omega$  test cable such as the 122 cm (48 in) When the test equipment hookup requires a dual banana plug, a BNC to Dual Banana Plug Adapter (HP P/N 1251-2277) is available.

#### HP 10017-67603 Coaxial Adapter Cable

HP P/N 10017-67603 is a 230 mm (9 in) 50  $\Omega$  slip-on adapter cable for miniature and standard HP probes that provides a coaxial interface to 0.64 mm (0.025 in) square pin circuit nodes. The cable is ideal for probing computer back planes as well as wire wrap terminals. HP P/N 10017-67604 miniature to standard probe adapter allows the cable to slip directly onto the HP easy IC miniature probe tip with the insulating barrel removed.

#### HP 10017-67604 Mini to Standard Probe Adapter

HP P/N 10017-67604 allows standard size slip-on probe tip accessories to be used with HP miniature probes. With the retractable insulating barrel removed from the miniature probe and replaced with the HP 10017-67604 adapter, the probe slides directly into the standard size probe tip accessories.

### Ordering Information

HP 10035A Probe Tip Kit

HP 10036B Probe Tip Kit

HP 10037B Probe Tip Kit

HP 10019A Cable Assembly

HP 10017-67603 Coaxial Adapter Cable

HP 10017-67604 Mini to Standard Probe Adapter



## Miniature Probe Accessories

### HP 10024A IC Test Clip

The HP 10024A IC test clip provides easy probing of dual in-line packages and includes four insulated circuit interface pins. Additional circuit interface pins are available (see Ordering Information) in packages of twelve pins. Each pin has a tip on each end so that probes such as those on HP logic analyzers can be connected for fast, functional checks of circuit operation.

### HP 10036B and HP 10037B Probe Tip Kits

The HP 10036B and HP 10037B probe tip kits increase probing versatility with an assortment of 6-32 screw-on tips. Slip-on to 6-32 adapters are included for compatibility with the miniature probes.

### HP 10028A Jumper Cable

The HP 10028A 50  $\Omega$  610 mm (24 in) miniature probe/jumper cable is designed primarily for bypassing suspected faulty circuits in densely populated IC circuits. The basic tip on either end of the cable inserts directly into an HP 10024A IC test clip, allowing easy temporary connections between IC's without the danger of shorting between pins. The cable can also be used as a 50  $\Omega$  1:1 probe to insert signals from an external source or as an input source to an external measuring device. For the latter use, probe tip to BNC adapter (HP P/N 1250-1454) is available.

### Digital Trigger Probe

The HP 10250A (TTL) 4-bit trigger probe is a useful service, production, and design troubleshooting tool that offers digital pattern triggering to enhance the use of oscilloscopes, logic analyzers, and other test equipment. The four inputs may be switched to HI, LO, or OFF (don't care) for convenient selection of the trigger point. No separate power supply is needed because probe power is obtained from the circuit under test.

## Probe Accessories

### Terminations

**HP 10100C:** 50  $\Omega$   $\pm$ 1% BNC male to BNC female feedthrough termination.

**HP 10100B:** 100  $\Omega$   $\pm$ 2  $\Omega$  BNC male to BNC female feedthrough termination.

### Standard Probe Tip Adapters

**HP 10011B slip-on to BNC probe tip adapter:** for probes HP 10004D, HP 10006D, HP 10007B, HP 10008B, HP 10013A, HP 10014A, HP 10016B, and HP 1124A.

**HP 10229A hook tip adapter:** retractable pincer tip provides firm connection to circuit nodes. Supplied with HP 1120A probe. Recommended accessory for HP 10020A resistive divider kit.

**HP P/N 10004-69515 IC probe tip adapter:** retractable pincers provide convenient connection to dual in-line packages for probes HP 10004D, HP 10006D, HP 10007B, HP 10008B, HP 10013A, HP 10014A, HP 10016B, and HP 1124A. Supplied with HP 10004D, HP 10005D, HP 10006D, HP 10014A, and HP 10016B.

### Ordering Information

**HP 10024A** IC test clip for easy probing of dual in-line packages; includes 4 insulated circuit interface pins

**HP 10024-69501** Interface Pin Kit for HP 10024A; includes 12 interface pins

**HP 1250-1454** BNC-to-probe adapter permits the miniature probes to be connected to BNC connectors to maintain fast pulse response.

**HP 10036B** Probe Tip Kit

**HP 10037B** Probe Tip Kit

**HP 10028A** Jumper Cable

**HP 10229A** Retractable Hook Tip Adapter

**HP 10004-69515** IC Probe Tip Adapter

**HP 10011B** BNC Probe Tip Adapter

**HP 10100C** 50  $\Omega$  Feedthrough Termination

**HP 10100B** 100  $\Omega$  ( $\pm$ 2  $\Omega$ ) Feedthrough Termination

## Servicing and Viewing Accessories

### Viewing Hoods

**HP 10140A:** collapsible viewing hood for HP 1700-series oscilloscopes.

### Light Filters

**HP 10173A:** RFI filter and contrast screen for HP 1700-series oscilloscopes.

**Blue light filter:** HP P/N 01740-02701 for HP 1700-series oscilloscopes.

### Rack Mount Slides and Adapters

**HP 10491B rack mount adapter:** adapts HP 1700-series oscilloscopes to standard 483 mm (19 in) rack; 222 mm (8 $\frac{3}{4}$  in) high, 540 mm (21 $\frac{1}{4}$  in) deep. Requires fixed slides (HP P/N 1490-0714) or pivoted slides (HP P/N 1490-0719) for slide mounting.

### Front Panel Covers

**HP P/N 5040-0516:** provides front panel protection for HP 1700-series oscilloscopes.

### Ordering Information

**HP 10140A** Viewing Hood for HP 1700-series (8 x 10 div.)

**HP 10176A** Viewing Hood for 12.7 cm (5 in) rectangular CRT

**HP 10173A** RFI Filter and Contrast Screen for HP 1700-series oscilloscopes (8 x div. CRT)

**HP 5020-0530** Amber Plastic Filter or 12.7 cm (5 in) rectangular CRT

**HP 5020-0567** Smoke Gray Plastic Filter for 12.7 cm (5 in) rectangular CRT

**HP 5060-0548** Blue Plastic Filter for 12.7 cm (5 in) rectangular CRT

**HP 01740-02701** Blue Light Filter for HP 1700-series oscilloscopes (8 x 10 div. CRT)

**HP 10491B** Rack Adapter for HP 1700-series oscilloscopes

**HP 1490-0714** Fixed slides for HP 180, HP 181 rack-style oscilloscopes and HP 10491B

**HP 1490-0719** Pivoted Slides for HP 180, HP 181 rack-style oscilloscopes and HP 10491B

**HP 1490-0768** Slide Adapter, required for securing slides to HP 180, HP 181 rack-style oscilloscopes

**HP 5040-0516** Front Panel Cover for HP 1700-series oscilloscopes.

# OSCILLOSCOPES & WAVEFORM ANALYZERS

Probes and Other Oscilloscope Accessories (cont.)

Models 197B, 10023A, 10029A, 10367A

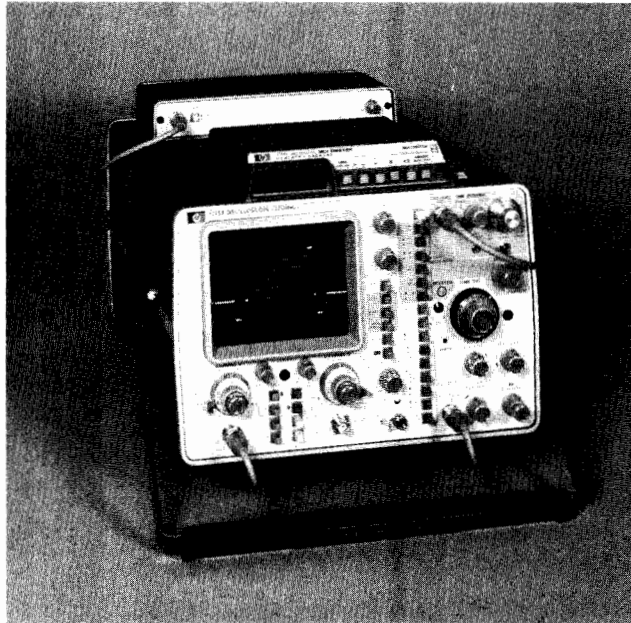

The HP 10029A TV/video sync retrofit kit can be added to any HP 1700-series oscilloscope except the HP 1726A for the display of composite video waveforms.

### Video Sync Retrofit Kit for HP 1700 Series

Any HP 1700-series oscilloscope except the HP 1726A can easily display composite video waveforms with the addition of the HP 10029A retrofit kit module. Consisting of a user-installable module, the retrofit kit mounts on the instrument top cover. Power for the module is received from the instruments; no other internal modifications are required in the oscilloscope.

The HP 10029A module operates completely external to the oscilloscope — BNC cables provide the necessary connections. Composite video waveforms are input to the module providing a 75  $\Omega$  input for impedance matching to most video signal sources. A vertical output signal (video) provides a method for connecting the signal to the instrument's vertical input channel. With the trigger signals from the TV/video sync module and proper use of the oscilloscope's standard controls, specific portions of the composite video waveform can be selected for viewing.

Field selection is easily accomplished with one button, and a single line scan control on the module enables you to examine an individual horizontal line precisely.

### Specifications

Input Impedance: 75  $\Omega$   $\pm$  3%. In TV clamp, ac-coupled with negative clamping to ground.

Maximum Input: 75  $\Omega$  or TV clamp mode, 5 V rms.

### Outputs

Main Trigger: 0.75 to <1 V square wave with main trigger slope (POS/NEG) selecting the alternate field in the frame.

Delayed Trigger: 0.75 to <1 V square wave. Delayed trigger slope selection must be set to NEG (with delayed sweep set in the "TRIG'D" mode) to engage single line scan.

TV Vertical: maintains minimum 20 MHz bandwidth.

### Ordering Information

HP 10029A TV/Video Sync Retrofit Kit

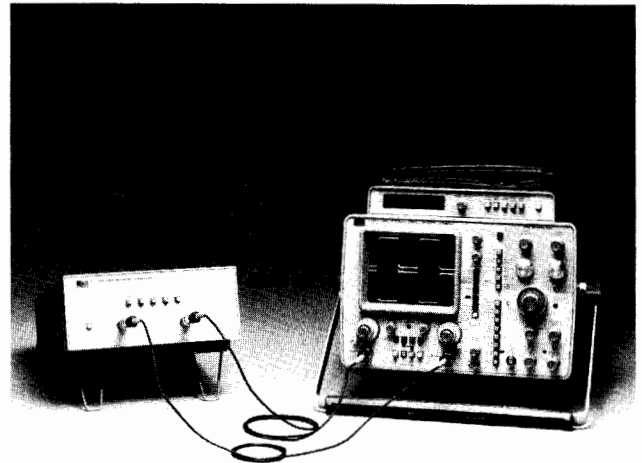

Combining the HP 1726A with the HP 10326A results in a complete solution for time interval measurement problems.

### HP 10326A Time Interval Standard

The HP 10326A Time Interval Standard is a signal source that provides a dual-channel time interval reference. The two channels, OUTPUT and  $\overline{\text{OUTPUT}}$ , offer a selectable square wave output with waveform periods of 5, 10, 20, 50, or 100 nanoseconds. These output signals can be delivered to probe tips or BNC connectors with the HP 10326A's accessory kit.

The waveform period accuracy of any selected square wave output is  $\pm$  5 picoseconds. This accuracy results from the purity of the crystal oscillator's frequency spectrum and the accuracy of the oscillator's frequency. Low subharmonic distortion permits short time intervals of a single period to be presented with a high degree of stability. Timing relationships between rising and falling edges in any combination are specified between output channels.

The waveform period accuracy and known timing relationships between edges of OUTPUT and  $\overline{\text{OUTPUT}}$  are convenient signals to evaluate system performance. Low subharmonic distortion of output signals is ideal for calibration and other applications which require extremely stable waveforms for timing analysis.

Specifications (See data sheet No. 5953-3911 for complete details.)

**Signal outputs:** OUTPUT,  $\overline{\text{OUTPUT}}$ , Trig Out; Square Wave Period (selectable) 5 ns, 10 ns, 20 ns, 50 ns, 100 ns.

Rise Time (20–80%): OUTPUT,  $\overline{\text{OUTPUT}}$   $\leq$  1.25 ns.

### Operating Characteristics (typical values)

Square Wave Amplitude (OUTPUT,  $\overline{\text{OUTPUT}}$ , Trig Out)  $\approx$  0.38 V p-p (fixed) into a 50  $\Omega$  load; warm-up time, 1 min.

### General

**Weight:** net, approx. 2.95 kg (6.5 lb); shipping, approx. 5.77 kg (12.7 lb).

**Dimensions:** 9.53 mm (3.75 in) high; 21.27 mm (8.375 in) wide; 27.94 mm (1.1 in) deep.

**Accessories furnished:** one BNC/probe adapter kit (HP P/N 10326-69501), one 2.3 m (7.5 ft) power cord, and one operating and service manual.

### Ordering Information

HP 10326A Time Interval Standard

Option 001 - delete Accessory Kit



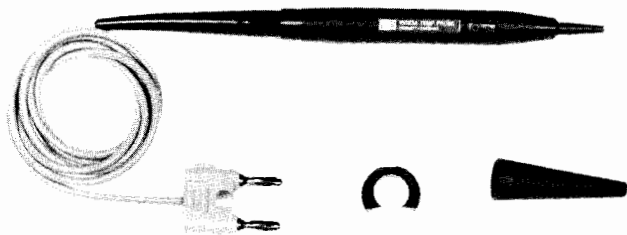

HP 10023A

### HP 10023A Temperature Probe

The HP 10023A temperature probe provides fast, accurate temperature measurements in a variety of thermal design, diagnostic, and testing applications. Surface temperatures are read directly in degrees Celsius on multimeters (DMM) having an input impedance of  $\geq 10$  megohms. A pencil-like probe tip easily accesses small components and a press-to-read switch make measurements easy; just press the button, touch the surface to be measured, and read its temperature directly on the DMM.

The probe is a self-contained temperature-to-voltage transducer with a forward-biased diode chip bonded to a small ceramic substrate in the probe tip. A calibrated, linear output of  $1 \text{ mV}/^\circ\text{C}$  is assured by individually characterizing each diode in a precision thermal reference bath. An integrated circuit resistor network is then laser trimmed to match each diode to its electronic compensation circuit.

The entire electronics assembly, including the battery, is packaged in the probe barrel. A standard dual banana plug output connector provides universal readout through most digital voltmeters including the built-in DMMs on HP's Option 034/035, 1700-series oscilloscopes.

### 10023A Specifications

#### Electrical

**Measurement range:**  $-55^\circ\text{C}$  to  $+150^\circ\text{C}$ .

**Output:**  $1 \text{ mV}/^\circ\text{C}$ .

**Short term repeatability:**  $\pm 0.3^\circ\text{C}$  (minimum of 48 hrs).

**Accuracy:**  $\pm 2^\circ\text{C}$  from  $0^\circ\text{C}$  to  $100^\circ\text{C}$ , decreasing linearly to  $+2^\circ\text{C}$ ,  $-4^\circ\text{C}$  at  $-55^\circ\text{C}$  and  $+4^\circ\text{C}$ ,  $-2^\circ\text{C}$  at  $+150^\circ\text{C}$ .

**Maximum voltage at tip:** 600 V (dc + peak ac).

**Tip capacitance to ground:** approx. 0.5 pF.

**Thermal response:**  $< 3 \text{ s}$  to settle within  $2^\circ\text{C}$  of final reading (liquid measurement) for a  $100^\circ\text{C}$  temperature change.

**DMM Input R:**  $\geq 10 \text{ M}\Omega$ .

#### General

**Operating environment probe tip to approx 13 mm (0.5 in) from probe tip:** temperature,  $-55^\circ\text{C}$  to  $+150^\circ\text{C}$ ; altitude, to 4600 m (15,000 ft); vibration, vibrated in three planes for 15 min each with 0.38 mm (0.015 in) excursion, 10 to 55 Hz.

**Operating environment (probe body):** temperature,  $0^\circ\text{C}$  to  $60^\circ\text{C}$  (battery limitation); humidity (non-condensing), to 95% relative humidity at  $+40^\circ\text{C}$ , altitude and vibration same as those for probe tip.

**Overall length:** approx 1.4 m (53 in).

**Weight:** net, 85 g (3 oz). Shipping, 312 g (11 oz).

**Battery life:** approx 50 hr (varies with ambient temperature).

**Low battery indication:** probe output indicates approx  $-70^\circ\text{C}$  on DMM. First indication of a low battery condition is a decreasing indication of  $1^\circ$  to  $2^\circ\text{C}/\text{min}$  with probe tip at a constant temperature.

**Accessories supplied:** one replacement battery (HP 1420-0256), one sliding lock collar (HP 10023-23201), and one probe tip cover (HP 00547-40005).

**Replacement batteries:** batteries may be purchased locally using the following part numbers, RAY-O-VAC®, RS 312-G or T-312-G; DURACELL® 10L125; or batteries with similar specifications.

\*RAY-O-VAC is a registered trademark of ESB, Inc.

\*DURACELL is a registered trademark of P. R. Mallory & CO.

### Ordering Information

HP 10023A Temperature Probe

HP 10023-60001 Replacement Tip, includes pre-calibrated tip and matching compensation network

### HP 197B Camera

The HP 197B is a versatile, general-purpose instrument for cathodray tube photographic recording. The camera features lift-off mounting and swing-away hinging by pressing a single latch release button. Interchangeable film backs enable capture of CRT display information on a complete spectrum of Polaroid® or conventional sheet, pack, or roll film. All controls are located outside of the camera for easy reading and fast adjustment during setup. A low-angle viewing port provides a direct view of the display through a flexible facemask while the camera is in the photographic position.

### Camera Mounting

On initial order, the HP 197B can be configured, with different camera adapters, to mount directly on a variety of instruments. Each camera adapter is attached to the camera body with a piano hinge and is an integral part of the camera. The HP 197B includes an HP 10376A adapter that directly interfaces to HP 1700-series oscilloscopes with 8 x 10 division CRTs. The HP 197B option 002 includes an HP 10378A adapter that directly interfaces to HP 180-series oscilloscopes. Model 197B Option 006 includes an HP 10375A adapter which directly interfaces with the majority of HP small-screen CRT displays.

By using camera bezel adapters, various camera configurations can be adapted to other instruments not directly compatible with the camera adapter. For mounting a variety of cameras to instruments both current and those no longer in production, refer to the HP 197B Camera Data Sheet. Copies of the 197B Data Sheet can be obtained from your local HP field office or by writing: Inquiries Manager, Hewlett-Packard Company, 1820 Embarcadero Road, Palo Alto, California 94303.

\*Registered Trademark of Polaroid, Inc.

\*Registered Trademark of Graflex, Inc.

### HP 197B Characteristics

**Reduction ratio:** continuously adjustable from 1:1 to 1:0.7. Reference scale provided on focus plate.

**Lens:** 75 mm, f/1.9 high transmission lens; aperture, f/1.9 to f/16.

**Shutter speeds:** 1/30, 1/15, 1/8, 1/4, 1/2, 1, 2, 4 seconds, Time and Bulb; shutter has a sync contact closure output for triggering external equipment and an input jack for remote operation.

**Camera back:** 83 mm x 108 mm (3.25 in x 4.25 in) Polaroid® pack back.

**Mounting:** lift on/off mounting with positive lock, swing-away hinging to left.

**Viewing:** low-angle, direct viewing through a flexible facemask.

**Shutter open indicator:** illuminated whenever shutter is open.

**Ultraviolet illumination:** light source and lens filter provide gratulic illumination and photographic speed enhancement.

**Focus:** adjustable with lock; split-image focusing plate provided.

**Size:** 267 H x 194 W x 356 mm D (10.5 in x 7.6 in x 14 in).

**Weight:** net, 4.5 kg (10 lb); shipping, 7.3 kg (16 lb).

**Power:** switch selectable 115 Vac  $\pm 10\%$  or 230 Vac  $\pm 10\%$ , 48 to 66 Hz\*, 10 VA max.

**Accessories furnished:** comb. split image focusing plate reduction ratio scale, 2.3 m (7.5 ft) power cord, and instruction manual.

### Ordering Information

#### HP 197B Camera

**001:** deletes ultraviolet illumination feature

**002:** replaces HP 197B adapter with HP 10378A adapter.

**006:** replaces HP 197B adapter with HP 10375A adapter.

**007:** meets UL listing requirements for medical and dental electronic equipment.

**009:** Camera Bezel Adapter for HP 1745A and HP 1746A oscilloscopes.

**910:** additional manual

**10367A** Camera Bezel Adapter for HP 182T

**Ultraviolet Light Kit** (P/N 00197-69507) for field installation of ultraviolet illumination feature.

\*Camera operates from 48 to 440 Hz, but does not meet the ac line to chassis leakage requirements of UL 544 listing above 66 Hz.



# OSCILLOSCOPES & WAVEFORM ANALYZERS

Testmobiles: Save Bench Space, Easily Moved

Models 1006A, 1007A, 1008A, and 1117B

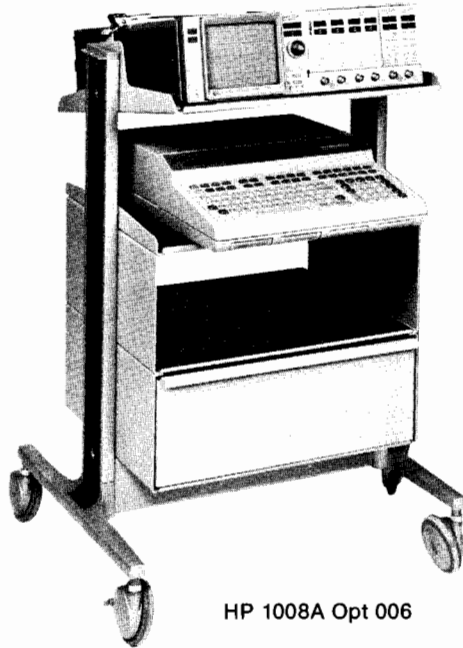

HP 1008A Opt 006



HP 1006A

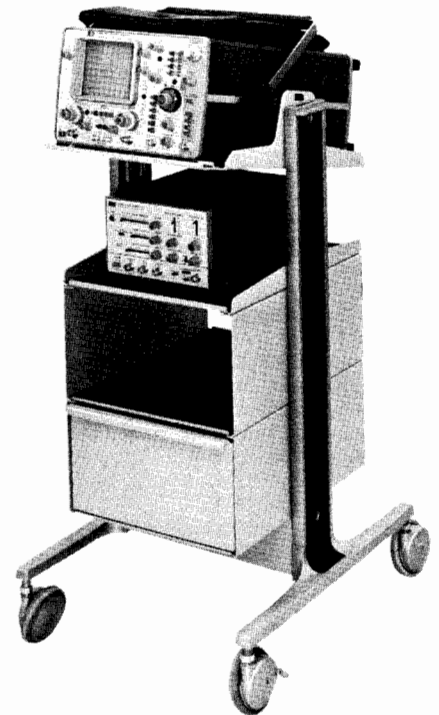

HP 1007A Opt 006

Hewlett-Packard testmobiles offer convenient portability for your oscilloscopes or instrumentation systems. The top tray on these testmobiles may be tilted to position your instrument for easy operation. The selection of testmobiles range from a basic model such as the HP 1006A, designed to hold a single oscilloscope or other instrument, to a testmobile such as the HP 1008A or HP 1117B that can be adapted to provide a complete mobile test system. Refer to the testmobile/instrument compatibility chart for assistance in selecting the testmobile that will best fit your requirements.

## HP 1007A, HP 1008A Description

These versatile testmobiles provide a sturdy, lightweight, stable platform for your oscilloscope or instrumentation system (see compatibility chart). Large angled wheels with a wide track move quietly and smoothly over most surfaces. The top trays are table-top height and can be tilted to a convenient viewing angle between 30° above and 30° below the horizontal position with a total of seven detent positions in 10° increments. The caps on each side rail are designed to hold three probes conveniently to reduce the possibility of damaging probes not in use.

## Testmobile/Instrument Compatibility

Testmobile HP Model Number	Instrument
1006A 1007A	All Hewlett-Packard 1700 series cabinet-style oscilloscopes, or other instruments that meet the height and weight requirements.
1008A	Hewlett-Packard instruments that are configured to be mounted in a standard 48.3 cm (19 in) rack and meet the testmobile height and weight requirements, such as the HP 1980B.
1117B	All instruments listed above.

## HP 1007A, HP 1008A Options

Many options are available so that the HP 1007A or HP 1008A can be easily tailored to your specific requirements. Refer to the option photographs with description to select the testmobile best suited to your requirements. Options apply to both the HP 1007A and HP 1008A. Option 008, U.S.-only five outlet power strip, is also available for convenient instrument operation.



HP 1006A

## HP 1006A Description

This is a sturdy general purpose testmobile for cabinet style oscilloscopes and other instruments (see compatibility chart). The tilt tray adjusts  $\pm 30^\circ$  in 10° increments. A base tray and an accessory rack add space for other instruments and accessories; and a convenient bracket holds three HP probes. Large rear wheels allow easy movement and locking front casters hold the testmobile in position. A five outlet power strip accessory is available for mounting under the tilt tray or beneath the accessory rack.

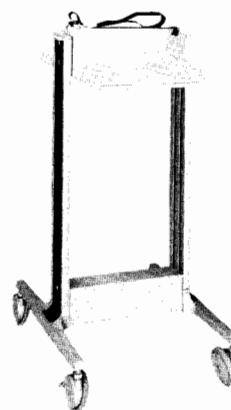

Basic Testmobile

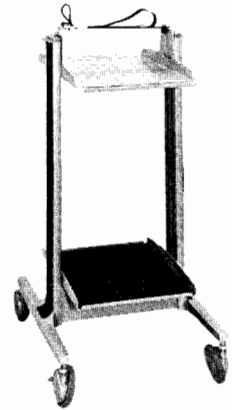

Opt 001: storage shelf  
load limit: 18 kg (40 lb).

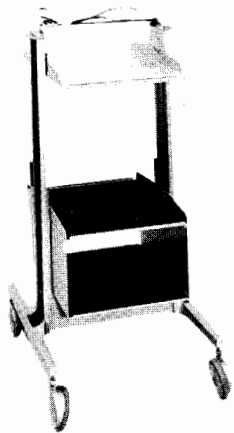

**Opt 002:** storage shelf and lower cabinet; load limit 18 kg (40 lb) each.

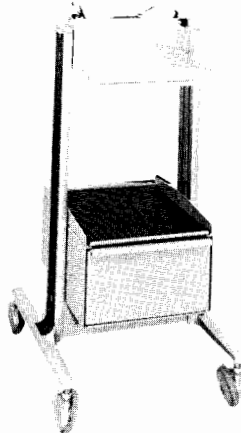

**Opt 003:** 15 cm (6 in) lockable drawer with shelf on top; load limit 11 kg (25 lb) in drawer and 18 kg (40 lb) on shelf.

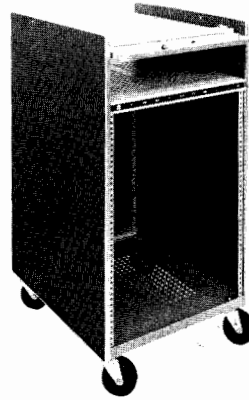

HP 1117B

### HP 1117B Description

The HP 1117B provides a mobile test station for cabinet and rack model instruments, with tilt tray angles from  $-15^{\circ}$  to  $+30^{\circ}$  in  $7\frac{1}{2}^{\circ}$  increments for easy viewing. In addition, other instruments can be mounted in the standard EIA racks of the lower compartment. Rack mounting height is 62.2 cm (24½ in), depth is 58.4 cm (23 in), and power distribution is provided with a built-in four outlet power strip. Optional accessory drawers 7.6 cm (3 in) and 20.3 cm (8 in) deep are available to provide convenient storage space. The drawers may be installed in many vertical positions of the lower compartment, allowing room for other rack-mounted equipment.

### Specifications

(see testmobile data sheet for complete specifications)

	HP 1006A	HP 1007A	HP 1008A	HP 1117B
Height	841 mm (33¼ in)	930 mm (36½ in)	930 mm (36½ in)	1003 mm (39½ in)
Overall width	502 mm (19¾ in)	584 mm (23 in)	759 mm (29¾ in)	511 mm (20¼ in)
Width of tray	322 mm (12¾ in)	321 mm (12½ in)	473 mm (18¾ in)	
Tilt tray angle	$\pm 30^{\circ}$	$\pm 30^{\circ}$	$\pm 30^{\circ}$	$-15^{\circ}$ to $+30^{\circ}$
Weight	net	11.8 kg (26 lb)	11 kg (25 lb)	13 kg (28 lb)
	shipping	14.5 kg (32 lb)	19 kg (41 lb)	22 kg (48 lb)
Max load on tilt tray	23 kg (50 lb)	34 kg (75 lb)	45 kg (100 lb)	45 kg (100 lb)
Max load below tilt tray	23 kg (50 lb)	see option descriptions	see option descriptions	56.7 kg (125 lb)

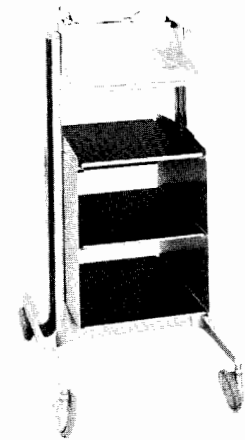

**Opt 004:** two storage cabinets with shelf on top; combined load limit, cabinets and shelf, 45 kg (100 lb).

**Opt 005:** storage cabinet and drawer in upper position with shelf on top; load limit 18 kg (40 lb) each on shelf and in cabinet, 11 kg (25 lb) in drawer.

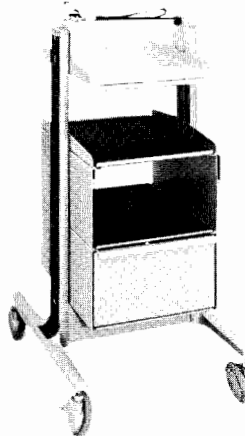

**Opt 006:** storage cabinet with shelf on top and drawer in lower position; load limit 18 kg (40 lb) each on shelf and in cabinet, 11 kg (25 lb) in drawer.

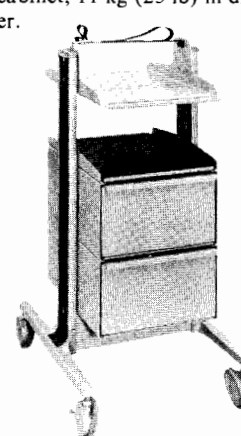

**Opt 007:** two lockable drawers with shelf on top; load limit 18 kg (40 lb) on shelf, 11 kg (25 lb) each drawer.

### Optional Accessories

**HP 10475A** 7.6 cm (3 in) drawer for HP 1117B testmobile

**Weight:** net, 4.1 kg (9 lb); shipping, 5.9 kg (13 lb).

**HP 10476A:** 20.3 cm (8 in) drawer for HP 1117B testmobile

**Weight:** net, 5.4 kg (11 lb); shipping, 8.2 kg (18 lb).

**HP 01008-61201** Probe Pod Holder holds three small Logic Analyzer probe pods such as HP 10230 and HP 10248

**HP 01008-68701** Rack Mount Kit for HP 1008A, 13.3 cm (5¼ in) high for mounting under the tilt tray

**HP 01007-60008** Power Strip kit adds Opt 008 power strip to all versions of HP 1006A, HP 1007A, HP 1008A testmobiles

### Ordering Information

**HP 1006A Testmobile**

**Opt 008** Power Strip

**HP 1007A, HP 1008A Testmobiles**

(see HP 1007A, HP 1008A Options for option descriptions)

**Opt 001:** storage shelf

**Opt 002:** storage shelf, lower cabinet

**Opt 003:** storage shelf, locking drawer

**Opt 004:** two storage cabinets, shelf

**Opt 005:** upper drawer, lower storage

**Opt 006:** lower drawer, upper storage

**Opt 007:** two locking drawers

**Opt 008:** power strip (5 outlet)

**HP 1117B Testmobile** (includes power strip)

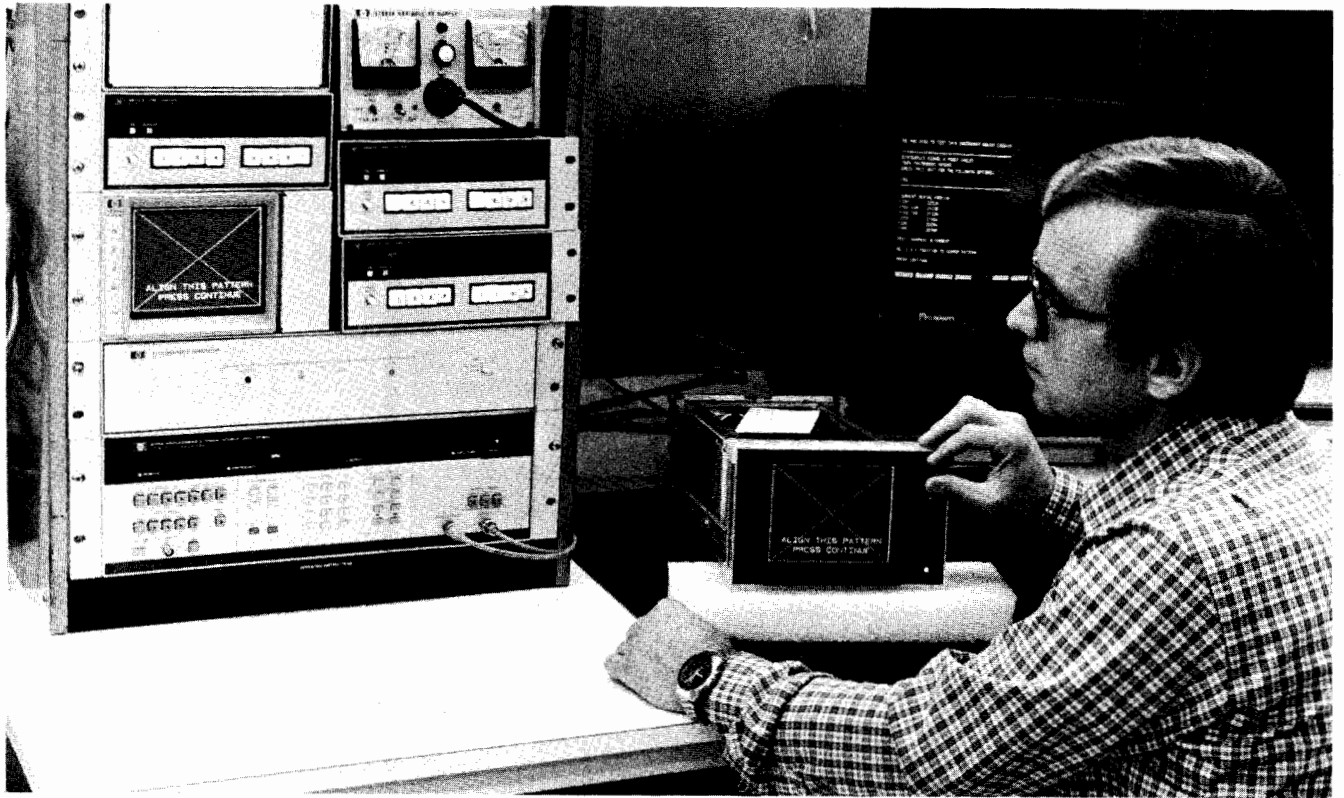

Selecting a graphics display is no longer a simple choice between an electrostatic or an electromagnetic cathode-ray tube (CRT). The trend to microcomputer and minicomputer control of instruments and systems is generating the need to display more complex pictures. Reduced memory costs are making it possible to design a greater variety of digital displays using either electrostatic or electromagnetic CRTs.

### Electrostatic CRT

The heart of HP graphics displays is an electrostatic CRT. Also included are X- and Y-axis deflection amplifiers, a Z-axis (video) amplifier, and both high and low voltage power supplies. HP small screen displays are available with or without cabinets. In addition, several rack and bench type cabinet configurations are available, giving your designer a high degree of flexibility in incorporating HP displays into your instrument or system.

The primary attributes of the electrostatic CRT are high writing speed and low power requirements. The deflection plates are voltage driven whereas electromagnetic CRTs are current driven, through a yoke and tuned circuit in raster-scan displays. Vector writing speeds of electrostatic CRT displays are typically ten times faster than high-performance electromagnetic CRT displays.

Power requirements become a significant consideration with large screen displays. All HP large screen displays meet environmental specifications without a fan. The maximum power of any HP display is 185 watts. This can be a benefit in reducing system cooling requirements.

### Digital Interfaces

The HP 1351A Graphics Generator provides a convenient digital interface between computers and controllers and the analog inputs in the majority of HP graphic displays. The HP 1351A converts digital inputs to analog outputs capable of driving HP's large screen displays. The very high resolution of these displays, combined with the HP 1351A's 8k vector/character generating capability, provides the complex drawing capability needed in computer-aided graphics systems such as CAD/CAM.

The HP 1345A is a high performance display that has a built-in digital interface, and it is ideal for microprocessor-based instrumentation and system applications. The HP 1345A represents a new concept in instrumentation displays with its 16-bit TTL I/O. The advantage of the 16-bit I/O is that digital interfacing to a microprocessor-based system provides a convenient, high performance interface. With the many peripheral interfacing adapters (PIAs) that are available,

interfacing a digital system to the HP 1345A can be accomplished in a fraction of the time required for interfacing displays with analog inputs. The 16-bit I/O also operates with 8- or 16-bit microprocessors, which assures compatibility with present and future instrument systems.

The HP 1347A HP-IB Display is designed for applications needing a peripheral small-screen display. This self-contained display's interface is HP-IB using HP-GL (HP Graphics Language), and it can copy its screen or memory contents to an HP-IB/HP-GL plotter. In addition, the HP 1347A's data-scrolling capability makes it useful in data-acquisition and monitoring applications.

### Imaging Applications

HP CRT displays have been used to present continuous-tone images both for direct viewing and photographic recording for many years. One of the first applications was to produce high-speed, random dot images from gamma cameras used in nuclear medicine. HP's advanced technology makes it possible to manufacture CRTs with highly uniform light output, which is essential in assuring the diagnostic accuracy of gamma camera pictures.



### Measurement Instruments

Most measurement instruments that produce line drawings operate in real-time. Because of the need for high writing speed they usually include an electrostatic CRT display. The HP 1340A and HP 1345A meet the needs of measurement instrument designers. The modular package makes them physically easy to incorporate into an instrument or system. Integrated circuit amplifiers provide flexibility when electrically integrating the HP 1340A with an instrument. DC voltage levels control X and Y amplifier gain and position as well as intensity. Either controls supplied with the HP 1340A or circuits in your instrument can be used to control the display. The HP 1345A/1346A have digital interfaces, making them ideally suited to digitally-controlled systems. CRT performance meets the picture drawing needs of both analog and digitally controlled instruments.

### Measurement Systems

The capability of the HP 1351S to update a portion of the picture without redrawing the entire display is extremely useful in measurement systems.

Radar and sonar system designers can benefit from the speed and versatility of HP

graphics display systems. Most of these systems display continually changing pictures the operator uses to make tactical decisions. He cannot afford to wait a significant length of time for pictures to be updated. Consequently, the high refresh rate of the HP 1351A and the high speed and resolution of HP's large screen displays make them good choices for such applications.

Analytical chemistry systems often need large-screen, high-resolution pictures to display various spectra. The HP 1351S and its 1020 x 1020 addressable resolution is an excellent match for analytical instrument specifications. Its memory versatility enables the system operator to store several spectra and quickly display various sequences of data for comparative analysis. All this can be done at ambient light levels because of the brightness of the HP 1351S Display System.

Some medical research and data acquisition systems require simultaneous display of several traces. It is possible to continuously update HP large screen displays through the HP 1351A Graphics Generator to simulate a multiple-trace chart recorder. Simulation systems usually operate in a real-time mode and require fast picture writing speeds. The

HP 1351S is being used in several simulation systems because it can display changes in the picture at rates faster than operator response times. Other benefits for simulation systems are the capability to operate multiple displays and to use a variety of CRT sizes.

### Computer Graphics

Computer graphics is one of the most rapidly growing branches in the computer field. Graphics is an extremely effective medium for communication between human and computer; the eye is able to absorb information in graphical form much faster than it can interpret information in tabular form.

Large-screen displays are well-suited to computer graphics applications, particularly in the areas of computer-aided design (CAD) and computer-aided manufacturing (CAM). Many CAD/CAM systems use interactivity, which allows the operator to draw and manipulate objects or elements by means of an input device like a tablet or light pen. The result of the action is seen in real-time on the display screen. To the user it appears that the picture is changing instantaneously in response to commands.



# GRAPHICS DISPLAYS

## Product Selection Guide

Features	Model Number — Digital Displays		
	HP 1345A	HP 1347A	HP 1351A
Interface	16-Bit TTL	HP-IB	HP-IB 16-Bit Binary (Opt 002) RS-232C (Opt 001)
Viewing Area	12.5 x 9.6 cm (31.75 x 24.4 in)	Same as HP 1345A	N/A
Addressable Resolution	0-2047X 0-2047Y	0-2047X 0-1512Y	0-1020X 0-1020Y
OEM Module w/o Power Supply	Yes	No	No
Fully Self-Contained Peripheral	No	Yes	Yes

Note: These are condensed specifications; refer to applicable data sheet for complete specifications, including options and accessories.

Features	Model Number — Small-screen Displays				
	HP 1332A	HP 1335A (conventional)	HP 1335A (storage)	HP 1336A	HP 1340A
Spot Size	≤0.30 mm	≤0.25 mm	≤0.50 mm	≤0.07 mm	≤0.46 mm
Resolution	31.5 lines/cm (80 lines/in)	39 lines/cm (99 lines/in)	20 lines/cm (51 lines/in)	140 lines/cm (356 lines/in) center screen	22 lines/cm (55 lines/in)
Settling Time	≤300 ns	≤300 ns	≤300 ns	≤500 ns	≤300 ns
Linearity	3%	3%	3%	3%	3%
Viewing Area	≈ 9.6 x 11.9 cm (3.8 x 4.7 in)	≈ 7.1 x 9 cm (2.8 x 3.6 in)	≈ 7.9 x 9 cm (2.8 x 3.6 in)	≈ 8 x 10 cm (3.2 x 3.9 in)	≈ 9.6 x 11.9 cm (3.8 x 4.7 in)

Note: these are condensed specifications; refer to applicable data sheet for complete specifications, including options and accessories.

Features	Model Number — Large-screen Displays			
	HP 1304A	HP 1310B	HP 1311B	HP 1317B
Spot Size	0.02 in	≤0.51 mm (0.02 in) center screen ≤0.70 mm (0.0275 in) corner	≤0.43 mm (0.017 in) center screen ≤0.51 mm (0.02 in) corner	≤0.51 mm (0.02 in) center screen ≤0.76 mm (0.03 in) corner
Resolution	≤20 lines/cm (50 lines/in)	≤20 lines/cm (50 lines/in) center screen ≥14 lines/cm (36 lines/in) corner	≤24 lines/cm (61 lines/in) center screen ≥20 lines/cm (51 lines/in) corner	≤19.7 lines/cm (50 lines/in) center screen ≥13 lines/cm (33 lines/in) corner
Settling Time	≤300 ns	≤500 ns	≤500 ns	≤500 ns
Linearity	≤3%	≤1%	≤1%	≤1%
Viewing Area	≈ 20 x 25 cm (7.9 x 9.8 in)	≈ 28 x 38 cm (11 x 15 in)	≈ 21.6 x 27.9 cm (8.5 x 11 in)	25.4 x 34.5 cm (10 x 13.5 in)

Note: these are condensed specifications; refer to applicable data sheet for complete specifications, including options and accessories.



# GRAPHICS DISPLAYS

## High Resolution Imaging Displays

Models 1332A, 1335A, 1336S



- Designed for OEM scientific measurement and diagnostic systems
- Easy to view and easy to photograph

- Variable persistence storage for monitoring applications
- Many options for versatility

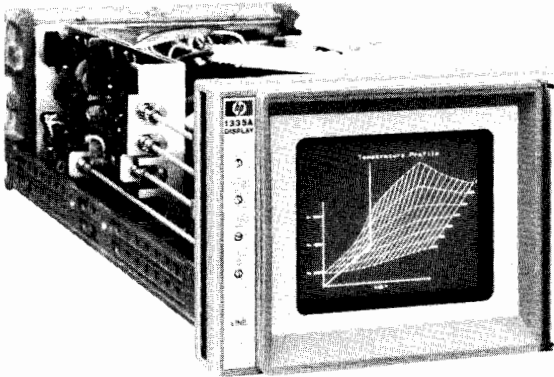

HP 1335A Storage Display

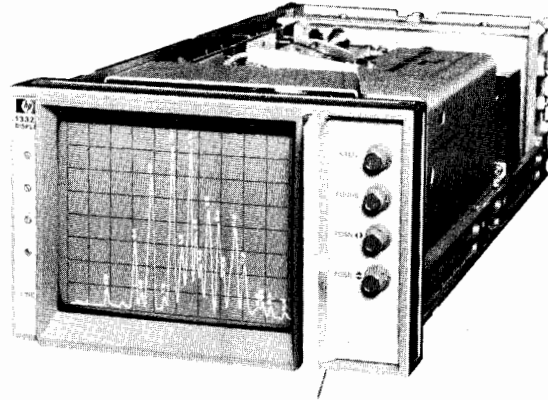

HP 1332A 7-inch (17.7 cm) XYZ Display

### Real-Time Graphics for High Resolution Imaging

The HP 1332A, HP 1335A, and HP 1336S graphics displays are designed to meet the high resolution and imaging requirements of OEM scientific measurement and diagnostic systems. Applications for these displays include spectrum, network, and chemical analyzers, nuclear medicine, medical ultrasound, and nondestructive test systems.

### Easy Viewing

The HP 1332A's high-resolution display is easy to view and is easy to photograph. It is bright enough for viewing in high ambient light while maintaining its resolution and gray shades when being photographed. The HP 1332A's CRT, which has a display area of 9.6 x 11.9 cm (3.7x4.6 in), has an accelerating potential of 22.5 kV, and it provides a bright, sharply-defined trace at all Z-axis drive levels and in all areas of the screen. Its spot screen of 0.035 mm (0.012 in) is maintained over the entire quality area. This is useful for displaying alphanumeric characters along the screen's extreme edges.

### Variable Persistence Storage

For variable persistence storage applications, the HP 1335A offers an exceptionally uniform display as needed in OEM medical and instrumentation systems. The HP 1335A's variable persistence mode can be used for monitoring slowly-changing phenomena because it increases persistence to match the refresh rate. In the storage mode, the HP 1335A's resolution is 20 lines per cm (50 lines/in) permitting it to retain sharp details. Furthermore, you can select any operating mode (store, write, conventional, variable persistence, or erase) either manually with front panel controls, remotely with program inputs, or with a combination of both.

### Basic Operation

The X- and Y-amplifiers of the HP 1332A and HP 1335A settle to within one spot diameter of final position in less than 300 ns, and they can slew linearly at deflection speeds of up to 25 cm/ $\mu$ s (10 in/ $\mu$ s). This speed permits them to draw thousands of points, vectors, and/or characters at high refresh rates without sacrificing brightness due to long wait times between successive points or vectors. A fast Z-axis rise time of 25 ns permits clearly-defined vector start and stop points to ensure that an image's resolution is not limited by video bandwidth. In addition, all amplifiers have a full differential, low-power design for stable, drift-free operation with minimum warmup.

### Options for a Custom Display

Many options are available for the HP 1332A and HP 1335A that allow you to tailor them for almost any OEM application. Options include a selection of input deflection factors, blanking ranges,

input polarity and impedance, differential inputs, and CRT phosphors. An optional TTL blanking input unconditionally overrides both the analog Z-axis input and the intensity control, and it can protect the CRT if the system fails. A gamma-correction option causes the light output to vary linearly (+/-20%) as the Z-axis input voltage changes. This reduces the complexity of the system circuitry when using Z-axis modulation to maintain constant brightness of vectors written at varying speeds.

### System Solution

The HP 1336S consists of display module (HP 1336A) and a separate power supply module (HP 1336P). Offering a choice of either 140 lines/cm or 90 lines/cm (through option 005) resolution, the HP 1336S can be used in multi-imaging applications such as in nuclear or ultrasound medical diagnostic systems.

### Designed-In Safety

Attention to safety requirements is involved in all aspects of HP graphics displays, from the initial design through manufacturing and quality control. In addition, regular inspections by UL and CSA inspectors ensure that end-user protection is built into every display. The HP 1332A, HP 1335A, and HP 1336S are listed with Underwriters Laboratories in accordance with the UL 544 Medical Safety Standard that defines detailed patient protection requirements.

### Cabinet Sizes

The HP 1332A and HP 1335A are 13.3 cm (5¼ in) high, half rack width, 49.5 cm (19½ in) long packages that can be combined with identical empty modules to form an attractive full-width horizontal or vertically-stacked OEM instrument. The HP 1336A Display Module has the same dimensions and the HP 1336P Power Supply Module has the same height and width but is 33.5 cm (13⅓ in) deep. If the HP 1336A/P are to be mounted together, HP 1336P Option 018 may be ordered to provide the same cabinet depth as the HP 1336A, with locking hardware to form a standard EIA rack-width unit.

### Ordering Information

HP 1332A Small Screen Display  
HP 1335A Small Screen, Variable Persistence Storage  
HP 1336A Display Module  
HP 1336P Power Supply Module  
HP 1336S Display System (includes HP 1336A, HP 1336P)  
HP 1336A or 1336S Opt 005  
HP 10183A Light Shield for HP 1332A, HP 1333A,  
HP 1335A, HP 1340A  
OEM and quantity discounts available.



- Fast settling time (HP 1304A:  $\leq 300$  ns)
- Designed for production test as well as monitoring and diagnostic systems

- Easy system integration
- Low power consumption (HP 1304A:  $\approx 60$  W nominal)

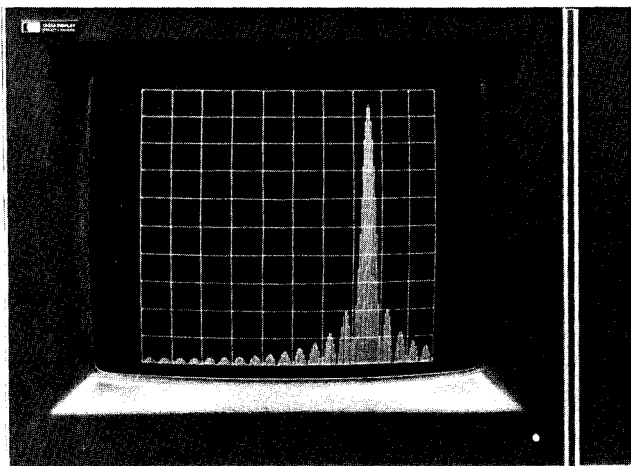

HP 1304A 14-inch (36 cm) XYZ Display

### High Performance Plus Easy System Integration

The HP 1304A (36 cm/14 in) large-screen display and the HP 1340A (15.3 cm/6 in) analog display module are designed for production test and measurement systems as well as for analytical instrumentation. They both provide high-quality graphics and are easy to integrate into instruments and systems.

#### HP 1304A Description

With its high writing speed and fast settling time ( $\leq 300$  ns), the HP 1304A is useful in monitoring applications requiring multiple traces to be displayed on-screen (e.g., a multiple-bed patient-monitoring system). The line brightness and resolution of the HP 1304A's CRT allow it to present up to 2000 characters or complex graphic data in normally-lighted industrial environments. Its neutral density contrast filter enhances the trace-to-background contrast for improved readability.

Its large viewing area (500 cm<sup>2</sup>/77.4 in<sup>2</sup>) make the HP 1304A useful for applications such as fast Fourier transform analyzers, automatic test systems, diagnostic ultrasonics, weather/harbor/fire control radar, patient monitoring, and chemical/physical analysis instruments.

#### HP 1340A Description

The HP 1340A is a rugged display module that is easy to integrate into an instrument or system console. HP offers a variety of cabinet configurations for the HP 1340A, simplifying system design. Also available is an option to make the HP 1340A a free-standing display for use with instruments that do not have a built-in display.

The HP 1340A's integrated circuits contain most of the X, Y, Z amplifier components, ensuring the HP 1340A's high reliability. The X and Y attenuators, input impedance, polarity, and bandwidth limiting are internally switch-selectable, providing design flexibility when the HP 1340A is used in a system or with more than one instrument.

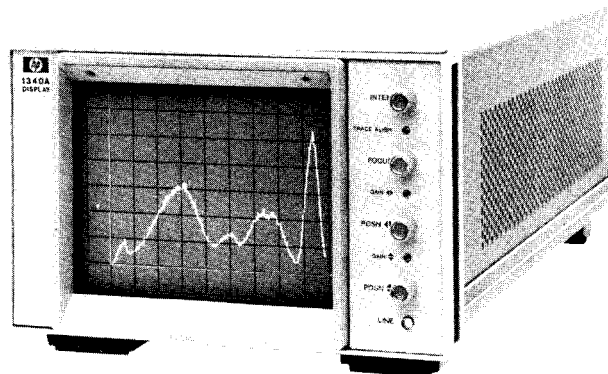

HP 1340A Display Module in HP cabinet (opt 315)

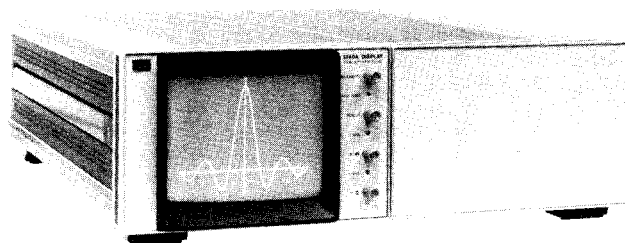

HP 1340A Display Module in HP cabinet (opt 317)

The HP 1340A has a separate control panel that can be located to suit the design. For simplicity in integrating the HP 1340A, its control functions are all dc inputs (0 to 5 V) to the IC amplifiers. The controls can be operated remotely from the HP 1340A, or you can order the HP 1340A without a control panel if you want to use your own controls.

The small space requirements of the HP 1340A and the light weight of dc-power option 002 make it ideal for airborne or system applications requiring minimum size and weight.

The HP 1340A's resolution, viewing area (114 cm<sup>2</sup>/17.7 in<sup>2</sup>), and brightness make it suitable for spectrum, network, and logic analyzers as well as for non-destructive test systems or instruments. It is also useful as a display for communication system analyzers, chemical and scientific analysis systems, and some medical diagnostic systems.

#### Ordering Information

**HP 1304A** Large Screen Display

**HP 1340A** Analog Display Module (with control panel)

**Opt. 315** System II half-rack Cabinet

**Opt. 317** Full rack with Cabinet

- HP-IB/HP-GL compatibility (HP 1347A)
- Random vector plotting
- Programmable intensity, speed, and line type

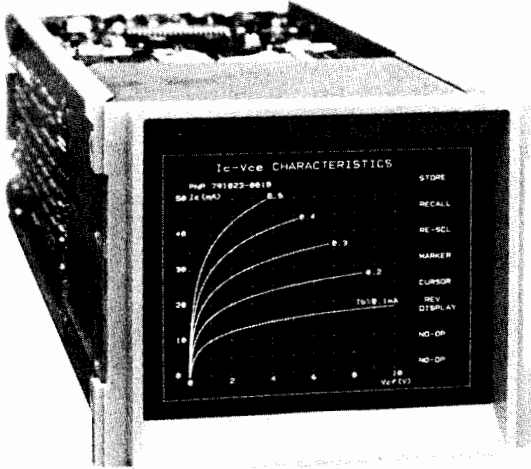

### Digital Displays—OEM and End-User Models

As the trend toward computer-controlled architecture and CRT graphics continues, digitally-interfaced displays will simplify the design and development of instruments and systems. HP's digitally-interfaced displays can be easily integrated into an instrument or system, and the HP electrostatic deflection CRT supplies fast writing-rates with high resolution and low power-consumption.

### HP 1345A Description

The HP 1345A is a high-performance, digital-display module that generates and displays information derived from digital information received through its 16-bit TTL I/O port. Its small package occupies a minimum of space, making it easy to design into an instrument or system. With a 2048 x 2048 addressable resolution, the HP 1345A provides high-resolution graphics and a crisp, well-focused electron beam.

In spectrum analyzers, the HP 1345A's high data acceptance and vector drawing rates allow complex traces to be generated as rapidly as new data are acquired. Multiple programmable intensity levels can be used to differentiate between complex overlapping traces.

When used in medical instrumentation, the HP 1345A's high resolution ensures that it faithfully preserves input signals for accurate diagnosis when monitoring physiological parameters. The speed of the HP 1345A allows it to update an entire picture, even one with several waveforms displayed, in real-time as new data are acquired.

The HP 1345A's light weight, low power requirement, and rugged construction make it ideal for use in portable or mobile equipment.

The HP 1345A module is a unitized structure, which is independently rugged without a cabinet. It can be easily integrated into almost any instrument or system console design. To simplify cabinet design, HP offers several OEM cabinets for the HP 1345A—these are attractively styled and accommodate circuitry for many applications.

### HP 1347A Description

The HP 1347A HP-IB Display combines full programmability with high-speed vector graphics in a self-contained unit. With its internal power supply, it is ideal for use as an instrumentation system's display. Housed in an HP cabinet, the HP 1347A is suitable for rackmounting or for bench use. The HP 1347A has an addressable resolution of 2048 x 1513, which is needed for detailed displays in waveform analysis, data acquisition, and process control and monitoring. Using random vector-plotting, the HP 1347A produces straight lines and smooth curves without the discontinuities produced by raster displays.

As with the HP 1346A, the HP 1347A has two HP-IB (IEEE-488) ports. One port allows a computer to input graphic commands and

- Bi-directional data-scrolling (HP 1347A)
- Plot and graph modes (HP 1346A, HP 1347A)
- Memory segmentation (HP 1346A, HP 1347A)

data to the display, and the other allows the HP 1347A to send graphical information off-line to an HP-IB/HP-GL plotter. This digital interface makes the HP 1347A easy to integrate as a peripheral in an instrumentation system.

### Data-scrolling Capabilities

A key feature of the HP 1347A is its capability to scroll data stored in memory horizontally and bi-directionally across the screen. With its scrolling capabilities, the HP 1347A can display up to 32 waveforms and can scroll graticules as well as text. Because the HP 1347A can store information in its memory and allow the user to scroll through that information, it is useful for monitoring and analyzing data. With its data-scrolling capabilities, the HP 1347A is faster to use than a paper strip-chart recorder, quickly giving you the data you need to analyze.

Data displayed on-screen when the HP 1347A is scrolling can be duplicated on an HP-IB/HP-GL plotter, giving you a "snapshot" of the scrolled data. The HP 1347A can resume scrolling after the plot is completed.

### Segmented Memory

With its 8k x 16 memory, the HP 1347A can store over 8000 characters or 4000 vectors. The HP 1347A's refresh memory is segmented, allowing it to store up to 64 separate pictures. These pictures can be displayed in rapid succession for animation/simulation applications. Segmentation also allows you to store reference data against which you can compare test data. When testing a particular instrument or component, you can also store sets of test instructions and pictures to be displayed.

### Graphing

The HP 1347A provides several functions that simplify generating graphs and grids. These include X and Y tick marks with user-defined lengths, reducing the time needed for generating axes. Another feature of the HP 1347A is its symbol mode, which causes a symbol (i.e., a character) to be drawn at the end of each vector. This allows characters to be inserted in the actual graphlines. These features facilitate drawing graphs that can be easily interpreted.

### Plotting

The HP 1347A gives you a full range of plotting capabilities, including plot relative, plot absolute, and scale. For example, a symbol defined with plot relative statements allows you to move the symbol by simply moving the start location because all other points in the symbol are relative to the starting point. Because the HP 1347A is HP-GL compatible, commands are defined with syntax similar to that of HP-GL plotters. This means that software instructions to the display are easily reformatted by the HP 1347A to drive HP-IB/HP-GL plotters from the off-line hardcopy port. This eliminates the need to write two separate programs for driving the HP 1347A and the plotter, reducing the programming and development time needed when adding CRT graphics to your system.

The HP 1347A is useful in data analysis, especially when you need to view the data in detail. The high addressable resolution of the HP 1347A allows data, such as voltages, to be shown in full range without obscuring minor variations. With the HP 1347A's data-scrolling capabilities, you can look through large amounts of data that have been previously stored. The data can be fed into the HP 1347A's memory (up to 32 traces) and scrolled through until the perturbation of interest is found. The data on-screen can then be copied to a plotter for a hard-copy record without plotting a lot of unnecessary information. In this way, the HP 1347A can be used as a softcopy strip-chart recorder, with hardcopy recording as needed.

### Ordering Information

HP 1345A Digital Display Module  
HP 1347A HP-IB Display



# GRAPHICS DISPLAYS

## Instrumentation Graphics Systems/Large-Screen Displays

### Models 1351S, 1351A, 1310B, 1311B, and 1317B



#### Computer Graphics Display System

The HP 1351S Graphics System provides a high-resolution, real-time method of generating bright line vectors and/or alphanumeric characters. This cost-effective system includes a high-quality, large-screen electrostatic CRT display (with programmable binary Z-axis control) and the HP 1351A Graphics Generator. The system gives bright graphics in minicomputer or desktop computer systems with a resolution of 1020 x 1020 addressable points on the CRT screen. In addition, it provides the fast information-throughput, rapid picture-manipulation, and complex vector-drawing capability needed in interactive computer graphics for computer-aided design/ computer-aided manufacturing (CAD/CAM) systems, and radar/simulation.

#### CAD/CAM Applications

**Modeling:** with the HP 1351S as part of a CAD system, a designer has a highly-interactive display system with which to create complex wire-frame models. Through a graphics tablet or keyboard, the designer can immediately see the results of inputs.

**Analysis:** a CAD/CAM system using the HP 1351S can also be used in stress analysis. Using the finite-element technique, the model is broken down into a network of simple elements that a computer uses to determine stress, deflections, and other structural characteristics.

**Kinematics:** CAD systems that include kinematic features for animating the motion of mechanisms are ideally suited to the fast-drawing and selective-erase capabilities of the HP 1351S.

**Drafting:** CAD systems with automated drafting are many times faster than manual drafting. Such a system requires a large, high-resolution CRT display for easy viewing.

#### Ordering Information\*

**HP 1351S** Display System (includes HP 1311B display)

**HP 1351A** Graphics Generator (supplied with HP 1351S)

\*An HP-IB cable is not supplied and must be ordered separately.

#### Options and Accessories

**001:** RS-232-C interface in lieu of standard HP-IB

**002:** 16-bit parallel interface in lieu of standard HP-IB

**510:** HP 1310B, 19 in X-Y display in lieu of HP 1311B

**517:** HP 1317B, 17 in X-Y display in lieu of HP 1311B

**604:** P-4 phosphor display, no graticule

**639:** P-39 phosphor display, no graticule

**908:** Rackmount hardware for HP 1351A and HP 1311B

#### Versatile Computer Graphics Displays

Hewlett-Packard's HP 1310B, HP 1311B, and HP 1317B large-screen displays offer the high writing-speed, fast settling-time, brightness, and contrast needed for the display of high-density graphics information. These displays are ideal computer peripherals with the high picture quality and dynamic performance required for complex computer-generated graphics. Any on-screen movement can be made in less than 500 ns, including settling time. This high-speed performance is particularly useful in radar and simulation, where many symbols must be moved about almost simultaneously. It is also useful in computer-aided design (CAD) applications, which require complex, high-density drawing capability.

These high-resolution displays remain exceptionally well-focused in all parts of the screen, which solves such difficult display problems as writing many characters around the picture edges while showing great detail in curves, graphs, or diagrams. Excellent image quality is further ensured with features such as a contrast-control circuit, which provides constant contrast with variations in intensity, and a flat, optical-quality glass contrast-filter, which eliminates trace diffusion and minimizes glare.

The HP 1310B, HP 1311B, and HP 1317B, are electrically almost identical, but offer a wide range of sizes and configurations to fit almost any high-speed, large-screen OEM display requirement. The HP 1317B is ideal for standard 48.3 cm (19 in) rack-mount applications requiring the largest possible screen area in the minimum vertical rack space. For table-top applications such as remote monitors, the HP 1310B and HP 1311B offer an attractively-styled enclosure with a tilt stand. Both displays may be ordered without the tilt stand (Opt 001) for mounting in standard 48.3 cm (19 in) racks or custom-designed enclosures.

#### Computer Interfacing

The increasing use of mini- and microcomputers for data bases and data reduction as well as design aids has resulted in a need for high-quality displays that easily interface with a computer. The HP 1351A Graphics Generator is an ideal interface between a computer and an HP 1310B, HP 1311B, or HP 1317B.

#### Ordering Information

For information on options and accessories, refer to the applicable large screen CRT data sheet.

**HP 1310B** 48 cm (19 in) Display

**HP 1311B** 36 cm (14 in) Display

**HP 1317B** 43 cm (17 in) Display

OEM discounts available

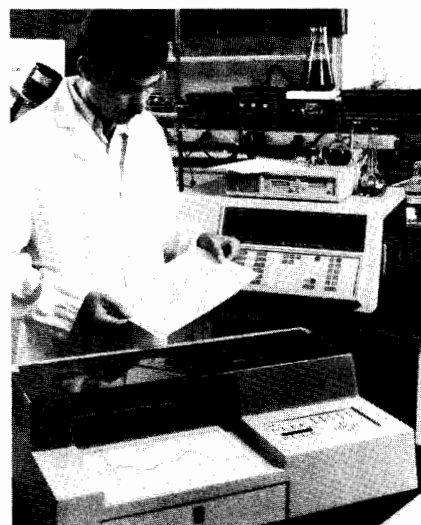
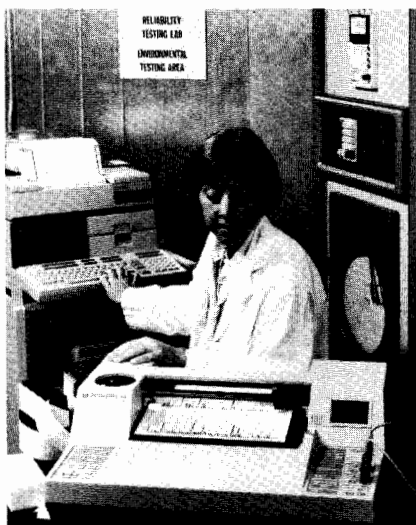

### Introduction

Whenever you measure and collect data with accuracy and precision, you need precise hardcopy records of your results. A hardcopy graphics device can improve your measurement system: plots provide permanent post-test results for analysis and documentation purposes and can be filed and retrieved as needed; output can be presented on overhead transparencies for effective communication during training sessions or meetings; and plots take less time than manual graphing and less money than speed camera film.

### Recording Analog Data

For measurements made from analog input signals, HP offers the 7090A Measurement Plotting System, a versatile measurement graphics instrument. The HP 7090A is a recorder that captures signals up to 3 kHz and plots annotated results on paper. An HP-IB interface allows both data transfer and control.

### Recording Digital Data

Hewlett-Packard has two solutions for obtaining hardcopy records from digital data input. Both the HP 7090A and HP's graphics plotters (HP 7470A, 7475A, and 7550A), with the appropriate hardware and software, can draw grids, annotate charts, and use many line types and colors to differentiate data.

Whether your application is manufacturing, engineering, education, or medicine, HP offers the products and performance features to meet your hardcopy graphics requirements. Check the table on pages 375 through 377 to help choose the best device for your HP instrument.

### Measurement Plotting System

The HP 7090A Measurement Plotting System is a new concept that provides a significant measurement advantage as well as unparalleled flexibility in hardcopy graphics. Functionally, the HP 7090A can replace traditional analog recorders in most applications, and, in addition, add significant and unique measurement and graphics capabilities. With its three input channels, dc to 3 kHz bandwidth, six-pen plotting system, and HP-IB interface, the HP 7090A goes beyond the capabilities of any single recorder or plotter.

The HP 7090A replaces traditional analog recorders; it offers superior dynamic performance and accuracy; 41,000 calibrated ranges; a 30 msec to 24-hour time base; 6 triggering modes with up to 100 percent pre-trigger capture; the ability to annotate with date, time, and setup conditions; and the ability to draw axes and grids which correspond to the recorded data.

### Graphics Plotters

Graphics plotters provide multi-color, professional quality hardcopy for digital data input. Selection is based on line quality, speed, output size, intelligence features, available software, interface, and budget considerations.

**Line quality and speed:** all HP plotters provide optimal line quality with a high mechanical resolution of 0.001 inches and a repeatability of 0.004 inches. These specifications assure smooth lines and characters. They perform at high speeds and allow speed adjustment for writing on different media.

**Output size:** your application will determine the output size required. Notebook size (8.5 x 11 in.) color plots are ideal for reports and overhead transparencies. Use them to summarize data, identify trends, compare results, and highlight exceptions. The larger 11 x 17 inch plots are especially useful for time lines, PERT charts, schematics, engineering drawings, and other applications where you need to show visual detail.

**Intelligence and software:** HP plotters feature built-in HP-GL (Hewlett-Packard Graphics Language) commands to control a large number of plotter functions. This plotter intelligence frees your system's CPU for other jobs and simplifies the user's programming task. Graphics software packages are available for use on all of HP's graphics plotters. See page 98 for more details.

### Graphic Plotters

Features	Media	Media Size	Model No.	Interface	Page
High-quality plotters for budget-sensitive applications. Two-pen (7470A) or six-pen (7475A) programmable. Paper-moving technology. Use fiber-tip pens.	Paper or transparency film	210 x 297 mm (8.5 x 11 in.)	7470A	RS-232-C/CCITT V.24	98
			Option 001		
			7470A	HP-IB (IEEE-488)	
			7470A	HP-IL*	
			Option 003		
		210 x 297 mm (8.5 x 11 in.) and 297 x 420 mm (11 x 17 in.)	7475A	RS-232-C/CCITT V.24	98
			Option 001		
			7475A	HP-IB (IEEE-488)	
			Option 002		
8-Pen plotter with automatic cut sheet paper feed unattended operation. Use fiber-tip and drafting pens.	Paper, transparency film, vellum, double-matte polyester film	210 x 297 mm (8.5 x 11 in.) and 297 x 420 mm (11 x 17 in.)	7550A	RS-232-C/CCITT V.24 and HP-IB (IEEE-488)	100

\*HP-IL is a serial interface for low cost portable systems.





# RECORDERS, PLOTTERS & PRINTERS

## Recorder/Plotter Selection Guide

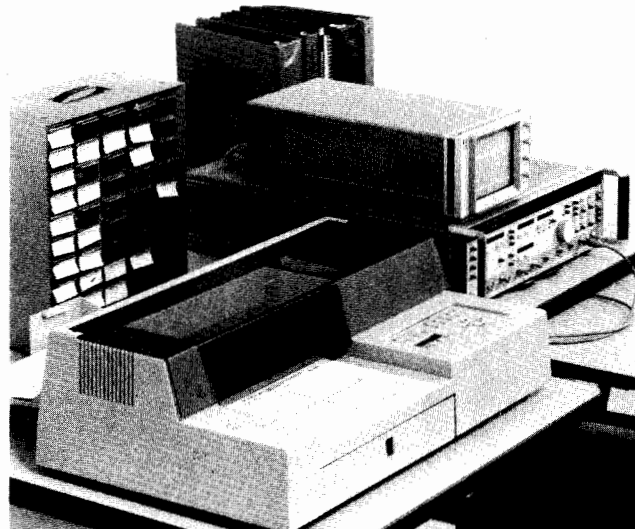

### Recommended Solutions

In the following pages, you will find a selection guide listing the graphics output devices suited to your instrument system - one of our three graphics plotters or the new HP 7090A Measurement Plotting System. The HP 7090A is not only a high-quality plotter, but also a recorder that captures signals up to 3 kHz.

HP instruments designed with micro-processors can control plotting from front-panel buttons or menu-driven softkeys. These instruments allow you to send graphics data directly from your instrument to a plotter. If your instrument has this capability, it will be listed with a "direct to plotter" output capability.

Other HP instruments require the appropriate controller and software in order to send graphics output to the plotter. These devices are

indicated by "indirect to plotter" output capability. If the system includes or requires a particular controller, that controller is indicated. Plotter software support is also indicated. Consult your local sales representative for controller information or software updates.

### Features

#### HP 7470A Graphics Plotter

- 2 pens
- 210 x 297 mm (8½ x 11 in.) media capability
- Paper and overhead transparency film, manual media loading
- Multi-color fiber-tip pens
- HP-IL, HP-IB, or RS-232-C/CCITT V.24 interface
- 38.1 cm/s (15 in./s) maximum pen speed
- 255 byte I/O buffer size

#### HP 7475A Graphics Plotter

- 6 pens
- 210 x 297 mm (8½ x 11 in.) and 297 x 420 mm (11 x 17 in.) media capability
- Paper and overhead transparency film, manual media loading
- Multi-color fiber-tip pens
- HP-IB or RS-232-C/CCITT V.24 interface
- 38.1 cm/s (15 in./s) maximum pen speed
- 1024 byte I/O buffer size

#### HP 7550A Graphics Plotter

- 8 pens
- 210 x 297 mm (8½ x 11 in.) and 297 x 420 mm (11 x 17 in.) media capability
- Paper and overhead transparency film, automatic media loading
- Vellum and polyester film, manual media loading
- Multi-color fiber-tip, roller-ball, and liquid-ink drafting
- HP-IB and RS-232-C/CCITT V.24 interface
- 80 cm/s (31.5 in./s) maximum pen speed
- 1024 byte default I/O buffer size
- 12,800 byte available I/O buffer size

#### HP 7090A Measurement Plotting System (in plotter mode)

- 6 pens
- 210 x 297 mm (8½ x 11 in.) and 297 x 420 mm (11 x 17 in.) media capability
- Paper and overhead transparency film
- Multi-color fiber-tip pens
- HP-IB interface
- 38.1 cm/s (15 in./s) maximum pen speed
- 1000 word I/O buffer size





### X-Y Recorder and Graphics Plotter Selection Guide for HP Instruments

HP Instrument	Output Capability*	Plotter Software Support	X-Y Recorder Outputs		Recommended HP Model
			Voltage	Penlift	
141T Spectrum Analyzer System	Direct to recorder		X -5 to 5 V Y 0 to -.8 V	YES (14 V pen up, 0 V pen down)	7090A
415E SWR Meter	Direct to recorder		Y 0 to 1 V	NO	7090A
432A/B/C 436A/438A Power Meters	Direct to recorder		Y 0 to 1 V	NO	7090A
853A Spectrum Analyzer Display	Direct to recorder	Front-panel controls select graticule and/or trace (no annotation)	X -5 to 5 V Y 0 to .8 V	YES (15 V pen up, 0 V pen down)	7090A 7470A 7475A 7550A
	Direct to plotter				
1040A High Speed Spectrophotometric Detector	Indirect to plotter System includes HP 85	HP software included for spectra and chromatographic analysis			7470A 7475A 7550A
1090A Liquid Chromatograph	Indirect to plotter System includes HP 85B	HP software included			7470A 7475A
1347A HP-IB Display	Dedicated plotterport	Program controller Front-panel control duplicates screen image onto plotter			7470A 7475A 7550A
	Direct to plotter				
1980B/S Oscilloscope Measurement Systems (with 19860A Digital Waveform Storage and 19811A Plot/Sequence ROM)	Direct to plotter or Indirect to plotter	Menu-driven softkeys provide graticule, trace, and/or annotation; HP 19800A Waveform Measurement Library software also available			7470A 7475A 7550A
2250S Data Acquisition/ Control System	Indirect to plotter	HP PMC/1000 software available			7470A
3046A/B/S Selective Level Measuring Systems	Indirect to plotter	Customer software required			7470A 7475A
3047A/S Spectrum Analyzer Systems	Indirect to plotter	HP software included with 3047S			7475A
3054A/C/DL/S Data Acquisition Systems	Indirect to plotter	Plotter software 3054 AIS; customer software required for 3054C/DC			7470A
3056DL/S Data Acquisition Systems	Indirect to plotter	Customer software required			7470A 7475A
3314A Function Generator	Direct to recorder		X -5 to 5 V	YES	7090A
3325A Synthesizer/Function Generator	Direct to recorder		X 0 to 10 V	YES TTL	7090A
3326A Two Channel Synthesizer	Direct to recorder		X 0 to 10 V	YES-TTL	7090A
3335A Synthesizer/Level Generator	Direct to recorder		X 0 to 10 V	NO	7090A
3336A/B/C Synthesizer/Level Generator	Direct to recorder		X 0 to 10 V	YES TTL	7090A
3350A/3357A/B Lab Automation System	Indirect to plotter System includes HP 1000	HP 19135C CPLOT/3350 software available			7470A 7475A 7550A
3421A Data Acquisition/ Control Unit	Indirect to plotter	Customer software required			7470A 7475A
3497A/S Data Acquisition/ Control Units/System	Indirect to plotter	Customer software required			7570A 7475A
3561A Dynamic System Analyzer	Direct to Plotter	Front-panel control duplicates screen image to plotter. Software similar to 3577, also adds annotation			7470A 7475A 7550A
	Indirect to Plotter				
3562A Dynamic Signal Analyzer	Direct to Plotter	Front-panel control duplicates screen image to plotter. Software similar to 3577, also adds annotation			7470A 7475A 7550A
	Indirect to Plotter				
3575A Gain/Phase Meter	Direct to recorder		Y1 10 mV/degree Y2 10 mV/dB	NO	7090A
3577A Network Analyzer	Direct to Plotter	Front-panel control duplicates screen image to plotter. Menu-driven software provides selectable graticule, trace, annotation, pen number, line type.			7470A 7475A 7550A
	Indirect to Plotter				
3580A Spectrum Analyzer	Direct to recorder		X 0 to 5 V Y 0 to 5 V	YES contact closure to ground during sweep	7090A
3581A Wave Analyzer 3581C Selective Voltmeter	Direct to recorder		X 0 to 5 V Y 0 to 5 V	YES contact closure to ground during sweep	7090A
3582A/S Spectrum Analyzer	Direct to recorder	Customer software required	X 0 to 5.25 V Y 0 to 5.25 V	YES contact closure during sweep	7090A 7470A 7475A
	Indirect to plotter				
3585A Spectrum Analyzer	Direct to recorder	HP software available	X 0 to 10 V Y 0 to 10 V	YES TTL	7090A 7070A 7475A
	Indirect to plotter				

\*\*"Indirect to plotter" requires an appropriate controller and software. "Direct to plotter" requires an address of (05) (L0).



HP Instrument	Output Capability "Indirect to plotter" requires an appropriate controller and software.	Plotter Software Support	X-Y Recorder Outputs		Recom- mended HP Models
			Voltage	Penlift	
3586A/B/C Selective Level Meter	Indirect to plotter	Customer software required			7470A 7475A
3708S Noise and Interference Test System	Indirect to Plotter	HP software available			7470A
3712A MLA Receiver	Direct to recorder		X -5 to 5 V Y -5 to 5 V	YES	7090A
3770B Telephone Analyzer	Direct to recorder (Special graph paper available)		X 0 to 5 V Y -5 to 5 V	NO	7090A
3776A/B PCM Terminal Test Set	Direct to Recorder or Direct to Plotter		Y 0 to 1 mA into 10Kohm max		7090A 7470A 7475A 7550A
3780A Error Measuring Set	Direct to Recorder				7090A
4061A/S Semiconductor Test System	Indirect to plotter	HP software included with 4061S			7470A 7475A
4062A/S Semiconductor Parametric Test System	Indirect to plotter	Customer software required			7470A 7475A
4140B pA Meter/DC Voltage Source	Direct to recorder  Indirect to plotter	  Customer software required	  X -10 to 10 V Y -5 to 5 V	  YES	  7090A 7090A
4145A Semiconductor Parameter Analyzer	Direct to plotter	Front-panel controls select trace and/or graticule, fixed characters			7470A 7475A 7550A
4191A RF Impedance Analyzer (with Option 004)	Direct to recorder		X 0 to 1 V Y1 0 to 1 V Y2 0 to 1 V	NO	7090A
(Option 004 not required)	Indirect to plotter	Customer software required			7470A 7475A
4192A LF Impedance Meter	Direct to recorder		X -1 to 1 V Y -1 to 1 V	YES TTL (low level at pen down)	7090A 7470A 7475A
	Indirect to plotter	Customer software required			
4193A Vector Impedance Meter	Direct to recorder		X 0 to 1 V Y1 0 to 1 V Y2 -1 to 1 V	YES	7090A 7470A
	Indirect to plotter	Customer software required			7475A
4280A 1 MHz C Meter/C-V Plotter	Direct to recorder		X -10 to 10 V Y -10 to 10 V	YES	7090A 7470A 7475A
	Indirect to plotter	HP software available			
5180A Waveform Recorder	Direct to recorder	Front panel controls provide fixed graticule, trace, annotation; 51800A Waveform Measurement Library	X -1 to 0 V Y -1 to 0 V	YES (0 V and 5 V)	7090A 7470A 7475B
5182A Waveform Recorder Generator	Indirect to plotter				7550A
5390A Frequency Stability Analyzer	Indirect to plotter	HP software provides graticule, trace, and characters			7470A 7475A
5420B Digital Signal Analyzer	Direct to plotter	Front-panel controls select graticule, trace, and/or characters			7470A 7475A 7550A
5423A Structural Dynamics Analyzer	Direct to plotter	Front-panel controls select graticule, trace, and/or characters			7470A 7475A 7550A
5427A Digital Vibration Test Control System	Direct to plotter	Front-panel controls select fixed-format graticule, trace, and/or characters			7470A 7475A 7550A
5451C Digital Fourier Analysis System	Direct to plotter	Front-panel controls select graticule, trace, and/or characters			7470A 7475A 7550A
55286S/88S Dimensional Metrology Analysis Systems	Indirect to plotter	Menu-driven software provides fixed-format plots with graticule and characters, selectable trace, title block, and vertical scale			7470A 7475A 7550A
5986A/87A/88A GCMS Systems	Indirect to Plotter System includes HP 1000	HP59785A software available			7470A 7475A 7550A
6901S Measurement and Analysis System	Direct to plotter	Menu-driven software provides fixed-format plots with graticule and characters, selectable trace			7470A 7475A 7550A
6940B/42A Multiprogrammers	Indirect to plotter	Customer software required			7470A 7475A 7550A
6942S Computer Aided Test System	Indirect to plotter	Customer software required			7470A 7475A 7550A
6944A/S Multiprong Grammer	Indirect to Plotter	Customer software required			7470A 7475A
8116A Pulse/Function Generator (with Option 001)	Direct to recorder		X 0 to 10 V (1.5 V/decade)	YES TTL	7090A
8165A Programmable Signal Source (with Option 002)	Direct to recorder		X 0 to 2.99 V (1 V/decade)	NO	7090A
8340A Synthesized Sweeper	Direct to recorder		X 0 to 10 V	YES	7090A
8350B Sweep Oscillator	Direct to recorder		X 0 to 10 V	YES	7090A



HP Instrument	Output Capability "Indirect to plotter" requires an appropriate controller and software.	Plotter Software Support	X-Y Recorder Outputs		Recommended HP Models
			Voltage	Penlift	
8405A Vector Voltmeter	Direct to recorder		Y1 0 to 1 V Y2 -5 to 5 V	NO	7090A
8410B Network Analyzer System — The following plug-ins are part of the 8410B system:					
8412A Phase-Magnitude Display	Direct to recorder		Y1 50 mV/dB Y2 10 mV/degree	NO	7090A
8414A Polar Display	Direct to recorder		X -2.5 to 2.5 V Y -2.5 to 2.5 V	NO	7090A
8408B/S Automatic Network Analyzer	Indirect to plotter	HP software duplicates screen image onto plotter			7470A 7475A 7550A
8450/51A Diode Array Spectrophotometers	Direct to plotter	Selectable graticule, trace, and characters			7470A 7475A 7550A
8505A Network Analyzer	Direct to recorder Indirect to plotter	HP software provides graticule, trace, and characters	X 0 to 7.5 V Y -1.25 to 1.25V	YES 200 mA current sink	7090A 7475A 7475A 7550A
8507D/S Automatic RF Network Analyzer System	Indirect to plotter	HP software provides graticule, trace, and characters			7470A 7475A 7550A
8510A Network Analyzer	Direct to Plotter	Front-panel controls select graticule, trace characters, pen and quadrant			7470A 7475A 7550A
8557A/58B/59A Spectrum Analyzers	Direct to recorder		X -5 to 5 V Y 0 to .8 V (with 853A and 180 mainframes)	YES (15 V pen up, 0 V pen down)	7090A 7470A 7475A 7550A
With 853A Display	Direct to plotter				
8565A Spectrum Analyzer	Direct to recorder		X -5 to 5 V Y 0 to .8 V	YES (15 V pen up, 0 V pen down)	7090A
8566B/S/68B/S Spectrum Analyzers	Direct to recorder Indirect to plotter	HP 85862/63 software packages available	X 0 to 10 V Y 0 to 10 V	YES (15 V pen up, 0 V pen down)	7090A 7475A
8569B Spectrum Analyzer	Direct to recorder Direct to plotter	Front-panel controls select graticule, trace, and/or characters	X -5 to 5 V Y 0 to .8 V	YES (15 V pen up, 0 V pen down)	7090A 7470A 7475A 7550A
8620C Sweep Oscillator	Direct to recorder		X 0 to 10 V	YES (5 V pen up)	7090A
8642A/B Sweep Oscillator	Direct to Recorder		X 0 to 10 V	YES-TTL	7090A
8660C Synthesized Signal Generator	Direct to recorder		X 0 to 8 V	YES (with Option H24)	7090A
8662A/63A/73B/C/D Synthesized Signal Generators	Direct to recorder		X 0 to 10 V	YES TTL	7090A
8683A/B/D/84A/B/D Signal Generators	Direct to recorder		X 0 to 10 V	NO	7090A
8750A Storage-Normalizer	Direct to recorder		X 0 to 1 V Y -4 to 4 V	YES (open collector driver, 20 V max)	7090A
8754A Network Analyzer	Direct to recorder		X 0 to 1 V Y -4 to .4 V	YES (5 V pen up, 0 V pen down)	7090A
8755S Scalar Network Analyzer System	Direct to recorder		Y -4 to 4 V	YES (open collector driver, 20 V max)	7090A
8757A Scalar Network Analyzer	Direct to Recorder or Direct to Plotter	Selectable graticule, trace, and labels	X 0 to 10 V Y 0 to 10 V		7090A 7470A 7475A 7550A
8756A/S Automatic Scalar Network Analyzer	Direct to plotter	8756A provides menu-driven softkeys, 8756S has menu-driven software to select graticule, trace, and/or characters (rev. 1 does not include 7550A in ID table)			7470A 7475A 7550A
8900C/D Peak Power Meter	Direct to recorder		Y 0 to 1 V	NO	7090A
8903A Audio Analyzer	Direct to recorder Indirect to plotter	Customer software required*	X 0 to 10 V Y 0 to 10 V	YES	7090A 7470A 7475A
8953A/S Transceiver Test System	Indirect to plotter	Customer software required*			7470A 7475A
8955A/S RF Test System	Indirect to plotter	Customer software required*			7470A
8970A Noise Figure Meter	Direct to recorder Indirect to plotter	Customer software required*	X 0 to 6 V Y 0 to 6 V	YES TTL	7090A 7470A 7475A

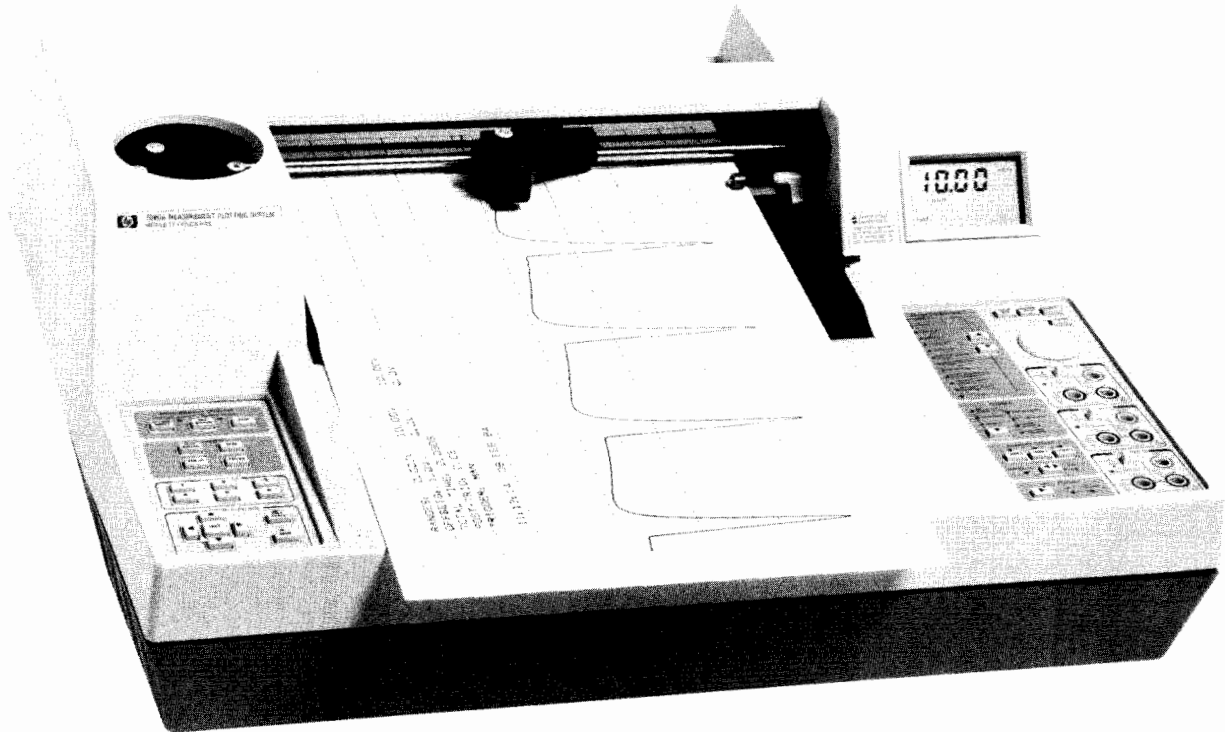

- Floating and guarded inputs
- DC to 3 kHz bandwidth, 33.3 kHz sampling rate
- 3 channels with simultaneous sampling
- 12-bit resolution, 1 k buffer/channel
- 6 trigger modes with up to 100% pre-trigger capture
- Full programmability and data transfer over HP-IB

**HP 7090A**

The HP 7090A is designed for low-frequency (< 3 kHz) measurement, analysis, and documentation. The 7090A merges several technologies - waveform recording, digital plotting, analog recording, and automated measurement - to provide a powerful solution to a broad range of measurement applications. It significantly increases the ability to measure and display low-frequency phenomena and substantially improves real-time recording and digital plotting ... all in one low-cost system.

### Signal Capture

Simultaneous sampling on each of three channels, 12-bit resolution, bandwidth of dc to 3 kHz (33.3 k samples/s maximum), and 1000 word memory per channel allow high resolution measurement, storage, and display.

### Flexible Triggering

The HP 7090A has six trigger modes which allow virtually any signal change to initiate signal capture, even decaying repetitive signals such as faults in a power line voltage, or in a transducer's carrier. Combined with pre-trigger capability, these trigger modes make the HP 7090A Measurement Plotting System ideal for turn-on/off characterization, fault monitoring and mechanical motion analysis.

### A System Component

All panel functions are programmable via the HP-IB interface. Data can be transferred from the internal 1 k-buffers or streamed in real time from the analog-to-digital converters at up to 500 points/s. In addition, the menu-driven HP 17090A Measurement Graphics Software package is available for HP 9000 Series 200

computers. The software allows easy data manipulation, storage and retrieval, and system integration.

### Versatile Capabilities

As the name implies, the HP 7090A Measurement Plotting System is also a high performance digital plotter. It is ideal for a graphics dump from a smart instrument (e.g. from an HP 8569B Spectrum Analyzer) or as part of an HP-IB system; you can also use the HP 7090A to take an X-Y dump from an analog instrument (e.g. from an HP 141T Spectrum Analyzer System). With the HP 7090A, hand annotation is unnecessary. The 7090A annotates setup conditions, date and time, selected data points from memory, and trigger information. It draws user-defined axes and grids, eliminating the need for pre-printed graph paper. The HP 7090A even lets you plot overhead transparencies for technical presentations.

### Applications

**Analog Recording:** Electrical, chemical, mechanical and medical fields all benefit from recording real-time X-Y and Y-T relationships. As an analog recorder, the HP 7090A has sensitivity to 5 mV full scale and 41,000 calibrated ranges for easy and quick calibration to measurement units. The HP 7090A's superior dynamic performance and high sensitivity provide users the versatility and accuracy required in laboratory environments.

**Capturing Low Frequency Electrical Transients:** General diagnostic monitoring (such as looking for relative timing sequences) and fault monitoring (capturing pre-trigger data for intermittent

failure analysis) are natural applications for the HP 7090A. Measuring Phase Relationships: The simultaneous sampling on all channels is ideal for measuring current/voltage phase relationships in power systems.

**Analog Instrument/Digital System Link:** The HP 7090A can integrate an analog instrument into an HP-IB system; the HP 7090A, with a controller can digitize output voltages from analog instruments for HP-IB system data entry.

**Mechanical and Electromechanical Testing:** Applications in which transducers convert velocity, acceleration, force, temperature or torque to voltage are a good fit for the HP 7090A. These applications have a maximum output frequency below 3 kHz. The HP 7090A's flexible trigger capabilities make it useful for one-shot electromechanical events such as clutch and mechanism engagements.

**Electromechanical Control Systems:** The HP 7090A can measure the response of a system to a stimulus; a typical use would be exciting the system with a step function and using the measured response to determine damping ratio and the natural frequency of the control system.

**Material Testing:** The HP 7090A can record classic stress-strain curves, particularly those obtained from destructive testing. The data is stored in a buffer, so even though the sample has been destroyed, the data can be viewed and rescaled in several different ways.

**Automatic Test:** When linked to an HP 9000 Series 200 computer, the HP 7090A is a good, inexpensive learning tool for small companies considering automatic test systems. Applications include environmental and production line testing and proof of performance records.

### Measurement Graphics Software

Combining an HP 7090A, an HP 9000 Series 200 computer and the HP 17090A Measurement Graphics Software produces a powerful menu-driven system for measurement, data manipulation, and data storage and retrieval. The menu-driven software, written in BASIC 2.0 for Series 200 computers, takes advantage of the HP 7090A's capabilities as a system component. No programming is necessary; once the HP 7090A is loaded with paper and pens and connected to the controller using an HP-IB cable, just load the software. All HP 7090A functions can be controlled by the computer.

**Program Capabilities:** There are six main functional areas of Measurement Graphics Software:

- Measurement Setup
- Measurement
- Display
- Annotation
- Data Manipulation
- Storage and Retrieval

The HP 17090A software helps you use the HP 7090A's features easily and effectively plus, it provides storage, annotation and data transformation options not available on the HP 7090A unit alone.

**Friendly, Menu-driven Interface:** Each menu allows the user to view several parameters simultaneously. Series 200 softkeys and cursor-control knob minimize keyboard input. The "help" softkey displays the available choices and ranges for each parameter setting.

**System Requirements:** Measurement Graphics Software is written in BASIC 2.0 and requires a minimum of 235 K of RAM after the operating system is loaded; however, 470 K is recommended for optimum program speed. The software is designed for use with an HP 9000 Series 200 computer and an HP 7090A Measurement Plotting System. The software is supplied on two 3.5 in. microfloppy or 5.25 in. minifloppy discs and is accompanied by a user's manual.

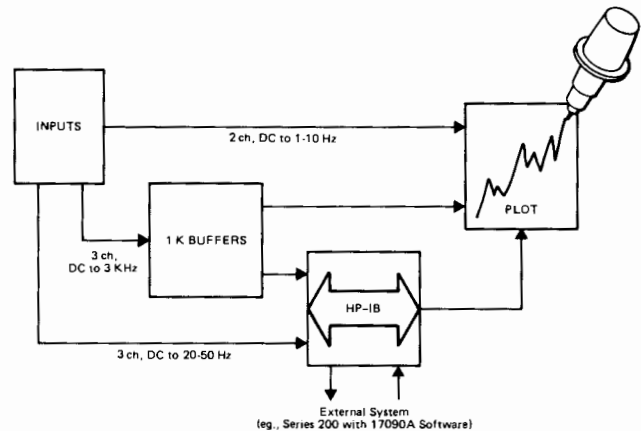

Possible data flow paths for the HP 7090A Measurement Plotting System.

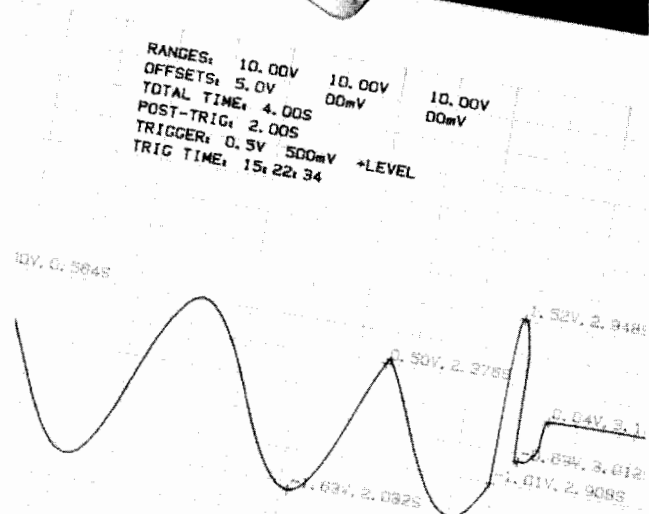
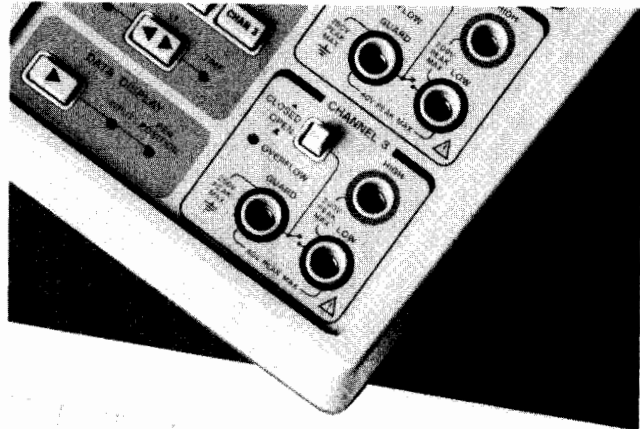



# RECORDERS, PLOTTERS & PRINTERS

## Measurement Plotting System

### Model 7090A (cont)

#### Specifications

##### Inputs:

Number of channels	3
Type of input	floating, guarded
Sensitivity	5 mV to 100 V full scale
Sensitivity ranges	41,000
Zero offset	±2 full scale or ±100 V maximum
Zero offset ranges	approximately 5% or range steps
Input impedance	1 Mohm, shunted by 45 pf (Nominal)
Maximum input voltage	200 V, dc or peak
Maximum source resistance	10 kohm
Common mode rejection ratio	140 dB dc; 100 dB ac @ 60 Hz with 1 kohm unbalance in LOW terminal and most sensitive range (at 25 C)

##### Electrical accuracy (@ 25 C, ±1 scale offset maximum):

Constant inaccuracy	
1 V to 100 V range	±0.15% of range
5 mV to 500 mV range	increases from ±0.15% of range @ 500 mV to ±0.26% of range @ 5 mV
Reading inaccuracy	±0.055% of reading
Temperature coefficient	
Constant inaccuracy	
1 V to 100 V range	±0.012% of range/degree C
5 mV to 500 V range	increases from ±0.012% or range/degree C @ 500 mV to ±0.044% of range/degree C @ 5 mV
Reading inaccuracy	±0.01% of reading/degree C

##### Timebase

Buffer mode	
Range	30 milliseconds to 24 hours
Number of ranges	4,700
Direct mode	
Range	1 second to 24 hours
Number of ranges	3,700
Accuracy	±0.1%

##### Dynamic Performance

Slewing Speed (Nominal)	
Direct mode	127 cm/s (50 in./s)
Plotting mode	75 cm/s (30 in./s)
Acceleration (Nominal)	2 g constant
Bandwidth (≥3dB)	3 kHz for all full scale ranges ≥ 20 mV 2.6 kHz for all full-scale ranges <20 mV 250 us at fastest timebase range

##### Peak capture

##### Memory per Channel

Size	1000 words
Resolution	12-bits

##### Trigger Characteristics

Internal Trigger	Inside or outside window to capture decaying repetitive signals, inside resets with each reverse transition; Above or below level, selectable over the full-scale range in 1.0% of range increments (NOMINAL); Source, channel 1
External Trigger	BNC connector, TTL level or contact closure to ground
Manual Trigger	Available from front-panel controls
Display	Up to 100% pre-trigger capture, up to 24 hour post-trigger delay before measurement start

#### Supplemental Characteristics

Writing System	6-pen carousel with automatic pen capping Fiber-tip pens for paper or transparencies
Digital Plotting	Intelligence: over 40 HP-GL instructions; five built in character sets including ANSI ASCII, HP 9825, French/German, Scandinavian,

##### Media

##### Programming

##### Scope Output

##### Digital Voltmeter (DVM) Mode

##### Pen Position Data Display

##### External Pen Lift Control

##### Analog-to-digital

##### Real-time Clock

##### Environmental Power Requirement

##### Size

##### Weight

##### Spanish/Latin America

Front-panel controls: P1, P2; pen position cursors; pen selection  
Interface modes (user selectable): listen only; listen/talk  
Types: paper, overhead transparency film  
Sizes (switch-selectable): A4/A (210 x 297 mm, 8.5 x 11 in.); A3/B (297 x 420 mm, 11 x 17 in.)  
HP-IB control of all recorder and plotter functions  
Software lockable front panel  
Allows use of X-Y oscilloscope to preview buffer contents  
Connectors: 2 BNC, vertical and horizontal  
Output: -10 V to 10 V (0 V corresponds to origin on chart); refreshed every 15 ms  
Resolution: 10-bit  
Allows panel display of dc voltage levels on selected channel input  
Sampling rate: 1/sec (NOMINAL)  
Allows cursor to move pen along plotted buffer data on selected channel, value shown on display, and coordinate pair can be printed at selected points.  
BNC connector, TTL level or contact closure to ground  
Max. sampling rate: 33.3 k samples/s  
Max. streaming rate over HP-IB:

	ASCII	Binary
1 channel	167/s	500/s
1 channel plus trigger	143/s	333/s
3 channels	59/s	167/s
3 channels plus trigger	59/s	167/s

Functions: second, minute, hour, day, year  
Controls: front-panel set, battery (lithium) backup  
Accuracy: ±4 sec/day @ 25 C  
Operating temperature: 0-55 C  
Source: 100, 120, 220, 240 V ac -10%, +5%  
Frequency: 48-66 Hz  
Consumption: 140 W  
Height: 205.5 mm (8.1 in.)  
Weight: 575.0 (22.6 in.)  
Depth: 465.0 (18.3 in.)  
Net: 15.7 kg (34.5 lbs)  
Shipping: 23.6 kg (18.3 lbs)

#### Accessories Supplied

	Part Number
Interfacing and Programming Manual	07090-90001
Operator's Manual	07090-90002
Pocket Guide	07090-90004

An assortment of pens and media are also shipped with each HP 7090A unit sold. Paper size and power cord are determined by destination.

#### Ordering Information

10833A or 45529A HP-IB (IEEE-488) 1-meter cable  
10833B or 45529B HP-IB (IEEE-488) 2-meter cable  
7090A Measurement Plotting System  
  Option 910 (duplicate set of manuals)  
17090A Measurement Graphics Software  
  Option 630 (3.5 in. disc size)  
  Option 655 (5.25 in. disc size)



# RECORDERS, PLOTTERS & PRINTERS

Low-Cost, Flexible X-Y Recorder

Model 7015B

381



- Low cost of ownership
- Choice of optional features

- Low price
- Full capability

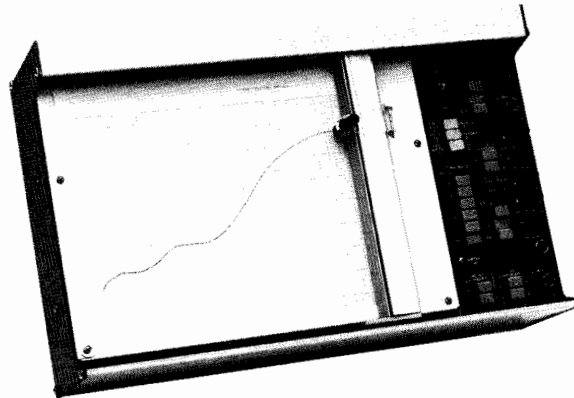

HP 7015B

## Model 7015B X-Y Recorders

The HP 7015B is a low-cost, one-pen X-Y recorder that allows charting on paper sizes up to ISO A4 or 216 x 280 mm (8.5 x 11 in.). All paper sizes up to the maximum are held securely by the trouble-free electrostatic paper hold-down. The unit is mounted in a sturdy case made from a single casting, assuring mechanical alignment and long life, even in rugged environments. The 7015B provides recording for a wide range of laboratory uses where there is a need for full capability at reasonable cost.

The 7015B has a full complement of capabilities. The standard features include an internal time base with sweep selections from 5 seconds to 20 minutes. The time base provides automatic pen control and accepts remote triggering from sweep start and reset. Also included are matched input filters, remote pen lift, and TTL-level remote control. The HP 7015B accepts TTL-level and low current (5 mA) contact closure for easy interface with external equipment.

## HP 7015B Performance Specifications

### Input Voltage

Metric: 5 mV/cm, 50 mV/cm, 500 mV/cm.

English: 0.01 V/in., 0.1 V/in., 1 V/in.; vernier adjustable overlapping all ranges

### Time Base

Metric: 0.1, 0.5, 1, 5, 10, 50 s/cm.

English: 0.5, 1, 5, 10, 50, 100 s/in.; remote sweep start and reset via TTL level or contact closure

### Input Types

Floating binding posts or circuit board rear connector

**Input resistance:** 1 M $\Omega$  constant

**Normal mode rejection:** greater than 50 dB at 50 and 60 Hz (40 dB/decade roll-off above 60 Hz)

**Common mode rejection:** 100 dB dc, 90 dB ac (decreases 20 dB/decade step in attenuation); measured with 1 k unbalance in HI terminal on most sensitive range

**Common mode voltage:** 40 V dc and peak ac maximum (conforms to IEC 348)

**Accuracy:**  $\pm 0.3\%$  of full scale at 25°C (includes linearity and resetability). Add  $\pm 0.2\%$  of deflection when not on most sensitive range; temperature coefficient:  $\pm 0.2\%/^{\circ}\text{C}$ ; time base:  $1.5\% \pm 0.1\%/^{\circ}\text{C}$

**Resetability:** less than 0.2% of full scale

**Overshoot:** less than 2% of full scale

**Slewing speed:** greater than 50 cm/s (20 in./s)

**Zero set:** Zero may be placed anywhere on writing area or electrically off-scale up to one full scale from zero index; adjustment by 10-turn high resolution control

**Environment:** operating temperature 0°C to 55°C; 95% RH (40°C)

## General Specifications

**Writing system:** fiber-tipped disposable pen

**Writing area:** 18 x 25 cm (7 x 10 in.)

**Platen size:** holds up to ISO A4 (21 x 30 cm) and 8.5 x 11 in.

**Size:** 267 H x 432 W x 135 mm D (10.5" x 17" x 5")

**Pen Lift:** electric (remote via TTL level or contact closure)

**Power:** switch selectable for 100, 120, 220, 240 V ac +5 -10%; 47.5 to 440 Hz; 70 VA maximum

**Weight:** net, 7.2 kg (16 lb); shipping, 10 kg (22 lb)

## Options

**001** Metric calibration

**908** Rack mount

## Ordering Information

**HP 7015B** Lab X-Y Recorder



# RECORDERS, PLOTTERS & PRINTERS

## General Use X-Y Recorder, Plus Time Base

Models 7035B, 17108A

- Precision recording
- Time base available
- Floating guarded inputs

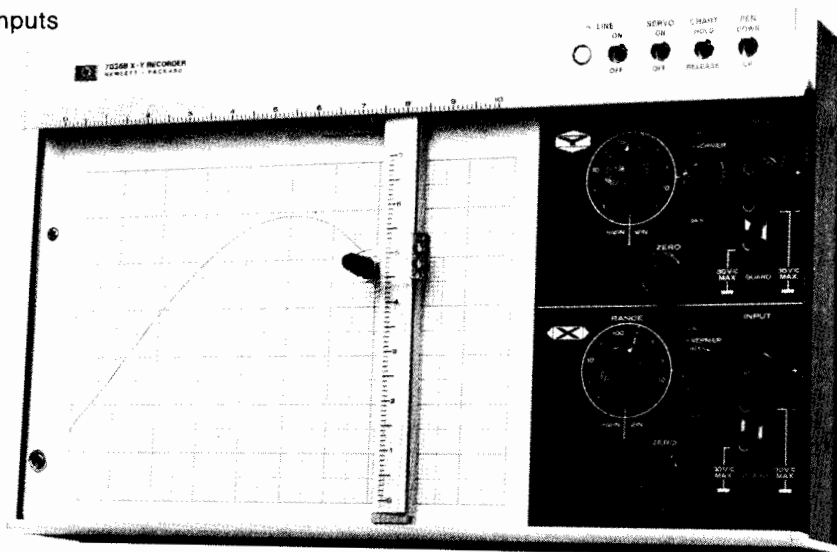

HP 7035B

### HP 7035B X-Y Recorder

The HP 7035B combines precision with low cost and general-use design to provide users with one X-Y recorder that serves most recording needs where medium dynamic performance is a requirement. Compact in design, the HP 7035B is well adapted to rack mounting with the addition of only two optional wing brackets. Other features are silent, trouble-free electrostatic paper holddown for paper sizes up to 216 x 280 mm (8.5 x 11 in.); floating guarded inputs to help eliminate the common mode voltage effects that are troublesome when recording from low level sources; and disposable pens with self-contained ink supply to allow simple, one-step replacement of ink, tip, and color.

Input connectors on the HP 7035B accept both open wire and plug-type connectors. In addition, the recorder provides five calibrated ranges (0.4 mV/cm to 4 V/cm) for each axis; signal scaling for full-scale deflection, and high input impedance (1 megohm, except the first two ranges).

### HP 17108A Time Base

The HP 17108A is a self-contained external time base that operates on either axis of the HP 7035B. By simply plugging in the HP 17108A, the HP 7035B is provided with five sweep speeds from 0.2 to 20 s/cm (0.5 to 50 s/in.). This module, powered by a single self-contained battery, is controlled by its own six-position range switch and three-position mode switch.



HP 17108A Option 002 mounted on recorder

### HP 17108A Specifications

**Sweep speeds:** 0.2, 0.4, 2, 4, 20 s/cm (0.5, 1, 5, 10, 50 s/in.)  
**Accuracy:** 5% of recorder full scale  
**Linearity:** 0.5% of full scale (20°C to 30°C)  
**Output voltage:** 0 to 1.5 V  
**Power:** replaceable mercury battery (100 h)

### HP 7035B Performance Specifications

**Input ranges:** 0.4, 4, 40, 400 mV/cm and 4 V/cm (1, 10, 100 mV/in.; 1 and 10 V/in.). Continuous vernier between ranges

**Input types:** floating guarded signal pair; rear connector

#### Input Resistance

Range		Input resistance
0.4 mV/cm	(1 mV/in.)	Potentiometric (essentially infinite at null)
Variable		11 kΩ
4 mV/cm	(10 mV/in.)	100 kΩ
Variable		100 kΩ
40 mV/cm	(100 mV/in.)	1 MΩ
& above	(& above)	

**Normal mode rejection:** >30 dB at 60 Hz; then 18 dB/octave

**Maximum allowable source impedance:** 20 kΩ on the most sensitive range; no restrictions on other ranges.

**Accuracy:** ±0.2% of full scale

**Linearity:** ±0.1% of full scale

**Resetability:** ±0.1% of full scale

**Zero set:** zero may be set up to one full scale in any direction from zero index. Lockable zero controls.

**Slewing speed:** 50 cm/s (20 in./s) nominal at 115 V.

**Common mode rejection:** 130 dB at dc & 100 dB at line frequency with up to 1 kΩ between the positive input and guard connection point and attenuator on most sensitive range. CMR decreased 20 dB per decade step in attenuation.

### HP 7035B General Specifications

**Electrostatic paper holddown:** grips 216 x 280 mm (8.5 x 11 in.) charts or smaller. Special paper not required.

**Pen lift:** electric pen lift capable of being remotely controlled.

**Size:** 265 H x 445 W x 121 mm D (10.5" x 17.5" x 4.8").

**Weight:** net, 8 kg (18 lb); shipping, 10.9 kg (24 lb).

**Power:** 115 or 230 V ±10%, 50 to 60 Hz, approximately 45 VA

### HP 7035B Options

**001** Metric calibration

**908** Rack mount

### HP 17108A Options

**002** HP 17108A Metric calibration

### Ordering Information

HP 7035B General purpose X-Y recorder

HP 17108A Time base plug-in

# RECORDERS, PLOTTERS & PRINTERS

High Performance General-Use X-Y Recorders

Models 7045B, 7046B

383

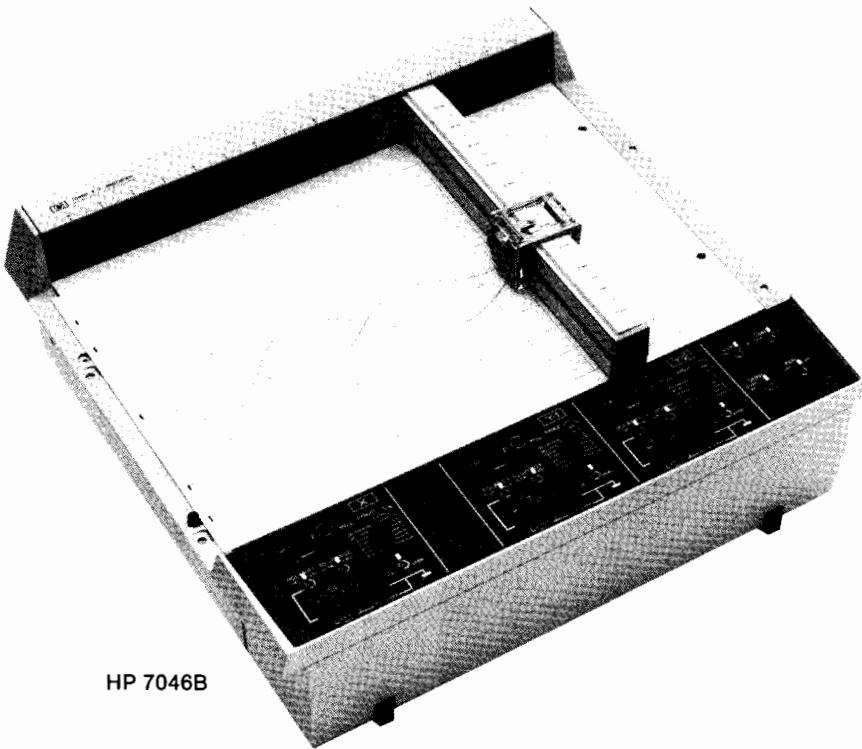

HP 7046B

Does your application require maximum general-use capability? Do you need two pens to draw two or three simultaneous variables? . . . Choose the HP 7046B

## The HP 7045B and 7046B

These general-use X-Y recorders have been designed to satisfy both current and future laboratory applications. The high-level performance and reliability of these recorders are the results of a design philosophy that has evolved through 30 years of Hewlett-Packard experience as a leading manufacturer of X-Y recorders.

Whether the buyer purchases the one-pen (X or T vs Y) HP 7045B or the two-pen (X or T vs Y1 & Y2) HP 7046B, the recorder will provide the following quality features:

**Very high dynamic performance:** with a combination of high slewing speed and acceleration, these recorders can capture fast changing signals that an ordinary recorder might miss. For example, the HP 7045B will, typically, record a signal from dc to 10 Hz at 2 cm peak-to-peak amplitude on either axis.

**TTL remote control:** with TTL or simple contact closure to ground, a rear connector offers easy interface to measurement systems. TTL provides remote control of sweep, start and reset, pen lift, servo mute, and chart hold. Pen lift, the most important action to be controlled remotely, is also available from a convenient rear-mounted banana jack connector.

**Wide chart size range:** accepts ISO A3, ISO A4, 8.5 x 11 in., 11 x 17 in., and any paper size under the maximum limit (ISO A3 or 11 x 17 in.). With this capability these recorders can fill a variety of charting needs.

**Environmental specifications:** each unit is designed to meet exacting Hewlett-Packard environmental specifications. For example, these units meet performance specifications through a temperature range of 0 °C to 55 °C and at relative humidities up to 95 percent. They also conform to rugged shock and vibration specifications.

**Other user-oriented features:** with this X-Y recorder line, the two design objectives were to produce precision instruments and to make these units easy to use. Major features include:

- Polarity reverse switch that eliminates need to reverse input leads
- Response switch on HP 7045B and 7046B that allows recorder response to be slowed to simplify initial set up
- Separate rear connector that provides a convenient remote pen lift control connection
- Built-in hardware that simplifies table or rack mounting



Do you have multi-users and many applications, need fast pen response but have no need to plot two simultaneous Y variables? . . . Choose the HP 7045B



# RECORDERS, PLOTTERS & PRINTERS

## High Performance General Use X-Y Recorders

Models 7045B, 7046B (cont'd)

### HP 7045B and 7046B Specifications

#### Performance Specifications

	HP 7045B VERY HIGH SPEED	HP 7046B 2-PEN, VERY HIGH SPEED
Type of input	Front and rear input. Floating, guarded. Polarity reversal switch on front panel.	
Input ranges	0.25, 0.5, 1, 2.5, 5, 10, 25, 50, 100, 250, 500 mV/cm. 1, 2.5, 5 V/cm. (0.5, 1, 2, 5, 10, 20, 50, 100, 200, 500 mV/in. 1, 2, 5, 10 V/in.) Continuous vernier between ranges.	
Input resistance	1 megohm constant on all ranges	
Source resistance	10 k $\Omega$ maximum on all ranges	
Accuracy	$\pm 0.2\%$ of full scale (includes linearity and deadband) at 25°C. Temp coefficient $\pm 0.01\%$ per °C	
Range Accuracy	$\pm 0.2\%$ of full scale $\pm 0.2\%$ of deflection (includes linearity and deadband) at 25°C. Temp coefficient $\pm 0.01\%$ per °C.	
Deadband	0.1% of full scale	
Common mode rejection	110 dB and 90 dB ac (exceeds 130 dB dc and 110 dB ac under normal lab environmental conditions) with 1 k $\Omega$ between HI and LO terminals. CMV applied between ground and LO, and attenuator on most sensitive range. CMR decreases 20 dB per decade step in attenuation.	
Normal mode rejection	Internal filter not available	

#### Dynamic Performance Specifications

Slewing speed	97 cm/s (38 in./s) typical under normal lab conditions. 76 cm/s (30 in./s) minimum.	
Acceleration peak-Y axis	7620 cm/s <sup>2</sup> (3000 in./s <sup>2</sup> )	6350 cm/s <sup>2</sup> (2500 in./s <sup>2</sup> )
-X axis	5080 cm/s <sup>2</sup> (2000 in./s <sup>2</sup> )	3800 cm/s <sup>2</sup> (1500 in./s <sup>2</sup> )
Overshoot	1% of full scale maximum.	

#### Offset Specifications

Zero offset	Zero may be placed anywhere on the writing area or electrically off scale up to one full scale from zero index.
-------------	---

#### Time Base Specifications

Time base	8 speeds: 0.25, 0.5, 1, 2, 5, 10, 25, 50 s/cm (0.5, 1, 2, 5, 10, 20, 50, 100 s/in.)
Time base accuracy	1.0% at 25°C. Temp coefficient at $\pm 0.1\%/C^\circ$

#### General Specifications

Power	100, 120, 220, 240 Vac +5 -10%; 48 to 440 Hz; 230 VA	100, 120, 220, 240 Vac +5 -10%; 48 to 440 Hz; 230 VA
Pen lift	Electric (remote via TTL level)	
Writing area	25 x 38 cm (10 x 15 in.)	
Weight	Net 13.7 kg (30 lb)	Net 16 kg (35 lb)
Size	400 H x 483 W x 165 mm D (15.8" x 19" x 6.5").	441 H x 483 W x 173 mm D (17.4" x 19" x 6.8").

#### HP 7045B Options

- 001 Time base
- 002 Event marker
- 006 Metric calibration

#### HP 7046B Options

- 001 Time base
- 002 Event marker
- 007 Metric calibration

#### Ordering Information

- HP 7045B Very high speed recorder
- HP 7046B 2-pen, very high speed recorder

# RECORDERS, PLOTTERS & PRINTERS

## Four and Eight-Channel Oscillographic Recorders

Models 7414A, 7418A & 8800 Series Signal Conditioners

385



- Thermal writing for low maintenance
- Z-fold paper for easy review/storage

- Available in benchtop configuration, mobile cart, up-right cabinet

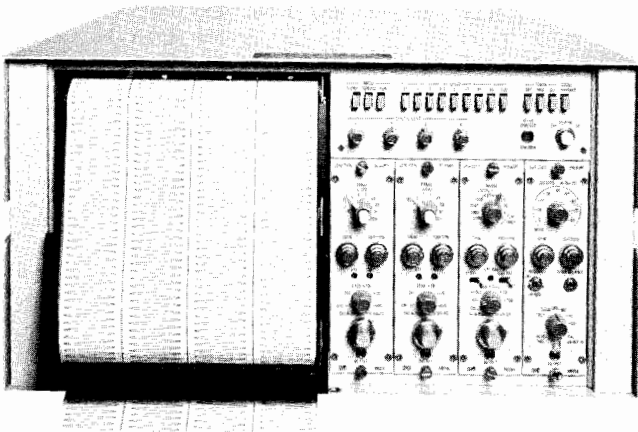

HP 7414A

HP 7414A 4-Channel and 7418A 8-Channel Oscillographic Recorders provide permanent reproducible records of multichannel, real-time data. A complement of HP 8800 Series Plug-in Signal Conditioners results in a system capable of meeting many measurement requirements in a reliable, versatile manner.

Thermal writing tips feature long stylus life and rectilinear presentations. A Z-fold chart paper pack loads easily, allows for convenient data review and storage. Two markers are supplied. The timer marker can be selected for one-second or one-minute marks. The event marker can be activated remotely or by front panel pushbutton.

### HP 7414A, 7418A, 8800 Series Plug-in Specifications

#### HP 7414A General Specifications

**Chart speeds:** 0.25, 0.5, 1.0, 2.5, 10, 25, 50, 100 mm/s. Speed regulation  $\pm 1\%$ . Paper weave less than 0.5 mm. Speed selected via front panel pushbuttons. Optional speeds in mm/min.

**Limiting:** electrical limiting keeps stylus within channel.

**Markers:** event (local or remote control) between ch 3 and 4. (Timer 1 min or 1 s selectable) between ch 1 and 2.

**Chart paper:** four 40 mm wide channels each with 50 div; time lines every 1 mm; heat sensitive Z-fold Permapaper<sup>®</sup> with green grid lines available in packs of 500 sheets, each 30 cm (12"). (HP part number 9270-0878).

**Paper loading:** no threading required.

**Remote operation:** rear panel connector provides for remote chart drive and event marker activation.

**Power:** 115/230 V ac  $\pm 10\%$ , 60 Hz, 350 VA (includes plug-ins) 50 Hz optional.

**Size:** 266.7 H x 482.6 W x 577.9 mm D (10 $\frac{1}{2}$ " x 19" x 22 $\frac{3}{4}$ "). Projection: 76.2 mm (3") from rack front.

**Weight:** net, 50.5 kg (112 lb); shipping, 59.5 kg (132 lb).

#### HP 7418A General Specifications

**Chart speeds:** 0.5, 1, 2.5, 5, 10, 25, 50, 100, 200 mm/s. Speed regulation  $\pm 1\%$ . Paper weave less than 0.5 mm. Speed selected via front panel pushbuttons (or remote). Optional speeds in mm/min.

**Chart paper:** eight 40 mm wide channels each with 50 divisions; time lines every 1 mm. Heat sensitive Chemical Thermal Paper standard for all system recorders except option 050. Permapaper<sup>®</sup> for Option 050 recorders only. Chemical Thermal Paper available in packs of 400 sheets, each 30.1 cm (12") long x 40.2 cm (15.8") wide (HP part number 9270-0563 red grid). Permapaper available in packs of 500 sheets, each 30.1 cm (12") long x 40.2 cm (15.8") wide (HP part number 9270-0946 green grid).

**Remote operation:** rear panel connector provides for chart drive and event marker, optional extra markers. Remote connector supplies -20 V.

**Power:** 115/230 V ac  $\pm 10\%$ , 60 Hz. Recorder only 575 VA; system plug-ins 695 VA.

**Size:** rack: 266.7 H x 482.6 W x 577.9 mm D (10 $\frac{1}{2}$ " x 19" x 22 $\frac{3}{4}$ "). Projection: 76.2 mm (3") from front of rack.

**Weight:** 50 kg (110 lb) including driver amplifiers.

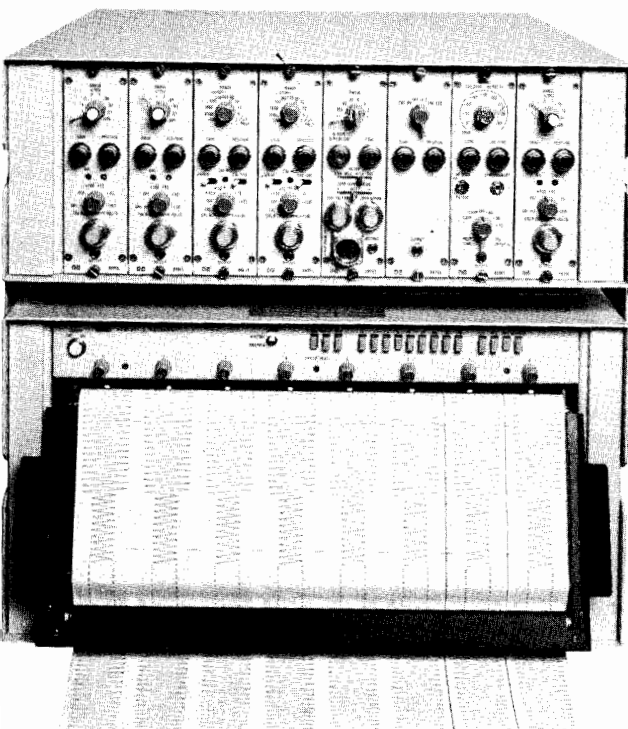

HP 7418A with Options 030 and 003



# RECORDERS, PLOTTERS & PRINTERS

## Four and Eight-Channel Oscillographic Recorders

Models 7414A, 7418A & 8800 Series Signal Conditioners (cont.)

- Plug-in versatility for HP 7414A/7418A

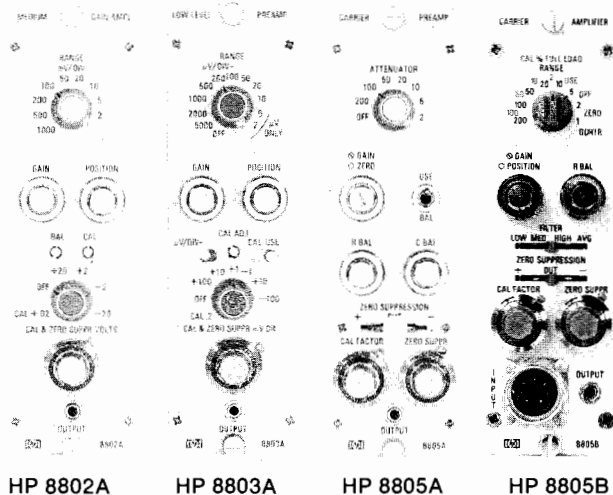

HP 8802A

HP 8803A

HP 8805A

HP 8805B

### HP 8801A Low Gain DC Amp

**Input ranges:** 5, 10, 20, 50, 100, 200, 500, 1000, 2000, 5000 mV/div; accuracy  $\pm 1\%$ .

**Max sensitivity:** 5mV/div (gain 20).

**Max fs input:** 250V.

**Input circuit & input frequency range:** resist. 500 k $\Omega$   $\pm 1\%$  each side bal to gnd; parallel with approx. 100 pF

**Rise time (10 div, 10-90%, 4% overshoot):** 5 ms.

**Calibration (referred to input):** 100 mV,  $\pm 1\%$ , internal.

**Output frequency response (-0.5 dB at 50 div):** 50 Hz.

**Zero suppression:**  $\pm 10$  and  $\pm 100$  V for single-ended or diff. signals. 10-T pot sets precise values of zero suppression voltages;  $\pm 50$  V max suppress on 5, 10, 20 mV/div ranges; max error of suppression  $\pm 0.5\%$  of suppression range, and 1% of indicated suppression.

**Output noise, max (less trace width):** 0.2 div, p-p.

**Zero drift, 20° to 40°C, 103 to 127 V (less trace width):** temp—1.25 div/10°C, 0.5 div/hr, constant ambient. Line voltage—0.15 div.

**Common mode rejection and tolerance:** 48 dB min, dc to 150 Hz;  $\pm 50$  V max on other ranges for  $< 1\%$  change in differential sensitivity.

**Output linearity (less trace width):** 0.25 div, after calibration for zero error to center scale +20 div.

### HP 8802A Medium Gain DC Amp

**Input ranges:** 1, 2, 5, 10, 20, 50, 100, 200, 500, 1000 mV/div; accuracy  $\pm 1\%$ .

**Max sensitivity:** 1 mV/div (gain 100).

**Max fs input:** 50 V.

**Input circuit and input frequency range:** resist 180 k $\Omega$   $\pm 1\%$ , each side bal to gnd, parallel with approx 100 pF.

**Rise time (10 div, 10-90%, 4% overshoot):** 5 ms.

**Calibration (referred to input):** 20 mV,  $\pm 1\%$ , internal.

**Output frequency response (-0.5 dB at 50 div):** 50 Hz.

**Zero suppression:**  $\pm 2$  V and 20 V for single-ended or differential signals; 10-T pot sets precise values of zero suppression voltages;  $\pm 12.5$  max suppression on 1, 2, 5 mV/div ranges; max error of suppression  $\pm 0.5\%$  of suppression range and 1% of indicated suppression.

**Output noise, max (less trace width):** 0.2 div, p-p.

**Zero drift, 20° to 40°C, 103 to 127 V (less trace width):** same as HP 8801A.

**Common mode rejection and tolerance:** 48 dB min dc to 60 Hz, 1000 mV/div range; 48 dB min. dc to 150 Hz other ranges  $\pm 12.5$  V on 1, 2, 5 mV/div ranges;  $\pm 125$  V on 10, 20, 50 mV/div ranges;  $\pm 500$  V max other ranges for less than 1% change in differential sensitivity.

**Output linearity (less trace width):** same as HP 8801A.

### HP 8803A High Gain DC Amp

**Input ranges:** 1, 2, 5, 10, 20, 50, 100, 200, 500, 1000, 2000, 5000  $\mu$ V/div; 10, 20, 100, 200, 500, 1000, 2000, 5000 mV/div; accuracy  $\pm 1\%$  on 5000  $\mu$ V/div to 20  $\mu$ V/div ranges,  $\pm 2\%$  on 10  $\mu$ V/div to 1  $\mu$ V/div; accuracy of  $\times 1000$  attenuator  $\pm 1\%$ .

**Max sensitivity:** 1  $\mu$ V/div (gain 100,000)

**Max fs input:** 250 V.

**Input circuit and input frequency range:** 1 M $\Omega$  min on  $\mu$ V range, independent of gain; 5 M $\Omega$  on mV range; floating and guarded.

**Rise time (10 div, 10-90%, 4% overshoot):** 5 ms. 6% overshoot.

**Calibration (referred to input):** 200  $\mu$ V  $\pm 1\%$  internal on  $\mu$ V/div range; 200 mV  $\pm 1\%$  internal on mV/div range.

**Output frequency response (-0.5 dB at 50 div):** 50 Hz.

**Zero suppression:**  $\mu$ V ranges  $\pm 1$ ,  $\pm 10$ ,  $\pm 100$  mV; mV ranges  $\pm 1$ ,  $\pm 10$ ,  $\pm 100$  V, 10-T pot sets precise values of zero suppression voltages; accuracy  $\pm 1\%$  suppression range.

**Output noise, max (less trace width):** 1.5 mm p-p at 1  $\mu$ V/div; 0.1 div, p-p min gain.

**Zero drift, 20° to 40°C, 103 to 127 V (less trace width):** temp— $\mu$ V range 1  $\Omega$ V/10°C referred to input,  $\pm 0.26$  div/10°C for 0 output &  $\pm 0.65$  div/10°C for fs output. mV range, 1 mV/10°C referred to input,  $\pm 0.26$  div/10°C for 0 output. Line voltage 0-0.07 div; fs 0.35 div.

**Common mode rejection and tolerance:**  $\mu$ V range, max source unbal of 1 k $\Omega$ ; 160 dB min at dc, 120 dB min at 60 Hz; mV range, max source unbal of 500 k $\Omega$ ; 100 dB min at dc, 60 dB min at 60 Hz dc. 300 V pk; 60 Hz. 1  $\mu$ V/div, 10 V rms; 2  $\mu$ V/div, 20 V rms; 5  $\mu$ V/div, 50 V rms; 10  $\mu$ V/div and 10 mV/div, 100 V rms; 20  $\mu$ V to 5000  $\mu$ V/div and 20 mV to 5000 mV/div, 200 V rms.

**Output linearity (less trace width):** 1 mV range 0.35 div, others 0.25 div after calibrating for zero error at center scale and +20 div.

### HP 8805A/B Carrier Preamp

**Input ranges:** X1, 2, 5, 10, 20, 50, 100, 200; accuracy  $\pm 2\%$ .

**Max sensitivity:** 10  $\mu$ V rms/div (gain 10,000 rms ac to dc)

**Max fs input:** 100 mV rms.

**Input circuit and input frequency range:** input impedance—HP 8805A approx 10 k $\Omega$ ; HP 8805B 1 M $\Omega$   $\pm 10\%$ ; single-ended. Min load resistance across excitation 100  $\Omega$ . Max impedance in series with input (transducer output impedance) 5 k $\Omega$ . Excitation—floating source 5 V rms nominal at 2400 Hz  $\pm 2\%$ . Internal switch allows use with full or half bridge transducer.

**Rise time (10 div, 10-90%, 4% overshoot):** 5.6 ms.

**Calibration (referred to input):** 2%  $\pm 0.02\%$  of transducer fs output. Adjust by Cal Factor control; accuracy  $\pm 55$   $\mu$ V/V out of 10mV/V. 8805B switchable Cal voltage to 2%, 10%, 50%, or 100%  $\pm 1\%$  of fs.

**Output frequency response (-0.5 dB at 50 div):** 50 Hz.

**Zero suppression:** 0-100% of transducer full load rating, for transducers having Cal Factor up to 10 mV/V at full load, 10-T pot with calibration dial; accuracy—1 dial div  $\pm 0.5\%$  of suppress range. Zero Supp Polarity switch, Separate R Bal control allows bucking of in-phase unbal to  $\pm 3$  mV/V regardless of Cal Factor.

**Output noise, max (less trace width):** approx. 0.2 div, p-p.

**Zero drift, 20° to 40°C, 103 to 127 V (less trace width):** temp—0.45 div/10°C; Line voltage—0.25 div.

**Common mode rejection and tolerance:** quadrature rejection and tolerance:  $> 40$ dB. Tolerance error:  $< \pm 2\%$  fs when quadrature voltage equal to twice in-phase signal required for center to edge deflection on chart. C Balance control permits bucking of transducer's quad unbalance of up to  $\pm 5$  mV/V. The HP 8805B has automatic C balance.

**Output linearity (less trace width):** 0.4 div after calibrating for zero error at center scale and +20 div.



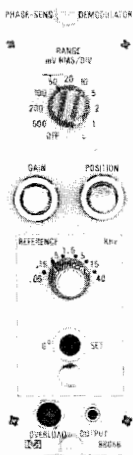

HP 8806B  
Opt. 002

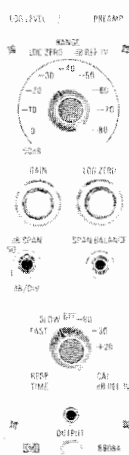

HP 8808A

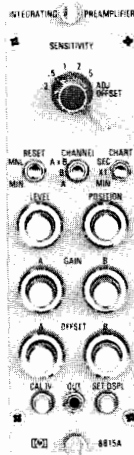

HP 8815A  
Opt. 002

### HP 8806B Phase Sensitive Demodulator

Must be purchased with minimum of one of the four available options.

**Input ranges:** sig input—0.5, 1, 2.5, 10, 20, 50, 100, 200, 500 mV/div;  $\pm 1\%$ , 50 Hz to 10 kHz;  $\pm 2\%$ , 10 kHz;  $\pm 3\%$ , 20 kHz to 40 kHz. Reference voltage—3 to 20 rms, 20 to 133 V rms.

**Max sensitivity:** 0.5 mV rms/div (gain 200 rms ac to dc).

**Max fs input:** 25 V rms full scale.

**Input circuit and input frequency range:** signal input: —transformer isolated, floating point and guarded; resistance approx 1 M $\Omega$ . Reference input: differential, transformer coupled; resistance approx 500 k $\Omega$  each side to ground, may be used single ended. 50 Hz to 40 kHz in 6 bands with variable frequency plug-in (Opt. 002); 60 Hz (Opt. 003), 400 Hz (Opt. 004) and 5 kHz (Opt. 005) fixed frequency phase shifter plug-in; special order phase shifter plug-ins 50 Hz to 40 kHz. Note: must order with frequency plug-in.

**Rise time (10 div, 10-90%, 4% overshoot):** 5 ms (5 kHz ref).

**Calibration (referred to input):** 1 V rms internal at carrier reference frequency;  $\pm 1\%$  50 Hz to 10 kHz;  $\pm 2\%$  10 kHz to 20 kHz;  $\pm 3\%$  20 kHz to 40 kHz.

**Zero suppression:** none. Phase shifter plug-ins allow control of reference phase over 360°. Fixed frequency: 0° to 90° dial; 2° graduations; any of 4 quadrants by panel switches; dial accuracy within  $\pm 3^\circ$ . Variable frequency: adjust thru 360°.

**Output noise, max (less trace width):** 7  $\mu$ V x square root of frequency response, referred to input.

**Zero drift, 20° to 40°C, 103 to 127 V (less trace width):** temp: 0.5 div/10°C; Line voltage: 0.25 div.

**Common mode rejection and tolerance:** CM: >40 dB up to 10 kHz 500 V rms, max. Quadrature tolerance: equal to amplitude of a fs, in-phase signal.

**Output linearity (less trace width):** 0.4 div after calibrating for zero error at center scale and +20 div.

### HP 8808A Log Level Preamp

**Input ranges:** 50 dB span: bottom scale —80, —70, —60, —50, —40, —20, —10, and 0 dB below 1 V (i.e. 100  $\mu$ V, 320  $\mu$ V, 1, 3.2, 10, 32, 100, 320 mV and 1 V). 100 dB span bottom scale —80, —70, —60, and —50 dB below 1 V.

**Max sensitivity:** 100  $\mu$ V rms sine wave corresponds to bottom scale output, —80 dB below 1 V.

**Max fs input:** 320 V rms.

**Input circuit and input frequency range:** single ended, resistance 1 M $\Omega$  min. 5 Hz to 100 kHz for <3 dB down from the midband level on “Slow” response range; 500 Hz to 100 kHz on “Fast” response range.

**Rise time (10 div, 10-90%, 4% overshoot):** fast, 20.5 rms (875 dB/s); slow, 2 s (9 dB/s).

**Calibration (referred to input):** internal from oscillator at approx 500 Hz. -80, -30, and  $\pm 20$  dBV = dB ref. to 1 V (100  $\mu$ V, 32 mV and 10 V) -80 +20 dBV internally adjustable: -30 dBV accuracy  $\pm 0.25$  dB (at 115 V line at 25°C).

**Output noise, max (less trace width):** 50 dB range: 0.8 div, p-p, 100 dB range: 0.4 div, p-p (max noise at bottom of recording chart).

**Output linearity (less trace width):** departure from log characteristics 50 dB: 1.25 div, 100 dB: 1 div, after calibrating for zero error at lower and upper ends of printed coordinates.

### HP 8809A Signal Coupler

**Input ranges:** continuously adjustable from 20 to 50 mV/div.

**Max sensitivity:** 30 mV/div (gain 3.33).

**Max fs input:** 0 to +2.5 V or 0 to -2.5 V.

**Input circuit and input frequency range:** switch selected: 1500  $\Omega$   $\pm 2\%$  or 100 k $\Omega$  min, incremental: single ended.

**Rise time (10 div, 10-90%, 4% overshoot):** 5 ms.

**Calibration (referred to input):** 600 mV  $\pm 2\%$ , internal.

**Output frequency response (-0.5 dB at 50 div):** 50 Hz.

**Output noise, max (less trace width):** 0.1 div, p-p.

**Zero drift, 20° to 40°C, 103 to 127 V (less trace width):** temp: 0.4 div/10°C at 30 mV sensitivity. Line voltage: 0.3 div.

**Common mode rejection and tolerance:** 50,000: 1 at dc.

Output linearity (less trace width): 0.4 div after calibrating for zero error at center scale and +20 div.

### HP 8815A Opt 002 General Purpose Integrator

**Sensitivity ranges:** 0.2, 0.5, 1, 2, 5. Sensitivity setting of 1 results in the following integrator outputs:

**Seconds integrator:** 1 volt per volt-second input (0.1 volt-seconds per recorded division, or 5 volt-seconds full scale).

**Minute integrator:** 1 volt per 60 volt-seconds input (6 volt-seconds per recorded division or 300 volt-seconds full scale). For other sensitivity settings, divide the above volt-second values by the sensitivity switch setting.

**Offset control:**  $\pm 2.8$  volts referred to input. Can be used with switch-selectable rectifier to rectify (or ignore) portions of roughly sinusoidal inputs.

**Drift:** seconds integrator,  $\pm 5$  mV/s, referred to output; minute integrator,  $\pm 15$  mV/min., referred to output.

# RECORDERS, PLOTTERS & PRINTERS

## Four and Eight-Channel Oscillographic Recorders

Models 7414A, 7418A & 8800 Series Signal Conditioners (cont.)

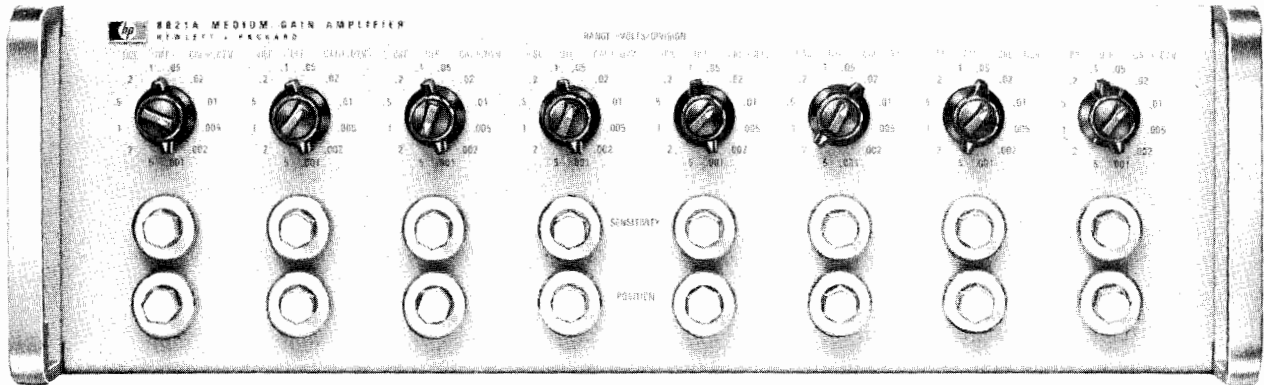

### HP 8821A Eight Channel Bank Amplifier

**Max sensitivity:** 0.001 V/div (Amplifier Gain 100).

**Max fs input:** 250 V (edge to edge).

**Input ranges (attenuation):** 0.001, 0.002, 0.005, 0.010, 0.020, 0.050, 0.1, 0.2, 0.5, 1, 2, 5 V/div. Attenuator accuracy (dc) ½% on 0.001 to 0.050 V/div ranges; 1% on 0.1 to 5 v/div ranges.

**Input circuit:** balanced, floating and guarded, 9 MΩ constant for all gain settings (0.001 to 0.050 V/div); 4.5 mΩ each side to ground (0.1 to 5 V/div).

**Common mode rejection:** 100 dB at 60 Hz, 0.001 V/div sensitivity, 1 kΩ source unbalance decreases to 66 dB at 0.05 V/div, 66 dB at 60 Hz, 0.01 to 5 V/div sensitivity. 1 kΩ source unbalance.

**Common mode tolerance:** ±20 V on 0.001 to 0.05 V/div ranges (6 most sensitive); ±250 V on 0.1 to 5 V/div ranges (6 least sensitive).

**Frequency response:** dc to <0.5 dB down at 50 Hz (50 div, p-p). dc to <3 dB down at 200 Hz (10 div p-p).

**Rise time (10 div, 10-90%, 4% overshoot):** <6 ms.

**Output linearity (less trace width):** linear within ±0.25 div. after setting mechanical zero of stylus to within ±1 div. of chart center and calibrating for zero error at center scale and ±20 div.

**Drift, 20° to 40°C, 115 V ±10%. 60 Hz (less trace width):** temp., <0.55%/10°C; line voltage, <±0.2 div.

**Calibration:** +0.02 V ±1% on 6 most sensitive ranges. Simulates +2 V ±2% at input on 6 least sensitive ranges.

**Temperature rating:** operating, 0°C to +55°C; storage, -40°C to 75°C.

### Ordering Information

**HP 7414A** 4-channel Oscillographic Recorder

**Opt 001:** rack mount kit with slides and mounting hardware; delete case.

**Opt 008:** 50 Hz operation

**Opt 015:** extra Event Marker, between channels 2 & 3

**Opt 025:** 60:1 speed reduction (50 Hz), requires Opt 008

**Opt 026:** 60:1 speed reduction (60 Hz)

**Opt 054:** installed in mobile cart. Rack space: 53 cm (21 in.). Cart height: 102 cm (40.75 in.). Includes paper take-up drawer.

**HP 7418A** 6 to 8-channel Oscillographic Recorder

**Opt 001:** 6 channel Hot-tip Thermal Recorder only; includes takeup tray. Plug-in preamplifiers require Opt 030 Power Supply; for 8-channel Bank Amplifiers (Power Supply included) select Opt 031 or 032

**Opt 002:** rack mount kit

**Opt 003:** bench-top configuration

**Opt 004:** 160 cm (63 in.) rack space cabinet. Cabinet height: 177 cm (72.5 in.). Includes paper takeup drawer.

**Opt 006:** Portable Cart with 71 cm (28 in.) rack space, includes Opt. 002. Cart height: 126 cm (50.5 in.).

**Opt 008:** 50 Hz operation

**Opt 009:** 230 Vac operation

**Opt 014:** extra Event Marker between channels 4 & 5

**Opt 015:** extra Event Marker between channels 5 & 6

**Opt 025:** 60:1 speed reduction (50 Hz), requires Opt 008

**Opt 026:** 60:1 speed reduction (60 Hz)

**Opt 030:** HP 8848A plug-in Preamplifier Power Supply, required for operation of HP 8800 preamplifiers

**Opt 031:** HP 8820A 8-channel Low Gain Bank Preamplifier

**Opt 032:** HP 8821A 8-channel Medium Gain Bank Preamplifier

**Opt 035:** rack mount kit for HP 29400 series cabinet

**Opt 050:** recorder equipped for permapaper operation only

**HP 8801A** Low Gain Preamplifier

**HP 8802A** Medium Gain Preamplifier

**HP 8803A** High Gain Preamplifier

**HP 8805A** Carrier Preamplifier

**Opt 002:** Harmonic Filter Kit, required when 267, 268, 270, or 1280B, C transducers are used

**HP 8805B Opt 012** Carrier Preamplifier without Harmonic Filter

**HP 8806B** Phase Sensitive Demodulator Preamplifier. Requires one of following plug-ins:

**Opt 002:** Variable Frequency Phase Shifter plug-in, 50 Hz to 40 kHz

**Opt 003:** 60 Hz Phase Shifter plug-in

**Opt 004:** 400 Hz Phase Shifter plug-in

**Opt 005:** 5 kHz Phase Shifter plug-in

**HP 8808A** Logarithmic Preamplifier

**HP 8809A** Signal Coupler Preamplifier

**HP 8815A Opt 002** General Purpose Integrator

**Opt 003:** Sample and hold (for digital display read-outs)

**HP 8821A** Medium Gain Bank Preamplifier (8-channel)

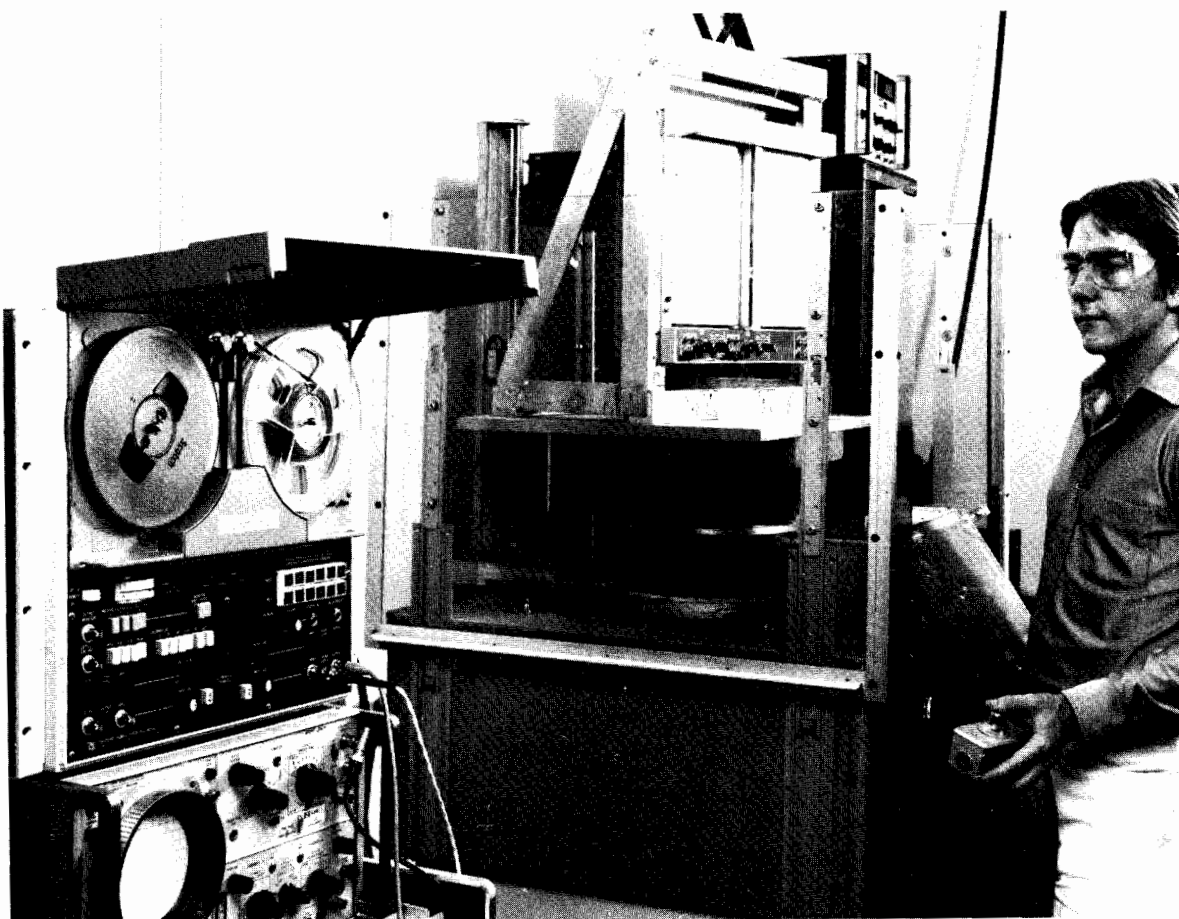

### Introduction

Instrumentation tape recorders (ITRs) are used to record, store, and reproduce test data for many and varied applications. The main reasons for using ITRs are economy, accurate data recording and reproduction, and long-term data storage. ITRs manufactured by Hewlett-Packard are 4 or 8-channel recorders using 1/4-inch tape. They are designed specifically for applications under 64 kHz. ITR recording provides nondestructive reproduction so data can be reproduced repeatedly without degrading the quality, and time-base can be contracted or expanded. Data is contracted by using faster tape speeds to reproduce slow-speed data or expanded by doing the reverse to produce, for example, lower frequency data for use on a graphics recorder.

### ITR Characteristics

**Direct record/reproduce electronics:** direct electronics accept frequencies above 100 Hz (approximate) and record the amplitude of the input signal on the tape as a proportional magnetic flux intensity. Because direct electronics require a "linear" relationship, changing tape type generally necessitates the re-equalization of each direct channel. Direct electronics also require that each recorded tape be degaussed (erased) fully before being reused.

**FM record/reproduce electronics:** FM electronics accept very low frequencies, including dc. In FM, the amplitude of the input signal is recorded as a frequency deviation from a "center" frequency, the maximum input amplitude being recorded as a 40% deviation. Because amplitude is converted to a frequency, FM tends to be insensitive to tape drop-outs, but sensitive to speed irregularities such as flutter. With FM, tape types can be changed without re-equalizing the channel. Since FM records to saturation, tape can be reused without degaussing with only a small (10 to 15 dB) loss in signal-to-noise ratio.

**Common frequency range:** FM and direct have a common segment of the frequency range in which either type of electronics can function. On Hewlett-Packard's ITRs this range is approximately 100 Hz to 5 kHz. The advantages of using direct electronics in this range are high frequency response at slow tape speeds and a general insensitivity to flutter. The advantages of FM are dc response and a general insensitivity to tape drop-outs.

**Tape speed control:** the tape speed is usually controlled by a phase-lock servo system in one of two ways. The more common method uses the servo system to control the

rotational speed of the tape capstan, employing a tachometer mounted on the capstan's shaft to monitor the speed. With this method, tape speed control is limited to approximately  $\pm 0.2\%$ , because of capstan irregularities, tape slippage, and tape stretching. The less common but more precise method uses a frequency reference placed on one track during recording as the speed reference for the phase-lock servo during reproduce. Tape servo generates a reproduce speed that is virtually identical to the record speed; the time difference between events in record and reproduce is indicated by the time base error specification (which assumes continuous phase-lock operation). The time base error figure represents a short-term specification, because drop-outs, etc., may cause momentary loss of phase lock.

**Flutter:** this is a short-term tape speed variation. It produces time base perturbations in direct electronics and noise in FM.

**Signal-to-noise ratio:** this is the ratio of maximum to minimum recordable amplitude expressed as a voltage ratio in dB. Basically, it represents the usable dynamic range.

**Tape selection:** it is recommended that instrumentation tape such as Ampex 797 always be used. Use of other quality tape may adversely affect head wear, signal-to-noise ratio, etc.



# RECORDERS, PLOTTERS & PRINTERS

## Instrumentation Tape Recorders and Degausser

Models 3964A, 3968A, and 13064A Degausser

- Continuing savings by recording on 1/4-inch tape
- Choice of 4 or 8-channel recorders
- Selection of FM or direct electronics

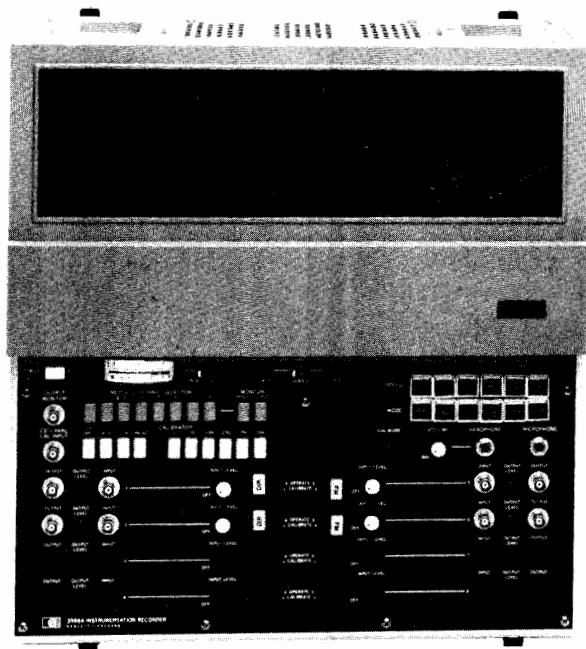

HP 3968A

- Six tape speeds, including 15/32 ips
- Remote control (TTL or optional HP-IB)
- Switch selection of tach or tape servo



HP 3964A

### HP 3964A and 3968A ITRs, HP 13064A Degausser

The 4-channel HP 3964A and 8-channel HP 3968A are quality instrumentation tape recorders (ITRs) that provide cost-saving operation by using 1/4-inch tape for a wide variety of recordings. Medical versions of the HP 3964A and 3968A (Options 009 and 010) are available. These versions include a UL 544 medical listing making them useful in hospitals, medical offices, and research facilities.

The HP 13064A bulk tape degausser erases a complete roll of tape cleanly in seconds. A thoroughly clean tape is necessary to obtain maximum signal-to-noise ratio.

Both the HP 3964A and the HP 3968A are precision-built ITRs with features that cut costs, enhance the usefulness of the units, and simplify recording tasks in laboratory, medical, production, and field use.

#### HP 3964A, 3968A Features

**Cost-saving 1/4-inch tape:** provides continuing savings for the life of the recorder. By using 1/4-inch tape, rather than 1/2-inch tape, users can save over 50 percent on tape costs.

**AC/DC calibrator:** provides an internal voltage source that simplifies the set up of input and output levels for each data channel. Six voltages, ac or  $\pm$ dc, can be pushbutton selected, applied, and monitored to check out each channel. In addition, there is an external connector to allow the use of scopes or other monitoring devices.

**Tach or tape servo control:** tach-servo and tape-servo systems are switch selectable.

**Flutter compensation:** improves the signal-to-noise ratio in FM by up to 12 dB in a vibrating environment. When switched on, flutter-generated noise introduced during record and reproduce is subtracted from all FM data channels during reproduce to improve performance. One FM channel is used for flutter compensation; this same channel can also be used for tape servo control, saving a data channel for recording when both flutter compensation and tape servo are required.

**Voice capability:** provides voice annotation capability on the fourth channel of the HP 3964A or the eighth channel of the HP 3968A, using the press-to-talk microphone. The voice channel accepts data only, voice only, or data with a voice interrupt. Microphone, speaker, and headphone jack are provided with both recorders.

**FM electronics-to-electronics (e-e) mode:** transfers the input signal automatically to output, bypassing the record/reproduce heads. This occurs when tape is below record/reproduce speed or in Fast Forward, Rewind, or Stop mode. E-E allows the unit to be set and calibrated without using tape.

#### Instrumentation Tape Recorder Notes

These technical application notes are available, at no charge, from your Hewlett-Packard sales office:

Topic	Application Note No.	HP Part Number
Dropouts	213-1	5952-2841
Crosstalk	213-2	5952-2844
Interchannel Time	213-3	5952-2848
Displacement Error		
Magnetic Tape Recording Handbook	89	5952-2820

#### HP 3964A, 3968A Transport Specifications

**Tape width:** 1/4 inch (6.3 mm)

**Reel size:** standard 7-inch (18 cm) plastic reel, totally enclosed by reel cover

#### Heads

**HP 3964A:** One 4-track record and one 4-track reproduce

**HP 3968A:** One 8-track record and one 8-track reproduce

Tape Speed* (ips)	15	7 1/2	3 3/4	1 7/8	1 5/16	1 5/32
Flutter (% p-p)	0.35	0.35	0.40	0.50	0.70	1.5
Time base error ( $\mu$ s)*	$\pm 4$	$\pm 5$	$\pm 7.5$	$\pm 15$	$\pm 25$	$\pm 50$
Start time (s) (typical)	3	1.5	0.9	0.5	0.5	0.5
Tape speed accuracy (s)	0.2	0.2	0.2	0.2	0.2	0.2

\*Tape servo operation

**Tape motion controls:** pushbutton selectable Forward Record, Reverse Record, Forward Play, Reverse Play, Fast Forward, Fast Rewind, and Stop

**EOT sensing:** tape drive stops automatically at the end of tape (EOT)

**Reel revolution counter:** 4-digit counter with pushbutton reset

# RECORDERS, PLOTTERS & PRINTERS

Instrumentation Tape Recorders & Degausser

Models 3964A, 3968A, 13064A Degausser (cont.)

391



## FM Record/Reproduce Specifications<sup>1</sup>

Tape Speed (ips)	Passband <sup>2</sup> (Hz)	Signal-to-noise <sup>3</sup> Ratio	
		HP 3964A	HP 3968A
15	dc-5000	48	46
7 1/2	dc-2500	48	46
3 3/4	dc-1250	48	46
1 7/8	dc-625	46	46
1 5/16	dc-312	44	44
1 5/32	dc-156	40	40

1. Based on use of Ampex 797 tape or equivalent
2. Frequency response over passband is  $\pm 1.0$  dB referenced to 10% of upper band edge frequency
3. Signal measured with carrier deviation  $\pm 40\%$  of upper passband without flutter compensation. Output filters of reproduce amplifiers selected for constant amplitude response. May also be selected for linear phase (transient) response

**Flutter compensation:** can improve signal-to-noise by up to 4 dB under static conditions and as much as 12 dB under conditions of vibration. Selected by rear panel switch.

**Distortion:** total harmonic distortion  $< 1.2\%$  @ 15 to 1 7/8 ips,  $< 2\%$  @ 1 5/16 to 1 5/32 ips.

**Linearity:**  $\pm 1.0\%$  of peak-to-peak output for best straight line through zero at  $\pm 40\%$  deviation

**DC drift:**  $\pm 0.1\%$  (max) of full scale output per  $^{\circ}\text{C}$

**Input level:** 1 V to 30 V (peak-to-peak); continuously adjustable

**Input impedance:** 100 k $\Omega$  nominal, shunted by  $< 100$  pF single-ended

**Output level:** 1 to 5 V (peak-to-peak); continuously adjustable

**Load impedance:** minimum load impedance 660  $\Omega$

## Direct Record/Reproduce Specifications<sup>1</sup>

Tape Speed (ips)	Passband ( $\pm 3$ dB) <sup>2</sup>		S/N Ratio (dB) <sup>3</sup>	
	HP 3964A	HP 3968A	HP 3964A	HP 3968A
15	70-64000 Hz	500-64000 Hz	38	36
7 1/2	50-32000 Hz	250-32000 Hz	38	36
3 3/4	50-16000 Hz	100-16000 Hz	38	36
1 7/8	50-8000 Hz	100-8000 Hz	38	36
1 5/16	50-4000 Hz	100-4000 Hz	38	35
1 5/32	50-2010 Hz	100-2000 Hz	37	35

1. Based on the use of Ampex 797 tape or equivalent
2. Reference to 10% of upper band edge
3. Referenced to a 500 Hz sine wave with a maximum of 1% third harmonic distortion when reproduced at 3 3/4 ips

**Input level:** 1 V to 30 V (p-p); continuously adjustable

**Input impedance:** 100 k $\Omega$  nominal, single-ended

**Output level:** 0.5 to 5 V (p-p); continuously adjustable

**Load impedance:** minimum load impedance 600  $\Omega$

**Calibrator:** internal signal source, peak ac and  $\pm$ dc levels of 0, 1.0, 1.414, 2.5, 5.0, and 10.0 volts  $\pm 2\%$

**Meter modes:** peak ac or dc, input or output

## HP 3964A, 3968A General Specifications

### Size

**HP 3964A:** 400 H x 427 W x 256 mm D (15.7" x 16.8" x 10.1")

**HP 3968A:** 445 H x 427 W x 256 mm D (17.5" x 16.8" x 10.1")

**Weight:** HP 3964A, 29.5 kg (65 lb); HP 3968A, 31.3 kg (69 lb)

**Power requirements:** 100, 120, 220, or 240 V,  $+5\%$ ,  $-10\%$ , 48-66 Hz; 110 W average

**Temperature:** storage,  $-40^{\circ}\text{C}$  to  $75^{\circ}\text{C}$ ; operating,  $0^{\circ}\text{C}$  to  $55^{\circ}\text{C}$ ; tape limit,  $10^{\circ}\text{C}$  to  $40^{\circ}\text{C}$

**Altitude:** storage, 15240 m (50000 ft); operating, 4500 m (15000 ft)

**Humidity:** the system, excluding tape limitations, will operate from 10% to 95% RH ( $25^{\circ}\text{C}$  to  $40^{\circ}\text{C}$ ), non-condensing

**Shock:** 30 g maximum (11 ms) non-operating

**Mounting:** rack mounting kit for equipment racks, 19-inch



HP 13064A

## HP 13064A Tape Degausser Specifications

**Tape size:** 1/4-inch (6.33 mm) tape on reels up to 10 1/2 inch (266 mm) in diameter

**Erasure:** 60 dB minimum

**Duty cycle:** one minute ON, three minutes OFF

**Size:** 67 H x 133 W x 171 mm D (2.6" x 5.25" x 6.75")

**Weight:** approximately 4.3 kg (9.5 lb)

**Power requirements:** 115 V ac  $\pm 10\%$ , 50-60 Hz (Opt 001); 230 V ac  $\pm 10\%$ , 50-60 Hz (Opt 002)

## HP 3964A, 3968A Options

### Record/Reproduce Channel Data Card Options

Option provides one data card. Specify one option for each channel, up to 4 for HP 3964A, up to 8 for HP 3968A.

**001** FM data card, standard

**030** FM data card, medical (must order Opt 009 or 010)

**002** Direct data card, standard

**031** Direct data card, medical (must order Opt 009 or 010)

### Medical ITR Options

**009** Medical version with white paint

**010** Medical version with standard paint

### Other Options

Specify no more than one of each option per mainframe

**003** Rear panel with BNC input/output connectors for each channel.

**HP 3964A**

**HP 3968A**

**004** Locking knob set (screwdriver adjustable)

**005** Metric speed annotation on pushbuttons

**007** HP-IB remote control of speeds and mode

**024** Loop adapter (accommodates 5 to 30-ft loop)

**026** Slides for 19 in. racks

**027** Slides for HP cabinets

**041** IRIG servo reference frequency

**070** Overlap. For two units. Provides automatic play/record commands for second recorder when first unit tape is low

## Ordering Information

**HP 3964A** 4-channel instrumentation tape recorder

**HP 3968A** 8-channel instrumentation tape recorder

**HP 13064A** Tape degausser (specify Option 001 for 115 V ac or 002 for 230 Vac, N/C for options)

**HP 13107A** Transit case for HP 3964A

**HP 13106A** Transit case for HP 3968A



# RECORDERS, PLOTTERS & PRINTERS

## Alphanumeric, 20 Column Thermal Printer

### Model 5150A

- Silent operation
- Optional scanner and clock
- Alphanumeric

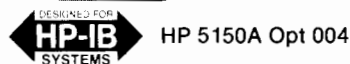
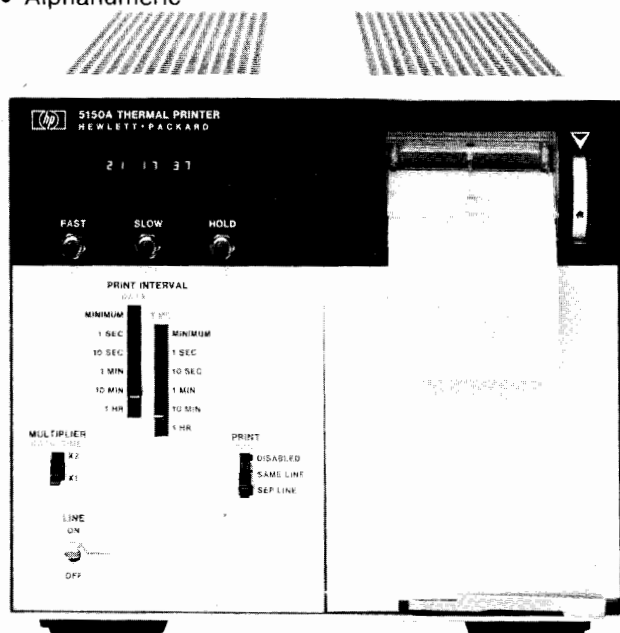

### General

The HP 5150A Thermal Printer is a versatile instrumentation printer designed to accept and record up to 20 columns of data from most HP digital instruments. Because it uses a thermal printing technique, it is extraordinarily quiet while in operation. Two input interfaces are available (one must be specified with the order) to allow data input from the HP Interface Bus (use Option 001) or from BCD-coded sources (use Option 002). Other options which add to the flexibility of this printer are the Option 003 Scanner, which can sequentially address and interrogate up to 13 instruments on the HP-IB, and the Option 004 Clock, which can be used with either the HP-IB or BCD Interfaces.

### Opt 001 HP-IB Interface

With Option 001 installed, the printer can accept up to 20 ASCII characters per line via the HP-IB. Inputs are interpreted according to the 64 member upper-case ASCII character set. With this interface, the printer can also serve as an "addressable listener" in a controller-based HP-IB system. HP-IB cable not supplied.

### Opt 002 BCD Interface

With Option 002 installed, the printer will accept 10 columns of TTL-level BCD data. Two Options 002's may be installed for 20-column print-out from one or two sources. The standard 16-member character set consists of 0 through 9, +, -, V, A, R, and [blank]. Special characters set which draw from the 64-character upper-case ASCII set may also be specified.

### Opt 003 Scanner

With both Options 001 and 003 installed, the printers can log data from up to 13 instruments on the HP-IB. Operation is asynchronous; that is, the printer will address the lowest address instrument, wait for data, print, then go to the next instrument.

### Opt 004 Clock

Used with either the HP-IB Interface or BCD Interface, this option gives the printer two additional capabilities: it can control the elapsed time between successive data printouts, and it can print the time of day immediately following each data printout. When used with the Option 003 Scanner, the clock controls the elapsed time between the initiation of successive scans.

### Specifications

**Character printer:** 5 × 7 dot matrix.

**Printing rate:** 3 lines per second.

**Line spacing:** approximately 2.5 lines per cm. (6 lines per inch).

**Paper advance mechanism:** direct drive, stepping motor.

**Paper:** thermal sensitive, in rolls (one roll supplied).

**Operating environment:** 0°C to 50°C temperature; 95% relative humidity.

**Power:** 100, 120, 220, or 240 volts, 48 to 440 Hz (50 or 60 Hz only for Opt 004), 100 VA.

**Dimensions:** half-rack module, 178 mm H x 216 mm W x 356 mm D (7" x 8½" x 14¼").

**Weight:** approx. 7 kg (16 lb) (HP 5150A +1 option).

### HP-IB Interface (Opt 001)

**Columns:** 20.

**Printed character set:** 64 ASCII characters (columns 2, 3, 4, and 5 of ANSI X3.4-1968, except "↑" in column 5, row 14).

**Input logic levels:** TTL (low <0.4 V, high >2.5 V).

**Data format:** byte-serial with storage, compatible with HP-IB.

**Inhibit (output):** holds NRD line of HP Interface Bus low following receipt of either CR or LF (selectable) until print is completed. This interval is approx. 250 ms minimum, or the duration of Option 004 Clock data print interval with clock in Hold mode.

### BCD Interface (Opt 002)

**Columns:** 10 (20 columns with two Options 002's installed).

**Character set:** 0 through 9, +, -, V, A, R, and [blank].

**Input logic levels:** TTL (low <0.4 V, high >2.5 V).

**Data format:** parallel BCD (8421); switch selects + or - true logic.

**Print command:** pos. or neg. TTL transition; 2 kΩ input impedance.

**Inhibit (output):** + or -, same levels as above; remains at true level until print is completed (approx. 250 ms minimum) or during Option 004 Clock data print interval with clock in Hold mode.

### Scanner (Opt 003)

**Instruments scanned:** 1 to 13.

**Cycle time of scan:** limited by the slowest of (a) response of instruments scanned, (b) 3 samples per second, or (c) Data Print Interval setting on Option 004 Clock.

**Compatibility:** HP Interface Bus (utilizes ASCII code).

**Identifier:** labels data line of each instrument with letters A-M.

**Protect feature:** bypasses non-responding instrument after 3 s.

### Clock (Opt 004)

**Data print interval:** selectable by front panel switches: minimum, 1 s, 2 s, 10 s, 20 s, 1 min, 2 min, 10 min, 20 min, 1 h, 2 h. Print interval will be that of input device if it is slower than the selected interval.

**Time print interval:** selectable by front panel switch, same intervals as above (intervals shorter than data interval prevented).

**Time print format:** selectable by front panel switch: disabled, same as data, or separate line from data.

**Display:** six-digit, seven-segment LED display of hours, minutes, seconds (00:00:00 to 23:59:59); settable via front panel switches.

**Time base:** line frequency (50 or 60 Hz, selectable by jumper).

### Operating Supplies/Accessories

HP 9281-0401 6-Roll box of paper, 76 metres (250 feet) each

HP 10533A BCD Interface Cable for HP 5300A

HP 10833A Interface Bus Cable, 1 metre

HP 10833B Interface Bus Cable, 2 metres

HP 10833C Interface Bus Cable, 4 metres

HP 10833D Interface Bus Cable, 0.5 metre

### Options

**001:** HP-IB Interface

**002:** BCD Interface

**003:** Scanner

**004:** Clock

**005:** BCD Interface Cable (HP 562A-16C)

**910:** Extra manual

### HP 5150A Thermal Printer



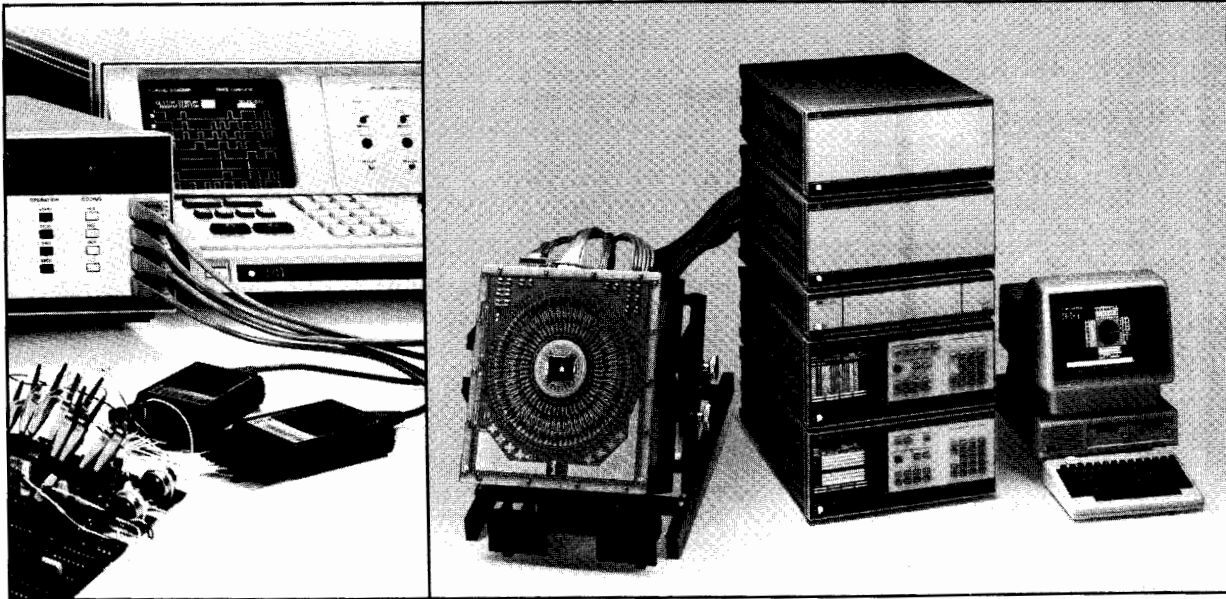

## Engineering Efficiency

HP's data generators and data analyzers are engineering tools which enhance, and, at the same time, simplify the evaluation of digital hardware. Enhanced because at-speed testing assures performance. Simpler because bench-top transportability plus front panel and HP-IB access mean quick set-up and fast response to engineering problems. Variable parameters and programmable data save time and equipment because they make dedicated solutions and unwieldy arrays of many different instruments unnecessary.

## Independence

Data generators and analyzers functionally test digital devices under real conditions independent of supporting hardware or large test systems. Models with variable timing and levels permit full characterization, are convenient and need no additional equipment.

Project times are consequently shortened because parallel development is feasible, and problems are detected earlier in design and

production engineering phases. Equipment accessibility makes QA and materials engineering less dependent on other areas, and at-speed module testing enhances system assurance.

Long term investment is ensured through flexibility. Pulse performance and choice of levels ensure suitability for all common logic families, and quality connectors mean swift adaptation to an IC, IC prototype, breadboard, board, module, etc., with specified performance at the device.

Separate packaging saves equipment and promotes mobility because the generators and analyzers can be paired to match input and output needs. Also, separate use is feasible for either multi-channel output devices which are essentially stimulus-independent, or multi-channel input devices with "simple" outputs which can be effectively monitored with an oscilloscope or voltmeter.

## Comprehensive

Data generators: include the Serial generators HP 8018A, for PCM and similar applications, and the sub-nanosecond HP 8080A.

Multi-channel requirements are met by the HP 8170A, with additional capability for hand-shake devices, and the HP 8016A with variable timing. High pin-count requirements are solved by the HP 8180A which has extensive timing capability and can be configured to the number of channels needed.

**Analyzer:** at-speed functional and ac-parametric testing is covered by the HP 8182A which is extendible for high pin counts on all types of digital hardware.

## Direct Measurement of ac Parameters

Performance credibility demands full specification of all timing and level criteria. With variable analog timing and levels, the HP 8180A Data Generator and HP 8182A Analyzer form a compact, comfortable solution for all engineering investigations. Parameters such as setup, hold and propagation times, sensitivity and dynamic fanout capability are measured directly. High resolution allows the exact pulse shape to be delivered, and precise sampling.

## Selection Chart

APPLICATION	Model Page	GENERATORS					ANALYZER
		8080 A 320	8018 A 175	8016 A 173	8170 A 174	8180 A/8181 A 170	8182 A 170
Functional and AC Parametric Test Functional Test only		ECL Digital Hardware	ECL, TTL, CMOS Serial Digital Hardware	ECL, TTL Digital Hardware	TTL, CMOS Digital Hardware, I/O.	ECL, TTL, CMOS and Mixed Logic IC's, Prototypes, Breadboards, Boards and Modules.	
Data Rate (Bits/s)		300 M	50 M	50 M	2 M	50 M	50 M
Channels		1-4	2, serializable	9, serializable	16	8-64	8-32
Bits/Channel		64	1k + prbs	32	1 - 4k	1k	1k
Variable Parameters		Level, Delay, Width	Level	Delay Width	—	Levels, Delays, Widths	Thresholds, Sampling Delay, Real-time Window



# DATA GENERATORS & DATA ANALYZERS

## Data Generator/Analyzer System

Models 8180A, 8181A, 8182A

- Digital ac parametric and functional characterization
- 50 MHz, 1 kbit/channel
- Direct measurements, 100 ps/10 mV resolution

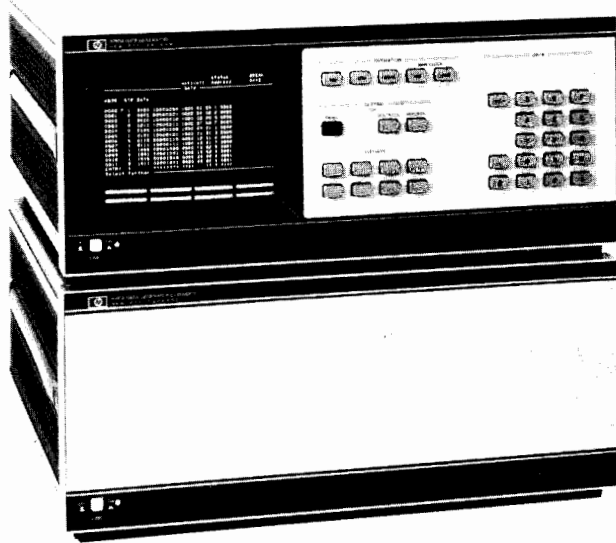

Upper: HP 8180A Data Generator  
Lower: HP 8181A Data Generator Extender  
Up to 64\* channels with HP 8180A and two 8181A's.

- Variable sampling point delay in synchronous operation
- Real-time data comparison
- Convenient softkey operating concept with live keyboard

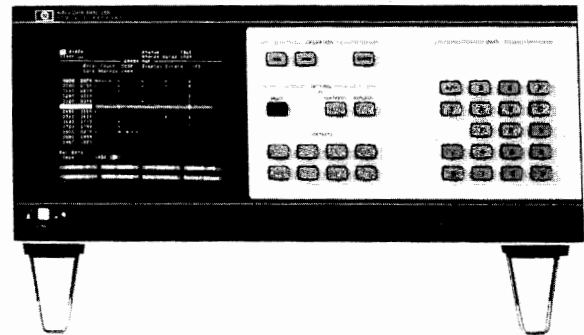

HP 8182A Data Analyzer (up to 32\* channels)

\*Number of channels can be doubled by parallel operation.

### An Affordable Engineering Tool for At-Speed Characterization of Digital Hardware.

This compact, benchtop system is designed for manual and automatic engineering investigations on all types of digital hardware. It also upgrades ATS to at-speed testing. Features such as the same high resolution for generator and analyzer, and matched control signals, guarantee the viability of these measurements. Modularity promotes cost-effectivity because the number of channels can be increased without loss of speed or memory.

The same guided operating concept speeds familiarization, and common HP-IB syntax and free format accelerate programming. Live keyboards give rapid parameter access without changing software. Data entry is simplified by the selectable patterns and extensive edit features. Mixed logic needs are solved because up to 6 different levels can be assigned to any number of individual channels.

**Data Generator** Timing capabilities include individual delay and

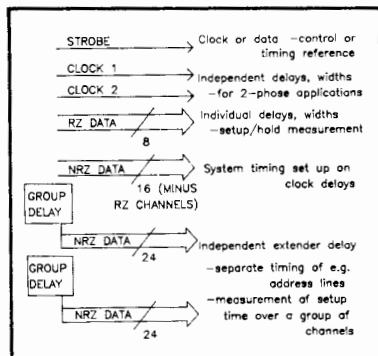

width on two clock channels for dual-phase applications, and on RZ data channels for setup and hold time measurements. HP 8181A Extender group delay allows separate timing of e.g. simulated address signals.

High-speed pulses and clean shape provide performance for all common logic. Variable, high resolution, levels allow worst-case conditions to be measured. The segmentable memory allows initiating and loop data (with exit on external command) to be set up.

**Data Analyzer** In addition to at-speed analysis, comparison and glitch detection, the HP 8182A also measures multichannel output timing like propagation delays because the sampling point is variable.

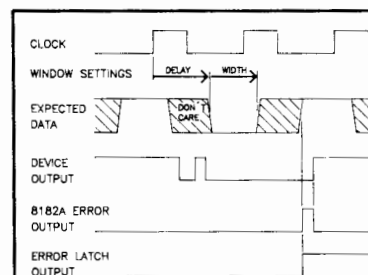

For investigations in e.g. the setup/hold interval, a real-time compare mode examines data stability throughout a programmable window: any deviation from the expected state is displayed and error signals permit operations such as 'stop on error' for trapping sporadic faults.

#### Real-time Compare Mode

Checks validity of each output data transfer.

#### Dual Threshold Mode

Checks out high and low levels simultaneously to verify dynamic performance at a glance.

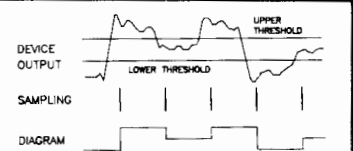

## Specifications

Specifications apply for operating temperatures from 0°C to 50°C.

### HP-IB Interface Functions

**HP 8180A, 8181A:** SH1, AH1, L4, SR1, RL1, T6, PP0, DC1, DT1, C0, E2.

**HP 8182A:** SH1, AH1, L4, SR1, RL1, T6, PP0, DC1, C0, E2.

## HP 8180A/8181A Data Generator/Extender

### Memory and Channels

**Memory depth:** 1024 bit/channel.

**Number of channels:** up to 64 using HP 8180A with two HP 8181A Extenders. Up to 128 channels with 2 sets of equipment in parallel operation.

### HP 8180A Channels

**RZ (return-to-zero) channels:** independent variable delay and width in each of up to 8 channels.

**NRZ (non-return-zero) channels:** Up to 16 channels minus the number of RZ channels. Fixed timing.

**Strobe channel:** NRZ data or clock. Fixed timing.

**Clock channels:** independent delay and width in each of 2 channels. Clock 1 can be selected to run continuously in Break state (see "Cycle modes").

### HP 8181A Channels

**NRZ:** up to 24 channels. Fixed timing within an Extender, group delay with respect to HP 8180A.

### Memory Segmentation

**Active Segment:** user-defined by first and last addresses (FAD, LAD) in the range 0 to 1023. Store/recall allows 10 different FAD/LAD pairs to be stored.

**Initializing segment:** segment 0 to FAD initializes DUT.

### Memory Loading

**Codes:** bin, oct, hex, dec (address codes: oct, hex, dec).

**Entry:** Keyboard or HP-IB.

**Displayed channel order:** user-defined.

**Line edit:** insert, delete, macro.

**Channel edit:** clear, set, copy, prbs, counts, entry mask.

### Cycle Modes

Single, Auto, Initialization + Auto, Gated, Initialization + Gated. (Initialization data is output at the beginning of the first cycle only).

**Break state:** implemented by manual or external BREAK command or by strobe channel bit. Data is held at current address. Manual or external RUN command cause same cycle to continue.

**Stop state:** implemented by manual or external STOP command. Data is held at current address and the cycle is terminated. Manual or external RUN command trigger a new cycle.

### Timing

**Clock period:** 20 ns to 950 ms (1.05 Hz to 50 MHz). Ext clock 0 to 50 MHz.

**Delay (relative to strobe channel):** 0.0 ns to 950 ms, max 90% period - 18 ns.

**Width:** 10.0 ns to 950 ms, max 90% period - 8 ns.

**Skew:**  $\leq 2$  ns for NRZ channels and RZ channels programmed for zero delay.

**Resolution:** 3 digits (best case 100 ps).

**Accuracy:**  $\pm 5\%$  of programmed value  $\pm 1$  ns.

**Jitter:**  $\leq 0.2\% + 100$  ps (+additional 50 ps for delay and width).

### Outputs

**Output impedance:** 50 Ohm.

**Data and clock:** 4 different high level/low level pairs can be defined and assigned to any number of individual outputs. Each channel has independent normal/complement switching. Common "off".

**Read-out:** can be selected for 50-Ohm or high-impedance load (common selection for all channels).

	50-Ohm load	High-impedance load
<b>High level:</b>	-1.50 to +5.50 V	-1.00 to +17.0V
<b>Low level:</b>	-2.00 to +5.00 V	-2.00 to +16.0 V
<b>Resolution:</b>	3 digits (10 mV)	3 digits (best case 20 mV)
<b>Amplitude:</b>	0.5 to 5.5 V	1.0 to 17 V

### Transitions

**10% to 90%:** (3 + 0.2 |amp|) ns (3 + 0.5 |amp|) ns

**20% to 80% at ECL levels:** 1.5 ns.

**Strobe:** ECL/TTL selectable.

## HP 8182A Data Analyzer

### Memory and Channels

**Memory depth:** 1024 bit/channel.

**Number of channels:** up to 32. Can be doubled by parallel operation of two HP 8182A's.

**Expected data memory:** 1024 bit/channel, segmentable.

**Codes:** bin, oct, hex (address code: dec).

**Entry:** Keyboard, HP-IB or read-in from DUT.

**Displayed channel order:** user-defined.

**Line edit:** word mask (don't care), insert, delete.

**Channel edit:** clear, set, copy, mask (don't care), exchange.

### Modes

**Analysis/store-and-compare:** synchronous sampling with variable analog sampling point delay or asynchronous sampling. Comparison with expected data, if required.

**Displays:** state list, diagram or error map.

**Glitch detection:** down to 5 ns. Memory depth is halved when glitch detection is selected.

**Trigger condition:** can be selected to start or stop analysis.

**Real-time compare:** comparison of actual with expected data throughout a time window. Window has variable analog delay and width. Real-time and latched error output signals are provided.

**Display:** error map.

**Trigger condition:** starts comparison.

### Timing

**External clock:** 0 to 50 MHz.

**Delay (relative to external clock):** 0.0 ns to 1 s, max 95% period - 1 ns.

**Compare window width:** 10.0 ns to 1 s, max 95% period - 9 ns.

**Channel skew:**  $\leq 2$  ns.

**Resolution:** 3 digits (best case 100 ps).

**Accuracy:**  $\pm 5\%$  of programmed value  $\pm 1$  ns.

**Internal clock:** 1 Hz to 50 MHz. (1-2-5 steps).

### Inputs

**Data:** 6 different thresholds or dual threshold pairs can be defined and assigned to any number of individual inputs. Each measuring channel selected for dual threshold operation occupies two normal channels.

**Clock:** programmable threshold and selectable slope (positive, negative, both).

**Input impedance:** 1 M $\Omega$ ,  $< 7$  pF.

**Control signals:** (100 k $\Omega$ /50  $\Omega$  selectable input impedance)

**Trigger arm and ext stop signals:** independent programmable thresholds and selectable slope (positive, negative, don't care).

**Trigger qualifier and clock qualifier signals:** independent programmable thresholds and selectable levels (high, low, don't care).

**Threshold range:** -10.0 to +10.0 V.

**Dynamic range:** threshold  $\pm 10$  V.

**Resolution:** 3 digits (best case 10 mV).

### Trigger

Trigger arm, word and qualifier, digital filter (1 to 16), clock and qualifier, delay (0 to 65535).

### Ordering Information

**HP 8180A Data Generator\*** (includes 8 NRZ channels)

**Opt 001** 4 additional NRZ channels

**Opt 002** 4 additional RZ channels

**HP 8181A Data Generator Extender** (includes 8 NRZ channels)

**Opt 001** 4 additional NRZ channels

**HP 8182A Data Analyzer\*** (includes 8 channels)

**Opt 001** 8 additional channels

### Accessories and Information

Refer to the next page for accessories. For more detailed information, the following publications are available: Product Brochure (5952-9548), Application Note 319 (5952-9549), HP 8180A/81A Technical Data (5952-9550), HP 8182A Technical Data (5952-9551), HP 15413A/14A Technical Data (5952-9556).

\*HP-IB cables not included, see page 675



# DATA GENERATORS & DATA ANALYZERS

Tri-State and Accessories for 8180/81/82A

Models 15406A to 15416A and 15421A to 15423A

## TRI-STATE EQUIPMENT, HP MODELS 15413A/14A

- 4-24 channels
- Levels programmable via 8180/81A
- Selectable 'inhibit' conditions
- Fast tri-state switching

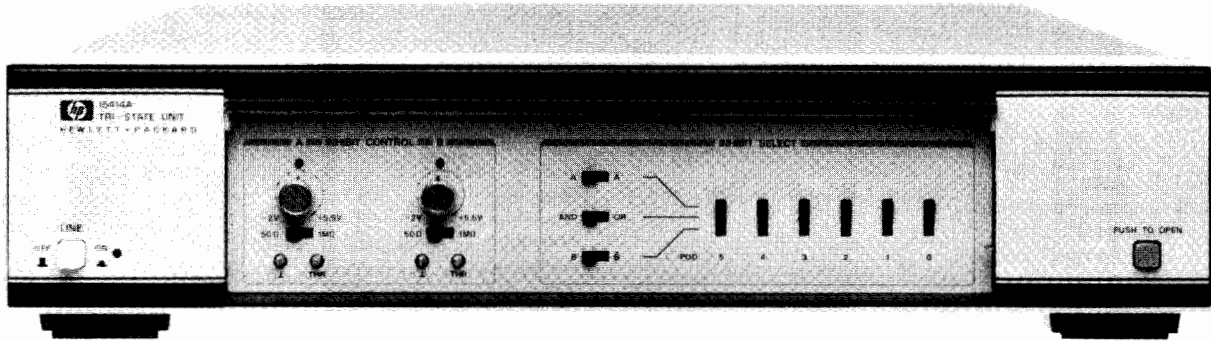

HP 15414A Tri-State Unit

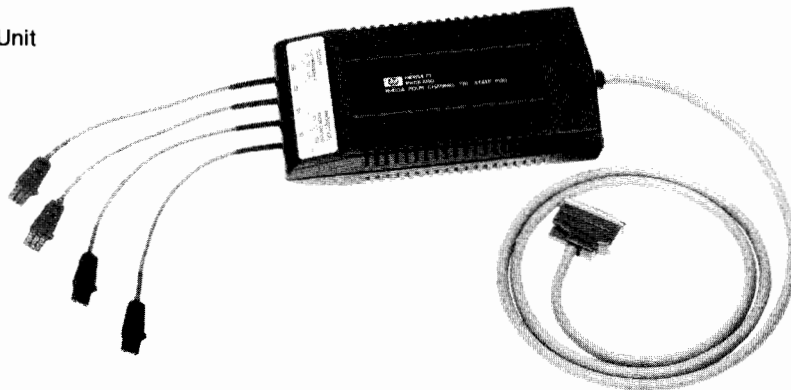

HP 15413A Tri-State Pod

The HP 15414A Tri-State unit and the HP 15413A Tri-State pods were developed in order to electronically disconnect the data generator/extender from a data bus. This is necessary in applications where other devices control the same bus lines. The data outputs are switched to high impedance by one or two inhibit signals applied to the HP 15414A. Selectable inhibit conditions allow individual control of 1 to 6 pods, each of which carry 4 data lines. The maximum data rate remains 50 MHz.

### HP 15413A Specifications

**Number of channels:** 4

#### On-State Characteristics

**Input level range:** -2V to 5.5V

**Output level accuracy (into open):** add +/- 50 mV to 8180A accuracy

**On-resistance:** < 30 Ohm

**Output transition time (into open) for a 5 V HP 8180/8181A input signal:** < 7ns

**With 100 pF load:** < 12ns

**Skew across all pods:** add 2ns to HP 8180A/81A specification

#### Off-State (Tri-State) Characteristics

**Off-resistance:** > 1 MOhm

**Residual capacitance:** < 35pF (typ. 30pF)

**Leakage current:** < 1μA

**t-on, t-off propagation delay with respect to inhibit input:** < 40ns

### HP 15414A Specifications

**Number of channels:** 24 (up to 6 x 15413A can be connected)

**Inhibit threshold range:** -2V to + 5.5V, adjustable

**Inhibit threshold accuracy:** voltage at monitor point +/- 50mV

**Inhibit threshold overdrive:** > 50 mV

**Min. inhibit amplitude:** 100mVpp

**Inhibit impedance:** switch selectable 50 Ohm/1 MOhm, 20pF

#### Ordering Information

HP 15414A Tri-State Unit

HP 15413A Tri-State Pod

Each pod includes a set of grabbers (HP 15408A)

### HP 8180A/8181A/8182A/15413A

#### ACCESSORIES

HP 15406A 8182A clock probe (supplied)

HP 15407A 8182A cable set with probes for 4 data channels (supplied)

HP 15408A 5 plug-on grabbers with ground leads (supplied with 8182A and 15413A)

HP 15409A 5 plug-on BNC adaptors (available)

HP 15410A 5 plug-on SMB adaptors (available)

HP 15411A 5 plug-on coax open-end adaptors (available)

HP 15412A 20 solder-in receptacles (supplied)

HP 15415A 5 plug-on miniproboscopes (for HP 10024A IC test clip) (available)

HP 15416A cable for parallel operation of 2 each HP 8182A (available)

HP 15421A cable for parallel operation of 2 each HP 8180A (available)

HP 15422A 8180A cable set for clock 1, clock 2 and strobe (supplied)

HP 15423A 8180/81A cable set for 4 data channels (supplied)



## HP 81800A Software Pac

The HP 81800A Software Pac reduces the software development time for HP 8180/81/82A instruments by providing programs and sub-programs which enable the user to perform measurements with a minimum of programming effort. With the Software Pac, the user can easily expand the HP 8180/81/82A measurement system to utilize the controller capabilities of an HP Series 200 computer for mass storage, documentation, and the measurement automation of appropriate peripheral instruments.

### The HP 81800A Software Pac comprises two program types:

The first is a ready-to-run program offering semi-automatic measurement capabilities, which are selected via SOFTKEY operation. The program allows the fast initialization of test sequences by an operator with little or no programming experience. In addition, management of an extended test database is facilitated and documentation aids are provided.

The second program type consists of multiple sub-programs and utility programs, which support the effective development of application software. The user can link the prepared measurement sub-programs to his testplan.

## HP 15424A Performance Board

The HP 15424A Performance Board offers high-quality connection and convenient adaptability to a Device Under Test (DUT). The product consists of a printed circuit motherboard, a device-dedicated, exchangeable DUT board and a kit containing connectors, screws and spacers etc. The whole package is designed to provide maximum flexibility for user configurations, and is assembled and configured by the user, according to his requirements.

The board has been designed with 50 Ohm strip-line signal paths to ensure high-speed pulse performance, and has a hollow center for wafer probing applications. Pads for relays, connectors, termination and user-defined circuits are provided. 84 pins allow the user to connect 57 single and 27 dual-directional HP 8180/81/81A channels to the board. The exchangeable DUT boards are compatible with industry standards. Additional DUT Boards are supplied as separate items.

## HP 15425A Test Head

This product is a complete, high-quality solution for interfacing the HP 8180/81/82A channels to the DUT in automated testing applications. The Test Head is supplied in a metal case and consists of an HP 15424A Performance Board, with connectors for the HP 8180/81/82A channels already fitted. A mechanism for cable fixturing and wafer prober/IC handler fixtures are also provided. An electrical interface allows relay switching to be performed via the HP-IB. Thus, switching between a dc parametric measurement instrument (e.g. HP 4140B or 4145A) and the HP 8180/81/82A AC parametric measurement system can become automated.

## Accessories

**HP 15426A solder-in receptacles:** Supplied in a pack of 20, these receptacles are for use with the HP 15424A Performance Board, offering a high-speed connection to the measurement system cables. The solder pins have 0.3" spacing.

**HP 15428A:** A pack of 20 dual-in-line relays for use with the HP 15424A Performance Board. Maximum current 250 mA.

## Ordering Information

HP 81800A Software Pac  
HP 15424A Performance Board  
HP 15425A Test Head  
HP 15426A Receptacles  
HP 15427A DUT Board  
HP 15428A Relays

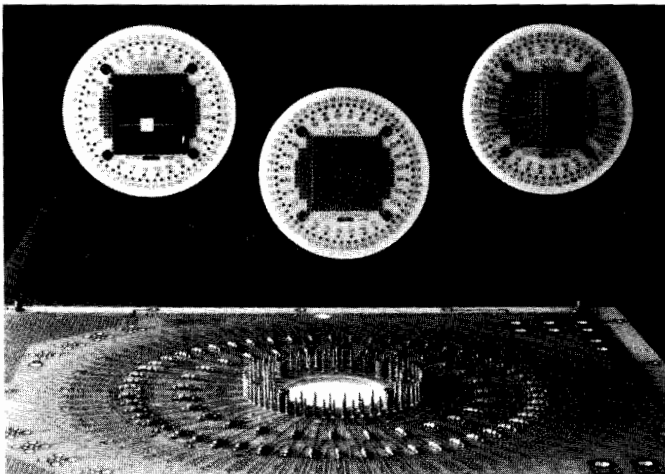



# DATA GENERATORS & DATA ANALYZERS

## 9-Bit Parallel, 32-Bit Serial, 50 MHz Word Generator

Model 8016A

- 2 complementary outputs per channel, RZ/NRZ formats
- Variable RZ width, 4 delay channels
- Channel serializer
- TTL/ECL output levels selectable

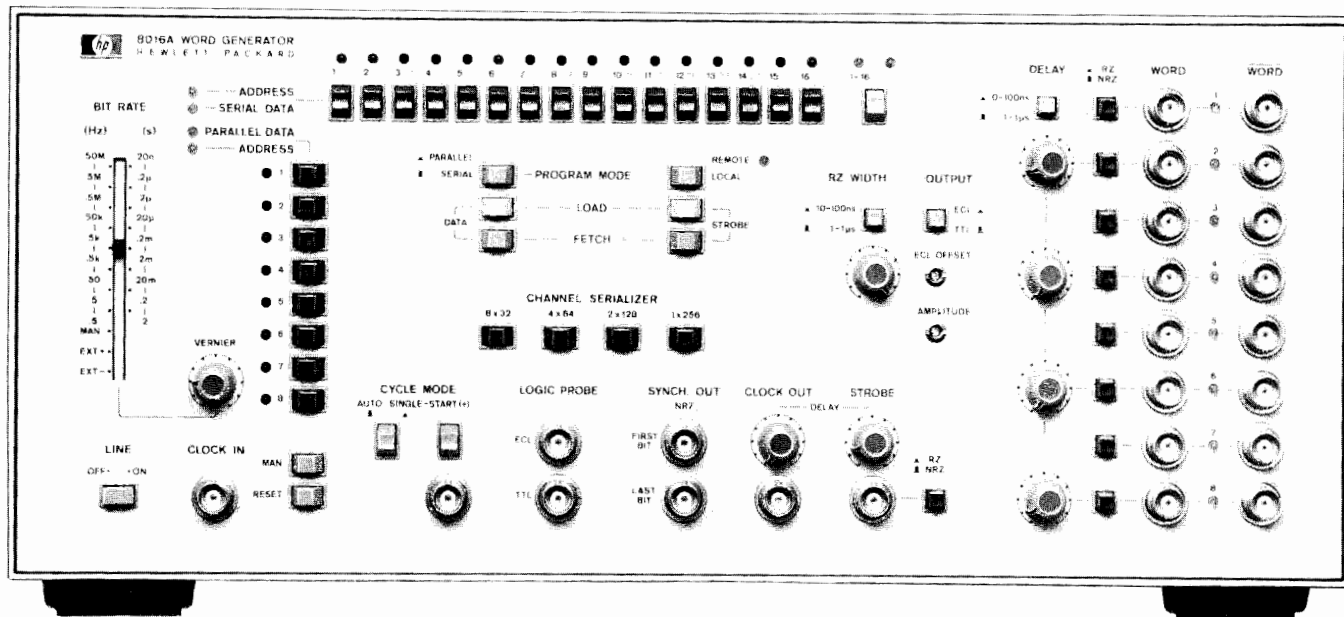

HP 8016A with Option 001



The HP 8016A is a 9-channel data generator capable of serialization up to 256 bits. For the digital designer the HP 8016A is a natural companion to multichannel data display devices such as logic analyzers. As a bench or systems component, the HP 8016A provides programmable digital patterns plus adjustable timing parameters necessary for testing ICs and circuit boards.

### Functional Test

Bit pattern programmability combined with fast cycle time (50 MHz clock) make the HP 8016A especially effective in simulating worst case conditions, e.g. high speed IC testing. The HP 8016A saves time in component evaluation environments because test setups can be rapidly built and reconfigured to meet the demands of testing small quantities of a wide variety of IC types.

### Parametric Test

Complete testing of digital circuits and systems requires not only digital patterns for functional test but control of the analog parameters of the pulses as well. Adjustable pulse widths, levels, and interchannel delays contribute to measurements such as setup and hold times, clock pulse width sensitivities, and system sensitivity to propagation delay variations. To meet these testing requirements, the HP 8016A includes 6 independent delay circuits. Output levels of the HP 8016A's 50  $\Omega$  output amplifiers are selectable for ECL or TTL test specifications and can be adjusted. In addition, a choice of RZ or NRZ formats with variable RZ pulse width is provided.

### Specifications

**Data capacity:** 8 data channels plus 1 strobe channel, each 32 bits. 8 data channels can be serialized as four 64-bit channels, two 128-bit channels or a single 256-bit channel.

**Data loading:** address channel, enter 32 serial bits in that channel. Alternatively, address parallel word, enter (max 8) bits in that word. Addressing/entry by pushbuttons/LEDs or via HP-IB (option 001).

**Data Outputs:** (50  $\Omega$  source into 50  $\Omega$  load).

**Format:** independent RZ/NRZ selection in each channel.

**RZ width:** single continuous adjustment in ranges 10-100 ns, 0.1-1  $\mu$ s.

**Width jitter:**  $\leq 0.2\% + 50$ ps

**Complement:** simultaneous normal and complement outputs for each channel.

**Delay:** channels 2, 4, 6, 8 can be delayed independently within the ranges 0-100 ns, 0.1-1  $\mu$ s with respect to odd channels.

**Jitter:**  $\leq 0.1\% + 5$  ps

**Skew (undelayed):**  $\pm 1$  ns

**Levels:** ECL/TTL selectable

**Transition times:**  $\leq 3.0$  ns (ECL  $\leq 2.5$  ns)

**Bit Rate**

**Internal:** 0.5 Hz to 50 MHz.

**External:** dc to 50 MHz, or manual.

### Data Cycling

**Auto:** Sequence recycles continuously.

**Single cycle:** Sequence is triggered/gated by external pulse/level.

### General

**Operating temperature:** 0°C to +50°C.

**Power:** 100/120/220/240 Vrms; +5%, -10%; 48 Hz to 66 Hz, 200 VA (maximum)

**Weight:** net, 14.5 kg (32 lb). Shipping 16 kg (35.3 lb).

**Size:** 177 H x 426 W x 422 mm D (7" x 16.8" x 16.6").

### Ordering Information

HP 8016A Word Generator

**Opt 001:** HP-IB for data loading\*

**Opt 907:** Front Handle Kit (Part No. HP 5061-0090)

**Opt 908:** Rack Flange (Part No. HP 5061-0078)

**Opt 909:** Opt 907, 908 combined (Part No. HP 5061-0084)

**Opt 910:** Additional Operating and Service Manual

\*HP-IB cables: Refer to page 675.



# DATA GENERATORS & DATA ANALYZERS

Logic Pattern Generator

Model 8170A

399



- 8k memory (32k option)
- 8 bit/16 bit parallel output



- 2 wire/3 wire handshake capability
- Internal and external addressing

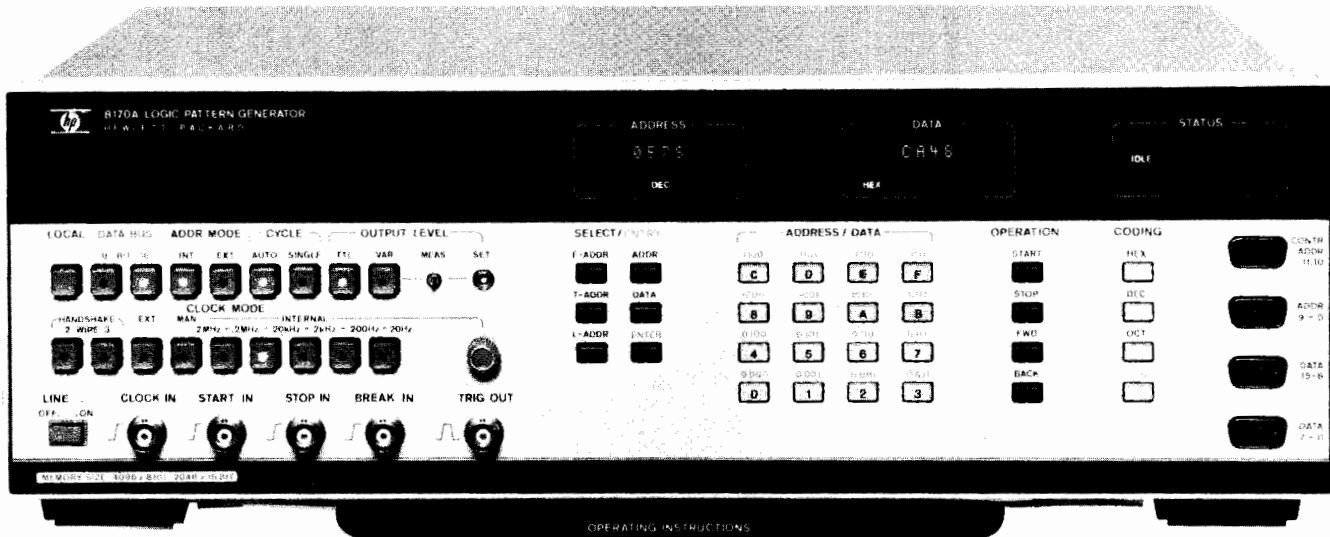

HP 8170A with Option 001



Parts, memories and peripherals can be verified at all stages in design and production because the HP 8170A allows testing in isolation from the system. Busses or devices can be stimulated synchronously or asynchronously with data from the HP 8170A's memory. Address outputs (Option 002) allow writing into a RAM for subsequent comparison on e.g. a logic analyzer. In external address mode, software can be set up, verified and modified in the HP 8170A before committing ROM's.

The HP 8170A memory can be programmed manually, via HP-IB or by selecting one of the fixed patterns. User codes can be used directly because conversion is handled automatically.

## Specifications

**Memory:** 8 kbit (32 kbit Opt 001). 8- or 16- bit width, selectable. Freely programmable or selectable patterns (Set/reset/prbs/count up/down).

### Address Modes

**Internal:** ascending sequence between user-defined addresses.

**External:** 10-line address plus 4 enable lines. Max rate 2 Mbit/s.

### Clocking

**Internal:** 20 Hz to 2 MHz in 5 ranges.

**External:** dc to 2 MHz.

**Manual:** forward/backward data stepping.

**Handshake:** 2-wire/3-wire (IEEE 488) selectable.

### Cycle Modes (applies to Int Address mode)

**Auto cycle:** data cycled continuously.

**Single cycle:** data is cycled once per Start In command.

### Outputs

**Data:** 8 or 16 lines, selectable. Pos/neg true selectable.

**Control:** data Valid. Pos/neg true selectable.

**Status:** 2 lines indicate whether data is clocked, static or off.

**Levels:** TTL or adjustable +3 V to +15 V.

**Address (via Opt 002 pod):** 10 lines, +2.4 V true, +0.5 V false.

## Inputs

**Address:** 10 lines (12 lines in Opt 001).

**Control:** ready for Data and data accepted lines.

**Enable:** 4 lines.

**Levels:** high +2.0 V, low +8.0 V.

**Remote control:** HP-IB, RS-232C (CCITT V.24).

## HP-IB

**Interface functions:** SH1, AH1, L4, SR1, RL1, T5, PP0, DC0, DT0, C0.

## General

**Power:** 100/120/220/240 V rms; +5%, -10%; 48-66 Hz, 110 VA max.

**Operating temperature:** 0°C to 55°C.

**Weight:** net 11 kg (24.3 lbs). Shipping 15 kg (33.2 lbs).

**Dimensions:** 133 H x 426 W x 422 mm D (5.2" x 16.8" x 16.6").

## Ordering Information

HP 8170A Logic Pattern Generator\*\*

**Opt 001:** 32 kbit Memory

**Opt 002:** Address Driver Pod (HP 15452A)

**Opt 907:** Front Handle Kit (HP part number 5061-0089)

**Opt 908:** Rack Mount Kit (HP part number 5061-0077)

**Opt 909:** Opt 907, 908 combined (HP p/n 5061-0083)

**Opt 910:** Extra Operating and Service Manual

**HP 15457A Pod Connector** (Pods can be easily plugged into DUT when this accessory is wired in)

**HP 15459A** 1.5 m pod extension cable

## Supplied Accessories

**HP 15453A** Address input pod

**HP 15454A** Control Pod

**HP 15455A** Data Pod (D0-D7)

**HP 15456A** Data Pod (D8-D15)

**HP 15458A** Snap-on Assembly (one per pod)

**HP 10230-62101** Hook-on Clip

\*For more on these codes refer to the HP-IB section of this catalog.

\*\*HP-IB cables not furnished, see page 675.

# DATA GENERATORS & DATA ANALYZERS

## 50 MHz Serial Data/PRBS Generator

Model 8018A

- 2048 bit, dual channel memory
- Variable word and pattern length
- TTL, ECL, CMOS compatible
- Programmable, prbs and mixed data

Option 001

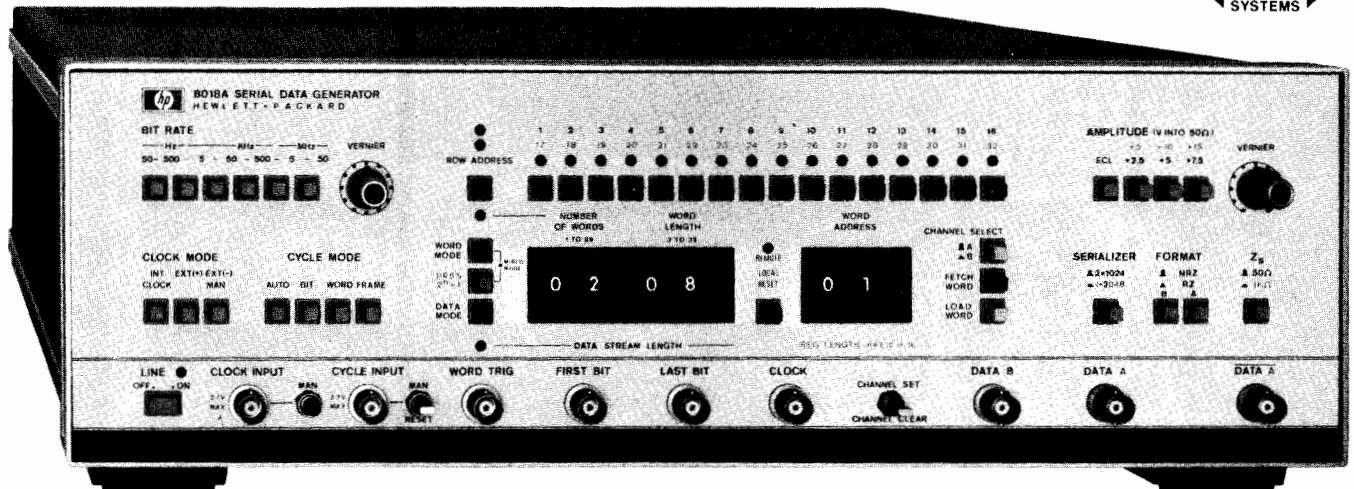

### HP 8081 With Option 001

With 2048 programmable bits, and a choice of pseudo-random binary sequences (prbs) ranging to over 1 Mbits, the HP 8018A is a powerful stimulator for serial digital systems and devices requiring high bit rate and fast pulses. Even preamble-data-post-amble data link patterns are feasible by combining prbs and programmed data. Useful synch outputs simplify testing by locking scope or analyzer to unique points in the data stream.

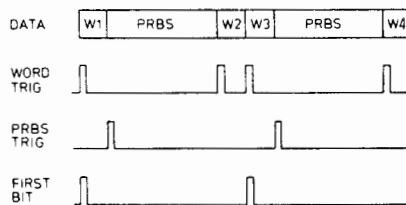

For data link patterns, mixed mode inserts a prbs after each odd word.

For dual-channel applications, the memory splits so that the outputs have independent 1 Kbits of data.

A high performance output amplifier adds to the HP 8018A's wide applicability. It delivers clean, 6 ns pulses with repetition rates from dc to 50 Mbits/s. Output amplitude is variable up to 15 volts into 50 Ω. This enables you to directly drive logic circuits ranging from TTL to CMOS. Output levels for emitter-coupled-logic (ECL) are also provided.

To handle patterns for repetitive tests more conveniently, data can be loaded via HP-IB (Option 001).

## Specifications

### Data Capacity and Modes

**Programmable memory:** 2 channels, each 1 kbit, serializable. Thumbwheel switches define data stream length or frame length (N words of Mbits), and set up synch signals accordingly.

**Prbs:** pseudo-random binary sequences of 511, 1023, 32767 and 1048575 bits. Synch pulse at beginning of sequence.

**Mixed:** prbs is inserted after every odd-numbered programmable word.

### Data Outputs

**Channel A:** simultaneous normal and complement outputs. ECL levels or variable +15 V amplitude. Selectable 50 Ω/1 kΩ output impedance, RZ/NRZ format.

**Data length:** up to 1024 bit or (serialized with B data) 1025 to 2048 bit.

**Transitions (50 Ω into 50 Ω):** ≤ 6 ns (ECL ≤ 5 ns)

**Preshoot, overshoot, ringing:** ≤ 10% (ECL ≤ 15%)

**Channel B:** normal output, 2.4 V (50 Ω into 50 Ω), up to 1024 bits, RZ/NRZ selectable.

### Bit Rate

**Internal:** 50 Hz to 50 MHz (40 MHz in Mixed mode), jitter 0.2%

**External:** dc to 50 MHz (40 MHz in Mixed mode) or manual.

### Data Cycling

**Auto:** sequence recycles continuously.

**Bit:** bits are triggered/gated by external pulses/level.

**Word:** words are triggered/gated by external pulses/level.

**Frame:** sequence is triggered/gated by external pulses/level.

**Manual:** switch triggers single bits/words/frame.

### General

**Power:** 100/120/220/240 V rms; +5%, -10%; 48 to 440 Hz. 230 V A max.

**Temperature range:** 0°C to 50°C.

**Weight:** net 12 kg (26.5 lbs). Shipping 16 kg (35.3 lbs).

**Size:** 133 H x 426 W x 422 mm D (5.2" x 16.8" x 16.6").

### Ordering Information

HP 8018A Serial Data Generator

**Opt 001:** HP-IB for data loading\*

**Opt 907:** Front Handle Kit (Part No. HP 5061-0089)

**Opt 908:** Rack Flange Kit (Part No. HP 5061-0077)

**Opt 909:** Opt. 907, 908 combined

(Part No. HP 5061-0083)

**Opt 910:** Extra Operating and Service Manual

\* HP-IB cables: refer to page 675.

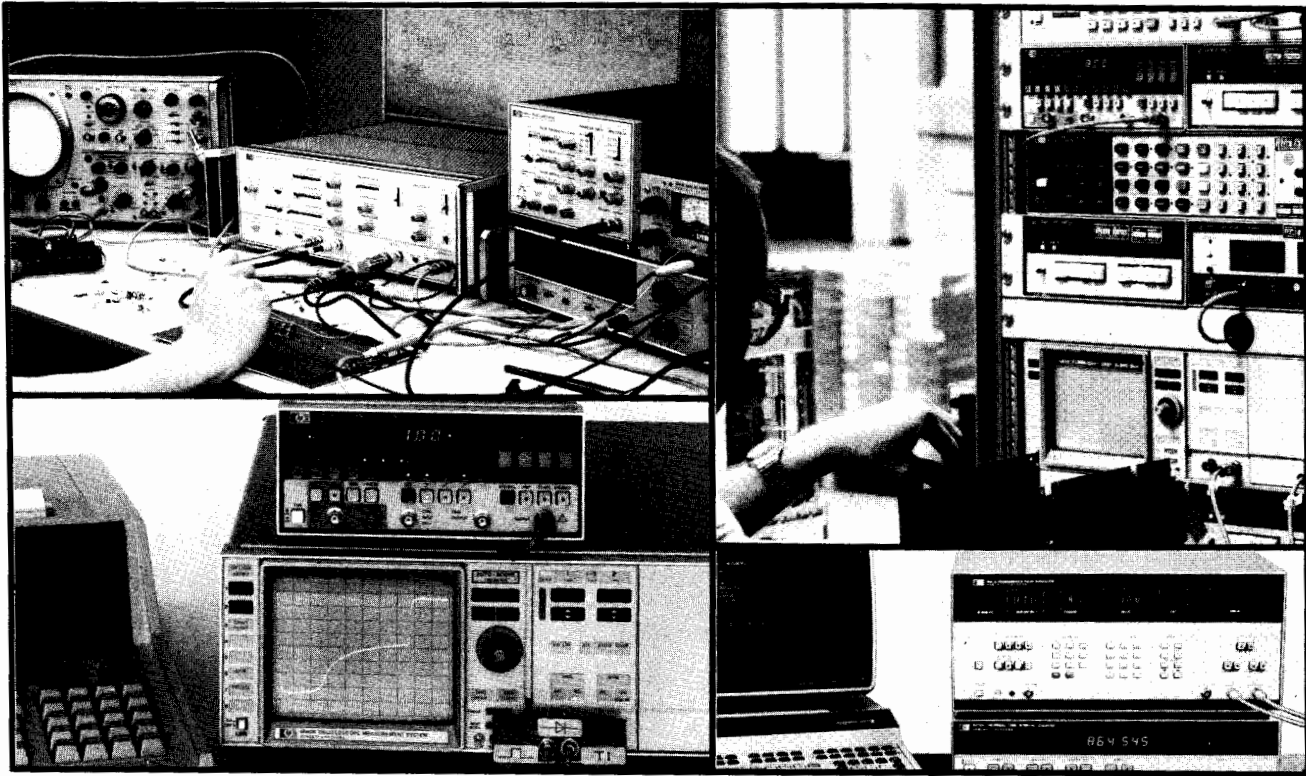

### Analog and Digital Test

HP's *pulse generators* range from simple, inexpensive units to high performance, microprocessor-based instruments offering precision pulse generation. Depending on model, variable clock speeds to 1 GHz and variable amplitudes up to 100 V are available.

Pulse parameters are independently variable for thorough characterization and worst-case testing. Variable pulse transitions permit parametric analysis like trigger circuit hysteresis, and the fastest settings are ideal for at-speed logic test and amplifier transient investigations.

*Pulse/function generators* combine pulse capability with all features expected of a function generator. The benefits are high flexibility for analog requirements plus an entry into logic test.

### Operating Comfort

Clear front panel layout, guided parameter selection, and error detection and recovery features, mean quick familiarization and rapid, error-free use. In addition, great emphasis is placed on ruggedness, reliability and serviceability. The generators are developed and produced using high quality standard components and custom-designed ICs. Resultant technical benefits are, for exam-

ple, broad operating temperature range and clean 50-Ohm output impedance.

Selectable polarity, complement and offset help make hook-up simpler and, for further flexibility, *inverters, adders and splitters* are available (page 414).

Complex waveform capability allows glitches, ringing and multi-level signals to be simulated. Constant numbers of pulses, unaffected by other parameters are available in HP's counted burst mode.

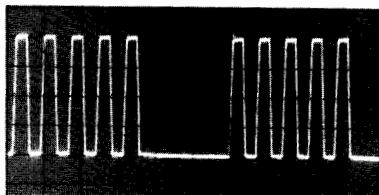

### Bench and Automatic Test

A new generation of very versatile models offer good repeatability and high operating comfort for fast, accurate testing. These instruments also offer HP-IB which makes bench automation a reality for time-consuming tests. Setup time is a minimum because the syntax is simple and uses the same command sequence as the front panel.

Straight-forward syntax helps develop ATS software quickly; good repeatability and error reporting eliminate the need for software measurement loops. Specified performance over the entire 0°C to 55°C operating temperature range guarantees reliability in system racks.

### Time Synthesis (page 415)

Time Synthesizers are mainly used in radar and laser ranging, component and circuit testing, and precise triggering and calibrating applications. They give a precisely timed output pulse with an accurate, adjustable delay which may be incremented in steps as small as 50 pico-seconds. A fixed, virtually jitter-free insertion delay allows phase locking to equipment under test.

### Logic Capability

**CMOS:** HP 8011A, 8015A, 8111A, 8112A, 8116A, 8160A

**TTL:** HP 8012B, 8013B, 8015A, 8111A, 8112A, 8116A, 8160A.

**S-TTL:** HP 8007B, 8082A, 8161A

**ECL:** HP 8082A (0.7 ns), 8080A (0.5 ns/0.2 ns, depending on configuration), HP 8161A (0.9 ns). Figures in brackets are the equivalent ECL switching time, 20% to 80% of amplitude.



# PULSE GENERATORS

## General Information (cont.)

### Pulse Generator Selection Chart

HP Model Page	Pulse Generators												Pulse/Function Generators		
	214B 309	8005B 315	8011A 315	8012B 316	8013B 316	8015A 317	8007B 318	8082A 319	8080A 320	8112A 310	8160A 312	8161A 312	8111A 330	8116A 331	8165A 333
Timing															
Max frequency (MHz)	10	20	20	50	50	50	100	250	300/1000	50	50	100	20	50	50
Transition time (ns)	15	10 var	10	5 var	3.5	6 var	2 var	1 var	0.8/0.3	5 var	6 var	1.3 var	10	6	5
Var width (ns) min	25	25	25	10	10	10	5	2	Sp Opt	10	10	4	25	10	10
Square/duty cycle (%)	1-10	Sq	Sq	Sq	Sq	Sq	Sq	Sq	Sq	1-99			10-90	10-90	20/50/80
Variable delay	•	•	•	•	•	•	•	•	•	•	•	•	•	•	•
Output (max values are quoted: see specifications for conditions).															
Amplitude (V)	100	10	16	10	10	30	10	5	4/2.4	32	20	5	32	32	20
Offset/Window (V)		±4/±10		±2.5/±7.5	±2.5/±7.5	±28/±16	±8/±18	±2/±5	±2/±4	±16/±16	±20/±20	±5/±5	±16/±16	±16/±16	±10/±10
Format	+/-	•	•	•	•	•	•	•	•	•	•	•	•	•	•
• = positive, negative, symmetrical, normal and complement formats.															
Outputs	1	+ and -	1	1	+ and -	2	1	1	Configurable	1	2-chan option	2-chan option	1	1	1
Additional outputs		TTL				TTL		Compl				Compl			
Operating Modes															
Trigger	•	•	•	•	•	•	•	•	•	•	•	•	•	•	•
Ext width				•	•	•	•	•	•	•	•	•	•	•	•
Gate	•	•	•	•	•	•	•	•	•	•	•	•	•	•	•
Ext burst	Option		Option			Option				•	•	•	Option	Option	•
Int burst														Option	
Double pulse	•	•	•	•	•	•	•	•	•	•	•	•	•	•	•
Control (Modulation) Modes										•	•	•	•	•	•

### Pulse Generator Definitions

**Time Reference Point:** Median (50% amplitude point on pulse edge).  
**Pulse Period:** The time interval between the leading edge medians of consecutive trigger output pulses.

**Trigger Delay:** Interval between trigger point of input signal and the trigger output pulse's leading edge median. Applies in trigger, external width, gate and burst modes.

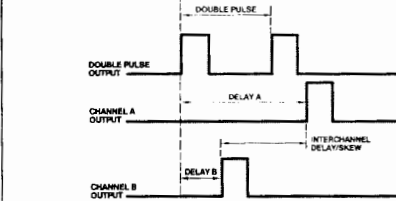
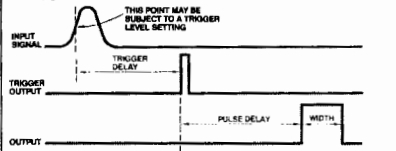

**Pulse Delay:** Interval between leading edge medians of trigger output pulse and output pulse.

**Double Pulse:** Interval between leading edge medians of the double pulse.

**Interchannel Delay/Skew:** Interval between corresponding leading edge medians.

**Pulse Width:** Interval between leading- and trailing-edge medians.

**Additional Information for Pulse Generators with Variable Transition Times**

**Pulse Width:** The specified and displayed value is that obtained with fastest edges; essentially equal to the interval from the start of the leading edge to the start of the trailing edge.

By designing so that the pulse edges turn about their start points, the interval from leading edge start to trailing edge start stays unchanged\* when transition times are varied. This is more convenient for programming and the width display is easy to interpret.

\*In practice, start points may shift with change in transition time.

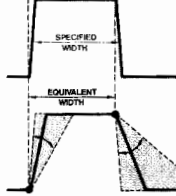

**Delay:** The specified and displayed value is that obtained with the fastest leading edge. For a slower edge, the actual delay exceeds the displayed delay because the displayed delay exceeds the combined shift of start-point and median.

**Transition Time:** Interval between the 10% and 90% amplitude points on the leading/trailing edge.

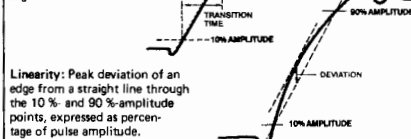

**Linearity:** Peak deviation of an edge from a straight line through the 10% and 90% amplitude points, expressed as percentage of pulse amplitude.

**Jitter:** Short-term instability of one event with respect to another. Unless stated otherwise, value is p-p, expressed as a percentage of the main parameter.

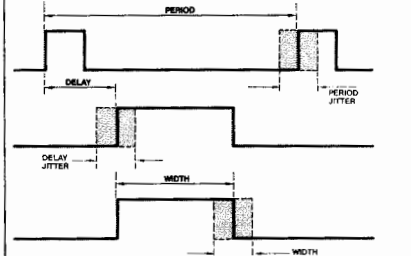

**Stability:** Long-term average instability, expressed as percentage of main parameter over a specific time duration, e.g. hour, year. Excludes jitter.

**Pulse Level:** High level and low level. Any limitation is expressed by an amplitude specification.

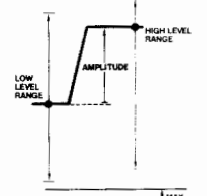

**Pulse Amplitude (alternative to level definition):** Pulse amplitude and offset\* are specified. Any limitation is expressed by a window (max high level, min low level).

\*Pulse generators use baseline offset. Function generator outputs are symmetrical and consequently use median offset.

**Preshoot, Overshoot, Ringing:** Preshoot and overshoot are peak distortions preceding/following an edge. Ringing is the positive peak and negative peak distortion excluding overshoot, on pulse top or base. A combined preshoot, overshoot, ringing specification of e.g. ± 5% implies:

- Overshoot/undershoot < 5%,
- Largest pulse-top oscillation < ± 5% of pulse amplitude.



**Settling Time:** Time taken for pulse levels to settle within level specification, measured from 90% point on leading edge.

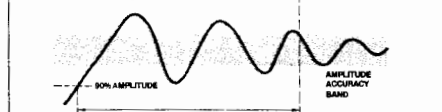

**Duty Cycle:** Percentage ratio of pulse width to period. In pulse/function generators, this term is also used to define sine and triangle symmetry.

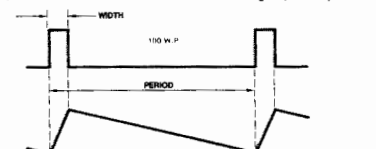

**Output Impedance/Resistance:** Effective pulse source impedance/dc resistance.

**Reflection Coefficient:** Reflection at pulse generator output expressed in percent of incident pulse amplitude. (Test pulse edges correspond to generator's fastest transitions).

**Repeatability:** When an instrument operates under the same environmental conditions, and with the same settings, the value of a parameter will lie within a band inside the accuracy window. Repeatability defines the width of this band.

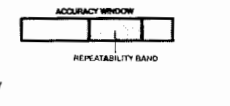

**HP-IB Programming Times**

**Listen Time:** The time an instrument occupies the bus to receive and verify a message. The NRFD signal is active during this period.

**Settling Time:** The time taken by the instrument to execute an HP-IB message, and for the output to settle within the accuracy specification. NRFD inactive.

**Execution Time:** The sum of Listen Time and Settling Time.

**Talk Time:** The time an instrument occupies the bus to output a specified string. Output data is typically instrument error status, or current or stored parameters.

# PULSE GENERATORS

## Fast, High Power Pulse Generator

### Model 214B



- High power 100 V, 2 A output
- 10 MHz repetition rate
- Constant duty cycle
- Counted pulse burst option

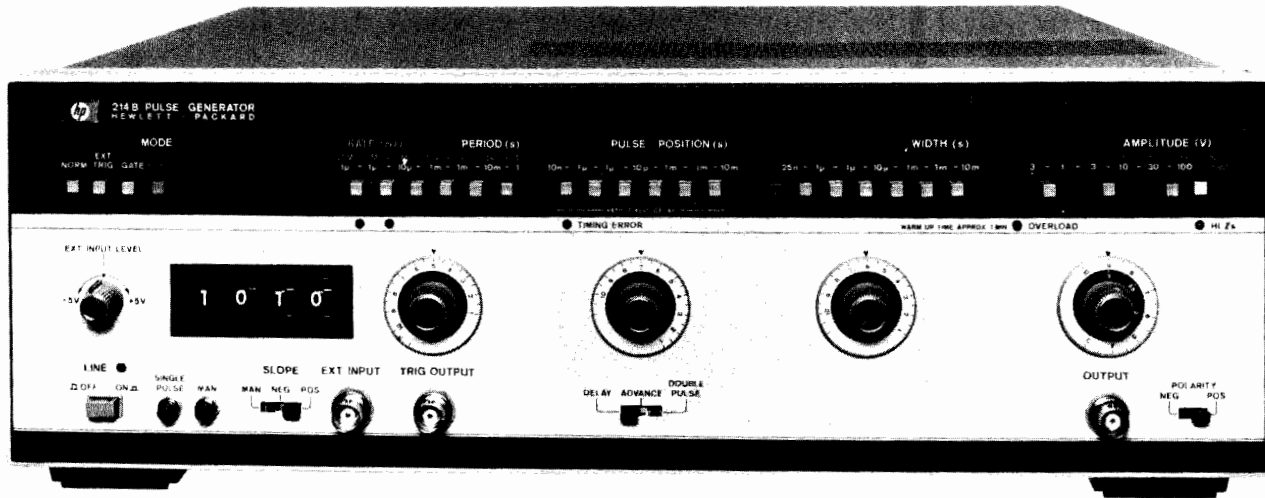

HP 214B with Option 001, Counted Burst.

The HP 214B pulse generator employs semiconductor technology for high power pulse generation at up to 10 MHz repetition rate. Delivering 100 V pulses with 15 ns risetimes, the HP 214B meets the speed demands of today's applications.

State-of-the-art VMOS FETS used as current sources for the output amplifier tubes enable pulse width to be specified down to 25 ns. The HP 214B is thus well-equipped for low duty cycle applications such as laser diode pulsing or transient simulation.

Where changing duty cycle threatens destruction to the device under test, the HP 214B Constant Duty Cycle (CDC) mode provides device protection. In CDC operation the duty cycle, hence power, remains constant as frequency is varied. The HP 214B is itself protected against excessive duty cycles via an overload protect circuit.

Easy operation is assured by the timing error indication. Calibrated dials enable fast accurate adjustments. Operating into unmatched loads, clean pulse shape is guaranteed by the low reactance 50  $\Omega$  source impedance. Pulse distortions such as preshoot and overshoot are specified as 5% at all amplitudes.

## Specifications

### Timing

**Repetition rate:** 10 Hz to 10 MHz in 6 ranges. In 30 V - 100 V amplitude range, maximum rep. rate is 4 MHz. Calibrated vernier provides continuous adjustment within ranges. **Vernier accuracy:**  $\pm(10\%$  of setting + 1% full scale). **Period Jitter:**  $\leq 0.1\%$  + 300 ps.

**Pulse delay/advance:** pulse can be delayed/advanced with respect to the trigger output from 10 ns to 10 ms ( $\pm$  fixed delay of 45 ns) in 5 ranges. Calibrated vernier provides continuous adjustment within ranges. **Vernier accuracy:**  $\pm(10\%$  of setting + 1% full scale) + fixed delay. **Position Jitter:**  $\leq 0.1\%$  + 500 ps

**Maximum pulse position duty cycle:**  $\geq 50\%$

**Double pulse:** 5 MHz maximum in all ranges except 30 V - 100 V range which is max. 2 MHz. Minimum separation is 100 ns.

**Pulse width:** 25 ns to 10 ms in 6 decade ranges. Calibrated vernier provides continuous adjustment within ranges. **Accuracy:**  $\pm(10\%$  of setting + 1% full scale) + 5 ns. **Width Jitter:**  $\leq 0.1\%$  + 500 ps.

**Max. duty cycle:**  $\geq 10\%$  for 30 - 100 V range.  $\geq 50\%$  all other ranges.

**Constant duty cycle mode (disabled in ext. trigger mode):** duty cycle of output pulse remains constant as the period is varied. The duty cycle limits in this mode are typically 8% fixed for the 10 M - 1 MHz range (max. 4 MHz); 2.5% to 10% for 1 MHz - .1 MHz range; .25% to 10% for .1 MHz - 10 kHz range; 0.1% for all other ranges. Calibrated vernier provides continuous adjustment within ranges.

**Accuracy:**  $\pm(15\%$  of setting + 1% of full scale).

### Trigger Output

**Amplitude:**  $\geq +5$  V (50 ohm into open circuit).

**Pulse width:** 10 ns typical.

### External Operating Modes

#### External Input (impedance 10 k ohm, dc coupled)

**Repetition rate:** dc to 10 MHz. **Sensitivity:** 500 mVpp, dc coupled.

**Slope:** pos. or neg. **Trigger level:** +5 V to -5 V adjustable.

**Maximum input level:**  $\pm 100$  V. **Trigger pulse width:**  $\geq 10$  ns.

**EXT TRIG mode:** an output pulse is generated for each input pulse.

**GATE mode:** gate signal turns on rep. rate generator synchronously. Last pulse always completed.

**BURST mode (optional):** preselected number of pulses generated on receipt of trigger signal. **Number of pulses:** 1 to 9999. Minimum spacing between bursts: 200 ns.

**Manual:** pushbutton can be used for triggering single pulses (EXT TRIG mode), generating gate signals (GATE mode) or triggering pulse bursts (BURST mode).

### Output

**Amplitude:** 0.3 V to 100 V in 5 ranges. Calibrated vernier provides adjustment within ranges. **Vernier accuracy:**  $\pm 10\%$  of setting.

**Source impedance:** fixed 50  $\Omega$  nominal on ranges up to 10 V. Selectable 50  $\Omega$  nominal or HI-Z on 10 - 30 - 100 V ranges (with 50  $\Omega$  / 50  $\Omega$  impedance, amplitude decreases to 5 - 15 - 50 V).

**Polarity:** pos. or neg. selectable.

**Transition times:**  $\leq 15$  ns for leading and trailing edges.

**Pulse top perturbations:**  $\leq \pm 5\%$  of amplitude.

### General

**Operating temperature:** 0°C to 55°C.

**Power:** 100/120/220/240 Vrms; +5%, -10%, 48 to 66 Hz, 360 VA max.

**Size:** 133 mm H x 426 mm W x 422 mm D (5.2" x 16.8" x 16.6").

**Weight:** net 13.6 kg (30 lb). Shipping 15.6 kg (34.3 lb).

### Ordering Information

#### HP 214B Pulse Generator

**Opt 001:** Counted Burst

**Opt 907:** Front Handle Kit (part number HP 5061-0089).

**Opt 908:** Rack Mount Kit (part number HP 5061-0077).

**Opt 909:** Opt 907, 908 Combined (part number HP 5061-0083).

**Opt 910:** extra Operating and Service Manual

# PULSE GENERATORS

## Programmable Low Cost Pulse Generator

### Model 8112A

- Full pulse capability
- Modulation
- Ramps and haversines
- Width/duty cycle
- Device protection
- Error recognition and self test

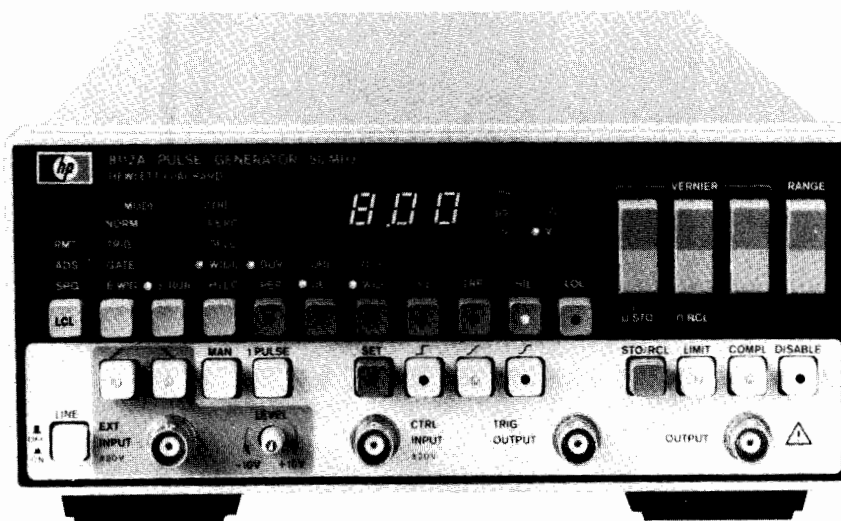

HP 8112A



The HP 8112A is fully programmable 50 MHz pulse generator with 5 ns transitions and 32 Vpp (into open circuit) max output amplitude. All pulse parameters are variable including delay and double pulse spacing.

Besides the comprehensive trigger modes, external modulation capabilities extend applicability. 3-level signals and upper level, width, period and delay-modulated signals are available. These can be combined with the trigger modes so that complex real-life signals like modulated bursts are simulated easily.

Step response and trigger hysteresis measurements require fast transitions or sawtooth signals as obtained in the HP 8112A's linear transition mode—either fixed 5 ns or variable from 6.5 ns. The new cosine transitions, also variable from 6.5 ns, mean that band-filtered signals are now just as simple to obtain.

Sensitive devices are protected by programming output limits and the upper level can be controlled by the device supply. Also, constant energy or constant width can be programmed.

Dual channel operation is feasible by operating HP 8112A's in a master/slave combination.

For really easy operation a green button gives error-free settings. A new softkey operating concept plus detailed error recognition make the HP 8112A's powerful versatility easy to handle.

### Specifications

Specifications apply with 50-ohm load, and temperatures in the range 0°C to 55°C.

#### Timing (specifications apply for min transition times)

- Period:** 20.0 ns to 950 ms.
- Delay:** 65.0 ns to 950 ms.
- Double pulse:** 20.0 ns to 950 ms.
- Width:** 10.0 ns to 950 ms.
- Accuracy:**  $\pm 5\%$  of progr value  $\pm 2$  ns (delay:  $\pm 4$  ns).
- Duty cycle:** 1% to 99% (Min: 10 ns. Max: period - 10 ns).

Accuracy:  $\pm 10\%$  of progr value.

**Pulse Characteristics** (voltages double when driving into open circuit)

#### Levels

- High level: -7.90 V to 8.00 V.
- Low level: -8.00 V to 7.90 V.

Accuracy:  $\pm 1\%$  of progr value  $\pm 3\%$  amplitude  $\pm 40$  mV.

Settling time: 100 ns + transition time.

#### Transition times

Fixed: 5 ns

Linear and Cosine: 6.5 ns to 95.0 ms (max edge ratio 1:20 within a 1.5-decade range. Ranges overlap by 0.5 decade).

Accuracy:  $\pm 5\%$  of programmed value  $\pm 2$  ns.

**Preshoot, overshoot, ringing:**  $\pm 5\% \pm 10$  mV (variable transitions),  $\pm 10\% \pm 10$  mV (fixed transitions).

**Output resistance:** 50 ohm  $\pm 5\%$ .

**Operating modes:** Normal, Trigger, Gate, Ext Width (pulse restoration), Ext Burst (1 to 1999 pulses).

#### Control (Modulation) Modes

**Period, delay, width** covered in 8 non-overlapping decades (max input frequency 20 kHz.).

**High level:** -8 V to +8 V, independent of progr low level (min input transition 200  $\mu$ s).

#### General

**HP-IB:** all keys programmable. Learn, status and error reporting capability. Interface functions: SH1, AH1, T6, L4, SR1, RL1, PP0, DC1, DT1.

**Memory:** retains current operating state. 9 store/recall locations, 1 fixed set of parameters.

**Repeatability:** factor 4 better than accuracy.

#### Environmental

Storage temperature: -40°C to +65°C.

Operating temperature: 0°C to 55°C.

Humidity: 95% RH, 0°C to 40°C.

**Power:** 100/120/220/240 V rms; +5%; -10%; 48 to 440 Hz; 120 VA max

**Weight:** net, 5.9 kg (13 lb). Shipping, 8.0 kg (18 lb).

**Size:** 89 H x 212.3 W x 450 mm D (3.5" x 8.36" x 17.7").

#### Ordering Information

**HP 8112A** Programmable Pulse Generator\*

**Opt 910:** Extra Operating and Service Manual

**HP 5061-2001:** Bail Handle Kit

**HP 5061-0072:** Rack Mount Kit (single HP 8112A)

**HP 5061-0074:** Rack Mount Kit (two instruments)

**HP 5061-0094:** Lock Link Kit (for use with HP 5061-0074)

\* HP-IB cables not supplied, see page 675



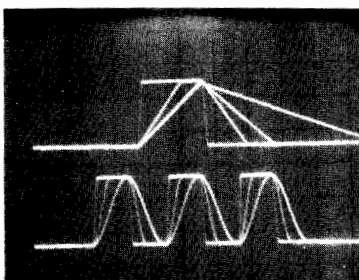

### Linear Transitions

(upper trace) supply everything from fast pulses through trapezoids to ramps and triangles. These solve the stimulus requirements for such diverse applications as transient response evaluation Schmitt trigger hysteresis measurements,

component stress characterization and materials testing. Variable transition times allow digital devices to be tested under the exact conditions specified by the IC manufacturer. Also, reflections caused by mismatch can be reduced by increasing the transition times.

### Cosine-Shaped Transitions

Selectable cosine edges reduce signal bandwidth for transmission line testing. As shown in the lower trace in the above photograph, even haversines (which are ideal for simulating radar and similar signals) can be generated when the pulse width is set equal to transition time.

### Counted Burst Mode

The external signal (upper trace) triggers a counted number of output pulses which can be used for clocking digital devices to an exact condition. The External signal can also be used to **trigger** single or double pulses, or to **gate** the output.

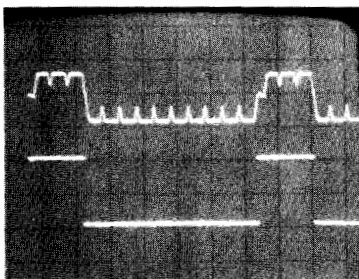
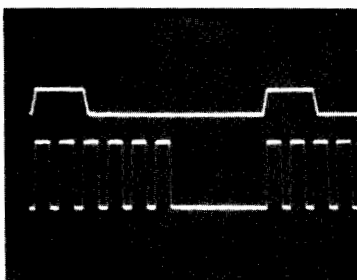

### External Width Mode

The clean lower trace has been recovered from the noisy signal applied to the HP 8112A's External Input.

### Flexible Transition Time Handling

allows excessive settings so that noise spikes (like those in the upper trace) as well as triangular waveforms can be generated.

### Delay Control Mode

Phase Modulated signals can be simulated by controlling delay with an external voltage. The lower trace shows the effect on a double-pulse signal.

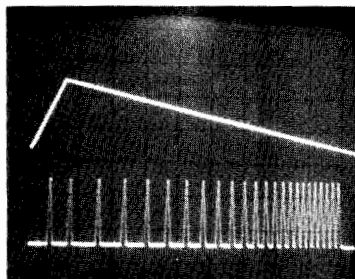
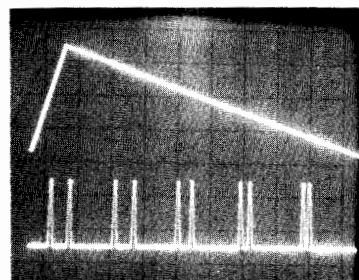

### Period Control

PLL tracking accuracy and settling time can be evaluated with the period-modulated signals (lower trace) generated in the Period Control mode.

### Width Control

As shown in the lower trace, PWM control signals can be simulated in this mode. As in the other timing control modes, the dynamic range is 1:10.

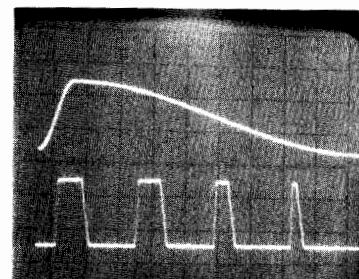

### Dual-Edge Triggering

Both edges can be selected for triggering as well as just positive or negative. The lower trace shows how a magnetic storage device signal can be simulated by applying a signal (upper trace) simultaneously as external trigger and high-level control voltage.

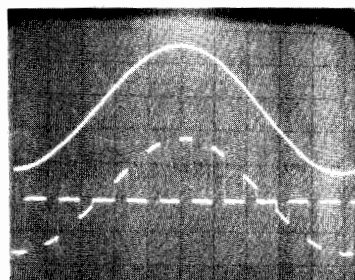
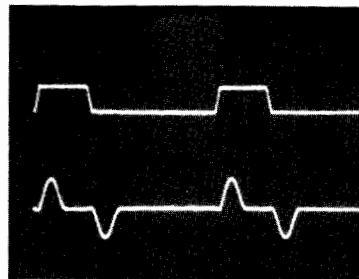

### High-Level Control

In addition to producing 3-level signals like that in the previous photograph, high-level control mode can be used for simulating PAM signals and also for protecting CMOS.

406

# PULSE GENERATORS

## Programmable Precision Pulse Generators

### Models 8160A, 8161A



- 50 MHz repetition rate
- 6.0 ns variable transition time
- 20 V output amplitude
- 1-3% pulse parameter accuracy
- Full dual channel capability (option 020)
- 1 year recalibration period

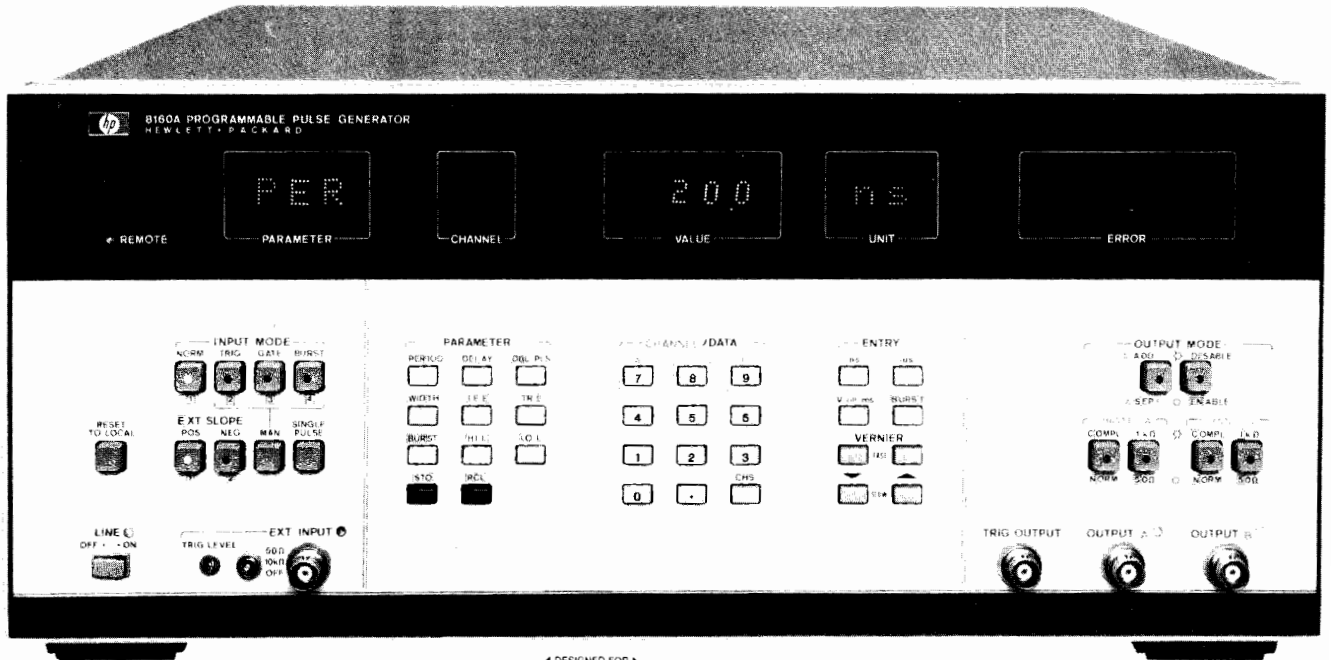

HP 8160A with Option 020, Dual Channel

- 100 MHz repetition rate
- 1.3 ns variable transition time
- 5 V amplitude
- 1-3% basic timing accuracy
- Full dual channel capability (option 020)
- 1 year recalibration period

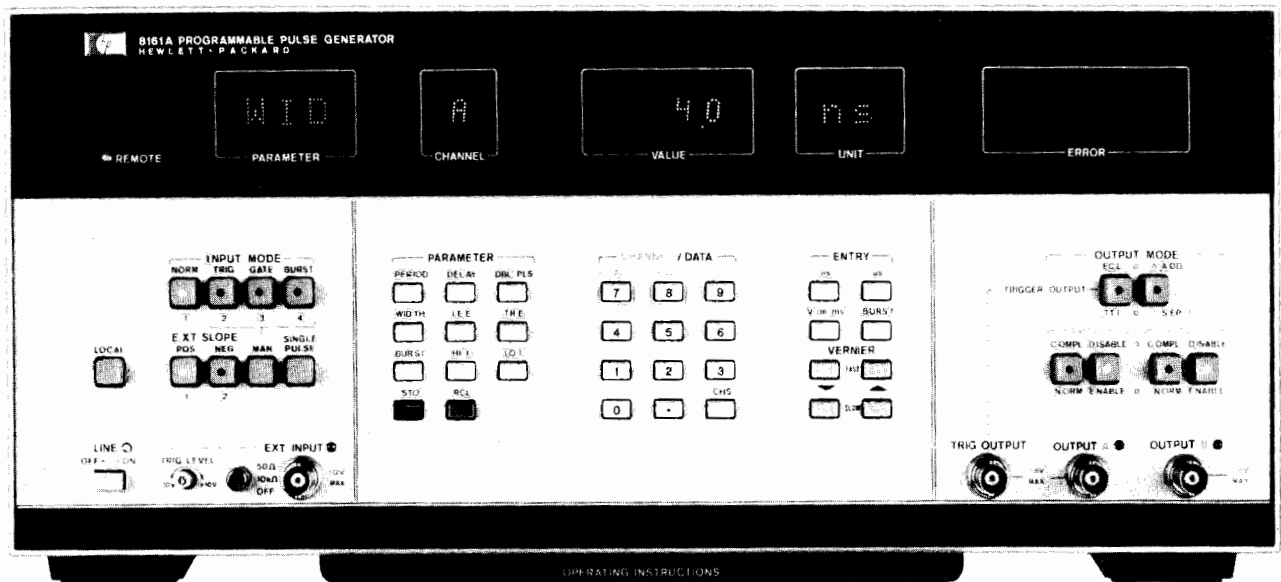

HP 8161A with Option 020, Dual Channel

The HP 8160A and 8161A are fully programmable pulse generators designed for high performance applications on the bench and in automatic test systems. Operation is made easy because the pulse parameters are controlled independently and do not inter-react. Dual channel options permit synchronous or complex waveforms to be generated. With its 50 MHz repetition rate, 20 V output, and 6 ns variable transition times, the HP 8160A is a general purpose pulse generator. The HP 8161A covers the high end of technology with its 100 MHz, 5 V and 1.3 ns variable transition times. Measured between the 20% to 80% amplitude points, these transitions are faster than 1 ns and meet ECL requirements.



HP 8161A input pulse (upper) and ECL memory output pulse (lower).

Combining high programming accuracy with microprocessor-based control capabilities, pulses can be set up without a measuring instrument. Pulse parameters are entered and displayed numerically, and generated with a basic timing accuracy of 1-3%, depending upon parameter.

An easy-to-use HP-IB interface brings high-accuracy pulses to automatic test. All parameters and operating modes are remotely programmable using straight-forward command sequences. Faster, easier program generation and reduced software costs are direct benefits.

### Precision Pulse Generation

Both models provide precision control over all parameters of their output pulses. The HP 8160A's leading and trailing edge transition times may be independently programmed down to 6 ns. The HP 8161A's transitions have a common control from 1.3 ns to 5 ns, and are independent above 5 ns. Variable transition times are indispensable when digital IC's need to be characterized: either the IC's data sheeted input transition time is required, or the IC's functioning range with various transitions needs to be evaluated.

Direct entry of the high and low levels of the output pulse enables easy adjustment to the logic levels concerned. Pulse width is variable from 4 ns (HP 8161A) or 10 ns (HP 8160A) to 1 s, giving a wide range of duty cycle programmability. Delay shifts the output pulse in relation to the trigger output or, in double pulse mode, defines the pulse spacing.

In the dual-channel versions, double pulse can be selected in either or both channels. This means, for example, that simultaneous clock and data signals can be generated.

### Complex Signals

Independent pulse parameters plus individual programmability of the Option 020's dual outputs are augmented by the A ADD B mode. Summation allows complex signals to be precisely and easily set up. Here are some examples:

Applications such as radar coincidence circuits and special codes in communications require 3- and 4-level signals. These are conveniently generated by combining channel A and channel B pulses.

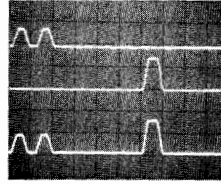
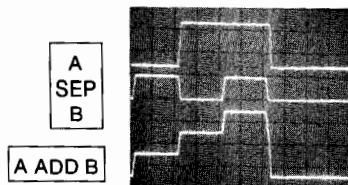

A  
SEP  
B

A ADD B

Transponder circuits need accurate delays, often with respect to a double-pulse interrogation signal. In the HP 8160A, this is arranged by operating one channel in double pulse mode and setting up the transponder delay in the other.

A critical test for digital circuits and IC's is its glitch and noise sensitivity, which can be easily performed with the A ADD B mode.

A  
SEP  
B

A ADD B

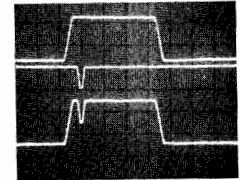

### Counted Burst

Using Burst Mode, a predetermined number of pulses is generated independent of frequency. Bursts from 0 to 9999 pulses in length may be produced, and can be triggered via an external signal manually or with an HP-IB command.

### Wide Temperature Range for System Reliability

The HP 8160A's and 8161A's 0-50°C operating range ensures calculable performance. Indeed, temperatures will generally be between 20-40°C where there is no derating factor.

### User Features

#### Fast, Reliable Setup

Microprocessor control promotes highly accurate pulses. Parameters are directly entered via the instrument's keyboard, and are then displayed on numeric LED's with 3-digit resolution.

In bench applications, the vernier controls give a fine adjust capability to "tweak-in" any pulse parameter. You can increment or decrement the selected parameter either in single steps or at speed.

Error detection by the microprocessor further simplifies pulse setup by solving the old problem of incompatible settings. Should pulse width exceed pulse period, for example, the microprocessor indicates a TIMING error. All possible mis-settings are detected and the type of error is indicated to aid rapid correction.

#### HP-IB Programming

Microprocessor control over all interface functions makes remote programming as easy and straight-forward as manual control. The instruments employ keystroke programming so that data entry via the HP-IB is an exact simulation of manual entry. Bus commands for each front panel key simply replace manual keystrokes.

#### Parameter Storage

Complete parameter and mode information for 9 independent instrument set-ups can be stored. Waveforms may be stored and recalled either manually or via the HP-IB.

By utilizing a single command to recall an entire instrument set-up, controller time is saved. In simple repetitive testing applications, storage of test waveforms gives a high degree of user convenience without an external controller.

# PULSE GENERATORS

## Programmable Precision Pulse Generators

### Models 8160A, 8161A (cont.)

#### Learn Mode

When interrogated by the system controller, the instruments output a character string to the interface bus. This string completely describes the pulser's current set-up or any one of its stored parameter sets. Using Learn Mode, you can enter and try out waveforms manually and then automatically transfer them via the HP-IB to the controller for storage in a program.

#### Verification Software for the 8160A

Test system accuracy is guaranteed by accessory software which verifies the HP 8160A's performance standards. The software is fully documented and comes recorded on a cassette suitable for HP Model 9825A Desktop Computer.

In the event of a failure, downtime is minimized because the software also delivers diagnostic information to accelerate repair and calibration.

### Specifications

(50-ohm source into 50-ohm load). Standard instruments are single channel. Option 020 provides independent dual channels with common pulse period.

Timing (with minimum transitions)	HP Model 8160A	HP Model 8161A
<b>Period</b> Range: Accuracy: Max Jitter:	20 ns to 999 ms. ±3% of progr value ±0.3 ns (period < 100 ns); ±2% of progr value (period ≥ 100 ns). 0.1% of progr value + 50 ps.	10 ns to 980 ms. ±3% of progr value ±0.5 ns (period < 100 ns); ±2% of progr value (period ≥ 100 ns). 0.1% of progr value + 50 ps.
<b>Delay, Double Pulse, Width</b> Delay Range: Double Pulse Range: Width Range: Accuracy: Max Jitter:	0.0 ns to 999 ms. 20.0 ns to 999 ms. 10.0 ns to 999 ms. ±1% of progr value ±1 ns. 0.1% + 50 ps (≤999 ns); 0.05% (999 ns < -≤9.99 μs); 0.005% (>9.99 μs).	0.0 ns to 990 ms. 8.0 ns to 990 ms. 4.0 ns to 990 ms. ±1% of progr value ±1 ns. 0.1% + 50 ps (≤999 ns); 0.05% (999 ns < -≤9.99 μs); 0.005% (>9.99 μs).
<b>Output Characteristics</b>  <b>Output levels</b> High Level Range: Low Level Range: Amplitude: Level Accuracy:  Settling Time:	<b>50 Ω into 50 Ω</b> -9.89 V to 9.99 V. -9.99 V to 9.89 V. 0.10 V min, 9.99 V max. ±1% of progr value ±1% of ampl ±50 mV. 40 ns.	<b>50 Ω into open or 1 kΩ into 50 Ω</b> -19.7 V to 19.9 V -19.9 V to 19.7 V 0.2 V min, 19.9 V max -4.95 V to 5.00 V. -5.00 V to 4.95 V. 0.06 V min, 5.00 V max. ±1% of progr value ±3% of ampl ±25 mV. 20 ns plus transition time.
<b>Transition Times (10 - 90% amplitude)</b> Leading Edge: Trailing Edge: Accuracy: Linearity:	6.0 ns to 9.99 ms. 6.0 ns to 9.99 ms. ±3% of progr value ±1 ns. ±3% for transitions > 30 ns.	1.3 ns to 900 μs. 1.3 ns to 900 μs. ±10% of progr value ±1 ns. ±5% for transitions > 30 ns.
<b>Preshoot, Overshoot, Ringing:</b>	±5% of ampl ±10 mV.	±5% of ampl ±10 mV (may increase to ±10% of ampl ±10 mV for transitions < 2.5 ns).
<b>A ADD B:</b>	Adds channel A and B outputs (Opt 020 only).	Adds channel A and B outputs (Opt 020 only).
<b>Output Format:</b>	Normal/Complement Selectable. (Independently selectable in each channel in Option 020.)	Simultaneous Normal and Complement Outputs. (Independently selectable in each channel in Option 020.)
<b>Source Impedance:</b>	50 ohm/1 kohm selectable.	50 ohm.

**Operating modes:** Normal, Trigger, Gate, Ext Burst (0-9999 pulses).

**HP-IB capability:** all modes and parameters can be programmed. Talk mode for status, error messages, stored parameters.

**Memory:** 9 programmable locations\*,  
1 location for active operating state\*,  
1 location with fixed parameter set.

**Capacity:** 1 complete operating state per location.  
\* Battery back-up for power-off storage

#### General

**Recalibration period:** 1 year.

**Repeatability:** factor 2 better than specified accuracy.

**Operating temperature:** 0°C to 50°C (Specifications apply from 20°C to 40°C. Accuracy derating factors for 0°C to 20°C and 40°C to 50°C).

**Power:** 115/230 V ac + 10%, -22%, 48-66 Hz; 675 VA max.

**Weight:** net 20.8 kg (46 lbs). Shipping 25 kg (55 lbs).

**Size:** 178 H x 426 x 530 mm D (7" x 16.8" x 20.9").

#### Ordering Information

**HP 8160A/8161A Programmable Pulse Generator\***

**Opt 001:** Rear panel inputs and outputs

**Opt 020:** Second channel (Rate common)

**Opt 907:** Front handle kit (P/N HP 5061-0090)

**Opt 908:** Rack flange kit (P/N HP 5061-0078)

**Opt 909:** Opt 907, 908, combined (P/N HP 5061-0084)

**Opt 910:** Additional Operating Manual

**08160-39910** Verification Software (HP 8160A only).

\* HP-IB cables not supplied, see page 675

# PULSE GENERATORS

## 20 MHz Pulse Sources

Models 8005B, 8011A



- Dual outputs, +10 V and -10 V
- TTL output
- Gating, square wave, double pulse modes

- Repetition rate 0.1 Hz to 20 MHz
- Positive/negative/symmetrical output
- Normal/complement switch

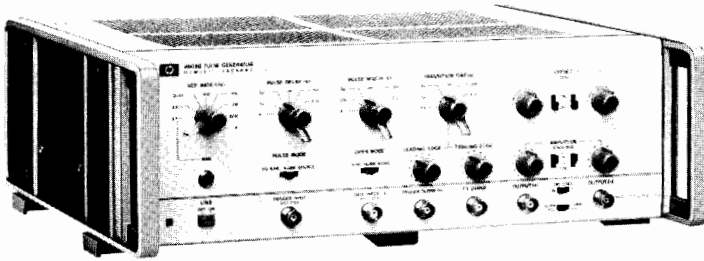

HP 8005B

The HP 8005B is a general purpose, triple output pulse generator. This instrument has all parameters variable and produces simultaneous pos. and neg. pulses. It also has a TTL output with all parameters variable except amplitude. This feature, together with the normal/complement facility, greatly improves the ease of operation.

### HP 8005B Specifications

#### Pulse Characteristics

**Transition times:**  $\leq 10$  ns to 2 s. Edges independently variable.  
**Non-linearity:** for transition times  $>30$  ns,  $< 4\%$  of pulse amplitude.  
**Preshoot, overshoot, ringing:**  $< 5\%$  of pulse amplitude.  
**Pulse width:**  $< 25$  ns to 3 s. **Jitter:**  $< 0.1\%$  of setting + 50 ps.  
**Max. duty cycle:**  $>80\%$  (0.3 Hz - 1 MHz),  $>50\%$  (1-20 MHz).  
**Square wave:** 0.15 Hz - 10 MHz.  
**Pulse delay:**  $< 100$  ns to 3 s. **Jitter:**  $< 0.1\%$  of setting + 50 ps.  
**Pulse outputs:** simultaneous pos., neg. and TTL outputs.  
**Pulse amplitude:** 300 mV to 10 V.  
**Output protection:** max. external voltage  $\pm 10$  V.  
**Source impedance:** 50 ohms  $\pm 10\%$  or high impedance selectable.  
**TTL compatible output:** +4.6 V norm. or comp. 50  $\Omega$  impedance.

#### Repetition Rate and Trigger

**Repetition rate:** 0.3 Hz to 20 MHz in 5 ranges. **Jitter:**  $< 0.1\%$  + 50 ps.  
**Double pulse:** 10 MHz max. Simulates 20 MHz.  
**Trigger output:**  $> +2$  V ampl. across 50 ohms. **Width:**  $> 6$  ns.

#### External Operating Modes

##### External Triggering (dc to 20 MHz)

**Delay:** approx. 35 ns trig. input to trig. output.  
**Maximum input:**  $\pm 10$  V. **Sensitivity:** sine 2 Vpp.  
**Impedance:** approx. 1k ohms, dc coupled. **Pulses:**  $\pm 1$  Vpeak.  
**Input pulse width:**  $\geq 10$  ns.

##### Gating

**Synchronous:** gate signal turns on repetition rate. Last pulse is always completed.  
**Asynchronous:** gate signal controls output of rate generator.  
**Gate Input (impedance 1 k ohms dc coupled)**  
**Amplitude:** 2 V to 20 V (max.). **Polarity:** negative.

#### General

**Operating temperature:**  $0^\circ\text{C}$  to  $55^\circ\text{C}$ .  
**Power:** 115/230 V rms; +10%, -15%; 48 to 440 Hz, 180 VA max.  
**Weight:** net 7 kg (15.5 lb). Shipping 9 kg (20 lb).  
**Size:** 130 H x 426 W x 290 mm D (5.1" x 16.8" x 11.4").

### Ordering Information HP 8005B, 8011A

HP 8011A Pulse Generator

**Opt 001:** Pulse Burst

**Opt 910:** extra Operating and Service Manual

**HP 15179A (for HP 8011A):** Adapter frame, Rack mount for 1 or 2 units, includes blank panel for single-unit operation.

HP 8005B Pulse Generator.

**Opt 908:** Rack Flange Kit (part number HP 5060-8740).

**Opt 910:** extra Operating and Service Manual.



HP 8011A with Option 001, Burst

The HP 8011A is a versatile, reliable, low cost pulse generator. This compact instrument features an uncomplicated design using high quality components to ensure long, dependable service. Ease of operation results from the logical and simple front panel layout. These qualities and the many pulse formats available emphasize the HP Model 8011A's cost-effectiveness in a wide application range.

### HP 8011A Specifications

#### Pulse Characteristics (50 ohm source/load impedances)

**Transition times:**  $< 10$  ns fixed.  
**Overshoot, ringing and preshoot:**  $< \pm 5\%$  of pulse amplitude. May increase to 10% at counter-clock wise positions of amplitude vernier.  
**Pulse width:** 25 ns to 100 ms in four ranges. Vernier provides continuous adjustment within each range.  
**Width jitter:**  $< 0.1\%$  + 50 ps on any width setting.  
**Maximum duty cycle:**  $> 50\%$  (100% using pulse complement)  
**Maximum output:** 8 V. With internal 50  $\Omega$  and external Hi-Z or internal Hi-Z/external 50  $\Omega$ , then 16 V max.  
**Attenuator:** 3-step attenuator provides the ranges 0.25 V - 1 V - 4 V - 16 V. Vernier provides continuous adjustment within each range.  
**Source impedance:** 50  $\Omega \pm 10\%$  shunted by 30 pF, except in 4 V - 16 V range which is 50  $\Omega$ /Hi-Z, switch selectable.  
**Polarity/format:** pos., neg., or sym./norm. or compl., switch select.

#### Repetition Rate and Trigger

0.1 Hz to 20 MHz in 5 ranges. Vernier provides continuous adjustment within each range. **Period jitter:**  $< 0.1\%$  + 50 ps of per. setting.  
**Square Wave:** 0.05 Hz to 10 MHz.  
**Trigger output:** dc coupled 50  $\Omega$  (typ.) source delivering  $\geq +1$  V into 50  $\Omega$  (can increase to +5 V). **Trigger pulse width:** 20 ns  $\pm 10$  ns.

#### External Operating Modes

**Input impedance:** 50  $\Omega \pm 10\%$ . **Trigger polarity:** positive.  
**Maximum input:**  $\pm 5$  V. **Sensitivity:** 1 V.  
**Manual:** front panel pushbutton for generating single pulse.  
**Repetition rate:** 0 to 20 MHz. In square wave, output frequency is half the input frequency.  
**Trigger source:** manual or ext. signal. Min. ext. signal width 20 ns.  
**Pulse burst mode (option 001):** preselected number of pulses generated on receipt of trigger.  
**Burst trigger source:** man. or ext. signal. Min. signal width 25 ns.

#### General

**Operating temperature:**  $0^\circ\text{C}$  to  $55^\circ\text{C}$ .  
**Power:** 100/120/220/240 V rms; +5%, -10%; 48 Hz to 440 Hz, 70 VA max.  
**Weight:** net, 4 kg (9 lb). Shipping, 6.5 kg (14.6 lb).  
**Dimensions:** 126 H x 200 W x 280 mm D (5" x 7.9" x 11").

# 410 PULSE GENERATORS

## 50 MHz Pulse Sources



### Models 8012B & 8013B

- Variable transition times down to 5 ns
- $\pm 10$  V amplitude; selectable source impedance
- Ideal for testing TTL

- Fixed 3.5 ns transition times
- 10 V amplitude; selectable source impedance
- 2 outputs



HP 8012B

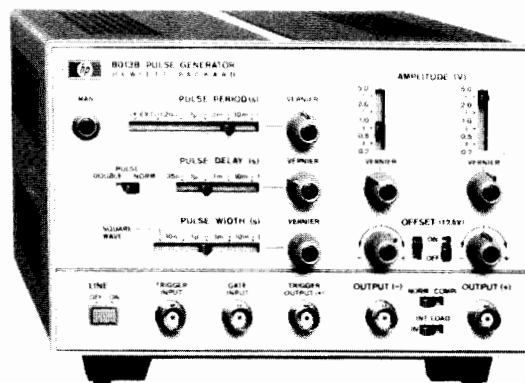

HP 8013B

The HP 8012B and 8013B are at the top of their class for versatility, ease of operation and wide range of application. They provide the ideal solution to almost all digital logic testing problems with fixed 3.5 ns transition times on the HP 8013B and variable transition times down to 5 ns on the HP 8012B. The well-composed layout of the front panel controls (horizontal controls for horizontal parameters, vertical controls for vertical parameters) enables output pulses to be set up quickly and accurately with minimum risk of incompatible settings. Both models feature normal and complement outputs and a switchable internal 50 ohm source.

**Pulse delay:** <35 ns to 1 s (with respect to trigger output) in four ranges; vernier provides continuous adjustment within ranges.  
**Delay jitter:** <0.1% + 50 ps on any setting.

**Repetition Rate and Trigger**  
 1 Hz to 50 MHz; for square wave output, frequency divided by factor 2.  
**Period jitter:** <0.1% + 50 ps on any rate setting.  
**Square wave:** 0.5 Hz to 25 MHz in four ranges. Duty cycle 50%  $\pm 5\%$  up to 1 MHz, tolerance increases to  $\pm 15\%$  at 25 MHz.  
**Trigger output:** > +1 V across 50  $\Omega$ , 16 ns  $\pm 10$  ns wide.

## Specifications

### Pulse Characteristics

Parameter	HP Model 8012B		HP Model 8013B	
	Int. load IN	Int. load OUT	Int. load IN	Int. load OUT
Transition times	5 ns–0.5s 6 ns–0.5s 4 ranges. Verniers provide separate control of both edges within ranges up to max. ratios of 100:1 or 1:100.		3.5 ns fixed	5 ns fixed
Source impedance	50 ohms $\pm 10\%$ shunted by typically 20 pF	>50 ohms	50 ohms $\pm 3\%$ shunted by typically 20 pF	>50 ohms

**External Triggering**  
 0 to 50 MHz; for square wave output, frequency divided by factor 2.  
**Trigger input:** sine waves 1.5 V p-p (about zero) or pulses >0.8 V either polarity, >7 ns wide. Maximum input  $\pm 7$  V.  
**Impedance:** 50  $\Omega \pm 10\%$ , dc coupled.  
**Delay:** 25 ns  $\pm 8$  ns leading edge trig. input to trig. output.  
**Manual:** pushbutton for single pulse.

**Gating**  
**Synchronous gating:** gating signal turns generator “on”. Last pulse is completed even if the gate ends during pulse.  
**Gate input:** dc-coupled; voltage at open connector approx. +1.8 V. Shorting current  $\leq 12$  mA. Input impedance  $\approx 160$   $\Omega$   
**Gate input signal:** voltage >+1.5 V or resistor > 1 k  $\Omega$  to ground enables rep. rate generator. Voltage <+0.8 V or resistor <160  $\Omega$  disables rep. rate generator. Input TTL compatible, max.  $\pm 5$  V.

Parameter	HP Models 8012B/8013B	
	Internal load IN	Internal load OUT
Overshoot ringing	$\pm 5\%$ of pulse amplitude	May increase to $\pm 10\%$ when amplitude is between 0.4–4 V
Maximum output	5 V across 50 ohms, 10 V across open circuit. Short cct. protection.	10 V across 50 ohms, Short cct. protection.
Attenuator	4-step, reduces output to 0.2 V.	4-step, reduces output to 0.4 V.
DC offset	$\pm 2.5$ V across 50 ohms. Independent of amplitude settings.	DC offset switched off.

**External Width and RZ**  
**External width:** output pulse width determined by width of drive input signal. Amplitude, transition times selectable. Trigger output independent of external width input signal.  
**RZ mode:** external drive input switched to delay generator. Period determined by period of drive input signal. Delay, amplitude and width selectable.  
**Input signal:** >+1 V, >7 ns wide. Max.  $\pm 5$  V. 50  $\Omega$  dc coupled.

**Linearity (HP 8012B):** for transition times >30 ns, maximum straight line deviation is 5% of pulse amplitude.  
**Preshoot:** <  $\pm 5\%$  of pulse amplitude.  
**Pulse width:** < 10 ns to 1 s in four ranges. Vernier provides continuous adjustment within ranges.  
**Width jitter:** <0.1% + 50 ps on any width setting.  
**Maximum duty cycle:** >75% from 1 Hz to 10 MHz, decreasing to  $\geq 40\%$  at 50 MHz. Up to 100% in COMPL mode.  
**Polarity:** HP 8012B; positive or negative selectable, NORM/COMPL/SYM selectable; HP 8013B, one positive + one negative channel, NORM/COMPL selectable.

**General**  
**Operating temperature:** 0°C to 55°C.  
**Power:** 100/120/220/240 V rms; +5%, -10%; 48 to 400 Hz, 100 VA max.  
**Weight:** net, 4kg (8.8 lb). Shipping, 6.5 kg (14.6 lb).  
**Size:** 126 H x 200 W x 280 mm D (5 x 7.9 x 11 in.)

**Ordering Information**  
**HP 8012B Pulse Generator**  
**Opt 910:** extra operating and service manual  
**HP 8013B Pulse Generator**  
**Opt 910:** extra operating and service manual  
**HP 15179A Adapter frame.** Rack mounting for 1 or 2 units, includes blank panel for single-unit requirements



# PULSE GENERATORS

50 MHz, Dual Output

Model 8015A

411



- Two independent  $\pm 16$  V outputs
- Additional TTL output

- Remote control and counted burst options
- Complex waveforms

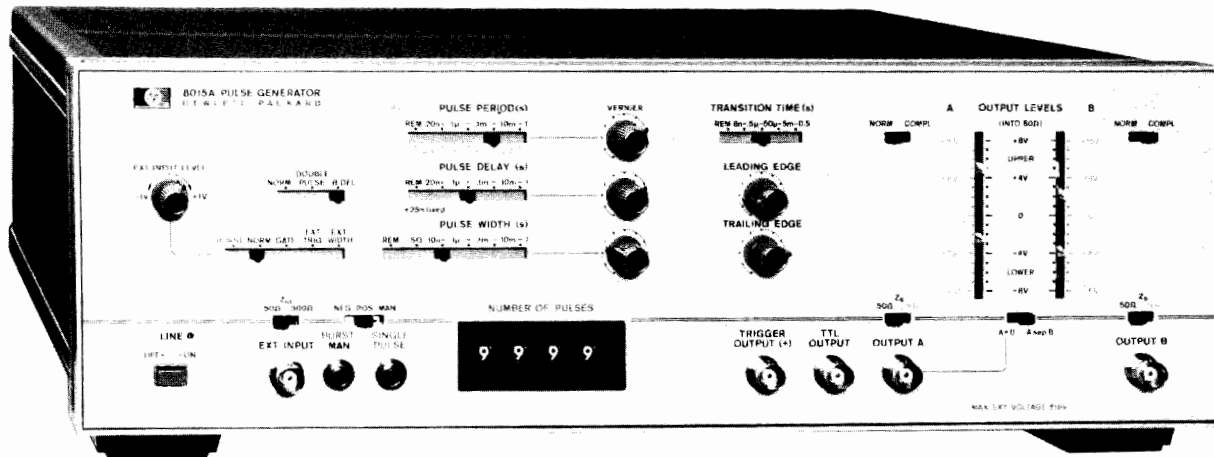

HP 8015A with Option 002, Burst

Offering B Delay mode in addition to variability of all pulse parameters, the HP 8015A is ideal for analyzing critical timing conditions, or generating 2-phase clocks.

A + B mode gives a 30 V output within a  $\pm 16$  V window. Combined with B Delay mode, three-level signals, special codes or simulated biomedical signals can be generated.

Option 002 Burst mode generates an exact number of pulses by means of an internal counter.

Direct access to either or both output amplifiers (Option 007) converts to MOS/CMOS levels. Alternatively, high-level tracking capability ensures that clock and data signals follow the supply, and thus safeguards CMOS devices.

For use in automatic test, Option 003 allows all pulse parameters to be controlled remotely.

## Specifications

### Timing

**Repetition rate:** 1 Hz to 50 MHz (square wave and double pulse to 25 MHz, A + B mode to 40 MHz, B delay 20 MHz).

**Width:** 10 ns to 1 s or square wave.

**Delay:** 20 ns to 1 s (both channels, interchannel or double pulse).

**Jitter:** 0.1% + 50 ps.

**Output** (50  $\Omega$  Output Impedance into 50  $\Omega$  termination. Voltages double in 50  $\Omega$  / 1 k $\Omega$  or 1 k $\Omega$  / 50  $\Omega$  operation).

**Magnitude:** 1 V to 8 V amplitude (2 V to 16 V in A + B mode).

**High level:** -7 V to +8 V. **Low level:** -8 V to +7 V.

**Transition times:** 6 ns to 0.5 s in four ranges, independent leading/trailing vernier adjustment.

**Non-linearity:** 5% for transitions > 30 ns.

**Preshoot, overshoot and ringing:** 5%.

**A + B mode:** sum of channel A and channel B outputs.

**Complement:** independently selectable.

**Impedance:** 50  $\Omega$  / 1 k $\Omega$ , independently selectable.

### Trigger Input

**Impedance:** 50  $\Omega$  / 500  $\Omega$  selectable.

**Level:** adjustable +1 V to -1 V (50  $\Omega$ ), +10 V to -10 V (500  $\Omega$ ).

**Slope:** + or - selectable.

### Auxiliary Outputs

**TTL:** 50  $\Omega$  output impedance, timing as channel A.

**Trigger output:** 1 V, 50  $\Omega$  into 50  $\Omega$ .

### Option 002 Burst Mode

**Burst length:** 1-9999 pulses, selectable.

**Pulse repetition rate:** 1 Hz to 40 MHz.

**Burst trigger:** trigger input.

**Minimum burst separation:** 200 ns.

### Option 003 Remote Control

**Timing ranges:** TTL or contact closure.

**Timing verniers:** current, voltage or resistor programming.

**Output levels:** voltage programming.

**Burst:** BCD, TTL/contact closure.

### Option 007 Amplifier and Tracking Modes

#### Dual Amplifier Mode

**Gain:** 0.8 to 6.4.

**Frequency response (-3 dB):** 0 to 80 MHz.

#### Upper Level Tracking Mode

**Upper level:** input voltage  $\pm 5\%$ .

**Lower level:** 0 V  $\pm 250$  mV.

**Settling time:** 400  $\mu$ s to  $\pm 5\%$  of final value.

### General

**Operating temperature:** 0°C to 55°C.

**Power:** 100/120/220/240 V rms; +5%, -10%; 48 to 440 Hz, 180 VA max.

**Weight:** net, 11 kg (24.26 lb). Shipping, 14.7 kg (32.4 lb).

**Size:** 133 H x 426 W x 346 mm D (5.2" x 16.75" x 13.6").

### Ordering Information

HP 8015A Pulse Generator

**Opt 002:** Pulse Burst

**Opt 003:** Remote Control

**Opt 007:** Dual Amplifier and Level Tracking modes

**Opt 907:** Front Handle Kit (Part No. HP 5061-0089)

**Opt 908:** Rack Flange Kit (Part No. HP 5061-0077)

**Opt 909:** Opt. 907, 908 combined

(Part No. HP 5061-0083)

**Opt 910:** Additional Operating and Service Manual

412 **PULSE GENERATORS**  
**100 MHz Pulse Source**  
**Model 8007B**

- Variable transition times down to 2 ns.
- Extremely linear slopes

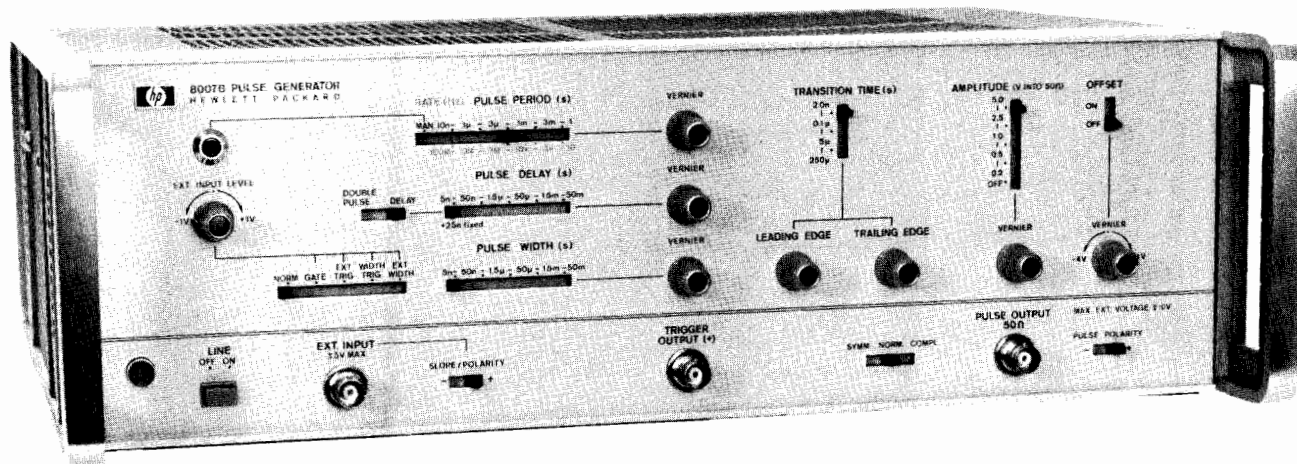

HP 8007B

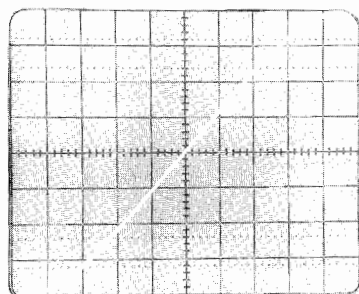

1 ns/cm  
 0.5 V/cm  
 1 GHz bandwidth

The HP 8007B is a high speed pulse generator that is well suited for STTL and ECL applications.

The output can be set to positive or negative polarity, complement or symmetrical to ground. A high dc-offset of up to  $\pm 4$  V is also included.

External triggering and synchronous gating are provided. The trigger level is adjustable for all externally controlled modes with the slope polarity selectable. This is very useful for avoiding malfunctions caused by noise and ringing on the external trigger signal.

In "External Width" mode the external input and pulse output have equal width. Transition times and amplitude of the output pulse can be set by the front panel controls. This mode is useful for shaping NRZ signals, as the width information is passed on to the output pulse unchanged.

The "Width Trigger" mode is suitable for RZ signal shaping. Width, transition times and amplitude are determined by the front panel controls.

## Specifications

### Pulse Characteristics (50 $\Omega$ source and load impedance)

**Transition times:** <2 ns to 250  $\mu$ s, three ranges (common for both transition times). Independent verniers for adjusting leading and trailing edge within each range up to maximum ratios of 1:50 or 50:1.  
**Linearity:** maximum deviation from a straight line between 10% and 90% points  $\leq 5\%$  of pulse amplitude.

**Preshoot, overshoot, ringing:** <  $\pm 5\%$  of pulse amplitude.

**Pulse width:** <5 ns to 50 ms in five ranges. Vernier provides continuous adjustment within ranges.

**Width jitter:** <0.1% on any width setting.

**Maximum duty cycle:** normal >50%; complement approx. 100%.

**Amplitude:** 5 V max (10 V across open circuit) to 0.2 V in four ranges; vernier adjustment within ranges. Pulse can be switched off.

**Pulse output:** + or - polarity selectable; normal, complement, or symmetrical to ground.

**Source impedance:** 50  $\Omega \pm 4 \Omega$  shunted by typ. 10 pF.

**DC-offset:**  $\pm 4$  V across 50  $\Omega$  load. Independent of amplitude setting, can be switched off.

**Pulse delay:** <30 ns to 50 ms with respect to trigger output. Five ranges, with continuous adjustment within ranges.

**Delay jitter:** <0.1% on any delay setting.

### Repetition Rate and Trigger

10 Hz to 100 MHz in 5 ranges. Continuous adjustment within ranges.

**Period jitter:** <0.1%.

**Double pulse:** available only up to pulse rate setting of 50 MHz, representing an output pulse rate of 100 MHz.

**Trigger output:** >+1 V across 50  $\Omega$ , 4ns  $\pm 2$  ns wide.

### External Triggering (0 to 100 MHz)

**Delay:** approx. 15 ns between trig. input and trig. output.

**Manual:** front panel pushbutton for single pulse.

### External Width and Width Trigger

**External width:** output pulse width determined by width of drive input.

**Width trigger:** external drive input switched to the width generator. Pulse width determined by front panel width setting.

**Rate generator:** provides trigger pulses independent of drive input.

### Synchronous Gating

Gating signal turns generator "on." Last pulse is completed even if gate ends during pulse.

### External Input

**Impedance:** 50  $\Omega$ , dc-coupled. Max input  $\pm 5$  V.

**Level:** adjustable from +1 V to -1 V, Polarity: + or -.

**Sensitivity:** sine waves 1 V p-p; pulses 1 V.

### General

**Operating temperature:** 0°C to +55°C.

**Power requirements:** 115 or 230 V rms; +10%, -15%; 48 to 440 Hz, 100 VA (maximum).

**Weight:** net, 8 kg (17.6 lb). Shipping, 9 kg (19.8 lb).

**Size:** 128 H x 426 W x 345 mm D (5" x 16.8" x 13.6").

### Ordering Information

HP 8007B Pulse Generator

Opt 908: Rack Flange Kit (Part No. HP 5060-8740)

Opt 910: Additional Operating and Service Manual

# PULSE GENERATORS

## 250 MHz Fast Pulse Source

### Model 8082A

413



- < 1 ns variable transition times
- Ultra-clean 50 ohm source

- Switch-selectable ECL levels
- Dual  $\pm 5$  V outputs

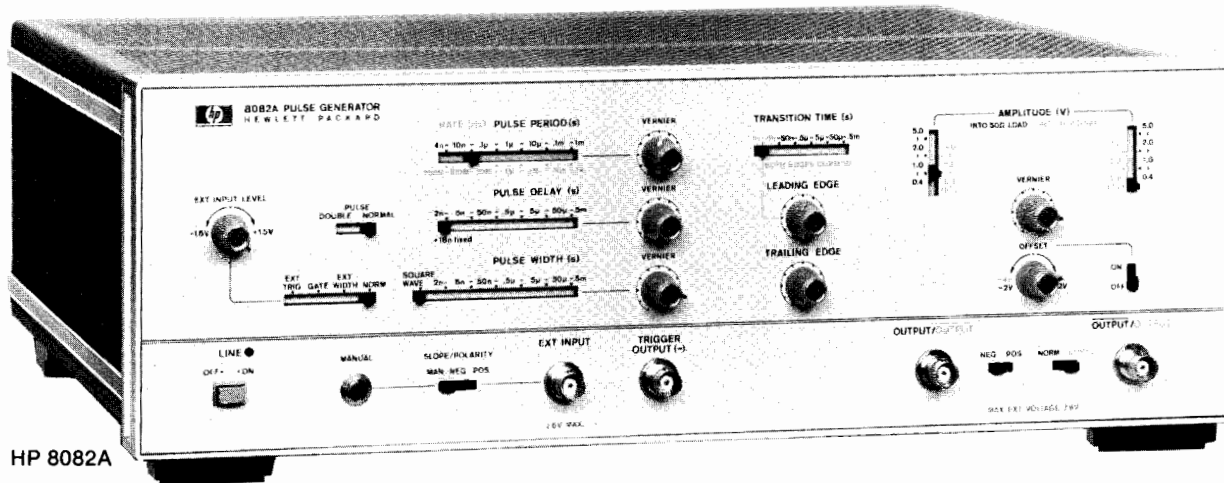

HP 8082A

The HP 8082A is Hewlett-Packard's fastest pulse generator with all pulse parameters variable. With repetition rates to 250 MHz, transition times down to 1 ns and amplitudes to 5 V, the HP 8082A is ideally suited for state-of-the-art TTL and ECL logic designs. Using the HP 8082A, you can rapidly test logic circuits under all operating conditions by simply varying pulse parameters. Although a highly sophisticated instrument, the HP 8082A is still easy to operate because of its logical front panel layout and switch selectable ECL output levels. Another feature that contributes to ease of operation is the square wave mode. You can, for example, carry out toggle rate tests in this mode up to 250 MHz without having to worry about pulse duty cycle.

Hybrid IC's, manufactured by Hewlett-Packard, are used extensively in the design of the HP 8082A. These ICs eliminate the need for fans, reduce power consumption and enable a low reactance 50 ohm source impedance to be used. This source impedance absorbs 98% of reflections from signals up to 4 V amplitude.

## Specifications

### Pulse Characteristics (50 $\Omega$ source and load impedance)

**Transition times:** < 1 ns – 0.5 ms (10% to 90%) in 6 ranges. < 750 ps (20% to 80%). Leading/trailing edges controlled together on fastest range, independently variable over 1:10 ratio on other ranges.

**Overshoot and ringing:**  $\leq \pm 5\%$  of pulse amplitude may increase to  $\pm 10\%$  with amplitude vernier CCW.

**Preshoot:**  $\leq \pm 5\%$  of pulse amplitude.

**Linearity:** linearity aberration for both slopes  $\leq 5\%$  for transition times > 5 ns.

**Output:** maximum amplitude is 5 V from 50  $\Omega$  into 50  $\Omega$ . Maximum output voltage is  $\pm 5$  V (amplitude + offset).

**Offset:**  $\pm 2$  V, into 50  $\Omega$ .

**DC-source impedance:** 50  $\Omega \pm 5\%$ .

**Reflection coefficient:** reflection is 2% typical for steps with 1 ns rise time applied to output connector on all amplitude ranges except 5 V range. On the 5 V range, the reflection may be 15%.

**Output protection:** cannot be damaged by open or short circuits or application of ext.  $\leq \pm 6$  V or  $\pm 200$  mA independent of control settings.

**Attenuator:** two separate three step-attenuators reduce the outputs to 1 V. Vernier is common for both outputs and reduces the output to 0.4 V minimum. A further position provides ECL-compatible outputs ( $-0.9$  V to  $-1.7$  V typ. open circuit).

### Timing

**Repetition rate:** 250 MHz to 1 kHz in 6 ranges.

**Period jitter:** < 0.1% of setting + 50 ps.

**Delay:** 2 ns – 0.5 ms in 6 ranges plus typ. 17 ns fxd. with respect to trigger output. Duty cycle > 50%.

**Delay jitter:** < 0.1% of setting + 50 ps.

**Double pulse:** up to 125 MHz max. (simulates 250 MHz).

**Pulse width:** < 2 ns – 0.5 ms in 6 ranges.

**Width jitter:** < 0.1% of setting + 50 ps.

**Width duty cycle:** > 50%.

**Square wave:** delay and double pulse are disabled, max. Rep. Rate 250 MHz. Duty cycle is 50%  $\pm 10\%$  up to 100 MHz, 50%  $\pm 15\%$  for > 100 MHz.

**Trigger output:** negative going Square Wave (50% duty cycle typ.) > 500 mV from 50  $\Omega$  into 50  $\Omega$ . Internal 50  $\Omega$  can be switched off by slide-switch on PC-board. Amplitude up to 1 V into 50  $\Omega$  up to 200 MHz.

**Trigger output protection:** cannot be damaged by short circuit or application of external  $\pm 200$  mA.

## External Operating Modes

### External Input

**Input impedance:** 50  $\Omega \pm 10\%$ , dc coupled.

**Maximum input:**  $\pm 6$  V.

**Trigger level:** adjustable  $-1.5$  V to  $+1.5$  V.

**Slope control:** positive, negative or manual selectable. In the manual position all ext. functions can be controlled by push button. Button pushed in simulates an "on-signal."

**Sensitivity:** sine-wave > 200 mV p-p pulses > 200 mV.

**Repetition rate:** 0 to 250 MHz.

### External-Controlled Modes

**External trigger:** there is approximately 7 ns delay between the external input and the trigger output. Rep. rate is externally controlled (is triggered by external signal). Trigger output provides the pulse-shaped input signal.

**Synchronous gating:** gating signal turns rep. rate generator on. Last pulse normal width even if gate ends during pulse.

**External width:** output pulse width determined by width of drive input. Rep. rate and delay are disabled. Trigger output provides shaped input signal.

## General

**Operating temperature:** 0°C to 55°C.

**Power:** 100/120/220/240 Vrms; +5%, -10%; 48-440 Hz. 85 VA max.

**Weight:** net, 7.9 kg (17.44 lb). Shipping 8.9 kg (19.63 lb).

**Size:** 133 mm H x 426 W x 345 mm D (5.2" x 16.75" x 13.6").

## Ordering Information

HP 8082A Pulse Generator

**Opt 907:** Front Handle Kit (part number HP 5061-0089).

**Opt 908:** Rack Flange Kit (part number HP 5061-0077).

**Opt 909:** Opt 907, 908 Combined (part number HP 5061-0083).

**Opt 910:** Additional Operating and Service Manual

# PULSE GENERATORS

## Configurable Pulse/Data Stimuli

### HP 8080A Series

Example: HP 8080A SO4

- 1 GHz, 300 ps transitions
- Interchannel delay

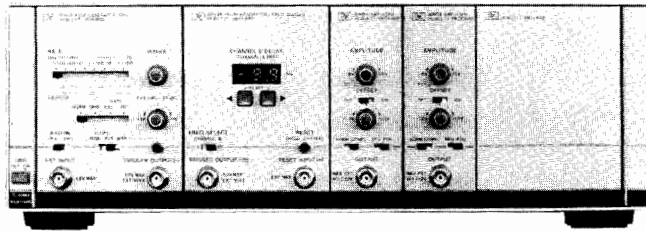

HP 8091A Rate Generator    HP 8092A Delay Generator    CHA CHB HP 8093A Output Amplifiers    HP 15400A Blank Panel

Example: HP 8080A DO1

- 300 MHz, 800 ps transitions
- Manually programmable data

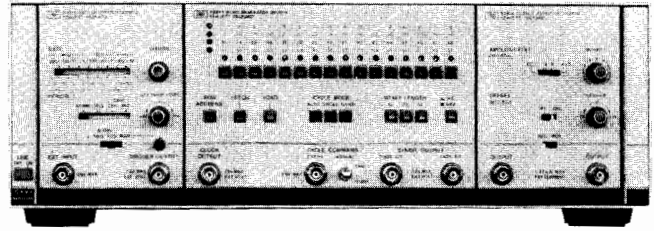

HP 8081A Rate Generator    HP 8084A Word Generator    HP 8083A Output Amplifier

Research and development in advanced technologies such as subnanosecond ICs, fiber optics and nucleonics, require fast pulses for thorough characterization. The HP 8080A can, for example, generate simultaneous 1 GHz clock and simulated NRZ data for testing today's fastest memories, or complementary data with up to 64 bits and fast 300 ps edges for state-of-the-art communication devices. Cost-effectivity is promoted because the HP 8080A's modular structure allows performance and capability to be tailored to the requirement.

Two examples are shown here. Full details of these and all other factory-systemized configurations are in the data sheet. Individual modules are also available for special applications or for extending an existing configuration. Ask for the systemizing and adjustment guidelines.

### Leading Characteristics (50-ohm load)

#### HP 8080A SO4

##### Timing

**Repetition rate:** 100 Hz – 1 GHz.

**Interchannel delay:**  $\pm 9.9$  ns in 0.1 ns steps.

**Channel B divider:** 0.5 f selectable for simulating NRZ data.

**Width:** Square wave.

**Modes:** Int, Ext Width, Gate, Manual.

**Independent 50-ohm Outputs Amplitude:** 0.6 V to 1.2 V<sub>pp</sub>.

**Offset:**  $\pm 1.2$  V.

**Transitions times (10% to 90%):** < 300 ps.

**Polarity:** selectable

**Format:** Normal/Complement selectable

#### HP 8080A DO1

##### Timing

**Repetition rate:** 10 Hz–300 MHz.

**Width:** square wave (RZ) or NRZ.

**Modes:** Int, Ext/Manual Width.

**Data cycle modes:** Ext/Man Single and Gated Cycle, Auto Cycle.

**Data:** Serial, 16/32/64 bit selectable.

**Simultaneous Normal and Complement 50-ohm Outputs**

**Amplitude:** 0.2 V to 2 V.

**Offset:**  $\pm 1$  V.

**Transition times (10% to 90%):** < 800 ps.

**Polarity:** selectable.

### General

**Operating temperatures:** 0°C to 55°C.

**Power:** 115/230 V rms; +10%, -22%; 48 to 66 Hz, 200 VA max.

**Weight:** (typical, HP 8080A Mainframe plus full complement of modules) 9.4 kg (16.6 lbs) net; 19.7 kg (43.3 lbs) shipping.

**Size:** (HP 8080A Mainframe): 133 H x 426 W x 422 mm D (5.24" x 16.77" x 16.61").

### Ordering Information

**HP 8080A Mainframe**

**Opt 907:** Front handle kit

**Opt 908:** Rack flange kit

**Opt 909:** Opt 907, 908 combined

**Opt S01:** (HP 8081/83A, 2 x HP 15400A)

**Opt S02:** (HP 8081/93A, 2 x HP 15400A, 15401A)

**Opt S03:** (HP 8091/93A, 2 x HP 15400A, 15401A)

**Opt S04:** (HP 8091/92A, 2 x HP 8093A, 15400A)

**Opt D01:** (HP 8081/83/84A)

**Opt D02:** (HP 8081/84/93A, 15401A)

**Opt D03:** (HP 8081/84A, 2 x HP 8093A)

**HP 8081A** 300 MHz Rate Generator module

**HP 8083A** 300 MHz Output Amplified module

**HP 8084A** 300 MHz Word Generator module

**HP 8091A** 1 GHz Rate Generator module

**HP 8092A** 1 GHz Delay Generator module

**HP 8093A** 1 GHz Output Amplifier module

**Opt H01:** For variable-width operation with HP 8092A

**Additional manuals:** Opt 910, per module

### Accessories Available

**HP 15400A** Blank Panel, 1/4 mainframe width

**HP 15401A** Blank Panel, 1/8 mainframe width

**HP 15402A** BNC Feedthru panel, 1/8 width

### Pulse Generator Accessories



HP 15104A/15115A

**HP 15104A** Pulse Adder/Splitter dc to 2 GHz

**HP 15116A** Pulse Inverter 3 MHz to 2 GHz

**HP 15115A** Pulse Splitter/Inverter 3 MHz to 2 GHz



HP 15116A

# PULSE GENERATORS

## High Resolution Time Synthesizer

Model 5359A



- Precise digital delays 0-160 ms
- 50 ps increments
- Jitter < 100 ps

- Programmable
- Fully synchronous to external trigger
- Automatic calibration

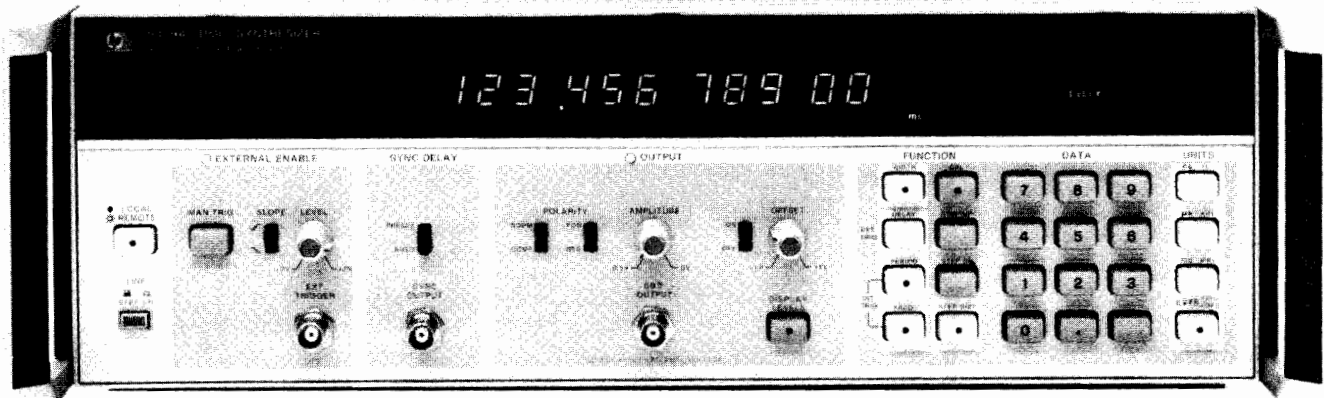

HP 5359A



The HP 5359A Time Synthesizer produces two extremely precise, low jitter time delays. These delays,  $T_d$  and  $T_w$ , are individually selectable by means of the keyboard, in 50 ps or greater steps to generate delays of up to 160 ms.

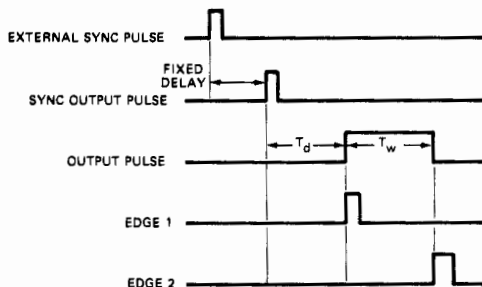

The HP 5359A has many applications and may be used for the calibration of Radar, Loran, DME and Tacan Systems, or for precision generation of delayed sweeps in oscilloscopes, and for extremely accurate "time positioning" control of external gates on frequency counters. In component and circuit test, the instrument may be used for extremely accurate delay line simulation.

### Condensed Specifications

#### Modes

**External trigger mode:** the delays from the sync out to the beginning of the output pulse, and the width of the output pulse, are selected.

**Internal trigger mode:** the "period" or "frequency", and the width of the output pulse, are selected.

#### Range

**Delay  $T_d$ :** 0 ns to 160 ms.

**Width  $T_w$ :** 5 ns to 160 ms (width & delay  $\leq$  160 ms).

**Period:** 100 ns min or width + 85 ns; 160 ms max.

**Frequency:** same as corresponding "period".

**Repetition rate:** 10 MHz max.

**Accuracy:**  $\pm 1$  ns  $\pm$  time base error.

**Insertion delay:** fixed at < 150 ns; selectable as < 50 ns for delays > 100 ns.

**Jitter:** typical 100 ps rms; maximum 200 ps rms (delays to 10 ms)

**External trigger input:** -2 V to + 2 V slope selectable.

**Sync output:** 1 V - 50  $\Omega$ ; 5 V - 1 M $\Omega$ . Width 35 ns nominal.

#### Output Pulse

**Amplitude:** 0.5 V to 5 V into 50  $\Omega$ .

**Polarity:** positive or negative.

**Offset:** -1 V to 1 V, or OFF.

**Transition time:** < 5 ns.

External voltage must not be applied. Offset and Amplitude voltage into 50  $\Omega$  may be displayed.

**EDGE 1 OUTPUT (rear panel):** occurs in Sync with leading edge of output pulse (same spec. as Sync out).

**EDGE 2 OUTPUT (rear panel):** occurs in Sync with falling edge of output pulse (same spec. as Sync out).

**Events mode:** substitutes external input (to 100 MHz) for the internally counted clock (delay and width must both be specified in terms of events instead of time).

**Triggered frequency mode:** the same as internal frequency mode except the output is a burst beginning in synchronism with an external trigger signal, and continues for the duration of this signal.

**Calibrate mode:** performs an internal calibration to remove the effects of internal delay differences.

**External probes:** provides outputs to control the HP 5363B probes and accepts inputs from the probes to include external devices in the calibration loop.

**HP-IB:** All controls except trigger levels are programmable as standard.

#### Time Base

High Stability Oven Oscillator

**Frequency:** 10 MHz

**Aging:**  $< 5 \times 10^{-10}$ /day

**Temperature:**  $< 2.5 \times 10^{-9}$ , 0°C to 50°C

**Line voltage:**  $< 1 \times 10^{-10}$ ,  $\pm 10\%$  from nominal

**Size:** 133 H x 426 W x 521 mm D (5.25" x 16.75" x 20.50").

**Weight:** 30 lbs.

**Power requirements:** 100, 120, 220, or 240 Vac +5% -10%, 48 to 66 Hz, less than 250 VA

**Front handles:** supplied with instrument.

#### Options and Accessories

**908:** Rack Flange Kit for use without handles

**913:** Rack Flange Kit for use with supplied handles

**HP 10870A:** Service Kit

**HP 5359A Time Synthesizer**



# AMPLIFIERS

## Microwave Amplifier

### Model 11975A

- 2 GHz to 8 GHz wideband frequency coverage
- 40 milliwatts (+16 dBm) output power
- Adjustable, calibrated power level

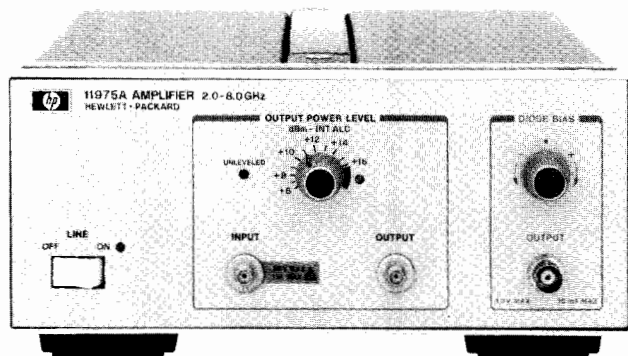

HP 11975A

### Convenient Microwave Amplifier

The HP 11975A is a general purpose microwave amplifier which offers versatility, convenience, and reliability at an economical price. Combining state-of-the-art GaAs FET technology with a regulated power supply and control circuits makes this amplifier a complete tool for lab and production.

### Broadband, Leveled Power

The amplifier delivers up to 40 milliwatts (+16 dBm) of leveled power for broadband input signals from 2 to 8 GHz. With  $\pm 1$  dB frequency response and  $\pm 2$  dB absolute power accuracy, the HP 11975A provides calibrated power for fixed or swept frequency needs.

### Versatile Features

The HP 11975A has many features designed for general purpose use:

**Automatic level control (ALC):** output power is normally leveled unless the ALC switch (rear panel) is OFF or less than minimum input power required for leveling is available. An unlevelled light indicates the non-ALC condition.

**Adjustable output power:** calibrated output power can be adjusted from +6 to +16 dBm. An uncalibrated light indicates when greater than +16 dBm is present at the output connector.

**Diode bias:** positive or negative bias current needed for some harmonic mixers is provided by a separate connector and control knob.

### Applications

The HP 11975A supports many general purpose testing needs:

- As an LO booster and isolation amplifier, the HP 11975A improves mixer performance and testing.
- As a pre-amplifier, the HP 11975A increases counter sensitivity and improves spectrum analyzer noise figure.
- As an LO line driver for a harmonic mixer (such as an HP 11517A or HP 11970), the HP 11975A increases sensitivity, improves frequency response, and reduces gain compression.

### Specifications

#### Frequency Specifications

**Frequency range:** 2.0 to 8.0 GHz in one band.

#### Output Specifications

##### Distortion

**Harmonics (2nd and 3rd):**  $< -20$  dBc for  $P_{out} \leq +16$  dBm.

**Non-harmonics:**  $< -60$  dBc typical for  $P_{out} \leq +16$  dBm.

**Third order intercept (ALC OFF):** +25 dBm typical.

**1 dB gain compression (ALC OFF):** +18 dBm typical.

**Noise figure:** 13 dB typical.

##### Output Power (ALC ON)

**Power level control:** single turn knob with 11 calibrated divisions in 1 dB steps; spring loaded detent for uncalibrated power above +16 dBm.

- Automatic level control (ALC)
- Diode bias supply for harmonic mixers

**Power range:** +6 dBm to +16 dBm.

**Absolute power accuracy:**  $\pm 2.0$  dB;  $\pm 1.5$  dB typical.

**Frequency response:**  $\pm 1.0$  dB;  $\pm 0.5$  dB typical.

**Uncalibrated power range:** +16.75 dBm to +19 dBm typical; uncalibrated light warns of high level.

**Reverse isolation:**  $> 40$  dB typical at +16 dBm output.

#### Output Connection

**Connector:** SMA female.

**Impedance:** 50 ohm nominal.

**SWR:** 1.7:1, ALC ON; 2.5:1 typical, ALC OFF.

**Short circuit protection:** continuous.

#### Input Specifications

**Minimum input power:** minimum power for leveling.

**Small signal gain:** gain with less than minimum input for leveling or with ALC switch OFF (rear panel).

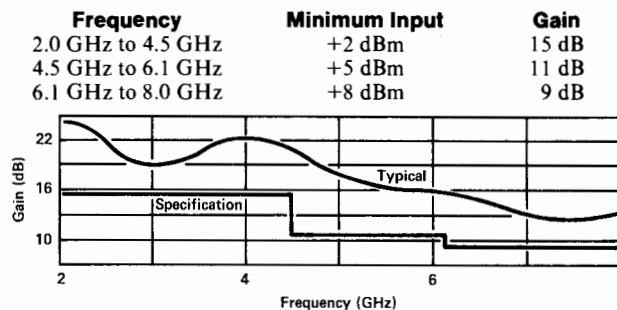

Small signal gain vs. frequency

#### Input Connection

**Connector:** SMA female.

**Impedance:** 50 ohm nominal.

**SWR (ALC OFF):** 2.7:1 typical.

**Maximum input:** +30 dBm (1 watt);  $\pm 35$  Vdc.

#### Diode Bias Specifications

**Bias control:** five turn knob for positive and negative current adjustment with 10  $\mu$ A resolution.

**Current range:** 0 to  $\pm 10$  mA typical for single diode load.

#### Output Connection

**Connector:** BNC female.

**Maximum voltage:**  $\pm 3$  Vdc typical.

**Short circuit protection:**  $\leq 11$  mA @ 25° C.

#### General Specifications

**Power requirements:** 100, 120, 220, or 240 Vac (user selectable), +5%, -10%; 48 to 440 Hz; less than 36 VA; convection cooled.

**Environmental:** per MIL-T-28800C, Type III, Class 5, Style E.

**Temperature:** operating 0° to +55° C; storage -40° to +75° C.

**EMI:** conducted and radiated interferences are in compliance with methods CEO3 and REO2 of MIL STD 461A and CISPR Pub. 11 (1975).

**Weight:** net, 3.04 kg (6.8 lb). Shipping, 5.45 kg (12.2 lb).

**Size:** 102 H  $\times$  213 W  $\times$  297 mm D (4.0"  $\times$  8.4"  $\times$  11.7").

#### Ordering Information

**HP 11975A Amplifier**

**Opt 001:** Type N Female Connectors

**Opt 907:** Front Handles

**Opt 910:** Extra Operating and Service Manual

**Rack Mounting Kit:** (HP P/N 5061-0072)



- Continuous 2 to 20 GHz coverage
- 15 dB gain



HP 8349A

The HP 8349A microwave amplifier delivers increased microwave power performance across a 2 to 20 GHz frequency range. This general-purpose broadband power amplifier is designed for maximum reliability and configured for the greatest convenience in interfacing with Hewlett-Packard's microwave sources, namely, the HP 8350 or HP 8620C sweep oscillators, the HP 8340A/8341A synthesized sweepers, and the HP 8672A or 8673 synthesized signal generators.

Providing 100 mW (+20 dBm) of unleveled output power and 80 mW (+19 dBm) of leveled power from 2 to 18.6 GHz (typically to 20 GHz), the HP 8349A is one of the most broadband solid-state power amplifiers available today. This general-purpose, broadband power performance is achieved using a GaAs FET design of multiple stages. This multiple stage design provides more than 15 dB of gain over the full 2 to 20 GHz range.

Externally leveled output power can also be provided by the HP 8349A without using an external coupler and detector, since these external leveling components are built-in and are compatible with Hewlett-Packard microwave sources. The HP 8349A is also equipped with an output power display. This display minimizes the need for an external power meter and enhances the amplifier's utility; for example, at the end of a long cable, where the microwave output needs to be amplified, leveled and measured.

Naturally, the versatile power control features of the microwave source (e.g., calibrated power, power sweep, power slope and remote power control via the Hewlett-Packard Interface Bus) can be accurately transmitted through the HP 8349A during external leveling operations.

### Applications

The HP 8349A is an excellent power amplifier for microwave measurements in a versatile bench-top arrangement or in a dedicated rack-mount system.

The broadband power of the HP 8349A is also ideal for making antenna efficiency and antenna pattern measurements.

The dynamic range of a scalar network analyzer measurement system is limited by the maximum output power of the microwave source and the sensitivity of the receiver. In the following configuration the effective dynamic range is typically extended by >20 dB by combining the calibrated dynamic range of the reference detector (R) with that of the transmission detector (b) in a ratio measurement (B/R). The HP 8349A makes this possible by extending the external crystal leveling power control of the microwave source.

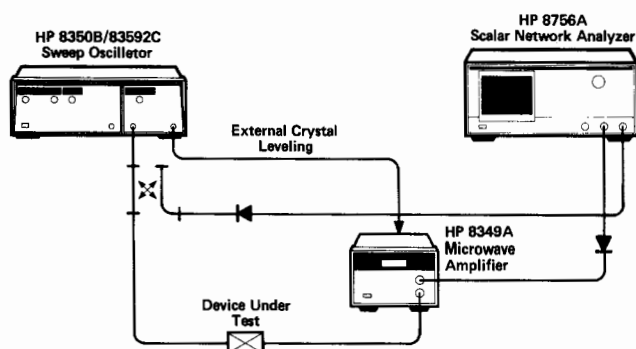

- 100 milliwatts across 2 to 20 GHz
- < 13 dB typical noise figure

Hewlett-Packard Application Note 327-1 discusses this application in detail, and shows how typically >80 dB of dynamic range can be achieved from 2.0 to 20 GHz using the HP 8349A amplifier, the HP 8350B/83592C sweep oscillator and the HP 8755C, 8756A, or the HP 8757A scalar network analyzer.

High power pulse measurements (20 dBm output power, 80 dB on/off ratio, 25 ns rise and fall times) from 2 to 20 GHz can be achieved using the HP 8349A amplifier and the HP 8340A or HP 8341A Opt. 006 synthesized sweeper or the HP 8673A synthesized signal generator.

RFI susceptibility tests can also greatly benefit from the high quality amplifying characteristics of the HP 8349A.

### Frequency Specifications

Range: 2.0-20 GHz

### Output and Input Specifications (25°C ±5°C)

Minimum Output Power (25°C ±5°C):

Frequency Range (GHz)	Input	Output	
		Leveled	Unleveled
2.0 to 18.6	5 dBm (3.2mW)	19 dBm (80mW)	20 dBm (100mW)
18.6 to 20.0 (typical)	6 dBm (4.0mW)	19 dBm (80mW)	20 dBm (100mW)

**Power Flatness (Leveled):** ±1.25 dB

**1 dB Compression Point:** +21 dBm, nominal

**Minimum Small Signal Gain (at -5 dBm input):** 15 dB

**Noise Figure:** <13 dB, typical

**Impedance (Input and Output):** 50 ohms, nominal

**SWR**

Frequency Range (GHz)	Input	Output	
		Leveled	Unleveled (typical)
2.0 to 5.0	≤2.8	≤2.5	≤4.8
5.0 to 11.0	≤2.8	≤2.5	≤3.8
11.0 to 18.0	≤2.8	≤2.5	≤3.2
18.0 to 20.0*	≤2.8	≤2.5	≤3.2

\*SWR from 18.0 to 20.0 GHz is typical

**Maximum Continuous Input, to the input or output ports:**

+27 dBm (RF), ±10V

### Spectral Purity

**Harmonics:** <-20 dBc, 2.0 to <11.0 GHz (at +20 dBm output).

<-30 dBc, 11.0 to 20.0 GHz (at +20 dBm output).

**Non-Harmonic Spurious:** ≤-55 dBc.

**Third Order Intercept:** +33 dBm, nominal.

### Pulse Transmission Capability

**Rise/Fall Time:** Typically <10 ns.

**Delay Time (input to output):** Typically <8 ns.

### General

**Reverse Isolation:** >50 dB, typical

**RF Input/Output Connectors:** Type N Female

**Size:** 133 H x 214 W x 366 mm D (5.2" x 8.36" x 13.6").

**Weight:** Net, 7 kg (15 lb); shipping, 14 kg (31 lb).

### Ordering Information

HP 8349A 2 to 20 GHz Microwave Amplifier

**Opt 001** Rear Panel RF Input/Output

**Opt 002** Rear Panel RF Input with Front Panel RF

Output

# 418 AMPLIFIERS

## RF Amplifiers Models 8447A/D/E/F

- Wide band (multi-decade)
- Low noise
- Flat response

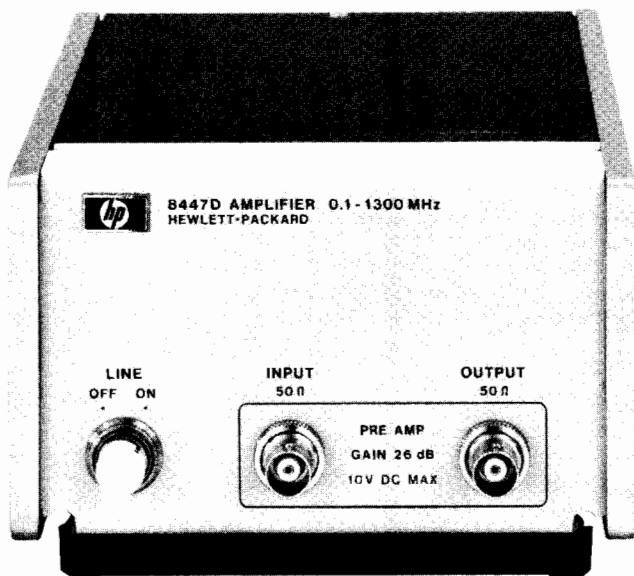

HP 8447D

The HP 8447 series of general purpose amplifiers offers high reliability and the convenience of a small, lightweight package.

### High Performance

These low noise, high gain amplifiers provide the flat frequency response and low distortion required for a wide range of uses. They can be used to improve the sensitivity of counters, spectrum analyzers,

RF voltmeters, EMI meters, power meters and other devices, or to increase the maximum power available from a signal generator or sweeper.

### Broadband Frequency Coverage

The HP 8447 series offers an amplifier for nearly every application in the 100 kHz to 1.3 GHz frequency range. The amplifiers' wide bandwidths are compatible with other wideband instruments used for making measurements involving broadband spectra.

### Options

Standard connectors are BNC (f) on all amplifiers.  
 Option 010 ..... N (f) connectors on single channel amplifier.  
 Option 001 ..... Dual channel amplifier, BNC (f) connectors.  
 Option 011 ..... Dual channel amplifier, N (f) connectors.  
**Note:** dual channel amplifiers are ideal for dual channel systems such as oscilloscopes or network analyzers. Channels may also be cascaded for increased small-signal gain.

### General

**Weight:** net, 1.56 kg (3.4 lb). Shipping, 2.30 kg (5.1 lb).  
**Size:** 85.8 H x 130 W x 216 mm D (3.4" x 5.1" x 8.5").  
**Power requirements:** 110 or 230 V ac  $\pm$  10%, 48-440 Hz, 15 watts.

### Ordering Information

**HP 8447A** Preamp  
**Opt 910:** Extra Operating and Service Manual (HP 8447A)  
**HP 8447D** Preamp  
**HP 8447E** Power Amp  
**HP 8447F** Preamp-Power Amp  
**Opt 910:** Extra Operating and Service Manual (HP 8447D/E/F)

### Specifications

	HP 8447A Preamp	HP 8447D Preamp	HP 8447E Power Amp	HP 8447F Preamp-Power Amp
Frequency Range	0.1-400 MHz	100 kHz-1.3 GHz	100 kHz-1.3 GHz	100 kHz-1.3 GHz
Typical 3 dB Bandwidth	50 kHz-700 MHz	50 kHz-1.4 GHz	50 kHz-1.4 GHz	50 kHz-1.4 GHz
Gain (Mean, per channel)	20 dB $\pm$ 0.5 dB at 10 MHz	>26 dB (20°C-30°C)	22 dB $\pm$ 1.5 dB (20°C-30°C)	
Gain Flatness Across Full Frequency Range	$\pm$ 0.5 dB	$\pm$ 1.5 dB	$\pm$ 1.5 dB	† HP 8447D AND 8447E COMBINED IN A SINGLE PACKAGE †
Noise Figure	<5 dB	<8.5 dB	<11 dB typical	
Output Power for 1 dB Gain Compression	>+6 dBm	>+7 dBm typical	>+15 dBm	
Harmonic Distortion	-32 dB for 0 dBm output	-30 dB for 0 dBm output (typical)	-30 dB for +10 dBm output	
Typical Output for <-60 dB Harmonic Distortion	-25 dBm	-30 dBm	-20 dBm	
VSWR	<1.7	<2.0 input <2.2 output 1-1300 MHz	<2.2 1-1300 MHz	
Impedance	50 $\Omega$	50 $\Omega$	50 $\Omega$	
Reverse Isolation	>30 dB	>40 dB	>40 dB	
Maximum DC Voltage Input	$\pm$ 10 V	$\pm$ 10 V	$\pm$ 10 V	
Options Available	001	001, 010, 011	010	



Signal sources are described by various names: oscillators, audio signal generators, synthesizers, function generators, etc. The names are typically associated with the application area. A signal generator is an oscillator that has modulation capability. Synthesizers are sine-wave sources generated digitally, using a process known as "fractional N", which gives them excellent frequency stability. The term oscillator refers exclusively to a sinusoidal source while a function generator always provides additional wave shapes, most often square waves, triangle waves and, increasingly, arbitrary waveforms.

Technological progress has lowered the cost of digitally derived sources. Hence, synthesizers are increasingly being used in place of oscillators. Synthesizers offer the user two important benefits, the ability to digitally enter frequency very precisely and extremely stable frequency output. In addition, function generators and arbitrary waveform generators are becoming digitally derived, which has tended to blur the traditional definitions of these products.

### Oscillators

In choosing a particular oscillator, frequency range, output level and distortion are the key considerations. Typically, oscillators used for testing of audio equipment, filters, amplifiers, etc., require total harmonic distortion (THD) to be less than 65 dB. Oscillators used in video testing must provide signals to at least 6 MHz and often to 10 MHz. For many general-purpose applications, high level signals are needed. Hewlett-Packard offers oscillators that meet these requirements.

### Distortion

Distortion in total harmonic terms is a measure of the oscillator's signal purity. It is represented as a ratio of the total harmonic content to the fundamental. Distortion is expressed either as dBs below the fundamental or as a percentage of the fundamental. A typical "good" value might be a THD of -60dB (0.1%), although -95dB is becoming necessary, especially in the audio entertainment and hi-fi areas. Hewlett-Packard offers this high level of signal purity in the integrated oscillator of the HP 339A Distortion Measurement Set.

### Frequency Stability

Frequency stability of an oscillator determines the ability of the instrument to maintain a selected frequency over a period of time. Component aging, power-supply variations and temperature changes all affect

stability. Carefully chosen components, such as precision resistors and variable capacitors in the frequency-determining networks, contribute to a long-term stability. Technology, particularly large scale integration, minimizes the adverse effects of temperature and in such situations all but eliminates the effects of discrete component aging.

### Amplitude Stability

Amplitude stability with time and over a desired frequency range is an important characteristic in most applications. Hewlett-Packard uses negative feedback techniques to minimize variations in amplitude with time and pays great attention to circuit elements that influence the frequency response of the oscillator.

Source Summary

Type	HP Model	Frequency Range	Page
Oscillator (Page 421)	200CD	100Hz - 100MHz	421
Function Generator (Page 422)	3310A/B	100Hz - 100MHz	422
	3311A	100Hz - 100MHz	423
	3312A	100Hz - 100MHz	424
	3314A	100Hz - 100MHz	425
Pulse/ Function Generator	8111A	100Hz - 100MHz	428
	8116A	100Hz - 100MHz	429
Synthesizer/ Function Generator	3325A	100Hz - 100MHz	432
	8165A	100Hz - 100MHz	431
Synthesizer/ Level Generator	3335A	100Hz - 100MHz	436
	3336A/B/C	100Hz - 100MHz	437 & 141



# FUNCTION GENERATORS & FREQUENCY SYNTHESIZERS

## General Information (con't)

### Function Generator Summary

	Function Generators				Pulse/Function Generators		Synthesizer/Function Generators	
	3310A/B	3311A	3312A	3314A	8111A	8116A	3325A	8165A
Frequency								
Min	0.5 mHz	0.1 Hz	0.1 Hz	1.0 mHz	1.0 Hz	1.0 mHz	1 $\mu$ Hz	1 mHz
Max	5.0 MHz	1.0 MHz	13 MHz	20 MHz	20 MHz	50 MHz	21 MHz-sine 11 MHz-square 11 kHz-triangle	50 MHz 20 MHz-pulse/ramp
Waveforms (symmetry)								
Sine	50%	50%	20-80%	5-95%	10-90%	10-90%	50%	50%
Square	15/50/85%	50%	20-80%	5-95%	10-90%	10-90%	50%	20, 50, 80%
Transition time	<30 ns	<100 ns	<20 ns	<9 ns	<10 ns	<6 ns	<20 ns	<5 ns
Triangle	15/50/80%	50%	20-80%	5-95%	10-90%	10-90%	50% + ramp	20, 50, 80%
Output (into 50 Ohms)								
Amplitude (p-p)	15 V	10 V	10 V	10 V	16 V	16 V	10 V	20 V
DC Offset	$\pm 5$ V	$\pm 5$ V	$\pm 5$ V	$\pm 5$ V	$\pm 8$ V	$\pm 8$ V	$\pm 5$ V	$\pm 5$ V
Output Impedance- $\Omega$	50	600	50	50	50	50	50	50/1000
Modes								
Counted Burst	—	—	—	1 to 1999	1 to 1999	1 to 1999	—	1 to 1999
Gate	ext-3310B	—	int/ext	int/ext	ext	ext	—	ext
Phase Lock	—	—	—	$\pm 200$ deg	—	—	$\pm 720$ deg	ext
Trigger	ext-3310B	—	int/ext	int/ext	ext	int/ext	—	ext
Arbitrary	—	—	—	150 vectors	—	—	—	—
Modulation/Sweep								
AM	—	—	int/ext	ext	—	ext	ext	option
FM	—	—	int/ext	ext	—	ext	PM	ext
PWM	—	—	—	—	—	ext	—	—
VCO	ext	ext	int/ext	ext	ext	ext	—	ext
Lin Sweep	—	—	int/ext	int	—	—	int	—
Log Sweep	—	—	—	int	—	option	int	option
Programmability	—	—	—	HP-IB	—	HP-IB	HP-IB	HP-IB
Catalog page	422	423	424	425	428	429	432	431
Notes		into 600 $\Omega$	50% above 1 MHz	also $\frac{1}{2}$ cycle bursts	50% above 1 MHz	20-80% above 1 MHz	40 Vp-p to 1 MHz option	

### Function Generators

The function generator is a versatile, multi-waveform signal source capable of very wide frequency coverage.

The HP 3310A/B, 3311A, 3312A, 3314A and 3325A offer a complete set of functions including sine, square, triangle, ramp and even arbitrary waveforms (HP 3314A). For extended pulse capabilities, the HP 8111A and 8116A Pulse/Function Generators include precise timing waveforms.

In addition to this complete set of waveforms, Function Generators include versatile modulation capabilities such as amplitude, frequency, phase, pulse width and VCO control.

The Function Generator is an indispensable, general-purpose signal source for production testing, instrument repair, and electronics laboratory. Diverse fields of applications in which the function generator is being used include medical research, education, chemical, communications, geophysics, industrial control, military and aerospace.

### Frequency Synthesizers

Today's measurement needs are placing increasingly stringent requirements on signal sources for greater frequency resolution and stability. Narrowband component testing, satellite and terrestrial communications, local oscillator and automatic test systems are only a few of the many applications that con-

tinually require higher precision sources.

Square waves, triangle waves, and pulses are signals typically associated with non-synthesized sources. This situation is changing. Precision signals of these types are finding important applications in mechanical, civil and environmental engineering.

Increased amplitude accuracy and resolution are also requirements in many applications. The telecommunications industry's Frequency Division Multiplex (FDM) systems require high amplitude accuracy and resolution (0.01 dB) as well as high frequency resolution and stability. These requirements are becoming commonplace in R&D and production test environments.

### Frequency Synthesis Techniques

Traditional approaches to indirect synthesis techniques require a phase-locked loop for every decade of frequency resolution. This method provides adequate performance, but many component parts leads to an expensive product. However, a new technique has been developed by Hewlett-Packard that allows a single phase-locked loop to offer multidigit resolution. The process is called Fractional Frequency Synthesis or Fractional N—a method of relating the VCO frequency to the crystal reference by other than an integer N. Up to 11 digits of frequency resolution can be achieved from a single phase-locked loop with this new technique. Significant cost savings and increased reliability result.

### Signal Quality

The common specifications that describe signal sources include frequency range and resolution, amplitude range and resolution, distortion and stability.

Additional specifications that are pertinent to the synthesizer are phase noise and spurious content. Phase noise describes the short-term frequency stability of a signal source. It is typically specified as single sideband spectral density or integrated (total) phase noise. Spurious signals are discrete, nonharmonically related signals appearing in the output.

### Synthesizers

Hewlett-Packard offers a wide range of high quality frequency synthesizers and synthesized signal generators covering the frequency range of dc to 26 GHz. In addition to being high performance synthesized signal sources, they incorporate many additional features which allow them to fulfill the needs of either bench or programmable applications.

The combined frequency ranges of the HP 8656B, 8660A/C, 8662A, 8663A, 8672A and 8673B,C, and D Synthesized Signal Generators span 10 kHz to 26 GHz. These generators couple the frequency accuracy and stability of synthesizers with the modulation capability and precise, calibrated, wide-range level control of high quality signal generators. In addition, each of these

# FUNCTION GENERATORS & FREQUENCY SYNTHESIZERS

General Information (con't)

421



generators offers HP-IB remote control of frequency, level and modulation.

## Synthesized Level Generators

The HP 3335A is a synthesized level generator covering the range of 200 Hz to 80 MHz. This instrument is ideal as a stand-alone generator with synthesizer stability or as a companion generator for the HP 3745A/B SLMS and HP 3586A/B/C Selective Level Meters. It offers the traditional range of connectors and output impedances, balanced and unbalanced, required by the

telecommunications industry. The HP 3336A/B/C is a 21-MHz synthesized level generator with a similar set of telecommunications features. It, too, is ideal as a stand-alone generator or as a companion for HP's 3586A/B/C Selective Level Meters. For more information on these generators, refer to the Telecommunications section of this catalog.

## Sweep Capability

The HP 3325A, 3330B, 3335A, 3336A/B/C, 8660C, 8662A, 8663A, and 8673B, C and D are among the most linear sweepers ever built. Keyboard control of microprocessors gives these instruments digital

control of sweep start/stop frequencies and sweep times.

## Synthesizer/Function Generator

The HP 3325A is a function generator whose functions are derived from a primary synthesized oscillator. It provides a high purity synthesized sine wave from 0.000001 Hz to 21 MHz, precision square waves to 11 MHz, linear ramps and triangle waveforms to 11 kHz, 11 digit resolution ( $1 \mu\text{Hz} < 100 \text{ kHz}$ ), wideband phase-continuous sweep, and HP-IB programmability. The low price makes the HP 3325A an excellent choice for automatic test systems or bench applications.

HP Model	Frequency Range	Frequency Resolution	Frequency Stability	Level Range dBm · 50 $\Omega$	Level Resolution	Remote Control	Other Features*
3325A*** (Pg. 432)	DC-21 MHz (sine) DC-11 MHz (square)	0.000001 Hz or 0.001 Hz (11 digits)	$5 \times 10^{-6}$ /yr	-56.02 to +23.98 (sine)	0.01 dB or 0.001 mV to 0.01 V (4 digits)	All functions	8, 11, 12, 13
3326A (Pg. 434)	DC-13 MHz	0.000001 Hz or 0.001 Hz (11 digits)	$5 \times 10^{-6}$ /yr	-56.02 dBm to +23.98 dBm	0.01 dB or 0.001 mV to 0.01V (4 digits)	All functions	8, 11, 12, 13, 18
3335A (Pg. 436)	200 Hz-80 MHz	0.001 Hz	$10^{-6}$ /day	-87 to +13	0.01 dB (4 digits)	All functions	2, 3, 8
3336A/B/C (Pg. 141 & 437)	10 Hz - 21 MHz	0.001 Hz or 11 digits	$1.5 \times 10^{-6}$ /day	-71 to +8	0.01 dB	All functions	8, 11, 12, 13
8656B (Pg. 421)	100 kHz to 990 MHz	10 Hz	$10^{-9}$ /day	-127 to +13	0.1 dB	Freq., ampl. & modulation	8, 14
8660A/C** (Pg. 448)	10 kHz to 2600 MHz	1 Hz or 2 Hz (10 digits)	$3 \times 10^{-9}$ /day	-146 to +13	Local: 10-dB steps plus Vernier remote: 1-dB steps	Freq., ampl. & modulation	Hp 8660A 5, 7, 8 HP 8660C 3, 5, 7, 8
8642A/B (Pg. 442)	100 kHz to 1050 MHz (A) 100 kHz to 121 MHz (B)	1 Hz	$2 \times 10^{-6}$ /yr ( $1 \times 10^{-9}$ /day opt.)	-140 to +20	0.1 dB	All functions	3, 4, 12, 13, 14
8662A** (Pg. 445)	10 kHz - 1280 MHz	0.1 Hz or 0.2 Hz (11 digits)	$5 \times 10^{-10}$ /day	-139.9 to +13	0.1 dB (4 digits)	Freq., ampl., modulation & sweep	3, 8, 14
8663A** (Pg. 445)	10 kHz to 2560 MHz	0.1 Hz or 0.2 Hz (11 digits)	$5 \times 10^{-10}$ /day	-129.9 to +16	0.1 dB	Freq., ampl., modulation & sweep	3, 8, 14, 15
8671A (Pg. 463)	2 to 6.2 GHz	1 kHz	$5 \times 10^{-10}$ /day	>+8	—	Freq., FM modulation	8, 9
8672A/8673B (Pg. 460)	2 to 18/26 GHz	1, 2, 3, 4 kHz	$5 \times 10^{-10}$ /day	-120/-100 to +3/0	Local: 10-dB steps plus Vernier remote: 1/0.1-dB steps	Freq., ampl. & modulation	8, 10/ 8, 16
8673C/D (Pg. 462)	50 MHz to 18.6/26 GHz	1, 2, 3, 4, kHz	$5 \times 10^{-10}$ /day	-100 to +2/ +5	Local: 10-dB steps plus Vernier remote: 0.1-dB steps	Freq., ampl. & modulation	8, 16, 17
8165A (Pg. 431)	1 mHz to 50 MHz	4 digits	$1 \times 10^{-6}$ /day	10.0 mV to 20 Vp-p	3 digits	Modulation & trigger	3, 8, 10

\*Other features: (1)  $10^{-9}$ /day freq. stability optional, (2)  $5 \times 10^{-10}$ /day, (3) digital freq. sweep, (4) digital ampl. sweep, (5) internal AM/FM,  $\Theta$ M, (6) external AM, (7)  $3 \times 10^{-9}$ /day stability Opt. 001, (8) HP-IB, (9) external FM, (10) external AM & FM, (11)  $5 \times 10^{-6}$ /week stability optional, (12) external AM &  $\Theta$ M, (13) phase-continuous sweep, (14) internal & external AM & FM, (15) independent and simultaneous A, FM, PM and pulse modulation, (16) external AM, FM, and pulse modulation, (17) harmonically-related spurious  $< -60$  dBc, (18) The HP 3326A is a two-channel synthesizer with internal modulation, square waves, discrete (user-defined) frequency sweep, and four operating modes including two-phase, two-tone, pulse, and two-channel.

\*\*The HP 8660A/C, 8662A, 8663A and 8672A are synthesized signal generators. They are discussed in detail in the section labeled "Signal Generators."

\*\*\*The HP 3325A Synthesizer/Function Generator includes squarewaves, positive and negative ramps, and triangle waveforms in addition to sinewaves.

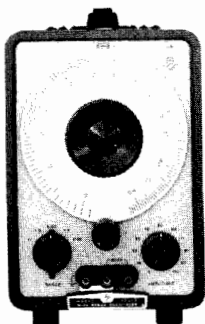

## HP 200C/D

### Specifications

**Frequency range:** 5 Hz to 600 kHz

**Number of ranges:** 5 overlapping

**Dial accuracy:**  $\pm 2\%$

**Flatness (1 kHz ref.):**  $\pm 1$  dB

### Output voltage:

(600  $\Omega$  load) 10 Vrms ( $> 160$  mW)

(open circuit) 20 Vrms

**Output impedance:** 600  $\Omega$

**Attenuator:** continuously variable

**Distortion:**  $< 0.5\%$  5 Hz to 20 Hz

$< 0.2\%$  20 Hz to 200 kHz

$< 0.5\%$  200 kHz to 600 kHz

**Hum and noise voltage:**  $< 0.1\%$  of rated output

**Balance:**  $< 0.1\%$  at lower frequencies approx. 1% at higher frequencies

**Input voltage:** 115 or 230 VAC  $\pm 10\%$ , 48-440 Hz

**Power consumption:** 90 VA

**Net weight:** 9.9 kg (22 lb)

**Shipping weight:** 10.8 kg (24 lb)

**Dimensions:** 292 mm H x 187 mm W x 365 mm D (11.5 x 7.4 x 14.4")

## Ordering Information

HP 200CD



# FUNCTION GENERATORS & FREQUENCY SYNTHESIZERS

## 0.0005 Hz to 5 MHz Function Generators

Model 3310A/B

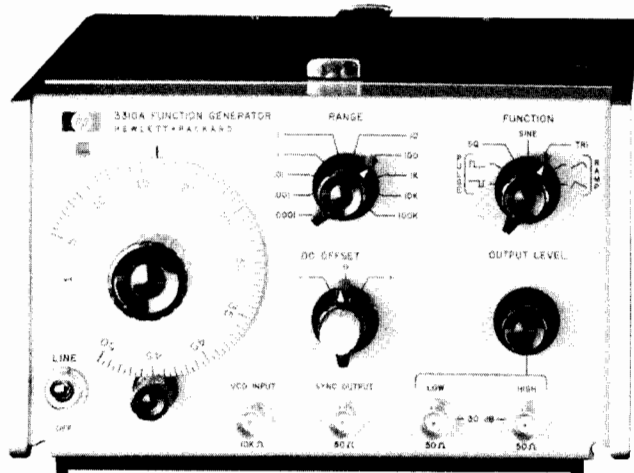

HP 3310A

### Description

The HP 3310A Function Generator is a compact voltage-controlled generator with 10 decades of range. Ramp and pulse functions are available in addition to sine, square and triangle. DC offset and external voltage control provide wide versatility. A fast rise time sync output is provided. Aspect ratio of nonsymmetrical function is 15%/85%.

The HP 3310B has all the features of the standard HP 3310A plus single and multiple cycle output capability.

### HP 3310A Specifications

**Output waveforms:** sinusoidal, square, triangle, positive pulse, negative pulse, positive ramp and negative ramp. Pulses and ramps have a fixed 15% or 85% duty cycle.

**Frequency range:** 0.0005 Hz to 5 MHz in 10 decade ranges.

#### Sine Wave Frequency Response

**0.0005 Hz to 50 kHz:**  $\pm 1\%$ ; 50 kHz to 5 MHz:  $\pm 4\%$ . Reference, 1 kHz at full amplitude into 50  $\Omega$ .

#### Dial Accuracy

**0.0005 Hz to 500 kHz all functions:**  $\pm(1\%$  of setting + 1% of full scale).

**500 kHz to 5 MHz sine, square and triangle:**  $\pm(3\%$  of setting + 3% of full scale).

**500 kHz to 5 MHz pulse and ramps:**  $\pm(10\%$  of setting + 1% of full scale).

**Maximum output on high:** >30 V p-p open circuit, >15 V p-p into 50  $\Omega$  (except for pulses at frequency >2 MHz).

**Pulse (frequency >2 MHz):** >24 V p-p open circuit, >12 V p-p into 50  $\Omega$ .

**Minimum output on low:** <30 mV p-p open circuit, <15 mV p-p into 50  $\Omega$ .

**Output level control:** range >30 dB. High and low outputs overlap for a total range of >60 dB; low output is 30 dB down from high output.

#### Sine Wave Distortion

**0.0005 to 10 Hz:** >40 dB (1%).

**10 Hz to 50 kHz (on 1 k range):** >46 dB (0.5%).

**50 kHz to 500 kHz:** >40 dB (1%).

**500 kHz to 5 MHz:** >30 dB (3%).

**Square wave and pulse response:** <30 ns rise and fall times at full output.

**Triangle and ramp linearity:** 0.0005 Hz to 50 kHz, <1%.

**Impedance:** 50  $\Omega$ .

#### Sync

**Amplitude:** >4 V p-p open circuit, >2 V p-p into 50  $\Omega$ .

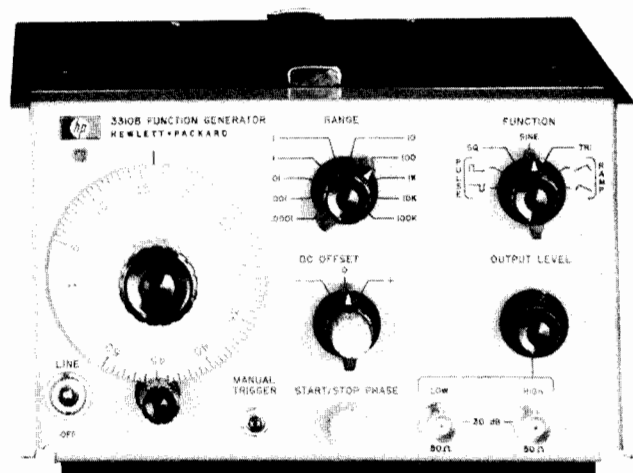

HP 3310B

### DC Offset

**Amplitude:**  $\pm 10$  V open circuit,  $\pm 5$  V into 50  $\Omega$  (adjustable).

**Note:** max V ac peak + V dc offset is  $\pm 15$  V open circuit,  $\pm 7.5$  V into 50  $\Omega$ .

**External frequency control:** 50:1 on any range.

**Input requirement:** with dial set to low end mark, a positive ramp of 0 to +10 V  $\pm 1$  V will linearly increase frequency 50:1. With dial set at 50, a linear negative ramp of 0 to -10 V  $\pm 1$  V will linearly decrease frequency 50:1. An ac voltage will FM the frequency about a dial setting within the limits  $(1 < f < 50) \times$  range setting.

**Linearity:** ratio of output frequency to input voltage ( $\Delta F/\Delta V$ ) will be linear within 0.5%.

**Sensitivity:** approximately 100 mV/minor division.

**Input impedance:** 10 k $\Omega$ .

### General

**Power:** 115 V or 230 V  $\pm 10\%$ , 48 Hz to 440 Hz, <20 VA max.

**Size:** 114 mm H (without removable feet) x 197 mm W x 203 mm D (4.5" x 7.8" x 8").

**Weight:** net, 2.7 kg (6 lb). Shipping, 4.5 kg (10 lb).

### Accessories Available

For rack mounting, order HP 5060-8762 Rack Adapter Frame; HP 5060-8540, HP 5060-8760 Filler panels.

### HP 3310B Specifications

Same as HP 3310A with the following additions:

**Modes of operation:** free run, single cycle, multiple cycle.

**Triggered frequency range:** 0.0005 Hz to 50 kHz (usable to 5 MHz in normal mode).

**Single cycle\*\*:** ext trigger (ac coupled) requires a positive-going square wave or pulse from 1 V p-p to 10 V p-p. The triggering signal can be dc offset, but  $(V_{ac} \text{ peak} + V_{dc}) \leq \pm 10$  V ext gate (dc coupled) will trigger a single cycle on any positive waveform  $\geq 1$  V but  $\leq 10$  V which has a period greater than the period of the HP 3310B output and a duty cycle less than the period of the HP 3310B output. The gate signal cannot exceed 10 V.

**Multiple cycle\*\*:** manual trigger causes the HP 3310B to free run when depressed. When the trigger button is released, the waveform stops on the same phase as it started. Ext. gate causes the HP 3310B to free run when the gate is held at between +1 and +10 V. When the gate signal goes to zero, the HP 3310B stops on the same phase as it started.

**Start-stop phase:** the start-stop phase can be adjusted over a range of approximately  $\pm 90^\circ$ .

### Ordering Information

HP 3310A Function Generator

HP 3310B Function Generator

\*\*This specification applies on the X.0001 to X 1k range only.



# FUNCTION GENERATORS & FREQUENCY SYNTHESIZERS

0.1 Hz to 1 MHz

Model 3311A

423

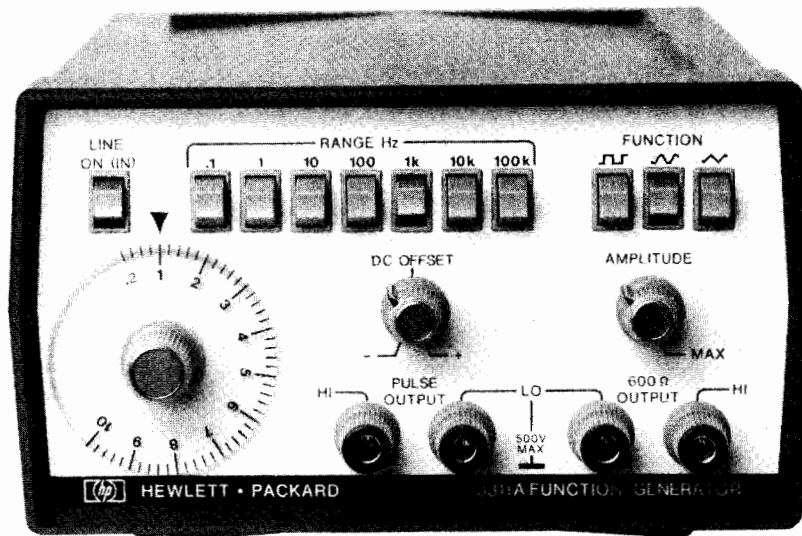

HP 3311A

## Description

The HP 3311A Function Generator offers wide functional capability at a modest price. This compact unit has seven decades of range from 0.1 Hz to 1 MHz. Pushbutton range and function selection add convenience to versatility. Added features normally not found on function generators in this price range are 10:1 voltage control and a separate pulse output suitable for synchronization or driving TTL logic circuits.

## Output

Ten V p-p into 600  $\Omega$  (20 V p-p open circuit). This output may be attenuated by >30 dB by a variable attenuator and offset by  $\pm 5$  V. The dc offset allows the sine, square, and triangle functions to be positioned to the most desired level. This feature adds to the usefulness of all three functions.

## VCO

The dc coupled voltage control allows the use of an external source to sweep the HP 3311A > 10:1 in frequency.

## Pulse Output

A separate TTL compatible pulse output provides current sinking for up to 20 TTL loads. The pulse has a 15/85 aspect ratio with a <25 ns rise time.

## Specifications

**Waveforms:** sinusoid, square, triangle, and positive pulse.  
**Frequency range:** 0.1 Hz to 1 MHz in seven decade ranges.  
**Dial accuracy:**  $\pm 5\%$  of full scale.  
**Isolation:** using an external supply, outputs may be floated up to  $\pm 500$  V relative to the instrument case (earth ground).

## 600 Ohm Output

**Maximum output amplitude:** 20 V p-p open circuit; 10 V p-p into 600  $\Omega$ .  
**Amplitude control:** continuously variable, >30 dB range. DC off-

set: up to  $\pm 10$  V open circuit,  $\pm 5$  V into 600  $\Omega$ , continuously adjustable and independent of amplitude control. Maximum  $V_{ac}$  peak +  $V_{dc}$  offset without clipping is  $\pm 10$  V open circuit,  $\pm 5$  V into 600  $\Omega$ .

**Output impedance:** 600  $\Omega \pm 10\%$ .

**Sine wave amplitude flatness:** within  $\pm 3\%$  of 10 kHz reference (maximum output amplitude) to 100 kHz,  $\pm 6\%$  to 1 MHz.

**Sine wave total harmonic distortion:** <3% (maximum output amplitude).

**Triangle linearity:** deviation <1% from best straight line at 100 Hz (maximum output amplitude).

**Square wave transition time:** rise time <100 ns; fall time <100 ns.

**Square wave time axis symmetry error:**  $\pm 2\%$  maximum to 100 kHz.

## Pulse Output

**Output amplitude:** >3 V positive (open circuit) TTL compatible.

**Duty cycle:** 13.5% to 16.5% of the total period.

**Transition times:** <25 ns.

## External Frequency Control

**VCO range:** >10:1 on any frequency range.

**Input requirement:** with frequency dial set to 1.0, a linear ramp of 0.0 V to  $-10$  V  $\pm 2$  V linearly increases frequency >10:1.

**Input impedance:** 10 k $\Omega \pm 10\%$  in parallel with <60 pF.

## General

**Operating temperature:** 0°C to 55°C; specifications apply from +15°C to +35°C.

**Storage temperature:**  $-40^\circ\text{C}$  to  $+75^\circ\text{C}$ .

**Power:** 100/120/220/240 V  $-10\%$ ,  $+5\%$  switchable; 48 Hz to 66 Hz;  $\leq 12$  VA.

**Size:** 89 mm H x 159 mm W x 248 mm D (3.5" x 6.3" x 9.8").

**Weight:** net, 1.5 kg (3.3 lb). Shipping, 2.5 kg (5.5 lb).

## HP 3311A Function Generator



# FUNCTION GENERATORS & FREQUENCY SYNTHESIZERS

## Function Generator

Model 3312A

- Two function generators in one instrument
- AM-FM, sweep, trigger, gate and burst

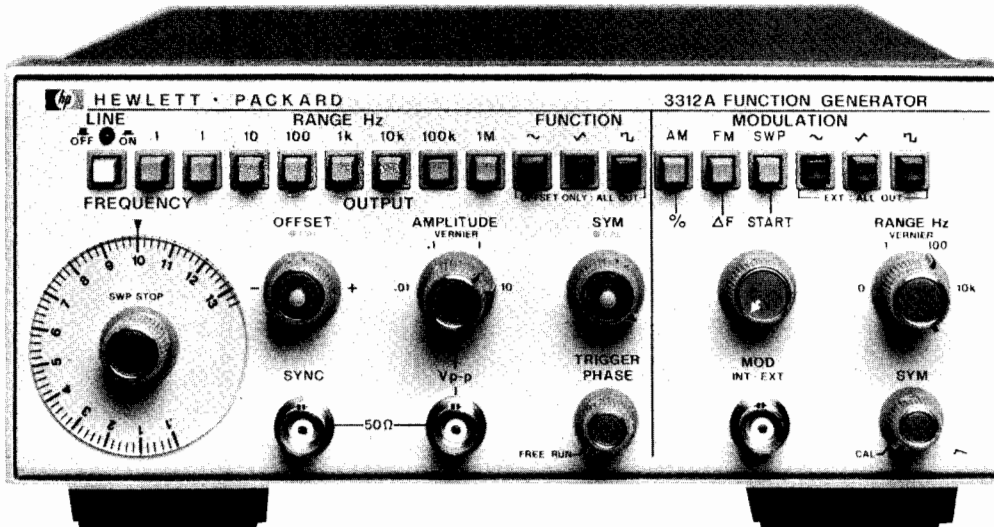

HP 3312A

### Description

Hewlett-Packard's 3312 A Function Generator combines two separate, independent function generators with a modulator section in one compact instrument.

The main generator can—via pushbutton control—be triggered by the modulation generator to provide sweep functions, AM, FM or tone burst.

Ten V p-p into 50  $\Omega$  provides adequate power for most applications. The output attenuator has a range of more than 10,000:1 so clean low-level signals from 10 V to 1 mV p-p into 50  $\Omega$  can be obtained. The main generator includes dc offset up to 10 volts p-p into 50  $\Omega$ .

The HP 3312A is an effective low cost solution for generating a multitude of functions.

### Specifications

**Output waveforms:** sine, square, triangle,  $\pm$  ramp, pulse, AM, FM, sweep, triggered and gated.

#### Frequency Characteristics

**Range:** 0.1 Hz to 13 MHz in 8 decades ranges.

**Dial accuracy:**  $\pm 5\%$  of full scale. Unspecified in Uncal Mode.

**Square wave rise or fall time (10% to 90%):** <20 ns.

**Aberrations:** <10%.

**Triangle linearity error:** <1% at 100 Hz.

**Variable symmetry:** 80:20:80 to 1 MHz.

**Sine wave distortion:** <0.5% (-46 dB) THD from 10 Hz to 50 kHz. (10 kHz range maximum). >30 dB below fundamental from 50 kHz to 13 MHz, at full-rated output.

#### Output Characteristics

**Impedance:** 50  $\Omega \pm 10\%$ .

**Level:** 20 V p-p into open circuit, >10 V p-p into 50  $\Omega$  at 1 kHz.

**Level flatness (sine wave):**  $\pm 3\%$  from 10 Hz to 100 kHz at full rated output (1 kHz reference).  $\pm 10\%$  from 100 kHz to 10 MHz.

**Attenuator:** 1:1, 10:1, 100:1, 1000:1 and >10:1 continuous control.

**Attenuator error:** <5%.

**Sync output:** impedance: 50  $\Omega \pm 10\%$ , >1 V p-p square wave into open circuit. Duty cycle varies with symmetry control.

**DC offset:** variable up to  $\pm 10$  volts. Instantaneous ac voltage + Vdc offset cannot exceed  $\pm 10$  V (open circuit) or  $\pm 5$  V (terminated 50 ohm).

#### Modulation Characteristics

**Types:** internal AM, FM, sweep, trigger, gate or burst; external AM, FM, sweep, trigger, gate or burst.

**Waveforms:** sine, square, triangle, ramp or variable symmetry pulse.

**Frequency range:** 0.01 Hz to 10 kHz.

**Output level:** >1.0 V p-p into 10 k $\Omega$ .

#### Amplitude Modulation

**Depth:** 0 to 100%.

**Modulation frequency:** 0.01 Hz to 10 kHz (internal). DC to >1 MHz (external).

**Carrier 3 dB bandwidth:** <100 Hz to >5 MHz.

**Carrier envelope distortion:** <2% at 70% sine wave modulation with  $f_c = 1$  MHz,  $f_m = 1$  kHz.

**External sensitivity:** <10 V p-p for 100% modulation.

#### Frequency Modulation

**Deviation:** 0 to  $\pm 5\%$  (internal).

**Modulation frequency:** internal: 0.01 Hz to 10 kHz; external: DC to >50 kHz.

**Distortion:** <-35 dB at  $f_c = 10$  MHz,  $f_m = 1$  kHz, 10% modulation.

#### Sweep Characteristics

**Sweep width:** >100:1 on any range.

**Sweep rate:** 0.01 Hz to 10 kHz, 90:10 ramp, and 0 Hz Range (provides manual setting of "Sweep Start" without modulation generator oscillating).

**Sweep mode:** repetitive linear sweep between start and stop frequency settings. Retrace time can be increased with symmetry control.

**Ramp output:** 0 to >-4 p-p into 5 k $\Omega$ .

#### Gate Characteristics

**Start/stop phase range:** +90° to -80°.

**Frequency range:** 0.1 Hz to 1 MHz (useful to 10 MHz).

**Gating signal frequency range (external):** dc to 1 MHz, TTL compatible.

#### External Frequency Control

**Range:** 1000:1 on any range.

**Input requirement:** with dial set at 10, 0 to -2 V  $\pm 20\%$  will linearly decrease frequency >1000:1. An ac voltage will FM the frequency about a dial setting within the limits (0.1 < f < 10) x range setting.

**Linearity:** 0.5% of Fmax for Fmax  $\leq 1$  MHz 5.0% of Fmax for Fmax > 1 MHz. Deviation is from a best fit straight line. VCO frequency span  $\leq 100:1$ .

**Input impedance:** 2.8 k $\Omega \pm 5\%$ .

#### General

**Operating temperature:** 0°C to +55°C; specifications apply from 0°C to 40°C.

**Storage temperature:** -40°C to +75°C.

**Power:** 100 V, 120 V, 220 V, 240 V +5%, -10%, switchable; 48 Hz to 440 Hz;  $\leq 25$  VA.

**Size:** 102 mm H x 213 mm W x 377 mm D (4" x 8.4" x 14.8").

**Weight:** net, 3.8 kg (8.4 lb). Shipping, 5.9 kg (13 lb).

HP 3312A Function Generator

# FUNCTION GENERATORS & FREQUENCY SYNTHESIZERS

## 1 MHz to 20 MHz Function Generator with Arbitrary Waveforms

Model 3314A

425



- Lin/Log sweeps
- AM/FM/VCO
- Phase lock  $\times N$  and  $\div N$

- Gate and counted burst
- 1/2 cycle mode
- Arbitrary waveform generator



HP 3314A

### HP 3314A Multi-Waveform Generator

The HP 3314A is a Function/Waveform Generator with the precision and versatility to produce numerous waveforms. Its feature set includes accurate sine, square, and triangle waves, with ramps and pulses available using variable symmetry. Additional features include counted bursts, gate, lin/log sweeps, AM, FM/VCO, dc offset, and phase lock. For increased versatility, the Arbitrary waveform mode allows a countless number of user defined waveforms. Since complete programmability is provided, all of these capabilities are available for ATE systems, as well as bench applications.

### Precise Functions

The HP 3314A provides sine, square, and triangle waveforms from 0.001 Hz to 19.99 MHz with an amplitude range of 0.01 mV to 10 Vp-p into 50 ohms, with optional 30 Vp-p into > 500 ohms.

Continuous waveforms are provided with high accuracy and low distortion, with frequency accuracy on the upper ranges of 0.01% and sine distortion  $< -55$  dBc to 50 kHz.

Pulses and ramps are provided to 2 MHz using the variable symmetry control over the full 5% to 95% symmetry range. This provides narrow pulses with 9 ns rise/fall times for digital circuit testing, and positive or negative ramps for amplifier testing and process control.

Independent dc offset to  $\pm 5$  V (into 50 ohms) can be added to any ac signal. A post-attenuator summing technique is used providing large ac signals with small offsets and vice versa.

### Burst and Gate

The HP 3314A's N Cycle burst mode generates an integer number of complete cycles at each trigger. Bursts of 1 to 1999 cycles are possible for use in applications ranging from sonar testing to digital circuits. Variable symmetry and start/stop phase can be used to produce single ramps and haversines.

Like burst mode, gate mode can be triggered internally or externally. In gate, the HP 3314A output consists of complete cycles, pulses or Arbs which start when the trigger is true, and stop after the trigger goes false. In gate and burst modes, the full frequency range applies for sine, square, triangle, pulse, and ramp waveforms.

### New 1/2 Cycle and "Integer" Phase Lock Modes

The new 1/2 Cycle burst mode allows simulation of specialized signals found in electronics. At each trigger, alternating 1/2 cycles of sines or triangles are produced. With the addition of variable start/stop phase and symmetry, pulses with variable rise/fall time and overshoot can be produced. Repetition rate, 1/2 cycle frequency, symmetry, and phase can be set independently to produce a variety of waveforms.

The  $\text{Fin} \times N$   $\text{Fin} \div N$  modes provide powerful phase locking capability. With "integer" phase lock, fractions or multiples of the reference signal can be provided, and  $\pm 200$  deg of phase offset is available. Since the HP 3314A phase locks to the plus or minus edge of the trigger signal, it can lock to a variety of signals such as sines, squares, pulses, ramps, and others—with complete control of output function, symmetry, N, phase, amplitude and offset.

### Modulation and Sweep

Complete AM, FM/VCO modulation give the HP 3314A versatile signal modifying capabilities. With 100 kHz bandwidths, AM and FM/VCO can be used separately or simultaneously to produce a multitude of waveforms.

Multi-frequency measurements can be made with the HP 3314A's sweep capabilities. Linear, logarithmic, and manual sweep make measurements of filters, amplifiers, and other networks convenient and accurate. X drive, marker, and trigger output signals are also provided.

### Arbitrary Waveforms

For specialized low frequency applications, the HP 3314A's Arbitrary (ARB) waveform mode lets you create custom waveforms as a series of voltage ramps or vectors. Values are easy to enter from the front panel using the modify knob as a "pencil" and an oscilloscope as a "pad". For remote programming, use a desktop or mainframe computer to calculate the values, then program them using the HP-IB. Arb waveforms are automatically stored in non-volatile memory for quick recall.

### Two Sources in One

A square wave trigger source is included for generation of complex waveforms with a single HP 3314A. The 0.5 MHz to 500 kHz internal trigger is useful in gated, burst, and phase locked waveforms. This signal is provided as an output for synchronizing the HP 3314A to other devices.

### Source for your System

Because all front panel controls are programmable, the HP 3314A's precision and versatility can be utilized in automated test systems.

System efficiency can be improved with standard features such as Service Request (SRQ) interrupt capability and buffered transfer mode.

In production test environments, the HP 3314A's Query commands can be used when an operator and computer are sharing control of the instrumentation. Parameters can be read from the HP 3314A into the computer where its computational capabilities can be utilized.



# FUNCTION GENERATORS & FREQUENCY SYNTHESIZERS

## 1 mHz to 20 MHz Function Generator with Arbitrary Waveforms

### Model 3314A (cont.)

#### Arbs Made Easy

With complete control of each vector, the modify knob is used as a "pencil" to draw the waveform on an oscilloscope.

1. After ~20 unit vectors have been inserted, use modify to set the marker, VMKR, to #1. Then set the height of #1 to 400.

2. Press V LEN and use modify to set the length to 3.

3. Press V HGT twice, and set the height of #2 to -190.

4. Continue to use V HGT and V LEN to create the desired waveform, and INS (insert) or DEL (delete) vectors as needed. Amplitude and frequency can now be set without affecting the vector values. Waveform parameters are automatically stored in non-volatile memory while they are being created.

5. Later, if a slightly different waveform is needed, just use the marker to select an individual vector, and modify its height and length without affecting the height and length of other vectors!

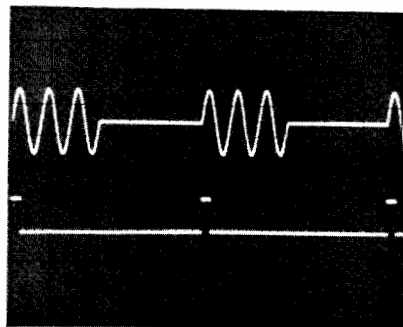
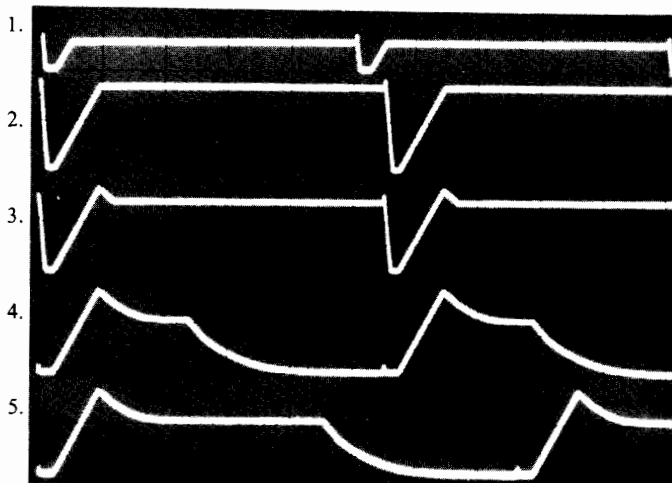

Counted burst with ext. trigger

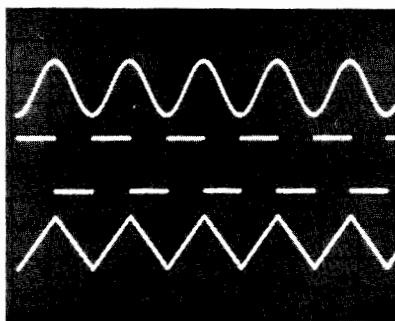

Sine, square, and triangle to 20 MHz

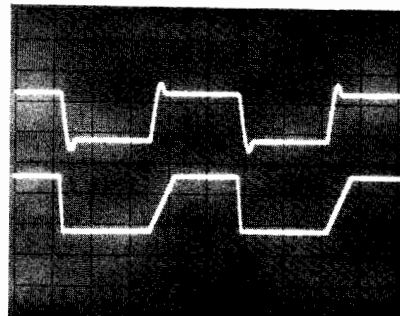

1/2 cycle mode simulating overshoot and variable rise/fall pulses

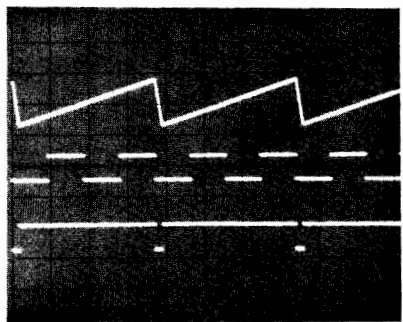

Ramp output phase locked to internal trigger. Shown with sync output.

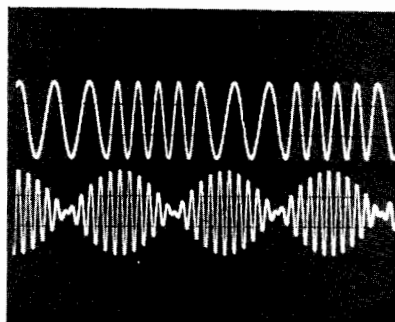

FM and AM (suppressed carrier)

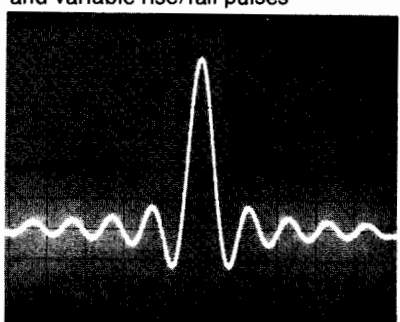

$\frac{\text{sine } x}{x}$  using ARB's

#### Specifications

##### Frequency

**Frequency range:** 0.001 Hz to 19.99 MHz-sine, square and triangle waveforms, 0.001 Hz through 2 MHz range when symmetry  $\neq$  50%

**Resolution:** 3 1/2 digits

##### Frequency Accuracy

HP-IB #	Range	Minimum Frequency		Maximum Frequency	Accuracy
		Range Hold	Autorange		
1	2 Hz	.001 Hz	.001 Hz	1.999 Hz	$\pm(0.4\% \text{ setting} + 0.2\% \text{ range})$
2	20 Hz	0.01 Hz	1.50 Hz	19.99 Hz	
3	200 Hz	0.01 Hz	15.0 Hz	199.9 Hz	$\pm(0.2\% \text{ setting} + 0.1\% \text{ range})$
4	2 kHz	0.01 kHz	150. kHz	1999. Hz	
5	20 kHz	0.01 kHz	1.50 kHz	19.99 kHz	
6	200 kHz	0.01 kHz	15.0 kHz	199.9 kHz	
<b>Synthesized</b>					
7	2 MHz	0.01 kHz	150. kHz	1999. kHz	$\pm(0.01\% \text{ setting} + 50 \text{ ppm/year})$
8	20 MHz	0.01 MHz	1.50 MHz	19.99 MHz	

Accuracy applies in the Free Run mode, with VCO Off, and Symmetry = 50% (Fixed)

##### Amplitude

**Amplitude range:** 1.0 mVp-p to 10 Vp-p into 50  $\Omega$

**Resolution:** 3 1/2 digits

HP-IB #	Range	Minimum	Maximum	Step Attenuator
1	10 mV	1.0 mV	10.00 mV	60 dB
2	100 mV	10.0 mV	100.0 mV	40 dB
3	1 V	.100 V	1.000 V	20 dB
4	10 V	1.00 V	10.00 V	0 dB

##### Absolute Amplitude Accuracy

$\pm(1\% \text{ of display} + 0.035 \text{ Vp-p})$ , sine and square wave

$\pm(1\% \text{ of display} + 0.06 \text{ Vp-p})$ , triangle

**Amplitudes:** 1.00 Vp-p to 10.00 Vp-p (Range 4)

**Frequency:** 10 kHz, Autorange ON

**Flatness-sine wave:** relative to 10 kHz, 1.00 V to 10.0 V (Range 4)



# FUNCTION GENERATORS & FREQUENCY SYNTHESIZERS

427



## Frequency Sweep

	Range (decades)	Start Freq	Stop Freq	Sweep Time
linear	0 to 2	≥.001 Hz	≤19.99 MHz	7.2 ms to 1999 s/sweep
log	1 to 7 (integer only)	≥0.2 Hz	≤19.99 MHz	40 ms to 1999 s/decade

## Manual Sweep

Modify knob tunes between start and stop frequencies. X drive follows sweep.

## X Drive Start/Stop Voltage

-5 V to +5 V into 1 kΩ load

## Z Axis Output

Blanking Pulse, > +5 V

Baseline, 0V ± 1 V

Marker Pulse, < -5 V into 1 kΩ load

## Modulation Inputs

	Bandwidth	Sensitivity	Range	Z
AM	dc to 100 kHz	2 Vp-p for 100% -1 Vdc for suppressed carrier	>100%	10 kΩ
FM	100 Hz to 100 kHz	±1 Vp for ±1% of range deviation	1% of Freq. range	10 kΩ
VCO	dc to 100 kHz	10%/volt	+1 to -10V	10 kΩ

## Waveform Characteristics

### Sine Harmonic Distortion

Individual harmonics will be below these levels, relative to the fundamental. Offset = 0V. Function Invert = OFF. Range Hold = OFF.

20 Hz	50 kHz	1490 kHz	19.99 MHz
-55 dB*		-40 dB	-25 dB

\*add 4 dB for ambient temperature 0 to 5°C and 45 to 55°C, 20 Hz to 50 kHz

## Square Wave Rise/Fall Time

< 9 ns, 10% to 90% at 10 Vp-p output

## N Integer

N = 1 to 1999, Preset to 1

For Phase-lock Fin ÷ N, Fin × N

or N CYCLE (counted burst)

## Function Invert

Inverts ac portion of signal outputs

Sine, square, triangle, ramp, pulse, and ARBs

Does not affect Sync and Trigger outputs or dc offset setting

## Phase

### Phase Offset—Phase Lock Modes

Resolution: 0.1°

Range: ±199.9°

Accuracy: ±2° (50 Hz to 15 kHz)

### Phase Offset is Referenced to

signal output for Fin ÷ N

signal input for Fin × N

### Start/Stop Phase—Burst Modes

Resolution: 0.1°

Range: ±90.0° for frequencies to 19.99 MHz

Accuracy: ±3° (applies from .001 Hz to 1 kHz)

## Trigger

### Internal Trigger

Range: .002 ms (500 kHz) to 1999 s (0.5 mHz) square wave.

Period Accuracy:

± (0.01% + 50 ppm/year) of displayed interval (excluding sweep intervals)

Trigger output: low < 0.5 V, high > 2.5 V; output resistance 1 kΩ

### External Trigger

For Gate, N Cycle, ½ Cycle, Fin × N, Fin ÷ N, and external sweep triggers

Frequency range: 50 Hz to 20 MHz

Trigger slope: selectable, positive or negative

Trigger level: Selectable to 0 V or +1 V

Trigger level hysteresis: ±0.15 V

Input resistance = 1 kΩ

## Symmetry

Symmetry range: 5% to 95% of period

Frequency range: 2 Hz to 2 MHz ranges

## Arbitrary Waveforms

Output consists of a series of voltage ramps called vectors. Arbitrary waveforms can be composed of 2 to 150 vectors. A maximum of 160 vectors can be stored in six available storage registers with a minimum of 2 vectors per waveform (#1 and return-to-start vectors).

## Waveform Parameters

Key	Range	Description
Δt	0.2 ms to 19.99 ms	sets the time value for each unit of V LEN (length)
V HGT	0 to ±1999	sets the relative height of an individual vector
V LEN	1 to 127	sets the length in time of an individual vector in integral multiples of Δt
V MKR	1 to 150	marker is used to select an individual vector
INS		insert is used to add a vector before the marker location
DEL		deletes the vector at marker location
FREQ	.002 Hz to 2.5 kHz	$\text{Freq} = \frac{1}{\Delta t(VLEN_1 + VLEN_2 + \dots VLEN_n)}$
AMPTD	.01 mV to 10 Vp-p	sets amplitude window for ARB waveform
OFFSET	0 to ± 5 Vdc	offsets the ARB waveform independent of AMPTD setting
PHASE	+90° to -90°	sets wave start/stop voltage within the window defined by AMPTD

Marker output: located on Z axis rear panel connector

Sync output: low during the return-to-start vector

Gate mode: allows external gating of ARB output-complete ARB waveforms only

## Option 001 - Voltage Multiplier

Simultaneous ×3 amplitude output on rear panel (into >500 Ω).

30 Vp-p max, dc to 1 MHz.

## General

### Specifications Apply When

Main signal output terminated into 50 ± 0.1 Ω

Warm-up > 30 minutes

Within ±5°C and 24 hours of last internal calibration

Temperature: 0 to 55°C

Relative humidity: <95% at 40°C

Altitude: <15,000 ft

Storage temperature: -40 to +75°C

### Power

100/120/220/240 V + 5% -10%, 48 to 66 Hz

90 VA maximum

Weight: net, 7.3 kg (16 lb). Shipping, 10.5 kg (23 lb).

Dimensions: 132.6 mm (5.22 in.) H x 212.3 mm (8.36 in.) W x 419.0 mm (16.50 in.) D

### HP-IB

IEEE Standard 488-1978 abbreviated definition

SH1 AH1 T6 TE0 L3 LE0 SR1 RL1 PP0 DC1 DT1 C0 E2

### Accessories Included

HP 11048C 50 Ω feed-through termination

50 ± 0.1 Ω

### Accessories

Transit case for one HP 3314A

HP P/N9211-2677

## Ordering Information

HP 3314A Function Generator

Option 001: simultaneous X3 output

## 1 Hz–20 MHz Pulse/Function Generator



Model 8111A

- Sine, triangle, square, haverfunctions
- 20 MHz, 32 Vpp for all waveforms
- Variable duty cycle or pulse width
- Trigger, gate, VCO and optional burst
- Digital display for all parameters
- Error recognition

HP 8111A with  
Option 001,  
Counted Burst.



The HP 8111A combines pulse generator and function generator capabilities in a single, compact unit. Triggered operation for all waveforms, and the ability to define rectangular waveforms in terms of pulse width or duty cycle, are examples of the HP 8111A's versatility.

**Saves Space and Equipment**

Small size and manifold capability make the HP 8111A an ideal source for service and bench. Digital display, error detector and good repeatability assure high operating confidence. This reduces the need for output monitoring and consequently saves equipment.

**Flexible**

Operating modes include VCO which permits frequency-shift keying and dc-to-frequency conversion as well as sweep and FM applications. Option 001's Burst mode simplifies tone burst generation and digital preconditioning by generating a precise number of waveform cycles. An "extra cycle" feature activated after a burst allows critical events to be examined.

Pulse mode's variable width down to 25 ns and clean 10 ns transitions provide useful digital test capability. High analog flexibility is assured because all waveforms can be generated in trigger and burst modes. Adjustable duty cycle up to 999 kHz means that CRT sawtooth waveforms and rectangular signals for dc motor control can be simulated.

**Specifications (50-ohm load resistance)****Waveforms**

sine, triangle, ramp, square, pulse, haverfunctions.

**Timing****Frequency**

**Range:** 1.00 Hz to 20.0 MHz (3-digit resolution).

**Accuracy (50% duty cycle):** 5% ( $\pm 10\%$  below 10 Hz).

**Jitter:**  $< 0.1\% + 50$  ps.

**Stability:**  $\pm 0.2\%$  (1 hour),  $\pm 0.5\%$  (24 hours).

**Duty Cycle** (sine, triangle, square, haverfunctions):

	Calibrated	Variable (below 1 MHz)
Range:	50% nominal	10% to 90%.
Resolution:	2 digits	2 digits.
Accuracy:	$\pm 1$ digit	$\pm 6$ digits ( $\pm 3$ in range 20 to 80%).

**Pulse Width**

**Range:** 25.0 ns to 100 ms (3-digit resolution).

**Accuracy:**  $\pm 5\% \pm 2$  ns.

**Output Characteristics**

(voltages double into high impedance)

**Amplitude**

**Range:** 1.60 mVpp to 16.00 Vpp ( $3\frac{1}{2}$  digit resolution).

**Accuracy:**  $\pm 5\%$  (at 1 kHz for sine and triangle).

**Flatness (sine, triangle):**  $\pm 3\%$  ( $+10\%$ ,  $-15\%$  above 1 MHz).

**Offset**

**Range:** 0.00 mV to  $\pm 8.00$  V (3-digit resolution).

**Accuracy:**  $\pm 0.5\%$  setting  $\pm 1\%$  ampl  $\pm 20$  mV

(ampl  $\geq 160$  mVpp),

$\pm 0.5\%$  setting  $\pm 1\%$  ampl  $\pm 1$  mV

(ampl  $< 160$  mVpp).

**Distortion:** THD (1 Hz–1 MHz)  $< 3\%$  ( $-30$  dB); harmonics (1 MHz–20 MHz)  $< -26$  dB. Distortion may increase by 3 dB below  $10^\circ\text{C}$  and above  $45^\circ\text{C}$ .

**Linearity (triangle):**  $< \pm 3\%$  ( $< \pm 1\%$  below 1 MHz)

**Pulse and Squarewave Performance**

**Transitions:**  $< 10$  ns.

**Perturbations:**  $< \pm 5\%$  ( $< \pm 10\%$  below 0.16 Vpp).

**Output impedance:**  $\pm 50$  ohm  $\pm 5\%$ .

**Modes**

normal, trigger\*, gate\*, VCO and (Option 001) burst\*.

\*Adjustable start-phase for haversine, havertriangle

**VCO range:** 2 decades, ext. signal 0.1 V to 10 V (dc to 1 kHz).

**Burst length:** 1 to 1999 periods for all waveforms.

**General**

**Repeatability:** factor 2.5 better than accuracy.

**Environmental**

**Storage temperature:**  $-40^\circ\text{C}$  to  $+75^\circ\text{C}$ .

**Operating temperature:**  $0^\circ\text{C}$  to  $55^\circ\text{C}$ .

**Humidity:** 95% RH,  $0^\circ\text{C}$  to  $40^\circ\text{C}$ .

**Power:** 100/120/220/240 V rms;  $+5\% - 10\%$ ; 48 to 440 Hz; 70 VA max.

**Weight:** net, 4.6 kg (10 lb). Shipping, 6.6 kg (15 lb).

**Size:** 89 H x 212.3 W x 345 mm D ( $3.5'' \times 8.36'' \times 13.6''$ ).

**Ordering Information**

HP 8111A Pulse/Function Generator

**Opt 001:** Burst

**Opt 910:** Extra Operating and Service Manual

HP 5061–2001: Bail Handle Kit

HP 5061–0072 Rack Mount Kit (single HP 8111A)

HP 5061–0074 Rack Mount Kit (two instruments)

HP 5061–0094 Lock Link Kit (for use with HP 5061–0074)



# FUNCTION GENERATORS & FREQUENCY SYNTHESIZERS

1 mHz–50 MHz Pulse/Function Generator

Model 8116A

429



- Sine, triangle, square, haversine functions and dc
- 1 mHz–50 MHz, 32 Vpp for all waveforms
- Variable (10 ns min) pulse width, 6 ns transitions

- Wide range of operating capability
- Self-prompting operating concept
- Error recognition and self test



HP 8116A with  
Option 001, Burst  
and Logarithmic  
Sweep.

The fully programmable HP 8116A features pulse as well as function generator capabilities in one small unit. A broad 1 mHz–50 MHz band for all waveforms and a wide choice of operating and modulating modes assure high flexibility. These factors, plus good repeatability, make the HP 8116A a sound, long-term investment.

## Unique Operating Concept Saves Engineering Time

HP's custom IC's have made it feasible to put the many HP 8116A capabilities into such a small volume. Handling is simplified by a unique, microprocessor-controlled, operating concept which ensures a clear overview of the compact front panel at all times. When the mode and waveform have been selected, illuminated labels show which parameters must be set. There's no clutter, no confusion.

**Auto vernier.** In normal mode, the HP 8116A's auto-vernier increments any desired parameter continuously until a stop signal is applied. This means that thresholds can be measured automatically, without a controller.

**Level or amplitude programming.** The HP 8116A's output can be programmed in terms of high and low levels or in terms of amplitude and offset. Consequently a direct, automatic, conversion is always feasible so that the HP 8116A can be programmed in the same terms as the device is specified.

**Safe limit.** Devices can be protected by the limit feature. This prevents the output from exceeding a given magnitude.

## Rectangular Waveforms

For applications such as laser diodes or dc motors, square waves can be programmed for constant duty cycles from 10% to 90%. For digital test, or for simulating very low duty-cycle events, pulse width can be programmed down to 10 ns. Square wave and Pulse modes provide clean 6 ns edges that are ideal for many technologies. Pulse width modulation and pulse recovery capability are available in Pulse mode.

## Sine and Triangle Functions

10% to 90% duty cycle, programmable in 1% steps, provides ramps and asymmetrical sine waves for testing VCO's, servos, amplifier linearity and industrial process control systems. Haversine functions,

available in External Trigger, Gate and Burst modes, extend the applications to areas such as telephone line and vibration testing.

## Modulation

All waveforms can be amplitude or frequency modulated. VCO operation allows frequency variation over two decades with an external voltage; consequently transducer output can be conditioned for mag tape recording, or frequency-shift keying or linear sweep can be carried out.

## Option 001

**10 1/2-decade log sweep.** Sweep mode covers the wide 1 mHz – 50 MHz band in a single up sweep. Test setups require no more than an X-Y recorder or scope because all necessary control signals are available. The HP 8116A sweeps can be internally triggered, if desired.

**Accurate, counted bursts.** A preprogrammed number of cycles of any waveform can be generated in Burst mode. With sine, triangle and square functions, bursts can be triggered internally as well as externally.

**Hold capability.** For material stress testing, low frequency functions can be held at instantaneous levels. Hold is controlled by an external signal.

## Low-Cost Automation for Bench and Systems

Powerful capability, small size and wide specified temperature range make the HP 8116A a good choice for automatic test systems. Also, the low cost means that it's now realistic to automate those routine bench jobs and leave more time for design. Comfortable software features such as easy syntax and flexible format contribute to rapid system design.

## Operating Confidence

There's reliance in the HP 8116A's output because proper operation is always ensured by the instrument's error detector. This helps the user to recover from an incorrect front panel or programming operation by indicating the offending parameter. Also, the built-in test and diagnosis feature verifies correct function each time the instrument is switched on.

Specifications overleaf



# FUNCTION GENERATORS & FREQUENCY SYNTHESIZERS

## 1 MHz–50 MHz Pulse/Function Generator

### Model 8116A (cont.)

#### Specifications

Specifications apply with 50-ohm load and temperatures in the range 0°C to 55°C.

#### Functions

Sine, triangle, ramp, square, pulse, haversine, havertriangle, dc.

#### Timing

##### Frequency

**Range:** 1 MHz to 50 MHz (3-digit resolution).

**Accuracy<sup>1</sup>** (pulse mode, 50% d/c):  $\pm 3\% \pm 0.3$  MHz below 100 kHz,  $\pm 5\%$  above 100 kHz.

**Jitter** (pulse mode, 50% d/c):  $< 0.1\% + 100$  ps.

**Stability:**  $\pm 2\%$  (1 hour),  $\pm 5\%$  (24 hours).

**Duty cycle:** (sine, triangle, square, haversine, havertriangle).

**Range:** 10% to 90% (20% to 80% above 1 MHz), 2-digit resolution.

**Accuracy<sup>1</sup>:**  $\pm 0.5$  digits ( $\pm 3$  digits above 1 MHz).

##### Pulse Width

**Range:** 10.0 ns to 999 ms (3-digit resolution).

**Accuracy<sup>1</sup>:**  $\pm 5\% \pm 2$  ns.

**Jitter:**  $< 0.1\%$  ( $0.2\% + 200$  ps for width  $\leq 10$   $\mu$ s).

##### Output Characteristics

(voltages double into high impedance).

##### Amplitude

**Range:** 10.0 mV<sub>pp</sub> to 16.0 V<sub>pp</sub> (3-digit resolution).

**Accuracy<sup>1</sup>:**  $\pm 5\%$  (at 1 kHz for sine and triangle).

**Flatness (sine):**  $\pm 3\%$  ( $\pm 5\%$  above 1 MHz,  $+5$   $-15\%$  above 10 MHz).

**Flatness (triangle):**  $\pm 3\%$  ( $\pm 5\%$  above 1 MHz,  $+5$   $-25\%$  above 10 MHz).

##### Offset and dc Mode

**Range:** 0.00 to  $\pm 7.95$  V (0 to  $\pm 795$  V mV for amplitude  $< 100$  mV<sub>pp</sub>).

**Resolution:** 3 digits.

**Accuracy<sup>1</sup>:** 0.5% of setting  $\pm 1\%$  of ampl  $\pm 40$  mV ( $+2$  mV if ampl  $< 100$  mV<sub>pp</sub>,  $\pm 20$  mV in dc mode).

**Distortion** (sine, normal mode, 50% duty cycle).

**Total harmonic distortion (10 Hz–50 kHz):**  $< 1\%$  ( $-40$  dB)\*.

**Harmonic related signals (50 kHz–1 MHz):**  $< -34$  dB,  
(1 MHz–50 MHz):  $< -23$  dB\*.

\*May increase by 3 dB below 10°C and above 45°C.

**Non-linearity** (triangle, ramp, 100 MHz–1 MHz):  $< \pm 3\%$ .

##### Pulse and Square Wave Characteristics

**Transitions:**  $< 6$  ns.

**Pulse perturbations:**  $< \pm 5\% \pm 2$  mV.

**Output impedance:** 50 ohm  $\pm 5\%$ .

#### Operating Modes

Normal, trigger\*, gate\*, external width.

#### Additional Modes in HP 8116A Option 001

**Logarithmic Up Sweep** (for all waveforms).

**Range:** Start and stop frequencies selectable up to full range (1 MHz–50 MHz).

**Sweep time:** selectable in 1-2-5 sequence from 10 ms to 500 seconds per decade.

**Sweep repetition:** continuous sweeps (internal sweep) or externally triggered.

**Counted Burst\*** (for all waveforms).

**Burst length:** 1 to 1999 cycles.

**Burst repetition:** internally triggered at selectable intervals from 100 ns to 999 ms (except in Pulse mode), or externally triggered, up to 40 MHz.

\*Selectable ( $-90^\circ$ ) start-phase for haversine, havertriangle.

#### Control Modes

**Frequency modulation:**  $\pm 5\%$  max deviation.

**Sensitivity:** 1 V for 1% deviation.

**Modulating frequency:** dc to 20 kHz.

#### Amplitude Modulation

**Sensitivity:**  $\pm 2.5$  V for 100% mod. ( $+2.5$  V to  $-7.5$  V for DSBSC).

**Modulating frequency:** dc to 1 MHz.

<sup>1</sup>Applies from 15°C to 35°C, %-error increases 0.05 per °C outside this range.

#### Pulse Width Modulation

**Range:** 10 ns to 1 s in 8 non-overlapping decade ranges.

Max. width ratio: 10:1.

**Sensitivity:**  $\pm 9$  V for 1:10 ratio.

#### Voltage-Controlled Oscillator

**Range:** 2 decades in range 1 MHz–50 MHz.

**Sensitivity:** 0.1 V to 10 V for 2 decades.

**Modulating frequency:** dc to 1 kHz.

#### Auxiliary Modes

**Manual:** simulates external input.

**1 cycle (option 001):** triggers single output cycle in Trigger, Gate and Ext Burst modes.

**Auto vernier:** continuous vernier which can be remotely or manually stopped.

**Limit:** programmable maximum output levels to protect DUT.

**Complement:** selectable normal/complement output.

**Disable:** relay disconnects output.

#### Auxiliary Inputs and Outputs

##### External Input

**Threshold:**  $\pm 10$  V adjustable.

**Max input voltage:**  $\pm 20$  V.

**Sensitivity:** 500 mV<sub>pp</sub>.

**Min pulse width:** 10 ns.

**Input impedance:** 10 k $\Omega$  typ.

**Trigger slope:** positive, negative and off.

##### Control Input

**Max input voltage:**  $\pm 20$  V.

**Input impedance:** 10 k $\Omega$  typ.

##### Trigger Output

**Output levels:** 0/2.4 V typ.

**Output impedance:** 50 ohm typ.

**X-Output** (Option 001) for sweep X-Y recording (rear panel).

**Output levels:** 0 V (= start frequency) to 10 V max.

**Slope:** 1.5 V per sweep decade.

**Marker Output** (Option 001) for sweep (rear panel).

**Output levels:** TTL

**Leading edge:** positive at selected marker frequency.

**Hold Input** (Option 001), rear panel.

**Input levels:** TTL

**Leading edge:** positive transition causes HP 8116A output ( $f < 10$  Hz) to hold at instantaneous level. Output droop 0.01% per second.

**Max input voltage:**  $\pm 20$  V

#### HP-IB Capability

All manual key operations are programmable. Talk mode provides learn, status byte and error report capabilities.

#### Memory

Battery-backup RAM retains current operating state.

#### General

**Repeatability:** factor 4 better than accuracy.

#### Environmental

**Storage temperature:**  $-40^\circ\text{C}$  to  $+70^\circ\text{C}$ .

**Operating temperature:**  $0^\circ\text{C}$  to  $55^\circ\text{C}$ .

**Humidity:** 95% RH,  $0^\circ\text{C}$  to  $40^\circ\text{C}$ .

**Power:** 100/120/220/240 V rms;  $+5\%$ ,  $-10\%$ ; 48 to 440 Hz; 120 VA max.

**Weight:** net, 5.9 kg (13 lb). Shipping, 8.0 kg (18 lb).

**Size:** 89 H x 212.3 W x 422 mm D (3.5" x 8.36" x 16.6").

#### Ordering Information

HP 8116A Programmable Pulse/Function Generator\*

**Opt 001:** Burst and Logarithmic Sweep

**Opt 910:** Extra Operating & Service Manual

HP 5061-2001: Bail Handle Kit

HP 5061-0072: Rack Mount Kit (single HP 8116A)

HP 5061-0074: Rack Mount Kit (two instruments)

HP 5061-0094: Lock Link Kit (for use with

HP 5061-0074)

\*HP-IB cables not supplied, see page 675.

# FUNCTION GENERATORS & FREQUENCY SYNTHESIZERS

## 50 MHz Programmable Signal Source

Model 8165A

431



- Pulse/function capability
- Sine, triangle, square to 50 MHz
- Pulses and ramps to 20 MHz
- Trigger, gate and counted burst
- Synthesizer stability, precision amplitude
- Storage of operating parameters

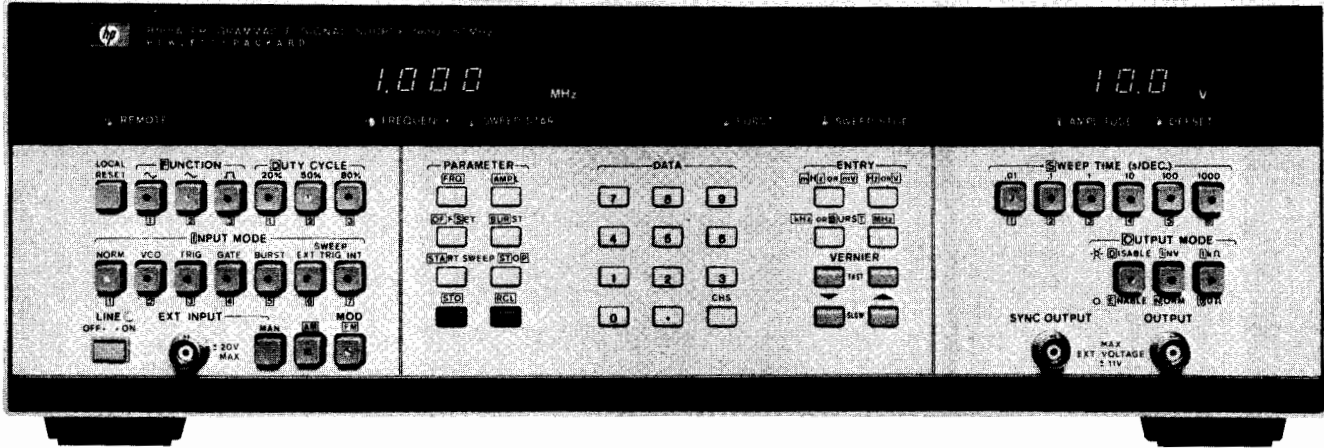

HP 8165A with option 002, AM and Logarithmic Sweep

### Versatility and Simplicity for Systems and Bench

The HP 8165A Programmable Signal Source is a versatile function generator with good accuracy and many trigger features. Microprocessor control assures rapid, accurate setup whether programming locally or via HP-IB.

### Operating Set Storage

Ten complete sets of operating information can be stored and recalled. In the event of power failure, battery back up retains all data plus the active settings.

### Stability and Resolution

Very stable frequency is ensured with phase lock loop techniques and internal crystal reference. The four-digit frequency display means a 1  $\mu$ Hz resolution in the 1 to 9.999 MHz range.

## Specifications

### Waveforms and Frequency Range

**Sine, square, triangle (50% duty cycle):** 1.000 mHz to 50.00 MHz.

**Pulse/ramp (20, 80% symmetry):** 1.000 mHz to 19.99 MHz.

**Haversine/havertriangle:** please inquire for special option.

### Output Characteristics

**Range:** amplitude and offset independently variable within  $\pm 10$  V window.

**Source impedance:** selectable 50  $\Omega \pm 1\%$  or 1 k $\Omega \pm 10\%$

**Amplitude:** 10.0 mVpp to 10.0 Vpp (50  $\Omega$  into 50  $\Omega$ )  
2.00 Vpp to 20.0 Vpp (1 k $\Omega$  into 50  $\Omega$ )

Accuracy	Sine V Vrms	Square	Triangle (50%)	Ramp (20%-80%)	Pulse (20%-80%)
<1kHz	$\pm 3\%$	$\pm 2\%$	$\pm 3\%$	$\pm 3\%$	$\pm 2\%$
1KHz-4.99MHz	$\pm 3\%$	$\pm 2\%$	$\pm 3\%$	$\pm 5\%$	$\pm 2\%$
5 MHz-19.9MHz	$\pm 8\%$	$\pm 5\%$	$\pm 10\%$	$\pm 10\%$	$\pm 5\%$
20MHz-50MHz	$\pm 8\%$	$\pm 5\%$	+5% to -20%	-	-

**Offset:** 0  $\pm 10$  mV to  $\pm 5.00$  V (50  $\Omega$  into 50  $\Omega$ )

0  $\pm 20$  mV to  $\pm 10.0$  V (1 k $\Omega$  into 50  $\Omega$ )

**Accuracy:**  $\pm 1\%$  programmed value  $\pm 1\%$  signal Vpp  $\pm 20$  mV.

### Sine Characteristics

**Distortion:** total harmonic distortion (THD) for fundamental up to 1 MHz:  $\pm 1\%$ .

**Harmonic signals:** (fundamental 1-10 MHz):  $\leq -36$  dB

**Harmonic signals:** (fundamental above 10 MHz):  $\leq -30$  dB.

**Non-harmonic:**  $\leq -40$  dB.

### Square/Pulse Characteristics

**Transition times:** (10% to 90%):  $\leq 5$  ns (50  $\Omega$  into 50  $\Omega$ ),  $\leq 7$  ns (1 k $\Omega$  into 50  $\Omega$ )

**Preshoot/Overshoot/ringing:**  $\leq \pm 5\%$  (50  $\Omega$  into 50  $\Omega$ ),  $\pm 10\%$  (1 k $\Omega$  into 50  $\Omega$ ).

### Triangle/Ramp Characteristics

**Linearity:** (10% to 90%):  $\leq \pm 1\%$  ( $\leq \pm 5\%$  above 5 MHz).

### Operating Modes

**Norm** (continuous phase locked), **VCO** (external sweep voltage), **Trig** (ext or man. one-shot), **Gate**, **Burst** (1-9999 counted cycles), **Frequency Modulation**

**HP-IB:** control and learn capability for all modes and parameters. **Interface functions\*:** SH1, AH1, T6, L4, SRI, RL1, PP0, DC0, DT1, C0, E1.

### General

**Memory:** non volatile. 10 addressable locations plus one for active operating state. Each location can store a complete set of operating parameters and modes.

**Power:** 100/120/220/240 Vrms;  $\pm 5\%$ ,  $-10\%$ ; 48 to 66 Hz, 200 V A max.

**Operating temperature:** 0 $^\circ$  to 50 $^\circ$ C

**Weight:** net 12 kg (26.5 lbs). Shipping 16 kg (35.3 lbs).

**Size:** 133 H x 426 W x 422 mm D (5.2" x 16.8" x 16.6").

### Ordering Information

**HP 8165A Programmable Signal Source\*\***

**Opt 002:** AM and logarithmic sweep

**Opt 003:** Rear Panel Connectors

**Opt 907:** Front Handle Kit (Part No HP 5061-0089)

**Opt 908:** Rack Mounting Kit (Part No HP 5061-0077)

**Opt 909:** Opt 907, 908 combined (Part No HP 5061-0083)

**Opt 910:** additional Operating and Service Manual

\*For more on these codes refer to the HP-IB section of this catalog.

\*\*HP-IB cables not supplied, see page 675.



# FUNCTION GENERATORS & FREQUENCY SYNTHESIZERS

## 1 $\mu$ Hz to 21 MHz Synthesizer/Function Generator

### Model 3325A

- Synthesizer
- Function generator
- Sweeper
- Programmable

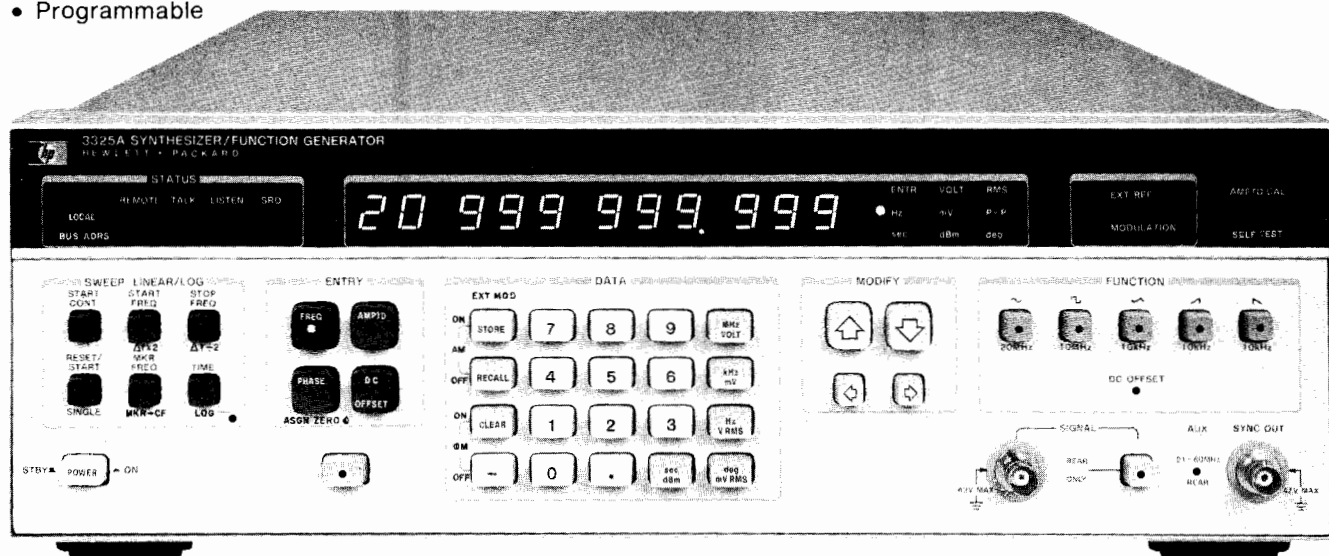

HP 3325A



### Description

The HP 3325A Synthesizer/Function Generator is an uncompromising, high performance synthesizer with 11 digit resolution, a function generator with precision waveforms, a wideband sweeper, and a fully programmable systems instrument.

### Synthesizer

The HP 3325A is first with microhertz resolution below 100 kHz along with frequency coverage from .000001 Hz to 20.999 999 999 MHz. Signal purity, accuracy and stability are as good or better than earlier stand-alone HP synthesizers. Harmonics are 65 dB down below 50 kHz and you can externally modulate with AM and PM.

### Function Generator

The HP 3325A is also a high performance function generator providing precision waveforms with synthesizer accuracy and resolution. Squarewaves to 10.999 999 999 MHz have 20 ns rise and fall times. Triangles and ramps with .05% linearity are available up to 10.999 999 999 kHz. All waveforms can be dc and phase offset.

### A Wideband Sweeper

A major contribution is wideband phase continuous sweep, covering up to the full frequency range of each waveform. Sweep log or linear, single or continuous without the phase discontinuities usually associated with synthesizers. Phase lock loop testing is made easier.

Make convenient swept frequency network measurement on filters, amplifiers or any passive or active network. Use the TTL marker to check the frequency of points of interest on a swept frequency display desired. Use the convenient "zoom" functions  $\Delta F \times 2$  and  $\Delta F \div 2$  to quickly change the frequency span for the display desired.

### Fully Programmable

All necessary functions are programmable on the HP-IB, including frequency, amplitude, all functions, phase and dc offset, modulation, all sweep parameters, amplitude cal and self-test, making the HP 3325A a very versatile and powerful addition to automatic test systems. The isolated interface combined with floating outputs and inputs and talk mode make the HP 3325A easy to use in Automatic Test Systems.

### More Features

The phase of the output can be changed  $\pm 719.9^\circ$  with  $0.1^\circ$  resolution. The phase is advanced (or retarded) with respect to the starting

phase. Two HP 3325A units can be phase locked together for dual phase output applications.

DC offset is capable of  $\pm 4.5$  Vdc on the standard instrument. The high voltage option (Opt 002) allows ac voltages up to 40 Vpp and ac + dc up to  $\pm 18$  V total (ac peak + dc).

Ten storage registers can be programmed with ten different combinations of function/parameter settings from the front panel, stored and then recalled.

The HP 3325A can display 11 digits of frequency and 4 digits of volts or millivolts from 1 mV to 10 volts peak to peak. Conversion to RMS or dBm is simple with the touch of a button.

### New Technology

The HP 3325A provides unprecedented performance per dollar thanks to several major contributions from advances in HP technology. A single loop Fractional-N synthesis technique allows synthesizer accuracy with 11 digits of resolution and, as an added bonus, phase continuous frequency sweep. Fewer parts and integrated circuit technology make the difference. A unique method of triangle and ramp waveform generation provides excellent linearity. Add microprocessor control and Hewlett-Packard Interface Bus (HP-IB) operation and the result is more performance, flexibility and versatility on the bench or in automatic test systems than previously available, and at a lower cost.

### Specifications

Refer to the HP 3325A data sheet for complete specifications.

### Waveforms

Sine, Square, Triangle, negative and positive Ramps.

### Frequency

#### Range

**Sine:** 1  $\mu$ Hz to 20.999 999 999 MHz

**Square:** 1  $\mu$ Hz to 10.999 999 999 MHz

**Triangle/ramps:** 1  $\mu$ Hz to 10.999 999 999 kHz

**Resolution:** 1  $\mu$ Hz, < 100 kHz

1 mHz  $\geq$  100 kHz

**Aging rate:**  $\pm 5 \times 10^{-6}$ /year, 20° to 30°C

**Warm-up time:** 20 minutes to within specified accuracy



## Main Signal Output (all waveforms)

**Impedance:** 50  $\Omega$

**Connector:** BNC; switchable to front or rear panel, nonswitchable with option 002, except by internal cable change.

## Amplitude

**Range:** 1 mV to 10 V p-p in 8 amplitude ranges, 1-3-10 sequence (10 dB steps), into 50  $\Omega$  load.

Function	Sine		Square		Triangle/Ramps	
	min	max	min	max	min	max
Units Displayed						
peak-peak	1.000 mV	10.00 V	1.000 mV	10.00 V	1.000 mV	10.00 V
rms	0.354 mV	3.536 V	0.500 mV	5.000 V	0.289 mV	2.887 V
dBm (50 $\Omega$ )	-56.02	+23.98	-53.01	+26.99	-57.78	+22.22

**Resolution:** 0.03% of full range or 0.01 dB (4 digits).

**Amplitude Accuracy** (without dc offset, relative to programmed amplitude and accuracy)

### Sinewave Amplitude Accuracy

1 mHz to 100 kHz:  $\pm 0.1$  dB,  $\geq 3$  Vpp;  $\pm 0.2$  dB,  $< 3$  Vpp

100 kHz to 20 MHz:  $\pm 0.4$  dB,  $\geq 3$  Vpp;  $\pm 0.6$  dB, 0.1 to 3 Vpp

### Squarewave Amplitude Accuracy

1 mHz to 100 kHz: 1%,  $\geq 3$  Vpp; 2.2%,  $< 3$  Vpp

100 kHz to 10 MHz: 11.1%,  $\geq 3$  Vpp; 13.6%,  $< 3$  Vpp

### Triangle Amplitude Accuracy

1 mHz to 2 kHz: 1.5%,  $\geq 3$  Vpp; 2.7%,  $< 3$  Vpp

2 kHz to 10 kHz: 5%,  $\geq 3$  Vpp; 6.2%,  $< 3$  Vpp

### Sinewave Spectral Purity

**Phase noise:** -60 dB for a 30 kHz band centered on a 20 MHz carrier (excluding  $\pm 1$  Hz about the carrier) with high-stability option 001 installed.

**Spurious:** all non-harmonically related output signals will be more than 70 dB below the carrier (60 dB with dc offset), or less than -90 dBm, whichever is greater.

**Sinewave harmonic distortion:** harmonically related signals will be less than the following levels (relative to the fundamental) at full output for each range:

Frequency Range	Harmonic Level
0.1 Hz to 50 kHz	-65 dB
50 kHz to 200 kHz	-60 dB
200 kHz to 2 MHz	-40 dB
2 MHz to 15 MHz	-30 dB
15 MHz to 20 MHz	-25 dB

### Squarewave Characteristics

**Rise/fall time:**  $\leq 20$  ns, 10% to 90% at full output

**Overshoot:**  $\leq 5\%$  of peak to peak amplitude, at full output

**Settling time:**  $< 1$   $\mu$ s to settle to within .05% of final value.

### Phase Offset

**Range:**  $\pm 719.9^\circ$  with respect to arbitrary starting phase or assigned zero phase

**Resolution:** 0.1 $^\circ$

**Accuracy:**  $\pm 0.2^\circ$

### DC Offset

**Range:** dc only (no ac signal): 0 to  $\pm 5.0$  V/50  $\Omega$ .

dc + ac: Maximum dc offset  $\pm 4.5$  V on highest range, decreasing to  $\pm 4.5$  mV on lowest range.

**Resolution:** 4 digits

### Sinewave Amplitude Modulation

**Modulation depth at full output for each range:** 0-100%

**Modulation frequency range:** dc to 400 kHz (0-21 MHz carrier frequency)

**Sensitivity:**  $\pm 5$  V peak for 100% modulation

### Sinewave Phase Modulation

**Range:**  $\pm 850^\circ$ ,  $\pm 5$  V input

**Modulation frequency range:** dc -5 kHz

### Frequency Sweep

#### Sweep Time

**Linear:** 0.01 s to 99.99 s

**Logarithmic:** 2 s to 99.99 s single, 0.1 s to 99.99 s continuous

**Maximum sweep width:** full frequency range of the main signal output for the waveform in use, except minimum log start frequency is 1 Hz.

**Phase continuity:** sweep is phase continuous over the full frequency range of the main output.

## Auxiliary Inputs and Outputs

**Reference input:** for phase-locking HP 3325A to an external frequency reference signal from 0 dBm to +20 dBm into 50  $\Omega$ . Reference signal must be a subharmonic of 10 MHz from 1 MHz to 10 MHz.

**Auxiliary frequency output:** 21 MHz to 60.999 999 999 MHz, under range coverage to 19.000 000 001 MHz, frequency selection from front panel; 0 dBm; output impedance 50  $\Omega$ .

**Sync output:** square wave with V (high)  $\geq 1.2$  V, V (low)  $\leq 0.2$  V into 50  $\Omega$ .

**X-Axis drive:** 0 to  $> +10$  V dc linear ramp proportional to sweep frequency, linearity, 10-90%,  $\pm 0.1\%$  of final value.

**Sweep marker output:** high to low TTL compatible voltage transition at selected marker frequency.

**Z-Axis blank output:** TTL compatible voltage levels capable of sinking 200 mA from a positive source.

**1 MHz reference output:** 0 dBm output for phase-locking additional instruments to the HP 3325A.

**10 MHz oven output:** 0 dBm internal high stability frequency reference output for phase-locking HP 3325A. (Opt. 001 only)

**HP-IB Interface Functions:** SH1, AH1, T6, L3, SR1, RL1, PP0, DC1, DT0, C0, E1.

**Recommended Accessory:** HP 7090A Measurement Plotting System.

### Option 001 High Stability Frequency Reference

**Aging rate:**  $\pm 5 \times 10^{-8}$ /week (72-h warm up);  $\pm 1 \times 10^{-7}$ /month (after 15 days continuous operation).

**Ambient stability:**  $\pm 5 \times 10^{-8}$  ( $0^\circ$  to  $+55^\circ\text{C}$ ).

**Warm-up time:** reference will be within  $\pm 1 \times 10^{-7}$  of final value 15 minutes after turn-on for an off time of less than 24 hours.

### Option 002 High Voltage Output

**Frequency range:** 1  $\mu$ Hz to 1 MHz

#### Amplitude

**Range:** 4.00 mVpp to 40.00 Vpp (500  $\Omega$ ,  $< 500$  pF load).

#### Accuracy and Flatness at Full Output

**Sine, square, and triangle waves:**  $\pm 2\%$  at 2 kHz

**Ramps:**  $\pm 2\%$  at 500 Hz

**Flatness:**  $\pm 10\%$  relative to programmed amplitude

**Sinewave distortion:** harmonically related signals will be the same as the standard instrument to 1 MHz

**Maximum output current:** 80 mA

**Output impedance:**  $< 2$   $\Omega$  at dc,  $< 10$   $\Omega$  at 1 MHz

**DC offset range:** 4 times the specified range of the standard instrument.

## General

### Operating environment

**Temperature:**  $0^\circ\text{C}$  to  $55^\circ\text{C}$ .

**Relative humidity:** 95%,  $0^\circ\text{C}$  to  $40^\circ\text{C}$ .

**Altitude:**  $\leq 15,000$  ft.

**Storage temperature:**  $-40^\circ\text{C}$  to  $+75^\circ\text{C}$ .

**Storage altitude:**  $\leq 50,000$  ft.

**Power:** 100/120/220/240 V, +5%, -10%, 48 to 66 Hz; 90 VA, 120 VA with all options; 10 VA standby.

**Weight:** 9 kg (20 lb) net; 14.5 kg (32 lb) shipping.

**Size:** 132.6 H x 425.5 W x 497.8 mm D (5.25" x 16.75" x 19.63").

### Ordering Information\*

HP 3325A Frequency Synthesizer

**Opt. 001** High Stability Frequency Reference

**Opt. 002** High Voltage Output

**Opt 907** Front Handle Kit (standalone orders P/N HP 5061-0089)

**Opt 908** Rack Flange Kit (standalone orders P/N HP 5061-0077)

**Opt 909** Rack Flange and Handle Combination Kit (standalone orders P/N HP 5061-0083)

\*HP-IB cable not supplied. See page 675



# FUNCTION GENERATORS & FREQUENCY SYNTHESIZERS

Two-Channel Synthesizer, DC to 13 MHz

Model 3326A



HP 3326A



The HP 3326A Two-Channel Synthesizer combines two independent synthesizers, flexible modulation, and control circuitry into a single, powerful package. This single instrument can provide precise phase offset, two-tone sweep, fast frequency switching, internal modulation, and pulse signals for bench or systems use.

### Complete Two-Phase Solution

The HP 3326A can provide two signals whose phase is adjustable and calibrated anywhere in its 13 MHz frequency range without an external phasemeter.

Self-calibration can be performed internally or externally and yields accuracy of  $\pm 0.2$  degrees below 100 kHz. Phase can be set with 0.01 degree resolution at all frequencies. Using its unique phase-calibration circuitry, calibrated multi-phase signals are easily achieved with two or more HP 3326As.

### Powerful Two-Tone Capability

The HP 3326A is the single-source answer for producing a wide variety of broadband two-tone signals. Its two channels can be offset up to  $\pm 100$  kHz, either in the CW mode or while sweeping.

Channel amplitudes and functions (sine or square) can be selected independently and provided from separate outputs or through the built-in signal combiner. Low sinewave distortion (harmonics are  $-80$  dBc below 100 kHz) makes low-distortion intermodulation measurements a simple task.

### Versatile ATE Source

With two complete synthesizers in a single instrument, rack space and power are conserved. Features like internal amplitude and phase modulation, two-tone, and pulse modes allow this one instrument to do the job of several sources.

All functions, modes, and parameters of the HP 3326A are completely programmable over the HP-IB. Maximum accuracy is ensured with amplitude/phase calibrations that can be enabled, disabled and initiated under remote control.

### High Performance Modulation and Pulses

Precise amplitude and phase modulation is easy with both channels of the HP 3326A. Each channel can be used with simultaneous AM and PM, or one channel can modulate the other. Amplitude modulation frequency is dc to 100 kHz and envelope distortion is better than  $-46$  dB.

In the pulse mode both pulse and pulse-complement outputs are provided. Symmetry range is 1% to 99% and is settable in 0.1% increments. In addition, both pulse amplitudes and their offsets are independently controllable.

### Other Features

The HP 3326A has a host of convenience features to speed and simplify signal generation. Nine complete setup states can be stored in nonvolatile memory, along with automatic storage of the power-off

state. A discrete sweep mode is available to generate from 2 to 63 frequency pairs with dwell times individually selectable for each frequency and each channel. Several flexible triggering modes allow hardware or software triggers to initiate frequency, amplitude, or phase changes, and sweeps.

DC offset is available in all modes, and all outputs are floating. Frequency resolution is 11 digits, and all sweeps and frequency changes are phase-continuous.

### Specifications

For complete specifications refer to the HP 3326A data sheet.

### Operating Modes

**Two Channel:** Channels A and B are independent

**Two-Phase:** Channels A and B are the same frequency, with calibrated phase offset between the two signals

**Two-Tone:** Channel B frequency offset 0 to 100 kHz from channel A frequency

**Pulse:** Channel B is the complement of Channel A

### Frequency (Waveforms are Sine, Square, Pulse, and DC)

**Range:** 0 Hz to 13 MHz

**Resolution:** 1  $\mu$ Hz below 100 kHz, 1 mHz at and above 100 kHz

**Stability:**  $\pm 5 \times 10^{-6}$ /year, 20° to 30°C. See also option 001, High Stability Frequency Reference.

**Accuracy:**  $\pm 5 \times 10^{-6}$  of selected value, 20° to 30°C, at time of calibration with standard frequency reference

### Sinewave Spectral Purity

**Harmonics:** Harmonically related signals will be less than the following levels relative to the fundamental:

	10 Hz	50 kHz	100 kHz	1 MHz	13 MHz
+23.98 dBm	-80 dBc	-70 dBc	-55 dBc	-35 dBc	
+13.98 dBm	-80 dBc	-80 dBc	-65 dBc	-50 dBc	
-56.02 dBm					

**Phase noise:**  $-66$  dBc (Option 001 only, for a 30 kHz band centered on a 10 MHz carrier excluding  $\pm 1$  Hz about the carrier)

### Main Signal Outputs (Channels A & B, All Waveforms Unless Noted)

**Connectors:** Front panel BNC female

**Impedance:** 50  $\Omega$ ; output may be floated to  $\pm 42$  V peak

**Sync A:** TTL level squarewave at Channel A frequency.

### Output Amplitude (Sine Mode)

**Range:** 1 mVpp to 10 Vpp in 8 ranges without DC offset. See also option 002 High Voltage Output

**Units:** Volts peak-peak, Volts rms, dBm (50  $\Omega$ ), dBV





**Resolution:** 0.1% of full range for peak-peak entry  
0.3% of full range for rms entry  
0.01 dB for dBm or dBV entry

**Accuracy:** Relative to programmed value after self-calibration

	0.001 Hz	100 kHz	1 MHz	13 MHz
+23.98 dBm	-----	-----	-----	-----
	±0.1 dB	±0.3 dB	±0.6 dB	
+3.98 dBm	-----	-----	-----	-----
			±0.8 dB	
-36.02 dBm	±0.2 dB	±0.4 dB	-----	-----
			±1.0 dB	
-56.02 dBm	-----	-----	-----	-----

### Squarewave and Pulse Characteristics

**Rise/fall time:** ≤15 ns, 10% to 90% at full output  
**Overshoot:** ≤5% of peak-to-peak amplitude at full output  
**Pulse width range:** 1% to 99% of period or 20 ns, whichever is greater  
**Pulse width resolution:** 0.1% of period  
**Pulse width accuracy:** ≤±1% of period ±20 ns  
**Amplitude accuracy:** ±2%, 0.001 Hz to 100 kHz

### DC Offset

**Range:** (See also option 002, high voltage output)  
**DC only:** 0 to ±5 V  
**DC+AC:** DC+AC peak ≤5V; Max. DC offset is affected by AC range, Maximum is 4.5 V decreasing to 4.5 mV on lowest range  
**Resolution:** 3 digits  
**Accuracy:** (After self-calibration)  
**DC only:** ±75 mV  
**DC+AC:** (Sinewave) 10 Hz to 1 MHz: ±2% of range  
1 MHz to 13 MHz: ±5% of range

### Phase Offset

(Channel A vs B in Two-Phase mode)  
**Range:** ±720 degrees  
**Resolution:** 0.01 degree  
**Accuracy:** After self-calibration, for equal-level sinewaves 1 V to 10 V peak-peak

0.1 Hz to 10 Hz	±0.5 degrees
10 Hz to 100 kHz	±0.2 degrees
100 kHz to 1 MHz	±0.3 degrees
1 MHz to 13 MHz	±2.0 degrees

### Amplitude Modulation

Specifications apply to Channel A and Channel B with external modulation or to Channel A internal modulation with Channel B as the modulation source. External modulation is allowed in all modes; internal modulation is allowed only in the two-channel mode.  
**Waveforms:** Sine, square, or (external only) pulse  
**Frequency Range:** Carrier: DC to 13 MHz  
Modulation: DC to 100 kHz  
**Modulation Depth:** 0 to 100%

### Phase Modulation

Specifications apply to Channel A and Channel B with external modulation or to Channel A internal modulation with Channel B as the modulation source. External modulation is allowed in all modes; internal modulation is allowed only in the two-channel mode.  
**Waveforms:** Sine, square, or (external only) pulse  
**Frequency Range:** Carrier: DC to 13 MHz  
Modulation: DC to 5 kHz  
**Phase Deviation:** 0° to 360°

### Frequency Sweep

**Sweep Types:** Linear, discrete  
**Sweep Forms:** Triangle, ramp  
**Sweep Time:** 5 ms to 1000 s  
**Sweep Elements** (Discrete): 2 to 63 frequency pairs and dwell times, user defined; dwell times = 5 ms to 1000 s/element  
**Maximum Sweep Width:** 13 MHz

### Output Combiner

Channel A and B are combined on the Channel A output. B output is off. Combiner may be used in the two-channel, two-phase, and two-tone modes. DC offset is automatically set to 0 V.

**Frequency Range:** DC to 13 MHz

**Return Loss:** >20 dB

### Auxiliary Outputs (All Connectors are Rear-Panel BNC)

**10 MHz reference:** +3 dBm output to phase lock other instruments to the HP 3326A

**10 MHz oven output:** +3 dBm oven-stabilized frequency reference (option 001 only)

**X-axis drive:** Linear ramp proportional to sweep time

**Z-axis blank:** TTL low during sweep

**Sweep Marker:** TTL low at selected marker frequency in sweep

**20-33 MHz LO:** >100 mV square wave output offset 20 MHz from Channel B output

### Auxiliary Inputs (All Connectors are Rear-Panel BNC)

**Reference Input:** For phase-locking to an external frequency reference. Signal of 1,2,5, or 10 MHz, ±10 ppm, 0 to +20 dBm

**External Trigger Input:** TTL level to initiate linear or discrete sweep on high to low transition

**Channel A and B external phase calibration inputs**

**Channel A and B external amplitude modulation inputs**

**Channel A and B external phase modulation inputs**

### HP-IB Remote Control

Compatible with IEEE Standard 488-1978

### Interface Functions:

SH1,AH1,T6,L4,SR1,RL1,PP0,DC1,DT1,C0,E1

### Option 001 High Stability Frequency Reference

**Stability:** ±5×10<sup>-8</sup>/week after 72 hours continuous operation  
±1×10<sup>-7</sup>/month after 15 days continuous operation

### Option 002 High Voltage Output

Multiplies the output level by 4 and expands the allowable DC offset range. Specifications apply to both channels in all modes with the internal combiner off.

**Frequency range:** DC to 1 MHz

**Output impedance:** <2 Ω, DC to 50 kHz; <10 Ω, 50 kHz to 1 MHz

**Amplitude range:** 4 mV to 40 Vpp into >500 Ω, <500 pF load without DC offset (must be entered in peak-to-peak units only)

**DC offset:** ±20 V, independent of amplitude range. DC + AC peak must not exceed 20 V

### Option 003 Rear Terminal Outputs

Provides Channel A and B main outputs only on rear panel BNC's. Front panel main outputs are removed. Specifications unchanged.

### General

**Power:** 100/120/220/240 V, +5%, -10%, 48 to 66 Hz; 120 VA, 150 VA with all options, 10 VA standby

**Weight:** 27 kg (60 lb) net, 37 kg (81 lb) shipping

**Dimensions:** 177 mm H x 425.5 mm W x 497.8 mm D (7" x 16<sup>3</sup>/<sub>4</sub>" x 19<sup>5</sup>/<sub>8</sub>" )

### Accessories Available

**HP 15507A Isolator:** For isolation of signal ground between frequency reference and instrument input/output

**HP 9211-2656 transit case** for protection in transportation and storage

### Ordering Information

HP 3326A Two-Channel Synthesizer

**Option 001** High Stability Frequency Reference

**Option 002** High Voltage Output

**Option 003** Rear Terminal Outputs

**Option 907** Front Handle Kit

**Option 908** Rack Flange Kit

**Option 909** Rack Flange and Handle Combination Kit

**Option 910** Extra Operating Manual

**Option 914** Delete Service Manual



# FUNCTION GENERATORS & FREQUENCY SYNTHESIZERS

## Synthesizer/Level Generator 200 Hz to 81 MHz

### Model 3335A

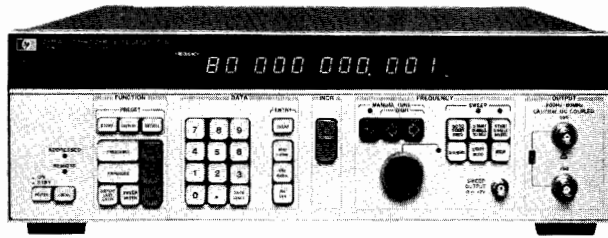

#### HP 3335A

- 1 mHz resolution
- High spectral purity
- Precision amplitude control
- Program storage
- HP-IB



#### Description

Covering a frequency range of 200 Hz–81 MHz, the HP 3335A Synthesizer/Level Generator has performance characteristics that make it ideally suited for the telecommunications industry, as well as for traditional synthesizer applications, including testing of Frequency Division Multiplex (FDM) equipment and R & D and production testing of communications systems. It features precision level control, millihertz resolution, high spectral purity, internal frequency sweep, HP-IB programmability and numerous user conveniences.

#### Internal Storage

Up to 10 different front panel settings (frequency, level,  $\phi$  incr, etc.) can be stored in internal memory registers for later recall. The DISPLAY key allows viewing of register contents without altering the synthesizer output.

#### Precision Amplitude

Increasing channel capacity of Frequency Division Multiplex (FDM) systems is continually placing more stringent requirements on the testing of transmission parameters. To meet these performance standards, the HP 3335A incorporates a state-of-the-art attenuator resulting in attenuator accuracies of up to  $\pm 0.25$  dB over the 81 MHz frequency range.

#### HP-IB Programmability

IEEE STD 488-1978 Definition SH1, AH1, T6, L3, SR1, RL1, PP0, DC1, DT0, C0, E1.

#### Frequency Stability

The HP 3335A synthesizes its output frequency from an internal temperature-controlled crystal oscillator which provides  $\pm 1 \times 10^{-8}$ /day frequency stability ( $\pm 5 \times 10^{-10}$  is optional). The HP 3335A can also be phase-locked to any external frequency standards.

#### Automatic Frequency Sweep

The HP 3335A combines the precision frequency accuracy and stability of a synthesizer with the time-saving convenience of a digital sweeper.

#### SLMS - Tracking Generator

The HP 3335A operates as a tracking generator with the HP 3746A/B Selective Level Measuring Set (SLMS), or the HP 3586A/B/C Selective Level Meter for automatic or semi-automatic testing of FDM systems. For closed-loop tracking where the HP 3335A and HP 3746A/B are in the same location, the frequency of the generator is controlled by the microprocessor in the SLMS.

#### Options

**Standard:** equipped with switch-selectable 50 $\Omega$  and 75  $\Omega$  outputs (BNC connectors).

**001:** High-stability frequency reference

**002/004:** Equipped with 75 $\Omega$  unbalanced and 124 $\Omega$  and 135 $\Omega$  balanced connectors per table.

	Option	Fits WECO Type	Spacing	Accepts WECO Type
75 $\Omega$	002	477B	N/A	358A 439A/440A
	004	560A		
124 $\Omega$	002	477B	16 mm (.625")	372A
	004	560A	12.7 mm (0.5")	443A
135 $\Omega$	002/004	223A	16 mm (.625")	241A

**003:** 75 $\Omega$  unbalanced BNC output and 150  $\Omega$  balanced output using a pair of BNC connectors at 20 mm (0.80 in.) spacings.

#### Abbreviated Specifications

(For complete specifications, refer to the HP 3335A data sheet.)

#### Frequency Range

**Standard:** 200 Hz–81 MHz;

**Opt. 002/004:** 75 $\Omega$ , 200 Hz–81 MHz; 124 $\Omega$ , 10 kHz–10 MHz; 135/150 $\Omega$ , 10 kHz - 2 MHz.

**Opt. 003:** 75 $\Omega$ , 200 Hz–81 MHz; 150 $\Omega$ , 10 kHz - 2 MHz

**Frequency resolution:** .001 Hz.

**Stability, long term:**  $\pm 1 \times 10^{-8}$ /day;  $\pm 1 \times 10^{-7}$ /month.

**Opt. 001** (high stability frequency reference)

**Aging rate:**  $\pm 5 \times 10^{-10}$ /day;  $\pm 2 \times 10^{-8}$ /month;  $\pm 1 \times 10^{-7}$ /year

**Warmup:** Within  $5 \times 10^{-9}$  of final value 20 minutes after turn-on at 25°C.

#### Spectral Purity

**Harmonic distortion:** 200 Hz–10 MHz:  $< -45$  dBc; 10 MHz–81 MHz;  $< -40$  dBc

**Phase noise** (30 kHz band, excluding  $\pm 1$  Hz, centered on the carrier): 9.9 MHz:  $< -63$  dBc; 20 MHz;  $< -70$  dBc; 40 MHz:  $< -64$  dBc; 81 MHz:  $< -58$  dBc

**Spurious:** nonharmonically related signals: the greater of  $-75$  dBc or  $-125$  dBm (50/75  $\Omega$ ),  $-97$  dBm (124  $\Omega$ ),  $-68$  dBm (135/150  $\Omega$ )

#### Amplitude Range

**Standard:** 50 $\Omega$ : +13.01 dBm to  $-86.98$  dBm; 75 $\Omega$ : +11.25 dBm to  $-88.74$  dBm.

**Opt. 002/004:** 75/124/135 $\Omega$ : +11.25 dBm to  $-88.74$  dBm

**Opt. 003:** 75/150 $\Omega$ : +11.25 dBm to  $-88.74$  dBm

**Signal balance (124 $\Omega$ , 135 $\Omega$ , 150 $\Omega$  balanced outputs):**  $> 60$  dB at 100 kHz

**Resolution:** 0.01 dB

**Absolute level accuracy (max. output at 100 kHz, 20°C to 30°C):** 50/75  $\Omega$   $\pm 0.05$  dB; 124/135/150  $\Omega$ :  $\pm 0.1$  dB

**Flatness (relative to 100 kHz, full amplitude):** 50/75 $\Omega$ : 1 kHz–25 MHz:  $\pm 0.07$  dB; 200 Hz - 81 MHz:  $\pm 0.15$  dB. 124 $\Omega$ : 10 kHz - 10 MHz:  $\pm 0.15$  dB, 10 kHz - 10 MHz  $\pm 0.4$  dB; 135/150 $\Omega$ : 10 kHz - 2 MHz:  $\pm 0.18$  dB

#### Attenuator:

Range: 0 to 98 dB in 2 dB steps

Accuracy: (1 year)

50 $\Omega$ :	ATTENUATION	FREQUENCY
	0 to 38 dB	$\pm 0.25$ dB
40 to 58 dB	$\pm 0.3$ dB	
60 to 98 dB	$\pm 0.9$ dB	

75 $\Omega$ :	ATTENUATION	FREQUENCY		
		200Hz	25 MHz	80 MHz
0 to 18 dB		$\pm 0.4$ dB	$\pm 1.5$ dB	
20 to 58 dB		$\pm 0.9$ dB	$\pm 2.5$ dB	
60 to 98 dB		$\pm 2.0$ dB	$\pm 5.0$ dB	

#### Options

**001:** Hi-stability reference  $\pm 5 \times 10^{-10}$ /day

**002:** Connector option (75/124/135 $\Omega$ )

**003:** Connector option (75/150 $\Omega$ )

**004:** Connector option (75 $\Omega$ , miniature WECO on 124/135 $\Omega$ )

**HP 3335A Synthesizer/Level Generator**

# FUNCTION GENERATORS & FREQUENCY SYNTHESIZERS

Synthesizer/Level Generator

Model 3336C

437

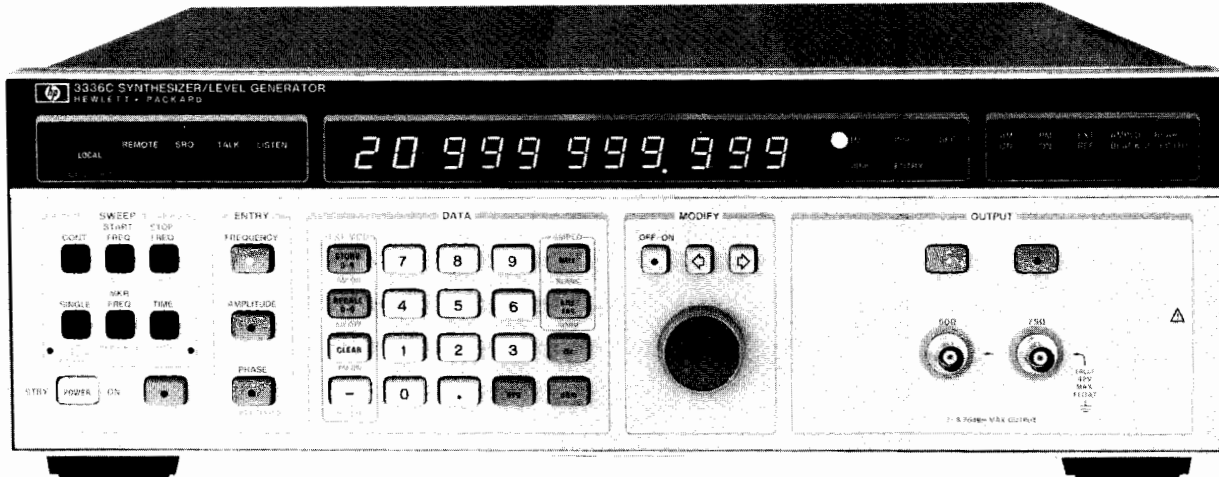

HP 3336C



## Description

Covering a frequency range of 10 Hz to 20.999 MHz, the HP 3336C is designed for traditional synthesizer applications as well as R&D and production testing of systems or components. It features precision level control, high spectral purity, optional frequency stability of  $\pm 5 \times 10^{-8}$ /week, internal frequency sweep and numerous user conveniences. All models include HP-IB.

## Precision Frequency Measurements

Major advances in HP technology have provided a single loop, fractional-N synthesis technique which allows synthesizer accuracy with 11 digits of resolution, with completely phase continuous frequency sweep over any of the instrument's frequency ranges. Microhertz resolution below 100 kHz allows precise frequency measurements over a range of 10 Hz to 20.999 999 999 MHz. Harmonics are below -60 dBc over the range from 50 Hz to 1 MHz (-50 dBc to 20 MHz), with spurious signals below -70 dBc or -100 dBm in the standard instrument, -115 dBm with an option. Integrated Phase Noise is -64 dBc (30 kHz BW).

## $\pm 0.05$ dB Amplitude Accuracy

New HP attenuator technology coupled with custom designs in leveling loops and thermal converters produce amplitude accuracies seen only in instruments at much greater cost. The fast leveling loop makes extremely flat sweeps possible at high sweep speeds. External leveling is also available for those custom applications where a control loop is desired.

## Other Features

Models HP 3336 A & B are also available for the telecommunications industry. See page 000. All three models (the HP 3336A, B & C) have 10 storage registers; amplitude blanking capability during frequency switching; linear or logarithmic phase continuous sweep capabilities; RPG (rotary pulse generator) to simplify modification of any digit in the display; phase offset capability; output connector and impedance flexibility; AM and PM modulation; and many other features. Refer to the data sheet for complete information.

## Abbreviated Specifications

### Frequency

**Range:** 10 Hz to 20.999 999 999 MHz

**Resolution:** 1  $\mu$ Hz for frequencies <100 kHz, 1 mHz for frequencies  $\geq$  100 kHz

**Aging rate:**  $\pm 5 \times 10^{-6}$ /year (20° to 30°C)

**Warm-up time:** 30 minutes to within specified accuracy

### Amplitude

**Range:** 50  $\Omega$ : -71.23 to +8.76 dBm; 75  $\Omega$ : -72.99 to 7.00 dBm

**Absolute accuracy:**  $\pm 0.05$  dB, 20° to 30°C (for the top 9.99 dB of amplitude range at 10 kHz),  $\pm 0.08$  dB, 0° to 55°C

**Flatness:** 50/75  $\Omega$ ,  $\pm 0.1$  dB ( $\pm 0.07$  dB with option 005) referenced to 10 kHz.

**Attenuator Accuracy:** (instruments without option 005)

10 Hz      1 MHz      10 MHz      20.9 MHz

10 to 19.99 dB	$\pm 1$ dB	$\pm 1.5$	$\pm 2$ dB
20 to 39.99 dB	$\pm 1.5$ dB	$\pm 2$ dB	$\pm 2.5$ dB
40 to 79.99 dB	$\pm 2$ dB	$\pm 2.5$ dB	$\pm 3$ dB

Note: Amplitude Accuracy is the sum of the Absolute Accuracy and, as necessary, Flatness and Attenuator Accuracy.

## Phase Offset

**Range:**  $\pm 719.9^\circ$  with respect to arbitrary reference phase.

## Amplitude Modulation

**Modulation depth:** 0 to 100%

**Modulation frequency range:** 50 Hz to 50 kHz

**Envelope distortion:**  $< -30$  dB to 80% modulation (1 kHz modulating freq.)

## Phase Modulation

**Range:** 0° to  $\pm 850^\circ$

**Linearity:**  $\pm 0.5\%$  from best fit straight line

**Modulation frequency range:** dc to 5 kHz

**Input sensitivity:**  $\pm 5$  V peak for 850° phase shift (170°/volt)

## Frequency Sweep

**Sweep time:** Linear; 0.01 s to 99.99 s. Single Log; 2 s to 99.99 s. Continuous Log; 0.1 s to 99.99 s.

**Maximum sweep width:** specified frequency range of selected output

**Minimum sweep width:** Log; 1 decade. Linear; minimum BW (Hz) = .1 (Hz/s) x Sweep Time (s)

**Phase continuity:** phase is continuous over full frequency range.

**Sweep flatness:** fast leveling  $\pm 0.15$  dB, 10 kHz to 20 MHz, .03 s

**Sweep time:** normal leveling;  $\pm 0.15$  dB, 50 Hz to 1 MHz, 0.5s sweep time.

**HP-IB Interface Functions:** SH1, AH1, T6, L3, SR1, RL1, PP0, DC1, DT0, C0, E1.

## General

### Operating Environment

**Temperature:** 0° to 55°C

**Relative humidity:**  $\leq 85\%$ , 0° to 40°C

**Altitude:**  $\leq 15,000$  ft, (4600 metres)

**Storage temperatures:** -50° to +65°C

**Storage altitude:**  $\leq 50,000$  ft, (15,240 metres)

**Power requirements:** 100/120/220/240 V, +5%, -10%, 48 to 66 Hz, 60 VA, (100 VA with all options), 10 VA standby

**Size:** 132.6 mm H x 425.5 mm W x 497.8 mm D, (5.2" x 16.8" x 19.6")

**Weight:** net, 10 kg. (22 lb). Shipping, 15.5 kg. (34 lb)

## Ordering Information

HP 3336C Synthesizer/Level Generator (General Purpose)

**Opt 004** High Stability Frequency Reference

**Opt 005** High Accuracy Attenuator

**Opt 907** Front Handle Kit

**Opt 908** Rack Flange Kit

**Opt 909** Rack Flange and Handle Kit



# SIGNAL GENERATORS

## Signal Generators to 40 GHz

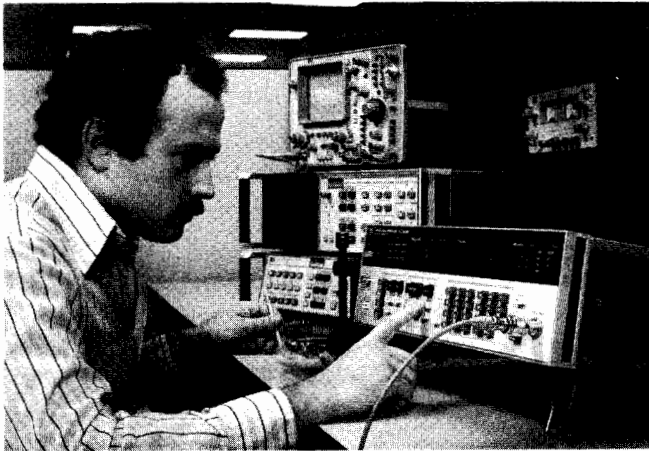

Hewlett-Packard offers a complete line of signal generators from 10 kHz to 40 GHz. This line includes synthesized and solid-state mechanically tuned generators as well as performance-proven vacuum tube signal generators. Each includes the following: 1) accurately calibrated variable frequency, 2) accurately calibrated variable output level, and 3) wide modulation capability.

HP signal generators provide the performance necessary for a wide variety of measurements, including receiver tests such as sensitivity and selectivity. Versatile modulation makes them ideal for signal simulation applications such as signal-to-noise ratio and antenna gain. They also provide power to drive mixers, bridges, and slotted lines.

### Synthesized Signal Generators

Collectively covering a frequency range from 10 kHz to 26.5 GHz, these versatile programmable signal generators are used in a wide variety of automated systems and high performance applications.

#### 10 kHz to 2560 MHz Low Noise Synthesized Signal Generators

The HP 8662A covers 10 kHz to 1280 MHz with calibrated output from +13 to -140 dBm. The HP 8663A shares the frequency synthesis circuitry of the HP 8662A and covers 100 kHz to 2560 MHz with calibrated levels from +16 to -130 dBm. Both generators feature extremely low phase noise and spurious while maintaining fast frequency switching. The low phase noise close to the carrier (-112 dBc/Hz at a 100 Hz offset) optimizes the HP 8662A and 8663A for critical low noise applications like local oscillator substitution and multiplication to microwave frequencies. In addition, the low noise at typical channel spacings (-132 dBc/Hz at 10 kHz offset) allows both in-channel and out-of-channel measurements to be made under programmable control. The HP 8662A has AM and FM. The HP 8663A offers AM, FM,  $\Phi$ M, and pulse modulation and a 10 Hz to 99.9 kHz modulation oscillator. Both the HP 8662A and 8663A feature precision digital sweep and full HP-IB programmability.

#### 0.1 to 2115 MHz High Performance Synthesized Signal Generators

The HP 8642A (0.1 to 1057.5 MHz) and HP 8642B (0.1 to 2115 MHz) offer excellent

spectral purity at carrier offsets beyond 10 kHz. Both share the same SAW resonator-based synthesis block diagram and differ primarily in frequency coverage. With SSB phase noise of -134 dBc/Hz at 20 kHz offset from a 1 GHz carrier and -100 dBc nonharmonic spurious, these generators are ideally suited to perform the most stringent of out-of-channel measurements on high performance RF communications receivers. Output levels from +20 dBm down to -140 dBm with  $\pm 1$  dB absolute level accuracy down to -127 dB allow these generators to drive high level mixers and pinpoint receiver sensitivity. RF leakage is specified at 0.5  $\mu$ V for confidence in low level tests. AM, FM,  $\Phi$ M and pulse modulation insure compatibility with most RF communications systems. AM is suited for avionics VOR and ILS systems and FM specifies 0.03% THD and typically 50 dB stereo separation. Frequency and amplitude sweep simplify device characterization.

The HP 8642A/B set a new standard for improved up-time in large ATE systems applications. A two-year recommended calibration interval, built-in diagnostic hardware and software and on-site repair and calibration contribute to improved ATE system productivity by keeping the HP 8642A/B up and running instead of out for repair.

#### 0.1 to 990 MHz Low Cost Synthesized Signal Generator

The HP 8656B, an economical programmable RF signal generator, provides synthesized signals from 0.1 to 990 MHz. The HP 8656B offers a wide range of standard features, including 10 Hz resolution, full keyboard control, reverse power protection to 50 W, and HP-IB programmability.

The HP 8656B features a new long-life output attenuator and  $\pm 1.0$  dB level accuracy for increased measurement accuracy and repeatability. Its low RF leakage permits testing of RFI-susceptible devices and its phase adjustment feature allows characterization of phase sensitive devices. The HP 8656B's flexible modulation, including simultaneous and FM rates from dc to 100 kHz, permits digital squelch tone tests as well as most communication receiver tests. Separate increment keys provide rapid and

easy setting of frequency, output and modulation. Because HP-IB is standard and frequency changes can be made in 150 ms, the HP 8656B is a cost-effective solution for in-channel measurements and an ideal general-purpose RF source for other applications.

#### 10 kHz to 2600 MHz Synthesized Signal Generator

The HP 8660A/C is a particularly versatile synthesized signal generator family, offering two mainframes and a variety of RF and modulation plug-ins. The HP 8660A mainframe utilizes thumbwheel switches for frequency selection. The HP 8660C has a more versatile keyboard control featuring synthesized digital sweep and frequency-step capability. Both HP-IB and BCD programming interfaces are available.

Three plug-in RF sections provide separate frequency ranges: 10 kHz to 110 MHz, 1 MHz to 1300 MHz, and 1 MHz to 2600 MHz. Output levels are calibrated over >140 dB range. Five different modulation plug-ins provide versatile combinations of AM, FM,  $\Phi$ M, and pulse modulation.

#### 0.01 to 26.5 GHz Microwave Synthesized Signal Generators

The HP 8670 series of microwave synthesizers and the HP 8340A and new HP 8341A synthesized sweepers cover five frequency ranges for measurement flexibility and broadband frequency coverage. They also feature good spectral purity and stability, versatile modulation, and full HP-IB programmability for signal simulation applications.

The HP 8671A is a synthesizer only, covering 2 to 6.2 GHz with a minimum output of +8 dBm and external FM capability. The HP 8672A is a 2 to 18 GHz AM/FM generator with calibrated output from +3 to -120 dBm (+8 dBm with Option 008). The HP 8672S provides all the capability of the HP 8672A, plus extended frequency coverage from 0.01 to 18 GHz and internal high-quality pulse modulation over the entire frequency range.

The HP 8673B spans 2 to 26.5 GHz, with +8 to -100 dBm output level. Internal pulse modulation as well as external metered AM and FM allow complex signal simulation. The HP 8673B, with proven performance and reliability, also features 1 to 4 kHz frequency resolution and stable digital sweep.

The HP 8673D has all the performance of the HP 8673B, with extended frequency coverage from 0.05 to 26.5 GHz, and harmonically related spurious outputs <-60 dBc from 2 to 26.5 GHz. Output power is >+5 dBm across the operating band. The HP 8673C offers all the above performance from 50 MHz to 18.6 GHz.

The HP 8340A (10 MHz to 26.5 GHz) and HP 8341A (10 MHz to 20 GHz) offer the same excellent CW performance as the HP 8670 series. They also have a high-performance sweep oscillator, providing wide and narrow band continuous analog sweeps. Other features include 1 to 4 Hz frequency resolution, high-quality internal pulse and amplitude modulation, and calibrated output power from +12 to -110 dBm. (Pulse modulation and 90 dB step attenuator are optional on the HP 8341A.)



## Solid-State, Mechanically Tuned Generators

Solid-state mechanically tuned generators combine fundamental oscillators with solid-state circuitry to yield excellent spectral purity for modern performance requirements.

### 2.3 to 18.0 GHz Solid-State Generators

The HP 8680 series solid-state signal generators are designed to meet the stringent requirements of modern microwave radar and communications testing. The HP 8683A and 8684A are optimized for communications receiver applications and feature low-distortion AM and FM, high spectral purity, and  $\pm 2.5$  dB output level accuracy.

The HP 8683B and 8684B add +10 dBm output power (standard) and high performance internal pulse modulation for radar/EW applications. An internal pulse generator provides wide ranges of rate, width and delay, and a custom pulse modulator yields >80 dB on/off ratio and <10 ns rise/fall times.

The HP 8683D and 8684D are extended-frequency versions of the HP 8683B and 8684B employing internal frequency doublers. Both are also capable of wideband FM for satellite communication applications. Peak deviations of  $\pm 10$  MHz at dc to 10 MHz rates make these products suitable for DBS receiver testing.

### 0.5 to 1024 MHz, High Performance

The performance leader of the RF mechanically tuned family is the HP 8640B signal generator, covering 450 kHz to 550 MHz. Frequency coverage can be extended to 1024 MHz with an internal doubler (Option 002), and an optional built-in audio oscillator extends the CW range down to 20 Hz (Option 001). The HP 8640B provides wide output level range from +19 to -145 dBm. High performance AM and FM and low phase noise at typical receiver channel spacings makes the HP 8640B an ideal generator for a wide variety of receiver measurements.

The HP 8640B with built-in counter has the ability to count external signals at frequencies up to 550 MHz and to phase-lock the generator's RF output to the counter time base for frequency stability of better than  $5 \times 10^{-8}$ /hour.

For avionics navigation and communications applications, the HP 8640B Option 004 can be combined with suitable external modulation sources for testing ILS, VOR, and VHF communications receivers.

### 10 to 520 MHz, Compact, Field Portable, Economy

Compact, portable signal generators form another part of the solid-state, mechanically tuned family. The HP 8654A and 8654B cover from 10 to 520 MHz, providing output power from +10 to -130 dBm. Small size and light weight make them well suited for

field maintenance and operational readiness checks in addition to general purpose signal generator applications. The HP 8654B has fully calibrated and metered AM and FM, whereas the HP 8654A is an AM generator with uncalibrated FM capability.

### Performance-Proven Vacuum Tube Signal Generators

The HP 8614A and 8616A are vacuum tube signal generators, covering 0.8 to 2.4 GHz and 1.8 to 4.5 GHz. They feature built-in PIN diode modulators, allowing internal or external output power leveling as well as high performance pulse and amplitude modulation.

HP 938A and 940A Frequency Doubler Sets provide low-cost 18 to 40 GHz signals by doubling the frequency of signal sources in the 9 to 20 GHz range.

### Signal Generator Accessories

A variety of accessories enhance the operation of HP signal generators. These include frequency doublers, balanced mixers, and a series of PIN modulators. The HP 11720A pulse modulator provides high performance pulse modulation capability from 2 to 18 GHz. The HP 11710B Down Converter extends the frequency range of the HP 8640 and HP 8654 down to 10 kHz.

## Signal Generator Summary

Frequency Range	HP Model	Characteristics	Page
10 to 520 MHz	8654A, 8654B Signal Generators	Calibrated and leveled output from +10 to -130 dBm. Amplitude and frequency modulation. Compact, portable (17.5 lb).	455
0.5 to 1024 MHz	8640B, 8640B Opt. 004 Signal Generators	Calibrated and leveled output from +19 to -145 dBm. AM, FM, and ext. pulse modulation. Built-in counter and phase lock capability. Avionics option available (Opt. 004).	451
0.1 to 1057.5 MHz 0.1 to 2115 MHz	8642A, 8642B Synthesized Signal Generators	High spectral purity. 1 Hz frequency resolution. $\pm 1$ dB absolute output level accuracy. AM, FM, $\Phi$ M and pulse. Sweep. On-site repair.	442
0.1 to 990 MHz	8656B Synthesized Signal Generator	$\pm 1.0$ dB absolute level accuracy from +13 dBm to -127 dBm in 0.1 dB steps. Calibrated AM and FM. Frequency resolution of 10 Hz. Time base aging rate of $\pm 2$ ppm/year.	440
0.01 to 1280 MHz	8662A Synthesized Signal Generator	Low noise. 0.1 Hz frequency resolution, $5 \times 10^{-10}$ /day stability. Calibrated and leveled output from +13 to -140 dBm. Digital sweep. Completely HP-IB programmable. AM/FM modulation.	445
0.1 to 2560 MHz	8663A Synthesized Signal Generator	Low noise. 0.1 Hz frequency resolution, $5 \times 10^{-10}$ /day stability. Calibrated and leveled output from +16 to -130 dBm. Digital sweep. Completely HP-IB programmable. AM, FM, $\Phi$ M, pulse modulation.	445
0.01 to 110 MHz 1 to 1300 MHz 1 to 2600 MHz	8660A, 8660C Synthesized Signal Generators	1 Hz frequency resolution, $3 \times 10^{-9}$ /day stability. Calibrated and leveled output from +13 to -146 dBm. HP-IB and BCD programmable. AM, FM, $\Phi$ M, pulse modulation. Plug-ins determine frequency range and modulation capability.	448
0.8 to 2.4 GHz 1.8 to 4.5 GHz	8614A, 8616A Signal Generators	Output +10 (HP 8616; +3 dBm above 3 GHz) to -127 dBm into 50 ohms, leveled below 0 dBm. Internal square-wave; external pulse, AM and FM. Auxiliary RF output.	458
2.3 to 6.5 GHz 5.4 to 12.5 GHz	8683/84 A,B Signal Generators	High spectral purity, stability. $\pm 2.5$ dB absolute level accuracy from +10 to -110 dBm (0 dBm, A models). AM, FM standard. High perf. internal pulse modulator and pulse generator with B models. Portable, rugged (19.1 kg).	456
2.3 to 13 GHz 5.4 to 18 GHz	8683/84 D Signal Generators	Same as B model except with wideband frequency coverage. DC coupled FM with $\pm 10$ MHz deviations available. -3dBm standard output power in doubled frequency band. +10 dBm available with option 001.	456
2 to 6.2 GHz	8671A Synthesizer	1 kHz frequency resolution, $5 \times 10^{-10}$ /day stability, +8 dBm minimum output. Completely HP-IB programmable. Ext. FM.	463
2 to 18 GHz	8672A Synthesized Signal Generator	1 to 3 kHz frequency resolution, $5 \times 10^{-10}$ /day stability. Calibrated and leveled output from +3 to -120 dBm. Completely HP-IB programmable. Metered external AM and FM.	461
0.01 to 18 GHz	8672S Synthesized Signal Generator	1 to 3 kHz frequency resolution, $5 \times 10^{-10}$ /day stability. Internal pulse modulator. Calibrated and leveled output from +2 to -120 dBm. Metered external AM and FM. Completely HP-IB programmable.	463
0.05 to 18.6 GHz	8673C Synthesized Signal Generator	Harmonics and sub-harmonics <-60 dBc. 1 to 3 kHz resolution. +2 to -100 dBm output. Pulse, amplitude and frequency modulation. Digital sweep. Completely HP-IB programmable.	462
0.01 to 20 GHz	8341A Synthesized Sweeper	1-3 Hz frequency resolution, $1 \times 10^{-10}$ /day stability. +10 to -20 dBm output. Amplitude modulation. Continuous analog sweep with spans from 100 Hz to 19.99 GHz completely HP-IB programmable.	459
2 to 26.5 GHz	8673B Synthesized Signal Generator	1 to 4 kHz frequency resolution, $5 \times 10^{-10}$ /day stability. +8 to -100 dBm output. Pulse, amplitude, and frequency modulation. Digital sweep. Completely HP-IB programmable.	460
0.05 to 26.5 GHz	8673D Synthesized Signal Generator	Harmonics and sub-harmonics <-60 dBc. 1 to 4 kHz resolution. +5 to -100 dBm output. Pulse, amplitude and frequency modulation. Digital sweep. Completely HP-IB programmable.	462
0.01 to 26.5 GHz	8340A Synthesized Sweeper	1 to 4 Hz frequency resolution, $1 \times 10^{-10}$ /day stability. +12 to -110 dBm output. Pulse and amplitude modulation. Continuous analog sweep with spans from 100Hz to 26.49 GHz. Completely HP-IB programmable.	459
18 to 26.5 GHz 26.5 to 40 GHz	938A, 940A Frequency Doublers	Driven by 9 to 13.25 GHz, 13.25 to 20 GHz sources (HP 8690, 8672A, 8672S, 8673B, 8673D, 8340A, 8350A, and 8620 series). 100 dB precision attenuator.	465



# SIGNAL GENERATORS

## Synthesized Signal Generator



Model 8656B

- 100 kHz to 990 MHz
- $\pm 1.0$  dB absolute level accuracy
- Amplitude offset and phase adjustment capability

- 150 millisecond frequency switching speed
- Versatile simultaneous modulation including dc FM
- Fully HP-IB programmable

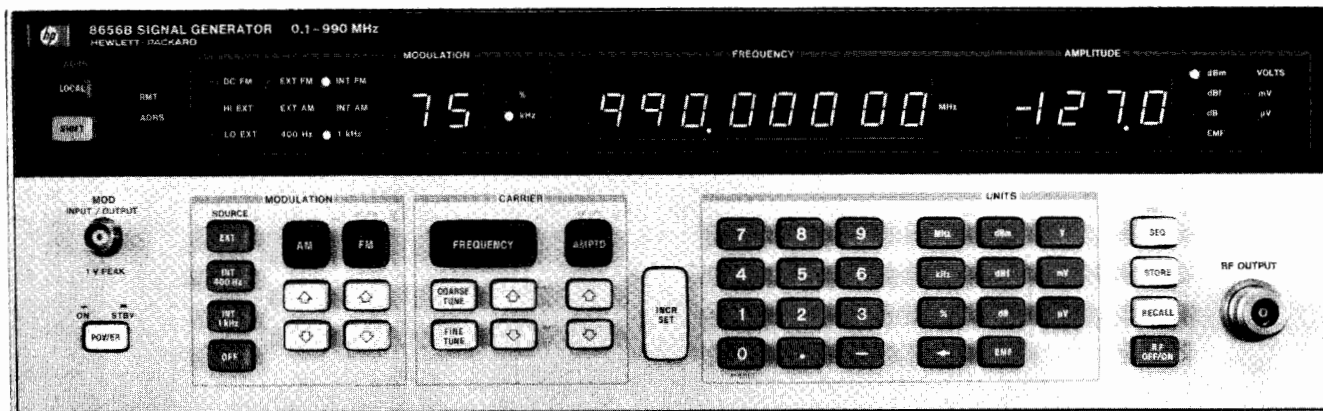

HP 8656B



### Description

The HP 8656B is a programmable synthesized signal generator that offers exceptional value through a powerful combination of performance, quality and economy.

### Frequency

The HP 8656B provides frequency coverage from 0.1 to 990 MHz (with under-range to 10 kHz). This wide range covers the IF and LO frequencies as well as the RF frequencies of most receivers. It also allows testing in a variety of communication systems including the 800 MHz FM mobile band and some telemetry bands. For automated testing, the 150 ms frequency switching speed of the HP 8656B (specified to be within 100 Hz of the final frequency) increases throughput. Frequency resolution of 10 Hz allows convenient setting of increments including narrow channel spacings, while characterization of phase sensitive devices is made easier with the help of the phase increment/decrement feature. The standard internal reference has an aging rate of 2 ppm/year. Improved stability and accuracy can be achieved by adding the optional  $1 \times 10^{-7}$ /day high stability time base (Option 001) or using an external reference of 1, 5 or 10 MHz.

### Output

The new output attenuator of the HP 8656B has been designed with high volume automatic test system use in mind. The 8656B also features  $\pm 1.0$  dB absolute level accuracy and 0.1 dB resolution for accurate receiver sensitivity tests, circuit characterization and R&D applications. The output levels are calibrated from +13 dBm (over-range to +17 dBm) to -127 dBm and may be set and displayed in any one of 14 convenient units including dBm, volts, dB $\mu$ V or Vemf. The output level can also be offset to compensate for cable and/or other losses external to the generator, or turned on or off with a dedicated key. Shielding keeps leakage at  $< 1.0 \mu\text{V}$  for testing RFI susceptible devices, and standard resettable reverse power protection for up to 50 watts guards against accidental damage from transmitters.

### Modulation

The HP 8656B's versatile modulation capabilities include simultaneous and mixed modulation modes (AM/AM, FM/FM and AM/FM) from internal (1 kHz and 400 Hz) and external sources. AM is ac coupled while FM can be either ac or dc coupled. The new, patented dc coupling technique used in the HP 8656B provides exceptional long term stability ( $< 500$  Hz/hour) and center frequency accuracy ( $\pm 10$  Hz) eliminating the need for retuning in the dc FM mode. For calibrated external modulation, a 1 V peak signal is required, and HI/LO annunciators on the HP 8656B indicate when the external signal is within 5% of the correct amplitude.

### Ease of Operation

A microprocessor-based controller provides a broad range of operating features for simple but efficient control. Keyboard data entry uses a function/data/units format, and all function entries are made using a left-to-right keystroke sequence. All information entered is visible via LED displays and annunciators. Modulation, frequency, and level functions can be individually incremented by step sizes that are set by convenient keyboard entries. In addition, resolution control keys allow coarse and fine tuning of frequency in decade steps.

Up to ten front-panel setups can be stored and recalled. A sequence function allows you to cycle through stored setups at the touch of a key or via remote control. The microprocessor also makes troubleshooting aids available at the front panel, enhancing the serviceability of the HP 8656B.

### HP-IB Programmability

Full HP-IB programmability is standard in the HP 8656B. Each programming command has an easy-to-remember, two-character, alpha-numeric HP-IB code that is also labeled next to each key. All functions are quickly and easily programmed using the same function/data/units format as in the manual mode.



## HP 8656B Specifications

### Frequency

**Range:** 100 kHz to 990 MHz (8 digit LED display).

**Frequency underrange:** 10 kHz with uncalibrated output (typical).

**Resolution:** 10 Hz.

**Accuracy and stability:** same as internal time base.

### Time Base Characteristics

Typical Characteristics	Standard Time Base	Option 001 Time Base
Aging Rate	±2 ppm/year	1x10 <sup>-7</sup> /day
Frequency	50 MHz	10 MHz
External Reference Input (rear panel)	Accepts any 1, 5, or 10 MHz (±0.002%) frequency standard at a level >0.15 Vrms into 50 ohms.	

**Frequency switching speed (to be within 100 Hz of final frequency):** <150 ms.

**Phase Offset:** adjustable via HP-IB or from the front panel in nominal 1 degree increments.

### Spectral Purity

**Spurious Signals (≤ +7 dBm output levels)**

**Harmonics:** < -25 dBc.

**Non-harmonic spurious (greater than 5 kHz from carrier in CW mode):** < -60 dBc.

**Sub-harmonics:** none.

### Residual FM

Post Detection	Frequency Range (MHz)			
Noise Bandwidth	0.1 to 123.5	123.5 to 247	237 to 494	494 to 990
0.3 to 3 kHz	<7 Hz rms	<2 Hz rms	<4 Hz rms	<7 Hz rms
0.05 to 15 kHz	<15 Hz rms	<4 Hz rms	<8 Hz rms	<15 Hz rms

**Residual AM (0.05 to 15 kHz post detection noise bandwidth):** <-75 dBc.

### Typical SSB Phase Noise (CW only)

Offset from Carrier	0.1 to 123.5 MHz (dBc/Hz)	123.5 to 247 MHz (dBc/Hz)	247 to 494 MHz (dBc/Hz)	494 to 990 MHz (dBc/Hz)
20 kHz	<-114	<-126	<-120	<-114

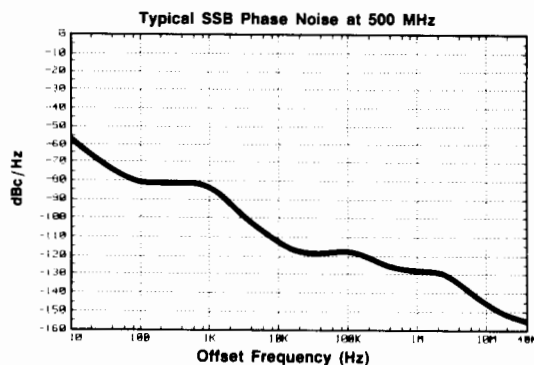

### Output

**Level range (into 50 ohms):** 13 dBm to -127 dBm (3½ digit LED display; uncalibrated output to 17 dBm).

**Resolution:** 0.1 dB.

**Absolute level accuracy:** <±1.0 dB; 123.5 to 990 MHz <±1.5 dB; f<sub>c</sub> < 123.5 MHz, levels > +7 dBm and <-124 dBm.

**Level flatness (100 kHz to 990 MHz):** ±1.0 dB at an output level setting of 0.0 dBm.

**Reverse power protection:** protects signal generator from application of up to 50 watts (typical) of RF power to 990 MHz into generator output; dc voltage cannot exceed 25V.

### Amplitude Modulation (2 digit LED display)

**AM depth<sup>1</sup>:** 0 to 99% to +7 dBm and 0 to 30% to +10 dBm.

**Resolution:** 1%.

**AM rate:** internal 400 Hz and 1 kHz, ±3%; external (1 dB bandwidth), 20 Hz to 40 kHz.

**AM distortion (at internal rates):** <1.5%, 0-30% AM; <3%, 31-70% AM; <4%, 71-90% AM.

**Indicator accuracy (for depths <90% internal rates and levels < +7 dBm)<sup>1</sup>:** ≤±(2% + 4% of reading).

**Incidental phase modulation (at 30% AM depth and internal rates):** <0.3 radian peak.

### Frequency Modulation (2 digit LED display)

#### FM Peak Deviation

Center Frequency (f <sub>c</sub> )	Maximum Peak Deviation (Δf <sub>pk</sub> )		
	Rates ≥50 Hz	Rates <50 Hz	DC Mode
0.1-123.5 MHz	99 kHz	4000 x Rate	99 kHz
123.5-247 MHz	50 kHz	1000 x Rate	50 kHz
247-494 MHz	99 kHz	2000 x Rate	99 kHz
494-990 MHz	99 kHz	4000 x Rate	99 kHz

**Resolution:** 100 Hz for deviations less than 10 kHz; 1 kHz for deviations greater than 10 kHz.

**FM rate:** internal 400 Hz and 1 kHz, ±3%; external (1 dB BW), dc coupled, dc to 50 kHz; ac coupled, 20 Hz to 50 kHz.

**Center frequency accuracy in dc FM mode:** <±500 Hz.

**Center frequency stability in dc FM mode:** <10 Hz/hour.

**FM distortion (internal rates and >1 kHz peak deviations):** <0.5%.

**Indicator accuracy<sup>1</sup>:** ±5% of reading at internal rates.

**Incidental AM (for center frequency ≥500 kHz, peak deviation <20 kHz and internal rates):** <0.1%.

### Remote Programming

**Interface:** HP-IB (Hewlett-Packard's implementation of IEEE - 488).

**Interface functions implemented:** SH0, AH1, T0, L2, SR0, RL1, PP0, DC1, DT0, C0 and E1. (For more on these functions, refer to the HP-IB section of this catalog.)

### General

**Operating temperature range:** 0 to +55° C.

**Leakage:** conducted and radiated interference is within the requirements of methods CE03 and RE02 of MIL STD 461B, FTZ 1115. Furthermore, RF leakage of less than 1.0 μV is induced in a two-turn loop, 2.5 cm in diameter, held 2.5 cm away from the front surface.

**Power requirements:** 100, 120, 220, or 240 V, (5, -10%); 48 to 66 Hz; 125 VA maximum.

**Weight:** net, 18.2 kg (40 lb); shipping, 23.6 kg (52 lb).

**Size:** 133 H x 425 W x 520 D mm (5.25" x 16.75" x 20.5"). 5.25" x 1 MW x 17", System II module. For cabinet accessories, see page 41.1.

**Rack slides and transit case:** HP part numbers are: slide kit, 1494-0018; tilt slide kit, 1494-0025; full module transit case, 9211-2661.

### Ordering Information

**HP 8656B** Signal Generator<sup>2</sup>

**Option 001:** High stability time base

**Option 002:** Rear panel input and output

**Option 907:** Front handle kit

**Option 908:** Rack flange kit

**Option 909:** Rack flange and front handle kit

**Option 910:** Extra operating & service manual

<sup>1</sup>AM depth and FM deviation are further limited by Indicator Accuracy specifications.

<sup>2</sup>HP-IB cables not supplied, see page 10.8 for description and prices.



# SIGNAL GENERATORS

## Synthesized Signal Generators

Models 8642A and 8642B

- 100 kHz to 2.115 GHz
- $< -147$  dBc/Hz SSB phase noise at 20 kHz offset
- $-100$  dBc nonharmonic spurious
- $+20$  dBm maximum output level
- AM, FM,  $\Phi$ M and pulse modulation
- On-site repair and calibration

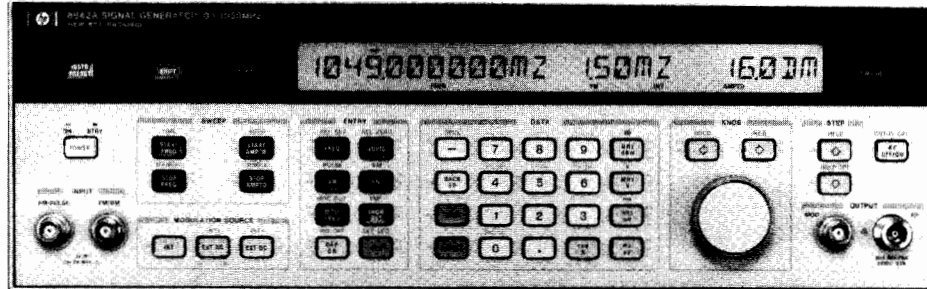

HP 8642A

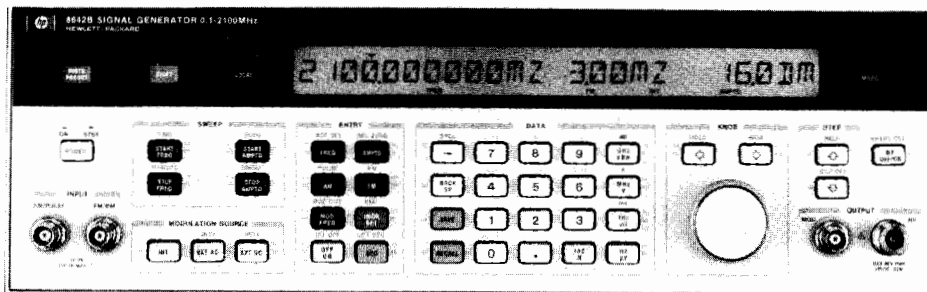

HP 8642B



### HP 8642A/B Synthesized Signal Generators

The HP 8642A and HP 8642B synthesized signal generators are high performance programmable signal generators intended for the most demanding out-of-channel RF receiver measurements and other stringent RF applications. The HP 8642A covers the frequency range from 100 kHz to 1057.5 MHz and the HP 8642B covers the frequency range from 100 kHz to 2115 MHz. The two generators are otherwise very similar.

#### Low SSB Phase Noise

The HP 8642A/B improve the state-of-the-art in SSB phase noise at typical receiver adjacent channel spacings over the cavity tuned HP 8640B signal generator. This improvement is made possible through the use of high-Q Surface Acoustic Wave resonator oscillators operating near 800 MHz. SSB phase noise 20 kHz offset from a 1 GHz carrier is  $-134$  dBc/Hz, approximately 6 dB lower than the HP 8640B. The HP 8642A/B are an ideal choice to characterize selectivity on high performance receivers up to 1 GHz or 2 GHz. Furthermore, their advanced control features simplify measurements on the bench and in ATE systems.

#### $-100$ dBc Spurious

Nonharmonic spurious are held to below  $-100$  dBc on the HP 8642A/B above 1 GHz and to below  $-94$  dBc on the HP 8642B above 1 GHz. These two generators allow receiver spurious rejection tests to be fully automated with the utmost confidence in test results. In the HP 8642A/B design, high performance mixers reduce typical synthesizer spurious, and rigid die castings with resilient RF gasketing provide up to 140 dB of circuit isolation to ensure low spurious content on the output.

#### $\pm 1$ dB Output Level Accuracy

Absolute output level accuracy is  $\pm 1$  dB down to  $-127$  dBm (0.1  $\mu$ V). In R & D or on the production line, the HP 8642A/B will accurately measure receiver sensitivities. Excellent output level repeatability is obtained with a high reliability attenuator specifically

designed for continuous ATE system use. At any output level setting, the attenuator can be fixed and level varied up or down 10 dB in a transient free manner.

#### Up to $+20$ dBm Output Level

Up to  $+20$  dBm is available from the HP 8642A/B to perform a variety of high level measurements, often eliminating the need for external amplifiers.

In ATE system use, this extra power is available to overcome cabling losses. Using the relative amplitude feature, the display can be offset to show correct output level at the end of the cable.

In receiver design, there is sufficient output power to drive high level mixers and perform receiver blocking tests. Intermodulation measurements can be made with high confidence since intermodulation distortion products on the HP 8642A/B are specified.

#### AM, FM, $\Phi$ M and Pulse Modulation

The HP 8642A/B offer AM, FM,  $\Phi$ M and pulse modulation across their full frequency ranges with a unique dual output section to improve modulation characteristics at lower carrier frequencies.

The HP 8642A/B, like their predecessor the HP 8640B, use an RF divider output chain to obtain lower frequency coverage with improved spectral purity. However, the HP 8642A/B can, on demand, switch in a separate heterodyne (HET) output section below 132.2 MHz to obtain improved modulation performance over the divided output.

For testing FM mobile radios, the HP 8642A/B have built-in 750  $\mu$ s preemphasis (FM PRE) to simplify receiver audio flatness tests. Simultaneous modulation capability allows two-tone modulation tests.

A low distortion internal modulation oscillator can be used to modulate the HP 8642A/B up to 100 kHz rates or as a standalone audio source. The output, available at the front panel, is programmable both in frequency and level providing an independent audio oscillator.

## Fit for ATE System Use

To improve instrument availability or "uptime", the HP 8642A/B have been designed to reduce failures and simplify the service procedure in the event of a failure. When used in ATE systems, the HP 8642A/B will improve overall system up-time, thus leading to increased productivity.

### Extended Calibration Interval

The recommended calibration interval for the HP 8642A/B is two years, the result of a quality design, environmental-type testing and stringent production control. This means the HP 8642A/B will be more available for critical measurements, not out for calibration. When calibration is necessary, the HP 8952A Signal Generator Test System can automatically verify most warranted specifications for the HP 8642A/B in less than 20 minutes.

### On-Site Repair and Calibration

The HP 8642A/B can be repaired and recalibrated on site in typically less than two hours. The fourteen internal modules that make up the HP 8642A/B all have rigid I/O specifications allowing a module-exchange repair strategy. Faulty modules can be quickly isolated using internal diagnostic hardware and software. A replacement module can be easily fitted and calibration data transferred to the instrument's main memory with a simple front-panel key sequence. Calibration and adjustments are primarily made electronically with ROM memory ICs and D/A converters.

### A Unique Help Feature

Convenient control features help save time when putting the HP 8642A/B to work in systems. By using the "HELP" feature, special function codes and associated operational descriptions can be displayed by the alphanumeric back-lit liquid crystal display. It is easy to scroll through these descriptions with the knob or the UP/DOWN keys. The "HELP" feature eliminates the need to check manuals or pull-out cards by providing easy access to all special functions.

Through the LCD, messages in English clearly show instrument state and inform users of entry errors to help write programs that run smoothly from the start.

## HP 8642A/B Specifications

### Frequency

**Range:** 100 kHz to 1057.5 MHz, HP 8642A; 100 kHz to 2115 MHz, HP 8642B.

**Bands:** Both generators cover their ranges in one continuous span. However, many other specifications are dependent on carrier frequency. To simplify such specifications, the HP 8642A and 8642B carrier frequency ranges are divided into bands shown in the table below.

Band	Carrier Frequency (MHz)	Band	Carrier Frequency (MHz)
10	1057.500001-2115 (HP 8642B)	4	16.523438- 33.046875
9	528.750001-1057.5	3	8.261719- 16.523437
8	264.375001- 528.75	2	4.130860- 8.261718
7	132.187501- 264.375	1	0.1 - 4.130859
6	66.093751- 132.1875	HET	0.1 -132.1875
5	33.046876- 66.09375		

**Resolution:** 1 Hz, 0.1 Hz with special function.

**Stability:** same as reference oscillator.

### Internal Reference Oscillator

**Typical stability, standard:** aging rate:  $\pm 2$  ppm/year.

**Stability, option 001:**  $< 10^{-9}$ /day aging rate after 8 days warm-up.

### Spectral Purity

**Residual FM; CW, AM or Angle Modulation  $\leq 1/3$  Maximum Peak Deviation:**

Carrier Frequency	Post Detection Bandwidth, kHz	
	0.3 to 3 (Hz rms)	0.05 to 15 (Hz rms)
band 10 (HP 8642B)	<5	<9
band 9	<2	<5
band 8	<1.2	<2
bands 1 thru 7	<1	<1.2
band HET	<3.5	<5

**SSB Phase Noise; CW, AM, or Angle Modulation  $< 1/60$  Maximum Peak Deviation:**

Carrier Frequency Band	SSB Phase Noise 20 kHz Offset dBc/Hz	SSB Phase Noise Floor 200 kHz Offset dBc/Hz
10	-125	-134
9	-134	-144
8	-137	-144
7	-141	-144
6	-144	-145
5	-145	-145
4	-146	-147
3	-147	-148
2	-148	-149
1	-137	-138
HET	-125	-137

**Residual AM:**  $< 0.01\%$  AM rms, 0.3 to 3 kHz post-detection BW.

### Spurious

Type of Spurious	HP 8642A/B Bands 1-9 and HET	HP 8642B Band 10
Harmonics		
Output Level $\leq +10$ dBm	-30 dBc	-25 dBc
Output Level $\leq +16$ dBm	-20 dBc	-20 dBc
Sub-harmonics	none	-45 dBc
Non-harmonics, $> 10$ kHz from the carrier	-100 dBc <sup>1</sup>	-94 dBc

### Output

**Level range:** from maximum available to  $-140$  dBm (0.023  $\mu$ V).

**Maximum Level Available:**

	HP 8642A	HP 8642B
+20 dBm (2.24 V)	bands 1 thru 7	bands 1 thru 8
+19 dBm (2.00 V)	band HET	band 9 & HET
+18 dBm (1.78 V)	band 8	n/a
+16 dBm (1.41 V)	band 9	band 10

**Resolution:** 0.1 dB.

**Absolute accuracy:**  $\pm 1$  dB, output level  $\geq -127$  dBm.

**Flatness:**  $\pm 0.75$  dB,  $+10$  dBm output level.

**Impedance:** 50 ohms nominal.

**SWR:**  $< 1.5:1$  for output levels  $< 0$  dBm;

$< 2.0:1$  for output levels  $\geq 0$  dBm.

**Reverse power protection:** 50W, 50 Vdc, HP 8642A;

25W, 50 Vdc, HP 8642B.

**Third order intermodulation:**  $< -55$  dBc at  $+12$  dBm, two generators 25 kHz apart into a resistive combiner. Typically decreases 10 dB for every 5 dB of combined level decrease.

**Available calibration units:** V, mV,  $\mu$ V, dBm, and EMF. REL ZERO or REF SET can be used to obtain settings such as dB $\mu$ V, dBEMFV, dBf, etc.

### Amplitude Modulation

**AM depth:** 0 to 99.9%, output level  $\leq +10$  dBm.

**AM resolution:** 0.1%.

**AM indicator accuracy at 1 kHz rate and up to 90% AM:**

$\pm (3\%$  of setting  $+1\%$  AM), HP 8642A/B;

$\pm (5\%$  of setting  $+1\%$  AM), HP 8642B band 10.

**AM distortion at 1 kHz rate:**

Depth, %	HP 8642A/B Distortion	HP 8642B Band 10 Distortion
0 to 30	$< 1\%$	$< 2\%$
30 to 70	$< 2\%$	$< 4\%$
70 to 90	$< 4\%$	$< 6\%$

**AM 3 dB bandwidth, depth  $\leq 90\%$ :**

DC to 100 kHz, external dc, bands 1 and 5 thru 10;

DC to 20 kHz, external dc, bands 2, 3, 4;

20 Hz low frequency limit, external ac and internal.

**Incidental phase modulation at 1 kHz rate and 30% AM:**  $< 0.2$  radians peak.

<sup>1</sup>Not specified in HET band.



# SIGNAL GENERATORS

## Synthesized Signal Generators

Models 8642A and 8642B (cont.)

### Frequency Modulation

#### Maximum FM deviation:

Carrier Frequency Band	Maximum Deviation DC Coupled	Maximum Deviation AC Coupled or Internal
10	3 MHz	(the smaller of) 3 MHz or $f_{mod} \times 2160$
9	1.5 MHz	1.5 MHz or $f_{mod} \times 1080$
8	750 kHz	750 kHz or $f_{mod} \times 540$
7	375 kHz	375 kHz or $f_{mod} \times 270$
6	187 kHz	187 kHz or $f_{mod} \times 135$
5	93.8 kHz	93.8 kHz or $f_{mod} \times 67.5$
4	46.9 kHz	46.9 kHz or $f_{mod} \times 33.75$
3	23.4 kHz	23.4 kHz or $f_{mod} \times 16.88$
2	11.7 kHz	11.7 kHz or $f_{mod} \times 8.44$
1	93.8 kHz	93.8 kHz or $f_{mod} \times 67.5$
HET	1.5 MHz	1.5 MHz or $f_{mod} \times 1080$

**FM resolution:** 0.7% of setting or 0.0004% of maximum deviation, whichever is larger.

#### FM indicator accuracy:

$\pm(5\%$  of setting +10 Hz).

Rates dc to 100 kHz, external dc coupling.

Rates 20 Hz to 100 kHz, external ac and internal.

**FM distortion:** 4% for maximum dc coupled deviation, 2% for  $\frac{1}{2}$  maximum dc deviation, 0.4% for  $\frac{1}{10}$  maximum dc coupled deviation, rates 20 Hz to 100 kHz.

**FM 3 dB bandwidth:** dc to 200 kHz, external dc; 20 Hz to 200 kHz, external ac; 20 Hz to 100 kHz, internal.

**Incidental AM:** 0.2%, 20 kHz peak deviation, 1 kHz rate, >400 kHz carrier frequency.

**Carrier frequency offset when entering FM or phase modulation modes:** AC and internal: none; DC: <500 Hz, HP 8642A/B; <1kHz, HP 8642B band 10.

### Phase Modulation

#### Maximum phase deviation:

Carrier Frequency Band	Maximum Deviation (Radians)
10	200
9	100
8	50
7	25
6	12.5
5	6.25
4	3.13
3	1.56
2	0.78
1	6.25
HET	100

**Phase modulation accuracy:**  $\pm(5\%$  of setting +0.09 radians), 1 kHz rate.

**Phase modulation resolution:** 0.7% of setting or 0.0004% of maximum deviation, whichever is greater.

**Phase modulation distortion:** <0.4%, 1 kHz rate.

**Phase modulation 3 dB bandwidth:** 20 Hz to 15 kHz, internal and external ac. DC to 15 kHz, external dc.

#### Pulse Modulation (for output levels $\leq +15$ dBm)

**Pulse on/off ratio:** >30 dB, HP 8642A/B; >45 dB, HP 8642B band 10.

**Rise/fall time:** <3  $\mu$ s, 10% to 90%.

**Maximum repetition frequency:** 50 kHz.

**Minimum pulse width:** 6  $\mu$ s.

**Nominal peak input threshold level:** 1.5 V.

#### Internal Modulation Oscillator

**Rates:** 20 Hz to 100 kHz.

**Frequency resolution:** 1% of setting.

**Frequency accuracy:** 2% of setting.

**Output level range:** 0 to 3V peak into 600 ohms.

**Output level resolution:** 4 mV.

**Distortion:** >0.5V peak: <0.02 kHz to 15.8 kHz; <0.15%, >15.8 kHz.

**Output level accuracy:**  $\pm(4\%$  +15 mV) within 1 second.

**Output impedance:** 600 ohms  $\pm 10\%$ .

### Frequency Sweep

#### Digitally stepped sweep:

**Start-stop sweep:** sweeps between two selected endpoints in a linear step-wise manner. Endpoints can be anywhere within the frequency range of the instrument.

#### Phase continuous sweep:

**Start-stop sweep:** instrument sweeps between two selected endpoints in a linear, phase continuous manner.

**Maximum span:** up to 400 kHz, HP 8642A/B; up to 800 kHz, HP 8642B band 10.

**X axis output:** 0 to 10 Vdc,  $\pm 10\%$ .

**Z axis output:** TTL positive true for crt display blanking during retrace.

### Remote Programming

**Interface:** HP-IB (Hewlett-Packard's implementation of IEEE-488-1978).

**Functions controlled:** all functions controlled from the front panel or over HP-IB from 00 to 30 (5 bit decimal equivalent).

**Interface function:** listener, talker, and controller.

**HP-IB interface functions implemented:** SH1, AH1, T5, TE0, L3, LE0, SRI, RL1, PP1, DC1, DT1, C1, C3, C28, E2.

### General

**Operating temperature range:** 0° to 55° C.

**Storage temperature:** -55° C to +75° C.

**Leakage:** conducted and radiated interference is within the requirements of MIL STD 462B method CE03 and RE02. Interference is also within the standards set by FTZ 1115. Also, RF leakage of <0.5  $\mu$ V is induced in a two turn loop 2.5 cm in diameter, held 2.5 cm away from any surface for output levels  $\leq 0$  dBm.

**Power requirements:** 100V, 120V, 220V, or 240V; +5%, -10%; 48 to 440 Hz; 300 VA max.

**Dimensions:** 133H X 425W X 617D mm (5.25 X 16.75 X 24.3 inches).

**HP System II module size:** 5/8H X 1MW X 23D.

**Weight:** Net 32.7 kg (71.5 lb); shipping 43 kg (95 lb).

### Supplemental Characteristics

#### Spectral Purity

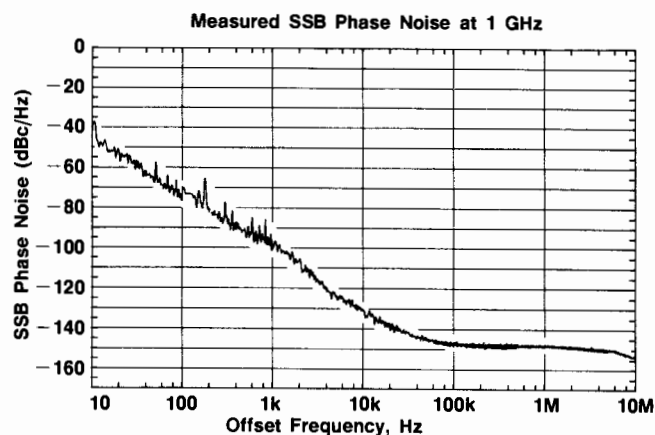

### Ordering Information

**HP 8642A Synthesized Signal Generator**

**HP 8642B Synthesized Signal Generator**

**Option 001:** High stability time base

**Option 002:** Rear panel inputs and outputs

**Option 710:** On-site repair manual

**Option 907:** Front handle kit

**Option 908:** Rack flange kit

**Option 909:** Front handle kit & rack flange kit

**Option 910:** Extra manual

**Option 914:** Delete service manual

# SIGNAL GENERATORS

## Synthesized Signal Generators

Models 8662A, 8663A

445



- 10 kHz to 1280 MHz frequency range
- $< -147$  dBc/Hz SSB phase noise at 10 kHz offset
- 0.1 Hz frequency resolution

- 100 kHz to 2560 MHz frequency range
- AM/FM/PM/pulse in one generator
- Internal variable modulation oscillator

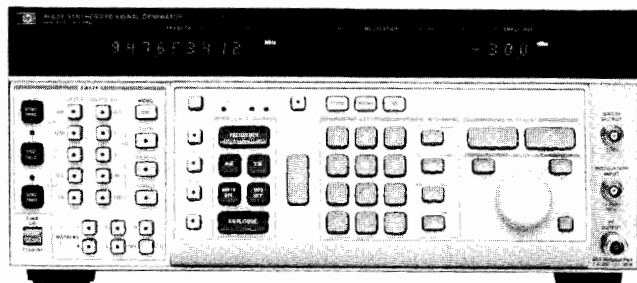

HP 8662A

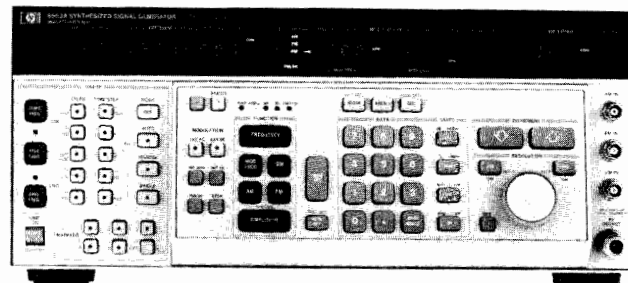

HP 8663A



### HP 8662A Synthesized Signal Generator

The HP 8662A derives exceptional RF performance from an indirect frequency synthesis technique that results in frequency resolution of 0.1 Hz from 10 kHz to 640 MHz and 0.2 Hz from 640 MHz to 1280 MHz.

Output level accuracy is held to  $\pm 1$  dB using microprocessor correction. This makes the HP 8662A an ideal generator for performing precise receiver sensitivity tests either manually or in automated systems.

The HP 8662A offers versatile phase-locked AM/FM using either internal 400 Hz and 1 kHz rates or externally applied modulating signals, which can be either dc or ac coupled. Several different modes of simultaneous modulation (such as AM + FM or FM + FM) are possible.

### Exceptional Spectral Purity

The key contribution of the HP 8662A is spectral purity. Fast-tuning, switched-inductance, voltage-controlled oscillators combined with a low noise reference multiplication chain result in very low SSB phase noise, especially at small offsets from the carrier. The phase noise at 20 kHz to 50 kHz offsets is comparable to that of the best cavity-tuned fundamental oscillators. Such excellent noise performance makes possible complete automation of receiver out-of-channel measurements.

With its excellent long and short-term frequency stability, high output power, fine frequency resolution, and broad frequency range the HP 8662A also meets the requirements of the most critical low noise local oscillator applications. In addition, its fast frequency switching and sweep capabilities also permit its use in many frequency agile and swept local oscillator applications.

An advanced microprocessor-based controller allows convenient keyboard control of all HP 8662A functions. For example, all functions can be incremented and decremented in any user-defined step size within the resolution of the synthesizer using the increment keys and the knob. Up to nine full front panel setups can be stored in the HP 8662A's memory and recalled for later use in any user-defined sequence at the touch of a pushbutton. This permits time-saving semi-automation of generator operation in production setups where the generator must perform many different tests.

### Precision Digital Sweep

Fast frequency switching combined with microprocessor control gives the HP 8662A a powerful sweep capability. Automatic, single, and manual modes are available for both linear and logarithmic sweeps with user-selectable step size and number of steps. Five different sweep speeds can be chosen and up to five amplitude or Z-axis markers can be set. All sweep parameters can be controlled with full synthesizer resolution.

### HP 8663A Synthesized Signal Generator

The HP 8663A provides all the features and the exceptional spectral purity of the HP 8662A with increased frequency range and modulation capability.

### Broad Frequency Range

The HP 8663A utilizes the complete frequency synthesis portion of the HP 8662A with the addition of an internal frequency doubler to achieve a broad frequency range of 100 kHz to 2560 MHz in a single instrument. In the HP 8663A, the exceptional spectral purity of the HP 8662A is maintained up to 1280 MHz. Above this, phase noise is typically increased 6 dB to a level of  $-124$  dBc/Hz at 10 kHz offset from a 2.5 GHz carrier. High output power of +16 dBm (with over-range to 19.9 dBm) is available for efficiently driving frequency translators when low noise microwave signals are needed. Combined with a microwave synthesizer such as the HP 8673A, full frequency coverage from 100 kHz to 26 GHz is possible.

### Flexible Modulation

Complete modulation capability across a wide carrier frequency range is the key contribution of the HP 8663A. AM and FM characteristics are similar to those offered in the HP 8662A. The HP 8663A adds high performance pulse and biphasic modulation with wide bandwidth linear phase modulation available with option 002. For complete flexibility the HP 8663A option 002 has the capability to simultaneously provide AM+FM+pulse+phase modulation across its entire frequency range. AM, FM, and linear phase are either AC or DC coupled while biphasic and pulse are DC coupled. This modulation flexibility assures exact signal simulation when testing complex systems such as those involving pulsed doppler radar and electronic warfare. An internal 100 kHz sinusoidal modulation synthesizer phase locked to the 10 MHz time base is standard. Microprocessor flexibility allows the sweep functions to be applicable to the internal audio synthesizer, as well as the RF synthesizer, making applications involving swept modulation possible with a single instrument.

### Similarity to the HP 8662A

Because the HP 8663A has been designed to be upward compatible with the HP 8662A, the two generators have identical control and performance characteristics for those functions that are common. Either generator can be combined with the HP 11729A Microwave Converter and the HP 3047A Phase Noise Measurement System to perform microwave phase noise measurements simply and quickly.



# SIGNAL GENERATORS

## Synthesized Signal Generators

Models 8662A, 8663A (cont.)

### HP 8662A Specifications

#### Frequency

**Range:** 10 kHz to 1280 MHz (1279.9999998 MHz).

**Resolution:** 0.1 Hz (0.2 Hz above 640 MHz).

**Accuracy and stability:** same as reference oscillator.

**Internal reference oscillator:** 10 MHz quartz oscillator. Aging rate  $< 5 \times 10^{-10}$ /day after 10 day warm-up (typically 24 hrs in normal operating environment).

#### Spectral Purity

##### Residual SSB Phase Noise in 1 Hz BW ( $320 \leq f_c < 640$ MHz)

Offset from Carrier				
10 Hz	100 Hz	1 kHz	10 kHz	100 kHz
-100 dBc	-112 dBc	-121 dBc	-131 dBc	-132 dBc

**SSB broadband noise floor in 1 Hz BW at 3 MHz offset from carrier:**  $< -146$  dBc for  $f_c$  between 120 and 640 MHz at output levels above +10 dBm.

#### Spurious Signals

	Frequency Range (MHz)				
	0.01 to 120	120 to 160	160 to 320	320 to 640	640 to 1280
Spurious non-harmonically related <sup>1,2</sup>	-90 dBc	-100 dBc	-96 dBc	-90 dBc	-84 dBc
Sub-harmonically related ( $\frac{1}{2}, \frac{3f}{2}$ , etc.)	none	none	none	none	-75 dBc
Power line (60Hz) related or microphonically generated (within 300 Hz) <sup>3</sup> .	-90 dBc	-85 dBc	-80 dBc	-75 dBc	-70 dBc
Harmonics	$< -30$ dBc				

#### Output

**Level range:** +13 to -139.9 dBm (1 V to  $0.023 \mu\text{V}_{\text{rms}}$  into 50  $\Omega$ ).

**Resolution:** 0.1 dB.

**Absolute level accuracy (+15° to +45°C):**  $\pm 1$  dB between +13 and -120 dBm,  $\pm 3$  dB between -120 and -130 dBm.

**SWR:** typically from 1.5 to 1.8 depending on output level and frequency.

**Reverse power protection:** typically up to 30W or  $\pm 8$  Vdc.

#### Amplitude Modulation

**Depth:** 0 to 95% at output levels of +8 dBm and below (+10 dBm in uncorrected mode). AM available above these output levels but not specified.

**Resolution:** 1%, 10 to 95% AM; 0.1%, 0 to 9.9% AM.

**Incidental PM (at 30% AM):** 0.15-640 MHz,  $< 0.12$  radian peak; 640-1280 MHz,  $< 0.09$  radian peak.

**Incidental FM (at 30% AM):** 0.15-640 MHz,  $< 0.12 \times f_{\text{mod}}$ ; 640-1280 MHz,  $< 0.09 \times f_{\text{mod}}$ .

**Indicated accuracy:**  $\pm 5\%$  of reading  $\pm 1\%$  AM. Applies for rates given in table below, internal or external mode, for depths  $\leq 90\%$ .

#### Rates and Distortion with Internal or External Modulating Signal

Frequency range	AM Distortion			
	AM rate	0-30% AM	30-70% AM	70-90% AM
0.15-1 MHz	dc-1.5 kHz	2%	4%	5.75%
1-10 MHz	dc-5 kHz	2%	4%	5.75%
10-1280 MHz	dc-10 kHz	2%	4%	5.75%

#### Frequency Modulation

**FM rates (1 dB bandwidth):** external ac, 20 Hz to 100 kHz; external dc, dc to 100 kHz.

**FM deviation:** from 25 to 200 kHz depending on carrier frequency.  
**Indicated FM accuracy:**  $\pm 8\%$  of reading plus 10 Hz (50 Hz to 20 kHz).

**FM resolution:** 100 Hz for deviations  $< 10$  kHz, 1 kHz for deviations  $\geq 10$  kHz.

**Incidental AM (AM sidebands at 1 kHz rate and 20 kHz deviation):**  $< -72$  dBc,  $f_c < 640$  MHz;  $< -65$  dBc,  $f_c \geq 640$  MHz.

**FM distortion:**  $< 1.7\%$  for rates  $< 20$  kHz,  $< 1\%$  for rates  $< 1$  kHz.

**Center frequency accuracy and long term stability in AC mode:** same as CW mode.

#### Supplemental Characteristics

##### Typical SSB Phase Noise

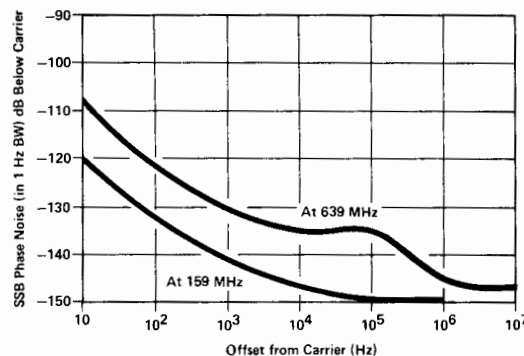

**Frequency switching speed:**<sup>4</sup> From 420  $\mu\text{sec}$  to 12.5 msec, depending on the programming mode.

### HP 8663A Specifications

The HP 8663A signal generator is related to the HP 8662A in both concept and structure. The HP 8662A concept of an extremely low phase noise signal source incorporating signal generator modulation capabilities and output characteristics is carried even further by the HP 8663A. While maintaining high spectral purity, the HP 8663A offers increased frequency range to 2560 MHz, increased output level to +16 dBm, and the addition of phase and pulse modulation. The result is a highly flexible and powerful signal generator that utilizes and extends the proven circuitry of the HP 8662A. Thus, the HP 8662A and HP 8663A share many of the same specifications as shown below:

#### Frequency

**Range:** 100 kHz to 2560 MHz (2559.9999996 MHz)

**Resolution:** 0.1 Hz ( $f_c < 640$  MHz)

0.2 Hz ( $640 \text{ MHz} \leq f_c < 1280$  MHz)

0.4 Hz ( $f_c \geq 1280$  MHz)

**Accuracy, stability, and internal reference oscillator:** identical to HP 8662A.

#### Spectral Purity

**Residual SSB phase noise in 1 Hz BW ( $320 \leq f_c < 640$  MHz):** identical to HP 8662A.

**Typical SSB phase noise:** identical to the HP 8662A for  $f_c$  between 100 kHz and 1280 MHz (see graph). For  $f_c$  between 1280 and 2560 MHz, the noise will be approximately 12 dB higher than the 639 MHz curve on the "typical SSB phase noise" graph.

**Spurious signals:** identical to HP 8662A except for  $f_c$  between 1280 and 2560 MHz the spurious non-harmonics are -78 dBc, the sub-harmonically related ( $f/2, 3f/2$ , etc.) are -40 dBc, and the power line (60 Hz) or microphonically generated spurious are -65 dBc.

**Harmonics:**  $< -30$  dBc,  $\leq +13$  dBm output,  $< -25$  dBc, +13 dBm to +16 dBm output,  $f_c < 1280$  MHz;  $< -25$  dBc,  $f_c \geq 1280$  MHz

#### Output

**Level range:** +16 dBm to -129.9 dBm

**Resolution:** 0.1 dB

**Absolute level accuracy (+15° to +45°C):**  $\pm 1$  dB, +16 dBm to -119.9 dBm;  $\pm 3$  dB for -120 dBm and below.

**SWR:**  $< 1.5$





### Amplitude Modulation

**Depth:** 0 to 95% at levels of +10 dBm and below

**Resolution:** 0.1%

**Incidental FM (at 30% AM):** identical to HP 8662A except:  $<0.3 \times f_{\text{mod}}$  for  $1280 \leq f_c < 2560$  MHz

**Indicated accuracy:**  $\pm 6\%$  of reading  $\pm 1\%$  AM (400 Hz and 1 kHz, depth 90%)

#### AM Bandwidth (1dB)

DC to  $>1.5$  kHz,  $0.15$  MHz  $\leq f_c < 1$  MHz;

DC to  $>5$  kHz,  $1$  MHz  $\leq f_c \leq 10$  MHz;

DC to  $>10$  kHz,  $f_c > 10$  MHz;

External dc coupling.

External ac coupling or internal; low frequency coupling is 20 Hz.

**Distortion (400 Hz and 1 kHz):**  $<2\%$  (0–30% AM)  
 $<4\%$  (30–70% AM)  
 $<6\%$  (70–90% AM)

### Frequency Modulation

**FM rates (1 dB bandwidth):** external ac, 20 Hz to 100 kHz, external dc, dc to 100 kHz.

**Maximum allowable peak deviation:** identical to HP 8662A for fc between 100 kHz and 1280 MHz. Up to 400 kHz for fc between 1280 and 2560 MHz.

**Indicated FM accuracy (50 Hz to 20 kHz):**  $\pm 9\%$  of setting +10 Hz.

**FM resolution:** 100 Hz to 1 kHz depending on fc and deviation setting.

**Incidental AM (AM sidebands at 1 kHz rate and 20 kHz deviation)**

$< -72$  dBc ( $10 \leq f_c < 640$  MHz)

$< -65$  dBc ( $640 \leq f_c < 2560$  MHz)

**FM distortion:**  $<1.25\%$  (400 Hz and 1 kHz rates)  
 $<1.75\%$  (rates less than 20 kHz)

### Phase Modulation (option 002)

**Maximum peak phase deviation:** from  $\pm 25^\circ$  for fc between 120 and 160 MHz up to  $\pm 400^\circ$  for fc between 1280 and 2560 MHz.

**Maximum rate:** from 10 kHz for fc between 0.15 and 10 MHz up to 10 MHz for fc between 250 and 2560 MHz.

**Phase deviation resolution:**  $1^\circ$  ( $0.1 \leq f_c < 640$  MHz)  
 $2^\circ$  ( $640 \leq f_c < 1280$  MHz)  
 $4^\circ$  ( $1280 \leq f_c < 2560$  MHz)

**Phase modulation distortion:** 10% at maximum rate

### Biphase Modulation

Biphase modulation is available on the standard HP 8663A for fc less than 640 MHz and available for all fc with option 002.

**Deviation:**  $\pm 90^\circ$

**Carrier null when modulated with 1 MHz, 50% duty cycle square wave:**  $> 25$  dBc.

**Modulation input required:** TTL positive true. The internal modulation oscillator can be used for 50% duty cycle modulation. External input is on rear panel.

### Pulse Modulation<sup>5</sup>

**Pulse on/off ratio:**  $>80$  dB (50–2560 MHz)

**Pulse rise/fall time:**  $<250$  ns (50–120 MHz);  $<780$  ns (120–640 MHz);  $<100$  ns ( $f_c \geq 640$  MHz)

**Pulse Repetition Frequency (50% duty cycle):**

Internal: 10 Hz to 99.9 kHz

External: 10 Hz to 2 MHz,  $50$  MHz  $< f_c < 640$  MHz

10 Hz to 5 MHz,  $f_c > 640$  MHz

#### Internal Modulation Oscillator

**Rates:** 10 Hz to 99.9 kHz

**Frequency resolution:** 3 digits

**Frequency accuracy:** same as reference oscillator.

**Output level (available on rear panel):** 1 volt peak into 600  $\Omega$

**Output impedance:** 600  $\Omega$

**Flatness (referenced to 1 kHz):**  $<\pm 1\%$

**Distortion:**  $<1\%$

### Other HP 8662A and HP 8663A Information

**Remote programming:** the HP-IB interface is standard on the HP 8662A and HP 8663A signal generators. All functions controlled from the front panel with the exception of the line switch are programmable with the same accuracy and resolution as in manual mode.

**Operating temperature range:**  $0^\circ$  to  $+55^\circ\text{C}$ .

**Leakage:** meets radiated and conducted limits of MIL STD 461A methods RE02 and CE03 as well as VDE 0871.

**Power requirements:** 115 (90–126) V or 230 (198–252) V; 48 to 66 Hz; 450 VA max.

**Weight:** HP 8662A: net 30 kg (65.5 lb.). Shipping 36 kg (80 lb.).

HP 8663A: net 33.8 (74 lb.). Shipping 40 kg (88 lb.).

**Size:** HP 8662A: 178 mm H x 425 mm W x 572 mm D (7" x 16.75" x 22.5")

HP 8663A: 178 mm H x 425 mm W x 642 mm D (7" x 16.75" x 25.3")

Note: depth includes front panel depth of 45 mm (1.75").

### Ordering Information

**HP 8662A** 1280 MHz Signal Generator<sup>6</sup>

**Option 001:** Rear panel RF output and mod input

**Option 003:** Specified SSB phase noise for 640 MHz output

**Option 907:** Front Handle kit

**Option 908:** Rack flange kit

**Option 909:** Rack flange & front handle kit

**Option 910:** Extra operating & service manual

**HP 11721A** External frequency doubler for operation to 2.56 GHz (HP 8662A only)

**HP 8663A** 2560 MHz Signal Generator<sup>6</sup>

**Option 001:** Rear panel RF output and mod inputs

**Option 002:** Wideband linear phase modulation

**Option 003:** Specified SSB phase noise for 640 MHz output.

**Option 907:** Front handle kit

**Option 908:** Rack flange kit

**Option 909:** Rack flange & front handle kit

**Option 910:** Extra operating & service manual

**HP 11714A** Service Support Kit (required for servicing HP 8662A/8663A)

<sup>1</sup>In the remote mode it is possible to have microprocessor clock related spurious signals spaced 3 MHz apart at an absolute level of typically less than  $-145$  dBm.

<sup>2</sup>Spurious signals can be up to 3 dB higher in the dc FM mode.

<sup>3</sup>At a 50 Hz line frequency, power line or microphonically related spurious signals may be up to 3 dB higher and appear at offsets as high as 1 kHz from the carrier.

<sup>4</sup>Due to automatic leveling loop bandwidth changes, brief (30 msec) level inaccuracies may occur when switching through 150 kHz and 1 MHz RF output frequencies.

<sup>5</sup>Pulse modulation is available for  $f_c < 50$  MHz but is unspecified.

<sup>6</sup>HP-IB cables not supplied, see page 675 for description and prices.



# SIGNAL GENERATORS

## Synthesized Signal Generators

Models 8660A and 8660C

- 10 kHz to 2600 MHz
- Synthesizer stability and accuracy
- 1 Hz resolution (2 Hz above 1300 MHz)

- Ten digit display
- Calibrated output over > 140 dB range
- AM, FM,  $\Psi$ M, or pulse modulation

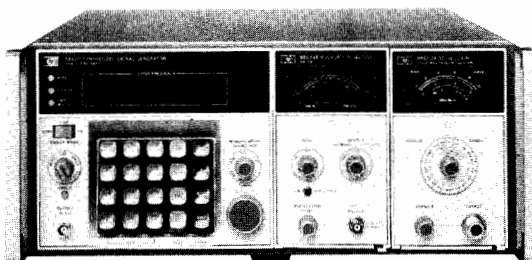

HP 8660C

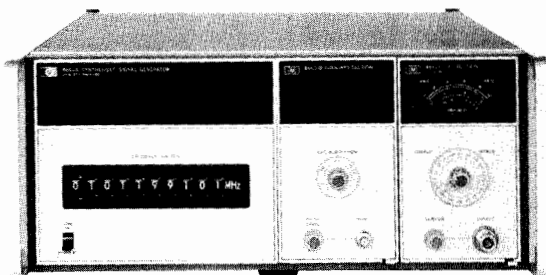

HP 8660A

## HP 8660A, 8660C Synthesized Signal Generators

### System Concept

The HP 8660 is a modular solid-state plug-in system. Each system includes: 1) a programmable synthesized signal generator mainframe, 2) an RF section plug-in, and 3) a modulation section. Synthesized accuracy and stability along with complete programmability make the HP 8660 ideal for most automated receiver and component testing situations.

### Mainframes

There are two mainframes, the HP 8660A and HP 8660C which both offer a BCD or optional HP-IB interface and operation from an internal or external frequency reference. The HP 8660A mainframe uses thumbwheel switches to select CW output frequencies. The HP 8660C mainframe provides direct keyboard entry of CW frequencies. Added capabilities of the HP 8660C include digital sweep, frequency stepping, control of frequency with a tuning knob, and a ten-digit numerical display.

### Plug-In RF Sections

The HP 86601A (0.01 – 110 MHz), HP 86602B (1 – 1300 MHz), and HP 86603A (1 – 2600 MHz) are the three RF section choices. The HP 11661B Frequency Extension Module (mainframe option 100) must be used with the HP 86602B and HP 86603A and is installed internal to an HP 8660 mainframe. When using the HP 8660A mainframe, the HP 86603A plug-in must be ordered with option 003.

### Plug-In Modulation

There are five modulation sections to choose from. The HP 86631B Auxiliary Section provides external AM and pulse modulation. The HP 86632B offers AM and FM and utilizes a free-running VCO to provide high FM deviations and rates while the HP 86633B provides AM and phase locked FM. The HP 86634A offers high performance phase modulation with rates to 10 MHz while the HP 86635A provides both FM and phase modulation. (The HP 86634A and HP 86635A must be used with option 002 RF Section.)

## HP 8660A, 8660C Mainframe Specifications

**Frequency accuracy and stability:** CW frequency accuracy and long term stability are determined by internal reference oscillator ( $3 \times 10^{-8}$ /day), or by external reference.

### Reference Oscillator

**Internal:** 10 MHz quartz oscillator. Aging rate less than  $\pm 3$  parts in  $10^8$  per 24 hours after 72 hours warm-up ( $\pm 3$  parts in  $10^9$  per 24 hours, Option 001).

**External:** rear panel switch allows operation from 5 MHz or 10 MHz frequency standard at a level between 0.5 and 2.5 Vrms into 170 ohms.

**Reference output:** rear panel BNC connector provides output of reference signal selected at level of at least 0.5 Vrms into 170 ohms.

**Digital sweep (HP 8660C):** auto, single, or manual. Selectable speeds 0.1, 1, or 50 seconds.

### Remote Programming

#### Functions

**HP 8660A:** all front panel frequency and output level (and most modulation functions) are programmable.

**HP 8660C:** CW frequency, frequency stepping (STEP $\uparrow$ , STEP $\downarrow$ ), output level, and most modulation functions are programmable. Note: digital sweep is NOT programmable.

#### Programming Input

**Connector type:** 36-pin Cinch type 57 (mating connector supplied). 24-pin Cinch type 57 for optional HP-IB interface (mating connector NOT supplied).

**Logic:** TTL compatible (negative true).

**Switching time:** less than 5 ms to be within 100 Hz of any new frequency selected. (Less than 100 ms to be within 10 Hz.)

### General

**Operating temperature range:** 0 to +55°C.

**Power:** 100, 120, 220, or 240 volts +5%, -10%, 48-66 Hz; approximately 350 watts.

**Weight (mainframe only):** net 23.2 kg (51 lb). Shipping, 28.6 kg (63 lb).

### Supplemental Characteristics

#### Typical Single Sideband Phase Noise

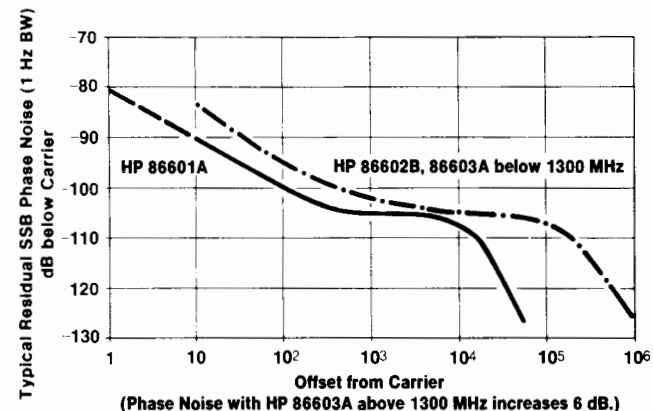

# SIGNAL GENERATORS

## Synthesized Signal Generators

### Models 8660A & 8660C (cont.)

10 kHz to 110 MHz

1 MHz to 1300 MHz

1 MHz to 2600 MHz

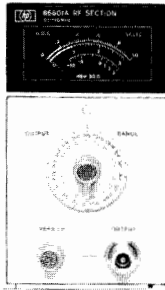

HP 86601A

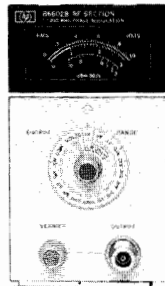

HP 86602B (HP 11661B required)

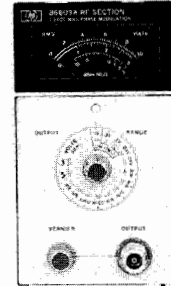

HP 86603A (HP 11661B required)

### RF Section Specifications (installed in HP 8660A or HP 8660C mainframe)

		HP 86601A	HP 86602B (requires HP 11661B)	HP 86603A (requires HP 11661B)	
FREQUENCY CHARACTERISTICS	Frequency Range	0.01–110 MHz (109.999999 MHz)	1–1300 MHz (1299.999999 MHz)	1–2600 MHz (2599.999998 MHz)	
	Frequency Resolution	1 Hz	1 Hz	2 Hz	
	Harmonics	<–40 dBc	<–30 dBc (<–25 dBc above +3 dBm)		
	Spurious Non Harmonically Related	<–80 dBc	<–80 dBc below 700 MHz <–80 dBc above 700 MHz within 45 MHz of carrier <–70 dBc above 700 MHz >45 MHz from carrier <–50 dBc on +10 dBm range		
	Power Line Related (CW, AM, φM only) <sup>2</sup>	<–70 dBc	<–70 dBc		
	Signal To Phase Noise Ratio (CW, AM, φM only) <sup>2</sup>	>50 dB	>45 dB		
OUTPUT CHARACTERISTICS	Output Level (into 50 Ω)	+13 dBm to –146 dBm	+10 to –146 dBm	+10 to –136 dBm	
	Output Accuracy (local and remote)	±1 dB, +13 to –66 dBm ±2 dB, –66 to –146 dBm	±1.5 to –76 dBm ±2.0 to –146 dBm	±2.5 dB to –76 dBm <sup>3</sup> ±3.5 dB to –136 dBm	
	Flatness (output level variation with frequency)	<±0.75 dB	<±1.0 dB	<±2.0 dB (1–2600 MHz)	
	Impedance	50 Ω			
MODULATION CHARACTERISTICS	AM	AM Modulation Depth	0 to 95%	0 to 90% <sup>4</sup>	
		3 dB Bandwidth:	0–30%	200 Hz, CF < 0.4 MHz 10 kHz, 0.4 < CF < 4 MHz 100 kHz, CF > 4 MHz	10 kHz, CF < 10 MHz 100 kHz, CF > 10 MHz
		0–70%	125 Hz, CF < 0.4 MHz 6 kHz, 0.4 < CF < 4 MHz 60 kHz, CF > 4 MHz	6 kHz, CF < 10 MHz 60 kHz, CF > 10 MHz	
		0–90%	100 Hz, CF < 0.4 MHz 5 kHz, 0.4 < CF < 4 MHz 50 kHz, CF > 4 MHz	5 kHz, CF < 10 MHz 50 kHz, CF > 10 MHz	
	Distortion, <sup>5</sup> THD at 30% AM at 70% AM at 90% AM	<1%, 0.4–110 MHz <3%, 0.4–110 MHz <5%, 0.4–110 MHz	<1% <3% <5%	<5% N/A N/A	
	FM	FM Rate	dc to 1 MHz with HP 86632B 20 Hz to 100 kHz with HP 86633B	dc to 200 kHz with HP 86632B and HP 86635A 20 Hz to 100 kHz with HP 86633B	
		Maximum Deviation (peak)	1 MHz with HP 86632B 100 kHz with HP 86633B	200 kHz with HP 86632B and HP 86635A 100 kHz with HP 86633B	400 kHz w/HP 86632B, 86635A 200 kHz w/HP 86633B
		Distortion, THD (at rates up to 20 kHz)	<1% up to 200 kHz dev. <3% up to 1 MHz dev.	<1% up to 200 kHz dev.	
	PULSE	Pulse Rise/Fall Time	200 ns	50 ns	
		ON/OFF Ratio (with pulse level control at max.)	>50 dB	>40 dB	
φM <sup>6</sup>	φM Rate	N/A	dc to 1 MHz with HP 86635A dc to 1 MHz for CF < 100 MHz dc to 10 MHz for CF ≥ 100 MHz with HP 86634A		
	Maximum Peak Deviation	N/A	0 to 100 degrees		
	Distortion, THD	N/A	<5% up to 1 MHz rates <7% up to 5 MHz rates <15% up to 10 MHz rates		
GENERAL	Weight	Net 5 kg (11 lb) Shipping 6.8 kg (15 lb)	Net 4.1 kg (9 lb) Shipping 5.5 kg (12 lb)	Net 5 kg (11 lb) Shipping 6.4 kg (14 lb)	
		HP 11661B: Net 2.3 kg (5 lb); shipping 2.7 kg (6 lb)			

<sup>1</sup>For output levels +3 dBm and below; slightly higher +3 to +7 dBm.

<sup>2</sup>Measured in a 30 kHz band centered on the carrier excluding a 1 Hz band centered on the carrier.

<sup>3</sup>For +3 to +7 dBm output levels, output accuracy and flatness will be slightly degraded (above 1300 MHz only)

<sup>4</sup>For RF output level meter readings from +3 dB to –6 dB and only at +3 dBm and below.

<sup>5</sup>Applies only at 400 Hz and 1 kHz rates with output meter set between 0 and +3 dB. At –6 dB meter setting the distortion approximately doubles.

<sup>6</sup>Phase modulation is only possible with Option 002 RF Sections.

# SIGNAL GENERATORS

## Synthesized Signal Generators

Models 8660A & 8660C (cont.)

Pulse/AM

AM/High Deviation FM

AM/ $\phi$  Locked FM

High rate  $\phi$ M

$\phi$ M/FM

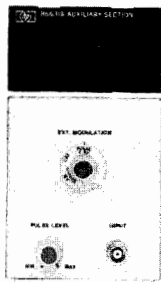

HP 86631B

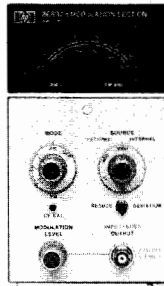

HP 86632B

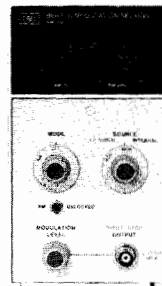

HP 86633B

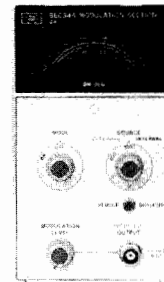

HP 86634A

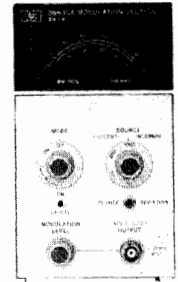

HP 86635A

### Modulation Section Specifications

		HP 86631B	HP 86632B	HP 86633B	HP 86634A	HP 86635A
	Functions	Ext. Only	Int. and Ext.	Int. and Ext.	—	—
AM	Indicated Accuracy (at 400 and 1000 Hz rates)	—	±5% of full scale With HP 86601A RF Section: ± 7%, center frequency ≥ 100 MHz. With HP 86603A RF Section: ± 10%, center frequency ≥ 1300 MHz.		—	—
FM	Functions	—	Int. and Ext., FM CF CAL	Int. and Ext.	—	Int. and Ext., FM CF CAL
	Center Frequency Long Term Stability	—	Typically less than 200 Hz/h	Same as in CW Mode ( $3 \times 10^{-8}$ /day)	—	Typically less than 200 Hz/h
	Indicated Accuracy (up to 20 kHz rates)	—	±5% of full scale		—	±5% of full scale
Pulse	Functions	Ext. Only	—	—	—	—
$\phi$ M	Functions	—	—	—	Int. and Ext.	Int. and Ext.
	Indicated Accuracy (15°C to 35°C)	—	—	—	±5% of full scale up to 100 kHz rates ±8% of full scale up to 2 MHz rates ±15% of full scale up to 10 MHz rates	
Meter		—	0–100% AM 0–10, 100, 1000 kHz FM Pk. Dev. (0–20, 200, 2000 kHz FM for CF ≥ 1300 MHz)	0–100% AM 0–10, 100 kHz FM Pk. dev. (0–20, 200 kHz FM for CF ≥ 1300 MHz)	0–100° Peak $\phi$ M (0–200° for CF ≥ 1300 MHz)	0–10, 100, 1000 kHz FM, 0–100° Pk $\phi$ M (0–20, 200, 2000 kHz FM, 0–200° Pk $\phi$ M for CF ≥ 1300 MHz)
Internal Modulation Source Output		None	400 Hz and 1 kHz ±5% 200 mV minimum into 10 k $\Omega$ . Available at front panel BNC connector			
Input Impedance		50 $\Omega$ Pulse 600 $\Omega$ AM	600 $\Omega$	600 $\Omega$	50 $\Omega$	600 $\Omega$
Weight		Net, 1.4 kg (3 lb) Shipping, 2.3 kg (5 lb)	Net, 2.7 kg (6 lb) Shipping, 4.1 kg (9 lb)	Net, 2.7 kg (6 lb) Shipping, 4.1 kg (9 lb)	Net, 1.8 kg (4 lb) Shipping, 3.2 kg (7 lb)	Net, 2.7 kg (6 lb) Shipping, 4.1 kg (9 lb)

### Ordering Information

HP 8660A Synthesized Signal Generator Mainframe

HP 8660C Synthesized Signal generator Mainframe

#### Options for HP 8660A, 8660C

**Option 001:**  $\pm 3 \times 10^{-9}$ /day internal reference oscillator

**Option 002:** no internal reference oscillator

**Option 003:** operation from 50 to 400 Hz line

**Option 004:** 100 Hz frequency resolution (200 Hz above 1300 MHz)

**Option 005:** HP-1B programming interface

**Note:** HP-1B cables not supplied, see page 00.00.

**Option 009:** (HP 8660A only) LED display indicates selected frequency in 1-2-4-8 BCD code

**Option 100:** HP 11661B factory installed inside main frame

**Option 908:** Rack Flange Kit

HP 86601A 0.01–110MHz RF Section

HP 86602B 1–1300 MHz RF Section

HP 86603A 1–2600 MHz RF Section

**Note:** HP 86602B and 86603A RF sections require an HP 11661B for operation.

**Option 001:** no RF output attenuator (all RF Sections)

**Option 002:** adds phase modulation capability (HP 86602B, 86603A only)

**Option 003:** allows operation of HP 86603A with HP 8660A mainframe

HP 11661B Frequency Extension Module

HP 86631B Auxiliary Section

HP 86632B AM/FM Modulation Section

HP 86633B AM/FM Modulation Section

HP 86634A  $\phi$ M Modulation Section

HP 86635A  $\phi$ M/FM Modulation Section

HP 11672A Service Accessory Kit

HP 11707A Test Plug-in

# SIGNAL GENERATORS

## Mechanically Tuned VHF Generator

Model 8640B



- 0.5 to 512 MHz frequency range with optional coverage to 1024 MHz
- +19 to -145 dBm output power range
- Low SSB phase noise
- Calibrated, metered AM, FM, and pulse modulation
- Internal phase lock/synchronizer, digital frequency readout, external count capability to 550 MHz

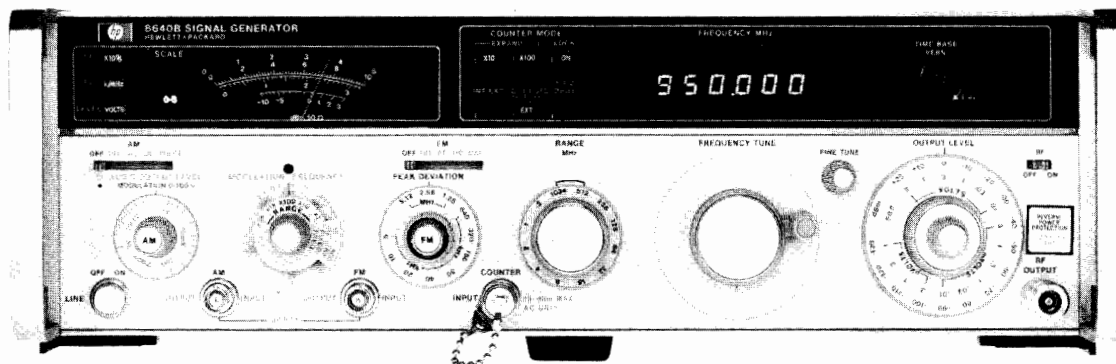

HP 8640B (with Option 001, 002, 003)

### HP 8640B Signal Generator

The HP 8640B Signal Generator covers the frequency range 500 kHz to 512 MHz (450 kHz to 550 MHz with band overrange) and can be extended to 1024 MHz with an internal doubler (Opt 002). Using the HP 11710B Down Converter, the HP 8640B frequency range can be extended down to 10 kHz. An optional audio oscillator (Opt 001) is also available with a frequency range of 20 Hz to 600 kHz. This broad coverage, together with calibrated output and modulation, provides for complete RF and IF performance tests on virtually any type of HF, VHF, or UHF receiver.

A solid state generator, the HP 8640B has an output level range of +19 to -145 dBm (2V to 0.013  $\mu$ V) which is calibrated, metered, and leveled to within  $\pm 0.5$  dB across the full frequency range of the instrument.

The HP 8640B generator provides AM, FM, and pulse modulation for a wide range of receiver test applications. This modulation is calibrated and metered for direct readout under all operating conditions.

A reverse power protection option (Opt 003) is available to eliminate instrument damage due to accidental transmitter keying. This module protects against up to 50 watts of applied power and automatically resets upon removal of the reverse power.

### Spectrally Pure Output Signals

Noise performance of the HP 8640B is extremely low beyond 10 kHz offsets. The high-Q cavity oscillator has been optimized with use of a low-noise microwave transistor for spectrally pure output signals. At a 20 kHz offset from the carrier, SSB phase noise is  $< -130$  dBc for carrier frequencies from 230 to 450 MHz, and rises to  $-122$  dBc at 550 MHz. The SSB phase noise level decreases by approximately 6 dB for each division of the output frequency down to the

broadband noise floor of better than 140 dB/Hz. This exceptional noise performance is also preserved during FM modulation and in the phase-locked mode.

### Built-in Counter

The internal 6-digit counter displays the output frequency and can also be used to count external input signals from 20 Hz to 550 MHz. This eliminates the need for a separate frequency counter in many measurement systems.

### Internal Pushbutton Synchronizer

At the push of a button, the HP 8640B built-in phase lock synchronizer locks the RF output frequency to the crystal time base used in the counter. In this locked mode, the output stability is better than  $5 \times 10^{-8}$ /h and the spectral purity and FM capability of the unlocked mode are preserved. For higher stability, it is possible to lock to an externally applied 5 MHz standard. Two HP 8640Bs can also be locked together for various 2-tone measurements.

In the phase locked mode, increased resolution is available by using the  $\frac{1}{2}$  digit increment button. For example, 500 Hz resolution is possible for frequencies between 100 and 1000 MHz.

### FM While Phase Locked

In the phase locked mode, full FM capability is preserved down to modulation rates of 50 Hz. The narrow bandwidth of the phase lock loop ( $< 5$  Hz) provides for FM modulation up to 250 kHz rates and insures no degradation in noise from the unlocked mode. This crystal stability, coupled with the precision modulation and low noise, makes the HP 8640B ideal for testing narrowband FM or crystal-controlled receivers.

# SIGNAL GENERATORS

Precision, High Stability, AM-FM VHF Signal Generator



Model 8640B (cont.)

## HP 8640B Specifications

(See technical data sheet for complete specifications.) All specifications apply over the nominal frequency ranges and over the top 10 dB of the output level vernier range unless otherwise specified.

### Frequency

**Range:** 500 kHz to 512 MHz in 10 octave ranges (to 1024 MHz with option 002 internal frequency doubler).

**Ranges and range overlap:** ranges extend approximately 10% below and 7% above the nominal frequency ranges shown below.

Frequency ranges (MHz)		
0.5-1	8-16	128-256
1-2	16-32	256-512
2-4	32-64	512-1024
4-8	64-128	(opt 002)

### Fine Tuning

**Unlocked:** >1000 ppm total range.

**Locked mode:** >±20 ppm by varying internal time base vernier.

### Internal Counter Resolution (unlocked)

Frequency Ranges (MHz)	Normal Mode	Expand X10	Expand X100
0.5-1	10 Hz	1 Hz	0.1 Hz
1-16	100 Hz	10 Hz	1 Hz
16-128	1 kHz	100 Hz	10 Hz
128-1024	10 kHz	1 kHz	100 Hz

### Optimum Counter Resolution When Phase-Locked

Frequency Ranges (MHz)	With 6 Digits	+1/2 Digit
0.5-0.9999995	1 Hz	0.5 Hz
1.0-9.999995	10 Hz	5 Hz
10.0-99.99995	100 Hz	50 Hz
100.0-999.9995	1 kHz	500 Hz
1000-1024	10 kHz	5 kHz

**Accuracy:** 6½ digit LED display with X10 and X100 expand; accuracy depends on internal or external reference used.

### Stability (after 2 hour warmup)

**Normal:** <10 ppm/10 min.

**Locked:** <0.05 ppm/h.

### Restabilization Time After Frequency Change

**Normal:** <15 min.

**Locked:** <1 min. after relocking to be within 0.1 ppm of steady state frequency.

### Output

**Range:** 10 dB steps and 18 dB vernier provide the following output power settings into 50Ω.

Frequency Range (MHz)	HP 8640B	With Option(s)		
		002	003	002/003
0.5 to 512	+19 to -145 dBm	+18.5 to -145 dBm	+18.5 to -145 dBm	+18 to -145 dBm
512 to 1024 (Option 002)		+13 to -145 dBm		+12 to -145 dBm

**Level Flatness (referred to output at 50 MHz and applies to 1 V range and for top 10 dB of vernier range)**

Frequency Range (MHz)	HP 8640B	With Option(s)		
		002	003	002/003
0.5 to 64	±0.5 dB	±0.75 dB	+0.75 dB -1.25 dB	+1.0 dB -2.0 dB
64 to 512		±1.0 dB		
512 to 1024 (Option 002)		±1.5 dB		±2.0 dB

**Level accuracy:** (worst case as indicated on level meter) ±1.5 dB to ±4.5 dB depending on level, frequency, and options installed.

### Spectral Purity

**Harmonics (at 1 volt, +10 dBm output range and below)**

>30 dB below fundamental, 0.5 to 512 MHz.

>12 dB below fundamental, 512 to 1024 MHz (option 002).

**Spurious Output Signals (excluding frequencies within 15 kHz of the signal whose effects are specified in residual AM and FM)**

Frequency Range (MHz)	Subharmonically Related	Non-harmonically Related
0.5 to 512	<-100 dBc	<-100 dBc
512 to 1024 (Option 002)	<-20 dBc	

<sup>1</sup>dBc = dB below the carrier.

**Residual AM (averaged rms):** 0.3 to 3 kHz post-detection noise bandwidth <-85 dBc.

**Residual FM (averaged rms):** 0.3 to 3 kHz post-detection noise bandwidth. (CW and up to 1/8 maximum allowable peak deviation.)

0.5 to 512 MHz: <5 Hz.

512 to 1024 MHz: <10 Hz.

**Measured SSB noise (typical):** in graph below, triangular markers indicate specified limits.

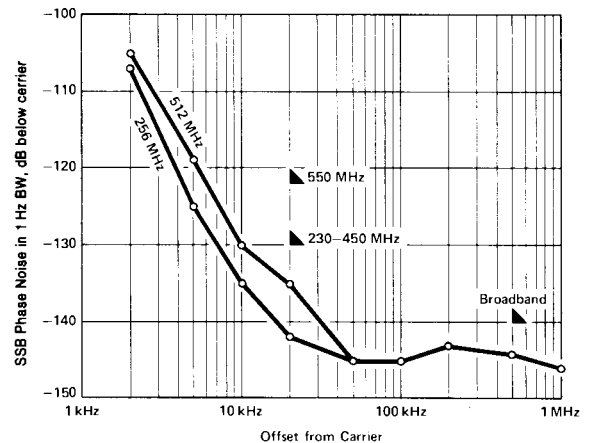



## Modulation

### General

**Types:** internal AM and FM; External AM, FM, and PULSE; simultaneous AM and FM or PULSE and FM.

**Internal modulation sources** (independently adjustable output level is available at front panel):

### Standard

**Frequency:** fixed 400 Hz and 1 kHz,  $\pm 3\%$ .

**Output level:** 10 mV to 1 V rms into 600 $\Omega$ .

**Optional** (internal variable audio oscillator Option 001):

**Frequency:** variable 20 Hz to 600 kHz,  $\pm 15\%$  plus fixed 400 Hz and 1 kHz  $\pm 3\%$ .

**Output level:** 1 mV to 3 V rms into 600 $\Omega$ .

### Amplitude Modulation

#### Depth

**0.5 to 512 MHz:** 0 to 100% for output levels from +13 dBm and below.

**512 to 1024 MHz:** 0 to 100% for output levels of +7 dBm and below, excluding the top 6 dB of output vernier range.

**AM rates:** INT and EXT ac, 20 Hz to AM 3 dB bandwidth; EXT dc, dc to AM 3 dB bandwidth.

#### AM 3 dB Bandwidth

Frequency Ranges	0 to 50% AM	50 to 90% AM
0.5 to 2 MHz	20 kHz	12.5 kHz
2 to 8 MHz	40 kHz	25 kHz
8 to 512 MHz	60 kHz	50 kHz
512 to 1024 MHz	60 kHz	50 kHz

#### AM Distortion (at 400 Hz and 1 kHz rates)

Frequency Ranges	0 to 30% AM	30 to 50% AM	50 to 90% AM
0.5 to 512 MHz	<1%		<3%
512 to 1024 MHz	<10%		<20%

#### External AM Sensitivity (400 Hz and 1 kHz rates)

**0.5 to 512 MHz:** (0.1  $\pm$  0.005)% AM per mV peak into 600 $\Omega$  with AM vernier at full clockwise position.

**512 to 1024 MHz:** nominal 0.1% AM per mV peak into 600 $\Omega$  with AM vernier at full clockwise position.

**Indicated AM Accuracy (400 Hz and 1 kHz rates using internal meter)**

**0.5 to 512 MHz:**  $\pm$ (5.5% of reading + 1.5% of full scale) from 0 to 50 $^\circ$ C.

**512 to 1024 MHz:** not specified; each generator can be individually calibrated using operating manual procedure.

#### Peak Incidental Phase Modulation (at 30% AM)

**0.5 to 128 MHz:** <0.15 radian.

**128 to 512 MHz:** <0.3 radian.

**512 to 1024 MHz:** <0.6 radian.

**Peak incidental frequency deviation:** equals peak incidental phase deviation x modulation rate.

#### Pulse Modulation<sup>1</sup>

	Frequency Ranges (MHz)					
	0.5-1	1-2	2-8	8-32	32-512	512-1024
Rise and Times Fall	<9 $\mu$ s	<4 $\mu$ s	<2 $\mu$ s	<1 $\mu$ s		<1 $\mu$ s typical
Pulse Repetition Rate	50 Hz to 50 kHz		50 Hz to 100 kHz	50 Hz to 250 kHz	50 Hz to 500 kHz	
Pulse Width Minimum <sup>2</sup>	10 $\mu$ s		5 $\mu$ s	2 $\mu$ s		
Pulse ON/OFF ratio at max. vernier	>40 dB					>60 dB
Peak Input Required	Nominally +0.5 V (5 V max). Sinewave or pulse return to zero into 50 $\Omega$					

<sup>1</sup>Pulse performance degrades below 500 Hz repetition rates.

<sup>2</sup>For level accuracy within 1 dB of CW (>0.1% duty cycle).

## Frequency Modulation

**Deviation:** maximum allowable deviation equals 1% of lowest frequency in each nominal output frequency range.

Frequency Range (MHz)	Maximum Peak Deviation (kHz)
0.5-1	5
1-2	10
2-4	20
4-8	40
8-16	80
16-32	160
32-64	320
64-128	640
128-256	1280
256-512	2560
512-1024	5120

**FM 3 dB bandwidth:** internal and external ac, 20 Hz to 250 kHz; external dc, dc to 250 kHz. (Locked mode: FM above 50 Hz only.)

#### FM Distortion (at 400 Hz and 1 kHz rates)

<1% for deviations up to  $\frac{1}{4}$  maximum allowable.

<3% up to maximum allowable deviation.

**External FM sensitivity:** 1 volt peak into 600 $\Omega$  yields maximum deviation indicated on PEAK DEVIATION switch with FM vernier at full clockwise position.

**Indicated FM accuracy (400 Hz and 1 kHz rates from 15 $^\circ$  to 35 $^\circ$ C, using internal meter):**  $\pm$ (7% of reading + 1.5% of full scale).

#### Incidental AM (at 400 Hz and 1 kHz rates)

**0.5 to 512 MHz:** <0.5% AM for FM up to  $\frac{1}{4}$  maximum allowable deviation; <1% AM for FM at maximum allowable deviation.

**512 to 1024 MHz (Opt 002):** <1% AM for FM up to  $\frac{1}{4}$  maximum allowable deviation; <7% AM for FM deviations up to maximum allowable.

## Counter

### External RF Input

**Frequency range:** 1 Hz to 550 MHz.

**Sensitivity:**  $\geq$ 100 mV rms into 50 $\Omega$ , ac only.

**Resolution:** 6-digit LED display.

Mode	Normal	Expand X10	Expand X100
0-10 MHz	100 Hz	10 Hz	1 Hz
10-550 MHz	10 kHz	1 kHz	100 Hz

**External reference input:** 5 MHz, nominally >0.5 V p-p (5 V maximum) into 1 k $\Omega$ .

**Internal Reference (after 2 hr warm-up and calibration at 25 $^\circ$ C)**

**Aging rate:** <0.05 ppm/hr; <2 ppm/90 days.

#### Temperature Drift

< $\pm$ 2 ppm from 15 $^\circ$  to 35 $^\circ$ C.

< $\pm$ 10 ppm from 0 $^\circ$  to 50 $^\circ$ C.

**Typical overall accuracy (within 3 months of calibration and from 15 $^\circ$  to 35 $^\circ$ C):**  $\pm$ 2 ppm.

## General

**Operating temperature range:** 0 $^\circ$  to 55 $^\circ$ C.

**Power requirements:** 100 or 120 volts (+5%, -10%) from 48 to 440 Hz; or 220 or 240 volts (+5%, -10%) from 48 to 66 Hz. 175 VA max (Option 002: 190 VA max).

**Weight:** net, 20.8 kg (46 lb). Shipping, 24.1 kg (53 lb).

**Size:** 140 H x 425 W x 476 mm D (5.5" x 16.75" x 18.75").

## Ordering Information

### 8640B Signal Generator

**Option 001:** internal variable audio oscillator, 20 Hz to 600 kHz

**Option 002:** internal doubler 512-1024 MHz

**Option 003:** reverse power protection

**Option 004:** avionics option

**Option 908:** rack mount kit

**Option 910:** extra operating and service manual

# SIGNAL GENERATORS

## Avionics VHF Signal Generator

Model 8640B Option 004

- Demodulated output from RF detector, ac and dc
- Phase shift less than  $0.01^\circ$  at 30 Hz

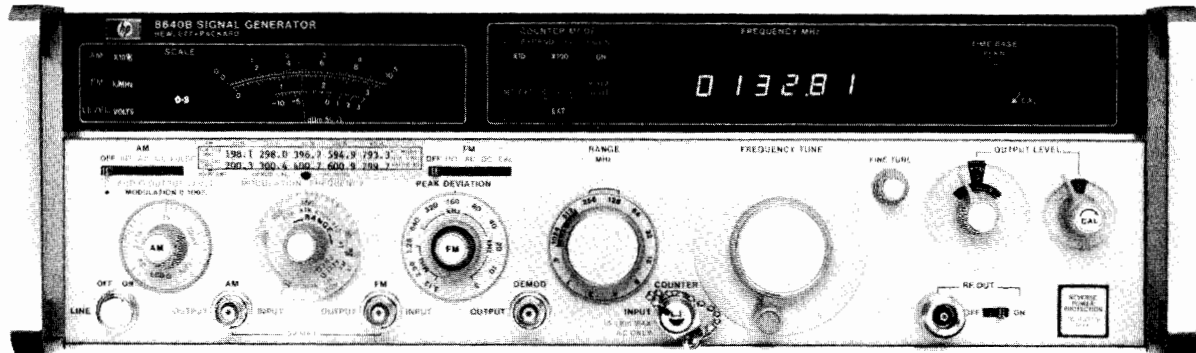

HP 8640B Option 004 (with Options 001, 003)

### HP 8640B Avionics Option 004 Signal Generator

The Hewlett-Packard Model 8640B Option 004 NAV/COM Signal Generator is an HP 8640B AM/FM Signal Generator specially adapted for testing ILS (Marker Beacon, Localizer and Glide Slope), VOR and VHF communications receivers used throughout the aviation industry. VOR, LOCALIZER and VHF communications frequencies (108 to 136 MHz) are available on one frequency band for rapid channel selection. GLIDE SLOPE (329 to 335 MHz) and MARKER BEACON (75 MHz) frequencies are also easily set using the 6-digit LED display.

The HP 8640B Option 004 provides highly stable, spectrally pure RF signals for testing narrow-channel, crystal controlled receivers. For avionics testing, external audio generators are required to provide the composite modulation. Designed with versatile AM and FM modulation, Option 004 features low distortion modulation when used with suitable, external VOR/ILS Audio Generators.

Operation and specifications of the HP 8640B Option 004 are the same as the Standard HP 8640B AM/FM Signal Generator with the following additions:

#### Demodulated Output

One front panel BNC connector provides demodulated output from the RF peak detector for precise AM settings. A choice of combined ac/dc at 1 V rms or ac only at 5 V rms is provided.

#### Output Level Setting

To ensure the best possible demodulated output linearity, Option 004 combines a 10 dB step attenuator and a 1 dB step attenuator with a vernier. This provides output levels from +15 dBm to -142 dBm (1.3 V to  $0.018 \mu\text{V}$ ). The output level can be read directly from the attenuator dial in 1 dB steps or from the front panel meter in dBm or volts.

#### External AM Input Impedance

External AM input impedance of 2 k $\Omega$  allows compatible operation with old and new generations of external audio generators.

#### Low Distortion Modulation

The HP 8640B Option 004 provides flat AM response and minimum phase shift at 30 Hz and 9960 Hz as well as constant group delay between 9 kHz and 11 kHz for accurate VOR and ILS testing.

### HP 8640B Option 004 Specifications

(These specifications apply to HP 8640B Option 004 in addition to standard HP 8640B specifications. See HP 8640B AM/FM Signal Generator technical data for complete specifications.)

#### Spectral Purity

**Noise:** SSB broadband noise floor greater than 1 MHz offset from carrier:  $< -130 \text{ dBc}$ .

#### Output Characteristics

**Range:** +15 dBm to -142 dBm (1.3 V to  $0.018 \mu\text{V}$ ).

**Attenuators:** a 10 dB step attenuator plus a 1 dB step attenuator with vernier allow selection of any output level over the full output level range.

**Vernier:**  $> 2 \text{ dB}$  continuously variable from a CAL detent position.

**Level flatness (referred to 190 MHz and for +10 to -10 dBm without option 003):**  $< \pm 0.75 \text{ dB}$  from 0.5 to 512 MHz;  $< \pm 0.5 \text{ dB}$  from 108 to 336 MHz.

#### Level Accuracy

Output Level (dBm)	+15 to -10	-10 to -50	-50 to -142	With Option 003
Total Accuracy as Indicated on Level Meter	$\pm 1.5 \text{ dB}$	$\pm 2.0 \text{ dB}$	$\pm 2.5 \text{ dB}$	Add $\pm 0.5 \text{ dB}$ except from 108 to 336 MHz

#### Modulation Characteristics

**Demodulated output (output vernier in CAL position, 108 to 118 and 329 to 336 MHz and 20% - 80% AM):** an internal selector switch allows selection of ac only or ac and dc at the demodulated output.

**AC only output:** directly proportional to AM depth (90 to 150 Hz modulation frequency).

**% AM equals:**  $(20 \pm 0.6)\%$  per V rms, 0 to  $55^\circ\text{C}$ ;  $(20 \pm 0.4)\%$  per V rms, 20 to  $30^\circ\text{C}$ ;  $(20 \pm 0.2)\%$  per V rms (using the DEMOD CAL label provided).

**AC and dc output:** ac output voltage is directly proportional to AM depth (90 to 150 Hz modulation frequency). dc output equals  $(1.414 \pm 0.010) \text{ V}$  dc with vernier in CAL position.

**% AM equals:**  $(100 \pm 3)\%$  per V rms, 0 to  $55^\circ\text{C}$ ;  $(100 \pm 2)\%$  per V rms, 20 to  $30^\circ\text{C}$ ;  $(100 \pm 1)\%$  per V rms (using the DEMOD CAL label provided).

#### AM Characteristics (+10 dBm output and below)

**External input impedance:** nominally 2 k $\Omega$ .

**Frequency response:**  $< \pm 0.04 \text{ dB}$  from 90 Hz through 150 Hz (108 to 118 and 329 to 335 MHz.);  $< \pm 0.1 \text{ dB}$ , 9 kHz through 11 kHz (108 to 118 MHz).

**Phase Shift From Audio Input to Demodulated Output (108 to 118 MHz, AM EXT DC mode)**

30 Hz  $< \pm 0.01^\circ$ ; 30 Hz to 10 kHz  $< \pm 3^\circ$ ; 9 kHz to 11 kHz  $< \pm 2^\circ$ .

#### Ordering Information

HP 8640B Signal Generator with Avionics Option 004

**Option 001:** Internal variable audio oscillator, 20 Hz to 600 kHz

**Option 002:** not available with Option 004

**Option 003:** Reverse power protection

**Option 908:** Rack mount kit

**Option 910:** Extra Operating and Service Manual

# SIGNAL GENERATORS

## AM-FM Solid-State Generator 10 to 520 MHz

Models 8654A, 8654B



- Calibrated output power
- Calibrated AM, FM; internal, external

- 25 Watt reverse power protection (optional)

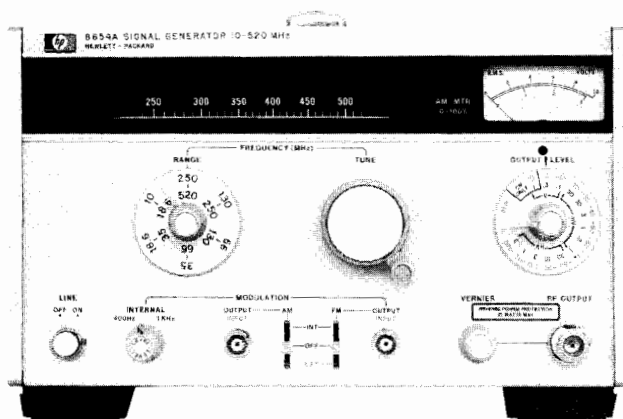

HP 8654A

### 8654A/B Signal Generators

The HP 8654A/B Signal Generators are portable, low-cost solid-state generators providing calibrated output and versatile modulation capabilities over the 10 to 520 MHz frequency range. They provide clean RF signals for testing receivers, amplifiers, antennas, and filter networks.

Its compactness allows the HP 8654 to fit easily into production, mobile, airborne, and shipboard test locations. Its rugged, lightweight construction is also suitable for field maintenance and service applications.

Effective RF shielding and output range permit receiver sensitivity measurements to be made down to power levels of 0.1  $\mu$ V.

### HP 8654A/B Specifications

#### Frequency Characteristics

**Range:** 10 to 520 MHz in 6 ranges.

**HP 8654A ranges (MHz):** 10 to 18.6, 18.6 to 35, 35 to 66, 66 to 130, 130 to 250, 250 to 520.

**HP 8654B ranges (MHz):** 10 to 19, 19 to 35, 35 to 66, 66 to 130, 130 to 270, 270 to 520.

**Accuracy:**  $\pm 3\%$  after 2-hour warm-up.

**Settability:** settleable to within 5 ppm of the desired frequency with an external indicator after 1-hour warm-up.

**Stability (after 2-hour warm-up and 15 min. after frequency change):**  $< (1 \text{ kHz plus } 20 \text{ ppm})/5 \text{ min.}$

#### Spectral Purity

**Harmonic distortion (output power  $\leq +3 \text{ dBm}$ ):**  $< -20 \text{ dBc}$ ;  $< -15 \text{ dBc}$  with Option 003.

**Subharmonics and non-harmonic spurious (excluding line related):**  $< -100 \text{ dBc}$ .

**Residual AM (average rms):**  $-55 \text{ dBc}$  in a 50 Hz to 15 kHz post-detection noise bandwidth.

**Residual FM on CW (averaged rms deviation):**  $< 0.3 \text{ ppm}$  in a 0.3 to 3 kHz post-detection noise bandwidth;  $< 0.5 \text{ ppm}$  in a 50 Hz to 15 kHz post-detection noise bandwidth.

#### Output Characteristics

**Range:** 10 dB steps and a 13 dB vernier provide power settings from +10 dBm to  $-130 \text{ dBm}$  (0.7 V to 0.07  $\mu$ V) into 50  $\Omega$ . With Option 003, maximum output power is +8 dBm (0.56 V).

**Impedance:** 50  $\Omega$  ac coupled, SWR  $< 1.3$  on 0.1 V range or lower. With Option 003, SWR  $< 1.5$  on 0.1 V range or lower.

**Level accuracy (total as indicated on level meter):** +10 to  $-7 \text{ dBm}$ ,  $\pm 1.5 \text{ dB}$ ;  $-7$  to  $-57 \text{ dBm}$ ,  $\pm 2.0 \text{ dB}$ ;  $-57$  to  $-97 \text{ dBm}$ ,  $\pm 2.5 \text{ dB}$ ;  $-97$  to  $-127 \text{ dBm}$ ,  $\pm 3 \text{ dB}$ .

**Level flatness:**  $\pm 1 \text{ dB}$  referenced to the output at 250 MHz for output levels  $> -7 \text{ dBm}$ .

**Auxiliary RF output:**  $> -7 \text{ dBm}$  (100 mV) into 50  $\Omega$ .

**Reverse power protection (option 003):** protects signal generator from accidental applications of up to 25 W (+44 dBm) of RF power (between 10 and 520 MHz) into generator output.

#### Modulation Characteristics

**Amplitude modulation:** specifications apply for output power  $< +3 \text{ dBm}$ . AM is possible above +3 dBm as long as the combination of the AM depth plus carrier output level does not exceed +9 dBm.

**Depth:** 0 to 90%

**Modulation rate:** internal, 400 and 1000 Hz  $\pm 10\%$ , external 3 dB bandwidth, dc to  $> 20 \text{ kHz}$ .

**External AM sensitivity:<sup>2</sup>**  $(0.1 \pm 0.01)\% \text{ AM/mV pk}$  into 600  $\Omega$ .

**Indicated AM accuracy:<sup>2</sup>**  $\pm (5\% \text{ of reading} + 5\% \text{ of full scale})$ .

**Peak incidental frequency deviation (30% AM):<sup>2</sup>**  $< 200 \text{ Hz}$ .

**Envelope distortion:<sup>2</sup>**  $< 3\%$ , 0 to 70% modulation;  $< 5\%$ , 70 to 90% modulation.

#### Frequency Modulation

**HP 8654A:** uncalibrated.

**HP 8654B:** fully calibrated.

**Peak deviation:** 0 to 30 kHz from 10 to 520 MHz.

0 to 100 kHz from 80 to 520 MHz.

**Deviation ranges:** 0 to 3 kHz, 0 to 10 kHz, 0 to 30 kHz, 0 to 100 kHz.

**Modulation rate:** internal, 400 and 1000 Hz  $\pm 10\%$ ; external 3 dB bandwidth, dc to  $> 25 \text{ kHz}$ .

**FM distortion:<sup>2</sup>**  $< 2\%$  for deviations up to 30 kHz,  $< 3\%$  for deviations up to 100 kHz.

**External FM sensitivity (with FM vernier fully clockwise):<sup>2</sup>** 1 volt peak yields maximum deviation indicated on peak deviation meter.

**Sensitivity accuracy (15° to 35°C):<sup>2</sup>**  $\pm 12\%$ . For 100 kHz deviation above 130 MHz, add 3%.

**Indicated FM accuracy (15° to 35°C):<sup>2</sup>**  $\pm (12\% \text{ of reading} + 3\% \text{ of full scale})$ . For 100 kHz deviation above 130 MHz, add 3% of reading.

**Incidental AM:<sup>2</sup>**  $< 1\% \text{ AM}$  at 30 kHz deviation.

**Frequency modulation, HP 8654A:** uncalibrated.

**Deviation:**  $> 0.1\%$  of carrier frequency, maximum.

**Modulation rate:** internal, 400 & 1000 Hz  $\pm 10\%$ . External 3 dB bandwidth, dc coupled to  $> 25 \text{ kHz}$  driven from 600  $\Omega$  or less.

**External FM sensitivity:** 10 V<sub>pk</sub> into 600  $\Omega$  yields  $> 0.1\%$  deviation ( $\pm 15 \text{ volts max}$ ).

#### General Characteristics

**Power:** 100 or 120 volts (+5%,  $-10\%$ ) from 48 to 440 Hz; or 220 to 240 volts (+5%,  $-10\%$ ) from 48 to 66 Hz. Power consumption is 25 VA max. 2.3 m (7.5 ft.) power cable furnished with mains plug to match destination requirements.

**Weight:** net, 8.0 kg (17.5 lb). Shipping, 9.5 kg (21 lb).

**Size:** 178 H x 267 W x 306 mm D (7" x 10.5" x 12").

#### Ordering Information

**HP 8654A** AM/FM Signal Generator

**HP 8654B** AM/FM Signal Generator

**Option 003:** Reverse power protection (for HP 8654A/B)

**Option 910:** Extra operating and service manual

<sup>1</sup>Specifications apply from 10 to 520 MHz for output power  $\geq +10 \text{ dBm}$  and over the top 10 dB of output level vernier range unless otherwise specified.

<sup>2</sup>400 and 1000 Hz modulation rates.



# SIGNAL GENERATORS

## Solid-State Microwave Signal Generators

### Models 8683/8684A,B,D

- Portable signal generators with high performance modulation
- Wide frequency ranges from 2.3-18 GHz
- Wideband FM for satellite video  $\pm 10$  MHz peak deviation
- dc-10 MHz rates

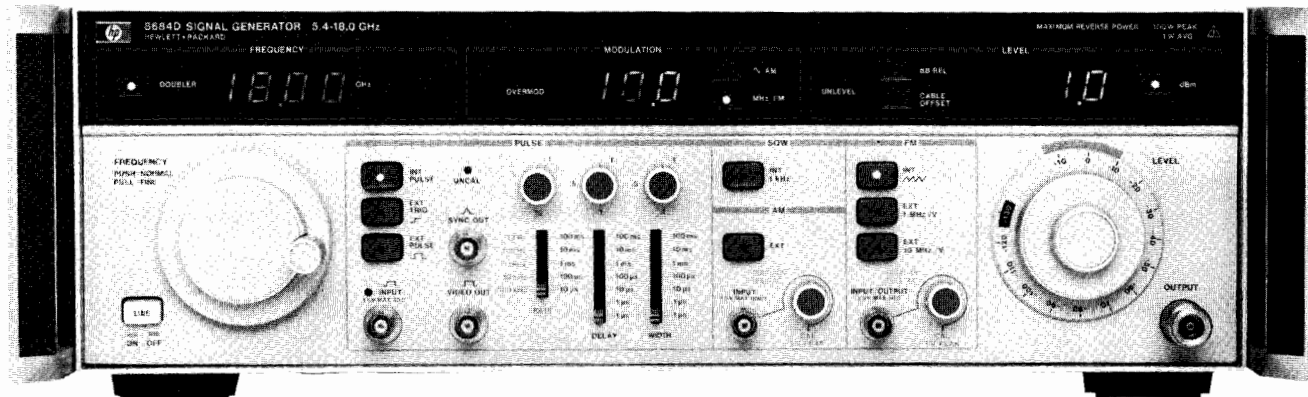

HP 8684D

### HP 8683/8684 Microwave Signal Generators

The HP 8683 and 8684 are rugged portable signal generators designed for demanding benchtop and field maintenance environments. Operating in four overlapping frequency ranges, with a choice of features including a high performance internal pulse generator, the family provides a wide range of benefits for various radar, communications and electronic warfare applications.

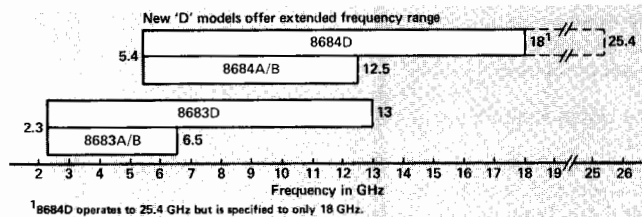

### Clean, Stable, Cavity-Tuned Oscillator

At the heart of each signal generator is a mechanically tuned cavity oscillator. State-of-the-art electronics teamed with sophisticated mechanical design provide excellent frequency stability, spectral purity and quick warm-up times necessary for accurate measurements. With low spurious outputs and a low noise floor, the HP 8683 and 8684 are excellent for receiver sensitivity measurements and out-of-channel communications receiver measurements where high performance at low signal levels is required.

### Microprocessor-Enhanced Measurement Accuracy

Characteristics of microwave components such as oscillators, amplifiers, and attenuators vary considerably with frequency and power level. An internal microprocessor effectively compensates for these variations, providing accurate output level in dBm, dB relative to a user-selected power level, or power level with a specified cable offset. These conveniences translate to faster measurements and reduced possibility of operator error in interpreting observations.

### Reliability and Serviceability

The HP 8683 and 8684 were designed with high reliability and serviceability as major considerations. The instruments exceed rigorous military specifications (MIL-T-28800C Class V) for operating and non-operating temperature, humidity, condensation, shock and vibration, and EMI. The instruments success in these tests is an indication that they are rugged enough to provide accurate, reliable measurements in environments where many instruments would fail. For added reliability in the A and B models Option 002 may be selected for reverse power protection. With this option the possibility of instrument failure due to operator error is substantially reduced, allowing for as much as 10 watts average or 2000 watts peak reverse power with no

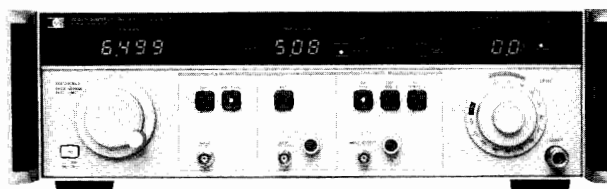

HP 8683A

damage to the instrument. The reliability of these generators is reflected in a demonstrated MTBF in excess of 20,000 hours.

Confidence in signal generator performance is provided by diagnostic tests which automatically execute at turn-on and monitor most critical nodes prior to entering the operation mode. If a failure is detected, in most cases it can be isolated to at least the circuit function level with the aid of the front panel display. The generators' open, accessible internal design and complete service manuals result in excellent serviceability, minimizing repair time if a failure should occur.

### HP 8683/8684 A,B,D Features

A variety of modulation capabilities, frequency ranges, and power specifications are available in the HP 8683/8684 microwave signal generator family.

Sharing the same rugged dependable design with the rest of the family, the A models provide AM and FM for conventional communications applications in an affordable package. All A models are specified to have maximum output power of 0 dBm throughout their frequency range; however, if required, Option 001 may be selected to provide +10 dBm output power.

The B and D models add a high performance pulse modulator and internal pulse generator for the simulation of a wide variety of sophisticated radar transmissions. Simultaneous FM and pulse allow chirping, while simultaneous AM and pulse allow simulation of antenna scan patterns. Of course, basic receiver sensitivity and AGC measurements can also be made easily.

For users with multi-band, broadband or general purpose applications, the D models, with twice the frequency coverage of the A and B models, offer exceptional performance, versatility and economy in a single box. Not only is frequency coverage increased, but in doubled mode, FM peak deviation is also doubled to 10 MHz at dc to 10 MHz rates making possible the direct test of satellite video receivers. If required, the high-power Option 001 may be selected to boost maximum output power in the frequency-doubled bands from -3 dBm to the +10 dBm level already provided in the main bands. By combining

proven, rugged, dependable design with the versatility of twice the frequency coverage and wideband FM, the D models offer cost-effective, high performance solutions to radar and communications receiver test problems.

Distinguishing features of the A, B, & D models			
	A	B	D
Output Power	0 dBm	+10 dBm	+10 dBm, -3 dBm <sup>1</sup>
Opt 001 Power	+10 dBm	N/A	+10 dBm <sup>1</sup>
Internal Pulse Generator/Modulator	No	Yes	Yes
FM Deviation (DC To 10MHz Rate)	5 MHz	5 MHz	10 MHz <sup>1</sup>

<sup>1</sup> These specifications for the doubled mode

## HP 8683A/B/D, HP 8684A/B/D Specifications

### Frequency Specifications

#### Range

**HP 8683A/B:** 2.3–6.5 GHz.

**HP 8683D:** 2.3–13.0 GHz.

**HP 8684A/B:** 5.4–12.5 GHz.

**HP 8684D:** 5.4–18.0 GHz.

**Resolution:** HP 8683, 5 MHz using a 4 digit LED display; HP 8684, 10 MHz using a 3 1/2 digit LED display.

**Calibration accuracy:** HP 8683A/B/D,  $\pm 1.25\%$  <4.0 GHz,  $\pm 0.75\%$  4.0 to 6.5 GHz; HP 8683D x2 band,  $\pm 1.25\%$  6.5 to 8.0 GHz,  $\pm 0.75\%$  >8 GHz; HP 8684A/B/D,  $\pm 1.25\%$  5.4 to 9.0 GHz,  $\pm 0.75\%$  9.0 to 12.5 GHz; HP 8684D x2 band,  $\pm 1.25\%$  12.5 to 18.0 GHz.

#### Stability (typical)

**vs. time (20 min. after turn-on):** <30 kHz/min.

**vs. time (60 min. after turn-on):** <100 kHz/hr.

**vs. temperature (0 to 55° C):** HP 8683, <15 MHz; HP 8684, <30 MHz.

**vs. line voltage (transients of +5%/-10%):** <20 ppm.

### Spectral Purity

**Harmonics (<18GHz, at specified max output):** <-25 dBc.

HP 8683/84D harmonics are unspecified in x2 frequency band.

**Fundamental feedthrough:** HP 8683D, <-25 dBc 6.5–9.5 GHz; HP 8684D, <-25 dBc.

**Spurious (non-harmonically related):** <-80 dBc; typ, <-90 dBc.

**Residual FM (50 Hz to 15 kHz post detection BW):** <5 kHz peak.

HP 8683/84D in doubled band: <10 kHz peak.

**Single-sideband phase noise (avg. rms, 1 Hz BW, 10 kHz offset from carrier, typical):** HP 8683A/B, <-72 dBc; HP 8683D, <-66 dBc; HP 8684A/B, <-65 dBc; HP 8684D, <-59 dBc.

**Residual AM (avg. rms, 300 Hz to 15 kHz post detection BW):** <0.15%.

### Output Specifications

**Range (leveled into 50Ω):** HP 8683/84A, 0 to -130 dBm; HP 8683/84A opt. 001 and HP 8683/84B, +10 to -130 dBm; HP 8683/84D, +10 to -130 dBm (main band), -3 to -130 dBm (x2 band), +10 dBm in x2 bands available with Option 001.

**Resolution:** 0.1 dB using a 3 1/2 digit LED display.

**Accuracy:**  $\pm 2.5$  dB from maximum specified output power to -110 dBm (to -100 dBm in x2 bands);  $\pm 3.5$  dB to -120 dB. Typ.  $\pm 0.9$  dB at -100 dBm. Option 002 affects level accuracy  $\pm 0.5$  dB.

**Flatness (power level >-10 dBm):**  $\pm 1.0$  dB.

**Reverse power protection:** the standard models typically accept 1 watt avg. or 100 watts peak power with no damage resulting. Option 002 (on A and B models only) increases this protection to 10 watts avg. or 2kW peak.

**Auxiliary output:** rear panel, typically >-15 dBm into 50Ω, prior to AM, pulse, or frequency doubling; source impedance approx. 50Ω.

### Modulation Specifications

**Types:** internal and external AM, FM, and Pulse (except HP 8683/84A). Simultaneous AM, FM, Pulse.

**Metering:** 3-digit LED, selectable for % AM or FM deviation.

### Amplitude Modulation

**Depth (1 kHz rate):** 0-70%.

**Rates (3 dB BW at 40% depth):** dc to 10 kHz (dc coupled); 50 Hz to 10 kHz (ac coupled).

**Distortion (THD):** <10% at 40% depth and 1 kHz rate.

**Indicated AM accuracy (depth 50%, 1 kHz rate):**  $\pm 5\%$  of full scale.

**Incidental FM (30% AM depth):** <15 kHz peak to peak. (<30 kHz p-p in doubled band, HP 8683/84D.)

**Internal AM:** fixed 1 kHz nom. square wave with 50  $\pm 5\%$  duty cycle.

### Frequency Modulation

**Peak deviation:** HP 8683/84 A/B,  $\pm 5$  MHz; HP 8683/84D,  $\pm 5$  MHz (main);  $\pm 10$  MHz (x2 band).

**Rates (3 dB BW):** dc to 10 MHz, 100 Hz to 10 MHz (ac coupled).

**Distortion:** <5% at 100 kHz rate and <1 MHz peak deviation.

**Indicated accuracy (typ., 10 MHz/V range):**  $\pm 10\%$  of full scale, deviations <5 MHz, 100 kHz rate.

**Incidental AM (rate <100 kHz, peak deviation <1 MHz):** <6%.

**Internal FM:** FM sawtooth with a fixed sweep rate of 1 kHz nom. and variable deviation up to  $\pm 5$  MHz ( $\pm 10$  MHz for D models, x2 bands).

**Phase lock input:** typical sensitivity of -5 MHz/V.

### Pulse Modulation

#### HP 8683/84 B/D Internal Pulse Generator

**Rate:** 10 Hz to 1 MHz continuously adjustable in 5 ranges.

**Width:** 50 ns to 100 ms continuously adjustable in 7 ranges.

**Delay (time between sync out and video out):** <50 ns to 100 ms in 7 ranges with continuous adjustment within ranges.

**Accuracy:** calibration accuracy is 20% of full scale.

#### HP 8683/84 B/D External Pulse Input Requirements

**Rate:** 0 to 1 MHz.

**Width:** >100 ns.

**Level:** on >+1.0 V peak; off <+0.4 V peak.

#### HP 8683/84 B/D RF Pulse Specifications

**Rise/fall time:** <10 ns.

**On/off ratio:** >80 dB.

**Minimum pulse width:** <100 ns.

**Maximum pulse repetition frequency:** >1 MHz.

**Peak pulse power:**  $\pm 0.5$  dB of level set in CW mode.

### General

**Operating temperature range:** 0° to 55°C.

**EMI:** MIL-STD-461, VDE0871, CISPR Pub. 11.

**Safety:** meets the requirements of IEC 348.

**Power:** 100, 120, 220 or 240V, +5%, -10%; 48 to 66 Hz; (Opt. 003 adds 400 Hz operation at 100 or 120 V); <200 VA max.

**Dimensions:** 145 H x 457 W x 472 mm D (5.7" x 18" x 18.6").

**Weight:** HP 8683, 17.9kg (39 lb) net, 23.4 kg (51 lb) shipping; HP 8684, 16.5 kg (36 lb) net, 22.0 kg (48 lb) shipping.

### Ordering Information

**HP 8683A** Microwave Signal Generator

**HP 8684A** Microwave Signal Generator

**Option 001:** +10 dBm output power, HP 8683/84 A

**HP 8683B** Microwave Signal Generator

**HP 8684B** Microwave Signal Generator

**HP 8683D** Microwave Signal Generator

**Option 001** +10 dBm in x2 band, HP 8683D

**HP 8684D** Microwave Signal Generator

**Option 001:** +10 dBm in x2 band, HP 8684D

**Option 002:** Reverse power protection

(except D models)

**Option 003:** 400 Hz line frequency operation (all models)

**Option 910:** Extra operating and service manual

**Option 913:** Rack mounting flange kit

**HP 11727A** Support kit





- Stable, easy to use, 800-2400MHz, 1800-4500MHz



HP 8614A

## HP 8614A, 8616A Signal Generators

The HP 8614A and 8616A Signal Generators provide stable, accurate signals from 800 to 2400 MHz (HP 8614A) and from 1800 to 4500 MHz (HP 8616A). Both frequency and attenuation are set on direct-reading digital dials. Selectable functions include CW, leveled output, square-wave modulation, and external AM, FM and pulse modulation. Modulation can be accomplished simultaneously with or without leveling.

Two RF power outputs are simultaneously available from separate front-panel connectors. One provides at least 10 mW (2 mW above 3000 MHz) or a leveled output from 0 to -127 dBm. The other is at least 0.5 mW across the band. This signal can be used for phase-locking the signal generators for extreme stability, or it can be monitored with a frequency counter for extreme frequency resolution without adversely affecting the primary output.

A unique PIN diode modulator permits amplitude modulation from dc to 1 MHz or RF pulses with a 2  $\mu$ s rise time. This broad modulation bandwidth permits remote control of output level or precise leveling using external equipment. The internal leveling is also obtained by using a PIN modulator.

The HP 8614A and 8616A can also be used with companion modulators, HP 8403A modulators and HP 8730-series PIN modulators to provide 80 dB pulse on/off ratio (see page 466). In addition, TWT amplifiers can be used with these generators to provide high power levels.

## Specifications

### HP 8614A

**Frequency range:** direct reading within 2 MHz, 800 to 2400 MHz.  
**Vernier:**  $\Delta$ F control has a minimum range of 1.0 MHz for fine tuning.

**Frequency calibration accuracy (0 dBm & below):**  $\pm 5$  MHz.

**Frequency stability:** approximately 50 ppm/ $^{\circ}$ C change in ambient temperature, less than 2500 Hz peak residual FM; 30 ppm change for line voltage variation of  $\pm 10\%$ .

**RF output power:** +10 dBm (0.707 V) into 50  $\Omega$  load. Output attenuation dial directly calibrated in dBm from 0 to -127 dBm. A second uncalibrated output (approximately -3 dBm) is provided on front panel.

**RF output power accuracy (with respect to attenuation dial):**  $\pm 0.75$  dB + attenuator accuracy (0 to -127 dBm) including leveled output variations.

**Attenuator accuracy:** +0, -3 dB from 0 to -15 dBm;  $\pm 0.2$  dB  $\pm 0.06$  dB/10 dB from -15 to -127 dBm; direct reading dial, 0.2 dB increments.

**Output impedance:** 50  $\Omega$ ; SWR < 2.0.

**Modulation:** on-off ratio at least 20 dB for square wave, pulse.

**Internal square wave:** 950 to 1050 Hz. Square wave can be synchronized with a +1 to +10 V signal at PULSE input.

**External pulse:** 50 Hz to 50 kHz; 2  $\mu$ s rise time, +20 to +100 V peak input.

**External AM:** dc to 1 MHz.

**External FM:** front-panel connector capacity-coupled to repeller of klystron; four-terminal rear-panel connector (Cinch-Jones type S304AB) is dc-coupled to repeller of klystron.

**Power source:** 115 or 230 V  $\pm 10\%$ , 50 to 60 Hz, approximately 130 W.

**Size:** cabinet, 141 H x 425 W x 467 mm D (5.5" x 16.75" x 18.4"); rack mount, 133 H x 416 W x 483 mm D (5.2" x 16.4" x 19").

**Weight:** net, 19.5 kg (43 lb). Shipping, 22.7 kg (50 lb).

**Accessory furnished:** HP 11500A Cable Assembly.

### HP 8616A

**Frequency range:** direct reading within 2 MHz, 1800 to 4500 MHz.  
**Vernier:**  $\Delta$ F control has a minimum range of 1.0 MHz for fine tuning.

**Frequency calibration accuracy (0 dBm & below):**  $\pm 10$  MHz.

**Frequency stability:** approximately 50 ppm/ $^{\circ}$ C change in ambient temperature, less than 2500 Hz peak residual FM; 30 ppm change for line voltage variation of  $\pm 10\%$ .

**RF output power:** +10 dBm (0.707 V) to -127 dBm into 50  $\Omega$  load, 1800 to 3000 MHz; +3 dBm to -127 dBm from 3000 to 4500 MHz into a 50  $\Omega$  load. Output attenuation dial directly calibrated in dBm from 0 to -127 dBm. A second uncalibrated output (approximately -3 dBm) is provided on the front panel.

**RF output power accuracy (with respect to attenuation dial):**  $\pm 1.0$  dB + attenuator accuracy (0 to -127 dBm).

**Attenuator accuracy:** +1, -2 dB from 0 to -10 dBm;  $\pm 0.2$  dB  $\pm 0.06$  dB/10 dB from -10 to -127 dBm.

**Output impedance:** 50  $\Omega$ ; SWR < 2.0.

**Modulation:** on-off ratio at least 20 dB for square wave, pulse.

**Internal square wave:** 950 to 1050 Hz. Other frequencies available on special order.

**External pulse:** 50 Hz to 50 kHz; 2  $\mu$ s rise time, +20 to +100 V peak input.

**External AM:** dc to 1 MHz.

**External FM:** front panel connector capacity-coupled to repeller of klystron; four-terminal rear panel connector (Cinch-Jones type S304AB) is dc-coupled to repeller of klystron.

**Power source:** 115 or 230 V  $\pm 10\%$ , 50 to 60 Hz, approximately 130 W.

**Size:** cabinet, 141 H x 425 W x 467 mm D (5.5" x 16.75" x 18.4"); rack mount, 133 H x 416 W x 483 mm D (5.2" x 16.4" x 19").

**Weight:** net, 19.5 kg (43 lb). Shipping, 22.7 kg (50 lb).

**Accessory furnished:** HP 11500A Cable Assembly.

## Ordering Information

HP 8614A Signal Generator (800-2400 MHz)

HP 8616A Signal Generator (1800-4500 MHz)

### HP 8614A and 8616A Options

**Option 001:** External modulation input connectors on rear panel in parallel with front-panel connectors; RF connectors on rear panel only.

**Option 908:** Rack mounting flange kit

**Option 910:** Extra operating and service manual



- 1 to 4 Hz frequency resolution
- Low spurious and phase noise
- 100 ns pulse width capability (optional on HP 8341A)
- +10 dBm to -110 dBm calibrated output (optional on HP 8341A)
- Complete analog sweeper
- DC to 100 kHz amplitude modulation

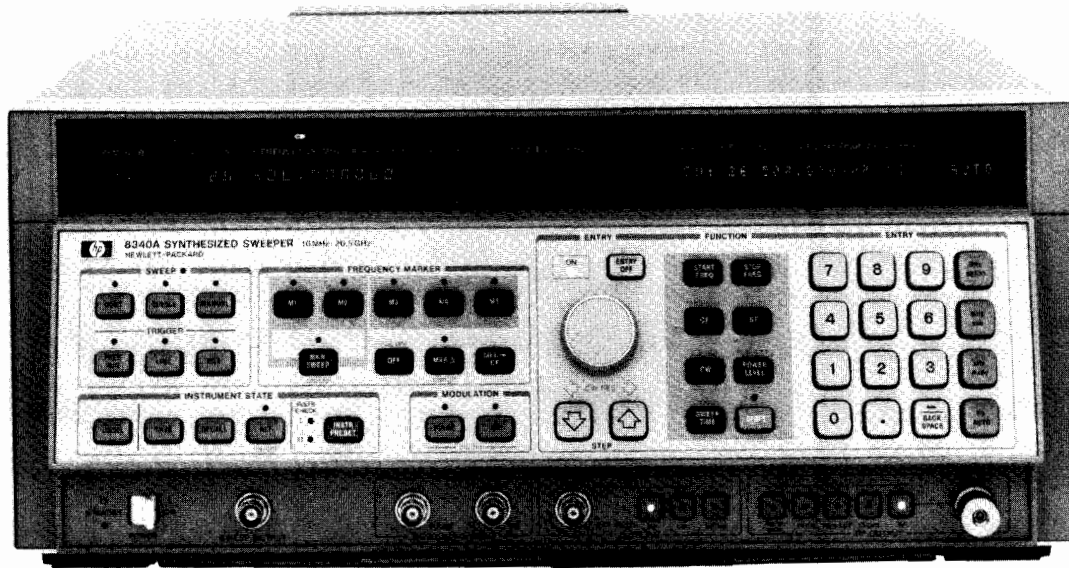

HP 8340A



### HP 8340A/41A Synthesized Sweepers

The HP 8340A/41A synthesized sweepers deliver the combined high-performance of a synthesizer and a broadband sweep oscillator in one efficient instrument that is completely controllable via the Hewlett-Packard Interface Bus (HP-IB). This efficient combination of performance and versatility is ideal for manual or automatic test systems and enables the HP 8340A/41A to replace a sweep oscillator, a frequency counter, an RF synthesizer, and a microwave synthesizer.

#### Frequency Precision and Spectral Purity

The synthesized broadband frequency coverage and the precise 1 to 4 Hz frequency resolution (depending on the frequency band of the HP 8340A/41A) are generated by indirect synthesis techniques. These techniques enable the HP 8340A/41A to achieve the same low single-sideband phase noise performance as the HP 8672A and 8673 series Synthesized Signal Generators.

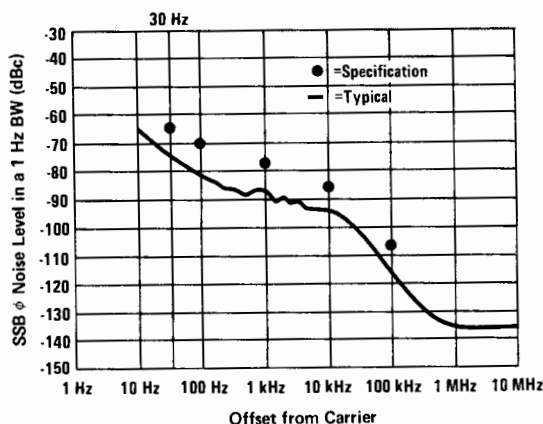

Typical HP 8340A Phase Noise performance from 2.3 to 7.0 GHz.

#### Stepped CW Switching Times

The HP 8340A/41A feature CW switching times of better than 50 ms (typically <35 ms). Additionally, a Fast Phase-lock programming

command can be used to reduce typical CW switching times to between 11 and 22 ms (depending on frequency step size and absolute frequency value).

#### Output Power

The HP 8340A/41A Opt 001 provide high output power which can be varied all the way down to the minimum level (-110 dBm) with 0.05 dB resolution.

The HP 8340A/41A also feature power sweep capability with >20 dB dynamic range for complete characterization of level-sensitive devices.

#### Pulse and AM Modulation

The HP 8340A/41A Opt 006 have a high-performance pulse modulator with an ON/OFF ratio >80 dB and rise and fall times <25 ns. Pulse amplitude is leveled and can be as narrow as 100 ns. The HP 8340A/41A Opt 006 also feature dc-coupled AM modulation with a 3 dB bandwidth of 100 kHz and a minimum depth of 90%. Pulse and amplitude modulation can be used simultaneously.

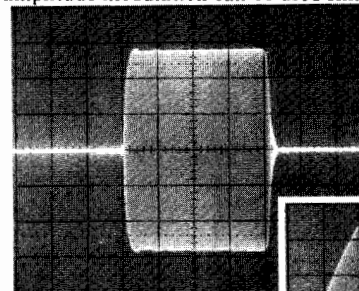

HP 8340A/41A Opt 006 pulse performance at 3 GHz. Pulse width=200 ns.

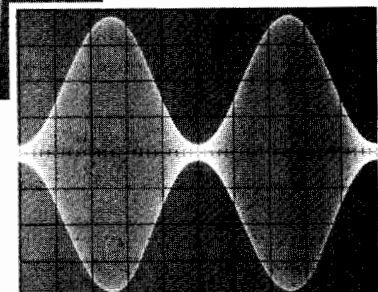

HP 8340A AM performance at 22 GHz. AM rate is 50 kHz and depth is 90%

For additional ordering and performance information about the HP 8340A and 8341A, refer to page 470.

# SIGNAL GENERATORS

## Synthesized Signal Generators

Models 8673B, 8672A

- 2 to 26.5 GHz frequency range
- 1 to 4 kHz frequency resolution
- Low spurious and phase noise
- +8 to -100 dBm calibrated output
- Internally leveled pulse modulation
- Metered AM/FM

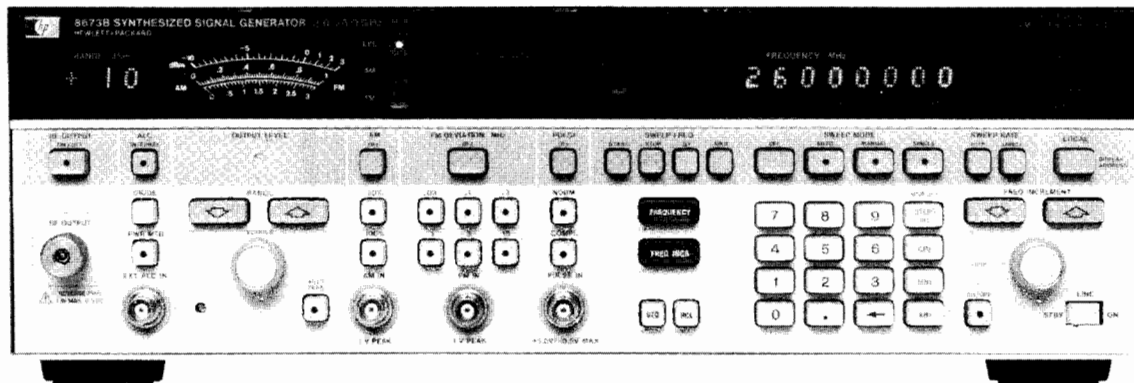

HP 8673B



## HP 8673B, 8672A Synthesized Signal Generators

The HP 8673B and 8672A synthesized signal generators deliver precise microwave signals over the 2.0 to 26.0 GHz and 2.0 to 18.0 GHz frequency ranges respectively. The generators feature a compact solid-state package (133mm, 5.25 in. high), calibrated and leveled output power, AM/FM modulation capability, and full programmability. The HP 8673B further features internally leveled pulse modulation and microprocessor-enhanced control facilitating digital sweep.

### Excellent Spectral Purity

For LO applications and many tests on radar and microwave communication systems, the HP 8672A and 8673B provide extremely stable frequencies. Output signals are derived by multiplying a fundamental 2.0 to 6.6 GHz - 1 kHz resolution YIG-tuned oscillator  $\times 1$ ,  $\times 2$ ,  $\times 3$ , or  $\times 4$  to yield resolutions of 1 to 4 kHz depending upon band of operation. Indirect synthesis phase-locks the YIG-tuned oscillator to a 10 MHz quartz crystal reference providing excellent long and short term stability (frequency drift  $< 5 \times 10^{-10}$  per day). Phase-locked loop responses are optimized to allow the HP 8672A/73B generators to exhibit the lowest possible single-sideband phase noise.

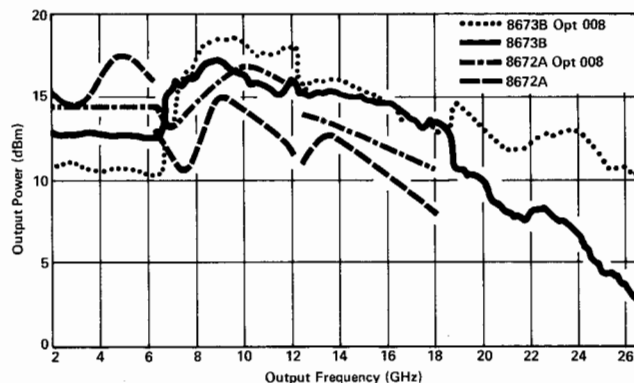

Figure 1. Maximum power typically available from HP 8673B, 8673B Option 008, 8672A, and 8672A Option 008 instruments at 25°C.

### Wide Dynamic Output Range

For broadband component and receiver testing applications, the HP 8673B and 8672A deliver exceptionally flat power outputs across their full frequency ranges. For receiver sensitivity measurements, power is internally (or externally) leveled and calibrated to -120 dBm on the HP 8672A and to -100 dBm on the HP 8673B. Maximum available power varies with frequency as shown in Figure 1. The HP 8672A Option 008 raises the guaranteed HP 8672A maximum output to +8 dBm from a standard +3 dBm. HP 8673B output power is guaranteed to be at least +8 dBm up to 18 GHz and 0 dBm up to 26 GHz (+7 dBm with option 008).

### Internally Leveled Pulse Modulation

The HP 8673B features an internal pulse modulator that provides high-quality pulse modulation over the entire 2.0 to 26.0 GHz range. The modulation is done before the frequency multiplication allowing the peak pulsed power to be leveled and calibrated to within typically  $\pm 1$  dB of the set level referenced to CW. ON/OFF ratios  $> 80$  dB and rise/fall times  $< 35$  ns make the HP 8673B ideal for use in pulsed radar test systems. Externally supplied TTL level drive signals determine pulse rates up to 1 MHz and leveled pulse widths as narrow as 100 ns.

### Calibrated AM/FM Modulation

To expand the versatility of the HP 8672A and 8673B in receiver testing applications, AM/FM capability is included. AM depth at rates up to 100 kHz can be accurately set using the front panel meter. Six ranges of metered FM are available at rates and peak deviations up to 10 MHz. Both AM depth and FM deviation are linearly controlled by varying the externally supplied modulating input voltage up to 1 V peak.

### Full Programmability and Digital Sweep

The HP 8673B and 8672A both provide full programmability of all front-panel functions for automatic test system applications. Over HP-IB, output level can be controlled in steps as fine as 1 dB (HP 8672A) and 0.1 dB (HP 8673B). In addition, the HP 8673B uses an internal microprocessor that facilitates convenient keyboard control, easy HP-IB program code generation following front-panel keystroke sequences, and digital sweep. Sweep spans can be set over the entire frequency range with variable rates, step sizes, and selectable markers available. Sweep outputs needed for compatibility with scalar and network analyzers are provided on the HP 8673B rear panel.



- 2 to 18 GHz frequency range
- Low spurious and phase noise
- Metered AM/FM

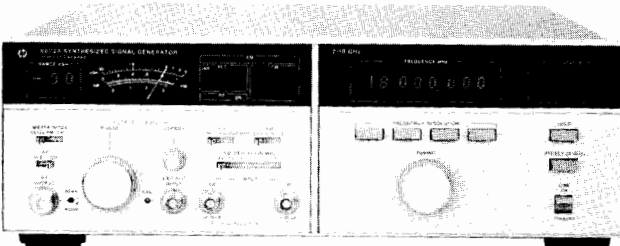

HP 8672A

## HP 8672A, 8673B Specifications

(HP 8672A and 8673B specifications are identical except for additional HP 8673B specifications in *italic type*.)

### Frequency Characteristics

**Frequency range:** 2.0–18.0 GHz (18.599997 GHz overrange).  
2.0–26.0 GHz (26.5 GHz overrange).

**Frequency bands:** band 1, 2.0–6.2 GHz; 2.0–6.6 GHz  
band 2, 6.2–12.4 GHz; 6.6–12.3 GHz  
band 3, 12.4–18.0 GHz; 12.3–18.6 GHz  
band 4, 18.6–26.0 GHz.

**Frequency resolution:** 1 kHz in Band 1, 2 kHz in Band 2, 3 kHz in Band 3, 4 kHz in Band 4.

**Time base:** internal 10 MHz ( $<5 \times 10^{-10}$ /day aging rate) or external 5 or 10 MHz.

**Frequency switching time:**  $<15$  ms ( $<20$  ms) to be within specified resolution, all bands.

### Spectral Purity

#### Single-sideband phase noise (1 Hz BW, CW mode):

F <sub>c</sub>	Offset from F <sub>c</sub>				
	10 Hz	100 Hz	1 kHz	10 kHz	100 kHz
Band 1	-58 dBc	-70 dBc	-78 dBc	-86 dBc	-110 dBc
Band 2	-52 dBc	-64 dBc	-72 dBc	-80 dBc	-104 dBc
Band 3	-48 dBc	-60 dBc	-68 dBc	-76 dBc	-100 dBc
Band 4	-46 dBc	-58 dBc	-66 dBc	-74 dBc	-98 dBc

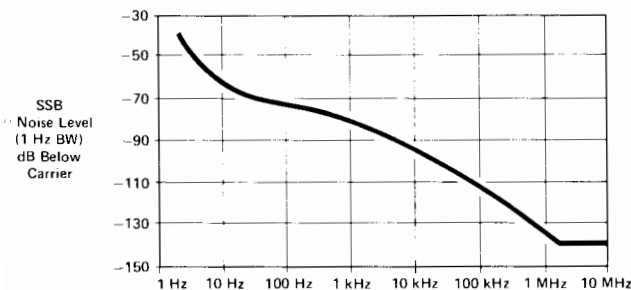

Figure 2. Typical HP 8672A & 8673B single-sideband phase noise performance using the internal standard, Band 1.

**Harmonics (up to maximum frequency, output level meter readings  $<0$  dB on 0 dBm range and below):**  $<-25$  dBc,  $<-40$  dBc.

**Sub-harmonics and multiples thereof:**  $<-25$  dBc, Bands 1–3;  $<-20$  dBc, Band 4.

### Spurious (CW and AM modes)

**Non-harmonically related:**  $<-70$  dBc, Band 1;  $<-64$  dBc, Band 2;  $<-60$  dBc, Band 3;  $<-58$  dBc, Band 4.

**Power line related and fan rotation related within 5 Hz below line frequency and multiples thereof:**

F <sub>c</sub>	Offset from F <sub>c</sub>		
	$<300$ Hz	300 Hz to 1 kHz	$>1$ kHz
Band 1	-50 dBc	-60 dBc	-65 dBc
Band 2	-44 dBc	-54 dBc	-59 dBc
Band 3	-40 dBc	-50 dBc	-55 dBc
Band 4	-38 dBc	-48 dBc	-53 dBc

### Output Characteristics

**Output level (+15°C to +35°C):** +3 to -120 dBm; +8 to -100 dBm up to 18 GHz, +4 to -100 dBm up to 22 GHz, 0 to -100 dBm up to 26 GHz.

**Flatness (0 dBm range, +15°C to +35°C):**  $\pm 0.75$  dB through Band 1,  $\pm 1.0$  dB through Band 2,  $\pm 1.25$  dB through Band 3,  $\pm 1.75$  dB through Band 4.

**Remote programming output level resolution:** 1.0 dB; 0.1 dB.

**Source impedance:** 50 ohms nominal.

### Pulse Modulation (HP 8673B)

**ON/OFF ratio:**  $>80$  dB.

**Rise/fall times:**  $<35$  ns.

**Minimum leveled pulse width:**  $<100$  ns.

**Pulse repetition frequency:** dc–1 MHz.

**Maximum peak power:** same as in CW mode.

**Peak level accuracy (relative to CW, +15°C to +35°C):**  $\pm 1.5$  dB.

**Pulse modulation input requirements:** normal mode, positive-true TTL levels; complement mode, negative-true TTL levels.

**Video feedthrough:** typically  $<-50$  dBc.

### Amplitude Modulation

**Rates (3 dB BW, 30% depth):** 10 Hz–100 kHz; 10 Hz–50 kHz (Option 008); 20 Hz–100 kHz.

**Sensitivity:** 30%/V, 100%/V ranges. Max. input 1 V peak into 600  $\Omega$ .

### Frequency Modulation

**Peak deviation (max.):** the smaller of 10 MHz or  $f_{mod} \times 5$ , Band 1; 10 MHz or  $f_{mod} \times 10$ , Band 2; 10 MHz or  $f_{mod} \times 15$ , Band 3; 10 MHz or  $f_{mod} \times 20$ , Band 4.

**Sensitivity:** 30, 100, 300 kHz/V and 1, 3, 10 MHz/V ranges.

Max. input 1 V peak into 50  $\Omega$ .

**Rates (3 dB BW typical):** 30, 100 kHz/V ranges: 50 Hz to 10 MHz; 300 kHz/V and 1, 3, 10 MHz/V ranges: 1 kHz to 10 MHz.

### Digital Sweep Characteristics (HP 8673B)

**Sweep function:** start/stop or  $\Delta F$  (span) sweep.

**Sweep modes:** manual, auto, or single sweep.

**Step size:** maximum of 9999 frequency points per sweep; minimum step size equals frequency resolution.

**Dwell time:** set from 1 to 255 ms per frequency.

**Markers:** 5 independent, settable frequency markers.

**Sweep outputs:** 0 to +10 V ramp start to stop; 1 V/GHz ramp (18 V maximum); Z-axis blanking/markers; tone marker; penlift.

### Remote Programming

All functions HP-IB programmable except line switch. The HP 8673B can output over the interface frequency and output level settings, error/malfunction codes, and operational status codes.

### Interface functions:

**HP 8673B:** SH1, AH1, T5, TE0, L3, LE0, SR1, RL1, PP1, DC1, DT1, C0, E1.

**HP 8672A:** SH1, AH1, T6, TE0, L4, LE0, SR1, RL0, PP2, DC1, DT0, C0, E1.

### General

**Operating temperature range:** 0°C to +55°C.

**Power:** 100, 120, 220, 240 V, +5%, -10%, 48–66 Hz; 400 VA max.

**Weight:** net, 27 kg (60 lb), 29 kg (64 lb). Shipping, 32.5 kg (72 lb), 34.5 kg (76 lb).

**Size:** 133 mm H x 425 mm W x 603 mm D (5.25" x 16.75" x 23.75").

### Ordering Information

HP 8673B Synthesized Signal Generator

HP 8672A Synthesized Signal Generator

**Option 001:** Delete RF output attenuator

**Option 002:** Delete reference oscillator

**Option 003:** Operation at 400 Hz line

**Option 004:** Rear panel RF output

**Option 005:** Rear panel RF output without RF attenuator

**Option 006:** Chassis slide kit

**Option 008:** +8 dBm (+7 dBm) output level

**Option 907:** Front panel handle kit

**Option 908:** Rack mounting flange kit

**Option 909:** Front panel handle kit plus rack mounting flange kit

**Option 910:** Extra operating and service manual

HP 11712A Support Kit (for HP 8672A)

HP 11726A Support Kit (for HP 8673B)

- 10 MHz to 26.5 GHz frequency range
- $< -60$  dBc harmonics/subharmonics
- Low SSB phase noise and spurious outputs
- $+5$  to  $-100$  dBm calibrated output
- 1 to 4 kHz frequency resolution
- Leveled pulse modulation/AM/FM

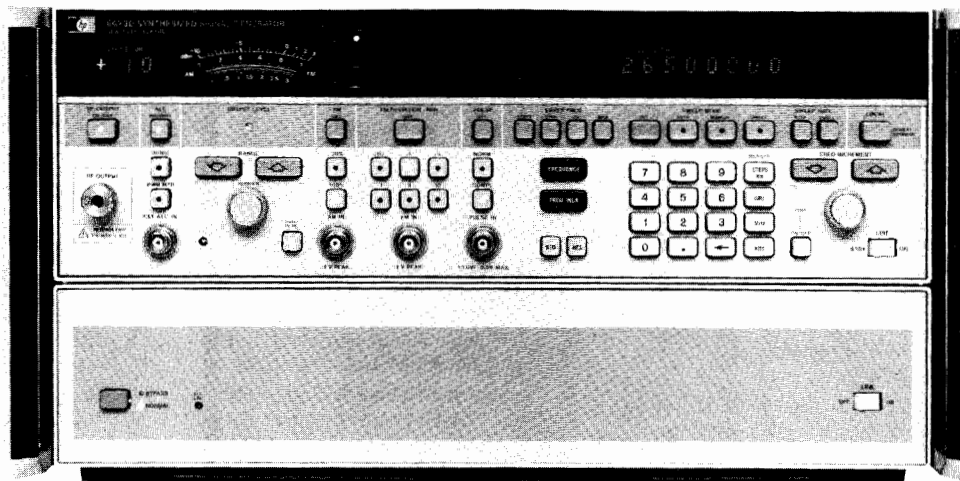

HP 8673D



## HP 8673C and 8673D Synthesized Signal Generators

Designed as versatile microwave test sources for broadband receiving systems, the HP 8673C and 8673D synthesized signal generators offer precise signal simulation capability in the 50 MHz to 26.5 GHz frequency range. The generators deliver spectrally pure frequencies, with harmonically related spurious outputs  $< -60$  dBc above 1.2 GHz. Internal solid state amplifiers guarantee that adequate levels will be delivered to the system under test, even after the signal has passed through a number of automatic test system switching paths. Output is leveled and calibrated to a low level of  $-100$  dBm, and maximum leveled output is specified to be at least  $+5$  dBm across the HP 8673D operating band. High performance pulse modulation ( $>80$  dB ON/OFF ratios,  $<40$  ns rise/fall times) is delivered via external video modulating signals, as are amplitude and frequency modulation. Simultaneous modulation is possible to simulate complex environments. All operating parameters are HP-IB programmable.

For source applications limited to Ku band and below, the HP 8673C offers 50 MHz to 18.6 GHz frequency coverage, with  $+5$  dBm levels to 16 GHz, and  $+2$  dBm to 18.6 GHz.

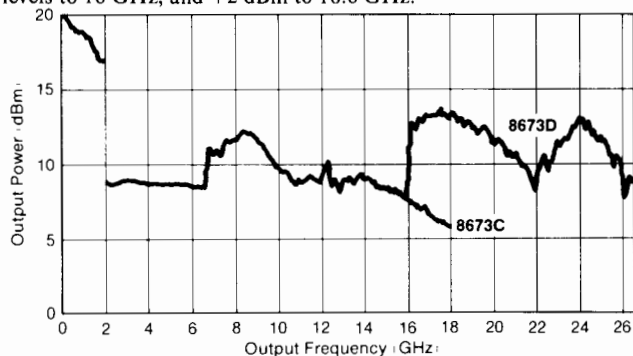

Figure 1. Maximum power typically available from the HP 8673C and 8673D at 25°C

## HP 8673C and 8673D Specifications

(HP 8673C and D specifications are identical to HP 8673B specifications with the following exceptions and/or additions.)

### Frequency Characteristics

#### Frequency range

HP 8673D: 50 MHz–26.0 GHz (10 MHz–26.5 GHz overrange);

HP 8673C: 50 MHz–18.6 GHz (10 MHz–18.6 GHz overrange).

**Frequency bands:** band 0, 50 MHz–2.0 GHz.

**Frequency resolution:** 1 kHz in Band 0.

**Frequency switching time:**  $<50$  ms to be within specified resolution, all bands.

### Spectral Purity

#### Single-Sideband Phase Noise (1 Hz BW, CW mode):

F <sub>C</sub>	Offset from F <sub>C</sub>				
	30 Hz	100 Hz	1 kHz	10 kHz	100 kHz
Band 0	-64 dBc	-70 dBc	-78 dBc	-86 dBc	-105 dBc

**Harmonics** (up to maximum frequency, output level meter readings  $<0$  dB on 0 dBm range and below):  $<-40$  dBc, 50 MHz–1.2 GHz;  $<-60$  dBc, 1.2–26.0 GHz.

**Subharmonics and multiples thereof:**  $<-60$  dBc.

#### Spurious (CW and AM modes)

**Non-harmonically related:**  $<-60$  dBc, Band 0.

**Power line related and fan rotation related within 5 Hz below line frequency and multiplies thereof:**

F <sub>C</sub>	Offset from F <sub>C</sub>		
	$<300$ Hz	300 Hz to 1 kHz	$>1$ kHz
Band 0	-50 dBc	-60 dBc	-65 dBc

### Output Characteristics

**Output level** ( $+15^\circ\text{C}$  to  $+35^\circ\text{C}$ ):  $+11$  to  $-100$  dBm, 50 MHz to 2 GHz;  $+5$  to  $-100$  dBm, 2 to 22 GHz;  $+6$  to  $-100$  dBm, 22–26 GHz ( $+2$  to  $-100$  dBm, 8673C 16–18.6 GHz).

**Flatness** (0 dBm range,  $+15^\circ\text{C}$  to  $+35^\circ\text{C}$ ):  $\pm 0.5$  dB through Band 0.

### Pulse Modulation

**Rise/fall times:**  $<20$  ns, Band 0.

### Frequency Modulation

**Peak deviation (max.):** the smaller of 10 MHz or  $f_{\text{mod}} \times 5$ , Band 0.

### Remote programming

**Interface functions:** SH1, AH1, T5, TL0, L3, LE0, SR1, RL1, PP1, DC1, DT1, C0, E1.

### General

**Power:** 100, 120, 220, 240V,  $+5\%$ ,  $-10\%$ , 48–66 Hz; 500 VA max.

**Weight:** net, 42.4 kg (94 lb). Shipping, 46.5 kg. (103 lb).

**Size:** 613 mm D x 425 mm W x 234 mm H (24.1" x 16.8" x 9.2").

### Ordering Information

HP 8673C Synthesized Signal Generator

HP 8673D Synthesized Signal Generator

**Option 001:** Delete RF output attenuator

**Option 002:** Delete reference oscillator

**Option 003:** Operation at 50/60/400 Hz line

**Option 004:** Rear panel RF output

**Option 005:** Rear panel RF out without attenuator

**Option 006:** Chassis slide kit

**Option 908:** Rack mounting flange kit

**Option 913:** Rack flanges for standard front handles

**Option 910:** Extra operating and service manual

# SIGNAL GENERATORS

## Synthesized Signal Generator, Synthesized Source

Models 8672S, 8671A



- 10 MHz–18 GHz frequency range
- Internal pulse modulator
- HP-IB programmability

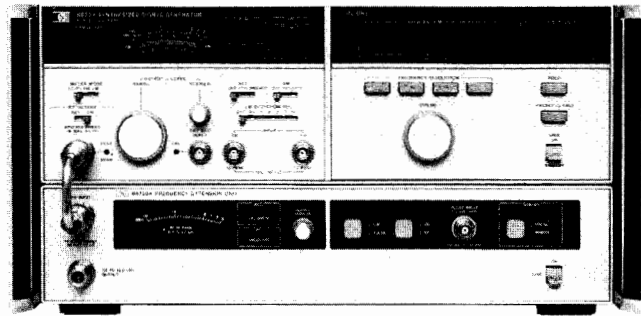

HP 8672S

### HP 8672S Synthesized Signal Generator

The HP 8672S synthesized signal generator consists of an HP 8672A synthesized signal generator and an HP 86720A frequency extension unit. The HP 86720A uses a heterodyne technique to extend the frequency coverage of a standard HP 8672A to a lower limit of 10 MHz. As a single 9-inch high package, the HP 8672S features 10 MHz to 18 GHz single-knob continuous frequency tuning, calibrated CW output power, and an internal pulse modulator allowing high-quality pulse modulation over the entire 10 MHz to 18 GHz frequency range. All front-panel functions, with the exception of the line switches, are HP-IB programmable.

Specifications for the HP 8672S are identical to those of a stand-alone HP 8672A for the 2 to 18 GHz frequency range with the exception of a 1 dB decrease in maximum output power and no AM modulation available below 2 GHz.

Existing HP 8672A signal generators can be retrofitted to the HP 8672S configuration by ordering the HP 86720A frequency extension unit and an HP 11731A or 11732A frequency extension retrofit kit.

### HP 8672S Specifications

(Specifications for the HP 8672S are identical to those of the standard HP 8672A with the following exceptions.)

#### Frequency Characteristics

**Frequency range:** 10 MHz–18.0 GHz (18.599997 GHz overrange).  
**Frequency resolution:** 1 kHz to 6.2 GHz, 2 kHz to 12.4 GHz, 3 kHz to 18.0 GHz.

**Non-harmonic spurious:**  $< -60$  dBc, 10 MHz–1.999999 GHz.

**Power line and fan rotation related spurious:** 10 MHz–6.2 GHz, same as HP 8672A 2.0–6.2 GHz.

**Single-sideband phase noise (1 Hz BW, CW mode):** 10 MHz–6.2 GHz, same as HP 8672A 2.0–6.2 GHz.

#### Output Characteristics

**Output level:** +13 dBm to  $-120$  dBm, 0.01–2.0 GHz; +2 dBm (+7 dBm, Opt. 008) to  $-120$  dBm, 2.0–18.0 GHz.

**Total indicated meter accuracy:** 0.01–2.0 GHz, same as HP 8672A 2–6.2 GHz degraded by 0.5 dB; 2.0–18.0 GHz, HP 8672A degrades by 0.25 dB.

**Level flatness:** same as HP 8672A degraded by  $\pm 0.25$  dB.

#### Modulation Characteristics

**Frequency modulation:** 0.01–2.0 GHz, same as HP 8672A 2–6.2 GHz.

**Pulse modulation:**  $> 80$  dB ON/OFF ratio;  $< 15$  ns rise/fall times; peak pulsed power within 1.0 dB of level selected in CW mode for 0.01–2 GHz, uncalibrated for 2.0–18.0 GHz.

#### General

**Programming:** all functions HP-IB programmable except line switches and meter mode.

**Interface functions:** SH1, AH1, T6, TL0, L4, LE0, SR1, RL0, PP2, DC1, DT0, C0, E1.

**Operating temperature range:** 0 to  $+55^\circ\text{C}$  ( $+15$  to  $+35^\circ\text{C}$  for specified performance).

**Size:** 222 H x 425 W x 620 mm D (8.8" x 16.8" x 24.4").

- 2–6.2 GHz frequency range
- Low spurious and phase noise
- +8 dBm minimum output power

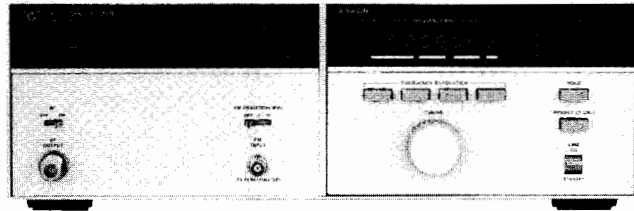

HP 8671A

### HP 8671A Synthesizer

The HP 8671A microwave frequency synthesizer covers the frequency range of 2.0 to 6.2 GHz in 1 kHz steps with excellent stability and spectral purity. It is well suited for most LO applications that require state-of-the-art performance as well as broadband capability.

### HP 8671A Specifications

(Specifications for the HP 8671A are identical to those of the standard HP 8672A 2.0–6.2 GHz with the following exceptions.)

#### Frequency Characteristics

**Harmonics:**  $< -15$  dBc.

#### Output Characteristics

**Power (unleveled):** +8 dBm (min.),  $+15$  to  $+35^\circ\text{C}$ .

**Flatness:**  $< 6$  dB total variation across full frequency band.

#### Amplitude Modulation

Not available.

#### Frequency Modulation

**Sensitivity:** 50 kHz/V and 5 MHz/V ranges; max input 2 V peak.

#### General

**Programming interface functions:** SH1, AH1, T6, TE0, L4, LE0, SR1, RL0, PP2, DC1, DT0, C0, E1.

**Weight:** net, 24 kg (53 lb). Shipping, 29.5 kg (65 lb).

#### Ordering Information

**HP 8672S Synthesized Signal Generator**

**Option 001:** Delete RF output attenuator

**Option 002:** Delete reference oscillator

**Option 003:** Operation at 50/60/400 Hz line

**Option 004:** Rear panel RF output

**Option 005:** Rear panel RF output without RF attenuator.

**Option 006:** Chassis slide kit

**Option 008:** +7 dBm output level

**Option 009:** Delete internal pulse modulator

**Option 010:** Delete pulse modulator and step attenuator

**Option 908:** Rack flange kit

**Option 913:** Rack flanges for standard front panel handles.

**Option 910:** Extra operating and service manuals

**HP 86720A Frequency Extension Unit**

**HP 11731A Frequency Extension Retrofit Kit**

**HP 11732A Frequency Extension Retrofit Kit**

**HP 8671A Microwave Frequency Synthesizer**

**Option 002:** No internal reference

**Option 003:** Operation at 50/60/400 Hz line

**Option 005:** Rear panel RF output

**Option 006:** Chassis slide kit

**Option 907:** Front panel handle kit

**Option 908:** Rack mounting flange kit

**Option 909:** Front panel handle plus rack mounting flange kit

**Option 910:** Extra operating and service manual

**HP 11712A Support Kit**

# SIGNAL GENERATORS

## Accessories, Frequency Doublers

Models 10514A, 10534A, 11509A, 11687A, 11690A, 11710B, 11721A

- Additional capabilities for signal generators

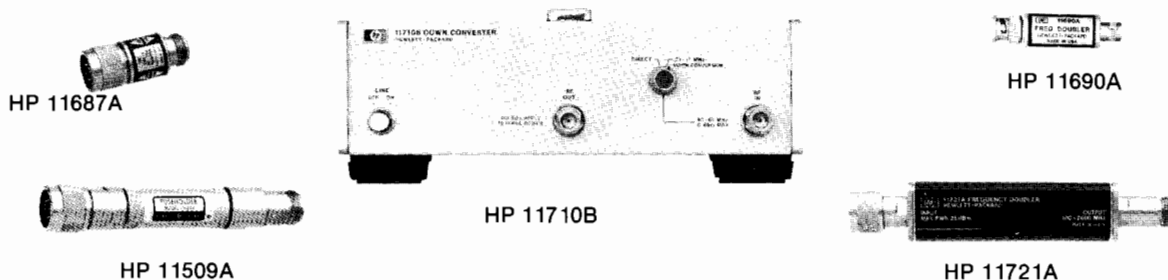

### HP 11509A Fuseholder

Accidental burnout of attenuators in HP 8640 and HP 8654 Signal Generators can be prevented by using this fuse element between the signal generator and a transceiver. The fuseholder has a frequency range of dc to 480 MHz, insertion loss of  $\leq 1$  dB, SWR of  $\leq 1.35$  (50  $\Omega$  load), and Type N connectors. Ten extra fuses are furnished.

### HP 11687A 50-75 $\Omega$ Adapter

This 50-75  $\Omega$  Adapter with Type N connectors is recommended for use with HP 8640, 8642, 8654, 8660, 8656, and 8662 Signal Generators for measurements in 75  $\Omega$  systems. The voltage calibration on the output level meter is unaffected by use of the adapter, but 1.76 dB must be subtracted from the dB scale on the meter to determine the output in dBm into 75  $\Omega$ . Frequency range is dc to 1300 MHz.

### HP 11690A Frequency Doubler

The HP 11690A extends the frequency range of all HP 8640 series Signal Generators by doubling the 256-512 MHz frequency band up to 1024 MHz (to 110 MHz with band overrange). All HP 8640's indicate the correct doubled output frequency on a dial or counter when the 512-1024 MHz range is selected. The HP 11690A will also perform well with any source meeting the input requirements of 200-550 MHz at +10 to +19 dBm. Conversion loss is  $< 13$  dB, output flatness has  $< 4$  dB total variation, and the 1st and 3rd input harmonics are suppressed  $> 20$  dB. Connectors are BNC.

### HP 11710B Down Converter

The HP 11710B Down Converter is an accessory for the HP 8640 and HP 8654 series signal generators. Frequency inputs from 50.01 to 61 MHz are down converted to the 10 kHz to 11 MHz range respectively. The output level and modulation functions of the HP 8640 and HP 8654 remain calibrated. A straight-through selection switch allows the input to pass through unchanged, and thus minimizes the necessity to move cables when testing. Option 001 provides rails and semi-rigid coax for combining the HP 11710B with an HP 8654A,B Signal Generator.

### HP 11710B Specifications

#### Input

**Down-conversion mode:** 50.01 to 61.00 MHz at  $\leq 0$  dBm.  
**Straight-through mode:** 0.01 to 1100 MHz (dc coupled).

#### Down-Converted Output

**Frequency range:** 10 kHz to 11 MHz.  
**Level range:** 0 to  $-107$  dBm  
**Level flatness:** RF source flatness  $\pm 0.5$  dB (referred to 4.0 MHz).  
**Total level accuracy:**  $\pm (1$  dB plus input level accuracy).  
**Harmonics:**  $> 35$  dB below the carrier (dBc).  
**Intermixing spurious:**  $> 60$  dBc.  
**Local oscillator feed-through (50 MHz):**  $< -100$  dBm.

### Internal Reference Characteristics

**Time base output:** 1 MHz or 5 MHz selectable, nominally  $> 0.5$  V p-p into 500  $\Omega$ . This will drive an HP 8640B external time base input.  
**Typical overall accuracy:** (within 3 months of calibration and from 15°C to 35°C):  $\pm 2$  ppm.

### General

**Operating temperature range:** 0 to 55°C.  
**Power requirements:** 100, 120, 220, 240V (+5%, -10%), 48 to 440 Hz; 25 VA maximum.  
**Weight:** net, 3.2 kg (7 lb); shipping, 4.5 kg (9 lb).  
**Size:** 102 H  $\times$  266 W  $\times$  295 mm D (4"  $\times$  10.5"  $\times$  11.6").  $\frac{1}{2}$  MW  $\times$  4 H  $\times$  11 D System 1 Module.

### HP 11721A Frequency Doubler

The HP 11721A Doubler is an ideal accessory for extending the usable frequency range of signal generators, frequency synthesizers, or other signal sources. Operating on input frequencies of 50 MHz to 1300 MHz, it provides a doubled output in the range of 100 MHz to 2600 MHz. The HP 11721A will work well with any RF source with an output in the range 50 to 1300 MHz.

The 50  $\Omega$  passive circuit of the HP 11721A offers low conversion loss, low spurious, and excellent flatness over its entire frequency range when operated above +10 dBm.

### HP 11721A Specifications

**Input frequency range:** 50 to 1300 MHz.  
**Output frequency range:** 100 to 2600 MHz.  
**Conversion loss (+13 dBm input, 50 to 1280 MHz):**  $< 15$  dB.  
**Spurious referenced to desired output frequency f (+13 dBm input with harmonics  $< -50$  dBc, 50 to 1280 MHz):**  $f/2$ ,  $-15$  dB;  $3f/2$ ,  $-15$  dB.  
**Input SWR:** 1.5 typical.  
**Input/output impedance:** 50  $\Omega$  nominal.  
**Operating temperature range:** 0 to +50°C.  
**Connectors:** input, type N male; output, type N female.  
**Size:** 161 L  $\times$  30 W  $\times$  20.5 mm H (6  $\frac{3}{8}$ "  $\times$  1  $\frac{1}{16}$ "  $\times$  1  $\frac{1}{16}$ ").  
**Weight:** net, .02 kg (0.5 lb); shipping, 0.4 kg (1 lb).

### Ordering Information

HP 11509A Fuseholder  
HP 11687A 50  $\Omega$ -75  $\Omega$  Adapter  
HP 11690A Frequency Doubler  
HP 11710B Down Converter  
Option 001: Combining Kit  
Option 910: Extra operating & service manual  
HP 11721A Frequency Doubler



# SIGNAL GENERATORS

Doublers, Pulse Modulator

Models 938A, 940A, 11720A

465



- Doubler sets for signal output 18-26.5 GHz, 26.5-40 GHz

- 2 to 18 GHz
- < 10 ns rise and fall times
- > 80 dB ON/OFF ratio

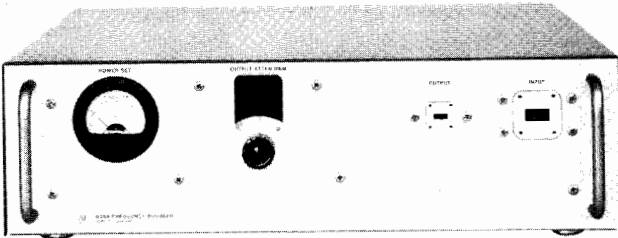

HP 938A

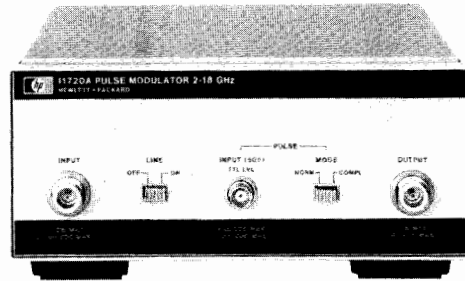

HP 11720A

## HP 938A, 940A Frequency Doubler Sets

The HP 938A supplies power from 18 to 26.5 GHz and HP 940A from 26.5 to 40 GHz when driven by 9 to 13.25 GHz and 13.25 to 20 GHz sources respectively. For manually tuned frequencies, HP 8683D Option 001 and HP 8684D Option 001 signal generators are ideal driving sources because of their excellent high power outputs and stable signal performance. For synthesized signal performance, the HP 8673B signal generator provides input signals up to 20 GHz, under programmed control. For a swept output, use a swept-frequency source such as the HP 8350B with appropriate RF units.

These frequency doubler sets consist of broadband harmonic generators suitably mounted in a waveguide section, a power monitor, a broad stopband low-pass filter, and a precision attenuator. The input signal may be CW, pulsed, or swept. Thus, the frequency doubler sets retain all the modulation versatility of the driving source.

The calibrated power monitor and precision, calibrated output attenuators allow the power output of the doubler to be calibrated even though the output of the driving source is not, and the attenuator allows output power to be accurately controlled over a range from 0 to 100 dB.

### HP 938A, 940A Specifications

**Frequency range:** HP 938A, 18 to 26.5 GHz; HP 940A, 26.5 to 40 GHz.

**Conversion loss:** less than 18 dB at 10 mW input.

**Output power:** approximately 0.5–1 mW when used with typical HP signal generators; input power 100 mW maximum.

**Output monitor accuracy:**  $\pm 2$  dB.

**Output attenuator accuracy:**  $\pm 2\%$  of reading or  $\pm 0.2$  dB whichever is greater.

**Attenuator range:** 100 dB.

**Output reflection coefficient:** approx. 0.33 at full output; less than 0.2 with attenuator set to 10 dB or greater.

**Output flange:** HP 938A, K-band flat cover flange for WR-42 waveguide; HP 940A, R-band flat cover flange for WR-28 waveguide.

**Input flange:** HP 938A, M-Band flat cover flange for WR-75 waveguide; HP 940A, N-Band flat cover flange for WR-51 waveguide.

**Accessories available:** HP 938A, waveguide adapters HP MP292B, MX292B, X-band flexible waveguide HP 11504A, P-band flexible waveguide HP 11503A; HP 940A, waveguide adapters HP NP292A, MP292B, P-band flexible waveguide HP 11503A.

**Size:** 137 H x 489 W x 457 mm D (5.4" x 19.25" x 18").

**Weight:** net, 9 kg (20 lb). Shipping, 11.8 kg (26 lb).

## HP 11720A Pulse Modulator

The HP 11720A pulse modulator is a high performance microwave pulse modulator covering the range of 2 to 18 GHz. Because of this wide frequency coverage, it can be used to increase the modulation capabilities of many microwave sources (sweepers or signal generators) and eliminate the need for several individual modulators in broadband applications.

The HP 11720A features extremely short rise and fall times (< 10 ns) and a high on/off ratio (> 80 dB), making it suitable for almost any pulsed RF application.

The HP 11720A contains all the necessary modulator drive circuitry to achieve specified performance so that a standard pulse generator, or any other source that can deliver > 3 V peak into 50 ohms, can supply the input. In addition, a normal/complement function is provided to adapt the HP 11720A to positive-true or negative-true logic inputs.

### HP 11720A Specifications

**Frequency range:** 2 to 18 GHz.

**ON/OFF ratio:** > 80 dB.

**Rise and fall times:** < 10 ns.

**Insertion loss:** < 6 dB, 2 to 12.4 GHz; < 10 dB, 2 to 18 GHz.

**Maximum RF input power:** +20 dBm.

**Maximum repetition rate:** > 5 MHz.

**Minimum RF pulse width:** < 50 ns.

**Video feedthrough:** < 60 mV peak-to-peak.

#### Pulse Input

**Normal mode:** > 3 V (on), < 0.5 V (off).

**Complement mode:** < 0.5 V (on), > 3 V (off).

**Impedance:** 50  $\Omega$  nominal.

**Operating temperature:** 0°C to +55°C.

**Power:** 100, 120, 220, 240 V +5, -10%; 48–400 Hz; 25 VA max.

**Weight:** net, 2.6 kg (6 lb). Shipping, 3.5 kg (8 lb).

**Size:** 101 mm H x 212 mm W x 290 mm D (4.0" x 8.4" x 11.4").  
½ MW x ¾ H x 11 D System II Module.

### Ordering Information

HP 938A or 940A Frequency Doubler

Option 910: Extra operating & service manual

HP 11503A Flexible Waveguide P-Band

HP 11504A Flexible Waveguide X-Band

HP 11720A Pulse Modulator

Option 910: Extra manual



# SIGNAL GENERATORS

## PIN Modulators, Pulse Driver

Models 8730 Series, 8403A

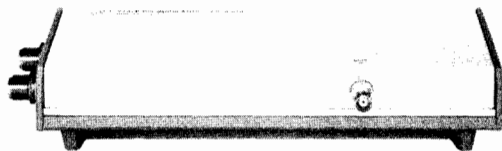

HP 8730B Series

### HP 8730 Series PIN Modulators

With HP 8730 series PIN modulators, signal sources, including klystrons, can be pulse-modulated, leveled or amplitude-modulated with sinusoidal and complex waveforms. Fast rise times, low incidental FM and a nearly constant impedance match to source and load are typical of these absorption-type modulators.

### HP 8403A Modulator

The HP 8403A provides complete control of the PIN modulators, supplying the appropriate modulation wave shapes and bias levels for fast rise times, rated on/off ratios and amplitude modulation. An internal square-wave and pulse modulator with PRF of 50 Hz to 50 kHz and adjustable pulse width and delay also provide square wave and pulses for general pulse applications. For applications requiring an absorption-type modulator plus controls in a single unit, a PIN modulator can be installed in the HP 8403A.

### HP 8403A Specifications

**Output Characteristics** (available separately at front panel).

**For driving HP 8730 PIN modulators:** AM and pulse output, pulse output specially shaped for optimum RF rise and decay times.

**For general pulse applications:** positive dc-coupled pulse 25 to 30 volts in amplitude, approximately symmetrical about 0 volt; no AM signal.

#### Modulation

##### Internal Square Wave

**Frequency:** variable from 50 Hz to 50 kHz.

**Symmetry:** better than 45/55%.

##### Internal Pulse

**Repetition rate:** variable from 50 Hz to 50 kHz.

**Delay:** variable from 0.1  $\mu$ s to 100  $\mu$ s, between sync out pulse and RF output pulse.

**Width:** variable from 0.1  $\mu$ s to 100  $\mu$ s.

### HP 8730 Series Specifications

	HP 8731B	HP 8732B	HP 8733B	HP 8734B	HP 8735B	HP 8731B-H10*
Frequency range (GHz)	0.8-2.4	1.8-4.5	3.7-8.3	7.0-12.4	8.2-12.4	0.4-1.2
Dynamic range (dB)	80	80	80	80	80	35
Max. residual atten. (dB) <sup>1</sup>	<2.0	<3.5 <sup>2</sup>	<3.0	<5.0	<5.0	<2.0
Typical rise time (ns) <sup>2</sup>	30	30	30	30	30	40
Typical decay time (ns) <sup>2</sup>	20	20	20	20	20	30
SWR, min. attenuation	1.6	1.6 <sup>4</sup>	2.0	2.0	2.0	1.5 <sup>7</sup>
SWR, max. attenuation	2.0	2.0	2.2	2.2	2.2	2.0 <sup>7</sup>
Forward bias input resistance (ohms)	100	100	100	100	100	300
RF connector type	N(f)	N(f)	N(f)	N(f)	W/G <sup>5</sup>	N(f)
Weight, net kg (lb)	2.5 (5.5)	2.7 (6.0)	1.4 (3.0)	1.4 (3.0)	1.4 (3.0)	2.5 (5.5)
shipping kg (lb)	3.3 (7.3)	3.5 (7.8)	1.9 (4.2)	1.9 (4.2)	1.9 (4.2)	3.3 (7.3)
Dimensions						
Height, mm (in)	57 (2.25)	57 (2.25)	57 (2.25)	57 (2.25)	57 (2.25)	57 (2.25)
Width, mm (in)	124 (4.9)	124 (4.9)	83 (3.25)	83 (3.25)	83 (3.25)	124 (4.9)
Depth, mm (in)	289 (11.4)	289 (11.4)	311 (12.3)	311 (12.3)	267 (10.5)	289 (11.4)

Maximum ratings: maximum input power, peak or CW: 1 W; bias limits: +20 V, -10 V.

Bias polarity: negative voltage increases attenuation.

RFI: radiated leakage limits are below those specified in MIL-I-6181D at input levels <1 mW; at all input levels radiated interference is sufficiently low to obtain rated attenuation.

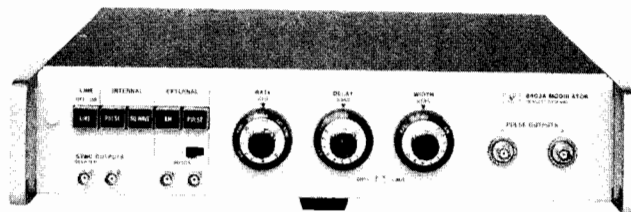

HP 8403A

#### External Sync

**Signal:** 5 to 20 volts peak, + or -, pulse or sine wave.

**Input impedance:** approximately 2000 ohms, dc-coupled.

#### Trigger Out

**Sync out:** simultaneous with or 0.1 to 100  $\mu$ s in advance of RF pulse, as set by delay control.

**Delayed sync out:** simultaneous with output pulse.

**Amplitude:** approximately -2 volts.

**Source impedance:** approximately 330 ohms.

#### External Pulse

**Amplitude and polarity:** 5 volts to 20 volts peak, + or -.

**Repetition rate:** maximum average PRF, 500 kHz/s.

**Input impedance:** approximately 2000 ohms, dc-coupled.

**Width:** minimum 0.1  $\mu$ s; maximum 1/PRF - 0.4  $\mu$ s.

**Amplitude Modulation** (with HP 8730 series)

**Frequency response:** dc to approximately 10 MHz (3 dB).

**Sensitivity:** approximately 10 dB/volt with HP 8730A series; approximately 20 dB/volt with HP 8730B series.

**Input impedance:** approximately 1000 ohms.

#### General

**Power:** 115 or 230 volts  $\pm$ 10%, 50 to 400 Hz, approximately 10 watts.

**Size:** 96 H x 425 W x 467 mm D (3.75" x 16.73" x 18.4").

**Weight:** net, 7.4 kg (16.5 lb). Shipping, 9 kg (20 lb).

#### Ordering Information

HP 8403A Modulator

#### Options

**002:** HP 8731B PIN Modulator installed in HP 8403A

**004:** HP 8732B PIN Modulator installed in HP 8403A

**006:** HP 8733B PIN Modulator installed in HP 8403A

**008:** HP 8734B PIN Modulator installed in HP 8403A

**009:** Input and Output Connectors on rear panel

**908:** Rack flange kit

**910:** Extra Manual

1. With +5 V bias.

2. 4 dB, 4 to 4.5 GHz.

3. Driven by HP 8403A Modulator.

4. 2.0 SWR, 4 to 4.5 GHz.

5. Fits 1 x 1/2 in. (WR 90) waveguide.

6. External high-pass filters required.

7. Excluding high-pass filters.



### Sweep Oscillators

Swept frequency oscillators are used in applications where the characteristics of a device must be determined over a wide, continuous range of frequencies. Combined with a broadband detector and display test set, sweep oscillators provide many benefits compared to CW frequency sources. A swept measurement provides a dynamic display of the data. The results of any adjustments to the unknown test device are seen immediately (real time) on the display. By replacing laborious point-by-point techniques swept measurements increase the speed and convenience of broadband testing. The continuous frequency characterization of the unknown device also eliminates the chance of missing important information between frequency points. Swept techniques are applicable in all phases of design, manufacture and maintenance.

### Hewlett-Packard Sweep Oscillators

Hewlett-Packard sweepers cover the entire frequency spectrum from dc to 40 GHz. Self-contained, multi-octave sweepers cover the frequency range to 110 MHz. The HP 8620 family of solid state oscillators provide a versatile choice of configurations—single band, straddle band, or very wide band plug-ins from 10 MHz to 22 GHz. 10 MHz to 40 GHz coverage is available in the HP 8350 family of plug-in sweep oscillators. The HP 8340A (10 MHz to 26.5 GHz) and new HP 8341A (10 MHz to 20 GHz) provide broadband synthesized frequency coverage with excellent stability ( $1 \times 10^{-9}$ /day) and phase noise. A chart of the individual frequency bands available appears on page 469.

### Sweep Oscillator Features

#### Sweep Flexibility

Every HP sweeper has several different sweep modes available for setting the frequency limits of the instrument. A full band or independently adjustable start/stop frequency sweep can be selected. Alternatively, a marker sweep or a symmetrical  $\Delta F$  sweep about the desired center frequency can be chosen. Switching from one sweep mode to another is a simple pushbutton operation. In the auto mode the sweep triggers automati-

cally. Sweep times from 0.01 to more than 100 seconds can be selected. A manual sweep is also available as a front panel control, a real convenience for calibrating displays such as X-Y recorders. An external trigger is provided as well for applications where the sweeper must be synchronized to other instrumentation or remotely controlled.

On all sweeps a linear voltage proportional to frequency is available on an external connector, which is useful for driving the horizontal input of a display. Blanking and pen lift signals are also provided at rear output connectors during retrace time when the RF is off.

Marker capability, both Z-axis intensity dots and RF pips, are available on HP sweepers to note your important measurement frequencies. Two or more independent markers are offered on all sweepers with up to five markers on the HP 8340A and new HP 8341A as well as the HP 8350 mainframe. Crystal markers are offered on the HP 86222B and 83522A 10 MHz to 2.4 GHz RF plug-ins, and the HP 83525A/B 10MHz to 8.4 GHz plug-ins.

Another powerful feature available on the HP 8340A/41A and 8350 sweeper mainframe is Save/Recall Mode. With Save/Recall Mode up to nine complete front panel states can be stored in memory and later recalled when the measurement is repeated. This saves considerable time when repetitive tests are required.

#### Power Output and Leveling

Power output is continuously adjustable at the front panel over approximately a 10 dB range of all plug-ins. Built-in attenuators are also available on most plug-ins for greater power control. Internal or external leveling is employed to obtain (1) a constant power output and (2) a good source match (low VSWR). This ensures high accuracy when making swept measurements.

The HP 8340A and new HP 8341A and 83500 series of plug-ins offer calibrated output power and internal leveling as standard features. Power is calibrated over a 15 dB range (40dB for the HP 8340A/41A) with 0.1 dB resolution (programmable to 0.02 dB); with an internal step attenuator, the calibrated range is extended to 85 dB (130 dB on the HP 8340A/41A).

When higher output power is required, the new HP 8349A microwave amplifier can be driven by the RF output of the sweeper to provide a full 20 dBm of output power from 2 to 20 GHz. The amplifier is capable of at least 15 dB of gain and can be easily leveled via its built-in directional detector and the automatic level control (ALC) circuitry of the sweeper (see Figure 1).

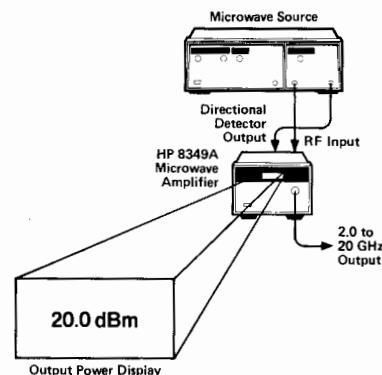
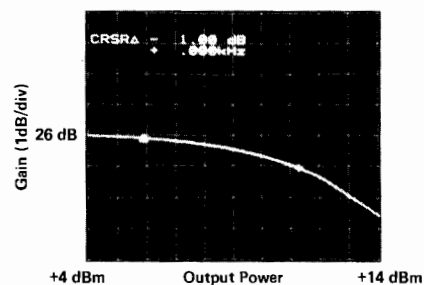

Figure 1.

Power as well as frequency can be swept with the HP 8340A/41A or the HP 8350 and 83500 series plug-ins. This means that both the frequency response and power response of level sensitive devices like transistors and amplifiers can be measured using the same test set-up. Using the power sweep function 1 dB gain compression can easily be measured at a CW frequency (Figure 2). Also, the ability to alternate between two discrete power levels on successive sweeps (HP 8340A/41A or 8350 and 83500





# SWEEP OSCILLATORS

## General Information (cont.)

series plug-ins) allows a swept measurement of 1 dB compression point. Output power characteristics can be optimized simultaneously (Figure 3).

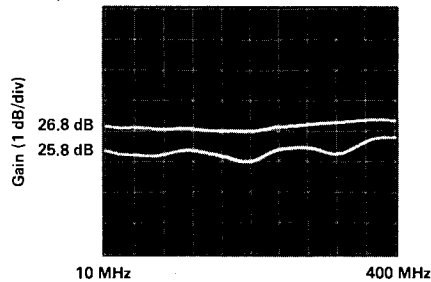

Figure 3.

### Modulation

Modulation capabilities further extend the sweeper's usefulness both as a sweeper and a signal generator for signal simulations. Wide AM and FM bandwidths are useful for a variety of tests on communication receivers. The flexible FM capability allows remote analog frequency programming, which is important for many applications.

External pulse modulation is also available on many plug-ins. Most plug-ins also accept the 27.8 kHz square wave modulation required by the HP 8755, 8756A and new HP 8757A scalar network analyzers directly, eliminating the need for an external modulator. The HP 8350 mainframe will supply the 27.8 kHz square wave modulation directly to the plug-in.

The HP 8340A and 8341A opt. 006 synthesized sweepers have extensive modulation capability, providing both internal pulse and AM modulation. The pulse modulation capability works for pulse widths as narrow as 100 ns, having rise and fall times less than 25 ns and an on/off ratio greater than 80 dB. The AM is dc coupled and has a 3 dB bandwidth of 100 kHz. The maximum modulation depth varies with available output power but it is never less than 90%. In addition, the HP 8340A and 8341A opt. 006 may simultaneously pulse and amplitude modulate the RF to simulate the effect of antenna scan on a pulse modulated signal.

### MLA Compatibility

In communications applications where up-converter simulation is required in conjunction with the HP Microwave Link Analyzer, the HP 86200 series of plug-ins provides this capability as an option in frequency ranges from 500 MHz to 18 GHz. Group delay of less than 1 nanosecond and linearity of better than 0.5% across 30 MHz across most of the frequency range permit very accurate RF to RF, RF to IF and RF to BB distortion measurements. See page 150 for more information.

### Programming

The HP 8340A/41A, 8350 mainframe and 83500 series plug-ins offer total HP-IB control of all front panel functions. Not only CW frequencies, but sweeps, markers, power levels, etc., can be remotely programmed via the HP-IB. This means there are no limitations to designing customized automatic systems for either component or system testing.

The HP 8620C solid state sweeper mainframe provides optional HP-IB programming capability. More than ten thousand frequency points per band permit very fine frequency control. In addition, band selection, sweep mode, RF attenuator, and remote-local can be

controlled remotely. This allows the sweeper to be used in a wide variety of automatic systems and sophisticated signal simulation applications.

Another way to improve the accuracy and stability of the HP 8350 or 8620C sweep oscillator is to phase-lock the output with the HP 5344S source synchronizer. With the HP 5344S the frequency may be set to a 1 Hz resolution and the long-term stability becomes  $5 \times 10^{-10}$ /day. In addition to phase-locking a CW frequency, the HP 5344S, when used with a sweeper, is also capable of phase-continuous locked sweeps up to 40 MHz wide and broadband sweeps with a phase-locked start frequency.

In many applications, a computer can be used to assimilate data from a network analyzer (HP 8756A/57A or 8510). With automatic systems the computer can completely set up the measurement, sweep width, markers, power level, etc., and then document the measurement results in a printed or plotted format. For operations requiring a minimum of user interactions specification comparisons can be made for automatic "go/no-go" testing. Using the programmable power capability of the HP 83500 series plug-ins, automatic power as well as frequency response testing is possible.

An example of this computer-aided test is the HP 85015A system software for the HP 8756A/57A scalar network analyzers. This software package allows you to configure and store complete measurements and measurement setups as well as customized output formats. There are a variety of test convenience features such as user-specified limit lines which aid the untrained eye. In addition, multiple calibrations and measurement data can be stored on disc (for significant time savings). All this power is accessed through an easy-to-use menu selection format.

### Digital Sweeping Synthesizers

The HP 3325A, 3330B, 3335A, 8642A/B, 8660C, 8662A/63A and 8673B/C/D combine the precision frequency accuracy and stability of a synthesizer with the time saving convenience of a sweeper. Instead of analog sweeps, however, these units provide a digital sweep. The digital sweep is a progression of discrete CW frequencies that can be stepped through at a specified rate. Parameters such as start/stop/center frequencies, sweep width, frequency step and sweep time are entered and executed through a convenient keyboard or remote programming. Some additional features are phase-continuous linear/log sweep in the HP 3325A and amplitude sweeping in steps as small as 0.01 dB in the HP 3330B. This, in conjunction with frequency sweeping, can provide a comprehensive family of curves.

### Sweeper Applications

Sweepers are an integral part of many kinds of test applications. Their versatility and extensive feature set make them the perfect choice for scalar/vector network analysis, noise figure measurements, frequency translation measurements, signal simulation and many other applications. The sweepers you will find in this book are designed to be compatible with all relevant measurement solutions from HP.

Sweepers are used extensively with swept scalar network analyzers to characterize the amplitude responses of broadband devices or with vector network analyzers when the amplitude and phase characteristics of the device (i.e. s-parameters) are needed. Examples of such analyzers are the HP 8757A scalar network analyzer and the HP 8510 vector network analyzer. The HP 8340A/41A and HP 8350B sweepers can be controlled by these analyzers via a private "system interface bus." This makes use of the sweeper's full programmability and creates synergistic performance; for instance, the ability to save and recall complete system setups and not just one instrument's.

The HP 8757A scalar network analyzer operates over the 10 MHz to 40 GHz frequency range (operation at higher frequencies can be achieved using the HP 11664C detector adapters). It is a three-channel (optional four-channel) diode detection receiver system with 76 dB dynamic range, -60 dBm sensitivity and ratio capability. Combined with the HP 8350B and broadband plug-ins such as the HP 83592A (0.01-20 GHz) or the HP 8340A/41A synthesized sweepers, it is ideal for simultaneous magnitude-only transmission and reflection measurements. With the HP 8757A, alternate sweep testing is possible where channel 1 is only permitted to respond to the sweepers current state, while channel 2 responds to the alternate state. This allows "simultaneous" measurements of both filter skirt and passband responses (see Figure 4).

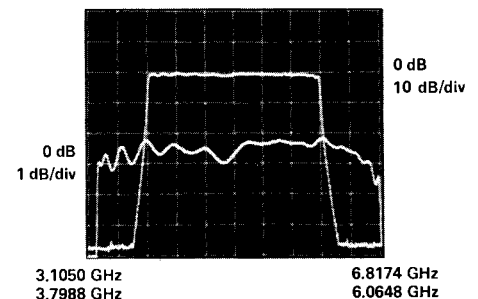

For measurements requiring low harmonics, the HP 83592C RF plug-in for the HP 8350 sweep oscillator mainframe offers -55 dBc harmonic suppression from 3.5 to 20 GHz.

For scalar measurements requiring more dynamic range, the HP 8349A microwave amplifier can be used to extend the dynamic range from 76 dB to typically 94 dB.

For measurements that require an entirely spurious-free environment or phase information, sweepers may be used with vector network analyzers such as the new HP 8510. Extremely high performance vector measurements can be made with the HP 8340A or 8341A and the HP 8510. For less demanding applications, the HP 8350B/83500 series sweepers can be used with the HP 8510. For instance, the HP 8350B/83522A can be used with the HP 8510 to make RF measurements with greater than 90 dB of dynamic range from 45 MHz to 2.4 GHz.



Noise figure measurements above 1500 MHz can be made using the HP 8970A noise figure meter with either the HP 8340A/8341A or the 8350 serving as the local oscillator. To perform these measurements the HP 8970A noise figure meter sends frequency commands over the interface bus (HP-IB) to tune the sweep oscillator to the frequency of interest. With this equipment noise figure and gain measurements can be made on microwave components such as amplifiers, transistors or mixers.

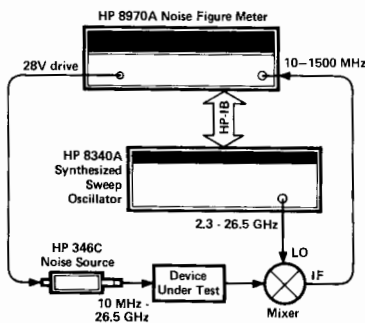

Two-tone sweep testing of devices such as mixers and receiver front ends requires two signals offset from each other by the IF. This is accomplished by phase-locking the difference frequency of two sweep oscillators to a very stable source. The sweepers may then be swept across the band of interest.

The modulation and built-in attenuator features of Hewlett-Packard sweep oscillators make them useful in many traditional CW signal generator applications. The excellent stability, phase noise, frequency range and modulation capability of the HP 8340A

and new 8341A make them well suited for most of these applications. In addition, accuracy, linearity, and flatness of the broadband plug-ins like the HP 83590A, 83594A, 83595A, 83592A/B/C, 86290B/C, 83525A/B, 86222A/B, and 83522A make them more than adequate in many applications requiring a general purpose CW generator.

For wideband applications these RF plug-ins feature performance that rivals octave band oscillators in the areas of frequency purity and accuracy, harmonics, flatness, and power.

For a complete discussion of swept frequency measurements the following application notes and others are available from your local Hewlett-Packard sales office.

- AN 155-2 "100 dB Dynamic Range Measurements Using the 8755 Frequency Response Test Set"
- AN 183 "High Frequency Swept Measurements"
- AN 187-6 "Frequency Performance of the 8620C Sweep Oscillator Under Remote Programming"
- AN 312-1 "Configuration of a Two-tone Sweeping Generator"
- AN 327-1 "Extended Dynamic Range of Scalar Transmission Measurements Using the HP 8756A or HP 8755C Scalar Network Analyzer"
- PN 8340A-1 "Increasing Frequency Switching Speed on the HP 8340A Synthesized Sweeper"
- PN 8340A-5 "60 GHz Frequency Coverage Using the HP 8340A Synthesized Sweeper and the WJ 1204-4X Frequency Extender"

- PN 8340A-6 "Reduced Harmonic Distortion Using the Integra TMF-1800H Tracking Filter with the HP 8340A Synthesized Sweeper"
- PN 8340A-7 "Microwave Noise Figure Measurements Using the 8340A Synthesized Sweeper with the 8970A Noise Figure Meter"
- PN 8350A-1 "Using the HP 8350A Sweep Oscillator with the Wiltron 560 Scalar Network Analyzer"
- PN 8350A-2 "Improved Frequency Accuracy by Calibrating HP 83590 Series RF Plug-ins to HP 8350A Sweep Oscillator Mainframe"
- PN 8350-3 "A Penlift Dwell Circuit for the HP 8350 Sweep Oscillator"
- PN 8350A-5 "60 GHz Frequency Coverage Using the HP 8350A Sweep Oscillator and WJ 1204-4X Frequency Extender"
- PN 8350-6 "Reduced Harmonic Distortion Using the Integra TMF-1800H Tracking Filter with the HP 8350 Sweep Oscillator"
- PN 8350A-7 "Microwave Noise Figure Measurements Using the 8350A Sweep Oscillator with the 8970A Noise Figure Meter"
- PN 8620C-1 "Using the HP 8620C Sweep Oscillator with the Wiltron 560 Scalar Network Analyzer"
- PN 8756A-1 "Automating the 8756A Scalar Network Analyzer"
- PN 8756A-3 "How to use the HP 5344S Source Synchronizer with the HP 8350B Sweep Oscillator and the HP 8756A Scalar Analyzer."

### Sweep Oscillator—Summary Chart

Frequency Range*	Model Number			Frequency Range											
	8350 Series	8620 Series**	Other Sweepers	100 kHz	1 MHz	10 MHz	100 MHz	1 GHz	2 GHz	4 GHz	8 GHz	12 GHz	18 GHz	26 GHz	40 GHz
0.1 Hz-13 MHz 10 Hz-21 MHz 1 μHz-21 MHz 1 mHz-50 MHz 200 Hz-80 MHz 10 kHz-1280 MHz 10 kHz-2600 MHz			3312A 3336A/B/C 3325A 8165A 3335A 8662A 8660C	←	←	←	←	←	←	←	←	←	←	←	←
100 kHz-110 MHz 100 kHz-1 GHz 100 kHz-2 GHz 100 kHz-2.56 GHz 10 MHz-1.3 GHz 10 MHz-2.4 GHz 10 MHz-8.4 GHz 10 MHz-20 GHz 10 MHz-26.5 GHz 50 MHz-18.6 GHz 50 MHz-26.5	83522A 83525A/B 83592A/B/C 83595A	86220A 86222A/B	8601A 8642A 8642B 8663A	←	←	←	←	←	←	←	←	←	←	←	←
1.7-4.3 GHz 2-8.4 GHz 3.6-8.6 GHz 2-18.6 GHz 2-20 GHz 2-22 GHz 2-26.5 GHz	83540A/B  83590A 83594A	86235A 86240A/B 86240C 86290B/C	86290B Opt H08 8673A					←	←	←	←	←	←	←	←
3.2-6.5 GHz		86241A						←	←	←	←	←	←	←	←
5.9-9.0 GHz 5.9-12.4 GHz 7-11 GHz 7.5-18.6 GHz 8-12.4 GHz	83545A	86242D 86245A 86250D Opt H08 86251A 86250D							←	←	←	←	←	←	←
10-15.5 GHz 12.4-18 GHz 17-22 GHz 18-26.5 GHz 26.5-40 GHz	83570A 83572A/B	86260B 86260A 86260C										←	←	←	←

\*Other Special Frequency Ranges Can Be Provided Upon Request.

\*\*HP 86200 Series RF Plug-ins are usable with the HP 8350A Mainframe via the HP 11869A Adapter. HP 83500 Series Plug-ins are not usable in the HP 8620C Mainframe.

# SWEEP OSCILLATORS

## Synthesized Sweepers



Models 8340A, 8341A

- 1 to 4 Hz frequency resolution
- Low spurious and phase noise
- 100 ns pulse width capability (optional on HP 8341A)
- +10 dBm to -110 dBm calibrated output (optional on HP 8341A)
- Complete analog sweeper
- DC to 100 kHz amplitude modulation

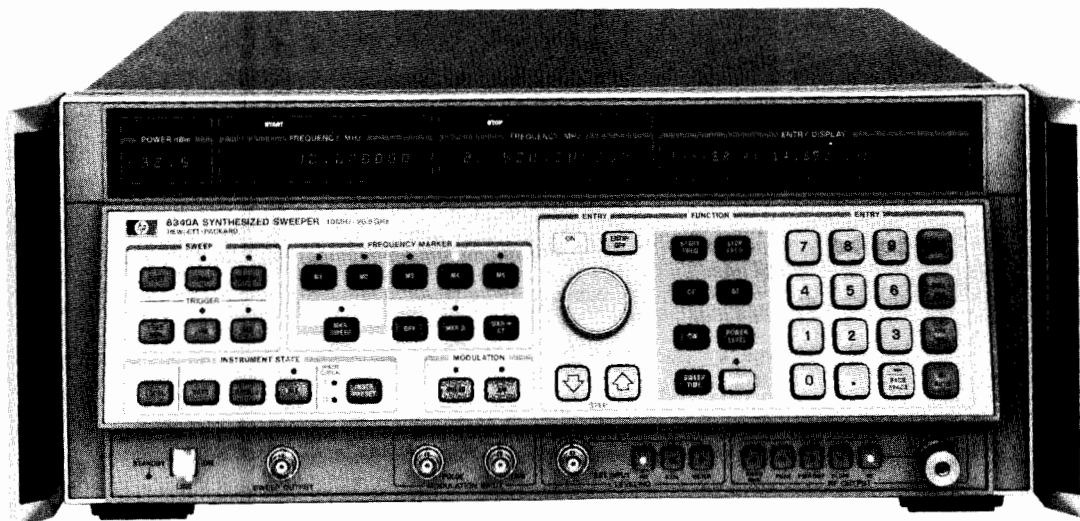

HP 8341A



### HP 8340A/8341A Synthesized Sweepers

The HP 8340A and new 8341A Synthesized Sweepers deliver the combined high-performance of a synthesizer and a broadband sweep oscillator in one instrument that is completely controllable via the Hewlett-Packard Interface Bus (HP-IB). This efficient combination of performance and versatility is ideal for manual or automatic test systems and in many cases enables the HP 8340A/41A to replace a sweep oscillator, a frequency counter, an RF synthesizer, and a microwave synthesizer.

### Synthesizer Precision and Spectral Purity

The synthesized broadband frequency coverage (10 MHz to 26.5 GHz on the HP 8340A and 10 MHz to 20 GHz on the HP 8341A) and the precise 1 to 4 Hz frequency resolution (depending on the frequency band of the HP 8340A or 8341A) are generated by indirect synthesis techniques. These techniques enable the HP 8340A/41A to achieve the same low single-sideband phase-noise performance as the HP 8672A and HP 8673 series of Synthesized Signal Generators. The HP 8340A/41A long-term stability is also outstanding at  $1 \times 10^{-9}$ /day (see specification on following page for more information).

The HP 8340A/41A also feature CW switching times of better than 50 ns (typically <35 ns). Additionally, a "Fast Phase-lock" programming command can be used to reduce typical CW switching times to between 11 and 22 ns (depending on frequency step size and absolute frequency value).

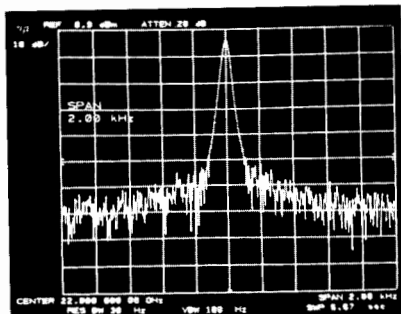

Spectrum Analyzer photo of HP 8340A signal at 22 GHz.

### Swept Capability

Analog sweep widths as narrow as 100 Hz or as broad as the full frequency range of the HP 8340A or 8341A permit rapid and thorough testing of any device within their broad frequency ranges. To simplify swept measurements, five frequency markers are provided along with useful marker functions such as marker sweep, marker to center frequency (MKR-CF), and marker difference. Direct compatibility with the HP 8510, 8756A/57A, 8410 and 8755 Network Analyzers also enhances the HP 8340A/41A's swept capability.

### Pulse and AM Modulation

The high performance pulse modulators of the HP 8340A/8341A Opt 006 offer >80 dB ON/OFF ratio and <25 ns rise and fall times. Pulse amplitudes are leveled for pulse widths as narrow as 100 ns. The HP 8340A/8341A Opt 006 also feature dc-coupled AM modulation with a 3 dB bandwidth of 100 kHz and a minimum depth of 90%. Pulse and amplitude modulation can be used simultaneously to simulate antenna scan patterns.

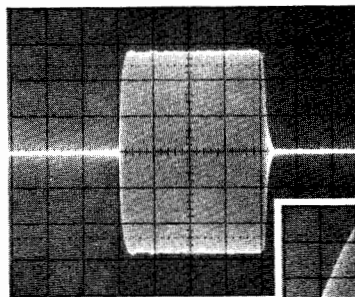

HP 8341A Opt 006 pulse performance at 3 GHz. Pulse width = 200 ns.

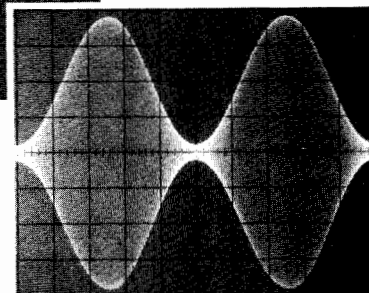

HP 8340A AM performance at 22 GHz. AM rate is 50 kHz and depth is 90%.



## Output Power

The HP 8340A/41A provide high output power which can be controlled down to  $-110$  dBm (opt. 001 or 004 on the HP 8341A) with 0.05 dB resolution. High power resolution is complemented by outstanding accuracy and flatness, as shown on the following page of specifications. The HP 8340A/41A also feature power sweep capability with  $>20$  dB dynamic range for complete characterization of level-sensitive devices.

## Usability and Programmability

The ENTRY DISPLAYS of the HP 8340A/41A always show the active functions and their current values, which can be easily changed via the data entry keyboard, the step keys or the knob. This friendly and responsive interaction with the user makes the HP 8340A/41A very easy instruments to operate. Complete HP-IB programmability also enables the HP 8340A/41A to effectively interact with computers via simple-to-use programming codes (for example, a CW frequency of 5 GHz can be programmed by: CW 5 GZ). Other HP-IB enhanced features, such as the "Fast Phase-lock" command, let users easily and fully exploit the powerful capabilities of the HP 8340A/41A.

## Network Analyzer Companions

Besides being excellent stand-alone general purpose sources, the HP 8340A and new HP 8341A are also ideal sources for precision microwave network analysis. Examples of this are the HP 8340A/41A with the HP 8510 and HP 8756A/57A network analyzers. The new HP 8510 vector network analyzer brings tremendous measurement capability to the microwave engineer that was never before available. A significant portion of this capability depends on the stability, signal purity and source/analyzer interface of the sweeper used. An example of this high performance is shown in Figure 1 where a single device under test was measured seven times with seven completely different HP 8510/8340A test systems. The repeatability (system to system) is remarkable. When the HP 8512A or 8514A 500 MHz to 18 GHz test sets are used with the HP 8510, the 10 MHz to 20 GHz HP 8341A is the recommended source and when the HP 8513A or 8515A 45 MHz to 26.5 GHz test sets are used, the 10 MHz to 26.5 GHz HP 8340A is recommended.

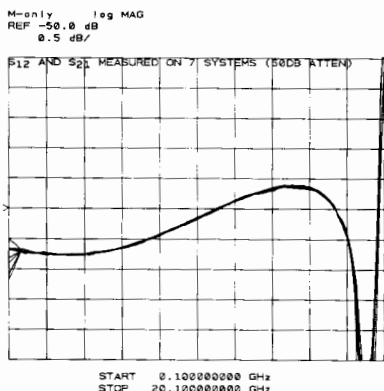

Both the HP 8340A and HP 8341A can also be teamed with the HP 8756A and new HP 8757A scalar network analyzers for precision scalar analysis, for instance, magnitude-only applications where data at accurate frequencies is needed. In addition to this frequency accuracy, the HP 8340A/8341A have a "phase-locked sweep." For sweep widths of  $n \times 5$  MHz or less ( $n$  = frequency band number), one of the phase-locked loops is swept producing synthesizer class frequency accuracy and stability in a continuous sweep. As an example, see Figure 2 where an 832 MHz SAW resonator is swept over a width of 400 kHz by the HP 8341A with less than 60 Hz of residual FM.

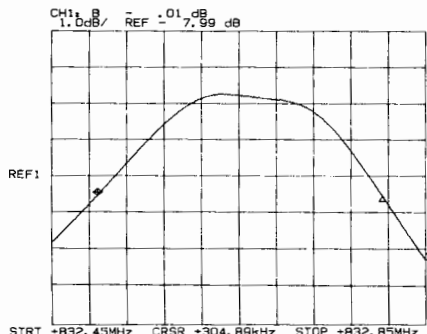

The HP 8341A is particularly well suited for scalar analysis because of its excellent performance for the price. Previously, if greater frequency

accuracy and stability was required of a swept source, the sweeper was combined with a source-locking counter or simply stopped and counted in CW mode. Now with the 10 MHz to 20 GHz HP 8341A, you can obtain the highest quality frequency accuracy, stability, and phase noise along with an analog sweeper. The HP 8341A has all this built into a single easy-to-use instrument at a price comparable to a broadband sweeper/source-locking counter combination.

## HP 8340A/8341A Specifications

(see technical data sheet for complete specifications)

### HP-IB Interface Functions

The following codes describe the HP-IB electrical capabilities of the HP 8340A/41A using IEEE Std 488-1978 mnemonics: SH1, AH1, T6, TE0, L4, LE0, SR1, RL1, PP0, DC1, DT1, C0, C1, C2, C3, C28, E1.

### Frequency

**CW Mode** (and Manual Sweep)

**Frequency Range:** HP 8340A, 10 MHz to 26.5 GHz  
HP 8341A, 10 MHz to 20.0 GHz

**Frequency Resolution:**

1 Hz, 0.01 to  $<7.0$  GHz  
2 Hz, 7.0 to  $<13.5$  GHz  
3 Hz, 13.5 to  $<20.0$  GHz  
4 Hz, 20.0 to 26.5 GHz (HP 8340A only)

**Accuracy:** Same as time base.

**Time Base:**

Internal 10 MHz time base.  
Aging Rate: less than  $1 \times 10^{-9}$ /day and  $2.5 \times 10^{-7}$ /year after 30 day warm-up.

Temperature Effect: typically  $<1 \times 10^{-8}$  SUP10/ $^{\circ}$ C.

Line Voltage Effect: typically  $<1 \times 10^{-8}$  SUP11/  $\pm 10\%$  line voltage change.

**Switching time:**  $<50$  ms to be within specified frequency resolution (PEAK function off).

(Fast Phase Lock Mode reduces typical switching time to  $<20$  ms).

**Frequency Bands:** For bands 0 and 1, the output is derived from the fundamental frequency of the internal 2.3 to 7.0 GHz YIG-tuned oscillator ( $n = 1$ ). For bands 2 (7.0-13.5 GHz), 3 (13.5-20 GHz), and 4 (20.0-26.5 GHz), the output is derived from the 2nd, 3rd, or 4th harmonic of the oscillator ( $n = 2, 3, \text{ or } 4$ ).

### Swept Mode

**Center Frequency/Sweep Width ( $\Delta F$ )**

**Range:** HP 8340A: 10.00005 MHz to 26.4999995 GHz (**center frequency**): 100 Hz to 26.49 GHz (**sweep width**). HP 8341A: 10.00005 MHz to 19.9999995 GHz (**center frequency**). 100 Hz to 19.99 GHz (**sweep width**).

**Resolution:** approximately 0.1% of sweep width ( $\Delta F$ ).

**Readout Accuracy:** (sweep time  $> 100$  ms)

$\Delta F \leq n \times 5$  MHz:  $\pm 1\%$  of indicated sweep width ( $\Delta F$ ).  $\pm$ time base accuracy.

$n \times 5$  MHz  $< \Delta F < n \times 100$  MHz:  $\pm 2\%$  of indicated sweep width ( $\Delta F$ ).  $\Delta F \geq n \times 100$  MHz:  $\pm 1\%$  of indicated sweep width ( $\Delta F$ ), or  $\pm 50$  MHz, whichever is less.

Where  $n$  = harmonic multiplication number (1 to 4). Refer to Frequency Bands description above.

### Start/Stop Frequency

**Range:** HP 8340A: 10 MHz to 26.4999999 GHz (Start); 10.0001 MHz to 26.5 GHz (Stop) HP 8341A: 10 MHz to 19.9999999 GHz (Start)

10.0001 MHz to 20.0 GHz (Stop)

**Resolution:** same as Center Frequency/Sweep Width.

**Readout Accuracy:** with respect to sweep out voltage (sweep time  $> 100$  ms): same as Center Frequency/Sweep Width Mode.

### Frequency Markers

All 5 markers are independently variable and have the same specifications.

**Range:** HP 8340A: 10 MHz to 26.5 GHz.

HP 8341A: 10 MHz to 20.0 GHz.

**Resolution:** same as Center Frequency/Sweep Width.

**Readout Accuracy:** same as Center Frequency/Sweep Width.

**Readout Accuracy in MKR  $\Delta$  Mode:** same as Center Frequency/Sweep Width.

**Swept Frequency Accuracy** (of any frequency covered by the sweep): same as Center Frequency/Sweep Width Mode.



# SWEEP OSCILLATORS

## Synthesized Sweepers (cont.)

Models 8340A, 8341A

### Spectral Purity

Specifications apply to CW mode and all swept modes unless otherwise stated.

**Spurious Signals** (expressed in dB relative to the carrier level (dBc) at ALC level of 0 dBm).

**Harmonics** (up to 26.5 GHz) of output frequency: <-35 dBc  
**Subharmonics and Multiples Thereof** (up to 26.5 GHz) of output frequency:

- <-25 dBc, 7.0 to <20.0 GHz
  - <-20 dBc, 20.0 to 26.5 GHz (HP 8340A only)
- Non-Harmonically related spurious** (CW and Manual Sweep mode only):

- <-50 dBc, 0.01 to < 2.3 GHz
- <-70 dBc, 2.3 to < 7.0 GHz
- <-64 dBc, 7.0 to <13.5 GHz
- <-60 dBc, 13.5 to <20.0 GHz
- <-58 dBc, 20.0 to 26.5 GHz (HP 8340A only)

### HP 8340A Single-Sideband Phase Noise (dBc/1 Hz Noise BW, CW Mode, all power levels)

Frequency Range (GHz)	Offset from Carrier				
	30 Hz	100 Hz	1 kHz	10 kHz	100 kHz
0.01 to < 2.3	-64	-70	-78	-86	-107
2.3 to < 7.0	-64	-70	-78	-86	-107
7.0 to <13.5	-58	-64	-72	-80	-101
13.5 to <20.0	-54	-60	-68	-76	-97
20.0 to 26.5	-52	-58	-66	-74	-95

### HP 8341A Single-Sideband Phase Noise (dBc/1 Hz Noise BW, CW Mode, all power levels)

Frequency Range (GHz)	Offset from Carrier				
	30 Hz	100 Hz	1 kHz	10 kHz	100 kHz
0.01 to < 2.3	-	-67	-75	-83	-107
2.3 to < 7.0	-	-67	-75	-83	-107
7.0 to <13.5	-	-61	-69	-77	-101
13.5 to <20.0	-	-57	-65	-73	-97

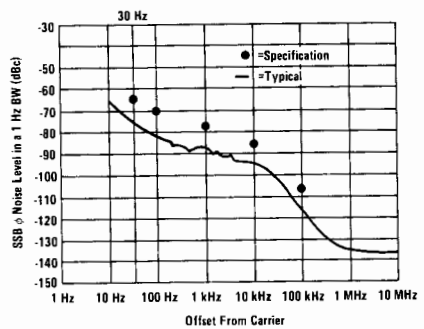

Typical HP 8340A Phase Noise performance from 2.3 to 7.0 GHz.

**Typical Residual FM in CW Mode:** <n × 60 Hz rms  
**Typical Residual FM in Swept Mode:**  
 $\Delta F > n \times 5 \text{ MHz}$ : <n × 25 kHz rms.  
 $\Delta F \leq n \times 5 \text{ MHz}$ : same as CW Mode.  
 Where n = harmonic multiplication number (1 to 4). Refer to Frequency Bands description above.

### RF Output

#### Output Power Range

#### HP 8340A Maximum Levelled Power (0°C to +35°C)

Frequency Range	Specified	Typical
0.01 to < 2.3 GHz	+10.0 dBm	+12 dBm
2.3 to < 7.0 GHz	+12.0 dBm	+16 dBm
7.0 to <13.5 GHz	+10.0 dBm	+12 dBm
13.5 to <20.0 GHz	+ 9.0 dBm	+11 dBm
20.0 to <23.0 GHz	+ 3.0 dBm	+ 5 dBm
23.0 to 26.5 GHz	+ 1.0 dBm	+ 3 dBm

### HP 8341A Maximum Levelled Power (0°C to +35°C)

+10 dBm, 0.01 to 20.0 GHz  
**Minimum Settable Power:** HP 8340A, -110 dBm, 0.01 to 26.5 GHz; HP 8341A, - 20 dBm, 0.01 to 20.0 GHz.

**RF Off:** When the RF key is turned off, the POWER dBm display will read OFF and a 0 dBm signal out of the RF connector will typically be attenuated to a level of <-100 dBm. Additional attenuation of the signal may be achieved by using the internal step attenuator.

### Output Power Resolution

**ENTRY DISPLAY:** 0.05 dB

**POWER dBm Display:** 0.1 dB

### HP 8340A Output Power Accuracy (0°C to +55°C)

Output Level Range	Frequency Range (GHz)		
	0.01 to <2.3	2.3 to <20	20 to 26.5
+20 to +10 dBm	-	±1.8 dB	±2.3 dB
+10 to -9.95 dBm	±0.9 dB	±1.5 dB	±2.0 dB
-10 to -19.95 dBm	±1.2 dB	±2.0 dB	±2.5 dB
-20 to -49.95 dBm	±1.5 dB	±2.3 dB	±2.8 dB
-50 to -79.95 dBm	±1.8 dB	±2.6 dB	±3.1 dB
-80 to -100 dBm	±2.1 dB	±2.9 dB	±3.4 dB
-100 to -110 dBm (typically)	±2.9 dB	±3.7 dB	±4.2 dB

### HP 8341A Output Power Accuracy

Output Level Range	Frequency Range (GHz)	
	0.01 to <2.3	2.3 to 20
+20 to -10 dBm	-	±1.6 dB
+10 to -10 dBm	±0.9 dB	±1.3 dB
-10 to -20 dBm	±1.7 dB	±2.1 dB

Accuracy specifications include power level variations with frequency and temperature (i.e. flatness, which is given below).

### HP 8340A Flatness (Internally levelled)

Output Level Range	Frequency Range (GHz)		
	0.01 to <2.3	2.3 to <20	20 to 26.5
+20 to +10 dBm	-	±1.2 dB	±1.7 dB
+10 to -9.95 dBm	±0.6 dB	±1.1 dB	±1.6 dB
-10 to -19.95 dBm	±0.9 dB	±1.6 dB	±2.1 dB
-20 to -49.95 dBm	±1.2 dB	±1.9 dB	±2.4 dB
-50 to -79.95 dBm	±1.4 dB	±2.2 dB	±2.7 dB
-80 to -100 dBm	±1.7 dB	±2.5 dB	±3.0 dB
-100 to -110 dBm (typically)	±1.9 dB	±3.1 dB	±3.6 dB

### HP 8341A Flatness (internally levelled)

Output Level Range	Frequency Range (GHz)	
	0.01 to <2.3	2.3 to 20
+20 to +10 dBm	-	±1.0 dB
+10 to -10 dBm	±0.6 dB	±0.9 dB
-10 to -20 dBm	±0.8 dB	±1.5 dB

**Output Level Switching Time:** typically <10 ms to be within ±0.1 dB of final value with no attenuator change (internal leveling only).

**Stability with Temperature:** typically ±0.01 dB/°C.

**Output Impedance:** 50Ω nominal.

**Source SWR** (internal leveling only):

Typically <1.3:1, 0.01 to <2.6 GHz.

Typically <1.6:1, 2.3 to <18.0 GHz.

Typically <2.0:1, 18.0 to 26.5 GHz. (20.0 GHz for HP 8341A)

## Power Sweep

### Range:

Displayed: 0 to 40 dB/sweep

Actual: At least 10 dB at any given frequency (at least 20 dB in DECOUPLED mode; see Figure 2 below).

**Resolution:** 0.05 dB/sweep

### Accuracy:

Starting Power Level: Same as Output Power Accuracy Power Sweep Width and Linearity:

**Resolution:** 0.05 dB/sweep

### Slope Compensation

**Calibrated Range:** 0 to 0.4 dB/GHz

**Resolution:** 0.001 dB/GHz

### External Leveling

**XTAL** allows the HP 8340A/41A to be externally leveled by crystal detectors of positive or negative polarity.

**METER** allows power meter leveling with any HP power meter.

**Range:** 500  $\mu$ V (-66 dBV) to 2V (+6 dBV) for **XTAL** or **METER** modes.

**Accuracy:** leveled voltage is shown in **ENTRY DISPLAY** in dBV. Accuracy of actual voltage at EXT INPUT relative to the displayed value is as follows:

$\pm 0.5$  dB,  $\pm 0.2$  mV.

**Loop bandwidth:** nominally 30 kHz in **XTAL** mode, 0.7 Hz in **METER** mode.

**Input Impedance:** nominally 1 M $\Omega$ .

## Pulse Modulation

Specifications apply only to CW frequencies. Pulse modulation is standard in the HP 8340A and available as option 006 in the HP 8341A.

**ON/OFF Ratio:** >80 dB.

**Rise ( $T_R$ ) and Fall ( $T_F$ ) Times:**  $\leq 25$  ns.

**Minimum Internally Leveled RF Pulse Width ( $T_{RF}$ ):**  $\leq 100$  ns.

**Minimum Unleveled RF Pulse Width:** typically  $< 25$  ns.

### Pulse Repetition Frequency:

100 Hz to 5 MHz (when internally leveled)

Typically dc to 20 MHz in non-leveled operation

**Maximum Peak Power:** same as CW and swept modes. See **RF OUT-PUT** specifications.

**Accuracy of Internally Leveled RF Pulse ( $V_p$ ) (relative to CW level)**

Pulse Width	Frequency Range (GHz)		
	0.01 to 0.4	0.4 to <2.3	2.3 to 26.5*
100 to <200 ns	—	+3/-0.3 dB	+1.5/-0.3 dB
200 to <500 ns	—	+1.5/-0.3 dB	$\pm 0.3$ dB
$\geq 500$ ns	—	$\pm 0.3$ dB	$\pm 0.3$ dB
1 to <2 $\mu$ s (typically)	+3/-0.3 dB	—	—
2 to <5 $\mu$ s (typically)	+1.5/-0.3 dB	—	—
$\geq 5$ $\mu$ s (typically)	$\pm 0.3$ dB	—	—

\*20.0 GHz for HP 8341A opt. 006

**Settling Time:** Settling time states the typical amount of time needed for the internally leveled RF pulse amplitude to be within 10% of its final value after a change in the pulse amplitude has been initiated. In the HP 8340A/41A, for pulse widths  $< 10$   $\mu$ s, settling time is the greater of 70  $\mu$ s or the time to generate 7 pulses. For pulse widths  $\geq 10$   $\mu$ s, settling time is 70  $\mu$ s divided by the duty cycle. Settling time can be reduced by pressing **SHIFT AM**, which effectively increases the ALC bandwidth. **SHIFT AM** also has the effect of causing some degradation in the pulse envelope as well as raising the minimum pulse repetition frequency from 100 Hz to 1 kHz.

**Overshoot, Ringing ( $V_{OR}/V_p$ ):**  $< 15\%$  typically.

**Pulse Width Compression ( $T_V - T_{RF}$ ):**  $\pm 5$  ns typically.

**Delay Time ( $T_D$ ):** 50 ns typically.

**Video Feedthrough ( $V_F/V_p$ ):**

$< 100\%$ , 0.01 to  $< 0.4$  GHz

$< 5\%$ , 0.4 to  $< 2.3$  GHz (for output power levels  $\leq +8$  dBm)

$< 0.2\%$ , 2.3 to 26.5 GHz (20.0 GHz for HP 8341A opt. 006)

**Sidebands caused by a pulse input when PULSE is OFF:** typically  $< -50$  dBc with a 30 kHz squarewave input from .01 to 7.0 GHz.

**Pulse Input:** TTL compatible. (Open circuit is TTL high level and keeps RF on). Damage level +12V, -20V.

## Pulse Definitions:

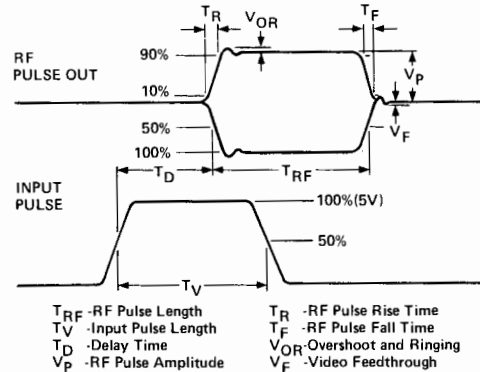

$T_{RF}$  - RF Pulse Length  
 $T_V$  - Input Pulse Length  
 $T_D$  - Delay Time  
 $V_p$  - RF Pulse Amplitude  
 $T_R$  - RF Pulse Rise Time  
 $T_F$  - RF Pulse Fall Time  
 $V_{OR}$  - Overshoot and Ringing  
 $V_F$  - Video Feedthrough

## Amplitude Modulation

Specifications below apply when the HP 8340A/41A are internally leveled, for waveforms whose envelope peak is at least 1 dB below maximum specified power.

**AM Depth:** 0-90%. Actual available depth will be greater than this in many cases and is determined by the difference of the maximum leveled power available at frequency of interest and  $-30$  dBm.

**AM Sensitivity:** (at a 1 kHz rate and 30% depth)  $100\%/V \pm 5\%$ . AM depth is linearly controlled by varying input level between 0 and  $\pm 1V$  peak. Nominal input impedance is 600 $\Omega$ .

**AM Bandwidth (30% Depth, PULSE off):** dc coupled, 3 dB point  $> 100$  kHz.

**AM Frequency Response (Flatness) Relative to a 1 kHz Rate at 30% depth (PULSE off):**  $\pm 0.20$  dB, dc to 10 kHz.

**Distortion:** typical values are given in Figure 3 below.

**Incidental  $\phi M$  in Peak Radians (Rates  $\leq 10$  kHz, 30% Depth):**  $< 0.4$  typically

**Incidental FM:** Incidental  $\phi M \times$  Modulation Frequency.

**AM Input Impedance:** nominally 600 ohms.

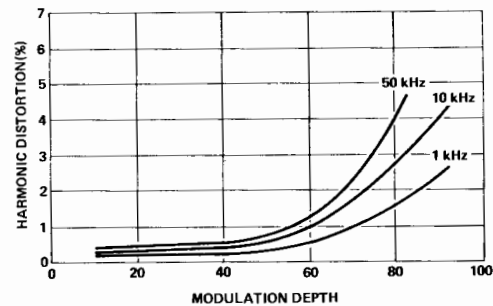

Figure 3. Typical HP 8340A AM distortion for various modulation rates and depths.

## Ordering Information

HP 8340A Synthesized Sweeper

**Option 001** Front Panel RF Output Without Attenuator

**Option 004** Rear Panel RF Output With Attenuator

**Option 005** Rear Panel RF Output Without Attenuator

**Option 006** Delete Pulse Modulation

**Option 007** Relaxed Phase Noise Specifications

**Option 910** Extra Operating and Service Manual

HP 8341A Synthesized Sweeper

**Option 001** Front Panel RF Output With Attenuator

**Option 002** +13 dBm Output Power, 2.3 to 18.6 GHz

**Option 004** Rear Panel RF Output With Attenuator

**Option 005** Rear Panel RF Output Without Attenuator

**Option 006** Pulse Modulation

**Option 007** Improved Phase Noise Specifications

**Option 910** Extra Operating and Service Manual

### Common Options

**Option 806** Rack Mount Slide Kit

**Option 850** HP 8410B/C Interface Cable

**Option 908** Rack Flange Kit

**Option 913** Rack Flange Kit for Instruments With Front Handles

**Option 914** Delete Service Manual

08340-60134 Support Kit

# SWEEP OSCILLATORS

## Model 8350 Series: 10 MHz to 40 GHz

### Model 8350 Series

- Versatile microprocessor-controlled mainframe
- Single-band, straddle-band and broad band plug-ins
- 10 MHz to 40 GHz in two plug-ins
- 10 mW output power to 26.5 GHz
- Total HP-IB programmability

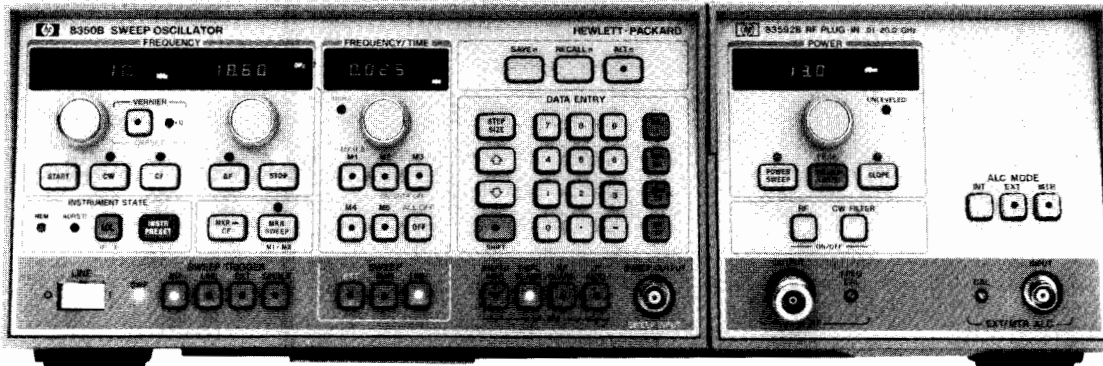

HP 8350B



### HP 8350 System

The HP 8350 is a powerful general-purpose source for swept microwave measurements, wideband CW signal generation and automatic testing. It incorporates the efficiency of microprocessor control with state-of-the-art YIG-tuned oscillators and GaAs FET amplifiers to produce a high performance sweep oscillator system ideally suited for either manual or automatic measurements.

You can easily configure a source to meet your application's frequency coverage and power requirements. Just combine the versatile HP 8350 mainframe with any of the 32 standard RF plug-ins (see table at right) and you are ready to make measurements. Both the advanced HP 83500 series plug-ins and the existing HP 86200 series plug-ins (via the HP 11869A adapter) are accepted by the HP 8350 mainframe.

### HP 8350 Mainframe

The HP 8350 has been designed to include many features that not only speed and simplify measurements but also improve accuracy. In addition, it is compatible with HP network analyzers, counters, noise figure meters, power meters, and microwave link analyzers to provide complete solutions.

All function values (sweep limit frequencies, marker frequencies, etc.) are indicated on high resolution digital displays. Function values are easily modified using the appropriate knob, step keys, or data entry keyboard.

Five independent, continuously variable markers are available to note your measurement frequencies. The active marker frequency or the difference frequency between any two markers is read easily from high resolution digital display. You can also use marker sweep to zoom in on a particular frequency span while retaining your original sweep limits.

Another particularly useful feature in making repetitive measurements is the HP 8350's Save/Recall Mode. Once the sweeper has been set for a particular measurement, all front panel settings (HP 8350 and HP 83500 series plug-in) can be *Saved* and later *Recalled* to repeat the measurement by accessing one of nine internal storage registers.

In the past, HP-IB programming of sweepers was limited to a series of CW frequencies. With the HP 8350 all front panel functions, e.g. sweeps, markers, sweep time, even output power (HP 83500 series plug-ins) can be programmed. This means there are no limitations in designing your own customized test systems. Utilizing the Learn Mode function, the HP 8350 becomes a "talker" as well as "listener" on the bus, transferring all manually entered front panel controls to the computer.

Full compatibility with both the HP 8510 and the HP 8410C Network Analyzers, the HP 8756A and the HP 8757A Scalar Network Analyzers are provided for convenient vector and scalar measurements with the HP 8350. The HP 5343A Counter can be combined with the HP 8350 to measure Start, Stop, or marker frequencies with

up to 100 kHz accuracy while sweeping. Improved frequency accuracy and stability may be achieved by using the HP 5344S Source Synchronizer with the HP 8350 to phase-lock the RF output. Microwave noise figure measurements may be made using the HP 8350 with the HP 8970A Noise Figure Meter. In addition, the HP 8350B, with an appropriate plug-in driving the HP 8349A microwave amplifier, provides up to +20 dBm of output power across a 2 to 20 GHz range.

### HP 83500 Series Plug-Ins

Broadband frequency coverage from 10 MHz to 40 GHz with high output power is provided in the HP 83500 series RF plug-ins. One plug-in, the HP 83595A, operates over the entire 10 MHz to 26.5 GHz range without sacrificing frequency accuracy ( $\pm 12$  MHz at 26.5 GHz). The HP 83592C, 10 MHz to 20 GHz RF plug-in has  $-55$  dBc harmonics and subharmonics from 2 to 20 GHz. The 18 GHz to 26.5 GHz band is filled by the HP 83570A RF plug-ins and boasts a 10 mW power level (comparable to most BWOs). The 26.5 to 40 GHz band is covered by the HP 83572A and HP 83572B RF plug-ins that have minimum unleveled power output of 2 mW and 5 mW respectively.

The HP 83500 series plug-ins offer output power level control previously unavailable on a swept source. Power level control is calibrated with 0.1 dB resolution and up to 80 dB range (with Opt 002 attenuator). Calibrated power sweeps are available for characterizing device performance as a function of power. Slope and internal leveling controls are standard on all units. The HP 83500 series plug-ins (except the HP 83572A/B) are also capable of power meter leveling with the HP 432A/B/C, 436A, and 438A power meters.

All HP 83500 series front panel functions are HP-IB programmable including power level. This means your automatic test systems can now characterize a device both as a function of frequency and input power level.

### HP 86200 Series Plug-Ins

Simply combining the HP 86200 series plug-in (including the one you may already own) with an HP 11869A Adapter makes all the convenient digital controls, markers, and HP-IB capability of the HP 8350 immediately available to you. The HP 86200 series are a particularly attractive plug-in choice when economical single-band operation is desired with the HP 8350 mainframe. For measurements with HP Microwave Link Analyzers, specially characterized HP 86200 series plug-ins can be used with the HP 8350 to create an upconverter for communications distortion measurements.

The HP 86290B/C plug-ins cover the 2-18 GHz frequency range with 10 mW and 20 mW of output power respectively. Frequency accuracy at 18 GHz is 20 MHz, exceeding that available on most single-band plug-ins. Both HP 83500 series and HP 86200 series plug-ins compatible with the HP 8350 mainframe are summarized in the table below. Note that the HP 11869A Adapter is required with all HP 86200 series plug-ins. See specifications on page 486.



HP 11869A

HP 83540A



HP 86290B

	HP Model number	Frequency range (GHz)	Leveled power output	Frequency accuracy (MHz)	Complete specifications on page
Broad-band Plug-ins	83595A	0.01-26.5	2.5 mW	±12	478, 479
	83594A	2-26.5	2.5 mW	±12	478, 479
	83592A/B	0.01-20	10 mW/20 mW*	±10	478, 479
	83592C	0.01-20	4 mW	±10	478, 479
	83590A	2-20	10 mW	±10	478, 479
	83525A/B	0.01-8.4	20 mW/10 mW	±12	480, 481
	83522A	0.01-2.4	20 mW	±5	480, 481
	86222A/B	0.01-2.4	20 mW	±10	490
	86290B	2-18.6	10 mW	±30	489
	86290C	2-18.6	20 mW	±30	489
Straddle-band Plug-ins	83540A/B	2-8.4	40 mW/20 mW	±12	482, 483
	86240A	2-8.4	40 mW	±20	491
	86240B	2-8.4	20 mW	±20	491
	86240C	3.6-8.6	40 mW	±20	491
	86251A	7.5-18.6	10 mW	±20	491
Single-band Plug-ins	86220A	0.01-1.3	10 mW	±10	492, 493
	86235A	1.7-4.3	40 mW	±20	492, 493
	86241A	3.2-6.5	3.2 mW	±30	492, 493
	86242D	5.9-9	10 mW	±35	492, 493
	83545A	5.9-12.4	50 mW	±20	482, 483
	86245A	5.9-12.4	50 mW	±40	492, 493
	86250D	8.0-12.4	10 mW	±40	492, 493
	86260B	10-15.5	10 mW	±50	492, 493
	86260A	12.4-18	10 mW	±50	492, 493
	86260C	17-22	10 mW	±50	492, 493
	83570A	18-26.5	10 mW	±30	484, 485
	83572A	26.5-40	1.6 mW (Opt 001)	±100	484, 485
	83572B	26.5-40	4 mW (Opt 001)	±100	484, 485

NOTE: The HP 11869A Adapter is required to interface HP 86200 series plug-ins with the HP 8350B mainframe.

\*HP 83592B: 20 mW to 18.6 GHz.

# SWEEP OSCILLATORS

Model 8350 Series: Mainframe



Model 8350B

- Accurate, high resolution, digital displays
- Five markers with marker  $\Delta$  and marker sweep
- Save/recall 9 complete front panel states
- Accepts all HP 83500 series plug-ins
- Total HP-IB programmability

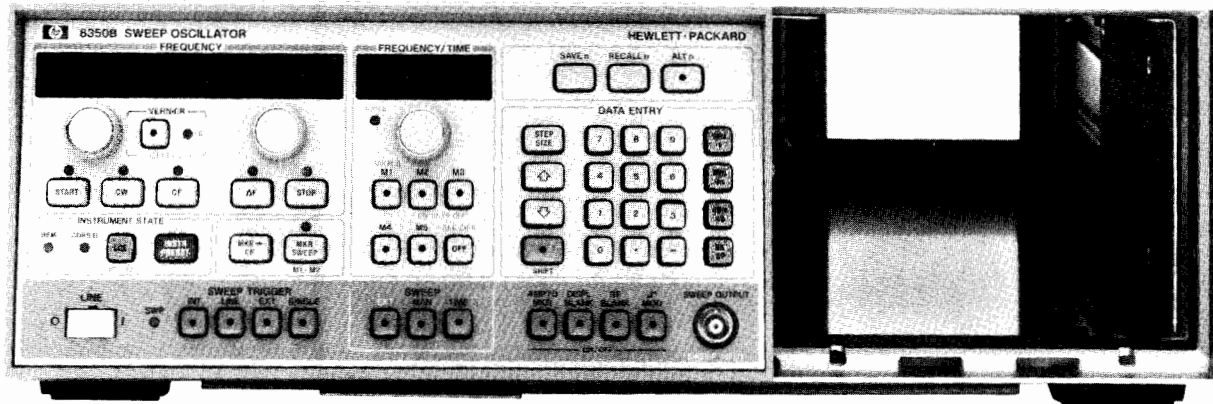

HP 8350B



## HP 8350B Mainframe

Sweep Oscillator applications are greatly expanded by the features of the HP 8350B. Along with the traditional swept and CW frequency functions the HP 8350B adds five markers with extensive capabilities, versatile data entry and complete HP-IB programmability. The HP 8350B mainframe accepts the HP 86200 series plug-ins via the HP 11869A Adapter as well as the wideband HP 83500 series plug-ins. In order to aid system set ups, the HP 8350B is directly compatible with the HP 8510, HP 8410C, HP 8757A and HP 8756A network analyzers. The frequency accuracy is easily enhanced when the HP 5343A counter is used to count the START, STOP, or ACTIVE MARKER frequency. For even more frequency accuracy and stability the HP 5344S Source Synchronizer may be used to phase-lock the RF output.

The HP 8350B has three methods of changing function values: control knobs, keyboard entry, or step key entry.

Five markers are available with the HP 8350B. These markers combined with the high resolution digital readout make the accurate location of important frequency responses easy. A key marker feature, marker  $\Delta$ , computes the difference between any two markers. This feature is particularly useful for measurements such as the determination of the bandwidth between 3 dB points. With the extensive marker capabilities key frequency ranges may be marked and swept. The markers can modify the center frequency (marker  $\rightarrow$  CF) or the START/STOP frequency (Marker Sweep). These expanded marker capabilities simplify sophisticated measurements.

A necessity in making repetitive measurements or automatic tests is the Save/Recall feature. Once the HP 8350B controls have been set for a particular measurement, all of the front panel controls can be "Saved" in a memory location and later "Recalled" when the measurement is repeated. This feature supplies nine memory locations,

each storing a complete front panel set-up. Memory storage or access may be done randomly or sequentially. Nonvolatile memory is included so that all memories are retained even when line power is removed.

The HP 8350B makes "simultaneous" comparison of two separate frequency ranges or power levels easy via the alternate sweep mode. When the alternate sweep mode is activated, the HP 8350B alternates between the current front panel setting and any stored memory setting on successive sweeps. The output from this function may be processed through a network analyzer such as the HP 8756A or the HP 8757A and viewed on a two channel display.

All front panel controls (except the ac line power switch) may be programmed or controlled via the HP-IB. The HP 8350B may interact as a listener or as a talker on the HP-IB. As a talker the HP 8350B is capable of outputting the manually entered front panel information to a controller. The HP-IB capabilities of the HP 8350B are far more extensive than in other sweepers hence increasing its range of applications.

As a result of the HP 8350's internal microprocessor design, a self test is performed at turn on or whenever the instrument preset function is activated. This function verifies that the HP 8350B is functioning properly. If there is a problem, error codes are displayed on the front panel to help locate the problem quickly to the board and component level.

In the HP 8350B the frequency resolution is determined by the digital-to-analog converters that are used to produce the tuning voltage and marker pulses. The center frequency resolution is 0.00038% of the full band (262,144 points across the band). The  $\Delta F$  resolution is variable such that higher resolution is provided for narrow sweep widths. The  $\Delta F$  resolution is 0.1% of the full-band range for full-band sweeps and improves to 0.0015% of the full-band range for very narrowband sweeps.





## HP 8350B Specifications

### Instrument Control

**Control knobs, step keys and data entry keyboard:** all instrument parameters whether time, frequency or power may be set three ways: control knobs, keyboard entry, or step keys. The step size either can be entered by the user or the pre-programmed default values may be used. The SHIFT key is used to effect the functions written in blue.

### Frequency Control Functions

**Range:** determined by RF plug-in unit used.

**Linearity:** refer to RF unit specifications.

**START/STOP sweep:** sweeps up from the START frequency to the STOP frequency.

**CF/ $\Delta$ F Sweep:** sweeps symmetrically upward, centered on CF.

$\Delta$ F: frequency width of sweep continuously adjustable from zero to 100% of frequency range.

$\Delta$ F Accuracy: refer to RF unit specifications.

CF Accuracy: refer to RF unit specifications.

CF Resolution: 0.00038% (262,144 points across band).

$\Delta$ F Resolution: 0.1% of full band (1024 points across band)  
0.012% of band for  $\frac{1}{8}$  of band or less  
0.0015% of band for  $\frac{1}{64}$  of band or less.

Display resolution: 5 digits.

**CW operation:** single frequency RF output.

**CW accuracy:** refer to RF unit specifications.

**CW resolution:** same as CF.

**Vernier:** adjusts CW frequency or swept center frequency up to 0.05% of RF plug-in band being swept.

**Vernier resolution:** 4 ppm (64 points between each CW point; 262,144 points across band).

**Offset:** allows the CW frequency or center frequency to be offset by any amount up to the full range of the plug-in.

**Resolution:** same as CF.

**Accuracy:** refer to RF unit specifications.

**Frequency markers:** five frequency markers are independently adjustable and fully calibrated over the entire sweep range. Amplitude or intensity markers available.

**Resolution:** 0.4% of selected sweep width (256 points/sweep).

**Accuracy:** refer to frequency accuracy.

**Marker output:** rectangular pulse, typically -5 volts peak available from the POS Z BLANK connector on rear panel.

**Marker sweep:** RF output is swept between Marker 1 and Marker 2.

**Marker $\rightarrow$ CF:** causes the CW or the swept center frequency to equal the frequency of the active marker.

### Sweep and Trigger Modes

**Internal:** sweep recurs automatically.

**Line:** sweep triggered by ac power line frequency.

**External trigger:** sweep is actuated by external trigger signal.

**Single:** selects mode and triggers a single sweep.

**Sweep time:** continuously adjustable from 10 ms to 100 seconds.

**Manual sweep:** front panel controls provide continuous manual adjustment of frequency between end frequencies.

**External sweep:** sweep is controlled by external signal applied to front or rear panel SWP OUTPUT/SWP INPUT connector.

**Sweep output:** direct-coupled sawtooth, zero to approximately  $\pm 10$  volts, at front or rear panel concurrent with swept RF output.

### Instrument State Storage

**Save n/recall n:** up to 9 different front panel settings can be stored in the HP 8350B via the Save n (n = 1 through 9) function. Settings can be recalled randomly or in sequence.

**Alt n:** causes the RF output to alternate on successive sweeps between the current front panel setting and a setting stored in memory.

### Instrument State

**Instrument preset:** sets the front panel of the HP 8350B into a pre-determined state. It also causes an internal analog and digital self-test to occur. If internal errors or failures are detected they are indicated via error codes.

**Local operation:** this key is used to return the HP 8350B to local control from the remotely controlled state. The REM lamp indicates remote control. The ADRS'D lamp indicates transmitted or received data over the HP-IB.

### Modulation

**External AM:** refer to RF unit specifications.

**Internal AM:** square wave modulation available at all sweep speeds. Factory preset to 27.8 kHz although selectable to 1000 Hz or 27.8 kHz. On/off ratio, refer to RF unit specifications.

**External FM:** refer to RF unit specifications.

**Phase-lock:** refer to RF unit specifications.

### Remote Programming (HP-IB)

The HP 8350B has both input and output capability. The HP-IB address can be displayed on the front panel and is selectable (any number from 0 to 31).

**Input mode functions:** all front panel controls except the ac line power switch are programmable. Numerical values typically have greater entry resolution than is displayed.

**Frequency resolution:** same as CF/ $\Delta$ F plus vernier.

**Power resolution:** see HP 83500 Series Plug-ins.

**Output mode functions:** the HP 8350B can output to a controller an instrument state message that describes the present instrument status.

**HP-IB interface functions:** SH1, AH1, T6, L4, SR1, RL1, PPO, DC1, DT1, CO, E1.

### General Specifications

**Nonvolatile memory:** continuous memory that retains the contents of all instrument state storage registers, the HP-IB address, and current instrument state when ac line power is off.

#### Blanking

**RF:** when enabled, RF turns off during retrace and remains off until next sweep.

**Display:** POS Z BLANK; direct-coupled rectangular pulse approximately +5.0 volts during retrace and bandswitch points of sweep. LNEG Z BLANK; direct-coupled rectangular pulse approximately -5.0 volts coincident in time with RF blanking.

**Pen Lift:** output to control the pen lift function of XY recorder at end point of sweep.

**Counter trigger (CNTR TRIG):** output for controlling the external trigger input of the HP 5343A Frequency Counter.

**Stop sweep:** input for stopping the progress of a forward sweep, used with HP 5343A Frequency Counter.

**Program connector:** additional control of and information on the HP 8350B instrument state is provided via a 25 pin rear panel connector.

**HP 8410C interface cable:** permits multi-octave operation of HP HP 8410C Network Analyzer with HP 8350B.

**Operating temperature range:** 0°C to +55°C.

**Power:** 100, 120, 220 or 240 volts  $\pm 10\%$ , 50 to 60 Hz (Option 400, 60 to 400 Hz). Approximately 270 volt-amperes including RF unit.

**Weight (not including RF unit):** Net 16.5 kg (36.4 lb). Shipping 22.7 kg (50 lb).

**Dimensions:** 425 mm wide, 133.3 mm high, 422 mm deep (16.75" x 5.25" x 16.6").

### Ordering Information

#### HP 8350B Sweep Oscillator Mainframe<sup>1</sup>

##### Options

**400:** 400 Hz Power Line Frequency Operation

**803:** HP 5343A Interface Cables

**850:** HP 8410C Source Control Cable

**908:** Rack Mounting Kit

**910:** Extra Manual

**913:** Rack Flange Kit for Instruments with

Front Handles

<sup>1</sup>For transit cases see page 688



# SWEEP OSCILLATORS

## Model 8350 Series: Broadband RF Plug-Ins

### Models 83595A, 83592A/B/C, 83594A, 83590A

- Calibrated output power with 0.1 dB resolution
- +13 dBm from 0.01 to 18.6 GHz
- 12 MHz frequency accuracy at 26.5 GHz

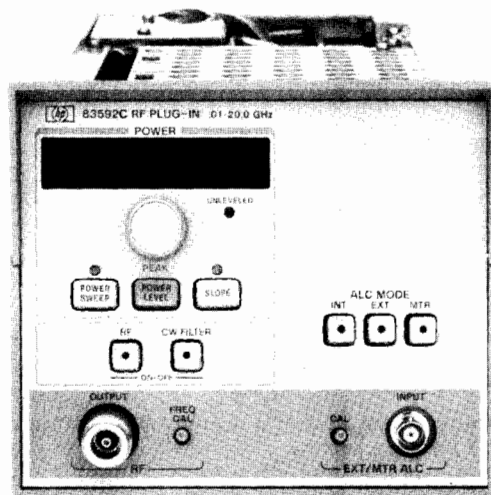

HP 83592C



The six HP 83590 series plug-ins feature ultra-wideband frequency coverage as exemplified by the HP 83595A which covers 0.01–26.5 GHz in a single sweep. While the HP 83590 series feature broadband sweeps, they still maintain narrowband precision. The frequency output exhibits excellent stability and accuracy. At 26.5 GHz the HP 83595A maintains an accuracy of  $\pm 12$  MHz. The HP 83592B does not sacrifice power for broadband high frequency coverage; the output power is internally leveled for a minimum +13 dBm (to 18.6 GHz) output with  $\pm 0.9$  dB flatness. The HP 83592C provides a clean test signal with  $-55$  dBc harmonic and subharmonic levels to maximize dynamic range. Power output capabilities have been expanded to provide power sweep and slope control. In addition, the HP 83590 series plug-ins are completely HP-IB programmable.

The most outstanding feature of the HP 83590 series plug-ins is their broad frequency range. Innovative technology is used to create this precision frequency range. The principle behind this technology is the Switched YIG Tuned Multiplier circuit (SYTM). The YTM circuit uses the output of a fundamental oscillator to drive a high-efficiency multiplier that has been integrated with a tracking YIG filter in order to create and select high order harmonics to be used as output frequencies.

A figure of merit for the HP 83590 series is their flat output power over the entire frequency range. The output power is internally leveled within 0.9 dB for a minimum output power of 10 dBm, with a displayed resolution of 0.1 dB. The power level may be controlled to a minimum settable power level of  $-5$  dBm. This level may be extended to  $-75$  dBm on the HP 83592A/B and HP 83590A with Option 002 (70 dB Step Attenuator) or to  $-60$  dBm on the HP 83592C, the HP 83595A and HP 83594A with Option 002 (55 dB Step Attenuator).

Since power parameters are critical to high frequency measurements, the HP 83590 Series (along with all HP 83500 series plug-ins) offer many modes of power output. In addition to a single power output, the HP 83590 Series offer a Power Sweep function. The Power Sweep function sweeps a power range for characterizing level sensitive devices like amplifiers and transistors. The Slope mode is also supplied to provide compensation for cable or test set losses. In all these modes the power output is internally monitored and leveled. If preferred, the power may be externally leveled. The HP 83590 Series plug-ins are capable of power meter leveling with the HP 432A/B/C, 436A, and 438A power meters.

HP-IB programmability is an essential feature when one of the HP 83590 series is used in automatic test systems. For example, the automated tests of amplifiers for gain compression are possible. These plug-ins are completely programmable, which means the power mode may be selected and the power level may be set with .02 dB resolution.

- $-55$  dBc harmonics and subharmonics from 3.5 to 20 GHz
- Internal leveling and slope standard
- HP-IB

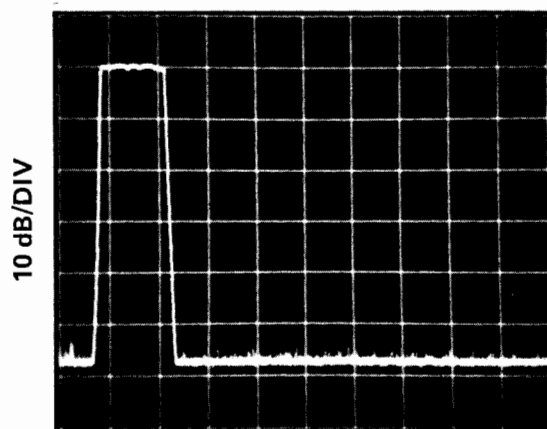

2.0 GHz

1.8 GHz/DIV

20.0 GHz

### General Specifications

**Sweep time (minimum):** 10 ms for a single band (Bands 0, 1, 2, 3, 4). 25 ms for full band (HP 83590A, 83592A/B).

**Switch points:** HP 83595A, 83592A/B/C: Internal bands are 0.01–2.4 GHz, 2.3–7.0 GHz, 6.9–13.5 GHz, 13.4–20.0 GHz and 19.9–26.5 GHz (HP 83595A only). Broadband switch points are at approximately 2.4 GHz, 7.0 GHz, 13.5 GHz and 20.0 GHz (HP 83595A only). HP 83594A, 83590A: Internal bands are 2.0–7.0 GHz, 6.9–13.5 GHz, 13.4–20.0 GHz and 19.9–26.5 GHz (HP 83594A only). Broadband switch points are at approximately 7.0 GHz, 13.5 GHz and 20.0 GHz (HP 83594A only).

**Auxiliary output:** HP 83595A, 83592A/B/C: Rear panel 2.3–7.0 GHz fundamental oscillator output, nominally 0 dBm. HP 83594A, 83590A: Rear panel 2.0–7.0 GHz fundamental oscillator output, nominally 0 dBm.

**Frequency reference output:** HP 83595A, 83592A/B/C: nominal 1V/GHz (0.01–19 GHz)  $\pm 20$  mV rear panel BNC output. HP 83594A, 83590A: nominal 1V/GHz (2–19 GHz)  $\pm 20$  mV rear panel BNC output.

**RF output connector:** HP 83595A, 83594A: Type APC 3.5 male. HP 83592A/B/C, 83590A: Type N female.

**Weight:** net, 6.0 kg (13.2 lb); shipping, 9.2 kg (20 lb).

### Improved Network Measurement Capabilities

These plug-ins are compatible with the:

- HP 8510 Network Analyzer
- HP 8410 Network Analyzer
- HP 8757A Scalar Network Analyzer
- HP 8756A Scalar Network Analyzer
- HP 8970A Noise Figure Meter
- HP 8709A Phase-Lock Synchronizer
- HP 5344S Source Synchronizer

### Output Characteristics

**Impedance:** 50  $\Omega$  nominal.

**VSWR:** <1.9:1

**Power Sweep** (with option 002 Power Sweep cannot cross an attenuator step)

**Calibrated range:** HP 83590A, 83592A/B/C: >10 dB (15 dB typical); HP 83594A, 83595A: 9 dB.

**Accuracy** (including linearity):  $< \pm 1.5$  dB typical.

**Resolution:** 0.1 dB.

**Slope Compensation** (with option 002 Slope cannot cross an attenuator step).

**Calibrated range:** up to 0.5 dB/GHz (10 dB over full range).

**Linearity:** <0.3 dB typical.

**Resolution:** 0.1 dB/GHz.

**Attenuator Accuracy** ( $\pm$ dB referenced from the 0 dB setting, HP 83590A, 83592A/B only).

Frequency Range (GHz)	Attenuator Setting (dB)						
	10	20	30	40	50	60	70
0.01-12.4	0.6	0.7	0.9	1.8	2.0	2.2	2.3
12.4-18.0	0.7	0.9	1.2	2.0	2.3	2.5	2.8
18.0-20.0	0.9	1.5	2.5	3.0	3.2	3.3	3.5

**Modulation Characteristics**

**External AM**

**Frequency response:** typically 100 kHz.

**Input impedance:** approximately 10 k $\Omega$ .

**Range of amplitude control:** typically 15 dB.

**Sensitivity:** 1 dB/V typical.

**Maximum input:** 15 V.

**Pulse In** (HP 83595A and 83592A/B/C only)

TTL Compatible: Logic high = RF on, logic low = RF off.

0.01 to 20.0 GHz: Squarewave modulation up to 30 kHz.

0.01 to 2.5 GHz

Rise/Fall Time: typically 50 ns.

Minimum Pulse Width

Leveled: 1 $\mu$ sec.

Unleveled: typically 200 ns.

2.5 to 20 GHz

Rise/Fall Time: typically 10 ns.

Minimum Pulse Width

Leveled: typically 1 $\mu$ s.

Unleveled: typically 100 ns.

**External FM**

**Maximum Deviations for Modulation Frequencies**

**DC to 100 Hz:**  $\pm$ 75 MHz.

**100 Hz to 1 MHz:**  $\pm$ 7 MHz.

**1 MHz to 2 MHz:**  $\pm$ 5 MHz.

**2 MHz to 10 MHz:**  $\pm$ 1 MHz.

**Sensitivity**

**FM Mode:** -20 MHz/V typical.

**Phase-lock mode:** -6 MHz/V typical.

**Input impedance:** 2 k $\Omega$  nominal.

**Frequency response** (DC to 2 MHz):  $\pm$ 3 dB.

**Ordering Information**

HP 83590A 2.0 to 20 GHz RF Plug-in

**Option 002:** 70 dB Step Attenuator

**Option 004:** Rear Panel RF Output

HP 83592A 0.01 to 20 GHz RF Plug-in

**Option 002:** 70 dB Step Attenuator

**Option 004:** Rear Panel RF Output

HP 83592B 0.01 to 20 GHz (13 dBm) RF Plug-in

**Option 002:** 70 dB Step Attenuator

**Option 004:** Rear Panel RF Output

HP 83592C 0.01 to 20 GHz (-55 dBc harmonics) RF

Plug-in

**Option 002:** 55 dB Step Attenuator

**Option 004:** Rear Panel RF Output

HP 83594A 2.0 to 26.5 GHz RF Plug-in

**Option 002:** 55 dB Step Attenuator

**Option 004:** Rear Panel RF Output

HP 83595A 0.01 to 26.5 GHz RF Plug-in

**Option 002:** 55 dB Step Attenuator

**Option 004:** Rear Panel RF Output

	HP 83592A/B/C HP 83590A (excluding Band 0)					HP 83595A HP 83594A (excluding Band 0)					
	Band 0	Band 1	Band 2	Band 3	Full Band	Band 0	Band 1	Band 2	Band 3	Band 4	Full Band
	.01-2.4	2.4-7.0	7.0-13.5	13.5-20	.01-20	.01-2.4	2.4-7.0	7.0-13.5	13.5-20	20-26.5	.01-26.5
<b>Frequency Characteristics</b> Accuracy: (25°C $\pm$ 5°C) CW Mode: (MHz) Typically: (MHz) All Sweep Modes (100ms Sweep Time): (MHz) Linearity: Typ. (MHz)	$\pm$ 5 $\pm$ 2 $\pm$ 15 $\pm$ 2	$\pm$ 5 $\pm$ 2 $\pm$ 20 $\pm$ 2	$\pm$ 10 $\pm$ 3 $\pm$ 25 $\pm$ 4	$\pm$ 10 $\pm$ 4 $\pm$ 30 $\pm$ 6	$\pm$ 10 $\pm$ 5 $\pm$ 50 $\pm$ 10	$\pm$ 5 $\pm$ 2 $\pm$ 15 $\pm$ 2	$\pm$ 5 $\pm$ 2 $\pm$ 20 $\pm$ 2	$\pm$ 10 $\pm$ 3 $\pm$ 25 $\pm$ 4	$\pm$ 10 $\pm$ 4 $\pm$ 30 $\pm$ 6	$\pm$ 12 $\pm$ 5 $\pm$ 35 $\pm$ 10	$\pm$ 50 $\pm$ 5 $\pm$ 80 $\pm$ 15
<b>Stability</b> With Temperature: Typically (MHz/°C) With 10% Line Voltage Change: (kHz) With 10 Power Level Change: (kHz) With 3:1 Load VSWR: (kHz) With Time (after 1 hour warmup at the same frequency) Typically (kHz) Residual FM (10 Hz-10kHz bandwidth, peak): (kHz)	$\pm$ 0.2 $\pm$ 50 $\pm$ 200 $\pm$ 100 <100 <8	$\pm$ 0.2 $\pm$ 50 $\pm$ 200 $\pm$ 100 <100 <5	$\pm$ 0.4 $\pm$ 100 $\pm$ 400 $\pm$ 200 <200 <7	$\pm$ 0.6 $\pm$ 150 $\pm$ 600 $\pm$ 300 <300 <9	$\pm$ 0.6 $\pm$ 150 $\pm$ 600 $\pm$ 300 <600 <5	$\pm$ 0.2 $\pm$ 50 $\pm$ 200 $\pm$ 100 <100 <5	$\pm$ 0.2 $\pm$ 50 $\pm$ 200 $\pm$ 100 <100 <5	$\pm$ 0.4 $\pm$ 100 $\pm$ 400 $\pm$ 200 <200 <7	$\pm$ 0.6 $\pm$ 150 $\pm$ 600 $\pm$ 300 <300 <9	$\pm$ 0.8 $\pm$ 200 $\pm$ 800 $\pm$ 400 <400 <12	$\pm$ 0.8 $\pm$ 200 $\pm$ 800 $\pm$ 400 <400 <12
<b>Output Characteristics</b> Maximum Leveled Power <sup>D</sup> : (mW) (25°C) Opt 002	10,(20) <sup>B</sup> 10,(16) <sup>B</sup>	10,(20) <sup>B</sup> (4) <sup>C</sup> 7,(14) <sup>B</sup> (3,2) <sup>C</sup>	10,(20) <sup>B</sup> (4) <sup>C</sup> 6,3,(14) <sup>B</sup> (2,5) <sup>C</sup>	10,(2,5) <sup>C</sup> 5,(1,4) <sup>C</sup>	10,(2,5) <sup>C</sup> 3,2,(1,4) <sup>C</sup>	10 10	10 7	10 6.3	10 5	2.5 1.25	2.5 1.25
<b>Power Level Accuracy</b> (Internally Leveled): (dB) Minimum Settable Power: (dBm) With Opt 002 Remote Programming Resolution Displayed: (dB) Settable (dB)	< $\pm$ 1.5 -5 -75,(-60) <sup>C</sup> 0.1 .02	< $\pm$ 1.3 -5 -75,(-60) <sup>C</sup> 0.1 .02	< $\pm$ 1.3 -5 -75,(-60) <sup>C</sup> 0.1 .02	< $\pm$ 1.4 -5 -75,(-60) <sup>C</sup> 0.1 .02	< $\pm$ 1.5 -5 -75,(-60) <sup>C</sup> 0.1 .02	< $\pm$ 1.5 -5 -60 0.1 .02	< $\pm$ 1.3 -5 -60 0.1 .02	< $\pm$ 1.3 -5 -60 0.1 .02	< $\pm$ 1.4 -5 -60 0.1 .02	< $\pm$ 1.7 -5 -60 0.1 .02	< $\pm$ 1.8 -5 -60 0.1 .02
<b>Power Variation</b> (Max. Rated Pwr) Internally Leveled: (dB) Externally Leveled (Excludes Coupler/Detector Variation) (For Negative Crystal Detector and Power Meter: (dB) With Temperature: (dB/°C)	< $\pm$ 0.9 < $\pm$ 2 0.1	< $\pm$ 0.7 < $\pm$ 2 0.1	< $\pm$ 0.7 < $\pm$ 2 0.1	< $\pm$ 0.8 < $\pm$ 2 0.1	< $\pm$ 0.9 < $\pm$ 2 0.1	$\pm$ 0.9 < $\pm$ 2 0.1	$\pm$ 0.7 < $\pm$ 2 0.1	$\pm$ 0.7 < $\pm$ 2 0.1	$\pm$ 0.8 < $\pm$ 2 0.1	$\pm$ 0.9 < $\pm$ 2 0.1	$\pm$ 1.0 < $\pm$ 2 0.1
<b>Residual AM</b> in 100 kHz Bandwidth: (dBc)	<-50	<-50	<-50	<-50	<-50	<-50	<-50	<-50	<-50	<-50	<-50
<b>Spurious Signals</b> Harmonically Related: (dBc) Typically: (dBc) Non-Harmonics: (dBc)	<-25,(20) <sup>B,E</sup> <-35 <sup>F</sup> <-25	<-25,( $\pm$ 55) <sup>E</sup> <-40,( $\pm$ 60) <sup>C</sup> <-50,( $\pm$ 55) <sup>C</sup>	<-25,( $\pm$ 55) <sup>C</sup> <-35,( $\pm$ 60) <sup>C</sup> <-50,( $\pm$ 55) <sup>C</sup>	<-25,( $\pm$ 55) <sup>C</sup> <-35,( $\pm$ 60) <sup>C</sup> <-50,( $\pm$ 55) <sup>C</sup>	<-25 <-35 <-25	<-25 <-35 <-25	<-25 <-35 <-50	<-25 <-35 <-50	<-25 <-35 <-50	<-25 <-35 <-50	<-20 <-35 <-50

<sup>A</sup> Band 1 on the HP 83590A and the HP 83594A covers 2.0-7.0 GHz, and Full Band on the HP 83590A and 83594A covers 2-20 GHz and 2-26.5 GHz.

<sup>B</sup> HP 83592B only.

<sup>C</sup> HP 83592C only.

<sup>D</sup> 0.5 dB lower with Opt 004.

<sup>E</sup> HP 83592C only; <-25 dBc (0.01-1.4 GHz)

<-45 dBc (1.4-2.4 GHz)

<-50 dBc (2.4-3.5 GHz)

<-55 dBc (3.5-7.0 GHz)

<sup>F</sup> HP 83592C <-35 dBc (0.01-1.4 GHz); <-50 dBc (1.4-2.4 GHz)



# SWEEP OSCILLATORS

Model 8350 Series: Broadband RF Plug-Ins (cont.)

Models 83522A, 83525A and 83525B

- 10 MHz–2.4 GHz and 10 MHz–8.4 GHz in one continuous sweep
- Calibrated output power
- Power sweep

- 1, 10, and 50 MHz crystal markers
- HP 83525B with  $< -45$  dBc harmonics from 2–8.4 GHz
- Complete HP-IB programmability

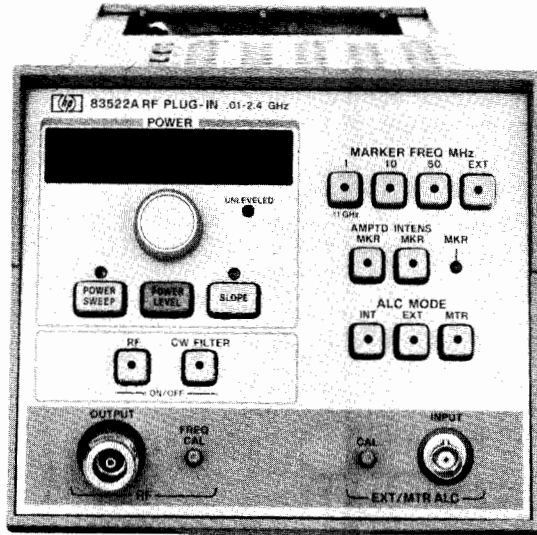

HP 83522A

Broadband frequency measurements may be made with the HP 83522A (10 MHz to 2.4 GHz) plug-in and the HP 83525A/B (10 MHz to 8.4 GHz) plug-in. These plug-ins have similar functions as well as individual merits which are all described in the following article.

### HP 83522A

The HP 83522A uses a heterodyne circuit to provide high performance 10 MHz to 2.4 GHz frequency coverage. This frequency range is covered in one continuous sweep having excellent frequency characteristics. Frequency accuracy is maintained within 5 MHz and the linearity is within 2 MHz over the full band. The power output is internally leveled to  $\pm 0.25$  dB flatness over the entire 10 MHz to 2.4 GHz range while maintaining a power level  $\geq 13$  dBm.

### HP 83525A/B

The HP 83525A/B cover the frequency range of 10 MHz to 8.4 GHz with excellent frequency stability, accuracy, and output power. This wide frequency range is created by automatically switching two bands together with a PIN diode switch. The lower frequency band covers 0.01–2.1 GHz which results from a heterodyne circuit. The upper frequency band is produced by a 2–8.4 GHz YIG oscillator. This 0.1 GHz frequency overlap is provided to enable smooth, narrowband sweeps around the switch point. On a full band sweep (10 MHz to 8.4 GHz) the band discontinuity at the switch point is typically  $< 8$  MHz. The HP 83525A/B maintain excellent frequency parameters with a lower band accuracy within  $\pm 5$  MHz and an upper band accuracy within  $\pm 12$  MHz. Full band frequency linearity is  $\pm 3$  MHz while the lower band maintains a linearity of  $\pm 2$  MHz.

The HP 83525A plug-in, with its extremely broad frequency range, does not sacrifice power. This plug-in provides at least +13 dBm of output power while being internally leveled to a flatness of  $\pm 1$  dB.

The HP 83525B plug-in provides the same outstanding specifications as the HP 83525A plus 45 dBc harmonics for maximum dynamic range in RF component and system measurements.

## HP 83522/83525 Common Features

### Crystal Marker Capability

A powerful feature offered by the HP 83522A and the HP 83525A/B is Crystal Marker capability. This capability provides harmonic markers at 10 or 50 MHz intervals over the full range of the HP 83522A and below 2 GHz with the HP 83525A/B. In addition, 1 MHz harmonic markers are available below 1 GHz with all three

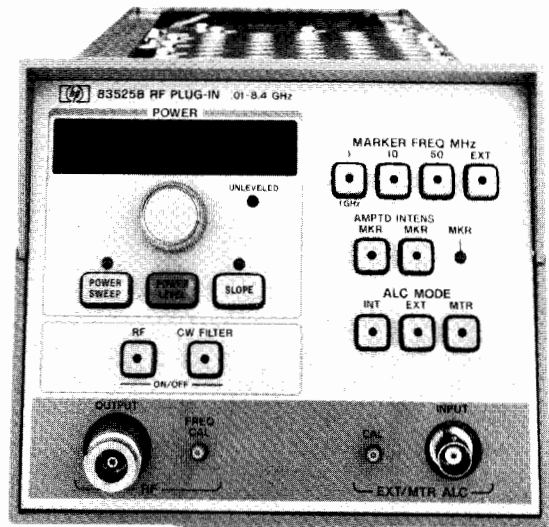

HP 83525B



plug-ins. These markers may be seen as either intensity spots or amplitude dips. The amplitude markers are compatible with the HP 8756A and 8757A Scalar Network Analyzers. These crystal markers simplify and speed up precision frequency measurements.

### Power Output

The HP 83522A and the HP 83525A/B plug-ins have a calibrated output power range of typically 15 dB that may be extended to  $> 80$  dB with Option 002 (70 dB attenuator). The output power level accuracy is within 1 dB on the HP 83522A and within 1.5 dB on the HP 83525A/B. The front panel digital resolution enables the power to be manually set to a 0.1 dB resolution. The power may be remotely HP-IB programmed to 0.02 dB resolution.

These plug-ins also offer a variety of power functions. An innovative feature offered on these plug-ins is Power Sweep, which sweeps the output power from one level to another. With this function, power response measurements may be made in a single test. Slope compensation is provided for situations that involve lossy cables or test setups. This function slopes the power to compensate for high frequency losses via a "Slope" control.

### Programmability

The HP 83522A and the HP 83525A/B are completely programmable plug-ins. This infers that the power level, power mode (Power Sweep, Slope, etc.), crystal markers and other plug-in functions may be externally controlled via the HP-IB. Programmability is a key feature for automatic test systems or production environments requiring multiple, repetitive tests.

### Network Measurements

Increased dynamic range scalar measurements can be made using either the HP 83522A or the 83525A with the HP 8756A or the HP 8757A Scalar Network Analyzer. The dynamic range is increased by internally modulating the RF output with the required 27.8 kHz square wave (produced by the HP 8350). This causes the output to be modulated before it is passed through the output amplifier, thereby avoiding modulation of the amplifier noise. The advantage of increased dynamic range is complemented by the simple interface between the sweep oscillator and the HP 8756A. In addition, these plug-ins are directly compatible with the HP 8510 and the HP 8410s' Network Analyzer, for vector and scalar measurements, the HP 8970A Noise Figure Meter for noise level analysis, and the HP 5344S Source Synchronizer for phase-lock applications.



## Frequency Characteristics

Range	HP 83522A	HP 83525A/B	
	0.01-2.4 GHz	0.01-8.4 GHz	
		0.01-2 GHz	2-8.4 GHz
<b>Accuracy*</b> (25°C ±5°C)			
CW Mode:	±5 MHz	±5 MHz	±12 MHz
Typically:	±1.5 MHz	±1.5 MHz	±3.5 MHz
All Sweep Modes	±15 MHz	±15 MHz	±20 MHz
Linearity Typically:	±2 MHz	±2 MHz	±3 MHz
<b>Stability</b>			
With Temperature: Typically	±200 kHz/°C	±200 kHz/°C	±200 kHz/°C
With 10% Line Voltage Change:	±20 kHz	±20 kHz	±20 kHz
With 10 dB Power Level Change:	±100 kHz	±100 kHz	±1 MHz
With 3:1 Load SWR:	±10 kHz	±10 kHz	±250 kHz
With Time (in 10 minute period after one hour warmup at the same frequency setting): Typically	<±100 kHz	<±100 kHz	<±200 kHz
Residual FM (10 Hz-10 KHz Bandwidth), peak	<5 kHz	<5 kHz	<7 kHz

## Output Characteristics

	HP 83522A	HP 83525A/B	
	0.01-2.4 GHz	0.01-2 GHz	2-8.4 GHz
<b>Maximum Leveled Output Power</b> (25°C ± 5°C) With Option 002	+20 mW +20 mW	+20 mW +20 mW	+20 mW/10 mW +20 mW/10 mW
<b>Power Level Accuracy</b> (Internally Leveled): Attenuator Accuracy (per 10 dB step, typical):	±1 dB ±0.3 dB	±1.5 dB ±0.3 dB	±1.5 dB ±0.3 dB
<b>Calibrated Range:</b> With Option 002:	15 dB 85 dB	15 dB 85 dB	15 dB 85 dB
<b>Resolution (displayed):</b>	0.1 dB	0.1 dB	0.1 dB
<b>Remote Programming (Settable):</b>	±0.01 dB	±0.01 dB	±0.01 dB
<b>Power Variation (Max. Rated Pwr)</b> Internally Leveled: Externally Leveled (Excludes Coupler/Detector Variation) For Negative Crystal Detector and HP 432A/B/C Power Meter: With Temperature:	±0.25 dB <±0.1 dB ±0.02 dB/°C	±1 dB <±0.1 dB ±0.02 dB/°C	±1 dB <±0.1 dB ±0.02 dB/°C
<b>Residual AM in 100 kHz Bandwidth:</b>	<-50 dBc	<-50 dBc	<-50 dBc
<b>Spurious Signals</b> Harmonics (for 10 mW output pwr): Typical: Non-Harmonics: Typical:	<-25 dBc <-30 dBc <-25 dBc <-30 dBc	<-25 dBc** <-30 dBc <-30 dBc <-35 dBc	<-25 dBc/ 45 dBc <-30 dBc/50 dBc <-60 dBc <-60 dBc
<b>Output VSWR (internally leveled)</b>	<1.5	<2.0	<1.6

**Unleveled indicator:** lights when RF power level is set too high to permit leveling over sweep range selected.

**Impedance:** 50 Ω nominal

### Power Sweep

**Calibrated range:** 15 dB

**Accuracy (including linearity):** <±1.5 dB typical

**Resolution:** 0.1 dB

### Slope Compensation

**Calibrated range:** up to 5 dB/GHz (10 dB over full range, typically 15 dB)

**Linearity:** <0.2 dB typical

**Resolution:** 0.01 dB/GHz

## Modulation Characteristics

### External AM

**Frequency response:** 100 kHz typically

**Input impedance:** Approximately 10 kΩ

**Range of amplitude control:** 15 dB typically

**Sensitivity:** 1 dB/V typically

**Maximum input:** 15 V

**Pulse modulation:** (HP 83525A/B, 2-8.4 GHz)

**Rise/fall time:** 20 ns typically

**Minimum pulse width:** Leveled: 1 μs (HP 83525A), 5 μs (HP 83525B) typically  
Unleveled: 100 ns typically

\*When calibrated using internal crystal markers and FREQ CAL adjustment.

\*\*83525A harmonics <- 20 dBc for 20 mW output power.

### Internal AM

Selectable (by internal jumper in HP 8350) to 1 kHz or 27.8 kHz square-wave modulation. 27.8 kHz modulation guarantees operation with HP 8755 Frequency Response Test Set.

**On/Off Ratio:** ≥ 30 dB (>40 dB above 2 GHz)

### External FM

#### Maximum Deviations for Modulation Frequencies

**DC to 100 Hz:** ±75 MHz

**100 Hz to 1 MHz:** ±7 MHz

**1 MHz to 2 MHz:** ±5 MHz

**2 MHz to 10 MHz:** ±1 MHz

#### Sensitivity

**FM Mode:** -20 MHz/V typical

**Phase-lock mode:** -6 MHz/V typical

**Input impedance:** 2 kΩ nominal

**Frequency response (dc to 2 MHz):** ±3 dB

## Crystal Marker Capability

**Internal crystal markers:** Harmonic markers of 10 and 50 MHz are available over the full range of the HP 83522A and below 2 GHz with HP 83525A/B. 1 MHz harmonic markers are available below 1 GHz with the HP 83522A and 83525A/B. Markers are output as intensity spots through the POS Z BLANK connector on the HP 8350 or as amplitude dips on the RF output.

**Accuracy of center frequencies (25°C):** ±5 x 10<sup>-6</sup>

**Typical Marker Width Around Center Frequency**

**1 MHz Markers:** ±100 kHz

**10 MHz Markers:** ±200 kHz

**50 MHz Markers:** ±300 kHz

**Temperature stability:** ±2 x 10<sup>-6</sup>/°C typical

**External marker input:** generates amplitude or Z-axis marker when sweep frequency equals external input frequency.

**Frequency range:** .01 to 2.4 GHz (2.0 GHz for HP 83525A/B)

**Marker width:** ±300 kHz

**Marker indicator light:** LED lights when coincident with crystal or external marker for accurate CW calibration.

## General Specifications

### Sweep Time (minimum over full band)

**HP 83522A (.01-2.4 GHz):** 10 ms

**HP 83525A/B (.01-8.4 GHz):** 17 ms

**Switch points (HP 83525A/B only):** low band .01-2.1 GHz, high band 2.0-8.4 GHz. Internal band switch point at 2.0-2.1 GHz.

**Frequency reference output:** nominal 1 V/GHz (over full sweep range); ±10 mV rear panel BNC output.

**RF Output connector:** type N female

**Weight:** net, 4.5 kg (10 lb); shipping, 7.7 kg (17 lb)

### Improved Network Measurement Capabilities

The HP 83522A and 83525A/B are compatible with the:

HP 8510 Network Analyzer

HP 8410 Network Analyzer

HP 8757A Scalar Network Analyzer

HP 8756A Scalar Network Analyzer

HP 8970A Noise Figure Meter (frequencies >2 GHz)

HP 8709A Phase-lock Synchronizer

HP 5344S Source Synchronizer

## Ordering Information

**HP 83522A** +13 dBm .01-2.4 GHz RF Plug-in

### Options

**002:** Programmable 70 dB Step Attenuator (10 dB steps)

**004:** Rear Panel RF Output

**HP 83525A** +13 dBm .01-8.4 GHz RF Plug-in

**HP 83525B** +10 dBm .01-8.4 GHz RF Plug-in

### Options

**002:** Programmable 70 dB Step Attenuator (10 dB steps)

**004:** Rear Panel RF Output

# SWEEP OSCILLATORS

## Model 8350 Series: RF Plug-Ins

### Models 83540A, 83540B and 83545A

- HP 83540A: 40 mW internally leveled 2–8.4 GHz output
- HP 83545A: 50 mW internally leveled 5.9–12.4 GHz output
- HP 83540B: < -45 dBc harmonics 2–8.4 GHz output
- Calibrated output power with 0.1 dB resolution
- Power sweep
- Complete HP-IB programmability

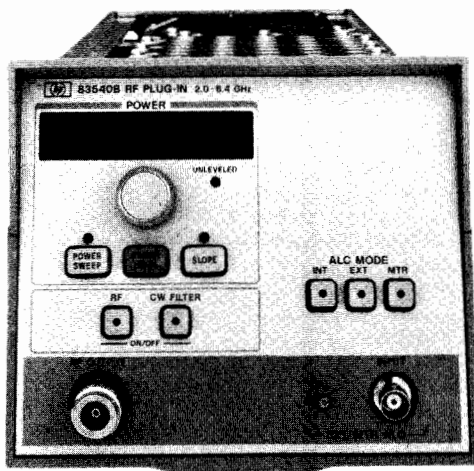

HP 83540B

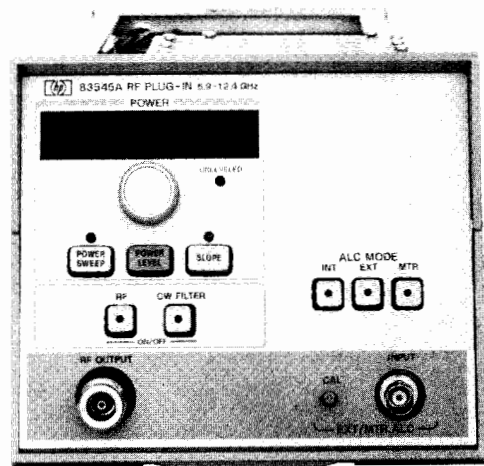

HP 83545A



### HP 83540A/B

High power, high performance, straddle band frequency coverage from 2–8.4 GHz is provided by the HP 83540 plug-ins. The output power is leveled at a minimum of 16 dBm from the HP 83540A and 13 dBm from the HP 83540B with variations less than 1 dB. The calibrated power output range is 15 dB which may be extended to >80 dB with Option 002 (70 dB Step Attenuator). These plug-ins also feature Power Sweep which allows realtime power response measurements to be made in a single test. Another power function is slope compensation which adjusts for high frequency cable or test set losses. All plug-in features are completely HP-IB programmable. The frequency outputs are accurate within 8 MHz while maintaining a full band linearity typically within 0.1%. In addition to its sweeper functions, the HP 83540 is also directly compatible with the HP 8756A and the HP 8757A Scalar Network Analyzers, the HP 8510 and the HP 8410C Network Analyzers.

The HP 83540B gives emphasis to signal purity with 45 dBc harmonics for extended dynamic range in precision RF scalar measurement systems.

The clear, high power test signal of the HP 83540B is produced by employing a YIG-filtered oscillator (YFO). The YFO consists of a broadband, YIG-tuned, 2–8.4 GHz oscillator driving a 100 mW power amplifier followed by another YIG element to filter the signal. By incorporating both YIG elements within the same magnetic housing and controlling them simultaneously, a very accurate, pure and powerful RF test signal is achieved.

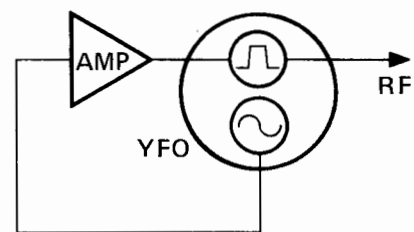

YIG-Tuned Oscillator





## HP 83545A

The HP 83545 plug-in features high performance 5.9-12.4 GHz frequency coverage with exceptionally high output power. The output power is internally leveled to at least 17 dBm, with power variations less than 0.6 dB. The calibrated output power has a range of 15 dB which is expandable to >80 dB with Option 002 (70 db Step Attenuator). A power sweep function is available for power response measurements. In addition, the HP 83545 provides slope compensation and complete HP-IB programmability. The frequency output is accurate to 20 MHz with excellent stability and linearity (typically 0.1%). Network analysis is simplified since the HP 83545 provides 27.8 kHz internal modulation for direct compatibility with the HP 8756A and the HP 8757A Scalar Network Analyzers, and it is also directly compatible with the HP 8510 and the HP 8410C Network Analyzers.

### Frequency Characteristics

**Linearity:** (HP 83540A/B, 83545A)  $\pm 0.1\%$  typical

**Reference output:** (HP 83540A, 83545A) dc-coupled voltage proportional to RF frequency. Typically 1V/GHz with accuracy of  $\pm 25$  mV.

### Output Characteristics

**Power level accuracy:**  $\pm 1$  dB typical

**Option 002 (70 dB step attenuator):** (HP 83540A, 83545A)  $\pm 0.2$  dB/10 dB step typical

### RF Power Leveling

**Internal:** Selected by front panel switch; refer to chart for figures. Standard for HP 83540 and HP 83545.

### External

**Crystal input:** approximately -10 to -200 mV for specified leveling at rated output; for use with negative polarity detectors such as HP 780 Series Directional Detectors, HP 423A/B and 424 series Crystal Detectors.

**Power meter input:** switch selects proper compensation for HP 432A/B/C, 436A, and 438A Power Meters.

**Indicator:** front panel indicator lights when RF power becomes unlevelled. Residual AM in 100 kHz bandwidth: >50 dBc

**Impedance:** 50  $\Omega$  nominal

### Power Sweep

**Calibrated range:**  $\geq 15$  dB

**With option 002:**  $\geq 14$  dB

**Accuracy:**  $\pm 1.5$  dB typical

**Resolution:** 0.1 dB

**Slope compensation:** compensates for high frequency power losses in external test sets by attenuating power at lower frequencies:

**Calibrated range:** up to 5 dB/GHz (10 dB max., typically 15 dB)

**Linearity:** <0.2 dB typical

**Resolution:** 0.01 dB/GHz

### General Specifications

**RF output connector:** type N female

**Sweep Time** (minimum over full band)

**HP 83540A/B** (2.0-8.4 GHz): 10 ms

**HP 83545A** (5.9-12.4 GHz): 10 ms

**Weight:** HP 83540A, 83545A: net, 4.5 kg (10 lb); shipping, 7.7 kg (17 lb).

### Improved Network Measurement Capabilities

The HP 83540A/B and 83545A are compatible with the:

HP 8510 Network Analyzer

HP 8410 Network Analyzer

HP 8755 Scalar Network Analyzer

HP 8756A Scalar Network Analyzer

HP 8757A Scalar Network Analyzer

HP 8970A Noise Figure Meter

HP 8709A Phase-lock Synchronizer

HP 5344S Source Synchronizer

### Frequency Characteristics

	HP 83540A	HP 83540B	HP 83545A
<b>Range:</b>	2-8.4 GHz	2-8.4 GHz	5.9-12.4 GHz
<b>Accuracy</b> (25°C $\pm 5^\circ$ C)			
CW Mode:	$\pm 15$ MHz	$\pm 12$ MHz	$\pm 20$ MHz
Typical:	$\pm 3.5$ MHz	$\pm 3.5$ MHz	$\pm 10$ MHz
All Sweep Modes: (for sweep time >100 msec)	$\pm 20$ MHz	$\pm 20$ MHz	$\pm 35$ MHz
<b>Stability</b>			
With Temperature:	$\pm 200$ kHz/ $^\circ$ C	$\pm 200$ kHz/ $^\circ$ C	$\pm 1.2$ MHz/ $^\circ$ C
With 10% Line Voltage Change:	$\pm 20$ kHz	$\pm 20$ kHz	$\pm 40$ kHz
With 10 dB Power Level Change:	$\pm 1$ MHz	$\pm 1$ MHz	$\pm 1.5$ MHz
With 3:1 Load SWR Change:	$\pm 250$ kHz	$\pm 250$ kHz	$\pm 250$ kHz
With Time: (in 10 minute time period after one hour warmup at the same frequency setting) Typ/10 min.	$\pm 200$ kHz	$\pm 200$ kHz	$\pm 200$ kHz
Residual FM: (in 10 Hz-10 kHz bandwidth, CW mode):	<9 kHz peak	<7 kHz	<15 kHz peak

### Output Characteristics

	HP 83540A	HP 83540B	HP 83545A
<b>Maximum Leveled Power</b> (25°C $\pm 5^\circ$ C) Opt 002 (70 dB step atten.)	>40 mW >32 mW	>20 mW >16 mW	>50 mW >40 mW
<b>Power Variation</b> (At max. rated power)			
Internally Leveled:	< $\pm 1$ dB	< $\pm 1$ dB	< $\pm 0.6$ dB
Unleveled: Typically	< $\pm 2$ dB	< $\pm 2$ dB	< $\pm 3$ dB
Externally Leveled (Excluding coupler and detector variation):			
Crystal Detector or Power Meter	< $\pm 0.1$ dB	< $\pm 0.1$ dB	< $\pm 0.1$ dB
<b>Spurious Signals:</b> (Below fundamental at specified maximum power)			
Harmonically Related:	<-20 dBc	<-45 dBc	<-17 dBc 5.9-7 GHz <-30 dBc 7-12.4 GHz
Typically:	<-25 dBc	<-50 dBc	-
Non-Harmonics:	<-60 dBc	<-60 dBc	<-60 dBc
Source VSWR: 50 nominal impedance			
Internally leveled:	<1.6	<1.6	<1.6
Unleveled: Typically	<2.5	<2.5	<2.5
<b>Modulation Characteristics</b>			
<b>External FM</b>			
Maximum Deviations for Modulation Frequencies			
DC to 100 Hz:	$\pm 75$ MHz	$\pm 75$ MHz	$\pm 75$ MHz
100 Hz to 1 MHz:	$\pm 7$ MHz	$\pm 7$ MHz	$\pm 7$ MHz
1 MHz to 2 MHz:	$\pm 5$ MHz	$\pm 5$ MHz	$\pm 5$ MHz
2 MHz to 10 MHz:	$\pm 1$ MHz	$\pm 1$ MHz	$\pm 1.5$ MHz
Sensitivity: Nominal			
FM Mode:	-20 MHz/V	-20 MHz/V	-20 MHz/V
Phase-lock Mode:	-6 MHz/V	-6 MHz/V	-6 MHz/V
<b>External AM</b>			
Input Impedance: nominal	10 k $\Omega$	10 k $\Omega$	10 k $\Omega$
Frequency Response: Typical	100 kHz	100 kHz	100 kHz
Range: Typical	15 dB	15 dB	15 dB
<b>Pulse Modulation</b>			
Rise/Fall Time: Typical	20 nsec	20 nsec	15 nsec
Minimum Pulse Width			
Leveled: Typical	1 $\mu$ sec	5 $\mu$ sec	1 $\mu$ sec
Unleveled: Typical	100 nsec	100 nsec	100 nsec
<b>Square Wave Response</b>			
On/Off Ratio: Typical	>30 dB	>30 dB	>40 dB
Symmetry: Typical	40/60	40/60	40/60
<b>Internal AM:</b>			
Selectable to 1 kHz or 27.8 kHz square wave (Guarantees HP 8755 Frequency Response Test Set compatibility)			
On/Off Ratio:	>30 dB	>30 dB	>40 dB

### Ordering Information

**HP 83540A** 2-8.4 GHz Plug-in

**HP 83540B** 2-8.4 GHz Plug-in

**HP 83545A** 5.9-12.4 GHz Plug-in

### Options

**002:** 70 dB Step Attenuator

**004:** Rear Panel RF Output Connector

# SWEEP OSCILLATORS

Model 8350 Series: RF Plug-Ins (cont.)



Models 83570A, 83572A and 83572B

- HP 83572B offers 5 mW minimum unlevelled 26.5-40 GHz output
- HP 83570A offers 10 mW internally levelled 18-26.5 GHz output
- HP 83570A offers low frequency auxiliary output for easy counting and phase-locking
- Calibrated output power with 0.1 dB resolution
- Power sweep
- Complete HP-IB programmability

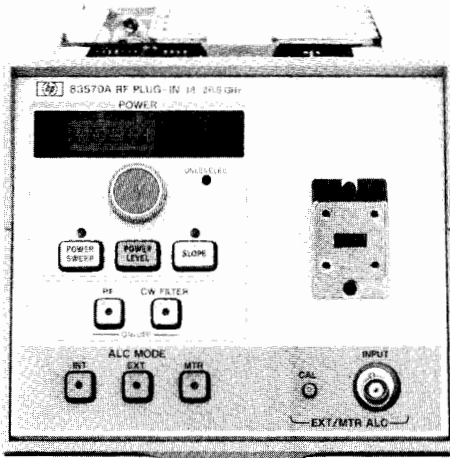

HP 83570A

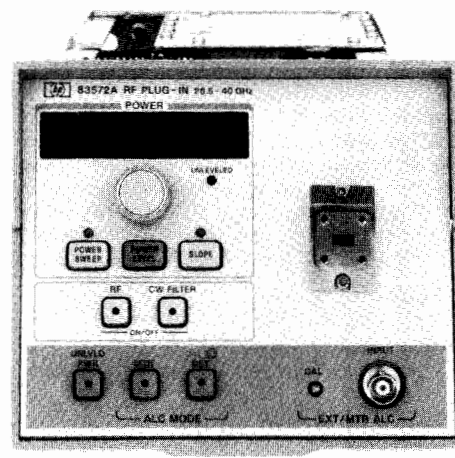

HP 83572A

## HP 83570A

Now precision measurements to 26.5 GHz are possible with the solid state HP 83570A plug-in. The HP 83570A plug-in maintains a minimum leveled output power of 10 dBm which is comparable to the output power of Backward Wave Oscillators. Power is internally leveled to a flatness  $< \pm 1.4$  dB. At the output, power losses are minimized with a waveguide output connector (a coaxial output connector may be made using the HP K281C adapter). Full range coverage of the HP 83570A extends from 18 GHz to 26.5 GHz. This frequency range maintains a 30 MHz frequency accuracy and 0.1% linearity. With high frequency coverage, complete HP-IB programmability and outstanding leveled output power, the HP 83570A plug-in, combined with the many features of the HP 8350 mainframe adds a new dimension to microwave measurements above 18 GHz.

The output power has a calibrated range of 11 dB which can be extended with external attenuators such as the HP 8495K. The power level may be manually set to a 0.1 dB resolution, or the power level may be remotely HP-IB programmed to a 0.02 dB resolution. In addition to a single output power, the HP 83570A also has a power sweep function. This function sweeps the power from one level to another. Another important feature that the HP 83570A offers is slope compensation. This compensates for high frequency power losses in external tests by attenuating the power at lower frequencies.

Scalar measurements at high frequencies may be easily made since the HP 83570A provides internal 27.8 kHz modulation required to interface with the HP 8756A or the HP 8757A Scalar Network Analyzer. In addition to simplifying the interface circuitry, internal modulation reduces connection losses which are critical at high frequencies.

The high output power and HP-IB programmability also make the HP 83570A ideal for use with the HP 8410 Network Analyzer and HP K8747A Test Set when making vector network measurements from 18 to 26.5 GHz. The +10 dBm output power (unavailable on other solid state sources) is required for proper operation of HP K8747A mixers.

## HP 83572A/B

The HP 83572A/B RF Plug-in extends the frequency coverage to 40.0 GHz. The plug-ins offer minimum unlevelled output power of 7 dBm (HP 83572B), and 3 dBm (HP 83572A) for maximizing the dynamic range of passive device measurements. Option 001 provides 6 dBm (HP 83572B), and 2 dBm (HP 83572A) minimum calibrated externally leveled output power for regulated power control during swept and CW operations. Full range coverage of the HP 83572 extends from 26.5 GHz to 40.0 GHz. This frequency range maintains a 100 MHz frequency accuracy and 0.2% linearity. With high frequency coverage, complete HP-IB programmability and outstanding leveled output power, the HP 83572 plug-ins extend the HP 8350 mainframe capabilities above 26.5 GHz.

The output power has calibrated range of 7 dB. The power level may be manually set to a 0.1 dB resolution, or the power level may be remotely HP-IB programmed to a 0.01 dB resolution. The HP 83572 also features Power Sweep which allows real time power response measurements of active devices. Another important feature is slope compensation which compensates for system/cable losses at high frequencies.

Scalar measurements at high frequencies may be easily made since the HP 83572 provides internal 27.8 kHz modulation (Option 006) required to interface with the HP 8756A or the HP 8757A Scalar Network Analyzer. In addition to amplifying the interface circuitry, internal modulation reduces connection losses which are critical at high frequencies.

The high output power and HP-IB programmability also make the HP 83572 ideal for use with the HP 8410 Network Analyzer and HP R8747B Test Unit when making vector network measurements from 26.5 to 40.0 GHz.



## Output Characteristics

### RF Power Leveling

**Unleveled:** selected by front panel switch; refer to chart for figures. Standard for HP 83572A/B.

**Internal:** selected by front panel switch; refer to chart for figures. Standard for HP 83570A.

### External

Crystal detector: approximately  $-10$  to  $-200$  mV for specified leveling at rated output; for use with negative polarity detectors such as HP 422 Series Crystal detectors.

Calibrated crystal detector (option 001): approximately  $-10$  to  $-200$  mV for specified leveling at rated output; for use with negative polarity detectors such as HP 422 Series Crystal detectors. SHIFT DET switch selects internal calibration for an external coupler, a crystal detector, and a BNC cable, all included in Option 001 of HP 83572.

Power meter input: switch selects proper compensation for HP 432A/B/C Power Meters.

Indicator: front panel indicator lights when RF power becomes unleveled. Residual AM in 100 kHz Bandwidth:  $<-50$  dBc.

Impedance: 50  $\Omega$  nominal

### Power Sweep

Calibrated range

HP 83570A:  $\geq 11$  dB.

HP 83572A/B (option 001 only):  $\geq 7$  dB, typical.

Accuracy:  $\pm 1.5$  dB typical.

Resolution: 0.1 dB

### Slope compensation

Calibrated range

HP 83570A: up to 5 dB/GHz (10 dB max, typically 11 dB).

HP 83572A/B (option 001 only): Up to 5 dB/GHz (7 dB max).

Linearity:  $<0.2$  dB.

Resolution: 0.1 dB/GHz

## General Specifications

**Sweep Time** (minimum over full band)

HP 83570A (18–26.5 GHz): 10 ms

HP 83572A/B (26.5–40.0 GHz): 10 ms.

### RF Output Connector

HP 83570A type WR42 waveguide.

HP 83572A/B type WR28 waveguide.

**Auxiliary output:** (HP 83570A) rear panel 9–13.25 GHz fundamental oscillator output, nominally 0 dBm.

**Weight:** net 5.4 kg (12 lbs). Shipping 8.7 kg (19 lbs).

### Improved Network Measurement Capabilities

The HP 83570A is Compatible with the

HP 8756A Scalar Network Analyzer\*\*

HP 8757A Scalar Network Analyzer\*\*

HP 5344S Source Synchronizer

HP 8410 Network Analyzer using the K8747A Test Set

The HP 83572A/B are Compatible with the

HP 8756A Scalar Network Analyzer\*\*

HP 8757A Scalar Network Analyzer\*\*

HP 8410 Network Analyzer using the R8747B Test Set

## Ordering Information

**HP 83570A** 18–26.5 GHz RF Plug-in (Internal leveling standard)

**HP 83572A** 26.5–40.0 GHz RF Plug-In

**Opt 001:** Calibrated External Leveling

**Opt 006:** Internal Pulse and Square Wave Modulation capability

**HP 83572B** 26.5–40.0 GHz RF Plug-in

**Opt 001:** Calibrated External Leveling

**Opt 006:** Internal Pulse and Square Wave Modulation capability

## Frequency Characteristics

	HP 83570A	HP 83572A/B
<b>Range</b>	18–26.5 GHz	26.5–40 GHz
<b>Accuracy</b> (25°C $\pm$ 5°C)		
CW Mode:	$\pm 30$ MHz	$\pm 100$ MHz
Typical:	$\pm 20$ MHz	$\pm 20$ MHz
All Sweep Modes:	$\pm 55$ MHz	$\pm 150$ MHz
Linearity typically:	$\pm 15$ MHz	$\pm 50$ MHz
<b>Stability</b>		
With Temperature:	800 kHz/°C	$\pm 8$ MHz/°C
With 10% Line Voltage Change:	$\pm 80$ kHz	$\pm 1$ MHz
With 10 dB Power Level Change:	$\pm 1$ MHz	$\pm 200$ kHz
With 3:1 Load SWR:	$\pm 500$ kHz	$\pm 100$ kHz
With Time: (in 10 minute time period after one hour warmup at the same frequency setting, typical)	$\pm 400$ kHz	$\pm 4$ MHz
Residual FM: (in 10 Hz–10 kHz bandwidth, CW mode):	$<30$ kHz	$<60$ kHz

## Output Characteristics

<b>Maximum Levelled Power</b> (25°C $\pm$ 5°C):	$>10$ mW	
<b>Minimum Unleveled Power</b> (25°C $\pm$ 5°C):		$>2$ mW (5 mW)*
Opt. 001 (at output of external leveling coupler):		1.0 dB less
Opt. 006 (at waveguide output of plug-in):		1.5 dB less
<b>Power Level Accuracy:</b> Typical		
Internally leveled:	$\pm 1.8$ dB	
Externally Levelled (Opt. 001):		$\pm 1.5$ dB
<b>Resolution</b> (displayed):	0.1 dB	0.1 dB
<b>Remote Programming</b> (settable)	$\pm 0.01$ dB	$\pm 0.01$ dB
<b>Power Variation</b> (At max. rated power)		
Internally Levelled:	$<\pm 1.4$ dB	
Unleveled: Typically	$<\pm 2$ dB	$<\pm 3$ dB
Externally Levelled (Excluding coupler and detector variation):		
Crystal Detector or Power Meter	$<\pm 0.1$ dB	$<\pm 0.2$ dB
<b>Spurious Signals:</b> (Below fundamental at specified maximum power)		
Harmonically Related:	$<-25$ dB	$<-50$ dB
Non-Harmonics:	$<-50$ dB	$<-50$ dB
<b>Source VSWR:</b> 50 $\Omega$ nominal impedance		
Internally leveled:	$<2.5$	
Externally leveled (Opt. 001)		$<1.5$
<b>Modulation Characteristics</b>		
<b>External FM</b>		
Maximum Deviations for Modulation Frequencies		
DC to 100 Hz:	$\pm 75$ MHz	$\pm 150$ MHz
100 Hz to 200 kHz:		$\pm 3.5$ MHz
100 Hz to 1 MHz:	$\pm 7$ MHz	
1 MHz to 2 MHz:	$\pm 5$ MHz	
2 MHz to 10 MHz:	$\pm 1.5$ MHz	
Sensitivity: Nominal		
FM Mode:	$-20$ MHz/V	$-20$ MHz/V
Phase-lock Mode:	$-6$ MHz/V	$-6$ MHz/V
<b>External AM</b>		
Frequency Response:		
Typically	100 kHz	10 kHz
Range of Amplitude Control (typically)		
Internally Levelled:	11 dB	—
Option 001 (externally leveled):	—	7 dB (11 dB)*
Unleveled:	—	30 dB
Sensitivity:	1 dB/V	1 dB/V (Opt. 001)
Input Impedance: Approx.	110 k $\Omega$	30 k $\Omega$

**Internal Square Wave Modulation** (Option 006 of HP 83572A/B) 1 kHz or 27.8 kHz square wave modulation selectable by internal jumper in HP 8350B. The 27.8 kHz modulation ensures operation with Hewlett-Packard scalar network analyzers.

On/Off Ratio:  $>25$  dB  $>20$  dB

Symmetry: 40/60 45/55

<b>External Pulse and Square Wave Modulation***</b>		
Pulse Input: TTL compatible		
Rise/Fall Time:	20 ns	300/50 ns
Minimum RF Pulse: Width (Typically)		
Internally Levelled:	1 $\mu$ s	—
Unleveled:	100 ns	500 ns
Modulation Rate:	—	0.5–1 MHz
On/Off Ratio:	$>25$ dB	$>20$ dB
Symmetry:	40/60	45/55

\*HP 83572B only

\*\*Requires HP 83572A/B Option 006

\*\*\*HP 83572A/B Option 006, unleveled output

# SWEEP OSCILLATORS

## Model 8350 Series: RF Plug-In Adapter

### Model 11869A

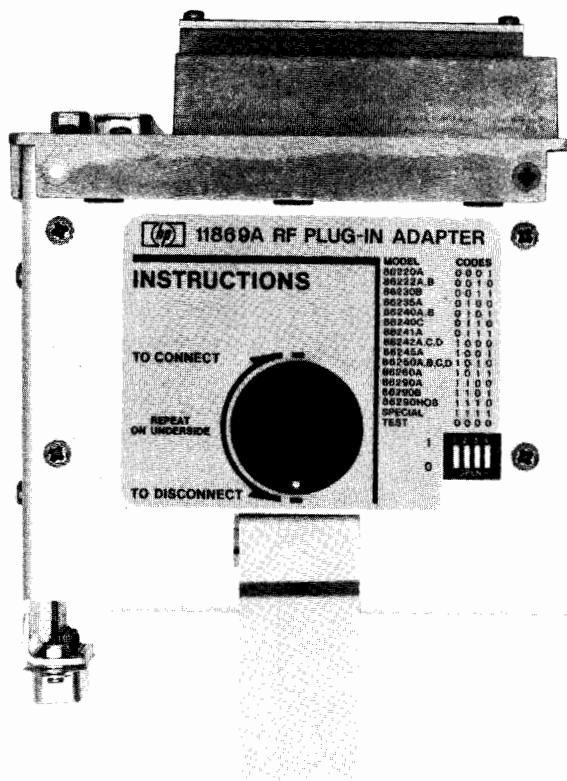

HP 11869A

#### HP 11869A Adapter

The HP 11869A Adapter provides the electrical and mechanical interface between the HP 8350 and 86200 series plug-ins. All of the HP 8350's standard operating features, including HP-IB remote programming, are available. However, specific plug-in functions (output power level, RF on/off, etc.) cannot be controlled or remotely programmed by the HP 8350 mainframe.

#### Plug-Ins with Rear Panel RF Output

Option 004 allows the adapter to be used with HP 86200 plug-ins that are equipped with rear panel RF output. Supplied with Option 004 are two pre-shaped, semi-rigid coax cables with the appropriate mating connectors so that the RF output can be extended to the rear panel of the adapter.

#### Rear Panel Description

On the rear panel of the HP 11869A are five hole plugs that can be removed to allow connections to be made to the rear panel. Four of the holes are for low frequency (small diameter) cables while one is for a high frequency (large diameter) RF cable. For user convenience the holes are labeled — AUX OUT, EXT ALC IN, PULSE IN, FREQ REF, and RF OUT.

#### Plug-Ins Compatible with the HP 11869A Adapter

The HP 11869A Adapter attaches to the back of the HP 86200 series plug-in and is equipped with a switch for setting the specific interface code for the plug-in being used.

The following plug-ins will operate in the HP 8350 by using the HP 11869A Adapter.

HP 86220A (0.01–1.3 GHz)	HP 86245A (5.9–12.4 GHz)
HP 86222A/B (0.01–2.4 GHz)	HP 86250A/B/C/D (8.0–12.4 GHz)
HP 86230B* (1.8–4.2 GHz)	HP 86251A (7.5–18.6 GHz)
HP 86235A (1.7–4.3 GHz)	HP 86260A (12.4–18.0 GHz)
HP 86240A/B (2.0–8.4 GHz)	HP 86260B (10.0–15.5 GHz)
HP 86240C (3.6–8.6 GHz)	HP 86260C (17.0–22.0 GHz)
HP 86241A (3.2–6.5 GHz)	HP 86290A* (2.0–18.0 GHz)
HP 86242A/C/D (5.9–9.0 GHz)	HP 86290B/C (2.0–18.6 GHz)
	HP 86290B H08 (2.0–22 GHz)

#### Special Plug-Ins

For factory modified HP 86200 series plug-ins with non-standard frequency coverage a special PROM must be inserted in the HP 11869A Adapter. Consult your local HP Sales and Service Office for further information.

#### Plug-Ins Not Compatible with the HP 11869A Adapter

The HP 8621B RF Drawer and 86300 series RF modules are not compatible with the HP 11869A and will not operate in the HP 8350.

**Furnished:** three BNC cables for extending plug-in rear panel inputs/out-puts to adapter rear panel; BNC/SMD (factory installed) for connecting plug-in FM input to adapter/mainframe; plug-in handle assembly for simplified installation in the HP 8350 mainframe.

**Weight:** Net, 0.9 kg (2 lb). Shipping, 2.7 kg (6 lb).

#### Ordering Information

##### HP 11869A Adapter

**Option 004:** Extension Cables for Plug-ins with Rear Panel RF Output

**Special PROM module:** For plug-ins with non-standard frequency coverage. (Consult Sales and Service Office)

**Option 006:** Type N Aux Out Interface Connector for HP 86251A and 86290A\*/B/C

\*Models 86230B and 86290A are obsolete as of April 1, 1984. However, existing models of HP 86230B and 86290A can interface to HP 8350 mainframe via the HP 11869A Adapter.

# SWEEP OSCILLATORS

Model 8620 Series: 10 MHz to 22 GHz  
Model 8620 Series



- Single-band, straddle-band and broadband plug-ins
- External phase-lock capability
- > 10 mW to 22 GHz



HP 8620C with HP 86222B, 86290B



## HP 8620 System

The Hewlett-Packard HP 8620 solid state sweeper system offers the flexibility of the HP 8620C mainframe in addition to a choice of singleband, multiband, straddle-band, and broadband plug-ins. The HP 8620 system also offers high output with solid state reliability—greater than 10 mW leveled to 22 GHz.

The fundamental oscillators used in the plug-ins and modules are YIG tuned transistor or bulk effect circuits. YIG tuning results in exceptional tuning linearity, low noise, and low spurious content; it also allows frequency modulation at high rates and wide deviations with low distortion.

## HP 8620C Sweeper Mainframe

The HP 8620C has many features which are highly useful in stringent applications. With convenient functionally grouped controls and lighted pushbutton indicators the mainframe offers extreme ease of operation and flexibility. In addition, it can be a completely HP-IB programmable source, an indispensable feature for automatic systems and signal simulation applications.

## HP 86222A/B and 86290B/C Broadband Plug-Ins

Now the 10 MHz to 18.6 GHz frequency range can be covered with just two plug-ins—the HP 86222A/B and 86290B/C. Besides their broad frequency range these plug-ins offer many special features including unique crystal markers in the HP 86222B and better than  $\pm 30$  MHz frequency accuracy in a HP 86290B/C even at 18 GHz.

## HP 86240A/B/C and 86251A Straddle-Band Plug-Ins

Covering more than an octave of frequencies the HP 86240A and B span 2 to 8.4 GHz and the HP 86251A spans from 7.5 to 18.6 GHz with major advances in power output and signal purity. The HP 86240A offers more than 40 mW while the HP 86251A provides over 10 mW of leveled output across the full band. All three plug-ins deliver a high quality test signal of low harmonic content with the HP 86240B providing harmonics of >45 dBc. This can be very important when making measurements across more than one octave.

## HP 86200 Series Single-Band Plug-Ins

The HP 86200 series of plug-ins covers both ends of the frequency spectrum from 10 MHz to 22 GHz with a choice of more than eleven plug-ins.

## Plug-In Compatibility with HP 8350

The entire line of HP 86200 series plug-ins can be used in the HP 8350 Sweep Oscillator mainframe with no degradation in performance by using the HP 11869A Adapter.

TYPICAL UNLEVELLED POWER OUTPUT

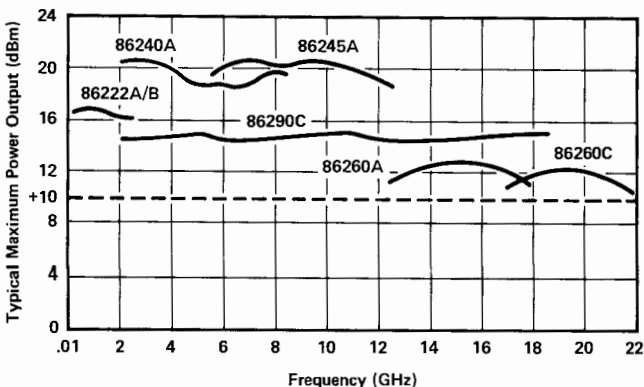

# SWEEP OSCILLATORS

## Model 8620 Series: Mainframe

### Model 8620C

- Optional BCD or HP-IB programming
- 3 markers

- 100%  $\Delta F$  capability, fully calibrated

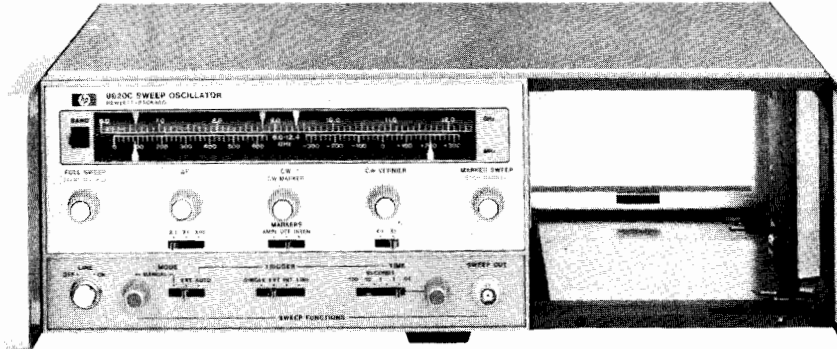

HP 8620C



The HP 8620C offers many features as standard equipment. For example, up to four separate bands and their respective frequency scales can be selected with a band select lever to the left of the dial scale. Pushbuttons, concentrically located in the frequency control knobs, light when actuated to indicate the sweep function in use. The sweep functions available are: FULL SWEEP, MARKER SWEEP, CW/ $\Delta F$  and CW. Three markers are available, controlled by the START MARKER, STOP MARKER, and CW MARKER knobs.

The HP 8620C is fully and continuously calibrated for any  $\Delta F$  sweep width. The sweep is symmetrical about the CW MARKER setting and three continuously variable  $\Delta F$  ranges are available by using the range switch below the  $\Delta F$  knob. This allows calibrated sweep widths of up to 1%, 10% or 100% of full band.

When in CW/ $\Delta F$  or CW modes, the CW VERNIER knob allows for excellent frequency resolution. In terms of improved frequency resolution the vernier increases the effective length of the dial scale to 7.5 metres (300 inches).

Another feature is the capability to fully program the sweeper. The standard HP 8620C includes inputs for band selection, sweep function selection, and analog frequency control. In addition to this, a more flexible digital frequency programming option is available to control the HP 8620C via the HP-IB (Option 011).

## 8620C Specifications

### Frequency

**Frequency range accuracy and linearity:** determined by band select lever and RF plug-in installed.

### Sweep Functions

**FULL SWEEP:** sweeps the full band as determined by the plug-in and the band select lever.

**MARKER SWEEP:** sweeps from START MARKER to STOP MARKER frequency settings: up to the full range of the plug-in can be set to sweep either up or down in frequency.

**$\Delta F$  Sweep:** sweeps symmetrically upward in frequency, centered on CW setting, CW vernier can be activated for fine control of center frequency.

**Width:** continuously adjustable and calibrated from zero to 1%, zero to 10%, or zero to 100% of frequency band.

**CW operations:** single-frequency RF output controlled by CW MARKER knob selected by depressing pushbutton in CW MARKER control.

**CW vernier:** calibrated directly in MHz about CW setting. CW vernier activated by pushbutton in CW vernier control. Zero to  $\pm 0.5\%$  or zero to  $\pm 5\%$  of full bandwidth, selectable with front panel switch.

**Frequency markers:** three constant width frequency markers are fully calibrated and independently adjustable over the entire range in FULL SWEEP function, controlled by START MARKER, STOP MARKER, and CW MARKER controls. In  $\Delta F$  sweep START and STOP MARKERS are available, and in MARKER SWEEP the CW MARKER is available. Front panel switch provides for the selection of either amplitude or intensity markers (amplitude modulating the RF output or Z-axis modulating the CRT display).

**Marker output:** rectangular pulse, typically  $-5$  volts peak available from Z-axis BNC connector on rear panel. Source impedance, approximately 1000 ohms.

### Sweep Modes (auto, line or externally triggered)

**Sweep time:** continuously adjustable from 0.01 to 100 seconds. Single sweep, manual sweep and external sweep control also available.

**Sweep output:** direct-coupled sawtooth, zero to approximately +10 volts, at front panel BNC connector, concurrent with swept RF output.

### Modulation

External AM, FM and phase-lock capability; internal 1000 Hz square wave AM modulation available.

### Remote Control

**Remote band select:** frequency range can be controlled remotely by three binary contact closure lines available at rear panel connector.

### Remote Frequency Programming, Opt 011 (HP-IB) Functions

**Band:** manual enable or remote control of up to four bands.

**Mode:** seven modes are selectable, including digital control in three modes with a resolution of 10,000 points.

### HP-IB interface functions

SH0, AH1, T0, L2, SR0, RL2, PP0, DC0, DT0, C0, E1.

### General

#### Blanking

**RF:** with blanking switch enabled, RF automatically turns off during retrace, and remains off until start of next sweep.

**Display (Z-AXIS/MKR/PEN LIFT output):** direct-coupled rectangular pulse approximately +5.0 volts coincident in time with RF blanking is on rear panel.

**Negative (negative blanking output):** direct-coupled rectangular pulse approximately  $-5.0$  volts coincident in time with RF blanking.

**Pen lift:** for use with X-Y recorders having positive power supplies. Transistor-switch signal is available on Z-AXIS/MKR/PEN LIFT connector. This signal is also available on the programming connector.

**Furnished:** 2.29 m (7½-foot) power cable with NEMA plug and calibration scale. With Option 011, an HP-IB connector/adaptor are included.

**Power:** 100, 120, 220, or 240 volts  $\pm 5 - 10\%$ , 50 to 400 Hz. Approximately 140 watts.

**Weight:** (not including RF unit): Net, 11.1 kg (24 lb). Shipping 13.4 kg (30 lb).

**Size:** 132.6 mm H x 425 mm W x 337 mm D (5.29" x 16.75" x 13.25").

### Ordering Information

**HP 8620C Sweep Oscillator Mainframe**

**Opt 011:** HP-IB Frequency Programming

**Opt 007:** Rear Sweep Out

**Opt 820:** 8410C Interface Cable

**Opt 908:** Rack Flange Kit



# SWEEP OSCILLATORS

Model 8620 Series: Broadband RF Plug-Ins

Models 86290B and 86290C

489



- +13 dBm 2 to 18.6 GHz with HP 86290C
- $\pm 30$  MHz frequency accuracy at 18.6 GHz

- Compatible with HP 8350 mainframe via HP 11869A adapter

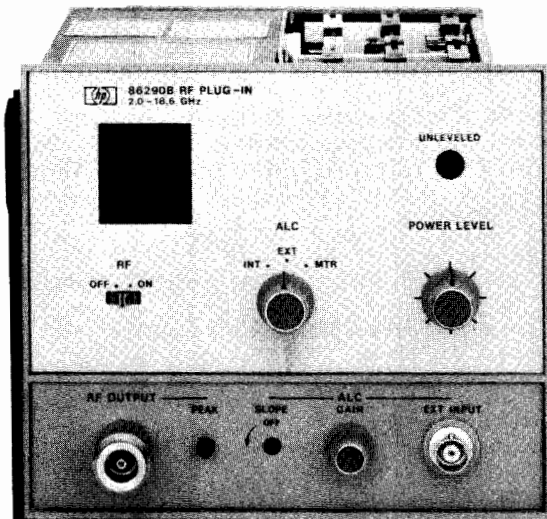

HP 86290B

The HP 86290B/C broadband plug-ins offer a continuous sweep from 2 to 18.6 GHz for broadband swept testing. In addition, higher frequency resolution is achieved by covering the 2 to 18.6 GHz range in three individual bands of 2 to 6.2, 6 to 12.4, 12 to 18.6. The HP 86290C offers outstanding electrical performance, producing >20 mW swept output over the 2 to 18.6 GHz range along with excellent linearity and low spurious and harmonic content. For scalar measurements the 27.8 kHz square wave modulation from the HP 8756 or the HP 8757 Scalar Network Analyzers is accepted directly through the EXTERNAL AM input. When performing phase/amplitude network analysis the interfacing between the sweeper and the HP 8410C Network Analyzer permits the HP 8410C to automatically phase lock over multi-octave sweeps for continuous swept 2 to 18.6 GHz phase and amplitude measurements.

## Specifications with Plug-In Installed in an HP 8620C Mainframe

### Frequency Characteristics

	Band 1	Band 2	Band 3	Band 4
Range: (GHz) HP 86290B/C	2-6.2	6-12.4	12-18.6	2-18.6
<b>Accuracy (25°C)</b>				
CW mode (or >100 ms sweep time): (MHz)	$\pm 20$	$\pm 30$	$\pm 30$	$\pm 80$
Remote programming: (typ.)	$\pm 2.5$	$\pm 2.5$	$\pm 3.5$	—
All sweep modes: (MHz)	$\pm 30$	$\pm 40$	$\pm 40$	$\pm 80$
Marker: (MHz)	$\pm 30$	$\pm 30$	$\pm 30$	$\pm 80$
Linearity (MHz) typ.:	$\pm 8$	$\pm 8$	$\pm 8$	$\pm 30$
<b>Frequency Stability</b>				
With temperature: (MHz/°C)	$\pm 0.5$	$\pm 1.0$	$\pm 1.5$	$\pm 2.0$
With 10% line voltage change: (kHz)	$\pm 100$	$\pm 100$	$\pm 100$	$\pm 100$
With 10 dB power level change: (kHz)	$\pm 200$	$\pm 400$	$\pm 600$	$\pm 600$
With 3:1 load VSWR, all phases: (kHz)	$\pm 100$	$\pm 200$	$\pm 300$	$\pm 300$
With time (in 10 minute period after 30 minute warmup): typically (kHz)	$\pm 300$	$\pm 600$	$\pm 900$	$\pm 900$
Residual FM (10 kHz bandwidth CW mode): (kHz peak)	<10	<20	<30	<30

### Output Characteristics

#### Maximum Levelled Power (25°C)

HP 86290B: +10 dBm, (Opt. 004: +9.5 dBm)

HP 86290C: +13 dBm, (Opt. 004: +12.5 dBm)

Power level control range: >10 dB

	Band 1	Band 2	Band 3	Band 4
<b>Power Variation (Max Rated Pwr)</b>				
Internally levelled: (dB)	$\pm 0.7$	$\pm 0.7$	$\pm 0.8$	$\pm 0.9$
Externally levelled (excluding coupler and detector variation)				
Crystal detector: -20 to -250 mV for specified leveling at rated output: (dB)	$\pm 0.15$	$\pm 0.15$	$\pm 0.15$	$\pm 0.15$
Power meter: internal leveling amplifier with compensation for HP models 432A/B/C provided: (dB)	$\pm 0.15$	$\pm 0.15$	$\pm 0.15$	$\pm 0.15$
With temperature, typically (dB/°C)	$\pm 0.1$	$\pm 0.1$	$\pm 0.1$	$\pm 0.1$

Residual AM in 100 kHz BW: <-55 dBc.

#### Spurious Signals

Harmonically related signals: <-25 dBc.

Non-harmonics: <-50 dBc.

Impedance: 50 $\Omega$  nominal.

SWR: <1.9 internally levelled.

RF output connector: type N female.

### Modulation Characteristics

#### External AM

Input impedance: approximately 10k $\Omega$ .

Frequency response: typically 100 kHz levelled.

#### Square Wave Response

On/Off ratio: >30 dB.

Symmetry: 40/60.

Attenuation for +5V input: >30 dB.

#### Internal AM (1000 Hz)

Square-wave on/off ratio: >25 dB.

RF blanking on/off ratio: >30 dB.

#### External FM

##### Maximum Deviations for Modulation Frequencies

DC to 100 Hz:  $\pm 75$  MHz.

100 Hz to 2 MHz:  $\pm 5$  MHz.

##### Sensitivity (typically)

FM mode: -20 MHz/V.

Phase-lock mode: -6 MHz/V.

### General

Sweep time (min): 10 ms single bands, 60 ms on 2 to 18.6 GHz band.

Auxiliary output: rear panel 2 to 6.2 GHz fundamental oscillator output, nominally -10 dBm.

Slope control: front panel control allowing compensation for frequency dependent test setup losses.

Peak control: front panel control for peaking power over desired frequency range.

Frequency reference output: nom. 1 V/GHz (2-18.6 volts)  $\pm 35$  mV rear panel BNC output.

Weight: net, 4.4 kg (9.6 lb); shipping, 5.9 kg (13 lb).

### Ordering Information

HP 86290B 2 to 18.6 GHz +10 dBm (10 mW) plug-in (internal leveling standard)

HP 86290C 2 to 18.6 GHz +13 dBm (20 mW) plug-in (internal leveling standard)

Opt 004: rear panel RF output



# SWEEP OSCILLATORS

## Model 8620 Series: Broadband RF Plug-Ins (cont.)

### Models 86222A and 86222B

- 10 MHz to 2.4 GHz in one, continuous sweep
- Internally leveled flatness  $\pm 0.25$  dB over full range

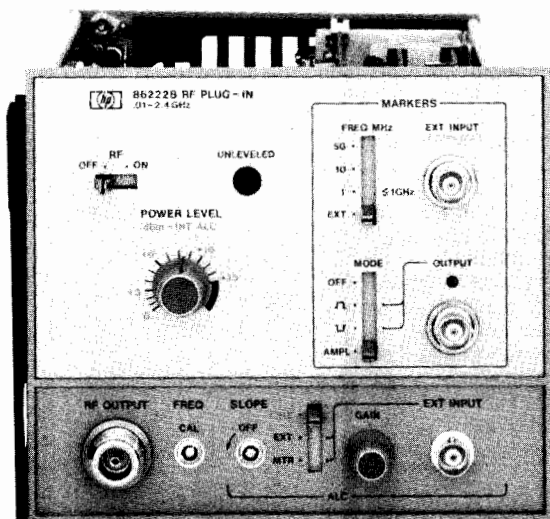

HP 86222B

The HP 86222A and 86222B RF plug-ins can provide CW or continuous swept 10 MHz to 2.4 GHz frequency coverage. Power output is calibrated from 0 to +13 dBm in 1 dB increments with  $\pm 0.25$  dB flatness and excellent linearity (2 MHz) over the entire 0.01 to 2.4 GHz range. For applications demanding precise frequency identification, the HP 86222B offers a crystal marker system which provides a comb of markers at 1, 10 or 50 MHz. Markers may be displayed as intensified spots on a CRT or as amplitude dips on the RF output (often useful for XY recordings). In addition, when the output frequency is coincident with a 50, 10 or 1 MHz comb of the internal crystal oscillator, a front panel LED lights for independent CW frequency calibration (75 kHz accuracy at 1 GHz). For scalar measurements, the 27.8 kHz square wave modulation from the HP 8756A or the HP 8757A Scalar Network Analyzer is accepted directly through the external AM input. For phase/magnitude network analysis the interfacing between the sweeper and the HP 8410C Network Analyzer permits the HP 8410C to automatically phase-lock over multi-octave sweeps.

### Specifications with Plug-In Installed in an HP 8620C Mainframe

#### Frequency Characteristics

**Range:** 10 MHz to 2.4 GHz.

#### Accuracy (25°C)

**CW mode:**  $\pm 10$  MHz.

**Remote programming:** typically  $\pm 1.5$  MHz.

**All sweep modes:**  $\pm 15$  MHz (>100 ms sweep time). Accuracy of HP 86222B may be enhanced to better than  $\pm 200$  kHz through use of crystal markers.

**Linearity:** typically  $\pm 2$  MHz.

#### Stability

**With temperature:**  $\pm 500$  kHz/°C.

**With 10% line voltage change:**  $\pm 20$  kHz.

**With 10 dB power level change:**  $\pm 100$  kHz.

**With 3:1 load SWR, all phases:**  $\pm 10$  kHz.

**With time (after 1-hour warm-up):** typically  $\pm 100$  kHz/10 min.

**Residual FM:** (10 kHz bandwidth; FM switch in NORM; CW Mode): <5 kHz peak.

#### Output Characteristics

**Maximum leveled power (25°C):** >20 mW (+13 dBm); typically >+15 dBm.

**Power level accuracy (internal leveling only):**  $\pm 1$  dB.

**Attenuator Opt 002:** add  $\pm 0.2$  dB/10 dB step.

#### Power Variation (at max. rated power)

##### Internally Leveled

**0.01 to 2.4 GHz:**  $\pm 0.25$  dB.

**Stability with temperature:** typically  $\pm 0.02$  dB/°C.

- 1, 10, and 50 MHz crystal marker combs with HP 86222B
- Compatible with HP 8350 mainframe via HP 11869A adapter

#### Externally Leveled (excluding coupler and detector variation)

**Crystal detector:** (-10 to -100 mV at rated output):  $\pm 0.1$  dB.

**Power meter (with HP 432A/B/C series power meters):**  $\pm 0.1$  dB.

**Residual AM in 100 kHz BW:** <-50 dBc.

#### Spurious Signals (below fundamental)

**Harmonics:** <-25 dBc at +13 dBm; typically <-30 dBc at +10 dBm.

#### Non-Harmonics

**0.01 to 2.3 GHz:** <-30 dBc at +13 dBm; typically <-40 dBc at +10 dBm.

**2.3 to 2.4 GHz:** <-25 dBc at +13 dBm; typically <-35 dBc at +10 dBm.

**Broadband noise in 100 kHz bandwidth:** typically <-70 dBm.

**Impedance:** 50  $\Omega$  nominal.

**SWR:** <1.5 internally leveled.

**Slope control:** allows variable compensation for frequency dependent losses in test set-up.

**RF output connector:** type N female.

### Modulation Characteristics

#### External AM

**Input impedance:** approximately 10 k $\Omega$ .

**Frequency response:** typically 150 kHz.

#### Square Wave Response

**On/Off ratio:** >30 dB.

**Symmetry:** 40/60, for > 10 dBm output power.

**Attenuation for +6 V input:** >30 dB.

#### Internal AM

**1 kHz square-wave On/Off ratio:** >30 dB.

**RF blanking On/Off ratio:** >30 dB.

#### External FM

##### Maximum Deviations for Modulation Frequencies

**DC to 100 Hz:**  $\pm 75$  MHz.

**100 Hz to 1 MHz:**  $\pm 5$  MHz.

**1 MHz to 2 MHz:**  $\pm 2$  MHz.

#### Sensitivity (typically)

**FM mode:** -20 MHz/V.

**Phase-lock mode:** -6 MHz/V.

### Crystal Marker Capabilities (HP 86222B only)

**Internal crystal markers:** harmonic markers of 10 and 50 MHz usable over full 0.01 to 2.4 GHz range and 1 MHz markers usable 0.01 to 1 GHz. Positive (+) or negative (-) voltage output pulses can be selected to Z-axis intensify a scope trace; or RF amplitude pips can be selected (at maximum sweep speed, pulse width optimized for approximately 10 markers/sweep).

**Accuracy of center frequencies (25°C):**  $\pm 5 \times 10^{-6}$ .

#### Typical Marker Width Around Center Frequency

**1 MHz markers:**  $\pm 75$  kHz.

**10 MHz markers:**  $\pm 200$  kHz.

**50 MHz markers:**  $\pm 300$  kHz.

**Temperature stability:** typically  $\pm 2 \times 10^{-6}$ /°C.

#### Marker output

**Pos. intensity mode:** nominally >3 V.

**Neg. intensity mode:** nominally -3 to -8 V, internally adjustable.

**Amplitude mode:** typically 0.5 dB, internally adjustable.

### General

**Weight:** net, 2.5 kg (5.5 lb); shipping, 4 kg (9 lb).

### Ordering Information

HP 86222A 0.01-2.4 GHz RF Plug-In (internal leveling standard)

HP 86222B 0.01-2.4 GHz RF Plug-In with Crystal and External Markers (internal leveling standard)

**Opt 002:** 70 dB Step Attenuator (10 dB steps)

**Opt 004:** Rear Panel RF Output

# SWEEP OSCILLATORS

## Model 8620 Series: Straddle Band RF Plug-Ins

Models 86240A, 86240B, 86240C and 86251A



- 7.5–18.6 continuous sweep with HP 86251A
- 45 dBc harmonics with HP 86240B
- Up to 40 mW output power with HP 86240A

- MLA compatibility with HP 86240C
- Usable in HP 8350 mainframe with HP 11869A plug-in adapter

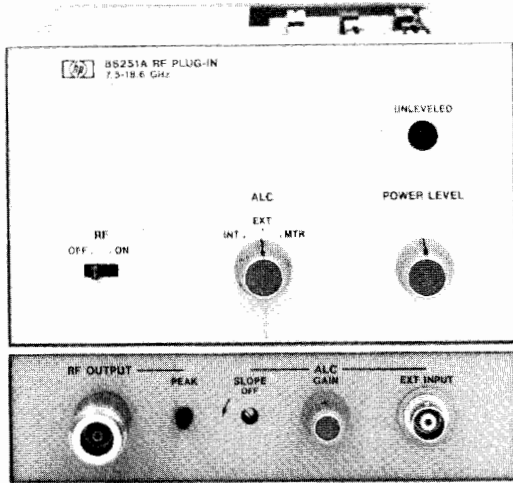

HP 86251A

### HP 86251A: 7.5–18.6 GHz

The HP 86251A excels in meeting the most stringent of swept or CW source requirements for precise Radar and ECM component measurements. Covering the essential frequency bands with one continuous sweep, the HP 86251A is ideal for testing active devices like multioctave TWTs or RF memories as well as passive devices like filters or isolators.

### HP 86240A/B: 2–8.4 GHz

The HP 86240A/B are designed for high power and superior performance with the HP 86240A delivering 40 mW of RF output power and the HP 86240B offering 45 dBc harmonics (typically <math>-50</math> dBc). For precise RF power level control, internal leveling and slope control are also available.

### HP 86240C RF Distortion Analysis of MW Links: 3.6–8.6 GHz

The HP 86240C can be used for MLA Upconverter Simulation as well as a general purpose sweeper. It is optimized for group delay of

less than 1 ns peak-to-peak over 30 MHz, linearity better than 0.5% and power output up to 40 mW. It has 10 MHz FM bandwidth, flat to  $\pm 1.5$  dB for noise loading applications, power control and internal leveling. For further information on MLA Upconverter Simulation refer to the Telecommunications Test Equipment section on page 150.

### Specifications

**with Plug-In Installed in an HP 8620C Mainframe (or HP 8350 mainframe using the HP 11869A plug-in adapter)**

#### Frequency Characteristics

**Linearity:** typically  $\pm 0.1\%$ .

**Residual FM** (in 10 kHz bandwidth, FM switch in NORM, CW Mode): <math><9</math> kHz peak, <math><30</math> kHz peak for HP 86251A.

**Reference output:** dc-coupled voltage proportional to RF frequency, voltage approximately 1 V/GHz.

#### Output Characteristics

**Internal Leveling:** selected by front panel switch; refer to RF plug-in specifications.

**Source SWR:** 50 $\Omega$  nominal impedance.

**Internally leveled:** <math><1.6</math> SWR for HP 86240. <math><1.9</math> SWR for HP 86251A.

**Unleveled:** typically 3 SWR.

**RF output connector:** type N female.

#### HP 86240C Modulation Characteristics

**External FM** (maximum deviation for modulation frequencies)

**DC to 100 Hz:**  $\pm 150$  MHz

**90 kHz to 10 MHz:**  $\pm 1.5$  MHz

**Frequencies response, dc to 10 MHz:**  $\pm 1.5$  dB

**Nominal Sensitivity**

**FM mode:** +20 MHz/volt

**Upconverter mode:** +20 MHz/volt

#### General

**Weight:** Net, 2.3 kg (5 lb); shipping, 3.2 kg (7 lb) for HP 86240A/B/C.

Net, 4.4 kg (9.6 lb); shipping, 5.9 kg (13 lb) for HP 86251A.

#### Options

**002:** 70 dB Step Attenuator (HP 86240A/B/C only)

**004:** Rear Panel RF Output

	HP 86240A	HP 86240B	HP 86240C	HP 86251A
<b>FREQUENCY</b>				
Frequency Range (GHz):	2.0–8.4	2.0–8.4	3.6–8.6	7.5–18.6
<b>Frequency Accuracy:</b> (25°C)				
CW Mode (MHz):	$\pm 25$	$\pm 25$	$\pm 25$	$\pm 60^1$
CW Remote Programming typically (MHz):	$\pm 3.5$	$\pm 3.5$	$\pm 3.5$	
All Sweep Modes (for sweep time >100 ms) (MHz):	$\pm 40$	$\pm 50$	$\pm 35$	$\pm 40$
<b>POWER OUTPUT</b>				
Maximum Leveled Power (25°C) (mW):	>40	>20	>40	>10
With Option 002 (mW):	>40	>20	>40	
<b>Power Variation:</b> (At Max Rated Power)				
Unleveled (Typically) (dB):	$\leq \pm 2$	$\leq \pm 3$	$\leq \pm 2$	$\leq \pm 5$
Internally Leveled:	$\leq \pm 1$	$\leq \pm 0.5$	$\leq \pm 0.8$	$\pm 0.8$
Externally Leveled (Excluding Coupler and Detector Variation) Crystal Detector and Power Meter (dB):	$\leq \pm 0.1$	$\leq \pm 0.1$	$\leq \pm 0.1$	$\pm 0.15$
<b>Spurious Signals:</b> (dB below fundamental at specified maximum power)				
Harmonics:	<math><-20</math> (@20 mW) <math><-16</math> (@40 mW) <math><-60</math>	<math><-45</math> (Typ <math><-50</math>)	<math><-20</math> (@20 mW) <math><-16</math> (@40 mW) <math><-60</math>	<math><-40</math>  <math><-50</math>
Nonharmonics:				
<b>Plug-in:</b>				

<sup>1</sup>CW mode installed in HP 8350 mainframe or remote programming in HP 8620C:  $\pm 20$  MHz.



# SWEEP OSCILLATORS

Model 8620 Series: Single Band RF Plug-Ins

Model 86200 Series and 11869A Adapter

- 10 MHz to 22 GHz coverage
- >50 mW from 5.9 to 12.4 GHz
- Compatible with HP 8350 mainframe via HP 11869A adapter

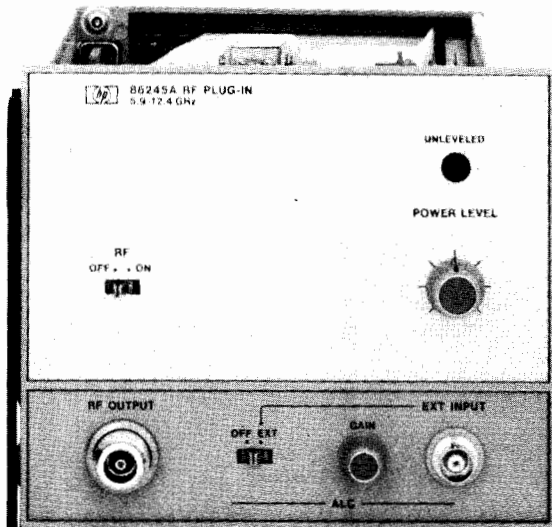

HP 86245A



HP 86260A

## HP 86200 Series

The HP 86200 series plug-ins feature a wide choice of bandwidths and power specifications for covering the 10 MHz to 22 GHz frequency range. The HP 86222A/B 10 MHz to 2.4 GHz plug-ins, the HP 86240A/B/C 2 GHz to 8.6 GHz plug-ins, and the HP 86290B/C 2 GHz to 18.6 GHz plug-ins cover multi-octave frequency ranges with exceptional frequency precision and RF output characteristics. See preceding pages for specifications on these plug-ins. For octave band applications, smaller range plug-ins covering, for instance, 5.9 GHz to 12.4 GHz are available with optional capability to operate as up-converters for MLA measurements. Internal leveling is standard on all HP 86200 series plug-ins.

## HP 11869A Adapter

The HP 86200 series can be used in the HP 8350 Sweep Oscillator mainframe with the addition of the HP 11869A Adapter. The HP 11869A provides the electrical and mechanical interface between the HP 86200 plug-in and the HP 8350 so that digital control of the plug-in is possible. All of the performance and features of the HP 8350 Sweep Oscillator mainframe are available when using the HP 86200 plug-ins and HP 11869A Adapter. For more information on the HP 11869A see page 486.

## Specifications

### With Plug-In Installed in an HP 8620C Mainframe

**Frequency linearity:** typically  $\pm 1\%$ .

**Frequency reference output:** typically 1 V/GHz dc-coupled voltage is available for referencing or phase-locking external equipment to the plug-in or for multi-octave operation with an HP 8410C.

**RF power leveling:** internal dc-coupled leveling amplifier and PIN modulator provided.

**Internal, standard:** selected by front panel switch; refer to RF plug-in specifications.

## External

**Crystal input:** approximately  $-20$  to 250 mV for specified leveling at rated output; for use with negative polarity detectors such as HP 780 Series Directional Detectors, HP 423A/B and 8470 Series Crystal Detectors.

**Power meter input:** leveling amplifier with compensation for HP 432A power meter included internally in all plug-ins except the HP 86241A.

**Indicator:** front panel indicator lights when RF power level is set too high to permit leveling over entire selected sweep range or when operating in unleveled mode.

**Residual AM in 100 kHz bandwidth:**  $< -50$  dBc.

## External AM

**Frequency response:** typically dc to 100 kHz unleveled, dc to 50 kHz leveled (at maximum leveled power).

**Input impedance:** approximately 5000 ohms.

**RF output connector:** type N Female.

**HP 8350 Compatibility:** the HP 11869A Adapter provides the electrical and mechanical interface so that the HP 86200 series plug-ins can be used in the HP 8350 Sweep Oscillator mainframe. For more information see the section on HP 11869A Adapter page

**Weight:** net, 2.3 kg (5 lb); shipping, 3.2 kg (7 lb).

## Options

**002:** 70 dB attenuator in 10 dB steps

**004:** rear panel RF output

**Upconverter simulation options:** options are available which guarantee compatibility with the HP Microwave Link Analyzer. For further information on these plug-ins refer to the Telecommunications Test Equipment Section beginning on page 150.

## Single Band Plug-Ins

Refer also to Broadband Models 86222A/B (0.01-2.4 GHz), 86240A/B/C (2-8.4 GHz), 86251A (7.5-18.6 GHz), and 86290B/C (2-18.6 GHz)

Specifications with plug-in installed in HP 8620C	HP 86220A	HP 86235A	HP 86241A	HP 86242D	HP 86245A	HP 86250D	HP 86260B	HP 86260A	HP 86260C
<b>Frequency range<sup>1</sup> (GHz):</b>	0.01-1.3	1.7-4.3	3.2-6.5	5.9-9.0	5.9-12.4	8.0-12.4	10.0-15.5	12.4-18.0	17.0-22.0
<b>Frequency accuracy</b>									
CW mode (MHz):	±10	±20	±30	±35	±40	±40	±50	±50	±50
Remote programming typically (MHz):	±6.0	±2.5	±10.5	±5.0	±20	±20	±25	±25	±25
All sweep modes (sweep time >100 ms) (MHz):	±15	±30	±33	±40	±50	±50	±70	±70	±70
<b>Stability:</b>									
With Temperature:	±600 kHz/°C	±500 kHz/°C	±650 kHz/°C	±750 kHz/°C	±1.2 MHz/°C	±1.2 MHz/°C	±5.4 MHz/°C	±5.4 MHz/°C	±5.4 MHz/°C
With 10% Line Voltage Change:	±20 kHz	±40 kHz	±30 kHz	±40 kHz	±40 kHz	±40 kHz	±180 kHz	±180 kHz	±180 kHz
With 10 dB Power Level Change:	±20 kHz	±1 MHz	±1 MHz	±1.5 MHz	±1.5 MHz	±1.5 MHz	±6 MHz	±6 MHz	±6 MHz
With 3:1 Load SWR Change, all Phases:		±250 kHz		±250 kHz	±250 kHz	±250 kHz			
With Time (after warm-up): Typ/10 min.	± 200 kHz	± 200 kHz	± 200 kHz	± 600 kHz	± 600 kHz	± 600 kHz		± 450 kHz	
<b>Residual FM</b> (10 kHz BW, FM switch in NORM) CW mode (kHz peak):	<5	<7	<7	<15	<15	<15	<25	<25	<25
<b>Maximum leveled power<sup>1</sup> (mW):</b>	10	>40	>7	>10	>50	>10	>10	>10	>10
<b>Power variation</b>									
Internally leveled (dB):	<±0.5	<±0.8	<±0.8	<±0.5	<±0.6	<±0.5	<±0.7	<±0.7	<±0.7
Externally leveled (dB) (excluding coupler & detector variation):	N/A	<±0.1	<±0.1	<±0.1	<±0.1	<±0.1	<±0.1	<±0.1	<±0.1
<b>Spurious signals:</b> (dB below fundamental, at specified max power)									
Harmonics:	<-25	<-20	<-16(3.2-3.8 GHz) <-20(3.8-6.5 GHz)	<-30	<-17(5.9-7 GHz) <-30(7-12.4 GHz)	<-30	<-25	<-25	<-25
Nonharmonics:	<-50	<-60	<-60	<-60	<-60	<-60	<-60	<-50	<-50
<b>Source SWR:</b> (50 Ω nom, Internally leveled)	<1.3	<1.6	<1.6	<1.6	<1.6	<1.6	<1.6	<1.6	<1.6
<b>External FM:</b>									
Max deviations (MHz) for modulation frequencies:									
DC-100 Hz:	±15	±75	±25	±100	±150	±150	±150 (DC-200 kHz)	±75 (DC-200 kHz)	±75 (DC-200 kHz)
DC-1 MHz:	±0.5	±5	±2	±7	±7	±7	±5(200 Hz-200 kHz)	±5(200 Hz-200 kHz)	±5(200 Hz-200 kHz)
Sensitivity (nom, MHz/V):	+3.5	-20/-6	-6	-20/-6	-20/-6	-20/-6	-20/-6	-20/-6	-20/-6
<b>AM:</b> Internal 1 kHz Square wave On/Off ratio & EXT AM sensitivity To -10 V (dB): EXT AM Response compatible with 8756A/8757A Mod drive signal:	>35 No	>30 Yes	>25 No	>40 Yes	>40 Yes	>40 Yes	>25 No	>25 No	>25 No
<b>Plug-in:</b> Opt 002 (70 dB Atten.)			N/A	N/A	N/A	N/A	N/A	N/A	N/A

<sup>1</sup> Special frequency band and high power outputs available on request.

# MICROWAVE TEST EQUIPMENT

Microwave Measurements and Products



## Microwave measuring techniques

Hewlett-Packard offers a complete line of microwave coaxial and waveguide measuring equipment. Measuring systems can be assembled from this equipment to make accurate reflection and transmission measurements on other components such as filters, mixers, cables, etc. Signal characteristics such as frequency, power, or spectral content may be measured using other associated equipment.

HP equipment capability ranges from inexpensive systems for point-by-point, narrow-band work to powerful analyzers which furnish dynamic displays of error-corrected network scattering parameters across wide frequency bands. Equipment selection and measuring techniques depend primarily on the accuracy, speed, and cost requirements of the application.

Some applications require complete phase and amplitude characterization of microwave components. These vector measurements are usually made in design labs to aid in component design or in evaluating performance to phase specifications. Such phase measurements require relatively sophisticated equipment and techniques.

But the majority of microwave measurements made in production, test, maintenance, and calibration require only amplitude (scalar) characteristics. Scalar test procedures are popular because they are straightforward, easy-to-use, and low cost, yet yield an excellent measure of the quality of the test part.

More detailed information is available in the Coaxial & Waveguide Measurement Accessories Catalog & Microwave Measurement Handbook, literature number 5952-8262.



# MICROWAVE TEST EQUIPMENT

Adapters, Waveguide Stands, Air Lines

Models 281A/B/C, 292A/B, 11515/6/A, 11540 Series, 11566/7/A, 11588A, 11606A

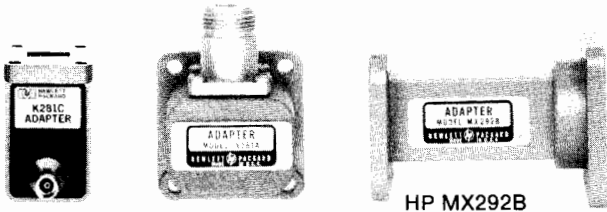

HP K281C    HP X281A

HP MX292B



HP 11566A

HP 11515A



HP 11606A

HP 11545-11548A

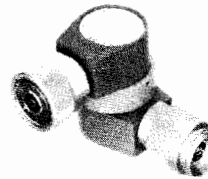

HP 11588A

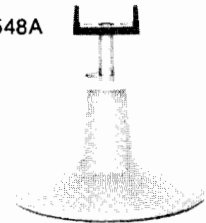

HP 11540A

## HP 281A/B/C, 292A/B, 11515A/6A Coax and Waveguide Adapters

HP 281A/B adapters transform waveguide transmission line into 50-ohm coaxial line. The HP 281C family has improved SWR.

HP 292A/B waveguide-to-waveguide adapters connect two different waveguide sizes with overlapping frequency ranges. HP 11515A/16A adapt circular to rectangular flanges in K-band and R-band.

### HP 281A/B/C Specifications

HP Model	SWR	Frequency Range (GHz)	Waveguide Size EIA	Coaxial Connector	W/G Flange UG-( ) U
S281A	1.25	2.60-3.95	WR284	N Female	584
G281A	1.25	3.95-5.85	WR187	N Female	407
J281A	1.25	5.30-8.20	WR137	N Female	441
H281A	1.25	7.05-10.0	WR112	N Female	138
X281A	1.25	8.20-12.4	WR90	N Female	135
X281B	1.25	8.20-12.4	WR90	APC-7	135
Option 013				N Female	
X281C	1.05	8.20-12.4	WR90	APC-7	135
Option 012				N Male	
Option 013				N Female	
P281B	1.25	12.4-18.0	WR62	APC-7	419
Option 013				N Female	
P281C	1.06	12.4-18.0	WR62	APC-7	419
Option 012				N Male	
Option 013				N Female	
K281C	1.07	18.0-26.5	WR42	APC-3.5 (f)	597
Option 012				APC-3.5 (M)	

### HP 292A/B, 11515A, 11516A Specifications

HP Model	Frequency Range (GHz)	SWR	W/G Size Flange to	W/G Size Flange
HX292B	8.2-10.0	1.05	WR 112 UG-51/U	WR 90 UG-39/U
MX292B	10.0-12.4	1.05	WR 75 Cover	WR 90 UG-39/U
MP292B	12.4-15.0	1.05	WR 75 Cover	WR 62 UG-419/U
NP292A	15.0-18.0	1.05	WR 51 Cover	WR 62 UG-419/U
NK292A	18.0-22.0	1.05	WR 51 Cover	WR 42 UG-595/U
11515A	18.0-26.5	-	WR 42 UG-425/U	WR 42 UG-595/U
11516A	26.5-40.0	-	WR 28 UG-381/U	WR 28 UG-599/U

## HP 11588A Swivel Adapter, 11606A Rotary Air Line

The HP 11606A rotary air line and the HP 11588A swivel adapter are capable of a full 360° of rotation. A combination of the air line and the adapter permits rigid coax movement in three dimensions. Even the most awkwardly shaped devices can be easily connected or disconnected in a coax system with the aid of these components. Insertion loss is <0.5 dB and uncertainty due to rotation is -57 dB.

## HP 11566A, 11567A Air Line Extension

**Impedance:** 50 ohms.  
**Frequency:** dc-18 GHz.  
**Reflection coefficient:** 0.018 + 0.001 (frequency in GHz).  
**Connector:** APC-7.  
**Length:** 11566A, 102.5 mm (4 in.); 11567A, 202.5 mm (8 in.).  
**Shipping weight:** 0.45 kg (1 lb).

## HP 11540 Series Waveguide Stand, Waveguide Holders

The HP 11540A waveguide stand locks HP waveguide holders at any height from 70 to 133 mm (2.75 in. to 5.25 in.). The waveguide holders are offered in five sizes to hold waveguide covering frequencies from 22 to 40 GHz.

### HP 11588A, 11606A Specifications

HP Model	Frequency Range GHz	SWR	Connectors	Dimensions mm (in)	Shipping Weight kg (lb)
11588A	DC-12.4	1.1	APC-7(m)(f)	42 x 59 x 30 (1 5/8 x 2 9/16 x 1 1/16)	0.28 (10 oz.)
11606A	DC-12.4	1.1	APC-7(f)	100 x 19 (4 x 3/4)	0.45 (1 lb)

### Ordering Information

HP 11566A Air line extension  
 HP 11567A Air line extension  
 HP 11540A Waveguide stand  
 HP 11545A X-Band,  
 HP 11546A P-Band, 11547A K-Band, 11548A R-Band  
 Waveguide holders



# MICROWAVE TEST EQUIPMENT

## Coaxial Fixed Attenuators

Models 8491A/B, 8492A, 8493A/B/C, 8498A, 11581/2/3A/3C, 33340A/B/C

- Flat frequency response
- Low SWR
- Specifications traceable to NBS

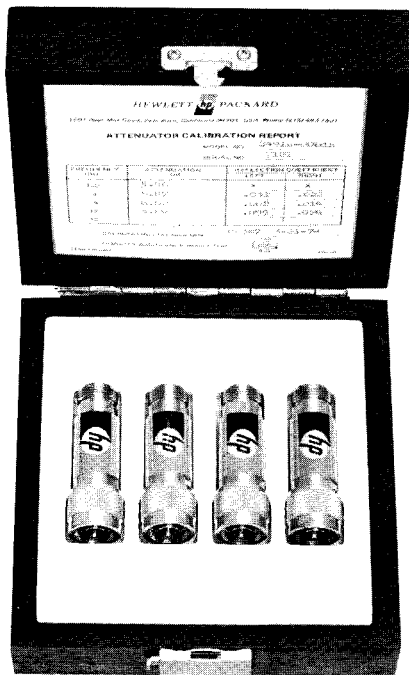

HP 11581A

### HP 8491A/B, 8492A, 8493A/B/C Fixed Attenuators

Hewlett-Packard coaxial fixed attenuators provide precision attenuation, flat frequency response, low SWR over broad frequency ranges at low prices. Attenuators are available in nominal attenuations of 3-dB and 6-dB, also 10-dB increments from 10 dB to 60 dB. These attenuators are swept-frequency tested to ensure meeting specifications at all frequencies. Calibration points are provided on a nameplate chart attached to each unit.

### HP 11581A, 11582A, 11583A/C Attenuator Sets

A set of four Hewlett-Packard attenuators—3, 6, 10 and 20 dB—are furnished in a handsome walnut accessory case. The HP 11581A set consists of HP 8491A attenuators; the HP 11582A set, HP 8491B attenuators; the HP 11583A set, HP 8492A attenuators; and the HP 11583C set, HP 8493C attenuators. The set includes calibration reports certified traceable to the National Bureau of Standards, containing both the attenuation and the reflection coefficients for each attenuator at four frequencies for the HP 11581A (dc, 4, 8, 12.4 GHz) and five frequencies for the HP 11582A and HP 11583A (dc, 4, 8, 12.4, 18 GHz). By specifying option 890, calibration data is given at 26 frequencies (HP 11581A) or 42 frequencies (HP 11582A and 11583A). The HP 11583C set includes option 890 calibration data. See next page for exact frequency lists.

These sets are ideal for calibration labs or where precise knowledge of attenuation and SWR is desired.

### HP 8498A High Power Attenuator

The HP 8498A Option 030 is designed to meet the needs of high power attenuation applications in the RF and microwave frequency range. It is specified from dc to 18 GHz at 25 watts average, 500 watts peak, from dc to 5.8 GHz and 125 watts peak from 5.8 to 18 GHz. Available only in a 30 dB model (option 030), the unit offers low SWR (<1.30 at 18 GHz) and good accuracy ( $\pm 1$  dB at 18 GHz). The unit also features 'human engineered' cooling fins that prevent operator burns even under continuous maximum input power conditions.



HP 33340C

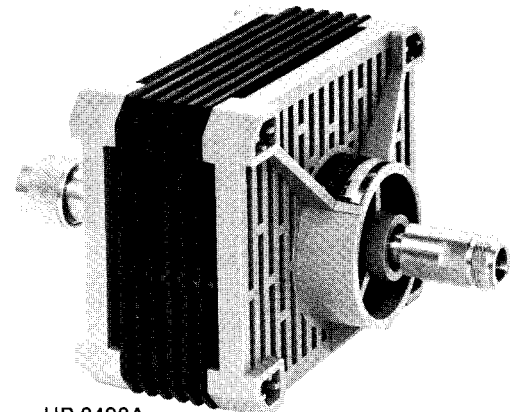

HP 8498A  
Option 030

### Option 890 Calibration Data

Extensive calibration data is available on HP attenuators at low cost. When option 890 is specified for the fixed attenuators or microwave step attenuators, standardized calibration data in frequency steps no larger than 500 MHz is provided over the frequency range of the units. This data is generated from measurements made on an HP 8542 Automatic Network Analyzer and features excellent accuracy (traceable to NBS) and low cost. Data is given for attenuation and the SWR (reflection coefficient for the HP 8493C) of each port and is provided in a protective plastic envelope.

Calibration data has important uses in applications such as RF substitution measurements and test system verification. Using the actual calibration data rather than data sheet specifications allows the attenuation uncertainty to be reduced 60% or more. Also, the calculated mismatch uncertainty for a test system is lower if the actual SWR data for the attenuators is used. Similar calibration data is used in HP production areas to verify the performance of manual and automated test systems. For automated system checkout, the calibrated unit is tested and the results are compared to the previously stored calibration data. If the differences are within the measurement uncertainty, proper operation is ensured. For step attenuators, the calibration data can be used in automated test systems to more accurately characterize a device's characteristics. By storing the calibration data for the individual steps, the measurement results can be adjusted by the actual amount of attenuation (for example, when a nominal 10 dB step is actually 9.6 dB).

The calibration data frequencies, prices, and ordering information for fixed attenuators are on the next page, and the same information for step attenuators is on page 499.

### HP 33340A/B/C Fixed Attenuators

The HP 33340A, 33340B and 33340C are coaxial fixed attenuators intended for OEM and systems use. Frequency range specifications are dc—12.4 GHz, dc—18 GHz and dc—26.5 GHz respectively. These OEM attenuators are similar to the HP 8493 series attenuators.

For more information regarding the HP 33340 series refer to the data sheet (5952-8279).

### Ordering Information

HP 33340A Coaxial Fixed Attenuator

Option 890

HP 33340B Coaxial Fixed Attenuator

Option 890

HP 33340C Coaxial Fixed Attenuator

Option 890



HP 8491A/B series



HP 8492 series



HP 8493A/B/C series

**Ordering Example**

Include appropriate frequency range/connector and attenuation designations from the ordering example below with every attenuator order.

**Calibration Data**

Include "Option 890" or "Option 894" in addition to attenuation option when ordering calibration data.

8491B Option 010 Option 890 or 894

**Connectors and Frequency Range**

- 1A:** Type N (m,f), dc-12.4 GHz
- 1B:** Type N (m,f), dc-18 GHz
- 2A:** APC-7, dc-18 GHz
- 3A:** SMA (m,f), dc-12.4 GHz
- 3B:** SMA (m,f), dc-18 GHz
- 3C:** APC 3.5 (m,f), dc-26.5 GHz
- 8A:** Type N (m,f), dc-18 GHz

8498 is available in a 30 dB model only

\* Not available for HP 8493A/B \*\* Not available for HP 8493C

**Attenuation**

- 003:** 3 dB
- 006:** 6 dB
- 010:** 10 dB
- 020:** 20 dB
- 030:** 30 dB
- 040:** 40 dB\*
- 050:** 50 dB\*\*
- 060:** 60 dB\*\*

**Option 890 Example**

HEWLETT PACKARD CALIBRATION REPORT			
MODEL: 8493B OPT 006/090	SER NO: 02521		
DATE: 11-08-83	TECHNICIAN: 33886		
MERC SYSTEM: 8542E SYSTEM A			
PORT IDENTIFICATION: With the label facing the user, PORT 1 is on the left and PORT 2 is on the right.			
FREQUENCY (MHZ)	ATTENUATION (DB)	SWR PORT 1	SWR PORT 2
100.00	5.84	1.004	1.009
300.00	5.85	1.002	1.009
500.00	5.86	1.005	1.009
700.00	5.85	1.005	1.010
900.00	5.87	1.004	1.009
1000.00	5.86	1.005	1.009
1250.00	5.89		
1500.00	5.91		
1750.00			
2000.00			

**Ordering Information**

- HP 11581A** 3, 6, 10, 20 dB HP 8491A set  
**Option 890** Calibration Data
- HP 11582A** 3, 6, 10, 20 dB HP 8491B set  
**Option 890** Calibration Data
- HP 11583A** 3, 6, 10, 20 dB HP 8492A set  
**Option 890** Calibration Data
- HP 11583C** 3, 6, 10, 20 dB HP 8493C set  
**Option 890** Calibration Data

**HP 8491A/B, 8492A, 8493A/B/C, 8498A, Option 890 Specifications**

HP Model	Frequency Range GHz	SWR Maximum	Maximum input Power	Attenuation Accuracy							Connector	
				3 dB (Option 003)	6 dB (Option 006)	10 dB (Option 010)	20 dB (Option 020)	30 dB (Option 030)	40 dB (Option 040)	50 dB (Option 050)		60 dB (Option 060)
8491A 3-30 dB	dc-12.4	dc-8 GHz: 1.2 8-12.4 GHz: 1.3	2 W Avg. 100 W Peak	±0.3 dB	±0.4 dB	±0.6 dB	±0.6 dB	±1 dB	—	—	—	N(m,f)
				—	—	—	—	—	±1.5 dB	±1.5 dB	±2 dB	
8491B 3-30 dB	dc-18	dc-8 GHz: 1.2 8-12.4 GHz: 1.3 12.4-18 GHz: 1.5	2 W Avg. 100 W Peak	±0.3 dB dc-12.4 GHz ±0.4 dB 12.4-18 GHz	±0.4 dB dc-12.4 GHz ±0.5 dB 12.4-18 GHz	±0.6 dB	±0.6 dB dc-12.4 GHz ±1.0 dB 12.4-18 GHz	±1 dB	—	—	—	N(m,f)
				—	—	—	—	±1.5 dB	±1.5 dB	±2 dB		
8492A 3-30 dB	dc-18	dc-8 GHz: 1.15 dc-12.4 GHz: 1.25 12.4-18 GHz: 1.35	2 W Avg. 100 W Peak	±0.3 dB dc-12.4 GHz ±0.4 dB 12.4-18 GHz	±0.4 dB dc-12.4 GHz ±0.5 dB 12.4-18 GHz	±0.6 dB	±0.6 dB dc-12.4 GHz ±1.0 dB 12.4-18 GHz	±1 dB	—	—	—	APC-7
				—	—	—	—	±1.5 dB	±1.5 dB	±2 dB		
8493A 3-20 dB	dc-12.4	dc-8 GHz: 1.2 8-12.4 GHz: 1.3	2 W Avg. 100 W Peak	±0.3 dB	±0.4 dB	±0.6 dB	±0.6 dB	—	—	—	—	SMA (m,f)
				—	—	—	—	±1 dB	—	—	—	
8493B 3-20 dB	dc-18	dc-8 GHz: 1.2 8-12.4 GHz: 1.3 12.4-18 GHz: 1.5	2 W Avg. 100 W Peak	±0.3 dB dc-12.4 GHz ±0.4 dB 12.4-18 GHz	±0.4 dB dc-12.4 GHz ±0.5 dB 12.4-18 GHz	±0.6 dB	±0.6 dB dc-12.4 GHz ±1.0 dB 12.4-18 GHz	—	—	—	—	SMA(m,f)
				—	—	—	—	±1 dB	—	—	—	
8493C	dc-26.5	dc-8 GHz: 1.1 8-12.4 GHz: 1.15 12.4-26.5 GHz: 1.25(1.27 Opt. 006)	2 W Avg. 100 W Peak	±0.5 dB dc-18 GHz ±1.0 dB 18-26.5 GHz	±0.6 dB dc-18 GHz ±0.6 dB	±0.3 dB	±0.5 dB	±0.7 dB	±1.0 dB	—	—	APC 3.5 (m,f)
				—	—	±0.5 dB	±0.6 dB	±1.0 dB	±1.3 dB	—	—	
8498A Option 030	dc-18	dc-2 GHz: 1.1 2-12.4 GHz: 1.2 12.4-18 GHz: 1.35	25 W Avg. 500 W Peak (dc-7 GHz) 125 W Peak (7-18 GHz) 500 watt-µs max. per pulse	—	—	—	—	±1 dB	—	—	—	N(m,f)
Option 890 Calibration Data	HP Models		Calibration Frequencies (MHz)									
	8491A, 8493A		100, 500, 1000, every 500 MHz to 12000, 12400. (26 frequencies)									
	8491B, 8492A, 8493B, 8498A 8493C		Same as above plus 12500 to 16000 8493B, 8498A in 500 MHz steps, 16000 to 18000 in 250 MHz steps. (42 frequencies)									
Option 894 Calibration Data	8492A		Same as HP 8492A Option 890 plus 110, 580, 1050 and 1520 MHz.									
	8493C		Same as HP 8493C Option 890 plus 100, 110, 500, 580, 1000, 1050, 1500 and 1520 MHz.									



# MICROWAVE TEST EQUIPMENT

## Variable Attenuators and OEM Step Attenuators

Models 375 Series, 382 Series, 33300 Series, 33320 Series

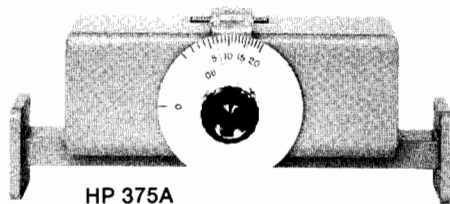

HP 375A

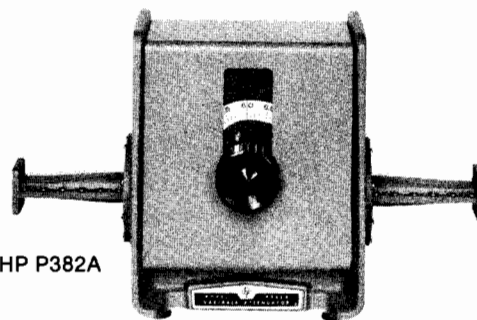

HP P382A

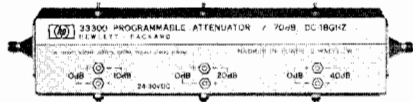

HP 33300A

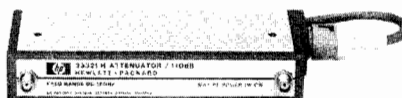

HP 33321H

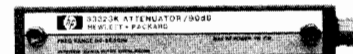

HP 33323K

### HP 33300 Series, 33320 Series OEM Step Attenuators

HP 33300 series step attenuators provide wideband programmable signal level control. Magnetic latching solenoids switch individual attenuating elements into and out of contact with a 50-ohm transmission line. C/D models have separate indicator contacts and A/B models have no indicator contacts. Three three-digit connector options (OXY) must be specified. X is the input connector, Y is the output connector, first digit is always 0. See specifications table for option numbers.

HP 33320 series step attenuators are compact versions of the HP 8494/5/6/7 bench attenuators on page 499 (same specifications) and are configured for designing into microwave systems and instru-

ments. Manual or electrically-actuated versions are available. The manual models take less than 1.5 square inches of panel space. OEM quantity discounts are available for HP 33300 and 33320 series.

### HP 375, 382 Series Waveguide Attenuators

Operation of these HP 382 series rotary-vane, continuously-variable attenuators depends on a mathematical law rather than on the resistivity of the attenuator card. They are direct-reading and provide accurate attenuation from 0 to 50 dB (60 dB for S382C) regardless of temperature and humidity.

HP 375A series variable flap attenuators consist of a short slotted section of waveguide in which a matched resistive strip is inserted.

### HP 33300 Series, 33320 Series Specifications

HP Model	Freq Range (GHz)	Mode	Range	Remarks
33300 A/B C/D	dc-18	Prog.	0-70 dB 10 dB steps	A&C models 12-15 V
33301 A/B C/D	dc-18	Prog.	0-42 dB 6 dB steps	B&D models 24-30 V
33304 A/B C/D	dc-18	Prog.	0-11 dB 1 dB steps	Connector options available:
33305 A/B C/D	dc-18	Prog.	0-110 dB 10 dB steps	0: N(f), 1: N(m) 2: 7mm(f), 3: 7mm(m) 5: SMA(f), 6: SMA(m)
33320A B	dc-4 dc-18	Manual	1-11 dB 1dB steps	Specifications identical to 8494 series page 499
33320G H	dc-4 dc-18	Prog.		
33321A B D	dc-4 dc-18 dc-26.5	Manual	0-70 dB 10 dB steps	Specifications identical to 8495 series page 499
33321G H K	dc-4 dc-18 dc-26.5	Prog.		
33322A B	dc-4 dc-18	Manual	0-110 dB 10 db steps	Specifications identical to 8496 series page 499
33322G H	dc-4 dc-18	Prog.		
33323K	dc-26.5	Prog.	0-90 dB 10 dB steps	Specifications identical to 8497K page 499 APC-3.5 only

### HP 375A, 382 Series Specifications

HP Model	Frequency Range (GHz)	Accuracy	Attenuation Range (dB)	Waveguide & Equivalent Flange
S382C	2.6-3.95	±1% of reading or 0.1 dB whichever greater ±2% above 50 dB	0-60	WR 284 UG-584/U
G382A	3.95-5.85	±2% of reading or 0.1 dB whichever greater	0-50	WR 187 UG-407/U
J382A	5.3-8.2	±2% of reading or 0.1 dB whichever greater	0-50	WR 137 UG-441/U
H382A	7.05-10.0	±2% of reading or 0.1 dB whichever greater	0-50	WR 112 UG-138/U
X382A	8.2-12.4	±2% of reading or 0.1 dB whichever greater	0-50	WR 90 UG-135/U
P382A	12.4-18.0	±2% of reading or 0.1 dB whichever greater	0-50	WR 62 UG-419/U
K382A	18.0-26.5	±2% of reading or 0.1 dB whichever greater	0-50	WR 42 UG-597/U
R382A	26.5-40.0	±2% of reading or 0.1 dB whichever greater	0-50	WR 28 UG-599/U
X375A	8.2-12.4	±1 dB, ±2 dB	0-20	WR 90 UG-39/U
P375A	12.4-18	±1 dB, ±2 dB	0-20	WR 62 UG-419/U

# MICROWAVE TEST EQUIPMENT

## Coaxial Step Attenuators

Models 355 Series, 8494/5/6/7 Series, 11713A, 11716A/B, 11717A

499



- Excellent repeatability
- Manual and programmable
- Calibration data available

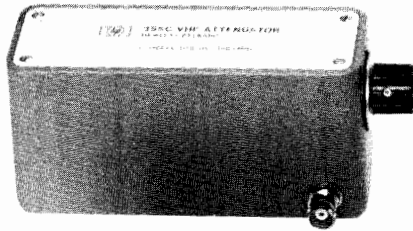

HP 355C

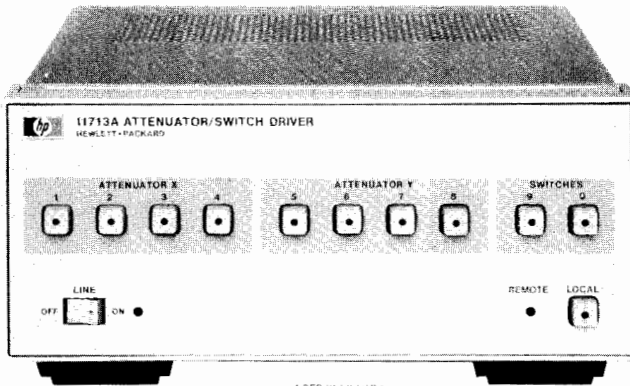

HP 11713A



### HP 355C/D/E/F Manual and Programmable Step Attenuators, dc to 1000 MHz

Precision attenuation from dc to 1000 MHz is available with these Hewlett-Packard attenuators. HP 355C/E provide 0 to 12 dB in 1-dB steps and HP 355D/F provide 0 to 120 dB in 10-dB steps. For the HP 355E and 355F models, attenuation programming is done through a 7-pin connector. All standard models are equipped with BNC connectors.

### HP 8494A/B/G/H, 8495A/B/D/G/H/K, 8496A/B/G/H, 8497K Manual and Programmable Step Attenuators, dc to 26.5 GHz

Four attenuation ranges are available: 0 to 11 dB in 1-dB steps (HP 8494), 0 to 70 dB in 10-dB steps (HP 8495), 0 to 110 dB in 10-dB steps (HP 8496) and 0 to 90 dB in 10 dB steps (HP 8497). There is choice of three connectors: Type N (f), SMA (f), and APC-7 (APC-3.5 on HP 8495D/K and 8497K only). Manual and programmable versions are available as well as coverage of three frequency ranges (dc-4 GHz, dc-18 GHz, and dc-26.5 GHz). Calibration data (SWR and attenuation) is available on the HP 8494/5/6/7 models as option 890. The data is generated by an automatic network analyzer test system and is given for each step of the attenuator at 14 frequencies (dc-4 GHz models), 47 frequencies (dc-18 GHz models), or 72 frequencies (dc-26.5 GHz); see frequency lists on next page. This data is very useful for improving measurement accuracy in manual and automated test systems.

Each attenuator consists of three or four attenuation sections connected in cascade. Attenuator sections are inserted and removed by cam-actuated "edge line" contacts. These contacts are gold-plated leaf-springs that ensure long life (over a million steps) and high repeatability (typically 0.03 dB).

The G, H, and K programmable models offer the same high performance as the manual models with the addition of fast switching solenoids. Attenuation programming is done through a 12-pin con-

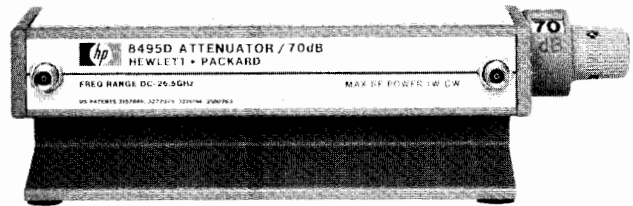

HP 8495D option 004

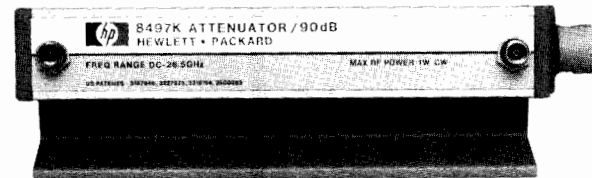

HP 8497K option 004

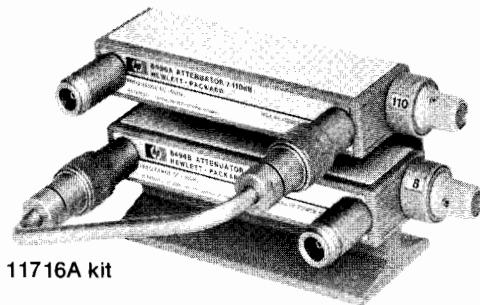

HP 11716A kit

ductor. For ease of connection to the driving circuit, each attenuator is provided with a five-foot cable assembly that includes the mating connector. With the HP 11713A Attenuator Driver, the attenuators are easily integrated into a Hewlett-Packard Interface Bus (HP-IB) automated system.

### HP 11716A/B Interconnection Kit

Convenient interconnection of 1-dB and 10-dB models is provided with the HP 11716A/B. These kits provide a rigid RF cable, mounting bracket, and screws to connect any pair of HP 8494/5/6 attenuators in series (see picture above). Attenuators must be ordered separately.

Equivalent versions of these attenuators for incorporation in equipment (i.e., "OEM") are available under model numbers HP 33320, 33321, 33322 and 33323. See following pages.

### HP 11713A Attenuator/Switch Driver

This instrument has all of the necessary features to provide HP-IB control of up to two programmable attenuators of the HP 8494/5/6/7 or HP 33320/1/2/3 series and concurrently up to two electro-mechanical switches (e.g., HP 8761B or 33311 series). Alternatively, the HP 11713A can be used to supply +24 V common and ten pairs of transistor switches (total current less than 1.25A) to control up to ten relays. The HP 11713A includes an integral power supply with short circuit protection that can simultaneously provide 125 milliamps at 24 volts to all contacts for control of the attenuators and switches, so no external power supply is needed. For convenience in connecting HP 8490 or HP 33320-series attenuators, two 5-foot cables with appropriate connectors are supplied.

A local mode and front-panel push buttons allow switches and attenuator sections to be operated manually. Switching time for the drivers is less than 10 milliseconds.

### Ordering Information

HP 11713A Attenuator/Switch Driver

HP 11716A Interconnection Kit for Type N (f) Connectors

HP 11716B Interconnection Kit for APC-7 Connectors

HP 11717A Attenuator/Switch Rack Mount Support Kit

# MICROWAVE TEST EQUIPMENT

## How to Order the HP 8494/5/6/7 Series Attenuators

Each order must include basic model number, suffix letter, and connector option.

Optional calibration data.

### HP 8494 A Option 001 Option 890

- 4 (1 dB step, 11 dB max)
- 5 (10 dB step, 70 dB max)
- 6 (10 dB step, 110 dB max)
- 7 (10 dB step, 90 dB max)

- A (Manual, dc—4 GHz)
- B (Manual, dc—18 GHz)
- D (Manual, dc—26.5 GHz)\*
- G (Programmable, dc—4 GHz)
- H (Programmable, dc—18 GHz)
- K (Programmable, dc—26.5 GHz)\*

- 001 (N-Female)
- 002 (SMA Female)
- 003 (APC-7)
- 004 (APC-3.5 Female)\*

\* Option 004 is only available on 'D' and 'K' models.

## HP 355 Series, 8494/5/6/7 Series Specifications

HP Model and (Switching Mode)	Frequency Range (GHz)	Incremental Attenuation (dB)	SWR Maximum (50 Ω Nominal)	Insertion Loss (0 dB setting)	Attenuation Accuracy	Power Rating, Minimum Life	Solenoid Voltage Speed Power	Size, Shipping Weight	Connector Options Available	
355C (Manual)	dc—1	0—12 1 dB steps	dc—0.25 GHz: 1.2 dc—0.5 GHz: 1.3 dc—1.0 GHz: 1.5	0.11 dB + 1.39 dB/GHz	±0.1 dB @ 1000 Hz ±0.25 dB: dc—0.5 GHz ±0.35 dB: dc—1.0 GHz	0.5 W avg 350 W peak 0.6 million steps	—	67 H × 70 W × 152 mm D (2.6" × 2.75" × 6") 1.4 kg (3 lb)	BNC (f) See Note 1	
355E (Programmable)										
355D (Manual)	dc—1	0—120 10 dB steps	dc—0.25 GHz: 1.2 dc—0.5 GHz: 1.3 dc—1.0 GHz: 1.5	0.11 dB + 1.39 dB/GHz	±0.3 dB @ 1000 Hz ±1.5 dB to 90 dB, and ±3 dB to 120 dB @ 1 GHz	0.5 W avg 350 W peak 0.6 million steps	—	67 H × 70 W × 152 mm D (2.6" × 2.75" × 6") 1.4 kg (3 lb)	BNC (f) See Note 1	
355F (Programmable)										
8494A (Manual)	dc—4	0—11 1 dB Steps	1.5	0.6 dB + 0.09 dB/GHz	±0.2 dB: 1—2 dB ±0.3 dB: 3—6 dB ±0.4 dB: 7—10 dB ±0.5 dB: 11 dB	1 W avg 100 W peak 10 μs max. 1 million steps	—	43 H × 73 W × 159 mm D (1.7" × 2.9" × 6.2") 0.9 kg (2 lb)	001 002 003 See Note 2	
8494G (Programmable)										
8494B (Manual)	dc—18	0—11 1 dB steps	dc—8 GHz: 1.5 dc—12.4 GHz: 1.6 dc—18 GHz: 1.9	0.6 dB + 0.09 dB/GHz	dc—12.4 GHz ±0.3 dB: 1—2 dB ±0.4 dB: 3—4 dB ±0.5 dB: 5—6 dB ±0.6 dB: 7—10 dB ±0.7 dB: 11 dB dc—18 GHz ±0.7 dB: 1—5 dB ±0.8 dB: 6—9 dB ±0.9 dB: 10—11 dB	1 W avg 100 W peak 10 μs max. 1 million steps	—	43 H × 73 W × 159 mm D (1.7" × 2.9" × 6.2") 0.9 kg (2 lb) 43 H × 73 W × 142 mm D (1.7" × 2.9" × 5.6")	001 002 003 See Note 2	
8494H (Programmable)										
8495A (Manual)	dc—4	0—70 10 dB steps	1.35	0.4 dB + 0.07 dB/GHz	±1.7% of setting or ±0.4 dB, whichever is greater	1 W avg 100 W peak 10 μs max. 1 million steps	—	43 H × 73 W × 130 mm D (1.7" × 2.9" × 5.1") 0.9 kg (2 lb) 43 H × 73 W × 114 mm D (1.7" × 2.9" × 4.5")	001 002 003 See Note 2	
8495G (Programmable)										
8495B (Manual)	dc—18	0—70 10 dB steps	dc—8 GHz: 1.35 dc—12.4 GHz: 1.5 dc—18 GHz: 1.7	0.4 dB + 0.07 dB/GHz	±3%: dc—12.4 GHz ±4%: dc—18 GHz % in dB from Atten. Setting	1 W avg 100 W peak 10 μs max. 1 million steps	—	43 H × 73 W × 130 mm D (1.7" × 2.9" × 5.1") 0.9 kg (2 lb) 43 H × 73 W × 114 mm D (1.7" × 2.9" × 4.5")	001 002 003 See Note 2	
8495H (Programmable)										
8495D (Manual)	dc—26.5	0—70 10 dB steps	dc—12.4 GHz: 1.6 12.4—18 GHz: 1.9 18—26.5 GHz: 2.2	0.5 dB + 0.13 dB/GHz	±3%: dc—12.4 GHz ±4%: dc—18 GHz ±7%: dc—26.5 GHz % in dB from Atten. Setting	1 W avg 100 W peak 10 μs max. 1 million steps	—	43 H × 52 W × 159 mm D (1.7" × 2.1" × 6.2") 0.9 kg (2 lb) 43 H × 52 W × 168 mm D (1.7" × 2.1" × 6.6")	004 APC-3.5 See Note 2	
8495K (Programmable)										
8496A (Manual)	dc—4	0—110 10 dB steps	1.5	0.6 dB + 0.09 dB/GHz	±1.7% of setting or ±0.4 dB, whichever is greater	1 W avg 100 W peak 10 μs max. 1 million steps	—	43 H × 73 W × 159 mm D (1.7" × 2.9" × 6.2") 0.9 kg (2 lb) 43 H × 73 W × 142 mm D (1.7" × 2.9" × 5.6")	001 002 003 See Note 2	
8496G (Programmable)										
8496B (Manual)	dc—18	0—110 10 dB steps	dc—8 GHz: 1.5 dc—12.4 GHz: 1.6 dc—18 GHz: 1.9	0.6 dB + 0.09 dB/GHz	±3%: dc—12.4 GHz ±4%: dc—18 GHz % in dB from Atten. Setting	1 W avg 100 W peak 10 μs max. 1 million steps	—	43 H × 73 W × 159 mm D (1.7" × 2.9" × 6.2") 0.9 kg (2 lb) 43 H × 73 W × 142 mm D (1.7" × 2.9" × 5.6")	001 002 003 See Note 2	
8496H (Programmable)										
8497K (Programmable)	dc—26.5	0—90 10 dB steps	dc—6 GHz: 1.25 6—12.4 GHz: 1.45 12.4—18.0 GHz: 1.6 18.0—26.5 GHz: 1.8	0.6 dB + 0.09 dB/GHz	±0.3 dB at 6 GHz 10 dB attenuation to +2.8 dB at 26.5 GHz 90 dB attenuation. See Data Sheet 5952-8278 for details.	1 W avg 100 W peak 10 μs max. 1 million steps	5 V or 24V	43 H × 52 W × 143 mm D (1.7" × 2.1" × 5.6") 0.9 kg (2 lb)	004 APC-3.5 See Note 2	
<b>Option 890 Calibration Data</b>		<b>Option 890 Frequency List (MHz)</b>				<b>Models</b>				
		DC to 4 GHz Models: 100, 300, 500, 700, 900, 1000, 1250, 1500, 1750, 2000, 2500, 3000, 3500, 4000				DC to 26.5 GHz Models every 500 MHz 2 to 16 GHz every 250 MHz 16 to 26.5 GHz				
		DC to 18 GHz Models: Same as above to 4000 MHz, every 500 MHz to 16000 (plus 12400 MHz), every 250 MHz from 16000 to 18000.				8494A/G, 8496A/G, 33320A/G, 33322A/G 8495A/G, 33321A/G  8494B/H, 8496B/H, 33320B/H, 33322B/H 8495B/H, 33321B/H 8495D/K, 8497K				
Note 1: 355C/D/E/F connector options (BNC (f) standard) Option 001 N(f) Option 005 BNC(f) Option 007 Transistor protection					Note 2: 8494/5/6/7 orders must specify connector option. See ordering example above. Option 001 N(f) Option 002 SMA(f) Option 003 APC-7 Option 004 APC-3.5 (HP 8495D/K, 8497K only)					



# MICROWAVE TEST EQUIPMENT

Transmission Reflection Test Sets, Power Splitters, Power Dividers

Models 8721A, 8502A/B, 11850A/B, 11667A/B, 11636A/B

501

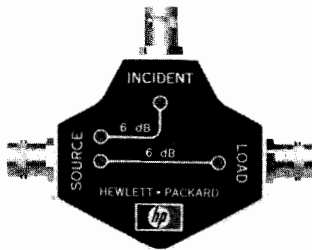

HP 8721A

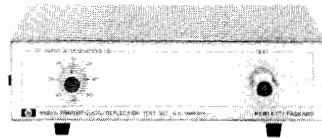

HP 8502A

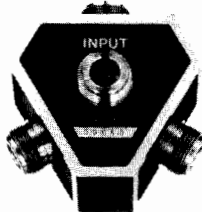

HP 11850A

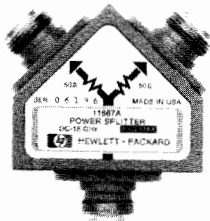

HP 11667A

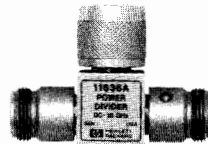

HP 11636A

## Description

Accurate broadband measurements of transmission and reflection parameters are highly dependent on the device used to separate signals for the measurement. Some devices separate the reflected and transmitted signals and some split power for ratio and comparison measurements.

### HP 8721A Directional Bridge

#### HP 8721A Option 008 75 Ohm Version

**Frequency range:** 0.1 - 110 MHz.

**Directivity:** >40 dB, 1 - 110 MHz, typically >30 dB, 0.1 - 1 MHz.

**Load port match:** >30 dB (VSWR <1.07).

**Transmission arm:** Nominal loss, 6 dB. Frequency response, <0.2 dB.

**Coupling arm:** Nominal coupling, 6 dB. Frequency response, <0.6 dB.

**Maximum input power:** +20 dBm.

**Weight:** net, 0.55 kg (0.25 lb); shipping, 1.1 kg (0.5 lb).

**Size:** 59 H x 39 W x 123 mm D (1.5 x 1 x 3.13 in.).

### HP 8502A 50 Ohm Transmission Reflection Test Set

#### HP 8502B 75 Ohm Transmission Reflection Test Set

The HP 8502 contains a power splitter and directional bridge that permits simultaneous transmission and reflection measurements with over 35 dB directivity from 500 kHz to 1.3 GHz. The HP 8502A Option H26 allows 50 ohm transmission/reflection measurements up to 2600 MHz. Detailed specifications on the HP 8502A and HP 8502B appear on page 558.

### HP 11850A 50 Ohm Power Splitter

#### HP 11850B 75 Ohm Power Splitter

These three-way power splitters are designed for ratio measurements from dc to 1.3 GHz. One output port provides the reference and the other two output ports can be used for independent transmission measurements. They provide 0.1 dB tracking and >32 dB output match. Detailed specifications are on page 558.

### HP 11667A Power Splitter (Type N)

#### HP 11667B Power Splitter (APC-3.5)

These two-way, two-resistor splitters provide good input and output source match in ratio measurement and source leveling applications. The HP 11667A operates from dc to 18 GHz with output match >17 dB and tracking <0.25 dB. The HP 11667B operates from dc to 26.5 GHz and has output source match >18 dB and tracking <0.4 dB. Detailed specifications are on page 558.

### HP 11636A/B Power Dividers/Combiners

The HP 11636A/B are two-way, three-resistor power dividers for use in non-ratio measurements. They can also be used as power combiners for combining two independent signals. They are ideal for fault location measurements made with the HP 8757S and the HP 85016A software.

#### Frequency Range

HP 11636A: DC to 18 GHz.

HP 11636B: DC to 26.5 GHz.

**Impedance:** 50 ohms nominal.

**Insertion loss:** 6 dB nominal.

	DC-10 GHz	DC-18 GHz	DC-26.5 GHz
<b>Input SWR</b>			
HP 11636A	<1.25	<1.35	
HP 11636B	<1.22	<1.29	<1.29
<b>Output SWR</b> (non-ratio measurements)			
HP 11636A	<1.25	<1.35	
HP 11636B	<1.22	<1.29	<1.29
<b>Output Tracking</b> (between output arms)			
HP 11636A	<0.4 dB	<0.5 dB	
HP 11636B	<0.25 dB	<0.25 dB	<0.5 dB
<b>Typical Phase Tracking</b> (between output arms)			
HP 11636A	2°	2°	
HP 11636B	2°	2.5°	3°

#### Maximum Input Power

HP 11636A +30 dBm

HP 11636B +27 dBm

#### Connectors

HP 11636A: Type N male input port, female output ports.

HP 11636B: APC-3.5 female on all ports.

#### Dimensions

HP 11636A: 42 H x 45 W x 18 mm D (1.64 x 1.75 x 0.69 in.)

HP 11636B: 40 H x 47 W x 10 mm D (1.6 x 1.9 x 0.4 in.)

#### Weight

HP 11636A: net, 0.14 kg (0.31 lb); shipping, 0.45 kg (1 lb)

HP 11636B: net, 0.06 kg (0.13 lb); shipping, 0.14 kg (0.3 lb)

## Ordering Information

HP 8721 Directional Bridge

**Option 008:** 75 Ohm Version

HP 8502A 50 Ohm Transmission Reflection Test Set

**Option H26:** 4 to 2600 MHz

HP 8502B 75 Ohm Transmission Reflection Test Set

HP 11850A 50 Ohm Power Splitter

**Option H26:** dc to 2.6 GHz

HP 11850B 75 Ohm Power Splitter

HP 11667A Power Splitter (DC - 18GHz)

**Option 001:** Type N Male Input, Type N Female Outputs

**Option 002:** Type N Female Input, APC-7 On Outputs

HP 11667B Power Splitter (DC - 26.5 GHz)

HP 11636A Power Divider (DC - 18 GHz)

HP 11636B Power Divider (DC - 26.5 GHz)

# MICROWAVE TEST EQUIPMENT

## Coaxial Single and Dual-Directional Couplers

Models 770 Series, 790 Series, 11691D, 11692D

- Broadband coverage
- High directivity
- Close tracking

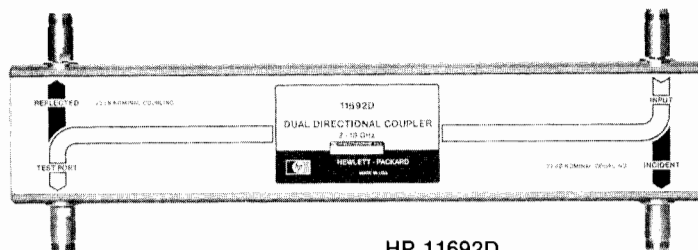

HP 11692D

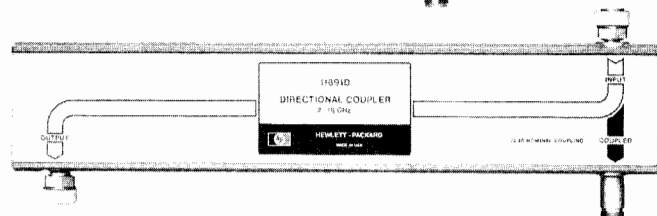

HP 11691D

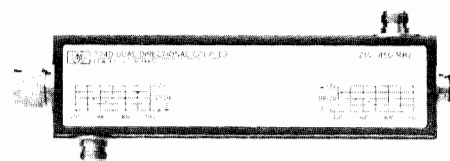

HP 774D

### HP 779D Directional Coupler

The HP 779D spans more than two octaves from 1.7 to 12.4 GHz with excellent directivity. With increased coupling factors (typically 24 dB), the HP 779 is useful down to 500 MHz. Upper frequency usefulness extends to 18 GHz with directivity reduced to about 15 dB. Various connector options are available.

### HP 790 Series Directional Couplers (octave bands)

The HP 790 directional couplers are ultra-flat, high directivity couplers which are ideal for power-monitoring applications in coaxial systems. Output coupling (ratio of output power from main and auxiliary arms) is specified rather than a coupling factor. Thus, no correction factor is required to account for insertion loss in the main arm.

### HP 11691D Directional Coupler

The HP 11691D is an ultra-wide-band single directional coupler covering 2 to 18 GHz with high directivity. It is useful as a power monitoring or leveling coupler, or for making reflection measurements. Couplers are preferred over broadband bridges in reflectometer applications in situations where the power level of the source is limited, or where simultaneous measurement of return loss and insertion loss is desired.

### HP 779D, 790 Series, 11691D Specifications

HP Model	Frequency Range (GHz)	Mean Output Coupling (dB)	Output Coupling Variation (dB)	Minimum Directivity (dB)	Equivalent <sup>1</sup> Source Match
779D	1.7-12.4	20 ± 0.5	±0.75	1.7-4 GHz: 30 4-12.4 GHz: 26	1.2
796D	0.96-2.11	20 ± 0.5	±0.2	30	1.13
797D	1.9-4.1	20 ± 0.5	±0.2	26	1.16
798C	3.7-8.3	10 ± 0.3	±0.3	20	1.25
11691D	2-18	22 Nominal	±1.0	2-8 GHz: 30 dB 8-18 GHz: 26 dB	1.2
<b>HP 796D-798C</b> Standard connectors Primary Line: N(f), N(m) Auxiliary Arm: N(f)					
<b>HP 779D</b> Standard connectors Primary Line: N(m) input, N(f) output; auxiliary arm: N(f)  <b>Option 010:</b> Primary Line: N(f) input, N(m) output; auxiliary output: N(f) Other options: APC-7 on any or all ports					
<b>HP 11691D</b> Standard connectors Primary line: APC-7, APC-7; Auxiliary Arm: N(f)  <b>Option 001:</b> All N(f) <b>Option 005:</b> All APC-7					
<sup>1</sup> Apparent SWR at the output port of a coupler when used in a closed-loop leveling system.					

### HP 774D-777D Dual-Directional Couplers (octave bands)

The economical HP 774D-777D couplers cover frequency spreads of more than two-to-one, each centered on one of the important VHF/UHF bands. With their high directivity and a mean coupling accuracy of ±0.5 dB, these couplers are ideal for reflectometer applications. Furthermore, the close tracking of the auxiliary arms makes these couplers particularly useful for reflectometers driven by sweep oscillators such as the HP 8350B with its appropriate plug-in. Power ratings are 50 W average, 500 W peak.

### HP 778D, 11692D Dual-Directional Couplers (multi-octave bands)

These couplers are ideal for swept-frequency reflectometer testing of broadband coaxial components. The HP 778D covers 100 MHz to 2 GHz and the HP 11692D covers 2 to 18 GHz. High directivity and close tracking of the auxiliary arms are featured. Various connector options are available. Both couplers handle 50 W average power. Peak power: HP 778D, 500 W; HP 11692D, 250 W.

### HP 774D, 775D, 776D, 777D, 778D, 11692D Specifications

HP Model	Frequency Range (GHz)	Nominal Coupling (dB)	Maximum Coupling Variation (dB)	Minimum Directivity (dB)	SWR Primary Line Maximum (50: Nom.)
774D	0.215-0.450	20	±1	40	1.15
775D <sup>1</sup>	0.450-0.940	20	±1	40	1.15
776D <sup>1</sup>	0.940-1.90	20	±1	40	1.15
777D	1.90-4.0	20	±0.4	30	1.2
778D	0.10-2.0	20	±1.5	0.1-1 GHz: 36 <sup>2</sup> 1-2 GHz: 32	1.1
11692D	2.0-18.0	22	+1 incident to test port	2-8 GHz: 30 8-18 GHz: 26 <sup>3</sup>	2-12.4 GHz: 1.3 12.4-18 GHz: 1.4
<b>HP 774D-777D</b> Standard connectors Primary Line: N(m), N(f) Auxiliary Arm: N(f), N(f)					
<b>HP 778D</b> Standard connectors Primary Line: N(m), 1(f); Auxiliary Arms: N(f), N(f)  <b>Option 011:</b> Primary Line, APC-7, N(f) <b>Option 012:</b> Primary Line, N(m), N(f)					
<b>HP 11692D</b> Standard connectors Primary line: N(f), APC-7; Auxiliary Arms: N(f), N(f)  <b>Option 001:</b> Primary Line, N(f), N(f) <b>Option 002:</b> Primary Line, N(f), N(m)					
<sup>1</sup> Maximum auxiliary arm tracking: 0.3 dB for HP 776D; 0.5 dB for HP 777D <sup>2</sup> 30 dB, 0.1 to 2 GHz, input port. <sup>3</sup> 24 dB with Type N connector on the test port.					

# MICROWAVE TEST EQUIPMENT

## Coaxial Directional Detectors and Waveguide Directional Couplers

Models 780 Series, 752 Series

503



- Flat frequency response
- Low equivalent source match
- High directivity to >40 dB

- Low SWR
- Coverage to 40 GHz

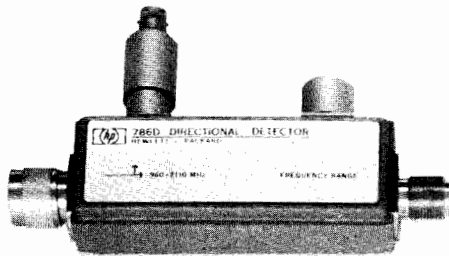

HP 786D

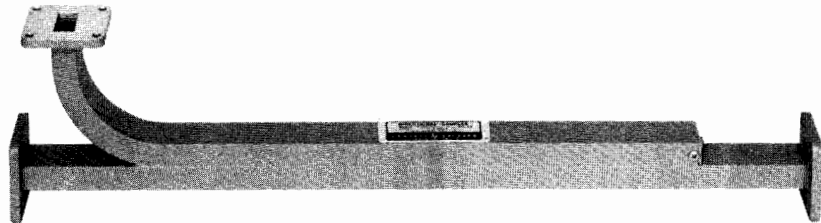

HP X752A

### HP 780 Series Directional Detectors

The HP 780 series detectors are directional couplers with built-in crystal detectors. The couplers have flat frequency response and good directivity, while the detectors have good frequency response plus high sensitivity. The configuration of the directional detector reduces the number of ambiguities over the standard system of separate coupler and detector and makes possible tighter correlation between main-arm power and detected signal. The directional detector is well suited for sweep oscillator leveling and can also be used to monitor power with a voltmeter or oscilloscope.

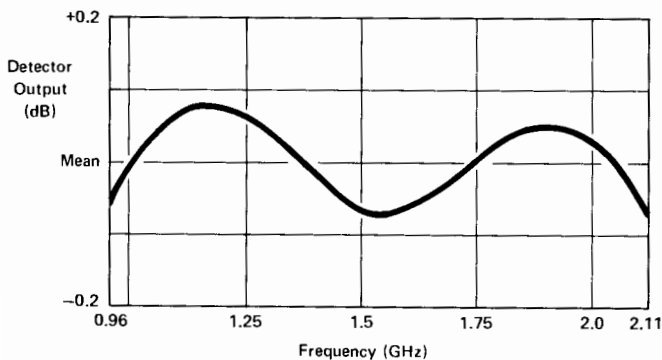

Figure 1. Typical HP 786D Frequency Response.

### HP 780 Series Specifications

#### Standard Connectors

**Output:** all models, N(f).

**Input:** HP 786D-788C, N(m); HP 789C, N(f).

HP Model	Frequency Range (GHz)	Frequency <sup>1</sup> Response	Equivalent <sup>2</sup> Source Match
786D	0.96-2.11	±0.2	1.13
787D	1.9-4.1	±0.2	1.16
788C	3.7-8.3	±0.3	1.25
789C	8-12.4	±0.5	1.25

<sup>1</sup>Includes coupler and detector variation with frequency as read on a meter calibrated for square-law detector (e.g., HP 415E).

<sup>2</sup>Apparent SWR at the output port of the directional detector when used in a closed-loop leveling system.

### HP 752 Series Waveguide Directional Couplers

The HP 752 series couplers are specified to meet a wide variety of microwave applications. Every coupler has a minimum directivity of 40 dB over its entire frequency range. Each coupler is swept-frequency tested to ensure that the main guide SWR and directivity specifications are accurate. Performance characteristics are unaffected by humidity, temperature, and time, making these units especially useful in microwave "standards" measurements.

The HP 752 couplers are an essential part of many waveguide measurement systems. Attenuation measurements, reflectometer set-ups, power measurements, source leveling and network analysis are just a few areas in which these couplers are used.

### HP 752 Series Specifications

HP Model	Frequency Range (GHz)	Nominal Coupling (dB)	Mean Coupling Accuracy (dB)	Maximum Coupling Variation (dB)	Minimum Directivity (dB)	Waveguide & Flange
X752A	8.2-12.4	3	±0.4	±0.5	40	WR90 UG-135/U
X752C	8.2-12.4	10	±0.4	±0.5	40	
X752D	8.2-12.4	20	±0.4	±0.5	40	
P752A	12.4-18.0	3	±0.4	±0.5	40	WR62 UG-419/U
P752C	12.4-18.0	10	±0.4	±0.5	40	
P752D	12.4-18.0	20	±0.4	±0.5	40	
K752A	18.0-26.5	3	±0.7	±0.5	40	WR42 UG-595/U
K752C	18.0-26.5	10	±0.7	±0.5	40	
K752D	18.0-26.5	20	±0.7	±0.5	40	
R752A	26.5-40.0	3	±0.7	±0.5	40	WR28 UG-599/U
R752C	26.5-40.0	10	±0.7	±0.5	40	
R752D	26.5-40.0	20	±0.7	±0.6	40	

# MICROWAVE TEST EQUIPMENT

## Coaxial Crystal Detectors



Models 420C, 423A/B, 8470A/B, 8471A, 8472A, 8473B/C, 33330B/C

- Flat frequency response
- High burnout protection

- Low SWR
- Field replaceable detector elements



HP 33330B



HP 8470B Opt 012



HP 423A



HP 8470A



HP 423B



HP 8470B



HP 8472A



HP 8471A

### HP 423B, 8470B, 8473B/C, 33330B/C Low Barrier Schottky Diode (LBSD) Detectors

The low-barrier Schottky diode (LBSD) detectors are a state-of-the-art addition to the HP family of high performance detectors. Various models provide coverage to 12.4, 18, and 26.5 GHz and input connectors are Type N, APC-7, or APC-3.5 depending on frequency range. Output connector is BNC (f) except for the HP 33330B/C (SMC).

Matched pairs (Opt 001), square-law load (Opt 002), and positive polarity output (Opt 003) are available for most models.

### HP 420C, 423A, 8470A, 8471A, 8472A Point-Contact Detectors

These point-contact detectors have been widely used for many years and provide high performance at an economical price. The HP 8470A, 8470A Opt 012, and 8472A provide APC-7, Type N, and SMA connector versions to 18 GHz. Matched pairs are available for applications requiring close detector tracking, and the HP 420C and 8470A can be supplied with video loads for optimum conformance to square law.

### Coaxial Crystal Detector Specifications

HP Model	Frequency Range (GHz)	Frequency Response (dB)	SWR Maximum (50Ω Nom.)	Low Level Sensitivity	Maximum Input (Peak or Average)	Short-Term Maximum Input (<1 min.)	Option 001 Matched Pair (order 2 units for each pair)	Options Available	Input Connector	Output Connector
420C	0.01-12.4 Point Contact	±2	2.0	>0.15 mV/μW	100 mW	0.1 watt	±1 dB	001 003	N (m)	BNC (f)
423B	0.01-12.4 LBSD	±0.2/octave to 8 GHz ±0.3 overall	<1.15 to 4 GHz <1.3 to 12.4 GHz	>0.5 mV/μW	200 mW	1 watt	±0.2 dB to 12.4 GHz	001 002	N (m) 003	BNC (f)
423A	0.01-12.4 Point Contact	±0.2/octave to 8 GHz ±0.5 overall	<1.2 to 4.5 GHz <1.35 to 7 GHz <1.5 to 12.4 GHz	>0.4 mV/μW	100 mW	0.1 watt	±0.2 dB to 8 GHz ±0.3 dB to 12.4 GHz	001 002 003	N (m)	BNC (f)
8470B	0.01-18.0 LBSD	±0.2/octave to 8 GHz ±0.3 to 12.4 GHz ±0.6 to 18 GHz	<1.15 to 4 GHz <1.3 to 15 GHz <1.4 to 18 GHz	>0.5 mV/μW	200 mW	1 watt	±0.2 dB to 12.4 GHz ±0.3 dB to 18 GHz	001 002 003	APC-7 N (m)	BNC (f)
8470A	0.01-18.0 Point Contact	±0.2/octave to 8 GHz ±0.5 to 12.4 GHz ±1.0 to 18 GHz	<1.2 to 4.5 GHz <1.35 to 7 GHz <1.5 to 12.4 GHz <1.7 to 18 GHz	>0.4 mV/μW	100 mW	0.1 watt	±0.2 dB to 8 GHz ±0.3 dB to 12.4 GHz ±0.6 dB to 18 GHz	001 002 003	APC-7 N (m)	BNC (f)
8473B	0.01-18.0 LBSD	±0.2/octave to 8 GHz ±0.6 to 18 GHz	<1.2 to 4.0 GHz <1.5 to 18 GHz	>0.5 mV/μW	200 mW	1 watt	±0.2 dB to 12.4 GHz ±0.3 dB to 18 GHz	001 003	APC-3.5 (m)	BNC (f)
8473C	0.01-26.5 LBSD	±0.6 to 20 GHz ±1.5 with a -3.5 dB slope, 20 to 26.5 GHz	<1.2 to 4 GHz <1.5 to 18 GHz <2.2 to 26.5 GHz	>0.5 mV/μW to 18 GHz >0.18 mV/μW to 26.5 GHz	200 mW	1 watt	±0.2 dB to 12.4 GHz ±0.3 dB to 18 GHz ±0.5 dB to 26.5 GHz	001 003	APC-3.5 (m)	BNC (f)
8472A	0.01-18.0 Point Contact	±0.2/octave to 8 GHz ±0.5 to 12.4 GHz	<1.2 to 4.5 GHz <1.35 to 7 GHz <1.5 to 12.4 GHz <1.7 to 18 GHz	>0.4 mV/μW	100 mW	0.1 watt	±0.2 dB to 8 GHz ±0.3 dB to 12.4 GHz ±0.6 dB to 18 GHz	001 003	SMA (m)	BNC (f)
33330B	0.01-18.0 LBSD	±0.6	<1.2 to 4.0 GHz <1.5 to 18 GHz	>0.5 mV/μW	200 mW	1 watt	±0.2 dB to 12.4 GHz ±0.3 dB to 18 GHz	001 003	APC-3.5 (m)	SMC (m)
33330C	0.01-26.5 LBSD	±0.6 to 20 GHz ±1.5 with a -3.5 dB slope 20 to 26.5 GHz	<1.5 to 18 GHz <2.2 to 26.5 GHz	>0.5 mV/μW to 18 GHz Degrades to 0.18 mV/μW at 26.5 GHz	200 mW	1 watt	±0.3 dB to 18 GHz ±0.5 dB to 26.5 GHz	001 003	APC-3.5 (m)	SMC (m)
8471A	100 kHz-1.2 GHz Point Contact	±0.6 (typical) ±0.1/100 MHz	1.3 (typical) 50Ω	>0.35 mV/μW	3 Vrms	3 Vrms	No	004 005 006	BNC (m)	BNC (f)

#### Options

**Option 001:** Matched response. Must order two (2) option 001s for a pair of detectors with matched frequency response.

**Option 002:** Optimum square law load.

**Option 003:** Positive polarity output.

#### HP 8471A

**004:** positive output

**005:** 75 ohm negative output

**006:** 75 ohm positive output

Point Contact Detectors				Low Barrier Schottky Diodes			
HP Model	Opt. 001	Opt. 002	Opt. 003	HP Model	Opt. 001	Opt. 002	Opt. 003
420C				423B			
423A				8470B			
8470A				8472B			
8472A				8473B			
				8473C			
				33330B			
				33330C			

# MICROWAVE TEST EQUIPMENT

## Waveguide Crystal Detectors; Frequency Meters

Models 422A, 424A, 532 Series, 536A, 537A

505

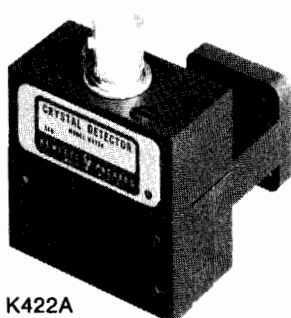

HP K422A

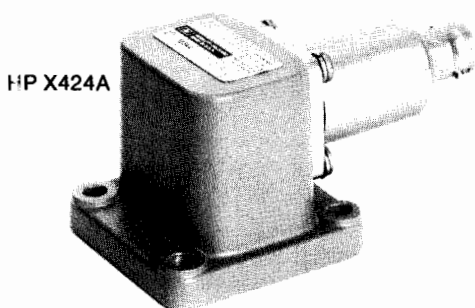

HP X424A

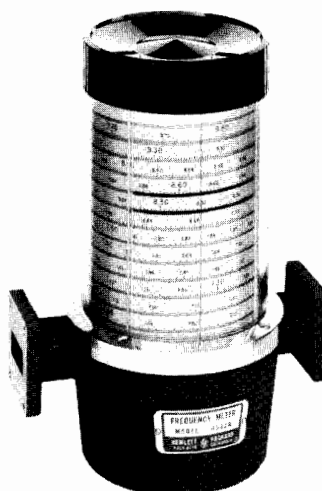

HP H532A

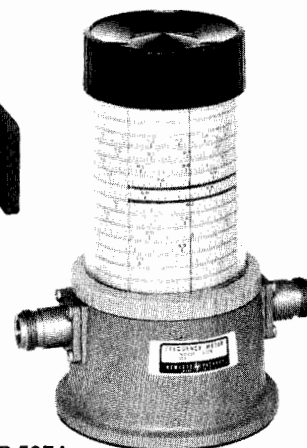

HP 537A

### HP 422 Series, 424 Series Crystal Detectors

The HP 422A and 424A families of crystal detectors combine high sensitivity with flat frequency response and low SWR to provide waveguide band coverage from 8.2 to 40 GHz. They deliver between 0.2 and 0.4 mV/ $\mu$ W output at low level and handle 100 mW peak input. SWR ranges from 1.35 at H-band to 3 at R-band.

For reflectometer applications in which both flat frequency response and square-law characteristics are important, these models can be supplied as matched pairs (Option 001) and with optimum square-law loads (Option 002).

### HP 422 Series, 424 Series Waveguide Crystal Detector Specifications

HP Model	Frequency Range (GHz)	Frequency Response (dB)	Option 001 Matched Response (dB)	Option 003 Positive Polarity Output Available	Waveguide & Equivalent Flange
X424A	8.2-12.4	$\pm 0.3$	$\pm 0.3$ dB	Yes	WR90 UG-135/U
P424A	12.4-18.0	$\pm 0.5$	$\pm 0.5$ dB	Yes	WR62 UG-419/U
K422A	18.0-26.5	$\pm 2$	$\pm 1$ dB	N/A	WR42 UG-595/U
R422A	26.5-40.0	$\pm 2$	$\pm 1$ dB	N/A	WR28 UG-599/U

Option 001: Matched response. Must order two (2) option 001's for a pair of detectors with matched frequency response.  
 Option 002: optimum square-law load.  
 Option 003: positive polarity output.

HP Model	Opt. 001	Opt. 002	Opt. 003
K422A P424A R422A X424A			

### HP 532 Series, 536A, 537A Frequency Meters

These direct-reading frequency meters measure frequencies from 8.2 to 40 GHz in waveguide and from 960 MHz to 12.4 GHz in coax quickly and accurately. Their long scales and numerous calibration marks provide high resolution which is particularly useful when measuring frequency differences or small frequency changes. Frequency is read directly in GHz so neither interpolation nor charts are required.

The instruments comprise a special transmission section with a high-Q resonant cavity which is tuned by a choke plunger. A 1 dB or greater dip in output indicates resonance; virtually full power is transmitted off resonance. Overall accuracy of each frequency meter includes allowance for 0 to 100 percent relative humidity and temperature variation from 13 to 33°C.

### HP 532 Series, 536A and 537A Specifications

HP Model	Frequency Range (GHz)	Overall Accuracy (%)	Calibration Increment (MHz)	W/G-Coax Equivalent Flange (Connector)
536A	0.96-4.20	0.96 to 1 GHz: 0.22 1 to 4.2 GHz: 0.17	2	Coax Type N(f)
537A	3.7-12.4	0.170	10	Coax Type N(f)
X532B	8.20-12.4	0.080	5	WR90 UG-39/U
P532A	12.4-18.0	0.100	5	WR62 UG-419/U
K532A	18.0-26.5	0.110	10	WR42 UG-595/U
R532A	26.5-40.0	0.120	10	WR28 UG-599/U



# MICROWAVE TEST EQUIPMENT

## Slotted Lines, Carriage, Probes, SWR Meter

### Models 415E, 442B, 444A, 447B, 809C, 810B Series, 816A

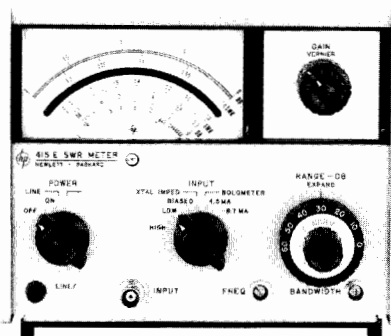

HP 415E



HP 442B



HP 447B

### HP 415E SWR Meter

HP 415E SWR Meter is a low noise, 1000 Hz tuned amplifier and voltmeter, calibrated in dB and SWR. Designed for use with square law detectors, it measures SWR, attenuation, and gain directly from metered scales, or drives an X-Y recorder for RF substitution measurements. Front panel INPUT switch selects unbiased low (50-200  $\Omega$ ) or high (2500-10,000  $\Omega$ ) impedance crystal, biased crystal (1 V into 1 k $\Omega$ ), or low or high current bolometer (4.5 or 8.7 mA  $\pm$  3% into 200  $\Omega$ ).

An internal precision 60 dB attenuator allows the HP 415E to operate over a 70 dB range in 10 or 2 dB steps, with  $\pm 0.05$  dB accuracy for a 10 dB step; maximum cumulative error between any two 10 dB steps is  $\pm 0.1$  dB. Sensitivity is 0.15  $\mu$ V rms for full scale deflection at maximum bandwidth (1  $\mu$ V rms on high impedance crystal input).

Continuously adjustable bandwidth can be adjusted from 15 Hz for maximum sensitivity at CW frequencies to 130 Hz for swept frequency uses. An optional rechargeable battery pack provides up to 36 hours of continuous operation for portable use. Weight: Net 4 kg (9 lb); shipping 5.8 kg (13 lb). Power: 115-230 V  $\pm$  10%, 50-400 Hz, 1 VA.

### HP 809C Slotted Line Carriage

The HP 809C carriage operates with the HP 816A coaxial slotted section and the HP 810B waveguide slotted sections. It is compatible with the HP 442B, 444A, and 447B coaxial probes. The carriage has a centimeter scale with a vernier reading to 0.1 mm, and provision is also made for mounting a dial gauge if more accurate probe position reading is required.

### HP 810B Series, HP 816A Slotted Sections

The HP 810B waveguide and HP 816A coaxial slotted sections are used with the HP 809C carriage. The HP 810B waveguide sections accept the HP 444A untuned probe or the HP 442B probe. The HP 816A coaxial line accepts the HP 447B probe.

### HP 810B Series, HP 816A Specifications

HP Model	Frequency Range (GHz)	SWR Residual	WG & Flange or Coax Conn.	Remarks
X810B	8.2-12.4	1.01	WR 90 UG-135/U	Use with 809C carriage & 444A Probe
P810B	12.4-18.0	1.01	WR 62 UG-419/U	
816A	1.8-18.0	1.02-1.04	Coaxial APC-7 N(f)	11512A N (m) Short 11565A APC-7 Short furnished. Use with HP 809C Carriage HP 447B Probe
Opt 011			Both APC-7	
Opt 022			N(m), N(f)	

### HP 442B, 444A, 447B Probes/Adapters

The HP 442B fits the HP 809C carriage and provides sampled RF at a Type N jack.

The HP 444A is an untuned probe for 2.6-18 GHz for use with the HP 809C carriage or other  $\frac{3}{4}$  inch (19 mm) mounting hole and the HP 810B waveguide sections. HP 447B is similarly used with the HP 809C and the HP 816A coaxial section for 1.8 to 18 GHz.

### Ordering Information

HP 442B RF probe

HP 444A Untuned probe

HP 447B Detector probe

HP 809C Slotted line carriage

HP 415E SWR Meter

Opt 001: rechargeable battery installed

Opt 002: rear panel input connector



# MICROWAVE TEST EQUIPMENT

## Coaxial and Waveguide Terminations

Models 905, 909-911, 914, 920, 923, 930



- Precision loads and shorts for measurements to 40 GHz

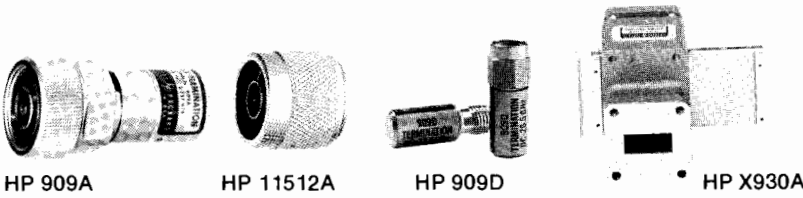

### HP 905A, 911A, 911C Coaxial Sliding Loads

The HP 905A, and 911A are movable, low reflection 50 Ω loads for precision measurements. The HP 905A is supplied with three interchangeable connectors, N-male, N-female and APC-7. The HP 911A is supplied with SMA male and female.

The HP 911C is a sliding load designed for 3.5 mm coaxial transmission lines and uses the APC-3.5 connector. This permits mode-free operation to 26.5 GHz. The HP 911C is furnished with interchangeable male and female connectors in a carrying case.

#### HP 905A, 911A, 911C Specifications

HP Model	Frequency Range (GHz)	Load SWR	Power Rating	Length (mm) in.	Shipping Weight
905A	1.8-18	1.05	1 W avg. 5 kW pk	(440) 17.25	(1.4 kg) 3 lb
911A	2-18	1.1, 2-4 GHz; 1.05, 4-18 GHz	1 W avg. 5 kW pk	(380) 14.87	(1.4 kg) 3 lb
911C	2-26.5	1.2, 2-10 GHz; 1.07, 10-26.5 GHz	1 W avg. 5 kW pk	(266) 10.5	(1.7 kg) 3.8 lb

### HP 908A, 909A/C/D Coaxial Fixed Terminations

The HP 908A, 909A and 909D terminations are low reflection loads for terminating 50 Ω coaxial systems in their characteristic impedance. The HP 909C is a precision ultra low reflection termination intended for use as a calibration standard.

#### HP 908A, 909A/C/D Specifications

HP Model	Frequency Range (GHz)	Impedance (ohms)	SWR	Power Rating	Connector
908A	dc-4	50	1.05	½ W avg. 1 kW pk	N male
909A	dc-18	50	1.05: 0-4 GHz 1.1: 4-12.4 GHz 1.25: 12.4-18 GHz	2 W avg. 300 W pk	APC-7
909A Option 012 Option 013	dc-18	50	1.06: 0-4 GHz 1.11: 4-12.4 GHz 1.3: 12.4-18 GHz	2 W avg. 300 W pk	Opt. 012 N male Opt. 013 N female
909C	dc-2	50	1.005	½ W avg. 100 W pk	APC-7
909C Option 012 Option 013	dc-2	50	1.01	½ W avg. 100 W pk	Opt. 012 N male Opt. 013 N female
909D	dc-26.5	50	1.07: dc-4 GHz 1.12: 4-12.4 GHz 1.22: 12.4-26.5 GHz	2 W avg. 100 W pk	APC-3.5 male
909D Option 011	dc-26.5	50			Opt. 011 APC-3.5 female

### HP 920B, X923A, X930A Waveguide Shorts

The HP 920B is a movable short, adjustable through at least half a wavelength at the low end of the band. The HP X923A is also a movable short, but is adjustable through about two wavelengths at 8.2 GHz.

The HP X930A is a shorting switch. SWR is less than 1.02 in the "through" position and greater than 124 in the "short" position.



#### HP 920B, X923A, X930A Specifications

HP Model	Frequency Range (GHz)	Waveguide Size EIA
X923A	8.2-12.4	WR90
P920B	12.4-18	WR62
K920B	18.0-26.5	WR42
R920B	26.5-40.0	WR28
X930A	8.2-12.4	WR90

### HP 910A/B, 914A Waveguide Fixed and Movable Terminations

The HP 910A/B are fixed terminations for waveguide systems. The HP 914A/B are similar to the HP 910A/B, except that their absorptive elements are movable and locking plungers control the position of the elements.

#### HP 910A/B, 914A/B Specifications

HP Model	Frequency Range (GHz)	SWR	Power Rating	Type	Waveguide Size (EIA)
X910B	8.2-12.4	1.015	1 watt	fixed	WR90
P910A	12.4-18	1.02	1 watt	fixed	WR62
X914B	8.2-12.4	1.01	1 watt	sliding	WR90
P914A	12.4-18	1.01	½ watt	sliding	WR62
K914B	18-26.5	1.01	½ watt	sliding	WR42
R914B	26.5-40	1.01	½ watt	sliding	WR28

### HP 11511A, 11512A, 11565A Coaxial Shorts

These shorts are used for establishing measurement planes for known reflection phase and magnitude in 50 Ω and 75 Ω coaxial systems for various connectors.

#### Ordering Information

- HP 11511A N-female short (50 ohm)
- HP 1250-1531 N-female short (75 ohm)
- HP 11512A N-male short (50 ohm)
- HP 1250-1530 N-male short (75 ohm)
- HP 11565A APC-7 short (50 ohm)
- HP 0960-0054 SMA-female short (50 ohm)
- HP 0960-0055 SMA-male short (50 ohm)



# MICROWAVE TEST EQUIPMENT

## Filters, Mixers, and Tuners

Models 360 Series, 362 Series, 870A, P932A, 10514A, 10534A

- Effective elimination of undesirable signals
- Low insertion loss through passband
- Correct waveguide discontinuities
- Measure microwave frequencies



HP X362A



HP P932A



HP 360D

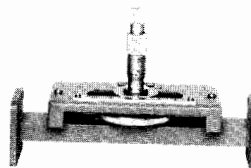

HP X870A

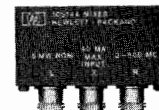

HP 10514A

### HP 360 Series Coaxial Low Pass Filters, HP 362 Series Waveguide Low Pass Filters

These Hewlett-Packard low-pass filters facilitate microwave measurements by eliminating undesirable signals (such as harmonics) from the measurement system. Suppression of such signals is particularly important in applications such as broadband reflection and transmission measurements or slotted line measurements where harmonics generated by the signal source could otherwise impair measurement accuracy.

### HP X870A, P870A Waveguide Slide-Screw Tuners

Waveguide slide-screw tuners are used primarily for correcting discontinuities or for "matching" waveguide systems. HP X870A covers 8.2-12.4 GHz in WR 90 waveguide and HP P870A covers 12.4-18.0 GHz in WR 62 waveguide. Both can correct a SWR of 20 to a value of 1.02, with a maximum loss of 2 dB.

### HP P932A Harmonic Mixer

This mixer can be used for frequency measurements and phase lock applications from 12.4 to 18 GHz. It accepts stable VHF signals from 100 to 1000 MHz and provides broadband, high sensitivity mixing with microwave signals from 12.4 to 18 GHz in WR 62 waveguide. With 0 dBm input signal it provides 0.4 mV p-p output.

### HP 10514A, 10534A Double Balanced Mixers

These mixers are excellent in a variety of mixing applications as well as AM, pulse, and square-wave modulation applications. The careful balancing of the hot carrier diodes in the HP 10514A and 10534A provides excellent output suppression of the local oscillator and input frequencies. Frequency ranges are 0.2-500 MHz for the HP 10514A and 0.05-150 MHz for the HP 10534A. Connectors are BNC.

#### Ordering Information

- HP X870A Waveguide tuner
- HP P870A Waveguide tuner
- HP P932A Waveguide harmonic mixer
- HP 10514A Double Balanced Mixer (0.2-500 MHz)
- HP 10534A Double Balanced Mixer (0.05-150 MHz)

#### HP 360 Series Coaxial Filter Specifications

HP Model	Cut-off Frequency (MHz)	Insertion Loss	Rejection	Impedance	SWR Maximum	Connectors	Overall Length mm (in)	Shipping Weight kg (lb)
360A	700	Less than 1 dB below 0.9 times cut-off frequency	Greater than 50 dB at 1.25 times cut-off frequency	50 Ω	<1.6 to within 100 MHz of cut-off	N (m,f)	276 (10.9)	0.9 (2)
360B	1200			50 Ω	<1.6 to within 200 MHz of cut-off	N (m,f)	183 (7.2)	0.9 (2)
360C	2200			50 Ω	<1.6 to within 300 MHz of cut-off	N (m,f)	274 (10.8)	0.9 (2)
360D	4100			50 Ω	<1.6 to within 300 MHz of cut-off	N (m,f)	187 (7.4)	0.45 (1)

#### HP 362 Waveguide Low Pass Filter Specifications

HP Model	Passband (GHz)	Stopband (GHz)	Passband Insertion Loss	Stopband Rejection	SWR Maximum	Waveguide Size	Equivalent Flange	Length mm (in)	Shipping Weight kg (lb)
X362A	8.2-12.4	16-37.5	<1 dB	At least 40dB	1.5	WR 90	UG-39/U	136 (5.4)	0.9 (2)
P362A	12.4-18.0	23-54			1.5	WR 62	UG-419/U	94 (3.7)	0.37 (13 oz)
K362A <sup>1</sup>	18.0-26.5	31-80			1.5	WR 42	UG-595/U	64 (2.5)	0.15 (5.3 oz)
R362A <sup>1</sup>	26.5-40.0	47-120	<2 dB	>35 dB	1.8	WR 28	UG-599/U	42 (1.7)	0.11 (4 oz)

<sup>1</sup>Circular Flange Adapters: For K-Band, specify HP 11515A (UG-425/U). For R-Band, specify HP 11516A (UG-381/U).

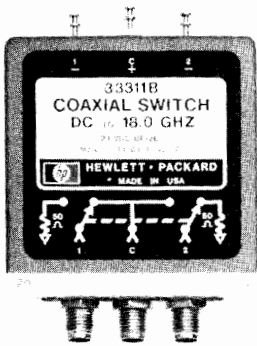

HP 33311B

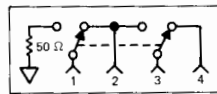

HP 33311B-C04

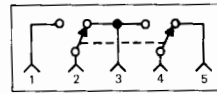

HP 33311B-C05  
Wiring Diagrams

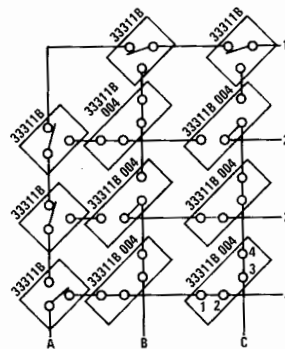

Typical Matrix Application



HP 8761A Option 001

PORT C

### HP 33311B/C Coaxial Switches

The HP 33311B and 33311C are high-isolation, single-pole, double-throw coaxial switches with excellent reliability, repeatability, and performance. They are designed for use in 50 Ω systems and have internally-switched 50 Ω terminations which results in all ports being matched. The switches are controlled by magnetic latching solenoids and switching current is automatically cut off when switching is complete.

### HP 8761A/B Coaxial Switches

The HP 8761 is a single-pole, double-throw coaxial switch with low standing-wave ratio, low insertion loss, and excellent isolation from dc to 18 GHz. Mechanically, the switch is a break-before-make type controlled by a latching solenoid. Any of seven coaxial connectors, or a 50-ohm termination, may be specified for each port.

### HP 33311B-C04/C05 Coaxial Switches

HP 33311B-C04/C05 are 4-port and 5-port coaxial switches, which can be connected as "transfer switches" to insert or remove a component from a signal path. In a test system, they can also switch in a device to be tested or provide the thru-connection/cross-connection functions in a microwave matrix switch. The HP 33311B-C04 has the additional feature of terminating port 1 in 50 ohms when it is inactive. In the label schematics above, the signal path connects to ports 2 and 3 while the device to be inserted connects between ports 1 and 4. Insertion loss, SWR, isolation, and solenoid drive power are all similar to the HP 33311B.

### HP-IB Compatible

The HP 33311B/C and the HP 8761A/B switches can be remotely controlled by HP-IB with either the HP 11713A or the HP 59306A. The HP 11713A attenuator switch driver is referenced on page 499. The HP 59306A HP-IB relay actuator is referenced on page 676.

### HP 33311B/C Specifications

#### Frequency Range

HP 33311B: dc to 18 GHz.

HP 33311C: dc to 26.5 GHz.

#### SWR (50 ohm characteristic impedance)

HP 33311B: <1.25, dc to 12.4 GHz; 1.5, 12.4 to 18 GHz.

HP 33311C: <1.3, dc to 10 GHz; <1.5, 10 to 16 GHz; <2.3, 16 to 26.5 GHz.

#### Insertion Loss

HP 33311B: <0.25 dB, dc to 2 GHz; <0.5 dB, 2 to 18 GHz.

HP 33311C: <0.25 dB, dc to 2 GHz; <0.5 dB, 2 to 10 GHz;

<0.8 dB, 10 to 16 GHz; <1.4 dB, 16 to 26.5 GHz.

#### Isolation

HP 33311B: >90 dB, dc to 18 GHz.

HP 33311C: >90 dB to 12.4 GHz; >85 dB, 12.4 to 18 GHz;

>50 dB, 18 to 26.5 GHz.

#### RF Connectors

HP 33311B: (3) SMA female.

HP 33311C: (3) APC-3.5 female (SMA compatible).

**Power:** 1 W average, 100 W peak (10 μs duration).

**Solenoid voltage (dc or pulsed):** 24 volts. Diode protected to reduce voltage transients.

**Switching speed:** <30 ms (including settling time).

**Life:** >1,000,000 switchings.

**Size:** 54 H x 53 W x 14 mm D (2.13" x 2.13" x 0.56") excluding connectors and solenoid terminals.

**Weight:** net, 88 gm (0.2 lb). Shipping, 220 gm (0.5 lb).

**Options:** 011, 5-volt solenoid voltage (only on HP 33311B).

### HP 8761A/B Specifications

**Characteristic impedance:** 50 ohms.

**Frequency range:** dc to 18 GHz.

#### Standing-Wave Ratio

Frequency	SWR		
	7-mm	N	SMA
dc-12.4 GHz	1.15 (1.20)	1.20 (1.25)	1.30 (1.30)
dc-18 GHz	1.20 (1.25)	1.25 (1.30)	1.35 (1.35)

SWR in parenthesis applies to switch with built-in termination

**Insertion loss:** <0.5 dB, dc to 12.4 GHz; <0.8 dB, dc to 18 GHz.

**Isolation:** >50 dB, dc to 12.4 GHz; >45 dB, dc to 18 GHz.

**Power:** 10 W average, 5 kW peak; built-in termination rated at 2 W average, 100 W peak.

**Switching energy:** 1.5 W for 20 ms (permanent magnet latching).

**Solenoid voltages (dc or pulsed):** 12 to 15 V, HP 8761A; 24 to 30 V, HP 8761B.

**Switching speed:** 35 to 50 ms (including settling time).

**Life:** >1,000,000 switchings.

**Size:** 41 H x 38 W x 38 mm D (1.6" x 1.5" x 1.5") excluding connectors and solenoid terminals.

**Weight:** net, 140 to 220 gm (0.3 to 0.5 lb). Shipping, 220 to 300 gm (0.5 to 0.7 lb).

### How to Order HP 8761A/B Switches

Specify solenoid voltage and connectors (including built-in 50-ohm termination) by the alphabetic suffix on the switch model number and the appropriate three-digit option number.

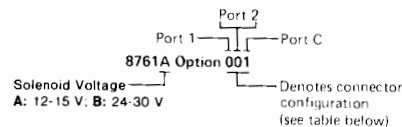

Option Code	Connector Type	Option Code	Connector Type
0	N (f)	4	APC-7 for UT-250 Coax
1	N (m)	5	SMA (f)
2	APC-7 w/Threaded sleeve	6	SMA (m)
3	APC-7 w/Coupling nut	7	50Ω Termination

### Ordering Information

HP 8761A/B order must include option number

HP 8761A/B Coaxial Switch (quantity 1-9)

HP 8761A/B Coaxial Switch (quantity 10-24)

HP 8761A/B Coaxial Switch with 50-ohm termination

HP 33311B Coaxial Switch (quantity 1-9)

HP 33311B Coaxial Switch (quantity 10-24)

HP 33311B-C04 Coaxial Switch (quantity 1-9)

HP 33311B-C05 Coaxial Switch (quantity 1-9)

HP 33311C Coaxial Switch (quantity 1-9)

HP 33311C Coaxial Switch (quantity 10-24)

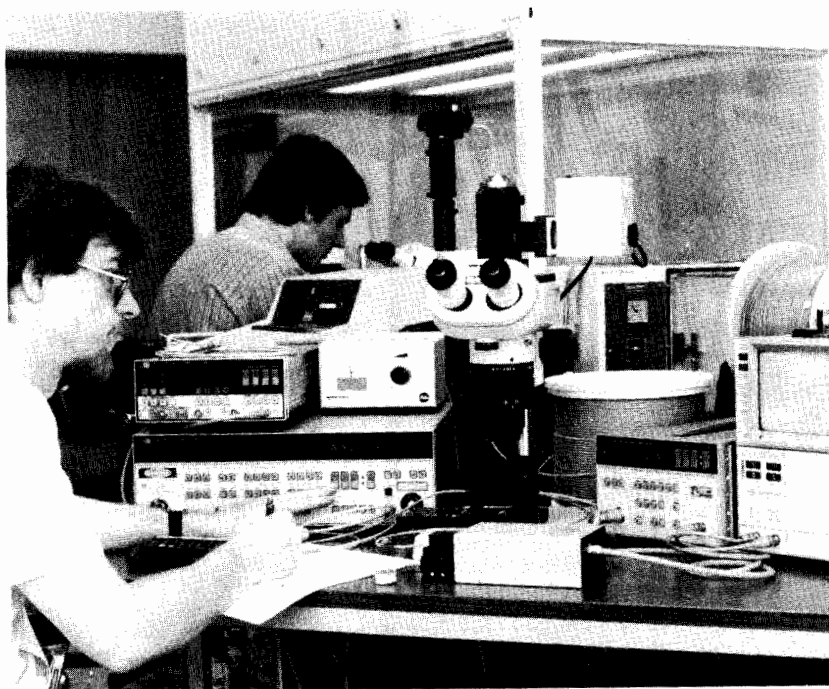

Probably the most remarkable fact about the evolution of fiber optics has been their rapid market growth. Design work began some twenty years ago, with trial projects carrying live telephone traffic being installed ten years later. Today, optical fibers are mass-produced for many applications worldwide.

### Technical Background

In general, all fiber optic systems incorporate the following elements: light source (LED or laser), optical fiber and receiving device (PIN-diode or APD) - all of which are linked by connectors or splicers. There exists a huge variety of systems for digital or analog applications, for point-to-point or network configurations, for short distance or long-haul connections; illustrating the great versatility of fiber optic technology.

### Light Sources

Light Emitting Diodes (LED's) are primarily used in short (2km max.) systems with bit rates below 100MHz. Their transmission capacity is limited by a broad emission spectrum and a low coupling efficiency. LED advantages are simple drive electronics, good reliability and low price.

Semiconductor lasers, on the other hand, feature a narrow spectral width and an excellent coupling efficiency, yielding transmission capacities 10 to 100 times higher than LEDs. Thus, lasers permit the realization of repeaterless data transmission over great distances.

### Optical Fibers

Inside the fiber propagating light is totally reflected at the core/cladding boundary due to corresponding differences in the refractive indices.

Fibers employed as transmission media fall into three categories:

**Step-Index Fibers.** The refractive indices of core and cladding change in the form of a step function. Step-index fibers have a comparatively simple manufacturing process and are suitable for short distance connections with low data rates. Their low bandwidth can be attributed to multimode dispersion, caused by the difference in total path lengths within the waveguide.

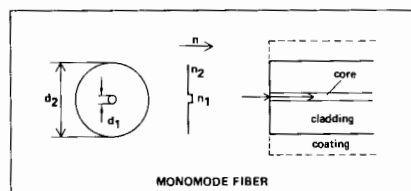
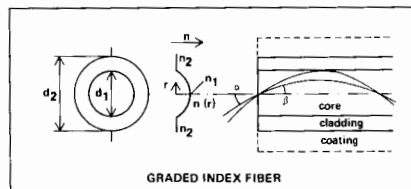
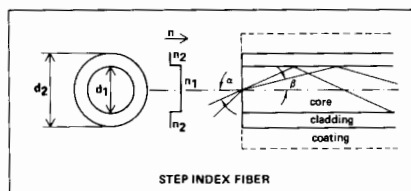

**Graded Index Fibers.** These feature a core having a non-uniform cross-sectional refractive index, which usually approximates a parabolic curve. The profile of these fibers reduces dispersion considerably, thus yielding bandwidths of 1 GHz x km. Graded index fibers are frequently used in systems where medium data rates with superior transmission quality is demanded.

**Monomode Fibers.** Installed when the fastest data handling rates are required. Monomode fibers feature bandwidths of up to several Gigabits. For this reason, they tend to be used typically in long-haul telecommunications systems where a high data handling capacity is mandatory.

The construction of the monomode fiber is similar to that of the step-index fiber; the difference being that the core is so small (approximately 8 um), that only one mode can propagate - thereby eliminating multimode dispersion.

### Receiving Devices

Photodetectors, such as PIN-diodes, and Avalanche Photodiodes (APD's) convert the light back into an electrical signal for further processing. Today, the majority of short-haul optical systems employ the PIN diode as the receiving element because it exhibits a large bandwidth (Gigabits). This property is combined with favorable linearity and high stability. When increased sensitivity is of concern (long-haul systems for instance), the APD is preferred. Owing to its non-linearity, this device is appropriate for purely digital applications, while the PIN diode can be used in both analog and digital systems.

### Wavelengths

Short wavelengths (800 to 850 nm), despite typical fiber attenuation properties of 4 dB/km, are easier to handle and more economical to implement than long wavelengths. For this reason, shorter wavelengths are popular in commercial systems, where short distances and low transmission capacities prevail (e.g. local area networks, computer interfaces, military equipment and industrial electronics).

Greater wavelengths (around 1300 nm), are employed chiefly in long-haul telecommunication systems. In this application, the significantly reduced attenuation properties (0.6dB/km) translate directly into greater transmission distances.

A number of projects are currently investigating the feasibility of transmissions in the 1550 nm range, where losses as low as 0.2 dB/km are expected to be achieved soon.



### Fiber Optic Test Environments

HP's line of fiber optic test equipment offers new measurement capabilities for laboratory and manufacturing engineers in a number of different application areas.

### Computers

The increasing sophistication of computers and their distributed services, prompted by the need for greater data handling capabilities and higher memory densities, has resulted in a demand for fiber optic systems. The mutual interfacing of central processors and the linking of them to peripheral devices, and data transmission within the mainframe, are becoming important application areas for fiber optic technology, because reduced bit errors - free from environmental interference - are assured.

### Local Area Networks

The development of Local Area Networks has been stimulated by the availability of low-cost, intelligent, digital terminal hardware and the trend towards distributed data acquisition and processing. Here also, optical fibers serve as the transmission medium in networks which may be configured as ring, star or bus structures. Such systems are primarily installed in business environments to support office operations, manufacturing facilities or private automatic branch exchanges; all taking advantage of the absence of crosstalk, electro-magnetic interference or ringing - often a problem in twisted pair and coax systems.

### Industrial Electronics

Industrial environments represent an ideal market for numerous fiber optic applications. Examples include power plants, railroad networks and the metal industry, where data acquisition, control and process signals need to be transmitted between remote locations and a communications center, without being affected by high energy fields.

In the field of medical electronics also, equipment must operate under stringent conditions, where noise-free control signals reduce the hazard to patients.

Some automobile manufacturers have begun to install optical fibers as transmission media in their products, in order to reduce weight. Fiber optic technology is of importance to engineers in the traffic control field, and in the control of industrial, chemical and biological processes - sometimes utilizing the fiber directly as sensor.

### Telecommunications

The telecommunications industry has traditionally been the sphere of greatest interest and highest investment for fiber optics technology. The majority of resources are employed to investigate, design and install new information transfer and processing equipment; long-haul transmission systems (submarine fiber optic cables linking continents, for example), and networks in high-traffic environments.

### Measurement Tasks

Designers, manufacturers and end-users of fiber optic components, modules or systems face a large variety of measurement tasks. These tasks range from purely physical measurements, such as fiber geometry or numerical aperture, to system performance tests in the time or frequency domains.

In design and production, fiber optic systems require stimuli for the thorough evaluation of individual system elements. The stimuli may be employed to characterize the effect of passive components in the signal path, with all signal parameters being selectable, so that lifelike conditions can be simulated. Furthermore, the stimulus is often used in lieu of the existing light source for system optimization or for measuring the receiver's critical parameters at absolute limits.

Testing the sensitivity of receivers or defining pulse response demands a stimulus like the HP 8150A Optical Signal Source. With the aid of this instrument, the user can perform parametric tests at calibrated optical levels, under fully-specified and precisely-controlled conditions.

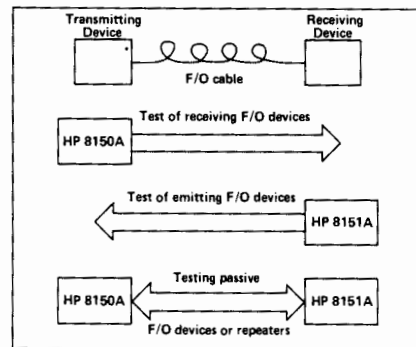

The HP 8150A and HP 8151A can be used to evaluate fiber optic devices, modules and systems.

Undoubtedly one of the most important and commonly performed measurement is that of optical power levels. The transmission of energy from one point in the system to another makes the verification of power levels during design, manufacturing and operational cycles essential. Such tests determine the magnitude of power emitted by a light source (laser, LED), and the power lost due to connectors, splices and fiber inhomogeneities. Hence, optical power meters tend to be the most widely used instruments for general purpose applications.

The HP 8151A Optical Pulse Power Meter is an excellent tool for verifying analog and digital power level parameters in terms of peak and average power.

### HP's Fiber Optic Test Solutions

Hewlett-Packard's fiber optic test equipment extends testing in the optical domain from functional checkout to parametric performance analysis in the lab, production testing, incoming inspection and quality assurance.

### The HP 8150A Optical Signal Source

The HP 8150A delivers accurate and repeatable, calibrated signals for evaluating the performance of fiber optic components and receivers. Its main element is an electrical-to-optical transducer which can be modulated by signals from DC to 250 MHz. This large bandwidth, coupled with variable transducer gain, caters for major network requirements, industrial links and a number of short-haul telecommunication systems.

The HP 8150A offers an output power range between 1 nW and 2 mW. Thus, very small, attenuated signals for receiver sensitivity testing can be generated in addition to the higher outputs required for overall systems test.

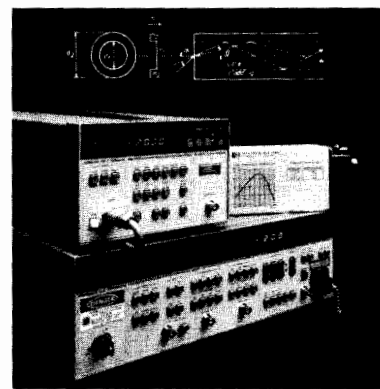

HP's fiber optic test equipment offers new ways to perform parametric tests with reliable and repeatable results.

### The HP 8151A Optical Pulse Power Meter

The HP 8151A performs precise power measurements, enabling the user to perform comprehensive characterization of fiber optic components and transmitters. Its unique peak and average power level measurement capability allows the user to determine the upper and lower power levels of optical signals.

A new dimension in optical power measurements is added by the HP 8151A's 250 MHz transducer. Its electrical output signal corresponds directly to the optical input, and can be applied to an oscilloscope or other instruments for the accurate evaluation of real-time signals.

For interfacing the HP 8151A to the optical source to be characterized, HP also offers Optical Heads. The HP 81511A is for use with short wavelengths, while the HP 81512A/B is for use in long wavelength applications.

### The HP 81519A Optical Receiver

This instrument is a high-performance opto-electric converter with a bandwidth of 400 MHz and excellent linearity. It can be used as an interface to standard electronic test equipment or as a general purpose transducer in fiber optic measurement setups.

### Accessories

For fast, simple adaptation to the device/system under test, a range of accessories complements the above products.





- E/O transducer capability with 250 MHz bandwidth
- Calibrated output power levels from 1 nW to 2 mW
- Built-in modulator (50 MHz)
- Wavelength 850 nm  $\pm$  10 nm

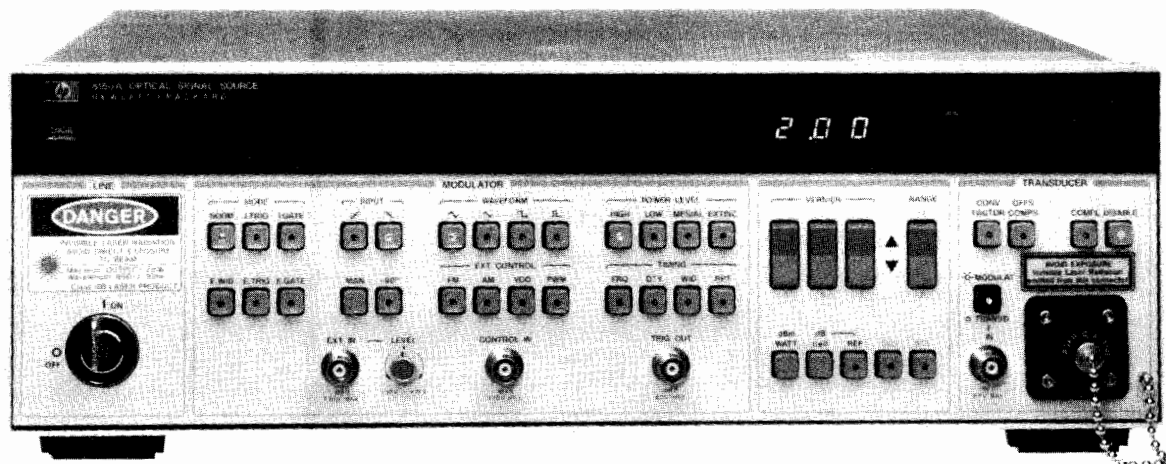

HP 8150A



The HP 8150A is a universal light stimulus for the parametric testing of fiber optic components and systems having an 850 nm operating wavelength. The instrument's transducer permits the conversion of both digital and analog electrical signals into their optical equivalents, up to a frequency of 250 MHz ( $-3$  dB optical). The internal modulator features additional capabilities which allow the HP 8150A to function as pulse/function generator with an optical output.

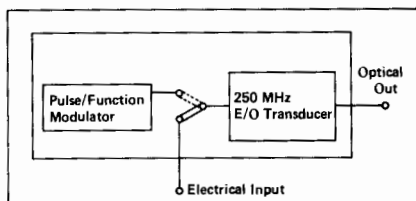

HP 8150A Blockdiagram

### Calibrated output levels

The HP 8150A's calibrated optical output levels are selectable by simply programming the desired values in the 1 nW to 2 mW wide dynamic range. This facilitates design verification and manufacturing testing, such as the performance evaluation of optical components and receivers, where repeatable and reliable results are essential. Since level parameter specifications refer directly to the open end of the 2 m pigtail fiber, the user has access to well-defined signal conditions at the optical output port with which to perform reliable measurements.

To maintain signal fidelity and calibration accuracy, multiple feedback loops control the optical path. Additionally, the instrument's laser diode always operates within its linear region. This feature contributes to extended lifetime and waveform purity.

### Transducer

In the transducer operating mode, the HP 8150A can be adapted to the user's needs in terms of absolute power levels, with its gain being adjustable from 1.80 nW to 1.80 mW per Volt of electrical input. Transition times of less than 2 ns ensure the generation of clean, high-speed digital signals up to a frequency of 250 MHz. Its large bandwidth and optical power range make the HP 8150A a suitable tool for testing large optical systems.

### Modulator

The modulator operating mode offers a straightforward method for generating accurate, calibrated, repeatable power levels, by simply programming high or low power values at the frontpanel, or via the HP-IB, to a resolution of three digits. In addition, the mesial power level (50% amplitude level) and extinction ratio values of signals are selectable, allowing the user to simulate the attenuation effects of fiber optic systems. A rearpanel monitor output allows the user to view the electrical signal responsible for modulating the transducer, via an oscilloscope. The internal modulator further offers the choice of various waveforms with adjustable duty cycles and true pulses with variable width. A host of other features, such as FM, AM and VCO, together with externally and internally activated operating modes contribute to the versatility of the HP 8150A as a stimulus for fiber optic system and automated bench applications.

### Traceability and safety

The specifications of the HP 8150A are traceable to the NBS and other national standard bureaus, such as PTB etc. The instrument is equipped with a frontpanel high-quality Diamond optical output connector, which ensures repeatable measurement results and prevents signal degradation, even after a large number of connections. The optical output has a numerical aperture of 0.2, and fiber dimensions of 50/125  $\mu$ m (graded index), thereby offering easy adaptation for testing most fiber optic systems.

A set of features is provided in order to meet international safety regulations. The secured optical output connector, for example, interrupts laser emission immediately the fiber is disconnected. The ON/OFF safety key, remote interlock facility and appropriate safety labelling are other standard HP 8150A features which help eliminate hazards to the operator.





## HP 8150A Specifications

### Optical characteristics

**Wavelength:** 850 nm  $\pm$  10 nm

**Output:** 50/125  $\mu$ m graded index, multimode; N.A. 0.2

### Transducer mode

**Conversion range:** 1.80 nW/V to 1.80 mW/V

**Stability:**  $\pm$  0.05 dB (12h,  $\Delta$ T  $\leq$   $\pm$  2°C)

**Accuracy:**  $\pm$  1 dB opt

**Electrical input swing:** 0.1 V<sub>pp</sub> to 1.0 V<sub>pp</sub>

**Electrical input window:** - 0.5 V to + 0.5 V

**Input impedance:** 50 Ohm

**Offset compensation range:** - 1.2 V to + 1.2 V

Signal-to-noise	10 Hz to 10 MHz	10 MHz to 400 MHz
Input 1 V <sub>pp</sub>	> 27 dB opt	> 15 dB opt
Input 0.1 V <sub>pp</sub>	> 17 dB opt	-----

**Bandwidth:** dc to 170 MHz (@ - 1.5 dB opt),  
to 250 MHz (@ - 3.0 dB opt)

**Flatness:**  $\pm$  0.25 dB opt (1 Hz to 99.9 kHz),  
 $\pm$  0.5 dB opt (100 kHz to 9.99 MHz),  
 $\pm$  1.5 dB opt (10 MHz to 170 MHz)

**THD:**  $\leq$  17 dB opt (10 Hz to 49.9 kHz),  $\leq$  2%

**Harmonic signals** (input 0.1 to 0.8V<sub>pp</sub>):

$\leq$  15 dB opt below fundamental (50 kHz to 999 kHz)

$\leq$  10 dB opt below fundamental (1 MHz to 170 MHz)

**Pulse response:** < 2.0 ns; perturbations: < 15% of amplitude

### Modulator mode (using internal pulse/function generator)

#### Output power

**High level:** 1.18 nW to 2.00 mW; **Low level:** 1.00 nW to 1.01 mW

**Mesial level:** 1.09 nW to 1.10 mW;

**Extinction ratio:** 1.18 to 10.0

**Accuracy High/Low/Mesial level:**  $\pm$  1.0 dB opt @ 30Hz

**Accuracy Extinction ratio:**  $\pm$  20% @ 30 Hz

**Flatness (Sine):**  $\pm$  0.4 dB opt (1 Hz to 99.9 kHz),

$\pm$  0.75 dB opt (100 kHz to 9.99 MHz),

$\pm$  1.0 dB opt (10 MHz to 50 MHz)

### Timing parameters of internal modulator

#### Frequency

**Range:** 1 mHz to 50 MHz (3-digit resolution)

**Accuracy\* (pulse mode, 50% d/c):**  $\pm$  3% below 100 kHz,  
 $\pm$  5% above 100 kHz

**Jitter (pulse mode, 50% d/c):** < 0.2% + 300 ps

**Stability:**  $\pm$  0.2% (1 hour),  $\pm$  0.5% (24 hours)

**Duty cycle (Sine, Triangle, Square, Haversine, Havertriangle)**

**Range:** 10% to 90% (20% to 80% above 1 MHz, 50% above 10 MHz)

**Resolution:** 1% steps

**Accuracy:**  $\pm$  0.5 digits ( $\pm$  3 digits above 1 MHz)

#### Pulse width

**Range:** 10.0 ns to 950 ms (3 digit resolution)

**Accuracy:**  $\pm$  5% of setting  $\pm$  2ns

**Jitter:** 0.3% + 300 ps (0.2% for width  $\geq$  10  $\mu$ s)

**Repetition time for internal trigger/internal gate**

**Range:** 100 ns to 950 ms (3 digit resolution)

**Accuracy:\***  $\pm$  5% of setting  $\pm$  5 ns

\*Applies from 15°C to 35°C, % error increases 0.05 per °C outside this range

### Waveform characteristics

**Sine (Normal mode, 50% d/c, Extinction ratio 1.18 to 5.00)**

**THD:**  $\leq$  - 15 dB opt  $\approx$  3% (10 Hz to 49.9 kHz)

#### Harmonic signals:

< - 13 dB opt below fundamental (50 kHz to 999 kHz),

< - 10 dB opt below fundamental (1 MHz to 50 MHz)

**Triangle/Ramp non-linearity:**  $\pm$  5%

#### Pulse and Squarewave

**Transition times** (10% to 90%): < 4 ns

**Perturbations:** <  $\pm$  10% of amplitude

### Operating modes

Normal, Ext. Trigger\*/Gate\*/Width, Int. Trigger\*/Gate\*

\*Selectable (- 90°) start phase for haversine/havertriangle

### Control Modes

**Frequency Modulation:**  $\pm$  5% max. deviation

**Sensitivity:** 1 V for 1% deviation

**Modulating frequency:** dc to 20 kHz

(dc to 3 kHz for frequencies > 10 MHz)

### Amplitude Modulation

**Sensitivity:**  $\pm$  2.5 V for 100% mod.

(+ 2.5 V, - 7.5 V for DSBSC)

**Modulating frequency:** dc to 1 MHz

### Pulse Width Modulation

**Range:** 10 ns to 1 s in 8 non-overlapping decade ranges; max. width ratio 1:10

**Sensitivity:**  $\pm$  6.5 V typ. for ratio 1:10

**Modulating Frequency:** dc to 20 kHz

### Voltage Controlled Oscillator

**Range:** 2 decades with 0.1 V to 10 V

**Modulating frequency:** dc to 1 kHz

### Auxiliary modes

**Watt/dBm:** power can be displayed as 'Watt' or 'dBm'

**dB rel:** for setting power relative to selected reference

**STO/RCL:** 8 complete operating states can be stored and recalled

**Man:** simulates external input

**Compl:** selectable normal/complement signal output

**Disable:** shutter interrupts optical signal path

### Auxiliary inputs and outputs

#### External input

**Threshold:**  $\pm$  10 V adjustable

**Max. input voltage:**  $\pm$  20 V; input impedance: 10 kohm

**Sensitivity:** 500 mV<sub>pp</sub>

**Min. pulse width:** 10 ns

**Trigger slope:** selectable pos./neg./off

#### Control input

**Max. input voltage:**  $\pm$  20 V; input impedance: 10 kohm

#### Trigger output

**Output levels:** 0 to 2.4 V into 50 ohm (4.8 V into open)

**Output impedance:** 50 ohms

#### Monitor output (rearpanel)

Signal shape corresponds to optical output signal. Amplitude is proportional to actual extinction ratio (EXR), but not correlated to the absolute output power level.

**Output levels (Into 50 Ohms):** 0 to 1 V (EXR = 10)

0.45 to 0.55 V (EXR = 1.18)

**Output impedance:** 50 ohms

### HP-IB capability

All manual key operations except trigger level can be programmed.

Talk mode provides learn, status byte and error report capabilities.

Interface functions: SH1, AH1, T6, L4, SR1, RL1, PP0, DC1, DT1, C0.

### Memory

Battery back-up RAM retains current operating state

### General

**Recalibration period:** 1 year

**Repeatability:** factor 4 better than accuracy

### Environmental

**Storage temperature:** - 40°C to + 65°C

**Operating temperature:** 0°C to + 55°C

**Humidity:** 95% R.H., > 0°C to + 40°C

**Power:** 100/120/220/240 Vrms; +5%, - 10%, 48 - 66 Hz, 140 VA

**Weight:** net 121.5 kg (27 lbs), shipping 16.5 kg (36.3 lbs)

**Size:** 133H x 426W x 422D mm (5.2" x 16.8" x 16.6")

### Ordering information

**HP 8150A Optical Signal Source**

**Opt 907:** Front handle kit (stand-alone orders;

HP P/N 5061-0089)

**Opt 908:** Rack mount kit (stand-alone orders;

HP P/N 5061-0077)

**Opt 909:** Rack flange and handle combination kit

(stand-alone orders: HP P/N 5061-0083)

**Opt 910:** Extra operating and service manual

**HP 81500C:** F/O cable Diamond HFS1/pigtail

(supplied with instrument)

**HP 15457A:** Cleaning kit (supplied with instrument)

For other fiber optic cables, see 'Fiber Optic Test Accessories' on page 515



# FIBER OPTIC TEST EQUIPMENT

## Optical Pulse Power Meter Model 8151A with 81511A/81512A/B

- Peak and average power measurements
- Accuracy  $\pm 2.5\%$
- O/E transducer capability



HP 81510A

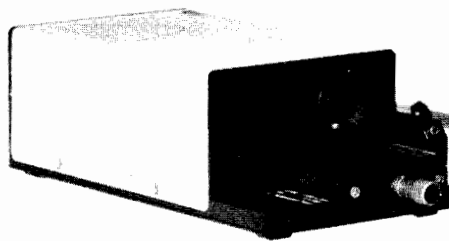

HP 81511A



HP 8151A



The HP 8151A, in combination with the HP 81511A/81512A/B Optical Heads, is a response measuring instrument for the level characterization of fiber optic components, modules and systems. In addition to performing average power measurements, the HP 8151A allows the user to accurately determine upper and lower peak power levels - important in digital applications. This feature is also useful for applications where non-repetitive or non-identical signals need to be evaluated, or where threshold levels are to be determined. The instrument's versatility is further enhanced by capabilities which allow the user to measure the amplitude, mesial power and extinction ratio of a signal.

The instrument's transducer has a frequency range of 250 MHz, and outputs an electrical signal which corresponds directly to the optical input waveform. The transducer output can be applied to other instruments for further processing, or displayed on an oscilloscope, for example. By using the transducer, timing related measurements as functions of optical power (e.g. propagation delay versus power) are possible.

HP-IB programmability is a standard feature of this instrument, thereby giving the user total remote control of all power meter functions.

### HP 81511A and HP 81512A/B Optical Heads

These products complement the operation of the HP 8151A Optical Pulse Power Meter. The HP 81511A Optical Head is for use at operating wavelengths between 550 and 950 nm (calibrated for 850 nm), and the HP 81512A/B for use between 900 and 1750 nm (calibrated for 1300 nm). It should be noted that the HP 8151A cannot be operated without an optical head. All heads carry interface adapters for fiber connectors (Standard 'Diamond', optional NEC/D3, and others) and bare fibers. The manual microdrive facilitates the optimum coupling of the fiber end to the PIN diode in the head. The HP 8151A's frontpanel trend meter assists in determining this coupling position.

A calibration grid on top of each optical head indicates any correction factors to be entered into the HP 8151A for operating wavelengths other than that at which the head is calibrated. Thus, the HP 8151A can be adapted to operate at any wavelength in the 550 to 1750 nm range.

### HP 8151A Specifications

#### Optical characteristics of HP 81511A/81512A/B Optical Heads

**Wavelength range** HP 81511A: 550 to 950 nm, cal for 850 nm  
HP 81512A/B: 900 to 1750 nm, cal for 1300 nm  
**Numerical Aperture:** 0.4 max.

#### Optical power measurements

**Parameters measured:** high, low, and mesial power levels, amplitude, extinction ratio, average power  
**Measurement range:** HP 81511A: +10 dBm to -60 dBm; HP 81512A: +10 dBm to -50 dBm; HP 81512B: 0 dBm to -60 dBm.  
**Resolution:** 3 digits (watts), 1 pW min., 4 digits (dB), 0.01 dB min.

#### Accuracy:

Range (dBm)	Hi/Low Peak Power		Average Power $\pm$ (of read + counts)
	$\pm$ (of read + counts)	Flatness	
+10 <sup>1)</sup>	0.3dB <sub>opt</sub> +5	200Hz-9.99MHz: $\pm 3$ dB <sub>opt</sub> of ampl. 10MHz-99.9MHz: $\pm 5$ dB <sub>opt</sub> of ampl.	0.1dB <sub>opt</sub> +5
0	0.25dB <sub>opt</sub> +10		0.1dB <sub>opt</sub> +5
-10 <sup>2)</sup>	0.35dB <sub>opt</sub> +50		0.1dB <sub>opt</sub> +5
		Bandwidth	
-20	0.2dB <sub>opt</sub> +10	10kHz	0.1dB <sub>opt</sub> +5
-30	0.2dB <sub>opt</sub> +10	6kHz	0.1dB <sub>opt</sub> +5
-40	0.2dB <sub>opt</sub> +10	4kHz	0.1dB <sub>opt</sub> +5
-50	0.2dB <sub>opt</sub> +20	4kHz	0.15dB <sub>opt</sub> +10
-60 <sup>2)</sup>	0.3dB <sub>opt</sub> +80	4kHz	0.2dB <sub>opt</sub> +50

<sup>1)</sup>For Flatness add.  $\pm 0.1$ dB<sub>opt</sub> of ampl.

#### Transducer (opto-electric)

Optical input signal is converted to its electrical equivalent. Actual waveform is dependent on measurement range.

#### Conversion Accuracy:

Range (dBm)	Conversion Factor DC	Accuracy of Conversion	Bandwidth w/o Lowpass	rms Noise [dBm]
+10 <sup>1)</sup>	1V/10mW	$\pm 3$ dB <sub>opt</sub> $\pm 10$ mV	DC-250MHz <sup>3)</sup>	-20
0	1V/1mW	$\pm 3$ dB <sub>opt</sub> $\pm 10$ mV	DC-250MHz <sup>3)</sup>	-30
-10	1V/1mW	$\pm 3.5$ dB <sub>opt</sub> $\pm 20$ mV	DC-250MHz <sup>3)</sup>	-30
-20	1V/10uW	$\pm 3$ dB <sub>opt</sub> $\pm 20$ mV	DC-10kHz	-50
-30	1V/1uW	$\pm 3$ dB <sub>opt</sub> $\pm 20$ mV	DC-6kHz	-60
-40	1V/1uW	$\pm 3$ dB <sub>opt</sub> $\pm 20$ mV	DC-4kHz	-70
-50	1V/10nW	$\pm 3$ dB <sub>opt</sub> $\pm 20$ mV	DC-4kHz	-70
-60 <sup>2)</sup>	1V/1nW	$\pm 3$ dB <sub>opt</sub> $\pm 50$ mV	DC-4kHz	-70

<sup>1)</sup> not valid for HP 81512B; <sup>2)</sup> not valid for HP 81512A; <sup>3)</sup> dc to 150 MHz for HP 81512A

#### Pulse response

**Transition time:**  $\leq 2$  ns full b/w ( $\leq 3$  ns for HP 81512A)  $< 10$  ns 50 MHz lowpass,  $\leq 100$  ns 6 MHz lowpass

**Perturbations:**  $\leq 10\%$  of amplitude

**Output impedance:** 50 ohm  $\pm 2\%$

#### HP-IB capability

Interface functions: SH1, AH1, T6, L4, SR1, RL1, PP0, DC1, DT1, C0

#### General

**Recalibration period:** 1 year

**Memory:** Battery back-up RAM retains current operating state

#### Environmental

**Storage temperature:** -40°C to +70°C

**Operating temperature:** 0°C to +55°C.

**Humidity:** 95% R.H.,  $> 0$ °C to +40°C

**Power:** 100/120/220/240 Vrms; +5%, -10%, 48 to 66 Hz, 100 VA max.

**Weight** HP 8151A: net 8 kg (17.5 lbs), shipping 10 kg (22 lbs)

HP 81511A: net 1.3 kg (2.9 lbs), shipping 2 kg (4.4 lbs)

HP 81512A/B: same as for HP 81511A

**Size:** HP 8151A: 140H x 220W x 530D mm (5.7" x 9" x 21.6")

HP 81511A: 60H x 96W x 200D mm (2.5" x 3.9" x 8.2")

HP 81512A/B: same as for HP 81511A

#### Ordering information

HP 8151A Optical Pulse Power Meter

Opt 910: Extra operating and service manual

Rack Mount options see Datasheet

HP 81511A Optical Head 550 to 950 nm

HP 81512A/B Optical Head 900 to 1750 nm

Note: The HP 8151A cannot be used without an optical head and connector adapter. For connector adapters and cleaning kit, see 'Fiber Optic Test Accessories' on page 515



- Calibrated O/E conversion
- dc to 400 MHz bandwidth
- $\pm 0.3$  dB opt conversion accuracy



HP 81519A

The HP 81519A is a linear transducer which converts optical signals into their electrical equivalents. The instrument is designed as a front-end interface to conventional electronic test equipment and as a general purpose receiving device for testing fiber optic modules and systems.

The Optical Receiver employs a PIN diode as receiving element and is calibrated for operation at a wavelength of 850 nm, with an operational range between 550 to 950 nm. The characteristic curve on top of the instrument indicates transducer gain in this range.

With the wide demodulation frequency band of DC to 400 MHz and an intrinsic transition time of less than 1.1 ns, the HP 81519A is a valuable tool for testing fiber optic devices in computer, local area network and aerospace applications. When operating in conjunction with other equipment, measurements such as pulse response and bandwidth in the time and frequency domains can be performed accurately. Connecting the HP 81519A to an oscilloscope, for example, makes performance analysis an easy task. In addition, the adjustable offset compensation feature allows the user to conveniently adapt the instrument's operating range to any optical input condition between 0 and 1 mW.

## HP 81519A Specifications

### Optical characteristics

- Wavelength range:** 550 to 950 nm, cal for 850 nm
- Input:** Adapts to core diameters up to 80  $\mu$ m; N.A.  $\leq 0.2$
- Input swing:** 1 mW (min. low level 0 mW, max. high 1.5 mW)
- Input connector:** Diamond HFS1; connector uncertainty:  $\pm 0.1$  dB

### Transducer characteristics

- Conversion, opto/electric**
- Conversion gain:**  $-1$  V/mW
- Accuracy:**  $\pm 0.3$  dB opt  $\pm 10$   $\mu$ W (@ 30 Hz)
- Small signal bandwidth:** dc to 400 MHz (@  $-3.0$  dB opt)
- Flatness of conversion:**  $\pm 0.35$  opt (dc to 150 MHz)
- NEP:**  $< 700$  nW (rms); **Distortion:** typ  $< -20$  dB opt (40 dB el.)
- Output (into 50 Ohm)**
- Range:**  $+0.5$  V to  $-0.5$  V; Output impedance: 50 Ohm  $\pm 2\%$
- Response**
- Intrinsic risetime:**  $\leq 1.1$  ns; Perturbations:  $< 10\%$  of ampl.

### General

#### Environmental

- Storage temperature:**  $-40^{\circ}\text{C}$  to  $+70^{\circ}\text{C}$
- Operating temperature:**  $0^{\circ}\text{C}$  to  $+55^{\circ}\text{C}$
- Humidity:** 95% R.H.,  $> 0^{\circ}\text{C}$  to  $+40^{\circ}\text{C}$
- Power:** 115/230 Vrms,  $+10\%$ ,  $-22\%$ , 48 to 66 Hz, 16 VA max.
- Weight:** net 1.7 kg (3.6 lbs), shipping 2.4 kg (5 lbs)
- Size:** 95H x 105W x 345D mm (3.8" x 4.3" x 13.6")

## Fiber Optic Test Accessories

### Interface cables

A set of interface cables which enable easy connection of the HP 8150A to the device under test is available. One end of the 2 m optical cable is terminated with the standard Diamond HFS1 (this end connects to the HP 8150A). The other end can be selected from the following:

Cable Configuration	Model No.
Diamond to HFS1	HP 81500A
Diamond to NEC D4	HP 81500B
Diamond to Amphenol 906	HP 81500E
Diamond to FC	HP 81500G
Diamond to F & G 3702	HP 81500J
Diamond to Stratos 430	HP 81500K
Diamond to AMP/SMA	HP 81500N
Diamond to Pigtail	HP 81500C*

\*50/125  $\mu$ m, G.I. supplied with HP 8150A

### Connector adapters

Exchangeable adapters, for use with HP 81511A/81512A Optical Heads simplify fiber connection. This is achieved by a receptacle that serves as a plug-in for cables with a mating connector. Or, if the user prefers, bare fiber adapters can be employed. The table below indicates adapter types available or in preparation.

Adapter Configuration	Model No.
Diamond HFS1	HP 81510A
NEC D4	HP 81510B
Amphenol 906	HP 81510E
HP SMA	HP 81510F
NTT/FC	HP 81510G
Western Electric	HP 81510H
F&G	HP 81510J
Stratos 430	HP 81510K
ITT/Cannon	HP 81510M
AMP/SMA	HP 81510N
Blank	HP 81510Z*
Pigtail 50/125 $\mu$ m	HP 81510C**
Pigtail 200/250 $\mu$ m	HP 81510D

\*Can be customized by user \*\*Supplied with HP 81511A

### HP 81510X X/Y/Z Drive

This high-precision mechanical device serves as a receptacle for connector adapters and can be retrofitted onto HP 81511A/81512A/B Optical Heads\*. The device allows the user to accurately position the inserted connector adapter in X, Y and Z axes, in order to achieve optimum coupling to the optical head's input.

\*Supplied with HP 81512B

### HP 5040-9346 Connector Adapter Case

The case conveniently holds up to six connector adapters for safe storage. The wooden box is lined with foam cushion which is custom-formed to fit the adapter dimensions.

### HP 15475A Cleaning Kit

The kit consists of cleaning brush, tissue and tape etc. to clean the optical surfaces of fibers and lenses. It is supplied in a plastic carrying case. This kit is supplied with the HP 8150A Optical Signal Source.

### HP 9300-1094 Safety Glasses

For eye protection from possible ocular hazards resulting from exposure to high-intensity, short wavelength laser emissions.

### Ordering information

- HP 81519A Optical Receiver
- Opt 910: extra operating and service manual
- HP 81510X X/Y/Z Drive
- HP 15475A Cleaning Kit
- HP 5040-9346 Connector Adapter Case
- HP 9300-1094 Safety Glasses



### Average Power Measurements

At microwave frequencies, power is the best measure of signal amplitude because, unlike voltage and current, power remains constant along a lossless transmission line. For this reason, power meters are almost indispensable for microwave measurements. Typical applications include monitoring transmitter power levels, calibrating signal generators, leveling signal sources, and measuring transmission characteristics of unknown devices.

To satisfy the requirements of this broad range of applications Hewlett-Packard has developed a family of general purpose microwave power meters and power sensors. The power sensors use a diode, thermocouple, or thermistor as the power sensing element, and it is important to understand the merits of each of these sensors before choosing a particular power meter.

### Power Meters and Sensors

Hewlett-Packard makes five average-reading power meters. The HP 438A is a dual channel power meter designed for ATE systems applications. The HP 435B and the 436A are analog and digital meters, which are designed to operate with HP's line of thermocouple and diode power sensors. The HP 432 power meters are designed to operate with HP's line of thermistor mounts: the HP 432A is an analog power meter, and the HP 432B is digital with BCD output.

Thermocouple power sensors are generally preferred for measuring power because they exhibit lower SWR and wider dynamic range than previously used thermistor elements. Low SWR is directly responsible for superior accuracy since mismatch errors are lower.

Thermocouple sensors (HP 8481, 8482, 8483, 8485A) are available from 100 kHz to 26.5 GHz and range from -30 dBm to +44 dBm. The HP 8484A diode sensor operates with the same meters and extends the input level down to -70 dBm. This sensor uses a Low-Barrier Schottky Diode to achieve exceptional 100 pW (-70 dBm) sensitivity and low noise and drift. Because the diode is always operated in its square law region (voltage out power in), the HP 8484A can be used to measure the true power of complex as well as CW waveforms.

Thermistor power sensors (HP 478A, 486A series) operate with the HP 432A and 432B power meters. Since these power meters are based on balanced bridge principles, they are used whenever a direct dc-substitution technique is required. In addition, waveguide thermistor mounts are available from 8.20 to 40 GHz.

### Peak Power Measurements

A frequent requirement in microwave work is the measurement of peak power in a periodic pulse. Rather than calculate peak power from an average power measurement, it would be more convenient to measure peak power directly. Hewlett-Packard produces two versatile instruments that accurately and conveniently measure peak power from 50 MHz to 18 GHz, and from 0 dBm to + 30

dBm on pulses with widths from 100 nanoseconds to CW.

The HP 8900C is an economical analog power meter calibrated in watts and dBm. The HP 8900D has an easy to read 3½ digit display calibrated in watts. Both of these peak power meters work with the HP 84811A peak power sensor that conveniently detaches from the meters for storage, re-calibration, or replacement.

The HP 8900C/D meters feature two modes of operation, Direct and Compare. In the Direct mode, the meter automatically measures and displays the maximum RF power.

In the Compare mode, an oscilloscope and a meter front panel control are used to measure power at arbitrary points on the pulsed waveform. In this mode, the detected pulse train and an accurate reference line, supplied by the HP 8900C/D, can be simultaneously displayed on the oscilloscope CRT. The front panel control moves the reference line up or down with respect to the detected waveform. The user can then measure power at any desired point on the waveform by simply moving the reference line to that point.

### Automatic Systems to Calibrate Power Sensors and Attenuators

Power sensors and attenuators, in most cases, are the standards against which signal levels are compared. For this reason, it is essential that they be periodically recalibrated to maintain measurement integrity. Power sensors and attenuators are calibrated by either a highly accurate and fast, but expensive automatic network analyzer or by an economical, manual, but slow and tedious system. There is very little calibration capability offered in between. But now, HP offers an automatic power sensor and attenuator calibration system, the HP 436A-E40. The heart of this system is a power meter based reflectometer controlled by the HP-85 computer.

Calibration systems similar to the HP 436A-E40 have been in use for several years at key Hewlett-Packard calibration laboratories throughout the world.

Figure 1 shows the system configuration. In operation, for power meter calibration, test signals are standardized against a specially calibrated power sensor standard. The sensor to be calibrated is compared against the standardized signals and a calibration chart is plotted.

The system is also ideal for attenuation calibration. The accuracy and linearity of power meters plus the low SWR of power sensors offer attenuation accuracy surpassed only by error correcting automatic network analyzers.

The reports for Cal Factor and attenuation are printed in either tabular or graph form and they include the calibration uncertainty. Coaxial power sensors and attenuators can be calibrated from 100 MHz to 26.5 GHz in 3 bands, 100 MHz to 2 GHz, 2 to 18 GHz, and 18 to 26.5 GHz. Waveguide thermistor sensors can be calibrated in X, P, and K bands.

### Literature

**Application Note 64-1, Fundamentals of RF and Microwave Power Measurements**, deals with the general theory of microwave power measurements. It covers the basic principals of measurement, calculation of measurement uncertainty, traceability, etc.

**Application Note 64-2, Extended Applications of Automatic Power Meters**, discusses an automatic power meter system for measuring attenuation gain saturation and the calibration factor of power sensors.

**Application Note 196, Automated Measurements using the 436A Power Meter**, contains several typical uses of the 436A with the HP-IB interface bus. All of these applications notes and a coaxial and waveguide catalog are available without charge. See page 38.

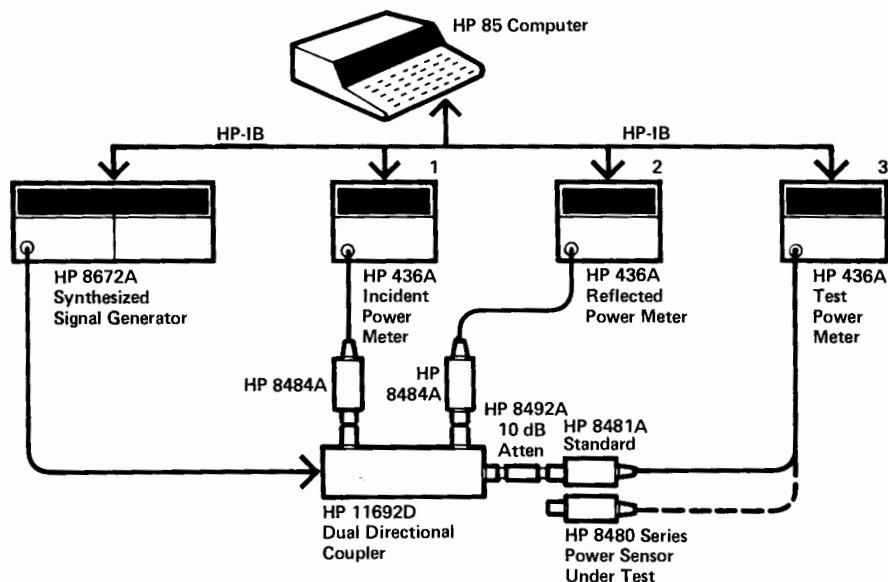
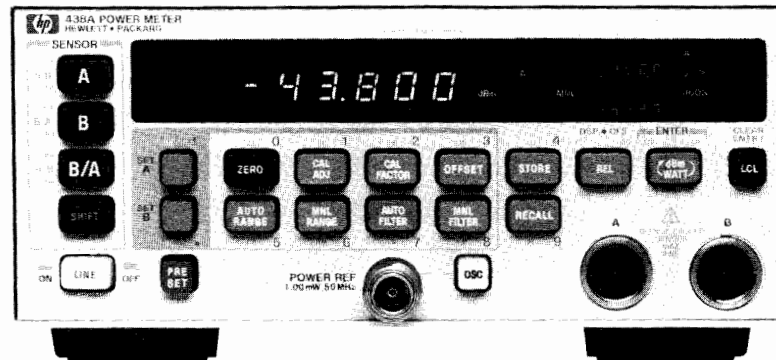

Figure 1. Power sensors and attenuators calibration system.

- Ideal for ATE applications
- Dual power sensors
- Innovative ratio & difference measurements



HP 438A



The HP 438A power meter is a dual channel power meter designed specifically for ATE systems. The compact front panel is designed to save space in rack mounted systems, while the dual channel design allows simple measurements of the ratio and difference of power levels from two separate sensors. Compatible with the HP 8480 series of thermocouple and diode sensors, the power and frequency range of the meter extends from  $-70$  dBm to 44 dBm and from 100 kHz to 26.5 GHz.

Important measurement contributions are a programmable digital filter for optimizing resolution and measurement speed, independent offset (in dB) values for each channel, 0.001 dB resolution available, and a power difference mode for displaying absorbed power in transmission lines. Up to 19 different operating states of the meter can be stored into non-volatile memory for later recall.

The programmable digital averaging filter gives the user control over the inherent tradeoff between speed and accuracy. The AUTO filter mode is usually adequate for fully settled readings with 0.01 dB resolution. Less digital averaging leads to faster but noisier readings, if speed is the critical issue.

The Hewlett-Packard Interface Bus (HP-IB) capability is standard on the HP 438A with programming codes printed on the front panel for easy reference. All measurement modes are programmable including zeroing, calibration, and Cal Factor. Complete interrupt capability with flexible SRQ operation optimizes the efficiency of program execution in automatic systems.

### HP 438A Specifications

**Frequency range:** 100 kHz to 26.5 GHz (depending on power sensor used).

**Power range:**  $-70$  dBm to +44 dBm (100 pW to 25 W), sensor dependent. Uses HP 8480 series power sensors; see sensor specs for details.

**Operating temperature range:** 0  $-55^{\circ}$ C.

#### Instrumentation Accuracy

**Single channel, linear mode:**  $\pm 0.5\%$ .

**Log mode:**  $\pm 0.02$  dB.

**Dual channel, linear mode:**  $\pm 0.10\%$ .

**Log mode:**  $\pm 0.04$  dB.

**Zeroing:** automatic,  $\pm 0.5\%$  full scale on most sensitive range.

#### Power Reference

**Power output:** 1.00 mW. Factory set to  $\pm 0.7\%$ , traceable to the U.S. National Bureau of Standards.

**Accuracy:**  $\pm 1.2\%$  worst case ( $\pm 0.9\%$  rss) for 1 year.

**Connector:** front panel type N female (also on rear panel, Opt 002).

#### Meter Adjustments

**Cal factor:** values from 1% to 150% in 0.1% steps can be entered to account for sensor frequency response. Sensor calibration: automatic self calibration to 1.00 mW.

#### General

**Display:** four digit display (five digits in high resolution mode) with

20% over-range capability on all ranges. Annunciators to indicate measurement mode, Cal Factor, offset value, fixed or automatic range and filter values, and error conditions.

**Recorder output:** linearly proportional to power in watts. One volt corresponds to full scale;  $1k\Omega$  output impedance, BNC rear panel female connector.

**Line voltage:** 100, 120, 220 or 240 Vac  $+5\%$   $-10\%$ . 100 and 120 volts, 48 to 66 Hz and 300 to 440 Hz. 220 and 240 volts, 48 to 66 Hz only.

**Power requirements:** 65 VA, 35 watts, maximum.

**Weight:** net, 5.9 kg (13 lb). Shipping, 9.1 kg (20 lb).

**Dimensions:** 89 mmH x 213 mmW x 418 mmD (3.5 x 8.4 x 16.8 in).

**HP-IB interface codes:** SH1, AH1, T5, TE0, L4, LE0, SR1, RL1, PP1, DC1, DT1, C0.

### Accessories

**Furnished:** HP 11730A, 2 each, 1.5 metre (5 ft) power sensor cables. Power cable, 1 each, 2.4 metres (7.5 ft). Mains plug matches destination requirements.

**Available:** To select non-standard lengths for power sensor cables, select option 004 (delete sensor cables) and order as required from HP 11730A-F, power sensor cables. Lengths are available from 1.5 metres (5 ft) to 61 metres (200 ft).

### 11730A-F Power Sensor Cables

The HP 11730 series power sensor cables are for use with the HP 435B, 436A, and 438A power meters and the HP 8480 series thermocouple and diode power sensors. These cables are designed to reduce RFI effects on low power readings with an improved shielding design in the cable itself. Cables may be ordered individually or in pairs in any combination desired for single and dual channel measurements.

The HP 11730A cable is the standard cable for the HP 435B, 436A, and 438A (2 cables shipped) meters. To order a non-standard cable, select Option 004 for the meter in question, and order the desired cable from below.

### Ordering Information

#### 438A Dual Channel Power Meter

**Option 002:** Rear panel sensor connectors (in parallel with front panel) and additional reference oscillator with rear panel output.

**Option 004:** Delete power sensor cables

**Option 910:** Additional manual

HP 11730A 1.5 metre (5 ft) sensor cable

HP 11730B 3.0 metre (10 ft) sensor cable

HP 11730C 6.1 metre (20 ft) sensor cable

HP 11730D 15.2 metre (50 ft) sensor cable

HP 11730E 30.5 metre (100 ft) sensor cable

HP 11730F 61.0 metre (200 ft) sensor cable



# POWER METERS

## Thermocouple Power Meter

### Model 436A

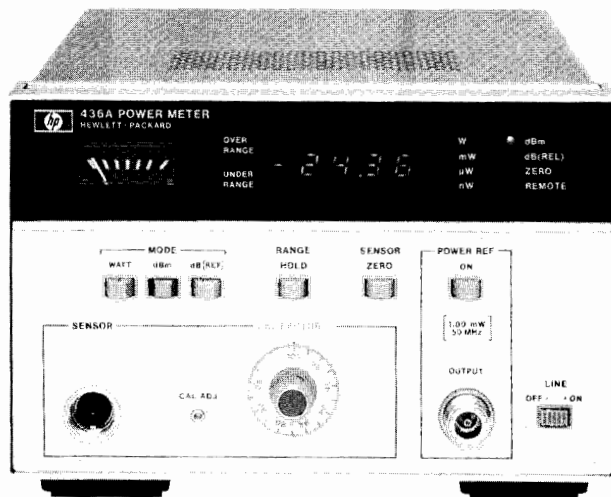

HP 436A



## HP 436A Power Meter

The HP 436A power meter is a general purpose digital power meter intended for manual and automatic RF and microwave power measurements. It is compatible with the entire series of HP 8480 power sensors. Depending on which power sensor is used, the HP 436A can measure power from  $-70$  dBm (100 pW) to  $+44$  dBm (25W) at frequencies up to 26.5 GHz.

The logically organized and uncluttered front panel, and the convenience of push-button operation and digital display make the HP 436A both easy to interpret and easy to use in any application. The auto ranging capability allows for "hands-off" operation.

The HP 436A measures either absolute or relative power. It displays absolute power in either watts or dBm, and relative power in dB.

The HP 436A Power Meter also features optional programmability; the Hewlett-Packard Interface Bus (HP-IB) interface is available. This interface allows full remote control of all power meter functions (CAL function can be programmed to either 100 percent or the CAL factor which has been manually set on the front panel). This option may be added by the user at a later time.

## HP 436A Specifications

**Frequency range:** 100 kHz to 26.5 GHz (depending on power sensor used).

**Temperature range:** 0–55°C.

**Power Range** (display calibrated in watts, dBm, and dB relative to reference power level).

**With HP 8481A, 8482A, 8483A, 8485A sensors:** 50 dB with 5 full-scale ranges of  $-20$ ,  $-10$ ,  $0$ ,  $10$ , and  $20$  dBm ( $10 \mu\text{W}$  to  $100$  mW).

**With HP 8481B or 8482B sensors:** 44 dB with 5 full-scale ranges of  $10$ ,  $20$ ,  $30$ ,  $40$ , and  $44$  dBm ( $10$  mW to  $25$  W).

**With HP 8481H or 8482H sensors:** 45 dB with 5 full-scale ranges of  $0$ ,  $10$ ,  $20$ ,  $30$  and  $35$  dBm ( $1$  mW to  $3$  W).

**With HP 8484A sensor:** 50 dB with 5 full-scale ranges of  $-60$ ,  $-50$ ,  $-40$ ,  $-30$ , and  $-20$  dBm ( $1$  nW to  $10 \mu\text{W}$ ).

### Accuracy

#### Instrumentation

**Watt mode:**  $\pm 0.5\%$ .

**dBm mode:**  $\pm 0.02$  dB  $\pm 0.001$  dB/°C.

**dB (REL) mode<sup>1</sup>:**  $\pm 0.02$  dB  $\pm 0.001$  dB/°C.

<sup>1</sup> Specifications are for within range measurements. For range-to-range accuracy add another  $\pm 0.02$  dB.

**Zero:** automatic, operated by a front-panel switch.

**Zero set:**  $\pm 0.5\%$  of full scale on most sensitive range, typical;  $\pm 1$  count on other ranges.

**Zero carry over:**  $\pm 0.2\%$  of full scale when zeroed on the most sensitive range.

**Power reference:** internal 50 MHz oscillator with Type N female connector on front panel (or rear panel, Option 003 only).

**Power output:** 1.0 mW. Factory set to  $\pm 0.7\%$  traceable to the National Bureau of Standards.

**Accuracy:**  $\pm 1.2\%$  worst case ( $\pm 0.9\%$  rss) for one year.

## Supplemental Characteristics

**Noise** (typical, at constant temperature, peak change over any one-minute interval): 20 pW (HP 8484A); 40 nW (HP 8481A, 8482A, 8483A, 8485A); 40  $\mu\text{W}$  (HP 8481B, 8482B); 4  $\mu\text{W}$  (HP 8481H, 8482H).

**Drift** (1 hour, typical, at constant temperature after 24-hour warm-up): 20 pW (HP 8484A); 10 nW (HP 8481A, 8482A, 8483A, 8485A); 10  $\mu\text{W}$  (HP 8481B, 8482B); 1  $\mu\text{W}$  (HP 8481H, 8482H).

**Response time** typical, measured at recorder output, 0 to 99% of reading:

Range 1 (most sensitive range)  $< 10$  seconds.

Range 2  $< 1$  second.

Ranges 3 through 5  $< 100$  milliseconds.

**Cal factor:** 16-position switch normalizes meter reading to account for calibration factor. Range 85% to 100% in 1% steps.

**Cal adj:** front-panel adjustment provides capability to adjust gain in meter to match power sensor in use.

**Recorder output:** linearly proportional to indicated power with 1 volt corresponding to full scale and 0.316 volts to  $-5$  dB; 1 k $\Omega$  output impedance, BNC connector.

**RF blanking:** open collector TTL; pulls low during meter zeroing. Useful for turning off RF input to sensor during auto-zeroing. BNC connector.

**Display:** four-digit display with 20% over-range capability on all ranges; analog uncalibrated peaking meter to show fast changes.

**Power consumption:** 100, 120, 220, or 240 V ( $+5\%$ ,  $-10\%$ ), 48 to 66 Hz, and 360 to 440 Hz;  $< 20$  V  $\cdot$  A ( $< 23$  V  $\cdot$  A with option 022).

**HP-IB Function codes:** AH1, C0, DC2, DT0, LE0, PP0, RL2, SH1, SR0, T3, TE0. (For more on these codes refer to the HP-IB section in this catalog.)

**Weight:** net, 4.5 kg (10 lb). Shipping, 5.5 kg (12 lb).

**Size:** 134 H x 213 W x 279 mm D (5.2" x 8.4" x 11.0").

## Accessories

**Furnished:** HP 11730A, 1.5 m (5 ft) cable for power sensor; 2.3 m (7.5 ft) power cable. Mains plug shipped to match destination requirements.

**Available:** To select non-standard lengths for power sensor cables, select option 004 (delete sensor cables) and order as required from HP 11730A-F, power sensor cables. Lengths are available from 1.5 metres (5 ft) to 61 metres (200 ft). To rack mount one HP 436A by itself, order HP 5061-0057 Rack Mount Adapter Kit.

## Ordering information

HP 436A Power Meter

**Option 003:** Reference oscillator output on rear panel only.

**Option 004:** Delete power sensor cable

**Option 022:** Digital input/output, fully compatible with HP Interface Bus (HP-IB)

**Option 908:** Kit for rack mounting one HP 436A

**Option 910:** Extra operating and service manual



# POWER METERS

## Thermocouple Power Meter, Range Calibrator

Models 435B, 11683A



HP 435B

### HP 435B Power Meter

The HP 435B power meter is an analog power meter, compatible with the entire series of HP 8480 power sensors. Depending on which sensor is used, the HP 435B can measure power from  $-65$  dBm to  $+44$  dBm, full scale, at frequencies from 100 kHz to 26.5 GHz. This versatile instrument also features  $<1\%$  instrumentation uncertainty, low noise and drift, auto-zero, recorder output, optional battery operation, and long cable options up to 61 m (200 ft).

### HP 11683A Range Calibrator

The HP 11683A calibrator is specifically designed for use with the HP 435B, 436A and 438A power meters. It allows verification of full-scale meter readings on all ranges, as well as meter tracking. Simply connect the cable between the power meter and calibrator. The CAL ADJ control on the power meter is used to set the meter to full scale on the 1 mW range. The calibrator and meter are then stepped through the other ranges verifying accuracy within  $\pm 1\%$  plus noise and drift. The HP 11683A also has a polarity switch which tests the Auto-Zero circuit.

### HP 435B Specifications

**Frequency range:** 100 kHz to 26.5 GHz (depending on power sensor used).

**Temperature range:** 0  $-55^{\circ}\text{C}$ .

**Power Range** (calibrated in watts and dB in 5 dB steps).

With HP 8481A, 8482A, 8483A or 8485A:  $-25$  dBm ( $3 \mu\text{W}$ ) to  $+20$  dBm (100 mW) full scale.

With HP 8481B or 8482B:  $+5$  dBm ( $3 \text{ mW}$ ) to  $+44$  dBm (25 W) full scale.

With HP 8481H or 8482H:  $-5$  dBm ( $0.3 \text{ mW}$ ) to  $+35$  dBm ( $3 \text{ W}$ ) full scale.

With HP 8484A:  $-65$  dBm ( $300 \text{ pW}$ ) to  $-20$  dBm ( $10 \mu\text{W}$ ) full scale.

### Accuracy

**Instrumentation:**  $\pm 1\%$  of full scale on all ranges.

**Zero:** automatic, operated by front-panel switch.

**Zero set:**  $\pm 0.5\%$  of full scale on most sensitive range, typical.

**Zero carryover:**  $\pm 0.5\%$  of full scale when zeroed on the most sensitive range.

**Power reference:** internal 50 MHz oscillator with Type N female connector on front panel (or rear panel, Option 003 only).

**Power output:** 1.00 mW. Factory set to  $\pm 0.7\%$  traceable to the National Bureau of Standards.

**Accuracy:**  $\pm 1.2\%$  worst case ( $\pm 0.9\%$  rss) for one year.

### Supplemental Characteristics

**Noise** (typical, at constant temperature, peak change over any one-minute interval): 20 pW (HP 8484A); 40 nW (HP 8481A, 8482A, 8483A, 8485A); 40  $\mu\text{W}$  (HP 8481B, 8482B); 4  $\mu\text{W}$  (HP 8481H, 8482H).

**Drift** (1 hour, typical, at constant temperature after 24-hour warm-up): 40 pW (HP 8484A); 15 nW (HP 8481A, 8482A, 8483A, 8485A); 15  $\mu\text{W}$  (HP 8481B, 8482B); 1.5  $\mu\text{W}$  (HP 8481H, 8482H).



HP 11683A

**Response Time** (typical, measured at recorder output, 0 to 99% of reading):

Range 1 (most sensitive range)  $<10.0$  seconds

Range 2  $<3.8$  seconds

Range 3  $<1.3$  seconds

Ranges 4 to 5  $<500$  milliseconds.

**Cal factor:** 16-position switch normalizes meter reading to account for calibration factor; range 85% to 100% in 1% steps.

**Recorder output:** linearly proportional to indicated power with 1 volt corresponding to full scale: 1 k $\Omega$  output impedance, BNC connector.

**RF blanking output:** provides a contact closure to ground. Used for turning off RF input to sensor during auto-zeroing. BNC connector.

**Cal adj:** front-panel adjustment provides capability to adjust gain of meter to match power sensor in use.

**Power consumption:** 110 or 120 V ( $+5\%$ ,  $-10\%$ ), 48 to 66 Hz and 360 to 440 Hz; also 220 or 240 V ( $+5\%$ ,  $-10\%$ ), 48 to 66 Hz only:  $<20\text{V} \cdot \text{A}$ .

**Weight:** net, 2.7 kg (5.9 lb). Shipping, 4.2 kg (9.2 lb).

**Size:** 155 H x 130 W x 279 mm D (6.3" x 5.1" x 11").

### Accessories

**Furnished:** HP 11730A, 1.52 m (5 ft) cable for the power sensor; 2.3 m (7.5 ft) power cable (mains plug shipped to match destination requirements).

**Available** (See page 687).

To select non-standard lengths for power sensor cables, select option 004 (delete sensor cables) and order as required from HP 11730A-F, power sensor cables. Lengths are available from 1.5 metres (5 ft) to 61 metres (200 ft).

**HP 11076A:** Carrying case.

**HP 5060-8762:** Rack adapter frame (holds three instruments the size of the HP 435B).

**Combining Cases** (See page 686).

**HP 1051A:** 286 mm (11.25 in.) deep.

**HP 1052A:** 416 mm (16.4 in.) deep.

These combining cases accept  $\frac{1}{2}$ -module Hewlett-Packard instruments for bench use or rack mounting.

### HP 11683A Range Calibrator

**Calibration functions:** outputs corresponding to meter readings of 3, 10, 30, 100 and 300  $\mu\text{W}$ ; 1, 3, 10, 30, and 100 mW.

**Calibration uncertainty:**  $\pm 0.25\%$  in all ranges.

**Power:** 100, 120, 220, or 240 Vac  $+5\%$ ,  $-10\%$ , 48–440 Hz, less than 10 V  $\cdot$  A.

**Weight:** net, 1.13 kg (2.5 lb). Shipping, 1.9 kg (4.2 lb).

**Size:** 89 H x 133 W x 216 mm D (3.5" x 5.25" x 8.5").

### Ordering Information

HP 11683A Range Calibrator

HP 435B Power Meter

HP 435B Options

**001:** Rechargeable battery installed provides up to 16 hours of continuous operation

**002:** Input connector placed on rear panel in parallel with front

**003:** Parallel sensor inputs front and rear panels, reference oscillator output on rear panel.

**004:** Delete power sensor cable

**910:** Extra operating and service manual

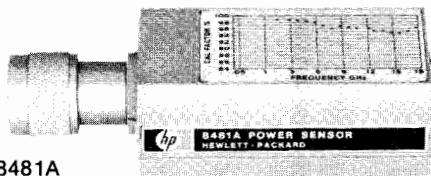

HP 8481A

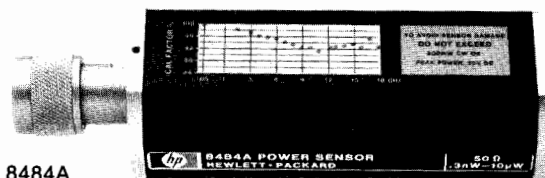

HP 8484A

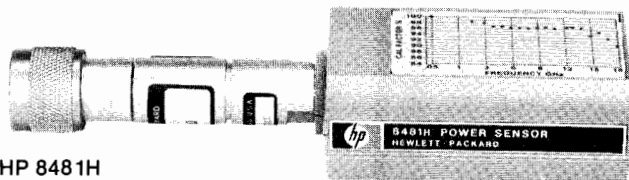

HP 8481H



HP 11708A

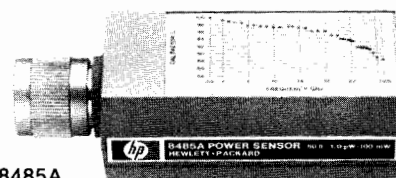

HP 8485A

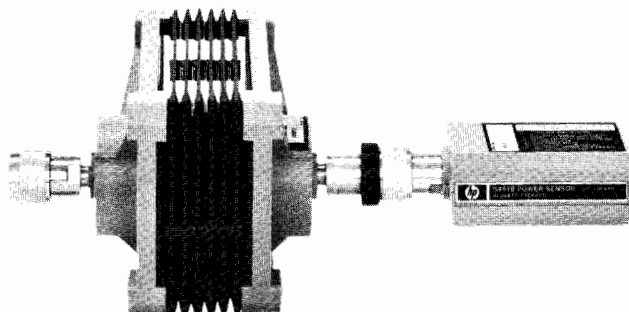

HP 8481B

### HP 8480 Series Power Sensors

The HP 8480 series of power sensors have been designed for use with the HP 435B, 436A, and 438A power meters. They feature wide frequency and power ranges in addition to very low SWR.

The power measurement range of these sensors is from 0.1 nW to 25 watts. With just three sensors a power measurement range of 114 dB can be achieved.

### Wide Frequency Range for Many Applications

Power measurements can be made over a frequency range of 100 kHz to 26.5 GHz. The four frequency ranges covered with these units are 10 MHz to 18 GHz, 100 kHz to 4.2 GHz, and 50 MHz to 26.5 GHz, in 50  $\Omega$  sensors and 100 kHz to 2 GHz, with the 75-ohm sensor.

### Low SWR for Low Measurement Uncertainty

The HP 8481/82/83/85 series of sensors use a silicon monolithic thermocouple as the sensing element. The small physical size of the thermocouple enables the sensors to have a very low SWR even at 26.5 GHz. A low SWR reduces mismatch uncertainty error, typically the largest single source of error in power measurements. The HP 8484A sensor uses a crystal detector for higher sensitivity and low SWR.

### Individually Calibrated for More Confidence in Results

Each sensor is individually calibrated, traceable to the National Bureau of Standards. A control on the meter compensates for power sensor Cal Factor at any frequency. A precise automatic network analyzer printout for Cal Factor and reflection coefficient in magnitude and phase is supplied with the HP 8481A/B/H, 8484A, and 8485A. This means you can significantly reduce mismatch uncertainty by calculating the mismatch error.

### High Power Sensors to 25 Watts

The HP 8481B and 8482B high power sensors both have a power range of 1 mW to 25 watts. The HP 8481B covers a frequency range of 10 MHz to 18 GHz and the HP 8482B has a frequency range of 100 kHz to 4.2 GHz.

Previous methods of measuring high power levels usually required adding a separate attenuator in front of a low power sensor. With the HP 8481/82B power sensors, the attenuator and sensor are combined into one unit. This reduces mismatch uncertainty error and improves accuracy by including the attenuator in the measured Calibration Factor curves. In addition, light-weight, heat-dissipating fins on the attenuator prevent burns.

### Medium Power Sensors to 3 Watts

The HP 8481H measures power from 100  $\mu$ W to 3 watts over a frequency range of 10 MHz to 18 GHz. The HP 8482H measures power from 30  $\mu$ W to 3 watts over a frequency range of 100 kHz to 4.2 GHz.

### Standard Sensors to 100 mW

The HP 8481A, 8482A, 8483A, and 8485A power sensors all measure power over a range of 1  $\mu$ W to 100 mW. The HP 8481A is a 50-ohm sensor with a frequency range of 10 MHz to 18 GHz. The HP 8482A is a 50-ohm sensor with a frequency range of 100 kHz to 4.2 GHz. The HP 8485A is a 50-ohm sensor with a frequency range of 50 MHz to 26.5 GHz. The HP 8483A is a 75-ohm sensor and covers a frequency range of 100 kHz to 2 GHz.

### High Sensitivity Sensors

The HP 8484A measures power from 0.1 nW to 10  $\mu$ W over a frequency range of 10 MHz to 18 GHz. It is furnished with the HP 11708A 50 MHz reference attenuator for precise calibration with 1 mW power meter reference oscillator. Noise and drift have been reduced to less than 5% of full scale on the 300 pW range (only 15 pW) when it is used with the HP 435B power meter. Noise and drift are even less with the HP 436A and 438A power meters.

### Broadband Power Sensor

The HP 8485A thermocouple power sensor covers a frequency range of 50 MHz to 26.5 GHz and a power range of -30 dBm to +20 dBm (1  $\mu$ W to 100 mW). Low SWR (<1.25 at 26.5 GHz) reduces mismatch uncertainty which increases power measurement accuracy. The ruggedized APC-3.5 input connector is SMA compatible and repeatable. The actual Cal Factor is plotted on each HP 8485A label at 34 frequencies. Each unit is shipped with a print-out which lists Cal Factor and the actual reflection coefficient in magnitude and phase.



### HP 8480 Series Specifications

HP Model	Nominal Impedance	Frequency Range	Power Range	Maximum Power	Power Linearity <sup>2</sup>	Maximum SWR (Reflection Coefficient)	Size mm (in.)	Shipping Weight kg (lb)	RF Connector
8481A	50 Ω	10 MHz-18 GHz	1 μW to 100 mW	300 mW avg. 15 W peak 30 W • μs (per pulse)	+10 to +20 dBm +2, -4%	10 MHz - 30 MHz: 1.40 (0.166) 30 MHz - 50 MHz: 1.18 (0.083) 50 MHz - 2 GHz: 1.10 (0.048) 2 - 12.4 GHz: 1.18 (0.083) 12.4 - 18 GHz: 1.28 (0.123)	30 x 38 x 105 (1.2 x 1.5 x 4.1)	0.5 (1)	N(m)
Option 001									APC-7
8481B	50 Ω	10 MHz-18 GHz	0-35°C, 1 mW-25W; 35°C-55°C, 1 mW-20 W	0-35°C: 30 W avg. <sup>1</sup> 35°C-55°C: 25 W avg. 10 MHz-5.8 GHz 500 W peak 5.8-18 GHz 125 W peak 500 W • μs (per pulse)	+35 to +44 dBm ±4%	10 MHz - 2 GHz: 1.10 (0.048) 2-12.4 GHz: 1.18 (0.083) 12.4-18 GHz: 1.28 (0.123)	83 x 114 x 248 (3.25 x 4.5 x 9.75)	1.5 (3.2)	N(m)
8481H	50 Ω	10 MHz-18 GHz	100 μW to 3W	3.5 W avg. 100 W peak 100 W • μs (per pulse)	+25 to +35 dBm ±5%	10 MHz - 8 GHz: 1.20 (0.091) 8-12.4 GHz: 1.25 (0.110) 12.4 - 18 GHz: 1.30 (0.130)	30 x 38 x 149 (1.2 x 1.5 x 5.9)	0.5 (1)	N(m)
8482A	50 Ω	100 kHz-4.2 GHz	1.0 μW to 100 mW	300 mW avg. 15 W peak 30 W • μs (per pulse)	+10 to +20 dBm +2, -4%	100-300 kHz: 1.60 (0.231) 300 kHz - 1 MHz: 1.20 (0.091) 1 MHz - 2 GHz: 1.10 (0.048) 2-4.2 GHz: 1.30 (0.130)	30 x 38 x 105 (1.2 x 1.5 x 4.1)	0.5 (1)	N(m)
8482B	50 Ω	100 kHz-4.2 GHz	0-35°C, 1 mW-25 W; 35°C-55°C, 1 mW-20 W	0-35°C: 30 W avg. <sup>1</sup> 35°C-55°C: 25 W avg. 500 W peak 500 W • μs (per pulse)	+35 to +44 dBm ±4%	100 kHz - 2 GHz: 1.10 (0.048) 2 GHz - 4.2 GHz: 1.18 (0.083)	83 x 114 x 248 (3.2 x 4.5 x 9.7)	1.5 (3.2)	N(m)
8482H	50 Ω	100 kHz-4.2 GHz	100 μW to 3W	3.5 W avg. 100 W peak 100 W • μs (per pulse)	+25 to +35 dBm ±5%	100 kHz-4.2 GHz: 1.20 (0.091)	30 x 38 x 149 (1.2 x 1.5 x 5.9)	0.5 (1)	N(m)
8483A <sup>3</sup>	75 Ω	100 kHz-2 GHz	1.0 μW to 100 mW	300 mW avg. 10 W peak 30 W • μs (per pulse)	+10 to +20 dBm +2, -4%	100-600 kHz: 1.80 (0.286) 600 kHz - 2 GHz: 1.18 (0.083)	30 x 38 x 105 (1.2 x 1.5 x 4.1)	0.5 (1)	N(m) 75 Ω
8484A <sup>4</sup>	50 Ω	10 MHz-18 GHz	0.1 nW to 10 μW	200 mW avg. 200 mW peak	-30 to -20 dBm ±1%	10-30 MHz: 1.40 (0.166) 30 MHz - 4 GHz: 1.15 (0.070) 4-10 GHz: 1.20 (0.091) 10-15 GHz: 1.30 (0.130) 15-18 GHz: 1.35 (0.149)	36 x 44 x 133 (1.4 x 1.7 x 5.2)	0.5 (1)	N(m)
8485A	50 Ω	50 MHz-26.5 GHz	1 μW to 100 mW	300 mW avg. 15 W peak 30 W • μs (per pulse)	+10 to +20 dBm +2, -4%	50 MHz-100 MHz: 1.15 100 MHz-2 GHz: 1.10 2-12.4 GHz: 1.15 12.4-18 GHz: 1.20 18-26.5 GHz: 1.25	30 x 38 x 95 (1.2 x 1.5 x 3.7)	0.5 (1)	APC3.5(m)

<sup>1</sup>For pulses greater than 30 W the maximum average power (Pa) is limited by the energy per pulse (E) in W • μs according to Pa = 30 - 0.02E.

<sup>2</sup>Negligible deviation except for those power ranges noted.

<sup>3</sup>Includes HP 1250-0597 adapter from 75 Ω type N to 50 Ω type N for calibration.

<sup>4</sup>The HP 11708A 30 dB attenuator for calibrating against a 0 dBm, 50 MHz power reference is shipped with the HP 8484A.

### Uncertainty of Calibration Factor Data for HP 8482A and 8483A

Frequency (MHz)	Sum of Uncertainties (%) <sup>1</sup>				Probable Uncertainties (%) <sup>2</sup>			
	HP Model				HP Model			
	8482A	8482B	8482H	8483A	8482A	8482B	8482H	8483A
0.1	±2.3	±5.7	±3.3	±2.6	±1.3	±2.8	±1.6	±1.5
0.3	2.2	5.7	3.2	2.5	1.2	2.8	1.6	1.4
1.0	2.2	5.7	3.2	2.5	1.2	2.8	1.6	1.4
3.0	2.2	5.7	3.2	2.5	1.2	2.8	1.6	1.4
10.0	2.5	5.7	3.5	3.0	1.3	2.8	1.6	1.6
30.0	2.6	5.7	3.6	3.1	1.4	2.8	1.7	1.6
50.0	0(ref)	2.7	0(ref)	0(ref)	0(ref)	2.7	0(ref)	0(ref)
100.0	3.1	5.6	4.1	3.9	1.6	3.3	1.9	2.0
300.0	3.1	5.6	4.1	3.9	1.6	3.3	1.9	2.0
1000.0	2.7	5.7	3.7	3.7	1.4	3.3	1.7	2.0
2000.0	2.7	5.5	3.7	3.9	1.4	3.1	1.7	2.1
4000.0	2.8	5.5	3.8	—	1.5	3.1	1.8	—

### Uncertainty of Calibration Factor Data for HP 8481A/B, 8484A and 8485A

Frequency (GHz)	Sum of Uncertainties (%) <sup>1</sup>					Probable Uncertainties (%) <sup>2</sup>				
	HP Model					HP Model				
	8481A	8481B	8481H	8484A	8485A	8481A	8481B	8481H	8484A	8485A
0.1	±3.1	±6.4	±4.1	±4.4	—	±1.6	±3.0	±1.9	±1.9	—
2	2.7	5.8	3.7	4.0	±3.6	1.4	3.1	1.7	1.8	±2.1
4	2.8	5.8	3.8	4.1	—	1.5	3.1	1.8	1.8	—
6	2.8	5.8	3.8	4.1	4.0	1.5	3.1	1.8	1.8	2.3
8	3.2	6.0	4.2	4.6	—	1.7	3.2	2.0	2.0	—
10	3.6	6.2	4.6	5.1	4.7	1.9	3.3	2.2	2.2	2.7
12	3.9	7.8	4.9	6.5	—	2.1	4.1	2.4	2.8	—
14	4.8	7.9	5.8	7.4	5.6	2.6	4.1	2.8	3.2	3.2
16	5.2	8.0	6.2	7.8	—	2.9	4.2	3.0	3.4	—
18	5.8	8.3	6.8	8.4	5.9	3.2	4.3	3.4	3.7	3.6
22	—	—	—	—	6.8	—	—	—	—	3.7
26.5	—	—	—	—	7.3	—	—	—	—	4.0

<sup>1</sup>Includes uncertainty of reference standard and transfer uncertainty. Directly traceable to NBS.

<sup>2</sup>Square root of sum of the individual uncertainties squared (RSS).

# POWER METERS

## Thermistor Power Meters & Power Meter Calibrator



Models 432A/B, 8477A

- Automatic zero
- High accuracy

- Recorder outputs, analog & digital
- Long cable options

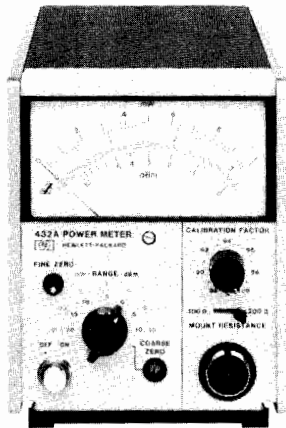

HP 432A

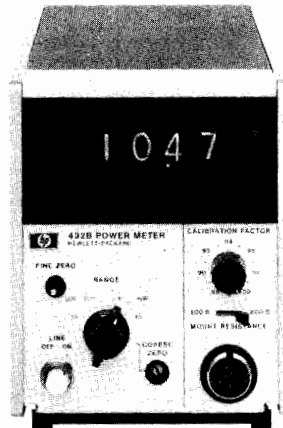

HP 432B

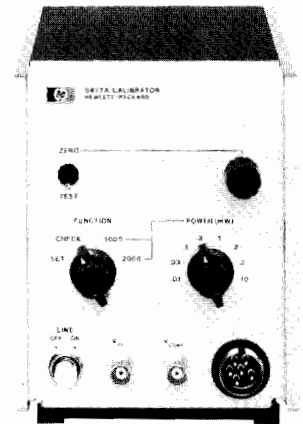

HP 8477A

### 432A/B Power Meters

**High accuracy—no thermoelectric error:** high accuracy over a wide temperature range is featured on the HP 432 power meters. By measuring the output voltage of the thermistor bridges, and computing the corresponding power, even higher accuracy of  $\pm 0.2\% \pm 0.5 \mu\text{W}$  can be obtained.

Accuracy can be maintained on even the most sensitive range because the error due to thermoelectric effect is reduced to a negligible level.

**Calibrated mounts:** each thermistor mount is furnished with data stating the Calibration Factor\* and Effective Efficiency\* at various frequencies across the operating range. For easy and accurate power measurements, the front panel of the HP 432 contains a calibration factor control, calibrated in 1% steps from 88% to 100%, that compensates for losses in the mount and eliminates the need for calculation.

**Instrument type:** automatic, self-balancing power meter for use with temperature-compensated thermistor sensor.

\*"Calibration Factor" and "Effective Efficiency" are figures of merit expressing the ratio of the substituted signal measured by the power meter to the microwave power incident on and absorbed by the sensor.

### Specifications (partial)

#### Power Range

**HP 432A:** seven ranges with full-scale readings of 10, 30, 100, and 300  $\mu\text{W}$ , 1, 3, and 10 mW; also calibrated in dBm from  $-20$  dBm to  $+10$  dBm full scale in 5 dB steps.

**HP 432B:** four ranges with full-scale readings of 10 and 100  $\mu\text{W}$ , and 1 and 10 mW.

**Noise:** less than 0.25% of full scale peak (typical).

**Response time:** at recorder output, 35 ms time constant (typical).

**Fine zero:** automatic, operated by front panel switch.

**Zero carryover:** less than 0.50% of full scale when zeroed on most sensitive range.

#### Meter

**HP 432A:** taut-band suspension, individually calibrated, mirror-backed scales. Milliwatt scale more than 108 mm (4.25 in.) long.

**HP 432B:** three digits with one digit overrange. 20% overrange capability on all ranges.

**Calibration factor control:** 13-position switch normalizes meter reading to account for thermistor sensor calibration factor. Range 100% to 88% in 1% steps.

**Thermistor sensor:** thermistor sensors are required for operation of the HP 432A/B. For microwave sensors HP 478B, 8478B and 486 series see page 523.

**Recorder output:** proportional to indicated power with 1 volt corresponding to full scale. 1 k $\Omega$  output impedance.

**BCD output:** 8, 4, 2, 1 code: "1" positive. TTL compatible logic. Operates with HP 5150A, Opt 002 (BCD) Digital Recorder. "Print" and "Inhibit" lines available. (HP 432B only.)

#### Power Consumption

**HP 432A:** 115 or 230 Vac  $\pm 10\%$ , 50 to 400 Hz, 1.5 watts.

**HP 432B:** 115 or 230 Vac  $\pm 10\%$ , 50 to 400 Hz, 10 watts.

#### Weight

**HP 432A:** net, 2.3 kg (5.5 lb). Shipping, 4.6 kg (10 lb).

**HP 432B:** net, 3 kg (6.5 lb). Shipping, 4.8 kg (10.5 lb).

**Size:** 130 W x 155 H x 279 mm D (5.2" x 6.1" x 11.0").

### HP 8477A Power Meter Calibrator

The HP 8477A calibrator is specifically designed for use with the HP 432 power meter. It allows you to verify full-scale meter readings on all ranges, and meter tracking. Simply connect three cables between the power meter and calibrator; no charts or additional instruments are required.

**Power:** 115 or 230 Vac  $\pm 10\%$ , 50 to 400 Hz, 3 watts.

### Ordering Information

HP 432A Power meter

HP 432B Power meter

#### HP 432A/B Options

**001:** rechargeable battery installed, provides up to 20 hours continuous operation (HP 432A only)

**002:** input connector placed on rear panel in parallel with front

**003:** input connector on rear panel only

**009:** 3.1 m (10 ft) cable for 110- $\Omega$  or 200- $\Omega$  sensor

**010:** 6.1 m (20 ft) cable for 100- $\Omega$  or 200- $\Omega$  sensor

**011:** 15.2 m (50 ft) cable for 100- $\Omega$  or 200- $\Omega$  sensor

**012:** 30.5 m (100 ft) cable for 100- $\Omega$  or 200- $\Omega$  sensor

**013:** 61 m (200 ft) cable for 100- $\Omega$  or 200- $\Omega$  sensor

**100:** 100 Vac operation, 48–66 Hz

**910:** extra operating and service manual

HP 8477A Power Meter Calibrator

## Thermistor Mounts, Peak Power Sensor & Peak Power Meters Models 478A, 8478B, 486 Series, 8900C/D, 84811A

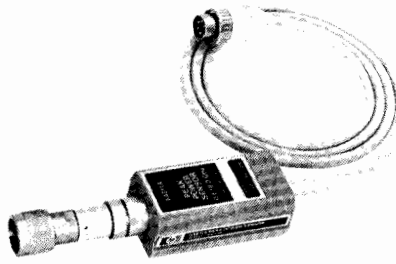

HP 84811A



HP 478A

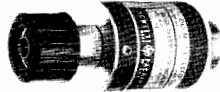

HP 8478B

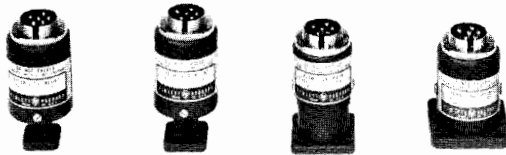

HP 486 Series

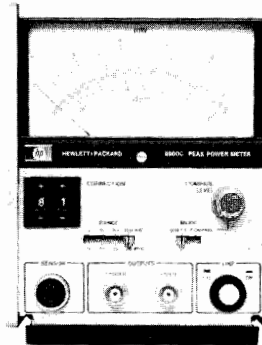

HP 8900C



HP 8900D

### HP 8900C/D Peak Power Meters

The HP 8900C and 8900D peak power meters directly display the peak power of RF pulses over a 100 MHz to 18 GHz frequency range. Measurements can be made on pulses with widths from 1  $\mu$ s (100 ns in Compare mode) to CW, and repetition rates from 100 Hz (0 Hz in Compare mode) to 100 kHz.

The HP 8900C is an economical analog meter calibrated in watts and dBm. The analog display with its large, easy-to-read scale makes it simple to peak or null pulsed power systems. The HP 8900D has a high resolution 3 1/2 digit digital display calibrated in watts. The direct reading display and range annunciators make the digital version a good choice for production and field applications where unambiguous or frequent readings are required.

### HP 8900C/D Peak Power Meters Specifications

**Frequency range:** 100 MHz to 18 GHz.

**Dynamic range:** 20 dB (0 to +20 dBm).

**HP 8900C:** 4 ranges of 3, 10, 30 and 100 mW full scale.

**HP 8900D:** 2 ranges of 10 and 100 mW full scale.

#### Pulse Response

##### Direct Mode

**Pulse width:** 1  $\mu$ s to CW.

**Repetition rate:** 100 Hz to 100 kHz.

##### Compare Mode

**Pulse width:** 100 ns (typical) limited by rise time specification.

**Repetition rate:** 0 to 100 kHz.

**Rise time:** 75 ns.

**Fall time:** 125 ns (as measured on video output).

**Power consumption:** 100 and 120 Vac +5, -10%, 48 -66 Hz and 360-440 Hz; 220 and 240 Vac +5, -10%, 48 -66 Hz.

Meter Accuracy	CW	Pulse	Transfer Accuracy CW to Pulse
Direct	$\pm 0.2$ dB	$\pm 0.35$ dB	$\pm 0.2$ dB
Compare	$\pm 0.2$ dB	$\pm 0.25$ dB	$\pm 0.1$ dB

### HP 84811A Peak Power Sensor Specifications

**Power range:** 0 to +20 dBm (1 mW to 100 mW).

**Frequency range:** 100 MHz to 18 GHz.

**SWR:** 100 MHz to 12 GHz < 1.5. 12 GHz to 18 GHz < 2.0.

**Maximum peak power:** +24 dBm (250 mW) for 5 minutes.

**Connector type:** N (male).

**Calibration:** every 2 GHz from 2 to 10 GHz. Every 1 GHz from 11 to 18 GHz.

**Operating temperature:** 0 to +55°C.

**Calibration accuracy:** (+10 to +40°C),  $\pm 0.7$  dB 0.1 to 12 GHz.  $\pm 1.0$  dB to 18 GHz. 0-10°C and 40-55°C: add  $\pm 0.2$  dB.

### Ordering information

HP 8900C Analog peak power meter

HP 8900D Digital peak power meter

HP 84811A Peak power sensor

### Temperature Compensated Thermistor Mounts

High efficiency and good RF match are characteristic of the HP 478A and 8478B coaxial and 486A series waveguide thermistor mounts. Used in conjunction with the HP 432 Power Meter they provide high accuracy even in routine power measurements. These thermistor mounts are temperature-compensated for low drift, even in the presence of thermal shocks, permitting measurement of microwave power as low as one microwatt. Each mount contains data showing Calibration Factor and Effective Efficiency at six frequencies, directly traceable to the National Bureau of Standards at those frequencies where NBS provides calibration service.

### HP 486, 478, 8478B Specifications

HP Model	Frequency range, GHz	Maximum SWR	Operating Resistance (Ohms)
478A	10 MHz to 10 GHz	1.75, 10 to 25 MHz 1.3, 25 MHz to 7 GHz 1.5, 7 to 10 GHz	200
8478B <sup>1</sup>	10 MHz to 18 GHz	1.75, 10 to 30 MHz 1.35, 30 to 100 MHz 1.1, 0.1 to 1 GHz 1.35, 1 to 12.4 GHz 1.6, 12.4 to 18 GHz	200
X486A	8.20 to 12.4	1.5	100
P486A	12.4 to 18.0	1.5	100
K486A <sup>2</sup>	18.0 to 26.5	2.0	200
R486A <sup>2</sup>	26.5 to 40.0	2.0	200

<sup>1</sup>Option 011: furnished with APC-7 RF connector

<sup>2</sup>Circular flange adapters:

K-band (UG-425/U) HP 11515A

R-band (UG-381/U) HP 11516A

### HP 84811A Peak Power Sensor

The HP 84811A peak power sensor works with the HP 8900C/D peak power meters to measure the peak power of RF pulses. It is supplied with a 4 foot flexible cable to easily reach the pulse source being measured. Any sensor can be used with any meter. The HP 84811A also conveniently detaches from the meter for storage, recalibration or replacement.



# NOISE FIGURE METER

## Noise Measurements

### Noise Figure

Modern receiving systems must often process very weak signals, and noise added by the receiving system components often determines whether or not an input signal can be processed properly. Noise figure is the figure of merit used to express how well a system and its components can process weak signals. It expresses the degradation in the S/N ratio as the signal passes through the system. Noise figure is unique and universal; it may be determined for transistors, amplifiers, mixers and entire systems. Considering the S/N ratio, it is often more economical to reduce the noise figure of the receiving system components than it is to increase the signal by increasing transmitted power or antenna gain.

Noise figure may also be expressed as the ratio of total output noise power (at a source temperature of 290K) compared to the output noise power if there were no noise added by the device under test (DUT), that is, a noise-free DUT. Consider the representation of the noise power at the output of a DUT vs. the temperature of the source impedance at the DUT input.

$$N_p = N_a + kGBT_s$$

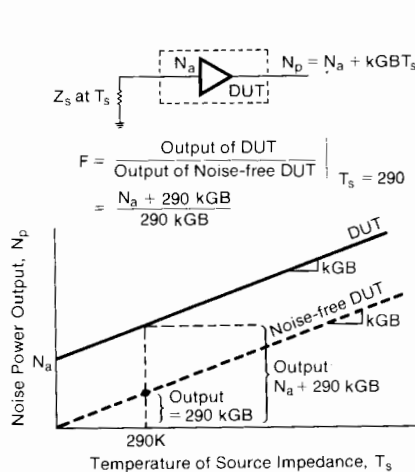

Figure 1. Available noise power and noise figure.

Figure 1 is a graph of the equation. In the equation,  $N_a$  is the noise added by the DUT,  $k$  is Boltzmann's constant,  $G$  is the gain of the DUT,  $B$  is bandwidth in Hz, and  $T_s$  is the temperature of the source termination in Kelvins. Thermal agitation energy of the source impedance causes movement of the free-charge in that impedance. Energy of the moving charge that occurs within the bandwidth of the DUT masquerades as input signal, gets processed by the DUT, and contributes to power output. At absolute zero, there is no thermal energy transferred from the source impedance and the only power at the output is noise added by the DUT,  $N_a$ . As the source temperature increases, the power output increases in accordance with the gain-bandwidth product and with Boltzmann's constant (which can be thought of as a conversion factor between two expressions for energy — kelvin temperature and joules). Noise figure is concerned with the behavior of the DUT compared to a noise-free DUT for a source temperature of 290K as shown in Figure 1. Noise figure is often expressed in dB by

$$F(\text{dB}) = 10 \log F$$

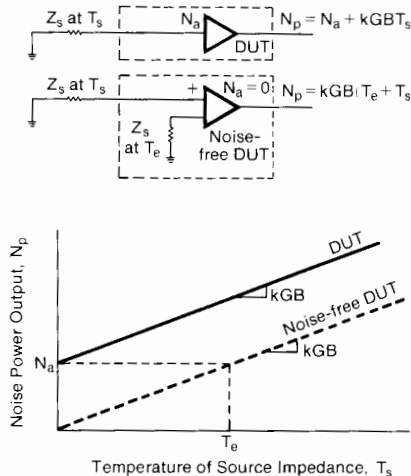

Figure 2. Available noise power & effective input noise temperature.

### Effective Input Noise Temperature — ( $T_e$ )

Another figure of merit, the effective input noise temperature  $T_e$ , gives the noise performance without reference to a standard source temperature (290K). It is therefore commonly used for satellite system work where source temperatures are usually much lower than 290K. Once again the DUT output is compared to the output if no noise were added by the DUT (Figure 2).  $T_e$  is the source temperature necessary for the source of the noise-free DUT to produce the same output noise power as the added noise of the actual DUT. For convenience, the DUT may be modeled as a noise-free DUT with an extra source impedance at temperature  $T_e$ .

### Noise Figure Measurement

Noise figure meters measure two points along the straight-line for the DUT (Figure 3), and then display the corresponding noise figure. The two source temperatures correspond to the noise source being turned on (for  $T_h$ ) and off (for  $T_c$ ). The cold temperature of

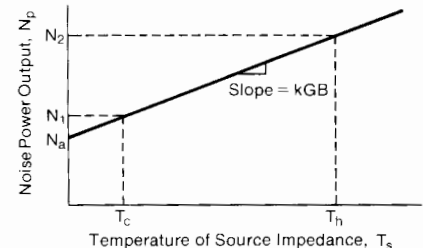
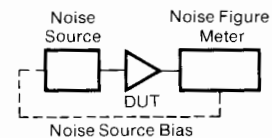

Figure 3. Available noise power and noise figure measurement.



a noise source usually corresponds to the ambient temperature. The hot temperature of a noise source is specified indirectly by its excess noise ratio (ENR), which is given by

$$\text{ENR} = 10 \log \frac{T_h - 290}{290}$$

Before the microprocessor was employed in noise figure meters, several simplifying assumptions had to be made about the noise measurements for the analog circuits of the noise figure meter to display the noise figure. Increasing the measurement accuracy meant backing out the effect of those assumptions with a myriad of calculations and often further measurements. Assumptions commonly made included that  $T_c$  was equal to 290K, that  $T_h$  was constant at all frequencies, and that the added noise of the measurement system had a negligible effect on the measurement result.

A modern, microprocessor-controlled noise figure meter, the HP 8970A, eliminated those assumptions. It allows variable values of the  $T_c$  and it uses a stored table of ENR values at 20 or more frequencies for the particular noise source being used. The noise figure meter automatically interpolates among the stored ENR values for the proper value at each measurement frequency. Through system calibration, the HP 8970A measures the noise contribution of the measurement equipment and sets a gain reference. It can then correct for the noise figure of the measurement system and calculate and display the noise figure and gain of the DUT alone.

The microprocessor also adds a lot of needed conveniences. Examples include the display of effective input noise temperature,  $T_e$ , or of noise figure, simultaneous gain measurement, and correction of measurement results for adapter loss.

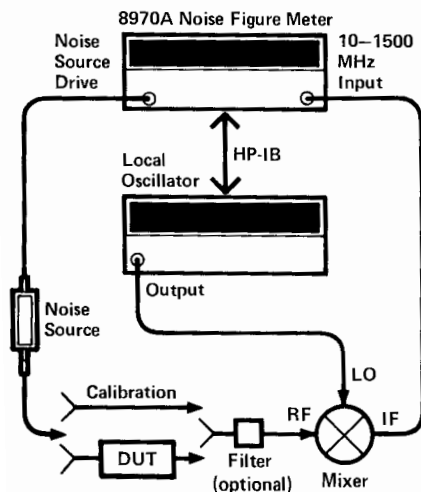

Figure 4. Swept microwave amplifier measurement.

### 10 MHz to 26.5 GHz Noise Figure Measurement

The HP 8970A can be tuned or swept anywhere between 10 and 1500 MHz. For testing devices and components with output frequencies above 1500 MHz, down conversion to the 10 to 1500 MHz range is necessary (see Figure 4). For measurements on amplifiers from 2 to 26.5 GHz, adding a suitable, commercially available, double-balanced mixer and a suitable LO (such as the HP 8672, 8673, 8340, or 8350) to the HP 8970A and its companion HP 346 series noise sources is all that is necessary. (For mixer and receiver measurement, see Product Note 8970A-1 mentioned below.) Since most low-noise LO's do not extend below 2 GHz, a different technique is often required from 1.5 to 2 GHz (single sideband, discussed in the next section). Through system calibration, the HP 8970A corrects for the noise contribution of the mixer, LO, and the HP 8970A. In Figure 4, the HP 8970A sends frequency commands over the interface bus (HP-IB) to tune the LO across the frequency band of interest. Thus, no external controller is necessary for error-corrected, swept, microwave measurements.

### Single Sideband vs. Double Sideband

When an ordinary mixer is used in the setup of Figure 4, all measurements are double sideband. (LO/Noise-source mixing provides two bands, upper and lower sideband, that will convert to the IF). Since the self-calibration and measurement are both double sideband, the HP 8970A will display the correct noise figure and gain. For double sideband measurement, it is best to have a low IF, since the measurement is like an average of upper and lower sideband values.

If double sideband measurement is inappropriate, such as when the DUT response varies rapidly with frequency or in the 1.5 to 2 GHz range mentioned above, a single sideband measurement must be made. For these cases a high IF is best, so that the unwanted sideband may be easily filtered.

For 1.5 to 2 GHz amplifier measurements, for example, one method is to fix the LO to a proper frequency (such as 2.4 GHz), sweep the HP 8970A input (such as from 900 to 400 MHz), and the lower test sideband will sweep from 1.5 to 2 GHz. The upper sideband (sweeping from 2.8 to 3.3 GHz) may be filtered easily (an HP 360C works well). Another method uses a swept LO and an appropriate high fixed IF, with the HP 8970A controlling the external LO. In either case, the HP 8970A displays the measurement frequency during the sweep (1.5 to 2 GHz) and the microprocessor takes care of all of the control chores automatically.

### Noise Figure Measurement Applications

Hewlett-Packard's noise figure measurement equipment is exceptional in a variety of applications. It exhibits the following benefits in these applications.

**Amplifiers:** 1) Simultaneous noise figure and gain measurement, 2) Results automatically corrected for ENR variations, ambient temperature, and mixer, LO, and IF noise contributions, 3) Real-time, swept, corrected output to oscilloscope for easy tuning (display is digitally stored), 4) Automatic control of an external LO for measurements above 1500 MHz without a separate computer.

**Transistors:** the above benefits, plus: 1) Easy real-time tuning for best noise figure and gain, 2) Real-time tuning to actual transistor  $F_{min}$  without second stage effects, 3) Easy single-sideband measurement (high HP 8970A IF makes filtering easy), 4) Low mismatch effects (the HP 346A features virtually identical impedance for  $T_h$  and  $T_c$ ), 5) Easy to program for automatic systems.

**Receivers and mixers:** 1) Simultaneous measurement of gain (conversion loss) and noise figure, 2) Tunable and swept IF from 10 to 1500 MHz, 3) No external IF gain needed, 4) Automatic ENR correction, even for broadband sweeps, 5) Effects of LO power, IF power, and IF frequency changes on noise figure are easily observed, 6) Easy to program.

### Literature

**Product Note 8970A-1, Applications and Operation of the 8970A Noise Figure Meter**, describes the HP 8970A and many of its applications in more detail. It is both an introduction to the HP 8970A and a summary reference manual.

**Product Note 8350A-7, Microwave Noise Figure Measurements Using the 8350A Sweep Oscillator with the 8970A Noise Figure Meter**, describes measurements with this popular combination of equipment.

**Programming Note 8970A/HP 85-1, Introductory Operating Guide for the 8970A Noise Figure Meter with the HP-85 Personal Computer**, shows the ease of programming the noise figure meter, local oscillator, and computer for automatic system using BASIC.

**Application Note 57-1, Fundamentals of RF and Microwave Noise Figure Measurements**, explains the theory behind noise figure and its measurement. This note includes an extensive glossary of noise related terms.



# NOISE FIGURE METER

Automatic Noise Figure Meter, Noise Sources

Models 8970A, 346A/B/C

- Accurate and simple, swept or CW measurements.
- Automatic operation, 10 MHz—26.5 GHz.
- Second stage correction.
- Display of both noise figure and gain.
- Calibrated display on oscilloscope or recorder.
- Powerful special function enhancements.

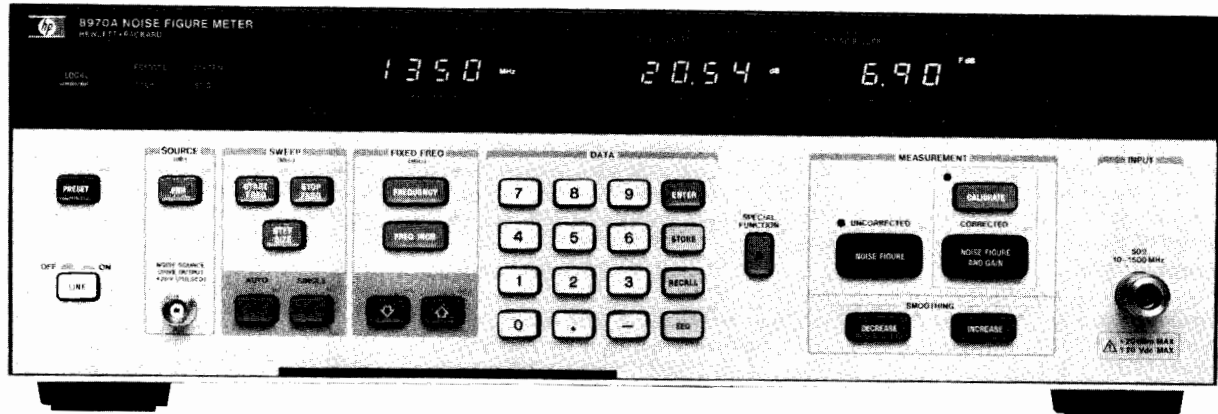

HP 8970A

## HP 8970A Noise Figure Meter

With the HP 8970A automatic noise figure meter, accurate and repeatable noise figure measurements are now easy. RF and microwave (with an external local oscillator) measurements from 10 MHz to at least 26.5 GHz are equally simple; any IF between 10 and 1500 MHz may be used. The ENR (Excess Noise Ratio) calibration table of the noise source may be stored in the HP 8970A, and a properly interpolated value is automatically used at each frequency. Automatic second stage correction makes accurate noise figure readings possible even for low gain devices. The HP 8970A's dynamic range allows it to measure either gain up to at least 40 dB (higher in some cases) or loss to  $-20$  dB, with no external attenuation or amplification required.

### Microprocessor and Controller Functions

The HP 8970A takes the mystery out of noise figure measurement. It uses a microprocessor to make the myriad calculations and corrections necessary for truly accurate, convenient and flexible noise figure measurement. The HP 8970A also acts as a controller to external HP-IB local oscillators (such as the HP 8673 synthesized signal generator or HP 8350 sweep oscillator) so that swept, broad-band microwave measurements of amplifiers, mixers, and transistors are essentially as simple as RF measurements.

In addition to acting as controller for an HP-IB local oscillator at microwave frequencies, the HP 8970A is fully programmable. Virtually all front panel buttons and functions are accessible over HP-IB, which is Hewlett-Packard's enhanced implementation of IEEE-488.

### Simple Calibration and Second Stage Correction

Accuracy is greatly enhanced because the HP 8970A measures its own noise figure (and that of the rest of the measurement system) at up to 81 points. It stores this information, interpolates if necessary, and corrects for it to remove second stage (measurement system) effects. The 8970A also measures the gain of the device under test (DUT).

### Display

The HP 8970A has an LED digital front panel display. For swept display of noise figure and gain on an oscilloscope, or x-y recorder, rear panel BNC connectors are available. Either display mode is easily and accurately scaled from the HP 8970A from the front panel to any resolution desired. The swept oscilloscope display allows the design engineer to optimize his DUT in real time for both corrected noise figure and gain. The noise figure display is easily changed from noise figure to effective noise temperature ( $T_e$ ) if desired, or Y factor.

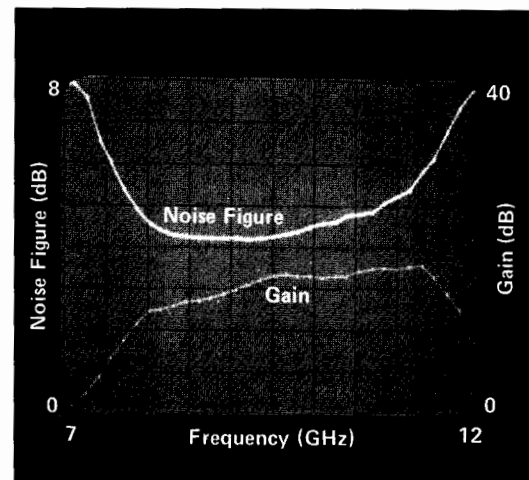

Typical oscilloscope display of amplifier.

### Front Panel and Special Functions

The HP 8970A front panel buttons control the number entry, calibration, and measurement functions. STORE, RECALL, and SEQ buttons allow up to 9 front panel settings to be stored and sequenced automatically or manually to save set-up time. Smoothing INCREASE and DECREASE buttons are used to average up to 512 readings before display, to eliminate flicker and increase accuracy.

The simple front panel control of the HP 8970A satisfies many noise figure measurement needs. In addition, for those who may need even greater measurement power, there are more than 150 special functions that are easily selected via a numerical code and the SP button. Two examples are hot-cold measurements and automatic compensation for losses at the input of the DUT. One special function is a catalog that quickly indicates the current special function status. Three pull-out cards serve as a mini-reference manual to the instrument, including most of the special functions, the HP-IB formats and codes, and typical measurement setups. A complete set of service-oriented special functions can also be accessed.

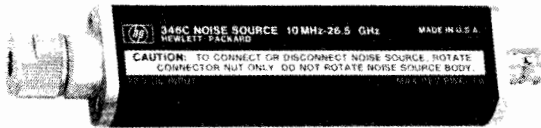

HP 346C

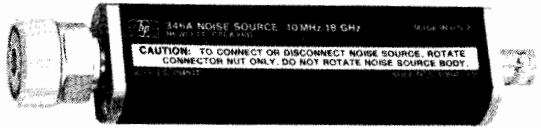

HP 346A (option 002)

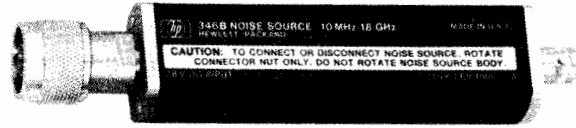

HP 346B (option 001)

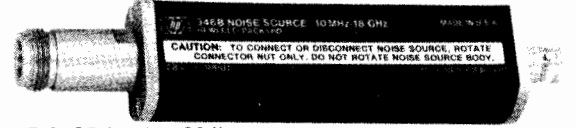

HP 346B (option 004)

## Noise Figure Measurement Repeatability and Accuracy

A very troublesome noise figure measurement problem is repeatability. For example, a vendor's system may not measure the same noise figure as his customer's. This is much less of a problem with the HP 8970A. Using randomly selected HP 8970As, HP 346Bs, mixers, and local oscillators, superimposed plots of a single DUT are routinely within 0.1 dB of each other.

The HP 8970A internal circuitry is so accurate and linear that instrumentation uncertainty is less than  $\pm 0.1$  dB. With the  $\pm 0.1$  dB ENR uncertainty of the HP 346B at most frequencies, and the uncertainties due to mismatch, total root-sum-square measurement uncertainties of less than  $\pm 0.25$  are easily attainable.

## HP 346A/B/C Broadband Noise Sources

The ideal companion to the HP 8970A is the HP 346 family of noise sources. These noise sources, covering the microwave frequency range up to 26.5 GHz as well as the UHF and IF ranges, make it unnecessary to maintain a different noise source for each frequency band. Each source has individually calibrated values of ENR at cardinal frequencies printed on its label (see illustration) for easy loading into the HP 8970A. The low SWR of each noise source reduces a major source of measurement uncertainty—re-reflections of test signals. The variety of connectors available reduces the need for degrading accuracy with connector adapters.

The HP 346 family of noise sources are designed for a broad range of measurement applications. The HP 346C covers the broadest frequency range, 10 MHz to 26.5 GHz. The HP 346B has a high excess noise ratio, low SWR, and a variety of connectors to make it a general purpose noise source. The HP 346A is especially designed for accurately characterizing the noise figure of DUTs which do not include an isolator at the input, such as GaAsFETs and many UHF amplifiers. Without an isolator such devices can change gain during the noise figure measurement and thereby cause large errors in measuring noise figure. The HP 346A has a very small change in reflection coefficient ( $< 0.01$ ) from ON to OFF to minimize the gain changes. The ENR is large enough ( $\sim 5.2$  dB) to accurately measure noise figures of low noise GaAsFETs and UHF amplifiers.

FREQ GHz	ENR dB	FREQ GHz	ENR dB	FREQ GHz	ENR dB
0.01	5.21	0.01	15.18	0.01	13.36
0.10	5.27	0.10	15.49	0.01	13.43
1.0	5.36	1.0	15.26	1.0	13.49
2.0	5.17	2.0	15.17	2.0	13.67
3.0	5.02	3.0	14.93	3.0	13.78
4.0	4.98	4.0	14.86	4.0	13.83
6.0	4.97	6.0	14.91	6.0	13.97
8.0	4.94	8.0	14.83	8.0	14.07
7.0	4.99	7.0	14.90	10.0	14.14
8.0	5.09	8.0	15.06	11.0	14.21
9.0	5.26	9.0	15.26	12.0	14.28
10.0	5.36	10.0	15.39	13.0	14.34
11.0	5.28	11.0	15.43	14.0	14.40
12.0	5.21	12.0	15.50	15.0	14.46
13.0	5.02	13.0	15.41	16.0	14.51
14.0	4.93	14.0	14.93	17.0	14.57
15.0	4.96	15.0	15.51	18.0	14.62
16.0	4.99	16.0	15.55	20.0	14.77
17.0	5.04	17.0	15.62	22.0	14.82
18.0	5.08	18.0	15.66	24.0	14.87
				25.0	14.93
				26.5	15.00

HP 346A

HP 346B

HP 346C

Example labels of 346 Noise Sources

## HP 346 Partial Specifications

(See technical data sheet for complete specifications.)

**Frequency range:** 10 MHz to 18 GHz for HP 346A/B; 10 MHz to 26.5 GHz for HP 346C.

**Excess noise ratio (ENR) limits:** HP 346A: 4.5 to 6.5 dB  
 HP 346B: 14 to 16 dB  
 HP 346C: 12 to 16 dB (10 MHz to 12 GHz) and 14 to 17 dB (12.0 to 26.5 GHz).

**Maximum SWR (reflection coefficient) on and off:**

**HP 346A/B:** 10 to 30 MHz — 1.3 (0.13)  
 30 to 5000 MHz — 1.15 (0.07)  
 5 to 18 GHz — 1.25 (0.11).

**HP 346C:** 10 MHz to 18 GHz — 1.25 (0.11)  
 18 to 26.5 GHz — 1.35 (0.15).

**Power required:**  $28 \pm 1$  Vdc.

**Dimensions:** 140 H x 21 W x 30 mm D (5.5" x 0.8 x 1.2").

**Weight:** net, 0.108 kg (3.5 oz). Shipping, 0.5 kg (1 lb).

## 8970A Partial Specifications

(See technical data sheet for complete specifications.)

**Noise figure measurement range:** 0 to 30 dB.

**Noise figure instrumentation uncertainty:**  $\pm 0.1$  dB for 0 to 55°C.

**Noise figure resolution:** 0.01 dB (0.001 dB over HP-IB).

**Gain measurement range:** -20 to at least 40 dB.

**Gain instrumentation uncertainty:**  $\pm 0.2$  dB.

**Gain resolution:** 0.01 dB (0.001 dB over HP-IB).

**Frequency range:** tunable from 10 to 1500 MHz.

**Tuning accuracy:** (from 10 to 40°C)  $\pm (1 \text{ MHz} + 0.01 \times \text{freq.})$ , 6 MHz maximum.

**Frequency resolution:** 1 MHz.

**Noise figure:** (for input power levels below -60 dBm)  $< 7 \text{ dB} + 0.003 \text{ dB/MHz}$ .

**Maximum operating input power:** -10 dBm.

**Maximum net external gain:** 80 dB between noise source and HP 8970A RF input.

**Noise source drive:**  $28.0 \pm 0.1$  volt.

**HP-IB capability:** SH1, AH1, T5, L4, SR1, RL1, PP0, DC1, DT1, C1, C3, C28, E1.

**Operating temperature:** 0°C to 55°C.

**Storage temperature:** -55°C to 75°C.

**Power:** 100, 120, 220, or 240 V (+5, -10%); 48-66 Hz; 150 VA maximum.

**Dimensions:** 146 H x 425 W x 476 mm D (5.75" x 16.8" x 18.8").

**Weight:** net, 15.5 kg (34 lb). Shipping, 18.5 kg (40 lb).

## Ordering Information

HP 8970A Noise Figure Meter

**Option 907:** Front panel handle kit

**Option 908:** Rack mounting flange kit

**Option 909:** Both options 907 and 908

**Option 910:** Extra operating and service manual

HP 346A Noise Source

HP 346B Noise Source

HP 346C Noise Source

**Option 001** (HP 346A/B only): Type N (male) connector

**Option 002** (HP 346A/B only): APC-7 connector

**Option 004** (HP 346A/B only): Type N (female) connector



# NETWORK ANALYZERS

## Complete Characterization of Linear Networks

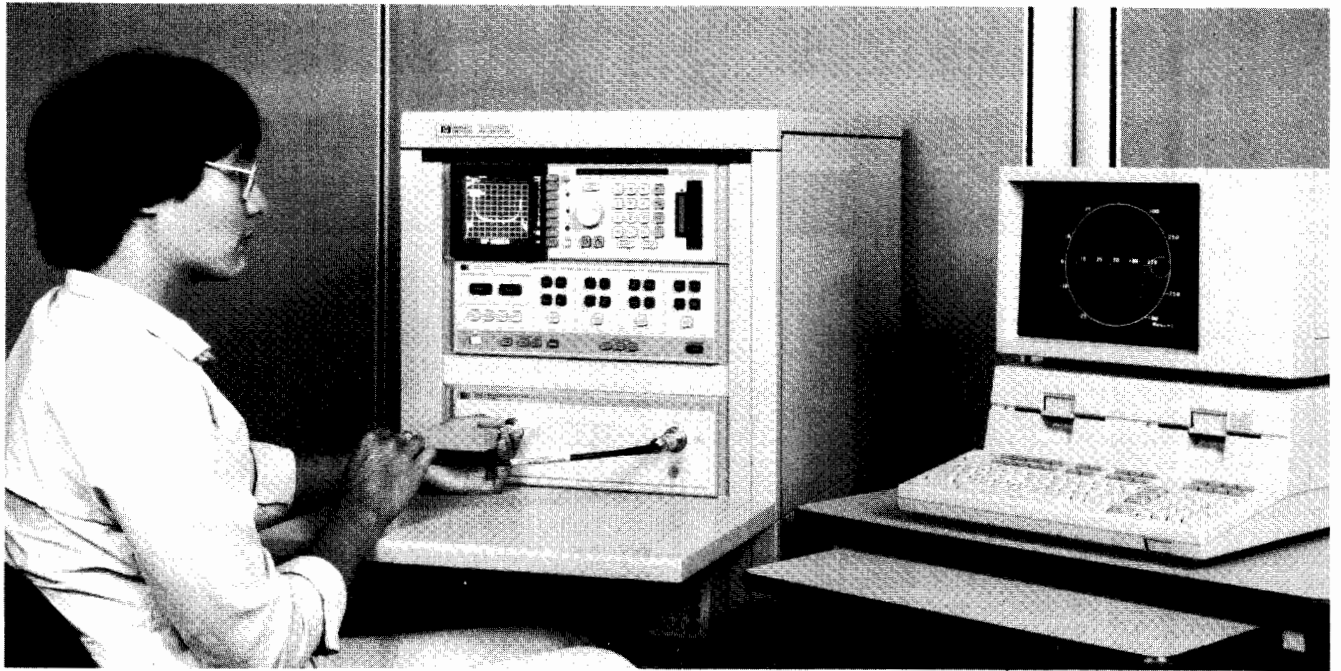

### Why Network Analysis?

Characterizing the behavior of linear networks that will be stimulated by arbitrary signals and interfaced with a variety of other networks is a fundamental problem in both synthesis and test processes. For example, the engineer designing a multi-component network must predict with some certainty the final network performances from knowledge of the individual components. Similarly, a production manager must know allowable tolerances on the products manufactured and whether the final products meet the specified tolerances. Network analysis offers a solution to these problems through complete description of linear network behavior in the frequency domain. Additionally, some network analyzers offer the capability to transform measurement data, taken in the frequency domain, to the time domain providing further insight into the behavior of linear networks.

Network analysis accomplishes the description of both active and passive networks by creating a data model of such component parameters as impedances and transfer functions. However, these parameters not only vary as a function of frequency but are also complex variables in that they have both magnitude and phase. Until the advent of the modern network analyzer, phase was difficult to measure at CW frequencies and often involved laborious calculations; these measurements were accomplished by conventional oscilloscopes at lower frequencies and slotted lines at microwave frequencies. However, swept network analyzers now measure magnitude and phase (the total complex quantity) as a function of frequency with less difficulty than conventional CW measurements. Impedance and transfer functions can then be conveniently displayed on a swept CRT, as in Figure 1, X-Y recorder, or computer controlled peripherals such as a printer and/or a plotter. HP computers also combine with network analyzers to give new levels of speed and accuracy in swept measurements that could only be attained previously by long calculations at CW frequencies.

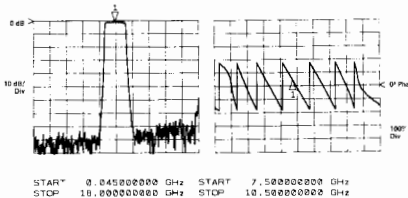

Figure 1. 45 MHz to 18 GHz measurement of magnitude and phase in a single sweep.

Thus, network analysis satisfies the engineering need to characterize the behavior of linear networks quickly, accurately, and completely over broad frequency ranges. In design situations, this minimizes the time required to test new designs and components, allowing more time to be spent on the design itself. Likewise, production test times may be minimized while reducing the uncertainties surrounding the test. Hewlett-Packard manufactures a full line of scalar network analyzers (magnitude only) and vector network analyzers (both magnitude and phase).

### What Is Network Analysis?

Network analysis is the process of creating a data model of the transfer and/or impedance characteristics of a linear network through stimulus-response testing over the frequency range of interest. All network analyzers in the HP product line operate according to this definition.

Creating a data model is important in that actual circuit performance often varies considerably from the performance predicted by calculations. This occurs because the perfect circuit element doesn't exist and because some of the electrical characteristics of a circuit may vary with frequency.

At frequencies above 1 MHz lumped elements actually become "circuits" consisting of the basic elements plus parasitics like stray capacitance, lead inductance, and unknown absorptive losses. Since parasitics depend on the individual device and its construction they are almost impossible to predict. Above

1 GHz component geometries are comparable to a signal wavelength, intensifying the variance in circuit behavior due to device construction. Further, lumped-element circuit theory is useless at these frequencies and distributed-element (or transmission-line) parameters are required to completely characterize a circuit.

Data models of both transfer and impedance functions must be obtained to completely describe the linear behavior of a circuit under test. At lower frequencies,  $h$ ,  $y$ , and  $z$ -parameters are examples of transfer and/or impedance functions used in network description; at higher frequencies, S-parameters are used to characterize input-output impedances and transfer functions. Therefore, a network analyzer must measure some form of a circuit's transfer and impedance functions to achieve its objective of complete network characterization. Figure 2 shows an example of a swept impedance measurement.

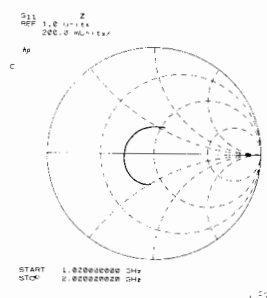

Figure 2. Input impedance of microcircuit amplifier is read directly with Smith Chart overlay for Polar Display.

Network analysis is generally limited to the definition of linear networks. Since linearity constrains networks stimulated by a

sine wave to produce a sine wave output, sine wave testing is an ideal method for characterizing magnitude and phase response as a function of frequency. In non-linear measurements phase is often meaningless and amplitude has to be defined with respect to individual frequency components. For non-linear measurements, refer to the sections on spectrum analyzers and wave analyzers (signal analyzers) in this catalog.

## Network Analyzers

Hewlett-Packard network analyzers are instruments that measure transfer and/or impedance functions of linear networks through sine wave testing. A network analyzer system accomplishes these measurements by configuring its various components around the device under test. The first requirement of the measurement system is a sine wave signal source to stimulate the device under test. Since transfer and impedance functions are ratios of various voltages and currents, a means of separating the appropriate signals from the measurement ports of the device under test is required. Finally, the network analyzer itself must detect the separated signals, form the desired signal ratios, and display the results.

### Signal Sources and Signal Separation

In the general case, any sine wave source meeting the network analyzer's specifications can be used to stimulate the device under test. For CW measurements a simple oscillator may suffice; for greater CW frequency accuracy a signal generator or synthesizer may also be desirable. If the analyzer is capable of swept measurements, great economies in time can be achieved by stimulating the device under test with a sweep oscillator or sweeping synthesizer. This allows quick and easy characterization of devices over broad frequency ranges. Some network analyzers will operate only with a companion source that both stimulates the device under test and acts as the analyzer's local oscillator.

At low frequencies it is not particularly difficult to separate the appropriate voltages and currents required for transfer and impedance function measurements. Signal separation is merely the process of establishing the proper shorts, opens, and connections at the measurement ports of the device under test. As frequencies increase, the problem of signal separation usually involves traveling waves on transmission lines and becomes correspondingly more difficult. Hewlett-Packard manufactures test sets (often called "transducers") applicable for separating the appropriate traveling waves in a variety of high frequency measurements.

### Broadband and Narrowband Detection

After the desired signals have been obtained from the test set (or transducer) they must be detected by the network analyzer; HP network analyzers can use one of two detection methods. Broadband detection accepts the full frequency spectrum of the input signal while narrowband detection involves

tuned receivers that convert CW or swept RF signals to a constant IF signal. There are certain advantages to each detection scheme.

Scalar network analyzers usually employ broadband detection techniques. Broadband detection reduces instrument cost by eliminating the IF section required by narrowband analyzers but sacrifices noise and harmonic rejection. However, noise is not a factor in many applications, and careful measurement techniques, using filters, can eliminate harmonic signals that would otherwise preclude accurate measurements. Broadband systems are generally source independent while some narrowband systems require companion tracking sources. Finally, broadband systems can make measurements where the input and output signals are not of the same frequency, as in the measurement of the insertion loss of mixers and frequency doublers. Narrowband systems cannot make these measurements.

Vector network analyzers normally employ narrowband detection techniques. Narrowband detection makes a more sensitive low noise detection of the constant IF possible. This allows increased accuracy and dynamic range for frequency selective measurements (as compared to broadband systems) and high resolution through IF substitution using precision IF attenuators. Source dependent narrowband systems utilize a companion tracking source not only to stimulate the device under test, but also to produce a signal offset from the RF by a fixed frequency for tuning the analyzer's constant IF.

### Signal Processing and Display

Once the RF has been detected, the network analyzer must process the detected signals and display the measured quantities. All HP network analyzers are multi-channel receivers utilizing a reference channel and at least one test channel; absolute signal levels in the channels, relative signal levels (ratios) between the channels, or relative phase difference between channels can be measured depending on the analyzer. Using these measured quantities, it is possible to either display directly as shown in Figure 2, or compute the magnitude and phase of transfer or impedance functions.

Magnitude measurements fall into two categories, relative and absolute; absolute measurements involve the exact signal level in each channel while relative measurements involve the ratios of the two signal channels. Absolute measurements are usually expressed in voltage (dBV) or in power (dBm). The units dBV are derived by taking the log ratio of an unknown signal in volts to a one volt reference. Similarly, dBm is the log ratio of unknown signal power to a one milliwatt reference.

Relative ratio measurements are usually made in dB, which is the log ratio of an unknown signal (Test Channel) with a chosen reference signal (Reference Channel). This allows the full dynamic range of the instrumentation to be used in measuring variations of both high and low level circuit responses. For example, 0 dB implies the two signal levels have a ratio of unity while  $\pm 20$  dB im-

plies a 10:1 voltage ratio between two signals.

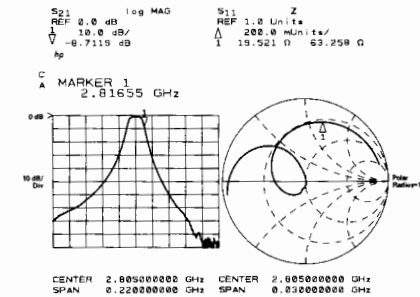

Figure 3. Simultaneous measurement of transmission response and passband reflection coefficient.

All network analyzer phase measurements are relative measurements with the reference channel signal considered to have zero phase. The analyzer then measures the phase difference of the test channel with respect to the reference channel.

Measurement results at CW frequencies may be displayed on analog meters, LEDs or computer controlled printers. Swept frequency measurements of amplitude and phase may be displayed versus frequency on CRTs, digital plotters or X-Y recorders. Insertion Loss is displayed in two different ways in Figure 4. The addition of digital storage and normalization to network analyzer CRTs ensures flicker-free traces and removal of frequency response errors for fast, real-time displays of test device responses versus frequency.

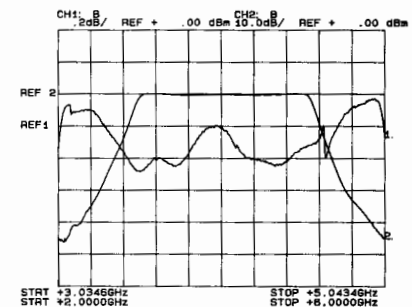

Figure 4. Simultaneous measurement of filter passband and skirts using alternate sweep.

## Low Frequency Network Analysis

Networks operating at frequencies below 10 MHz are generally characterized by measuring the gain and phase changes through the network and the associated input and output impedances; h, y, and z-parameters as well as other lumped-component models are typical analytical and computational tools used to represent these measurements. The first derivative of phase with respect to frequency, group delay, is an important measurement of distortion in communication systems. Hewlett-Packard produces a broad line of instrumentation capable of measuring all of these parameters.

Phase information complements amplitude data in the measurement of low frequency parameters. Phase is more sensitive to





# NETWORK ANALYZERS

## Complete Characterization of Linear Networks (cont.)

network behavior and it is a required component of complex impedance and transfer functions. For instance, phase is required to determine the frequency of network resonances (poles) and anti-resonances (zeros). This is because the phase shift of a network transfer function is exactly zero at the frequency of resonance. Phase information is also vital in circuit design, particularly loop design, where phase margins are critical.

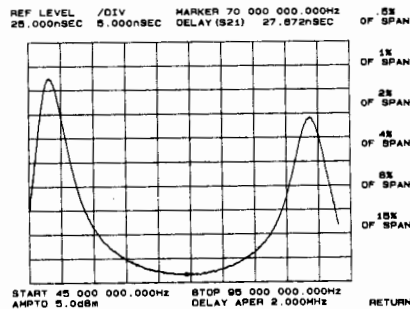

Figure 5. Direct measurement of group delay with digital readout at marker.

Phase data is also required to measure delay distortion or group delay of networks. Delay distortion occurs when different frequency components of a complex waveform experience nonlinear phase shifts as they are transmitted through a network. Group delay is a measure of this distortion and is defined as:

$$T_g = - \frac{d\theta}{d\omega}$$

There are several techniques for measuring group delay; the most common techniques are phase slope, amplitude modulation, frequency modulation, and frequency deviation. Most HP network analyzers can make measurements with at least one of these techniques while several analyzers measure and display group delay directly. Choice of a group delay measurement technique is dependent on the particular device under test and the resolution required.

An alternative method for measuring phase distortion is deviation from linear phase or differential phase. Deviations from linear phase can be measured by introducing enough electrical length in the network analyzer's reference channel to linearize a device's phase shift. Once this has been accomplished it is possible to observe any variations in phase shift linearity at high resolution. Since group delay is the derivative of phase ( $d\theta/d\omega$ ), nonlinearities in phase shift correspond directly to changes in a device's group delay. Figure 6 shows deviation from linear phase and group delay. Introduction of electrical length in the measurement channel may be accomplished by physically adding cable, or it may be accomplished electronically on some network analyzers.

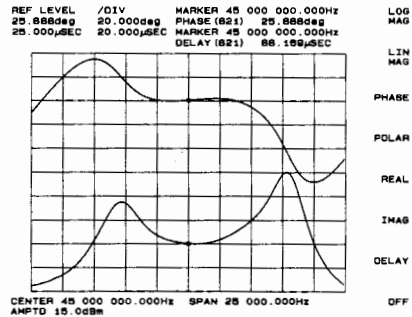

Figure 6. Two independent techniques for measuring filter phase distortion.

At lower frequency (typically  $\leq 50$  kHz) digital signal analysis using Fast Fourier Transformations (FFT) can also be used to determine the magnitude and phase of transfer characteristics. This subject is treated in the signal analyzers section of this catalog.

### High Frequency Network Analysis

Measurements of voltages and currents become more and more difficult as frequency increases. Consequently, h, y, and z parameters lose their usefulness at high frequencies. High frequency network behavior can be better described using transmission line theory in terms of forward and reverse travelling waves. Thus, travelling waves make a logical replacement for voltages and currents in high frequency measurements.

Scattering parameters or S-parameters were developed to characterize linear networks at high frequencies. S-parameters define the ratios of reflected and transmitted traveling waves measured at the network ports. A two-port device is modeled with S-parameters in Figure 7.  $S_{11}$  is the complex re-

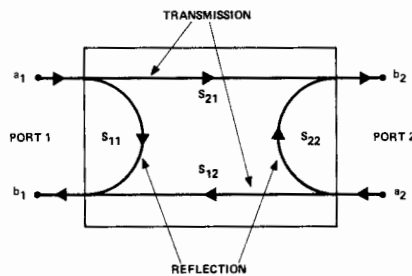

Figure 7. S-parameter model for a two-port linear network.

flexion coefficient at port 1 and is the ratio of  $b_1/a_1$ , if  $a_2 = 0$  (port 2 terminated in its characteristic impedance).  $S_{21}$  is the complex transmission coefficient from port 1 to port 2,  $b_2/a_1$ , if  $a_2 = 0$ . The "a" and "b" signals represent the amplitude and phase of the incident and emerging or reflected traveling waves. By reversing the ports and terminating port 1 in its characteristic impedance,  $S_{22}$  and  $S_{12}$  can be similarly defined. From these definitions, the following equations can be derived:

$$\begin{aligned} E_{r1} &= S_{11}E_{i1} + S_{12}E_{i2} \\ E_{r2} &= S_{21}E_{i1} + S_{22}E_{i2} \end{aligned}$$

where incident signals act as independent variables determining the signals leaving the network. The definition of an S-parameter can be easily extended to multiport networks; measurement is also easily accomplished by terminating additional ports in their charac-

teristic impedances. Thus, S-parameters completely describe linear network behavior in the same manner as low frequency parameters.

S-parameters offer numerous advantages to the microwave engineer because they are both easy to use and easy to measure. They are easy to measure because the device is terminated in its characteristic impedance, allowing swept broadband frequency measurement without tuning, enhancing the stability of active devices, and permitting a test set up to be used for different devices. The design process is simplified because S-parameters are directly applicable to flow graph analysis. HP network analyzers and the appropriate test sets will measure and directly display  $S_{21}$  or  $S_{12}$  as gain or attenuation and  $S_{11}$  or  $S_{22}$  as reflection coefficient, return loss or impedance. Figure 8 shows measurements of both  $S_{21}$  and  $S_{11}$ . Also, S-parameters may be directly related to h, y, and z-parameters through algebraic transformations.

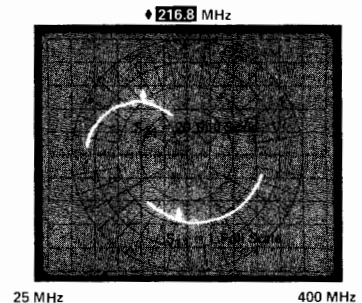

Figure 8. Simultaneous measurement of transistor S-parameters.

### Additional Capabilities

Precision design work and manufacturing tolerances demand highly accurate measurements, but most errors in network measurements are complex quantities that vary as a function of frequency. By characterizing and virtually removing these systematic errors, measurement accuracies are improved by several orders of magnitude. Hewlett-Packard now offers network analyzers with built-in, high-speed computational hardware that can perform the complex mathematics required for sophisticated error correction. In many cases, this improvement in accuracy is provided in real time, permitting operator adjustment to the network being characterized while maintaining a high level of measurement accuracy. Other network analyzers, when combined with HP desktop computers into measurement systems, also offer accuracy enhancement through error correction.

Adding the computational capabilities of a digital computer can complement the network analyzer's versatility through simplifying and speeding measurements, data processing, and accuracy enhancement. Hewlett-Packard has combined network analyzers and computers into measurement systems and now offers some analyzers that may be easily interfaced with HP desktop computers through the Hewlett-Packard Interface Bus.

Computer controlled network analyzers can be programmed to set up and make many measurements automatically. The measurement process is further accelerated by the computer's ability to store, transform, sum-





marize, and output data in a variety of formats to a number of peripherals. These capabilities make the computer controlled network analyzer ideal for both computer aided design or automatic production testing.

## Network Analyzer Product Line

Hewlett-Packard offers a complete line of network analyzers capable of measurements through the 1 Hz to 40 GHz frequency range. Further information and detailed specifications on individual network analyzers are available on the following pages (see matrix on page 533 for specific page numbers).

### HP 3575A

The HP 3575A measures phase and amplitude or gain. With the HP 3575A, the complete response picture is available at a reasonable cost from a single instrument, over an 80 dB range, from 1 Hz to 13 MHz. The HP 3575A uses a broadband measurement technique, which is attractive because the measurement is not constrained by internal tracking source or dedicated external device. The HP 3575A is not dependent on the wave shape, thus measurements can be made on a variety of waveforms such as triangle and square waves.

### HP 3577A

The HP 3577A network analyzer is a combination of superb measurement performance and outstanding network analysis capabilities. The broadband 5 Hz to 200 MHz measurement capability is provided by precise analog design. The accuracy and display flexibility are the result of digital signal processing. Simplicity of operation is the benefit of innovative microprocessor control.

Use the internal synthesized source from 5 Hz to 200 MHz with 0.001 Hz resolution and settability. Measure with 100 dB of dynamic range and 0.02 dB and 0.2 degree dynamic accuracy. Make critical low level measurements with  $-130$  dBm sensitivity in the 1 Hz resolution bandwidth. Move the display marker to resolve points of interest to 0.001 dB and 0.005 deg. Automatic measurements are easy with the HP 3577A's simple programming codes that minimize software development time.

Characterize magnitude/phase performance such as insertion loss/gain, attenuation, group delay, or input/output power. Make simultaneous reflection/transmission measurements with the HP 35677A/B S-parameter test set. Measure reflection quantities such as reflection coefficient, return loss, or impedance. Make higher accuracy reflection measurements possible with built-in vector error correction.

Application areas include communications, crystal filter testing, amplifier and component characterization as well as sonar and disc drive testing.

### HP 8405A

The HP 8405A vector voltmeter is a dual-channel RF millivoltmeter and phasemeter. It reads the absolute voltages on either of two channels and simultaneously determines the phase relationship between them. CW measurements can be made over the frequency range 1 MHz to 1 GHz.

Besides its use as a voltmeter, applications of the HP 8405A include:

- 1) Transmission measurements (gain, loss, phase shift and return loss) in 50  $\Omega$  systems.
- 2) Group delay and amplitude modulation index.
- 3) In-circuit probing.
- 4) S-parameters in 50  $\Omega$  systems.

Application Notes 77-3, 77-4, and 91 are available for more detail on the above measurements.

### HP 8754A

The HP 8754A is a completely integrated stimulus/response system for testing a wide variety of networks (such as filters, amplifiers, and attenuators) in the 4 to 2600 MHz frequency range. By combining a swept source, three channel tuned receiver, and polar/rectilinear CRT display into a single compact package, outstanding performance can be achieved at an economical price. Magnitude, phase, polar reflection coefficient and impedance are all measured directly over 80 dB of spurious free dynamic range. Frequency accuracy is provided by a crystal marker system and, since three receiver inputs are available, network transmission and reflection parameters can be measured simultaneously. Additionally, a complete line of 50  $\Omega$  and 75  $\Omega$  power splitters, transmission/reflection test sets, and S-parameter test sets, is available. A high impedance probe can also be used if necessary, and an external signal generator can be used directly to characterize narrowband devices such as crystal filters.

### HP 8505A/8507D

The HP 8505A network analyzer provides measurement capability from 500 kHz to 1.3 GHz. Three RF input ports, each with 100 dB of dynamic range, make possible simultaneous network measurements of reflection and transmission parameters. Two independent yet identical display channels are each capable of displaying magnitude, phase, deviation from linear phase and group delay of either the transmission or reflection characteristics of an RF network. These parameters can be displayed in rectangular, in polar coordinates or both formats at the same time. The swept source, which is an integral part of the analyzer, offers extreme frequency flexibility through seven different modes of operation.

The HP 8507D is an automatic network analyzer using the HP 8505A with HP-IB interface and one of the HP 9816S, 9826S, or 9836S computers. The HP 8507D is well suited for laboratory applications because of the accuracy enhancement software available with the system. The HP 8507D is also well suited for manufacturing applications where fast, repeatable testing is necessary. Test data can also be reformatted and outputted to an external plotter for permanent documentation.

### HP 8410C/8408B

The HP 8410C network analyzer system measures the transmission and reflection characteristics of linear networks in the form of gain, attenuation phase shift, reflection coefficient, normalized impedance and S-parameters in the frequency range of 110 MHz to 40 GHz.

The HP 8410C is a ratiometer using both reference and test signal inputs; consequently, the sweeper output must be divided into channels. This is accomplished by a "Test Set" whose other major function can be to provide the switching required for making transmission and reflection measurements with minimum or no changes in the measurement setup. Hewlett-Packard offers test

sets covering various frequency ranges and switching functions.

Another major instrument required in the HP 8410 measurement system is a unit for the detection and display of the IF amplitude and phase. Three plug-in displays (for the HP 8410C mainframe) are available for this purpose: a phase-gain indicator with meter readouts for CW measurements; a phase-gain display for displaying log amplitude and phase versus frequency; and a polar display for displaying amplitude and phase in polar coordinates.

The HP 8410C is capable of swept measurements over multi-octave bands through 18 GHz. Between 18 GHz and 40 GHz, 2 GHz windows may be viewed. Measurements of more than 60 dB of attenuation and 40 dB of gain are possible.

The HP 8408B is a low cost, automatic network analyzer system based on the HP 8410C network analyzer, the HP 8350B sweeper and the HP 85F desktop computer. Using automatic error correction techniques, primarily in reflection, the HP 8408B offers the capability of making more accurate measurements than with the HP 8410C manual system.

### HP 8510A/8510T

The HP 8510 series microwave vector network analyzers provide complete measurement capability for characterization of linear networks from 45 MHz to 26.5 GHz. Two independent, yet identical, display channels can be used to view the log/linear magnitude, phase, or group delay response of a test device. The display channels may be viewed individually or simultaneously with measurement results presented in either a rectangular or polar/smith chart format. Powerful trace math, data averaging, smoothing, and electrical delay functions provide performance improvement and measurement flexibility. Internal, non-volatile, storage of instrument front panel states, calibration sets, and measurement data is available. A built-in tape cassette unit extends the storage capacity. Measurement results may be printed or plotted directly to a compatible peripheral without the need of an external computer. The system is completely programmable through the Hewlett-Packard Interface Bus.

An internal, high-speed computer controls all aspects of system operation and data processing, and provides the powerful capability to perform the complex mathematics required for vector error correction. Frequency response, one port, and full two port measurement calibrations are available. System speed is such that measured data is error-corrected, yet displayed in virtual real time, allowing for operator adjustment of the test device while retaining a high level of measurement accuracy.

Optionally, transformation of measured data from the frequency domain to the time domain is available, providing the ability to view the response of a test device as a function of time. The time domain response presents the individual responses of a network as a function of time (or



# NETWORK ANALYZERS

## Complete Characterization of Linear Networks (cont.)

distance), permitting identification of specific discontinuities within the test device. Individual responses can be isolated within settable "gates," and viewed in the frequency domain without the effect of the responses outside the gate.

A total measurement system comprises a source (either the HP 8350 series sweep oscillators or HP 8340A/8341A synthesized sweepers) and one of four broadband test sets. The test sets provide either reflection/transmission or full S-parameter measurement capability. The S-parameter test sets include test channel attenuators and bias networks for application in active device characterization. All four test sets include an integrated three- or four-channel frequency converter. The HP 8511A is a four-channel frequency converter covering the 45 MHz to 26.5 GHz frequency range, and it can be combined with a customer supplied test setup for customized test requirements. Additionally, a complete line of calibration/verification kits, test port return cables, and other measurement accessories are available.

The HP 8510T network analyzer system provides, under one model number, the highest performance network measurement system available. Covering 45 MHz to 26.5 GHz, it includes the HP 8515A S-parameter test set and HP 8340A synthesized sweeper in a four foot high mobile rack along with a comprehensive array of standards, verification kits, and accessories. Also, included are system installation and one year on-site warranty.

### Scalar Network Analyzers

Scalar (magnitude only) network analyzers use economical broadband diode detectors for swept frequency measurements. These detectors, along with broadband bridges, permit transmission and reflection measurements from 10 MHz to 26.5 GHz with one system. Because many devices can be sufficiently characterized by magnitude versus frequency measurements, the need for complex, costly phase measuring circuitry in the network analyzer is eliminated. A scalar measurement system usually consists of a scalar network analyzer, sweep oscillator, detectors and a signal separation device (such as a directional coupler or bridge). In addition, many scalar systems utilize computers for automatic testing and data collection. Scalar network analyzers have enjoyed wide acceptance in research and development, manufacturing and field service testing applications.

### HP 8757A/8757S

The HP 8757A is Hewlett-Packard's highest performance scalar network analyzer. It can make swept frequency transmission and reflection measurements over the 10 MHz to 40 GHz frequency range. Each of the four inputs (with optional fourth detector input) can be displayed independently in an absolute power measurement mode (A, B, C or R) or in a ratio measurement mode (A/R, B/R, C/R or any other combination). A built-in trace memory for each channel enables normalized measurements that can be saved with the front panel settings in the SAVE/RECALL registers. Adaptive normalization ensures that the calibration data

remains valid even if the frequency span is narrowed. When used with the HP 8350B, 8341A or 8340A sweep oscillator, the SAVE/RECALL registers also save the sweeper state.

The HP 8757A will operate with any general purpose sweep oscillator; however, a special, dedicated interface exists between the HP 8757A and the HP 8350B, 8341A or 8340A sweep oscillator. This System Interface Bus enables the HP 8757A to act as a system controller providing frequency annotation on the CRT as well as allowing for the storage and recall of both instruments settings (as mentioned above).

The new HP 8757A is completely compatible with all existing detectors (such as the HP 11664 family), power splitters (HP 11667A/B), directional bridges (HP 85021A/B/C and HP 85020A/B) and other scalar measurement accessories. A new detector, the HP 85025A, enables the HP 8757A to make scalar measurements on either modulated (ac) or unmodulated (dc) RF signals. In the dc mode this detector and analyzer make accurate swept power measurements. The HP 11664 detectors can measure RF signals over the power range of +16 dBm to -60 dBm for more complete characterization of large dynamic range components such as filters and switches.

Alongside the CRT are several keys whose functions are defined in the HP 8757A internal memory. These "soft keys" make a large number of measurement functions available without adding front panel complexity. For example, the "open/short cal" soft key guides the user through the steps involved in an open/short calibration for reflection measurements. The plot soft key allows the user to plot the output to an HP-IB plotter of the CRT trace, graticule and annotation.

Other soft keys allow the user to make measurements that have previously required a computer. For example, the cursor soft keys enable the user to measure the 3 dB (or any other value) frequencies of a band limited device. Another soft key allows the user to specify limit lines that appear on the CRT for simple pass/fail testing. After the device under test has been adjusted, measurement results can be plotted and titled using the plot soft keys.

Add a computer for fully automated transmission and reflection testing. All functions and front panel controls are programmable via the HP-IB with simple 3 letter codes. In addition to complete programmability, the HP 8757A can output data back to a computer very fast. A 401 point trace of measurement data can be transmitted in 35 milliseconds.

The HP 8757S automatic scalar network analyzer system is an ordering convenience that consists of all the instruments and accessories needed for automated measurements of insertion loss or gain, return loss, SWR, and power. The system is based on the HP 8757A scalar network analyzer and is controlled by an HP 9000 series 200 computer over the HP-IB. Also included in the system are a sweep oscillator, a high directivity (40 dB) directional bridge, detectors, accessories, and the HP 85015A or HP 85016A system software.

The HP 85015A system software allows the user to configure and run automatic scalar measurements with simple menu selections. No programming is needed to perform, display, plot or print scalar measurements.

The HP 85016A transmission line test software enables the user to completely characterize coaxial cables and waveguide runs. Measure insertion and return loss of the transmission line, calculate an inverse Fast Fourier Transform, and plot return loss versus distance to locate bad connections and faults.

### HP 8756A/8756S

The HP 8756A is a microprocessor based scalar analyzer that measures swept frequency transmission and reflection. Its "soft keys" offer a subset of the functions defined for the new HP 8757A described above. The 3 detector inputs can be displayed on either display channel in a power measurement mode or ratio measurement mode. A built-in trace memory for each channel enables normalized measurements to be made at any resolution or offset. A fully annotated graphics CRT displays the measurement trace, scale per division, input being measured, and start and stop frequencies (when using an HP 8350B, 8341A or 8340A sweep oscillator).

The HP 8756A uses an ac detection scheme to reduce the effects of RFI, noise, and time and temperature drift. The HP 11664 detectors described above are also compatible with the HP 8756A, as are the directional bridges, power splitters, and other measurement accessories.

All functions and front panel controls of the HP 8756A are programmable via the HP-IB. With an HP 9000 series 200 computer, the HP 8756S automatic scalar network analyzer can make fully automated transmission and reflection measurements. The HP 85015A and HP 85016A software products are completely compatible with the HP 8756S.

### HP 8755C/8755S

The HP 8755S is an economy scalar network measurement system designed to make absolute power and ratio measurements from 10 MHz to 40 GHz. The HP 8755S consists of the HP 8755C scalar network analyzer plug-in that fits into an HP 182T display unit, an HP 8750A storage normalizer and 3 HP 11664A diode detectors. The HP 8755S can be operated with any general purpose sweep oscillator (such as the HP 8350B or 8620C). In addition to its long established use in laboratory applications, the size and portability of the HP 8755S make it well suited for field service and manufacturing environments.

The HP 8755C has two independent display channels and 3 detector inputs that permit the simultaneous display of reflection and transmission characteristics. The HP 8750A storage-normalizer will store in memory a trace for each channel and subtract it from the measured trace for normalized measurements. A complete family of directional bridges in a variety of connector types and frequency ranges from 10 MHz-26.5 GHz offer high directivity (>40 dB) for very accurate measurements. For further information refer to page 542.



## Network Analyzer Product Line Summary

HP Model	Frequency Range	Source	Measurement Capabilities
3577A Network Analyzer Page 544	5 Hz to 200 MHz	Synthesized Source	Transfer functions, magnitude/phase, insertion loss/gain, attenuation, electrical length, gain compression, Group Delay, Deviation from Linear Phase HP-IB Programmable
3582A Spectrum Analyzer Page 625	20 mHz to 25.599 kHz	Built-in source that is selectable as either random or pseudorandom. The noise signal is automatically band-limited and band-translated to match the analysis.	Transfer function amplitude and phase. Coherence function. Transient capture and analysis.
3575A Gain Phase Meter Page 548	1 Hz-13 MHz	None	Gain, Phase and Amplitude Low Frequency Analysis
8405A Vector Voltmeter Page 553	1 MHz-1 GHz (CW)	HP 3200B Oscillator, VHF Signal Generators, HP 8654 (UHF), and HP 8640 A/B	Voltmeter Transfer Functions, impedance in 50 $\Omega$ systems Group Delay, Amplitude Modulation Index S-parameters in 50 $\Omega$ systems
8754A Network Analyzer Page 550	4-2600 MHz	Swept source included external source usable.	Magnitude and phase transmission coefficient reflection coefficient and return loss S-parameters, impedance.
8505A RF Network Analyzer Page 554	500 kHz-1.3 GHz	Swept Source Included	Complex Transfer functions—Gain/Loss or S-parameters Complex Impedance— $\Gamma$ , Return Loss, $R_{\pm}$ , $\Gamma_X$ Distortion—Group Delay, Deviation from Linear Phase Digital Readout of Data while sweeping Frequency Counter included HP-IB with Learn Mode
8507S Automatic Network Analyzer Page 560	500 kHz-1.3 GHz	Swept Source Included	HP 8507D Network Analyzer Subsystem HP 85011A System Software HP 9816, 9826, or 9836 Computer Automatic Measurements with Data Formatting and Graphics. Error corrected measurements.
8755S Scalar Network Analyzer Page 543	10 MHz-40 GHz	HP 8350 or 8620 Series Sweep Oscillators	Scalar Transmission/Reflection Measurements 50 $\Omega$ Coax Measurements 10 MHz-26.5 GHz 75 $\Omega$ Coax Measurements 10 MHz-2.4 GHz Waveguide Measurements 18 GHz-40 GHz
8756A Scalar Network Analyzer Page 542	10 MHz-40 GHz	HP 8350 or 8620 Series Sweep Oscillators, HP 8340A/8341A Synthesized Sweeper	Scalar Transmission/Reflection Measurements 50 $\Omega$ Coax Measurements 10 MHz-26.5 GHz 75 $\Omega$ Coax Measurements 10 MHz-2.4 GHz Waveguide Measurements 18 GHz-40 GHz Open/Short Averaging, Normalization, Averaging Storage Registers, HP-IB Programmable
8756S Automatic Scalar Network Analyzer Page 542	10 MHz-40 GHz	HP 8350 Series Sweep Oscillators, HP 8340A/8341A Synthesized Sweeper	Automatic Scalar Transmission/Reflection Measurements Custom configurable test sequences Automatic data collection and storage HP 9816, 9826 or 9836 Computer
8757A Scalar Network Network Analyzer page 535	10 MHz-40 GHz	HP 8350 or 8620 Series Sweep Oscillators, HP 8340A or 8341A Synthesized Sweepers	Scalar Transmission/Reflection Measurements 50 $\Omega$ Coax Measurements 10 MHz-26.5 GHz 75 $\Omega$ Coax Measurements 10 MHz-2.4 GHz Waveguide Measurements 18 GHz-40 GHz
8757S Automatic Scalar Network Analyzer Page 534	10 MHz-40 GHz	HP 8350 or 8620 Series Sweep Oscillators, HP 8340A or 8341A Synthesized Sweepers	Automatic Scalar Transmission/Reflection Measurements Custom configurable test sequences Transmission line testing with fault location HP 9816, 9826 or 9836 Computer
8410C Network Analyzer Page 568	110 MHz-40 GHz	HP 8350, 8620 Series Sweep Oscillators	Transmission/Reflection Characteristics, S-Parameters 50 $\Omega$ Coax Measurements 110 MHz to 18 GHz Waveguide Measurements 8.2 GHz to 40 GHz Continuous Multioctave Measurements with HP 8620 and 8350 Series Sweepers DC Bias for Semiconductor Measurements
8408S Automatic Network Analyzer Page 575	110 MHz-18 GHz	HP 8350 or 8620 Series Sweep Oscillators	Automatic Transmission/Reflection Measurements Full Error Correction in Reflection Measurements Tracking Error Correction in Transmission Measurements HP 8410C Network Analyzer System HP 85F Desktop Computer
8510 Series Network Analyzer Page 562	45 MHz to 26.5 GHz	HP 8350 Series Sweep Oscillators HP 8340A, 8341A Synthesized Sweepers	Transmission/Reflection Characteristics S-parameters Active device characterization Full error correction in real time Time domain capability Full HP-IB programmability

# NETWORK ANALYZERS

## Automatic Scalar Network Analyzer System (10 MHz to 40 GHz)



### Model 8757S

- Measure insertion loss or gain, VSWR, and power
- Customize automatic tests without programming
- Plot and display data
- Troubleshoot waveguide and coax

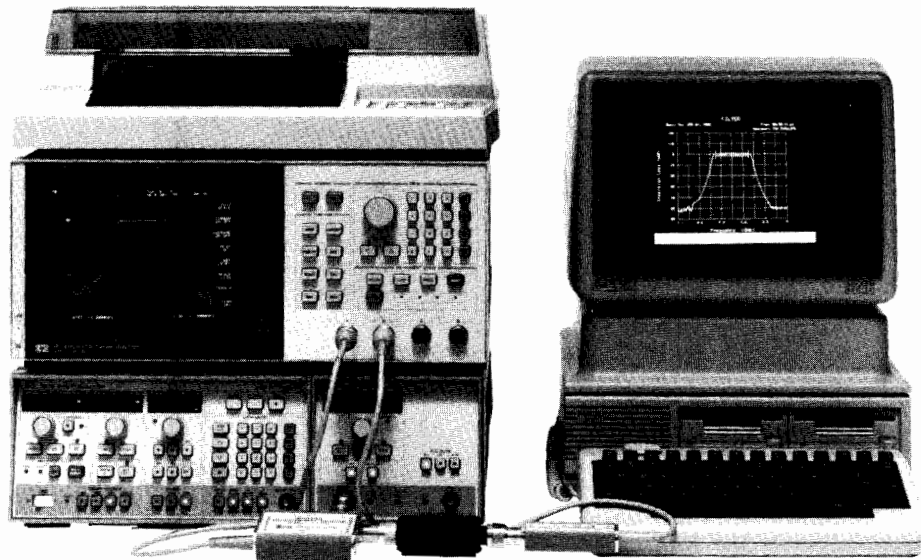

HP 8757S

The HP 8757S is a complete automatic scalar network analyzer for measurements of insertion loss or gain, return loss, and power from 10 MHz to 40 GHz. The system is based on the HP 8757A scalar network analyzer and is controlled by an HP Series 200 computer, HP 9816, 9826, or 9836, over the Hewlett-Packard Interface Bus (HP-IB). Also included in the system are a swept source (HP 8350B sweep oscillator with RF plug-in or HP 8340A/8341A synthesized sweeper), a high directivity (40 dB) directional bridge, detectors, accessories, and the HP 85015A/B or 85016A system software. All analyzer and source controls are completely programmable.

### Increase Productivity

The HP 85015A/B system software saves time and money in scalar measurements, and allows you to increase throughput without any programming. The simple menus and soft keys guide you through the measurement process. Informative "help" messages are always available for extra guidance. Frequently performed measurements may be saved for future use on the computer disc. When these test configurations are later recalled, the system is completely programmed with frequency limits, measurement channels, calibration data . . . everything you need to perform and display scalar measurements. The chances for operator error are greatly reduced, and repeatable, accurate data is ensured.

### Troubleshoot Transmission Lines

The HP 85016A transmission line test software adds accurate fault location to the system. In addition to the frequency response of waveguide runs and coaxial cables, plot return loss data as a function of distance along the line. Locate bad connections and faults that cause reflections in the frequency range of interest.

### Flexible Plot and Print Formats

Plot or print data and CRT graphics in your choice of formats without any programming. Select automatic scaling of either the vertical or horizontal axes (or both). Customize your own plot configuration with or without labels, grid lines, limit lines, and out-of-spec indicators. Plot up to four plots on a single page or print the data in the format you find most useful.

### Easy to Use

In either manual or automatic operation, the HP 8757S is easy to operate. The fully annotated HP 8757A CRT is the system's control center with convenient display of frequency, power, and scaling parameters. Manual measurements can be easily controlled with the front panel function keys. With the system software and the entire HP 8757S system, even complex scalar measurements can be performed with ease.

### High Performance

Each component of the HP 8757S is a high performance instrument in its own right. Together they form a very high performance automatic scalar network analyzer.

The HP 8757A scalar network analyzer offers 76 dB of dynamic range (+16 to -60 dBm) in three (or optionally four) independent inputs (A, B, (C), and R) when used with the HP 11664A/E detectors. Single inputs or ratio combinations of the inputs can be displayed on any of four independent display channels. Using AC modulation and detection, the HP 8757A provides excellent performance in the presence of unmodulated noise and spurious signals. The HP 11664 detectors cover the range from 10 MHz to 40 GHz and the HP 11664C detector adapter can be used with waveguide detectors for higher frequency operation. The HP 85025A AC/DC detector covers the range from 10 MHz to 18 GHz and offers the choice between AC and DC detection. In DC mode, the HP 85025A can be used to provide excellent swept power measurements (dBm).

The HP 8757A speeds repetitive measurements. With a single command from the HP Series 200 computer, the HP 8757A can transfer 401 points of measurement data to the computer with 0.01 dB resolution in only 35 milliseconds.

Test signals are provided by the HP 8350B sweep oscillator with an RF plug-in or by the HP 8340A/8341A synthesized sweepers. All source front panel functions are fully programmable via HP-IB and are also easy to use in manual applications. Frequency and power entries can be made with a knob, a numeric keypad, or with increment and decrement keys. Up to nine independent front panel settings may be saved or recalled at the touch of a key or through HP-IB.

# NETWORK ANALYZERS

## Scalar Network Analyzer, 10 MHz to 40 GHz

Model 8757A



- 76 dB dynamic range
- Accurate swept power measurements (dBm)
- 40 dB directivity bridges

- Four independent display channels
- Limit testing built in
- Save/recall setup and cal data
- Direct plotter output

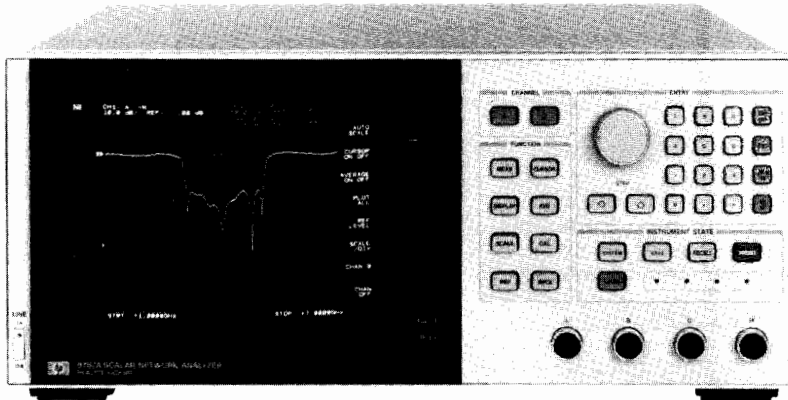

HP 8757A Option 001

### Description

Measure insertion loss or gain, return loss, SWR, and power quickly and accurately with the new HP 8757A scalar network analyzer. With high performance detectors and directional bridges and a companion HP source and digital plotter, the HP 8757A becomes the basis of a complete measurement system with superb performance.

### Performance

The HP 8757A features 76 dB of dynamic range (-60 dBm to +16 dBm) when used with the HP 11664A/E detectors. With square wave modulation and detection (AC), the HP 11664 detectors enable reliable, drift-free measurements from 10 MHz to 40 GHz. With the new HP 85025A/B AC/DC detector, make scalar measurements with or without modulation. In DC mode (no modulation), use the HP 85025A/B to make accurate swept-frequency measurements of power (dBm).

High directivity bridges (>40 dB) covering RF and microwave frequencies help produce excellent measurement results. Using the HP 85020A/B and 85021A/B/C directional bridges, make accurate measurements of reflection and transmission parameters simultaneously.

Calibrate your test system, and make normalized measurements with 0.01 dB vertical resolution. Select the optimum horizontal resolution for your application, by choosing 101, 201, 401, 801, or 1601 data points. Lower resolution allows faster sweep times. Calibrate with full 1601 point resolution over your frequency range. Then zoom in on a narrower frequency span and retain calibration. The HP 8757A interpolates the calibration data automatically.

### Easy to Use

With a combination of simple front panel keys and powerful menu-driven soft keys, the HP 8757A allows you to set up the system and make accurate measurements fast. Menus appear on the display, and you control them with the front panel soft keys. The soft keys give you powerful capabilities without adding front panel complexity. Press "Cal" and let the menu guide you through calibration procedures. Press "Autoscale" to bring your measurement into view quickly. Activate the "Cursor" and dial it to any point on your data trace for an accurate high resolution reading of magnitude (and frequency with the HP 8350B/8340A/8341A). Measurements are fast and easy.

### Productivity Without a Controller

The HP 8757A increases productivity in scalar measurements even without a controller. Decrease the time it takes you to set up and make measurements, while improving the quality of the results.

Four independent display channels add new capabilities to the

system. Each channel can display the data taken from any of the three (or optionally four) detector inputs. Each channel can display a single input (A, B, C), R) or a ratio combination of two inputs (A/R, B/R, A/B, etc.). With four inputs, measure multi-port devices or characterize several devices simultaneously. Or compare the response of the test device to the stored response of your "reference" device.

Enter your own limit lines for easy comparison of measurement results to upper and lower specification limits. Or use these lines as your own reference calibration and remove the frequency responses of devices that are inserted after calibration.

When used with the HP 8350B sweep oscillator or the HP 8340A/8341A synthesized sweepers, the HP 8757A acts as a system controller by managing the source via the "8757 System Interface." Using this interface the HP 8757A can extract frequency information and annotate the display. When used alone, the HP 8757A can save and recall up to nine front panel states in non-volatile memory, complete with calibration or measurement data, limit lines, and plot labels. With the system interface and a companion HP source, the HP 8757A can save and recall not only its own front panel state, but the source's as well. Configure often repeated measurements only once. Then just recall that set-up and connect your device.

Combining the HP 8757A with an HP 8350B/8340A/8341A also enables the useful "alternate sweep" function, which allows you to sweep different frequency ranges or power levels and display them both in real time.

The HP 8757A can adapt to any sweep ramp input in the 0-10 V range, such as a 2-5 V ramp. Test voltage-controlled oscillators and attenuators, using your test voltage ramp to drive the HP 8757A display. Plot output power or attenuation versus tuning voltage.

### Document Your Results

The HP 8757A also uses the "8757 System Interface" to drive an HP-IB digital plotter. Plot what appears on the CRT or define your own plot and plot size. Get crisp, permanent, annotated plots without a controller.

### Millimeter Wave Measurements

Use the HP 8350B sweep oscillator with the HP 83572A/B option 001/006 to make measurements in the 26.5 to 40 GHz range with the HP 8757A and the HP 11664D Waveguide Detector. Use the HP R752C waveguide directional coupler to perform simultaneous ratio measurements of reflection and transmission. Frequencies above 40 GHz can be accommodated with the HP 11664C detector adapter and a suitable waveguide detector.



# NETWORK ANALYZERS

## 8757 System Components

Models 8757A, 85021A/B/C, 85020A/B

### HP 8757A Specifications

#### Amplitude Characteristics

**Dynamic range on all three (or four) inputs (A, B, (C), and R).**

Detector	Range
HP 11664A	+16 to -60 dBm
HP 11664E	+16 to -60 dBm
HP 11664D	+10 to -50 dBm
HP 85025A	
AC mode	+16 to -55 dBm
DC mode	+16 to -50 dBm

**Dynamic accuracy:** dynamic accuracy of a single channel measurement using the HP 11664A/E detectors. Measurement taken at 25°C and at 50 MHz.

±(0.1 dB + 0.01 dB/dB) from +10 to -40 dBm

±(0.2 dB + 0.02 dB/dB) from -40 to -60 dBm

**Scale resolution:** 0.1, 0.2, 0.5, 1, 2, 5, 10, or 20 dB per division. Independently controlled for each channel.

**Reference offset:** offset level adjustable in 0.01 dB increments from -70 to +20 dBm (power measurement) or -90 to +90 dB (ratio measurement).

#### Display characteristics

##### Resolution

**Vertical:** 0.003 dB (power measurement)

0.006 dB (ratio measurement)

0.01 dB for "Display Cursor"

**Horizontal:** 101, 201, 401, 801, or 1601 data points

**Sweep time/number of traces:** minimum sweep time and maximum number of display traces depend on horizontal resolution.

Number of Points	Minimum Sweep Time	Number of Traces
101	50 ms	4
201	100 ms	4
401	200 ms	4
801	200 ms	2
1601	200 ms	1

**Averaging:** 2,4,8,16,32,64,128, or 256 traces may be averaged.

**Normalization:** traces are stored and normalized with the highest resolution, independent of display scale/division or offset. Calibration data can be saved and recalled with instrument states, and is interpolated when the frequency span is decreased.

#### HP-IB Characteristics

**Transfer formats:** Data may be transferred either as ASCII strings (nominally six characters per reading) or as 16 bit integers (most significant byte first). Readings may be taken at a single point, or an entire trace may be transferred at once.

##### Transfer speed:

ASCII format, 401 point trace: 800 ms typical.

ASCII format, point: 10 ms typical.

Binary format, 401 point trace: 35 ms typical.

Binary format, point: 5 ms typical.

#### System Interface

**Description:** the HP 8757A system interface is a dedicated HP-IB port used exclusively by the HP 8757A to control and extract information from a swept source and a digital plotter.

**Swept sources:** HP 8350B with RF plug-in, HP 8340A/8341A synthesized sweeper, or any source that provides a sweep ramp in the range of 0-10 volts (e.g., 2-5 volts).

**Plotters:** HP 7470A, 7475A, 7550A, 7090A, 9872C

#### General Specifications

**Power requirements:** 48 to 62 Hz, 115/230 V ±10%, typically 100 watts.

**Dimensions:** 178 H x 425.5 W x 482 mm D (7.0 x 16.75 x 19.0 in.).

**Weight:** net, 21 kg (46 lb); shipping, 26 kg (57 lb).

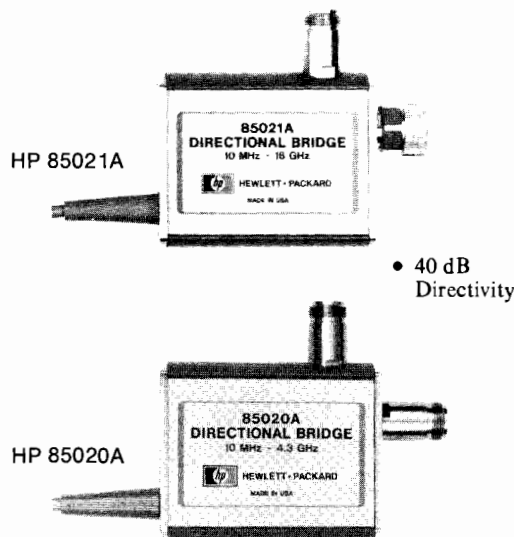

### Directional Bridges

The HP 85020A/B and HP 85021A/B/C are directional bridges designed especially for the HP 8757A, 8756A and 8755C scalar network analyzers. Each bridge features outstanding directivity and test port match in a compact, rugged package.

Within each bridge, one zero-bias Schottky diode detector measures the return loss of the test device. Ratio measurements can be made by adding a power splitter (HP 11667A/B) and detector (HP 11664A/D/E).

#### HP 85021A/B/C Directional Bridges

The three microwave directional bridges cover the 10 MHz to 26.5 GHz frequency range. Accurately measure SMA devices over the full 10 MHz to 26.5 GHz frequency range with the HP 85021B Bridge with its precise APC 3.5 test port connector. For 10 MHz to 18 GHz reflection measurements choose the HP 85021C with its Type-N test port connector or the rugged APC-7® test port connector of the HP 85021A.

#### HP 85021A/B/C Specifications

##### Frequency Range

HP 85021A: 0.01 to 18 GHz.

HP 85021B: 0.01 to 26.5 GHz.

HP 85021C: 0.01 to 18 GHz.





**Nominal impedance:** 50 ohms.

**Input Connector**

**HP 85021A:** Type-N Female.  
**HP 85021B:** APC-3.5 Female.  
**HP 85021C:** Type-N Female.

**Output Connector**

**HP 85021A:** APC-7.  
**HP 85021B:** APC-3.5 Female.  
**HP 85021C:** Type-N Female.

**Maximum power to input port:** +23 dBm.

**Directivity**

**HP 85021A:** 0.01 to 0.04 GHz: 36 dB.  
 0.04 to 18 GHz: 40 dB.  
**HP 85021B:** 0.01 to 0.04 GHz: 36 dB.  
 0.04 to 20 GHz: 40 dB.  
 20 to 26.5 GHz: 36 dB.  
**HP 85021C:** 0.01 to 12.4 GHz: 36 dB.  
 12.4 to 18 GHz: 34 dB.

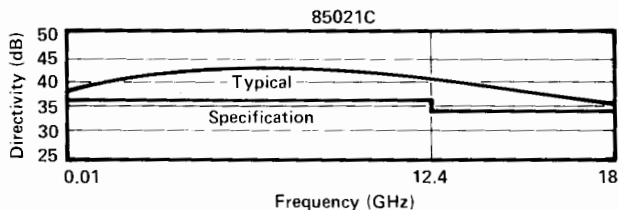
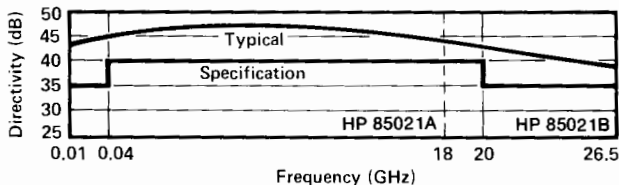

**Test Port Match (SWR)**

**HP 85021A/C:** 0.01 to 8.4 GHz: 1.15.  
 8.4 to 12.4 GHz: 1.25.  
 12.4 to 18 GHz: 1.40.  
**HP 85021B:** 0.01 to 8.4 GHz: 1.15.  
 8.4 to 20 GHz: 1.40.  
 20 to 26.5 GHz: 1.75.

**Typical Input Port Match (SWR)**

**HP 85021A/C:** 0.01 to 8.4 GHz: <1.22.  
 8.4 to 18 GHz: <1.43.  
**HP 85021B:** 0.01 to 8.4 GHz: <1.22.  
 8.4 to 20 GHz: <1.43.  
 20 to 26.5 GHz: <1.93.

**Typical Insertion Loss**

**HP 85021A/B/C:** 6.5 dB at 10 MHz.  
 8.0 dB at 18 GHz.  
**HP 85021B:** 10 dB at 26.5 GHz.

**Typical detector flatness:** +3, -1 dB (with leveled RF).

**Typical minimum input power** (for a 40 dB return loss measurement): +7 dBm at 18 GHz.

**Dimensions:** 15 H x 110 W x 96 mm D (1.0 x 4.3 x 3.9 in).

**Weight:** net, 0.5 kg (1.2 lb); shipping, 2.3 kg (5 lb).

**HP 85020A/B Directional Bridges**

The economical HP 85020A/B directional bridges also offer high (40 dB) directivity and excellent port match at RF (to 4.3 GHz) frequencies. For 50 ohm measurements choose the HP 85020A. The HP 85020B is designed for 75 ohm environments. Both RF bridges have Type-N connectors.

**HP 85020A/B Specifications**

**Frequency Range**

**HP 85020A:** 0.01 to 4.3 GHz.  
**HP 85020B:** 0.01 to 2.4 GHz.

**Nominal Impedance**

**HP 85020A:** 50 ohms.  
**HP 85020B:** 75 ohms.

**Connectors:** Type-N Female.

**Maximum power to input port:** +23 dBm.

**Directivity**

**HP 85020A:** 0.01 to 3 GHz: 40 dB.  
 3 to 4.3 GHz: 34 dB.  
**HP 85020B:** 0.01 to 2.4 GHz: 40 dB.

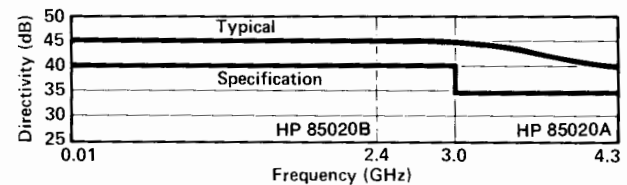

**Test Port Match (SWR)**

**HP 85020A:** 0.01 to 3 GHz: 1.20.  
 3 to 4.3 GHz: 1.25.  
**HP 85020B:** 0.01 to 1.3 GHz: 1.25.  
 1.3 to 2.4 GHz: 1.39.

**Typical Input Port Match (SWR)**

**HP 85020A:** 0.01 to 4.3 GHz: 1.25.  
**HP 85020B:** 0.01 to 2.4 GHz: 1.25.

**Typical insertion loss:** 6.5 dB.

**Typical detector flatness:** ±0.5 dB.

**Typical minimum input power** (for a 40 dB return loss measurement): +4 dBm.

**Dimensions:** 25 H x 110 W x 96 mm D (1.0 x 4.3 x 3.9 in).

**Weight:** net, 0.5 kg (1.2 lb); shipping, 2.3 kg (5 lb).

# NETWORK ANALYZERS

## 8756 System Accessories



Models 11664A/C/D/E, 85025A/B, 85023A, 85022A/B/C/D, 85015A, 11668A, 85016A, 11678A



HP 11664A



HP 11664D



HP 11664E



HP 11664C

### HP 11664A Detectors

**Function:** designed specifically for use with the HP 8757A, 8756A and 8755C scalar network analyzers, the HP 11664A detects the envelope of the 27.8 kHz modulated microwave signal.  
**Frequency range:** 10 MHz to 18 GHz.

### Tracking between Two HP 11664A Detectors

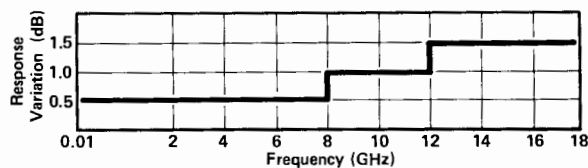

### Typical Frequency Response

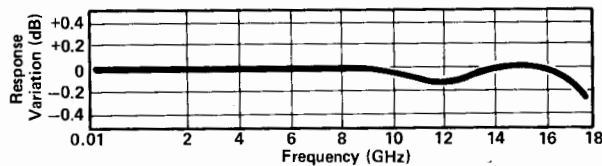

### Return Loss

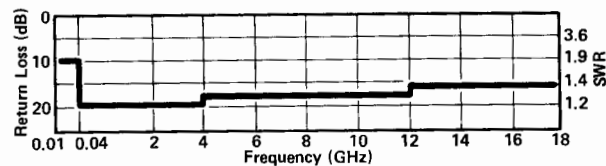

**Impedance:** 50 ohms nominal.

**Connector:** N-Male.

### HP 11664E Detectors

(All specifications are the same as the HP 11664A with the following differences):

**Frequency range:** 10 MHz to 26.5 GHz.

**Tracking between two HP 11664E Detectors:** tracking between two detectors at the same power level is typically <2 dB from 10 MHz to 26.5 GHz.

### Return Loss:

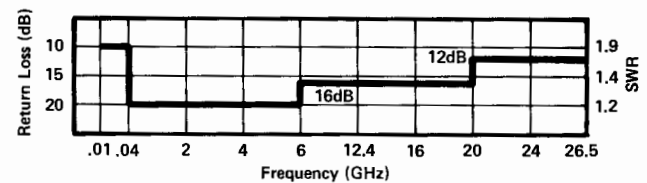

**Connector:** APC 3.5 Male.

### HP 11664D Detectors

**Function:** designed specifically for use with the HP 8757A, 8756A, and 8755C scalar network analyzers. The HP 11664D detects the envelope of the 27.8 kHz modulated microwave signal.

**Frequency range:** 26.5 to 40 GHz.

**Frequency response flatness:** ±1.5 dB.

**Return loss:** >12 dB (<1.7 SWR).

### Dynamic range:

With HP 8757A, 65 dB (-55 to +10 dBm).

With HP 8756A or 8755C, 60 dB (-50 to +10 dBm).

**Maximum input power:** +16 dBm.

**Amplitude variation due to temperature:** ±0.6 dB from 0° C to 55° C.

**Dynamic accuracy (typical):** ±(0.2 dB +0.02 dB/dB) referenced to 0 dBm at 25° C.

**Input waveguide:** EIA size WR-28.

**Recommended sources:** HP 8350A/B sweeper manframe with HP 83572A/B Option 006 RF plug-in.

**Weight:** net, 0.24 kg (0.5 lb); shipping, 1.0 kg (2.2 lb).

### HP 11664C Detector Adapter

The HP 11664C detector adapter is used to adapt any standard diode detector output (low barrier Schottky or point contact crystal, positive or negative bias) with the HP 8757A, 8756A or 8755C scalar network analyzer. You can extend the frequency range of the scalar network analyzer to that of the diode detector used. For example, the HP R422A waveguide crystal detector with the HP 11664C detector adapter allows the HP 8757A, 8756A or 8755C scalar network analyzer to make transmission and reflection measurements up to 40 GHz. Two adjustments allow you to accurately match the diode detector to the scalar network analyzer.

**Connector:** BNC Male.

**Weight:** net 0.17 kg (0.4 lb). Shipping 0.9 kg (2 lb).

### HP 85025A/B AC/DC Detector

Designed only for use with the HP 8757A scalar network analyzer in either AC or DC modes from 10 MHz to 18 GHz with the HP 85025A and from 10 MHz to 26.5 GHz with the HP 85025B. In AC, these detectors detect the envelope of a 27.8 kHz modulated signal. In DC, no modulation is required.



HP 85023C

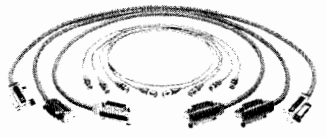

HP 85022A

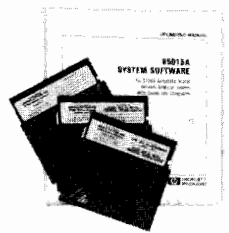

HP 85015A

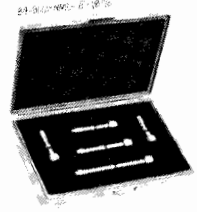

HP 11678A

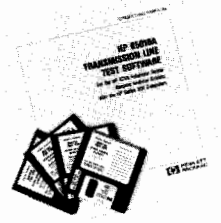

HP 85016A



HP 11668A

**HP 85023A/B/C/D Verification Kits**

The HP 85023A/B/C/D system verification kits each contain a set of precision components used to perform a system verification procedure for the HP 8757S/56S Scalar Network Analyzer System. This procedure, which is in the HP 8757A/56A Operating and Service Manual, checks system installation and can be used as a daily functional test.

Choose a system verification kit to match your device under test. For APC-7 applications, select the HP 85023A. If you are measuring SMA or APC-3.5 devices, choose the HP 85023B. For 50 ohm, Type-N applications, select the HP 85023C. These kits (HP 85023A/B/C) all include an open, short, 10 dB fixed attenuator, 50 ohm termination, and a source to directional bridge adapter of the corresponding connector type. The HP 85023D verification kit, for 75 ohm Type-N measurements, consists of a short, a 75 ohm termination, a 50 ohm 10 dB fixed attenuator and two HP 11852A 50 to 75 ohm minimum loss pads (for 50/75 ohm impedance conversion).

**Frequency range:** HP 85023A/C, dc to 18 GHz.  
HP 85023D, dc to 1.3 GHz.  
HP 85023B, dc to 26.5 GHz.

**Connector type:** HP 85023A, APC-7.  
HP 85023B, APC-3.5.  
HP 85023C, Type-N, 50 ohm.  
HP 85023D, Type-N, 75 ohm.

**Characteristic impedance:** HP 85023A/B/C, 50 ohm.  
HP 85023D, 75 ohm.

**Weight:** net, 0.5 kg (1.2 lb); shipping, 1.2 kg (2.9 lb).

**HP 85022A System Cable Kit**

The HP 85022A contains all the BNC and HP-IB cables to connect an HP 8350B sweep oscillator (or HP 8340A synthesized sweeper), an HP Series 200 computer, and a printer to the HP 8757A or 8756A. This kit contains 3 one-metre HP-IB cables (HP 10833A), 3 two-foot BNC cables (HP 11170B), and 1 four-foot BNC cable (HP 11170C).

**BNC connectors:** N-Male, N-Male.

**BNC impedance:** 50 ohm.

**Weight:** net, 0.5 kg (1.2 lb); shipping, 1.2 kg (2.9 lb).

**HP 85015A/B System Software for HP 8757S/8756S**

Save frequently performed measurement procedures and calibration data for future use. Measure insertion loss, gain, power and reflection coefficient. The HP 85015 allows you to customize your test sequence and then print or plot the output in your choice of formats. The HP 85015 includes two system discs and a data disc for either 5.25 inch or 3.5 inch disc drives. Choose the option that corresponds to your computer configuration.

**Weight:** net, 0.5 kg (1.2 lb); shipping, 1.2 kg (2.9 lb).

**HP 85016A Transmission Line Test Software for HP 8757S/8756S**

Add accurate transmission line fault location to the HP 85015A/B system software. In addition to frequency response, plot return loss of cables and waveguides as a function of distance. The HP 85016A includes three system discs and one data disc for either 5.25 inch or 3.5 inch disc drives. Choose the option that corresponds to your computer configuration.

**Weight:** net, 0.5 kg (1.2 lb); shipping, 1.2 kg (2.9 lb).

**HP 11668A High Pass Filter**

The HP 11668A high pass filter accessory is recommended when making measurements on active devices that have gain below 50 MHz. Use of the HP 11668A, placed after the HP 11665B, reduces the modulator drive feedthrough from 8 mV to 1 mV and prevents possible amplifier saturation. Use of the HP 11668A filter is not necessary for passive measurements since the feedthrough from the HP 11665B is -65 dBm and causes no degradation in system performance.

**Frequency range:** 50 MHz to 18 GHz.

	Insertion Loss	Return Loss
50-100 MHz	≤2.5 dB	≥12 dB
100 MHz-8 GHz	≤1.0 dB	≥16 dB
8-12 GHz	≤1.0 dB	≥14 dB
12-18 GHz	≤1.5 dB	≥14 dB

**Maximum input:** +27 dBm.

**Connectors:** N-female, N-male.

**Weight:** net, 0.13 kg (5 oz); shipping, 0.28 kg (10 oz).

**HP 11678A Low Pass Filter Kit**

**Description:** the HP 11678A low pass filter kit contains five filters. Low pass filters reduce harmonics generated by the RF source when making precision measurements.

**Frequency Range** (low pass filters, cutoff frequency fc)

- HP 11668A: 2.8 GHz.
- HP 11689A: 4.4 GHz.
- HP 11684A: 6.8 GHz.
- HP 11685A: 9.5 GHz.
- HP 11686A: 13.0 GHz.

**Insertion loss:** <1.1 dB at 0.95 fc.

**Rejection** (at 1.25 fc): greater than 40 dB.

**Impedance:** 50 ohm normal.

**Connectors:** N-Female, N-Male.

**Weight:** net, 0.44 kg (1 lb); shipping, 1.2 kg (2.9 lb).

**Service Products**

**HP 8757+23N/8756+23N Onsite Installation (where available)**

Be sure your HP 8757S or 8756S automatic scalar network analyzer system is operating from the start by having an HP Customer Engineer configure your system at your site. After you have unpacked the equipment the HP Customer Engineer will assemble and verify the operation of your system.

**HP 8757S+23B/8756S+23B Onsite Service (where available)**

Increase your total system uptime by ordering onsite service. An HP Customer Engineer will come to your site to perform all repairs for one year.

# NETWORK ANALYZERS

## 8757/8756 System Accessories (cont.)

Models 11667A/B, 11636A/B, 11665B, 11679A/B, 11852A

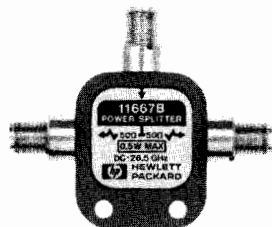

HP 11667B

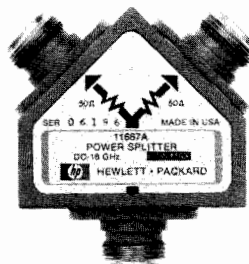

HP 11667A



HP 11665B

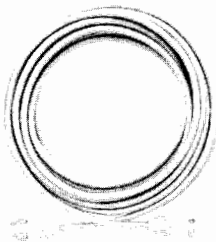

HP 11679A

### HP 11667A/B Power Splitter

The HP 11667A/B power splitters are recommended when making wideband ratio measurements using the HP 8757A, 8756A or 8755C scalar network analyzer. These two-resistor type splitters provide excellent output SWR at the auxiliary arm when used for source leveling or ratio measurement applications. The tracking between output arms over a frequency range from dc to 18 GHz allows wideband measurements to be made with a minimum of uncertainty.

#### Frequency Range:

HP 11667A: DC to 18 GHz.

HP 11667B: DC to 26.5 GHz.

**Impedance:** 50 ohms nominal.

**Insertion Loss:** 6 dB nominal.

	DC to 4 GHz	DC to 8 GHz	DC to 18 GHz	DC to 26.5 GHz
<b>Input SWR:</b>				
HP 11667A:	≤1.15	≤1.25	≤1.45	
HP 11667B:	≤1.22	≤1.22	≤1.22	≤1.29
<b>Equivalent Output SWR:</b> (leveling or ratio measurements)				
HP 11667A:	≤1.10	≤1.20	≤1.33	
HP 11667B:	≤1.22	≤1.22	≤1.22	≤1.22
<b>Output Tracking:</b> (between output arms)				
HP 11667A:	≤0.15 dB	≤0.20 dB	≤0.25 dB	
HP 11667B:	≤0.20 dB	≤0.20 dB	≤0.20 dB	≤0.25 dB
<b>Typical Phase Tracking:</b> (between output arms)				
HP 11667A:	0.5 deg	1.5 deg	3.0 deg	
HP 11667B:	1.5 deg	1.5 deg	1.5 deg	2.5 deg
<b>Maximum Input Power:</b>	+27 dBm.			

### Connectors:

HP 11667A: N-female on all ports.

HP 11667B: APC-3.5 female on all ports.

### Dimensions:

HP 11667A: 46 H x 52 W x 19 mm D (1.8 x 2.0 x 0.7 in).

HP 11667B: 40 H x 47 W x 10 mm D (1.6 x 1.9 x 0.4 in).

### Weight:

HP 11667A: net, 0.14 kg (0.31 lb); shipping, 0.22 kg (0.5 lb).

HP 11667B: net, 0.06 kg (0.13 lb); shipping, 0.14 kg (0.3 lb).

### HP 11636A/B Power Dividers

The HP 11636A/B power dividers/combiners are recommended when making wideband comparison measurements without ratioing, and in fault location measurements with the HP 8757S/85016. Detailed specifications are on page 501.

### Other Signal Separation Devices

Many other signal separation devices are available from HP for use with the HP 8757A, 8756A and 8755C. Coaxial couplers from 0.1 to 18 GHz are available with the HP 770 series, the 790 series, and the HP 11692. Higher directivity HP 752 series waveguide couplers can also be used with the HP 8757A, 8756A or 8755C with the addition of appropriate HP 281 series waveguide-to-coax adapters.

### 11665B Modulator

**Function:** absorptive on-off modulator designed for and powered by the HP 8757A, 8756A or 8755C scalar network analyzers.

Frequency Range	Return Loss On and Off	Insertion Loss On Off
15-40 MHz	≥10 dB	≤7.0 dB ≥35 dB
40 MHz-4 GHz	≥15 dB	≤3.2 dB ≥35 dB
4-8 GHz	≥12 dB	≤3.8 dB ≥40 dB
8-12.4 GHz	≥8 dB	≤4.3 dB ≥45 dB
12.4-18 GHz	≥8 dB	≤5.0 dB ≥45 dB

**Modulator drive feedthrough:** ≤8 mV (peak) at 27.8 kHz at either port when powered by the HP 8757A, 8756A or 8755C. Reduced to ≤1 mV (peak) using the HP 11668A. (See HP 11668A High Pass Filter).

**Drive current:** nominally +50 mA in On condition, -50 mA Off condition.

**Weight:** net, 0.17 kg (6 oz); shipping, 0.9 kg (2 lb).

### HP 11679A/B Extension Cables

For applications where it is inconvenient to have the network analyzer near the test device, the HP 11679A 25-foot extension cable or HP 11679B 200-foot extension cable fits directly between the HP 11664 detector and display. Remote detector operation is permitted without performance degradation.

### HP 11852A 50 ohm/75 ohm Minimum Loss Pad

The HP 11852A is a low SWR minimum loss pad required between 75 ohm devices and 50 ohm sources and detectors. For more information, see page 559.

**Ordering Information**

The HP 8757S Automatic Scalar Network Analyzer is ordered with multiple line items to give you maximum flexibility in specifying a system that meets your needs. This ordering guide lists the HP 8757S line items required for software compatibility. It is not necessary to order any line item you already own. Consult your local HP Sales Office if you would like assistance.

**HP 8757S Scalar Network Analyzer System**

This system model number ensures coordination of shipments and compatibility of instruments and software.

**Analyzer**

HP 8757A Scalar Network Analyzer  
Opt. 001 Fourth detector input

**Sweep Oscillators** (choose either HP 8350B with an RF Plug-in 8340A or 8341A)

HP 8350B Sweep Oscillator Mainframe  
HP 83522A 0.01-2.4 GHz RF Plug-in  
HP 83592A 0.01-20 GHz RF Plug-in  
HP 83595A 0.01-26.5 GHz RF Plug-in  
Other RF Plug-in (see HP 8350B catalog entry for model and options)

HP 8340A 0.01-26.5 GHz Synthesized Sweeper  
HP 8341A 0.01-20 GHz Synthesized Sweeper

**Directional Bridges** (choose at least one)

HP 85021A 0.01-18 GHz, APC-7, 50 ohm  
HP 85021B 0.01-26.5 GHz, APC-3.5 female, 50 ohm  
HP 85021C 0.01-18 GHz, Type-N female, 50 ohm  
HP 85020A 0.01-4.3 GHz, Type-N female, 50 ohm  
HP 85020B 0.01-2.4 GHz, Type-N female, 75 ohm

**Detectors** (choose at least one)

HP 11664A 0.01-18 GHz, Type-N male  
Opt. 001 0.01-18 GHz, APC-7  
HP 11664E 0.01-26.5 GHz, APC-3.5 male  
HP 11664D Waveguide Detector 26.5-40 GHz  
HP 11664C Detector Adapter  
HP 85025A AC/DC Detector 0.01-18 GHz  
HP 85025B AC/DC Detector 0.01-26.5 GHz

**System Verification Kits** (choose at least one)

HP 85023A APC-7, 50 ohm  
HP 85023B APC-3.5, 50 ohm  
HP 85023C Type-N, 50 ohm  
HP 85023D Type-N, 75 ohm

**Filter Kits**

HP 11668 High Pass Filter Kit  
HP 11678 Low Pass Filter Kit

**System Cable Kit**

HP 85022A System Cable Kit

**Computer** (choose one)

HP 9816S Series 200, Model 16S Computer (select option)  
Opt. 630 for use with HP 9121D Disc Drive  
Opt. 650 for use with HP 82901M Disc Drive  
HP 9826S Series 200, Model 26S Computer  
HP 9836S Series 200, Model 36S Computer  
HP 98256A 256K byte Memory Board (required for all computers)

**Disc Drives** (one required for HP 9816S)

HP 9121D 3.5 inch Dual Flexible Disc Drive  
HP 82901M 5.25 inch Dual Flexible Disc Drive

**Software** (choose one option)

HP 85015A System Software for HP 8757S  
Opt. 630 for HP 9816S Computer with HP 9121D Disc Drive  
Opt. 650 for HP 9816S Computer with HP 82901M Disc Drive  
Opt. 655 for either HP 9826S or 9836S Computer  
HP 85016A Transmission Line Test Software for HP 8757S  
Opt. 630: For HP 9816S Computer with HP 9121D Disc Drive  
Opt. 655: For either HP 9826S or 9836S Computer

**Recommended Accessories**

**Printer** (choose at least one)

HP 2673A Intelligent Graphics Printer  
HP 2932A Impact Graphics Printer

**Plotter** (choose at least one)

HP 7470A Opt. 002 Two-pen Graphics Plotter (8.5" x 11")  
HP 7550 Eight-pen Vector Plotter (11" x 17")

**Optional Accessories** (for ratio and/or modulation measurements)

HP 11636A Power Divider DC to 18 GHz  
HP 11636B Power Divider DC to 26.5 GHz  
HP 11665B Modulator  
HP 11667A Power Splitter DC to 18 GHz  
Opt. 001 N-male on input port; N-female on output ports:  
Opt. 002 N-female on input port; APC-7 on output ports:  
HP 11667B Power Splitter DC to 26.5 GHz  
HP 11852A 50 to 75 ohm Minimum Loss Pad

**Service and Support Products**

HP 8757S+23N Onsite Installation (where available)  
HP 8757S+23B Onsite Service (where available)

**Compatible HP 8350B Plug-Ins**

(HP 86200 series plug-ins require the HP 11869A adapter for use with the HP 8350)

HP Model Number	Frequency Range (GHz)	Power Out (mW)
83595A	0.01-26.5	2.5
83592A	0.01-20.0	10
83592B	0.01-20.0	20
83592C	0.01-20.0	4
83525A	0.01-8.4	20
83525B	0.01-8.4	10
83522A	0.01-2.4	20
83594A	2.0-26.5	2.5
83590A	2.0-20.0	10
83540A	2.0-8.4	40
83540B	2.0-8.4	20
83545A	5.9-12.4	50
83570A	18.0-26.5	10
83572A**	26.5-40.0	2
83572B**	26.5-40.0	2
86222A	0.01-2.4	20
86222B	0.01-2.4	20
86220A*	0.01-1.3	10
86235A	1.7-4.3	40
86290B	2.0-18.6	10
86290C	2.0-18.6	20
86240A	2.0-8.4	40
86240B	2.0-8.4	20
86240C	3.6-8.6	40
86241A*	3.2-6.5	3.2
86245A	5.9-12.4	50
86242D	5.9-9.0	10
86250D	8.0-12.4	10
86251A	7.5-18.6	10
86260B*	10.0-18.6	10
86260A*	12.4-18.0	10
86260C*	17.0-22.0	10

8620C sweep oscillator mainframe  
8350B sweep oscillator mainframe  
11689A adapter for HP 86200 plug-in

\* Requires HP 11665B modulator.  
\*\* Requires Option 006 for internal 27.8 kHz modulator.



# NETWORK ANALYZERS

## Scalar Network Analyzer, 10 MHz to 40 GHz

### Model 8756A

- High (40 dB) directivity bridges
- "Autoscale" for fast measurements
- Full HP-IB programmability
- Fully annotated digital display
- Nine "Save/Recall" registers
- Direct digital plot capability

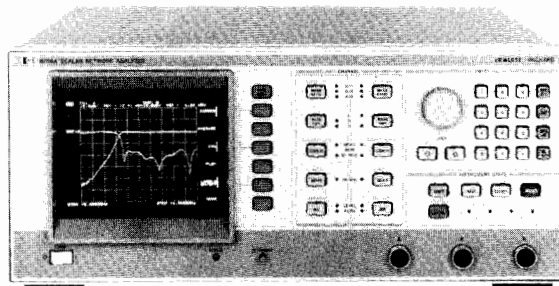

HP 8756A



### Description

Measure insertion loss and gain, return loss, and absolute power quickly and accurately with the HP 8756A scalar network analyzer. These scalar measurements can be performed over a broad 10 MHz to 40 GHz frequency range. The HP 11664 diode detectors and ac modulation make accurate, reliable, and drift-free measurements. High-directivity directional bridges covering RF and microwave frequencies produce excellent reflection measurements. The HP 85020 and 85021 bridges, HP 11664 detectors and other scalar accessories are described on pages 536 through 537.

### Easy-to-Use

The HP 8756A features two independent display channels with separate controls. Most measurements can be performed using only five keys for each channel.

Make even faster measurements with one key—the "Autoscale" key. Press it and the built-in microprocessor chooses the optimum scale and reference level to display your measurement.

### For Automatic or Manual Systems

When used with the HP 8350B sweep oscillator or HP 8341A/8340A synthesized sweepers, the HP 8756A acts as a system controller by managing the other instruments through the "HP 8756 System Interface." Using the system interface, the HP 8756A extracts frequency information from the sweeper and uses it to annotate the digital display.

When used alone, the HP 8756A can save and recall up to nine front-panel states. With the HP 8350B or 8340A, it saves and recalls not only its own front-panel state, but the sweeper's as well.

Another benefit of the HP 8756A/8350B combination is "Alternate Sweep"; the ability to sweep two different frequency ranges or power levels and display them simultaneously.

System control also extends to an HP-IB digital plotter. The HP 8756A can directly plot the CRT's image onto a plotter such as the HP 7475A or 7470A. Crisp, permanent, annotated plots can be created just by selecting the Plot soft key.

### Programmability Features

Since all of the controls of the HP 8756A are completely programmable, computer-controlled automatic systems can make full use of the HP 8756A and its built-in features. Measured data can be taken from the HP 8756A in two ways: the traditional method of point-by-point at CW frequencies, or by Trace Transfer. Using Trace Transfer, the HP 8756A can transfer a complete 400-point measurement within milliseconds over the Hewlett-Packard Interface Bus (HP-IB). In either case, measurements are transferred with 0.01 dB resolution, regardless of front panel settings.

### Specifications

**Function:** The HP 8756A processes and displays the demodulated 27.8 kHz signals from the HP 11664 detectors and the HP 85020 or 85021 bridges.

**Dynamic range:** +10 dBm to -50 dBm in all three inputs (A, B, and R).

**Dynamic accuracy:** dynamic accuracy of a single channel measurement using HP 11664A/B/E Detector. Measurement taken over +10 to -50 dBm at 25°C and at 50 MHz.

±(0.1 dB + 0.01 dB/DB) from +10 to -40 dBm.

±(0.2 dB + 0.02 dB/DB) from -40 to -50 dBm.

**Scale resolution:** 0.1, 0.2, 0.5, 1, 2, 5, 10, or 20 dB per division. Independently controlled for each measurement channel.

**Reference offset:** offset level adjustable in 0.01 dB increments from -70.00 to +20.00 dBm (absolute) or -90.00 to -90.00 dB (ratio).

### Resolution

**Vertical:** 0.006 dB for display.

0.01 dB for "Display Cursor."

**Horizontal:** 401 points.

**Sweep time:** minimum sweep time ≥ 150 ms.

**Averaging:** 2, 4, 8, 16, 32, 64, 128, or 256 traces may be averaged. Independent control of each display channel.

**Normalization:** traces are stored and normalized to 0.006 dB resolution, independent of scale/division or offset. The horizontal resolution is 401 points.

**Transfer formats:** data may be transferred as either ASCII strings (nominally 6 characters per reading) or as 16 bit integers. Readings may be taken at a single point or as an entire 401 point measurement trace.

### Transfer Speed

ASCII format, trace: 800 ms typical.

ASCII format, point: 10 ms typical.

Binary format, trace: 35 ms typical.

Binary format, point: 5 ms typical.

**Description:** the HP 8756A System Interface is an HP-IB port used exclusively by the HP 8756A to control and extract information from a sweep oscillator and a digital plotter.

**Sweep oscillators:** HP 8350B with RF plug-in, HP 8340A or 8341A

**Plotters:** HP 7470A Opt. 002, HP 7475A Opt. 002, HP 7550A Opt. 002, HP 9872C

**Power requirements:** 48 to 62 Hz, 115/230V ±10%, typically 100 watts.

**Dimensions:** 178 H x 425.5 W x 451 mm D (7.0 x 16.75 x 17.75 in.).

**Weight:** Net, 15 kg (33 lb). Shipping, 20 kg (44 lb).

### Ordering Information

HP 8756A scalar network analyzer



# NETWORK ANALYZERS

## Scalar Network Analyzer System, 10 MHz to 40 GHz

### Model 8755S

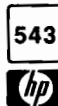

- Economical scalar measurement system
- 10 MHz to 40 GHz frequency range
- Absolute & ratio measurement capability

- 60 dB dynamic measuring range for each detector
- Free of interference from stray fields or unwanted signals

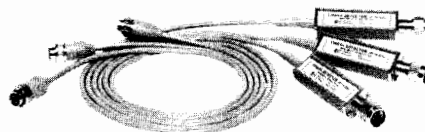
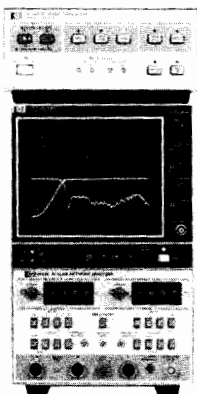

### HP 8755S Scalar Network Analyzer System

The HP 8755S is an economy network measurement system designed to make absolute power and ratio measurements over the 10 MHz to 40 GHz frequency range. It is a versatile system for scalar (amplitude only) impedance and transmission measurements.

Common measurements made with the HP 8755 are simultaneous insertion and return loss, amplifier gain and gain compression, and mixer conversion loss and return loss, all on a swept frequency basis.

The HP 8755S system can interface with sources having alternate sweep capability, such as the HP 8350 sweep oscillator, allowing two independent frequency and power ranges to be displayed on consecutive sweeps. With this powerful capability, measurements of amplifier compression and filter pass/stop band response become simple manual measurements.

The HP 8750A storage-normalizer improves both the accuracy and convenience of swept frequency measurements. System frequency response error is eliminated by subtracting a digitally stored calibration trace from the measurement trace using the HP 8750 input minus memory mode. The input minus memory mode also facilitates comparison measurements by providing a single trace display of the difference between two devices. The HP 8750A has digital storage for flicker-free displays so that a complete trace is seen independent of the RF sweep rate. This is a real benefit when device constraints require a slow sweep rate as when making narrow band filter measurements. The HP 8750A also makes x-y plotting much more convenient by automatically outputting the x, y and penlift signals from digital memory at the push of a single button.

### HP 8755C Scalar Network Analyzer Plug-in

**Function:** the HP 8755C plug-in processes demodulated 27.8 kHz signals from the HP 11664 detectors (R,A,B) for logarithmic display on HP 180 series oscilloscopes.

**Resolution:** independent for each channel in steps of 10, 5, 1, 0.25, or 0.1 dB per division.

**Offset:** independent for each channel.  $\pm 59.9$  dB in 0.1 dB increments.

### Display Units

HP 180 "T" series displays are recommended for use with the HP 8755C. They provide zero offset recorder outputs, and both positive and negative 5-volt retrace blanking inputs.

**Large screen (HP 182T):** this display unit is contained in the HP 8755S standard configuration. It has an  $8 \times 10$  division internal graticule with 1 div=1.29 cm. and medium persistence P39 phosphor.

**Rack mount (HP 180TR):** this display unit is contained in the HP 8755S Option 001 system configuration. It has an  $8 \times 10$  division internal graticule with 1 div = 1 cm. and medium persistence P39 phosphor.

The HP 182T and 180TR are directly compatible with the HP 8750A storage-normalizer.

### HP 8750A Storage-Normalizer

**Function:** provides digital storage display and digital normalization for both channels of the HP 8755. The HP 8750A connects directly to the HP 8755/182T via a single cable.

### Common System Specifications

#### Power Measurement Range

**Single channel:** +10 dBm to -50 dBm (noise level).

**System Accuracy** (ratio measurements)

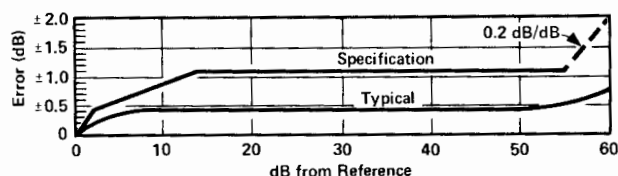

Accuracy curve shows system uncertainty for a relative measurement with +10 dBm incident at the test detector when the 0 dB reference is set. Accuracy when calibration levels below +10 dBm are used remains the same, except the additional 0.2 dB/dB uncertainty should be added for measurements below -45 dBm. This curve includes system noise, offset uncertainty, and crosstalk, and assumes the reference detector power remains fixed between calibration and test. Refer to detector, coupler, or bridge specifications to determine system frequency response.

#### Absolute Measurements

Absolute power incident on a detector is displayed with respect to the 0 dBm POSITION line when the OFFSET CAL switch is turned OFF. Accuracy at any power level is typically  $\pm 0.5$  dB not including detector frequency response or mismatch errors. For applications requiring more precision, increased accuracy can be obtained if the HP 8755 display is calibrated at a specific power level using a power meter. The stability of the HP 8755 then permits accurate power measurements repeatable to hundredths of dBs.

**Temperature range:** operation, 0 to 55°C; storage, -40°C to 75°C.

**Power:** 48 to 440 Hz, 115/230 V  $\pm 10\%$ , typically 100 watts.

#### Ordering Information

The HP 8755S system and its options are configured of separate instruments and components solely for ordering convenience. If a different display or optional connectors are desired, each part of the system should be listed separately. The HP 11664 detectors, HP 85020 and 85021 bridges and other scalar analyzer accessories are described on pages 536 through 538.

HP 8755S scalar network analyzer system consists of:

- 8755C scalar network analyzer
- 182T display
- 11664A detectors (3 each)
- 8750A storage-normalizer

**Opt 001:** rack mount version

**Opt 003:** adds HP 11665B modulator

**Opt 004:** deletes HP 8750A storage-normalizer

**Opt 005:** replaces (3) HP 11664A with (3) HP 11664B

HP 8755C scalar network analyzer plug-in only

HP 8750A storage normalizer

HP 182T large screen cabinet scope display

HP 180TR standard screen rack display



# NETWORK ANALYZERS

Audio/IF/RF Network Analyzer, 5Hz to 200MHz

Model 3577A

- 5 Hz to 200 MHz
- 100 dB dynamic range
- 0.001 Hz resolution
- $\pm 0.02$  dB dynamic accuracy
- Companion S-parameter test set
- Menu driven for operational simplicity
- Direct hard copy to plotter
- Internal calibration

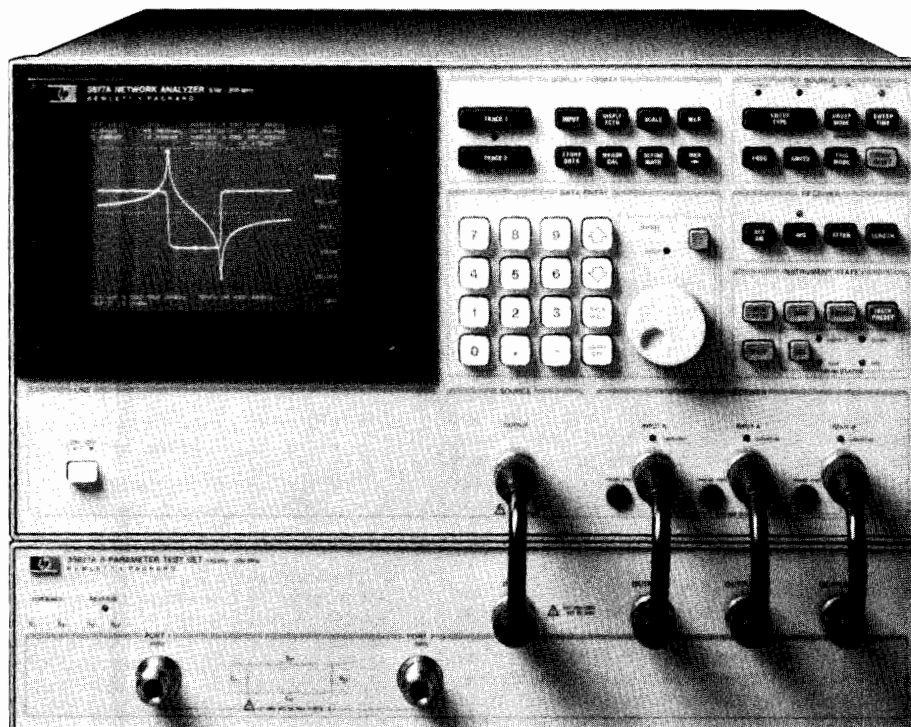

The HP 3577A Network Analyzer provides cost-effective, high performance network measurements from 5 Hz to 200 MHz for higher productivity in design and production. The companion HP 35677A/B S-Parameter Test Sets and full line of accessories ensure a complete measurement solution. Innovative analog and digital design are combined for superb accuracy, resolution and operational simplicity.

Convenient soft-key selection of measurement functions allows you to quickly measure transfer functions, magnitude/phase, insertion loss/gain, attenuation, electrical length and gain compression. In addition, measurement of phase distortion parameters such as group delay and deviation from linear phase can be made with high resolution. With the HP 3577A's flexible receiver input impedances, you can measure in either 50- $\Omega$  or high impedance (1 M $\Omega$ ) environments. Use the HP 35677A or HP 35677B S-Parameter Test Sets with the HP 3577A to make reflection measurements such as return loss, reflection coefficient and impedance in 50- $\Omega$  or 75- $\Omega$  systems, while simultaneously displaying transmission parameters.

### Measurement Convenience

The built-in autoscale function puts the measurement on the screen quickly with a full scale display. Digital Display Markers with Marker  $\rightarrow$  Min or Max and Marker Offset capabilities provide accurate, high resolution read out of data points on a fully annotated dual trace display. Direct Digital Plot (using an HP graphics plotter without a computer) of displayed traces, graticule, annotation and marker data provides quick, cost-effective hard copy of measurement results. Non-volatile Save/Recall Memory of five front panel instrument states is convenient for making rapid and repeatable measurements.

### Measurement Versatility

User-Defined Vector Math functions operate on measured data, constants and functions to present measurement results in the form you need. Multiple Display Formats with electronic graticules provide accurate display in rectangular, polar or Smith chart coordinates. Frequency Sweep (Logarithmic, Linear or Alternate) and Amplitude Sweep capabilities meet measurement needs in a wide range of applications. Accessories such as S-Parameter Test Sets, Power Splitters, Minimum Loss Pad, Cables, Calibration Kits, Transistor Fixtures, Adapters, and Current and Voltage Probes ensure a complete solution to your measurement needs.

### HP-IB Programmability

The full measurement capability of the HP 3577A is programmable over the Hewlett-Packard Interface Bus (HP-IB). Automatic measurements are easy with the HP 3577A's simple programming codes that minimize software development time. Quickly access a single point or an entire trace of 401 data points in either fast binary or ASCII modes. Customize the CRT display via the HP-IB using the built-in graphics display capability to draw test limit lines, operator instructions or connection diagrams.

### Built-in Accuracy Enhancements

Normalization enhances measurement accuracy by removing frequency response and other errors quickly with the push of a button. Vector Error Corrections are used to remove the effects of directivity, frequency response and source match for high accuracy reflection measurements. Vector Noise Averaging of both magnitude and phase reduces noise, making high resolution group delay and accurate low level measurements easy.

# NETWORK ANALYZERS

## Audio/IF/RF Network Analyzer, 5Hz to 200 MHz

### HP Model 3577A (Con't)



### 3577A Specifications

#### Source

**Frequency Range:** 5 Hz to 200 MHz  
**Frequency Resolution:** 0.001 Hz  
**Stability:**  $\pm 5 \times 10^{-8}$ /day, 0 to 55° C  
**Level Range:** +15 dBm to -49 dBm (1.26Vrms to 793  $\mu$ Vrms; 2dBV to -62 dBV) into a 50  $\Omega$  load  
**Resolution:** 0.1 dB  
**Accuracy:**  $\pm 1$  dB at +15 dBm and 100 kHz. Below +15 dBm, add the greater of  $\pm 0.02$  dB/dB or 0.2 dB  
**Flatness:** 1.5 dBp-p from 5 Hz to 200 MHz  
**Impedance:** 50  $\Omega$ ; > 20 dB return loss at all levels  
**RF Output Connector:** 50  $\Omega$  Type N female  
**Sweep Types:** Linear, alternate, cw and log frequency; log amplitude  
**Sweep Time:** 100 ms/span to 200 ms span for frequency sweep; 1 ms/step to 16 s/step for amplitude sweep  
**Sweep Modes:** Continuous, single, manual.  
**Trigger Modes:** Free run, immediate, line, external.

#### Receiver

**Input Characteristics**  
**Frequency Range:** 5 Hz to 200 MHz.  
**Inputs:** Three receiver inputs (A, B and R).  
**Input Impedance:** Selectable 50  $\Omega$  with >25 dB return loss, or 1 M $\Omega$  in parallel with approximately 30 pF.  
**Input Connectors:** 50  $\Omega$  Type N female.  
**Resolution Bandwidth:** Selectable 1 kHz, 100 Hz, 10 Hz, or 1 Hz  
**Sensitivity (Due to noise and internal crosstalk between source and receiver inputs):**

Resolution Bandwidth	Minimum Freq.	Minimum Freq. - 30 kHz		30 kHz - 200 MHz (50 $\Omega$ )	
		Maximum Input Level		Maximum Input Level	
		0 dBm -13 dBV (20 dB atten)	-20 dBm -33 dBV (0 dB atten)	0 dBm -13 dBV (20 dB atten)	-20 dBm -33 dBV (0 dB atten)
1 Hz	100 Hz	-110 dBm	-130 dBm	-110 dBm	-130 dBm
10 Hz	100 Hz	-100 dBm	-120 dBm	-110 dBm	-130 dBm
100 Hz	500 Hz	-90 dBm	-110 dBm	-105 dBm	-125 dBm
1 kHz	5 kHz	-80 dBm	-100 dBm	-95 dBm	-115 dBm

**Crosstalk:** >100dB isolation between inputs.  
**Electrical Length/Reference Plane Extension:** Provides equivalent electrical line length, or delay at inputs A,B and R. Range:  $-3 \times 10^8$  m to  $+3 \times 10^8$  m, or +1 s to -1 s.  
**Resolution:** 5 digits or 0.1 cm (3.3 ps) whichever is greater.  
**Accuracy:**  $\pm 0.1$  cm or  $\pm 0.02\%$  whichever is greater.

#### Magnitude Characteristics

**Range:** Maximum Input Level to Sensitivity.  
**Resolution**  
**Marker:** 0.001 dB (log); 5 digits (linear).  
**Display:** 0.01 dB/div to 20 dB/div (log absolute); 0.01 dB/div to 200 dB/div (log ratio); 0.1 nV/div to 10 V/div (linear absolute);  $10^{-10}$ /div to  $10^{20}$ /div (linear ratio).  
**Display Units:** dB, dBm, dBV, V, and linear ratio.  
**Accuracy (at 100 kHz, 25° C, and Maximum Input Level)**  
**Absolute (A,B,R):**  $\pm 0.2$  dB.  
**Ratio (A/R, B/R, A/B):**  $\pm 0.15$  dB (50  $\Omega$ );  $\pm 0.2$  dB (1 M $\Omega$ ).

#### Dynamic Accuracy:

Error		Input Level Relative to Maximum Allowable
Resolution Bandwidth		
1 kHz, 100 Hz, 10 Hz	1 Hz	
$\pm .04$ dB	$\pm .04$ dB	0 dB to -10 dB
$\pm .02$ dB	$\pm .02$ dB	-10 dB to -50 dB
$\pm .05$ dB	$\pm .05$ dB	-50 dB to -60 dB
$\pm .15$ dB	$\pm .25$ dB	-60 dB to -80 dB
$\pm .75$ dB	$\pm .75$ dB	-80 dB to -90 dB
$\pm .75$ dB	$\pm 3.00$ dB	-90 dB to -100 dB

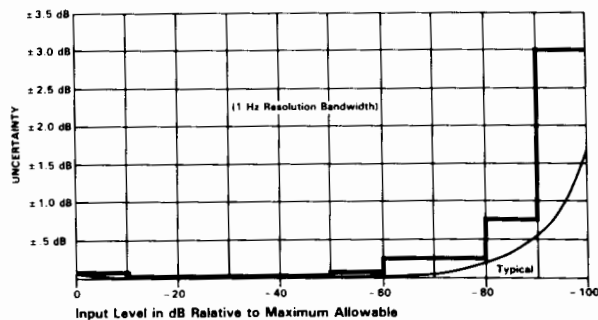
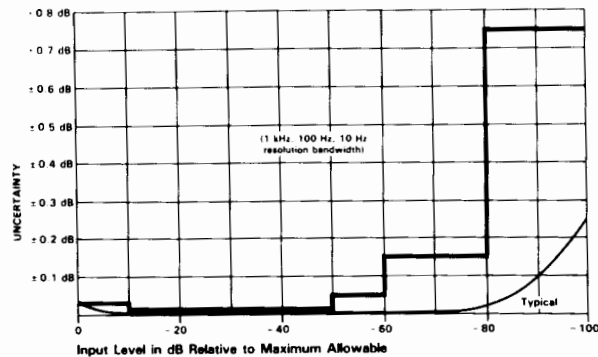

#### Frequency Response<sup>1</sup> (when driven from a 50 $\Omega$ source and with 50 $\Omega$ receiver input impedance)

**Absolute (A,B,R):** 0.3 dBpp from 20 Hz to 20 MHz; 0.6 dBpp from 5 Hz to 200 MHz.  
**Ratio (A/R, B/R, A/B):** 0.3 dBpp from 20 Hz to 20 MHz; 0.4 dB from 5 Hz to 200 MHz.

#### Reference Level

**Range:** -207 dBm to +33 dBm (-220 dBV to +20 dBV) (log absolute); -400 dB to +400 dB (log ratio); 0 V to 10 V (linear absolute); 0 to  $10^{20}$  (linear ratio).  
**Resolution:** 0.001 dB (log); 5 digits (linear).

#### Stability

**Temperature:** Typically  $< \pm 0.02$  dB/°C.  
**Time:** Typically  $< \pm 0.05$  dB/hour at 25° C.

#### Phase Characteristics (A/R, B/R, A/B)

**Range:**  $\pm 180$  deg.  
**Resolution**  
**Marker:** 0.005 deg (0.0001 rad)  
**Display:** 0.01 deg/div to 200 deg/div (0.00018 rad/div to 3.49 rad/div).  
**Accuracy (at 100 kHz, 25° C, and Maximum Input Level):**  $\pm 2.0^\circ$ .



# NETWORK ANALYZERS

Audio/IF/RF Network Analyzer, S-Parameter Test Sets, Accessories

Model 3577A (Cont.), 35677 A/B, 35678 A/B, 35679 A/B

## Dynamic Accuracy:

Error*	Input Level Relative to Maximum Allowable
± .4 deg	0 dB to -10 dB
± .2 deg	-10 dB to -50 dB
± .5 deg	-50 dB to -60 dB
± 1.5 deg	-60 dB to -80 dB
± 7.5 deg	-80 dB to -100 dB

\*Specifications do not apply below -60 dB in a 1 Hz Resolution Bandwidth

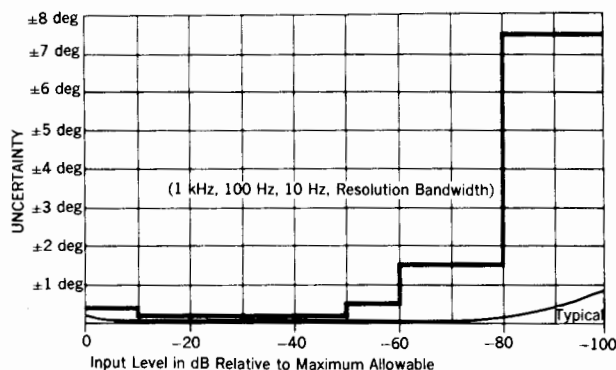

**Resolution:** 0.01°.

### Stability

**Temperature:** Typically  $\pm 0.05$  deg/°C.

**Time:** Typically  $\pm 0.05^\circ$ /hour at 25°C.

### Polar Characteristics

Range, Resolution, Display Units, Dynamic Accuracy, Frequency Response, Uncertainty, Crosstalk, Reference Level, and Stability specifications are the same as the corresponding magnitude and phase characteristics.

### Full Scale Magnitude Range

**Absolute (A,B,R):** 0.1 nV to 10 V

**Ratio (A/R, B/R, A/B):**  $10^{-10}$  to  $10^{20}$

### Real Imaginary Characteristics

Range, Dynamic Accuracy, Frequency Response, Uncertainty, Crosstalk, Stability specifications are the same as the corresponding magnitude and phase characteristics.

### Resolution

**Marker:** 5 digits

**Display:** 0.1 nV/div to 10 V/div for absolute;  $10^{-10}$  to  $10^{20}$  for ratio

### Reference Level

**Range:**  $\pm 10$  V for absolute;  $\pm 10^{20}$  for ratio

**Resolution:** 5 digits

### Delay Characteristics

#### Normalized Accuracy:

**Dynamic Phase Accuracy**  
 $360 \times \text{Aperture [Hz]} \pm 2\text{ns}$

### Reference Level

**Range:**  $\pm 10^3$ s.

**Resolution:** 5 digits.

### Display Characteristics

**Annotation:** Start/stop, center/span or CW frequency, source level, scale/div, reference level, delay aperture, marker data, and soft key functions.

**Graticules:** Rectangular logarithmic and linear, polar, and Smith. All graticules are electronically generated.

**Traces:** Two simultaneous traces may be present with a rectangular graticule. One trace with polar or Smith graticules.

**Markers:** Each trace has one main marker and an offset marker. Markers indicate data at corresponding trace coordinates in the same units as used to set the Reference Level. Markers can be used to modify certain display parameters. Marker resolution is the same as horizontal display resolution.

### Reference Line Position

**Rectangular Graticule:** 0% to 100% full scale deflection in 0.05% increments.

**Polar/Smith Chart Graticule:**  $\pm 500$  deg in 0.001 deg increments.

**Data Storage:** Measured data can be stored in vector format in non-volatile storage registers D1, D2, D3, D4. Stored data can be redisplayed later or operated on with Vector Math.

**Vector Math:** Input Magnitude and Phase Data, Stored Data, and User Defined Constants and Functions can be mathematically combined into expressions which define displayed or stored data. Mathematical operations are: add, subtract, multiply, and divide.

### Calibration

**Transmission:** Both traces can be normalized to measured data with full accuracy and resolution.

**Reflection:** Corrects for directivity, frequency response and source match errors.

### Noise Averaging

**Type:** Exponentially weighted vector averaging on successive sweep data.

**Averaging Factor:** Selectable 1 (off), 4, 8, 16, 32, 64, 128, 256.

**Linear Phase Slope Compensation:** Provides linear phase slope offset of  $-72,000^\circ/\text{span}$  to  $+72,000^\circ/\text{span}$ .

### Programming Characteristics

**Capability:** Remote programming is via the Hewlett-Packard Interface Bus (HP-IB). The HP 35677A/B S-Parameter Test Sets are programmable through the HP 3577A interface only.

**Interface Functions:** SH1, AH1, T5, TE0, L4, LE0, SR1, RL1, PP1, DC1, DT1, C0, E1. For more on these codes refer to the HP-IB section of this catalog.

**Output Data Transfer Time:** 401 data points (single parameter) can be transferred directly to an HP 200 series computer in Basic language as follows:

**ASCII mode:** Typically 1500 ms.

**Binary floating point mode:** Typically 160 ms.

**Graphics Capabilities:** 12 lines of text with 40 alphanumeric characters per line, and high resolution line vectors can be displayed through HP-IB commands.



### General Characteristics

#### External Reference Frequency Input

**Frequency:** 10 MHz/N. N is an interger from 1 to 100.

**Level:** 0 dBm  $\pm$  10 dB, nominal.

**Impedance:** 50  $\Omega$ , nominal.

**Connector:** BNC female, rear panel.

#### Reference Frequency Output

**Frequency:** 10 MHz.

**Level:** Typically 0 dBm.

**Impedance:** 50  $\Omega$ , nominal.

**Connector:** BNC female, rear panel.

**External Trigger:** Triggers on negative TTL transition or contact closure to ground.

**Connector:** BNC female, rear panel.

**Plotter Control:** Directly compatible with HP-IB graphics plotters that use Hewlett-Packard Graphics Language (HP-GL) with listen only capability. HP 7470A, HP 7475A, HP 7550A, HP 7090A

**Save/Recall:** Front panel setups can be stored in non-volatile memory locations 1 through 5. Last state is saved when power is removed.

### Operating Conditions

**Temperature:** 0° C to +55° C.

**Relative Humidity:** <95% at 40 C.

**Altitude:** <4,572 m (15,000 ft).

### Non-Operating Conditions

**Temperature:** -40° C to +75° C.

**Altitude:** <15,240 m (50,000 ft).

**Power:** 115V +10%, -25% (47 Hz to 440 Hz), or 230 V +10%, -15% (47 Hz to 66 Hz), 450 VA maximum.

**Weight:** 31 kg (67 lb) net; 41 kg (90 lb) shipping.

**Dimensions:** 222 mm H x 426 mm W x 578 mm D (8.75 in. x 16.75 in. x 22.75 in.).

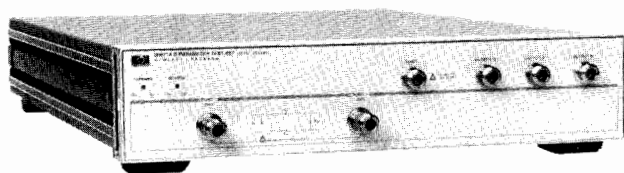

### HP 35677A/B S-Parameter Test Set Specifications

**Frequency Range:** 100 kHz to 200 MHz.

#### Test Port Impedance

**HP 35677A:** 50  $\Omega$ .

**HP 35677B:** 75  $\Omega$ .

**Directivity:** >40 dB.

#### Frequency Response

**Transmission ( $S_{21}$ ,  $S_{12}$ ):**  $\pm$ 1 dB,  $\pm$ 5°.

**Reflection ( $S_{11}$ ,  $S_{22}$ ):**  $\pm$ 1 dB,  $\pm$ 5°.

#### Port Match

**Test Ports 1, 2:** HP 35677A, >26 dB; HP 35677B, >24 dB.

**Test Ports 1, 2 open/short ratio:** HP 35677A, <  $\pm$ 0.75 dB magnitude and <  $\pm$ 5° phase; HP 35677B, <  $\pm$ 1 dB magnitude and <  $\pm$ 7.5° phase.

**Input Port:** >20 dB return loss.

**Output Ports A, B, and R:** >26 dB return loss.

**Test Port Isolation:** > 100 dB.

#### Insertion Loss

**RF Input to Test Port 1 or 2:** HP 35677A, typically 13 dB; HP 35677B, typically 19 dB.

**RF Input to Output Ports A, B, or R:** HP 35677A, typically 19 dB; HP 35677B, typically 31 dB.

### Test Port Reciprocity:

**Transmission ( $S_{21}$ ,  $S_{12}$ ):** typically <  $\pm$ 0.5 dB magnitude and <  $\pm$ 5° phase.

**Reflection ( $S_{11}$ ,  $S_{22}$ ):** Typically <  $\pm$ 0.5 dB magnitude and <  $\pm$ 5° phase.

**Incident Power Ratio (Test Port 1 to Test Port 2):** Typically <  $\pm$ 1.5 dB.

**RF Input Maximum Operating Level:** +25 dBm or  $\pm$  30 Vdc.

**RF Input Damage Level:** +27 dBm or  $\pm$ 30 Vdc.

**Port 1 or 2 Damage Level:** +27 dBm or  $\pm$ 30 Vdc.

### Connectors

**Input Port and Output Ports A, B, and R:** 50  $\Omega$  Type N female.

**Test Ports 1 and 2:** HP 35677A, 50  $\Omega$  Type N female; HP 35677B, 75  $\Omega$  Type N female.

**DC Bias Inputs:** BNC female, rear panel.

**DC Bias Range:** Typically  $\pm$ 30 Vdc and  $\pm$ 20 mA with some  $\circ$  radiation of RF specifications; 200 mA damage level.

### Accessories Supplied

4 ea. 190 mm (7.5 in.) 50  $\Omega$  cables with Type N male connectors for connection to HP 3577A (HP Part No. 8120-4387).

1 ea. Test Set interconnect cable to HP 3577A (HP Part No. 35677-61620).

1 ea. Rear Panel Lock Foot Kit (HP Part No. 5061-0099).

1 ea. Service Manual (HP Part No. 35677-90010).

### Recommended Accessories

**HP 35677A:** HP 35678A 50  $\Omega$  Type N Calibration Kit; HP 35679A 50  $\Omega$  Type N Test Port Extension Cables.

**HP 35677B:** HP 35678B 75  $\Omega$  Type N Calibration Kit; HP 35679B, 75  $\Omega$  Type N Test Port Extension Cables.

**Programming:** The HP 35677A/B are completely controlled through the HP 3577A using the HP 3577A interconnect cable. All programming is accomplished through the HP 3577A HP-IB interface.

**Power:** All power is obtained through the HP 3577A interconnect cable.

**Weight:** 6 kg (13 lb) net; 12 kg (12 lb) shipping.

**Dimensions:** 90 mm H x 426 mm W x 584 mm D (3.5 in. x 16.75 in. x 22.75 in.). Add 1/8 inch to depth to include front panel connectors.

### Accessories

#### HP 35678A/B Calibration Kits

The HP 35678A and HP 35678B are used with the HP 35677A/B to make vector error corrections for high accuracy reflection measurements in 50  $\Omega$  Type N and 75  $\Omega$  Type N connector systems, respectively. These standards and adapters are supplied with a convenient storage case.

#### HP 35679A/B Test Port Extension Cables

The HP 35679A and HP 35679B are used to extend test ports for measurement of devices having any two port geometry in either 50 or 75  $\Omega$  systems. The HP 35679A is used with the HP 35677A, HP 11850A/B and the HP 11667A. The HP 35679B is used with the HP 35677B. The HP 3577A is also compatible with most oscilloscope probes, the HP 1120 active probe, HP 11667A and HP 11850A/B power splitters, HP 11852A minimum loss pad, and the HP 11853A, HP 11854A, HP 11855A and HP 11856A accessory kits.

### Ordering Information

**HP 3577A** Network Analyzer

**Option 907:** Front handle kit

**Option 908:** Rack mount kit

**Option 909:** Rack mount and front handle kit

**Option 910:** Extra operating and service manuals  
Service Accessory Kit

**HP 35677A** S-Parameter test set (50  $\Omega$ )

**HP 35677B** S-Parameter test set (75  $\Omega$ )

**Option 907** front handle kit

**Option 908** rack mount kit

**Option 909** rack mount and front handle kit

**Option 910** extra service manual

**HP 35678A** 50  $\Omega$  calibration kit

**HP 35678B** 75  $\Omega$  calibration kit

**HP 35679A** 50  $\Omega$  type N test port extension cables

**HP 35679B** 75  $\Omega$  type N test port extension cables

548 **NETWORK ANALYZERS**  
**Gain/Phase Meter**  
**Model 3575A**

- dBV, dB ratio and degrees from 1 Hz to 13 MHz

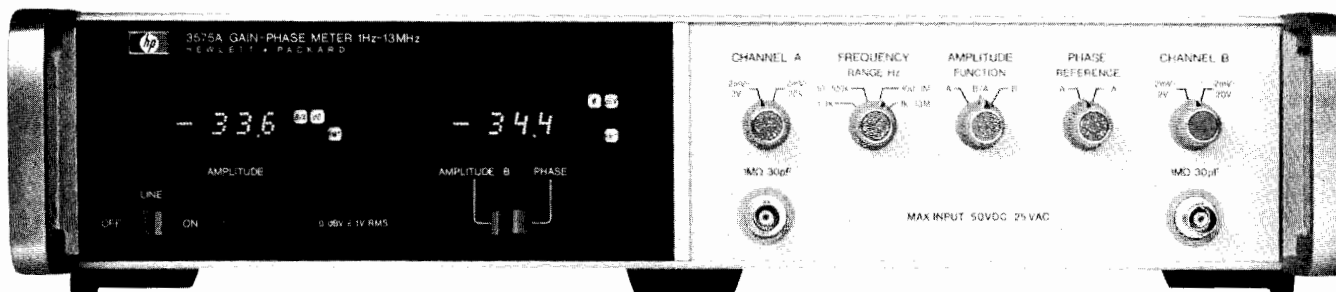

HP 3575A Option 001 dual panel meters

### Description

The HP 3575A Gain-Phase Meter is a versatile two-channel analyzer which can measure and display the absolute amplitude level or amplitude ratio of signals present at the inputs. In addition, the HP 3575A can measure the phase relationship of the two signals. This analyzer is a broadband detector, which is easy to use because no frequency tuning is required.

Since a dedicated tracking source is not required to operate with the HP 3575A, a wide selection of stimuli is possible. This flexibility coupled with a variety of possible amplitude, gain and phase outputs (LED display, analog outputs, and optional BCD) gives you a wide choice of cost/results tradeoffs. For example, you may wish to manually plot your network response data on a Bode diagram in which case a low cost sinewave oscillator stimulus may be used. For easier, quicker results you may select the HP 7090A plotter and let the instruments plot your response. You may use a calculator or computer to control a programmable stimulus source and the HP 3575A to provide automatic measurements. Here you have a wide range of computation and output possibilities.

### Phase

The phase relationship of two signals is indicated over a range of  $\pm 192$  degrees with 0.1 degree resolution. A unique logic circuit (patent) design allows the HP 3575A to make stable phase measurements in the presence of noise. This feature minimizes the error to less than two degrees for a signal-to-noise ratio of 30 dB. One of three band limiting filters may be selected to get further noise rejection.

The HP 3575A is also capable of measuring the phase relationship of a variety of waveforms, such as square waves and triangle waves. Even harmonic and in-phase odd harmonic components of these signals cause no phase measurement error. For out-of-phase odd harmonic signal-to-harmonic ratios of 40 dB, measurement errors are less than 0.6 degree as shown in Figure 1.

### Amplitude

The amplitude of either channel or the ratio of the two can be measured over an 80 dB dynamic range and 100 dB measurement range. Resolution is 0.1 dB. Results are displayed in dBV for channel amplitude and dB for ratio measurements. Digit blanking and channel overload annunciators will turn on if the maximum allowable signal level at either channel input is exceeded.

### Readout

The standard three-digit LED display may be selected by the operator to indicate the amplitude of channel A or B, gain or phase. A second three-digit LED display is optionally available for simultaneous display of amplitude and phase readings. Lighted annunciators identify the measurement function, units and remote status.

### Programmable

Two programmable options both offer full control of front panel functions and BCD output of information (amplitude, ratio or phase) contained in both digital displays. The two options give the user a choice of negative true or positive true outputs.

### Applications

The HP 3575A can solve network analysis problems in the 1 Hz to 13 MHz frequency range where complex measurements (gain or phase or both) are required. A few of the many measurements it can make are gain and phase response of feedback systems, envelope delay and return loss of transmission lines, complex impedance of components, and insertion loss of mixers and frequency doublers. Bode plots and Nichols charts are useful graphical tools for analyzing many of these response data.

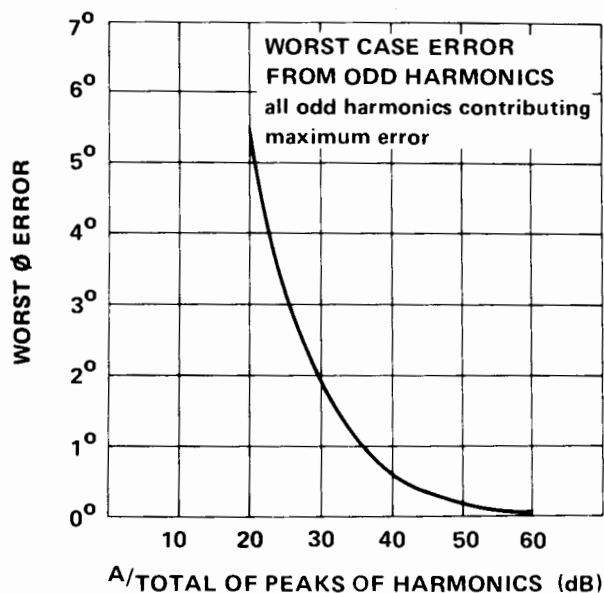

Figure 1. Worst case error from odd harmonics.





## Specifications

### Phase Accuracy\*

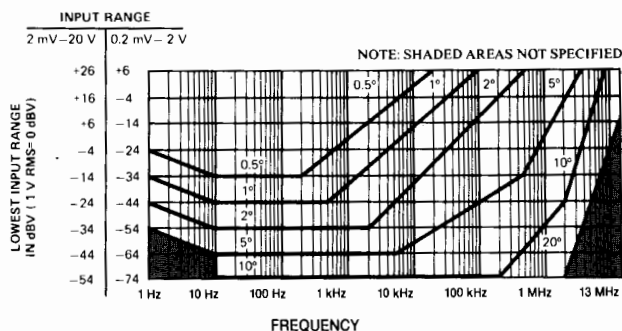

\*Conditions: Temperature: 25°C ± 10°C; Frequency range switch on lowest applicable range; Analog Output accuracy (rear panel).

**Input signal range:** 200 μV rms to 20 V rms.

### Harmonic Rejection

**Even harmonics:** no error.

**Odd harmonics:** (in phase) no error.

**Odd harmonics:** (out of phase) 0.57° worst case error when total odd harmonic distortion is 40 dB below the fundamental.

**Noise tolerance:** 2° error for a 10 kHz, 1 V sine wave on one channel. One volt sine wave added to Gaussian noise (limited to a 1 MHz bandwidth and 30 dB S/N ratio) on the other channel. The 100 Hz to 1 MHz frequency range was used.

### Display

**Range:** ±180° with 12° of overrange.

**Resolution:** 0.1°.

**Panel meter accuracy:** ±3 counts (0.3 degrees/dB/dBV). The panel meter error must be added to the phase and amplitude errors to obtain the display error.

### Inputs

**Impedance:** 1 MΩ 30 pF.

**Protection:** ±50 V dc, 25 V rms.

### Response Time to Achieve 95% of Final Reading

Frequency Range	Time
1 Hz to 1 kHz	20 s
10 Hz to 100 kHz	2 s
100 Hz to 1 MHz	0.2 s
1 kHz to 13 MHz	20 ms

Rear terminal inputs are available as a special (HP 3575A-C09). Digital (Opt. 002). 0, +5 V; ground true. Twelve lines to fully program all functions.

### Outputs

#### Analog

**Phase:** 10 mV/degree.

**Amplitude:** 10 mV/dB or dBV.

**Output impedance:** 1 kΩ

**Digital (Opt 002):** 0, +5 V; ground true. 31 output lines (1-2-4-8 BCD).

**Digital readout:** 3½ digits with sign and annunciators. Four readings per second, fixed.

### Amplitude Accuracy\*

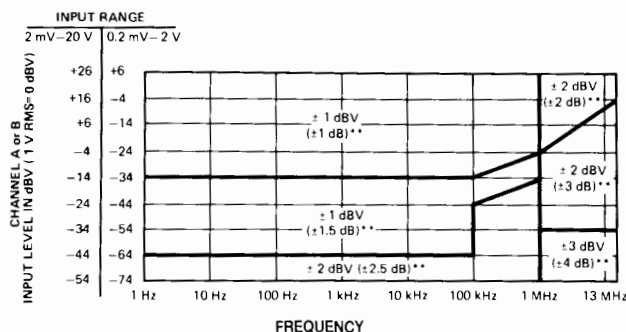

\*Conditions: Temperature: 25°C ± 10°C; accuracy applies to dB V and ratio measurements with the same frequency on both channels; for ratio measurements, the lowest level channel determines accuracy; analog output accuracy (rear panel).

\*\*Ratio (B/A) tolerances

**Amplitude functions:** A dBV, B dBV or B/A dB.

**Amplitude reference:** (A dBV, B dBV) 1 V rms = 0 dBV.

### Display

**Range:** A dBV, B dBV: -74 dBV to +26 dBV (in two ranges). B/A dB: -100 to +100 dB. (Both input signals must be within the range of 0.2 mV rms to 20 V rms)

**Resolution:** 0.1 dBV, 0.1 dB.

### General

**Power:** 115 V/230 V ± 10%, 48 Hz to 440 Hz, 40 VA.

**Weight:** net, 8.3 kg (18.4 lb). Shipping, 11.3 kg (25.8 lb).

**Size:** 88 H x 425 W x 337 mm D (3.47" x 16.75" x 13.25").

**Accessories furnished:** extender boards, line cable and 50-pin connector (Opt 002 and 003 only).

**Recommended Accessories:** HP 7090A Measurement Plotting System.

### Options

**001 Dual panel meters:** HP's 3575A Opt 001 is equipped with two digital readouts and two analog outputs for simultaneous amplitude and phase readings. This option has no additional measurement capability over the standard instrument.

Dual analog outputs: rear panel BNC connectors provide dc output voltages that correspond to the respective panel meter readings.

**001:** Dual Readout

**002/003 Programmable:** HP 3575A Opt 002 and Opt 003 are equipped with dual panel meters and dual analog outputs (same as Opt 001) plus BCD outputs and complete remote control capability. Opt 002 has negative true output levels and Opt 003 has positive true output levels. BCD information from the HP 3575A (Opt 002) can be read by the HP 9800 series HP Desktop Computers with appropriate interfacing.

**002:** Programmable (negative true output levels)

**003:** Programmable (positive true output levels)

**908:** Rack Flange Kit

**910:** Extra Product Manual

**HP 3575A Gain/Phase Meter**



# NETWORK ANALYZERS

RF Network Analyzer, 4 MHz to 1300 MHz (optional to 2600 MHz)

Model 8754A

- Integrated source, receiver, and display
- H26 option covers 4 to 2600 MHz
- Three inputs, two measurement channels
- 80 dB dynamic range

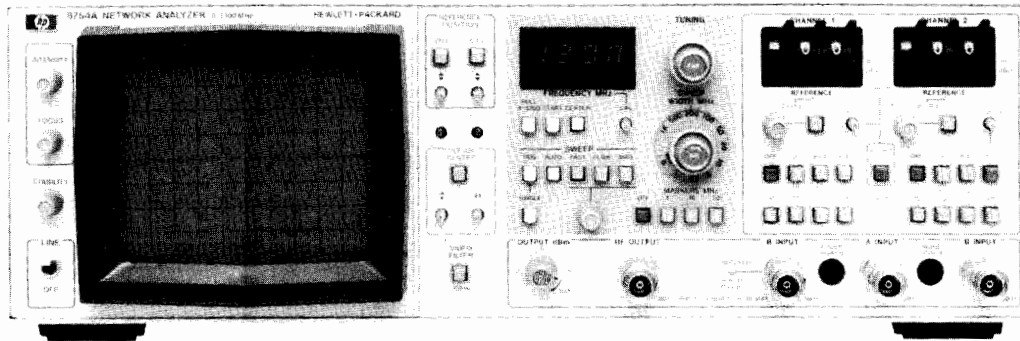

HP 8754A

## Description

The HP 8754A is a complete stimulus/response test system which combines a 4-1300 MHz swept source, three-input narrowband, tuned receiver, and both rectilinear and polar displays in a compact package. The convenient built-in source incorporates digital display of the start or center frequency, the ability to sweep all or any portion of the 4-1300 MHz range, and crystal markers at 1, 10, or 50 MHz intervals to enable accurate frequency calibration and measurement. The receiver provides 80 dB dynamic range in two independent measurement channels to allow simultaneous measurement of any two transmission or reflection parameters using a single test setup. Measurements of absolute power, magnitude ratio, phase angle, and reflection coefficient (or return loss) are displayed on the fully calibrated CRT with resolutions up to 0.25 dB and 2.5 degrees per major division. With these features the HP 8754A offers a new level of operating convenience and technical performance to swept magnitude and phase measurements in laboratory, production, and field testing applications at an economical price.

A comprehensive line of 50-ohm and 75-ohm test sets allow you to tailor your test setup for a specific measurement using the minimum of equipment, or to provide the maximum in versatility for a wide range of applications. Signal separation devices include the HP 11850 Power Splitter for precision transmission measurements, the HP 8502 Transmission/Reflection Test Set for simultaneous transmission and reflection measurements, the HP 8748A S-Parameter Test Set to measure both forward and reverse S-Parameters. Also available for in-circuit testing is the HP 1121A AC Probe (probe power is supplied directly from the front panel of the HP 8754A). Matched cable sets, precision adapters, and transistor fixtures provide convenient, reliable connections to the test device. Adding the HP 8750A Storage Normalizer provides flicker-free rectilinear displays regardless of sweep rate. The HP 8750A will automatically store and subtract out the frequency response of a test set or cable if necessary, eliminating the need to use a grease pencil when making normalized measurements. For applications that require exceptional frequency accuracy and stability, the HP 8754A may be used with external sources such as the HP 8660, 8662A, 8663A or 8640 Signal Generators.

## Coverage to 2600 MHz

The HP 8754A Option H26 provides an economical solution for magnitude and phase measurements to 2600 MHz. Frequency coverage to 2600 MHz is obtained by adding an external frequency doubler (supplied with Option H26) to the RF source output and engaging the "DOUBLER" pushbutton on the front panel. The external frequency doubler doubles the RF output frequency while the

"DOUBLER" pushbutton changes the phase lock circuitry that enables the receiver to lock onto and track signals up to 2600 MHz. In this doubled mode of operation it is necessary to multiply the indicated frequency settings by two for a proper reading. The frequency span between the 1, 10 and 50 MHz crystal markers is also doubled but their excellent accuracy and stability are unaffected. The performance of the source and doubler combination is specified from 100 MHz to 2600 MHz although it is usable down to 8 MHz.

A comprehensive line of 50-ohm 2600 MHz test sets and accessories allow you to tailor your test setup for a specific measurement. For the maximum in versatility, use the HP 8748A Option H26 S-Parameter Test Set which allows characterization of forward and reverse S-Parameters without physically reversing the device. Other test sets include the HP 8502A Option H26 Transmission/Reflection Test Set for simultaneous transmission and reflection measurements and the HP 11850A Option H26 Power Splitter for transmission measurements. Matched cable sets, adapters and transistor fixtures with coverage up to 2600 MHz are also available for connections to test devices.

## HP 8754A Network Analyzer Specifications

**Frequency range:** 4 to 1300 MHz. Option H26 coverage is 4 to 2600 MHz; 4 to 1300 MHz in normal mode, 100 to 2600 MHz in doubled mode (usable down to 8 MHz).

**Sweep modes:** linear full sweep (4 to 1300 MHz or 8 to 2600 MHz in doubled mode) and calibrated sweep widths with variable start or center frequency.

**Sweep widths:** selectable sweep width ranges from 1 to 1000 MHz (2 to 2000 MHz with Option H26) in a 1, 2, 5 sequence, plus CW. A vernier allows continuous adjustment of sweep width within each range and calibration to internal crystal makers.

**Spectral Purity** (+10 dBm RF output level)

**Residual FM** (swept and CW):  $\leq 7$  kHz rms (10 kHz bandwidth).

**Harmonics:**  $-28$  dBc.

**Output power range:** 0 to +13 dBm typical,  $\pm 0.5$  dB flatness. Option H26 100 to 2600 MHz: (measured at the output of the doubler with +10 dBm at the input, frequency doubler has approx. 14 dB of conversion loss).

Residual FM (swept or CW):  $\leq 14$  kHz rms (10 kHz bandwidth).

Harmonics: Second typically  $-15$  dBc, Third typically  $-25$  dBc.

**Output power range:** 0 to +13 dBm typical,  $\pm 0.5$  dB flatness.



## Receiver

**Frequency:** 4 MHz to 1300 MHz. Option H26 ("DOUBLER" pushbutton engaged): 8 to 2600 MHz.

**Input channel:** two test inputs (A and B) and one reference (R) input.

**Input connectors:** type-N Female, 50 ohms nominal impedance.

**Input port match:**  $\geq 20$  dB Return Loss (1.22 SWR).

Option H26:

1300 to 2000 MHz:  $\geq 13$  dB Return Loss (1.58 SWR).

2000 to 2600 MHz:  $\geq 9$  dB Return Loss (2.10 SWR).

**Maximum input level:** 0 dBm at R, A, B inputs.

**Damage level:** +20 dBm (50 Vdc).

**Noise level:**  $< -80$  dBm at A and B inputs.

**Minimum R input level:**  $-40$  dBm ( $\geq -40$  dBm required to operate R input phase-lock).

**Crosstalk between channels:**  $> 83$  dB.

**Error Limits:**

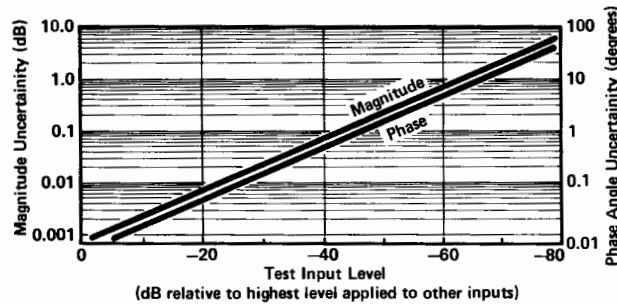

## Magnitude frequency response (flatness)

Absolute (A,B):  $\pm 1$  dB.

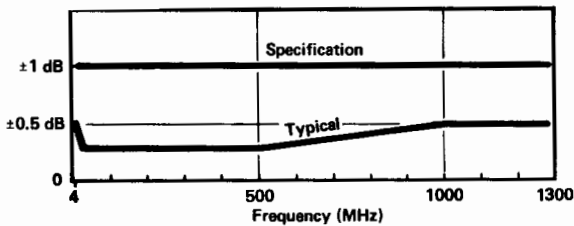

Ratio (A/R, B/R):  $\leq +0.3$  dB.

Option H26: 8 to 2000 MHz:  $\leq \pm 0.7$  dB.

8 to 2600 MHz:  $\leq \pm 1.3$  dB.

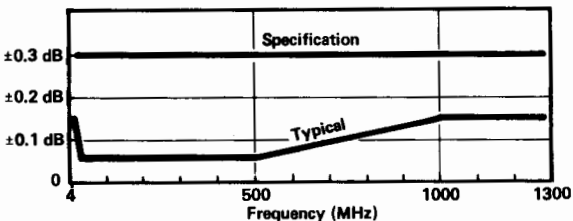

**Magnitude dynamic accuracy:**  $\pm 0.3$  dB from 0 to  $-50$  dBm,  $\pm 0.5$  dB from  $-50$  to  $-60$  dBm,  $\pm 1$  dBm from  $-60$  to  $-70$  dBm,  $\pm 2.5$  dB from  $-70$  to  $-80$  dBm.

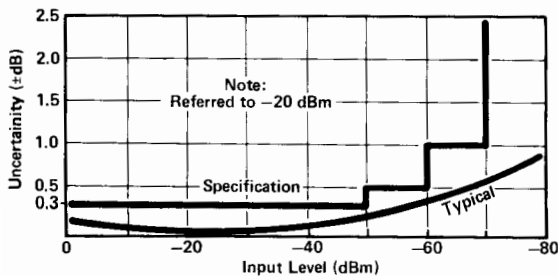

**Magnitude reference offset range:**  $\pm 199$  dB in 1 dB steps. Vernier provides variable offset for calibration.

**Absolute power measurements (A, B, and R):** typically  $\pm 0.5$  dBm at 0 dBm, 50 MHz input.

**Phase frequency response:**  $\pm 2.5^\circ$  (typically  $\pm 1^\circ$ ); Option H26 1300-2600 MHz,  $\pm 5^\circ$ .

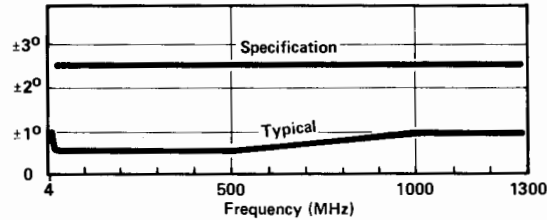

**Phase range:**  $\pm 180^\circ$ .

**Phase dynamic accuracy:**  $\pm 2^\circ$  from 0 to  $-50$  dBm,  $\pm 4^\circ$  from  $-50$  to  $-70$  dBm.

**Phase reference offset range:**  $\pm 199^\circ$  in  $1^\circ$  steps. Vernier provides variable offset for calibration.

**Electrical length adjustment range:** typically 0 to 16 cm length for transmission phase; typically 0 to 8 cm reference plane extension for reflection measurements. Option H26 (to 2600 MHz) typically up to 8 cm for transmission phase; up to 4 cm for reflection.

## Display

**Measurement functions:** CRT displays either polar trace or Channel 1 and Channel 2 rectilinear traces.

**Reference position:** independent reference lines for Channel 1 and Channel 2 and polar center can be set to any position for calibration.

**Video filter:** typically 100 Hz (10 kHz without filter).

**Graticule size:** rectilinear 10 cm by 8 cm; polar 8 cm in diameter.

**Smith chart overlays:** 2, 1, 0.2 and 0.1 full scale (furnished).

**CRT photography:** Tektronix C-5B Oscilloscope Camera is recommended (UV illumination will not excite P39 CRT phosphor for graticule exposure).

**Resolution:** 10, 2.5, 1, 0.25 dB magnitude per major division. 90, 45, 10, 2.5 degrees phase per major division.

**Accuracy:**  $\pm 2\%$   $\pm 0.05$  division for rectilinear trace. Within 2.5 mm for polar trace.

## General

**Sweep output:**  $-5$  V to  $+5$  V.

**External sweep inputs:** 0 to 10 V nominal.

**X-Y Recorder/External CRT Output**

**Horizontal and vertical:** 0.1 V/div.

**Penlift/blinking:**  $+5$  V Blanking and Penlift.

**External marker input:** typically  $-13$  dBm RF signal produce a marker at the frequency of the RF signal.

**Magnitude/phase output:**  $-10$  mV/degree and  $-100$  mV/dB.

**Probe power:** Two  $+15$  Vdc and  $-12.6$  Vdc.

**Storage-Normalizer interfaces:** directly compatible with the HP 8750A Storage-Normalizer. HP 8501A Storage-Normalizer requires a single internal adjustment for compatibility.

**Programming connector:** outputs include magnitude/phase and sweep outputs and inputs described above as well as measurement mode selection by TTL levels or contact closures.

**External source:** the HP 8754A sweep-out voltage is provided to frequency modulate (sweep) an external signal generator for narrow-band measurement applications. A sweep input is provided to synchronize the CRT display for use with an externally swept source (HP 8620 and 8350 series).

## Temperature

**Operating:**  $0^\circ$  to  $55^\circ$  C except where noted.

**Storage:**  $-40^\circ$  C to  $+75^\circ$  C.

**EM:** VDE 0871/0875 and CISPR publication 11.

**Safety:** conforms to the requirements of IEC 348.

**Power:** selection of 100, 120, 220 and 240 V  $\pm 5\%$   $-10\%$ . 48 to 66 Hz, 20 VA max.

**Size:** 425.5 mm W x 133 mm H x 505 mm D (16 $\frac{3}{4}$ " x 5 $\frac{1}{4}$ " x 19 $\frac{7}{8}$ ").

**Weight:** net, 16.8 kg (37 lb); shipping, 19 kg (42 lb).

# NETWORK ANALYZERS

## RF Network Analyzer

Model 8754A (cont.)

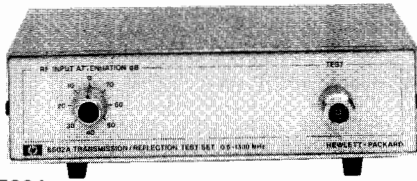

HP 8502A

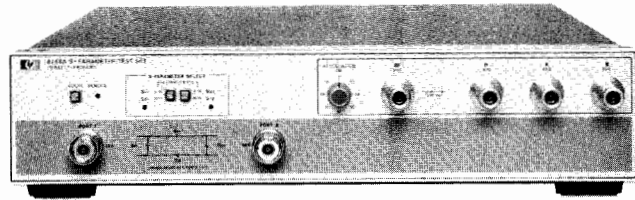

HP 8748A

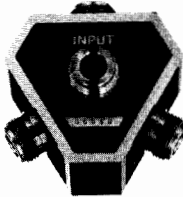

HP 11850A

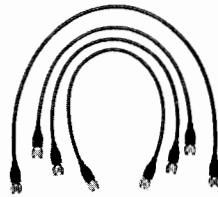

HP 11851A

### HP 8748A 50 Ohm S-Parameter Test Set Specifications

**Frequency Range:** 4 to 1300 MHz. Option H26: 4 to 2600 MHz.

**Directivity:**  $\geq 40$  dB.

Option H26: 4 to 1300 MHz,  $\geq 35$  dB.

1300 to 1600 MHz,  $\geq 30$  dB.

#### Frequency Response<sup>1</sup>:

**Transmission** ( $S_{21}$ ,  $S_{12}$ ):  $\pm 1$  dB,  $\pm 8^\circ$ .

Option H26 (2600 MHz frequency range):

4 to 1300 MHz:  $\pm 1$  dB,  $\pm 8^\circ$ .

1300 to 2600 MHz:  $\pm 1.5$  dB,  $\pm 15^\circ$ .

**Reflection** ( $S_{11}$ ,  $S_{22}$ ):  $\pm 2$  dB,  $\pm 15^\circ$ .

Option H26 (2600 MHz frequency range):

4 to 1300 MHz:  $\pm 2$  dB,  $\pm 15^\circ$ .

1300 to 2600 MHz:  $\pm 3$  dB,  $\pm 20^\circ$ .

#### Port Match<sup>2</sup>:

**Test Port 1 and 2:**  $\geq 26$  dB Return Loss ( $\leq 1.11$  SWR).

**Test Port 1 and 2 open/short ratio:**  $\pm 0.75$  dB and  $\pm 6^\circ$  from 4 to 1000 MHz,  $\pm 0.9$  dB and  $\pm 7.5^\circ$  from 1000 to 1300 MHz.

Option H26:

Test Port 1 and 2:

4 to 1300 MHz, 22 dB Return Loss.

1300 to 2600 MHz, 17 dB Return Loss.

Test Port 1 and 2 open/short ratio:

4 to 1300 MHz:  $\pm 1.2$  dB,  $\pm 10^\circ$ .

1300 to 2600 MHz:  $\pm 1.5$  dB,  $\pm 15^\circ$ .

#### Insertion Loss:

**Input to Test Port 1 or 2:** 13 dB nominal.

**Input to Port A, B or R:** 19 dB nominal.

Option H26: same

**Maximum Operating Level:** +20 dBm.

**RF Attenuator Range:** 0 to 70 dB in 10 dB steps.

**Test Port Connectors:** APC-7.

**DC Bias Input Range:**  $\pm 30$  Vdc,  $\pm 200$  mA.

**Includes:** cables for connection to HP 8754 and Reference Plane Extension Cable Kit.

**Recommended Accessory:** HP 11857A Test Port Extension Cables, HP 11608A Transistor Fixture, or HP 11600B, 11602B Transistor Fixtures.

**Power:** 20Vdc, supplied from HP 8754 via interface cable (included).

**Size:** 432mmW x 90mmH x 495mmD (17" x 3½" x 19½").

**Weight:** net, 9.1 kg (20 lb); shipping, 11.3 kg (25 lb).

### HP 8502A 50 Ohm Transmission/Reflection Test Set

### HP 8502B 75 Ohm Transmission/Reflection Test Set

**General:** the HP 8502 contains a power splitter and directional bridge that permits simultaneous transmission and reflection measurements.

Detailed specifications on the HP 8502A and 8502B appear on page 558. The HP 8502A Option H26 is intended as an accessory to the HP 8754A Option H26 and allows 50 ohm transmission/reflection measurements up to 2600 MHz. For interconnections from the HP 8502 to the HP 8754A use the HP 11851A RF Cable Set. The major specifications of the HP 8502A option H26 are:

**Frequency Range:** 4 to 2600 MHz.

#### Directivity:

4 to 1300 MHz:  $\geq 35$  dB.

1300 to 2600 MHz:  $\geq 30$  dB.

#### Frequency Response:

##### Transmission:

4 to 1300 MHz:  $\leq 0.9$  dB,  $\leq \pm 10^\circ$ .

1300 to 2600 MHz:  $\leq \pm 1.5$  dB,  $\leq \pm 15^\circ$ .

##### Reflection:

4 to 1300 MHz:  $\leq \pm 1.8$  dB,  $\leq \pm 10^\circ$ .

1300 to 2600 MHz:  $\leq \pm 3.0$  dB,  $\leq \pm 15^\circ$ .

#### Port Match:

##### Test Ports:

4 to 1300 MHz:  $\geq 22$  dB Return Loss ( $\leq 1.17$  SWR).

1300 to 2600 MHz:  $\geq 17$  dB Return Loss ( $\leq 1.33$  SWR).

##### Test Port Open/Short Ratio:

4 to 1300 MHz:  $\leq \pm 1.2$  dB,  $\leq \pm 10^\circ$ .

1300 to 2600 MHz:  $\leq \pm 1.5$  dB,  $\leq \pm 15^\circ$ .

##### Reference and Reflection Port:

4 to 1300 MHz:  $\geq 22$  dB ( $\leq 1.17$  SWR).

1300 to 2600 MHz:  $\geq 17$  dB ( $\leq 1.33$  SWR).

##### Input Port

4 to 1300 MHz:  $\geq 20$  dB ( $\leq 1.22$  SWR).

1300 to 2600 MHz:  $\geq 12$  dB ( $\leq 1.67$  SWR).

### HP 11850A 50 $\Omega$ Three-Way Power Splitter

### HP 11850B 75 $\Omega$ Three-Way Power Splitter

**General:** one output port provides the reference output and the other two output ports can be used for independent transmission measurements. Use the HP 11851A RF Cable Set for interconnections. Detailed specifications on page 558.

### HP 11851A RF Cable Set

**General:** three 61 cm (24 in.) 50  $\Omega$  cables, phase matched to  $\pm 4^\circ$  and one 86 cm (34 in.) 50  $\Omega$  cable. Used with HP 8502A/B and 11850A/B. Detailed specifications on page 559.

### HP 11857A APC-7 Test Port Extension Cables

**General:** two precision 50  $\Omega$  cables phase matched to  $\pm 2^\circ$  to connect test device between HP 8748A test ports. Detailed specifications on page 559.

### Transistor Fixtures

**General:** three transistor fixtures can be used with the HP 8748A. The HP 11600B and 11602B require use of the HP 11858A Transistor Fixture Adapter. The HP 11608A transistor fixture connects directly to the HP 8748A. Detailed specifications on pages 572 and 574.

### Adapter Kits

**General:** the HP 11853A, 11854A, 11855A, and 11856A accessory kits are available to provide precision Type N and BNC adapters and calibration standards for use with the HP 11850A/B, 8502A/B, and 8748A test setups. Detailed specifications on page 559.

<sup>1</sup>  $\pm$ degrees, specified as deviation from linear phase.

<sup>2</sup> Effective port match for ratio measurements.

### Ordering Information

HP 8754A Network Analyzer

Opt H26: 4-2600 MHz

Opt 908: Rack Flange Kit

Opt 910: Extra Manual

Opt 913: Rack Mount Kit

HP 11850A 50  $\Omega$  Three-Way Power Splitter

Opt H26: 4-2600 MHz (50  $\Omega$ )

HP 11850B 75  $\Omega$  Three-Way Power Splitter

HP 8502A 50  $\Omega$  Transmission/Reflection Test Set

Opt H26: 4-2600 MHz (50  $\Omega$ )

HP 8502B 75  $\Omega$  Transmission/Reflection Test Set

HP 11851A RF Cable Set

HP 11857A Test Port Extension Cables

HP 8748A 50  $\Omega$  S-Parameter Test Set

Opt 907: Front Handle Kit

Opt 908: Rack Flange Kit

Opt 909: Rack Mount Flange/Front Handle Kit

Opt H26: 4-2600 MHz (50  $\Omega$ )

# NETWORK ANALYZERS

Vector Voltmeter

Model 8405A

553



- Accurate voltage and phase measurement
- 1 to 1000 MHz
- 50/75  $\Omega$  coaxial measurements

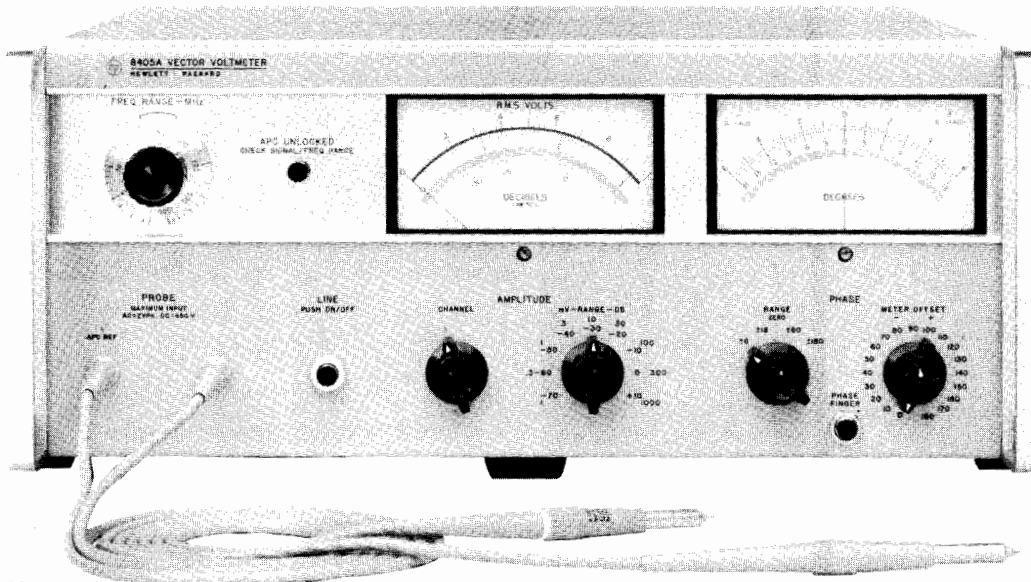

HP 8405A

The HP 8405A Vector Voltmeter measures voltage vectors described by both magnitude and phase. This capability makes the HP 8405A a unique instrument for about any design and test application in the frequency range 1 to 1000 MHz.

In addition to absolute voltage measurements, capabilities include insertion loss and computed group delay of bandpass filters and other transmission devices, gain and phase margin of amplifiers, complex impedance of mixers, antennas, matching the electrical lengths of cables, s-parameters of transistors, amplitude modulation index, RF distortion measurements and in-circuit probing. Simultaneous 50/75 ohm coaxial transmission and reflection measurements can be made using the HP 8502A/B transmission/reflection test set, and 50/75 ohm coaxial high resolution transmission comparison measurements can be made using the HP 11850A/B three-way power splitter. The HP 11852A 50-to-75 ohm minimum loss pad can be used to adapt the HP 11536A 50 ohm tee to a 75 ohm environment.

The HP 8405A achieves this measurement versatility through its two-channel capability enabling voltage magnitude measurements in either channel, thus allowing ratio measurements and phase difference measurements between the two channels. Gain or loss in excess of 90 dB and phase measurements with 0.1° resolution over a 360° phase range are possible.

Accuracy is achieved through the 1 kHz bandwidth entailing response only to the fundamental frequency of the input signal. Also, phase-locked coherent sampling to translate 1 to 1000 MHz RF signals to 20 kHz IF signals enables accurate detection of voltage magnitude and phase. Automatic phase-locked tuning makes it possible to select the one of 21 overlapping octave ranges which contains the input signal frequency by simply rotating a switch.

## Specifications

**Frequency range:** 1 MHz to 1 GHz in 21 overlapping octave bands; tuning automatic within each band.

**Isolation between channels:** 1 to 300 MHz, >100 dB; 300 to 1,000 MHz >80 dB.

**Maximum input:** ac, 2 V peak; dc,  $\pm 50$  V.

**Input impedance (nominal):** 0.1 M $\Omega$  shunted by 2.5 pF; 1 M $\Omega$  shunted by 2 pF when HP 11576A 10:1 Divider is used; 0.1 M $\Omega$  shunted by 5 pF when HP 10216A Isolator is used. AC coupled.

### Voltage Range (rms)

Channel	1 - 10 MHz	10 - 500 MHz	500 - 1000 MHz
A	1.5 mV - 1.0 V	300 $\mu$ V - 1.0 V	500 $\mu$ V - 1.0 V
B	<100 $\mu$ V - 1.0 V	<100 $\mu$ V - 1.0 V	<100 $\mu$ V - 1.0 V

**Voltmeter ranges:** 100  $\mu$ V to 1 V rms full scale in 10 dB steps.

**Voltage ratio accuracy:** 1-200 MHz, 0.2 dB for -60 to 0 dB ranges and 0.5 dB for -70 dB and +10 dB ranges; 200-1000 MHz, 0.2 dB for -60 to -10 dB ranges, 0.5 dB for -70 dB and 0 dB ranges and 1.5 dB for +10 dB range.

**Phase range:** 360° indicated on zero-center meter with end-scale ranges of  $\pm 180^\circ$ ,  $\pm 60^\circ$ ,  $\pm 18^\circ$ , and  $\pm 6^\circ$ .

**Phase resolution:** 0.1° at any phase angle.

**Phase meter offset:**  $\pm 180^\circ$  in 10° steps.

**Phase accuracy:**  $\pm 1.5^\circ$  (equal voltage Channel A and B).

**Accessories furnished:** two HP 11576A 10:1 Dividers, two HP 10216A Isolators, two HP 10218A BNC Adapters, six ground clips for HP 11576A or 10216A; six replacement probe tips.

**Bandwidth:** 1 kHz.

**Power:** 115 or 230 V  $\pm 10\%$ , 50 to 60 Hz, 35 W.

**Weight:** net, 13.9 kg (31 lb); shipping, 16.3 kg (36 lb).

**Size:** 177 H x 425 W x 467 mm D (7.0" x 16.75" x 18.38").

### HP 11570A Accessory Kit

**50  $\Omega$  Tee:** HP 11536A: for monitoring signals on 50  $\Omega$  transmission lines without terminating line. Kit contains two with type N RF fittings.

**50  $\Omega$  Power splitter:** HP 11549A: all connectors Type N female.

**50  $\Omega$  Termination:** HP 908A: for terminating 50  $\Omega$  coaxial systems in their characteristic impedance.

**Shorting plug:** HP 11512A: Shorting Plug, Type N male.

### Ordering Information

HP 8405A Vector Voltmeter

Opt 002: linear dB scale

HP 11570A Accessory Kit (measurement in 50  $\Omega$  systems only)



# NETWORK ANALYZERS

## RF Network Analyzer, 500 kHz to 1.3 GHz

### Model 8505A

- 100 dB of dynamic range
- Digital readout of data with analog display
- Direct group delay and deviation from linear phase
- High performance sweep oscillator
- Complete family of 50  $\Omega$  and 75  $\Omega$  test sets
- Digital storage and normalization

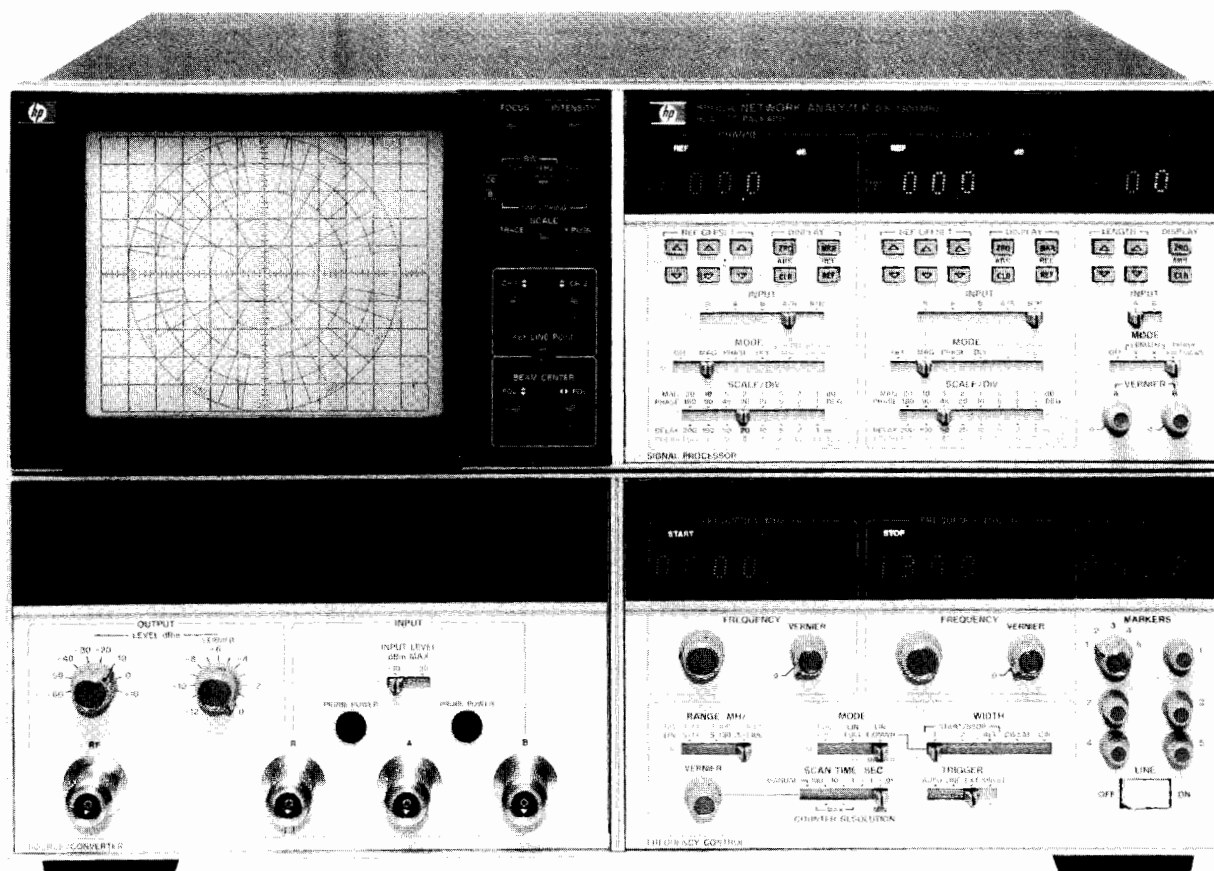

HP 8505A



The HP 8505A is a high performance RF network analyzer operating over the 500 kHz to 1.3 GHz frequency range. It accurately and easily measures complex impedance; transfer functions and group delay of coaxial components and semiconductors. Because both magnitude and phase are measured, it is possible to completely characterize the linear behavior of either active or passive networks.

Since magnitude and phase can be measured and displayed over 100 dB of dynamic range (-10 to -110 dBm), it is a simple process for the HP 8505A to measure transmission loss of high rejection devices such as filters or gain and return loss of small signal devices like amplifiers. Distortion parameters like group delay, deviation from linear phase, and deviation from constant amplitude are measured in an equally straightforward manner. Group delay is measured and displayed directly to resolutions of 1 ns per major division using a new linear FM measurement technique. A unique new electrical line stretcher compensates for the linear phase shift of the device under test so that phase non-linearities may be examined at high resolution (1° per major division). Amplitude deviations with frequency can be similarly observed to resolutions 0.1 dB per major division with clear, crisp trace stability. In addition, it is possible to read out swept amplitude, phase and delay digitally at any one of five continuously variable markers with resolutions of 0.01 dB, 0.1°, and 0.1 ns respectively.

Many of the HP 8505A's high performance features and operating conveniences are derived from the fact that it is a completely integrated system including both the sweep oscillator and receiver. The basic instrument also includes a built-in frequency counter, polar and rectangular displays on the same CRT, the new electronic line stretcher, group delay measurement, and frequency selective digital readings of swept amplitude, phase and delay. The frequency counter with resolutions up to 100 Hz adds further precision to the measurements by allowing frequency as well as amplitude, phase and delay to be read out at any of the five markers. The HP 8505A is fully programmable in a straightforward fashion using the Hewlett-Packard Interface Bus (HP-IB operation is standard). The user can configure a customized automatic system or for convenience HP offers a fully configured system, the HP 8507D. (See pages 560, 561.)

Companion instruments include the HP 11850A Three Way Power Splitter for high resolution transmission comparison measurements, the HP 8502A Transmission/Reflection Bridge for simultaneous transmission and reflection measurements, and the HP 8503A S-parameter Test Set for complete characterization of two port devices in a single test set-up. The HP 8501A Storage-Normalizer adds digital storage, normalization, signal averaging, increased resolution, and graphics to HP 8505A measurements.



## HP 8505A Specifications

### Source

#### Frequency Characteristics

**Frequency range:** 500 kHz to 1.3 GHz in three ranges, 500 kHz to 13 MHz, 500 kHz to 130 MHz and 500 kHz to 1.3 GHz.

**Swept frequency accuracy:**  $\pm 1\%$  of range for linear sweep.

**CW frequency accuracy:**  $\pm 2$  counts  $\pm$  time-base accuracy.

**Frequency stability:** better than  $\pm 0.01\%$  of reading  $\pm 0.01\%$  of frequency range over 10 minutes after warm-up.

**Frequency counter characteristics:** frequency counter measurements are made at any one of five continuously variable marker positions without interrupting the swept RF signal.

#### Resolution (least significant digit)

Frequency Range (MHz)	0.5 to 13	0.5 to 130	0.5 to 1300
10 ms Sweep time	10 kHz	100 kHz	1 MHz
100 ms Sweep time	1 kHz	10 kHz	100 kHz
>1 second Sweep time	100 Hz	1 kHz	10 kHz

**Counter accuracy:**  $\pm 2$  counts  $\pm$  time-base accuracy.

**Marker frequency accuracy:**  $\pm 0.002\%$  of scan width  $\pm$  counter accuracy. Measured in CW  $\pm \Delta F$ .

**Time-base accuracy:**  $\pm 5$  ppm  $\pm 1$  ppm/ $^{\circ}$ C  $\pm 3$  ppm/90 days.

#### Output Characteristics

**Output power range:** +10 dBm to -72 dBm.

**Attenuator accuracy:**  $\pm 1.5$  dBm over 70 dB range.

**Vernier accuracy:**  $\pm 1$  dB.

**Leveling:**  $\pm 0.5$  dB from 500 kHz to 1.3 GHz.

**Impedance:** 50  $\Omega$ ;  $\geq 16$  dB return loss at -10 dBm output level (<1.38 SWR).

#### Residual FM

Frequency Range (MHz)	0.5 to 13	0.5 to 130	0.5 to 1300
Residual FM	50 Hz rms	200 Hz rms	2 kHz rms
Bandwidth	20 Hz-1 kHz	20 Hz-1 kHz	20 Hz-10 kHz

**Harmonics:** >25 dB below main signal at +10 dBm output level.

**Sub-harmonics and spurious signals:** below -50 dBm at +10 dBm output level.

#### General Characteristics

**Sweep modes:** linear Full, Log Full, Start/Stop 1, Start/Stop 2, Alternate, CW  $\pm \Delta F$ , and CW.

**Sweep times:** 10 ms to 100 s in decade ranges.

**Trigger modes:** auto, line sync., single scan or external sync.

**RF Output connector:** type N female.

### Receiver

**Frequency range:** 500 kHz to 1.3 GHz.

#### Input Characteristics

**Input channels:** three channels (R, A, and B) with 100 dB dynamic range.

**Damage level:** +20 dBm or  $\geq 50$  V dc.

**Noise** (average, 10 kHz BW): -110 dBm from 10 to 1300 MHz; -100 dBm from 2 to 10 MHz; -95 dBm from 0.5 to 2 MHz.

**Impedance:** 50  $\Omega$ ;  $\geq 20$  dB return loss (<1.22 SWR). Typically >26 dB return loss (<1.11 SWR).

#### Magnitude Characteristics

**Absolute frequency response** (A, B, R):  $\pm 1.5$  dB.

**Ratio frequency response** (A/R, B/R):  $\pm 0.3$  dB from 0.5 MHz to 1.3 GHz.

**Dynamic accuracy:**  $\pm 0.01$  dB/dB from -20 to -40 dBm;  $\pm 0.2$  dB from -10 to -50 dBm;  $\pm 0.5$  dB from -50 to -70 dBm;  $\pm 1.0$  dB from -70 to -90 dBm;  $\pm 2.0$  dB from -90 to -100 dBm;  $\pm 4.0$  dB from -100 to -110 dBm.

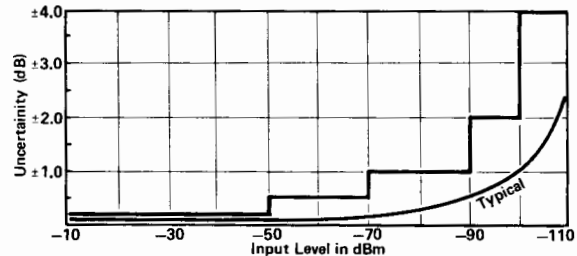

**Crosstalk error limits:** >100 dB isolation between inputs.

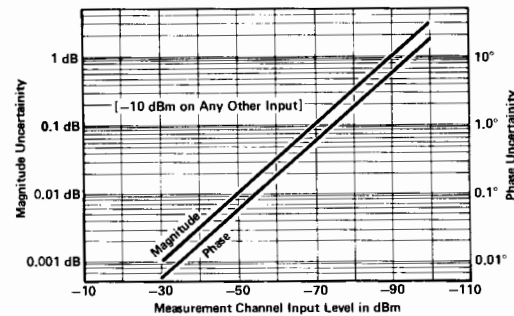

**Reference offset range:**  $\pm 199.9$  dB.

**Reference offset accuracy:**  $\pm 0.03$  dB  $\pm 0.003$  dB/dB of offset.

**Marker measurement resolution:** 0.01 dB over any <10 dB range; 0.1 dB over any  $\geq 10$  dB range.

**CRT display resolution:** 0.1 dB to 20 dB/division in 1, 2, 5 sequence.

#### Phase Characteristics

**Frequency response:**  $\pm 3^{\circ}$  from 500 kHz to 750 MHz;  $\pm 5^{\circ}$  from 750 MHz to 1.3 GHz.

**Range:**  $\pm 180^{\circ}$ .

**Accuracy:**  $\pm 0.01^{\circ}$ /degree for  $\pm 170^{\circ}$ ;  $\pm 0.01^{\circ}$ /degree  $\pm 0.5^{\circ}$  for  $\pm 180^{\circ}$ .

**Dynamic accuracy** (in 10 kHz Bandwidth):  $\pm 0.02^{\circ}$ /dB from -20 to -40 dBm;  $\pm 0.5^{\circ}$  from -10 to -50 dBm;  $\pm 1^{\circ}$  from -50 to -70 dBm;  $\pm 3^{\circ}$  from -70 to -90 dBm.

**Crosstalk:** see amplitude crosstalk specification.

**Reference offset accuracy:**  $\pm 0.3^{\circ} \pm 0.5\%$  of offset.

**Marker measurement resolution:**  $\pm 0.1^{\circ}$  over <100 $^{\circ}$  range and  $1^{\circ}$  for  $\geq 100^{\circ}$  range.

**CRT display resolution:**  $1^{\circ}$  to  $180^{\circ}$  per division in 8 steps.

**Polar characteristics:** frequency Response, Dynamic Response, Reference Offset and Marker Measurement specifications are the same as magnitude and phase characteristics.

**CRT display accuracy:** actual value is within less than 3 mm circle of the displayed value.

**Tracking between dB offset controls and polar full switch positions:**  $\leq 0.2$  dB.

**Full scale magnitude range:** 1 to 0.01 in a 1, 0.5, 0.2 sequence.

#### Delay Characteristics

**Frequency response:**  $\pm 1$  ns from 1 MHz to 1.3 GHz.

**Delay accuracy:**<sup>1</sup>  $\pm 3\%$  of reading  $\pm 3$  units (Units = 1 ns for 0.5 to 1300 MHz range, 10 ns for 0.5 to 130 MHz range, and 100 ns for 0.5 to 13 MHz range.).

<sup>1</sup> $\pm 3$  units may be calibrated out with thru connection.

# NETWORK ANALYZERS

## RF Network Analyzer, 500 kHz to 1.3 GHz (cont.)

### Model 8505A

#### Range Resolution and Aperture

Frequency Range (MHz)	0.5 to 13	0.8 to 130	4.0 to 1300
Range	0 to 80 $\mu$ s	0 to 8 $\mu$ s	0 to 800 ns
Resolution			
CRT:	100 ns	10 ns	1 ns
Marker:	100 ns	10 ns	1 ns
Marker with Delay scale/Div Switch set to:			
	10 ns (<1 $\mu$ s)	1 ns (<100 ns)	0.1 ns (<10 ns)
Aperture <sup>1</sup>	7 kHz	20 kHz	200 kHz

**Reference offset range:**  $\pm 1999$  dB.

**Reference offset accuracy:**  $\pm 0.3$  units  $\pm 0.3\%$  of offset.

#### Electrical Length/Ref. Plane Extension Characteristics Calibrated Electrical Length Range and Resolution<sup>2</sup>

Frequency Range (MHz)	0.5 to 13	0.5 to 130	0.5 to 1300
Range X1	$\pm 19.9$ m	$\pm 1.99$ m	$\pm 19.9$ cm
X10	$\pm 100$ m	$\pm 10$ m	$\pm 1$ m
Resolution X1	10 cm	1 cm	0.1 cm
X10	1 m	10 cm	1 cm

**Calibrated electrical length accuracy:**  $\pm 3\%$  of reading  $\pm 1\%$  of range.

**Linear phase substitution (degrees/scan) range:**  $\pm 1700^\circ$  per scan with  $0^\circ$  offset.

$$\frac{\pm 1.4 \text{ km}}{\text{scan width (MHz)}} \quad \text{or} \quad \frac{\pm 4.7 \mu\text{s}}{\text{scan width (MHz)}}$$

**Linear phase substitution resolution:**  $10^\circ$

**Linear phase substitution accuracy:**  $\pm 3\%$  of reading  $\pm 10^\circ$  / scan.

**Phase compensation linearity:**  $< 0.2\%$  of phase slope inserted.

#### General Characteristics

**RF input connectors:** type N female.

**Display bandwidth:** selectable IF bandwidths of 10 kHz and 1 kHz. A video filter position is also provided.

**CRT overlays:** Smith Charts (2, 1, 0.5, 0.2, 0.1 full scale), Log Charts (10 MHz, 100 MHz and 1000 MHz).

**CRT photography:** HP 197A Opt 006 camera or HP 197A with HP 10375A Bezel Adapter required to fit HP 8505A display. A CRT illumination control is provided.

#### Auxiliary Outputs

**Channel 1 and 2 outputs:** 0.25 V/display division.

**Sweep output:** 0.25 V/display division.

**Pen lift:** dc coupled, 200 mA current sink.

#### Programming

The HP 8505A has a remote programming interface using the Hewlett-Packard Interface Bus with Learn Mode. One 0.5 m (HP 10833D) HP-IB cable included.

**Power:** selection of 100, 120, 200 or 240 V  $\pm 5\%$   $-10\%$ , 50 to 60 Hz, approximately 275 watts.

**Size:** 279 H x 426 W x 553 mm D (11 x 16.75 x 21.75 in.).

### HP 8505A Opt 005 Specifications (phase-lock operation)

#### Source

##### Frequency Characteristics

**Modes (HP 8505A):** CW and CW  $\pm \Delta F$  only.

**Range and Resolution (HP 8505A and 8656B):**

(Total frequency range is 500 kHz to 990 MHz)

	HP 8656B Frequency Ranges (MHz)	HP 8505A Frequency Range MHz		
		0.5 to 13	0.5 to 130	0.5 to 1300
CW Resolution (set on HP 8656)	All freq. ranges	10 Hz	10 Hz	10 Hz
$\pm \Delta F$ Resolution (set on HP 8505)	All freq. ranges	1 Hz	10 Hz	100 Hz
Max +/- $\Delta F$	0.5-123.5 123.5-247 247-990	1.3kHz	13kHz 13 kHz	50kHz 99kHz

#### Range and Resolution (HP 8505A and 8642B):<sup>2</sup>

(Total frequency range 500 kHz to 1300 MHz)

	HP 8642B Frequency Ranges (MHz)	HP 8505A Frequency Range MHz		
		0.5 to 13	0.5 to 130	0.5 to 1300
CW Resolution (set on HP 8642)	All freq. ranges	1 Hz	1 Hz	1 Hz
$\pm \Delta F$ Resolution (set on HP 8505)	All freq. ranges	1 Hz	10 Hz	100 Hz
Max +/- $\Delta F$ <sup>3</sup>	0.5-132 <sup>1</sup> 132-1300	1.3 kHz	13 kHz	130 kHz 130 kHz

**Typical system residual FM:** the residual FM of a phase-locked HP 8505A approaches that of the HP 8642A/B or 8656B.

#### Output Characteristics

Power output, harmonics, spurious outputs, RF noise, etc. are determined by the HP 8642A/B or the HP 8656B.

#### Receiver

Magnitude and phase characteristics are unchanged with the exception of the dynamic range specification.

#### Delay Characteristics

**Accuracy:**  $\pm 3\%$  of reading  $\pm 3$  units. Units: 1  $\mu$ s for 0.5-1300 MHz; 10  $\mu$ s for 0.5-130 MHz; 100  $\mu$ s for 0.5-13 MHz.

**Range, resolution and aperture: (HP 8642A/B or 8656B) (HP 8505A indicated units x 1000)**

	8505 Frequency Range (MHz)		
	0.5-13	0.5-130	0.5-1300
Range	0-80 ms	0-8 ms	0-800 $\mu$ s
Resolution:			
CRT & Digital Marker	100 $\mu$ s	10 $\mu$ s	1 $\mu$ s
Digital Marker with Delay Switch Setting	10 $\mu$ s	1 $\mu$ s	100 ns
	<1 ms	<100 $\mu$ s	<10 $\mu$ s
Aperture <sup>4</sup>	1.5 kHz	2.0 kHz	4.0 kHz

#### Electrical Length Characteristics

**Accuracy:**  $\pm 3\%$  of reading  $\pm 3\%$  of range.

**Calibrated electrical length, range, and resolution<sup>5</sup>:** (HP 8642A/B or 8656B): (HP 8505A digital readouts  $\times 1000$ ) give electrical length 1000 times larger and resolution divided by 1000.

#### General Characteristics

##### RF Inputs

**L.O. drive input level:** 10 dBm  $\pm 2$  dB (Rear panel BNC).

**RF input level:** 0 dBm  $\pm 2$  dB (Rear panel BNC).

**Tunable FM output:**  $\pm 1.3$  V maximum (rear panel BNC with output level controlled by  $\pm \Delta F$  control on front panel of HP 8505A).  $\pm 1.3$  V output is obtained independent of the frequency range switch setting.

**Capture range of phase-lock loop:** 100 kHz (0.5-13 MHz range); 400 kHz (0.5-130 MHz range); 4 MHz (0.5-1300 MHz range).

**Standard/phase-lock operation:** rear panel switch can disable all phase-lock circuitry when using the instrument in its standard (non phase-lock) operating mode.

<sup>1</sup>Heterodyne band.

<sup>2</sup>HP 8642A and the HP 8505A have a total frequency range of 500 kHz to 1057.5 MHz. Resolution and  $\Delta F$  performance is the same as the HP 8642B.

<sup>3</sup>Max deviation for the HP 8642A/B exceeds 1 MHz for various frequency bands.

<sup>4</sup>Typical measurement Aperture using linear FM modulation technique.

<sup>5</sup>Vernier provides continuous adjustment of electrical length. Calibrated Electrical Length Linearity:  $\Delta\theta = 0.7\% \times 1.2 f$  (MHz)  $\times 1$  (metres).

# NETWORK ANALYZERS

## RF Network Analyzer: Storage Normalizer

### Model 8501A

557

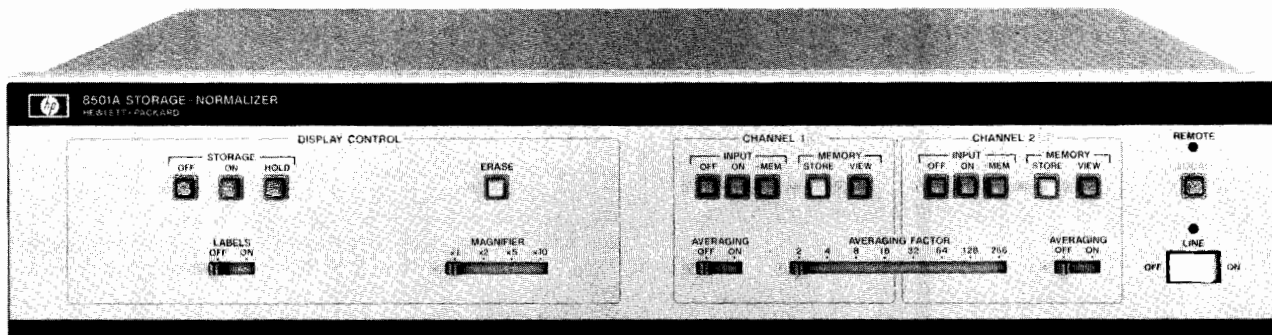

HP 8501A



## Description

The HP 8501A high performance Storage-Normalizer is a dedicated accessory that extends the measurement capability of your HP 8505A RF Network Analyzer (500 kHz to 1.3 GHz). Flicker-free displays with digital storage and CRT annotation of major control settings provide convenient easy documentation. Using normalization, frequency response errors are simply removed. In addition, the HP 8501A can digitally average signals to dramatically improve signal-to-noise ratios and magnify the display for high accuracy measurements. With a desktop computing controller, computer graphics capability is added to the HP 8505A for displaying corrected data, operator messages, or computer programs.

## HP 8501A Specifications

### Display

#### Rectangular Displays

**Horizontal display resolution:** two display channels, 500 points per channel (0.2% of full scale, 0.24 mm).

**Vertical display resolution:** 500 points displayed full scale (0.2% of full scale) plus a 50% overrange (250 points) both above and below full screen.

#### Polar Displays

**Display resolution:** two display channels, 250 points per polar display (0.2% of full scale, 0.2 mm in X and Y).

**Display tracking:** visual offsets between direct HP 8505A and stored displays are approximately  $\pm 1/2$  CRT minor division ( $\pm 1$  mm).

**Horizontal input sweep times:** 100 s max/10 ms min.

**Conversion time:** 10 ms max for 500  $\pm 2$  data points (20  $\mu$ s per point).

**Display refresh time:** nominally 20 ms depending upon information displayed.

**Line generator:** a line generation technique is used to connect points on a CRT display, yielding a smooth continuous trace.

**Markers:** all five markers are also available in the digital display mode.

### Output

**Auxiliary outputs XYZ:** (BNC female connectors on rear panel).

X—1 V full screen, 83 mV/div (12 div).

Y—1 V full screen, 100 mV/div (10 div).

Z—1 volt blanks display, +2 volts unblank display. (Signal compatible for all HP CRT displays such as 1332, 1304, or 1310).

**Offsets:** the X, Y, and polar display offsets can be adjusted over a  $\pm 10\%$  range of screen by means of potentiometers on the rear panel of the HP 8501A.

**Labeling interface:** all major control settings of the HP 8505A, the HP 8503A and phase-lock indication are displayed on the CRT.

## HP-IB Interface

### HP-IB Interface Capabilities

#### Remote Programming

**Learn mode:** this feature provides the ability to output the current instrument state to a computing controller.

**Input data:** data for graphics or other purposes can be sent to the HP 8501A at a rate of:

**ASCII mode:** 600 points per second.

**Binary mode:** 10000 points per second.

**Output data:** data can be read from the HP 8501A at a rate of:

**ASCII mode:** 800 points per second.

**Binary mode:** 9000 points per second.

**Graphics:** data for graphics can be read into the HP 8501A and viewed in two types of displays.

**Text displays:** 22 lines of text with 54 characters per line can be displayed on the CRT.

**Vector display:** lines can be drawn on the display between any two points with a resolution of 432 points in X and 360 points in Y (nominal).

### General

#### Display Controls

**Storage off:** the HP 8501A is bypassed so the display returns to normal analog operation.

**Storage on:** turns on digitally stored display.

**Storage hold:** the current display is not updated and is frozen for CRT photography or further analysis.

**Erase:** display and memory are erased.

**Labels:** switches all display labeling on or off.

**Magnifier:** expands the display by a factor of 1, 2, 5, or 10.

#### Processing Functions (channel 1 and 2)

**Input off:** display of channel 1 (2) is blanked.

**Input on:** channel 1 (2) measurement is displayed.

**Input mem:** the difference between the channel 1 (2) measurement and the stored memory content is displayed (normalization).

**Memory store:** the current measurement is stored in memory.

**Memory view:** the stored memory content is displayed.

**Averaging:** the data averaging function for channel 1 (2) is switched on or off.

**Averaging factor:** the degree of averaging is selectable from 2, 4, 8 ... to 256. The current averaged trace is always displayed and updated at the sweep rate.

**Local:** returns the HP 8501A control to the front panel from remote HP-IB control.

**Includes:** 0.5 m HP-IB cable and the processor interconnect cable.

**Accessories:** the HP 11864A Accessory Kit provides the labeling interface boards and connectors for retrofitting the HP 8505A. Labeling interface now standard on the HP 8505A.

**Power:** selection of 100, 120, 220, or 240 V +5%–10%, 50 to 60 Hz and <140 VA (<140 watts).

**Size:** 90 H x 426 W x 534 mm D (3.5" x 16.75" x 21.0").

**Weight:** net, 12.25 kg (27 lb); shipping, 14 kg (31 lb).

# NETWORK ANALYZERS

RF Network Analyzer, 500 kHz to 1.3 GHz (cont.)

Models 8503A/B, 8502A/B, 11850A/B, 11851A-11858A, 11857B, 1121A

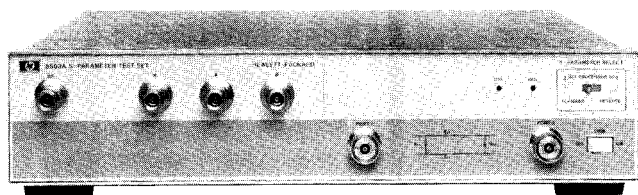

HP 8503A

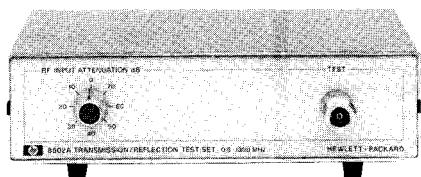

HP 8502A

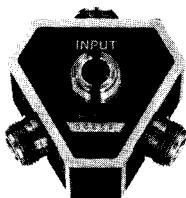

HP 11850A

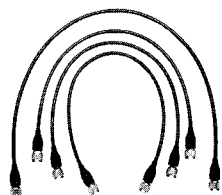

HP 11851A



HP 1121A

**HP 8502A 50 Ω Transmission/Reflection Test Set**

**HP 8502B 75 Ω Transmission/Reflection Test Set**

**Frequency range:** 500 kHz to 1.3 GHz.

**Impedance:** HP 8502A, 50 Ω; HP 8502B, 75 Ω.

**Directivity:** ≥40 dB.

**Frequency Response**

**Transmission:** ≤±0.8 dB and ≤±8°.

**Reflection:** ≤±1.5 dB and ≤15° from 0.5–1300 MHz; ≤±10° from 2–1300 MHz.

**Port Match**

**Test port:** ≥26 dB return loss from 2–1300 MHz (≥24 dB for HP 8502B); ≥20 dB return loss from 0.5–2 MHz (≥18 dB for HP 8502B).

**Test port open/short ratio:** ±0.75 dB and ±6° from 2–1000 MHz (±0.9 dB and ±7.5° for HP 8502B); ±0.9 dB and ±7.5° from 1000–1300 MHz; ±1.25 dB and ±10° from 0.5–2 MHz.

**Reference and reflection ports:** ≥25 dB return loss from 2–1000 MHz; ≥23 dB return loss from 0.5–1300 MHz.

**Input port:** ≥23 dB return loss.

**Nominal Insertion Loss**

**Input to test port:** 13 dB (HP 8502A), 19 dB (HP 8502B).

**Input to reference port:** 19 dB (HP 8502A), 19 dB (HP 8502B).

**Input to reflection port:** 19 dB (HP 8502A), 31 dB (HP 8502B).

**Maximum operating level:** +20 dBm.

**Damage level:** 1 watt CW.

**RF attenuator range:** 0 to 70 dB in 10-dB steps.

**Connectors test port:** 50 Ω Type N Female for HP 8502A and 75 Ω Type N Female for HP 8502B; all other RF ports 50 Ω Type N Female; Bias input, BNC Female.

**DC bias input:** ±30 V dc and ±200 mA.

**Includes:** HP 8502B includes 50 Ω/75 Ω minimum loss pad.

**Recommended accessory:** HP 11851A RF Cable Kit for either HP 8502A or 8502B.

**Size:** 61.5 H x 101 W x 204 mm D (2.44" x 7.5" x 8.0").

**Weight:** net, 1.7 kg (3.25 lb); shipping, 3.1 kg (7 lb).

**HP 8503A 50 Ω S-Parameter Test Set**

**HP 8503B 75 Ω S-Parameter Test Set**

**Frequency range:** 500 kHz to 1.3 GHz.

**Impedance:** HP 8503A, 50 Ω; HP 8503B, 75 Ω.

**Directivity:** ≥40 dB.

**Frequency Response**

**Transmission (S<sub>12</sub>, S<sub>21</sub>):** ±1 dB, ±12° from 0.5–1300 MHz.

**Reflection (S<sub>11</sub>, S<sub>22</sub>):** ±2 dB, ±20° from 0.5–1300 MHz; ±15° from 2–1300 MHz.

**Port Match**

**Test ports 1 and 2:** ≥26 dB return loss from 2–1300 MHz (≥24 dB for HP 8503B), ≥20 dB return loss from 0.5–2 MHz (≥18 dB for HP 8503B).

**Test port 1 and 2 open/short ratio:** ≤±0.75 dB and ±6° from 2–1000 MHz (±0.9 dB and ±7.5° for HP 8503B); ≤±0.9 dB and 7.5° from 1000–1300 MHz; ±1.25 dB and ±10° from 0.5–2 MHz.

**Reference and return ports:** ≥23 dB return loss from 2–1000 MHz; ≥20 dB return loss from 0.5–2 MHz and 1000–1300 MHz.

**RF input port:** 20 dB return loss from 0.5–1300 MHz.

**Maximum operating level:** +20 dBm.

**Damage level:** 1 watt CW.

**Connectors:** test ports, 50 Ω APC-7 for HP 8503A and 75 Ω Type-N Female for HP 8503B; all other RF connectors, 50 Ω Type-N Female; Bias inputs BNC Female.

**DC bias input:** 30 V dc, ±200 mA.

**Includes:** four 19 cm (7.5") cables for connection to HP 8505A.

**Recommended accessory:** HP 11857A 50 Ω Test Port Extension Cables or HP 11857B/C 75 Ω Test Port Extension Cables.

**Programming:** programming via HP-IB; 0.5 m HP-IB cable included.

**Power:** 100, 120, 220, or 240 V +5%–10%, 50 or 60 Hz; approx. 10 watts (15 watts for HP 8503B).

**Size:** 90 H x 426 W x 553 mm D (3.5" x 16.75" x 21.0").

**Weight:** net, 9.1 kg (20 lb); shipping, 11.3 kg (25 lb).

**Accessories**

**HP 11850A 50 Ω Power Splitter**

**HP 11850B 75 Ω Power Splitter**

**Frequency range:** dc to 1.3 GHz.

**Impedance:** HP 11850A, 50 Ω; HP 11850B, 75 Ω.

**Tracking between any two output ports:** ≤0.1 dB and ≤1.5°.

**Equivalent source match (ratio or leveling):** ≥32 dB return loss (≤1.05 SWR).

**Input port match:** ≥20 dB return loss.

**Nominal insertion loss:** 9.54 dB for HP 11850A; 7.78 dB for HP 11850B.

**Frequency response absolute:** input to output ≤0.2 dB.

**Maximum operating level:** +20 dBm.

**Burn-out level:** ≥1 watt CW.

**Connectors:** HP 11850A, 50 Ω Type N female; HP 11850B, three outputs 75 Ω Type N female; RF input, 50 Ω Type N female.

**Recommended accessory:** HP 11851A RF Cable Kit.

**Includes:** HP 11850B includes three 50 Ω/75 Ω Minimum Loss Pads

**Size:** 46 H x 67 W x 67 mm D (1.88" x 2.63" x 2.63").

**Weight:** net, 1.8 kg (4 lb); shipping, 3.1 kg (7 lb).

#### HP 11851A RF Cable Kit

**General:** three 610 mm (24 in.) 50 Ω cables phase matched to 4° at 1.3 GHz and one cable 860 mm (34 in.). Connectors are Type N Male. Recommended for use with HP 8502A/B Transmission/Reflection Test Set and HP 11850A/B Power Splitter.  
**Weight:** net, 0.91 kg (2 lb); shipping, 1.36 kg (3 lb).

#### HP 11852A 50 Ω/75 Ω Minimum Loss Pad

**General:** the HP 11852A is a low SWR minimum loss pad required for transmission measurements on 75 Ω devices with HP 8505A receiver (50 Ω).  
**Frequency range:** dc to 1.3 GHz.  
**Insertion loss:** 5.7 dB.  
**Return loss:** 75 Ω side, 50 Ω side terminated: typically ≥34 dB (≤1.04 SWR). 50 Ω side, 75 Ω side terminated: typically ≥30 dB (≤1.06 SWR).  
**Typical flatness:** ≤0.1 dB from dc to 1.3 GHz.  
**Maximum input power:** 250 mW (+24 dBm).  
**Connectors:** 50 Ω Type N female and 75 Ω Type N male.  
**Size:** 14 D x 70 mm L (0.56" x 2.75").  
**Weight:** net, 0.11 kg (4 oz); shipping, 0.26 kg (9 oz).

#### HP 11853A 50 Ω Type N Accessory Kit

**General:** the HP 11853A furnishes the RF components required for measurement of devices with 50Ω Type N Connectors using the HP 11850A, 8502A, or 8503A (8503A also requires the HP 85032A). Kit contains a Type N Female short, a Type N Male short, two Type N Male barrels, two Type N Female barrels and storage case.  
**Weight:** net, 0.91 kg (2 lb); shipping, 1.36 kg (3 lb).

#### HP 11854A 50 Ω BNC Accessory Kit

**General:** the HP 11854A furnishes the RF components required for measurement of devices with 50Ω BNC Connectors using the HP 11850A, 8502A, or 8503A (8503A also requires the HP 85032A). Kit contains two Type N Male to BNC Female adapters, two Type N Male to BNC Male adapters, two Type N Female to BNC Female adapters, two Type N Female to BNC Male adapters, a BNC Male short and storage case.  
**Weight:** net, 1.13 kg (2½ lb).

#### HP 11855A 75 Ω Type N Accessory Kit

**General:** the HP 11855A provides the RF connecting hardware generally required for measurement of devices with 75 Ω Type N connectors using the HP 8502B, 8503B or 11850B. Kit contains two 75 Ω Type N Male barrels, two Type N Female barrels, a 75 Ω Type N Female short, a 75 Ω Type N Male short, a 75 Ω Type N Male termination, and storage case.  
**Weight:** net, 0.91 kg (2 lb); shipping, 1.36 kg (3 lb).

#### HP 11856A 75 Ω BNC Accessory Kit

**General:** the HP 11856A provides the RF connecting hardware generally required for measurement of devices with 75 Ω BNC connectors using the HP 8502B, 11850B, or 8503B. Kit contains two Type N Male to BNC Female adapters, two Type N Male to BNC Male adapters, two Type N Female to BNC Female adapters, two Type N Female to BNC Male adapters, a BNC Male short, a 75 Ω BNC Male termination, and storage case.  
**Weight:** net, 0.91 kg (2 lb); shipping, 1.36 kg (3 lb)

#### HP 11857A 50 Ω APC-7 Test Port Extension Cables

**General:** two precision 61 cm (24 in.) cables, phase matched to 2° at 1.3 GHz for use with HP 8503A S-parameter test set. Connectors are 50 Ω APC-7.  
**Weight:** net, 0.91 kg (2 lb); shipping, 2.3 kg (5 lb).

#### HP 11857B 75 Ω Type N Test Port Extension Cables

**General:** two precision 61 cm (24 in.) cables, phase matched to 2° at 1.3 GHz for use with HP 8503B S-parameter test set. One cable has 75 Ω Type N Male connectors on both ends; the other has one Type N Male and one Type N Female connector.  
**Weight:** net, 0.91 kg (2 lb); shipping, 2.3 kg (5 lb).

#### HP 11858A Transistor Fixture Adapter

**General:** the HP 11858A adapts the HP 11600B and 11602B transistor fixtures (vertical test port configuration) to the HP 8503A S-parameter test set. Connectors are APC-7.  
**Weight:** net, 0.91 kg (2 lb); shipping, 1.36 kg (3 lb).

#### HP 1121A

**General:** 1:1 active probe for making measurements without disturbing circuitry and measuring voltage transfer functions in systems different from 50 Ω. 10:1 and 100:1 dividers and BNC adapter also furnished.  
**Frequency response:** ±0.5 dB and ±2% from 0.1—110 MHz with a bandwidth (3 dB) of 1 kHz to >500 MHz and gain 0 dB ±1 dB.  
**Input impedance:** 100 kΩ, shunt capacitance of 3 PF at 100 MHz. With 10:1 or 100:1 divider, 1 MΩ, shunt capacitance 1 PF at 100 MHz.  
**Output impedance:** 50 Ω nominal.  
**Maximum input:** 300 mV rms, +80 V dc; with 10:1 divider, 30 V rms, ±350 V dc.  
**Power:** supplied by HP 85205A through PROBE PWR jacks.  
**Weight:** net, 0.7 kg (1.5 lb). Shipping, 1.2 kg (2.5 lb).

#### Ordering Information

- HP 8505A\* RF Network Analyzer
- Opt 005: Phase Lock
- Opt 908: Rack Mounting Kit (for use without front handles)
- Opt 910: Extra Manual
- Opt 913: Rack Mounting Kit
- HP 8503A\* 50 Ω S-Parameter Test Set
- Opt 908: Rack Mounting Kit (for use without front handles)
- Opt 910: Extra Manuals
- Opt 913: Rack Mounting Kit
- HP 8503B\* 75 Ω S-Parameter Test Set
- Opt 908: Rack Mounting Kit (for use without front handles)
- Opt 910: Extra Manual
- Opt 913: Rack Mounting Kit
- HP 8501A\* Storage Normalizer
- Opt 908: Rack Mounting Kit (for use without front handles)
- Opt 910: Extra Manual
- Opt 913: Rack Mounting Kit
- HP 8502A 50 Ω Transmission/Reflection Test Set
- Opt 910: Extra Manual
- HP 8502B 75 Ω Transmission/Reflection Test Set
- Opt 910: Extra Manual
- HP 11850A 50 Ω Power Splitter
- HP 11850B 75 Ω Power Splitter
- HP 11851A RF Cable Kit
- HP 11852A 50 Ω to 75 Ω Minimum Loss Pad
- HP 11853A 50 Ω Type N Accessory Kit
- HP 11854A 50 Ω BNC Accessory Kit
- HP 11855A 75 Ω Type N Accessory Kit
- HP 11856A 75 Ω BNC Accessory Kit
- HP 11857A 50 Ω APC-7 Test Port Extension Cables
- HP 11857B 75 Ω Type N Test Port Extension Cables
- HP 11858A Transistor Fixture Adapter
- HP 11864A Labeling Interface Kit
- HP 1121A AC Probe Kit

\*Front Handles are standard

# NETWORK ANALYZERS

## Automatic Network Analyzer System, 500 kHz to 1.3 GHz

### Model 8507S

- Improve productivity in lab and factory
- Accuracy enhancement
- Ease of operation via HP-IB
- HP 9816S, 9826S or 9836 Computer
- Learn mode
- Graphics transfer to computer

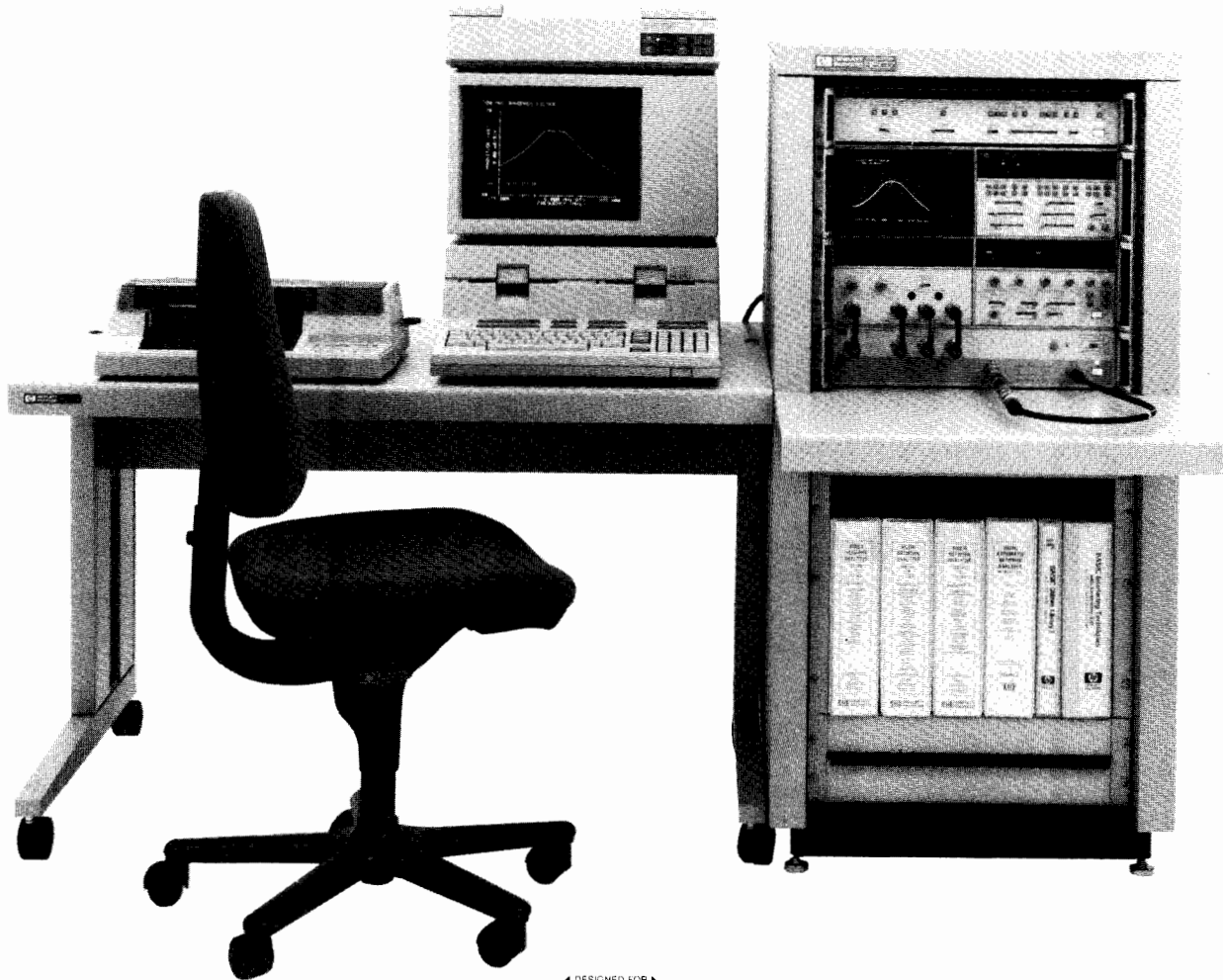

HP 8507S



### Description

The HP 8507S is an Automatic Network Analyzer System based on the HP 8505A Network Analyzer that is controlled by one of the HP Series 200 computers (HP 9816, 9826S, 9836S, or 9836CS). Mating this versatile, easy-to-use desktop computer with the completely programmable network analyzer produces a powerful RF network measurement tool for both lab and production use.

### Cost Effective Solutions

In laboratory applications, engineers gain greater circuit insight via the speed and ease with which the HP 8507S accumulates and summarizes data. Use the HP 85011A Software for accuracy enhancement and data output formatting or program the instruments yourself with easy to use HP-IB commands. With only a few hours training, engineers with no previous programming experience have been able to write customized programs that solve specialized measurement problems. In production environments, the HP 8507S can dramatically reduce the time and cost of making complicated limit tests on all types of components. Testing programs with built-in operator instructions can minimize training cost, ensure uniform test procedures and eliminate subjective decisions.

### Simplicity and Flexibility of HP-IB

Configuration of the standard HP 8507S is a simple matter since it is programmed via the Hewlett-Packard Interface Bus. For example, perhaps your RF measurement application requires a programmable power supply for transistor biasing or a digital voltmeter. Simply choose an instrument from the selection of HP-IB programmable instruments and add it to your HP 8507S using universal HP-IB cables.

It is equally easy to get started making measurements since the HP 8507S comes with software (HP 85011A) that complements the Hewlett-Packard hardware. Included are programs for 8 or 12 term accuracy enhancement and general network analyzer applications. In addition, a system check-out program is provided.

### Learn Mode Operation

The "Learn" mode of operation has extended traditional automatic operation to a new level of operator convenience. The desktop computer can accept (Learn) a data string from the network analyzer that defines all of the manually set front panel control settings. This is accomplished by a single keystroke. Once stored in the desktop computer (or permanently recorded on a flexible disc) this data string can then be used to automatically return the network analyzer to its exact original test conditions. And this can all be done without the operator ever writing a single program line!



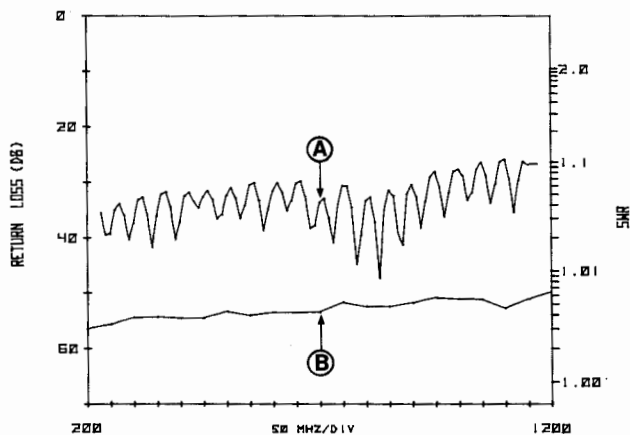

### Accuracy Enhancement

The HP 85011A System Software permits frequency tracking, mismatch, and directivity errors to be characterized by applying known standards. These stored system errors are then removed from the measurement of the unknown to provide a degree of accuracy exceeding that possible with the standard HP 8505A.

### An Example

The plots on the left show the result of software accuracy enhancement. Curve A depicts raw measurements on a 50 dB return loss termination at the end of a six-foot RG 214 cable—a typical application problem in testing in temperature chambers. Curve B shows the results after calibrating at the end of the cable—a 25 dB improvement.

### Data in the Form you Need

With the desktop computers, it is a simple matter to obtain customized printed or plotted outputs. Or you may want to store data on tape for later analysis. Data can be analyzed or statistically summarized directly, bypassing the laborious and error-prone task of manually recording and re-entering data. Data reformatting such as converting return loss to SWR or S-parameters to Y-parameters can be accomplished also.

## HP 8507S Automatic Network Analyzer

### Ordering Information

#### System Reference

#### HP 8507S Automatic Network Analyzer

This system reference number ensures coordinated delivery and compatibility of instrument and software

#### Network Analyzer Subsystem

#### HP 8507D Network Analyzer Subsystem

Includes: HP 8505A Network Analyzer  
 HP 8501A Storage Normalizer  
 HP 8503A S-Parameter Test Set  
 HP 85031A APC-7 Calibration Kit  
 Systems Cabinet and Cables  
 System Assembly and Checkout

**Opt. 002:** Delete Systems Cabinet

**Opt. 005:** Add HP 8505A Phase Lock

**Opt. 910:** Extra Set of Manuals

**Opt. 913:** Rack Mounting Kit

#### Calibration Kits

HP 85031A APC-7 Calibration Kit (included with HP 8507D)

HP 85032A 50Ω Type-N Calibration Kit

HP 85033A SMA Calibration Kit

HP 85033B APC-3.5 Calibration Kit

#### Computers (choose one)

HP 9816S Series 200, Model 16S Computer (select option)

**Opt. 630** for use with HP 9121D Disk Drive

**Opt. 650** for use with HP 82901M Disk Drive

HP 9826S Series 200, Model 26S Computer

HP 9836S Series 200, Model 36S Computer

HP 9836CS Series 200, Model 36CS Computer

**Disk Drives** (one required for HP 9816S)

HP 9121D 3.5 inch Dual Flexible Disk Drive

HP 82901M 5.25 inch Dual Flexible Disk Drive

**Software** (choose one option)

HP 85011A System Software for HP 8507D

**Opt. 630** for HP 9816S Computer with HP 9121D Disk Drive

**Opt. 655** for either HP 9826S or 9836S Computer

**Printer** (choose one)

HP 2673A Thermal Graphics Printer

HP 2932A Impact Graphics Printer Opt. 046

HP 2225A Think Jet Graphics Printer

HP 2671G Thermal Graphics Printer

#### System Furniture

HP 92214B Work Station Table

HP 92209C Ergonomic Chair

#### Plotters

HP 7470A Opt. 002 Two Pen Plotter

HP 7475A Opt. 002 Six Pen Plotter

HP 7550A Eight Pen Plotter

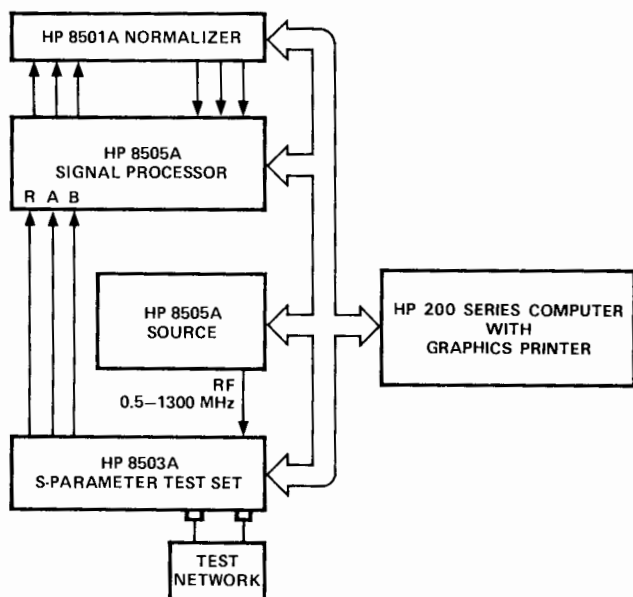

## HP 8507S Calibration Kits

### HP 85031A Verification and APC-7 Calibration Kits

Included with HP 8507D. Contains Precision APC-7 Load, APC-7 Short, and two verification standards.

### HP 85032A Type N Calibration Kit

For use with HP 8507S. Contains 2 APC-7 to N-Male Adapters, 2 APC-7 to N-Female Adapters, 1 N-Male Load, 1 N-Female Load, 1 N-Female Short, 1 N-Male Short.

### HP 85033A SMA Calibration Kit

For use with HP 8507S. Contains 2 APC-7 to SMA-Male Adapters, 2 APC-7 to SMA-Female Adapters, 1 SMA-Male Load, 1 SMA-Female Load, 1 SMA-Female Short, and 1 SMA-Male Short.

### HP 85033B APC-3.5 Calibration Kit

For use with the HP 8507S. Contains 2 APC-3.5 Male to APC-7 Adapters, 2 APC-3.5 Female to APC-7 Adapters, 1 APC-3.5 Male and Female Short, 1 APC-3.5 Male and Female Shielded Open with center pin extenders, and 1 Male and Female 50 Ω Loads.

# NETWORK ANALYZERS

## Microwave Network Analyzers, 45 MHz to 26.5 GHz



### 8510 Series

- 45 MHz to 26.5 GHz frequency range
- "Real Time" error-corrected measurements
- 50 dB effective directivity, 40 dB effective source and load match
- 80 dB to 100 dB dynamic range
- 0.001 dB, 0.01 degree, 0.01 nanosecond measurement resolution
- Time domain analysis

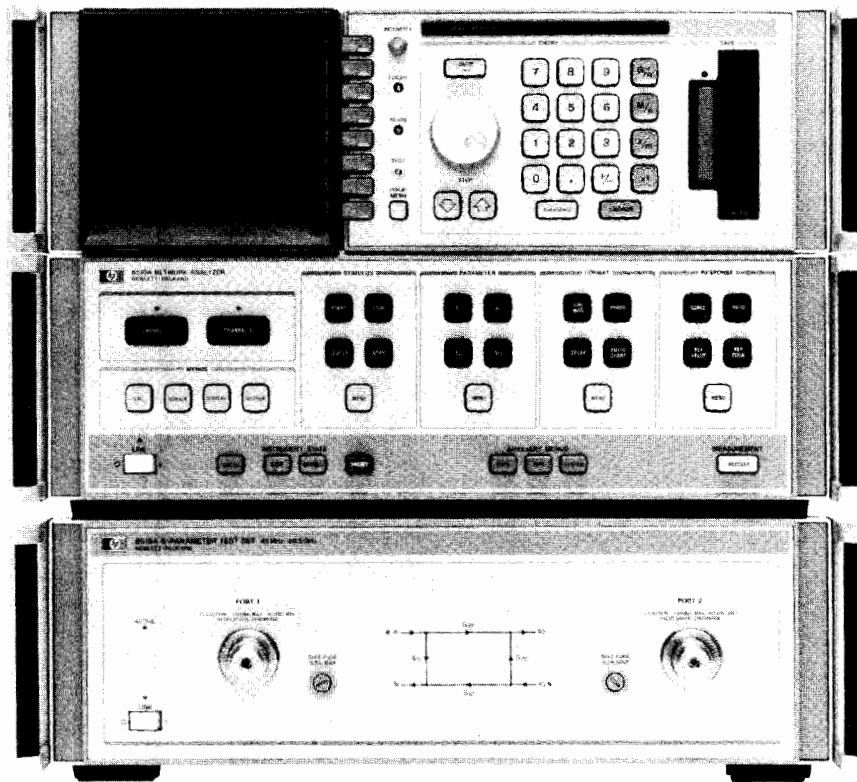

HP 8510A

### Description

The HP 8510 series microwave vector network analyzers provide a complete solution for characterizing the linear behavior of either active or passive networks over the 45 MHz to 26.5 GHz frequency range. A complete system comprises the HP 8510A network analyzer, one of four HP 851XA broadband test sets, and a compatible RF source.

The test sets are offered in one of two measurement test setup configurations. The reflection/transmission test sets provide the capability to simultaneously measure the complex reflection and transmission characteristics of a test device. The S-parameter test sets offer a single test setup solution for complete characterization of two-port devices. Each measurement presented on the CRT display consists of 51, 101, 201, or 401 discrete points of data, and when the system source is a synthesizer, the frequency of each data point is synthesized.

Measurement results can be displayed on one of two completely independent, yet identical, channels. The channels may be displayed individually, or simultaneously, with results presented in either logarithmic/linear magnitude, phase, or group delay format on rectangular or polar coordinates. Direct measurement of normalized impedance is possible with the Smith chart format. The value and frequency of any one data point can be read with one of five independent markers. The entire measurement trace can be copied directly to a plotter, such as the HP 7470A, 7475A, or 7550A without the need of an external computer. Also, a list of the trace values can be sent to a printer such as the HP 9876A or 2225A.

Powerful measurement enhancement functions are also available. Data averaging can be employed to effectively narrow the receiver IF

bandwidth, extending dynamic range and reducing signal-to-noise ratio. Trace smoothing aids in the interpretation of measurement results and is used to control the aperture of group delay measurements. The equivalent of an electronic line stretcher is available via the electrical delay function.

Built-in storage provides the capability to save and recall up to eight different front panel states, eight separate measurement calibrations, and four separate measurements in nonvolatile memory. Extension of the internal storage capacity is practically limitless via the built-in tape cassette unit.

All the functions of the HP 8510 system are completely programmable from an external computer through the Hewlett-Packard Interface Bus. Also, measurements can be transferred to a computer in one of four data transfer formats. CRT graphics, such as limit lines, can be written to the HP 8510 to aid in test procedures. The built-in tape drive can, as well, be used to provide permanent storage of CRT graphics.

### High Performance

Along with the capability to completely characterize a microwave network with a single connection over the extremely broad 45 MHz to 26.5 GHz frequency range, the HP 8510 system offers wide dynamic range. Depending on the test set used, 80 dB to 100 dB of dynamic range is available. The precision IF processing and detection system contributes as little as  $\pm 0.05$  dB and  $\pm 0.5$  degree measurement uncertainty at a level of 50 dB below the reference. Meaningful resolutions of 0.001 dB, 0.01 degree, and 0.01 nanosecond are easily achievable.

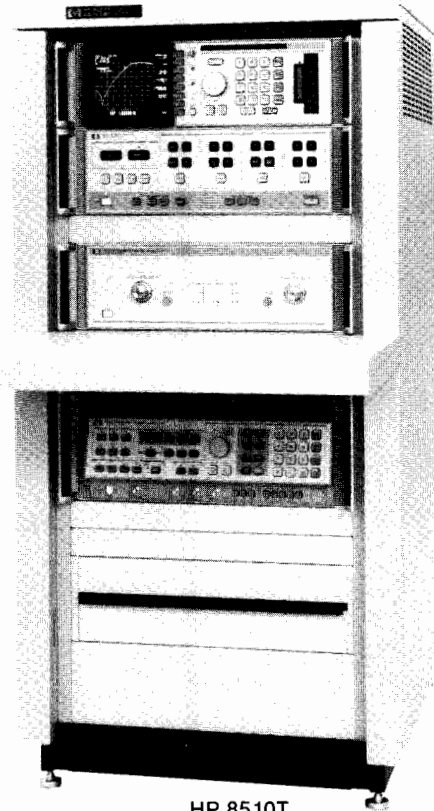

HP 8510T

### “Real Time” Error Correction

The fundamental accuracy limitations in most microwave measurements are due primarily to uncertainties associated with systematic errors in the microwave hardware (directivity, mismatch, frequency response, etc.). The HP 8510A's built-in, high speed computer provides the capability to characterize and effectively remove the impact of systematic errors through accuracy enhancement techniques. Effective directivity is improved to 50 dB, and effective source and load match to better than 40 dB. The data processing speed of the system is such that a fully error-corrected, 401 point trace of data is updated in under one second. This virtual “real time” display of error-corrected data means that you can easily adjust your test device while it's being measured, with the assurance that you are viewing the data at the highest possible accuracy.

Hewlett-Packard supplies kits of measurement calibration standards for precision 7 mm, precision 3.5 mm, and Type N connector interfaces. The HP 8510 system, also, provides the capability to measure devices in other coaxial interfaces, and waveguide, given the proper calibration standards.

### Time Domain Analysis

The HP 8510 (with option 010) has the capability of displaying the time domain response of a network, obtained by computing the Inverse Fourier Transform of the frequency domain response. The time domain response displays the reflection coefficient of the network versus time, which displays the magnitude and location of each individual discontinuity, or else the transmission coefficient versus time, which displays each individual transmission path.

The HP 8510 offers two time domain modes. The Low Pass mode provides the traditional Time Domain Reflectometer (TDR) measurement capability and gives the response of the network to a (mathematically simulated) step or impulse stimulus. This mode gives information of the type of impedance (R, L, or C) present at a discontinuity. The Band Pass time domain mode, which has only the impulse stimulus, may be used over any frequency range to give the time domain response of frequency-selective devices (such as waveguide).

Gating is another powerful time domain feature that may be used to selectively isolate a single response in time and then convert just that response back to the frequency domain. For reflection measurements, this provides the capability to view the return loss of individual portions of a microwave component without disturbing the actual circuit. For transmission measurements, one can view the frequency and time domain responses of individual transmission paths.

The HP 8510A time domain capability can give great insight into the design of microwave components. Another useful application is cable fault location. Gating can be used in a variety of applications such as removing fixturing residuals or removing the effects of multipath and ground clutter in antenna measurements.

### Compatible Sources

The HP 8340A and 8341A synthesized sweepers with the HP 8510 provide the best, most accurate measurements, regardless of the parameter selected. They combine a high resolution synthesizer with a broadband sweeper to cover the full frequency range of the HP 8510. With the HP 8340A you obtain 4 Hz resolution at 26.5 GHz for CW frequencies, phase locked narrowband (<5 MHz) sweeps, and fully synthesized start frequencies for broadband sweeps.

The HP 8350B sweep oscillator family is also fully compatible with the HP 8510. Coupled with this versatile sweeper mainframe, you can choose from a wide variety of RF plug-ins.

### HP 8510T Network Analyzer System

The HP 8510T is the highest performance system in the HP 8510 series. It provides, under one model number, everything needed to make precision measurements in the 45 MHz to 26.5 GHz frequency range. The system includes the HP 8510A with option 010, the 8515A S-Parameter Test Set, and an HP 8340A Synthesized Sweeper with options 005, 006, and 007. A comprehensive array of test and measurement accessories including the HP 85050A 7 mm Calibration Kit, HP 85051A 7 mm Verification Kit, HP 85052A 3.5 mm Calibration Kit, along with RF return cables and adapters, are supplied. The instruments are installed in the portable HP 85043A system rack.

When you purchase HP 8510T you not only obtain a high performance network measurement system, you are also provided with the total solution. Included with the HP 8510T are an impressive array of support products including on-site maintenance for one year, installation, and calibration at no extra charge.

### HP 85043A System Rack

The HP 85043A System Rack is a rack standing only 123.7 cm (48.7”) high with a width of 60.0 cm (23.6”) and a depth of 80.0 cm (31.5”). Complete with support rails and ac power distribution (suitable for 50 to 60 Hz, 100-240 Vac), it includes rack mounting hardware for all instruments. Thermal design is such that no rack fan is needed.

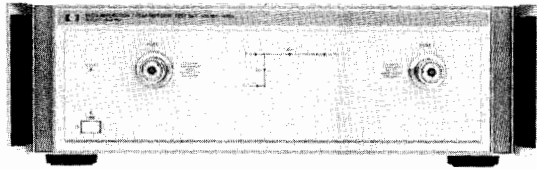

HP 8512A

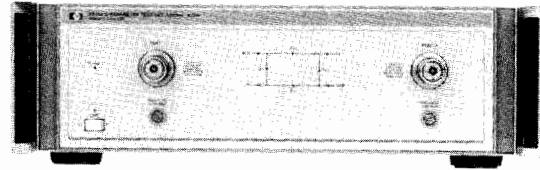

HP 8514A

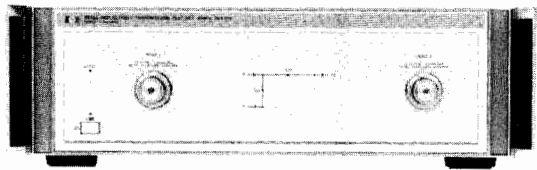

HP 8513A

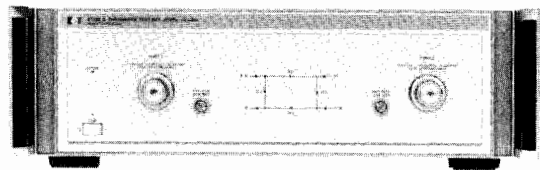

HP 8515A

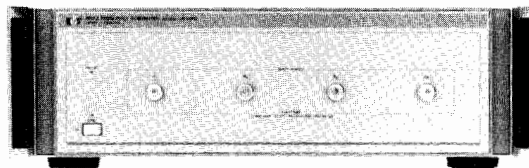

HP 8511A

#### HP 8512A Reflection/Transmission Test Set

The HP 8512A Reflection/Transmission Test Set provides the capability to simultaneously measure the complex reflection and transmission characteristics of a test device from 45 MHz to 18 GHz in transmission and 500 MHz to 18 GHz in reflection. Reflection measurements to 45 MHz is achievable with some loss (about 30dB) in dynamic range. An HP 8512A-based system offers very broad dynamic range with the highest accuracy available. The test ports have rugged precision 7-mm connectors and may be adapted to other interfaces with the appropriate precision adapters. The test set includes an integrated three-channel frequency converter.

#### HP 8513A Reflection/Transmission Test Set

The HP 8513A Reflection/Transmission Test Set provides the capability to simultaneously measure the complex reflection and transmission characteristics of a test device over the 45 MHz to 26.5 GHz frequency range. An HP 8513A-based system offers the capability to measure a network over an extremely wide frequency range with just one connection, over a wide dynamic range with high accuracy. The test ports are a special, ruggedized, version of the precision 3.5-mm connector interface that is completely compatible with any connector in the 3.5 mm family. The test set includes an integrated three-channel frequency converter.

#### HP 8514A S-Parameter Test Set

The HP 8514A S-Parameter Test Set provides the capability to measure all four S-parameters of a two port device with a single connection over the 45 MHz to 18 GHz frequency range. Measurements to 45 MHz are achievable with some loss (about 30 dB) in dynamic range. The S-parameter test set architecture is ideal for measuring two-port devices where it is not convenient to physically reverse the device to measure the reverse parameters, or for networks that need to be adjusted while being measured with full error-correction employed. The test ports have rugged precision 7-mm connectors

and may be adapted to other connector interfaces with the appropriate precision adapters. Along with an integrated, four-channel frequency converter, the test set includes two 90-dB step attenuators for changing the incident power level at the test port and two bias networks for applying dc bias to the test port center conductor in active device test applications.

#### HP 8515A S-Parameter Test Set

The HP 8515A S-Parameter Test Set provides the capability to measure all four S-parameters of a two-port device with a single connection over the 45 MHz to 26.5 GHz frequency range. The S-parameter test set architecture is ideal for measuring two port devices where it is not convenient to reverse the device to measure the reverse parameters, or for networks that need to be adjusted while being measured with full error-correction employed. The test ports are a special, ruggedized, version of the precision 3.5 mm interface that is completely compatible with any connector in the 3.5 mm family. Along with an integrated, four-channel frequency converter, the test set includes two 90-dB step attenuators for changing the incident power level at the test port and two bias networks for applying dc bias to the test port center conductor in active device test applications.

#### HP 8511A Frequency Converter

The HP 8511A is a four-channel frequency converter covering the 45 MHz to 26.5 GHz frequency range. An HP 8510A/8511A combination results in a system that can be customized to unique test requirements with the addition of customer-supplied test setup hardware. Examples include multi-port device measurements and antenna characterization. Each of the four inputs operates over the full dynamic range of the system, from 85 dB to 100 dB. Isolation between channels is typically greater than 100 dB. Dynamic accuracy is better than  $\pm 0.05$  dB and  $\pm 0.2$  degree at a test channel level of  $-50$  dBm.



# NETWORK ANALYZERS

Accessories



Models 85050A, 85051A, 85052A, 85053A, 85054A, 85130A, 85131A/B, 85132A/B

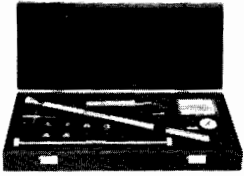

HP 85050A

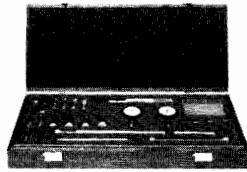

HP 85052A

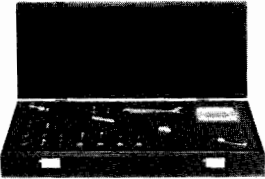

HP 85054A



HP 85051A

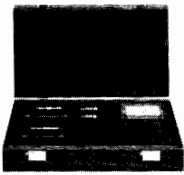

HP 85053A



HP 85130A

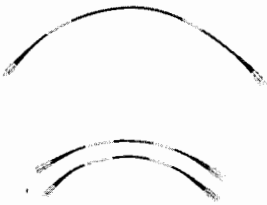

HP 85131A/B



HP 85132A/B

## Calibration Kits

Error-correction procedures require that the systematic errors in the measurement system be characterized by measuring known devices (standards) on the system over the frequency range of interest. The calibration kits in the HP 8510 family contain precision standard devices to characterize the systematic errors of the HP 8510 system. Hewlett-Packard offers several calibration kits in various connector interfaces that are compatible with the HP 8510.

### HP 85050A 7 mm Calibration Kit

The HP 85050A 7 mm Calibration Kit contains a set of precision calibration standards used to calibrate the HP 8510 system for measurements of devices with precision 7-mm connectors. The calibration standards include open and short circuits, and fixed and sliding terminations. Also included are a precision 7-mm connector gage and tools for verifying and maintaining the connector interfaces.

**Option 010:** Adds a precision 30-cm beadless airline that is useful in time domain applications.

**Option 020:** Deletes precision 7-mm connector gage and tools.

### HP 85052A 3.5 mm Calibration Kit

The HP 85052A 3.5 mm Calibration Kit contains a set of precision calibration standards used to calibrate the HP 8510 system for measurements of devices with 3.5-mm connectors (precision 3.5 mm or SMA). The calibration standards include open and short circuits, and fixed and sliding terminations. Also included are precision 7-mm to 3.5-mm adapters. Connector gages are supplied for verifying critical mechanical tolerances of the 3.5-mm connector interface.

**Option 010:** Adds precision 15-cm beadless airline that is useful in time domain applications.

**Option 020:** Deletes precision 3.5-mm connector gages.

### HP 85054A Type N Calibration Kit

The HP 85054A Type N Calibration Kit contains a set of precision calibration standards used to calibrate the HP 8510 system for measurements of devices with Type N connectors. The calibration standards include open and short circuits, and fixed and sliding terminations. Also included are precision 7-mm to Type N adapters.

## Verification Kits

Measuring known devices, other than the calibration standards, is a straightforward way of verifying that the HP 8510 system is operating properly. Hewlett-Packard offers verification kits that include standard devices, with data, for verifying the error-corrected measurement performance of the HP 8510 system.

### HP 85051A 7 mm Verification Kit

The HP 85051A 7 mm Verification Kit contains a set of precision devices, with data, used to verify the error-corrected performance of the HP 8510 system. The devices have precision 7-mm connectors and include 20-dB and 50-dB attenuators, a 10-cm beadless airline, and a 10-cm beadless stepped impedance airline (25 ohms nominal).

### HP 85053A 3.5 mm Verification Kit

The HP 85053A 3.5 mm Verification Kit contains a set of precision devices, with data, used to verify the error-corrected performance of the HP 8510 system. The devices have precision 3.5-mm connectors and include 20-dB and 40-dB attenuators, a 7.5-cm beadless airline, and a 7.5-cm beadless stepped impedance airline (25 ohms nominal).

## Test Port Return Cables

Hewlett-Packard offers a variety of high quality RF cables that are used to return the transmitted signal to the test set when measuring two-port devices.

### HP 85131A 3.5 mm Test Port Return Cable

The HP 85131A is a single test port return cable for use with either the HP 8513A or 8515A test sets (when connecting the device directly to Port 1).

**Frequency Range:** dc to 26.5 GHz

**Length:** 91 cm (36 in.)

**VSWR:** 1.22:1, typical

**Connectors:** Special 3.5 mm, and precision 3.5 mm (female)

### HP 85131B 3.5 mm Test Port Return Cable Set

The HP 85131B is a pair of test port return cables for use with the HP 8515A test set. The device is connected between the cables during measurement.

**Frequency Range:** dc to 26.5 GHz

**Length:** 66 cm (24 in.) each

**VSWR:** 1.22:1, typical

**Connectors:** Special 3.5 mm, and precision 3.5 mm (one male, or female)

### HP 85132A 7 mm Test Port Return Cable

The HP 85132A is a single test port return cable for use with either HP 8512A or 8414A test sets (when connecting the device directly to Port 1). When used with the HP 85130A adapter set, the HP 85132A can also be used with the HP 8513A and HP 8515A test sets when measuring devices with precision 7-mm connectors.

**Frequency Range:** dc to 18 GHz

**Length:** 91 cm (86 in.)

**VSWR:** 1.2:1, typical

**Connectors:** Precision 7 mm

### HP 85132B Test Port Return Cable Set

The HP 85132B is a pair of test port return cables for use with the HP 8514A test set. The device is connected between the cables during measurement. When used with the HP 85130A adapter set, the HP 85132A set can also be used with the HP 8515A set when measuring devices with precision 7-mm connectors.

**Frequency Range:** dc to 18 GHz

**Length:** 66 cm (24 in.) each

**VSWR:** 1.2:1, typical

**Connectors:** Precision 7 mm

### HP 85130A Special 3.5 mm to 7 mm Adapter Set

The HP 85130A kit contains a set of precision special 3.5-mm to 7-mm adapters used for converting the test ports of the HP 8513A and 8515A test sets to a precision 7-mm interface. The HP 85132A or 85132B cables are used as the test port return cables when the HP 85130A adapters are connected to the test set.

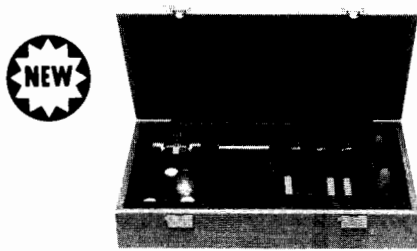

HP 85041A



HP 8717B

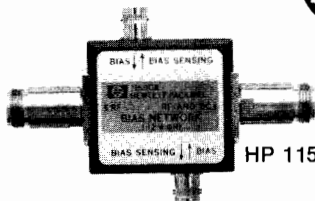

HP 11590B



HP 11612A



HP 11635A

### Active Device Test

Hewlett-Packard offers an extensive array of accessories designed for the needs of active device test and measurement, including fixtures, bias supplies, bias networks, and application software.

#### HP 85041A Transistor Test Fixture Kit

The HP 85041A Transistor Test Fixture (TTF) kit is a comprehensive measurement system for testing and characterizing stripline packaged microwave transistors. When used with the HP 85014A Active Device Measurement software, fully error-corrected, deembedded measurements can be made.

**Frequency Range:** dc to 18 GHz

**Transistor Package Inserts:** 70 mil and 100 mil

**Verification Devices:** Short and through circuits

**Connectors:** precision 7 mm

**Accessories Supplied:** fixture stand, torque tool, tweezers, and lid opening tool

#### HP 8717B Transistor Bias Supply

The HP 8717B transistor bias supply provides manual or automatic biasing for transistor testing. This supply 8717B has two meters for independently monitoring current and voltage. Bias connections are conveniently selected for all transistor configurations with a front panel switch.

**Voltage Ranges:** 1,3,10,30,100 V

**Current Ranges:** 0.1,0.3,1,3,10,30,100,300,1000 mA

**Accuracy:** 4% of full scale for both current and voltage

**Option 001:** programmable D/A converter

**Option 011:** programming cable for HP Series 200 computers

#### HP 11590B Bias Network

The HP 11590B is a rugged, broadband bias network. This bias network provides dc bias to the center conductor of a coaxial line which can be connected to the device under test while blocking DC bias from the RF circuit.

**Frequency Range:** 1.0 to 12.4 GHz (Option 001, 1.0 to 18.0 GHz)

**Maximum insertion loss:** 1.0 dB, 0.1 - 1.0 GHz

0.8 dB, 1.0 - 12.4 GHz

1.2 dB, 12.4 - 18.0 GHz (Option 001)

**Minimum return loss:** 16 dB, 0.1 - 1.0 GHz

19 dB, 1.0 - 12.4 GHz

14 dB, 12.4 - 18.0 GHz (Option 001)

**Maximum Bias Current:** 0.5 A, each bias port

**Maximum Bias Voltage:** 100 V

**Connectors:** BNC for dc bias; type N female for RF (Option 001, precision 7 mm)

#### HP 11612A Bias Network

The HP 11612A is an insertable, extremely broadband bias network with excellent port match and low insertion loss. This bias network provides dc bias to the center conductor of a coaxial line which can be connected to the device under test while blocking DC bias from the RF circuit.

**Frequency Range:** 45 MHz to 26.5 GHz

**Insertion loss:** 0.8 dB, 45 MHz - 12.4 GHz

(max) 1.3 dB, 12.4 - 26.5 GHz

**Minimum return loss:** 20 dB, 45 MHz - 8.0 GHz

18 dB, 8.0 - 18.0 GHz

14 dB, 18.0 - 26.5 GHz

**Maximum Bias Current:** 0.5 A

**Maximum Bias Voltage:** 40 V

**Connectors:** SMB snap-on for dc bias; precision 3.5 mm for RF

#### HP 11635A Bias Decoupling Network

The HP 11635A bias decoupling network is a recommended accessory for prevention of bias oscillations when biasing microwave bipolar transistors with any HP bias network or s-parameter test set. Installing the HP 11635A between the bias supply and the base bias network prevents low frequency oscillations.

#### Application Software

Hewlett-Packard offers several application software packages that complement the HP 8510 system providing automated calibration and measurement capability. Software is available for HP 200 Series desktop computers with either BASIC 2.0 or 3.0 operating systems on both 3 1/2" and 5 1/4" disc media.

#### HP 85014A Active Device Measurement Application Pac

The HP 85014A software pac provides the capability to the HP 8510 system for measurement of RF and microwave transistors. Features include automated device biasing with the HP 8717B bias supply, system calibration, and de-embedding of s-parameters when using the HP 85041A transistor test fixture. It is also usable with other HP transistor fixtures as well as user-designed fixtures. Plotted and listed output of device S, H, Y, and Z parameters, as well as the device Amplifier Summary and Termination Summary are provided. Also available is the capability to store and retrieve s-parameter data in formats suitable for computer aided design applications.

#### HP 85013A Basic Measurements Application Pac

The HP 85013A software pac provides the capability to automate the HP 8510 system for applications where the system is required to emulate the user interface of the HP 8409 series automatic network analyzers. All the features of the HP 8409 series operating system are provided for including the capability to measure up to 401 related (Start/Stop/Step) or unrelated (individual CW) frequency points.





## Support Products

Hewlett-Packard offers a complete group of support products specifically tailored to achieve maximum HP 8510 productivity. Several of these products are described below.

### HP 8510A + 24D Basic Measurements Using the HP 8510 Network Analyzer System

With two enrollments included in the purchase price of the HP 8510A, this three day, lab intensive training course introduces students to the operation of the HP 8510 system including error-correction and time domain fundamentals. The training course provides the opportunity for users to accelerate on the basic operation learning curve, allowing maximum utilization of the system to be achieved in a shorter time.

### HP 8510T + 23N On-Site System Installation (where available)

The HP 8510T+23N provides for complete installation of the HP 8510 system in either table top or racked configurations. Included are pre-installation inspection, on-site installation, and verification. Also included is a retrofit of one customer owned HP 8350 series sweep oscillator for HP 8510 compatibility.

### HP 8510T + 23A Basic System Maintenance and Calibration (where available)

The HP 8510T+23A provides complete on-site maintenance and calibration support for an HP 8510 system. Included are next-day on-site response when repairs are needed, preventive maintenance, and on-site calibration performed twice a year with NBS (or other standard agency) traceable devices.

## Ordering Information

### Analyzer

HP 8510A Network Analyzer

Option 010 Time Domain Capability

### Test Sets (choose at least one)

HP 8512A R/T Test Set (0.5 to 18.0 GHz)

HP 8513A R/T Test Set (45 MHz to 26.5 GHz)

HP 8514A S-Parameter Test Set (0.5 to 18.0 GHz)

HP 8515A S-Parameter Test Set (45 MHz to 26.5 GHz)

HP 8511A Frequency Converter (45 MHz to 26.5 GHz)

**Sources** (choose either the HP 8340A/8341A or the HP 8350B with an RF Plug-in)

HP 8340A 0.01 to 26.5 GHz Synthesized Sweeper (with options 005, 006, 007)

HP 8341A 0.01 to 20.0 GHz Synthesized Sweeper (with option 005)

HP 8350B Sweep Oscillator (choose one of these recommended plug-ins)

HP 83592A 0.01 to 20.0 GHz (with option 004)

HP 83595A 0.01 to 26.5 GHz (with option 004)

**Calibration Kits** (choose one for each connector type to be used)

HP 85050A 7 mm Calibration Kit

Opt. 010 30 cm beadless airline

Opt. 020 delete connector tools

HP 85052A 3.5 mm Calibration Kit

Opt. 010 15 cm beadless airline

Opt. 020 delete connector tools

HP 85054A Type N Calibration Kit

### Verification Kits

HP 85051A 7 mm Verification Kit

HP 85053A 3.5 mm Verification Kit

**Test Port Return Cables** (choose at least one)

HP 85131A 3.5 mm Test Port Return Cable

HP 85131B 3.5 mm Test Port Return Cable Set

HP 85132A 7 mm Test Port Return Cable

HP 85132B 7 mm Test Port Return Cable Set

HP 85130A Special 3.5 mm to 7 mm Adapter Kit

### Transistor Test Accessories

HP 85041A Transistor Test Fixture Kit

HP 8717B Transistor Bias Supply

(when used with HP 85014A software must order)

Opt. 001 Programming Capability

Opt. 011 Programming Cable

HP 98622A GPIO Interface

HP 11590B Bias Network

HP 11612A Bias Network

HP 11635A Bias Decoupling Network

### System Rack

HP 85043A System Rack

**Software** (choose one option)

HP 85013A Basic Measurements Application Pac

Opt. 630 3 1/2" disc

Opt. 655 5 1/4" disc

HP 85014A Active Device Measurements Application Pac

Opt. 630 3 1/2" disc

Opt. 655 5 1/4" disc

### Support Products

HP 8510A + 24D User Course

HP 8510T + 23N On-site Installation (where available)

HP 8510T + 23A On-site Service (where available)

### Systems

HP 8510T Network Analyzer System

# NETWORK ANALYZERS

## Microwave Network Analyzer, 110 MHz to 40 GHz

### Model 8410 Series

- Economical vector performance
- Measures all network parameters
- Multioctave swept frequency measurements
- Eliminate harmonic and spurious responses

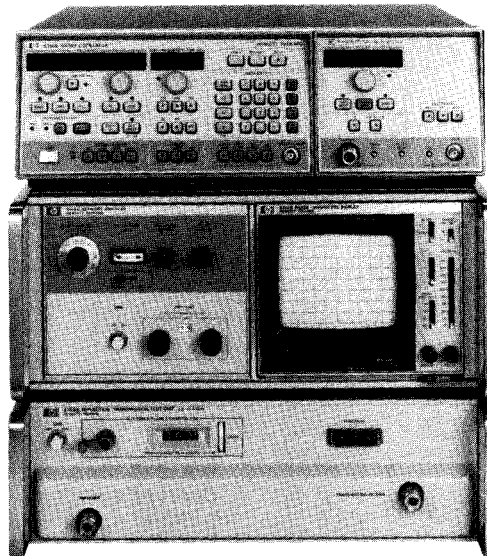

#### Receiver

The HP 8410C network analyzer and HP 8411A harmonic frequency converter comprise the nucleus of the swept-frequency system which provides magnitude and phase measurement capability from 110 MHz to 18 GHz in coax and 12.4 to 40 GHz in waveguide. Automatic frequency locking allows continuous multioctave sweeps. Frequency conversion from RF to IF gives high sensitivity and greater than 60 dB dynamic range, free of spurious and harmonic responses. Calibrated IF substitution makes possible accurate gain or insertion loss measurements.

#### Displays

The HP 8412B Phase/Magnitude Display displays magnitude and phase versus frequency. The HP 8414B Polar Display provides a polar plot of magnitude and phase. These displays are interchangeable plug-ins for the HP 8410C mainframe. The HP 8418B Auxiliary Display Unit can be added to provide simultaneous rectilinear and polar display capability.

#### Sources

Although the HP 8410C can produce octave-width sweeps using any swept source, continuous multi-octave sweeps limited only by the frequency range of the test set are possible with the HP 8620C or 8350A Sweep Oscillators.

#### Test Sets

The HP 8745A, 8743B, 8746B, and 85040B test sets contain all necessary splitters and couplers required to provide stimulus to the device under test and route the reference and reflected or transmitted signals to the receiver. Accessories allow the test sets to be configured for active and passive coaxial measurements as well as for semiconductor measurement applications.

#### System Ordering Convenience

HP 8410S systems enable ordering a complete network analyzer system, except for source, using a single model number. Each option has been configured for making general measurements on coaxial or semiconductor devices. The HP 8410S systems enable the operator to view a real time CRT display over octave or multioctave bands with a dynamic range of 60 dB amplitude and 360° phase. Multioctave, continuous network measurements over the frequency range of 2 to 18 GHz are possible when the HP 8410C is used with the HP 8620C or 8350A Sweep Oscillator.

The HP 8410S systems' upper frequency limit for coaxial and semiconductor measurements is 12.4 GHz; however, individual instruments may be ordered that will expand coaxial measurement capability to 18 GHz (option 018 instruments) and waveguide measurements from 8.2 GHz to 40 GHz (HP 8747A series).

#### HP 8410S Network Analyzer Systems

GENERAL PURPOSE MEASUREMENTS			All HP 8410S Systems Include the Following Instrument Model Numbers: HP 8410C, 8411A, 8412B, 8414B, 11609A, and 8750A opt. 003									
Frequency Range	Option No.	Measurement Port Configuration	HP 8743B	HP 8745A	HP 8746A	HP 8717B	HP 11600B	HP 11602B	HP 11608A	HP 11604A	HP 11610B	HP 11650A
0.11 to 2 GHz	110	Coaxial (APC-7)		X						X		X
0.11 to 12.4 GHz	310	Coaxial (APC-7)	X	X						X	X	X
2 to 12.4 GHz	210	Coaxial (APC-7)	X								X	X
SEMICONDUCTOR CHARACTERIZATION												
0.11 to 2 GHz	400	T018/T072 Packages		X		X	X					
0.11 to 2 GHz	401	T05/T012 Packages		X		X		X				
0.5 to 12.4 GHz	500	Stripline			X	X			X			

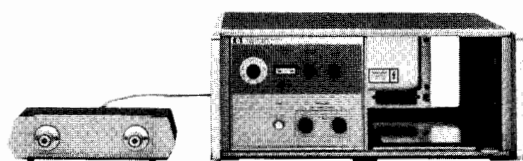

HP 8411A

HP 8410C

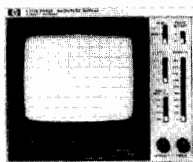

HP 8412B

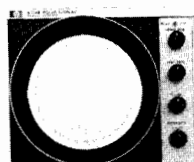

HP 8414B

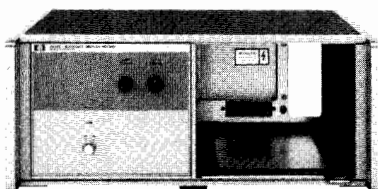

HP 8418B

## Specifications

### HP 8410C/8411A Network Analyzer

**Function:** HP 8411A converts RF signals to IF signals for processing in HP 8410C mainframe. HP 8410C is the mainframe for display plug-in units. Mainframe includes tuning circuits (octave bands or multioctave bands when used with HP 8620C or 8350A sweep oscillator), IF amplifiers and precision IF attenuator. HP 8410C allows injection of an external local oscillator used in automatic applications to lock the HP 8410C receiver to an external source such as the HP 3335A.

**HP 8410C frequency range:** 0.11 to 18 GHz.

**HP 8411A frequency range:** 0.11 to 12.4 GHz.

**Opt 018:** 0.11 to 18 GHz.

**HP 8411A input impedance:** 50 ohms nominal. SWR <1.5, 0.11 to 2.0 GHz; <2.0, 2.0 to 16.0 GHz; 3, 6.0 to 18.0 GHz.

**Channel isolation:** >65 dB, 0.1 to 6 GHz; >60 dB, 6 to 12.4 GHz; >50 dB, 12.4 to 18 GHz.

#### Magnitude Range

**Reference channel:** -18 to -35 dBm, 0.11 to 12.4 GHz; -18 to -25 dBm from 12.4 to 18.0 GHz.

**Test channel:** -10 to -75 dBm from 0.11 to 12.4 GHz; -10 to -68 dBm from 12.4 to 18 GHz.

**Maximum RF input to either channel:** 50 mW.

**IF gain control:** 69 dB range in 10 dB and 1 dB steps with a maximum cumulative error of  $\pm 0.2$  dB.

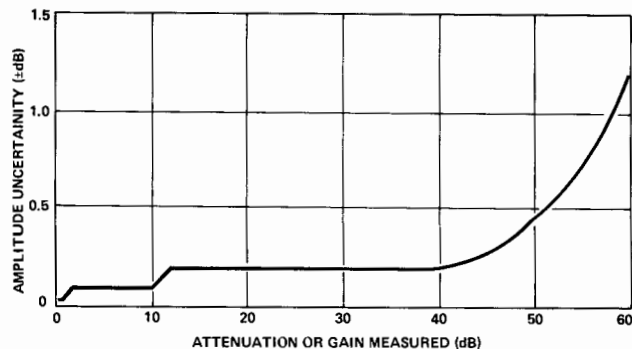

### Phase

**Phase range:** 0 to 360°

**Control:** vernier control  $\leq 90^\circ$

**Connectors (HP 8411A):** APC-7.

**Power:** 115 or 230 V  $\pm 10\%$ , 50-60 Hz, 70 watts (includes HP 8411A).

### Weight

**HP 8410C:** net, 14.9 kg (33 lb); shipping, 18.5 kg (41 lb).

**HP 8411A:** net, 3.2 kg (7 lb); shipping, 4.5 kg (10 lb).

### Size

**HP 8410C:** 191 H x 425 W x 467 mm D (7.5" x 16.75" x 18.38").

**HP 8411A:** 67 x 228 W x 143 mm D (2.63" x 9" x 5.63") exclusive of connectors and cable.

### HP 8412B Phase-Magnitude Display

**Function:** plug-in CRT display unit for HP 8410C. Displays relative amplitude in dB and/or relative phase in degrees between reference and test channel inputs versus frequency. Programmable 180° phase offset by ground closure.

#### Amplitude

**Range:** 80 dB display range with selectable resolutions of 10, 2.5, 1 and 0.25 dB/division.

**Accuracy:** 0.08 dB/dB from midscreen.

#### Phase

**Range:**  $\pm 180^\circ$  display range with selectable resolutions of 90, 45, 10, and 1°/division.

**Accuracy:** 0.065°/degree from midscreen.

**Phase offset:** 0.3°/20° step cumulative <3°.

**Power:** 23 watts supplied by mainframe.

**Weight:** net, 7.8 kg (17 lb); shipping, 10 kg (22 lb).

**Size:** 152 H x 186 W x 395 mm D (6" x 7.28" x 15.56") excluding front panel knobs.

### HP 8414B Polar Display

**Function:** plug-in CRT display unit for HP 8410C. Displays amplitude and phase data in polar coordinates on 5-in. cathode ray tube.

**Range:** normalized polar coordinate display; magnitude calibration 20% of full scale per division. Scale factor is a function of IF setting on HP 8410C. The beam center function is controllable by an external contact closure.

**Accuracy:** error circle on CRT  $\pm 3$  mm.

**Power:** 35 watts supplied by mainframe.

**Weight:** net, 5.8 kg (13 lb); shipping, 8.1 kg (18 lb).

**Size:** 152 H x 186 W x 395 mm D (6" x 7.28" x 15.56") excluding front panel knobs.

### HP 8418B Auxiliary Display Holder

**Function:** the HP 8418B auxiliary display holder provides power for operating of the HP 8412B, 8413A or the 8414B display units. Used in conjunction with the HP 8410C network analyzer, it provides the capability of viewing amplitude and phase readout in both rectangular and polar coordinates simultaneously. Includes a remotely programmable 0-70 dB IF attenuator required for autoranging in automatic applications.

**Weight:** net, 11.2 kg (25 lb); shipping, 19.7 kg (44 lb).

**Size:** 177 H x 483 W x 450 mm D (6.97" x 19" x 17.13").

## Ordering Information

HP 8410C mainframe

**Opt 908:** Rack Flange Kit

HP 8411A Frequency Converter

**Opt 018:** 0.11 to 18 GHz

HP 8412B Phase-Magnitude Display

HP 8414B Polar Display

HP 8418B Auxiliary Display Holder

**Opt 908:** Rack Flange Kit

570 **NETWORK ANALYZERS**  
 Test Sets and Accessories  
 Model 8410 Series



HP 8745A

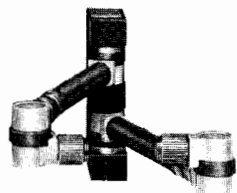

HP 11604A

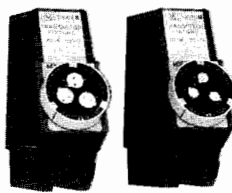

HP 11602B HP 11600B

**HP 8745A S-Parameter Test Set**

**Function:** wideband RF power splitter and reflectometer with calibrated line stretcher. Pushbutton operated for either forward or reverse transmission or reflection measurements with network analyzer.

**Frequency range:** 100 MHz to 2 GHz.

**Impedance:** 50 ohms nominal.

**Source reflection coefficient:**  $\leq 0.057$ , 0.11 to 2.0 GHz.

**Termination reflection coefficient:**  $< 0.10$ , 100, to 200 MHz;  $< 0.063$ , 200 MHz to 2.0 GHz.

**Directivity:**  $\geq 36$  dB, below 1 GHz;  $\geq 32$  dB, 1 to 2 GHz.

**Reference plane extension:** 0 to 15 cm for reflection; 0 to 30 cm for transmission.

**Maximum RF power:** 2 watts.

**Connectors:** RF input type N female; all other connectors APC-7; Option 001, type N female.

**Remote programming:** ground closure.

**Power:** 115 or 120 V  $\pm 10\%$ , 50 to 400 Hz, 40 watts.

**Weight:** net, 15.4 kg (34.25 lb); shipping, 18.0 kg (40 lb).

**Size:** 140 H x 425 W x 654 mm D (5.50" x 16.75" x 25.75").

**HP 11604A Universal Extension**

**Function:** mounts on front of HP 8745A; connects to device under test. Rotary air-lines and rotary joints connect to any two port geometry.

**Frequency range:** dc to 2 GHz.

**Impedance:** 50 ohms nominal.

**Reflection coefficient:** 0.035.

**Acc. included:** semi-rigid coax. cable, HP Part #11604-20021.

**Weight:** net, 1.8 kg (4 lb); shipping, 2.2 kg (5 lb).

**Size:** 127 H x 32 W x 267 mm D (5" x 1.25" x 10.50").

**HP 11600B/11602B Transistor Fixtures**

**Function:** mounts on front of HP 8745A S-parameter test set; holds devices for S-parameter measurements in a 50 ohm, coax circuit. Other devices also fit the fixture (tunnel diodes, etc.).

**Transistor Base Patterns**

**Model 11600B:** accepts TO-18/TO-72 packages.

**Model 11602B:** accepts TO-5/TO-12 packages.

**Calibration references:** short circuit termination and a 50 ohm through-section.

**Frequency ranges:** dc to 2 GHz.

**Impedance:** 50 ohms nominal.

**Reflection coefficient:**  $< 0.05$ , 100 MHz to 1.0 GHz;  $< 0.09$ , 1.0 to 2 GHz.

**Connectors:** hybrid APC-7; Option 001, type N female.

**Weight:** net 1.1 kg (2.38 lb); shipping, 1.8 kg (4 lb).

**Size:** 152 H x 44 W x 229 mm D (6" x 1.75" x 9").

**HP 8410S Opt 110 Specifications**

**Function:** the HP 8410S option 110 measurement system configuration is described on page 34.39. Following are specifications describing measurement capabilities of the HP 8410C/8411A when used with the HP 8745A/11604A over the frequency range of 110 MHz to 2 GHz.

**Frequency range:** 0.11 to 2.0 GHz.

**RF input:** 20 dB range between +5 dBm and -12 dBm.

**Source reflection coefficient:**  $\leq 0.067$ , 0.11-2.0 GHz.

**Termination reflection coefficient:**  $\leq 0.11$ , 100-200 MHz;  $\leq 0.07$ , 200-2000 MHz.

**Directivity:**  $\geq 28$  dB 0.11-1.0 GHz;  $\geq 27$  dB 1.0-2.0 GHz.

**Insertion loss, RF input to test port:** 4 dB nominal.

**Frequency Response**

**Transmission:** typically  $< \pm 0.35$  dB amplitude and  $< \pm 5^\circ$  phase.

**Reflection:** typically  $< \pm 0.06$  magnitude and  $\pm 5^\circ$  phase with a short on the test port.

**Transmission measurement accuracy:** (see common performance specifications).

**Reflection measurement accuracy (using HP 8414B):** sources of error included in the accuracy equations are directivity, source match, and polar display accuracy.

**Magnitude Accuracy**

$\rho_u = \pm(0.0398 + 0.03 \rho_L + 0.067 \rho_L^2)$  0.11-1.0 GHz.

$\rho_u = \pm(0.0447 + 0.03 \rho_L + 0.067 \rho_L^2)$  1.0-2.0 GHz.

$\rho_u$  = magnitude uncertainty.

$\rho_L$  = measured reflection coefficient magnitude.

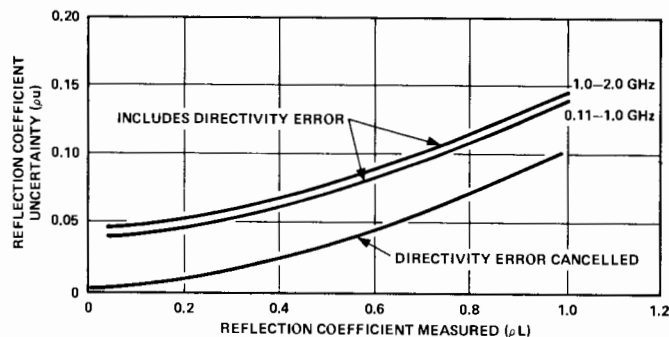

**Phase Accuracy**

$\Phi_u = \sin^{-1} \rho_u / \rho_L$  for  $\Phi_u < 90^\circ$ .

$\Phi_u$  = phase uncertainty.

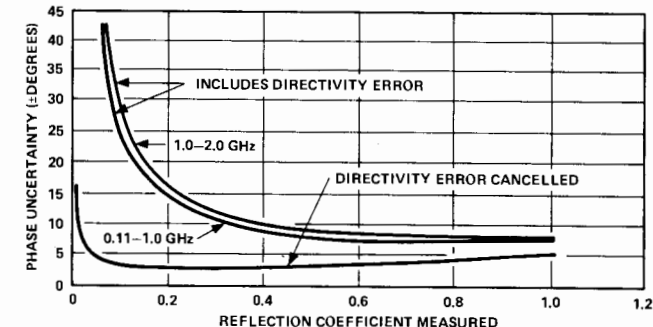

See HP 8410S network analyzer systems table for price and instrument breakdown.

**Ordering Information**

HP 8745A Test Set

Opt 001: Type N Test Port Connectors

Opt 908: Rack Flange Kit

HP 11604A Universal Arm Extension

HP 11600B/11602B Transistor Fixtures

Opt 001: Type N Female Connectors

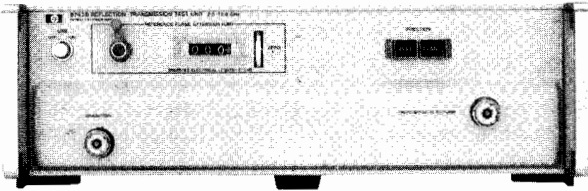

HP 8743B



HP 11610B

### HP 8743B Reflection/Transmission Test Unit

**Function:** wideband RF power splitter and reflectometer with calibrated line stretcher. Pushbutton operated for either transmission or reflection measurement with network analyzer. Designed for use with the HP 11610B test port extension cable.

**Frequency range:** 2 to 12.4 GHz (Opt 018: 2 to 18 GHz).

**Impedance:** 50 ohms nominal.

**Source reflection coefficient:**  $\leq 0.09$ , 2.0 to 8.0 GHz;  $\leq 0.13$ , 8.0 to 12.4 GHz;  $< 0.2$ , 12.4 to 18 GHz.

**Termination reflection coefficient:**  $\leq 0.13$  in reflection mode, 2.0 to 12.4 GHz;  $\leq 0.2$  in transmission mode, 2.0 to 12.4 GHz; typically  $< 0.2$ , 12.4 to 18 GHz.

**Directivity:**  $\geq 30$  dB, 2.0 to 12.4 GHz;  $\geq 18$  dB, 12.4 to 18 GHz.

**Reference plane extension:** 0 to 15 cm for reflection; 0 to 30 cm for transmission.

**Connectors:** RF input, type N female; all other connectors APC-7.

**Remote programming:** ground closure.

**Power:** 115 or 230 V  $\pm 10\%$ , 50-400 Hz, 15 W.

**Weight:** net, 12.1 kg (29 lb); shipping, 15.3 kg (34 lb).

**Size:** 140 H x 425 W x 467 mm D (5.50" x 16.75" x 18.38").

### HP 11610B Microwave Cable

**Function:** a high quality semirigid coaxial cable used with the network analyzer at frequencies up to 18 GHz. It is designed for applications which require excellent magnitude and phase repeatability from connection to connection. The cable exhibits minimum change in transmission characteristics when flexed during normal use. The HP 11610B is the recommended transmission return cable for use with the HP 8743B and the HP 8746B.

**Frequency range:** dc to 18 GHz.

**Impedance:** 50 ohms nominal. Reflection coefficient of ports  $< 0.14$ .

**Insertion loss:**  $< 0.7$  dB + 0.12 dB/GHz.

**Stability with three repeated flexings:**  $< 0.3$  dB,  $< 0.5$  degrees + 0.12 degrees/GHz change.

**Connectors:** APC-7.

**Length:** 1.07 m (42 inches).

### HP 8410S Opt 210 Specifications

**Function:** the HP 8410S Option 210 measurement system configuration is described on page 34.39. Following are specifications describing measurement capabilities of the HP 8410C/8411A when used with the HP 8743B/11610B over the frequency range of 2 GHz to 12.4 GHz.

**Frequency range:** 2.0 to 12.4 GHz.

**RF input:** 20 dB range between +12 dBm and -5 dBm.

**Source reflection coefficient:**  $\leq 0.09$ , 2-8 GHz;  $\leq 0.13$ , 8-12.4 GHz.

**Termination reflection coefficient:**  $\leq 0.09$ , 2-8 GHz;  $\leq 0.13$ , 8-12.4 GHz.

**Directivity:**  $\geq 30$  dB, 2-12.4 GHz.

**Insertion loss, RF input to test port:** 20 dB nominal.

#### Frequency Response

**Transmission:** typically  $< \pm 0.5$  dB amplitude and  $< \pm 5^\circ$  phase.

**Reflection:** typically  $< \pm 0.09$  magnitude and  $< \pm 6^\circ$  phase, with a short on the unknown port.

**Transmission Measurement accuracy** (see Common Performance Specifications).

**Reflection measurement accuracy (using HP 8414B):** sources of error included in the accuracy equations are directivity, source match, and polar display accuracy.

#### Magnitude Accuracy

$\rho_u = \pm(0.0316 + 0.03 \rho_L + 0.09 \rho_L^2)$  2-8 GHz.

$\rho_u = \pm(0.0316 + 0.03 \rho_L + 0.13 \rho_L^2)$  8-12.4 GHz.

$\rho_u$  = magnitude uncertainty.

$\rho_u$  = measured reflection coefficient magnitude.

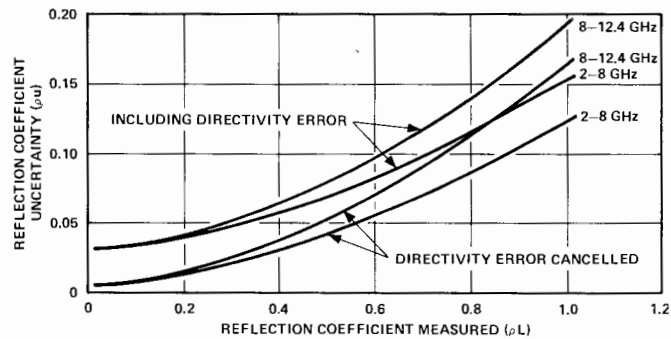

#### Phase Accuracy

$\Phi_u = \sin^{-1} \rho_u / \rho_L$  for  $\Phi_u < \pm 90^\circ$ .

$\Phi_u$  = phase uncertainty.

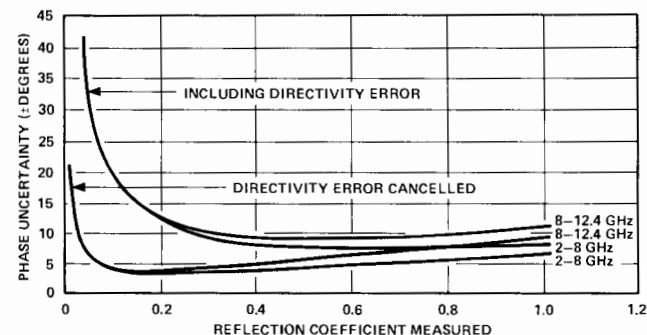

See HP 8410S network analyzer systems table for price and instrument breakdown.

#### Ordering Information

HP 8743B Reflection/Transmission Test Unit

Opt 018: 2 to 18 GHz

Opt 908: Rack Flange Kit

HP 11610B Microwave Cable

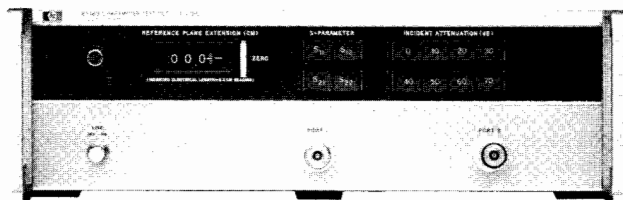

HP 8746B



HP 11608A

### HP 8746B S-Parameter Test Set

**Function:** wideband RF power divider and reflectometer with calibrated line stretcher and a selectable 0-70 dB incident signal attenuator. Provides internal bias for completely characterizing two port active devices.

**Frequency range:** 0.5 to 12.4 GHz.

**Source and termination reflection coefficient:**  $\leq 0.13$ .

**Directivity:**  $\geq 30$  dB, 0.5 to 4.0 GHz;  $\geq 26$  dB, 4.0 to 12.4 GHz.

**Incident attenuation:** 0-70 dB in 10 dB steps  $\pm 5\%$ .

**Reference plane extension:** adds 0 to 15 cm for reflection, 0 to 30 cm for transmission.

**Remote programming:** ground closure.

**Transistor biasing:** via 36-pin connector.

**Connectors:** input type N female, test ports APC-7.

**Opt 001:** provides 10 dB higher power level at the test port.

**Power:** 115 or 230 V  $\pm 10\%$ , 48 to 440 Hz, 110 VA max.

**Weight:** net, 16.1 kg (35 lb); shipping, 19.1 kg (42 lb).

**Size:** 140 H x 425 W x 467 mm D (5.5" x 16.75" x 18.38").

### HP 11608A Transistor Fixture

**Function:** provides the capability of completely characterizing stripline transistors. A through-line microstrip and bolt-in grounding structure machineable by customer is included.

**Frequency range:** dc to 12.4 GHz.

**Reflection coefficient:**  $< 0.05$ , dc to 4 GHz;  $< 0.07$ , 4.0 to 8.0 GHz;  $> 0.15$ , 8 to 12.4 GHz.

**Package Styles**

**Opt 003:** 0.205 inch diameter packages.

**Calibration references:** option 003 only, short circuit termination and a 50-ohm through-section.

**Connectors:** APC-7 hybrid.

**Weight:** net, 0.9 kg (2 lb); shipping, 1.4 kg (3 lb).

**Size:** 25 H x 143 W x 89 mm D (1" x 5.63" x 3.5").

### HP 8410S Opt 500 Specifications

**Function:** the HP 8410S option 500 measurement system configuration is described on page 34.39. Following are specifications describing measurement capabilities of the HP 8410C/8411A when used with the HP 8746B/11608A over the frequency range of 500 MHz to 12.4 GHz.

**Frequency range:** 0.5 to 12.4 GHz.

**Transistor dc bias selection;** front panel slide switches establish proper dc biasing for both Bi-polar and FET transistors. The voltage and current controls operate independently and are continuously adjustable over a current range of 0 to 500 mA and a voltage range of 0 to 30 Vdc.

**RF input:** 20 dB range between +12 and -5 dBm.

**Incident attenuation range:** 0 to 70 dB in 10 dB steps.

**Source reflection coefficient:** (typically)  $\leq 0.132$ , 0.5 to 4.0 GHz;  $\leq 0.135$ , 4.0 to 8.0 GHz;  $\pm 0.141$ , 8.0 to 12.4 GHz.

**Termination reflection coefficient:** (typically)  $< 0.139$ , 0.5 to 4.0 GHz;  $< 0.148$ , 4.0 to 8.0 GHz; GHz;  $\pm 0.170$ , 8.0 to 12.4 GHz.

**Directivity:**  $\geq 28$  dB, 0.5 to 4.0 GHz;  $\geq 24$  dB, 4 to 8.0 GHz;  $\geq 23$  dB, 8.0 to 12.4 GHz.

**Frequency response:** (typically)  $< 0.5$  dB,  $\pm 7$  degrees, 0.05 to 4.0 GHz;  $< 0.75$  dB,  $\pm 7$  degrees, 4.0 to 8.0 GHz;  $< 1.25$  dB,  $\pm 7$  degrees, 8.0 to 12.4 GHz.

**Transmission measurement accuracy:** (see Common Performance Specifications).

**Reflection measurement accuracy:** sources of error included in the accuracy equation are directivity and source match.

### Magnitude Accuracy

$\rho_u = \pm(0.04 + 0.08 \rho_L + 0.13 \rho_L^2)$  0.5 to 4.0 GHz.

$\rho_u = \pm(0.06 + 0.09 \rho_L + 0.135 \rho_L^2)$  4.0 to 8.0 GHz.

$\rho_u = \pm(0.074 + 0.098 \rho_L + 0.14 \rho_L^2)$  8.0 to 12.4 GHz.

$\rho_u$  = magnitude uncertainty.

$\rho_L$  = measured reflection coefficient magnitude.

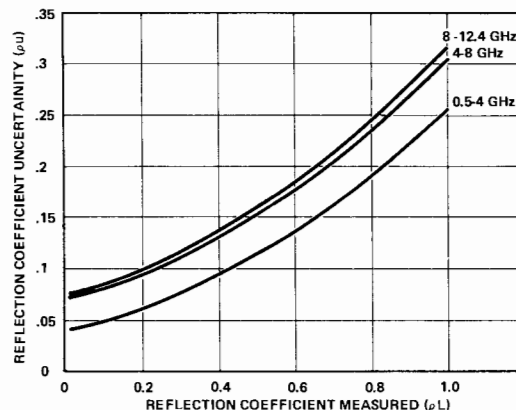

### Phase Accuracy

$\Phi_u = \sin^{-1} \rho_u / \rho_L$  for  $\Phi_u < 90^\circ$ .

$\Phi_u$  = phase uncertainty.

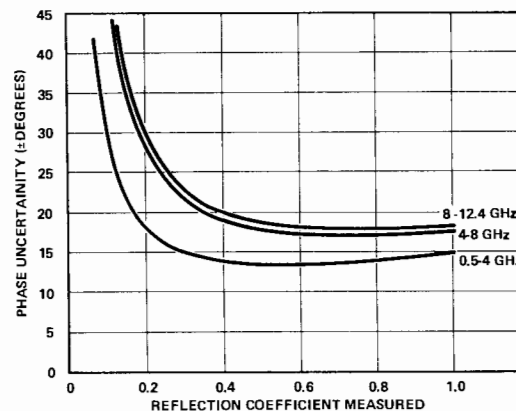

See HP 8410S network analyzer systems table for price and instrument breakdown.

### Ordering Information

HP 8746B Test Unit

Opt 001: Large Signal

Opt 908: Rack Flange Kit

HP 11608A Transistor Fixture Customer Machineable

Opt 003: 0.205 inch diameter package style



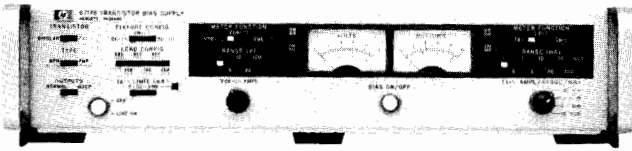

HP 8717B

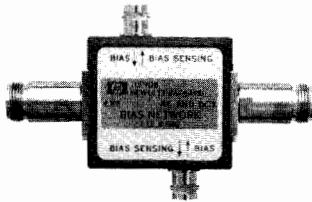

11590B

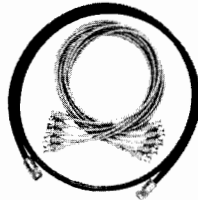

HP 11609A



HP 11650A

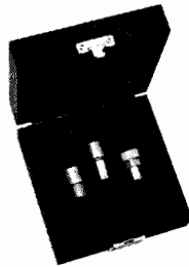

HP 11866A



HP 85032A



HP 85033A

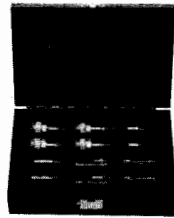

HP 85033B

### HP 8717B Transistor Bias Supply

**Function:** for manual or programmable transistor testing. It is particularly useful with the HP 11600B, 11602B, and 11608A Transistor Fixtures. The HP 8717B has two meters for independently monitoring current and voltage on any of the three leads of a transistor under test. Bias connections are conveniently selected for all transistor configurations with a front panel switch. Special circuitry protects sensitive devices from excessive current transients which commonly occur in less sophisticated supplies.

**Voltage ranges:** 1, 3, 10, 30, 100 V.

**Current ranges:** 0.1, 0.3, 1, 3, 10, 30, 100, 300, 1000 mA.

**Accuracy:** 4% of full scale for both current and voltage.

**Option 001:** programmable D/A converter.

**Weight:** net, 9.0 kg (20 lb); shipping, 11.0 kg (25 lb).

**Size:** 86 H x 425 W x 336 mm D (3.38" x 16.75" x 13.5").

### HP 11590B Bias Network

**Function:** auxiliary unit for use with the HP 11600B, 11602B and 11608A transistor fixtures. Bias networks route dc bias to the center conductor of a coaxial line while blocking the dc bias from the input RF circuit.

**Frequency range:** HP 11590B—0.1 to 12.4 GHz; HP 11590B Option 001—0.1 to 18.0 GHz.

**Connectors:** BNC for dc biasing; type N female for RF (Option 001, APC-7).

**Weight:** net, 0.3 kg (0.67 lb); shipping, 0.5 kg (1 lb).

**Size:** 29 H x 76 W x 114 mm D (1.38" x 3" x 4.5").

### HP 11650A Accessory Kit

**Function:** accessories normally used for transmission and reflection tests with the HP 8745A and 8743B.

**Weight:** net, 1.34 kg (3 lb); shipping, 2.23 kg (5 lb).

### HP 11609A Cable Kit

**Function:** interconnecting cables normally required for network measurements using the HP 8410C network analyzer.

**Weight:** net, 0.9 kg (2 lb); shipping, 1.36 kg (3 lb).

### HP 11866A APC-7 Calibration Kit

**Function:** a 50Ω (>52 dB return loss 2 GHz) termination, a short circuit and a shielded open circuit are used with automatic network analyzers to quantify directivity, source match, and frequency tracking errors.

**Weight:** net 0.57 kg (1.25 lb); shipping, 0.91 kg. (2.0 lb).

**Size:** 50.8 H x 7 W x 12.7 D (2.0" x 5.0" x 5.0").

### HP 85032A Type N Calibration Kit

**Function:** provides two Type N male to APC-7 adapters, two Type N female to APC-7 adapters, as well as one each Type N male and female short circuits and 50Ω (<1.01 SWR at 2 GHz) terminations. Option 001 adds one each male and female Type N shielded open circuits.

### HP 85033A SMA Calibration Kit

**Function:** provides two SMA male to APC-7 adapters, two SMA female to APC-7 adapters, as well as one each SMA male and female short circuits and 50Ω (<1.06 SWR at 1 GHz) terminations.

### HP 85033B APC-3.5 Calibration Kit

**Function:** provides two APC-3.5 male to APC-7 adapters, two APC-3.5 female to APC-7 adapters, as well as one each APC-3.5 male and female short circuits shielded open circuits with center pin extenders, and 50Ω (<1.03 SWR at 2 GHz) terminations. This kit is specially designed for use with HP 8409-series older generation automatic network analyzer systems and provides superior accuracy when measuring SMA devices.

### Ordering Information

**HP 8717B** Transistor Bias Supply

**Opt 001:** Programmable D/A Converter

**Opt 908:** Rack Flange Kit

**HP 11590B** Bias Network

**Opt 001:** APC-7 Connectors, 0.1-18 GHz

**HP 11650A** Accessory Kit

**HP 11609A** Cable Kit

**HP 11866A** APC-7 Calibration Kit

**HP 85032A** N Calibration Kit

**Opt 001:** Shielded Open Circuits

**HP 85033A** SMA Calibration Kit

**HP 85033B** APC-3.5 Calibration Kit

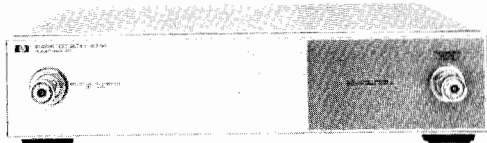

HP 85040B

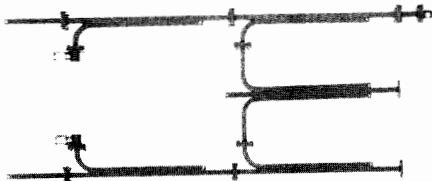

HP X8747A and HP P8747A

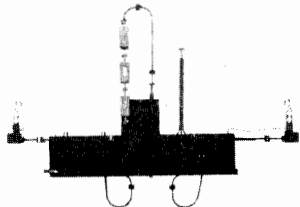

HP K8747A and HP R8747B

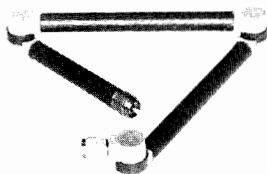

HP 11605A

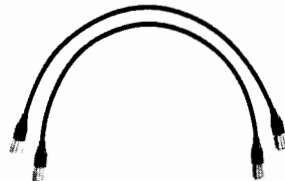

HP 11857A

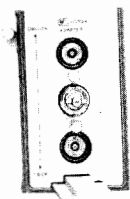

HP 11599A

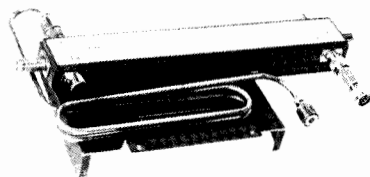

HP 11607A

#### HP 85040B 0.5–18 GHz Reflection/Transmission Test Set

The HP 85040B is a reflection/transmission test set designed for automatic systems, specifically the HP 8408B Automatic Network Analyzer. Switching between transmission and reflection is done with an external 24-Volt signal from the HP 11713A Attenuator/Switch Driver via a cable supplied with the HP 85040B.

**Frequency range:** 0.5 to 18 GHz (0.1 to 18 GHz transmission only)

**Impedance:** 50 ohms nominal.

**Maximum Operating Level** (with HP 8411A installed)

**RF input:** +8 dBm.

**Test port:** +10 dBm.

**Transmission return:** –10 dBm, +17 dBm damage level.

**Connectors:** RF input type N female; all other RF connectors APC-7.

**Source reflection coefficient:** <0.2.

**Directivity:** >24 dB, 0.5 to 8 GHz; >20 dB, 8 to 18 GHz.

**Typical Insertion Loss**

RF In to RF Out: <9 dB.

RF Out to HP 8411A (Reflection Mode): <38 dB, 0.5 to 2 GHz; <31 dB, 2 to 18 GHz.

**Typical Performance with Accuracy Enhancement in HP 8408B System (in APC-7)**

**Reflection**

**Directivity:** 40 dB.

**Source match:** 1.05 SWR.

**Frequency response:** <0.05 dB, <0.5 degree.

**Transmission**

**Source match:** 1.3 SWR

**Load match:** 1.2 SWR.

**Frequency response:** <0.05 dB, <0.5 degree.

#### HP X8747A, P8747A Reflection/Transmission Test Units

**Function:** waveguide setup for measuring reflection and transmission parameters of waveguide devices with the network analyzer.

**Frequency range:** HP X8747A, 8.2–12.4 GHz; HP P8747A, 12.4–18 GHz.

#### HP K8747A, R8747B Reflection/Transmission Test Units

**Function:** waveguide setup for measuring reflection and transmission parameters of waveguide devices with the network analyzer; down-converts with built-in mixers to the frequency range of the HP 8411A.

**Frequency range:** HP K8747A, 18–26.5 GHz; HP R8747B, 26.5–40 GHz.

#### HP 11605A Flexible Arm

**Function:** mounts on front of HP 8743B test set; connects to device under test. Rotary air-lines and rotary joints connect to any two-port geometry. Primarily intended for use with existing HP 8743As but can be used with HP 8743B (HP 11610B recommended for use with HP 8743B).

**Frequency range:** dc to 12.4 GHz (Opt 018, 2 to 18 GHz).

**Impedance:** 50 ohms nominal. Reflection coefficient of ports:  $\leq 0.11$ , dc to 12.4.

**Opt 018:**  $\leq 0.23$ , 2.0 to 12.4 GHz;  $\leq 0.31$ , 12.4 to 18 GHz.

**Connectors:** APC-7.

**Weight:** net, 1.8 kg (4 lb); shipping, 2.7 kg (6 lb).

**Length:** 257 mm (10.09") closed; 648 mm (25.50") extended.

#### HP 11857A 50 $\Omega$ APC-7 Test Port Extension Cables

**General:** two precision 61 cm (24 in.) cables, for use with HP 8745A S-parameter test set. Connectors are 50  $\Omega$  APC-7.

**Weight:** net, 0.91 kg (2 lb); shipping, 2.3 kg (5 lb).

#### HP 11599A Quick Connect Adapter

**Function:** quickly connects and disconnects the HP 8745A and the transistor fixtures or HP 11604A universal extension.

**Weight:** net, 0.4 kg (0.88 lb); shipping, 0.9 kg (2 lb).

**Size:** 127 H x 76 W x 108 mm D (5" x 3" x 4.5").

#### HP 11607A Small Signal Adapter

**Function:** used with the HP 8745A S-parameter test set. The incident signal levels to the test device are reduced to the –20 to –40 dBm range.

**Weight:** net 4.1 kg (4.63 lb); shipping, 4.5 kg (10 lb).

**Size:** 60 H x 413 W x 244 mm D (2.38" x 16.25" x 9.63").

#### Ordering Information

HP 85040B 0.5–18 GHz Reflection/Transmission Test Set

HP 11605A Flexible Arm

Opt 018: 0.11 to 18 GHz

HP 11857A 50  $\Omega$  APC-7 Test Port Extension Cables

HP 11599A Quick Connect Adapter

HP 11607A Small Signal Adapter

HP X8747A Waveguide Test Set

HP P8747A Waveguide Test Set

HP K8747A Waveguide Test Set

HP R8747B Waveguide Test Set

# NETWORK ANALYZERS

## Automatic Network Analyzer System, 500 MHz to 18 GHz Model 8408S



- 40 dB effective directivity
- Economical reflection and transmission measurements
- 8-term vector error-correction
- Friendly, easy-to-use

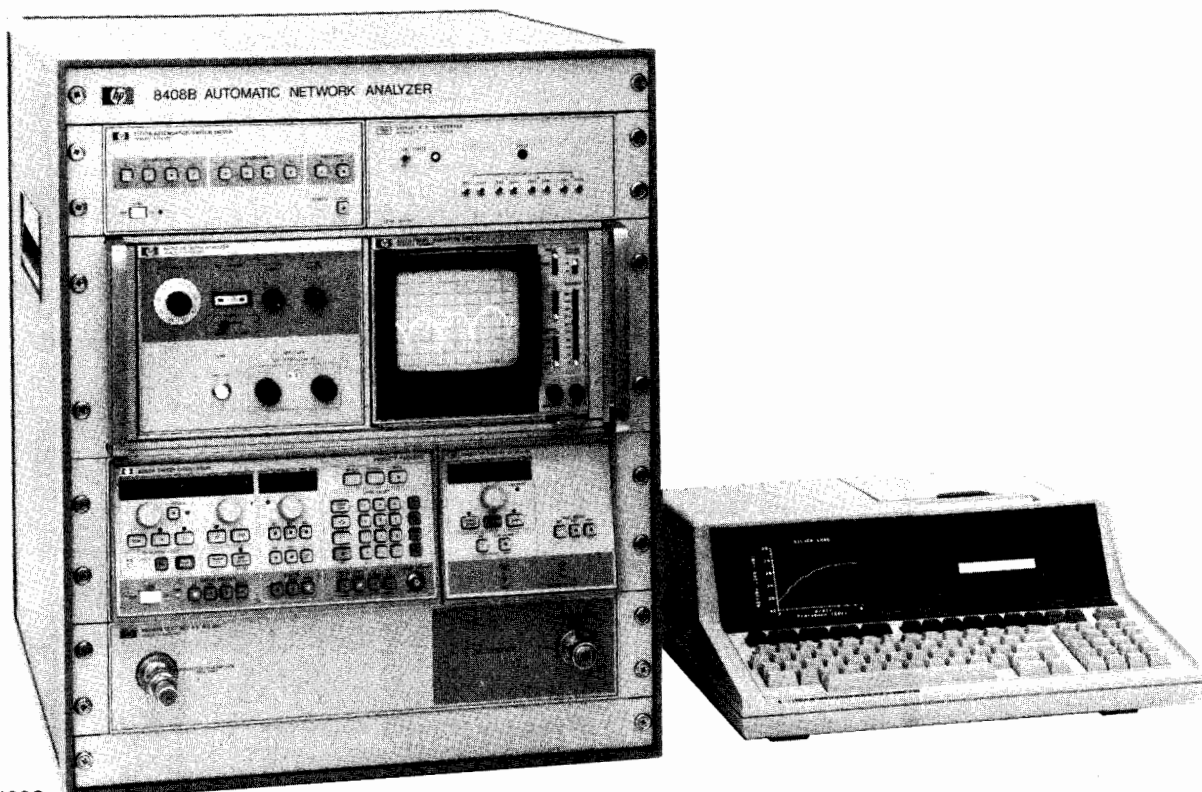

HP 8408S

### Description

The HP 8408S Automatic Network Analyzer is a complete microwave network measurement system composed of a network analyzer (receiver), reflection/transmission test set, programmable source, computing controller, and accuracy enhancement pac for making vector error-corrected measurements. The HP 8408S system is fully assembled and integrated at the factory. All accessories and cables necessary for making transmission and reflection measurements are supplied with the system, including calibration standards for measurements in APC-7.

Utilizing a single broadband source and test set, this system measures return loss and transmission (magnitude and phase) over the 500 MHz to 18 GHz frequency range. To verify that the proper connections have been made or to adjust the test device, a real-time CRT display of swept magnitude and phase is provided over the selected frequency range. The test set is a one-path reflection transmission test set. The HP 85040B Test Set is a low cost test set designed for automatic systems. When used with the HP 11873B Accuracy Enhancement Pac in the HP 8408S system, measurements can be made from 500 MHz to 18 GHz with an effective system directivity better than 40 dB.

The HP 8408S is a tuned receiver that allows both magnitude and phase information of the test signal to be obtained. In comparison to a magnitude-only (scalar) measurement system, a tuned receiver provides a 60 dB measurement range that is immune to measurement ambiguities caused by source harmonics or spurious signals. Using phase information, system errors like directivity and source match can be measured and effectively removed. Hence magnitude measurements can be made with much greater accuracy than in scalar systems.

The HP 8408S makes vector error-corrected measurements by initially measuring several calibration standards in order to quantify and store the repeatable system errors. Then at each measurement frequency the measured data is enhanced by using an 8-term error

correction model that effectively removes these system errors. By using vector error-correction and the appropriate calibration standards, the effective system directivity is better than 40 dB at the measurement test port using the desired test connector type.

The HP 11873A Accuracy Enhancement Pac provided with the system allows the user to immediately make measurements at up to 100 frequencies. The software guides the user via simple prompts through the initial setup, calibration, measurement, and output sequences in order to simplify system operation. After measuring the test device, the data can be displayed in a tabular listing, plotted versus frequency in a rectangular format, or plotted in a polar format. Direct the output to the CRT or the internal thermal printer for hard copy results. When plotting, you even have the option of selecting the scale values or letting the software automatically scale the data for you. By adding a graphics plotter, system measurements can be plotted for analysis, documentation, and presentation. Recommended plotters include the 8-pen HP 7550A, the 6-pen HP 7475A, and the 2-pen HP 7470A.

For measurements in APC-3.5 or Type-N, the proper calibration standards and adapters are available. For APC-3.5 and SMA, use the HP 85033B Calibration Kit and HP 911C Sliding Load. For Type-N, use the HP 85032A Option 001 Calibration Kit. The sliding load provided with the system can be used for APC-7 and Type-N.

### Ordering Information

#### System Reference

HP 8408S Automatic Network analyzer

#### Network Analyzer Subsystem

HP 8408B Network Analyzer Subsystem 0.5-18 GHz

Option 001: 2-18 GHz only

Option 003: Delete Sweep Oscillator Plug-in

#### Computer

Model 85B Personal Computer

HP 82936A ROM Drawer

HP 00085-15002 Print/Plot ROM

HP 00085-15004 Matrix ROM

HP 82937A HP-IB Interface

# NETWORK ANALYZERS

## Storage-Normalizer

Model 8750A



- Digital storage and normalization
- Simple CRT photos and x-y recordings
- Use with HP network and spectrum analyzers

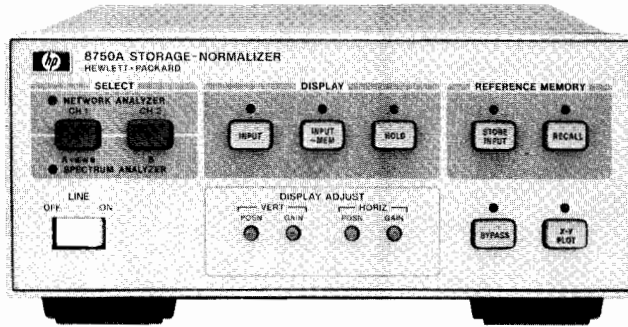

HP 8750A

With HP's versatile 8750A Storage-Normalizer, you can make your network analyzer or spectrum analyzer measurements faster, easier, and more accurately through the simple addition of digital storage and normalization. This useful instrument accessory is directly compatible via a single interface cable with the following recently produced or appropriately modified Hewlett-Packard instruments; the HP 8755 Scalar Network Analyzer, the HP 8410/8412A, the HP 8754A and the HP 8505A Networks Analyzers and HP 8557A, 8558B, 8565A and 8559A Spectrum Analyzers. A special I/O Adapter (opt 001 or opt 002) is available for interfacing instruments (like HP 140 Series Spectrum Analyzers) that are not directly compatible with the HP 8750A. An external oscilloscope can then be used for digitally stored and normalized displays. (The HP 8750A is not compatible with the HP 8414A Polar Display or the polar mode of the HP 8505A or the HP 8754A.)

In network analyzer applications, digital storage always yields a flicker-free display of the complete device response, facilitating easy adjustment of test devices under slow sweep conditions. Measurement accuracy is also improved since frequency response errors can be automatically removed through digital normalization. This effectively eliminates the need to manually record calibration traces on a CRT or x-y recorder and allows high resolution measurements of attenuator, amplifier, or filter passband flatness.

In spectrum analyzer applications, the HP 8750A's digital storage feature simplifies many difficult tests requiring slow scan times such as high resolution modulation measurements. Drift tests are also easy since two traces, a stored reference and the current input, can be displayed simultaneously.

Hard copy documentation can be obtained quickly and easily since data can be frozen on the CRT for straightforward CRT photography or output to an x-y recorder at a constant 30 second sweep rate.

### Supplemental Performance Characteristics

#### Display

**Horizontal memory resolution:** two display channels, 256 points per channel (0.4% of full scale, 8 bit word)

**Vertical memory resolution:** 512 points displayed full scale (0.2% of full scale, 10 bit word) plus a 50% overrange (256 points) both above and below full screen.

**Horizontal input sweep rates:** 100 s max./10 ms min.

**Display refresh rate:** 6 ms.

#### Video Detection

**Network analyzer:** average detection (20 kHz).

**Spectrum analyzer:** peak detection.

#### Input/Output

##### A/D Horizontal Input

**Network analyzer:** 0 to 10 V nominal. Offset  $\pm 0.5$  V and Gain Adjust for 6 to 15 V sweep.

**Spectrum analyzers:**  $\pm 5$  V nominal. Offset  $\pm 0.5$  V and Gain Adjust for  $\pm 4.5$  to  $\pm 5.5$  V.

##### A/D Vertical Input

**Network analyzer:**  $\pm 1$  V min. and  $\pm 2$  V max, with continuous gain adjustment. Offset  $\pm 0.3$  V.

**Spectrum analyzer:** 0 to 0.8 V or 0 to  $-0.8$  V. Offset  $\pm 0.1$  V and Gain Adjust  $\pm 10\%$ .

##### D/A Horizontal Output

**Network analyzer:** gain adjustment for 1 to 3 V peak. Offset adjustment  $+0.5$  to  $-1.5$  V.

**Spectrum analyzer:** gain adjustment for 1 to 3 V peak. Offset  $+0.5$  to  $-1.5$  V.

##### D/A Vertical Output

**Network analyzer:** same as Vertical Input with  $\pm 10\%$  adjustment range.

**Spectrum analyzer:** same as Vertical Input with  $\pm 10\%$  adjustment range.

##### X-Y Recorder Outputs

**Horizontal range and accuracy:**  $0 \pm 20$  mV to 1 V nominal, settable within  $\pm 3\%$  of full scale. BNC female output (rear panel).

**Vertical range and accuracy:**  $\pm 4$  V  $\pm 3\%$  BNC female output (rear panel).

**Sweep time:** 30 s per displayed trace.

**Penlift output:** BNC female (rear panel with open collector -driver 20 V maximum.)

##### Controls

**Select:** LED display indicates network or spectrum analyzer operation depending on the plug-in interface card.

##### Display

**Input:** initiates digital storage.

**Input-mem (input minus memory):** stored Reference trace is subtracted from input data (normalization).

**Hold:** freezes display for CRT photos or further analysis.

##### Reference Memory

**Store input:** current input trace is stored as Reference.

**Recall:** displays stored Reference trace.

**Bypass:** bypasses HP 8750A so display is returned to conventional analog operation.

**X-Y Plot:** initiates X-Y plots.

##### General

**Interface cards:** the HP 8750A is supplied with two general plug-in interface cards, one for use with the HP Spectrum Analyzers listed above and one for use with the HP 8407A/8412A and 8505A Network Analyzer. When the HP 8750A is to be used primarily with an 8755C Scalar Network Analyzer, HP 8350B/8620C sweep oscillator, HP 8410B/8412A Network Analyzer, or the HP 8754A Network Analyzer, calibration and adjustment of the HP 8750A to these instruments can be greatly simplified by ordering one of the plug-in interface cards dedicated to these instruments (Opt. 003 and 004). All offset and gain adjustments are significantly reduced. When Opt. 003 or 004 are ordered, the two general interface cards are also included, so you have the flexibility to change your test set-up at any time.

**Power:** selection 100, 120, 220, or 240 V  $+5\%$   $-10\%$ . 48 to 440 Hz and  $<20$  VA ( $<20$  watts).

**Size:** 102 H x 212 W x 280 mm D (4" x 8.4" x 11.2").

**Weight:** net, 2.72 kg (6.1 lbs); shipping, 5.0 kg (11 lbs).

##### Ordering Information

HP 8750A Storage-Normalizer

**Opt 001:** BNC Interface Adapter (Deletes direct interface cable)

**Opt 002:** BNC Interface Adapter (Retains direct interface cable)

**Opt 003:** HP 8755C or 8412A/8620C Plug-in Interface Card

**Opt 004:** HP 8754A Plug-in Interface Card

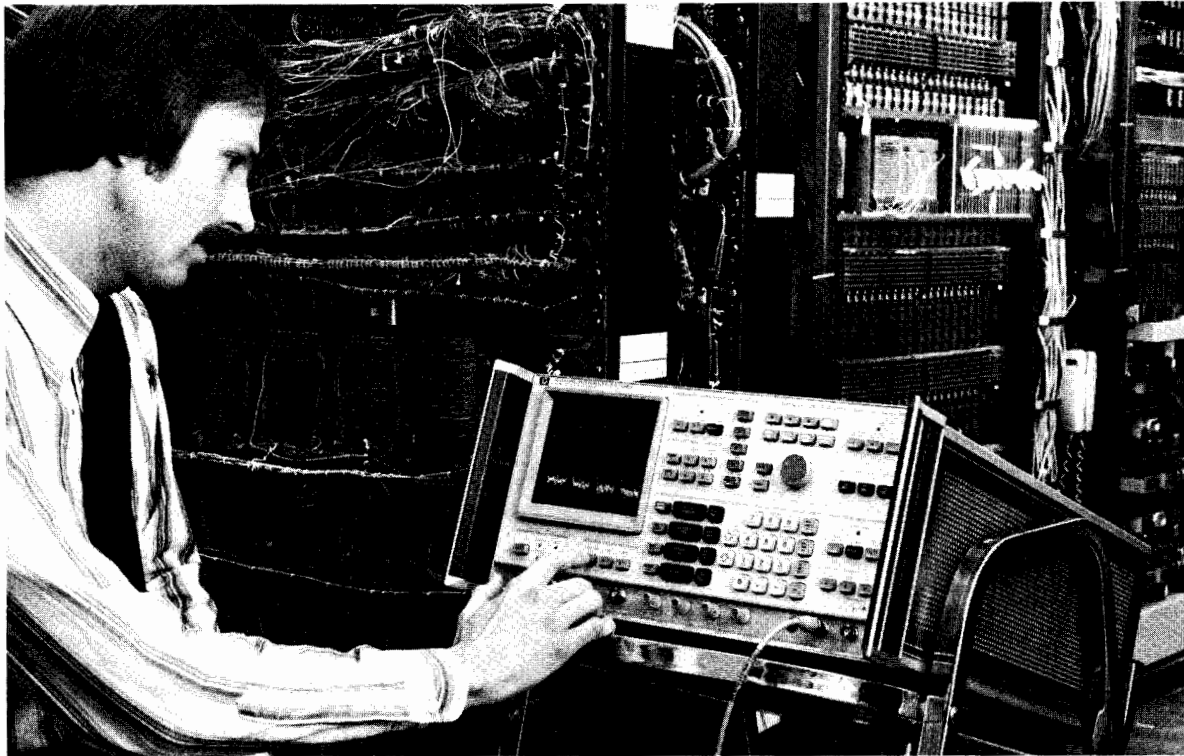

Analysis of signals in the frequency domain is an important measurement concept which is widely used for providing electrical and physical system performance information. Several examples will illustrate some important applications where signal analyzers are useful.

### Mechanical Measurements

Noise and vibration levels are of major concern to manufacturers and users of mechanical structures such as aircraft, automobiles, and bridges. With an appropriate motion-to-electrical signal transducer the spectrum analyzer or the Fourier analyzer can examine vibration signals in the frequency domain. This makes it possible to monitor and analyze vibration components of rotating machines associated with unbalance, worn bearings or worn gears, and to identify a structure's natural modes of vibration.

### Communications

In the fields of telecommunications, the spectrum, modulation, wave and audio analyzers provide vital operational performance verification of transceivers and multiplex systems. Unwanted signals such as carrier leak signals, out-of-band noise, and cross modulated signals must be identified. System gain, loss, distortion and pilot tone measurements must also be made. These measurements are discussed in more detail in the Telecommunications Test Equipment section of this catalog.

### Electronic Testing

Finally, in the general field of electronics, there are four primary uses for the signal analyzer. First, the analyzer is used to identify and measure signals which result from non-linear effects in the process of amplification, filtering, and mixing. Second, the purity of signal sources is commonly observed. Third, the modulation analyzer serves a spe-

cial purpose in analyzing modulated communication signals by measuring and displaying RF power, frequency and modulation characteristics. Fourth, the signal analyzer with a companion tracking generator is used as an amplitude-only network analyzer for frequency response measurements of filters, amplifiers, and many other types of networks.

### Basic Analyzers

This section discusses the definition and use of several types of instruments for frequency response signal analysis: spectrum analyzers, digital Fourier analyzers, wave analyzers, distortion analyzers, audio analyzers, modulation analyzers and measuring receivers.

Each of these instruments measures basic properties of a signal in the frequency domain, but each uses a different technique. The spectrum analyzer is a swept receiver that provides a visual display of amplitude versus frequency. It shows on a single display how energy is distributed as a function of frequency, displaying the absolute value of Fourier components of a given waveform. The Fourier analyzer uses digital sampling and transformation techniques to form a Fourier spectrum display that has phase as well as amplitude information. The wave analyzer is the true tuned voltmeter, showing on a meter the amplitude of the energy in a specific frequency window which is tunable over a specific frequency range. The distortion analyzer performs an almost reciprocal function to that of the wave analyzer. It collectively measures the energy outside a specific bandwidth tuning out the fundamental signal and displaying the energy of the harmonics and other distortion products on a meter. The audio analyzer performs the same measurement function as a distortion analyzer but also includes the additional measurement functions of SINAD, signal to noise ratio, frequency count, true rms DVM

and dc DVM. The modulation analyzer tunes to the desired signal and recovers the entire modulation envelope of AM, FM and phase modulation for processing and display. The measuring receiver adds to the capabilities of the modulation analyzer the ability to very accurately measure signals down to  $-127$  dBm.

### Different Views

Figure 1 shows a graphical representation of the way five of the analyzers view a signal and one harmonic. The time domain scan of the signal is presented in Figure 1a.  $A(t)$  is the complex voltage waveform as it would be viewed on an oscilloscope. The dashed lines represent the vector components of the signal:  $A_1(t)$ , the fundamental and  $A_2(t)$  the second harmonic. In Figure 1b the spectrum analyzer displays the frequency spectrum showing both vector components and their amplitude relationship.

The Fourier analyzer uses digital signal processing techniques to extract both the amplitude and phase information about each spectral component. Conceptually the Fourier analyzer can be viewed as measuring a large number (up to 2048) of parallel filters as shown in Figure 1c. These filters are actually very specialized digital filters so that precise, repeatable results can be obtained. With this arrangement of parallel filters the complete display is generated in the time that it takes to analyze the lowest frequency component. HP Fourier analyzers presently cover the range of dc to 100 kHz.

The wave analyzer in Figure 1d measures the amplitude and frequency of the signal in the frequency window to which it is tuned. This window can be moved to measure the amplitude of the second harmonic, thereby making a precise comparison with the fundamental. This technique is practical from 15 Hz to above 32 MHz.



# SIGNAL ANALYZERS

## Wave, Distortion, Modulation, Spectrum and Fourier Analyzers (cont.)

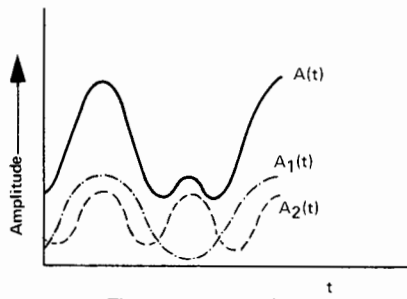

Figure 1a. Waveform

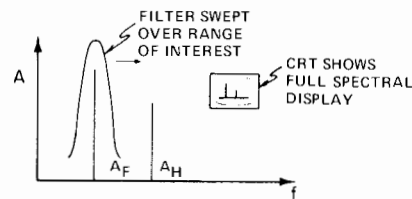

Figure 1b. Spectrum analyzer

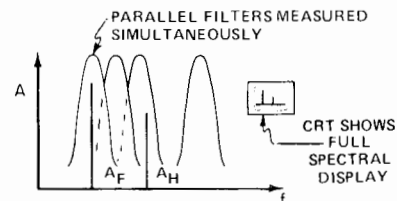

Figure 1c. Fourier analyzer

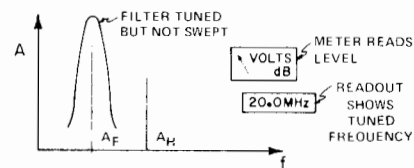

Figure 1d. Wave analyzer

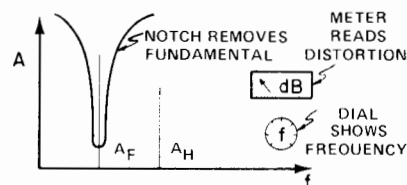

Figure 1e. Distortion analyzer

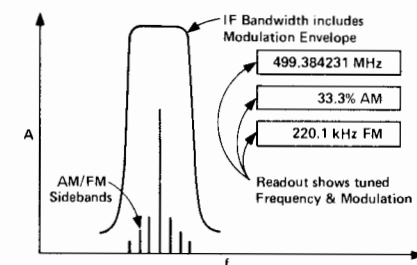

Figure 1f. Modulation analyzer

The distortion analyzer as pictured in Figure 1e rejects the fundamental to which it has been tuned and measures the energy everywhere else within the instrument's frequency spectrum. Distortion, as a percentage or in dB down from the fundamental, is displayed

directly on a meter. Hewlett-Packard distortion analyzers cover 5 Hz to 600 kHz.

The modulation analyzer of Figure 1f and the measuring receiver tune to a desired frequency just as the wave analyzer does. Their IF bandwidths and detection systems are designed to pass the entire modulation envelope so that percent modulation, distortion, residual and peak deviation measurements can be made. All close-in spectral components are combined in the measurement.

The following section considers each instrument technique, showing the particular strength and flexibility of each.

### Hardcopy Records

Signals and harmonics can be reproduced on printers and plotters for analysis, comparisons, and documentation. Report quality hard copy saves time and money when graphical representations are needed for reports or presentations. For more information, see the X-Y Recorder and Graphics Plotter Selection Guide for HP Instruments in the Recorders, Plotters & Printers section of this catalog.

### Spectrum Analyzers

To display useful information about a frequency scan, a spectrum analyzer must be sensitive, frequency stable, free of spurious responses over a wide band, and have calibrated accuracy in the CRT display. The examples which follow best demonstrate the wide variety of information which can be measured on the spectrum analyzer.

### Measurements with the Spectrum Analyzer

**CW signal:** the most basic spectrum analysis measurement is the single CW signal.

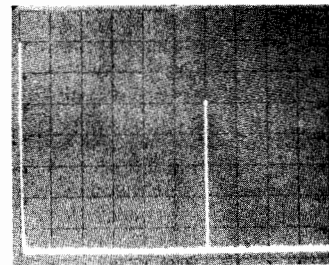

Pictured is a  $-30$  dBm signal at 60 MHz. The zero frequency indicator is at the far left graticule line.

**Spectral purity of a CW signal:** one very important oscillator signal measurement is spectral purity. This 70 MHz carrier has power line related sidebands ( $\pm 60$  Hz) which are 65 dB down.

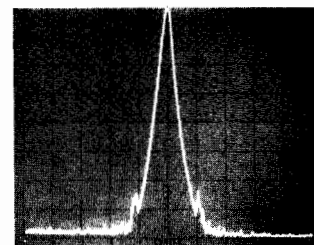

Such sidebands may result from power supply ripple. The 50 Hz/division spectrum analyzer scan and the 10 Hz analyzer bandwidth provide the high degree of resolution required to see these sidebands.

**Frequency conversion products:** the spectrum analyzer is well suited for frequency conversion measurements such as the output of a balanced mixer as shown.

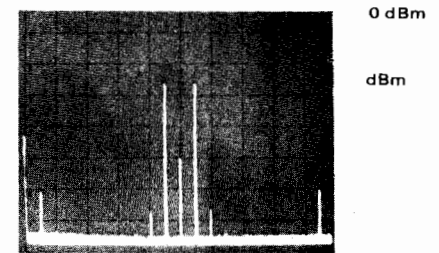

With the 50 MHz local oscillator input at 0 dBm and a 5 MHz,  $-30$  dBm mixer signal, two sidebands at 45 MHz and 55 MHz result. The sidebands are  $-36$  dBm, giving the mixer a 6 dB conversion loss. The local oscillator has 60 dB isolation and the 5 MHz signal has 41 dB isolation. Second order distortion products at 40 and 60 MHz are 40 dB below the desired mixer outputs.

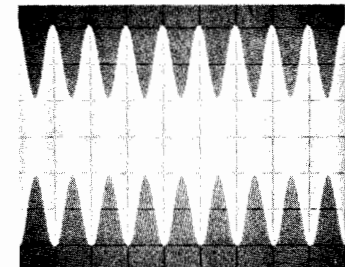

Oscilloscope

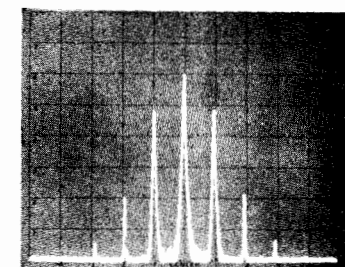

Spectrum Analyzer

**Amplitude modulation:** percent amplitude modulation is often more easily measured with the spectrum analyzer than it is with the oscilloscope. This is especially true for low level modulation.

With the oscilloscope time display, percent modulation,  $M$ , is measured as a ratio of the signal's dimensions:  $M = 100 \frac{(6-2)}{(6+2)} = 50\%$ . In the spectrum analyzer display, whose vertical calibration is 10 dB/division, the carrier and sidebands differ by 12 dB, the voltages in the sidebands are  $\frac{1}{4}$  of that of the carrier and again,  $M = 50\%$ . At the same time the second and third harmonic distortion of the sidebands can be measured at 28 and 44 dB respectively.



**Frequency modulation:** information transmitted by FM can be characterized by the spectrum analyzer.

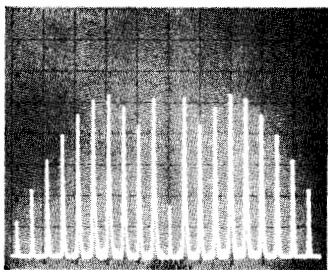

20 kHz Low Deviation FM

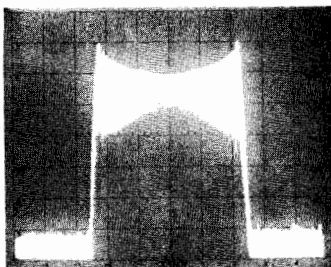

0.5 MHz High Deviation FM

Low deviation FM is applied to a 60 MHz carrier in the first photo. The deviation has been adjusted for the second carrier null ( $M = 5.52$ ). The sideband spacing is 10 kHz, the modulation frequency; therefore,  $\Delta f$  peak =  $5.52 \times 10 \text{ kHz} = 55.2 \text{ kHz}$ .

The second photo is an example of a high deviation FM. The transmission bandwidth is 2.5 MHz.

**Pulsed CW power:** by viewing the spectra of a repetitive RF pulse on the spectrum analyzer, pulse width, average and peak power, occupied bandwidth, and duty cycle can be determined.

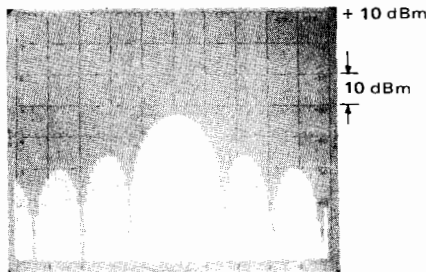

0.5 MHz 6.3 GHz

From the spectral output shown the pulse's complete characteristics are determined: 6.3 GHz RF at 0 dBm, pulsed at 50 kHz rate. The pulse width is 1.3  $\mu\text{s}$ .

**EMI:** Spectrum analyzers have long been a useful tool in the evaluation of electromagnetic interference (EMI). They are valuable for preliminary design troubleshooting and qualification testing. The spectrum analyzer's ability to display wide frequency spans provides "quick look" capability for locating EMI "hot spots". The high performance spectrum analyzers (HP 8566B and HP 8568B)

offer full programmability, allowing automatic EMI measurements. With the addition of the Quasi-Peak Adapter (HP 85650A), these analyzers can make quasi-peak measurements used in commercial EMI tests.

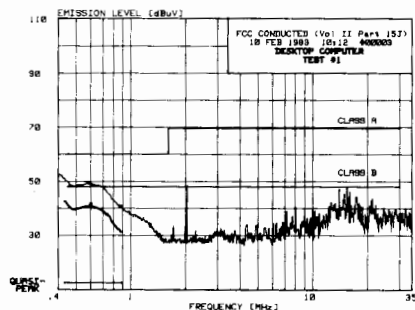

Plot of FCC conducted emissions test using peak and quasi-peak detection

**Noise:** spectrum analysis is effective in measuring impulse noise, random noise, carrier to noise ratio, and amplifier noise figure.

**Phase noise:** the short term frequency fluctuations of a sine wave source can be measured directly as phase modulation sidebands. Hewlett-Packard spectrum analyzers with narrow resolution and synthesized internal frequency sources can make many phase noise measurements directly. Bandwidth corrections, analyzer corrections, data averaging and setup calibration factors can be accounted for by Hewlett-Packard microprocessor controlled spectrum analyzers. All instrument controls, data transfer and data reduction can be handled by easy-to-write software for Automatic Spectrum Analyzers.

**Frequency response:** using a tracking signal source and a spectrum analyzer the frequency response of filters can be displayed with ease.

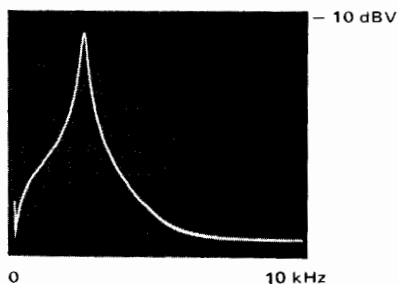

In this case, an audio filter used in a communications system is being measured. Since the input reference level to the filter is -13 dBV, the insertion loss at 2.4 kHz is 4 dB. Extremely high Q devices can be measured with this system.

### Spectrum Analyzer Capabilities

To be useful in making measurements in the frequency domain, the analyzer must be capable of making quantitative measurements. Specifically, an analyzer must:

1. make absolute *frequency* measurements
2. make absolute *amplitude* measurements
3. operate over a *large amplitude dynamic range*

4. have *high resolution* of frequency and amplitude

5. have *high sensitivity*

6. provide means of *observing, preserving, and recording* its output in a convenient and rapid manner by using variable persistence, digital storage and adaptive sweep. Hewlett-Packard spectrum analyzers excel in these six measures of performance. Let us consider each of these performance standards in greater detail.

**Absolute frequency measurements:** frequency readout accuracy depends upon the tuning and readout techniques employed, as well as the stability of the spectrum analyzer's frequency reference. The absolute frequency accuracy read off the slide-rule type of frequency dial is approximately 1% of full scale. Synthesized local oscillators allow accuracies to  $\pm 4 \text{ Hz}$  at 1500 MHz in narrow frequency spans. When the spectrum analyzer is used in conjunction with a tracking generator (a source whose frequency is the same as the analyzer tuning frequency) accuracy much better than 1% can be achieved by counting the generator output.

**Extended frequency capabilities:** the frequency range of microwave spectrum analyzers can be extended to the millimeter frequency bands where waveguide transmission lines are required. This frequency extension is accomplished by using external harmonic mixers to convert the millimeter signal frequency down into the range of the spectrum analyzer. Hewlett-Packard Harmonic Mixers provide a high level of performance for measurements in these millimeter frequency bands from 18 to 60 GHz. Their characteristics include excellent absolute amplitude accuracy and low conversion loss, the latter providing high sensitivity. In addition, no mixer bias is required, allowing full waveguide band measurements to be made easily and accurately. The non-biased feature also makes these mixers highly suitable for fully automatic systems, since there is no need to adjust a bias current over the frequency range to achieve the best flatness. For more information on millimeter measurements, refer to page 621.

**Absolute amplitude measurements:** all Hewlett-Packard spectrum analyzers are absolutely calibrated for amplitude measurements. This means the spectrum analyzer indicates to the user what the log/reference level or linear sensitivity is regardless of control settings. Either a warning light or CRT message indicates an uncalibrated condition, making operation of the analyzer easy and foolproof.

Microprocessor controlled analyzers feature built-in calibration routines which account for changes in analyzer controls such as the resolution bandwidth and RF attenuator.

**Dynamic range:** the dynamic range of a spectrum analyzer is defined as the difference between the input signal level and the average noise level or distortion products, whichever is greater. Hence, dynamic range can be either distortion limited, noise limited or display limited. Hewlett-Packard micro-



# SIGNAL ANALYZERS

## Wave, Distortion, Modulation, Spectrum and Fourier Analyzers (cont.)

processor controlled analyzers can be set to ensure that distortion products of on-screen signals will be below a certain level.

**Frequency and amplitude resolution:** frequency resolution is the ability of the analyzer to separate signals closely spaced in frequency. The frequency resolution of an analyzer is a function of three factors: 1) minimum IF bandwidth, 2) IF filter shape factor, 3) spectrum analyzer stability.

The minimum IF bandwidth ranges down to 1 Hz on Hewlett-Packard spectrum analyzers.

One way to define IF filter shape factor is the ratio of 60 dB bandwidth to 3 dB bandwidth. Filter shape factor specifies the selectivity of the IF filter. Hewlett-Packard spectrum analyzers have IF filter shape factors as low as 5:1.

Analyzer frequency stability also limits resolution. The residual FM (short term stability) should be less than the narrowest IF bandwidth. If not, the signal would drift in and out of the IF pass band. Hewlett-Packard analyzers have excellent stability. Low frequency and microwave frequency models are available with residual FM <1 Hz, enabling the measurement of noise sidebands. The stabilization circuitry is completely automatic and foolproof. No signal recentering, manual search, or checking is required.

Amplitude resolution is a function of the vertical scale calibration. Hewlett-Packard analyzers offer both log calibration for observing large amplitude variations (10, 5, 2 and 1 dB/div) and linear calibration for observing small amplitude variations.

**Sensitivity:** sensitivity is a measure of an analyzer's ability to detect small signals, and is often defined as the point where the signal level is equal to the noise level or  $(S+N)/N=2$ . Since noise level decreases as the bandwidth is decreased, sensitivity is a function of bandwidth. The maximum attainable sensitivity ranges from -150 dBm to -125 dBm with Hewlett-Packard analyzers.

**Variable persistence, digital storage, and adaptive sweep:** high resolution and sensitivity both require narrow bandwidths and consequently slow sweep rates. Because of these slow sweeps, both digital display and variable persistence are virtually indispensable in providing a bright, steady flicker-free trace.

The digital storage feature on Hewlett-Packard analyzers covering audio to microwave frequency ranges make measurements and CRT photography simple. It gives the CRT display a dot matrix connected by line generators for an unbroken and uniform intensity scan. In addition, the microprocessor controlled analyzers feature CRT annotation to completely describe the data characteristics displayed.

On low frequency analyzers, adaptive sweep effectively speeds the measurement times. On the very slow sweep times (required when using the 1 Hz bandwidth), adaptive sweep allows the scan to sweep rap-

idly when no signals occur and slow down when a signal is above a preset level. The measurement time savings can be greater than 20:1.

### Tracking Preselector

The only way to simultaneously avoid spurious, multiple, harmonic and image responses is to filter the RF signal through a tracking preselector. This is an electronically tuned bandpass filter that automatically tracks the analyzer's tuning. A preselector improves the spurious-free range of the analyzer from 70 dB to 100 dB.

### Tracking Generator

A tracking generator expands the measurement capability of the spectrum analyzer by providing a signal source which tracks the tuning frequency of the analyzer. The source/receiver combination can be used to measure insertion loss, frequency response, return loss and allow precision frequency counting.

It helps make these additional measurements with increased distortion-free dynamic range, sensitivity and selectivity. The tracking generator is also an excellent stable sweeping generator. The residual FM varies from <1 Hz to <200 Hz for Hewlett-Packard tracking generators.

### Automatic Spectrum Analyzers

The measurement capability of a spectrum analyzer can be greatly enhanced by allowing a desktop computer to control instrument functions and record frequency and amplitude information. Data can be gathered and processed into a variety of formats at a very rapid rate. Through comprehensive self-calibration, automatic spectrum analysis offers amplitude accuracy of up to  $\pm 0.4$  dB with 0.01 dB resolution. User cost savings are realized through faster measurements, lower operator skill requirements, and unattended operation capability.

Further discussion of computer based automatic spectrum analysis can be found on page 598.

### Frequency Stability Analysis

Frequency stability and spectral purity are important parameters when characterizing most signal sources. Long term stability or frequency drift due to aging or temperature effects is generally measured with a precision frequency counter such as the HP 5345A; random fluctuations in frequency or period can also be measured in the time domain, using an electronic counter and the Allan Variance technique.

Another measure of frequency stability is the phase spectral density. The most common method of making this measurement is to phase-lock the unknown to a clean reference source, mixing the two signals together in a phase detector and analyzing the low frequency output on a wave or spectrum analyzer. This technique allows the phase noise sidebands to be measured in the absence of the carrier, and can result in measurement sensitivities of -170 dBc or better.

Analogue spectrum analyzers are required for noise measurement at high offset fre-

quencies (above 25kHz). However, at lower offsets (below approximately 100 Hz), their bandwidths become large in comparison to the frequencies being measured. In these cases, the use of FFT-based spectrum analyzers becomes necessary.

Insuring the accuracy of a phase noise measurement can be quite a problem. Non-ideal phase detectors and amplifiers will introduce measurement errors, and the phase-locked loop used to control the reference source will attenuate the noise signal at certain frequencies.

The HP 3047A Phase Noise Measurement System contains both a conventional and an FFT spectrum analyzer, and allows measurement of phase noise sidebands over the offset frequency range 0.02 Hz to 40 MHz. Phase detectors are provided for carriers from 5 MHz to 18 GHz, and require only an appropriate external reference source such as the HP 8662A. An extensive software package handles all operator interface, graphics and data storage, as well as complete error characterization and correction. Overall accuracy is an excellent  $\pm 2$  dB. -170 dBc sensitivity is provided by a special low noise input amplifier. The HP 3047A Phase Noise Measurement System is described on page 636.

### Fourier Analyzers

The Fourier analyzer uses digital signal processing techniques to provide measurement capability over and above that of a swept spectrum analyzer. Some of these include the precise measurement of random signals obscured by noise, measurement of the joint properties or relationships of two or more signals, measurements of statistical properties of signals, and measurements of very low frequency (e.g. below 5 Hz) or very closely spaced (e.g. less than 1 Hz) signals.

Fourier analyzers are based on the calculation of the Discrete Fourier Transform using a highly efficient algorithm known as the Fast Fourier Transform. As shown in Figure 2, this algorithm calculates the magnitude and phase of each frequency component from a block of time domain samples of the input signal.

The block diagram that is involved is shown in Figure 3. First, the input signal is filtered to remove out-of-band components. Next, the input is sampled and digitized at regular  $\Delta t$  intervals until a full block of samples called a time record has been collected. The processor then executes the desired series of computations on the time data to produce the frequency domain results. These results, which are stored in memory, can be analyzed on a CRT display, plotted, or processed further to provide the user additional useful information.

$$X(k \Delta f) = \sum x(n \Delta t) e^{-j2\pi(n)k/N}$$

EACH FREQUENCY POINT IS COMPOSED OF A MAGNITUDE AND PHASE VALUE      EACH FREQUENCY POINT CONTAINS INFORMATION FROM ALL TIME DOMAIN SAMPLES      COMPLEX FACTOR

Figure 2

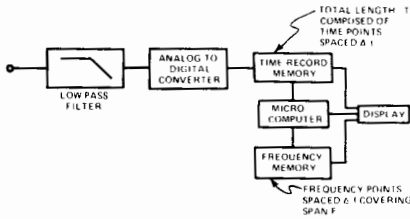

Figure 3

When two or more input channels are provided, signals can be sampled simultaneously. The processor can then additionally compute joint properties of the signals. This is useful for characterizing the transfer function of a linear device and for investigating cause/effect relationships.

The digital nature of Fourier analysis insures *high accuracy, stability and repeatability*. In addition, there are several specific advantages that are achieved.

### Low Frequency Coverage

The Fourier transform calculates equally spaced frequency components from DC to the maximum frequency. By simply varying the sample rate it is possible to make measurements down to a few micro Hertz. For such low frequency measurements, the laws of physics dictate a long observation time. Since the Fourier transform simultaneously calculates all frequency points from one set of observation points, a one to two order of magnitude speed improvement over a swept measurement is possible.

### High Frequency Resolution

By digitally translating a band of frequencies down to DC it is possible to provide very high frequency resolution over the entire range. This technique, known as Band Selectable Fourier Analysis, can provide resolution of a few millihertz as shown in Figure 4. Here a 5 Hz band of frequency located at 3 kHz is analyzed showing 0.48 Hz sidebands over 20 dB down.

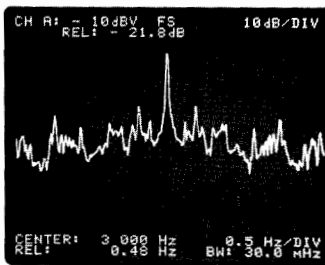

Figure 4

### Direct Transfer Function Measurements

With simultaneous sampling of both the input and output of an electrical, mechanical, or acoustical system, it is possible to directly characterize transfer functions. Since the Fourier analyzer measures the frequency components simultaneously, energy must also be provided at these frequencies. This can be done with a broadband white noise signal, a pseudorandom noise signal or an impulse. Results presented in magnitude/phase or real/imaginary format help quickly illus-

trate the performance characteristics of a system.

The measurement of the coherence function can additionally provide a measure of the validity of a transfer function. It can distinguish portions of the output power that are not directly caused by the input, but may instead be due to additive noise, distorted products, or unmeasured inputs.

### Systems Compatibility

Since the Fourier analyzer is basically all digital, interfacing to a computing controller or other digital peripherals is relatively simple. Remote programming and data input/output can considerably expand the range of potential applications.

### Fourier Analyzer Applications

The versatility and performance of the Fourier analyzer make it an ideal tool for a variety of applications as a few specific examples will illustrate.

In the general area of electronics, the Fourier analyzer functions as a very high performance spectrum and network analyzer. It can be very useful for measuring phase noise or for characterizing filters.

In the field of communications, the Fourier analyzer can be very useful for characterizing audio signals, such as modems and touch tone signals.

When combined with a microphone the Fourier analyzer can be useful in characterizing acoustic devices, such as loud speakers.

With a motion transducer the Fourier analyzer can be used to analyze the vibration signatures of rotating machines. This can be very useful in helping to establish scientific maintenance policies.

The transfer function of a mechanical structure can illustrate how the structure responds to vibration inputs. This is extremely important in optimizing the design of structures that will be subjected to substantial vibration.

### Wave Analyzers/SLMs

Wave analyzers are known by several different names: frequency selective voltmeter, carrier frequency voltmeter, and selective level meter. These names describe the instrument's function rather well.

As mentioned in the introduction to this section, a wave analyzer can be thought of as a finite bandwidth window filter which can be tuned throughout a particular frequency range.

Signals will be selectively measured as they are framed by the frequency window. Thus, for a particular signal, the wave analyzer can indicate its frequency (window position) and amplitude. Amplitude is read on an analog meter; frequency is read on either a mechanical or electronic readout.

The uses of wave analyzers can be categorized into three broad areas: 1) amplitude measurement of a single component of a complex frequency system, 2) amplitude measurement in the presence of noise and interfering signals and, 3) measurement of signal energy appearing in a specified, well defined bandwidth.

### Wave Analyzer/SLM Considerations

#### Frequency Characteristics

**Range:** should be selected with the future in mind as well as present requirements.

**Accuracy and resolution:** should be consistent with available bandwidths. Narrow bandwidths require frequency dial accuracy to place the narrow window in the proper position for measurement. Accuracy of instruments with selectable bandwidths is determined by the basic center frequency accuracy of the IF bandwidths filters in addition to the local oscillator frequency accuracy.

**Readout:** usually an LED display.

**Stability:** frequency stability is important when using narrow bandwidths and for long term signal monitoring. Stability is best achieved with automatic frequency control (AFC) or frequency synthesis. AFC locks the local oscillator to the incoming signal and eliminates any relative drift between the two. A frequency synthesized local oscillator allows frequency accuracy of  $<1 \times 10^{-5}$  with 0.1 Hz resolution.

**Sweep:** some instruments are equipped with sweep to allow use as a spectrum analyzer. Readout is a CRT or X-Y recorder.

#### Amplitude Characteristics

**Range:** the amplitude range is determined by the input attenuator and the internal noise of the instrument. Sensitivity is defined as the lowest measurable signal equal to the noise level for a unity signal-to-noise ratio (often called tangential sensitivity). Sensitivity will vary with bandwidth and input impedance.

**Dynamic range:** defined as the dB ratio of the largest and smallest signals that can be simultaneously accommodated without causing an error in the measurement.

**Attenuators:** the amplitude range switch is an attenuator in the input and IF stages. Intermodulation distortion is lowest when the input amplifier has the minimum signal applied and the IF gain is greatest. Conversely the internal noise, important when making sensitive measurements, is lowest with maximum input signal and lowest IF gain. Newer instruments use auto-ranging techniques.

**Accuracy:** amplitude accuracy is a function of frequency, input attenuator response, IF attenuator performance, calibration oscillator stability and accuracy, and meter tracking. Often specifications are expanded to separately describe each contributor.

**Readout:** amplitude readout is usually a meter calibrated in dB and/or volts or a LED digital display. Linear voltage meters are used to allow the user to see down into the noise at the bottom of the scale. Digital readouts are often used with an analog meter to aid in tuning to signals. Expanded scale meters allowing expansion of any 1 or 2 dB portion of the scale into a full scale presentation allow resolution of input level changes of a few hundredths of a dB while LED displays allow .01 dB resolution. This is useful when the wave analyzer is used as a sensitive indi-



# SIGNAL ANALYZERS

## Wave, Distortion, Modulation, Spectrum and Fourier Analyzers (cont.)

cator in bridge or comparison measurements. The expanded scale meter is included in some instruments and is an optional accessory on others.

### Input Characteristics

**Impedance:** may be high impedance bridging input or terminating impedance to match standard transmission lines. High frequency measurements require matched systems to avoid error-producing standing waves on interconnecting cables. The measure of impedance accuracy is usually return loss or reflection coefficient ( $RL=20 \log \rho$ ). In low frequency instruments, percent accuracy is used. High input impedance instruments are usually poorer in high frequency and noise performance and are usually low frequency instruments. High impedance at high frequencies is accomplished by using a bridging probe to place the impedance at the point of measurement. The probe may be active with unity gain or passive with 20-30 dB insertion loss.

**Input arrangement:** input may be balanced to ground or unbalanced. Communications system usage typically requires balanced input. Standard 600 and 135/150  $\Omega$  balanced inputs are limited in frequency to less than 1 MHz and 124  $\Omega$  balanced to less than 10 MHz in most instruments. The impedance may be balanced to ground with the center point grounded or may be completely isolated from ground. Unbalanced inputs do not have frequency range limitations.

### Network Analysis Application

**Frequency response testing:** with its tracking generator output, the wave analyzer is particularly useful for measuring filter and amplifier frequency responses. If a notch filter is being measured, for example, a narrow band measurement like that provided by a wave analyzer is essential for obtaining acceptable accuracy. A broadband technique will lead to some misleading results. For example, a notch filter may be driven with a flat oscillator and the response measured with a broadband voltmeter. The notch filter will reject the oscillator's fundamental tone, but pass its harmonics which are in the voltmeter's measurement range. Thus, an error results. If the voltmeter were frequency selective, like a wave analyzer, the harmonics would be rejected and the true level of the notch would be measured. Accurate and fast measurements can be made because Hewlett-Packard wave analyzers track and detect on the tracking generator frequency.

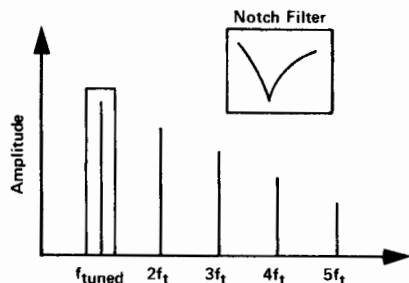

Only signal detected by wave analyzer. For example, the notch of a filter can be accurately measured to its full depth.

### Distortion, Audio Analyzers

Harmonic distortion is one of many types of distortion created in communications equipment, audio and ultrasonic sound systems. Nonlinear elements in amplifiers cause harmonic related frequencies from a pure tone stimulus to be created at the output. Hence, to a listener, a poor reproduction quality becomes apparent. The total of these frequency components present in a signal, in addition to the fundamental frequency, can be measured quickly and easily with Hewlett-Packard distortion and audio analyzers.

The ratio of these frequency components to the amplitude of the fundamental is the total harmonic distortion (THD) as defined by the following equation (1):

$$THD = \frac{\sqrt{\sum (\text{harmonics})^2}}{\text{fundamental}}$$

The Hewlett-Packard distortion and audio analyzers consist of a narrow band rejection filter and broadband detector. Before the fundamental is rejected, the analyzer first measures the amplitude of the fundamental, all the harmonic components, and noise. Then the rejection filter is employed to remove the fundamental. The ratio of the two measurements is an approximation of equation (1) above and is defined by the following equation (2):

$$THD = \frac{\sqrt{\sum [(\text{harmonics})^2 + (\text{noise})^2]}}{\sqrt{\sum [(\text{fundamental})^2 + (\text{harmonics})^2 + (\text{noise})^2]}}$$

An approximation error of 1/2% can be expected for the THD levels of 10%. However, distortion levels as high as 10% are seldom encountered in most measurement situations. The harmonic content of the stimulus source must not be more than a third of the distortion expected to be caused by the system under test.

### Audio Analyzers

The Audio Analyzer performs several basic low frequency measurements in addition to distortion, making it a general purpose audio test set. The audio analyzer includes the SINAD function for testing mobile radio receiver sensitivity. It contains a low distortion audio oscillator for stimulus response testing in combination with its distortion analyzer. It contains a true rms voltmeter and dc voltmeter for accurate measurement of complex waveform levels. Swept ac level and swept distortion measurements can be made when using the audio analyzer with a suitable X-Y recorder. Signal/noise ratio measurements are performed automatically when using the internal source and rms voltmeter. A reciprocal frequency counter is also included that continuously counts the frequency of the input signal.

These basic capabilities provide a general purpose instrument that represents high value in three major applications areas: 1) General audio component characterization, 2) radio transceiver audio measurements, 3) HP-IB systems. The Audio Analyzer provides sophisticated measurement capa-

bilities with significantly reduced operator interaction.

### True Harmonic Distortion Measurements

The Hewlett-Packard desktop computer controlled automatic spectrum analyzers provides a rapid means of measuring true harmonic distortion levels. The fundamental and its harmonic components are rapidly measured one at a time and the distortion is computed by applying equation (1). In production test situations, distortion calculations can be stored on tape for future reference and/or plotted for hard copy needs. Limit testing can also be applied.

### Modulation Analyzers/Measuring Receivers

A modulation analyzer is a precision receiver designed to detect the entire modulation envelope of a signal under test. It can measure and display the carrier characteristics of RF frequency and power as well as AM, FM and phase modulation characteristics such as AM depth, peak deviation, residual modulation, and various ratios associated with them. The modulation analyzer also faithfully recovers the actual modulating signal for further analysis such as distortion testing.

Applications for modulation analyzers and measuring receivers include transmitter testing, signal generator calibration and RF signal characterization. The precision receiver capability allows comprehensive testing of the transmitter. All phases of design, production test, and maintenance of transmitters and their modules and subassemblies are applications. Because the measuring receiver can measure very low RF signal levels (to -127 dBm) as well as modulation and RF frequency, it is ideal for metrology and calibration labs for signal generator and attenuator calibration.

### Capabilities

The unique measurement capabilities of modulation analyzers are easily shown on system tests with multiple-mode modulations such as simultaneous AM and FM. For example, if both amplitude and frequency modulation are present on a signal, a complex modulation spectrum is produced. To demonstrate this, an HP 8640B Signal Generator was 46.5% amplitude modulated with a 5 kHz triangular wave and 4.5 kHz peak frequency modulated with a 5 kHz sine wave simultaneously. The picture below shows the resulting signal as seen on a spectrum analyzer.

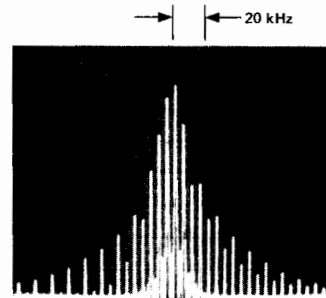

Spectrum Analyzer display of simultaneous AM (46.5%) and FM (4.5 kHz peak deviation) modulation.



Unequal, complex sidebands result and little data can be deduced. However, since a modulation analyzer faithfully recovers both modulation signals in independent detection systems insensitive to each other, it is easy to separate and read directly the various modulation components involved.

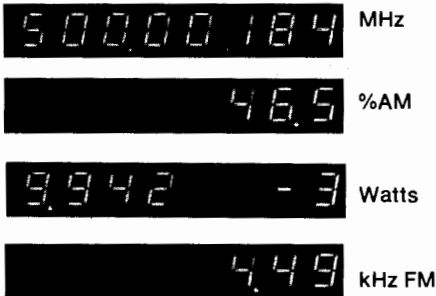

Modulation Analyzer displays of RF signal parameters.

In addition, since the modulation analyzer handles the full complex modulation envelope, it measures and displays RF power and average frequency of the entire signal. The readings are all available at the push of a button.

The independent detection systems demodulate the waveforms. If further analysis is desired, the modulation analyzer characterizes audio signal level, frequency and dis-

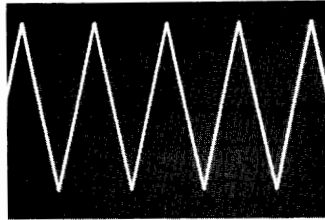

Recovered 5 kHz AM input signal viewed on oscilloscope.

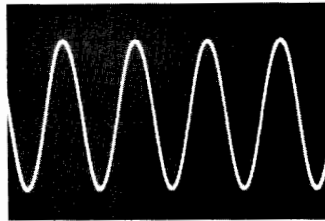

Recovered 5 kHz FM input signal.

ortion of both internally demodulated audio signals and external audio signals.

Since the AM and FM detection systems are independent and highly insensitive to each other, incidental modulation measurements can be made with high precision. For example, even with 90% amplitude modulation, the FM demodulator will accurately in-

dicade incidental FM. Such capability is valuable for design of oscillators, modulators, mixers and other components. It is very difficult to separate multiple modulation effects on spectrum analyzer displays because the effects are combined.

The HP 8901A/B Modulation Analyzers contain selectable filters to provide commonly used system characteristics for low-pass and high-pass filtering and FM de-emphasis. Thus measurement of transmitter modulation frequency response doesn't require additional equipment. Selectable detectors, including peak hold, allow measurements such as transmitter modulation limiting to be made very easily.

The measuring receiver can also serve as a high sensitivity, selective frequency counter and power meter. Since the superheterodyne design allows high sensitivity amplification of low level modulated signals, frequency counting of signals as low as -100 dBm is possible with good rejection of other signals.

Display and computational conveniences speed typical transmitter measurements and improve confidence in results. For example, ratio keys allow any measurement to be expressed in % or dB relative to any other measured or key-entered value. Such computations are valuable in applications such as mobile FM measurements, where hum and noise is expressed relative to an industry standard of 60% of maximum allowable deviation.

## Signal Analyzers Selection Guide Spectrum Analyzers

Frequency Range	Amplitude Calibration Range	Bandwidths		HP Model Description	HP Companion Instruments	Page
		Min	Max			
0.02 Hz-25.6 kHz	-120 to +30 dBV	0.02 Hz	363 Hz	3582A Spectrum Analyzer		625
0.02 Hz-40 MHz (Extendable to 18 GHz)	-130 to +30 dBm	0.02 Hz	30 kHz	3047A Phase Noise Measurement System (Direct Spectrum Mode)	8566B Spectrum Analyzer 8568B Spectrum Analyzer (Used as Downconverters)	636
0.02 Hz-40 MHz (Offset from Carrier) 5 MHz to 18 GHz (Carrier Range)	-170 dBc	0.02 Hz	30kHz	3047A Phase Noise Measurement System (Phase Noise Mode)	8662A/8663A Synthesized Signal Generator 11729B Carrier Noise Test Set	636
5 Hz-50 kHz	-150 to +30 dBm	1 Hz	300 Hz	3580A Spectrum Analyzer		623
20 Hz-300 kHz	-142 to +10 dBm	10 Hz	10 kHz	8556A Tuning Section Plug-In <sup>1</sup>		612
20 Hz to 40.1 MHz	-137 dB to +30 dBm	3 Hz	30 kHz	3585A Spectrum Analyzer		585
1 kHz-110 MHz	-140 to +10 dBm	10 Hz	300 kHz	8553B Tuning Section Plug-In <sup>1</sup>	8443A Tracking Generator	614
10 kHz-350 MHz	-117 to +20 dBm	1 kHz	3 MHz	8557A Spectrum Analyzer Plug-In <sup>2</sup>		604
100 kHz-1250 MHz	-122 to +10 dBm	100 Hz	300 kHz	8554B Tuning Section Plug-In <sup>1</sup>	8444A Tracking Generator (500 kHz-1250 MHz)	616
100 kHz-1500 MHz	-117 to +30 dBm	1 kHz	3MHz	8558B Spectrum Analyzer Plug-In <sup>2</sup>	8444A Opt. 059 Tracking Generator (500 kHz-1500 MHz)	606
100 Hz-1500 MHz	-137 dBm to +30 dBm	10 Hz	3 MHz	8568B Spectrum Analyzer and 8568S Automatic Spectrum Analyzer	8444A Opt. 059 Tracking Generator (500 kHz-1500 MHz) 85650A Quasi-Peak Adapter	592 598
10 MHz-21 GHz	-111 dBm to +30 dBm	1 kHz	3 MHz	8559A Spectrum Analyzer <sup>2</sup>		608
100 Hz-22 GHz <sup>2</sup> (Extendable to 300 GHz)	-134 dBm to +30 dBm	10 Hz	3 MHz	8566B Spectrum Analyzer and 8566S Automatic Spectrum Analyzer	85650A Quasi-Peak Adapter 11970K/A/Q/U Harmonic Mixers	595 598
10 MHz-22 GHz <sup>2</sup> (Extendable to 40 GHz and above)	-122 dBm to +30 dBm	100 Hz	3 MHz	8565A Spectrum Analyzer	8750A Storage-Normalizer 8444A Opt. 059 Tracking Generator (10 MHz-1500 MHz)	602
10 MHz-22 GHz <sup>2</sup> (Extendable to 115 GHz and above)	-123 to +30 dBm	100 Hz	3 MHz	8569B Spectrum Analyzer	8444A Opt. 059 Tracking Generator (10 MHz-1500 MHz) 11971K/A Harmonic Mixers	600
10 MHz-18 GHz (Extendable to 40 GHz and above)	-127 to +10 dBm	100 Hz	300 kHz	8555A Tuning Section Plug-In <sup>1</sup>	8444A Opt. 059 Tracking Generator (10 MHz-1500 MHz) 8445B Automatic Preselector (10 MHz-18 GHz)	618

NOTE 1: For use in display mainframes HP 140T and 141T with IF section plug-ins HP 8552A or 8552B (page 610).

NOTE 2: For use in display mainframes HP 853A, 180TR, 181T/TR and 182T.

NOTE 3: Frequency range extendable to 60 GHz through the use of the HP 11970 series Harmonic Mixers. For higher frequency coverage, other external mixers are commercially available.

# SIGNAL ANALYZERS

## Wave, Distortion, Modulation, Spectrum and Fourier Analyzers (cont.)

### Modulation Analyzers/Measuring Receivers

Frequency Range	Modulation Measurements	Amplitude Measurement Range	Audio Frequency Count + Distortion Measurement	HP Model Number	Page
150 kHz-1300 MHz	AM, FM, $\phi$ M	+30 to 0 dBm	No	8901A	648
150 kHz-1300 MHz	AM, FM, $\phi$ M	+30 to -20 dBm	Yes	8901B	648
150 kHz-1300 MHz	AM, FM, $\phi$ M	+30 to -127 dBm	Yes	8902A	644
150 kHz - 18 GHz or 26.5 GHz	AM, FM, $\phi$ M	+30 to -105 dBm	Yes	8902S	646

### Dynamic Signal Analyzers

Frequency Range	Amplitude Calibration Range	Resolution Points		HP Model Description	Functions Available	Page
		Min	Max			
DC-25 kHz	7 Steps From $\pm 0.1$ to $\pm 10$ V	256	32,000 (See Note 2)	5423A Structural Dynamic Analyzer (See Note 3) 5420B Digital Signal Analyzer	Time Average Linear Spectrum Auto Spectrum Transfer Function Coherence Function Histogram Correlation Impulse Response	633
0.1-25 kHz	7 steps from $\pm 0.125$ to $\pm 8$ V	256 PS 128 TF	1024 PS 512 TF	5427A Digital Vibration Control System (Analysis Mode)	Power Spectrum (PS) Transfer Function (TF) Transient Capture Shock Response Spectrum	635
0.02 Hz-25.6 kHz	9 steps from 3 mV to 30 V RMS	256	$> 1.3 \times 10^6$ (See note 2)	3582A Spectrum Analyzer	Voltage Spectrum Phase Spectrum Transfer Function Coherence Function Digital Averaging	625
0.0001 Hz - 100 kHz	78 steps from 3 mV to 22 V RMS	400	$> 9.7 \times 10^6$ (See note 2)	3561A Dynamic Signal Analyzer	Voltage Spectrum Phase Spectrum 1/3 Octave Spectrum Time Domain Waveform	627
64 $\mu$ Hz to 100 kHz	78 steps from +3.972 mV	801 to +31.547 V	$> 3.9 \times 10^6$ (See Note 2)	3562A Dynamic Signal Analyzer	Power Spectrum Linear Spectrum Frequency Response Coherence Function Histogram Correlation Impulse Response Waveform Recording Data Throughput Demodulation Vector Averaging Orbit Diagram	630

NOTE 1: Standard range is DC to 50 kHz, expandable with options to 100 kHz.  
NOTE 2: Equivalent number of points using Band Selectable Analysis.  
NOTE 3: Also includes modal analysis capability.

### Distortion/Audio Analyzers

Fundamental Frequency Range	Minimum Distortion	Auto Set Level	Auto Nulling	True RMS	AM Detector	Filters	HP Model No.	Internal Source	HP-IB	Page
5 Hz to 600 kHz	0.03% (-70 dB)	•	•	•	•	•	334A	•	•	642
							334A Opt 002			642
10 Hz-110 kHz	0.0018% (-95 dB)	•	•	•	•	•	339A	•	•	641
20 Hz-100 kHz	0.01% (-80 dB)	•	•	•	Note 1	•	8903A*	•	•	651

\*The HP 8903A also performs Frequency Count, Signal/Noise, SINAD, watts, ac/dc volts measurements.  
NOTE 1: The HP 8901A Modulation Analyzer (page 648) provides complete demodulation of AM, FM, and  $\phi$ M signals.

### Wave Analyzers/Selective Level Meters

Frequency Range	Selective Bandpass	Dynamic Range		Freq. Readouts	Type of Inputs	Type of Outputs	Modes of Operation	HP Model Number	Page
		Absolute	Relative						
15 Hz to 50 kHz	3 Hz 10 Hz 30 Hz 100 Hz 300 Hz	0.1 $\mu$ V-300 V full scale	$> 85$ dB	5-place digital	Banana Jacks	rec: 5 V full scale, with pen lift BFO, Local Oscillator, tuning loudspeaker, and headphone jack	AFC, normal, BFO	3581A/ 3581C	643
									119
50 Hz to 32.5 MHz	20 Hz 400 Hz 3100 Hz	-130 to +20 dBm	$> 80$ dB	LED, 0.1 Hz Resolution	50/75 $\Omega$ , BNC 600 $\Omega$ Banana Jacks	Tracking Generator Audio/Loud Speaker 1 MHz Ref.	Wideband Selective USB/LSB	3586C (3336C*)	588 437
50 Hz to 32.5 MHz	20 Hz 400 Hz 1740/2000 Hz Optional 3100 Hz WTD	-130 to +20 dBm	$> 70$ dB	LED 0.1 Hz Resolution	75 $\Omega$ BNC/WECO 124 $\Omega$ WECO 135 $\Omega$ WECO 150 $\Omega$ Siemens 600 $\Omega$ WECO/ Siemens	Tracking Generator Audio/Loud Speaker 1 MHz Ref.	Wideband Selective SSB	3586A/B (3336A/B*) (3335A)	141
									141 436

\*Tracking Synthesizers.



# SIGNAL ANALYZERS

## 20 Hz to 40 MHz Spectrum Analyzer

### Model 3585A

585



- 80 dB dynamic range
- 3 Hz resolution bandwidth
- $\pm 0.4$  dB amplitude accuracy
- Self-calibrating

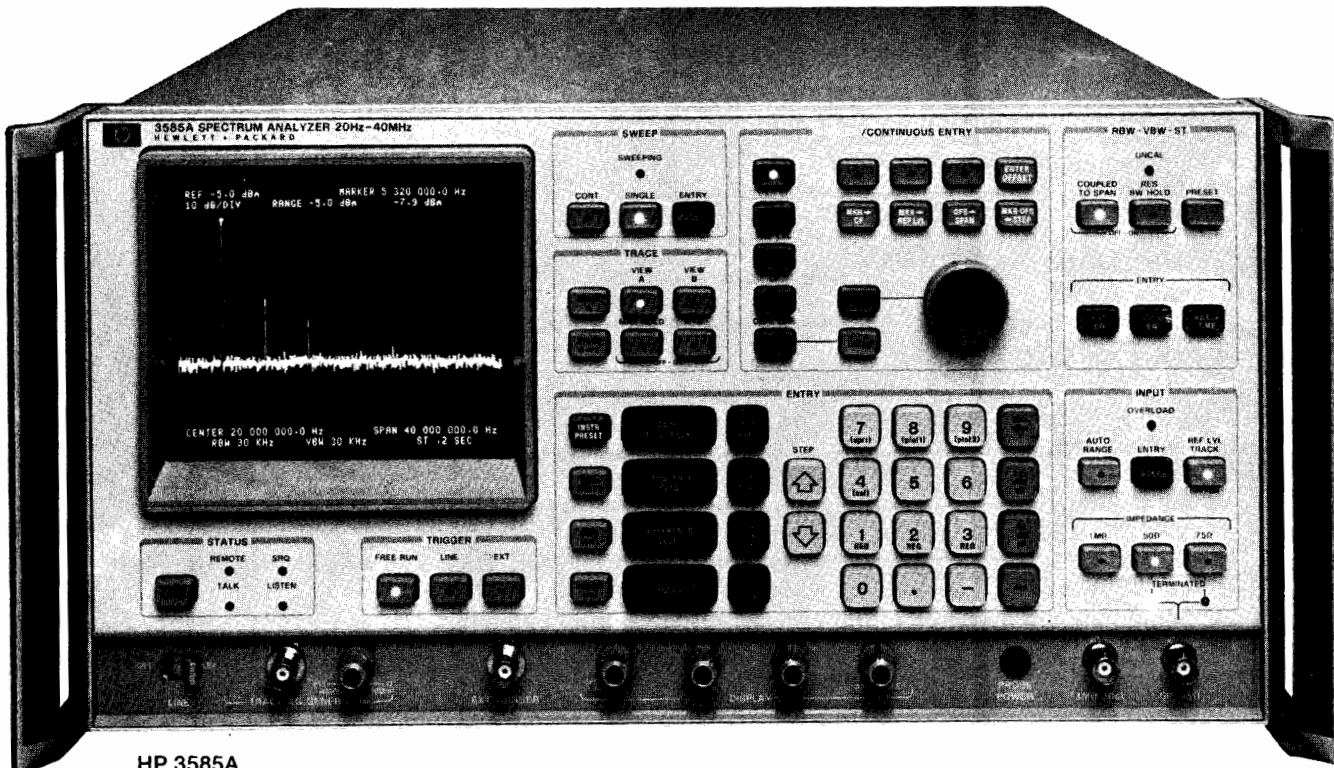

HP 3585A  
(Shown with Opt. 907)



## Description

The HP 3585A Spectrum Analyzer has a fully synthesized local oscillator controlled by a microprocessor. The result of this state-of-the-art contribution offers outstanding performance over its frequency range of 20 Hz to 40.1 MHz. Center frequency and span settings have 0.1 Hz resolution and  $1 \times 10^{-7}$ /mo. stability over its entire operating range. The frequency precision and stability enables the 3 Hz resolution bandwidth filter to be used for close-in analysis even at 40 MHz.

An automatic internal calibration routine, administered by the microprocessor, provides up to  $\pm 0.4$  dB accuracy over most of the measurement range. Improvements in measurement performance of this magnitude cannot be realized by the user unless the basic limitations of the CRT display are bypassed. This has been accomplished by digitizing the detected video signal, which is then stored in memory. Photographic documentation of the display is greatly simplified by displaying all the essential frequency, amplitude and resolution parameters alpha-numerically around the edge of the CRT.

The power of the microprocessor provides a bonus by making this analyzer easier to use. Several of the usually tedious operations, such as centering a signal, raising it to the reference level, etc., are now simplified with dedicated key operated routines working in conjunction with the display marker. Adjustment of resolution and video bandwidth when modifying span is now an automatic function unless individual manual selection is required. In addition, new functions have been added, such as noise power density measurements and offset capability for both frequency and amplitude.

## Measurement Power & Convenience

The power and convenience of the HP 3585A's microcomputer-based controls and CRT readout simplify and speed use in so many ways that previously impractical analysis now becomes routine. Functions such as center frequency and amplitude reference level may be keyboard-set with 0.1 Hz and 0.1 dB v precision, varied with an 'analog' knob (actually a rotary pulse-generator), or incrementally key-stepped. The autoranging input attenuator eliminates the error-prone task of adjusting the attenuator to achieve the correct mixer level.

A tunable marker in the HP 3585A makes basic measurements precise and quick by directly measuring a signal or by speeding the process of magnifying the portion of the spectrum to be analyzed. With the marker set to the signal peak, signal amplitude and frequency (with counter accuracy) are numerically displayed on the CRT. A second marker makes relative measurements instantly available with numerical display of the difference in amplitude and frequency between the two markers. This is useful for modulation, distortion measurements, and bandwidth measurement. For example, in the case of telecommunications applications, the second marker can be set at harmonic or channel spacing from the first so the operator can simply step frequencies to track higher order harmonics or additional channels.

Amplitude and frequency may be offset to normalize values to some reference signal such as a pilot tone or to reflect the relative value of a signal. Other amplitude units, such as dBV or volts, can be chosen. On any occasion all settings can be stored, then later recalled with a short key sequence. As many as three sets of settings may be stored.



# SIGNAL ANALYZERS

## 20 Hz to 40 MHz Spectrum Analyzer (cont.)

### Model 3585A

Two different traces, each of 1001 horizontal points, may be taken, stored in memory, then shown separately or together as desired while comparisons among them may be calculated and displayed digitally on the CRT. A Max Hold key causes the largest amplitude in successive sweeps to be displayed, making it easy to measure residual FM or drift. A built-in tracking generator, with a maximum output of 0 dBm, enables frequency response measurements to be made.

#### Automatic Measurements

Not only are all HP 3585A functions remotely-programmable via the HP Interface Bus (IEEE Standard 488-1975), the instrument also can be commanded to transfer its measurements out via the bus for interpretation and further interaction by a computing controller. The analyzer can be remotely tuned with the precision of the synthesizer, while retaining analog sweep and exceptional spectral purity.

#### HP-IB Interface Functions:

SH1, AN1, T6, L4, SR1, RL1, TP0, DC1, DT1, C0

#### Frequency Accuracy

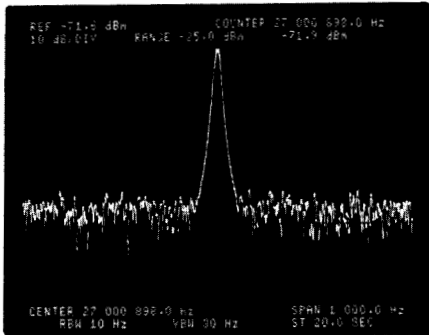

Counter measurements with spectrum analyzer selectivity and sensitivity can be made to  $1 \times 10^{-7}$ /mo. stability while sweeping or manually tuning.

#### Dynamic Range

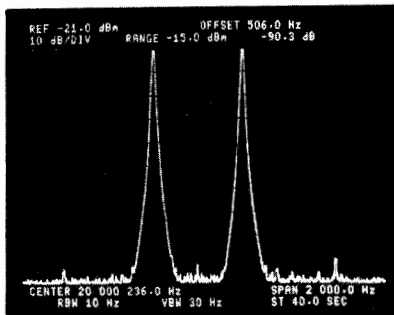

>80 dB spurious free dynamic range with full scale inputs of -25 dBm to +30 dBm in 5 dB steps. Autoranging input provides full dynamic range with no guesswork.

#### Internal Calibration

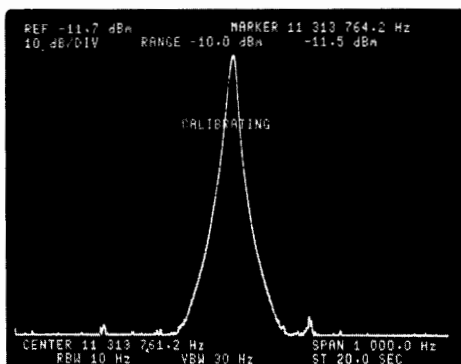

Maximum accuracy is assured at all times by an automatic internal calibration routine which compensates for frequency and amplitude errors in measurements made at the reference level at the center of the screen.

#### Swept Response Measurements

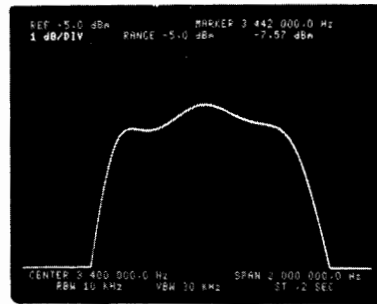

The built-in tracking generator offers superb stability and resolution for crystal filters as well as excellent flatness for wideband devices. The 1 dB/div. amplitude scale is used to expand and resolve small amplitude differences with .01 dB resolution using the marker readout.

#### Marker Aided Measurements

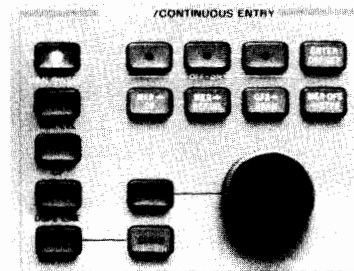

Along with the marker readout capability, there are three additional functions: counter measurements, noise level measurements, and offset (relative) measurements. The four operating aids just above the knob indicate that the marker or offset value can be directly entered into the center frequency, reference level, frequency span, or center frequency step size.

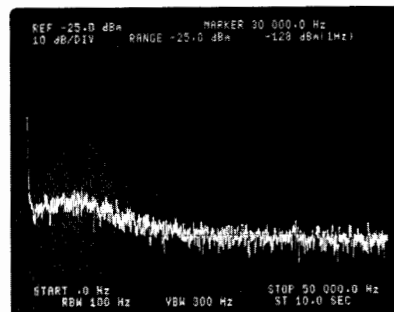

#### Noise Measurement

The noise level key displays RMS noise density normalized to a 1 Hz bandwidth at the marker position. All correction factors are accounted for in the internal measurement routine.

#### Terminal Interaction

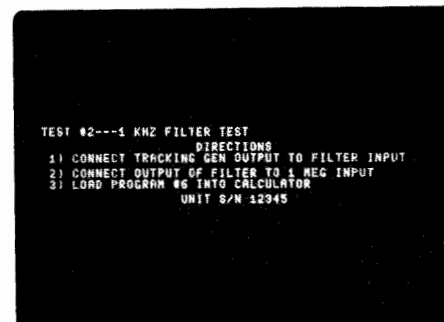

Measurement routines selected from the controller memory via the



analyzer keyboard, such as this filter test, can provide instructions to the operator to minimize errors and reduce training time for complex measurements.

## Specifications

### Frequency

**Measurement range:** 20 Hz to 40.1 MHz

### Displayed Range

#### Frequency Span

**Range:** 0 Hz to 40.1 MHz variable with 0.1 Hz resolution or 10 Hz to 40 MHz in 1, 2, 5 steps

**Accuracy:**  $-0\% + 0.2\%$  of frequency span setting

#### Center, Start/Stop, and Manual Frequency

**Range:** 0 Hz to 40.1 MHz with 0.1 Hz resolution

**Accuracy:**  $1 \times 10^{-7}$ /month of frequency

### Marker

**Readout accuracy:**  $\pm 0.2\%$  of frequency span  $\pm$  resolution bandwidth

**Counter accuracy:**  $\pm 0.3$  Hz  $\pm 1 \times 10^{-7}$ /month of counted frequency for a signal 20 dB greater than other signals and noise in the resolution bandwidth setting

### Resolution

#### Resolution Bandwidths

**Range:** 3 dB bandwidths of 3 Hz to 30 kHz in a 1, 3, 10 sequence

**Accuracy:**  $\pm 20\%$  at the 3 dB points

**Selectivity:** 60 dB/3 dB <11:1

### Amplitude

**Measurement range:**  $-137$  dBm to  $+30$  dBm (50/75  $\Omega$ ) or equivalent level in dBV or volts, 31 nV to 22 V (1 M $\Omega$ )

### Displayed Range

**Scale:** 10 division CRT vertical axis with Reference Level at the top graticule line

**Calibration:** 10, 5, 2 and 1 dB/division from the Reference Level

**Input range:**  $-25$  dBm to  $+30$  dBm in 5 dB steps

### Reference Level (relative to input range)

**Range:**  $-100$  dB to  $+10$  dB

**Accuracy (using 1 or 2 dB/div., at midscreen with sweep rate reduced by 4 or at the manual frequency)**

#### 50/75 $\Omega$ Input

+10 dB	-50 dB	-70 dB	-90 dB
$\pm 0.4$ dB	$\pm 0.7$ dB	$\pm 1.5$ dB	

1 M $\Omega$  Input - add to above

20 Hz	10 MHz	40.1 MHz
$\pm 0.7$ dB	$\pm 1.5$ dB	

### Amplitude Linearity (referred to reference level)

0 dB	-20 dB	-50 dB	-80 dB	-95 dB
$\pm 0.3$ dB	$\pm 0.6$ dB	$\pm 1.0$ dB	$\pm 2.0$ dB	

### Frequency Response (referred to center of span)

50/75  $\Omega$  input:  $\pm 0.5$  dB

#### 1 M $\Omega$ Input

20 Hz	10 MHz	40.1 MHz
$\pm 0.7$ dB	$\pm 1.5$ dB	

### Marker

#### Amplitude Accuracy

**Midscreen at the reference level:** use Reference Level accuracy from  $+30$  dBm to  $-115$  dBm, add Amplitude Linearity below  $-115$  dBm.

**Anywhere on screen:** add Reference Level Accuracy, Amplitude Linearity and Frequency Response.

### Dynamic Range

**Spurious Responses (image, out of band, and harmonic distortion)**

50/75  $\Omega$  input:  $< -80$  dB referred to a single signal equal to or less than Input Range

1 M $\Omega$  input:  $< -80$  dB except second harmonic distortion  $< -70$  dB

### Intermodulation Distortion

50/75  $\Omega$  input:  $< -80$  dB referred to the larger of two signals

each  $\geq 6$  dB below Input Range except 2nd order IM from 10 MHz to 40 MHz  $< -70$  dB

1 M $\Omega$  input:  $< -70$  dB

**Residual responses (no signal at input):**  $< -120$  dBm using  $-25$  dBm range

### Average Noise Level

50/75  $\Omega$  Input

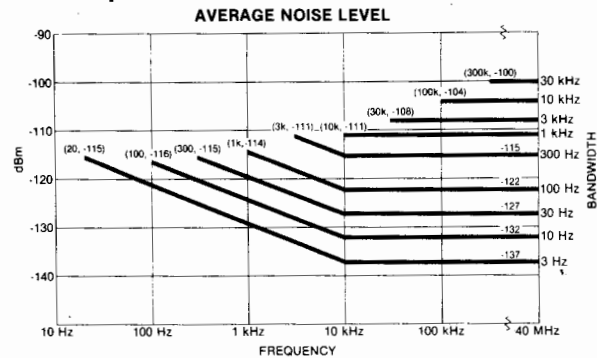

1 M $\Omega$  input: Below 500 kHz add 12 dB to above

### Sweep

**Modes:** continuous, single or manual

**Trigger:** free Run, Line, or External

**Time:** 0.2 s full sweep to 200 s/Hz of Frequency Span (swept time excluding auto calibration cycles)

### Input

#### Signal Inputs

50/75  $\Omega$ :  $> 26$  dB return loss, BNC connector

1 M $\Omega$ :  $\pm 3\%$  shunted by  $< 30$  pF, BNC connector

#### Maximum Input Level

50/75  $\Omega$ : 13 V peak ac plus dc relay protected against overloads to 42 V peak.

1 M $\Omega$  input: 42 V peak ac plus dc (derate by factor of two for each octave above 5 MHz).

**External trigger input:** negative going TTL level or contact closure required to initiate sweep.

**External reference input:** 10 MHz (or subharmonic to 1 MHz), 0 dBm minimum level

### Output

#### Tracking Generator

Level: 0 dBm to  $-11$  dBm with a single turn knob

Frequency accuracy:  $\pm 1$  Hz relative to analyzer tuning

Frequency response:  $\pm 0.7$  dB

Impedance: 50  $\Omega$ ;  $> 14$  dB return loss

**Probe power:**  $+15$  Vdc,  $-12.6$  Vdc; 150 mA max.

Suitable for powering HP 1120A Active Probe

#### External Display

X, Y: 1 volt full deflection; Z:  $< 0$  V to  $> 2.4$  V

Recorder:

X Axis: 10 V full scale

Y Axis: 10 V full scale

Z — penlift output TTL

**IF:** 350 kHz,  $-11$  dBV to  $-15$  dBV at the reference level

**Video:** 10 V at the reference level

**Frequency reference:** 10.000 MHz  $\pm 1 \times 10^{-7}$ /month,  $+10$  dBm into 50 $\Omega$

### General

#### Environmental

**Temperature:** operating 0 $^{\circ}$ C to 55 $^{\circ}$ C

**Humidity:**  $< 95\%$  RH except 300 Hz BW  $< 40\%$  RH

**Warm-up time:** 20 minutes at ambient temperature

**Power requirements:** 115 V ( $+11\%$   $-25\%$ ), 48–440 Hz

230V ( $+11\%$   $-18\%$ ), 48–66 Hz

180 watts 3A max

**Weight:** 39.9 kg (88 lb)

**Size:** 229 mm (9") H  $\times$  426 mm (16.75") W  $\times$  635 mm (25") D

### Ordering Information

**Opt. 907:** Front Handle Kit

**Opt. 908:** Rack Flange Kit

**Opt. 909:** Combined Opt. 907 and 908

**Opt. 910:** Extra Manual

**HP 3585A Signal Analyzer**



# SIGNAL ANALYZERS

## 50 Hz to 32.5 MHz Selective Level Meter

### Model 3586C

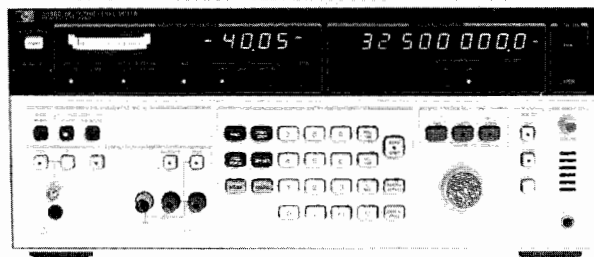

HP 3586C

### Description

The HP 3586C selective Level Meter is designed for general purpose wave analysis applications in the design, manufacture, and maintenance of electronic systems.

Microprocessor control and HP-developed fractional-N synthesis provides precise frequency setting and time saving ease-of-use features, and the HP 3586C is fully HP-IB programmable.

The HP 3586C Selective Level Meter covers the frequency range from 50 Hz to 32.5 MHz, allowing measurement of audio, sonar, and other low frequency systems as well as high frequency communications and subsystems. Input impedances of 50, 75, or 600  $\Omega$  with 10 k $\Omega$  bridging adds measurement flexibility for a wide variety of applications.

Wideband power measurements can be made up to 32.5 MHz and down to -45 dBm. Measure selectively in LO distortion or LO noise modes or use USB or LSB for single sideband demodulation of a carrier.

### Measurement Precision

Signal levels are measured with up to  $\pm 0.2$  dB accuracy down to -80 dBm with .01 dB resolution and bandwidth choices of 20, 400, or 3100 Hz. Automatic level calibration eliminates the need for manual calibration operations prior to critical level measurements. Frequency can be set precisely with 0.1 Hz resolution and  $\pm 1 \times 10^{-5}$  stability ( $\pm 2 \times 10^{-7}$  optional). The built-in frequency counter allows you to measure the frequency of a signal greater than -100 dBm within the filter bandwidth chosen and then tune the center of the filter passband precisely to that signal with one keystroke.

### Selective Measurements

Make measurements on signals as close as 80 Hz spacing with 50 dB rejection using the 20 Hz filter. Use the extremely selective 3100 Hz filter for telecommunications channel level or noise measurements with 60 dB carrier rejection and 75 dB adjacent channel rejection, or demodulate the upper or lower sideband signal for further processing and listen to it with the speaker output.

### Digital or Analog Frequency Control

Frequencies may be entered directly on the keyboard with 0.1 Hz resolution and then changed by entering any step size and stepping up or down in frequency, or use the analog frequency tune control. The analog frequency tune control will change frequency in automatically chosen steps proportional to the bandwidth chosen, or in the step size entered.

### Tracking Synthesizer

The HP 3586C will operate in the frequency tracking mode with either the HP 3336C Synthesizer (see page 436) for measurements up to 20.9 MHz, or the HP 3335A Synthesizer (see page 435) for full frequency coverage up to 32.5 MHz. The tracking synthesizer will automatically tune to the frequency programmed on the HP 3586C in the tracking mode when their HP-IB interfaces are connected together with a bus cable.

Use the tracking mode to save time in amplitude-only network analysis or for loop-around measurements in telecommunications systems.

### Frequency Response Measurements

The HP 3586C includes a rear panel tracking output of approximately 0 dBm amplitude and  $\pm .5$  dB flatness at the same frequency as the passband center frequency. The tracking output has the same accuracy, stability and resolution as the HP 3586C center frequency specifications. This means the tracking output can be used for frequency response testing of high-Q filters and other selective networks. External attenuators can be used to adjust the input and output levels of the device under test to acceptable ranges.

For applications requiring improved amplitude accuracy and flatness, full amplitude range control without external attenuators, or better signal purity, use the HP 3336C or HP 3335A tracking synthesizer in place of the HP 3586C tracking output. By automatically tracking the frequency of the HP 3586C, the tracking synthesizers improve the accuracy and flexibility of frequency response measurements without increasing the measurement time.

### Distortion Measurements

The front panel convenience features of the HP 3586C allow fast, accurate measurement of individual harmonic levels. To measure harmonic levels relative to the fundamental, first measure the fundamental signal level, and enter that level as an offset. Then, enter a frequency step size equal to the fundamental frequency. Now you can quickly step to the harmonic frequencies and measure the harmonic distortion directly without time-consuming calculations. When the exact fundamental frequency is unknown, the built-in counter can be used to measure the fundamental frequency, thereby ensuring precise tuning and accurate measurement.

Intermodulation distortion can also be measured quickly by storing the intermod frequencies and front panel settings in the non-volatile storage registers of the HP 3586C.

Verifying the total harmonic distortion specifications of sources and amplifiers is a laborious measurement unless a special purpose distortion analyzer is used. With a simple routine in a controller such as the HP 85B Personal Computer, the HP 3586C can be used to quickly measure total harmonic distortion as well as individual harmonic levels.

TOTAL HARMONIC DISTORTION TEST			
FUNDAMENTAL FREQ		ABSOLUTE AMP	
10.805.1 Hz		1.18 dBm	
HARMONIC FREQ		RELATIVE AMP	
2	21.610.2 Hz	-50.65 dB	
3	32.415.3 Hz	-50.36 dB	
4	43.220.4 Hz	-72.35 dB	
5	54.025.5 Hz	-50.55 dB	
6	64.830.6 Hz	-67.73 dB	
THD = -46.89 dB OR 0.45 %			

The HP 3586C and an HP computer were used to characterize a function generator for total harmonic distortion as well as harmonic level.

# SIGNAL ANALYZERS

50 Hz to 32.5 MHz Selective Level Meter

Model 3586C (con't)

589



## HP 3586C Specifications

### Frequency

**Frequency range:** 50/75  $\Omega$  unbalanced input, 50 Hz to 32.5 MHz; 600  $\Omega$  Balanced Input, 50 Hz to 108 kHz

**Frequency resolution:** 0.1 Hz

**Center frequency accuracy:**  $\pm 1 \times 10^{-5}$ /year, ( $\pm 2 \times 10^{-7}$ /year with option 004).

**Counter accuracy:**  $\pm 1.0$  Hz in addition to center frequency accuracy for signals within the 60 dB bandwidth of the IF filter chosen or greater than -100 dBm (largest signal is measured).

**Frequency display:** 9 digit LED

### Selectivity

**3 dB bandwidth,\***  $\pm 10\%$ : 20 Hz, 400 Hz, 3100 Hz

\*Noise bandwidth is the same as the 3 dB bandwidth

**60 dB bandwidth:** 3100 Hz BW,  $\pm 1850$  Hz; 400 Hz BW,  $\pm 1100$  Hz; 20 Hz BW,  $\pm 90$  Hz

**Adjacent channel rejection:** 75 dB minimum at  $\pm 2850$  Hz, 3100 Hz BW

**Passband flatness**  $\pm 0.3$  dB

### Passband Flatness

Bandwidth	Flatness Range	Flatness
3100 Hz	$\pm 1000$ Hz	$\pm 0.3$ dB
400 Hz	$\pm 50$ Hz	
20 Hz	$\pm 3$ Hz	

### Amplitude

**Measurement range:** +20 to -120 dBm

**Amplitude resolution:** .01 dB

**Level accuracy:** 10 dB auto range, low distortion mode, after calibration, signal at  $\pm 1$  Hz from center frequency.

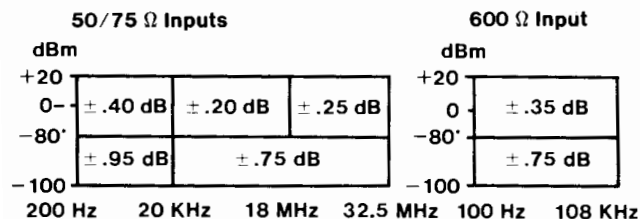

\*20 Hz & 400 Hz BW below -90 dBm

**Level accuracy:** 100 dB range (after calibration), add correction to 10 dB auto-range accuracy for dB below full scale. (Not required when in 10 dB auto-range.)

dB Below Full Scale	Accuracy Correction
0 to -20 dB	$\pm .25$ dB
-20 to -40 dB	$\pm .50$ dB
-40 to -80 dB	$\pm 2.0$ dB

**Wideband power accuracy:** after calibration, 100 dB range, average on, -45 to +20 dBm.

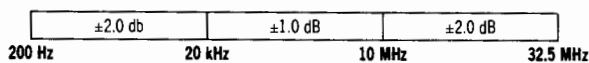

### Dynamic Range

#### Spurious Responses

-110 dBm maximum or the following, whichever is greater:

**Image rejection (100-132 MHz):** -80 dBc

**IF rejection:** 15625 Hz, -80 dBc; 50 MHz, -60 dBc

**Spurious signals:** >1600 Hz offset, >-80 dBc; 300 Hz to 1600 Hz, >-75 dBc

**Residual spurious:** -110 dBm maximum; <350 Hz, -95 dBm

### Distortion

**Harmonic distortion:** -75 dB below full scale, low distortion mode, above 4 kHz.

**Intermodulation distortion:** two-tone second and third order, separation 10 kHz to 1 MHz, -78 dB below full scale. Either tone  $\geq 10$  MHz, -70 dB.

### Noise Floor (full scale setting -35 to -120 dBm)

Frequency	Bandwidth	Noise Level
100 kHz to 32.5 MHz	3100	-114 dBm
	20 Hz, 400 Hz	-120 dBm
2 kHz to 100 kHz	All	-105 dBm

The noise floor for full scale settings of -30 to +25 dBm will be 75 dB below full scale for >100 kHz, or 55 dB below full scale for <100 kHz.

### Signal Inputs

Impedance	Frequency	Mating Connector
50/75 ohms unbalanced 600 ohms balanced	50 Hz to 32.5 MHz 50 Hz to 108 kHz	BNC Dual Banana Plug 0.75 inch Spacing

**Return loss:** 50/75  $\Omega$ , 30 dB; 600  $\Omega$ , 25 dB

**Balance:** 600  $\Omega$ ; 40 dB

### Demodulated Audio Output

**Output level:** 0 dBm into a 600  $\Omega$  load

**Output connector:** 1/4" jack, mates with WECO 347.

### Auxiliary Signal Inputs/Outputs

**Tracking output:** 0 dBm rear panel tracking output

**Ext. reference input:** 1 MHz to 10 MHz or sub-harmonic input.

**Reference output:** 10 MHz at 8 dBm output (also 10 MHz oven oscillator on instruments with option 004).

**Probe power:** front panel dc output for HP active high impedance accessory probes, (+15, -12 Vdc)

**HP-IB Interface Functions:** SH1, AH1, T6, L4, SR1, RL1, PP1, DC1, DT1, C1, C3, C28

**Additional outputs:** audio, phase jitter and meter output.

### Options

**Option 004: High stability frequency reference:** 10 MHz oven stabilized reference oscillator improves frequency stability to  $\pm 2 \times 10^{-7}$ /year.

## General

### Operating Environment

**Temperature:** 0° to 55°C

**Relative humidity:** 95%, 0° to 40°C

**Altitude:**  $\leq 15,000$  ft.,  $\leq 4600$  metres

**Storage environment temperature:** -40°C to 75°C

**Storage altitude:**  $\leq 50,000$  ft.,  $\leq 15,240$  metres

**Power:** 100/120/220/240 V, +5%, -10%, 48 to 66 Hz, 150 VA

**Weight:** 23 kg. (50 lb) net; 30 kg. (65 lb) shipping

**Size:** 177 mm H x 425.5 mm W x 475.5 mm D (7" x 16.75" x 16.75")

### HP 3586C Selective Level Meter\*

**Opt 004:** High Stability Frequency Reference

**Opt 907:** Front Panel Handles

**Opt 908:** Rack Flange Kit

**Opt 909:** Rack Flange & Handle Combination Kit

### Accessories

**HP 1124A:** High Impedance Probe

\*HP-IB cables not supplied. See page 675.

# SIGNAL ANALYZERS

## Spectrum Analyzers, 100 Hz to 300 GHz

### Models 8568B & 8566B

- 100 Hz to 1.5 GHz coverage with counter accuracy
- 100 Hz to 300 GHz coverage with synthesizer accuracy
- 2 to 22 GHz preselected range
- 10 Hz resolution bandwidth
- Trace markers with amplitude and frequency readout
- 16K of RAM for trace data or custom routines
- Create and run routines without controller
- Plot results with or without controller

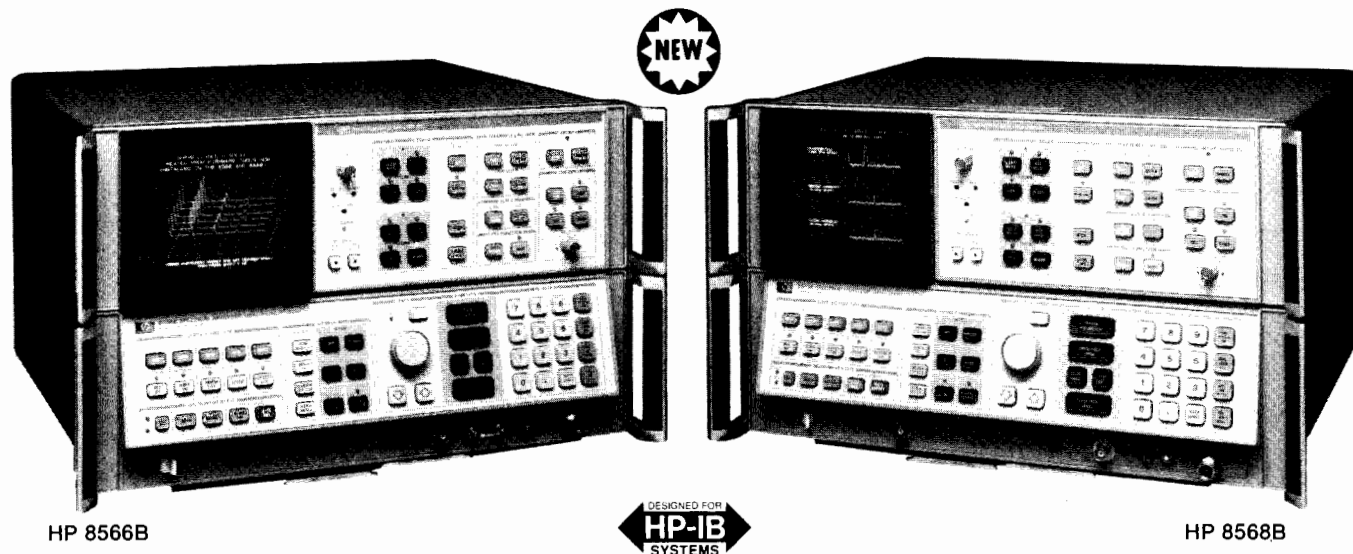

The HP 8568B and 8566B are high performance spectrum analyzers for bench and HP-IB system use. The HP 8568B operates over a 100 Hz to 1500 MHz frequency range. The HP 8566B operates over a 100 Hz to 22 GHz range, and has preselection from 2 to 22 GHz. The HP 8568B frequency range may be extended to 300 GHz with commercially available mixers. (For external-mixing information, refer to Product Note 8566A-2 or contact your local HP field engineer.)

Each analyzer is designed around its own internal bus and controlled by its own microcomputer to yield significant improvements in RF measurement performance, new operational and data processing features, and unparalleled flexibility under program control. Each analyzer contains 16K of RAM for storing measurement and data processing routines, which can be created and stored with or without a controller. The performance specifications for the HP 8568B and 8566B are on pages 592 and 595.

#### Performance

Exceptional frequency stability in both the HP 8568B and 8566B makes measurements with 10 Hz resolution bandwidths possible. Superior spectral purity and narrow resolution let you measure clean oscillators directly at RF frequencies. The 10 Hz resolution bandwidth also yields sensitivities to  $-135$  dBm, which makes greater than 85 dB spurious-free dynamic range achievable. A frequency reference error of  $1 \times 10^{-7}$ /day together with the analyzer resolution and sensitivity allow measurements of unequal accuracy of small signals in the presence of large signals.

#### Usability

Control settings are conveniently notated on the CRT. To activate a function, press a front panel key, then select the function value using the knob, step keys, or numeric keyboard.

Make measurements following conventional "zoom" techniques, using the center frequency, frequency span, and reference level controls. Use the preset function to set all analyzer controls to a convenient starting point. Since certain functions are coupled, a calibrated display is easily maintained. For example, resolution bandwidth and sweeptime change automatically when frequency span is reduced.

Use the four tunable markers to measure a signal, or to examine closely a portion of the spectrum. Set a marker at a signal peak to measure the signal amplitude and frequency, which are notated on the CRT. Two markers make relative measurements, such as modulation or distortion measurements, by displaying the amplitude and frequency difference between the markers. Marker information lets you step between evenly spaced portions of the spectrum, like communication channels or signal harmonics, or "zoom-in" on a portion of the spectrum. Other marker functions include converting the noise level at the marker to the RMS noise density normalized to a 1 Hz bandwidth.

Once analyzer controls are set, their configuration can be saved in memory and later recalled to repeat measurements. An internal battery protects memory contents if power fails.

#### Versatile CRT Display and Plotting Capabilities

All displayed information resides in digital memory which refreshes the CRT at a flicker-free rate. Display multiple traces to measure residual FM or drift, or to conduct real-time surveillance of a wide frequency range. The number of traces displayed is limited by the size of the CRT only. Display titles may be added.

By adding a graphics plotter, system measurements can be plotted for analysis, documentation, and presentation. Recommended HP-IB plotters include the 8-pen HP 7550A, the 6-pen 7475A, the 2-pen 7470A and 7090A Measurement Plotting System which records and annotates analog measurements as well as digital. Plot with or without a controller.

#### Softkey Programming Lets you Create the Spectrum Analyzer Measurement "Personality"

Softkey programming lets you create measurement routines tailored to your needs. Stored in the analyzer, they can be executed when needed as easily as the analyzer's built-in functions. By defining custom softkeys in the spectrum analyzer, you can create a measurement "personality" that makes the analyzer more efficient for your types of measurements.



Load a keystroke sequence into a softkey from the front panel, using the title function (**SHIFT E**), or load a keystroke sequence into a softkey from a computer:

```
10 OUTPUT 718;"KEYDEF 5,"""
20 OUTPUT 718;"MKPK HI;TS;MT1;SP200KZ;""""
30 END
```

Execute the stored routine pressing three keys:

**SHIFT**, a number, **HZ**

Because the HP 8566B and 8568B contain built-in, flow-of-control functions (**REPEAT**, **UNTIL**, **IF**, **THEN**, **ELSE**, and **ENDIF**), measurement routines can be created and stored without the use of a computer. This frees computer time for handling other system components or data processing.

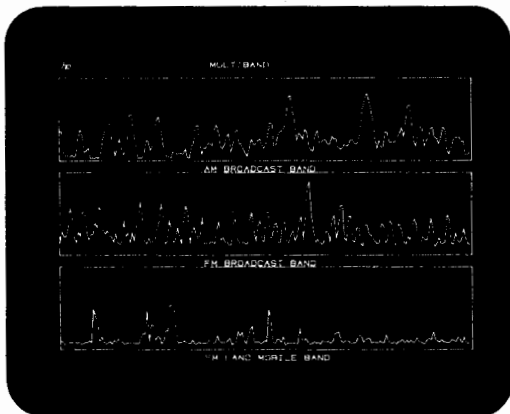

Surveillance Measurement of Multiple Bands Displayed Simultaneously

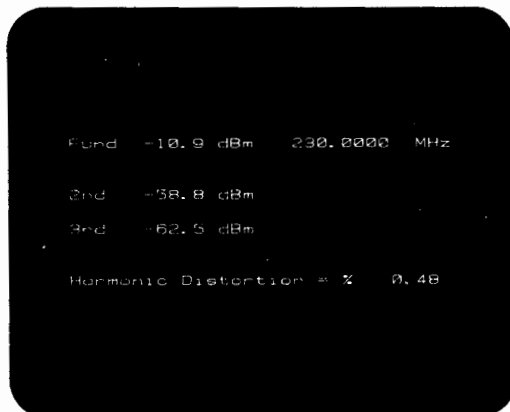

Harmonic Distortion Measurement

### Automatic Measurement Capability

Operate the HP 8566B and 8568B via the HP Interface Bus (IEEE Standard 488-1975) to control all front panel functions, or manipulate or store trace information. The display is accessible for annotation and graphing purposes.

Analyzer and HP-IB commands are easy to understand. For example, CF 20 MZ sets the analyzer center frequency to 20 MHz. Built-in firmware features, such as instrument preset, peak search, and automatic zoom, and flow-of-control commands further simplify writing software.

New signal processing commands include PWRBW, which calculates power bandwidth of a signal, and PEAKS, which identifies all responses on the display. The RMS function finds the RMS value of trace data; MPY multiplies two traces point-by-point.

Flow-of-control functions let you implement your own routines. Since the analyzer can make more decisions and process more data, a system controller can devote more time to handling other measurement or processing tasks.

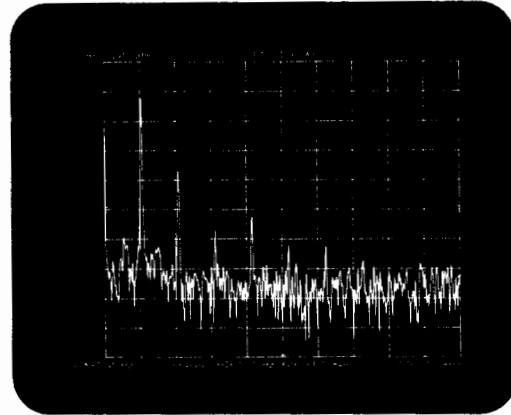

FFT. Performs a fast-fourier transform on the analyzer video signal.

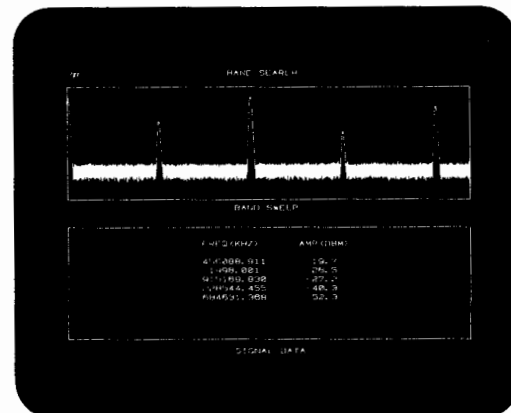

PEAKS. Identifies all responses on the display

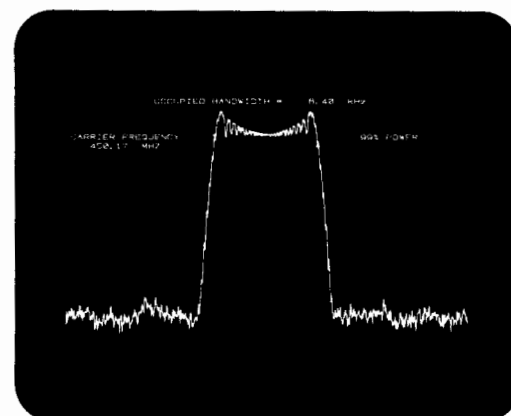

PWRBW. Returns the power bandwidth of a signal.

### Compatibility and Retrofit for HP 8566A/8568A Users

Programs written for the HP 8566A or 8568A will also run on the HP 8566B and 8568B. The HP 85862A HPL Software PAC and HP 85863A BASIC Software Library are also compatible. If you would like to enhance your HP 8566A or 8568A with the HP 8566B or 8568B capabilities, contact your Hewlett-Packard service center for retrofit information.

# SIGNAL ANALYZERS

## Spectrum Analyzer, 100 Hz to 1500 MHz

### Model 8568B

- 100 Hz to 1.5 GHz frequency range
- Frequency counter accuracy
- Expanded firmware feature set
- Direct plot capability
- Enhanced signal processing power
- 16K-bytes of user definable RAM

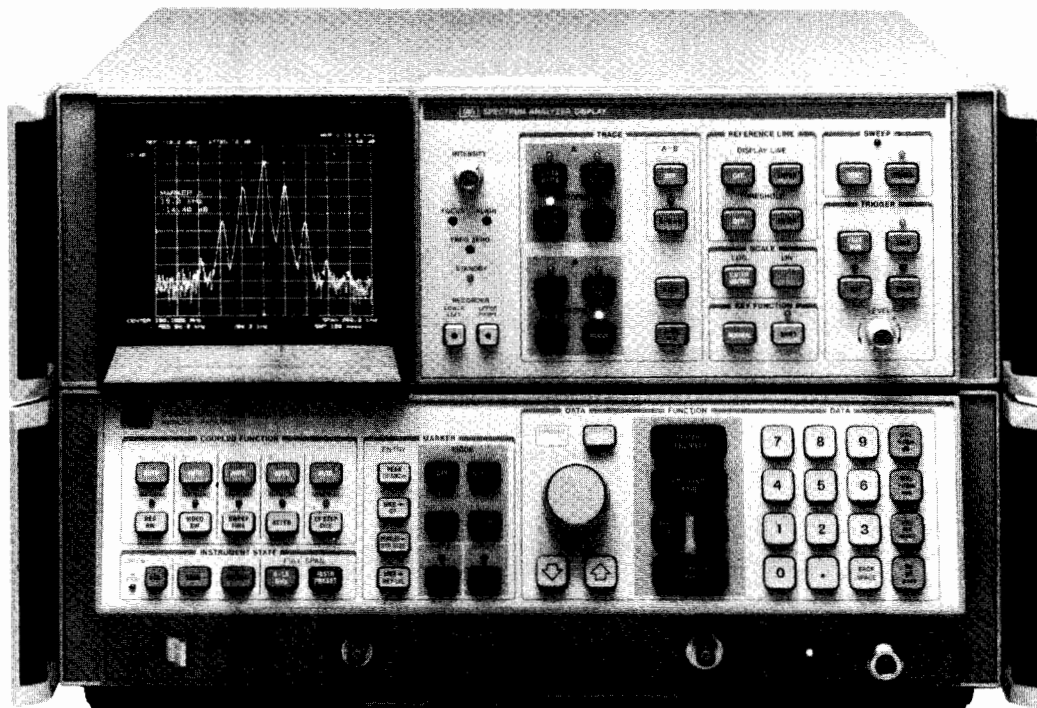

HP 8568B

The HP 8568B Spectrum Analyzer is a high performance spectrum analyzer for bench and remote operation which covers the 100 Hz to 1.5 GHz frequency range. Frequency stabilized local oscillators and an internal counter bring unequalled measurement precision to RF spectrum analysis. Exceptional frequency stability and local oscillator spectral purity enables the use of a 10 Hz resolution bandwidth to make difficult, close-in sideband measurements on RF signals.

The HP 8568B offers 16K of RAM for user defined routines which are accessible via HP-IB or from the front panel. This softkey programming opens new horizons of operator convenience features by allowing the operator to create measurement routines tailored to his or her particular application without the need for a controller.

All HP 8568B functions are programmable via HP-IB (IEEE 488-1975). Many high level functions are internally available and return results instead of data to the controller. This allows the controller to perform other tasks, thus execution time can be decreased. Friendly programming codes and easily recognizable mnemonics facilitate learning the analyzer language.

Programs written for the HP 8566A or 8568A will also run on the HP 8566B and 8568B. If you have an HP 8566A or 8568A and would like to enhance your analyzer by adding the capabilities of the "B" version, retrofit kits are available.

## HP 8568B Specifications

### Frequency Displayed Range

**Frequency span:** 100 Hz to 1500 MHz over 10 division CRT horizontal axis. In zero span, the instrument is fixed tuned at the center frequency.

**Full span (0-1500 MHz):** is immediately executed with a 0-1.5 GHz or INSTR PRESET keys.

**Frequency span accuracy:** for spans > 1 MHz,  $\pm(2\%$  of the indicated frequency separation between two points +0.5% span); for spans  $\leq 1$  MHz,  $\pm(5\%$  of frequency separation +0.5% span).

**Center frequency:** 0 Hz to 1500 MHz. Center frequency step size may be set using the numeric keyboard or MKR/ $\Delta$ →STP SIZE key.

**Readout accuracy:** span  $\geq 100$  Hz:  $\pm(2\%$  of frequency span + frequency reference error  $\times$  tune frequency +10 Hz) after adjusting freq zero at stabilized temperature.

**Start-stop frequency:** permissible values must be consistent with those for center frequency and frequency span. SHIFT O sets the analyzer start and stop frequencies equal to the frequencies of the two  $\Delta$  markers.

**Readout accuracy:** center frequency accuracy +  $\frac{1}{2}$  frequency span accuracy.

### Marker

**Normal:** displays the frequency at the horizontal position of the tunable marker.

**Accuracy:** center frequency accuracy + frequency span accuracy between the marker and center frequencies.

PEAK SEARCH positions the marker at the center of the largest signal response present on the display to within  $\pm 10\%$  of resolution bandwidth. MKR → CF sets the analyzer center frequency equal to the marker frequency; MKR/ $\Delta$  → STP SIZE sets the center frequency step equal to the marker frequency.

**Frequency count:** displays the frequency signal on whose response the marker is positioned. The marker must be positioned at least 20 dB above the noise or the intersection of the signal with an adjacent signal and more than four divisions up from the bottom of the CRT.

**Accuracy:** for span  $\leq 100$  kHz: frequency reference error  $\times$  displayed frequency  $\pm 2 \times$  frequency counter resolution. For span > 100 kHz but  $\leq 1$  MHz: freq. ref. error  $\times$  displayed frequency  $\pm (10 \text{ Hz} + 2 \times$  frequency counter resolution). For span > 1 MHz:  $\pm (10 \text{ kHz} +$  frequency counter resolution).

**Frequency reference error:** aging rate  $< 1 \times 10^{-9}$ /day; temp stability  $< 7 \times 10^{-7}$ ,  $^{\circ}$  to  $55^{\circ}$ C (after 30 day warm-up).

**Signal track:** re-tunes the analyzer to place a signal identified by the marker at the center of the CRT and maintain its position. Useful when reducing frequency span to zoom-in on a signal; also keeps a drifting input signal centered.

$\Delta$ : displays the frequency difference between the stationary and tunable markers. Reference frequency need not be displayed.

**Accuracy:** same as frequency span accuracy; in the FREQ COUNT mode, twice the frequency count uncertainty plus drift during the period of the sweep (typically  $< 10$  Hz/minute). MKR/ $\Delta$  → STP SIZE sets the center frequency step size equal to the frequency difference between the markers. SHIFT O sets the analyzer start stop frequencies equal to the frequencies of the two markers.

**Zoom:** makes it possible to reduce the frequency span about the marker (or signal in the signal track and freq count modes) using the step down key.

### Resolution

**Resolution bandwidth:** 3 dB bandwidths of 10 Hz to 3 MHz in a 1, 3, 10 sequence. Bandwidth may be selected manually or coupled to frequency span.

**Bandwidth accuracy:** calibrated to:  $\pm 10\%$ , 1 MHz to 3 kHz;  $\pm 20\%$ , 1 kHz to 10 Hz, 3 MHz bandwidths.



**Bandwidth selectivity:** 60 dB/3 dB bandwidth ratio: <15:1, 3 MHz to 100 kHz; <13:1, 30 kHz to 10 kHz; <11:1, 3 kHz to 30 Hz. 60 dB points on 10 Hz bandwidth are separated by <100 Hz.

#### Stability

**Residual FM:** <3 Hz peak-to-peak for sweep time  $\leq 10$  sec; span <100 kHz, resolution bandwidth  $\leq 30$  Hz, video bandwidth  $\leq 30$  Hz.

**Drift:** <10 Hz/minute of SWEPTIME after 1 hr. warmup at stabilized temperature, for frequency span  $\leq 100$  kHz. Spans >100 kHz but  $\leq 1$  MHz, <100 Hz/minute of SWEPTIME; >1 MHz, <300 kHz/minute of SWEPTIME.

#### Spectral Purity

**Noise sidebands:** >80 dB below the peak of a CW signal at frequency offsets  $\geq 30$  x resolution bandwidth setting, for resolution bandwidths  $\leq 1$  kHz.

**Line related sidebands:** >85 dB below the peak of a CW signal.

#### Amplitude

**Measurement range:** -135 dBm to +30 dBm.

#### Displayed Range

**Scale:** over a 10 division CRT vertical axis with the Reference Level at the top graticule line.

#### Calibration

**Log:** 10 dB/div for 90 dB display from Reference Level.

5 dB/div for 50 dB display

2 dB/div for 20 dB display expanded from

1 dB/div for 10 dB display reference level

#### Linear

10% of Reference Level/div when calibrated in voltage.

#### Fidelity

**Log:** (over 0 to 90 dB display)

**Incremental accuracy:**  $\pm 0.1$  dB/dB

**Maximum cumulative error:** (from the reference level)

$\leq \pm 1.0$  dB;  $\geq 30$  Hz resolution bandwidth

$\leq \pm 2.1$  dB; 10 Hz resolution bandwidth

**Linear:**  $\pm 3\%$  of Reference Level.

#### Reference Level

#### Range

#### Log

+60.0<sup>1</sup> to -139.9 dBm or equivalent in dBmV, dB  $\mu$ V, volts.

#### Linear

228.6<sup>1</sup> volts to 0.22  $\mu$ volts full scale.

**Accuracy:** the sum of the following factors determines the accuracy of the reference level readout. Depending upon the measurement technique followed after calibration, various of these sources of uncertainty may not be applicable.

An internal error correction function calibrates and reduces the uncertainty introduced by analyzer control changes from the error calibration state (-7 dBm reference level, 1 dB/div scale, 10 dB RF attenuation, 1 MHz bandwidth) when SHIFT W is executed just prior to the signal measurement (i.e., at the same temperature) within the 20°-30° range.

**Calibrator uncertainty:**  $\pm 0.2$  dB.

**Frequency response (flatness) uncertainty<sup>2</sup>:** (with  $\geq 10$  dB of RF attenuation) input #1:  $\pm 1$  dB, 100 Hz to 500 MHz;  $\pm 1.5$  dB 100 Hz to 1500 MHz; input #2:  $\pm 1$  dB, 100 kHz to 1500 MHz.

**Amplitude temperature drift:** at -10 dBm reference level with 10 dB input attenuation and 1 MHz resolution bandwidth,  $\pm 0.05$  dB/°C (eliminated by recalibration).

**Input connector switching uncertainty:**  $\pm 0.5$  dB when calibration and measurement do not use the same RF input.

**Input attenuation switching uncertainty:**  $\pm 1.0$  dB over 10 dB to 70 dB range.

**Resolution bandwidth switching uncertainty<sup>2</sup>:** (referenced to 1 MHz bandwidth)—corrected (uncorrected)

Resolution BW	20-30°C		0-55°C
	(After 1 Hour Warm-up)		
10 Hz	$\pm 1.1$ dB	$(\pm 2.0$ dB)	$(\pm 4.0$ dB)
30 Hz	$\pm 0.4$ dB	$(\pm 0.8$ dB)	$(\pm 2.3$ dB)
100 Hz to 1 MHz	$\pm 0.2$ dB	$(\pm 0.5$ dB)	$(\pm 2.0$ dB)
3 MHz	$\pm 0.2$ dB	$(\pm 1.0$ dB)	$(\pm 2.0$ dB)

**Log scale switching uncertainty:**  $\pm 0.1$  dB corrected ( $\pm 0.5$  dB uncorrected).

**IF Gain uncertainty:** corrected (uncorrected). Assuming the internal calibration signal is used to calibrate the reference level at -10 dBm and the input attenuator is fixed at 10 dB, any changes

in reference level in the following ranges will contribute 1F gain uncertainty:

Reference Level	20-30°C	0-55°C
0 to -55.9 dBm		
10 Hz Res BW	$\pm 1.0$ dB ( $\pm 1.6$ dB)	$(\pm 2.0$ dB)
$\geq 30$ Hz Res BW	0 dB ( $\pm 0.6$ dB)	$(\pm 1.0$ dB)
-56.0 to -129.9 dBm		
10 Hz Res BW	$(\pm 2.0$ dB) <sup>3</sup>	$(\pm 2.5$ dB)
$\geq 30$ Hz Res BW	$(\pm 1.0$ dB) <sup>3</sup>	$(\pm 1.5$ dB)

Each 10 dB decrease (or increase) in the amount of input attenuation at the time of calibration and measurement will cause a corresponding 10 dB decrease (or increase) in the absolute reference level settings described above.

**RF Gain uncertainty (due to 2nd LO shift):**  $\pm 0.1$  dB corrected ( $\pm 1.0$  dB uncorrected)

**Error correction accuracy:** (applicable when controls are change from the error calibration state if SHIFT W and SHIFT X are used):  $\pm 0.4$  dB.

#### Marker

**Normal:** displays the amplitude at the vertical position of the tunable marker.

**Accuracy:** equals the sum of calibrator uncertainty, reference level uncertainty, and scale fidelity between the reference level and marker position.

PEAK SEARCH positions the marker at the peak of the largest signal present on the display. MKR  $\rightarrow$  REF LVL set the analyzer reference level equal to the marker amplitude. RMS noise density in a 1 Hz bandwidth is read out using SHIFT M, by sampling the displayed trace and arithmetically correcting for the analyzer envelope detector response, log shaping, and measurement bandwidth.

$\Delta$ : displays the amplitude difference between the stationary and tunable markers. Reference frequency need not be displayed.

**Accuracy:** equals the sum of scale fidelity and frequency between the two markers.

#### Reference Lines

**Display line:** movable horizontal line with amplitude readout.

**Threshold:** movable horizontal trace threshold with amplitude read-out.

**Accuracy:** equals the sum of calibrator uncertainty, reference level uncertainty, and scale fidelity between the reference level and reference line.

#### Dynamic Range

**Spurious responses:** for a total signal power  $\leq -40$  dBm at the input mixer of the analyzer, all image and out-of-band mixing responses, harmonic and intermodulation distortion products are >75 dB below the total signal power for inputs 10 MHz to 1500 MHz; >70 dB below the total signal power for input signals 100 Hz to 10 MHz.

**Video bandwidth:** post detection low pass filter used to average displayed noise: bandwidth variable from 1 Hz to 3 MHz in a 1, 3, 10 sequence. All bandwidths are nominal except 3 MHz, which is a minimum. Video bandwidth may be selected manually or coupled to resolution bandwidth.

**Displayed noise:** bandwidth variable from 1 Hz to 3 MHz in a 1, 3, 10 sequence. Video bandwidth may be selected manually or coupled to resolution bandwidth.

**Digital video averaging:** displays the sweep-to-sweep average of the trace over a specifiable number of sweeps with SHIFT G, video averaging is turned off with SHIFT H.

**Gain compression:** <0.5 dB for signal levels  $\leq -10$  dBm at the input mixer.

#### Sweep

#### Trigger

**Free run:** sweep triggered by internal source.

**Line:** sweep triggered by power line frequency.

**Video:** sweep triggered by detected waveform of input signal at an adjustable level; signal must be  $\geq 0.5$  div peak-to-peak.

**External:** sweep triggered by rising edge of signal input to rear panel BNC connector: trigger source must be >2.4 volt (5 volt max).

#### Continuous

Sequential sweeps initiated by the trigger: 20 msec full span to 1500 sec full span in 1, 1.5, 3, 5, 7.5, 10 sequence.

<sup>1</sup>Maximum input must not exceed +30 dBm (damage level).

<sup>2</sup>30 kHz and 100 kHz bandwidth switching uncertainty figures only applicable  $\leq 90\%$  relative humidity.

<sup>3</sup>Correction only applies over the 0 dBm to -55.9 dBm range.



# SIGNAL ANALYZERS

## Spectrum Analyzer, 100 Hz to 1500 MHz

### Model 8568B (cont.)

**Accuracy:** sweep time  $\leq 100$  sec,  $\pm 10\%$ ;  $>100$  sec,  $\pm 20\%$ .

**Zero frequency span:** 1  $\mu$ sec full sweep (10 divisions) to 10 msec full sweep in 1, 2, 5 sequence; 20 msec full sweep to 1500 sec full sweep in 1, 1.5, 2, 3, 5, 7.5, 10 sequence.

**Accuracy:** same as continuous.

Sweep time may be set manually or automatically for the frequency span, resolution bandwidth and video bandwidth selected.

**Single:** single sweep armed on activation and initiated by trigger (sweep  $\geq 20$  msec only).

### Display

**Trace:** A and B are two independent signal response memories each having 1001 horizontal data positions and vertical resolution of 0.1%. Memory contents are displayed on the CRT at a rate independent of the analyzer sweep time. Trace A is displayed brighter than trace B.

**Clear/write:** clears memory contents when first activated, then writes the analyzer signal response into the memory each sweep and displays memory.

**Max hold:** retains in memory and displays the largest signal level occurring at each horizontal data position over the repetitive sweeps beginning at the time the function is activated.

**View:** stops writing into memory and displays memory without changing its contents.

**Blank:** stops writing into memory and blanks the trace while retaining the last response in memory.

#### Arithmetic

**A-B  $\rightarrow$  A:** initially subtracts the stored memory contents of B from the current memory contents of A and writes the difference into A; this process continues as the A memory is updated at the sweep rate. To accomplish  $A+B \rightarrow A$  use SHIFT c.

**A  $\rightleftharpoons$  B:** exchanges A and B display memory contents.

**B-DL  $\rightarrow$  B:** subtracts the amplitude of the display line from the memory contents of B and writes the difference into B.

A third signal response memory, C (also with a 1001 data positions), can be used for signal response storage. It is accessed indirectly by transferring memory contents between B and C.

**B  $\rightarrow$  C:** SHIFT l.

**B  $\rightleftharpoons$  C:** SHIFT i.

**View C:** SHIFT j.

**Blank C:** SHIFT k.

#### Annotation

**Title:** allows the user to write characters into a specified area on the CRT by pushing SHIFT E and typing the keys next to the blue front panel characters and data numbers desired. Use BACKSPACE for corrections.

**Blank:** SHIFT o blanks (SHIFT p unblanks) all CRT characters and control setting readouts. SHIFT m blanks (SHIFT n unblanks) the CRT graticule.

### Input

#### RF Inputs

The standard instrument configuration is as follows:

**Input #1:** 100 Hz to 1500 MHz, 50  $\Omega$ , BNC connector (Fused); dc coupled.

**Reflection coefficient:** typically  $<0.20$  (1.5 SWR) to 500 MHz,  $<0.33$  (2.0 SWR) 500 MHz to 1500 MHz;  $\geq 10$  dB input attenuation.

**Input #2:** 100 kHz to 1500 MHz, 50  $\Omega$ , Type N connector; ac coupled.

**Reflection coefficient:** typically  $<0.20$  (1.5 SWR);  $\geq 10$  dB input attenuation.

**LO emission:** typically  $<-75$  dBm (0 dB RF Atten).

**Isolation:**  $>85$  dB between inputs.

**Also available:** input #1, 100 kHz to 1500 MHz, 75  $\Omega$ , BNC connector, ac coupled (Opt 001).

#### Maximum Input Level

**AC:** continuous power, +30 dBm (1 watt); 100 watts, 10  $\mu$ sec pulse into  $\geq 50$  dB attenuation.

**DC:** Input 1, 0 volts; Input 2,  $\pm 50$  volts.

**Input attenuator:** 70 dB range in 10 dB steps. Zero dB attenuation accessible only through numeric/unit keyboard. Attenuation may be selected manually or coupled to reference level to insure a  $-10$  dBm

input mixer drive level for full-screen signals; other mixer levels may be specified using SHIFT, (comma) and entering the desired amplitude through the keyboard.

**Accuracy:**  $\pm 1.0$  dB over 10-70 dB range.

**External frequency reference input** (rear panel)

Must equal 10 MHz  $\pm 50$  Hz, 0 dBm (+10 dBm max.), 50  $\Omega$  nominal input impedance. Analyzer phase noise performance may be degraded when an external frequency reference is used.

**Quasi-peak** (rear panel; nominal values)

**Video input:** 0-2 Volts. 139  $\Omega$  input impedance.

**21.4 MHz input:** input is nominally  $-11$  dBm (with spectrum analyzer input attenuator set to 10 dB). 50  $\Omega$  input impedance.

### Output

**Calibrator:** 20 MHz  $\pm 20$  MHz x frequency reference error ( $1 \times 10^{-9}$ /Day),  $-10$  dBm  $\pm 0.2$  dB; 50  $\Omega$ .

**Probe power:** +15 V,  $-12.6$  V; 150 mA max.

#### Auxiliary (rear panel; nominal values)

**Display:** X, Y and Z outputs for auxiliary CRT displays. X, Y: 1 volt full deflection; Z: 0 to 1 V intensity modulation,  $-1$  V blank. BLANK output (TTL level  $>2.4$  V for blanking) compatible with most oscilloscopes.

#### Recorder

**Horizontal sweep output (x axis):** a voltage proportional to the horizontal sweep; 0 V for left edge to +10 V for right edge.

**Video output (y axis):** detected video output proportional to vertical deflection of CRT trace. Output increases 100 mV/div from 0 to 1 V. Output impedance  $\leq 475 \Omega$ .

**Penlift output (z axis):** 15 V blanking output during retrace.

**21.4 MHz IF:** a 50  $\Omega$ , 21.4 MHz output related to RF input to the analyzer. Output nominally  $-20$  dBm for a signal at the reference level. Bandwidth controlled by the analyzer's resolution bandwidth setting.

**1st LO:** 2-3.7 GHz,  $>+4$  dBm; 50  $\Omega$  output impedance.

**Frequency reference:** 10.000 MHz, 0 dBm; 50  $\Omega$  output impedance.

**Quasi-peak** (rear panel; nominal values)

**Video output:** 0-2 volts. Output impedance  $<139 \Omega$ .

**21.4 MHz output:** output is nominally  $-11$  dBm (with spectrum analyzer input attenuator set to 10 dB). 50  $\Omega$  output impedance.

### HP-IB Interface Functions

SH1, AH1, T6, L4, SR1, RL1, PP0, DC1, DT1, C0, E1. For more on these codes, refer to the HP-IB section of this catalog.

### General

#### Environmental

**Temperature:** operating  $0^\circ\text{C}$  to  $55^\circ\text{C}$ , storage  $-40^\circ\text{C}$  to  $+75^\circ\text{C}$ .

**Humidity:** operating  $<95\%$  R.H.,  $0^\circ\text{C}$  to  $40^\circ\text{C}$  except as noted.

**EMI:** 8568A conducted and radiated interference is within the requirements of CE03 and RE02 of MIL STD 461A, VDE 0871, and CISPR pub'n 11.

**Power requirements:** 50 to 60 Hz; 100, 120, 220 or 240 volts (+5%,  $-10\%$ ); approximately 450 VA (40 VA in standby). 400 Hz operation is available as Opt 400.

**Weight:** total net, 45 kg (100 lb); Display/IF Section, 21 kg (46 lb); RF Section, 24 kg (54 lb). Shipping net, 72 kg (158 lb); Display/IF Section, 27 kg (60 lb); RF Section, 32 kg (70 lb); Manuals and Accessories, 13 kg (28 lb).

**Size:** 267 H x 425.5 W x 558.8 mm D (10.5" x 16.75" x 22").

#### Ordering Information

**HP 8568B Spectrum Analyzer**

**Opt 001:** 75  $\Omega$  (BNC), 100 kHz to 1500 MHz RF Input #1

**Opt 010:** Rack Slide Kit

**Opt 400:** 400 Hz Power Line Frequency Operation

**Opt 908:** Rack Flange Kit

**Opt 910:** Extra Manual

**Opt 913:** Rack Flange Kit to Mount Instruments With Handles

**HP 8568A + 01K Retrofit Kit**

# SIGNAL ANALYZERS

## Spectrum Analyzer, 100 Hz to 300 GHz

Model 8566B

595



- 100 Hz to 22 GHz, external mixing to 300 GHz
- Synthesizer frequency accuracy
- Direct plot capability

- Expanded firmware feature set
- Enhanced signal processing power
- 16K-bytes of user RAM

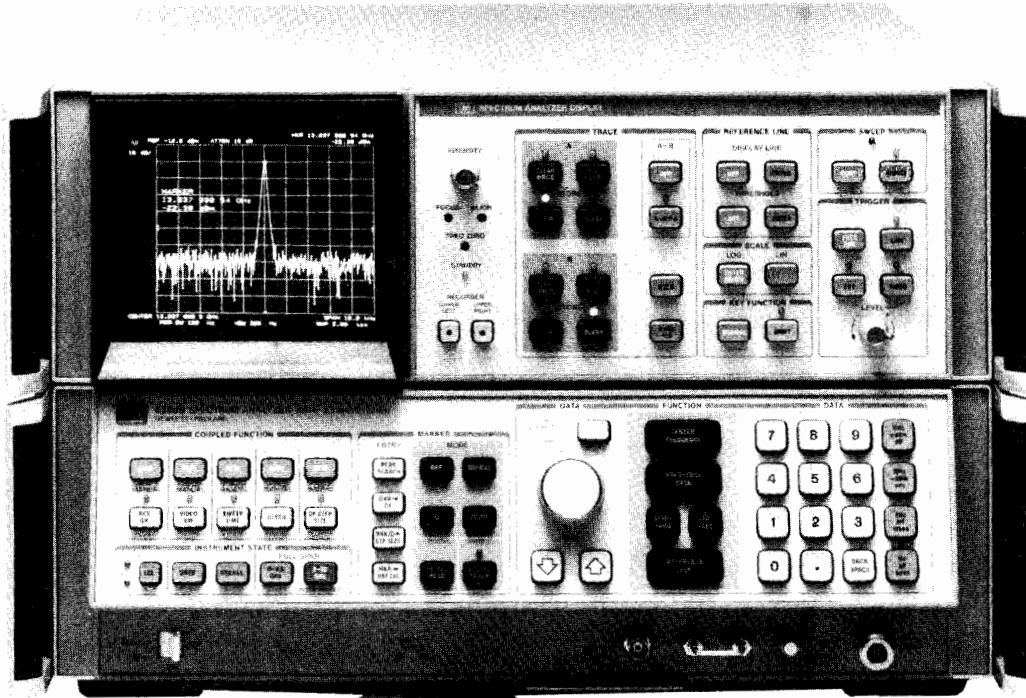

HP 8566B

The HP 8566B Spectrum Analyzer is a high performance spectrum analyzer for bench and remote operation which operates from 100 Hz to 22 GHz using internal mixing. The frequency range may be extended to 60 GHz with the 11970 series external mixers and to 300 GHz with commercially available mixers. (For more information on external mixing, see Product Note 8566A-1 or contact your local HP field engineer). A synthesized local oscillator yields counter-like accuracy at microwave and millimeter wave frequencies. 10 Hz resolution bandwidth and a superior frequency stability allow difficult measurements such as line-related sideband characterization at 22 GHz.

A unique integrated preselector/mixer provides high sensitivity with preselection from 2 GHz to 22 GHz. For example, in a 10 Hz resolution bandwidth, the sensitivity at 18 GHz is  $< -119$  dBm. Programs written for the HP 8566A or 8568A will also run on the HP 8566B and 8568B. If you have an HP 8566A or 8568A and would like to enhance your analyzer by adding the capabilities of the "B", retrofit kits are available.

### HP 8566B Specifications

#### Frequency

**Measurement range:** 100 Hz to 22 GHz with internal mixer, dc coupled input; 18.6 GHz to 60 GHz with the 11970 series external mixer set; 60 GHz to 300 GHz with commercially available external mixers.

#### Displayed Values

**Center frequency:** 0 Hz to 300 GHz.

**Readout accuracy:** (AUTO resolution bandwidth after adjusting frequency zero at stabilized temperature, and using the error correction function, SHIFT W and SHIFT X) spans  $\leq n \times 5$  MHz:  $\pm(2\%$  of frequency span + frequency reference error  $\times$  center frequency + 10 Hz); spans  $> n \times 5$  MHz:  $\pm(2\%$  of frequency span +  $n \times 100$  kHz + frequency reference error  $\times$  center frequency) where  $n$  is the harmonic number, depending on center frequency:

n	Center Frequency (internal mixing)	n	Center Frequency (external mixing)
1	0 Hz to 5.8 GHz	6	18.6 GHz to 26.5 GHz
2	5.8 GHz to 12.5 GHz	8	26.5 GHz to 40.0 GHz
3	12.5 GHz to 18.6 GHz	10	40.0 GHz to 60.0 GHz
4	18.6 GHz to 22 GHz		

For center frequencies  $> 60.0$  GHz, refer to the Frequency Diagnostic (KSR) display for the value of  $n$ .

**Frequency span:** 0 Hz to 22 GHz over 10 division CRT horizontal axis; variable in approximately 1% increments.

**Full span:** 0 to 2.5 GHz and 2 to 22 GHz. 2 to 22 GHz is selected with INSTR PRESET.

**Readout accuracy:** spans  $\leq n \times 5$  MHz,  $\pm 1\%$  of indicated frequency separation; spans  $> n \times 5$  MHz,  $\pm 3\%$  of indicated frequency separation.

**Start/stop frequency:** SHIFT O sets the analyzer start and stop frequencies equal to the frequencies of the two  $\Delta$  markers.

**Readout accuracy:** same as center frequency.

**Frequency reference error:**  $< 1 \times 10^{-9}$ /day and  $< 2 \times 10^{-7}$ /year.

#### Resolution

**Resolution bandwidth:** 3 dB bandwidths of 10 Hz to 3 MHz in a 1, 3, 10 sequence. Bandwidth may be selected manually or coupled to frequency span.

**Bandwidth accuracy:** calibrated to:  $\pm 20\%$ , 3 MHz to 10 Hz;  $\pm 10\%$ , 1 MHz to 3 kHz.

**Bandwidth selectivity:** 60 dB/3 dB bandwidth ratio:  $< 15:1$ , 3 MHz to 100 kHz;  $< 13:1$ , 30 kHz to 10 kHz;  $< 11:1$ , 3 kHz to 30 Hz. 60 dB points on 10 Hz bandwidth are separated by  $< 100$  Hz.

#### Stability

**Residual FM (typical):** for fundamental mixing ( $n = 1$ );  $< 50$  kHz peak-to-peak, frequency span  $\geq 5$  MHz;  $< 200$  Hz peak-to-peak, frequency span  $\leq 5$  MHz;  $< 5$  Hz peak-to-peak, frequency span  $< 100$  kHz;  $< 0.2$  Hz peak-to-peak, frequency span  $< 5$  kHz.

**Drift (typical):** after 1 hour warm-up at stabilized temperature. COUPLED FUNCTION not required.

#### Frequency Span

$< 100$  kHz  
100 kHz to 5 MHz  
 $\geq 5$  MHz

#### Center Frequency Drift

$< 10$  Hz/minute of sweep time  
 $< 500$  Hz/minute of sweep time  
 $< 5$  kHz/minute of sweep time

Because the analyzer is phase locked at the beginning of each sweep, drift occurs only during the time of one sweep.

#### Spectral Purity

**Noise sidebands:**  $> 85$  dB below the peak of a 5.8 GHz CW signal at 1 kHz offset;  $> 79$  dB for 12.5 GHz signal;  $> 75$  dB for 18.6 GHz signal;  $> 73$  dB for 22 GHz signal; all for resolution bandwidth  $\leq 100$  Hz.



# SIGNAL ANALYZERS

## Spectrum Analyzer, 100 Hz to 300 GHz

### Model 8566B (cont.)

**Power line related sidebands;** >80 dB below the peak of a 5.8 GHz CW signal, <360 Hz offset.

#### Amplitude

**Measurement range:** -134 dBm to +30 dBm.

#### Display Range:

**Scale:** over a 10 division CRT vertical axis with the Reference Level at the top graticule line.

#### Calibration

**Log:** 10 dB/div for 90 dB display from Reference Level.

5 dB/div for 50 dB display	expanded from
2 dB/div for 20 dB display	Reference Level
1 dB/div for 10 dB display	

**Linear:** 10% of Reference Level/div when calibrated in voltage.

#### Fidelity

Log	Incremental	Cumulative
	±0.1 dB/dB over	<±1.0 dB max over 0 to 80
	0 to 80 dB display	dB display, 20-30°C.
		<±1.5 dB max over 0 to 90
		dB display.

**Linear:** ±3% of Reference Level

#### Reference Level

##### Range

**Log:** +30.0 to -99.9 dBm or equivalent in dBmV, dBμV, Volts  
Readout expandable to +60.0<sup>1</sup> volts to -119.9 dBm (-139.9 dBm for <1 kHz resolution bandwidth) using SHIFT I.

**Linear:** 7.07 volts to 2.2 μvolts full scale. Readout expandable to 223.6<sup>1</sup> volts to 2.2 μvolts (0.22 μvolts for <1 kHz resolution bandwidth) using SHIFT I.

**Accuracy:** the sum of the following factors determines the accuracy of the reference level readout. Depending upon the measurement technique followed after calibration with the CAL signal, various of these sources of uncertainty may not be applicable. Specifications are with the preselector tracking optimized with MARKER PRESELECTOR PEAK function.

An internal error correction function calibrates and reduces the uncertainty introduced by analyzer control changes from the error calibration state (-7 dBm reference level, and 100 MHz center frequency) when SHIFT W and SHIFT X are executed just prior to the signal measurement (i.e. at the same temperature) within 20-30°C. range.

**Calibration uncertainty:** ±0.3 dB.

**Frequency response (flatness) uncertainty:** ±0.6 dB, 100 Hz to 2.5 GHz; ±1.7 dB, 2.0 GHz to 12.5 GHz; ±2.2 dB, 12.5 GHz to 20 GHz; ±3.0 dB, 20 GHz to 22 GHz; for 10 dB attenuator setting. Cumulative flatness ±2.2 dB, 100 Hz to 20 GHz. COUPLED FUNCTION not required as long as display remains calibrated.

**Absolute amplitude calibration uncertainty:** ±0.6 dB. The certainty of setting the frequency response curve absolutely when using the internal CAL signal or any other calibration signal in the 100 Hz to 2.5 GHz band.

**Amplitude temperature drift:** at -10 dBm reference level with 10 dB input attenuation and 1 MHz resolution bandwidth. ±0.03 dB/°C (eliminated after recalibration).

#### Scale Fidelity

Log	Incremental	Cumulative
	±0.1 dB/dB	over 0 to 90 dB display
		±1.0 dB ≥ 30 Hz Resolution BW
		±2.1 dB 10 Hz Resolution BW

**Linear:** ±3% of reference level

**Resolution bandwidth switching uncertainty<sup>2</sup>:** referenced to 1 MHz bandwidth, corrected (uncorrected).<sup>3</sup>

Resolution BW	Uncertainty
10 Hz	±1.1 dB (±2.0 dB)
30 Hz	±0.4 dB (±0.8 dB)
100 Hz to 1 MHz	±0.2 dB (±0.5 dB)
3 MHz	±0.5 dB (±1.0 dB)

**Log scale switching uncertainty:** corrected (uncorrected). ±0.1 dB (±0.5 dB).

**IF gain uncertainty:** corrected (uncorrected). Assuming the internal calibration signal is used to calibrate the reference level at -10 dBm and the input attenuator is fixed at 10 dB, any changes to the reference level function value from -10 dBm will contribute IF gain uncertainty.

#### Range

0 to -55.9 dBm	
10 Hz Resolution BW	±1.0 dB (±1.6 dB)
≥30 Hz Resolution BW	0 dB (±0.6 dB)
-56.0 to -129.9 dBm <sup>4</sup>	
10 Hz Resolution BW	±2.0 dB (±2.0 dB)
≥30 Hz Resolution BW	±1.0 dB (±1.0 dB)

#### Uncertainty

The range values change with different input attenuator settings. Each 10 dB decrease (or increase) in the amount of input attenuation at the time of calibration and measurement will cause a corresponding 10 dB decrease (increase) in absolute reference level settings described above.

**RF gain uncertainty:** corrected (uncorrected) 0 dB (±0.2 dB). The gain change between preselected and non-preselected bands.

**Error correction:** ±0.4 dB

When the error correction function is used (SHIFT W and SHIFT X), amplitude uncertainty is introduced because additional IF gain is used to offset errors in the switching of resolution BW, amplitude scales and RF gain.

#### Dynamic Range

**Spurious responses:** (signals generated by the analyzer due to input signals). For signals <-40 dBm all harmonic and intermodulation distortion >70 dB below input signal.

**Second order harmonic distortion:** for mixer levels ≤-40 dBm: <-70 dBc, 100 Hz to 50 MHz; <- 80 dBc, 50 MHz to 700 MHz; <-70 dBc, 700 MHz to 2.5 GHz. For mixer levels ≤-10 dBm: <-100 dBc, 2 to 22 GHz.

**Third order intermodulation distortion:** third order intercept (TOI): >+5 dBm, 100 Hz to 5 MHz; >+7 dBm, 5 MHz to 5.8 GHz; >+5 dBm, 5.8 to 18.6 GHz; >+5 dBm (typical), 18.6 GHz to 22 GHz; >+5 dBm (typical), 2 to 22 GHz for >100 MHz signal separation.

**Image responses:** (due to input signals 642.8 MHz above or below the tuned frequency) <-70 dBc, 100 Hz to 18.6 GHz; <-60 dBc, 18.6 GHz to 22 GHz.

**Multiple responses:** (due to the input signal mixing with more than one L.O. harmonic) <-70 dBc, 100 Hz to 22 GHz.

**Out-of-band responses:** (due to input signals outside the preselector's frequency span) <-60 dBc, 2 to 22 GHz.

**Residual responses:** (signals displayed by the analyzer independent of input signals) With 0 dB input attenuation and no input signal: <-100 dBm, 100 Hz to 5.8 GHz; <-95 dBm, 5.8 GHz to 12.5 GHz; <-85 dBm, 12.5 GHz to 18.6 GHz; <-80 dBm, 18.6 GHz to 22 GHz.

**Gain compression:** <1.0 dB, 100 Hz to 22 GHz with ≤-5 dBm at input mixer.

**Average noise level:** with 0 dB input attenuation and 10 Hz resolution bandwidth. <-95 dBm, 100 Hz to 50 kHz; <-112 dBm, 50 kHz to 1.0 MHz; <-134 dBm, 1.0 MHz to 2.5 GHz; <-132 dBm, 2.0 GHz to 5.8 GHz; <-125 dBm, 5.8 GHz to 12.5 GHz; <-119 dBm, 12.5 GHz to 18.6 GHz; <-114 dBm, 18.6 GHz to 22 GHz.

**Video bandwidth:** post detection low pass filter used to average displayed noise bandwidth variable from 1 Hz to 3 MHz in a 1,3,10 sequence. Video bandwidth may be selected manually or coupled to resolution bandwidth.

**Digital video averaging:** displays the sweep-to-sweep average of the trace over a specifiable number of sweeps with SHIFT G, video averaging is turned off with SHIFT H.

#### Reference Lines

**Display line:** movable horizontal line with amplitude readout.

**Threshold:** movable horizontal trace threshold with amplitude readout.

**Accuracy:** equals the sum of calibrator uncertainty, and scale fidelity between the reference level and reference line.

#### Marker

The marker is a bright dot placed upon the display trace which is positioned horizontally by the DATA controls. The marker amplitude and frequency are read out continuously.

<sup>1</sup>Maximum input must not exceed +30 dBm (damage level).

<sup>2</sup>Accounted for under Error Correction Accuracy.

<sup>3</sup>Uncorrected values apply over 20-30°C range.

<sup>4</sup>Correction only applies over the 0 dBm to -55.9 dBm range.





## Frequency

**Normal:** displays the frequency at the horizontal position of the tunable marker. PEAK SEARCH positions the marker at the center of the largest signal response present on the display to within  $\pm 10\%$  of resolution bandwidth. Following peak search, SHIFT K moves marker to next higher trace maximum. Subsequent SHIFT K entries move marker to sequentially lower maxima. MKR $\rightarrow$ CF sets the analyzer center frequency equal to the marker frequency; MKR/ $\Delta$  $\rightarrow$ STP SIZE sets the center frequency step size equal to the marker frequency.

**Accuracy:** same as center frequency accuracy.

**Signal track:** re-tunes the analyzer to place a signal identified by the marker at the center of the CRT and maintain its position (provided the signal remains on-screen during the period of one sweep). Useful when reducing frequency span to zoom-in on a signal; also keeps a drifting input signal centered.

$\Delta$ : displays the frequency difference between the stationary and tunable markers. Reference frequency may be outside current frequency span accuracy. MKR/ $\Delta$  $\rightarrow$ STP SIZE sets the center frequency difference between the markers. SHIFT O sets the analyzer start and stop frequencies equal to the frequencies of the two markers.

**Accuracy:** same as frequency span accuracy.

**Zoom:** makes it possible to reduce the frequency span about the marker (or signal in the track mode) using the step down key.

## Amplitude

**Normal:** displays the amplitude at the vertical position of the tunable marker. PEAK SEARCH positions the marker at the peak of the largest signal present on the display.

MKR $\rightarrow$ REF LVL sets the analyzer reference level equal to the marker amplitude. RMS noise density in a 1 Hz bandwidth is read out using SHIFT M, by sampling the displayed trace and arithmetically correcting for the analyzer detector response, log shaping, and measurement bandwidth.

**Accuracy:** same as reference level accuracy plus scale fidelity between the reference level and marker position.

$\Delta$ : displays the amplitude difference between the stationary and tunable marker. Reference frequency may be outside current frequency span.

**Accuracy:** same as frequency response uncertainty and scale fidelity between two markers.

**Preselector peak:** with the marker at the peak of a displayed input signal, preselector peak automatically adjusts preselector tracking for maximum response. SHIFT = resets the preselector tuning to the nominal factory preset condition. If the marker is not activated when preselector peak is used, a peak search will be exercised prior to preselector peaking. FPKA performs a fast preselector peak.

## Sweep

Trigger, continuous and single is the same as the HP 8568B, pages 594 and 593.

## Sweeptime

### Zero Frequency Span

**With digital storage:** 20 msec full sweep to 1500 sec full sweep  $n \sim 1\%$  increments.

**Without digital storage:** 1  $\mu$ sec full sweep to 10 msec in 1, 2, 5 sequence.

### Marker (sweeps > 20 msec only)

**Normal:** displays time from beginning of sweep to marker position.

$\Delta$ : displays time difference between stationary and tunable marker.

## Display

The display functions are the same as the HP 8568B, page 594.

## Input

**RF input:** 100 Hz to 22 GHz, precision female type N connector, dc coupled.

**SWR (typical):** 1.2, 100 Hz to 2.5 GHz; 1.5, 2 GHz to 5.8 GHz; 1.9, 5.8 GHz to 22 GHz; with 10 dB input attenuation.

**LO emission (typical):**  $< -80$  dBm when preselected;  $< -90$  dBm when not preselected.

### Maximum Input Level

**AC:** +30 dBm (1 watt), continuous power, from 50 ohm source. Mixer protected by diode limiter, 100 Hz to 2.5 GHz.  $< 100$  watts, 10  $\mu$ sec pulse with  $\geq 50$  dB RF attenuation ( $\leq 0$  dBm peak to input mixer).

**DC:**  $< 100$  mA current damage level.

**Input attenuator:** 70 dB steps. Zero dB attenuation accessible only through numeric/unit keyboard. Attenuation may be selected manually or coupled to reference level to insure a  $-10$  dBm input mixer drive level for full-screen signals; other mixer levels may be specified using SHIFT , and entering the desired amplitude through the keyboard.

**Accuracy:**  $\pm 1.0$  dB over 10–70 dB range.

## IF Input

### Maximum Input Level

**AC:** +10 dBm, continuous power, from 50  $\Omega$  source.

**DC:** 20 volts with rise time of  $< 1$  volt/ $\mu$ sec.

**Sensitivity:**  $-30$  dBm at 321.4 MHz produces full-scale CRT deflection  $\pm 1.0$  dB when KSU has been executed.

### Quasi-Peak (rear panel; nominal values)

**Video input:** 0–2 Volts. 139 $\Omega$  input impedance.

**21.4 MHz input:** input is nominally  $-11$  dBm (with spectrum analyzer input attenuator set to 10 dB). 50 $\Omega$  input impedance.

## Output

**Calibrator:** 100 MHz  $\pm$  (frequency reference error).  $-10$  dBm  $\pm 0.3$  dB, 50  $\Omega$  impedance.

### Auxiliary

Auxiliary outputs are the same as the HP 8568B, page 594.

**21.4 MHz IF (rear panel):** a 50  $\Omega$ , 21.4 MHz output related to the RF input to the analyzer. In log scales, the IF output is logarithmically related to the RF input signal; in linear, the output is linearly related. The output is nominally  $-20$  dBm for a signal at the reference level. Bandwidth is controlled by the analyzer's resolution bandwidth setting; amplitude controlled by the input attenuator, and IF step gain positions.

### IF Output (front panel)

#### Maximum Input Level

**AC:** +10 dBm, continuous power, from 50  $\Omega$  source.

**DC:** 20 volts with rise time of  $< 1$  volt/ $\mu$ sec.

**1st LO output (front panel):** 2.3 to 6.2 GHz,  $> +5$  dBm., 50  $\Omega$  output impedance (nominal).

**Maximum input level:** +27 dBm (0.5 watt) total power into 50  $\Omega$  impedance.

**Frequency reference (rear panel):**  $> -5$  dBm, 50  $\Omega$  output impedance

**Sweep plus tune output (rear panel):** 10.000 MHz, 0 dBm; 50  $\Omega$  output impedance.

**10 MHz output (rear panel):**  $> -5$  dBm, 50  $\Omega$  output impedance.

**Sweep plus tune output (rear panel):**  $-1.0$  volt per GHz of tune frequency,  $> 10$  k $\Omega$  load.

**Accuracy:**  $-1$  V/GHz  $\pm 20\% \pm 10$  mV.

**Quasi-Peak (rear panel; nominal values)**

**Video output:** 0–2 volts. Output impedance  $> 10$   $\Omega$ .

**21.4 MHz output:** output is nominally  $-11$  dBm (with spectrum analyzer input attenuator set to 10 dB). 50 $\Omega$  input impedance.

## HP-IB Interface Functions

SH1, AH1, T6, L4, SR1, RL1, PP0, DC1, DT1, C0, E1. For more on these codes, refer to the HP-IB section of this catalog.

## General

### Environmental

**Temperature:** operating 0°C to 55°C, storage  $-40$ °C to +75°C.

**Humidity:** operating  $< 95\%$  R.H., 0°C to 40°C except as noted.

**EMI:** conducted and radiated interference is within the requirements of CE03 and RE02 of MIL STD 461A, VDE 0871, and CISPR pub'n 11.

**Power requirements:** 50 to 60 Hz; 100, 120, 220, or 240 volts (+5%,  $-10\%$ ); approximately 650 VA (40 VA in standby). 400 Hz operation is available as Opt 400.

**Weight:** total net 50 kg (112 lb): Display/IF Section, 21 kg (47 lb); RF Section, 24 kg (53 lb). Shipping, Display/IF Section 31 kg (69 lb); RF Section 39 kg (87 lb).

**Size:** 267 H x 425.5 W x 598.5 mm D (10.5" x 16.75" x 23.56").

## Ordering Information

HP 8566B Spectrum Analyzer

Opt 010: Rack Slide Kit

Opt 400: 400 Hz Power Line Frequency Operation

Opt 908: Rack Flange Kit

Opt 910: Extra Manual

Opt 913: Rack Flange Kit to Mount Instruments with Handles

HP 8566A+01K Retrofit Kit



# SIGNAL ANALYZERS

## Automatic Spectrum Analyzers, 100 Hz to 22 GHz

### Models 8566S & 8568S

- Choice of BASIC or HPL system software
- HP 9000 Series 200 computer for powerful computer capability
- Assortment of printers and plotters to choose from
- Software to minimize program development time
- Ease of operation via HP-IB
- 16K of analyzer RAM for user-defined routines



HP 8568S

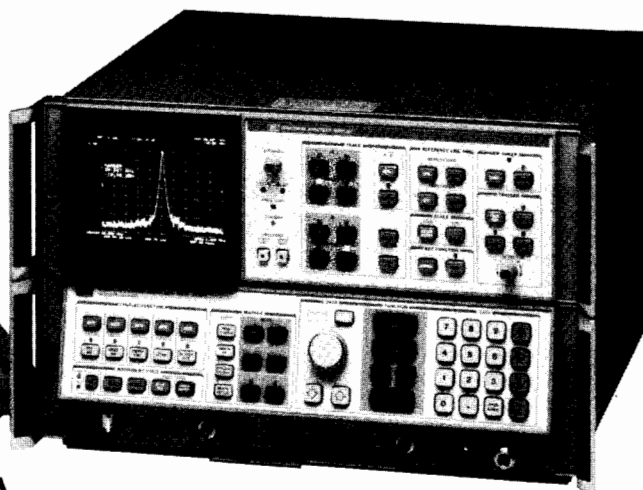

The HP 8566S and 8568S Automatic Spectrum Analyzers are systems based on the HP 8566B and 8568B Spectrum Analyzers respectively. They are ideal for automatic systems applications due to their synthesized local oscillators, full programmability, direct and indirect plotter output, high level firmware function set, and 16,000 bytes of non-volatile memory for user-defined routines. Each system has an HP 9000 Series 200 Desktop Computer, which has the powerful Motorola MC68000 16-bit microprocessor and up to 2 megabytes of main memory. System Software is available in either BASIC or HPL languages. A wide variety of HP-IB printers and plotters are available for this system to provide the user with a great deal of flexibility to tailor the system for his or her needs. Operator training is available through the HP 8566A +24D or 8568A +24D Spectrum Analyzer Operation Course which is an intensive 4-day course that illustrates basic programming techniques for remote operation of these two spectrum analyzers. Course size is purposely kept small and hands-on operation is emphasized to facilitate getting the full benefits of the course. The frequency range of the HP 8566S can be extended above 22 GHz by using external mixers. (See page 621 for more information on the HP 11970 series mixers.)

#### System Software

System software is available in both HPL (HP 85862A Software PAC) and BASIC (HP 85863A Software Library) languages for maximum user flexibility. Either package supplies high level software routines (subprograms) to aid the system programmer in developing custom programs for specific applications. In effect, they act as extensions of the spectrum analyzer's built-in firmware, thus enabling a user to write programs on a more conceptual level. For example, many measurements require the maximum amount of dynamic range available on the spectrum analyzer, given its current settings of center frequency, resolution bandwidth, and the maximum input level expected. Choosing the correct value of input attenuation which will

result in the greatest dynamic range normally requires knowledge of the spectrum analyzer's distortion and sensitivity characteristics. Subprogram \*OPT-RANGE will automatically compute the optimum value of attenuation and set the spectrum analyzer's attenuator accordingly. Thus, by including \*OPT-RANGE as part of the program, a user no longer needs to be concerned with the details of this aspect of the measurement. The HP 85862A HPL Software Pac also includes a set of Measurement Programs and Utility Programs which make extensive use of the Subprogram Library and illustrate how the subprograms can be utilized. The system software comes on a 5¼ inch flexible disc (3½-inch discs are also available) for use with an HP Series 200 computer. Also included is a manual which provides extensive documentation and line-by-line annotation of each program.

#### Major System Components

Spectrum Analyzer:	HP 8566B or 8568B
Desktop Computer:	HP Series 200, Model 216, 226, or 236
Printer:	HP 2671A, 2671G, or 2673A
Plotter:	HP 7090A, 7470A, 7475A, or 7550A
Software:	HP 85862A (HPL) or 85863A (BASIC)
Operation Training Course:	HP 8566A +24D or 8568A +24D

#### Ordering Information

**HP 8566S** Automatic Spectrum Analyzer (HP 8566B based system)

**HP 8568S** Automatic Spectrum Analyzer (HP 8568B based system)

For complete ordering information, prices, delivery, and available options, contact your local HP field engineer.

# SIGNAL ANALYZERS

## EMI Measurement Solution

Models 85864A, 85650A, 8566B, 8568B and EMI Accessories



- EMI measurement capability for MIL-STD, FCC, VDE (CISPR) testing
- Measurement software for fully automatic EMI testing
- Accessories available for making a complete EMI test system

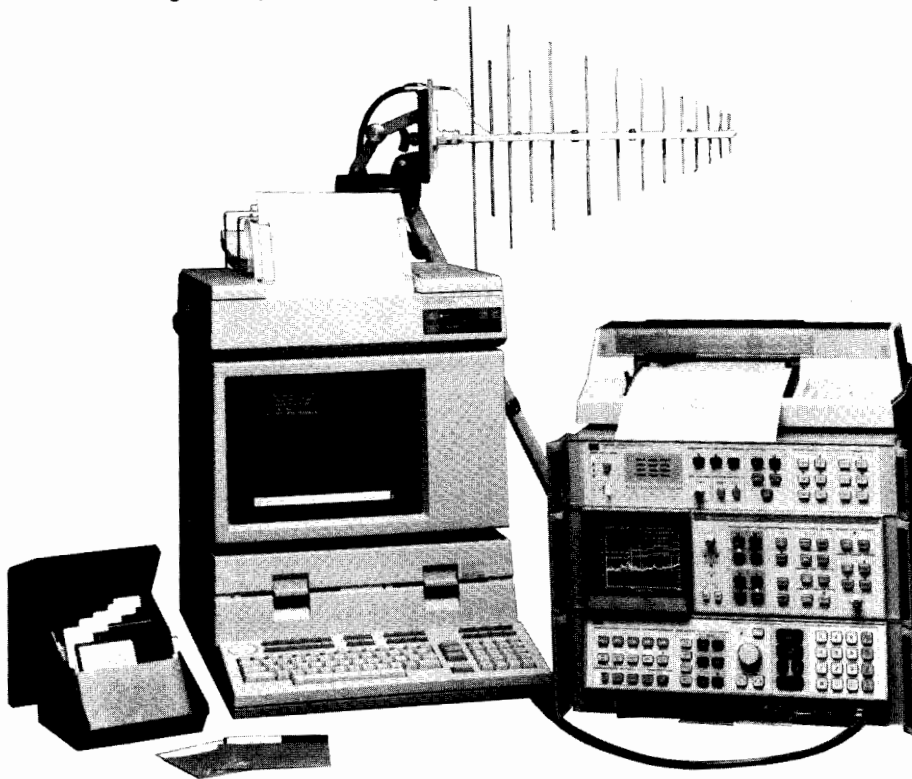

Typical System Configuration for Commercial EMI Measurements

The spectrum analyzer has long been a useful tool in the evaluation of electromagnetic interference (EMI) spectra for troubleshooting and preliminary qualification testing. The HP 8566B and the 8568B Spectrum Analyzers, with high performance and full programmability, allow difficult and time consuming EMI compliance tests to be completed automatically.

The spectrum analyzer's ability to display wide frequency scans provides "quick-look" capability, making it effective for locating EMI "hot spots" manually. The full programmability and the graphics display capability for log plots, limit lines and hard copies makes the HP 8566B and 8568B very powerful and effective measurement tools for EMI applications requiring automation.

The HP 85864A EMI Measurement Software program added to the capability of the HP 8566B and 8568B Spectrum Analyzers provides you with a powerful combination for MIL-STD and Commercial (FCC, VDE, CISPR) EMI testing. Most common EMI tests are provided with the software library on diskettes for easy use or a custom test can be implemented within minutes for individual testing needs. After completion of a measurement the software has a variety of analysis features for diagnosing or identifying the measured emissions. You can 'Zoom-to-local' and identify the type or source of emission, print the peak responses of the measured emissions above a desired threshold level, perform a quasi-peak measurement over a selected portion of the measurement range, or mark and note specific responses for identification on a report. The HP 85864A also provides hard copy output (plotted or printed) and disc storage capability for saving measured data or new test setups.

The HP 85650A Quasi-Peak Adapter can be attached to the spectrum analyzer to provide manual and automatic quasi-peak detection capability with the resolution bandwidths recommended by CISPR Publication 16 and FCC Rules and Regulations Volume II Part 15J. In addition, the Quasi-Peak Adapter provides such convenience features as a loudspeaker for audio signal characterization, and an Adapter "bypass" mode.

Other accessories such as amplifiers, filters and transducers can be added to achieve a complete EMI measurement system. A partial list of these accessories is shown below, for a complete list including antennas, current probes and LISN's contact your nearest HP field representative.

### Ordering Information

HP 85864A	EMI Measurement Software*
HP 8566B	100Hz - 26GHz Spectrum Analyzer
HP 8568B	100Hz - 1.5GHz Spectrum Analyzer
HP 85864A-KO1	MIL-STD 461B REO2 Transducer Kit
HP 85864A-KO3	MIL-STD 461B CEO3 Transducer Kit
HP 85864A-KO4	Commercial Radiated Emissions Transducer Kit
HP 85864A-KO5	Commercial Conducted Emissions Transducer Kit
HP 85650A	Quasi-Peak Adapter
HP 8447A-H64	10kHz - 50MHz Pre-Amplifier
HP 8447D	100kHz - 1.3GHz Pre-Amplifier
HP 8349A-HO1	1GHz - 20GHz Amplifier
HP 11713A	Attenuator Switch/Driver
HP 8494H-001	Attenuator (0-11dB, 1dB steps)
HP 8495H-001	Attenuator (0-70dB, 10dB steps)
HP 7470A	2-Pen Graphics Plotter
HP 7475A	6-Pen Graphics Plotter
HP 2671G	Thermal Graphics Printer
HP 2673A	Thermal Graphics Printer

\*Uses Series 200 Model 26 or 36 Computer with BASIC Language and Extensions. Also requires 1.1 Megabyte of memory [four (4) HP 98256A memory boards].

600



# SIGNAL ANALYZERS

## Microwave Spectrum Analyzer, 10 MHz to 115 GHz

### Model 8569B

- 0.01 to 22 GHz, external mixing to 115 GHz & above
- Internal preselection, 1.7 to 22 GHz
- Wide resolution range, 100 Hz to 3 MHz
- Simple three knob operation
- Digital display of dual traces and control settings
- Direct plotter output - no controller needed

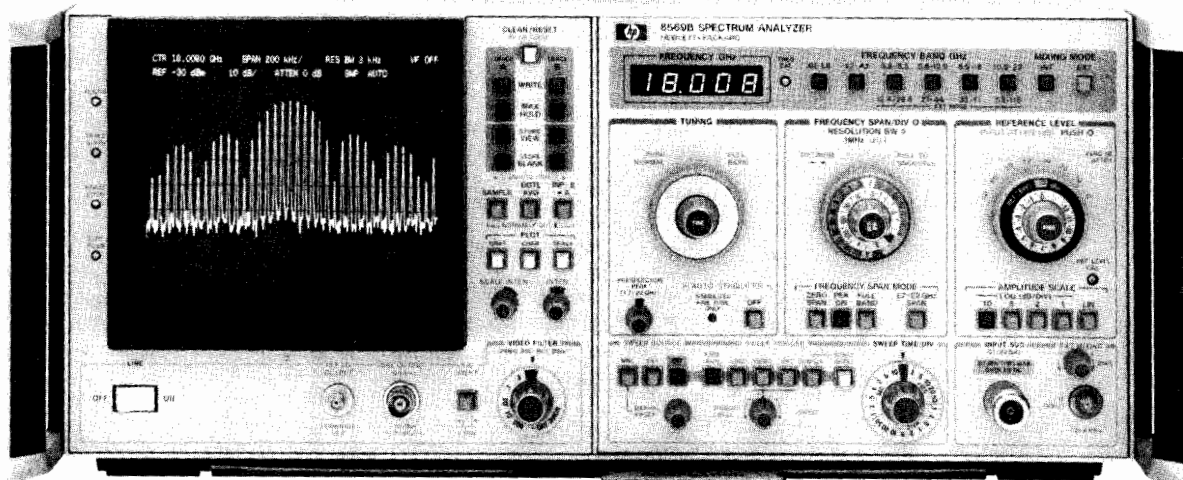

HP 8569B



### HP 8569B Spectrum Analyzer

High performance and simple operation are combined with unique new microprocessor-controlled capabilities in the HP 8569B Microwave Spectrum Analyzer. Excellent sensitivity and internal preselection assure the wide, spurious-free measurement range necessary for production applications, while the digital display and coupled controls speed measurement routines. The internal frequency range of 10 MHz to 22 GHz is extended to 40 GHz using external mixers with the HP 8569B Option E02 and to 115 GHz and above with other commercially available mixers. For more information on external harmonic mixers see page 621. For semi-automatic operation, connect a desktop computer to the HP 8569B via HP-IB to allow access to the displayed trace data and the control settings necessary to analyze or record measurements, or display operator messages and prompts on the CRT. Direct, hard copy output to a digital plotter is possible without the need of a controller or any programming.

#### Wide Range of Signal Resolution

Optimum resolution is possible for a wide range of signal characteristics with ten IF filters available from 100 Hz to 3 MHz. Fully automatic stabilization in narrow spans reduces residual FM to allow accurate measurements of closely spaced signals using the narrow bandwidths. The wide 1 and 3 MHz resolution bandwidths allow fast sweeps in wide spans and increased dynamic range for pulsed RF applications. All resolution filters are Gaussian-shaped for repeatable measurements, faster undistorted sweeps, and best pulse response.

#### High Accuracy and Wide Dynamic Range

Absolute signal levels from  $-123$  to  $+30$  dBm are easily and accurately measured using IF substitution because the HP 8569B displays the reference level value directly on the CRT above the graticule. Damage to the mixer is prevented for signal levels of  $+30$  dBm with a built-in limiter below 1.8 GHz and a preselector from 1.7 to 22 GHz. The internal preselector also ensures maximum use of this wide measurement range by reducing internal distortion products as much as 120 dB. In addition, flat frequency response ensures accuracy for relative as well as absolute power measurements.

#### Convenient Operation with Digital Display

Preset the HP 8569B to the color-coded, "basic operation," settings and use the coupled controls to make most measurements in three

easy steps: tune to the signal, select a span and raise it to the reference level. While in the AUTO sweeptime position, a calibrated amplitude display is ensured. However, the microprocessor also monitors manually-selected sweeptimes and displays a warning if the sweep speed chosen is too fast for calibrated measurements. Signals are displayed on either of two independent digitally stored traces with all major control settings annotated above the graticule area. Display processing capabilities include Max Hold, digital averaging and trace normalization for extended measurement capability.

#### HP-IB Includes Direct Plotter Control

A hard-copy record of the displayed traces, control settings and graticule can be made on a digital plotter via HP-IB quickly and simply using the HP 8569B's front-panel pushbuttons without need for a controller. For maximum capability, attach a controller to the HP 8569B to read the trace data and control settings for a measurement analysis or recording on tape. Also, you can illustrate the test parameters for each measurement with display lines and instruct the operator with messages on the analyzer CRT. The controller can verify correct control settings before taking the test data or going on to the next step.

#### HP 8444A Option 059 Tracking Generator

Characterize the frequency response of devices up to 1500 MHz by using the HP 8444A Option 059 Tracking Generator with the HP 8569B. Dynamic range is greater than 90 dB and system response errors can be removed using trace normalization. In addition, increase the analyzer's frequency accuracy to  $\pm 10$  kHz using a counter with the tracking generator.

#### HP 8569B Specifications

##### Frequency Specifications

**Frequency range:** 0.01 to 22 GHz with internal mixer, 18 to 40 GHz with HP 8569B Opt. E02 external mixers. Extendable to 115 GHz and above with other commercially available mixers. See page 621 for more information on external harmonic mixers.

**Tuning Accuracy** (digital frequency readout in any span mode)

**10 MHz to 115 GHz:**  $\pm(5$  MHz or  $0.2\%$  of center frequency, whichever is greater,  $+20\%$  of Frequency Span/Div).



## Frequency Spans

**1.7 to 22 GHz:** multiband span from 1.7 to 22 GHz in one sweep.

**Full band:** displays spectrum of entire band selected.

**Per division:** 1 kHz to 500 MHz/div in a 1, 2, 5 sequence.

**Span width accuracy:**  $\pm 5\%$ , 500 MHz to 20 kHz/div un-stabilized;  $\pm 15\%$ , 100 kHz to 1 kHz/div, stabilized.

**Zero span:** analyzer becomes a manually tuned receiver.

## Spectral Resolution and Stability

**Resolution bandwidths:** resolution (3 dB) bandwidths from 100 Hz to 3 MHz in 1, 3, sequence. Bandwidth and span width are independently variable or may be coupled for optimum display when control markers are aligned ( $\blacktriangleleft$ ).

**Resolution bandwidth accuracy:** 3 dB points are  $\pm 15\%$ .

**Selectivity:** (60 dB/3 dB bandwidth ratio):  $< 11:1$ , 100 Hz to 1 kHz;  $< 15:1$ , 3 kHz to 3 MHz.

**Total residual FM:** (fundamental mixing 0.01 to 4.1 GHz):  $< 100$  Hz p-p in 0.1 second. First LO automatically stabilized for frequency spans  $\leq 100$  kHz/div.

**Noise sidebands:**  $> 75$  dB down,  $\geq 30$  kHz from signal in a 1 kHz Res. Bandwidth and a 10 Hz (0.01) Video Filter.

## Amplitude Specifications

### Amplitude Range—Internal Mixer

**Total power:** +30 dBm, +137 dB $\mu$ V (1 watt).

**Damage levels:** (50 ohm nominal source impedance):

**dc:** 0 V with 0 dB input attenuation (1 A),  $\pm 7$  V with  $\geq 10$  dB input attenuation (0.14 A).

**Peak pulse power:** +50 dBm ( $< 10$   $\mu$ s pulse width, 0.01% duty cycle with  $\geq 20$  dB input attenuation).

**Gain compression:**  $< 1$  dB for  $-7$  dBm signal, 0 dB input atten.

**Average noise level:** see table below for max. avg. noise level with 1 kHz res. bandwidth (0 dB atten. and 3 Hz video filter).

Frequency Band (GHz)	First IF in MHz	Harmonic Mode	Noise Level (dBm)	Frequency Response* ( $\pm$ dB max)
0.01-1.8	2050	1-	-113	1.2
1.7-4.1	321.4	1-	-110	1.5
3.8-8.5	321.4	2-	-107	2.5
5.8-12.9	321.4	3-	-100	2.5
8.5-18	321.4	4+	-95	3.0
10.5-22	321.4	5+	-90	4.5
12.4-26.5	321.4	6+	Depends on the external mixer that is used with the HP 8569B.	See page 621
21-44	321.4	10+		
33-71	321.4	16+		
53-115	321.4	26+		

\*Frequency response includes input attenuator, preselector and mixer frequency response plus mixing mode gain variation (band to band).

## Reference Level

**Reference level range:** +60 dBm (+30 dBm max. input) to  $-112$  dBm in 10 dB steps and continuous 0 to  $-12$  dB calibrated vernier.

**Reference level accuracy:** auto Sweep setting of Sweep Time/Div control insures a calibrated display within these limits:

**Calibrator output:** (100 MHz  $\pm 10$  kHz):  $-10$  dBm  $\pm 0.3$  dB.

**Reference level variation:** (input atten. at 0 dB, 20° to 30°C):  $-10$  to  $-70$  dBm:  $\pm 0.5$  dB;  $-80$  to  $-100$  dBm:  $\pm 1.0$  dB.

**Vernier:** (0 to  $-12$  dB continuous); maximum error  $\pm 0.5$  dB.

**Input attenuator:** 0-70 dB in 10 dB steps.

**Step size variation:**  $\pm 1.0$  dB, 0.01 to 18 GHz;  $\pm 1.5$  dB, 0.01 to 22 GHz. Maximum cumulative error:  $\pm 2.5$  dB.

**Frequency response:** see table above.

**Switching between bandwidths:** 3 MHz to 100 Hz,  $\pm 1.0$  dB.

## Calibrated Display Range

**Log:** 1, 2, 5, and 10 dB/div over 8 divisions.

**Linear:** 0.56  $\mu$ V to 224 V in 50 ohm.

## Display Accuracy

**Log:**  $\pm 0.1$  dB/dB; maximum cumulative error  $\pm 1.5$  dB.

**Linear:**  $< \pm 3\%$  over full 8 division deflection.

**Residual responses** (no signal present at input):  $< -90$  dBm.

**Signal identifier:** available from 10 MHz to 115 GHz.

## Signal Input/Output Characteristics

**Input SWR** (input impedance 50 ohm nominal)

**Input atten. at 0 dB:**  $< 1.5$ , 0.01-1.8 GHz;  $< 2.0$ , 1.7-22 GHz.

**Input atten. at  $\geq 10$  dB:**  $< 1.3$ , 0.01-1.8 GHz;  $< 2.0$ , 1.7-22 GHz.

**LO emission from RF input** (1.4 to 5.2 GHz):  $< -60$  dBm, 0.01 to 1.8 GHz;  $< -80$  dBm, 1.7 to 22 GHz.

**Input Protection** (for input signals from 0.01 to 22 GHz)

**0.01 to 1.8 GHz:** internal diode limiter.

**1.7 to 22 GHz:** preselector protects mixer to +30 dBm.

**321.4 MHz IF input:** SMA female connector is a port for bias current output ( $\pm 5$  mA) and IF return from an external mixer.

**LO output:** 2 to 4.46 GHz with minimum power of +8 dBm.

## Sweep Specifications

### Sweep Time

**Auto:** sweep time is automatically controlled by Frequency Span/Div, Resolution Bandwidth and Video Filter controls to maintain an absolute amplitude calibrated display.

**Calibrated sweep times:** 2  $\mu$ s to 10 s/div in 1, 2, 5 sequence.

## Digital Display

**Traces:** dual trace, digitally stored display with a resolution of 481 horizontal by 801 vertical points for each trace.

**Control readout:** major control settings annotated on the CRT include Center or Marker frequency, Frequency Span/Div, Resolution BW, Video Filter, Reference Level, Scale Factor, RF Input Attenuator and Sweep Time/Div.

**Signal processing:** Max Hold, trace normalization, sample detection mode, digital avg. and dB $\mu$ V Reference Level readout.

**Internal service routines:** front-panel pushbuttons access test patterns to perform maintenance of digital hardware.

## HP-IB

**Direct plotter control:** all displayed information can be transferred to an HP-IB plotter by using only front-panel pushbuttons.

## Controller Interface Functions

**Trace data transfer:** all trace data values can be transferred to or from an HP 8569B with a controller.

**Control readout:** all displayed control settings can be transferred to a controller to check measurement conditions.

**Input messages:** controller-input instructions or annotation can be displayed within two 63-character lines on the analyzer CRT.

**Sweep control:** sweeps can be initiated and monitored.

Note: HP-IB cables are not supplied with the HP 8569B.

## HP-IB Interface Functions

AH1, DC1, L4, SH1, T7. For more information on these codes, refer to the HP-IB section of this catalog.

## General Specifications

**Temperature range:** operating 0° to +55°C, storage  $-40^\circ$  to +75°C.

**Humidity range** (operating): 95% R.H., 0°C to 40°C.

**EMI:** conducted and radiated interference is in compliance with MIL-STD 461A Methods CE03 and RE02, CISPR Publication 11 (1975), and Messemppaenger-Postverfuegung 526/527/79 (Kennzeichnung Mit F-Nummer/Funkschutzzeichen).

**Power requirements:** 48-66 Hz; 100, 120, 220 or 240 volts ( $-10\%$  to  $+5\%$ ); 280 VA max (400 Hz operation available as Opt 400).

**Size:** 188 H x 426 W x 552 mm D (7" x 16.8" x 21.8").

**Weight:** net 29.2 kg (64 lb). Shipping 41 kg (90 lb).

## Standard Options Available

**Opt 001, Internal Comb Generator:** 100 MHz comb signals visible through 22 GHz for increased frequency accuracy (error  $< 0.007\%$ , typically  $\pm 1$  MHz at 22 GHz) and preselector peaking verification.

**Opt 002, Delete 100, 300 Hz Bandwidths:** standard specifications apply except minimum resolution bandwidth is 1 kHz with 15:1 shape factor, residual FM  $< 200$  Hz when stabilized.

**Opt 003, High Power LO:** provides  $\geq +14$  dBm for direct use with mixer (e.g. HP 11971 series).

**Opt 400, 50 to 400 Hz Power Supply**

**HP Part No. 1450-0654—Transit Case:** Order HP Part No. 1490-0913 also for castors.

## Ordering Information

HP 8569B Spectrum Analyzer

**Opt 001:** Internal Comb Generator

**Opt 002:** Delete 100, 300 Hz Bandwidths

**Opt 003:** High Power LO

**Opt 400:** Internal 50 to 400 Hz Power Supply

**Opt 908:** Rack Flange Kit Without Handles

**Opt 910:** Extra Operating & Service Manual

**Opt 913:** Rack Flange Kit with Handles

**Opt E02:** 18 to 40 GHz External Mixer System

HP 8444A Opt 059 Tracking Generator



# SIGNAL ANALYZERS

## Spectrum Analyzer, 10 MHz to 40 GHz

### Model 8565A

- 0.01 to 22 GHz, external mixing to 40 GHz
- Internal preselection 1.7 to 22 GHz
- Wide resolution range, 1 kHz to 3 MHz standard
- Simple three knob operation
- CRT bezel readout displays control settings

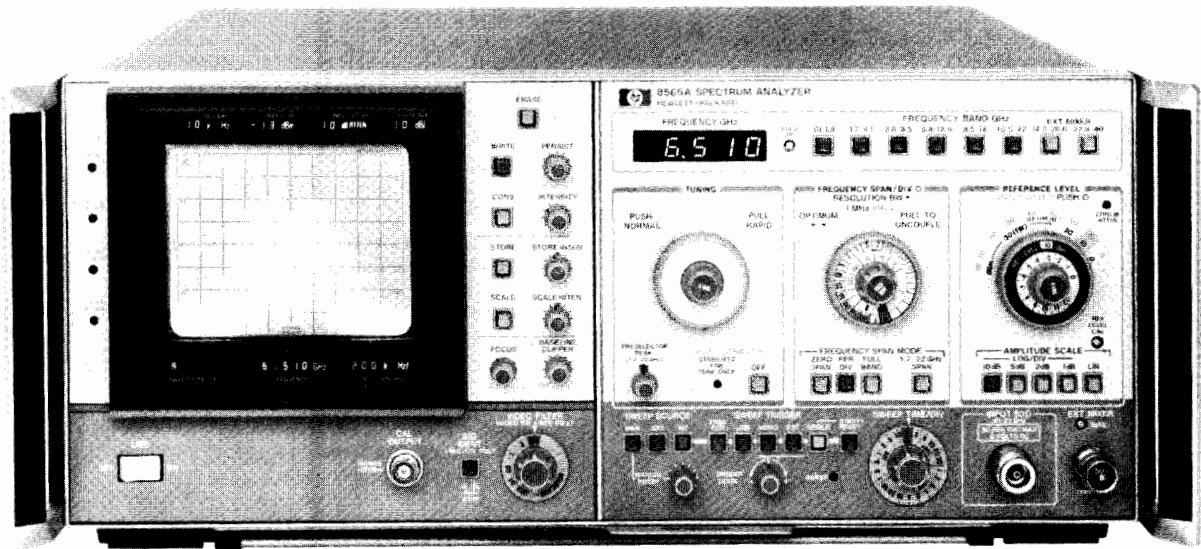

HP 8565A

### HP 8565A Spectrum Analyzer

Covering from 0.01 to 22 GHz with its internal mixer, the HP 8565A has built-in preselection and brings accuracy plus convenience to microwave spectrum analysis. The wide range, spurious-free display, compact design and ease of use make it well suited for lab, production, or field applications requiring accurate measurement from IF through microwave frequencies. The HP 8565A can cover 0.01 to 22 GHz in just two spans for rapid location of signals prior to close-in analysis in one of six bands. Coverage is easily extended up to 40 GHz with the HP 11517A External Mixer.

#### High Resolution

Fully automatic stabilization in narrow spans reduces residual FM and drift. Standard resolution bandwidths range from 1 kHz to 3 MHz. The 1 and 3 MHz bandwidths allow fast sweeps in wide spans and increased dynamic range for pulsed RF; the narrow bandwidths allow measurement of closely spaced signals. Option 100 provides additional 100 Hz and 300 Hz IF bandwidth filters, and residual FM is < 100 Hz when stabilized. This 100 Hz resolution is usable up to 8.5 GHz and the 300 Hz resolution bandwidth to 22 GHz. All resolution filters are Gaussian-shaped for repeatable measurements, faster un-distorted sweeps and best pulse response.

#### Absolute Amplitude Calibration

Absolute signal levels from -112 dBm to +30 dBm are easily measured because the HP 8565A always displays the value of the reference line with LEDs in the CRT bezel and at the reference level control. Changes in RF, IF gain, and preselector loss are automatically included. In addition, flat frequency response ensures accuracy for relative as well as absolute power measurements.

#### Wide Dynamic Range

Internal preselection (1.7 to 22 GHz) enables you to measure distortion products as much as 100 dB down. Even for closely spaced signals or measurements below 1.7 GHz, all distortion products are more than 70 dB down. In either case, maximum dynamic range is ensured even for 1 watt signals with the 70 dB input attenuator. An input limiter (0.01 to 1.8 GHz) and the internal preselector (1.7 to 22 GHz) enable the HP 8565A to withstand RF signals up to +30 dBm for all input attenuator settings.

#### Designed for Convenience

Coupled controls allow you to make most measurements in 3 simple steps. Green color coded keys preset the HP 8565A for normal operation so a measurement only requires that you tune to a signal, select a desired span, and raise it to the reference level. Automatically selected sweep times ensure a calibrated display for all combinations of frequency span, resolution bandwidth and video filtering.

The CRT bezel LEDs display all pertinent control settings to give you all the information needed for signal evaluations in one central location. These data are also captured in CRT photos.

### HP 8444A Option 059 Tracking Generator

Make swept frequency response measurements to  $\pm 1.7$  dB from 10 to 1300 MHz ( $\pm 2.7$  dB up to 1500 MHz) with greater than 90 dB of dynamic range. The output is absolutely calibrated at 0 dBm and continuously variable to  $< -10$  dBm. The frequency of unknown signals as well as the frequency of any point on the frequency response curve can be measured from the external counter output using the low-cost HP 5300/5305B Counter.

### HP 8750A Storage-Normalizer

The analyzer is made even easier to use with the digital storage of the HP 8750A because there is no need to re-adjust intensity or persistence as the sweep time changes. With the push of a button, a signal can be frozen on the CRT and then compared directly to the current input signal. Traces can also be compared arithmetically (i.e., normalized) to automatically remove frequency response variations. This is especially useful when used with the HP 8444A Opt. 059 Tracking Generator.

### HP 8565A Specifications

#### Frequency Specifications

**Frequency range:** 0.01 to 22 GHz with internal mixer, 14.5 to 40 GHz with HP 11517A External Mixer. Extendable to 220 GHz with other commercially available mixers and using signal ID as in Application Note 150-14.

#### Tuning Accuracy (digital frequency readout in any span mode)

**Internal mixing:** 0.01 to 2.5 GHz  $< \pm(5$  MHz +20% of Frequency Span/Div.); 2.5 to 22 GHz  $< \pm(0.2\%$  of center frequency + 20% of Frequency Span/Div.).

**External mixing:** 14.5 to 40 GHz  $< \pm(0.7\%$  of center frequency + 20% of Frequency Span/Div.).

#### Frequency Spans

**1.7 to 22 GHz:** multiband span from 1.7 to 22 GHz in one sweep.

**Full band:** displays spectrum of entire band selected.

**Per division:** eighteen calibrated spans from 1 kHz per div. to 500 MHz per div. in a 1, 2, 5 sequence, plus a full band span, "F".

**Span width accuracy:** the frequency error for any two points on the display for spans from 500 MHz/div to 20 kHz/div (un-stabilized) is less than  $\pm 5\%$  of the indicated separation; for stabilized spans 100 kHz/div and less, the error is less than  $\pm 15\%$ .

**Zero span:** analyzer becomes a manually tuned receiver.





## Spectral Resolution and Stability

**Resolution bandwidths:** resolution (3 dB) bandwidths from 1 kHz to 3 MHz in 1, 3 sequence. Bandwidth and span width are independently variable or may be coupled for optimum display when control markers are aligned (▶◀).

**Resolution bandwidth accuracy:** 3 dB points  $\leq \pm 15\%$ .

**Selectivity (60 dB/3 dB bandwidth ratio):**  $< 15:1$ .

**Stability:** total residual FM (fundamental mixing 0.01 to 4.1 GHz): stabilized,  $< 200$  Hz p-p in 0.1 s; unstabilized  $< 10$  kHz p-p in 0.1 s.

**Stabilization range:** first LO automatically stabilized for frequency spans 100 kHz/div or less. First LO residual FM typically 30 Hz p-p when stabilized.

**Noise sidebands:**  $> 70$  dB down,  $> 30$  kHz from center of CW signal in a 1 kHz Res. Bandwidth and a 10 Hz (0.01 x) Video Filter.

## Amplitude Specifications

### Amplitude Range – Internal Mixer

#### Measurement Range

**Total power:**  $+30$  dBm (1 watt).

**Damage levels** (50  $\Omega$  nominal source impedance):

**dc:** 0 V with 0 dB input atten,  $\pm 7$  V with  $\geq 10$  dB input atten.

**ac:** 0 V with 0 dB input atten, 10 V peak with  $\geq 10$  dB input atten.

**RF** (signals above 10 MHz):  $+ 30$  dBm for any attenuator setting.

**Gain compression:**  $< 1$  dB for 0 dBm input level with 0 dB attenuation.

**Average noise level:** see table below for max. avg. noise level with 1 kHz Res. Bandwidth (0 dB atten and 3 Hz video filter).

Frequency Band (GHz)	First IF in MHz	Harmonic Mode	Noise Level (dBm)	Frequency Response* ( $\pm$ dB MAX)
0.01-1.8	2050	1-	-112	1.2
1.7-4.1	321.4	1-	-109	1.7
3.8-8.5	321.4	2-	-103	2.5
5.8-12.9	321.4	3-	-94	2.5
8.5-18	321.4	4+	-87	3.5
10.5-22	321.4	5+	-75	4.5

\*Frequency response includes input attenuator, preselector and mixer frequency response plus mixing mode gain variation (band to band).

### Amplitude Range - HP 11517A External Mixer

**Measurement range:** saturation (gain compression  $< 1$  dB),  $-15$  dBm. Damage level  $> +10$  dBm.

**Sensitivity** (average noise level in a 10 kHz IF bandwidth): 14.5-18 GHz  $< -80$  dBm, 18-26.5 GHz  $< -70$  dBm, 26.5-40 GHz  $< -60$  dBm. Typical sensitivity is 10 dB better for each band.

**> 40 GHz:** for signal analysis above 40 GHz with commercially available mixers see Application Note 150-14.

#### Reference Level

**Reference level range**  $+70$  dBm ( $+30$  dBm max. input) to  $-102$  dBm in 10 dB steps and continuous 0 to  $-12$  dB calibrated vernier.

**Reference level accuracy:** the Auto Sweep setting of the sweep time/div control insures a calibrated display within these limits:

**Calibrator output (100 MHz  $\pm$  10 kHz):**  $-10$  dBm  $\pm 0.3$  dB.

**Reference level variation (input attenuator at 0 dB, 20° to 30° C):** 10 dB steps  $< \pm 0.5$  dB (0 to  $-70$  dBm);  $< \pm 1.0$  dB (0 to  $-90$  dBm).

**Vernier (0 to  $-12$  dB)** continuous: maximum error  $< 0.5$  dB.

**Input attenuator:** (at preselector input, 0-70 dB in 10 dB steps).

**Step size variation:**  $< \pm 1.0$  dB, 0.01 to 18 GHz;  $< \pm 1.5$  dB, 0.01 to 22 GHz.

**Maximum cumulative error over the 0 to 60 dB range:**  $< \pm 2.4$  dB, 0.01 to 18 GHz, 0 to 60 dB;  $< \pm 2.5$  dB, 0.01 to 22 GHz, 0 to 40 dB.

**Frequency response:** see table above.

**Switching between bandwidths:** 3 MHz to 1 kHz,  $\pm 1.0$  dB

#### Calibrated Display Range

**Log:** (expanded from reference level down): 70 dB 10 dB/div, 40 dB 5 dB/div, 16 dB 2 dB/div and 8 dB 1 dB/div.

**Linear:** full scale from 1.8  $\mu$ V ( $-102$  dBm in 50  $\Omega$  to 707 volts ( $+70$  dBm) in 10 dB steps and continuous 0 to  $-12$  dB vernier.

#### Display Accuracy

**Log:**  $< \pm 0.1$  dB/dB, but  $< \pm 1.5$  dB over full 70 dB display range.

**Linear:**  $< \pm 3\%$  of reference level.

**Residual responses (no signal present at input):** with 0 dB input atten, fundamental mixing (0.01 to 4.1 GHz)  $< -90$  dBm.

**Signal identifier:** available from 10 MHz to 40 GHz and in all Freq. Span/Div settings for signal identification.

### Signal Input Characteristics

**Input impedance:** 50 ohm nominal, 0.01 to 22 GHz.

**Input connector:** precision Type N female.

#### Input SWR

**Input attenuator at 0 dB:**  $< 1.5$ , 0.01 to 1.8 GHz;  $< 2.0$ , 1.7 to 22 GHz.

**Input attenuator at  $\geq 10$  dB:**  $< 1.3$ , 0.01 to 1.8 GHz;  $< 2.0$ , 1.7 to 22 GHz.

**LO Emission (2.00 to 4.46 GHz):**  $-50$  dBm, 0.01 to 1.8 GHz;  $-85$  dBm, 1.7 to 22 GHz.

#### Input Protection (for input signals from 0.01 to 22 GHz)

**0.01 to 1.8 GHz frequency band:** internal diode limiter.

**1.7 to 22 GHz frequency bands:** saturation of YIG filter (pre-selector) occurs at total input signal power levels below input mixer damage.

**External mixer input:** BNC female connector is a port for LO power transfer, bias current and IF return.

### Sweep Specifications

#### Sweep Time

**Auto:** sweep time is automatically controlled by Frequency Span/Div, Resolution Bandwidth and Video Filter controls to maintain an absolute amplitude calibrated display.

**Calibrated sweep times:** 21 internal sweep times from 2  $\mu$ s/div to 10 s/div in 1, 2, 5 sequence.

### Display Characteristics

**Cathode Ray Tube (aluminized P31 phosphor, 8  $\times$  10 div internal graticule)**

#### Persistence

**Conventional:** natural persistence of P31 phosphor.

**Write:** continuously adjustable from 0.2 s to full storage.

**Storage time:** continuously adjustable from 1 minute (full brightness) to  $> 30$  minutes (minimum brightness).

**Write speed:** continuously adjustable to vary CRT sensitivity to capture large signal deflections in fast sweeps.

**CRT Bezel readout:** bezel LEDs display the following measurement data (included in CRT photographs taken with the HP 197B Opt 001, 006 Oscilloscope Camera): Ampl. Scale Factor, Ref. Level, Input Atten., Res. Bandwidth, Sweeptime/Div., Freq., Freq. Span/Div.

### General Specifications

**Temperature range:** operating 0°C to 55°C, storage  $-40^\circ$  to  $+75^\circ$ C.

**Humidity range (operating):**  $< 95\%$  R.H. 0°C to 40°C.

**EMI:** Conducted and radiated interference is in compliance with MIL-STD 461A Methods CE03 and RE02, CISPR publication 11 (1975), and Messemppaenger-Postverfuegung 526/527/79 (Kennzeichnung Mit F-Nummer/Funkschutzzeichen).

**Power requirements:** 48-66 Hz; 100, 120, 200 or 240 volts ( $-10\%$  to  $+5\%$ ); 220 VA max (400 Hz operation available as Opt 400).

**Size:** 188 H x 426 W x 552 mm D (7" x 16.8" x 21.8").

**Weight:** net 29.5 kg (64 lb). Shipping 39 kg (85 lb).

#### Standard Options Available

**Opt 100, 100 and 300 Hz resolution bandwidths:** adds 100 Hz and 300 Hz resolution bandwidths with 11:1 shape factor, residual FM  $< 100$  Hz when stabilized and improves sensitivity by 10 dB.

**Opt 200—Calibration in dB $\mu$ V**

**Opt 400—400 Hz Power Supply**

**HP Part No. 1540-0654 - Transit Case.** Order HP Part No. 1490-0913 also for castors.

#### Ordering Information

HP 8565A Spectrum Analyzer

**Opt 100:** 100 Hz and 300 Hz Resolution Bandwidths

**Opt 200:** Calibration in dB $\mu$ V

**Opt 400:** Internal 50 to 400 Hz Power Supply

**Opt 908:** Rack Flange Kit

**Opt 910:** Extra Operating and Service Manual

**Opt 913:** Rack Flange Kit for instruments with handles

HP 11517A External Mixer (taper section req'd)

HP 11518A Taper Section, 12.4 to 18 GHz

HP 11519A Taper Section, 18 to 26.5 GHz

HP 11520A Taper Section, 26.5 to 40 GHz

HP 8444A Opt 059 Tracking Generator, 10 to 1500 MHz

HP 8750A Storage-Normalizer

# SIGNAL ANALYZERS

## Spectrum Analyzer, 0.01 to 350 MHz



### Models 8557A/853A

- Rugged portability
- Simple, three knob operation
- Direct plotter control

- Display annotation and storage accessories
- Digital display with trace arithmetic
- Resolution bandwidths from 1 kHz to 3 MHz
- Optional 75  $\Omega$  input with dBm or dBmV calibration

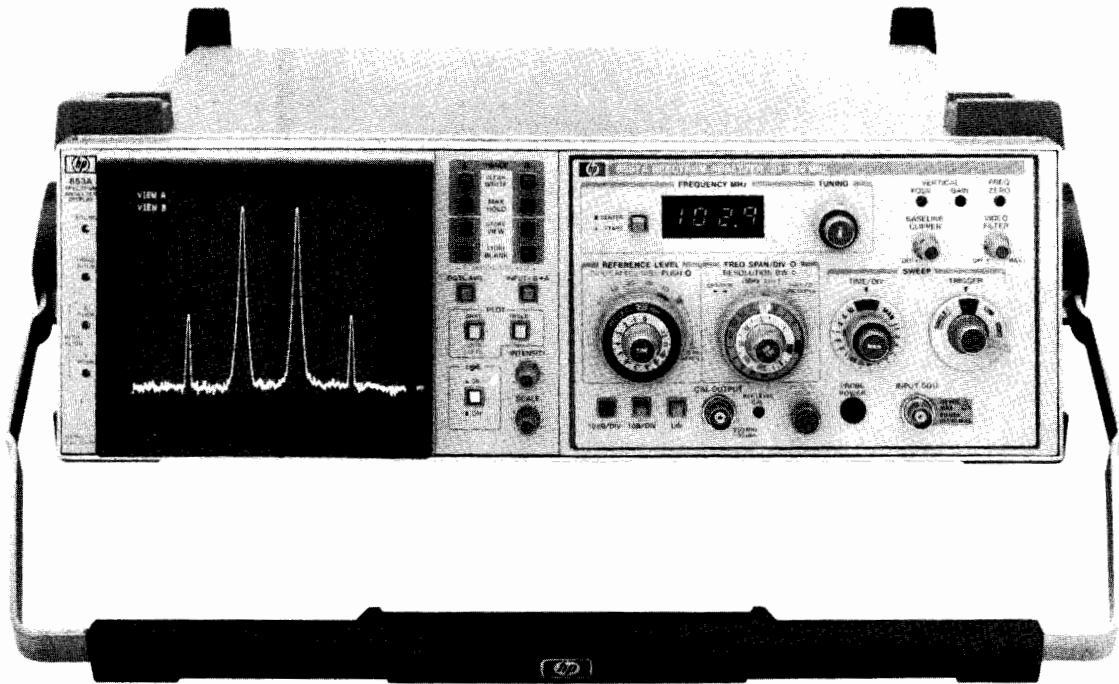

### HP 8557A Spectrum Analyzer Plug-In Performance Plus Economy

The HP 8557A is a 10 kHz to 350 MHz spectrum analyzer plug-in for use with the HP 853A or 182T display. The high performance and convenient operation of this economical unit is ideally suited for a variety of applications in production, R & D or field service measurements.

#### Simple 3-Knob Operation

Preset the HP 8557A to the color-coded, "basic-operation" settings, and use the coupled controls to make most measurements in three easy steps. Tune to the signal; the LED readout displays its frequency. Zoom-in on the signal by reducing the span width; the resolution bandwidth, video filter, and sweep time automatically change to an optimum value for a calibrated display. Then, change the reference level to bring the peak of the signal to the top of the screen for the most accurate amplitude measurement.

#### Absolute Amplitude Calibration

Signal levels can be read directly from the CRT in dBm (dBmV for Option 002) without the use of external standards or calculations. The signal level represented by the top CRT graticule line is always indicated by the reference level control, and vertical scale factors of 10 dB/div, 1 dB/div or linear can be selected.

#### Optional 75 $\Omega$ Input

Two options are available which allow measurements in 75  $\Omega$  systems. Option 001 has 75  $\Omega$  impedance, but retains the dBm power calibration. Option 002 is also 75  $\Omega$ , but the amplitude is calibrated in dBmV for measurements on systems such as CATV.

### HP 853A Spectrum Analyzer Display

#### Digital Display

The HP 853A is a digital display mainframe for use with the HP 8557A spectrum analyzer plug-in. Signals are displayed on either of two independently stored digital traces. Display processing capabilities include maximum hold, digital averaging, and trace normalization for extended measurement capability. A built-in microprocessor manages the display operation and provides built-in test routines for display calibration and test (accessible via the front panel).

#### HP-IB Capability Includes Direct Plotter Control

A hard-copy record of the displayed traces and graticule can be made on a digital plotter via HP-IB by simply using the HP 853A's

frontpanel pushbuttons; a controller is not required. Although the analyzer controls are not programmable, some HP-IB capabilities include using a controller for recording trace data or for operator prompts on the HP 853A CRT. The digital display and processing functions can be remotely programmed, and analyzer sweeps can be initiated via HP-IB.

#### Two Configurations

The display is offered in two styles. The HP 853A (pictured) is a ruggedized, portable mainframe complete with tilt-bail handle and drip proof, protective front cover. The HP 853A is ideally suited for rugged, field service environments and any areas where system mobility is required. The HP 853A Option 001 offers the digital display in a full module bench or rack mount configuration.

#### Software

The Solid State Camera Software, which runs on the HP 75D Portable Computer, provides a low cost, portable alternative to CRT photos. One program, "Camera", allows the user to permanently store spectrum analyzer display traces along with display annotations. After being stored in the computer's memory or on magnetic card or tape, the display information can later be recalled for viewing on the HP 853A display or for making hard copies with a plotter. Another program, "Limitgen", allows test limit lines to be drawn on the HP 853A display. For more details, see page 608 in the HP 8559A Spectrum Analyzer section.

### HP 8557A Specifications

#### Frequency Specifications

**Frequency range:** 0.01 to 350 MHz.

#### Frequency Spans

**Full band:** displays entire spectrum, 0.01 to 350 MHz.

**Per division:** 5 kHz to 20 MHz/div in a 1, 2, 5 sequence.

**Zero span:** analyzer functions as a manually tuned receiver.

#### Frequency Accuracy

**Tuning accuracy:**  $\pm$  (3 MHz + 10% of frequency span per division).

**Frequency span accuracy:**  $\pm$ 10% of displayed frequency separation.

#### Spectral Resolution

**Resolution bandwidths:** eight selectable resolution (3-dB) bandwidths from 1 kHz to 3 MHz in a 1, 3 sequence. Bandwidth and frequency span are independently variable or may be coupled for optimum display when control markers are aligned (▶◀).



**Resolution bandwidth accuracy:** 3-dB points are  $\pm 20\%$  ( $+10^\circ$  to  $+40^\circ\text{C}$ ).

**Selectivity:** (60-dB/3-dB bandwidth ratio)  $< 15:1$ .

#### Spectral Stability

**Residual FM:**  $< 1$  kHz p-p in 0.1 second.

**Noise sidebands:**  $\geq 75$  dB down,  $> 50$  kHz from center of CW signal with 1 kHz resolution bandwidth and full video filtering.

#### Amplitude Specifications

**Amplitude range:**  $-117$  dBm to  $+20$  dBm.

#### Maximum Input (safe) Levels

**Total power:**  $+20$  dBm (100 mW, 2.24 Vrms).

**Voltage:**  $\pm 30$  Vdc or 30 V RMS ( $< 100$  Hz).

**Gain compression:** typically  $< 1$  dB for  $-10$  dBm signal, 0 dB input attenuation.

**Average noise level:**  $< -107$  dBm with 10 kHz resolution bandwidth, 0 dB input attenuation, and maximum (MAX) video filtering.

#### Calibrated Display Range

**Log:** 70 dB with 10 dB/div scale; 8 dB with 1 dB/div scale.

**Linear:** 8 divisions with linear (LIN) amplitude scale.

#### Amplitude Accuracy

**Calibrator:**  $-30$  dBm  $\pm 1$  dB (into 50  $\Omega$ ), 250 MHz  $\pm 50$  kHz.

**Reference level:** 10 dB steps and a 12 dB vernier for calibrated adjustment from  $-112$  dBm to  $+40$  dBm<sup>1</sup>.

**Step accuracy (with 0 dB input attenuation):**  $-10$  to  $-80$  dBm:  $\pm 0.5$  dB;  $-10$  to  $-100$  dBm:  $\pm 1.0$  dB.

**Vernier accuracy:**  $\pm 0.5$  dB.

**Frequency response:**  $\leq \pm 0.75$  dB with 10 dB input attenuation (includes input attenuator and mixer flatness).

**Input attenuator:** 0 to 50 dB, selectable in 10 dB steps.

**Step accuracy:**  $\leq \pm 0.5$  dB per 10 dB step.

**Maximum cumulative error:**  $\leq \pm 1.0$  dB.

#### Bandwidth Switching (amplitude variation)

**3 MHz to 300 kHz:**  $\leq \pm 0.5$  dB.

**3 MHz to 1 kHz:**  $\leq \pm 1.0$  dB.

#### Display Fidelity

**Log incremental accuracy:**  $\pm 0.1$  dB/dB from Reference Level.

**Log maximum cumulative error:**  $\leq \pm 1.5$  dB over 70 dB range.

**Linear accuracy:**  $\pm 3\%$  of Reference Level.

#### Spurious Responses

**Second harmonic distortion:**  $> 70$  dB below a  $-40$  dBm signal ( $> 1$  MHz) with 0 dB input attenuation;  $> 60$  dB below for signals 20 kHz to 1 MHz.

**Third order intermodulation distortion:**  $> 70$  dB below two  $-40$  dBm input signals ( $> 1$  MHz) separated by  $\geq 50$  kHz and with 0 dB input attenuation;  $> 60$  dB below for signals 10 kHz to 1 MHz.

**Image and multiple responses:**  $> 70$  dB below a  $-40$  dBm input signal ( $> 1$  MHz) with 0 dB input attenuation;  $> 60$  dB below for signals 20 kHz to 1 MHz.

**Residual responses:**  $< -100$  dBm with 0 dB input attenuation and no signal present at input.

#### Sweep Characteristics

##### Sweep Time

**Automatic:** sweep time is automatically adjusted to maintain absolute amplitude calibration for any combination of frequency span, resolution bandwidth, and video filter bandwidth.

**Calibrated sweep times:** 0.1 msec to 10 sec/div in 1, 2, 5 sequence with  $\pm 10\%$  typical accuracy.

**Manual sweep:** spectrum analyzer may be swept manually in either direction with front panel control.

#### Signal Input Characteristics

**Input impedance:** 50  $\Omega$  nominal; type BNC female connector.

**Input SWR:** typically  $< 1.5$  with  $\geq 10$  dB input attenuation.

#### Output Characteristics

**Probe power:**  $+15$  V,  $-12.6$  V, and GND (150 mA max). Use HP 1120A, 1121A, or 1124A high impedance probes.

## HP 853A Characteristics

### Digital Display

**Traces:** dual trace, digitally stored display with resolution of 481 horizontal by 801 vertical points for each trace.

**Signal processing:** maximum hold, digital averaging, and trace normalization.

**Internal service routines:** front panel pushbuttons access test rou-

ties to perform maintenance of digital hardware.

## HP-IB

**Direct plotter control:** all displayed information can be transferred to an HP-IB plotter with front panel pushbuttons.

### Controller Interface Functions

**Trace data transfer:** all trace data values can be transferred to or from the HP 853A with a controller.

**Input messages:** controller input instructions or annotation can be displayed on either of two 60 character lines.

**Display control:** all trace processing functions can be remotely controlled.

**Sweep control:** analyzer sweeps can be initiated and monitored.

**HP-IB Interface Functions<sup>2</sup>:** SH1, AH1, T5, L4, SR1, RL1, PP0, DC1, DT1, C0, and E2.

## Output Characteristics (Rear Panel)

**Vertical output, AUX A:** BNC output (50  $\Omega$ ) provides detected video from 0 to 0.8 V for 8 divisions deflection on CRT display.

**Penlift/blanking, AUX B:** BNC output provides 0V pen down/unblanking signal at low impedance; 15V penlift/blanking at 10 k $\Omega$  impedance.

**21.4 MHz IF output, AUX C:** BNC output (50  $\Omega$ ) provides a signal which is proportional to the RF input. Level is about  $-10$  dBm (into 50  $\Omega$ ) with a signal displayed at the Reference Level. Output is controlled by settings of Resolution BW, Input Atten, and Reference Level.

**Horizontal output, AUX D:** BNC output (5 k $\Omega$ ) provides horizontal sweep from  $-5$  V to  $+5$  V for full 10 division CRT horizontal deflection.

**HP-IB interface port:** 24 pin connector provides digital interface for IEE 488-1978 standard parallel bus.

## General

### General Specifications

**HP 182T compatibility:** the HP 8557A Spectrum Analyzer is compatible with the HP 182T and 853A displays. The HP 182T is a normal persistence, cabinet style display which provides non-buffered, rear panel, auxiliary outputs (for unattenuated vertical, horizontal, and penlift outputs). However, the HP 182T does not offer the digital display, HP-IB and direct plotter control, or the portability features of the HP 853A.

**Temperature range:** operating  $0^\circ$  to  $+55^\circ\text{C}$ ; storage  $-40^\circ$  to  $+75^\circ\text{C}$ .

**EMI:** conducted and radiated interference is within requirements of Methods CE03 and RE02 of MIL-STD 461A, CISPR Publication 11 (1975), and Messempfaenger Postverfuegung 526/527/79 (Kennzeichnung Mit F-Nummer/Funkschutzzeichen).

**Power:**  $< 200$  VA with display, 48 to 440 Hz (48 to 66 Hz at 220 or 240 Vac); with HP 853A: 100, 120, 220, or 240 Vac,  $+5\%$ ,  $-10\%$ ; with HP 182T: 115 or 230 Vac,  $\pm 10\%$ .

### Weight

**HP 8557A:** net, 5.0 kg (10 lb). Shipping 8.5 kg (18 lb).

**HP 853A:** net, 15.9 kg (35 lb). Shipping 18.6 kg (41 lb).

**HP 853A Opt 001:** net, 14.5 kg (32 lb). Shipping, 17.3 kg (38 lb.)

### Size

**HP 853A/8557A:** 158.8 H x 501.7 W x 524.5 mm D (6.25" x 19.75" x 20.65").

**HP 853A Opt 001/8557A:** 133 H x 425.5 W x 473.3 mm D (5.25" x 16.75" x 18.65").

## Ordering Information

**HP 8557A Spectrum Analyzer**

**Opt 001:** 75 ohm input, dBm calibration

**Opt 002:** 75 ohm input, dBmV calibration

**Opt 910:** Extra Operation and Service Manual

**HP 853A Portable Spectrum Analyzer Display**

**Opt 001:** Full Module Bench/Rack Configuration

**Opt 910:** Extra Operation and Service Manual

**Solid State Camera Software:** HP part no. 75-00853

**HP 182T Cabinet Style, Normal Persistence Display**

<sup>1</sup> Input not to exceed maximum levels.

<sup>2</sup> A simple modification is required for HP 8557A plug-ins with serial prefix 2106A and lower (modification kit, HP part number 00853-60057).

<sup>3</sup> For more on these codes refer to the HP-IB section of this catalog.



# SIGNAL ANALYZERS

## Spectrum Analyzer, 0.1 to 1500 MHz

### Models 8558B/853A & 8444A Option 059

- Rugged portability
- Simple three knob operation
- Direct plotter control
- Display annotation and storage accessories
- Digital display with trace arithmetic
- Resolution bandwidths from 1 kHz to 3 MHz
- 0.5 to 1500 MHz tracking generator available
- Optional 75  $\Omega$  input with dBm or dBmV calibration

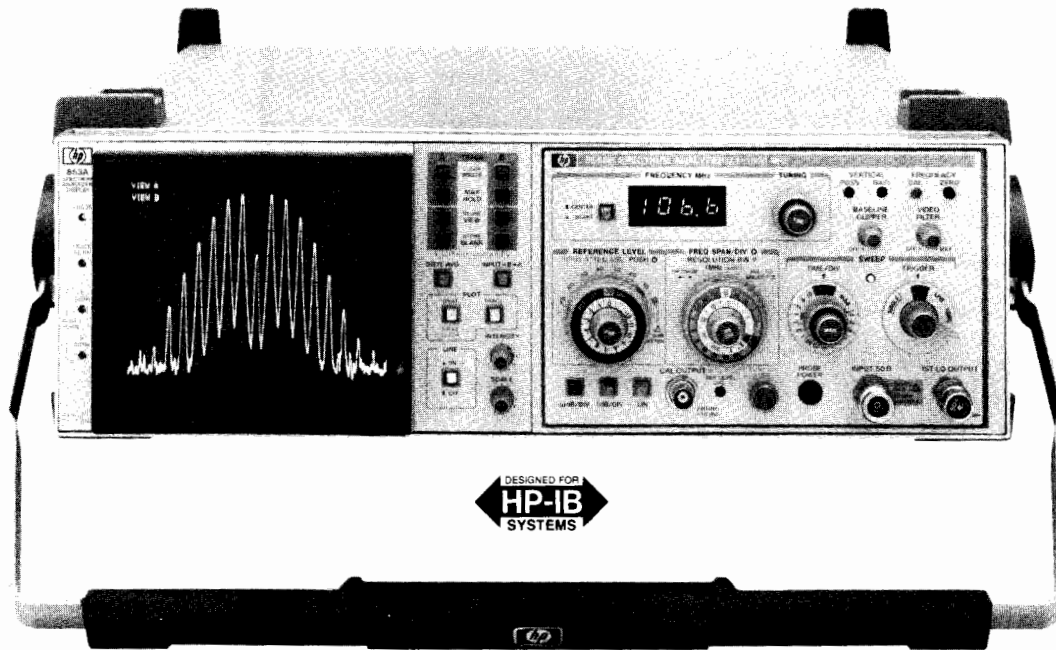

HP 8444A Opt. 059

## HP 8558B Spectrum Analyzer Plug-In

### Performance Plus Economy

The HP 8558B is a 100 kHz to 1500 MHz spectrum analyzer plug-in for use with the HP 853A or 182T display. The high performance and convenient operation of this economical unit is ideally suited for a variety of applications in production, R&D or field service measurements.

### Simple, 3-knob Operation

Preset the HP 8558B to the color coded, "basic-operation" settings, and use the coupled controls to make most measurements in three easy steps. Tune to the signal; the LED readout displays its frequency. Zoom-in on the signal by reducing the span width; the resolution bandwidth, video filter, and sweep time automatically change to an optimum value for a calibrated display. Then, change the reference level to bring the peak of the signal to the top of the screen for the most accurate amplitude measurement.

### Absolute Amplitude Calibration

Signal levels can be read directly from the CRT in dBm (dBmV for Option 002) without the use of external standards or calculations. The signal level represented by the top CRT graticule line is always indicated by the reference level control, and vertical scale factors of 10 dB/div, 1 dB/div, or linear can be selected.

### Optional 75 Ohm Input

Two options are available which allow measurements in 75 ohm systems. Option 001 has 75  $\Omega$  impedance but retains the dBm power calibration. Option 002 is also 75  $\Omega$ , but the amplitude is calibrated in dBmV for measurements on systems such as CATV.

### EMI Option H98

A hardware modification to the HP 8558B extends the low-frequency coverage to 10 kHz, calibrates the display in dB $\mu$ V, and provides resolution filters with 6-dB bandwidths of 9 kHz and 120 kHz. With these enhancements, the HP 8558B is useful for FCC and VDE emission testing.

## EMI Measurement System Option E98

A portable, semi-automatic EMI measurement system is provided by combining HP 8558B Option H98 (above) with HP 853A computer accessories and software (see the "Software" section below). The system consists of HP 8558B Option H98, HP 853A Display, HP 75D Portable Computer, HP 82700A Memory Module, HP 82169A Interface, HP 82161A Cassette Drive, HP 82176A Cassettes, HP 82715A Card Holders, and Solid State Camera Software with user's manual (HP part number 75-00853). The following is a plot of test results with limit lines for an actual EMI test using Option E98:

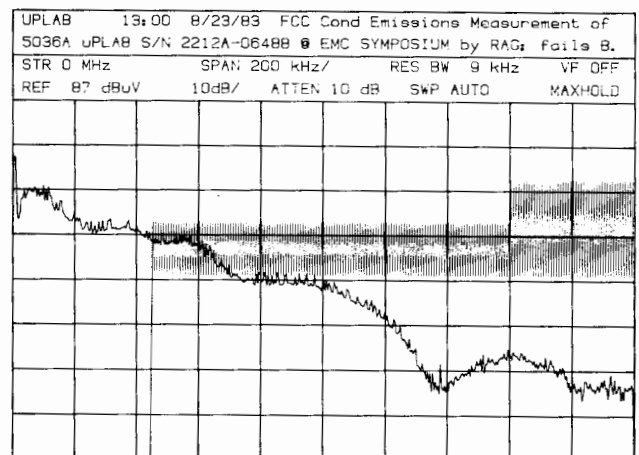

## HP 8444A Option 059 Tracking Generator (0.5-1500 MHz)

Make swept frequency response measurements from 0.5 to 1500 MHz with greater than 90 dB of dynamic range. The output is absolutely calibrated at 0 dBm and continuously variable to -10 dBm. Frequency of an unknown signal, as well as any point on a frequency response curve, can be measured by using the external counter output and a frequency counter such as the HP 5300B/5305B.



## HP 853A Spectrum Analyzer Display

### Digital Display

The HP 853A is a digital display mainframe for use with the HP 8558B Spectrum Analyzer plug-in. Signals are displayed on either of two independently stored digital traces. Display processing capabilities include maximum hold, digital averaging, and trace normalization for extended measurement capability. A built-in microprocessor manages the display operation and provides built-in test routines for display calibration and test (accessible via the front panel).

### HP-IB Capability Includes Direct Plotter Control

A hardcopy record of the displayed traces and graticules can be made on an HP-IB digital plotter by simply using the HP 853A's front-panel pushbuttons; a controller is not required. Although analyzer controls are not programmable, some HP-IB applications include using a controller for recording trace data or for placing operator prompts on the HP 853A CRT. The digital display and processing functions can be remotely programmed, and analyzer sweeps can be initiated via HP-IB.

### Two Configurations

The display is offered in two styles. The HP 853A (pictured) is a ruggedized, portable mainframe complete with tilt-bail handle and drip-proof, protective front cover. The HP 853A is ideally suited for rugged, field environments and any areas where system mobility is required. The HP 853A Option 001 offers the digital display in a full module bench or rack mount configuration.

### Software

The Solid State Camera Software provides a low cost, portable alternative to CRT photos. One program, "Camera", allows permanent storage of spectrum analyzer display traces along with display annotations. Another program, "Limitgen", allows test limit lines to be drawn on the HP 853A display. For more details, see page 608 in the HP 8559A Spectrum Analyzer section.

## HP 8558B Specifications

### Frequency Specifications

**Frequency range:** 0.1 to 1500 MHz.

### Frequency Spans

**Per division:** 5 kHz to 100 MHz/div in a 1, 2, 5 sequence.

**Zero span:** analyzer functions as a manually tuned receiver.

### Frequency Accuracy

**Tuning accuracy:** (+10°C to +40°C)

**0-195 MHz:**  $\pm(1 \text{ MHz} + 20\% \text{ frequency span per division})$ .

**195-1500 MHz:**  $\pm(5 \text{ MHz} + 20\% \text{ frequency span per division})$ .

**Frequency span accuracy:**  $\pm 5\%$  of displayed frequency separation.

### Spectral Resolution

**Resolution bandwidths:** eight selectable resolution (3-dB) bandwidths from 1 kHz to 3 MHz in a 1, 3 sequence. Bandwidth and frequency span are independently variable or may be coupled for optimum display when control markers are aligned (▶◀).

**Resolution bandwidth accuracy:** 3-dB points are  $\pm 20\%$  (+10° to +40°C).

**Selectivity:** (60-dB/3-dB bandwidth ratio)  $< 15:1$ .

### Spectral Stability

**Residual FM:**  $< 1 \text{ kHz p-p}$  in 0.1 second.

**Noise sidebands:**  $\geq 65 \text{ dB}$  down,  $\geq 50 \text{ kHz}$  from center of CW signal with 1 kHz resolution bandwidth and full video filtering.

### Amplitude Specifications

**Amplitude range:** -117 to +30 dBm.

### Maximum Input (safe) Levels

**Total power:** +30 dBm (1W, 7.1 Vrms).

**Voltage:**  $\pm 50 \text{ V dc}$  or  $50 \text{ V RMS}$  ( $< 100 \text{ Hz}$ ).

**Peak pulse power:** +50 dBm (100W,  $< 10 \mu\text{s}$  pulse width, 0.01% duty cycle) with  $\geq 20 \text{ dB}$  input attenuation.

**Gain compression:** typically  $< 1 \text{ dB}$  for -10 dBm signal, 0 dB input attenuation.

**Average noise level:**  $< -107 \text{ dBm}$  with 10 kHz resolution bandwidth, 0 dB input attenuation, and video filter at MAX.

### Calibrated Display Range

**Log:** 70 dB with 10 dB/div scale; 8 dB with 1 dB/div scale.

**Linear:** 8 divisions with linear (LIN) amplitude scale.

### Amplitude Accuracy

**Calibrator:** -30 dBm  $\pm 1 \text{ dB}$  (into 50  $\Omega$ ), 280 MHz  $\pm 300 \text{ kHz}$ .

**Reference level:** 10 dB steps and a 12 dB vernier for calibrated adjustment from -112 dBm to +60 dBm.<sup>1</sup>

**Step accuracy (with 0 dB input attenuation):** -10 to -80 dBm:  $\pm 0.5 \text{ dB}$ ; -10 to -100 dBm:  $\pm 1.0 \text{ dB}$ .

**Vernier accuracy:**  $\pm 0.5 \text{ dB}$ .

**Frequency response:**  $\leq \pm 1.0 \text{ dB}$  with 10 dB input attenuation (includes input attenuator, mixer flatness, and internal limiter).

**Input attenuator:** 0 to 70 dB, selectable in 10 dB steps.

**Step accuracy:**  $< \pm 0.5 \text{ dB}$  per 10 dB step.

**Maximum cumulative error:**  $< \pm 1.0 \text{ dB}$ .

### Bandwidth Switching (amplitude variation)

**3 MHz to 300 kHz:**  $< \pm 0.5 \text{ dB}$ .

**3 MHz to 1 kHz:**  $< \pm 1.0 \text{ dB}$ .

### Display Fidelity

**Log incremental accuracy:**  $\pm 0.1 \text{ dB/dB}$  from Reference Level.

**Log maximum cumulative error:**  $\leq \pm 1.5 \text{ dB}$  over 70 dB range.

**Linear accuracy:**  $\pm 3\%$  of Reference Level.

### Spurious Responses

**Second harmonic distortion:**  $> 70 \text{ dB}$  below a -40 dBm input signal with 0 dB input attenuation;  $> 60 \text{ dB}$  below for signals 100 kHz to 5 MHz.

**Third order intermodulation distortion:**  $> 70 \text{ dB}$  below two -30 dBm input signals ( $> 5 \text{ MHz}$ ) separated by  $\geq 50 \text{ kHz}$  and with 0 dB input attenuation;  $> 60 \text{ dB}$  below for signals 100 kHz to 5 MHz.

**Image and multiple responses:**  $> 70 \text{ dB}$  below a -40 dBm input signal ( $> 5 \text{ MHz}$ ) with 0 dB input attenuation;  $> 60 \text{ dB}$  below for signals 100 kHz to 5 MHz.

**Residual responses:**  $< -100 \text{ dBm}$  with 0 dB input attenuation and no signal present at input.

## Sweep Characteristics

### Sweep Time

**Automatic:** sweptime is automatically adjusted to maintain absolute amplitude calibration for any combination of frequency span, resolution bandwidth, and video filter bandwidth.

**Calibrated sweep times:** 0.1 ms to 10 sec/div in 1, 2, 5 sequence with  $\pm 10\%$  typical accuracy.

**Manual sweep:** spectrum analyzer may be swept manually in either direction with front panel control.

## Signal Input Characteristics

**Input impedance:** 50  $\Omega$  nominal; precision Type-N female connector.

**Input SWR:** typically  $< 1.5$  with  $\geq 10 \text{ dB}$  input attenuation.

## Output Characteristics

**1st LO output:** BNC output provides +10 dBm nominal signal (into 50  $\Omega$ ), 2.05 to 3.55 GHz.

**Probe power:** +15 V, -12.6V, and GND (150 mA max). Use HP 1120A, 1121A, 1123A, or 1124A high impedance probes.

## HP 853A Characteristics

For more information on the HP 853A Display, see page 605 in the HP 8557A Spectrum Analyzer section.

## General

### General Specifications

For information on HP 182T compatibility, temperature range, EMI compliance, and power requirements, see page 605 in the HP 8557A Spectrum Analyzer section.

### Weight

**HP 8558B:** net, 5.5 kg (12 lb). Shipping 10.5 kg (23 lb).

**HP 853A:** net, 15.9 kg (35 lb). Shipping 18.6 kg (41 lb).

**HP 853A Opt 001:** net, 14.5 kg (32 lb.) Shipping, 17.3 kg (38 lb).

### Size

**HP 853A/8558B:** 158.8 H x 501.7 W x 524.5 mm D (6.25" x 19.75" x 20.65").

**HP 853A Opt 001/8558B:** 133 H x 425.5 W x 473.3 mm D (5.25" x 16.75" x 18.65").

## Ordering Information

**HP 8558B** Spectrum Analyzer

**Opt 001:** 75  $\Omega$  input, dBm calibration

**Opt 002:** 75  $\Omega$  input, dBmV calibration

**Opt 910:** Extra Operating and Service Manual

**Opt E98:** EMI Measurement System

**Opt H98:** EMI Option

**HP 853A** Portable Spectrum Analyzer Display

**Opt 001:** Full Module Bench/Rack Configuration

**Opt 910:** Extra Operation and Service Manual

**Solid State Camera Software:** HP part no. 75-00853

**HP 182T** Cabinet Style, Normal Persistence Display

<sup>1</sup> Input not to exceed maximum levels.

<sup>2</sup> A simple modification is required for HP 8558B plug-ins with serial prefix 2145A and lower (modification kit, HP part number 00853-60058).





# SIGNAL ANALYZERS

Spectrum Analyzer, 0.01 to 21 GHz

Models 8559A/853A

- Rugged portability
- Simple three-knob operation
- Direct plotter control
- Display annotation and storage accessories
- Digital display with trace arithmetic
- Resolution bandwidths from 1 kHz to 3 MHz
- Absolute amplitude calibration in all bands

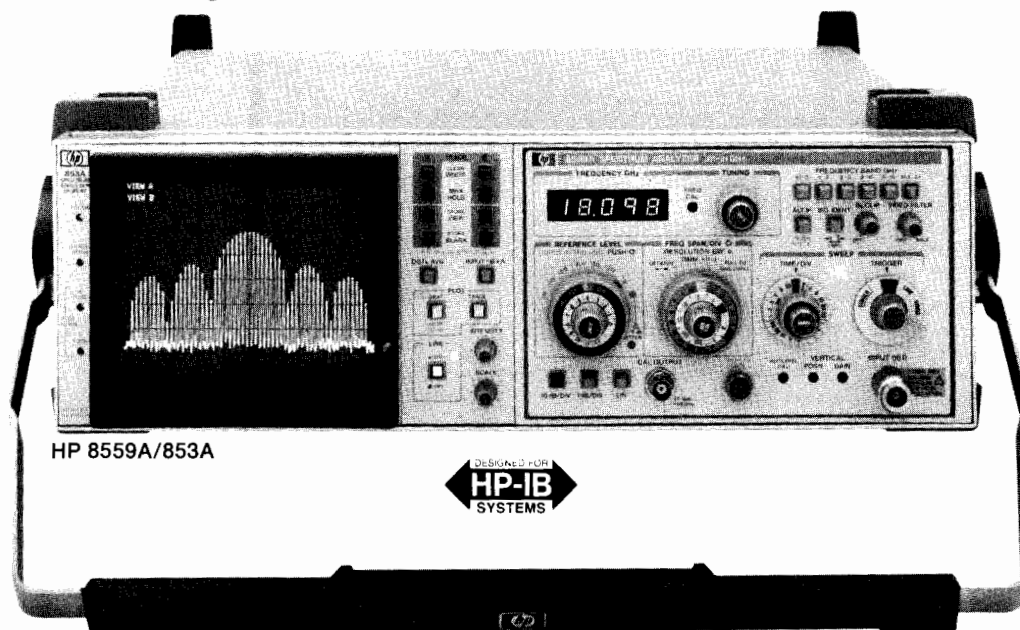

## HP 8559A Spectrum Analyzer Plug-in Performance Plus Economy

The HP 8559A is a 0.01 to 21 GHz spectrum analyzer plug-in for use with the HP 853A or 182T display. The high performance and convenient operation of this economical unit is ideally suited for a variety of applications in production, R&D or field service environments.

### Simple 3-Knob Operation

Preset the HP 8559A to the color coded, "basic operation" settings, and use the coupled controls to make most measurements in three easy steps. Tune to the signal; the LED readout displays its frequency. Zoom-in on the signal by reducing the span width; the resolution bandwidth, video filter, and sweep time automatically change to an optimum value for a calibrated display. Then, change the reference level to bring the peak of the signal to the top of the screen for the most accurate amplitude measurement. A signal identifier is available in all bands to provide assurance of correct measurements.

### Absolute Amplitude Calibration

Signal levels can be read directly in dBm from the CRT without the use of external standards or calculations. The signal level represented by the top CRT graticule line is always indicated by the reference level control, and vertical scale factors of 10 dB/Div, 1 dB/Div, or linear can be selected.

### HP 11870A Low Pass Filter (dc to 2.6 GHz)

For RF measurement applications needing extended coverage to 2.6 GHz, the HP 11870A low pass filter will reject signals above 3 GHz by more than 60 dB for image-free measurements over the entire 10 MHz to 2.6 GHz range.

## HP 853A Spectrum Analyzer Display Digital Display

The HP 853A is a digital display mainframe for use with the HP 8559A spectrum analyzer plug-in. Signals are displayed on either of two independently stored digital traces. Display processing capabilities include maximum hold, digital averaging, and trace normalization for extended measurement capability. A built-in microprocessor manages the display operation and provides access to built-in test routines for display calibration and test (accessible via the front panel).

### HP-IB Capability Includes Direct Plotter Control

A hard-copy record of the displayed traces and graticule can be made on a digital plotter via HP-IB by simply using the HP 853A's front-panel pushbuttons; a controller is not required. Although analyzer controls are not programmable, some HP-IB applications in-

clude using a controller for recording trace data or for operator prompts on the HP 853A CRT. The digital display and processing functions can be remotely programmed, and analyzer sweeps can be initiated via HP-IB.

## Two Configurations

The display is offered in two styles. The HP 853A (pictured) is a ruggedized, portable mainframe complete with tilt-bail handle and drip proof, protective front cover. The HP 853A is ideally suited for rugged, field service environments and any areas where system mobility is required. The HP 853A Option 001 offers the digital display in a full module bench or rack mount configuration.

## Software

The Solid State Camera Software provides a low cost, portable alternative to CRT photos. One program, "Camera", allows the user to annotate the display with a title and with spectrum analyzer control settings. Both trace and annotation can be permanently stored in the computer's memory (3 traces), on magnetic card (1 trace each), and on magnetic cassette (over 80 traces). After being stored, the display information can later be recalled for viewing on the HP 853A display or for making hard copies with a plotter. Another program, "Limitgen", allows test limit lines to be drawn on the HP 853A display.

The HP 853A software adds measurement capability to many spectrum analyzer applications: EMI measurements are aided by display limit line generation; FCC digital radio masks can be drawn on the display; recording spectrum analyzer display data is useful for proof-of-performance testing, electric field strength measurements, remote location testing, and communication band occupancy monitoring; and production measurements are enhanced by display comparison testing to specification lines or to ideal response shapes.

To implement the software for the HP 853A, the following parts and equipment configuration are needed (refer to other sections of this catalog for ordering and pricing information): HP 853A Spectrum Analyzer Display; HP 8557A, 8558B, or 8559A Spectrum Analyzer; HP 75D Portable Computer; HP 82700A 8k-Byte Memory Module; HP 82169A HP-IB Interface; HP 82708A Magnetic Cards; HP 82715A Card Holders; Solid State Camera Software HP part number 75-00853; HP 7470A or 7475A Plotter (optional); HP 82161A Cassette Drive (optional); and HP 82176A Cassettes (optional).



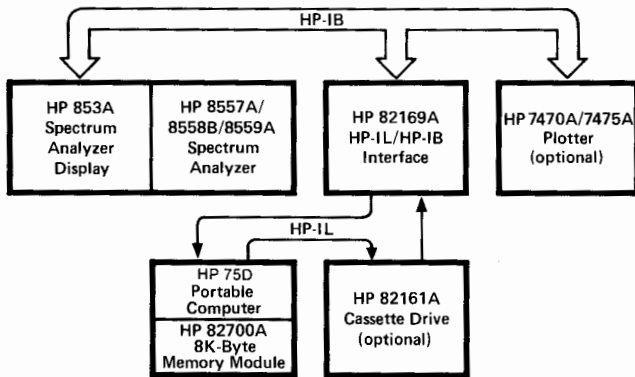

## HP 8559A Specifications

### Frequency Specifications

**Frequency range:** 0.01 to 21 GHz in six selectable ranges.

#### Frequency Spans

**Fullband:** displays entire spectrum of selected band.  
**Per division:** 10 kHz to 200 MHz/div in a 1, 2, 5 sequence.  
**Zero span:** analyzer functions as a manually tuned receiver.

#### Frequency Accuracy

**Tuning accuracy:** 0.01 to 3 GHz:  $\leq \pm(1 \text{ MHz} + 0.3\% \text{ of center frequency})$ ; 3 to 21 GHz:  $\leq \pm(5 \text{ MHz} + 0.2\% \text{ of center frequency})$ .  
**Frequency span accuracy:**  $\leq \pm 5\%$  of displayed frequency separation.

#### Spectral Resolution

**Resolution bandwidths:** eight selectable resolution (3-dB) bandwidths from 1 kHz to 3 MHz in a 1, 3 sequence. Bandwidth and frequency span are independently variable or may be coupled for optimum display when control markers are aligned (▶◀).  
**Resolution bandwidth accuracy:** 3-dB points are  $\leq \pm 15\%$  (except for 3 MHz bandwidth:  $\leq \pm 30\%$ ).

**Selectivity:** (60-dB/3-dB bandwidth ratio)  $< 15:1$

**Spectral stability:** (fundamental mixing, bands 0.01-3 GHz and 6-9 GHz)

**Residual FM:**  $< 2 \text{ kHz p-p}$  in 0.1 second.  
**Noise sidebands:**  $\geq 70 \text{ dB}$  down,  $\geq 30 \text{ kHz}$  from center of CW signal with 1 kHz resolution bandwidth and video filter at MAX.

### Amplitude Specifications

**Amplitude range:** -111 to +30 dBm.

#### Maximum Input (safe) Levels

**Total power:** +20 dBm (100 mW, 2.2 Vrms) with 0 dB input attenuation; +30 dBm (1 watt, 7.1 Vrms) with  $\geq 10 \text{ dB}$  input attenuation.  
**Voltage:**  $\pm 7.1 \text{ Vdc}$  or  $7.1 \text{ V RMS}$  ( $< 100 \text{ Hz}$ ).  
**Peak pulse power:** +50 dBm (100 watts, 10  $\mu\text{sec}$  pulse width, 0.01% duty cycle) with  $\geq 30 \text{ dB}$  input attenuation.

**Gain compression:**  $< 0.5 \text{ dB}$  for a  $-10 \text{ dBm}$  input level, with 0 dB input attenuation.

**Average noise level:** see table below for maximum average noise level with 1 kHz resolution bandwidth, 0 dB input attenuation, and video filtering at MAX.

Frequency Range (GHz)	Avg. Noise Level (dBm/1 kHz)	Frequency Response ( $\pm \text{ dB max.}$ )	Amplitude Accuracy <sup>1</sup> ( $\pm \text{ dB max.}$ )
0.01-3	-111	1.0	2.3
6.0-9	-108	1.0	2.3
3.0-9	-103	1.5	2.8
9.0-15	-98	1.8	3.1
6.0-15	-93	2.1	3.4
12.1-18	-92	2.3	3.6
18.0-21	-90	3.0	4.3

**Alternate IF:** regular IF at 3.0075 GHz; alternate IF available at 2.9925 GHz for all frequency bands (minimum frequency is 25 MHz).

#### Calibrated Display Range

**Log:** 70 dB with 10 dB/div scale; 8 dB with 1 dB/div scale.  
**Linear:** 8 divisions with linear (LIN) amplitude scale.

#### Amplitude Accuracy

**Calibrator:**  $-10 \text{ dBm} \pm 0.3 \text{ dB}$  (into 50  $\Omega$ ), 35 MHz  $\pm 400 \text{ kHz}$ .

**Reference level:** 10 dB steps and a 12 dB vernier for calibrated adjustment from  $-112 \text{ dBm}$  to  $+60 \text{ dBm}^2$ .

**Step accuracy (with 0 dB input attenuation):**  $-10$  to  $-80 \text{ dBm}$ :  $\pm 0.5 \text{ dB}$ ;  $-10$  to  $-100 \text{ dBm}$ :  $\pm 1.0 \text{ dB}$ .

**Vernier accuracy:**  $\pm 0.5 \text{ dB}$ .

**Frequency response:** see table above; includes input attenuator, mixer flatness, and mixing mode gain variation (band to band), with 0 or 10 dB input attenuation.

**Input attenuator:** 0 to 70 dB, selectable in 10 dB steps.

**Step accuracy:**  $\leq \pm 1.0 \text{ dB}$  per 10 dB step (0 to 60 dB, 0.01 to 18 GHz).

**Maximum cumulative error:**  $\leq \pm 2.4 \text{ dB}$  (0 to 60 dB, 0.01 to 18 GHz).

#### Bandwidth Switching (amplitude variation)

**3 MHz to 300 kHz:**  $\leq \pm 0.5 \text{ dB}$ .

**3 MHz to 1 kHz:**  $\leq \pm 1.0 \text{ dB}$ .

#### Display Fidelity

**Log incremental accuracy:**  $\pm 0.1 \text{ dB/dB}$  from Reference Level.

**Log maximum cumulative error:**  $\leq \pm 1.5 \text{ dB}$  over 70 dB range.

**Linear accuracy:**  $\pm 3\%$  of Reference Level.

### Spurious Responses

**Second harmonic distortion:** typically  $> 70 \text{ dB}$  below a  $-40 \text{ dBm}$  signal with 0 dB input attenuation.

**Third order intermodulation distortion:** typically  $> 70 \text{ dB}$  below two  $-30 \text{ dBm}$  input signals separated by  $\geq 50 \text{ kHz}$  with 0 dB input attenuation.

**Residual responses:**  $< -90 \text{ dBm}$  with 0 dB input attenuation and no signal present at input (0.01<sup>3</sup>-3 GHz, 6-9 GHz).

**Signal identifier:** available in all frequency bands and spans, useable from 10 MHz to 100 kHz/div.

### Sweep Characteristics

#### Sweep Time

**Automatic:** sweep time is automatically adjusted to maintain absolute amplitude calibration for any combination of frequency span, resolution bandwidth and video filter bandwidth.

**Calibrated sweep times:** 2  $\mu\text{sec}$  to 10 sec/div in a 1, 2, 5 sequence (except 2 sec/div),  $\pm 10\%$  accuracy ( $\pm 20\%$  for 5/10 sec/div).

**Manual sweep:** spectrum analyzer may be swept manually in either direction with front panel control.

### Signal Input Characteristics

**Input impedance:** 50  $\Omega$  nominal; precision type-N female connector.

**Input SWR:** typically  $< 2.0$ , 0 dB input attenuation;  $< 1.3$ , 10 dB input attenuation.

### HP 853A Characteristics

For information on the HP 853A Display, see page 605 in the HP 8557A Spectrum Analyzer section.

### General

#### General Specifications

For information on HP 182T compatibility, temperature range, EMI compliance, and power requirements, see page 605 in the HP 8557A Spectrum Analyzer section.

#### Weight

**HP 8559A:** net, 5.5 kg (12.1 lb). Shipping 9.1 kg (20 lb).

**HP 853A:** net, 15.9 kg (35 lb). Shipping 18.6 kg (41 lb).

**HP 853A Opt 001:** net, 14.5 kg (32 lb). Shipping, 17.3 kg (38 lb).

#### Size

**HP 853A/8559A:** 158.8 H x 501.7 W x 524.3 mm D (6.25" x 19.75" x 20.65").

**HP 853A Opt 001/8559A:** 133 H x 425.5 W x 473.7 mm D (5.25" x 16.75" x 18.65").

### Ordering Information

**HP 8559A Spectrum Analyzer**

**Opt 910:** Extra Operating and Service Manual

**HP 853A Portable Spectrum Analyzer Display**

**Opt 001:** Full Module Bench/Rack Configuration

**Opt. 910:** Extra Operation and Service Manual

**Solid State Camera Software:** HP part no. 75-00853

**HP 182T Cabinet Style, Normal Persistence Display**

<sup>1</sup>Using IF substitution, total accuracy is sum of frequency response, calibration, and reference level errors.

<sup>2</sup>Input level not to exceed maximum levels.

<sup>3</sup>25 MHz with Alternate IF ON.

<sup>4</sup>A simple modification is required for HP 8559A plug-ins with serial prefix 2208A and lower (modification kit, HP part number 00853-60059).

# SIGNAL ANALYZERS

## HP 141T Spectrum Analyzer System, 20 Hz to 40 GHz

### Model 141T System

- 20 Hz to 18 GHz, external mixing to 40 GHz
- Absolute amplitude calibration

- Tracking generators for component test
- Tracking preselector simplifies measurements



Hewlett Packard's 141T Spectrum Analyzer system permits measurements at frequencies ranging from 20 Hz to 18 GHz with four plug-in tuning sections. For measurements in the 18 to 40 GHz region, an accessory external mixer may be used with the microwave tuning section. The modularity of the system allows you to keep pace with changing measurement requirements.

An HP 141T Spectrum Analyzer system is comprised of a mainframe/display, one tuning section, and one IF section. Each tuning section covers a different frequency range permitting purchase of those which best meet current requirements. The HP 8556A covers from 20 Hz to 300 kHz, the HP 8553B from 1 kHz to 110 MHz, the HP 8554B from 100 kHz to 1250 MHz, and the HP 8555A from 10 MHz to 18 GHz. The IF sections, the HP 8552A or HP 8552B, provide bandwidth/gain selection and detection. Unless otherwise noted, the specifications shown here apply to a spectrum analyzer which contains an HP 8552B IF section.

For swept frequency testing of components, the HP 8443A or HP 8444A Tracking Generator can function as a swept signal source which, through locking, accurately tracks the frequency to which the analyzer is tuned. A microwave tracking preselector, the HP 8445B, simplifies measurements and improves the dynamic range of the HP 8555A Tuning Section for dense signal environments.

The spectrum analyzer displays amplitude and frequency accurately with a large dynamic range.

The following pages contain detailed performance specifications for each configuration of the spectrum analyzer, preselector, and tracking generators.

#### Absolute Amplitude Calibration

Calibrated frequency and amplitude measurements may be made over the entire frequency range. Logarithmic or linear scaling allow display of amplitude in dBm or voltage respectively. A warning light is provided to indicate uncalibrated conditions due to improper control settings.

#### Frequency Calibration

Three scan modes allow simple, accurate measurements. In the FULL SCAN mode the entire tuning section band is displayed. A marker is provided to identify and select signals of interest.

After a signal is selected in the FULL SCAN mode, switching to PER DIVISION mode allows analysis of the signal in narrow scans. Noise sidebands and low deviation FM are examples of measurements that might be made in this mode.

The analyzer can be used as a fixed tuned receiver by selecting the ZERO SCAN mode. In this mode the analyzer provides a time domain display with a calibrated time base, controlled by the scan time setting. Demodulating AM radio is a simple example of a ZERO SCAN measurement.

#### High Resolution

In frequency domain analysis it is often necessary to resolve close-in sidebands, such as line related modulation. Bandwidths as narrow as 10 Hz are provided in the HP 8553B to obtain this resolution. Use of such narrow bandwidths is made possible by frequency stabilization.

#### High Sensitivity, Low Distortion

For best measurement accuracy, a wide dynamic range is essential. Wide dynamic range requires both high sensitivity and low internal distortion.

Signals as low as  $-142$  dBm can be measured using the HP 8553B tuning section. For most measurements the HP 141T system offers in excess of 70 dB distortion free dynamic range. For many measurements with the HP 8555A Tuning section, the HP 8445B Preselector can increase dynamic range to greater than 100 dB.

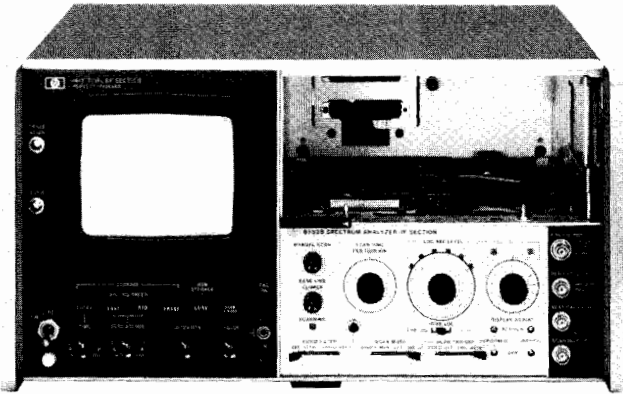

HP 141T, 8552B

### Mainframe/Storage Display

The HP 141T Mainframe provides variable persistence and storage. When narrow bandwidths are selected, sweep time must be reduced to maintain amplitude calibration. Variable persistence permits displayed traces of constant intensity even for long sweep-times. The storage feature allows traces to be held for comparison or photographing.

### IF Section Features

In addition to providing calibrated bandpass filtering the IF Section offers several user convenience features. Selectable video filters improve signal discernibility when S/N is low and permit display of average noise level. Recorder outputs, compatible with analog XY recorders, are provided. Amplitude and frequency calibration from the front panel are possible using the internal calibration source.

### Tracking Generators for Component Test

Tracking generators—leveled sources which track the tuned frequency of the analyzer—allow precise frequency measurements on two port devices with high dynamic range. Three tracking generators permit characterization of device performance up to 1500 MHz with a nominal dynamic range of 100 dB. The HP 8556B includes a tracking generator and the HP 8443A and HP 8444A may be used with the HP 8553B and HP 8554B Tuning Sections respectively.

### HP 8750A Storage-Normalizer

Digital trace storage and display with the HP 141T System is possible with the HP 8750A (Opt. 001) and an external oscilloscope. Digital storage provides a flicker-free display for any sweep speed and allows comparison of two traces. When a tracking generator is used, the normalization feature of the HP 8750A reduces the effect of system frequency response on the measurement.

## General Specifications

### HP 141T Spectrum Analyzer System

**Input impedance:** 50  $\Omega$  nominal. Reflection coefficient  $<0.30$  (1.85 SWR), input attenuator  $\geq 10$  dB.

**Maximum input level:** peak or average power +13 dBm (1.4 V ac peak),  $\pm 50$  V dc.

**Attenuator:** 0 to 50 dB in 10 dB steps.

**Scan time:** 16 internal scan rates from 0.1 ms/div to 10 sec/div in a 1, 2, 5 sequence, and manual scan (8552B only).

#### Scan Time Accuracy

**0.1 ms/div to 20 ms/div:**  $\pm 10\%$ .

**50 ms/div to 10 s/div:**  $\pm 20\%$ .

### Scan Mode

**Int:** analyzer repetitively scanned by internally generated ramp; synchronization selected by scan trigger

**Single:** single scan with front panel reset.

**Ext:** scan determined by 0 to +8 volt external signal.

**Manual:** scan determined by front panel control.

**Scan trigger:** for internal scan mode, select between

**Auto:** scan free-runs.

**Line:** scan synchronized with power line frequency.

**Ext:** scan synchronized with  $>2$  volt (20 volt max.) signal.

**Video:** scan internally synchronized to envelope of RF input.

### Auxiliary Outputs

**Vertical output:** 0 to  $-0.8$  V for full deflection.

**Scan output:**  $-5$  V to  $+5$  V for 10 div CRT deflection.

**Pen lift output:** 0 to 14 V (0 V, pen down).

## Display Characteristics

### HP 141T

**Plug-ins:** accepts Models 8552A/B, 8553B, 8554B, 8555A and 8556A.

### Cathode-Ray Tube Type

Post-accelerator storage tube, 9000 volt accelerating potential; aluminumized P31 phosphor.

### Cathode-Ray Tube Graticule

8  $\times$  10 division (approx, 7.1 cm  $\times$  8.9 cm) parallax-free internal graticule.

### Persistence

**Normal:** natural persistence of P31 phosphor (0.1 second).

#### Variable

**Normal writing rate mode:** continuously variable from less than 0.2 second to more than one minute.

**Maximum writing rate mode:** from 0.2 second to 15 seconds.

**Erase:** manual; erasure takes approximately 350 ms.

**Storage time:** normal writing rate; more than 2 hours at reduced brightness (typically 4 hours).

**Fast writing speed:** more than 15 minutes.

**EMI:** conducted and radiated interference is in compliance with MIL-STD 461A Methods CEO3 and REO2, CISPR publication 11 (1975), and Messemphaenger-Postverfuegung 526/527/79 (Kennzeichnung Mit F-Nummer/Funkschutzzeichen).

**Temperature range:** operating, 0°C to +55°C; storage,  $-40^\circ\text{C}$  to  $+75^\circ\text{C}$ .

**Power requirements:** 100, 120, 220, or 240 V  $\pm 5\%$ ,  $-10\%$ . 50 to 60 Hz, normally less than 225 watts (includes plug-ins used).

### Weight

**Model 8552A or 8552B IF section:** net, 4.1 kg (9 lb). Shipping 6.4 kg (14 lb).

**Model 141T display section:** net, 19.2 kg (43 lb). Shipping, 26 kg (57 lb).

**Tuning section:** see following pages.

**Size:** model 141T with plug-ins: 221 H  $\times$  425 W  $\times$  416 mm D (8.8"  $\times$  16.8"  $\times$  16.4").

**Special order:** chassis slides and adapter kit.

## Ordering Information

HP 141T Variable Persistence Display

Opt 908: Rack Flange Kit

HP 8552A Economy IF Section

HP 8552B High Resolution IF Section



# SIGNAL ANALYZERS

## HP 141T Spectrum Analyzer System: 20 Hz to 300 kHz

### Model 8556A

- Accurate signal level measurements ( $\pm 0.95$  dB)
- Accurate frequency measurements ( $\pm 3$  Hz)
- High sensitivity ( $-152$  dBV)
- Built-in tracking generator

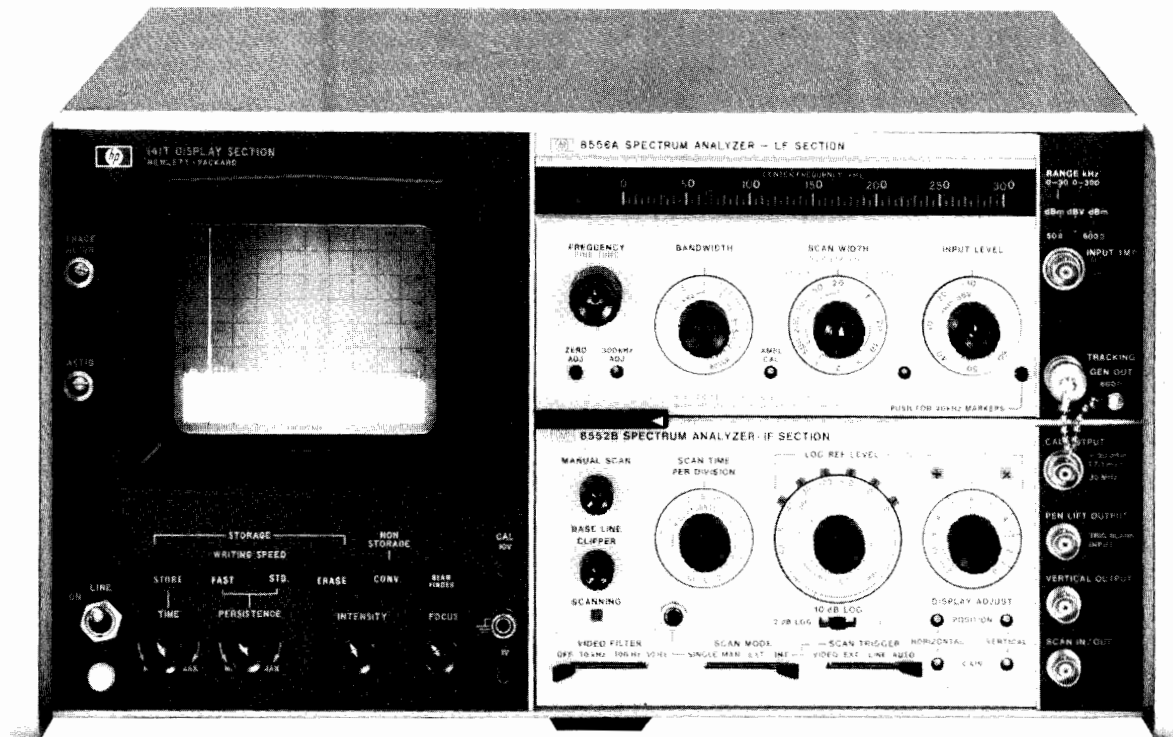

HP 8556A (141T, 8552B)

### Measurement Flexibility

The HP 8556A offers a frequency range of 20 Hz to 300 kHz. It is compatible with impedances normally encountered at audio frequencies. The input may be either balanced or unbalanced and measurement units may be dBV, dBm or Volts.

### Frequency Range

In addition to the 300 kHz tuning scale, a 30 kHz tuning scale is provided for greater tuning resolution at low frequencies. The HP 8556A may be swept about the tuned frequency, from 0 Hz to a selectable stop frequency, or fixed tuned to any frequency in its tuning range. Crystal markers with 20 kHz spacing may be selected to ensure accurate frequency measurements.

### Amplitude Calibration

The HP 8556A is calibrated for dBm in 600 and 50 ohms, as well as dBV and volts. Accurate reference level control ( $\pm 0.2$  dB) and vernier ( $\pm 0.25$  dB) allow accurate amplitude measurements when using the IF substitution method.

### Resolution—Sensitivity

Bandwidths of from 10 Hz to 10 kHz are provided with the HP 8556A. The 10 Hz bandwidth is useful for measurements close to the carrier such as power line sidebands. The 10 Hz bandwidth together with the low noise figure of the HP 8556A, allow signals as low as  $-152$  dBV (25 nV) to be measured.

### Isolated Input

The isolated input prevents spurious signal pickup due to ground currents between the analyzer and the signal source. The high input impedance permits the use of an oscilloscope probe. An optional balanced input is transformer coupled to provide isolation and high common mode rejection.

### Tracking Generator

The frequency of low level signals can be measured to  $\pm 3$  Hz accuracy with a frequency counter connected to the output of the built-in tracking generator. Swept insertion loss measurements with 140 dB dynamic range and return loss measurements are also possible using the tracking generator.

## Specifications—with HP 8552B IF Section

### Frequency Specifications

**Frequency range:** 20 Hz to 300 kHz. Tuning dial ranges of 0–30 kHz and 0–300 kHz.

**Scan width:** (on a 10-division CRT horizontal axis)

**Per division:** 10 calibrated scan widths from 20 Hz/div to 20 kHz/div in a 1, 2, 5 sequence.

**0–10 f:** 10 calibrated preset scans, from 200 Hz to 200 kHz in a 1, 2, 5 sequence. Analyzer scans from zero frequency to ten times the scan width per division setting.

**Zero:** analyzer is a fixed tuned receiver.

### Frequency Accuracy

**Center frequency accuracy:** 0–30 kHz Range:  $\pm 500$  Hz; 0–300 kHz Range:  $\pm 3$  kHz.

**Marker accuracy:** RF markers every 20 kHz accurate to within  $\pm 0.01\%$ . Markers controlled by front panel on/off switch.

**Scan width accuracy:** frequency error between any two points on the display is less than  $\pm 3\%$  of the indicated frequency separation.

**Stability**

**Residual FM:** sidebands >60 dB down 50 Hz or more from CW signal, scan time  $\geq 1$  sec/div, 10 Hz bandwidth.  
**Noise sidebands:** more than 90 dB below CW signal, 3 kHz away from signal, with a 100 Hz IF bandwidth.  
**Frequency drift:** less than 200 Hz/10 min.

**Resolution**

**Bandwidth ranges:** IF bandwidths of 10 Hz to 10 kHz are provided in a 1, 3, 10 sequence.  
**Bandwidth accuracy:** individual IF bandwidth 3 dB points calibrated to  $\pm 20\%$  (10 kHz bandwidth  $\pm 5\%$ ).  
**Bandwidth selectivity:** 60 dB/3 dB IF bandwidth ratios, with IF section: <11:1 for IF bandwidths from 10 Hz to 3 kHz; <20:1 for 10 kHz bandwidth. For 10 Hz bandwidth, 60 dB points are separated by less than 100 Hz.

**Amplitude Specifications**

**Absolute Amplitude Calibration**

**Log Calibration Modes**

dBV	0 dBV = 1 V rms
dBm-600 $\Omega$	0 dBm = 1 mW-600 $\Omega$
dBm-50 $\Omega$	0 dBm = 1 mW-50 $\Omega$

Input impedance is 1 M $\Omega$ . dBm ranges are referenced with input properly terminated externally.

**Log calibration range:** from -150 dBm/dBV to +10 dBm/dBV.  
**Log display range:** 10 dB/div on a 70 dB display, or 2 dB/div on a 16 dB display.

**Linear sensitivity:** from 0.1  $\mu$ V/div to 1 V/div in a 1, 2, 10 sequence. Linear sensitivity vernier X1 to X0.25 continuously.

**Dynamic Range**

**INPUT LEVEL control:** -10 to -60 dBm/dBV in 10 dB steps. Accuracy  $\pm 0.2$  dB. Marking indicates maximum input levels for 70 dB spurious-free dynamic range.  
**Average noise level:** (specified with a 600  $\Omega$  or less source impedance and INPUT LEVEL at -60 dBm/dBV)

Mode	1 kHz IF Bandwidth	10 Hz IF Bandwidth
dBm-50 $\Omega$	<-122 dBm (180 nV)	<-142 dBm (18 nV)
dBm-600 $\Omega$	<-130 dBm (250 nV)	<-150 dBm (25 nV)
dBV	<-132 dBV (250 nV)	<-152 dBV (25 nV)
Linear	<400 nV	<40 nV

**Video filter:** averages displayed noise; bandwidth of 10 kHz, 100 Hz, and 10 Hz. Bandwidth accuracy  $\pm 20\%$ .

**Spurious responses:** input signal level  $\leq$  INPUT LEVEL setting; out of band mixing responses, harmonic and intermodulation distortion products are all more than 70 dB below the input signal level 5 kHz to 300 kHz; 60 dB, 20 Hz to 5 kHz. Third order intermodulation products are more than 70 dB below the input signal level, 5 kHz to 300 kHz with signal separation >300 Hz.

**Residual responses (no signal present at input):** with the -INPUT LEVEL at -60 dBm/dBV and the input terminated with 600  $\Omega$  or less, all line related residual responses from 0 to 500 Hz are below -120 dBm/dBV. All other residual responses are below -130 dBm/dBV.

Amplitude Accuracy	Log	Linear
Frequency response	$\pm 0.2$ dB	$\pm 2.3\%$
Amplitude display	$\pm 0.25$ dB/dB but not more than $\pm 1.5$ dB over 70 dB display range	$\pm 2.8\%$ of full 8 div display

**Log reference level control:** provides 90 dB IF gain control in 10 dB steps. Accurate to  $\pm 0.2$  dB ( $\pm 2.3\%$ ).

**Log reference level vernier:** provides continuous 12 dB range. Accurate to  $\pm 0.1$  dB ( $\pm 1.2\%$ ) in 0, -6, -12 dB positions; otherwise  $\pm 0.25$  dB ( $\pm 2.8\%$ ).

**Amplitude measurement accuracy:**  $\pm 0.95$  dB with proper technique.

**General**

**Scan time:** 16 internal scan rates from 0.1 ms/div to 10 sec/div in a 1, 2, 5 sequence.

**Scan Mode**

**Int:** analyzer repetitively scanned internally.  
**Ext:** scan determined by 0 to +8 volt external signal.  
**Single:** single scan actuated by front panel button.  
**Manual:** scan determined by front panel control.

**Input level:** provides 50 dB control of input preamplification and attenuation to prevent input overload. INPUT LEVEL markings of -60 dBm/dBV to -10 dBm/dBV indicate maximum input level for a minimum of 70 dB spurious-free dynamic range. Accuracy  $\pm 0.2$  dB (2.3%).

**Input impedance:** 1 M $\Omega$  shunted by  $\approx 32$  pF.  
**Maximum input level:** 10 V rms,  $\pm 200$  V dc. Ground terminals of BNC input connectors are isolated from the analyzer chassis ground to minimize ground loop pickup at low frequencies.

**Maximum voltage, isolated ground to chassis ground:**  $\pm 100$  V dc.  
**Isolated ground to chassis ground impedance:** 100 k $\Omega$  shunted by approximately 0.3  $\mu$ F.

**Gain compression:** for input signal level 20 dB above INPUT LEVEL setting, gain compression is less than 1 dB.

**Tracking Generator Specifications**

**Frequency range:** tracks the analyzer tuning, 20 Hz to 300 kHz.  
**Amplitude range:** continuously variable from 100 mV rms to greater than 3 V rms into an open circuit.

**Amplitude accuracy:** with TRACKING GEN LEVEL in CAL position and 20 kHz markers off, output level at 100 kHz is 100 mV  $\pm 0.3$  dB into an open circuit.

**Frequency response:**  $\pm 0.25$  dB 50 Hz to 300 kHz.

**Output impedance:** 600  $\Omega$ .

**Residual FM:** <1 Hz peak-to-peak.

**Power requirements:** 100, 120, 200, or 240 V +5%, -10%, 50 to 60 Hz, normally less than 225 watts.

**Weight:** Model 8556A LF section: net, 3.7 kg (8 lb). Shipping, 5.3 kg (12 lb).

**Size:** 102 H x 226 W x 344 mm D (4" x 8.9" x 13.5").

**Specifications with HP 8556A Options 001, 002-Balanced Input**

**Amplitude**

**Log Calibration Modes-Balanced (bridged) Input**

dBm-135 $\Omega$ (Option 001)	0 dBm = 1 mW-135 $\Omega$
dBm-150 $\Omega$ (Option 002)	0 dBm = 1 mW-150 $\Omega$
dBm-600 $\Omega$ (Option 001 or 002)	0 dBm = 1 mW-600 $\Omega$
dBm-900 $\Omega$ (Option 001 or 002)	0 dBm = 1 mW-900 $\Omega$

Input impedance is typically 15 k $\Omega$ . dBm ranges are referenced with input properly terminated externally.

**Input**

**Maximum input levels:** normal Mode,  $\pm 20$  V rms or  $\pm 150$  V dc for normal mode (symmetrical) signals between input signal connectors; Common Mode, 200 V rms at 60 Hz or  $\pm 500$  V dc for common mode (asymmetrical) voltages between input signal connectors and GUARD or instrument chassis; GUARD,  $\pm 100$  V dc from GUARD to instrument chassis. (GUARD to chassis impedance is approximately 100 k $\Omega$  shunted by 0.3  $\mu$ F.)

**Balance (symmetry):** 0 -30kHz Range, greater than 80 dB, 50 Hz to 1 kHz; 1 -300 kHz range, greater than 60 dB, 1 kHz to 20 kHz.

**Ordering Information**

**HP 8556A RF Section**  
**Opt 001:** Balanced input  
**Opt 002:** Balanced input

# SIGNAL ANALYZERS

HP 141T Spectrum Analyzer System: 1 kHz to 110 MHz

Models 8553B & 8443A

- 10 Hz resolution bandwidth
- High sensitivity ( $-140$  dBm)
- Accurate amplitude measurements ( $\pm 1.25$  dB)
- 10 Hz frequency accuracy with tracking generator



HP 8553B (141T, 8552B) 8443A

The HP 8553B covers the frequency range 1 kHz to 110 MHz. This frequency range includes audio, video, navigation aids, communications basebands, broadcast AM and FM, and TV. This analyzer features high sensitivity, stability and resolution. The HP 8443A Tracking Generator improves frequency measurement accuracy and provides a tracking source for swept frequency testing of components.

### Frequency Range

The frequency range of the HP 8553B extends from audio through the FM broadcast band. In the PER DIVISION mode, scan widths from 200 Hz to 100 MHz can be selected. ZERO SCAN mode allows operation as a fixed tuned receiver with a time domain display. In addition to the full range dial scale, a 0-11 MHz dial scale provides better tuning resolution at low frequencies.

### Resolution-Stability

Bandwidths ranging from 10 Hz to 300 kHz may be selected when using an HP 8553B. Wide bandwidths are useful for measurement of FM or other broadband spectra. The 10 Hz bandwidth allows measurement of 60 Hz sidebands which are greater than 60 dB down from the carrier. Low residual FM due to phase-lock stabilization makes this resolution possible. This low residual FM also permits characterization of oscillator stability.

### Amplitude Calibration

The HP 8553B is calibrated for either dBm or Volts over the range  $-142$  dBm (18 nV) to  $+10$  dBm (0.7 V). An accurate amplitude reference is provided by the internal calibrator. This reference together with low frequency response variations ( $\pm 0.5$  dB) make possible accurate measurements of absolute amplitude. Calibrated in-circuit made measurements may be made at frequencies from 100 kHz to 110 MHz when using the HP1121A Active Probe with the HP 8553B.

### Sensitivity

Low noise figure and 10 Hz bandwidth result in high sensitivity for the HP 8553B. In a 10 Hz bandwidth signal levels of  $-140$  dBm may be measured. With the addition of a low noise preamp, such as the HP 8447, sensitivity can be improved by at least 15 dB.

### HP 8443A Tracking Generator-Counter

To complement the HP 8553B, the HP 8443A Tracking Generator provides a tracking source with a frequency range of 100 kHz to 110 MHz. A built-in counter permits precision frequency measurements and RF attenuators allow precise control of output amplitude.

### Frequency Accuracy

Frequency measurements with an accuracy of  $\pm 10$  Hz are possible when using an HP 8443A. In the TRACK ANALYZER mode, the HP 8443A displays the counted frequency of a tunable marker. The RESTORE mode allows individual signals to be counted in a wide scan without fine tuning.

### Swept Frequency Measurements

With the HP 8443A, the HP 8553B can be used to measure both insertion and return loss over the 100 kHz to 110 MHz frequency range. The excellent stability of the HP 8443A permits use of the 10 Hz bandwidth, providing a 130 dB dynamic range for swept frequency response measurements. A system (HP 8553B/8443A) frequency response of  $\pm 1.0$  dB insures accurate characterization of DUT frequency response.





## Specifications—with HP 8552B IF Section

### Frequency Specifications

**Frequency range:** 1 kHz–110 MHz (0–11 MHz and 0–110 MHz tuning ranges).

**Scan Width (on 10-division CRT horizontal axis)**

**Per division:** 18 calibrated scan widths from 20 Hz/div to 10 MHz/div in a 1, 2, 5 sequence.

**Preset:** 0–100 MHz, automatically selects 300 kHz bandwidth IF Filter.

**Zero:** analyzer is fixed tuned receiver with selectable bandwidth.

### Frequency Accuracy

**Center frequency accuracy:** the dial indicates the display center frequency within  $\pm 1$  MHz on the 0–110 MHz tuning range;  $\pm 200$  kHz on the 0–11 MHz tuning range with FINE TUNE centered, and temperature range of 20°C to 30°C.

**Scan width accuracy:** scan widths 10 MHz/div to 2 MHz/div and 20 kHz/div to 20 Hz/div: Frequency error between two points on the display is less than  $\pm 3\%$  of the indicated frequency separation between the two points. Scan widths 1 MHz/div to 50 kHz/div: Frequency error between two points on the display is less than  $\pm 10\%$  of the indicated frequency separation.

### Resolution

**Bandwidth:** IF Bandwidths of 10 Hz to 300 kHz are provided in a 1, 3, 10 sequence.

**Bandwidth accuracy:** individual IF bandwidths' 3 dB points calibrated  $\pm 20\%$  (10 kHz bandwidth  $\pm 5\%$ ).

**Bandwidth selectivity:** 60 dB/3 dB IF bandwidth ratios: 10 Hz to 3 kHz bandwidths,  $< 11:1$ , 10 kHz to 300 kHz bandwidths,  $< 20:1$ ; 60 dB points on 10 Hz bandwidth separated by  $< 100$  Hz.

### Stability

**Residual FM stabilized:** sidebands  $> 60$  dB down 50 Hz or more from CW signal, scan time  $\geq 1$  sec/div, 10 Hz bandwidth (typically less than 1 Hz peak-to-peak).

**Residual FM unstabilized:**  $< 1$  kHz peak-to-peak.

**Noise sidebands:** more than 70 dB below CW signal, 50 kHz or more away from signal, with 1 kHz IF bandwidth.

**Long term drift (after 1-hour warm-up), stabilized:** 100 Hz/10 min; unstabilized: 5 kHz/min, 20 kHz/10 min.

### Amplitude Specifications

#### Absolute Amplitude Calibration Range

**Log:** from  $-130$  to  $+10$  dBm, 10 dB/div on a 70 dB display or 2 dB/div on a 16 dB display.

**Linear:** from  $0.1 \mu\text{V/div}$  to  $100 \text{ mV/div}$  in a 1, 2 sequence on an 8-division display.

#### Dynamic Range

**Average noise level:**  $< -110$  dBm with 10 kHz IF bandwidth.

**Video filter:** averages displayed noise; 10 kHz, 100 Hz, and 10 Hz bandwidths.

**Spurious responses:** are below a  $-40$  dBm signal at the input mixer as follows: All image and out-of-band mixing responses, -harmonic and intermodulation distortion more than 70 dB down, 2 MHz to 110 MHz; more than 60 dB down, 1 kHz to 2 MHz. Third order intermodulation products more than 70 dB down, 1 kHz to 110 MHz (Signal separation  $> 300$  Hz).

**Residual responses (no signal present at input):** with input attenuation at 0 dB:  $< -110$  dBm (200 kHz to 110 MHz);  $< -95$  dBm (20 kHz to 200 kHz).

#### Amplitude Accuracy

Frequency response  
(Flatness: attenuator settings  $> 10$  dB):

1 kHz to 110 MHz  
Amplitude Display

#### Log

$\pm 0.5$  dB  
 $\pm 0.25$  dB/dB  
but not more than  $\pm 1.5$   
dB over the full  
70 dB display range

#### Linear

$\pm 5.8\%$   
 $\pm 2.8\%$  of  
full 8 div  
deflection

**Calibrator amplitude:**  $-30$  dBm,  $\pm 0.3$  dB

**Calibrator frequency:** 30 MHz,  $\pm 3$  kHz.

**Log reference level control:** provides 70 dB range (60 dB below 200 kHz), in 10 dB steps. Accurate to  $\pm 0.2$  dB ( $\pm 2.3\%$ , Linear Sensitivity).

**Log reference level vernier:** provides continuous 12 dB range. Accurate to  $\pm 0.1$  dB ( $\pm 1.2\%$ ) in 0,  $-6$ , and  $-12$  dB positions; otherwise  $\pm 0.25$  dB ( $\pm 2.8\%$ ).

**Amplitude measurement accuracy:**  $\pm 1.25$  dB with proper technique.

### General Characteristics

**Input impedance:** 50  $\Omega$  nominal, BNC connector. Reflection coefficient  $< 0.13$  (1.3 SWR), input attenuator  $\geq 10$  dB. A special 75  $\Omega$  version of the HP 8553B/8552B is available, as is a 75  $\Omega$  matching transformer, the HP 11694A.

**Maximum input level:** peak or average power  $+13$  dBm (1.4 V ac peak),  $\pm 50$  V dc, 1 dB compression point,  $-10$  dBm.

**Scan time:** 16 internal scan rates from 0.1 ms/div to 10 sec/div in a 1, 2, 5 sequence, or manual scan.

#### Scan Mode

**Int:** analyzer repetitively scanned internally.

**Ext:** scan determined by 0 to  $+8$ -volt external signal.

**Manual:** scan determined by front panel control.

**Attenuator:** 0 to 50 dB, in 10 dB increments, coupled to Log Reference Level indicator; automatically maintains absolute calibration. Attenuator accuracy  $\pm 0.2$  dB.

**Power requirements:** 100, 120, 220, or 240 V  $+5\%$ ,  $-10\%$ , 50 to 60 Hz, normally less than 225 watts.

**Weight:** Model 8553B RF Section: net, 5.5 kg (12 lb). Shipping, 7.8 kg (17 lb).

**Size:** 102 H x 226 W x 334 mm D (4" x 8.9" x 13.5").

### Tracking Generator-Counter (HP 8443A)

**Frequency range:** 100 kHz to 110 MHz.

**Amplitude range:**  $< -120$  dBm to  $+10$  dBm in 10 and 1 dB steps with a continuous 1.2 dB vernier.

#### Amplitude Accuracy

**Frequency response (flatness):**  $\pm 0.5$  dB.

**Absolute:** 0 dBm at 30 MHz:  $\pm 0.3$  dB.

**Output impedance:** 50  $\Omega$ , BNC connector, ac coupled, reflection coefficient  $\leq 0.09$  (1.2 SWR) with output  $< 0$  dBm.

#### Counter

**Display:** 7 digits with 1 digit over-range. Reads to  $\pm 10$  Hz increments.

**Resolution (gate time):** 1 kHz (1 ms), 100 Hz (10 ms), 10 Hz (100 ms).

**Accuracy:**  $\pm 1$  count  $\pm$  time base accuracy.

**Time base aging rate:**  $< 3 \times 10^{-9}$ /day (0.3 Hz/day) after warm-up.

**External counter inputs:** 10 kHz to 120 MHz, 50  $\Omega$ ,  $-10$  dBm min.

**Power:** 100, 120, 220, or 240 V  $+5\%$ ,  $-10\%$ , 48 to 440 Hz 75 watts.

**Weight:** Model 8443A: net, 11.04 kg (24.3 lb). Shipping, 14.47 kg (31.9 lb).

**Size:** 88.2 H x 425 W x 467 mm D (3.5" x 16.8" x 18.4").

### Ordering Information

HP 8553B RF Section

HP 8443A Tracking Generator-Counter

# SIGNAL ANALYZERS

## HP 141T Spectrum Analyzer System: 100 kHz to 1250 MHz

### Models 8554B & 8444A

- High resolution (100 Hz)
- Frequency response  $\pm 1$  dB
- Companion tracking generator
- Optional internal limiter



HP 8554B (141T, 8552B) 8444A

The HP 8554B RF Section covers the frequency range from 100 kHz to 1250 MHz. This band includes baseband, AM/FM Broadcast, VHF/UHF TV, mobile communications, and VHF/UHF navigation systems. Typical measurements include modulation, intermodulation, harmonics and spurious. Noise power density and carrier to noise ratio can also be measured. The frequency response of filters, amplifiers, mixers or modulators can be measured and displayed when a companion tracking generator is used.

### Absolute Calibration

Amplitude measurements can be made with an accuracy of  $\pm 2.8$  dB over the range +10 to -122 dBm. This accuracy can be improved to  $\leq \pm 1.75$  dB with IF substitution techniques. The log display mode (dBm) provides a 70 dB calibrated range, while the linear display mode (volts) provides maximum resolution of  $1 \mu\text{V}$  per division. The calibrated reference level (top graticule line) can be set with IF gain to values from +10 to -72 dBm. An UNCAL light warns of control settings which may cause loss of amplitude calibration.

### Frequency Response

Excellent flatness ( $\pm 1$  dB) insures high accuracies for relative amplitude measurements such as harmonic distortion. Full band sweep allows display of the entire tuning range, 100 kHz to 1250 MHz.

### Frequency Resolution

Low residual FM allows selection of bandwidths as narrow as 100 Hz. This bandwidth provides the resolution needed to measure close-in sidebands such as those due to power line harmonics or third order

intermodulation distortion. Available bandwidths range from 100 Hz to 300 kHz in a 1, 3, 10 sequence. The filters used are synchronously-tuned which have an excellent response to pulsed signals and permit the lowest sweep time for a given bandwidth.

### Sensitivity

High sensitivity ( $-122$  dBm/100 Hz) and low spurious levels ( $-65$  dBc) allow accurate measurements of low level signals such as might be encountered in EMI applications. The sensitivity/spurious performance also provides the dynamic range required for signals with large amplitude separation such as intermodulation distortion or incidental AM.

### Frequency Stabilization

Frequency stabilization reduces residual FM to less than 100 Hz peak-to-peak for scans of 200 kHz or less. The stabilization in narrow scans is implemented by phase-locking the local oscillators to a crystal reference.

### HP 8444A Tracking Generator

The HP 8444A Tracking Generator utilizes the LO's of the HP 8554B to generate an output signal whose frequency equals the tuned frequency of the HP 8554B. The tracking generator can provide a swept source for frequency response measurements. The HP 8444A also provides control of output signal amplitude to prevent overdriving the DUT.

For precise frequency measurements of low level signals, the tracking generator provides a constant amplitude auxiliary output signal, which can be used to drive a frequency counter.



## HP 8554B Specifications—with HP 8552B IF Section

### Frequency Specifications

**Frequency range:** 100 kHz to 1250 MHz.

**Scan Width (on 10-division CRT horizontal axis)**

**Per division:** 15 calibrated scan widths from 100 MHz/div to 2 kHz/div in a 1, 2, 5 sequence.

**Preset:** 0-1250 MHz, automatically selects 300 kHz bandwidth IF filter.

**Zero:** analyzer is fixed-tuned receiver.

### Frequency Accuracy

**Center frequency accuracy:** the dial indicates the display center frequency within 10 MHz.

**Scan width accuracy:** frequency error between two points on the display is less than 10% of the indicated separation.

### Resolution

**Bandwidth:** IF bandwidths of 0.1 to 300 kHz provided in a 1, 3, 10 sequence.

**Bandwidth accuracy:** individual IF bandwidth 3 dB points calibrated to  $\pm 20\%$  (10 kHz bandwidth  $\pm 5\%$ ).

**Bandwidth selectivity:** 60 dB/3 dB IF bandwidth ratio  $< 20:1$  for IF bandwidths from 10 kHz to 200 kHz. 60 dB/3 dB bandwidth ratio  $< 11:1$  for IF bandwidths 100 Hz to 3 kHz.

### Stability (residual FM)

**Stabilized:**  $< 100$  Hz peak-to-peak.

**Unstabilized:**  $< 10$  kHz peak-to-peak.

**Noise sidebands:** more than 70 dB below CW signal, 50 kHz or more away from signal, with 1 kHz IF bandwidth.

### Amplitude Specifications

#### Absolute Amplitude Calibration Range

**Log:** from  $-122$  to  $+10$  dBm. 10 dB/div on a 70 dB display, or 2 dB/div on a 16 dB display.

**Linear:** from  $0.1 \mu\text{V/div}$  to  $100 \text{ mV/div}$  in a 1, 2 sequence on an 8-division display.

#### Dynamic Range

**Average noise level:**  $< -102$  dBm with 10 kHz IF bandwidth.

**Spurious responses:** all image and out-of-band mixing responses, harmonic and intermodulation distortion products are more than 65 dB below a  $-40$  dBm signal at the input mixer.

**Residual responses (no signal present at input):** with input attenuation at 0 dB:  $< -100$  dBm.

#### Amplitude Accuracy

	Log	Linear
Frequency response (flatness)		
100 kHz to 1250 MHz	$\pm 1$ dB	$\pm 12\%$
Switching between bandwidths (at $25^\circ\text{C}$ )	$\pm 0.5$ dB	$\pm 5.8\%$
Amplitude display	$\pm 0.25$ dB/dB but not more than $\pm 1.5$ dB over the full 70 dB display range.	2.8% of full 8 div deflection

#### Calibrator Output

**Amplitude:**  $-30$  dBm,  $\pm 0.3$  dB.

**Frequency:** 30 MHz,  $\pm 3$  kHz.

**Log reference level control:** provides 70 dB range (60 dB below 200 kHz), in 10 dB steps. Accurate to  $\pm 0.2$  dB ( $\pm 2.3\%$ , Linear Sensitivity).

**Log reference level vernier:** provides continuous 12 dB range. Accurate to  $\pm 0.1$  dB ( $\pm 1.2\%$ ) in 0,  $-6$ , and  $-12$  dB positions; otherwise  $\pm 0.25$  dB ( $\pm 2.8\%$ ).

**Amplitude measurement accuracy:**  $\pm 1.75$  dB with proper technique.

### RF Input Specifications

**Input impedance:** 50  $\Omega$  nominal. Typical reflection coefficient  $< 0.30$  (1.85 SWR), input attenuator  $\geq 10$  dB.

**Maximum input level:** peak or average power  $+13$  dBm (1.4 V ac peak),  $\pm 50$  V dc.

### General

**Scan time:** 16 internal scan rates from 0.1 ms/div to 10 sec/div in a 1, 2, 5 sequence, and manual scan.

#### Scan Time Accuracy

0.1 ms/div to 20 ms/div:  $\pm 10\%$ .

50 ms/div to 10 s/div:  $\pm 20\%$ .

#### Weight

**Model 8554B RF section:** net, 4.7 kg (10.3 lb). Shipping 7.8 kg (17 lb).

**Size:** 102 H x 226 W x 344 mm D (4" x 8.9" x 13.5").

## HP 8444A Specifications

### Specifications for Swept Frequency Response Measurements

**Dynamic range:**  $> 90$  dB from spectrum analyzer 1 dB gain compression point to average noise level (approximately  $-10$  dBm to  $-100$  dBm). Spurious responses not displayed.

**Gain compression:** for  $-10$  dBm signal level at the input mixer, gain compression  $< 1$  dB.

#### Absolute Amplitude Calibration Range

**Tracking generator** (drive level to test device: 0 to  $-10$  dBm continuously variable. 0 dBm absolutely calibrated to  $\pm 0.5$  dB at 30 MHz).

**Frequency range:** 500 kHz to 1250 MHz.

**Frequency resolution:** 1 kHz.

#### Stability

**Residual FM** (peak-to-peak): stabilized,  $< 200$  Hz; unstabilized,  $< 10$  kHz.

#### Amplitude Accuracy

**System frequency response:**  $\pm 1.50$  dB.

**Tracking generator calibration:** 0 dBm at 30 MHz to  $\pm 0.5$  dB.

### Specifications for Precision Frequency Measurements

**Frequency accuracy:** for unknown signals  $\pm 10$  kHz. (Tracking drift typically 50 kHz/10 min after 2-hour warm-up). For points on frequency response curve, counter accuracy  $\pm$  Residual FM (200 Hz).

#### Counter Mode of Operation

**Manual scan:** scan determined either by front panel control of HP 8552B IF Section or by external scan signal provided by the HP 8444A.

**Zero scan:** analyzer is fixed-tuned receiver. Counter reads center frequency to accuracy of tracking drift.

**Counter output level:** typically 0.1 V rms.

### Specifications for Sweep/CW Generator

**Frequency:** controlled by spectrum analyzer. Range 500 kHz to 1250 MHz with HP 8554B. Scan widths are as enumerated on this page.

**Frequency accuracy.**  $\pm 10$  MHz using spectrum analyzer tuning dial. Can be substantially improved using external counter output.

**Flatness:**  $\pm 0.5$  dB.

#### Spectral Purity

**Residual FM** (peak-to-peak): 200 Hz.

**Harmonic distortion:** 25 dB below output level (typical).

**Nonharmonic (spurious) signals:**  $> 35$  dB below output level.

**Long term stability:** drift typically less than 30 kHz/hour when stabilized after 2-hour warm-up.

**Sweep width:** 20 kHz to 1000 MHz.

**Sweep rates:** selected by Scan Time per Division on spectrum analyzer.

### General

**Temperature range:** operation,  $0^\circ\text{C}$  to  $55^\circ\text{C}$ , storage  $-40^\circ\text{C}$  to  $75^\circ\text{C}$ .

**EMI:** conducted and radiated interference is in compliance with MIL-STD 461A Methods CE03 and RE02, CISPR publication 11 (1975), and Messempfaenger-Postverfuegung 526/527/79 (Kennzeichnung Mit F-Nummer/Funkschutzzeichen).

**Power:** 115 V and 230 V, 48 to 440 Hz, 12 watts max.

**Weight:** net, 7.1 kg (15.6 lb). Shipping, 9.5 kg (21 lb).

**Size:** 88.2 H x 425 W x 467 mm D (3.5" x 16.8" x 18.4").

### Ordering Information

HP 8554B RF Section

Opt 003: Internal Limiter

HP 8444A Tracking Generator

# SIGNAL ANALYZERS

## HP 141T Spectrum Analyzer System: 10 MHz to 40 GHz



### Models 8555A, 8444A Option 059 & 8445B

- 10 MHz to 18 GHz, external mixing to 40 GHz
- High sensitivity ( $-125$  dBm)
- 100 Hz resolution
- Companion tracking generator to 1.5 GHz

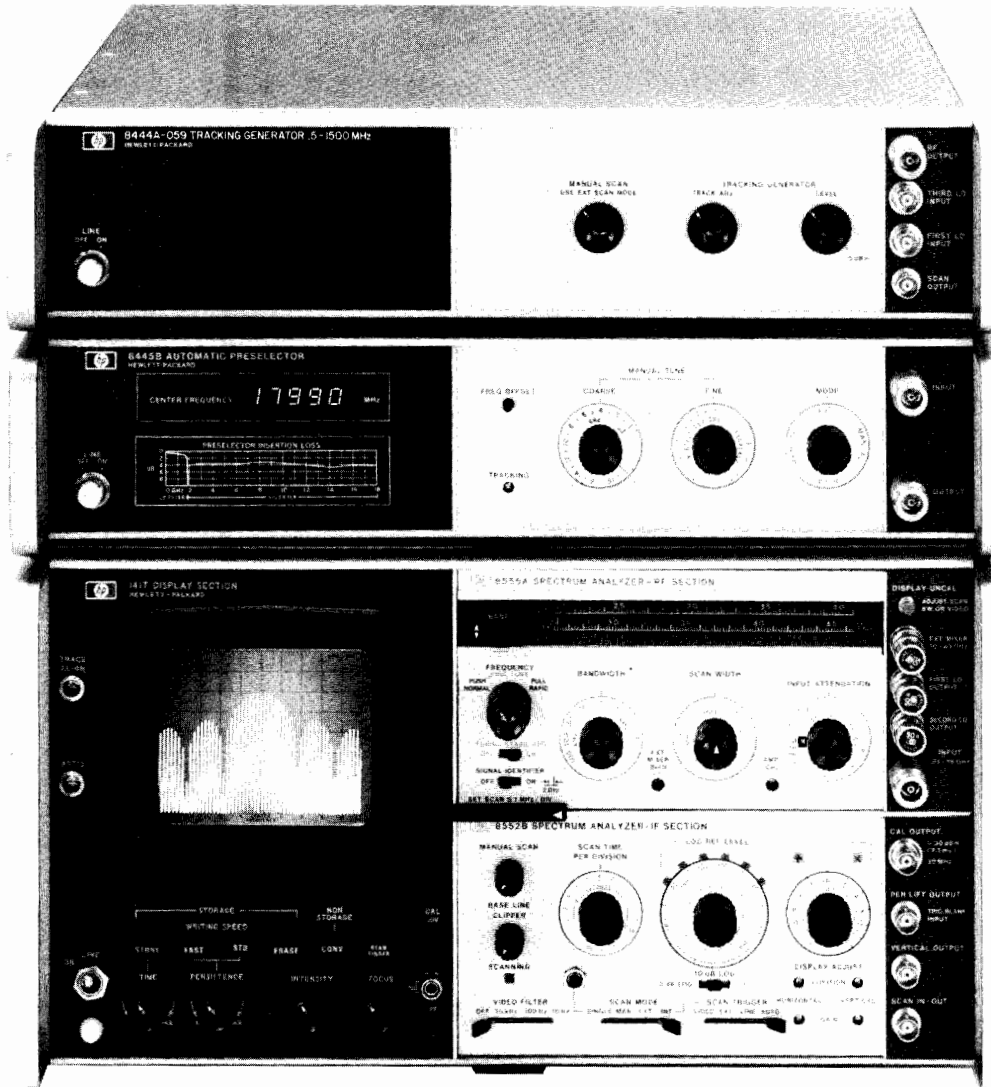

HP 8555A (141T, 8552B) 8444A Opt 059, 8445B

The HP 8555A Tuning Section offers multiband coverage from 10 MHz to 18 GHz. The range can be extended to 40 GHz with the HP 11517A external waveguide mixer (see page 621). The HP 8555A provides high sensitivity ( $-125$  dBm), high resolution (100 Hz) and frequency scans as wide as 8 GHz. The HP 8555A is well suited for measurements necessary during both the design and production phases of microwave devices and systems.

### Amplitude Calibration

Absolute amplitude calibration permits accurate amplitude measurements over the range from  $+10$  to  $-125$  dBm. The exceptional flatness of the HP 8555A, which is  $\pm 2$  dB out to 18 GHz, enhances the accuracy of relative power measurements.

### High Sensitivity

With the 100 Hz bandwidth selected, the sensitivity of the HP 8555A is  $-125$  dBm in the fundamental mixing band and  $-100$  dBm in the 4th harmonic band. This sensitivity permits measurements of low level signals. When these signals are close to the noise floor, a video filter of 10 kHz, 100 Hz or 10 Hz can be selected to improve discernability of the signal.

### High Resolution/Stability

The low residual FM of the HP 8555A ( $<100$  Hz p-p) allows a 100 Hz bandwidth to be selected which permits the user to resolve sidebands due to low frequency modulations. The stability of the HP 8555A also allows measurement of the spectral purity of a DUT.



### HP 8445B Tracking Preselector

The HP 8445B Tracking Preselector contains a YIG filter which tracks the tuned frequency of the analyzer over the range 1.8 to 18 GHz. The preselector suppresses the image and multiple responses which result from harmonic mixing. The preselector can also reduce distortion and increase dynamic range when signal separation exceeds the preselector bandwidth. For tuned frequencies below 1.8 GHz, a low pass filter prevents image and multiple responses.

An optional LED display provides a readout of marker frequency with 1 MHz resolution.

### HP 8444A Option 059 Tracking Generator

The tracking generator provides a leveled, calibrated signal output with a frequency equal to the tuned frequency of the HP 8555A. This enables swept frequency tests such as insertion loss and return loss at frequencies up to 1500 MHz. With the addition of an external frequency counter, precise measurement of frequency is possible.

### HP 8555A Specifications—with HP 8552B IF Section

#### Frequency Specifications

**Frequency range:** 0.01–40 GHz.

#### Tuning Range

**With internal mixer:** 0.01–18.0 GHz.

**With external mixer:** 12.4–40 GHz.

#### Harmonic Mixing Mode

**Signal identification:** not required when preselector is used. The signal identifier allows positive identification of all responses.

#### Scan Width

**Full scan:** the width of the scan depends on mixing mode. Scan width =  $n \times 2000$  MHz, where  $n$  is the mixing mode; e.g. for  $n = 2$ , scan width is 4 GHz. Maximum scan width full screen is 8 GHz with coaxial mixer. Preselector necessary to make wide scans usable.

**Per division:** 16 calibrated scan widths from 2 kHz/div to 200 MHz/div in a 2, 5, 10 sequence.

**Zero scan:** analyzer becomes fixed-tuned receiver.

#### Frequency Accuracy

**Dial accuracy:**  $n \times (\pm 15 \text{ MHz})$  where  $n$  is the mixing mode.

**Scan accuracy:** frequency error between two points on the display is less than  $\pm 10\%$  of the indicated separation.

**Stability:** residual FM stabilized  $< 100$  Hz peak-to-peak (fundamental mixing).

**Noise sidebands:** for fundamental mixing. More than 70 dB below CW signal 50 kHz or more away from signal, with 1 kHz IF bandwidth and 100 Hz video filter.

#### Frequency Drift

**Long term drift:** at fixed center frequency after 2-hour warm-up (Typical).

**Stabilized:**  $\pm 3.0$  kHz/10 min.

**Unstabilized:**  $\pm 25$  kHz/10 min.

**Stabilization range:** first LO can be automatically stabilized to internal crystal reference for scan widths of 100 kHz/div or less.

#### Resolution

**Bandwidth range:** selectable 3 dB bandwidths from 100 Hz to 300 kHz in a 1, 3, 10 sequence.

**Bandwidth shape:** approximately gaussian.

**Bandwidth selectivity:** 11:1 to 20:1 (60 dB/3 dB).

**Bandwidth accuracy:** individual IF bandwidth 3 dB points calibrated to  $\pm 20\%$  (10 kHz bandwidth,  $\pm 5\%$ ).

### Amplitude Specifications

#### Measurement Range

**Log reference level:** from  $-60$  dBm to  $+10$  dBm.

**Linear sensitivity:** from  $0.1 \mu\text{V}/\text{div}$  to  $100 \text{ mV}/\text{div}$ .

**Sensitivity and frequency response with internal coaxial mixer noise level:** specified for 1 kHz bandwidth.

#### Frequency Response with 10 dB Input Attenuator Setting

Frequency Range (GHz)	Mixing Mode (n)	Average Noise Level (dBm max.)	Frequency Response* (dB max.)
0.01-2.05	1-	-115	$\pm 1.0$
1.50-3.55	1-	-117	$\pm 1.0$
2.07-6.15	2-	-108	$\pm 1.3$
2.60-4.65	1+	-117	$\pm 1.0$
4.11-6.15	1+	-115	$\pm 1.0$
4.13-10.25	3-	-103	$\pm 1.5$
6.17-10.25	2+	-105	$\pm 1.5$
6.19-14.35	4-	-95	$\pm 2.0$
8.23-14.35	3+	-100	$\pm 2.0$
10.29-18.00	4+	-90	$\pm 2.0$

\*Includes mixer frequency response, RF attenuator frequency response, mixing mode gain variation, RF input VSWR.

### Sensitivity and Frequency Response with HP 11517A External Wave-guide Mixer and Appropriate Waveguide Tapers

#### Average Noise Level 10 kHz Bandwidth (dBm typical)

Frequency Range (GHz)	Mixing Mode (n)	Average Noise Level (dBm)
12.4-18.0	6-	-90
18.0-26.5	6+	-85
26.5-40.0	10+	-75

**Frequency response:** typically  $\pm 3$  dB over 1 GHz frequency scans.

**Residual responses:** referred to input on fundamental mixing:  $< -90$  dBm.

#### Display Range

**Log:** 70 dB, 10 dB/div and 2 dB/div, expanded on a 16 dB display.

**Linear:** from  $0.1 \mu\text{V}/\text{div}$  to  $100 \text{ mV}/\text{div}$  in a 1, 2, sequence on an 8-division display.

### Spurious Responses Due to Second Harmonic Distortion with Preselector

Frequency Range	Power Incident on Input Mixer	2nd Harmonic Distortion
0.01-1.85 GHz	-40 dBm	-63 dB
1.85-18.0 GHz	0 dBm	-100 dB

### Spurious Responses Due to Third Order Intermodulation Distortion with Preselector

Frequency Range	Signal Separation	Power Incident on Input Mixer	Third Order Intermodulation Distortion
0.01-18.0 GHz	$> 1$ MHz $< 20$ MHz	-30 dBm	-70 dB
0.01-1.85 GHz	$> 70$ MHz	-30 dBm	-70 dB
1.85-18.0 GHz	$> 70$ MHz	0 dBm	-100 dB

**Video filter:** post detection filter used to average displayed noise. Nominal bandwidths: 10 kHz, 100 Hz, and 10 Hz.

**Gain compression:** for internal mixer gain compression  $< 1$  dB for  $-10$  dBm peak or average signal level to input mixer. 11517A External Mixer (12.4-40 GHz) gain compression  $< 1$  dB for  $-15$  dBm peak or average signal level to input mixer.

#### Amplitude Accuracy

**IF gain variation with different bandwidth settings:** (at  $20^\circ\text{C}$ .)

**Log:**  $\pm 0.5$  dB.

**Linear:**  $\pm 5.8\%$

# SIGNAL ANALYZERS

## HP 141T Spectrum Analyzer System: 10 MHz to 40 GHz

Models 8555A, 8444A & 8445B (cont.)

### Amplitude Display

**Log:**  $\pm 0.25$  dB/dB, but not more than  $\pm 1.5$  dB over the full 70 dB display range.

**Linear:**  $\pm 2.8\%$  of full 8-division deflection.

**Log reference level:** accurate to  $\pm 0.2$  dB ( $\pm 2.3\%$  linear sensitivity).

**Log reference level vernier:** accurate to  $\pm 0.1$  dB (1.2%) in 0, -6, and -12 dB positions; otherwise,  $\pm 0.25$  dB ( $\pm 2.8\%$ ).

**Input attenuator range:** 0-50 dB in 10 dB steps, manual safety lockout for 0 dB position.

**Frequency response:** typically  $\pm 0.6$  dB from 10 MHz to 18 GHz.

**Calibrator output:** amplitude -30 dBm,  $\pm 0.3$  dB. Frequency 30 MHz  $\pm 3$  kHz.

**Absolute calibration accuracy:** overall accuracy is a function of measurement technique. With the appropriate technique, absolute accuracy of  $\pm 1.6$  dB (fundamental mixing) and  $\pm 2.6$  dB (4th harmonic mixing) is achievable.

### Input Characteristics

**Input impedance:** 50 ohms nominal (0.01-18 GHz).

**Reflection coefficient:**  $< 0.13$  (1.30 SWR) for 0.01-7.5 GHz;  $< 0.23$  (1.6 SWR) for 7.5-18 GHz.

**Maximum input level:** peak or average power +13 dBm (1.0 V ac rms) incident on mixer (+30 dBm with Opt 002), +33 dBm incident on input attenuator.

**RF input connector:** type N female.

**LO emission:** -10 dBm without preselector, -80 dBm with preselector over recommended operating ranges (10 dB input attenuator setting).

### General

**Scan time:** 16 internal scan rates from 0.1 ms/div to 10 sec/div in a 1, 2, 5 sequence.

**Power requirements:** 100, 120, 220 240 V +5%, -10%, 50-60 Hz, normally less than 225 watts (varies with plug-in units used).

**Weight:** net, 16.8 kg (14.9 lb). Shipping, 8.7 kg (19 lb).

**Size:** 102 H x 226 W x 344 mm D (4" x 8.9" x 13.5").

### Specifications with Option 002;

#### Internal Limiter Installed

All specifications are the same as for the standard unit except the following:

**Frequency range:** 0.1-12.4 GHz, usable over 0.01-18 GHz range.

#### Maximum Input Level

**Continuous:** 1 W (+30 dBm).

**Pulse:** 75 watts peak, pulse width  $\leq 1$   $\mu$ s, 0.001 duty cycle.

**Reflection coefficient:**  $< 0.33$  (2.0 SWR).

**Frequency response (flatness):**  $< \pm 0.5$  dB degradation in response, 0.1-12.4 GHz.

## HP 8445B Tracking Preselector

### Frequency Specifications

**Frequency range:** dc-1.8 GHz low-pass filter. 1.8-18 GHz tracking filter.

**Tracking filter 3 dB bandwidth:** typically 20-45 MHz.

**Tracking filter skirt roll-off:** characteristics of a three-pole filter. (Nominal: 18 dB/octave.)

### Insertion Loss

	Frequency	Insertion Loss (Except Opt. 004)	Insertion Loss (Opt. 004)
Low-Pass Filter	D-1.8 GHz	$< 2.5$ dB	*
	@2.05 GHz	$> 50$ dB	*
Tracking Filter	1.8-12 GHz	$< 8$ dB	$< 7$ dB
	12-18 GHz	$< 10$ dB	$< 8$ dB

\*Low-Pass Filter deleted with Opt 004.

### Typical Preselector Minimum Insertion Loss at 25°C.

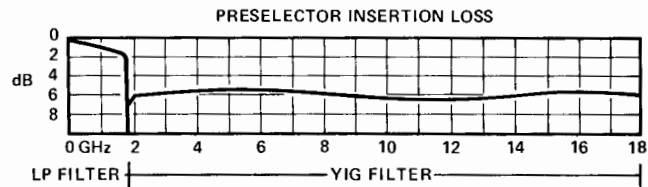

**Out-of-band rejection:** for YIG filter 1 GHz from center of pass-band  $> 70$  dB.

### Digital Frequency Readout (option 003)

#### Function

**Full scan mode:** displays frequency at inverted marker.

**Per division scan:** displays center frequency.

**Manual or remote operation of preselector:** displays tuned frequency of filter.

**Resolution:** 1 MHz.

**Accuracy:** 0.01-1.0 GHz:  $\pm 6$  MHz.

1.0-4.0 GHz:  $\pm 8$  MHz.

4.0-18 GHz:  $\pm 0.2\%$

### Input Specifications

**Input connector:** precision Type N female.

**Input VSWR:** typically  $< 2.0$  (1.8-18 GHz).

**Limiting level:** (maximum input level for  $< 1$  dB signal compression),  $> +5$  dBm.

**Damage level:**  $> +20$  dBm.

### General

**Remote function:** YIG filter frequency can be set by externally supplied voltage.

**Power requirements:** 100, 120, 220, or 240 V + 5%, -10%, 48 to 440 Hz, less than 110 watts.

**Weight:** net, 8.8 kg (19.5 lb). Shipping, 11.9 kg (26 lb).

**Size:** 88.2 H x 425 W x 467 mm D (3.5" x 16.8" x 18.4").

## HP 8444A Opt 059 Tracking Generator

**Frequency range:** 0.5 MHz to 1500 MHz.

**Frequency resolution:** 1 kHz.

**Residual FM (peak-to-peak):** 200 Hz (stabilized).

### Amplitude Range

**Spectrum analyzer display:** from -130 dBm to +10 dBm, 10 dB/div on a 70 dB display or 2 dB/div on a 16 dB display (HP 8552B only).

**Tracking generator (drive level to test device):** 0 to -10 dBm continuously variable.

### Amplitude Accuracy

**System frequency response:**  $\pm 2.7$  dB.

**Tracking generator calibration:** 0 dBm at 30 MHz to  $\pm 0.5$  dB.

**Dynamic range:**  $> 90$  dB.

**Counter output:** typically 0.1 V rms.

### General

**Power:** 115 V and 230 V, 48 to 440 Hz, 12 watts max.

**Weight:** net, 7.1 kg (15.6 lb). Shipping, 9.5 kg (21 lb).

**Size:** 85.2 H x 425 W x 467 mm D (3.5" x 16.8" x 18.4").

### Ordering Information

HP 8555A Tuning Section

Opt 001: APC-7 connectors

Opt 002: Internal limiter

Opt 005: Video tape

HP 8445B Tracking Preselector, dc -18GHz

Opt 001: APC-7 connectors

Opt 002: Add manual controls

Opt 003: Add digital frequency readout

Opt 004: Delete low-pass filter

Opt 005: Delete interconnect rigid coax

HP 8444A Opt 059 Tracking Generator

HP 11517A External Mixer (taper section req'd)

HP 11518A Taper Section, 12.4 to 18 GHz

HP 11519A Taper Section, 18 to 26.5 GHz

HP 11520A Taper Section, 26.5 to 40 GHz



# SIGNAL ANALYZERS

Harmonic Mixers, 18 to 60 GHz

Models 11970/11971 Series & 11517A

621



- Low conversion loss
- Individually amplitude calibrated

- No bias or tuning adjustments
- High 100 mW safe input level

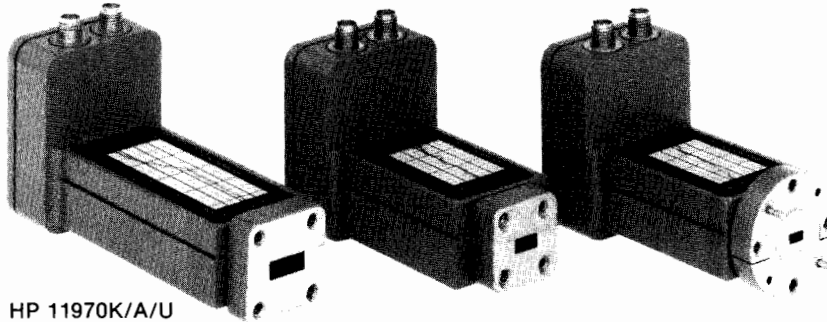

HP 11970K/A/U

## HP 11970 and 11971: Exceptional Performance

The HP 11970 and 11971 Series of waveguide mixers are general purpose harmonic mixers employing a state-of-the-art, dual-diode design to achieve very flat frequency response and low conversion loss. Mixers are available in four waveguide frequency bands: HP 11970K/11971K: 18 to 26.5 GHz; HP 11970A/11971A: 26.5 to 40 GHz; HP 11970Q, 33 to 50 GHz; and HP 11970U: 40 to 60 GHz. The HP 11970K/A/Q/U mixers are designed for a LO of 3 to 6.1 GHz and the HP 11971 K/A mixers are optimized for a 2 to 4.5 GHz LO. Conversion loss of each mixer is calibrated to an accuracy of  $\pm 2.0$  dB.

## Easy to Use

The excellent frequency response and low conversion losses of the HP 11970 and 11971 Harmonic Mixers are achieved **without external dc bias** or tuning stubs. With no adjustments to make, the measurement process for a manual operator is simplified, as well as the software and computer controlled hardware of an automated measurement system.

## HP 11517A Harmonic Mixer

The low cost and wide frequency range of the HP 11517A Harmonic Mixer provides a very economical solution covering 12.4 to 40 GHz for measurements not requiring amplitude calibration. Making measurements in more than one waveguide band is accomplished quickly and easily with a change of the waveguide adapter. The IF range of DC to 2 GHz and LO range of 2 to 6 GHz makes this biased mixer compatible with a wide range of test instruments.

## Frequency Extenders for Spectrum Analyzers

The HP 11970 and 11971 Harmonic Mixers are fully compatible with the HP 8566A and HP 8569B Spectrum Analyzers respectively. The HP 11975A 2 to 8 GHz Amplifier provides the optimum LO power level to the mixers from these spectrum analyzers. The low conversion loss of the mixers yields excellent sensitivity over the full waveguide band without the inconvenience of any signal-peaking adjustments. Very accurate frequency and amplitude measurements are read directly from the spectrum analyzer's display after calibration using each mixer's individual calibration report.

The HP 11517A Harmonic Mixer provides a very economical frequency extension for the HP 8555A and 8565A Spectrum Analyzers. DC bias for the HP 11517A is provided by the spectrum analyzers and the built-in signal identifier allows quick verification of the frequency of any signal displayed.

## HP 11970 and 11971 Specifications

**IF range:** DC to 1300 MHz.

**LO amplitude range:** +14 to +18 dBm, +16 dBm optimum.<sup>1</sup>

**Calibration accuracy:**  $\pm 2.0$  dB with optimum LO amplitude.

**Typical RF input SWR:** < 2.2:1.

**Bias requirements:** None.

**Typical odd order suppression:** > 20 dB.

**Maximum CW RF input level:** +20 dBm (100 mW).

**Maximum peak pulse power:** +24 dBm (250 mW) with <1 usec pulse (avg. power: +20 dBm).

**Environmental:** Meets MIL-T-28800C, Type III, Class 3, Style C.

**IF/LO connectors:** SMA female.

## HP 11970 Series Specifications

**LO input frequency range:** 3.0 to 6.1 GHz.

HP Model	Frequency Range (GHz)	LO Harmonic Number	Maximum Conversion Loss (dB)	8566A Noise Level, 1 kHz BW (dBm)	Frequency Response (dB)	8566A Amplitude Accuracy (corr'd, dB)	Typical Gain Compression (<1 dB, q dBm)
11970K	18-26.5	6+	24	-110	$\pm 1.9$	$\pm 3.2$	-3
11970A	26.5-40	8+	26	-108	$\pm 1.9$	$\pm 3.2$	-5
11970Q	33-50	10+	28	-104	$\pm 1.9$	$\pm 3.2$	-7
11970U	40-60	10+	28	-104	$\pm 1.9$	$\pm 3.2$	-7

## HP 11971 Series Specifications

**LO input frequency range:** 2.0 to 4.5 GHz.

HP Model	Frequency Range (GHz)	LO Harmonic Number	Maximum Conversion Loss (dB)	8569B Noise Level, 1 kHz BW (dBm)	Frequency Response (dB)	8569B Amplitude Accuracy (corr'd, dB)	Typical Gain Compression (<1 dB, dBm)
11971K	18-26.5	6+	24	-110	$\pm 2.1$	$\pm 3.3$	-3
11971A	26.5-40	10+	28	-106	$\pm 2.1$	$\pm 3.3$	-7

## HP 11517A Specifications

**IF range:** DC to 2000 MHz.

**LO frequency range:** 2.1 to 6.1 GHz.

**LO amplitude range:** 0 to +10 dBm, +10 dBm optimum.<sup>1</sup>

**Typical flatness:** (with bias peaked):  $\pm 3$  dB, over 1 GHz frequency span.

**Maximum CW RF input level:** +10 dBm (10 mW).

**Typical DC bias range:** 0 to 3.5 mA.

**Typical 3 dB gain compression level:** -15 dBm.

**Noise level** (using HP 8555A or 8565A with 1 kHz BW): -85 dBm, 12.4 to 18 GHz; -80 dBm, 18 to 26.5 GHz; -70 dB, 26.5 to 40 GHz.

**Waveguide adapters:** 12.4-18 GHz: HP 11518A; 18-26.5 GHz: HP 11519A; 26.5-40 GHz: HP 11520A.

## Ordering Information

HP 11970K 18 to 26.5 GHz Mixer

HP 11970A 26.5 to 40 GHz Mixer

HP 11970Q 33 to 50 GHz Mixer

HP 11970U 40 to 60 GHz Mixer

HP 11970T 18 to 40 GHz Mixer Set and Case

**Opt 001:** Adds 40 to 60 GHz Mixer to 11970T

**Opt 002:** Adds 33 to 50 GHz Mixer

HP 11971K 18 to 26.5 GHz Mixer

HP 11971A 26.5 to 40 GHz Mixer

HP 11971T 18 to 40 GHz Mixer Set and Case

**Opt 009:** Mixer Connection Set contains three 1 meter

low-loss SMA cables, a wrench, and an allen driver for

use with any of the mixers listed above. Space is provided

in storage case for cables and tools.

HP 11517A Harmonic Mixer (Waveguide Adapter required)

HP 11518A 12.4 to 18 GHz Waveguide Adapter

HP 11519A 18 to 26.5 GHz Waveguide Adapter

HP 11520A 26.5 to 40 GHz Waveguide Adapter

HP 11975A 2 to 8 GHz Amplifier

<sup>1</sup> The HP 11975A Amplifier or a similar amplifier with leveled output power (typically  $\pm 0.5$  dB) can be used to provide sufficient LO power to the mixers.

**SIGNAL ANALYZERS****Spectrum Analyzer Accessories**

Models 11975A, 8447 Series &amp; 11970/11971 Series

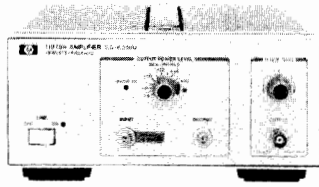

HP 11975A

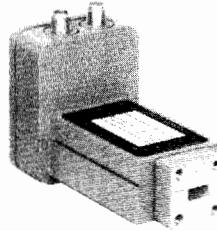

HP 11970/11971 Series

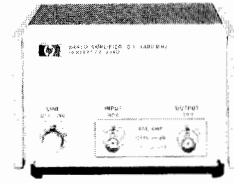

HP 8447 Series



HP 11693A



HP 11867A



HP 11694A

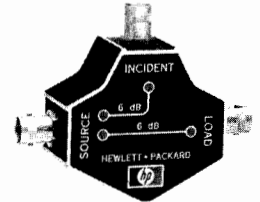

HP 8721A



HP 8406A



HP 1121A

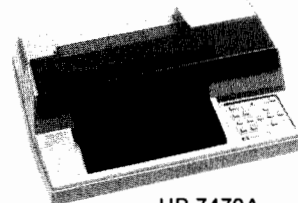

HP 7470A

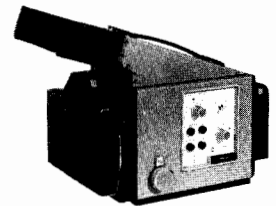

HP 197B

**HP 8447 Series Amplifiers (0.1 to 1300 MHz)**

The HP 8447 Series Amplifiers feature low noise and wide bandwidth. This makes them ideal for improving spectrum analyzer sensitivity and noise figure while providing input isolation. Accurate measurements over a wide frequency range are assured due to the broad frequency coverage, flat frequency response, and low distortion of these amplifiers. (See page 418.)

**HP 11975A Amplifier (2 to 8 GHz)**

A wide variety of sources can be leveled to  $\pm 1$  dB and amplitude calibrated up to +16 dBm using the HP 11975A in a stimulus response system. As a preamp, the small signal gain of the HP 11975A varies between 9 and 15 dB depending on the frequency. For measurements above 18 GHz, the HP 11975A is ideal for amplifying the local oscillator signal from a spectrum analyzer or network analyzer to drive a waveguide mixer like the HP 11970 or 11971 Series Harmonic Mixers. (See page 416.)

**HP 11970 and 11971 Series Harmonic Mixers (18 to 60 GHz)**

Each of these mixers provides low conversion loss and flat frequency response (typically  $\pm 1.5$  dB) over a full waveguide band of the 18 to 60 GHz frequency range. Optimized for 2 to 6 GHz local oscillator signals, the mixers are characterized for conversion loss and require no dc bias or tuning adjustments which could affect measurement accuracy and repeatability. (See page 621.)

**HP 11867A and 11693A Limiters**

The input circuits of spectrum analyzers, counters, amplifiers, and other instrumentation is protected against high power levels with minimum effect on measurement performance. The HP 11867A RF Limiter (dc-1800 MHz) begins reflecting signal levels over 1 milliwatt without damage up to 10 watts avg. power and 100 watts peak power. Insertion loss is  $< 0.75$  dB. The HP 11693A Microwave Limiter (0.1-12.4 GHz, useable to 18 GHz) guards against input signals over 1 milliwatt up to 1 watt avg. power and 10 watts peak power.

**HP 11694A 75 $\Omega$  Matching Transformer (3 to 500 MHz)**

Allows measurements in 75 $\Omega$  systems while retaining amplitude calibration. VSWR is  $< 1.2$ , and insertion loss is  $< 0.75$  dB. See Options 001 and 002 for 75 $\Omega$  versions of the HP 8557A and 8558B.

**HP 8721A Directional Bridge (100 kHz to 100 MHz)**

For making return loss measurements using a swept source such as the HP 8443A Tracking Generator and a spectrum analyzer. 6dB insertion loss and 6dB coupled to auxiliary arm. Frequency response  $\pm 0.5$ dB (0.1-110MHz). Directivity  $> 40$ dB (1 to 110 MHz). Load part return loss  $< 0.03$ . Max input power +20 dBm. 50 $\Omega$ ; Option 008: 75 $\Omega$ . (See page 501.)

**HP 1121A Active Probe (0.1 to 500 MHz)**

Provides high impedance input ( $> 100$  k $\Omega$  shunted by  $< 3$  pF) input to spectrum analyzer for measurements on sensitive circuits. Probe power is supplied by most HP Spectrum Analyzers and flat response with unity gain assures accurate, convenient measurements. (See page 559.)

**HP 8406A Frequency Comb Generator**

Produces frequency markers at 1, 10, and 100 MHz increments accurate to  $\pm 0.01\%$  and useable to beyond 5 GHz. An external oscillator can be used to generate precision interpolation sidebands. For an internal comb generator option to the HP 8569B, see page 601.

**HP Plotters and Recorder**

Produce hard copy records of measurement data in either a computer-based system or directly from a plotter-controlling instrument. Plotter controls on the HP 8569B Spectrum Analyzer or the HP 853A Spectrum Analyzer Display send the displayed information directly to an HP 7470A, 7475(A or B), or 7090A. The HP 7090A is a new combination Plotter-Recorder Waveform Sampler.

**HP 197B CRT Camera**

For a permanent record of a CRT display. See page 363 for the necessary adapters.

**Ordering Information**

HP 8447A 0.1 to 400 MHz Preamp  
 HP 8447D 0.1 to 1300 MHz Preamp  
 HP 8447E 0.1 to 1300 MHz Power Amplifier  
 HP 8447F 0.1 to 1300 MHz Preamp and Power Amplifier  
 HP 11975A 2 to 8 GHz Amplifier  
 HP 11970/11971 Series Harmonic Mixers see page 621  
 HP 11867A RF Limiter  
 HP 11693A Microwave Limiter  
 HP 11694A 75 $\Omega$  Matching Transformer  
 HP 8721A Directional Bridge  
 HP 1121A Active Probe  
 HP 8406A Frequency Comb Generator  
 HP 7470A Plotter  
 HP 197B CRT Camera

# SIGNAL ANALYZERS

## 5 Hz to 50 kHz Spectrum Analyzer

### Model 3580A

623

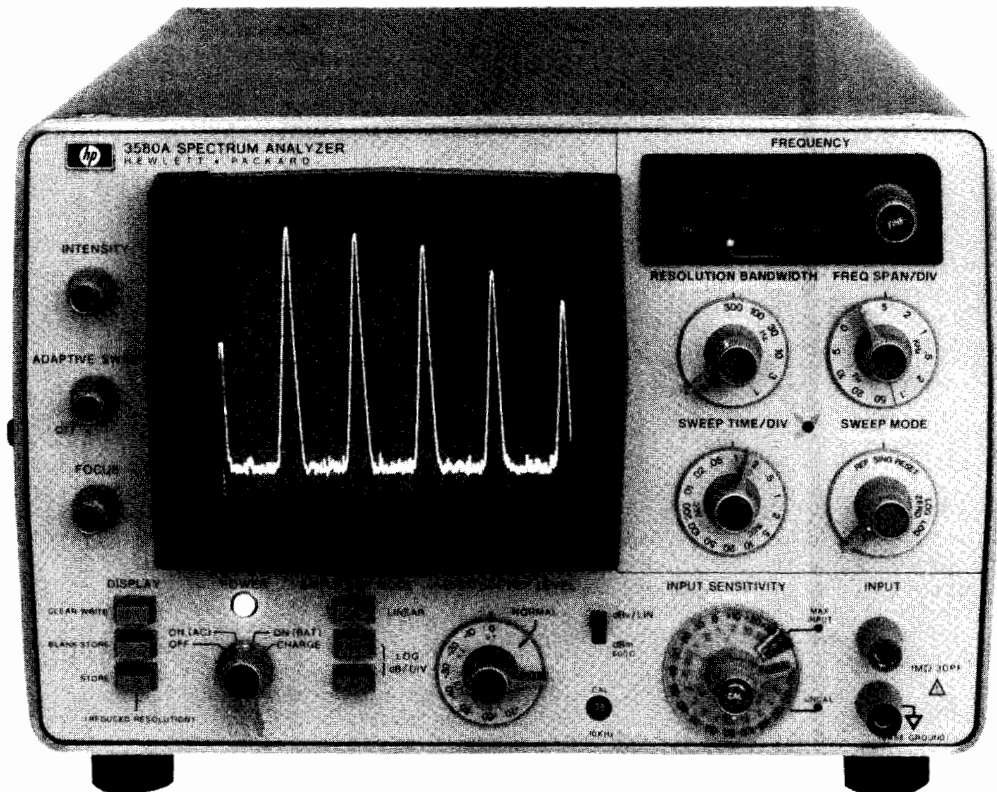

HP 3580A

### Description

Hewlett-Packard's 3580A Spectrum Analyzer is a low frequency high performance analyzer. Its 1 Hz bandwidth allows the user to examine noise and extraneous signal content close in to a signal of interest.

For low frequency applications where sweep speeds can be slow and time-consuming, a special feature, adaptive sweep, allows the user to set a threshold above which only the spectra of interest are observed. In this mode, the CRT is rapidly swept. When a signal is encountered, the sweep slows down to reproduce full response. A factor of ten speed gain is possible.

Digital storage is another important feature which enhances the display for slowly swept low frequency signals. The analyzed signals are digitized and stored in memory. Trace information is then read from memory at a rate appropriate for obtaining an analog-like display.

### Digital Storage for Spectra Comparison

Digital storage makes it possible to store one or two traces. When two are stored, both may be simultaneously displayed for easy comparison as shown below.

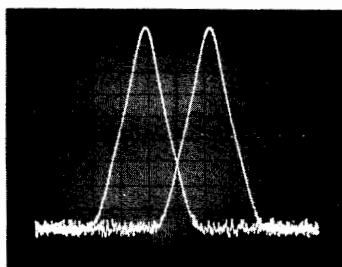

### Adaptive Sweep

A tremendous savings in sweep time can be achieved by using adaptive sweep. In the left trace below, over 80 dB of dynamic range is used to look at low level signals and noise. Two hundred seconds were required to make the sweep. In the right trace, the baseline is raised to give 50 dB of dynamic range. Noise and other responses are not analyzed, so the sweep now takes only 14 seconds.

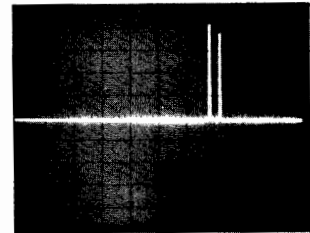
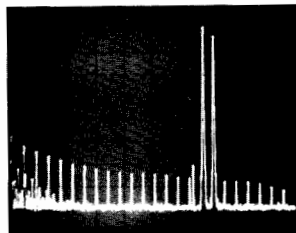

### 1 Hz Bandwidth

When using a 1 Hz bandwidth 60 Hz line related spectra are clearly exposed as shown in the left trace. An analysis of the same signal with a 10 Hz bandwidth will not resolve the line related spectra as shown on the right.

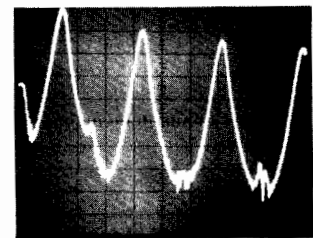
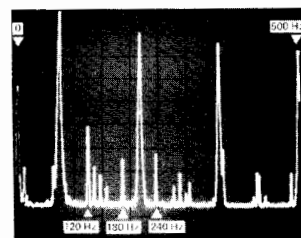



# SIGNAL ANALYZERS

## 5 Hz to 50 kHz Spectrum Analyzer (cont.)

Model 3580A

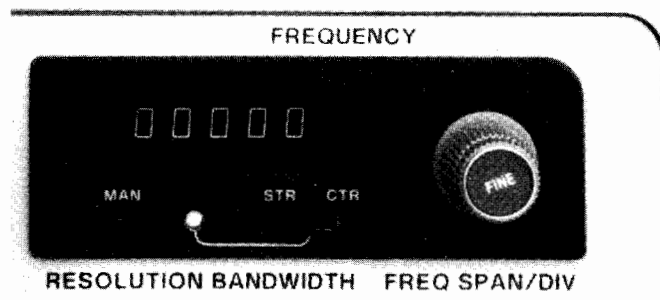

### Digital Frequency Display

This display provides 1 Hz resolution for setting analysis range and for determining tuned frequency. In the automatic sweep modes, the sweep start or center frequency is displayed. In the manual sweep mode, actual tuned frequency is indicated. This mode effectively provides a cursor function for easy and accurate determination of the frequency at any point on the screen.

### Internal Calibration Signal

A 10 kHz pulse derived from a crystal can be used to compensate for internal errors. A 10 kHz calibration potentiometer is provided so the 10 kHz fundamental can be adjusted to fall on the top line of the display. With this feature, operation and calibration can be verified for most of the instrument.

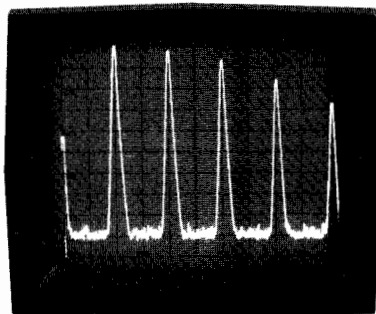

## Specifications

### Frequency Characteristics

**Range:** 5 Hz to 50 kHz.

### Digital Frequency Display

**Resolution:** 1 Hz

**Accuracy:**  $\pm 3.5$  Hz, 0 to 55°C.

**Typical stability:**  $\pm 10$  Hz/hr after 1 hour;  $\pm 5$  Hz/°C.

**Bandwidths:**  
(accuracy  $\pm 15\%$ )  
**Shape factor:**

1 Hz (25°C $\pm$ 5°C)	3 Hz	10 Hz	30 Hz	100 Hz	300 Hz
10					8

**Out of range blank:** if controls are set so portions of displayed signal lie below 0 Hz or above 50 kHz, the baseline is displayed.

### Amplitude Characteristics

#### Overall Instrument Range

Linear: 20 V – 100 nV full scale  
Log: +30 dBm or dB V;  
–150 dBm or dB V

### Amplitude Accuracy

Frequency response:

20 Hz–20 kHz

5 Hz–50 kHz

Switching between bandwidths (25°C):

3 Hz–300 Hz

1 Hz–300 Hz

Amplitude display

Input attenuator

Amplitude reference level:

(IF attenuator)

Most sensitive range

All other ranges

Log      Linear

$\pm 3$  dB     $\pm 3\%$   
 $\pm 5$  dB     $\pm 5\%$

$\pm 5$  dB     $\pm 5\%$   
 $\pm 1$  dB     $\pm 10\%$

$\pm 2$  dB     $\pm 2\%$   
 $\pm 3$  dB     $\pm 3\%$

$\pm 1$  dB     $\pm 10\%$   
 $\pm 1$  dB     $\pm 3\%$

**Dynamic range:** 80 dB

**IF feedthru:** input level > 10 V, –60 dB; < 10 V, –70 dB.

**Spurious responses:** > 80 dB below input reference level.

**Smoothing:** 3 positions, rolloff is a function of bandwidth.

**Overload indicator:** this LED indicator warns of possible input amplifier overloading. Without this indication it would be possible to introduce spurious responses without knowing it.

### Sweep Characteristics

**Scan width:** 50 Hz to 50 kHz.

**Log sweep:** 20 Hz to 43 kHz  $\pm 20\%$  after 3 sweeps.

**Sweep times:** 0.1 s to 2000 s.

**Rep:** repetitive sweeps over the specified band.

**Reset:** resets to the beginning of the sweep—used to adjust start or center frequency.

**Manual:** in combination with the concentric knob, manual sweep fully duplicates the span of the electronic sweep.

**Adaptive sweep:** when in adaptive sweep below the threshold level, scan speed is 20 to 25 times faster. Threshold is adjustable to cover 0–60% of screen. Signals greater than about 6 dB above threshold are detected and swept slowly.

**Sweep error light:** this LED indicates a sweep that is too fast to capture full response. When the light is on, response can be > 5% lower than it should.

**Zero scan:** to look at the time varying signal at the center or start frequency within the bandwidth selected, the zero scan is used.

### Output Characteristics

**Tracking generator output:** (also known as BFO or tracking oscillator output).

**Range:** 0 to 1 V rms into 600  $\Omega$ .

**Frequency response:**  $\pm 3\%$ , 5 Hz to 50 kHz.

**Impedance:** 600  $\Omega$ .

**Total harmonic and spurious content:** 40 dB below 1 volt signal level.

### X-Y Recorder Analog Outputs

**Vertical:** 0 to +5 V  $\pm 2.5\%$ .

**Horizontal:** 0 to +5 V  $\pm 2.5\%$ .

**Impedance:** 1 k $\Omega$ .

**Pen lift:** contact closure to ground during sweep.

**Recommended Accessory:** HP 7090A Measurement Plotting System.

**Size:** 203.2mm H x 285.8mm W x 412.8mm D (8" x 11¼" x 16¼").

**Weight:** net, 12.25 kg (27 lb); HP 3580A Opt 001: net, 15.88 kg (35 lb).

**Temperature range:** 0°C to 55°C.

**Power:** 100 V, 120 V, 220 V, or 240 V  $\pm 5\%$  – 10%; 48 to 440 Hz; 35 VA max.

**Opt 001 battery:** 5 hours from full charge. 14 hours to fully recharge. The internal battery is protected from deep discharge by an automatic turn off. Useful life of batteries is over 100 cycles.

### Ordering Information

**HP 3580A Spectrum Analyzer**

**Opt 001:** internal rechargeable battery

**Opt 002:** balanced input

**Opt 003:** rack mount

# SIGNAL ANALYZERS

## Dual-Channel, Dynamic Signal Analyzer 0.02 Hz to 25.5 kHz

### Model 3582A



- Transfer function magnitude and phase measurements
- Coherence function measurement
- Phase spectrum measurement
- Transient capture and frequency domain analysis
- Internal periodic and random noise source
- Band selectable analysis for 0.02 Hz resolution
- Alphanumeric CRT annotation and marker readout

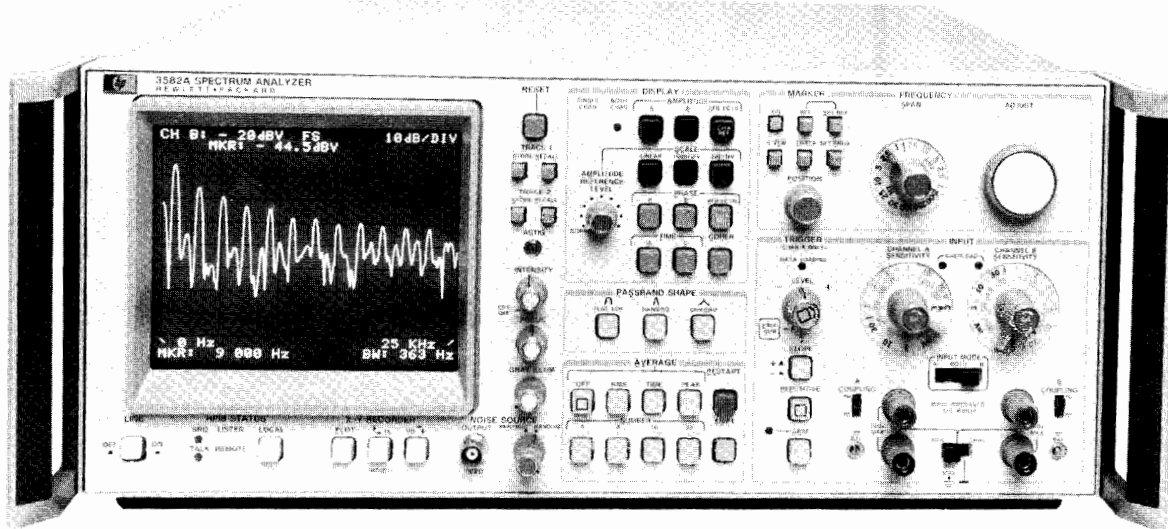

HP 3582A



### Description

The HP 3582A offers outstanding value in a dual-channel, real-time spectrum analyzer that solves bench and systems measurement problems in the frequency range of 0.02 Hz to 25.599 kHz. Sophisticated LSI digital filtering combined with microcomputer execution of the Fast Fourier Transform (FFT) provides exceptional measurement capability and performance.

### Exceptional Frequency Resolution

The ability to resolve closely spaced spectral components is often critical in the study of subtle phenomena such as structural transfer functions. Unlike conventional dynamic signal analysis which extends from dc to some maximum frequency, the HP 3582A can "zoom in" to analyze any selected band of frequencies with dramatically improved resolution. The start or center frequency of the 5 Hz to 25 kHz band analysis spans can be adjusted in 1 Hz increments to cover the entire frequency range of the instrument. This provides resolution down to 20 mHz across the entire range for spectrum analysis or 40 mHz for transfer functions, representing as much as 5000 to 1 improvement over conventional "baseband" analysis.

### Excellent Low Frequency Coverage

Many electrical and physical measurements have significant spectral information in the audio and sub-audio range. With frequency ranges from 25 kHz down to 1 Hz full scale, the HP 3582A is extremely well suited to these types of measurements.

### Real Time Measurement Speed

Long measurement times can be a major limitation of swept low frequency spectrum analyzers. In high volume testing or in applications requiring substantial on-line tuning these long measurement times are both expensive and inconvenient. Since the HP 3582A uses an advanced microcomputer to execute the Fast Fourier Transform (FFT), it can perform equivalent measurements as much as one to two orders of magnitude faster than a swept analyzer.

### Wide Dynamic Range

In many applications the information of interest is contained not in the high amplitude fundamental, but rather in the low amplitude components. For a spectrum analyzer to provide useful information about these low level components in the presence of a large signal, it must offer wide dynamic range. The HP 3582A dynamic range is specified as 70 dB.

### Phase Spectrum Measurement

Most spectrum analyzers can measure only the amplitude spectrum of a signal, yet complete characterization in the frequency domain also requires phase information. Signals with identical amplitude spectra, but different phase spectra can differ significantly. The advanced digital signal processing techniques incorporated in the HP 3582A provides direct measurement of phase spectra.

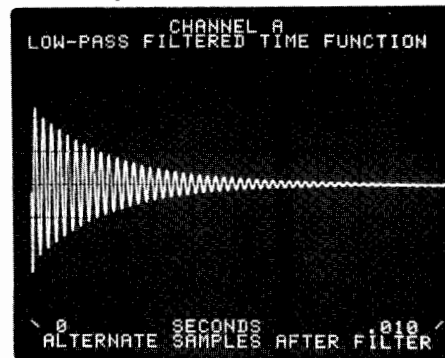

Figure 1: Captured transients can be measured in either the time or the frequency domain.

### Transient Capture and Analysis

Many signals such as mechanical shocks and electrical transients may occur infrequently and spontaneously and may last only for a brief period of time. Swept spectrum analyzers generally cannot handle these transient signals. By using digital processing techniques, the HP 3582A can capture and analyze transients as short as a few milliseconds. This means that spectrum analysis and transfer function analysis are no longer limited to stable, time invariant signals.

### Transfer Function Measurement with the Internal Noise Source

Many electrical circuits and mechanical systems can be treated as linear networks and can be characterized by the magnitude and phase of their transfer functions.

Most spectrum analyzers can measure only the magnitude portion of the transfer function—and even then only by assuming a flat drive signal. The HP 3582A directly measures the complete transfer function, both magnitude and phase. With dual channels analysis of



# SIGNAL ANALYZERS

## Dual-Channel, Dynamic Signal Analyzers 0.02 Hz to 25.5 kHz

### Model 3582A

linear and non-linear networks, respectively. In addition, the sources are bandlimited to concentrate all stimulus energy in the analysis range.

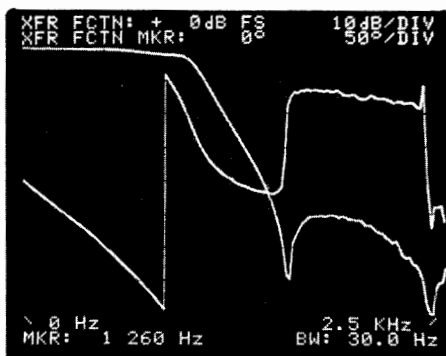

Figure 2: Transfer function amplitude and phase are measured with real time speed.

### Coherence Function Measurement

The measurement of a device transfer function assumes that the device under test is linear and that no portion of the output is caused by noise or extraneous signal sources. In active electronic circuits or mechanical structures these conditions can easily be violated - yet such violations are very difficult to identify. The HP 3582A coherence function simplifies this problem by indicating the probability for causality between the two input signals at each frequency. If the coherence between input and measured output is low, the output signal contains a large amount of energy that is not related to the input. Thus, the transfer function measured at that frequency is not reliable.

### Digital Averaging Capability

Many spectral measurements contain both discrete signals and random noise components. Obtaining proper amplitude readings can be difficult if the random components are really the ones of interest or are of nearly the same amplitude as the discrete signals.

The digital averaging techniques incorporated in the HP 3582A help solve these problems. The RMS averaging mode takes the power average of 4 to 256 successive spectra in order to reduce the uncertainty of the estimate of random spectral components.

When a synchronizing trigger signal is available, the TIME average can enhance the signal-to-noise ratio by as much as 24 dB. Since it involves the averaging of successive time records before transformation, it is also significantly faster than other types of averaging.

### Powerful HP-IB Capability

All major front panel controls with the exception of the verniers are fully programmable via the HP-IB. The programming codes are simple and are logically derived from the front panel control labels.

From the HP-IB it is a simple matter to command the HP 3582A to output results in a usable form. Not only can the various control settings be retrieved, but numeric marker data can be extracted. More importantly, the full display can be read in ASCII format along with complete annotation.

### HP 3582A Specifications

#### Frequency

**Range:** 0.02 Hz to 25.5 kHz with the low frequency limit the result of dc response.

**Spans:** 1 Hz to 25 kHz in a 1-2.5-5-10 sequence. The 1 Hz and 2.5 Hz spans are usable only in the 0-start mode.

**Accuracy:**  $\pm 0.003\%$  of display center frequency.

**Resolution:** 0.4% of the frequency span for single channel or 0.8% of the frequency span for dual channels.

### Filter Passband Shape

	Flat Top	Hanning	Uniform
<b>3 dB Bandwidth (single channel)</b>	$(1.4 \pm 0.1\%$ of span)	$(0.58 \pm 0.05\%$ of span)	$(0.35 \pm 0.02\%$ of span)
<b>Shape Factor</b>	$2.6 \pm 0.1$	$9.1 \pm 0.2$	$716 \pm 20$

### Amplitude

#### Display Modes

**Log:** 10 dB/division or 2 dB/division

**Linear:** constant voltage/division

#### Measurement Range

**Log:** +30 dBV to -120 dBV noise floor

**Linear:** +30 V to 1  $\mu$ V noise floor

**Dynamic range:** 70 dB

**DC response:** adjustable to >40 dB below maximum input level

#### Accuracy

**Accuracy at the Passband Center**  $\pm 0.5$  dB

**Flat top filter:** +0, -0.1 dB

**Hanning filter:** +0, -1.5 dB

**Uniform filter:** +0, -4.0 dB

**Note:** overall accuracy is the sum of the accuracy at the passband center plus the selected filter accuracy.

#### Resolution

**Log:** 0.1 dB

**Linear:** 3 digits

### Phase

**Display range:** +200° to -200°

**Accuracy:**  $\pm 10^\circ$

**Resolution:** 1°

### Transfer Function

#### Measurement Range

**Log:** +160 dB full scale to -80 dB full scale

**Linear:**  $4 \times 10^8$  full scale to  $4 \times 10^{-8}$  full scale

**Phase display range:** +200 degrees to -200 degrees

#### Accuracy

Amplitude	0.4 dB	0.8 dB	
	$\phi$	$\pm 2^\circ$	$\pm 5^\circ$
	.02 Hz	5 kHz	25.5 kHz

**Coherence:** Range 0.0 to 1.0 with 0.01 resolution

### Input

**Impedance:**  $10^6 \Omega \pm 5\%$  shunted by <60 pF from input high to low (for less than 75% relative humidity)

**Isolation:** input low may be floated up to 30V

**Coupling:** switch selection of ac or dc coupling. The low frequency 3 dB roll off is <1 Hz.

**Common Mode Rejection:** > 58 dB

### Output

**X-Y Recorder Level:** 0 V to 5.25 V  $\pm 5\%$

**Noise Source Level:** From <10 mV to >500 mV RMS into > 50  $\Omega$ .

### General

#### Environmental

**Temperature:** 0° C to 55° C operating; -40° C to +75° C storage

**Humidity:** <95% R.H. 0° C to 40° C

**Power Requirements:** 100, 120, 220 or 240 volts (+5%, -10%); 48-66 Hz; less than 150 VA

#### Dimensions

**Size:** 425.5 W x 552.5 D x 188 mmH (16.75" x 21.75" x 7.4")

**Weight:** net, 24.5 kg (54 lb); shipping, 29 kg (63 lb)

### HP 3582A Spectrum Analyzer



# SIGNAL ANALYZERS

Single Channel, Dynamic Signal Analyzer 0.000125 Hz to 100 kHz

Model 3561A

627



- Spectrum and network analysis, waveform recording,  $1/3$  and  $1/1$  octave analysis
- High accuracy,  $\pm 0.15$  dB
- 80 dB dynamic range and full alias protection
- High speed (7.5 kHz Real Time Rate)
- Band selectable zoom analysis for 640  $\mu$ Hz resolution
- Full CRT annotation and softkey ease-of-use
- Auto-ranging, auto-calibration, auto-scaling
- Internal non-volatile memory stores 2 traces and 6 states. Optional bubble (non-volatile) memory stores 127 traces and states.

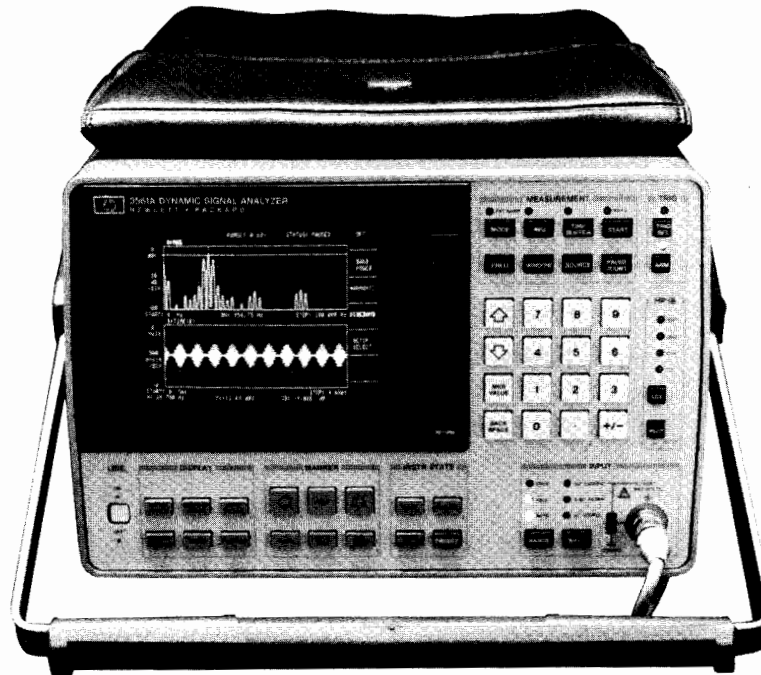

HP 3561A

## Description

The HP 3561A is a versatile, single channel, real time spectrum analyzer with applications in electronics, vibration analysis, and acoustics. It is actually several instruments in one, operating in both the frequency domain and the time domain. In the frequency domain it serves as a spectrum analyzer with  $\pm 0.15$  dB amplitude accuracy and 2 degrees triggered phase accuracy. Utilizing the built-in tracking noise source, it also can serve as a network analyzer. (Trace math can be used when phase response or high accuracy is desired.) Digital signal processing allows the HP 3561A to digitally synthesize  $1/3$  or  $1/1$  octave filters, providing a high accuracy, drift free octave analyzer. Operating in the time domain the HP 3561A can be used as a low frequency digital storage oscilloscope. The HP 3561A contains a 40k-sample time buffer and complete triggering flexibility, so waveform recording is easy. Time or frequency measurements can be stored in an optional non-volatile "bubble" memory for later analysis. Annotated hardcopy is easily obtained by pressing "plot"... the HP 3561A will control HP-GL plotters and raster dump printers directly. All of these capabilities in one portable instrument make the HP 3561A a powerful addition to any bench, and with a standard HP-IB interface, the HP 3561A makes an excellent systems instrument as well.

## Spectrum Analysis

The HP 3561A offers swept analyzer performance with FFT speed. Up to two orders of magnitude speed improvement can be realized, especially in measurements requiring 1 Hz or better frequency resolution. The HP 3561A delivers 158 dB of automatically calibrated measurement range, from +27 dBV (22.4 volts RMS) to -131 dBV (0.28 microvolts RMS). Dynamic range is 80 dB, and amplitude accuracy is  $\pm 0.15$  dB on the +27 dBV to -40 dBV ranges ( $\pm 0.25$  dB on the -41 dBV to -51 dBV ranges). Signals can be read in RMS volts, volts squared, milliwatts, dBV, dBm (with user-selected impedance), and user-defined engineering units. Band, harmonic and sideband

power can be computed directly using the built-in special marker functions. Frequencies spaced as narrow as 640  $\mu$ Hz can be resolved throughout the 100 kHz range, with frequency accuracy  $\pm 0.003\%$  of display center frequency. Phase spectra relative to a trigger signal can be measured with up to 2 degrees phase accuracy, useful for machinery balancing.

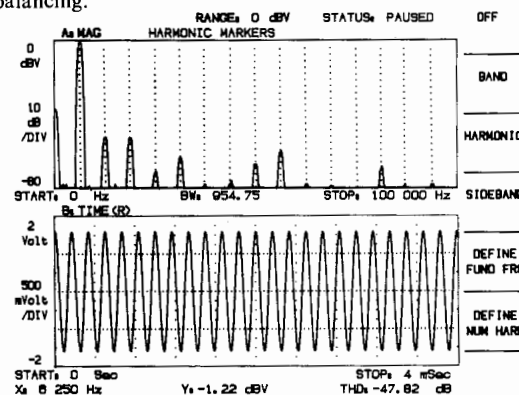

Harmonic marker function computes total harmonic distortion (THD) directly in dB or percent.

## Network Analysis

A band-limited, band-translated noise source allows the HP 3561A to make amplitude and phase frequency response measurements. To make a network measurement, connect the internal noise source to the device under test, adjust the source amplitude, and measure the input spectrum. Store the input spectrum in memory and measure the response spectrum. A simple trace math operation produces the desired frequency response. Amplitude resolution is 0.01 dB and phase resolution is 0.1 degree.



# SIGNAL ANALYZERS

## Single Channel, Dynamic Signal Analyzer 0.000125 Hz to 100 kHz

### Model 3561A (con't)

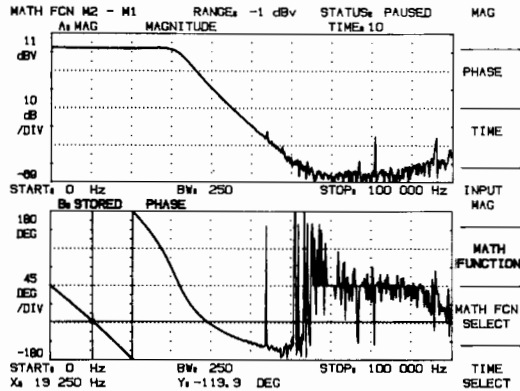

Figure 2: Network amplitude and phase response are measured using the unique internal noise source and trace math.

### Waveform Recording

A high linearity 13 bit analog-to-digital converter makes the HP 3561A a natural for waveform recording. Forty-three sample rates ranging from 256 kHz to 0.026 Hz can be selected. If other sample rates are required, the analyzer can be made to sample on an external TTL clock signal. Up to 40k samples of time data can be stored internally in buffer memory, with complete trigger control. Trigger on an analog level with positive or negative slope and variable level. In either mode you can specify pre- or post-trigger values from 40k samples pre-trigger to 1023k samples of post-trigger delay. Data collected in the time domain is easily analyzed in the frequency domain, making the HP 3561A extremely useful in analyzing transients and other non-steady-state signals.

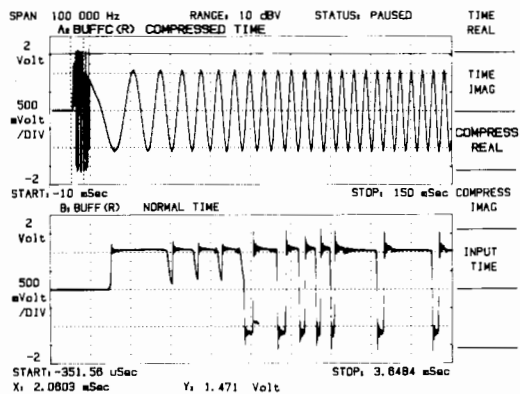

Figure 3: Up to 40,000 samples of a transient waveform can be captured, with analysis in either the time domain or the frequency domain.

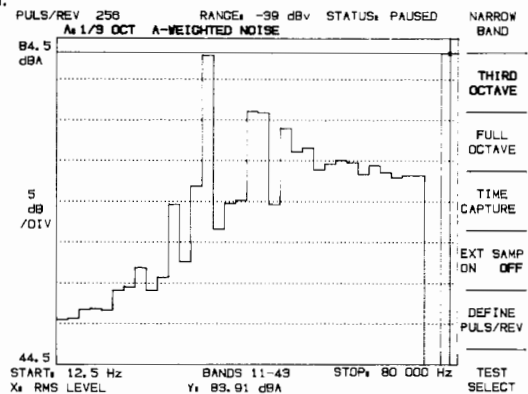

Figure 4: The combination of octave and narrowband analysis makes the HP 3561A a powerful instrument for noise and vibration analysis.

### 1/3 and 1/1 Octave Analysis

Octave analysis is often used in acoustic and vibration work for analyzing signals that are "proportional bandwidth". That is, they exhibit bandwidths that are proportional to their center frequencies. The HP 3561A digitally synthesizes a series of parallel bandpass filters, each with

bandwidth proportional to center frequency. The advantage of the digital technique is better stability and accuracy — there are no analog components to drift, age, or respond to temperature. A built-in hardware A-weight filter can be switched in for acoustic signals where the effects of the human ear must be taken into account.

### Digital Averaging

Digital averaging is provided for improving a measurement in the presence of noise. RMS, RMS exponential, time and peak averaging are provided. Automatic overload signal rejection can be invoked to prevent an otherwise valid reading from being contaminated by one overloaded spectrum. A fast average display mode can be selected which speeds up the averaging process by turning off the display refresh during intermediate averages. This can result in a factor of 3 speed improvement over normal averaging mode. Coupled with its high real time rate, the HP 3561A can make averaged measurements in the same amount of time it formerly took to make an unaveraged measurement!

### Flexible Display Formats and Complete Annotation

Display a single trace, two traces in upper/lower format, or two traces overlaid in front/back format. When several traces must be viewed at once, use the "spectral map" format which can display up to 60 separate traces stacked onto one display. Choose log or linear frequency spacing and log or linear amplitude units. Define your own units, give them a name, and the analyzer will read out in your units! Each trace is completely annotated and can be labelled with your own alphanumeric trace label. A view state display function is provided to quickly give you a summary of the analyzer's current setup state.

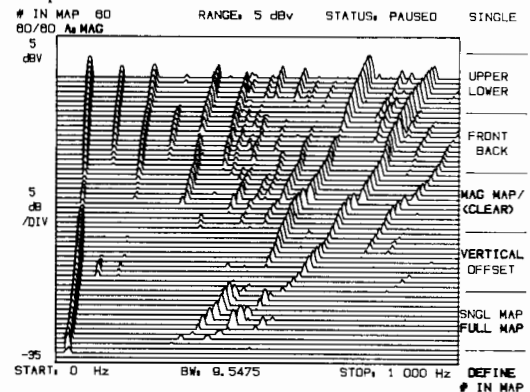

Figure 5: Spectral maps greatly reduce the time required to analyze changes in up to 60 successive measurements.

### Internal Mass Storage

The standard HP 3561A contains 2 traces and 6 setup states of nonvolatile memory. When more storage is required, such as when you wish to store a 40,000-sample waveform captured in waveform recording mode, the "bubble memory" option can be installed. This non-volatile memory allows you to store any combination of 127 traces and states internally. Data stored in internal memory can be transferred via HP-IB to a computer for further analysis or archiving.

FILENAME	INDEX	TYPE	SIZE	DEFINE FILENAME
SWEPT		BUFFERED	7	USE CAT FILENAME
AMP-ACC		SETUP	1	STORE
SWEPTTEST		SETUP	1	BUFFER
TEST-01		SETUP	1	
XFER		SETUP	1	
JIN, 0		TRACE	1	RECALL
JIN, 2		TRACE	1	BUFFER
JIN, 4		TRACE	1	
JIN, 6		TRACE	1	DELETE
				ABORT

BUBBLE RECORDS AVAILABLE FOR NEW STORES: 112 CATALOG ON OFF

Figure 6: Traces and setups are stored in bubble memory by file name. The bubble memory catalog makes recall of stored files easy.

### Annotated Hardcopy

You can obtain fast hardcopy of any display just by pressing the plot button. The HP 3561A controls HP-GL plotters and HP raster dump printers directly. A "marker plot" key allows you to annotate several locations on a plot with amplitude and frequency, or amplitude and time. Simply tune the cursor to the point of interest, press marker plot and the



analyzer annotates the location of interest. Do this as many times as you wish for complete, accurate documentation of measurements.

```

+-DELAY 1.0 Sec      RANGE: 2 dBv      STATUS: PAUSED      SLOPE
                                     POS NEG
NARROW BAND MODE      EXT SAMPLE OFF
FREQUENCY:
BASEBAND              CENTER: 250 Hz      DEFINE
SPAN: 500 Hz          % OF RNG
TIME: 800 uSec
TRIGGER:
INTERNAL              DELAY: 10 Sec      DELAY
AUTO ARM              ON OFF
AVERAGE:
OFF
WINDOW:
FLAT TOP              BW: 4.77375 Hz      DEFINE
SOURCE:
OFF
INPUT:
DC COUPLING          ICP CURRENT OFF      A WEIGHT FLTR OFF
UNITS:
X: Hz
Y: dBv
  
```

Figure 7: Plots of the view state display provide quick hard copy of instrument setup for complete measurement documentation.

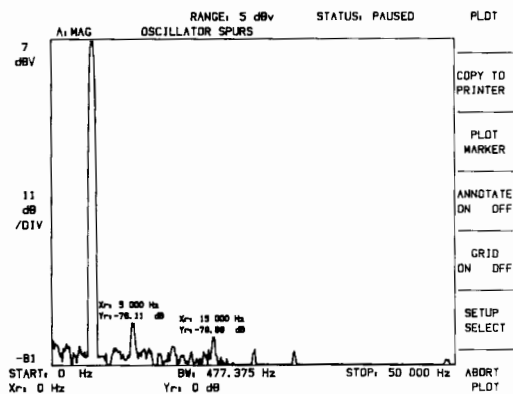

Figure 8: The marker plot function prints x and y marker values for any number of points on the plot.

### Other Features

In most noise and vibration measurements, a transducer is used to convert the physical phenomena to voltage. These transducers generally require some type of signal conditioning. The HP 3561A contains an internal power supply for ICP type (integrated circuit piezoelectric) transducers. This eliminates an extra piece of equipment, which enhances portability and saves money. Trace math operations are provided that allow you to manipulate traces like numbers on a calculator. This is useful for converting units, compensating for systematic errors, and displaying spectra as a percentage of some reference value.

## HP 3561A Specifications

### Frequency

**Range:** 0.000125 Hz to 100 kHz

**Spans:** 0.01024 Hz to 100 kHz in a 1, 2, 2.5, 5, 10 sequence. Other spans are available but are too numerous to list here.

**Accuracy:**  $\pm 0.003\%$  of display center frequency.

**Resolution:** 0.25% of frequency span.

**Window:** Flat Top, Hann, Uniform, and Exponential.

### Bandwidth

3 dB Bandwidth  
(% of frequency span)

	Flat Top	Hann	Uniform
3 dB Bandwidth (% of frequency span)	0.90%	0.37%	0.25%

**Real Time Bandwidth:** (Typical) Single display, 3.0 kHz. Fast average display, 7.5 kHz.

### Amplitude

**Measurement Range:** +27 to -120 dBV noise floor (22.4 VRMS to 1  $\mu$ V noise floor.) Input range is selected in 1-dB steps from +27 to -51 dBV. Optimum range is determined automatically in the autorange mode.

**Dynamic range:** 80 dB

### Accuracy at the Passband

**Center:**  $\pm 0.15$  dB +27 to -40 dBV input ranges  
 $\pm 0.25$  dB -41 to -51 dBV input ranges

**Flat Top window:** +0, -0.01 dB

**Hann window:** +0, -1.5 dB

**Uniform window:** +0, -4.0 dB

**Note:** Overall accuracy is the sum of the accuracy at the passband center plus the selected window accuracy.

### Resolution

**Log:** 0.01 dB

**Linear:** 4 digits

### Phase

**Accuracy:**  $\pm 2$  degrees, dc-10 kHz;  $\pm 10$  degrees, 10-100 kHz (signals no more than 40 dB below full range).

**Resolution:** 0.1 degree.

### Input

**Impedance:**  $1 \times 10^6$  ohms  $\pm 5\%$  shunted by 95 pF maximum.

**Isolation:** Input low may be connected to chassis ground or floated up to 30 volts RMS (42 volts peak) above ground.

**Coupling:** signal may be ac or dc coupled. Low frequency 3-dB point < 1 Hz in ac mode.

**A-weighting:** Hardware A-weighting filter conforms to ANSI standard S1.4-1971 (R1976).

**ICP current:** Nominal 4 mA current source provided, compatible with integrated circuit piezoelectric accelerometers.

### Output

**Source:** Band-limited, band-translated, pseudo-random, random, or impulse, or TTL "synch" signals are available on rear panel. Level is selectable between 0.7 and 0.007 volts RMS, nominal. Impedance  $50 \Omega \pm 5\Omega$ .

**Print/Plot:** Controls HP-GL plotters and HP raster dump printers directly.

### Display

**General:** Magnitude, phase, time and math traces may be selected. Units available are; Horizontal: Hz, seconds, RPM, orders; linear or log spacing. Vertical: dBV, dBm (selectable Z), volts, volts squared, and user-defined units.

**Scale:** Linear or log magnitude scales may be selected. Full scale, dB/division, and degrees/division are user definable. Center scale user definable in phase or time traces.

**Math:** Arithmetic operations can be performed on new or recalled frequency spectra. Add, subtract, multiply, divide, integrate, differentiate and user-defined constants are provided. 1/BW is provided for Power Spectral Density (PSD) computations.

### Internal Memory

	Non-volatile	Volatile
<b>Standard:</b>	2 traces, 6 states	40 time records
<b>Optional:</b>	traces + states + (1 + 2* time capture records)= 127	40 time records

### Marker

Single, relative, harmonic, sideband, and power cursors are provided. THD can be calculated from up to 20 harmonics. Sideband power relative to specified carrier can be calculated from up to 10 sidebands. MKR to peak, MKR to center, MKR to full scale and marker peak track are provided.

### General

**Power:** 100/120 Vac +5%, -10%, 48-440 Hz; 220/240 Vac +5%, -10%, 48-66 Hz.

**Weight:** 15 kg (33 lb) net, 21.6 kg (47.5 lb) shipping.

**Dimensions:** 335 mm W x 595 mm D x 197 mm H (13.2" x 23.4" x 7.8")

**\*HP -IB Interface Functions:** Implementation of IEEE Std. 488-1978 SH1, AH1, T5, TE0, L4, LE0, SR1, RL1, PP0, DC1, DT1, C0.

### Ordering Information

HP 3561A Dynamic Signal Analyzer

Option 001 Extended Non-volatile Memory

# SIGNAL ANALYZERS

Dual-Channel, Dynamic Signal Analyzer 64  $\mu$ Hz to 100 kHz  
Model 3562A

- Network analysis
- Spectrum analysis
- Transient analysis
- Waveform recording
- Frequency response analyzer
- Modulation analysis
- Direct control of disc drives
- Direct control of HP-GL plotters

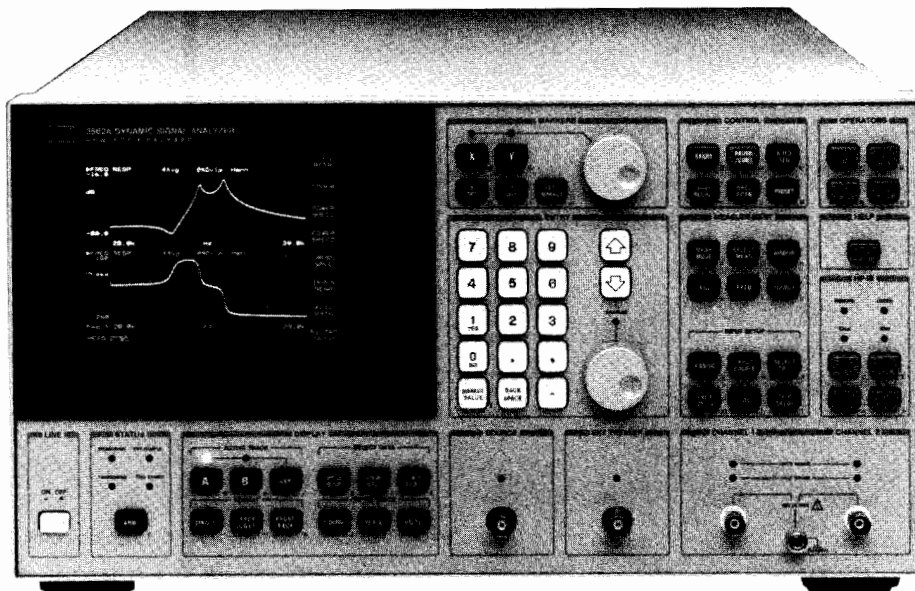

HP 3562A

The HP 3562A Dynamic Signal Analyzer is a dual-channel fast-Fourier transform-based network, spectrum and waveform analyzer which provides analysis capabilities in both the time and frequency domains. The dc-to-100 kHz frequency range, 150 dB measurement range and 80 dB dynamic range of the analyzer makes it a powerful solution for testing and analysis in electronics, mechanics and electro-mechanical control systems.

Two high performance input channels and a built-in signal source (noise and sine signals) address network analysis on the bench or in a test system. Zoom analysis with frequency resolution to 25.6  $\mu$ Hz plus a powerful AM, FM and PM demodulation function makes the HP 3562A a versatile spectrum analyzer. For transient or waveform analysis, signals can be sampled, digitized then stored in an internal memory, or directed via HP-IB to an external disc drive (without a computer). The stored waveforms can be recalled and analyzed in the time and frequency domains (baseband and zoom analysis).

Additional features include a full range of data analysis capabilities such as vector averaging, block-operation Waveform Math, a 40-pole/40-zero Curve Fitter and Frequency Response Synthesis. Front panel operations can be automated without a computer with built-in Auto Sequence programming, or with computers through complete HP-IB programmability. For documentation of results with hardcopy or mass storage, the HP 3562A can control digital plotters and external disc drives directly via HP-IB.

## Network Analysis

Accurate, high resolution frequency response measurements of electronic and mechanical systems can be performed with Linear Resolution FFT, Logarithmic Resolution and Swept Sine analysis. A built-in signal source provides a variety of random noise and sinewave signals to meet the requirements of the system under test.

Linear Resolution is the measurement technique common to all Dynamic Signal Analyzers. In the HP 3562A, 2048-point time records are Fourier-transformed into 801-line frequency spectra. For

network analysis, frequency response magnitude and phase, as well as input and output power spectra, can be measured with 801 lines of resolution. Accuracy for the frequency response magnitude and phase is  $\pm 0.1$  dB and  $\pm 0.5^\circ$ .

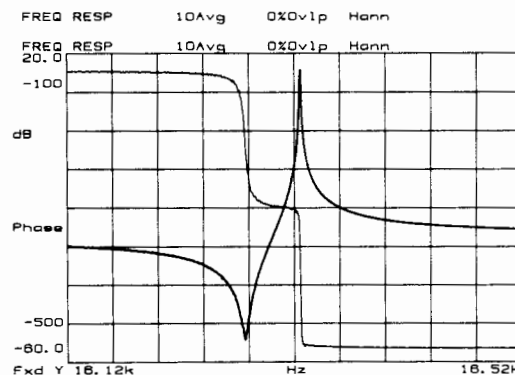

Logarithmic Resolution uses the speed of Linear Resolution FFT measurements to create frequency responses similar to a log-sweep swept sine test. Linear Resolution points are combined internally (rather than just reformatted), on the fly, to create 80-point-per-decade measurements over 1 to 5 decades. Start and stop frequencies can be selected in a 1-2-5 sequence from 0.1 Hz to 100 kHz (for a 0.1 Hz start frequency the maximum stop frequency is 10 kHz — 5 decades).

The Swept Sine mode reconfigures the HP 3562A as a powerful swept sine frequency response analyzer. The source can generate linear or logarithmic sweeps with increasing or decreasing frequency; user-selectable sweep rate and resolution are also standard source

functions. Input channel functions include user-selectable averaging and integration time; automatic input ranging can be activated to provide over 130 dB of dynamic range for measurements of high performance systems.

### Spectrum Analysis

On-line analysis of distortion, drift, modulation and phase noise can benefit from the speed and accuracy of the HP 3562A. High resolution measurements are typically 100 times faster than tuned spectrum analyzers — and, since the HP 3562A is an FFT-based analyzer, you can see transient events that a tuned analyzer would probably miss.

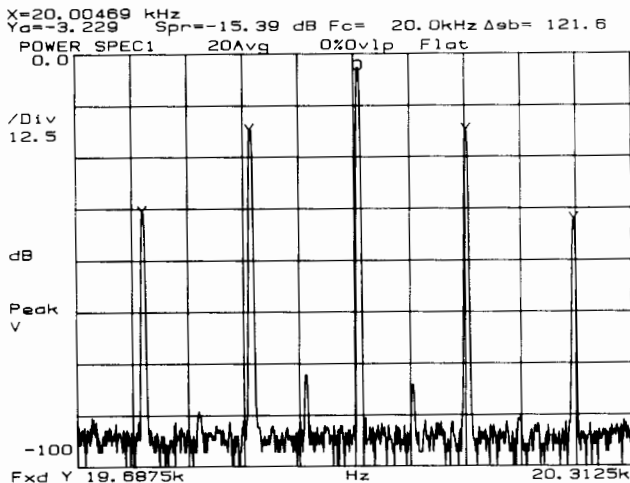

The HP 3562A is essentially a dual-channel spectrum analyzer which provides resolution to 25.6  $\mu$ Hz anywhere within the dc-to-100 kHz measurement range. Single channel accuracy is  $\pm 0.15$  dB with 80 dB of dynamic range. Modulation analysis can be performed on either or both channels with harmonic and sideband markers as well as with the built-in demodulation capability: zoom measurements can be AM, FM or PM demodulated with carrier frequencies up to 99.9 kHz.

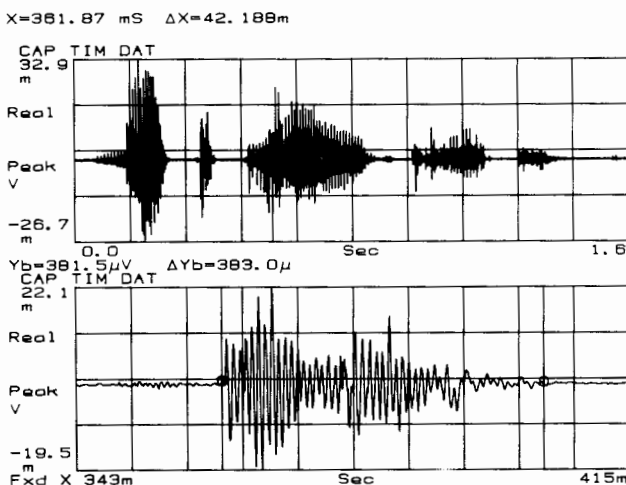

### Waveform and Transient Analysis

Perform complete analysis of waveforms and transients in the time and frequency domains. Sampled and digitized waveforms can be

stored in internal memory (single-channel Time Capture) or on disc in an external disc drive (single- or dual-channel Time Throughput). Data can be recalled for time domain analysis as single time records or as a compressed display of up to 10 time records (Time Capture mode). Data can also be recalled for baseband and zoom analysis in the frequency domain, with vector averaging if needed.

A complete array of triggering capabilities are included to enhance both waveform recording modes. Pre- and post-trigger delays can be specified to capture the rising edge of a transient or to compensate for delays in the system under test.

### Data Throughput to a Disc Drive

When access to prototypes is limited, make your test time more efficient with the Time Throughput capability: through direct control of external disc drives, the HP 3562A can store time data directly to disc without a computer. Set up a measurement and specify the quantity of single- or dual-channel data to be collected. Time data will be sampled, digitized and stored on disc for later analysis as individual time records or as baseband and zoom frequency spectra.

### Hardcopy and Mass Storage with Plotters and Disc Drives

To speed and simplify documentation of results, direct control of plotters and disc drives via HP-IB is a standard feature in the HP 3562A. Literally anything displayed on the analyzer screen can be plotted or saved on disc: measurement results, setup state tables, synthesis tables, curve fit tables and Auto Sequence or Auto Math program listings. Plotting is enhanced with user-selectable line types, pens (up to 8) and paging controls. For mass storage operations, files can be given 8-letter user-defined names; and disc catalog can be recalled and displayed to show file name, type (data, setup, etc.) and date and time of storage.

### Automation for Improved Productivity

Versatile automation capabilities and a wide range of response-only or stimulus/response measurement functions in the HP 3562A help you create productive solutions for your automated testing needs. As a standalone solution, the analyzer can "learn" a series of keystrokes and then perform them on command (Auto Sequence programming). Up to five Auto Sequence programs can be stored internally, with additional programs stored in an external disc drive.

For networked HP-IB systems, the HP 3562A provides complete HP-IB programmability. Custom display graphics and messages can be created through direct programming of the high resolution vector display — user-defined softkey menus can also be created to simplify interactive testing. Rear-panel outputs for large screen displays are also standard.

### HP 3562A Specifications

#### Frequency

**Measurement Range:** 64  $\mu$ Hz to 100 kHz, both channels, single- or dual-channel operation

**Accuracy:**  $\pm 0.004\%$  of frequency reading

**Resolution:** Span/800, both channels, single- or dual-channel operation

Spans:	Baseband	Zoom
Number of spans	66	65
Min span	10.24 mHz	20.48 mHz
Max span	100 kHz	100 kHz
Time record (seconds)	800/span	800/span

**Window Functions:** Hann, Flat Top, Uniform, Force, Exponential, and User Defined

Window Parameters:	Flat Top	Hann	Uniform
3 dB BW (% of span)	0.45	0.185	0.125

**Typical Real Time Bandwidth:** 10 kHz single-channel, 5 kHz dual-channel, with fast averaging on.



# SIGNAL ANALYZERS

## Dual-Channel, Dynamic Signal Analyzer 64 $\mu$ Hz to 100 kHz

Model 3562A (cont.)

### Amplitude

#### Accuracy

Defined as Full Scale Accuracy at any of the 800 calculated frequency points. Overall accuracy is the sum of absolute accuracy, window flatness and noise level.

#### Absolute Accuracy

Single Channel (Channel 1 or Channel 2)  $\pm 0.15$  dB  $\pm 0.015\%$  of input range (+27 dBV to -40 dBV)

$\pm 0.25$  dB  $\pm 0.025\%$  of input range (-41 dBV to -51 dBV)

#### Frequency Response Channel Match:

$\pm 0.1$  dB,  $\pm 0.5$  degree

#### Window Flatness

**Flat Top:** +0, -0.01 dB

**Hann:** +0, -1.5 dB

**Uniform:** +0, -4.0

**Noise Floor:** (Flat top window, 50  $\Omega$  source, 50  $\Omega$  input termination) 20 Hz to 1 kHz (1 kHz span)  $< -127$  dBV ( $-134$  dBV/ $\sqrt{\text{Hz}}$ )

1 kHz to 100 kHz (100 kHz span)  $< -117$  dBV ( $-144$  dBV/ $\sqrt{\text{Hz}}$ )

**Dynamic Range:** All distortion (intermodulation and harmonic), spurious and alias products  $\geq 80$  dB below full scale input range

### Phase

**Accuracy:** Single channel

$< 10$  kHz  $\pm 2.5^\circ$

10 kHz to 100 kHz  $\pm 12.0^\circ$

### Inputs

**Input Impedance:** 1 M  $\Omega$   $\pm 5\%$  shunted by 100 pF maximum

**Input Coupling:** The inputs may be ac or dc coupled; ac rolloff is  $< 3$  dB at 1 Hz

**Crosstalk:** -140 dB (50  $\Omega$  source, 50  $\Omega$  input termination)

#### Common Mode Rejection:

10 Hz to 66 Hz 80 dB

66 Hz to 500 Hz 65 dB

**Common Mode Voltage:** ac plus dc, input terminated with 0  $\Omega$

#### Input Range

(in dBV)	dc to 5 kHz	5 kHz to 100 kHz
+27 to +8	42.0 V peak	42.0 V peak
+7 to -12	42.0 V peak	10.0 V peak
-13 to -51	18.0 V peak	1.0 V peak

**External Trigger Input Impedance:** 50 k $\Omega$   $\pm 5\%$

**External Sampling Input:** TTL compatible input for signals  $\leq 256$  kHz (maximum sample rate).

#### External Reference Input

**Input Frequencies:** 1, 2, 5 or 10 MHz  $\pm 0.01\%$

**Amplitude Range:** 0 dBm to +20 dBm (50  $\Omega$ )

### Trigger

**Trigger Modes:** Free Run, Input Channel 1, Input Channel 2 and External Trigger. Free Run applies to all Measurement Modes; Input Channel 1, Input Channel 2 and External Trigger apply to the Linear Resolution, Time Capture and Time Throughput measurement modes.

#### Trigger Conditions

**Free Run:** A new measurement is initiated by the completion of the previous measurement.

**Input:** A new measurement is initiated when the input signal to either Channel 1 or Channel 2 meets the specified trigger conditions. Trigger Level range is  $\pm 110\%$  of Full Scale Input Range; Trigger Level is user-selected in steps proportional to the input range.

**External:** A new measurement is initiated by a signal applied to the front panel External Trigger input. Trigger Level range is  $\pm 10$  V peak; Trigger Level is user selected in 80 mV steps.

### Trigger Delay

**Pre-Trigger:** The measurement can be based on data from 1 to 4096 samples (1/2048 to 2 time records) prior to trigger conditions being met. Resolution is 1 sample (1/2048 of a time record).

**Post-Trigger:** The measurement is initiated from 1 to 65 536 samples (1/2048 to 32 time records) after the trigger conditions are met. Resolution is 1 sample (1/2048 of a time record).

### Source

**Source Types:** Band limited, band translated random noise, burst random, sine chirp, burst chirp, fixed sine and swept sine signals are available from the front panel Source output. DC Offset is also user-selectable.

**Output Impedance:** 50  $\Omega$   $\pm 5$   $\Omega$

**Output Level:**  $\leq \pm 10$  V peak (ac + dc) into a  $\geq 10$  k $\Omega$ ,  $< 1000$  pF load. Maximum current = 50 mA.

**AC Level:**  $\pm 5$  V peak ( $\geq 10$  k $\Omega$ ,  $< 1000$  pF load)

**DC Offset:**  $\pm 10$  V peak in 100 mV steps. Residual offset at 0 V offset  $\leq 10$  mV.

**% In-Band Energy** (1 kHz span, 5 kHz center frequency)

**Random Noise:** 70%

**Sine Chirp:** 85%

**Accuracy and Purity:** Fixed or Swept Sine

**Flatness:**  $\pm 1$  dB

**Distortion** (including subharmonics):

dc to 10 kHz -60 dB

10 kHz to 100 kHz -40 dB

### General

Specifications apply when AUTO CAL is enabled, or within 5 $^\circ$ C and 2 h of last internal calibration.

**Ambient temperature:** 0 $^\circ$  to 55 $^\circ$  C.

**Relative Humidity:**  $\leq 95\%$  at 40 $^\circ$  C.

**Altitude:** 4,572 m (15,000 ft)

#### Storage

**Temperature:** -40 $^\circ$  to +75 $^\circ$  C.

**Altitude:**  $\leq 15,240$ m (50,000 ft)

#### Power:

100/120 VAC +5% -10%, 48 to 440 Hz

220/240 VAC +5% -10%, 48 to 66 Hz

450 VA maximum

#### Weight:

26 kg (56 lb) net

35 kg (77 lb) shipping

#### Dimensions:

222 mm (8.75 in) high

426 mm (16.75 in) wide

578 mm (22.75 in) deep

### HP-IB

Implementation of IEEE Std 488-1978

**HP-IB Interface Functions<sup>1</sup>:** SH1 AH1 T5 TE0 L4 LE0 SR1 RL1 PP0 DC1 DT1 C0. Supports the 91XX and 794X families of HP disc drives, as well as Hewlett-Packard Graphic Language (HP-GL) digital plotters.

### Accessories Supplied

Operating, Programming and Service Manuals

### Accessories Available

Transit Case for one HP 3562A: HP P/N 9211-2663

### Ordering Information

**HP 3562A** Dynamic Signal Analyzer

**Option 907** Front Handle Kit

**Option 908** Rack Mount Kit

**Option 909** Rack Mount and Front Handle Kit

**Option 910** Extra Operating Manuals

**Option 914** Delete Service Manuals

<sup>1</sup>For more on these codes refer to the HP-IB section of this catalog.



# SIGNAL ANALYZERS

## Structural Dynamics Analyzer

### Model 5423A



- Dual-channel transfer function
- Band-selectable analysis
- Fully calibrated annotated display

- Powerful post-measurement processing
- Digital data storage
- Band limited random noise generator with burst mode



HP 5423A



The HP 5423A Structural Dynamics Analyzer is a high performance dual-channel instrument capable of a number of both time domain and frequency domain measurements over a 25 kHz range. In addition to broad measurement capability, the HP 5423A Structural Dynamics Analyzer provides complete facilities for analyzing the vibration characteristics of mechanical devices and displaying the results in the form of an animated mode shape. The instrument is particularly adapted to solving problems associated with structural vibration and noise, rotating machinery, electro-mechanical control systems, acoustics and a host of similar applications which call for advanced low-frequency analysis.

Among the important standard features are a fully annotated and calibrated dual-trace display, permanent digital storage for measurement results, band selectable analysis, extensive data processing, advanced triggering capability, external sampling capability, calibration in engineering units and a built-in band-limited random noise generator with a new burst random mode. Capable of both stimulus-response and response-only analysis, its measurement repertoire includes:

- Transfer Function
- Coherence Function
- Impulse Response
- Auto Spectrum
- Cross Spectrum
- Linear Spectrum
- Time Record
- Amplitude Histogram
- Auto Correlation
- Cross Correlation

Important capabilities such as independent pre and post trigger delay on each input channel, overlap processing, and external sampling insure that the instrument's measurement power can be effectively applied to a wide range of problems.

A built-in "waveform calculator" is useful for processing measured or synthesized data and greatly extends the basic capabilities. Examples of useful computed functions include:

- Data Comparisons
- Resonant Frequency
- % Critical Damping
- Open Loop Gain
- Calibration in %
- Mechanical Impedance
- Total Harmonic Distortion
- Coherent Output Power
- Signal-to-Noise Ratio
- Transmissibility
- Function Synthesis
- Power

### Operation

Operation of a structural dynamics analyzer has never been easier. A novel "menu" concept replaces the rotary and toggle switches commonly used to control an instrument's operation. The entire current set-up state, including measurement type, bandwidth, input ranges, etc., is displayed on the CRT at the push of a key. Changes to the set-up are made by selection from displayed lists (menus) or by direct numerical input from the control keyboard.

Once set up, measurements are easily executed and may be paused or continued at will. Results are always fully calibrated and annotated. A self-test feature verifies proper operation.

### Data Display

The HP 5423A features a fully annotated and calibrated, dual trace, three-format display which provides for ease of data interpretation. Each display trace is totally independent of the other in terms of the data which the user selects for display, the horizontal and vertical ranges over which it is displayed, and the coordinate system chosen. The user may select from up to 13 available coordinate systems, including complex plots such as Nyquist, at the push of a key. Display traces may be viewed one at a time in full format or simultaneously in either an upper/lower or overlaid format.

Dual X and Y axis cursors provide numerical data readout, in either absolute or relative terms, on both axes simultaneously in full format. Any area of the display may be graphically expanded for optimum viewing. Cursors may be either swept or set explicitly, via numerical entry, to desired locations. Harmonic cursors are provided. The X axis cursors may also be used to set the frequency range over which the instrument will operate, thereby concentrating its resolution into the bandwidth of interest.

The display section also contains a digital recorder which provides permanent storage of measurement results on small removable tape cartridges and eliminates the need to repeat time consuming and expensive testing. Stored measurements may be easily recalled for display, plotting, or further processing.

#### SETUP STATE

MEASUREMENT :	TRANSFER FUNCTION			
AVERAGE :	25	.	STABLE	
SIGNAL :	RANDOM			
TRIGGER :	FREE RUN	.	CHNL 1	
CENT FREQ :	2.00000 KHZ			
BANDWIDTH :	800.000 HZ			
TIME LENGTH :	320.000 μS			
ΔF :	3.12500 HZ	ΔT :	625.000 μS	
ADC CHNL	RANGE	AC/DC	DELAY	CAL (C1/C2)
1	5 V	AC	0.0 S	33.3333
2	10 V	DC	10.0000 S	20.0000

# SIGNAL ANALYZERS

## Structural Dynamics Analyzer (con't)



### Model 5423A

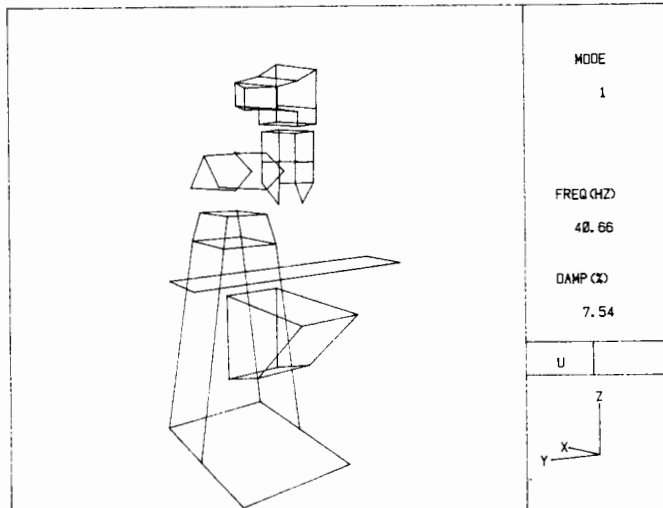
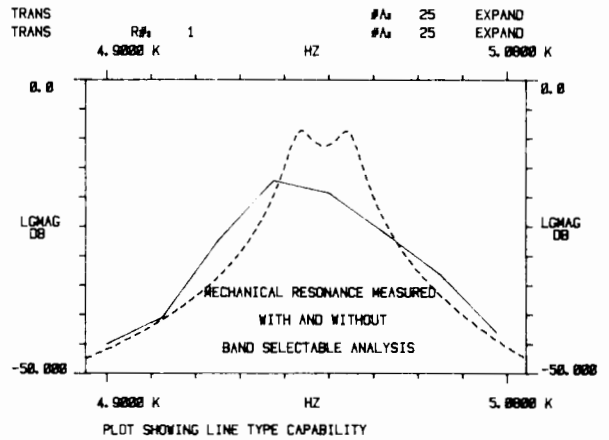
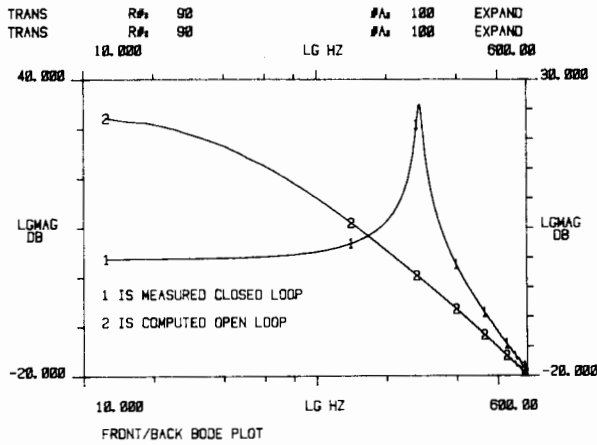
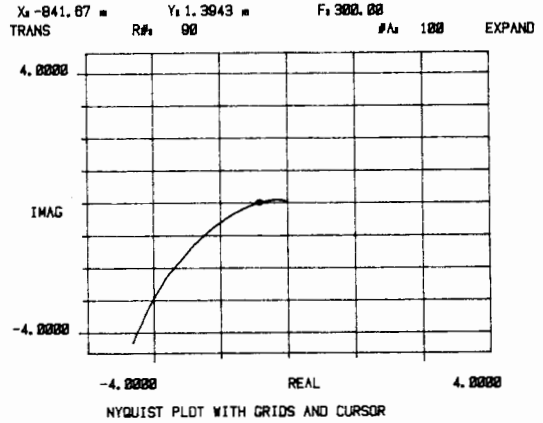
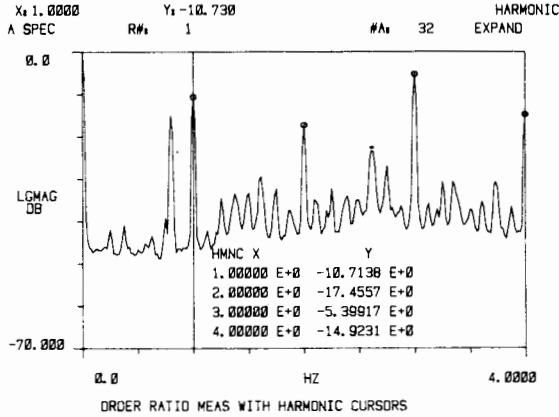

### Dynamic Analysis

The HP 5423A provides, for the first time in a transportable, easy to use, low cost instrument, complete dynamic analysis capability. Frequency response measurements are made at points of interest on the test structure. The HP 5423A then analyzes the raw data to determine the frequency and damping associated with the structure's natural modes of vibration. In addition, the deflection pattern or mode shape of the structure is calculated for each mode of vibration. Results are available in tabular form or as an animated display with perspective to ease interpretation.

Mode shape display features include the ability to view the structure from any desired direction and distance. Amplitude and speed of animation are easily controlled and the structure can be made to rotate about any desired axis. A split-screen format facilitates compari-

son of different modes of vibration and may also be used to observe the structure in three dimensions with stereo viewers.

### HP-IB\*

The HP 5423A includes an HP-IB interface to provide for instrument control and data transfer to and from external computing controllers. In addition, the instrument is directly compatible with the HP 7470, HP 7475, and HP 7550 graphic plotters. A separate computing controller, with its attendant cost and programming requirements, is not needed. The user merely presses the plot or print key and the instrument will reproduce the desired information in hard copy form on the plotter.

### Ordering Information

HP 5423A Structural Dynamics Analyzer

\*HP-1B cables not supplied, see page 675 for description and prices

# SIGNAL ANALYZERS

## Digital Vibration Test Control System

Model 5427A



- Random test flexibility for use with MIL, IEC, and other standards
- Automatic out-of-tolerance detection protects device under test

- Economical expansion for sine and transient control
- Ultra-high random control resolution: 512 lines standard (1024 lines optional)

### Description

Closed-loop control of environmental and/or developmental vibration test stimuli for random, transient, and sine testing is available in the HP 5427A.

The basic HP 5427A Vibration Test Control system consists of: 2-channel (expandable to 4) analog-to-digital converter for processing feedback information; 21MX-E series, microcoded digital processor; HP 1335A Persistence CRT display; HP 2648A Graphics Terminal; pushbutton control unit; HP 9885M Flexible Disc storage unit; cabinet and programs for random control.

The HP 5427A is the ideal vibration control system for production vibration testing where random, transient and sine testing are required and offers a selectable set of analysis routines especially designed for easy operation by laboratory personnel. The following vibration test control capabilities apply to the HP 5427A.

### System Operation

Random, sine and transient control follow the same logical operational phases. First, the appropriate disc is loaded and the test program or setup (envelope, alarm and abort limits, test time, calibrations, etc.) is loaded from disc storage in response to search codes or names. If a new program or modifications are desired, a friendly question-and-answer sequence is used. Once a new setup has been generated or changes made, it can be assigned a new name and stored for later use.

After a satisfactory setup is obtained, the operate phase allows control of the actual test via pushbuttons on the central control panel. Removable snap-on overlay panels clearly label buttons for the type of test desired. Choices of on-line displays and a save button allow saving of data for later plotting, including auxiliary PSD measurements during random control.

After the test, results and all saved data are available for review or documentation. The graphics terminal or an optional HP-IB compatible digital plotter provide fully labeled, report-quality plots of test results. In random control, fully labeled plots can be obtained while the test is running (open loop) using the terminal or an optional HP-IB plotter such as the HP 7470A.

### Specification Summary

#### Random Control

**Resolution:** 64, 128, 256, or 512 lines (1024 lines optional)

**Bandwidth:**  $\Delta f$  to 5000 Hz

**Loop time:** <0.9s for 256 lines, 2500 Hz bandwidth, one control channel and full display

**Dynamic range:** >65 dB

**Accuracy rms PSD accuracy:**  $\pm 2\%$

**Control PSD accuracy:**  $\pm 1.0$  dB (90% confidence level) Higher accuracies are typically achievable with increased control spectrum averaging.

#### Sine Control

**Frequency range:** 0.1 to 5000 Hz. Upper and Lower sweep frequency limits and starting frequency may be specified anywhere in the frequency range (resolution: 0.1 Hz).

**Sweep rate:** 0.001 to 100 octaves/minute log, 1 to 100,000 Hz/minute linear, operator selectable.

**Harmonic components:** >60 dB below full level fundamental output

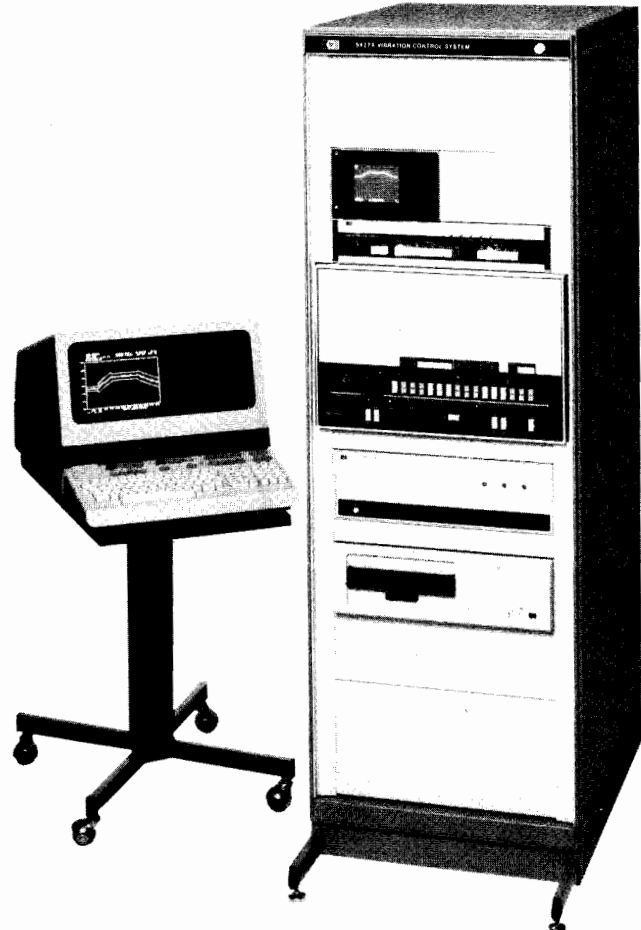

HP 5427A

**Sweep time accuracy:**  $\pm 0.25\%$  or  $\pm 52$  ms, whichever is greater

**Amplitude accuracy:** the greater of  $\pm 2.5$  mV or  $\pm 1\%$  of specified reference value.

**Output dynamic range:** 72 dB

#### Transient Control

**Classical reference waveforms:** half-sine, terminal peak sawtooth, triangle or rectangle

**Polarity:** positive or negative

**Duration range:** 0.5 to 100 ms

**Duration accuracy:**  $\pm 5\%$  for half-sine and terminal peak sawtooth at pulse baseline crossover points

**Shock response spectrum synthesis:** time domain waveforms are synthesized from a user-specified shock response spectrum (SRS) off-line in the setup mode

**Resolution:** 1/N octave, N is any integer from 1 to 9

**Frequency range:** 2 decades nominal, 2.6 decades maximum

**Maximum frequency:** 1/Nth octave below 10,240 Hz

#### Ordering Information

HP 5427A Vibration Test Control System

**Option 070** High resolution random (1024 lines)

**Option 075** Transient control

**Option 080** Sine control

636 **SIGNAL ANALYZERS**  
**Automated Spectrum Analysis**  
**Model 3047A Phase Noise Measurement System**



Calibrated, Automatic Measurement of

- Phase noise
- Amplitude noise
- Spurious signals
- Close-in sidebands



The HP 3047A Phase Noise Measurement System combines the speed and millihertz resolution of Fast Fourier Transform (FFT) Spectrum Analysis with the frequency range of Swept Spectrum Analysis. This unique measurement combination is joined with the powerful computational and control capabilities of a desktop computer to give a wide variety of calibrated spectrum analyzer measurements, including phase noise.

**Phase Noise Measurements**

When used with the HP 3047A, the term phase noise includes all forms of frequency and phase instability. Frequency and phase noise as well as undesired modulation such as power-line phase modulation and phase jitter are included in the term and can be measured by the HP 3047A Phase Noise Measurement System.

The complexity of phase noise measurements increases with increasing source performance. For relatively noisy sources, the noise can be measured directly on an existing spectrum analyzer. However, for many sources this measurement is not sensitive enough. If the spectrum analyzer is preceded by a frequency discriminator or phase detector, the system sensitivity can be increased at the cost of additional measurement hardware. The Phase Noise Measurement Mode of the HP 3047A is designed to reduce the difficulty of making accurate phase noise measurements with either the frequency discriminator or quadrature phase detector techniques.

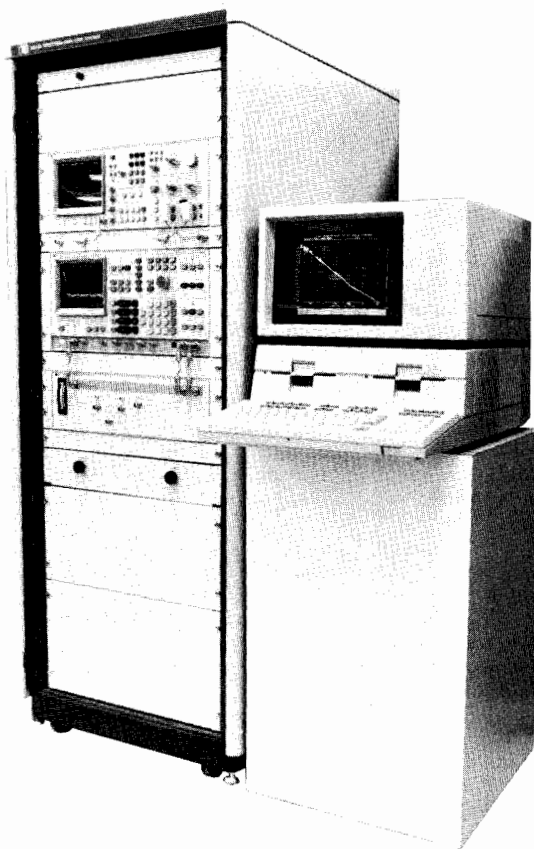

HP 3047A system is controlled by an HP 9836A.

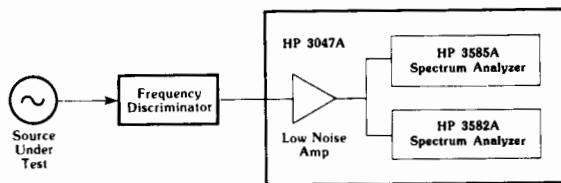

**Frequency Discriminator Method**

**Frequency Discriminator**

With the HP 3047A, fully calibrated measurements are possible with user-supplied frequency discriminators. The HP 3047A software gives instructions for setting up an input signal of known characteristics, then calibrates the system (plus discriminator) as a whole. Overall accuracy is an excellent  $\pm 2$  dB. Although this approach does not optimize sensitivity or bandwidth, it is simple, which makes it quite attractive for a number of applications.

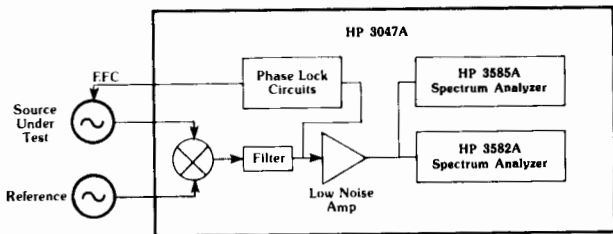

**Phase Detector Method**

**Quadrature Phase Detector**

This phase detection scheme offers the dual benefits of high sensitivity and broad band operation. Until now, these benefits were difficult to realize, due to the need to set up and characterize a phase locked loop. Thanks to the power of the HP 9836A desktop computer, these procedures are now fully automated. After the user has connected his unknown and reference sources to the HP 3047A, system software establishes the phase locked loop, fully characterizes it and performs all the calculations involved in producing a fully calibrated measurement. Accuracy is again  $\pm 2$  dB.

**Phase Noise Measurement Mode—Abbreviated Specifications**

**Phase Detector Inputs**

Carrier Frequency Range: 5 MHz to 18 GHz in two ranges

	Frequency Range	Return Loss	Isolation
Low Frequency Inputs:	5 MHz to 1.6 GHz	5 dB (3.5 VSWR)	15 dB
High Frequency Inputs: (may be deleted with Option 110)	1.2 GHz to 18 GHz	5 dB (3.5 VSWR)	15 dB

(The frequency range can be extended with a customer-supplied mixer or frequency discriminator.)



**Typical HP 3047A  
Phase Noise  
Measurement**

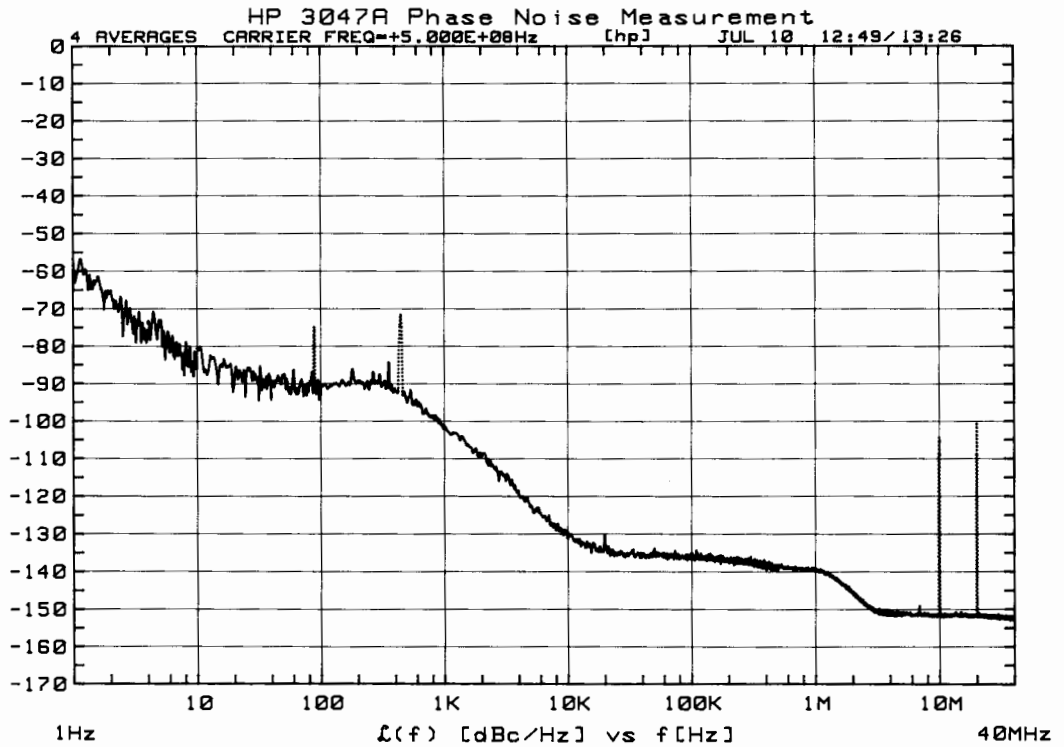

**Amplitude**

	5 MHz-1.6 GHz		1.2 GHz-18 GHz	
	L input	R input	L input	R input
Maximum Signal Level (dBm)	+23	+23	+10	+10
Minimum Signal	+15	-5	+7	+0

**Signal Input Port** (for use with external phase detector or frequency discriminator)

Frequency Range: 0.02 Hz to 40.1 MHz  
Input Impedance: 50  $\Omega$ , Return Loss 9.5 db (2:1 VSWR)  
Max Amplitude: 1 volt peak  
Spurious Signals:  $< -100$  dBm

**Accuracy**

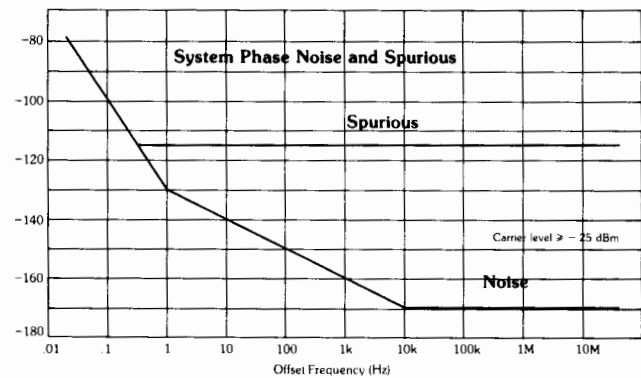
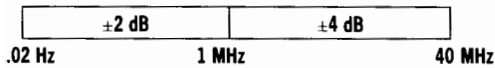

**Noise and Spurious Degradation with Input Signal Level**

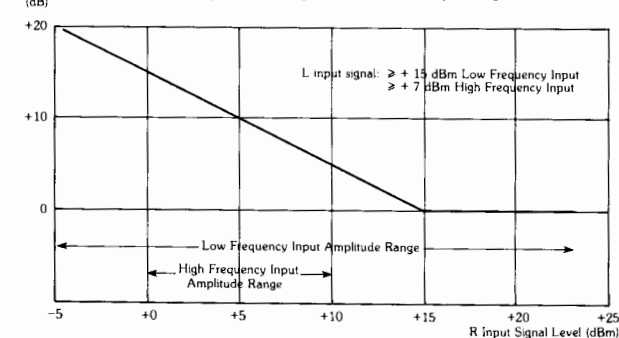

Accuracy: External phase detector measurements or frequency discriminator measurements calibrated with  $\pm 1$  dB accurate signals.

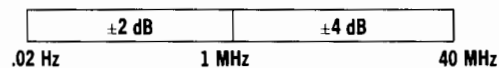

# SIGNAL ANALYZERS

## Automated Spectrum Analysis, Carrier Noise Analysis

Models 3047A, (continued,) 11729B



### Direct Spectrum Mode

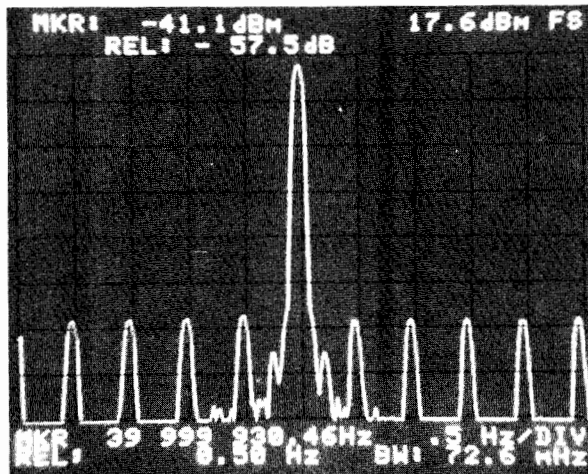

Direct spectrum measurement with 0.072 Hz bandwidth

In the Direct Spectrum Mode the system hardware is used as a down converter to bring 19 kHz to 40 MHz signals into the frequency range of the HP 3582A Real Time Spectrum Analyzer. This allows the very high resolution and measurement speed of the Real Time Spectrum Analyzer to be used up to 40 MHz. In this mode the system is capable of resolution bandwidths as narrow as 0.02 Hz and is one to two orders of magnitude faster than a swept spectrum analyzer. The system provides these measurements over the wide dynamic range of 70 dB, calibrated in both frequency and amplitude.

### Noise Sideband Mode

While the HP 3047A can measure very high quality sources in the Phase Noise Mode, moderate performance sources can be measured more easily in the Noise Sideband Mode. In this mode the system measures both AM and PM noise without additional hardware. The system software connects the HP 3047A input to the HP 3585A and the output of the analyzer is fed into an internal phase detector. The output of the detector is connected to the HP 3582A Analyzer and the phase noise measured over the .02 Hz to 25 kHz range. In addition, a second detector is provided which outputs the AM noise of the signal to the second channel of the HP 3582A Analyzer.

Sources with noise greater than the HP 3585A Spectrum Analyzer's local oscillators are very easy to measure with HP 3047A in this mode. The source under test is just connected to the HP 3047A and the measurement is run. There is no need for a high quality reference or for a frequency discriminator.

### Ordering Information

#### HP 3047S Phase Noise Measurement System

By ordering the system instrumentation, software and controller under this model number, total system compatibility is insured.

#### HP 3047A System Instrumentation

Includes HP 3582A and HP 3585A Spectrum Analyzers, HP 35601A Spectrum Analyzer Interface, system software and system rack with all associated power and signal cabling.

(Specify one power line option)

**300:** 100 Vac operation

**320:** 120 Vac operation

**330:** 220 Vac operation

**340:** 240 Vac operation

HP 9836A Controller configurations are priced beginning

Full details on available system options and recommended controller configurations are given in the HP 3047S Ordering Information Guide.

- 5 MHz to 18 GHz
- Phase noise and AM noise measurements
- Low system noise floor

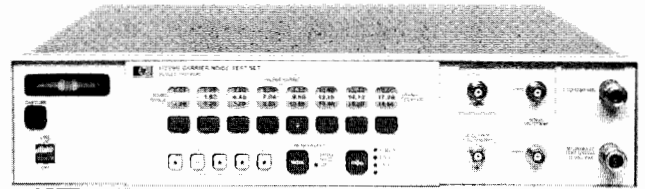

HP 11729B



### HP 11729B Carrier Noise Test Set Versatile Noise Measurements

The HP 11729B, combined with an HP 8662A synthesized signal generator and a baseband spectrum analyzer, form a complete broadband measurement system for phase noise and AM noise testing of microwave oscillators, 5 MHz to 18 GHz. With one versatile measurement system, direct AM noise measurements and two methods of phase noise measurements can be made, at offsets from the carrier of <math>< 1\text{ Hz}</math> to 10 MHz. These three operating modes allow a wide variety of sources, from low noise stabilized sources to free-running sources with high drift to be measured. The HP 11729B may be ordered with either full frequency coverage, or in a number of band configurations to better match the application.

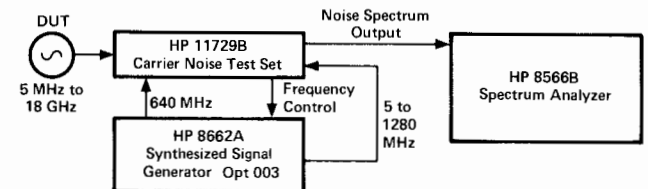

Complete carrier noise characterization system can be assembled from standard instruments.

### Built-in Low Noise Reference

The HP 11729B/8662A combination includes the critical low noise microwave reference signal (which determines the system noise floor). The wide frequency range and low system noise floor of the HP 11729B/8662A enable a single system to be used on a broad range of sources. Typical system noise for a 10 GHz source is less than  $-123\text{ dBc/Hz}$  at a 10 kHz offset, allowing characterization of most high-performance sources.

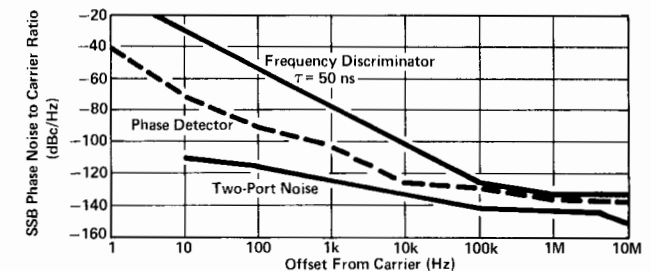

Typical HP 11729B/8662A system sensitivity using the phase detector and frequency discriminator methods at X-Band. Typical HP 11729B two-port noise.





## Two Phase Noise Measurement Modes

A choice of two phase noise measurement methods optimizes the measurement to the type of oscillator being measured. The phase detector method is ideal for synthesizers or stable free-running sources. The HP 11729B/8662A simplifies the phase detector method by providing all the necessary circuitry, including the low noise microwave reference source, the loop VCO, and a variable bandwidth phase-lock-loop.

The frequency discriminator method is best suited for sources with high level, low-rate phase noise such as free-running sources. The HP 11729B/8662A implements a convenient frequency discriminator (delay line/mixer technique), allowing sources to 18 GHz to be tested with a discriminator operating at an IF frequency less than 1.3 GHz. The HP 11729B/8662A contain all necessary hardware, except a simple user-supplied delay element that can be as simple as a length of inexpensive 50-ohm coaxial cable.

## Direct AM Noise Measurements

The HP 11729B Option 130 offers convenient, direct AM noise measurements with typical sensitivity of less than -165 dBc/Hz. The HP 8662A provides a convenient calibration signal, and the same baseband analyzer used for phase noise measurements can be used for AM noise measurements.

## Fully Programmable for System Integration

The fully HP-IB programmable HP 11729B/8662A is easily configured into manual or automatic carrier noise measurement systems with available spectrum analyzers (such as the HP 8566B, 8568B, 3561A, 3585A, or 3582A). In addition, the HP 11729B/8662A is an integral part of the HP 11740S automatic phase noise measurement system. The choice of analyzer determines the offset frequencies that can be measured. System noise floor is set by the HP 11729B/8662A. (For more information, refer to the HP 11729B Product Notes.)

## Abbreviated HP 11729B/8662A Specifications

**Frequency Range:** 5 MHz to 18 GHz in 8 bands.

### Absolute System Noise Floor, Phase Detector Method

System noise is specified only when the HP 11729B is used with an HP 8662A Option 003. (The HP 8663A Option 003, operated below 1280 MHz, may be used in place of the HP 8662A with no change in system performance.) These system noise specifications apply for the phase detector method, locking via the EFC of the HP 8662A crystal oscillator. Locking via the HP 8662A dc FM changes the noise on the tunable HP 8662A signal, and therefore total system noise. See the HP 11729B data sheet for more information.

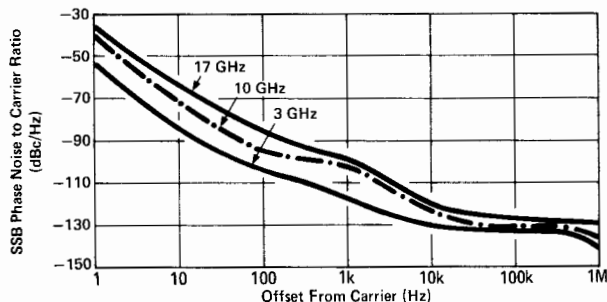

Typical HP 11729B/8662A System Noise (phase detector method, locking via EFC).

## Test Signal Requirements

**Amplitude:** +7 dBm minimum to +18 dBm maximum (typically useable to -15 dBm with noise floor degradation).

## RF Source Requirements

HP 8662A or 8663A Option 003.

## HP 11729B Outputs

### IF Output

**Bandwidth:** 5 to 1280 MHz.

**Level:** +7 dBm minimum.

### Noise Spectrum Outputs

1) Noise Spectrum Output <1 MHz: dc coupled, 600  $\Omega$  nominal.

2) Noise Spectrum Output <10 MHz: 10 Hz to 10 MHz, 50  $\Omega$  nominal, nominal 40 dB of gain over <1 MHz output.

3) Auxiliary Noise Spectrum Output: dc coupled, 600  $\Omega$  nominal.

## Phase Lock Loop Function

### Frequency Control Outputs

**To crystal oscillator:**  $\pm 10$ V.

**To dc FM:**  $\pm 1$ V.

**Lock bandwidth factor:** nominal 1, 10, 100, 1k, 10k selectable.

**Loop characteristics:** dependent on method of phase lock chosen; typical loop bandwidths can range from 0.5 Hz to 100 kHz.

## Remote Programming

All front panel functions are HP-IB programmable. In addition, the HP 11729B can output current settings and out-of-lock indication.

**Interface functions:** AH1, SH1, T5, L3, TE0, LE0, SR1, RL1, PP1, DC1, DT0, C0.

## AM Noise Detection (Option 130)

**Frequency:** 5 MHz to 18 GHz.

**Input level:** 0 dBm minimum to +18 dBm maximum.

**AM noise floor (at +10 dBm input level, dBc/Hz):**

Offset from Carrier (Hz)	Typical	Specified
1k	-147	-138
10k	-152	-145
100k	-161	-155
1M	-165	-160

## General

**Operating temperature range:** 0° to +55°C.

**Power:** 100, 120, 220, 240 V, +5%, -10%; 48 to 66 Hz; <75 VA max.

**Weight:** net, 10.4 kg (23 lb); shipping, 13.2 kg (29 lb).

**Size:** 425 W x 99 H x 551 mm D (21.7 x 16.8 x 3.9 in.). 1 MW x 3 1/2 H x 20 D System II module.

## Ordering Information

**HP 11729B Carrier Noise Test Set (5 MHz to 18 GHz)**

Note: Each of options 003 to 027 (only one may be ordered) also includes 0.005 to 1.28 GHz coverage

**Option 003** (1.28 to 3.2 GHz)

**Option 007** (3.2 to 5.76 GHz)

**Option 011** (5.76 to 8.32 GHz)

**Option 015** (8.32 to 10.88 GHz)

**Option 019** (10.88 to 13.44 GHz)

**Option 023** (13.44 to 16.0 GHz)

**Option 027** (16.0 to 18.0 GHz)

**Option 130:** AM noise detection

**Option 140:** Rear panel connectors

**Option 907:** Front panel handle kit

**Option 908:** Rack mounting flange kit

**Option 909:** Front panel handle plus rack mounting flange kit

**Option 910:** Extra operating and service manual



# SIGNAL ANALYZERS

## Automated Phase Noise Analysis

### Model 11740A

- Fully automated
- Built-in low noise reference
- High accuracy

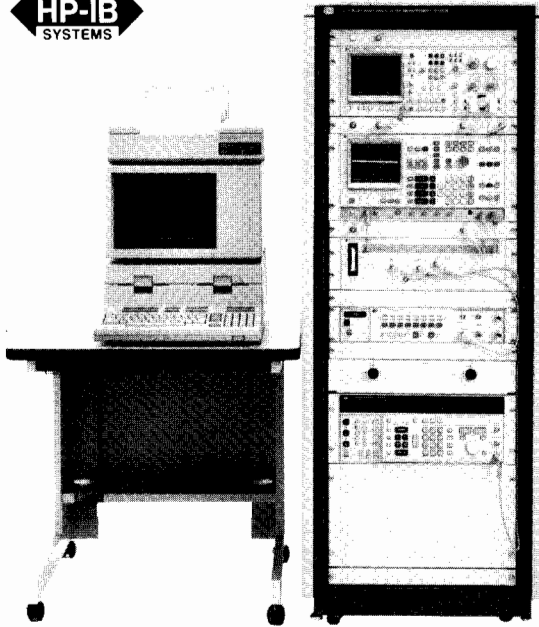

HP 11740S

## HP 11740A Microwave Phase Noise Measurement System

The HP 11740A Microwave Phase Noise Measurement System is a complete, automatic system for phase noise measurements on carriers from 5 MHz to 18 GHz. It combines the specified low noise floor of the HP 11729B/8662A with all the capabilities of the HP 3047A phase noise measurement system. The integrated HP 11729B/8662A is used as a low noise reference and downconverter, translating the input signal to an intermediate frequency (IF). This IF signal is phase detected against the tunable HP 8662A front panel signal using the HP 3047A hardware. The detected baseband signal is then measured automatically by the spectrum analyzers resident in the HP 3047A.

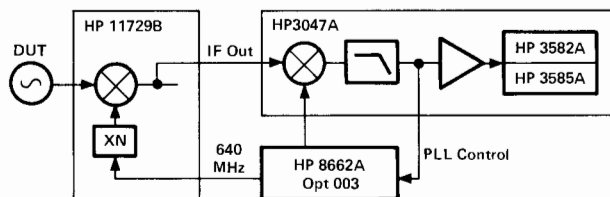

HP 11740A simplified block diagram.

### Integrated Low Noise Reference

When used as a fully automatic system in the phase detector method of phase noise measurement, the software automatically controls the HP 11729B/8662A as the critical reference oscillator for sources > 1.28 GHz, or the HP 8662A (or HP 8663A) is controlled for measurements on sources less than 1.28 GHz (2.56 GHz). The HP 11729B/8662A provides the lowest noise floor for a microwave reference offered by HP. Typical system noise for a 10 GHz source is less than -123 dBc/Hz at a 10 kHz offset, allowing characterization of most high-performance sources. If desired, a user-supplied reference source can be set manually.

- Powerful measurement software
- Absolute and two-port phase noise measurements

### System Accuracy

The HP 11740A has specified system noise floor and excellent specified system accuracy (measurement of all phase noise present at the input to the phase detector) of  $\pm 2$  dB. (If the phase noise of the test source is > 10 dB higher than the noise of the HP 11729B/8662A, then the noise of the test source alone can be measured with typically +2.5/-2.0 dB accuracy.) This complete system includes automatic characterization of the phase lock loop, allowing phase noise measurements to be made at offsets from < 1 Hz to 40 MHz from the carrier, on synthesized or free-running oscillators.

### Powerful Measurement Software

All measurement modes and capabilities of the HP 3047A are preserved. As well as the phase noise mode (phase detector or frequency discriminator methods), direct spectrum mode and noise sideband mode are also available. The powerful data manipulations of the HP 11740A allow the data to be displayed as  $S_{\phi}(f)$ ,  $\mathcal{L}(f)$ ,  $S_{\Delta f}(f)$ , or  $S_y(f)$ .

### Absolute and Two-Port Phase Noise

As well as providing a complete solution for automatic absolute phase noise measurements on sources, the HP 11740A can also be used for two-port phase noise measurements on devices. The built-in HP 8662A (8663A) can be used as a reference for devices to 1.28 (2.56) GHz.

### Abbreviated Specifications

(Phase Noise Mode, phase detector method, using the integrated HP 11729B/8662A as the reference source.)

#### Test Signal Input

**Frequency range:** 5 MHz to 18 GHz.

**Amplitude:** for test frequencies > 1.28 GHz; +7 dBm minimum to +20 dBm maximum. For test frequencies < 1.28 GHz; -5 dBm minimum to +23 dBm maximum.

#### System Specifications

**Accuracy:** the system will measure the combined noise output of the phase detector with  $\pm 2$  dB accuracy for offsets from 0.02 Hz to 1 MHz, and  $\pm 4$  dB accuracy for offsets from 1 MHz to 40 MHz.

#### Absolute system noise floor:

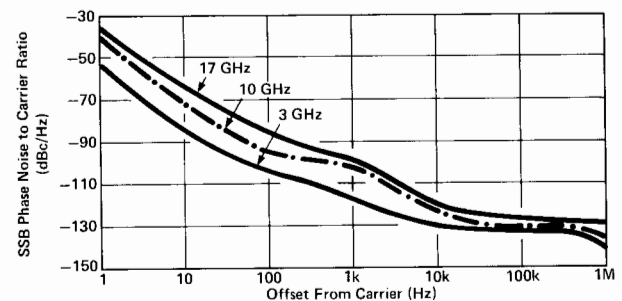

Typical HP 11729B/8662A system noise (phase detector method, locking via EFC).

**Other measurement modes:** standard HP 3047A specifications apply to all other measurement conditions.

### Ordering Information

HP 11740S Microwave Phase Noise Measurement System

HP 11740A System Instrumentation

Includes HP 11729B Carrier Noise Test Set, HP 8662A Synthesized Signal Generator, HP 3582A and 3585A Spectrum Analyzers, HP 35601A Spectrum Analyzer Interface, system software, and system rack with all associated power and signal cabling.

Requires HP Series 200 Model 36 Computer System appropriately configured. Full details are available from your local HP sales office.



- Ultra low distortion measurements
- Built-in low distortion oscillator
- Automatic
- True RMS detection

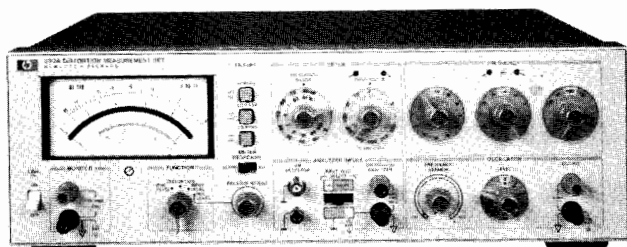

HP 339A

### Description

Hewlett-Packard's Model 339A Distortion Measurement Set is an ultra low distortion measuring system complete with total harmonic distortion (THD) analyzer, true-rms voltmeter, and sinewave oscillator. This small, lightweight bench measurement set allows you to make THD distortion measurements as low as 0.0018% over a 10 Hz to 110 kHz frequency band including harmonics to 330 kHz.

For fast and easy THD measurements the built-in tracking oscillator in HP's 339A saves test time because you tune one instrument instead of two. Frequency and level measurements are easy to do with HP's 339A's voltmeter, which offers you a 1 mV to 300 V measurement range. The Relative Level mode has been included to further simplify frequency response measurements. Just set a 0 dBm reference at any frequency from 10 Hz to 110 kHz. Gain measurements can be read directly from the easy-to-read meter.

### Operation Simplicity

Automatic frequency tuning and set-level features allow you to make rapid, error free THD measurements. The HP 339A's built-in tracking oscillator eliminates the need to find the fundamental frequency and tune the analyzer for a null. Just select your oscillator frequency and the rest is automatic. Automatic set-level saves time by automatically setting 0 dB (100%) reference in the distortion measuring mode. Front panel directional indicators light when the input range setting is improper insuring accurate and repeatable measurements. Automatic set-level also greatly simplifies measurements where distortion as a function of level (SINAD<sup>1</sup>, for example) is desired. Without this feature, measurements are very time consuming and tedious.

When an external stimulus is used, analyzer tuning is simplified by directional indicator lights for reaching the fundamental null quickly and easily.

### Specifications

#### Distortion

**Fundamental frequency range:** 10 Hz to 110 kHz continuous frequency coverage in 4 decade ranges with 2-digit resolution. Distortion analyzer and oscillator are simultaneously tuned.

**Distortion measurement range:** 0.01% full scale to 100% full scale (-80 dB to 0 dB) in 9 ranges.

**Detection and meter indication:** true rms detection for waveforms with crest factor  $\leq 3$ . Meter reads dB and % THD (Total Harmonic Distortion). Meter response can be changed from NORMAL to VU ballistics with a front panel switch.

#### Distortion Measurement Accuracy

20 Hz to 20 kHz:  $\pm 1$  dB

10 Hz to 50 kHz: +1, -2 dB

50 kHz to 110 kHz: +1.5, -4 dB

**Note:** the above specifications apply for harmonics  $\leq 330$  kHz.

#### Fundamental Rejection (3 V scale or above)

10 Hz to 20 kHz: > 100 dB

20 kHz to 50 kHz: > 90 dB

50 kHz to 110 kHz: > 86 dB

#### Distortion Introduced by Instrument (input > 1V rms)

10 Hz to 10 kHz: < -95 dB (0.0018%) THD

10 kHz to 20 kHz: < -92 dB (0.0035%) THD

20 kHz to 30 kHz: < -90 dB (0.0056%) THD

30 kHz to 50 kHz: < -85 dB (0.01%) THD

50 kHz to 110 kHz: < -70 dB (0.032%) THD

**Residual noise** (fundamental frequency settings < 20 kHz, 80 kHz filter IN, source resistance  $\leq 1$  k $\Omega$  shielded): < -92 dB referenced to 1V.

**Input level for distortion measurements:** 30 mV to 300 V rms (100 mV range minimum).

**Input impedance:** 100 k $\Omega$   $\pm 1\%$  shunted by < 100 pF input High to Low.

**Monitor:** provides scaled presentation of input signal after fundamental is removed for further analysis using oscilloscope or low frequency spectrum analyzer. Output voltage: 1V rms  $\pm 5\%$  open circuit for full scale meter indication, proportional to meter deflection. Output resistance: 1k $\Omega$   $\pm 5\%$ .

**Auto set level:** no set level adjustment required. Distortion measurements are made directly over 10 dB range selected by input range switch. Two LED annunciators provide a fast visual indication to change input range for valid distortion measurement. Correct range is indicated when both annunciators are extinguished.

**Automatic fine tuning:** using internal oscillator: No separate analyzer tuning necessary when using internal oscillator as signal source. Oscillator frequency controls simultaneously tune the analyzer. Using external frequency source: Two LED annunciators provide a quick visual indication for the operator to increase or decrease the frequency. When the analyzer is rough tuned to within one least significant digit of the fundamental frequency, the indicator lights are extinguished and the HP 339A auto-null circuitry takes over to provide a fast, accurate null without tedious operator tuning.

**Input filters (usable on all functions):** low pass: 30 kHz -3 dB point at 30 kHz, + 2.6 kHz, -3 kHz with 60 dB/decade rolloff. Provides band limiting required by FCC for proof-of-performance broadcast testing. 80 kHz -3 dB point at 80 kHz, + 7 kHz, -7.9 kHz with 60 dB/decade rolloff. Normally used with fundamental frequencies < 20 kHz to reduce the effect of higher frequency noise present in the measured signal. High Pass: 400 Hz -3 dB point at 400 Hz, + 35 Hz, -40 Hz with 60 dB/decade rolloff. Normally used with fundamental frequencies > 1 kHz to reduce the effect of hum components in the input signal.

**DC isolation:** input low may be connected to chassis ground or floated to 30 V to reduce the effects of ground loops on the measurement.

#### Relative Input Level Mode

Provides a ratio measurement relative to an operator selected reference level with readout directly in dBV or dBm (600 $\Omega$ ). Voltage range, frequency range, accuracy specifications, and monitor are the same as in Voltmeter mode. (Accuracy is relative to 0 dB set level input.)

#### Oscillator

**Frequency range:** 10 Hz to 100 kHz in 4 overlapping decade ranges with 2 digit resolution. Frequency vernier provides continuous frequency tuning between 2nd digit switch settings.

<sup>1</sup>SINAD is a sensitivity measurement computed from the ratio of signal plus noise and distortion to noise and distortion.



# SIGNAL ANALYZERS

## Distortion Analyzers

### Model 339A (cont.), 334A

**Output level:** variable from < 1 mV to > 3 V rms into 600  $\Omega$  with 10 dB/step Level control and > 10 dB Vernier adjustment. OSC Level position on function switch allows a quick check of oscillator level without disconnecting leads to device under test. Off position on Oscillator Level control provides fast signal-to-noise measurement capability. Oscillator output terminals remain terminated in 600 $\Omega$ .

**Frequency accuracy:**  $\pm 2\%$  of selected frequency (with Frequency Vernier in Cal position).

Level flatness: 20 Hz to 20 kHz:  $\leq \pm 0.1$  dB  
10 Hz to 110 kHz:  $\leq \pm 0.2$  dB

**Distortion ( $\geq 600\Omega$  load,  $\leq 3V$  output)**

10 Hz to 20 kHz: < -93 dB (0.0022%) THD  
20 kHz to 30 kHz: < -85 dB (0.0056%) THD  
30 kHz to 50 kHz: < -80 dB (0.01%) THD  
50 kHz to 80 kHz: < -70 dB (0.032%) THD  
80 kHz to 110 kHz: < -65 dB (0.056%) THD

**Output resistance:** 600 $\Omega \pm 5\%$

**Voltmeter**

**Voltage range:** 1 mV rms full scale to 300 V rms full scale (-60 dB to +50 dB full scale, meter calibrated in dBV and dBm into 600 $\Omega$ ).

**Detection and meter indication:** true rms detection for waveforms with crest factor  $\leq 3$ . Meter reads true rms volts, dBm into 600 $\Omega$ , and dBV.

**Accuracy (% of range setting)**

20 Hz to 20 kHz:  $\pm 2\%$

10 Hz to 110 kHz:  $\pm 4\%$

**Frequency range:** 10 Hz to 110 kHz.

**Input impedance:** 100 k $\Omega \pm 1\%$  shunted by < 100 pF between input High to Low.

**Monitor:** provides scaled presentation of input signal for further analysis using oscilloscope or low frequency spectrum analyzer. Output voltage: 1V rms  $\pm 5\%$  open circuit for full scale meter indication, proportional to meter deflection. Output resistance: 1 k $\Omega \pm 5\%$ .

**Option 001**

**Voltage range:** 0.1 mV rms full scale to 300 V rms full scale (-80 dBV to +50 dBV full scale); (.1 mV and .3 mV ranges—external source resistance must be < 10 k $\Omega$ .)

**Accuracy: 1 mV to 300 V Ranges**

20 Hz to 20 kHz  $\pm 2\%$

10 Hz to 110 kHz

**.1 mV and .3 mV Ranges**

20 Hz to 20 kHz:  $\pm 2\%$

10 Hz to 30 kHz:  $\pm 4\%$

30 kHz to 80 kHz: +10/-30%

**Noise Floor (600 $\Omega$  source impedance)**

30 kHz filter < 6  $\mu$ V

80 kHz filter < 8  $\mu$ V

**AM Detector**

**Frequency range:** carrier frequencies: 550 kHz to 1.6 MHz. Modulation frequencies: 20 Hz to 20 kHz.

**Distortion introduced by AM detector (with 30 kHz filter switched IN):** up to 85% Modulation: < -36 dB (1.6%) THD  
85% to 95% Modulation: < -30 dB (3%) THD

**Input level:** maximum: 60V peak. Modulation signal level: 2V rms minimum; 10V rms maximum.

**Monitor (with modulated RF carrier applied to AM detector input).**

**Distortion mode:** provides scaled presentation of demodulated input signal after fundamental is removed.

**Voltmeter and relative input mode:** provides scaled presentation of demodulated input signal. Output voltage and output resistance are the same as in Distortion mode.

**General**

**Power:** 100/120/220/240 V + 5%, - 10% 48 Hz to 66 Hz line operation, 200 mA maximum.

**Size:** 146 mm H x 426 mm W x 375 mm D (5.75" x 16.75" x 14.75").

**Weight:** net 8.2 kg (18 lb). Shipping 11.3 kg (25 lb).

**HP 339A Distortion Measurement Set  
Option 001**

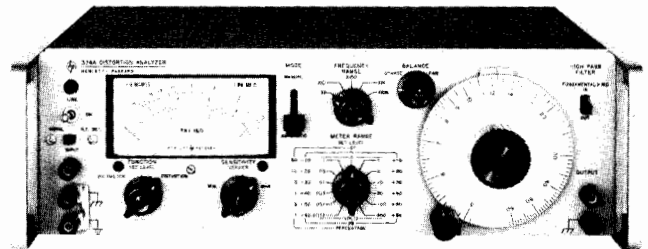

HP 334A

## Description

Hewlett-Packard's model HP 334A Distortion Analyzer measures total distortion down to 0.1% full scale at any frequency between 5 Hz and 600 kHz; harmonics are indicated up to 3 MHz. Noise levels as low as 25 microvolts can be measured. The HP 334A includes automatic fundamental nulling and amplitude modulation detector. A Meter with VU ballistic characteristics and a 30 kHz low pass filter are optional.

## HP 334A Specifications

**Input level for distortion measurements:** 0.3 V rms for 100% set level or 0.245 V for 0 dB set level (up to 300 V may be attenuated to set level reference).

**Harmonic Measurement Accuracy (full scale)**

**Fundamental Input Less Than 30 V**

Range	$\pm 3\%$	$\pm 6\%$	$\pm 12\%$
100%-0.3%	10 Hz-1 MHz	10 Hz-3 MHz	
0.1%	30 Hz-300 kHz	20 Hz-500 kHz	10 Hz-1.2 MHz

**Fundamental rejection:** > 80 dB

**Residual distortion:** > -70 dB (0.03%) from 5 Hz to 200 kHz; > -64 dB (0.06%) from 200 kHz to 600 kHz. Meter indication is proportional to average value of a sine wave.

**Frequency calibration accuracy:** better than  $\pm 5\%$  from 5 Hz to 300 kHz. Better than  $\pm 10\%$  from 300 to 600 kHz.

**Input impedance:** distortion mode: 1 M $\Omega \pm 5\%$  shunted by < 70 pF.

**DC isolation:** signal ground may be  $\pm 400$  V dc from external chassis  
**Voltmeter range:** 300  $\mu$ V to 300 V rms full scale (13 ranges) 10 dB per range. Average responding calibrated in rms.

**Noise measurements:** voltmeter residual noise on the 300  $\mu$ V range: < 25  $\mu$ V rms, when terminated in 600 (shielded) ohms.

**Output:** 0.1  $\pm 0.01$  V rms open circuit.

**Output impedance:** 2 k $\Omega$

**Automatic nulling mode:** set level: at least 0.2 V rms

**Frequency ranges:** X1, manual null tuned to less than 3% set level: total frequency hold-in  $\pm 0.5\%$  about true manual null. X10 through X10k, manual null tuned to less than 10% of set level; total frequency hold-in  $\pm 1\%$  about true manual null.

**Automatic null accuracy:** 5 Hz to 100 Hz: meter reading within 0 to +3 dB of manual null. 100 Hz to 600 kHz: meter reading within 0 to +1.5 dB of manual null.

**High pass filter:** 3 dB point at 400 Hz with 18 dB per octave roll off.

**AM detector:** 550 kHz to 65 MHz; 40 Vp-p max input.

**Distortion introduced by detector:** carrier frequency: 550 kHz-1.6 MHz: < 50 dB (0.3%) for 3-8 V rms carriers modulated 30%. 1.6 MHz-65 MHz: < 40 dB (1%) for 3-8 V rms carriers modulated 30%.

**General**

**Power:** 115 or 230 V  $\pm 10\%$ . 48 to 66 Hz.

**Size:** 426 mm W x 126 mm H x 337 mm D (16.75" x 5" x 13.25").

**Weight:** net 7.89 kg (17.75 lb). Shipping 10.35 kg (23 lb).

**HP 334A Distortion Analyzer**

**Opt 001** VU Characteristics

**Opt 002** 30 kHz low pass filter

**Opt 003** (combined 001 and 002)

# SIGNAL ANALYZERS

15 Hz to 50 kHz Wave Analyzer

Model 3581A

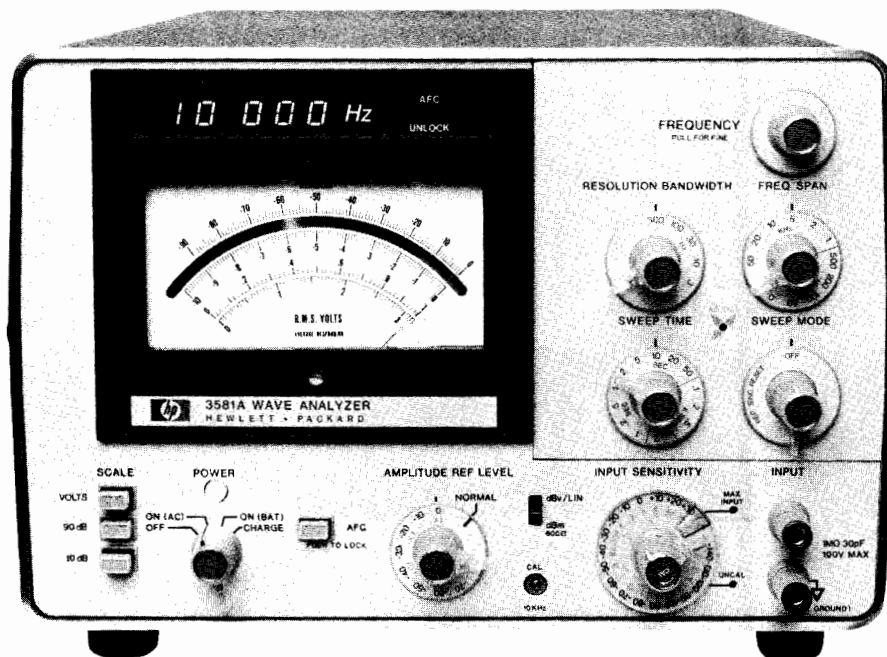
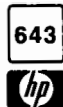

HP 3581A

## Description

Hewlett-Packard's 3581A Wave Analyzer resolves and measures the amplitude and frequency of spectral components. This instrument offers accurate amplitude and good frequency resolution in the form of a portable, easy-to-use measuring tool. Since not all signals originate from a stable frequency source, the HP 3581A incorporates an AFC circuit which locks to a drifting signal for stable, accurate measurements.

The HP 3581A has other important features that are necessary when making measurements of small voltages from transducers and harmonic signals. Its 30 nV sensitivity becomes important for these measurements. Battery operation can be used to reduce the line related interference common in low level measurements so only the real spectrum is measured.

Digital readout of tuned frequency is located above the analog meter. It has been grouped with the meter for ease of reading. Resolution of the digital readout is 1 Hz for any frequency between 15 Hz and 50 kHz. Readout is updated five times per second so delay between tuning and reading is minimized.

Four meter scales are used to provide a wide range of displays. Two scales are used for linear voltage readings. Two log scales provide either a 90 dB or 10 dB display. In any case, the large meter with its mirror backing can present readings in dBV, dBm or volts. A meter was specifically chosen for amplitude display rather than digital readout because it is easier to peak a meter reading and because it's much easier to get a feel for noise or other amplitude variations by watching the meter. The same voltage used to drive the meter is also available on the rear panel for driving X-Y recorders.

## Specifications

### Frequency Characteristics

**Range:** 15 Hz to 50 kHz.

**Display:** 5 digit LED readout.

**Resolution:** 1 Hz.

**Accuracy:**  $\pm 3.5$  Hz., 0 to 55°C.

**Typical stability:**  $\pm 10$  Hz/hour after 1 hour and  $\pm 5$  Hz/°C.

**Automatic frequency control (AFC) hold-in range:**  $\pm 800$  Hz.

### Amplitude Characteristics

#### Instrument Range

**Linear:** 30 V to 100 nV full scale.

**Log:** +30 dBm or dBV to -150 dBm or dBV.

#### Amplitude Accuracy

Frequency response,  
15 Hz-50 kHz

**Log**  
 $\pm 0.4$  dB

**Linear**  
 $\pm 4\%$

**Dynamic range:** >80 dB.

**Noise sidebands:** greater than 70 dB below CW signal. 10 bandwidths away from signal.

**Spurious responses:** >80 dB below input reference level.

### Sweep Characteristics

**Scan width:** 50 Hz to 50 kHz, adjustable in a 1-2-5 sequence from 50 Hz to the full frequency range.

**Sweep error light:** this LED indicates a sweep that is too fast to capture full response. When the light is on, response will be lower than it should be.

**External trigger:** a short to ground stops the normal sweep. Opening the short then enables a sweep.

### Input Characteristics

**Impedance:** 1 M $\Omega$ , 30 pF.

**Maximum input level:** 100 V rms,  $\pm 100$  V dc.

### Output Characteristics

**Tracking generator output:** (also known as BFO or tracking oscillator output).

**Range:** 0 to >1 V rms into 600  $\Omega$ .

**Frequency response:**  $\pm 3\%$  15 Hz to 50 kHz.

#### X-Y Recorder Analog Outputs

**Vertical:** 0 to +5 V  $\pm 2.5\%$ .

**Horizontal:** 0 to +5 V  $\pm 2.5\%$ .

**Impedance:** 1 k $\Omega$ .

**Recommended Accessory:** HP 7090A Measurement Plotting System.

**Pen lift:** contact closure to ground during sweep.

**Restored output:** acts as a narrow band amplifier.

### General

**Power requirements:** 100 V, 120 V, 220 V, or 240 V +5% -10%, 48 Hz to 440 Hz, 10 VA typical.

**Size:** 412.8 mm H x 203.2 mm W x 285.8 mm D (16 $\frac{1}{4}$ " x 8" x 11 $\frac{1}{4}$ ").

**Weight:** 11.5 kg (23 lb). Opt 001: 13.5 kg (30 lb).

### Options

#### HP 3581A Wave Analyzer

**001:** Internal battery 12 hours from full charge. Internal battery is protected from deep discharge by an automatic turnoff. Useful battery life is over 100 cycles.

**003:** Rack Mount

**910:** Extra set manuals

# SIGNAL ANALYZERS

## Measuring Receiver, 150 kHz to 1300 MHz

### Model 8902A



- RF power: digital power meter accuracy
- Tuned RF level: 0 dBm to -127 dBm dynamic range
- AM and FM, 1% accuracy;  $\emptyset$ M, 3% accuracy
- RF frequency: 10 Hz resolution
- Audio: frequency, level and distortion

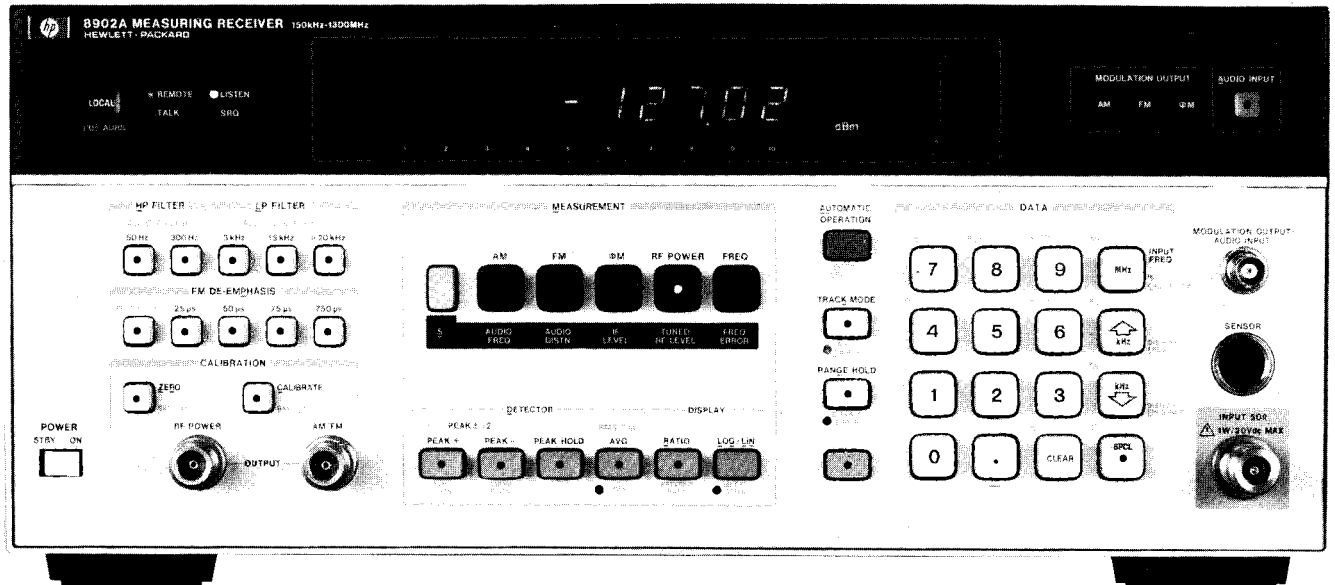

HP 8902A

### HP 8902A Measuring Receiver

The HP 8902A Measuring Receiver combines five precise measurement functions into one fully automatic, HP-IB programmable instrument. It accurately measures RF power, tuned RF level, modulation and RF frequency, and characterizes audio signals. For precise signal analysis, the HP 8902A Measuring Receiver provides the performance you need.

RF Power delivers the accuracy and resolution of a high performance power meter. The HP 8902A with the HP 11722A Sensor Module measures power from +30 dBm to -20 dBm at frequencies from 100 kHz to 2.6 GHz. The HP 8902A also accepts all HP 8480 series power sensors for extended measurement capability.

Tuned RF Level's minimum sensitivity of -127 dBm with exceptional accuracy is a major contribution of the HP 8902A. You can make relative level measurements with accuracy you would only expect from a transfer standard:  $\pm 0.02$  dB  $\pm 1$  digit (worst case) for up to 10 dB step, increasing to  $\pm 0.30$  dB  $\pm 1$  digit at 110 dB step.

AM and FM measurements offer 1% accuracy (3% accuracy for  $\emptyset$ M) and fast one-key operation. The HP 8902A has extremely low internal noise, and very low AM/ $\emptyset$ M and  $\emptyset$ M/AM conversion, for accurately measuring residual and incidental AM, FM and  $\emptyset$ M on a wide range of simple and complex modulated signals.

RF frequency of complex modulated signals can be difficult to measure, but not with the HP 8902A. It tunes to the largest input signal or to any user specified frequency. The HP 8902A counts signals with 10 Hz resolution.

Audio distortion, frequency and level measurements provide comprehensive characterization of the modulation signal.

#### Metrology and Calibration

The HP 8902A Measuring Receiver makes signal generator and attenuator calibration easier than ever before.

The HP 8902A quickly and accurately measures your signal generator's RF frequency, RF level flatness, output level accuracy to -127

dBm, incidental and residual AM, FM and phase modulation and characterizes the demodulated audio signals.

For attenuator calibration and other relative measurements, the HP 8902A gives you the accuracy and dynamic range you need. Tuned RF Level makes relative measurements with 127 dB dynamic range and 0.01 dB resolution. The combined dynamic range of Tuned RF and RF Power is 157 dB.

#### RF Signal Characterization

The HP 8902A Measuring Receiver is an excellent lab and production tool for accurately characterizing RF signals from 150 kHz to 1300 MHz.

Level measurements down to -127 dBm with superb accuracy make the HP 8902A ideal for testing devices such as antennas, multiplexers, log/linear amplifiers, filters and mixers. Unlike diode detectors, the HP 8902A's power meter accurately measures signals with harmonics and spurious.

The HP 8902A makes accurate AM to  $\emptyset$ M and AM to AM conversion measurements of phase and amplitude sensitive devices such as bandpass filters and multiple channel receivers. Excellent isolation between AM and FM makes it simple to separate the AM and  $\emptyset$ M of AM stereo, incidental AM of FM transmitters and the AM, FM and  $\emptyset$ M components of complex signals.

#### Automatic Test Systems

The HP 8902A is an important component of automatic RF test systems. All functions — power, level, frequency count, modulation, audio analysis — are fully automatic and easily programmed. With these measurements combined into one instrument, interfacing requirements, hardware costs, and software development time are reduced.

The HP 8902A's excellent measurement accuracy and dynamic range also make it a valuable tool for calibrating automatic test systems.



# SIGNAL ANALYZERS

## Measuring Receiver, Sensor Module

Models 8902A, 11722A

645



### HP 8902A Specifications

#### RF Power (with HP 11722A Sensor Module)

**Range:** +30 dBm (1W) to -20 dBm (10  $\mu$ W).  
**Frequency range:** 0.1 MHz to 2.6 GHz.  
**Linearity:**  $\pm 0.02$  dB (within range)  $\pm 0.02$  dB per range change from reference range  $\pm 0.5$  digit.  
**Input SWR:** <1.15.

#### Tuned RF Level

**Range:** 0 dBm to -127 dBm.  
**Frequency range:** 2.5 MHz to 1300 MHz.  
**Relative accuracy:**  $\pm 0.02$  dB  $\pm 0.02$  dB per IF range change  $\pm 0.04$  dB per RF range change  $\pm 1$  digit.

#### RF Frequency

**Range:** 150 kHz to 1300 MHz.  
**Maximum resolution:** 10 Hz.

#### Amplitude Modulation

**Rates:** 20 Hz to 100 kHz.  
**Depths:** to 99%.  
**Accuracy:**  $\pm 1\%$  of reading  $\pm 1$  digit, for rates 50 Hz to 50 kHz and depths  $\geq 5\%$ .

#### Frequency Modulation

**Rates:** 20 Hz to 200 kHz.  
**Deviations:** to 400 kHz.  
**Accuracy:**  $\pm 1\%$  of reading  $\pm 1$  digit, for rates 50 Hz to 100 kHz.

#### Phase Modulation

**Rates:** 200 Hz to 20 kHz.  
**Deviations:** to 400 radians.  
**Accuracy:**  $\pm 3\%$  of reading  $\pm 1$  digit.

#### Audio Level, Frequency and Distortion Capability

**Audio Level**  
**Accuracy:**  $\pm 4\%$  of reading, 100 mV to 3V.  
**Audio Frequency**  
**Display resolution:** 6 digits, to 250 kHz.  
**Audio Distortion**  
**Accuracy:**  $\pm 1$  dB, 400 Hz and 1 kHz.

#### Ordering Information

##### HP 8902A Measuring Receiver

- Option 001:** rear panel instead of front panel connections for input, modulation output, and calibrators
- Option 002:**  $1 \times 10^{-9}$ /day internal reference oscillator
- Option 003:** Rear panel connections which allow use with an external local oscillator
- Option 004:** Operation from 48 Hz to 400 Hz power line (temp. <40°C)
- Option 021:** Add HP 11722A Sensor Module
- Option 907:** Front panel handle kit
- Option 908:** Rack mounting flange kit
- Option 909:** Front panel handle plus rack mounting flange kit
- Option 910:** Extra manuals

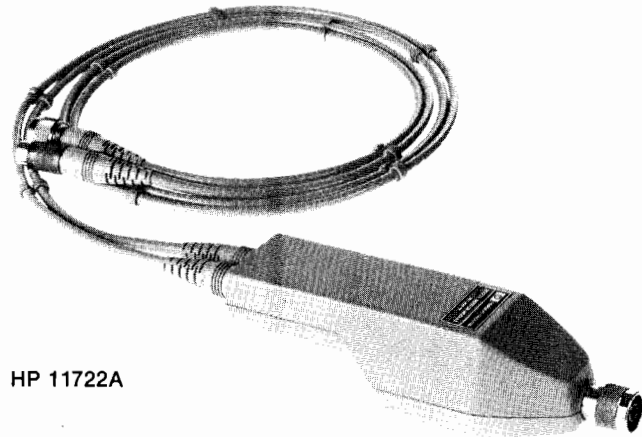

HP 11722A

### HP 11722A Sensor Module

The HP 11722A Sensor Module was designed for use with the HP 8901B Modulation Analyzer and HP 8902A Measuring Receiver. The HP 11722A contains a silicon monolithic thermocouple as a power sensing element.

With the HP 11722A Sensor Module, you get all the performance of the HP 8901B or 8902A, plus superb power measurement accuracy, at a single connector. You can characterize a signal without switching back and forth between the power sensor and the analyzer's RF input.

Each HP 11722A Sensor Module is individually calibrated, traceable to the U.S. National Bureau of Standards. The calibration factors are printed on the sensor module for easy reference. Enter these factors into the HP 8901B or 8902A's non-volatile memory and the instrument automatically compensates for the power sensor's efficiency and mismatch loss at each frequency.

### HP 11722A Specifications

**Frequency range:** 100 kHz to 2.6 GHz.  
**Power range:** +30 dBm (1 watt) to -20 dBm (10  $\mu$ W).  
**Input SWR (Connected to an HP 8901B or 8902A):** <1.15, for RF power measurements.  
**Power sensor linearity:** +2%, -4%; +30 dBm to +20 dBm. Negligible deviation, levels <+20 dBm.  
**Calibration factors:** each HP 11722A Sensor Module is individually calibrated. The calibration factors are printed on the HP 11722A Sensor Module for easy reference.

#### Cal Factor Uncertainty

Frequency	RSS Uncertainty	Worst Case Uncertainty
0.1 MHz	0.7%	1.6%
0.3 MHz	0.7%	1.6%
1.0 MHz	0.8%	1.7%
3.0 MHz	0.8%	1.7%
10.0 MHz	0.9%	2.0%
30.0 MHz	0.9%	2.0%
50.0 MHz	0.0% (ref.)	0.0% (ref.)
100.0 MHz	1.1%	2.2%
300.0 MHz	1.1%	2.2%
1000.0 MHz	1.1%	2.2%
2600.0 MHz	1.2%	2.3%

#### Ordering Information

**HP 11722A Sensor Module**  
**Option 910:** Extra manual



- RF power: digital power meter accuracy
- Tuned RF level: 0 dBm to -105 dBm dynamic range
- AM and FM: 1% accuracy  $\Phi$ M: 3% accuracy
- RF frequency: 10 Hz resolution
- Audio: frequency, level and distortion

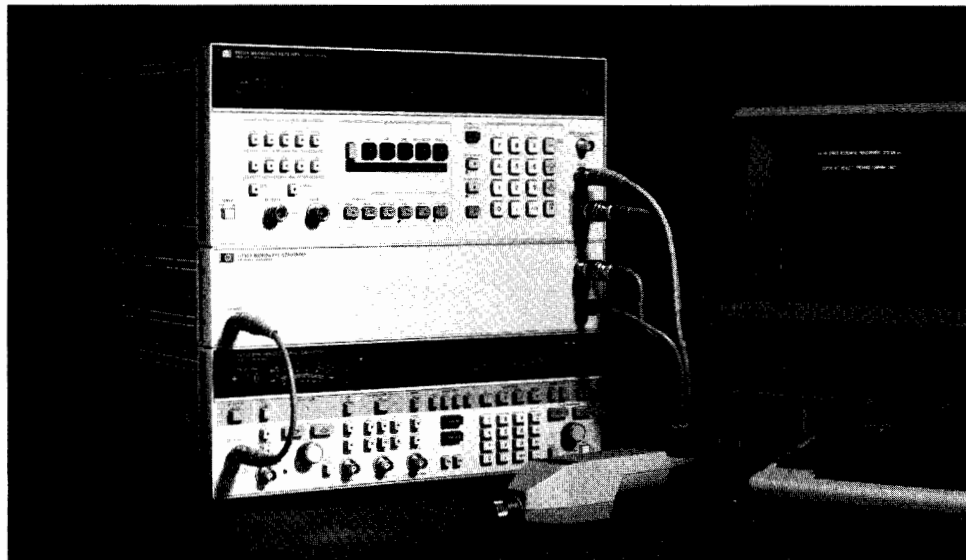

HP 8902S

**HP 8902S Microwave Measurement System**

The HP 8902S Microwave Measurement System extends the superb measurement performance of the HP 8902A Measuring Receiver to microwave frequencies. The HP 8902S system delivers the accuracy and resolution of a high performance power meter at frequencies from 50 MHz to 26.5 GHz and levels from +30 dBm to -105 dBm. It accurately measures AM, FM and  $\Phi$ M, including residuals and incidentals, with a single keystroke. The HP 8902S counts signals to 26.5 GHz with 10 Hz resolution and excellent long-term frequency stability.

The HP 8902S Microwave Measurement System consists of the HP 8902A Measuring Receiver, HP 11793A Microwave Converter, HP 11792A Sensor Module, an instrument controller, HP 11794A Software Pac and a choice of microwave local oscillators. You can choose from the HP 8672A and 8673B/D Synthesized Signal Generators and the HP 8340A and 8341A Sweep Oscillators.

**Improves Quality**

The HP 8902S minimizes measurement errors. The system's high performance instruments deliver superb accuracy: AM and FM,  $\pm 1\%$ ; level and power,  $\pm 0.02$  dB  $\pm 0.02$  dB/10 dB; and carrier frequency, 10 Hz resolution.

Special care is taken to minimize the HP 8902S's input SWR, RFI susceptibility and insertion loss. 26.5 GHz hardware and a specially-designed flexible RF input cable with extremely stable insertion loss and input SWR help make your measurements repeatable.

**Saves Time**

The HP 8902S is both easy to use and fast. It functions as a single instrument. You select the frequency and measurement from the front panel of the HP 8902A and the system, under the control of the HP 11794A software, does the rest. In only seconds the software asks the HP 8902A for the frequency you entered, calculates and sets the local oscillator (LO) frequency, and releases the HP 8902A to make the measurement and display the results.

Even difficult tasks such as measuring levels down to -105 dBm, residual FM down to <17 Hz, and incidental  $\Phi$ M of <0.03 radians in the presence of 50% AM, are performed in a few seconds.

The HP 8902S can be assembled and running in minutes. For critical down-time applications, move the HP 8902S to the device under test and test it in place.

**Increases Confidence**

The HP 8902S performs fast, accurate and repeatable microwave measurements traceable to the U.S. National Bureau of Standards. The HP 8902S consists of general purpose HP-IB programmable equipment which can also be used separately for other applications. Add the HP 8903A Audio Analyzer and HP 11795A Software Pac and the system expands to become an HP 8952S Microwave Signal Generator Test System.

**HP 11793A Microwave Converter**

The HP 11793A Microwave Converter down converts microwave signals to the frequency range of the HP 8902A Measuring Receiver. When you want to make a tuned RF level, modulation or frequency measurement above 1.3 GHz, the HP 11793A Microwave Converter routes the signal through its internal mixer. Below 1.3 GHz, signals are routed directly to the input of the HP 8902A.

The HP 11793A requires +8 dBm leveled output from the local oscillator. For LOs with insufficient power above 18 GHz, the HP 11793A offers an optional 18 to 26.5 GHz amplifier.

**HP 11792A Sensor Module (50 MHz to 26.5 GHz)**

When used with the HP 11793A Microwave Converter, the HP 11792A Sensor Module gives you all the performance of the HP 8902S system, plus superb power measurement accuracy, at a single connector. You can characterize a signal without manually switching back and forth between the power sensor and the receiver input.

Each HP 11792A Sensor Module is individually calibrated, traceable to the U.S. National Bureau of Standards. The calibration factors are printed on the sensor module for easy reference. Enter these factors into the HP 8902A's non-volatile memory and the instrument automatically compensates for the power sensor's efficiency and mismatch loss at each frequency. The 11792A is available with either a 3.5 mm precision or Type-N connector.

# SIGNAL ANALYZERS

## Microwave Measurement System, Signal Generator Test Set

Models 8902S, 8952A, 11795A

647



### 8902S Specifications

#### RF Power (with HP 11792A Sensor Module)

**Range:** +30 dBm (1W) to -20 dBm (10 μW).

**Frequency range:** 50 MHz to 26.5 GHz.

**Linearity:** ±0.02 dB (within range) ±0.02 dB per range change from reference range ±0.5 digit.

**Input SWR:** <1.10,  $f_c \leq 2.0$  GHz.

<1.28, 2.0 GHz <  $f_c \leq 18$  GHz.

<1.40, 18.0 GHz <  $f_c \leq 2.65$  GHz.

#### Tuned RF Level<sup>1</sup>

**Frequency range<sup>2</sup>:** 2.5 MHz to 26.5 GHz.

#### Range:

+10 dBm to -117 dBm, 2.5 MHz  $\leq f_c \leq 1300$  MHz.

0 dBm to -100 dBm, 1300 MHz <  $f_c \leq 18.0$  GHz.

0 dBm to -97 dBm, 18.0 GHz <  $f_c \leq 26.5$  GHz.

**Relative accuracy:** ±0.02 dB ±0.02 dB per IF range change ±0.04 dB per RF range change ±1 digit. Add ±0.18 dB, for levels >-10 dBm above 1300 MHz.

#### RF Frequency

**Range<sup>2</sup>:** 150 kHz to 26.5 GHz.

**Maximum resolution:** 10 Hz.

**Time base aging rate:** <5X10<sup>-10</sup>/day, for HP 8672A, HP 8673B/D; <1X10<sup>-9</sup>/day, for HP 8340A, HP 8341A.

#### Amplitude Modulation

**Frequency range<sup>2</sup>:** 150 kHz to 26.5 GHz.

**Rates:** 20 Hz to 100 kHz.

**Depths:** to 99%.

**Accuracy:** ±1% of reading ±1 digit, for rates 50 Hz to 50 kHz and depths ≥5%.

#### Frequency Modulation

**Frequency range<sup>2</sup>:** 150 kHz to 26.5 GHz.

**Rates:** 20 Hz to 200 kHz.

**Deviations:** to 400 kHz.

**Accuracy:** ±1% of reading ±1 digit, for rates 50 Hz to 100 kHz.

#### Phase Modulation

**Frequency range<sup>2</sup>:** 150 kHz to 26.5 GHz.

**Rates:** 200 Hz to 20 kHz.

**Deviations:** to 400 radians.

**Accuracy:** ±3% of reading ±1 digit.

#### General

**Temperature:** Operating, 15° C to 35° C; storage, -25° C to 60° C.

**Power:** 100, 120, 220, or 240V (+5%, -10%); 48-66 Hz; 1300 VA maximum (worst case).

**Weight:** Net 122.3 kg (270 lb); shipping, 153.3 kg (338.3 lb) worst case.

#### Ordering Information

##### HP 8902S Microwave Measurement System

The HP 8902S system consists of an HP 8902A Measuring Receiver, HP 11792A Sensor Module, HP 11793A Microwave Converter, HP 11794A Software Pac, a controller, two HP 10833 HP-IB cables, three accessory cables (included with HP 11793A) and a choice of synthesized microwave local oscillators. For complete ordering information, see the "HP 8902S Microwave Measurement System Ordering Information" guide, or call your HP sales office.

<sup>1</sup>An HP 11722A Sensor Module may be used with the HP 8902S to make tuned RF level measurements from 2.5 MHz to 1300 MHz at levels from 0 dBm to -127 dBm.

<sup>2</sup>Frequency range may be limited by the frequency range of the LO.

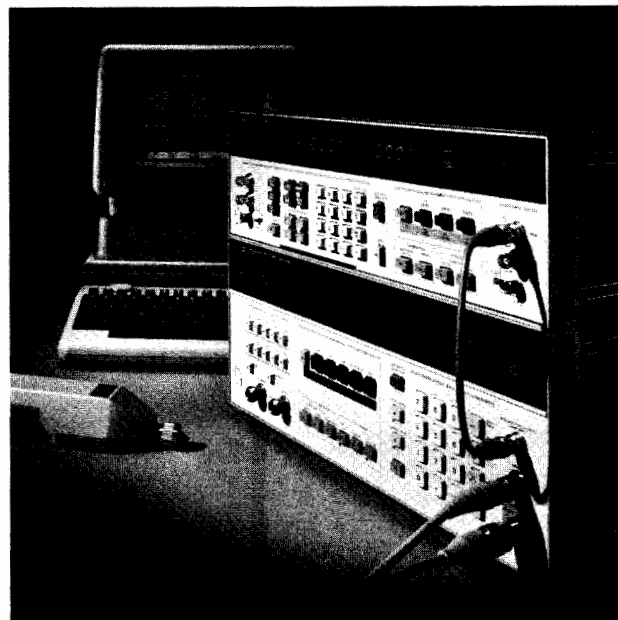

HP 8952S

### HP 8952S Signal Generator Test System

The HP 8952S Signal Generator Test System eases your signal generator calibration workload, performing automatic performance verification for incoming inspection, maintenance, and calibration. The HP 8952S includes the HP 8902A Measuring Receiver, the HP 8903A Audio Analyzer, a printer, and your choice of four HP 9000 controllers: Model 216S, 220S, 226S, and 236S. The frequency range of the HP 8952S can be extended from 1.3 GHz to 26.5 GHz by adding the HP 11792A Sensor Module, the HP 11793A Microwave Converter and a synthesized microwave signal generator. With these instruments you can perform 80% of all tests typically required to verify both RF and microwave signal generator performance.

The HP 8952S Test System makes fast, accurate and repeatable measurements and provides you with a hardcopy output of the results. The system is easy to use and is easily expanded to include additional instruments.

To test your HP signal generators, select from the HP 11795A Software Pac series. Each Software Pac follows the verification procedures called out by the appropriate signal generator service manual.

Future software pacs will include instrument drivers for adding an HP 8568B or HP 8566B Spectrum Analyzer, HP 1980B Oscilloscope Measurement System, or HP 8116A Pulse/Function Generator to your system for complete testing of signal generator performance.

#### Ordering Information

##### HP 8952A Signal Generator Test Set

##### HP 11795A Software Pac

##### Option 101, User Interface

(Required to run Performance Verification software options)

##### Performance Verification Options (select one or more):

**204**, HP 8640B Performance Verification software

**208**, HP 8656A Performance Verification software

**209**, HP 8656B Performance Verification software

**214**, HP 8662A Performance Verification software

**216**, HP 8663A Performance Verification software

**317**, HP 8672A Performance Verification software

##### Disc Medium Options (select only one)

**630**, 3.5 inch disc medium for HP 9121S/D or HP 9133A

**650**, 5.25 inch disc medium for HP 82901M or HP 9135A

**655**, 5.25 inch disc medium for HP 9826S/9836S



# SIGNAL ANALYZERS

## Modulation Analyzer, 150 kHz to 1300 MHz

### Models 8901A, 8901B

- Measures AM and FM to 1% accuracy
- Measures RF frequency
- Measures RF Power

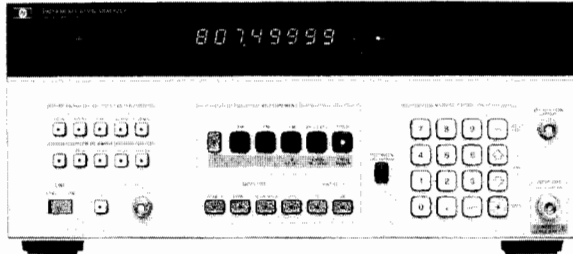

HP 8901A

## HP 8901A and HP 8901B Modulation Analyzers

The HP 8901A and HP 8901B Modulation Analyzers combine the capabilities of several RF instruments to give complete, accurate characterization of modulated signals in the 150 kHz to 1300 MHz frequency range. Both instruments very accurately measure modulation and recover the modulation signal. They determine RF frequency and measure RF power. The major additional capabilities of the HP 8901B are its improved power meter accuracy, its ability to use external power sensors, to make adjacent channel power measurements or carrier noise measurements (with options 030-037) and its ability to count audio frequencies and measure distortion on 400 Hz and 1 kHz signals. Both instruments are fully automatic and make all major measurements with the push of a key or under HP-IB control.

### Modulation Measurement Accuracy

Very accurate modulation measurements along with very low internal noise enable the HP 8901A/B to characterize even high performance signal sources. Their detection systems are configured for wideband recovery of the entire modulation spectrum so that highly precise measurements such as signal-to-noise or distortion can be made on the modulation signal. Modulation depth and deviation accuracy is generally  $\pm 1\%$  of reading. Residual AM noise in a 50 Hz to 3 kHz bandwidth is  $< 0.01\%$  while FM noise is  $< 8$  Hz for 1300 MHz carrier frequencies, decreasing linearly to  $< 1$  Hz below 100 MHz. Because the AM and FM demodulators are independent and highly insensitive to each other and because the analyzer has very low residual AM and FM, accurate incidental AM and FM measurements can be made.

Three detectors are available for depth and deviation measurements: positive peak, negative peak, and an average-responding detector with rms (sinewave) calibration. A PEAK HOLD function captures and displays the maximum peak modulation of a signal and is ideal for making transient measurements such as modulation limiting on mobile radios. The HP 8901B also has a true rms detector and the ability to measure peak to peak divided by two.

For measuring convenience, two high-pass (50 Hz and 300 Hz) and three low-pass (3 kHz, 5 kHz and  $> 20$  kHz) post-detection filters for filtering the recovered modulation are included. The  $> 20$  kHz Bessel filter minimizes overshoot on square-wave modulation. This allows accurate measurement of signals which are digitally modulated, such as FSK. Four de-emphasis networks commonly used in FM systems (25, 50, 75, and 750  $\mu$ s) are also provided.

A modulation output provides calibrated signal levels relative to the displayed modulation reading. The HP 8901B can make measurements on this demodulated signal such as frequency and distortion level.

Modulation calibrators (standard on the HP 8901B, Option 010 on the HP 8901A) provide two precision modulation standards. One is an amplitude modulated signal whose depth is calibrated to better than 0.1% accuracy. The second standard is a frequency modulated signal with peak deviation calibrated to 0.1% accuracy. The HP 11715A AM/FM Test Source is necessary to fully test and calibrate other modulation parameters.

- Low internal noise
- Completely automatic

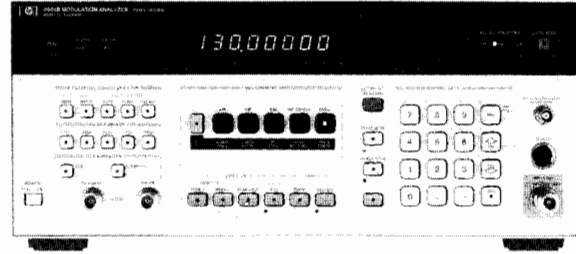

HP 8901B

### Frequency Measurements

The HP 8901A/B Modulation Analyzers are more than just high quality modulation meters. They also perform as frequency counters. Resolution for the HP 8901A's 150 kHz to 1300 MHz frequency counter is 10 Hz below 1000 MHz and 100 Hz above 1000 MHz. Resolution is 10 Hz for the HP 8901B. Sensitivity is  $-25$  dBm (12 mV rms) below 650 MHz and  $-20$  dBm (22 mV rms) above 650 MHz. The standard instrument's time base stability is  $1 \times 10^{-6}$ /month, or an optional time base is available with  $1 \times 10^{-9}$ /day stability.

### RF Power Measurements

The HP 8901A uses a diode detection circuit to measure RF input power. This technique measures peak voltage and is calibrated from 1 mW to 1 W for sinewave inputs. The RF level measurement accuracy is  $\pm 1.5$  dB from 150 MHz to 1300 MHz.

The HP 8901B delivers the accuracy and resolution of a high performance power meter. The HP 8901B, with the HP 11722A Sensor Module, measures power from  $+30$  dBm to  $-20$  dBm at frequencies from 100 kHz to 2.6 GHz. The HP 8901B also accepts all HP 8480 series power sensors for extended measurement capability.

### Adjacent Channel Power and Direct Spectrum Phase Noise Measurements

The HP 8901B offers optional selective power measurement capability (options 030-037). With this capability you can quickly and accurately make adjacent channel power measurements to CEPT standards. The HP 8901B provides a choice of selectable filters for testing transceivers with 12.5, 20, 25 and 30 kHz channel spacings.

To meet the CEPT standard at frequencies greater than 300 MHz, the HP 8901B requires an external local oscillator (LO) such as the HP 8656B Synthesized Signal Generator. Dedicating a signal generator as the external LO is not necessary. When not being used as the LO, a built-in RF switch in the HP 8901B routes the signal generator's output out the back panel.

Used with a low-phase-noise external LO, the HP 8901B also makes single-sideband (SSB) phase noise measurements to 1.3 GHz. To make the phase noise measurement, you just select the carrier noise filter and the frequency offset from the carrier (5 kHz to 1300 MHz). The HP 8901B then makes a selective power measurement (2.5 kHz BW) and converts the power to a 1 Hz bandwidth. The noise floor of the HP 8901B is  $-150$  dBc/Hz. The HP 8901B's measurement accuracy is better than  $\pm 0.5$  dB down to  $-139$  dBc. Adding the HP 11793A Microwave Converter and a low-phase-noise microwave source such as the HP 8673B Synthesized Signal Generator extends this measurement to 26.5 GHz.

### HP 8901A/8901B Specifications

#### RF Input

**Frequency range:** 150 kHz to 1300 MHz

#### Operating Level

**150 kHz–650 MHz:** 12 mVrms to 7 Vrms

**650 MHz–1300 MHz:** 22 mVrms to 7 Vrms

**Input impedance:** 50  $\Omega$  nominal

**Tuning:** manual frequency entry, automatic, or track (frequencies  $> 10$  MHz only).



**Acquisition time (automatic operation):** ~1.5 seconds.  
**Maximum safe input level (typical):** ac: 35 V<sub>rms</sub> (25 W for source SWR <4); dc: 40 V.

### Frequency Modulation Rates

**150 MHz–10 MHz:** 20 Hz to 10 kHz  
**10 MHz–1300 MHz:** 20 Hz to 200 kHz  
**10 MHz–1300 MHz:** 20 Hz to 20 kHz with 750 μs filter.

### Deviations

**150 kHz–10 MHz:** 40 kHz peak maximum  
**10 MHz–1300 MHz:** 400 kHz peak maximum  
**10 MHz–1300 MHz:** 40 kHz peak maximum with 750 μs filter.

### Accuracy<sup>1,2</sup>

**250 kHz–10 MHz:** ±2% of reading ±1 digit, 20 Hz to 10 kHz rates.  
**10 MHz–1300 MHz:** ±1% of reading ±1 digit, 50 Hz to 100 kHz rates; ±5% of reading ±1 digit, 20 Hz to 200 kHz rates.

### Demodulated Output Distortion<sup>3</sup>

**400 kHz–10 MHz:** <0.1% THD, deviations <10 kHz.  
**10 MHz–1300 MHz:** <0.1% THD, rates and deviations <100 kHz.  
**AM rejection (for 50% AM at 400 Hz and 1 kHz rates):** <20 Hz peak deviation measured in a 50 Hz to 3 kHz BW.  
**Residual FM (50 Hz to 3 kHz BW):** <8 Hz rms @ 1300 MHz, decreasing linearly with frequency to <1 Hz rms for 100 MHz and below.

### Maximum Deviation Resolution

0.1 Hz (rms detector on HP 8901B only), 4 kHz peak deviation  
 1 Hz, <4 kHz peak deviation  
 10 Hz, 4 kHz to 40 kHz peak deviation  
 100 Hz, 40 kHz to 400 kHz peak deviation  
 Resolution is increased one digit with 750 μs de-emphasis and pre-display "on" and with rms detector.  
**Stereo separation (50 Hz to 15 kHz):** >47 dB typical.

### Phase Modulation

**Carrier frequency:** 10 MHz to 1300 MHz.  
**Rates:** 200 Hz to 20 kHz; typically usable from 20 Hz to 100 kHz with degraded performance.  
**Deviation and Maximum Resolution**

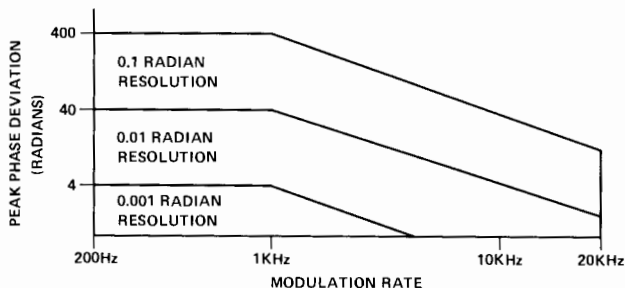

**Accuracy<sup>1</sup>:** ±3% of reading ±1 digit  
**Demodulated output distortion:** <0.1% THD  
**AM rejection (for 50% AM at 1 kHz rate)<sup>1</sup>:** <0.03 radian peak deviation (50 Hz to 3 kHz BW)

### Amplitude Modulation Rates

**150 kHz–10 MHz:** 20 Hz to 10 kHz  
**10 MHz–1300 MHz:** 20 Hz to 100 kHz.  
**Depth:** to 99%

### Accuracy<sup>1,2,4</sup>

**150 kHz–10 MHz:** ±2% of reading ±1 digit, 50 Hz to 10 kHz rates, >5% depth; ±3% of reading ±1 digit, 20 Hz to 10 kHz rates.  
**10 MHz–1300 MHz:** ±1% of reading ±1 digit, 50 Hz to 50 kHz rates, >5% depth; ±3% of reading ±1 digit, 20 Hz to 100 kHz rates.  
**Flatness (variation in indicated AM depth for constant depth on input signal):** 10 MHz to 1300 MHz: ±0.3% of reading ±1 digit, 90 Hz to 10 kHz rates, 20 to 80% depth.  
**Demodulated output distortion:** <0.3% THD for ≤50% depth; <0.6% THD for ≤95% depth.  
**FM Rejection (at 400 Hz and 1 kHz rates, 50 Hz to 3 kHz BW)<sup>5</sup>**  
**250 kHz to 10 MHz:** <0.2% AM for <5 kHz peak deviation.  
**10 MHz to 1300 MHz:** <0.2% AM for <50 kHz peak deviation.  
**Residual AM (50 Hz to 3 kHz BW):** <0.01% rms.  
**Maximum Depth Resolution**  
 0.01% for depths ≤39.99%; 0.1% for depths ≥40%. Resolution increases 1 digit with rms detector (HP 8901B only).

### Frequency Counter

**Range:** 150 kHz-1300 MHz.  
**Accuracy:** ±3 counts of least significant digit ± reference accuracy.  
**Internal Reference**  
**Frequency:** 10 MHz.  
**Aging rate:** <1x10<sup>-6</sup>/month (optional<sup>5</sup>: 1x10<sup>-9</sup>/day).  
**Maximum Resolution**  
**HP 8901A:** 10 Hz for frequencies <1 GHz; 100 Hz for frequencies ≥1 GHz.  
**HP 8901B:** 10 Hz.

### HP 8901A RF Level (Peak Voltage Responding, RMS Sine Wave Power Calibrated)

**Range:** 1 mW to 1W  
**Instrumentation accuracy:** ±1.5 dB (150 kHz to 1300 MHz); 0.7 dB typical.  
**SWR:** ≤650 MHz: ≤1.3; 1300 MHz: ≤1.5.  
**Resolution:** 0.1 mW for level 0.1 to 1W.  
 0.01 mW for levels 0.01 to 0.1W.  
 0.001 mW for levels <0.01W.

### HP 8901B RF Level (True RMS)

**Frequency range with HP 11722A:** 100 kHz to 2.6 GHz.  
**Power range:** -20 dBm to +30 dBm.  
**RF Range Linearity (Using Recorder Output)**  
 ±0.02 dB, RF ranges 2 – 5  
 ±0.03 dB, RF range 1  
 Using front-panel display, add ±1 count of least-significant digit.  
**RF Range-to-Range Change Error**  
 ±0.02 dB/RF range change from reference range  
**Input SWR:** <1.15, using HP 11722A Sensor Module  
**Zero Set (Digital Settability of Zero)**  
 ±0.07% of full scale on lowest range.  
 Decrease by a factor of 10 for each high range.  
**RF Power Resolution**  
 0.1% of full scale in watts or volts mode,  
 0.01 in dBm or dB relative mode.

<sup>1</sup> Peak residuals must be accounted for in peak readings.  
<sup>2</sup> But not to exceed: 50 Hz to 40 kHz rates for stated accuracy with rms detector (HP 8901B only).  
<sup>3</sup> With 750 μs de-emphasis and pre-display "off", distortion is not specified for modulation outputs >4 V peak. This can occur near maximum deviation for a measurement range at rates >2 kHz.  
<sup>4</sup> For peak measurements only, AM accuracy may be affected by distortion generated by the Modulation Analyzer. In the worst case, this can decrease accuracy by 0.1% of reading for each 0.1% of distortion.  
<sup>5</sup> After 30 day warm-up.

# SIGNAL ANALYZERS

Modulation Analyzer, 150 kHz to 1300 MHz; AM/FM Test Source

Models 8901A, 8901B, 11715A

## HP 8901B Selective Power Measurements (options 030-037)

**Frequency range:** 10 MHz to 1.3 GHz.

**Carrier power range:** +30 dBm to -20 dBm, 12.5, 20, 25 and 30 kHz filters; +30 dBm to -10 dBm, Carrier Noise Filter.

**Dynamic range:** 115 dB.

**Carrier rejection (temp.  $\leq 35^\circ\text{C}$ ):** >90 dB, for offsets  $\geq 1$  channel spacing or 5 kHz, whichever is larger.

**Relative accuracy:**  $\pm 0.5$  dB, SSB Power  $\geq -95$  dBc or SSB Power  $\geq -139$  dBc/Hz.

**Filter bandwidths:** 2.5 kHz, Carrier Noise Filter  
8.0 kHz, 12.5 kHz Filter  
15.0 kHz, 20/25 kHz Filter  
30.0 kHz, Cellular Radio Filter

## Power Reference

**Power output:** 1.00 mW. Factory set to  $\pm 0.7\%$ , traceable to the U.S. National Bureau of Standards.

**Accuracy:**  $\pm 1.2\%$  worst case ( $\pm 0.9\%$  rss) for one year ( $0^\circ\text{C}$  to  $55^\circ\text{C}$ ).

## Audio Filters

**High pass (3 dB cutoff frequency):** 50 Hz and 300 Hz

**Low pass (3 dB cutoff frequency except >20 kHz filter):** 3 kHz, 15 kHz, >20 kHz.

**De-emphasis filters:** 25  $\mu\text{s}$ , 50  $\mu\text{s}$ , 75  $\mu\text{s}$ , and 750  $\mu\text{s}$ .

## Calibrators (Standard HP 8901B, Option 010 HP 8901A)

**AM calibrator depth and accuracy:** 33.33% depth, nominal; internally calibrated to an accuracy of  $\pm 0.1\%$ .

**FM calibrator deviation and accuracy:** 34 kHz peak deviation, nominal; internally calibrated to an accuracy of  $\pm 0.1\%$ .

## General Characteristics

**Operating temperature range:**  $0^\circ$  to  $55^\circ\text{C}$ .

**Power requirements:** 100, 120, 220, or 240 V ac (+5, -10%); 48-66 Hz; 200 VA max.

**Weight:** HP 8901A—net 20 kg (44 lb), shipping 25 kg (55 lb); HP 8901B—net 23 kg (52 lb), shipping 31 kg (69 lb).

**Size:** HP 8901A, 190 mm H x 425 mm W x 468 mm D (7.5 in. x 16.8 in. x 18.4 in.); HP 8901B, 190 mm H x 425 mm W x 551 mm D (7.5 in. x 16.8 in. x 21.7 in.)

## Ordering Information

### HP 8901A Modulation Analyzer

**Option 001:** Rear panel connectors

**Option 002:**  $1 \times 10^{-9}$ /day internal reference

**Option 003:** Connections for external local oscillator

**Option 004:** Operation from 48 to 440 Hz power (Temp.  $< 40^\circ\text{C}$ )

**Option 010:** AM and FM calibrators

### HP 8901B Modulation Analyzer

**Option 001:** Rear panel connectors

**Option 002:**  $1 \times 10^{-9}$ /day internal reference

**Option 003:** Connections for external local oscillator

**Option 004:** Operation from 48 to 440 Hz power (Temp.  $< 40^\circ\text{C}$ )

**Option 030:** High selectivity (select only 2 filter options)

**Option 032:** 12.5 kHz filter

**Option 033:** 20.0/25.0 kHz filter

**Option 035:** Cellular Radio Filter

**Option 037:** Carrier Noise Filter

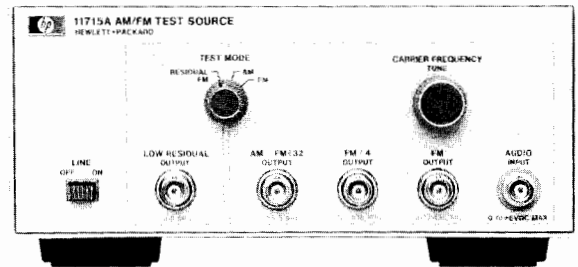

HP 11715A

## HP 11715A AM/FM Test Source

The HP 11715A AM/FM Test Source provides very flat, wide-bandwidth, and low distortion amplitude or frequency modulated RF signals. Designed primarily for performance tests and adjustments of the HP 8901A/8901B Modulation Analyzer and HP 8902A Measuring Receiver, it will also serve as a high quality modulated test oscillator where its frequency ranges apply.

The major components of the HP 11715A are a low-noise voltage controlled oscillator (VCO), two digital dividers, and a double-balanced mixer. The VCO is the primary signal source, with a typical frequency range of 330 to 470 MHz at the FM OUTPUT. FM is produced by directly coupling the external modulation source to the VCO's tune input, providing very wide bandwidth modulation with low phase shift. This design also ensures very little incidental AM.

The HP 11715A can also be used in conjunction with an HP 8901A/8901B/8902A as a calibrated signal source for special applications. In particular, the U.S. commercial FM broadcast band of 88 to 108 MHz is covered by the FM  $\div 4$  OUTPUT of the HP 11715A.

## HP 11715A Specifications

### FM Outputs

#### Frequency Range

**AM FM  $\div 32$  output:** 11 to 13.5 MHz

**FM  $\div 4$  output:** 88 to 108 MHz

**FM output:** 352 to 432 MHz

#### Peak Deviation

**11 to 13.5 MHz carrier:** >12.5 kHz

**88 to 108 MHz carrier:** >100 kHz

**352 to 432 MHz carrier:** >400 kHz

#### Distortion

<0.025% THD ( $< -72$  dB) for

Carrier frequency	Peak deviation	Modulation rate
12.5 MHz	12.5 kHz	<10 kHz
100 MHz	100 kHz	<100 kHz
400 MHz	400 kHz	<100 kHz

### Flatness

**dc to 100 kHz rates:**  $\pm 0.1\%$

**dc to 200 kHz rates:**  $\pm 0.25\%$

**Stereo separation (88 to 108 MHz carrier, 75 kHz peak deviation, 1 kHz rate):** >60 dB typical

### AM Output

**Frequency range (AM FM  $\div 32$  output):** 11 to 13.5 MHz

**Depth:** to 99%

#### Distortion

**50% AM, 20 Hz to 100 kHz rates:** <0.05% THD ( $< -66$  dB)

**95% AM, 20 Hz to 100 kHz rates:** <0.1% THD ( $< -60$  dB)

**Flatness:** 50 Hz to 50 kHz rates,  $\pm 0.1\%$ ;

20 Hz to 100 kHz rates,  $\pm 0.25\%$

**Linearity:** <95% AM,  $\pm 0.1\%$ ; <99% AM,  $\pm 0.2\%$

## Ordering Information

HP 11715A AM/FM Test Source



# SIGNAL ANALYZERS

## Audio Analyzer, 20 Hz to 100 kHz

Model 8903A



- Measures distortion, SINAD, signal-to-noise
- Measures true rms volts, dc volts, frequency

- Programmable low distortion source

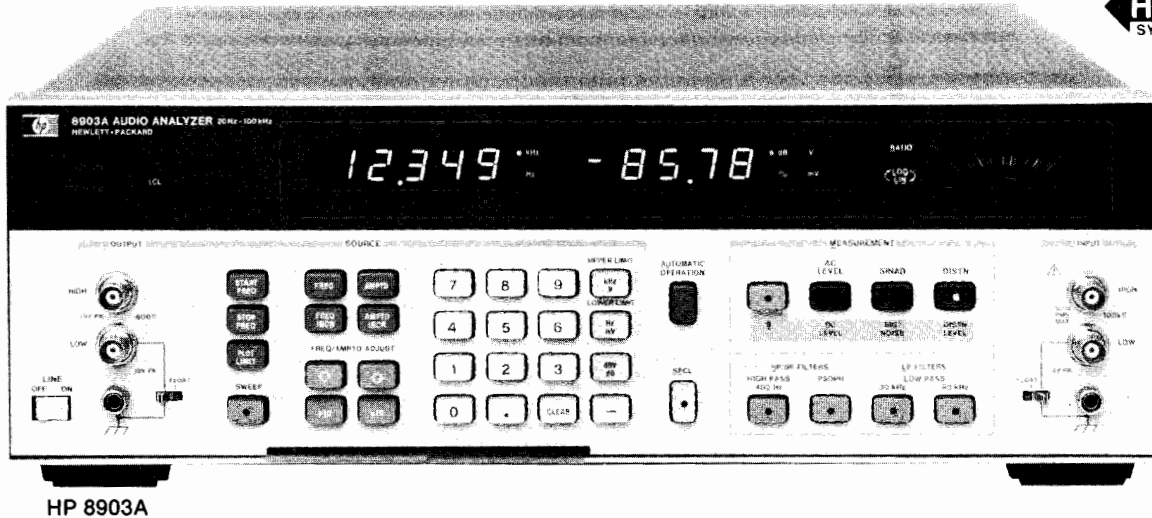

### HP 8903A Audio Analyzer

The HP 8903A Audio Analyzer combines the capabilities of several instruments under microprocessor control to yield accurate and rapid characterizations of audio signals in the range of 20 Hz to 100 kHz. It contains an audio source, measures distortion, SINAD, signal-to-noise ratio, ac and dc level, and counts frequency completely automatically with either a single front panel keystroke or under HP-IB remote control. This combination reduces the number of instruments and complexity of setup needed in many applications.

The analyzer is ideally suited for performing audio measurements on transceivers. Along with a suitable signal generator and modulation analyzer, receiver sensitivity and transmitter distortion measurements can be made accurately and rapidly.

With the internal source and measurement functions enhanced by microprocessor control, the HP 8903A has more measurement capability and less display ambiguity than separate instruments. The Audio Analyzer makes true rms measurements for ac level and distortion, thus assuring more accurate measurements of complex waveforms and noise. The ability to perform swept measurements makes it an extremely versatile stand-alone bench instrument for general audio stimulus/response work. Its programmability over HP-IB is well suited to system applications.

### Transceiver Testing

The Audio Analyzer performs several measurements and contains various features specifically designed for receiver testing. The most common audio measurements are SINAD for FM receivers and signal-to-noise for AM receivers. In the HP 8903A, these measurements are optimized for measuring the noisy signals encountered in receiver testing. Measurements of SINAD are indicated both by the analog meter and the digital display. The specially marked meter for EIA and CEPT sensitivity and selectivity results in fast, accurate, repeatable measurements. Also, a psophometric filter allows testing to CEPT standards.

By combining the HP 8903A with the HP 8901A Modulation Analyzer, you can make all common transmitter tests. The HP 8903A provides the tone for microphone inputs, measures transmitter audio distortion, and counts squelch tones. Distortion measurements can be made using the 400 Hz high pass filter to reject squelch tones. In rapid frequency count mode, counter measurements can be made at a rate of 8 ms/reading, allowing burst counting of squelch tone frequencies. In rapid source mode, the HP 8903A can switch frequencies rapidly enough to generate multiple tone squelch sequences. All functions are remotely programmable.

### Audio Testing

The HP 8903A simplifies general audio testing by combining several traditional audio instruments into one. It is fully automatic and autoranging, so most measurements take only a single keystroke. Microprocessor control of all functions greatly enhances measurement flexibility. For example, distortion can be displayed in either percent or dB. In ac level you can choose between volts, dBV, or watts by entering the load resistance from the keyboard. You can establish a reference and make measurements in percent or dB relative to a measured or entered value. Using the source increment/decrement keys and relative display mode it is easy to determine parameters such as the 3 dB points of filters and amplifiers. With both low-distortion source and analyzer built in, the HP 8903A makes stimulus-response measurements. Internal processor control over all functions expands this capability to powerful swept characterization. With only a few keystrokes you can measure frequency response and swept distortion characteristics of filters, high quality amplifiers, audio IC's, and other devices. Hard copy results are easily generated with an X-Y recorder connected to the analyzer's rear panel outputs.

### Systems Applications

The Audio Analyzer is a powerful HP-IB system component. Many low frequency functions frequently required in automatic systems are combined in the HP 8903A. In many cases it does the work of an audio synthesizer, digital voltmeter, frequency counter, and custom interface with notch filters. All measurements are available at a single input connector. As a result, interfacing requirements, hardware cost, and software development time are reduced. The HP 8903A makes a major contribution by automatically measuring distortion under HP-IB control. It also provides a low distortion programmable source. Typical combined distortion of both source and analyzer at 1V is <0.003% between 20 Hz and 20 kHz.

Often systems applications involve measuring low level ac signals. The HP 8903's most sensitive range features a full scale ac level display of .300 mV with an accuracy of 4% of reading (2% of reading >50 mV, 20 Hz to 20 kHz). The ac converter is true rms for correct noise measurements and the 3 dB bandwidth is greater than 500 kHz.

Large measurement systems often have troublesome noise problems. The HP 8903A has 30 kHz and 80 kHz low-pass filters to reject high frequency noise. Also, the 400 Hz high-pass filter rejects line related hum and noise more than 68 dB. Floating the input or output can break insidious ground loops, and provide up to 60 dB of common mode rejection.

Two special binary programming modes are available in remote operation. Rapid frequency count mode provides a packed four byte output for fast counting. Also, the rapid source mode allows the internal source to be programmed directly with five bytes.



# SIGNAL ANALYZERS

## Audio Analyzer 20 Hz to 100 kHz

### Model 8903A (cont.)

#### HP 8903A Specifications

##### Source

**Frequency range:** 20 Hz to 100 kHz.

**Frequency resolution:** 0.3%

**Frequency accuracy:** 0.3% of setting.

**Output level range:** 0.6 mV to 6V open circuit.

**Output level resolution:** 0.3% or better.

**Output level accuracy (open circuit):** 2% of setting, 60 mV to 6V, 20 Hz to 50 kHz; 3% of setting, 6 mV to 6V, 20 Hz to 100 kHz; 5% of setting, 0.6 mV to 6 mV, 20 Hz to 100 kHz.

**Flatness (1 kHz reference):**  $\pm 0.7\%$ , 20 Hz to 20 kHz;  $\pm 2.5\%$ , 20 Hz to 100 kHz.

**Distortion & noise:** the higher of:  $-80$  dB or  $30 \mu\text{V}$ , 20 Hz to 20 kHz, 80 kHz BW;  $-70$  dB or  $95 \mu\text{V}$ , 20 kHz to 50 kHz, 500 kHz BW;  $-65$  dB or  $169 \mu\text{V}$ , 50 kHz to 100 kHz, 500 kHz BW.

**Impedance:**  $600\Omega \pm 1\%$ .

**Sweep mode:** logarithmic sweep with up to 500 points/decade or 255 points between entered start and stop frequencies, whichever is smaller.

##### AC Level

**Full range display:** 300.0V, 30.00V, 3.000V, 0.3000V, 30.00 mV, 3.000 mV, 0.3000 mV.

**Overrange:** 33% except on 300V range.

**Accuracy:**  $\pm 2\%$  of reading, 30V to 300V, 20 Hz to 1 kHz;  $\pm 2\%$  of reading, 50 mV to 30V, 20 Hz to 20 kHz;  $\pm 4\%$  of reading, 0.3 mV to 30V, 20 Hz to 100 kHz.

**AC Converter:** true-rms responding for signals with crest factor  $\leq 3$  and harmonics up to 80 kHz typical. 3 dB measurement BW:  $> 500$  kHz typical. Average detection selectable by internal jumpers.

##### DC Level

**Full range display:** 300.0V, 48.00V, 16.00V, 4.00V.

**Overrange:** 33% except on 300V range.

**Accuracy:**  $\pm 0.75\%$  of reading, 400 mV to 300V;  $\pm 3$  mV,  $< 400$  mV.

##### Distortion

**Fundamental frequency range:** 20 Hz to 100 kHz.

**Display range:** 0.001% to 100%,  $-99.99$  dB to 0 dB.

**Accuracy:**  $\pm 1$  dB, 20 Hz to 20 kHz;  $\pm 2$  dB, 20 kHz to 100 kHz.

**Input voltage range:** 50 mV to 300V.

**Residual noise and distortion:** the higher of: 0.01%,  $-80$  dB, or  $30 \mu\text{V}$ , 20 Hz to 20 kHz, 80 kHz BW; 0.032%,  $-70$  dB, or  $95 \mu\text{V}$ , 20 kHz to 50 kHz, 500 kHz BW; 0.056%,  $-65$  dB, or  $169 \mu\text{V}$ , 50 kHz to 100 kHz, 500 kHz BW.

**Displayed resolution:** 0.0001%,  $< 0.1\%$  distortion; 0.001%, 0.1% to 3% distortion; 0.1%, 3% to 30% distortion; 0.1%,  $> 30\%$  distortion.

**Detection:** true rms (average detection selectable by internal jumpers).

##### SINAD<sup>1,2</sup>

**Fundamental frequency range:** 20 Hz to 100 kHz.

**Display range:** 0 dB to 99.99 dB.

**Accuracy:**  $\pm 1$  dB, 20 Hz to 20 kHz;  $\pm 2$  dB, 20 kHz to 100 kHz.

**Input voltage range:** 50 mV to 300V.

**Detection:** true rms (average detection selectable by internal jumpers).

**Resolution:** 0.01 dB for SINAD ratios  $> 25$  dB. For ratios  $< 25$  dB the display is rounded to the nearest half dB to reduce digit flickering of noise signals. (Full resolution is available by defeating this feature using special function 16.1.)

**Analog meter:** active in SINAD only and for SINAD ratios  $< 18$  dB (or 24 dB using special function 7.1.)

**Tuning:** notch filter is tuned to analyzer source frequency.

##### Signal to Noise

**Frequency range:** 20 Hz to 100 kHz.

**Display range:** 0 dB to 99.99 dB.

**Accuracy:**  $\pm 1$  dB.

<sup>1</sup>SINAD is a sensitivity measurement computed from the ratio of signal plus noise and distortion to noise and distortion.

<sup>2</sup>Residual noise and distortion same as for distortion mode.

**Input voltage range:** 50 mV to 300V.

**Residual noise:** the higher of  $-80$  dB or  $30 \mu\text{V}$ , 80 kHz BW;  $-70$  dB or  $95 \mu\text{V}$ , 500 kHz BW.

**Resolution:** same as SINAD.

**Operation:** the analyzer displays the ratio of the input voltages as the internal source is automatically switched on and off.

##### Frequency Counter

**Range:** 20 Hz to 150 kHz<sup>3</sup>.

**Resolution:** 5 digits<sup>4</sup>.

**Accuracy:**  $0.004\% \pm 1$  digit.

**Input sensitivity:** 50 mV in distortion and SINAD modes, 5.0 mV in ac level and sig/noise modes.

**Counting technique:** reciprocal with 2 MHz timebase.

##### Audio Filters

**400 Hz high pass filter:** 3 dB cutoff frequency, 400 Hz  $\pm 40$  Hz; 140 dB/decade rolloff.

**Psophometric filter (CCITT recommendation P53):** deviation from ideal response:  $\pm 0.2$  dB at 800 Hz;  $\pm 1$  dB, 300 Hz to 3 kHz;  $\pm 2$  dB, 50 Hz to 3.5 kHz;  $\pm 3$  dB, 3.5 kHz to 5 kHz.

**30 kHz low pass filter:** 3 dB cutoff frequency, 30 kHz  $\pm 2$  kHz; 60 dB/decade rolloff.

**80 kHz low pass filter:** 3 dB cutoff frequency, 80 kHz  $\pm 4$  kHz; 60 dB/decade rolloff.

##### Rear Panel Inputs/Outputs

**Recorder output:** X: 0-10 Vdc (typical) corresponding to log of oscillator frequency.

Y: 0-10 Vdc (typical) corresponding to displayed value and entered plot limits.

**Recorder output resistance:** 1 k $\Omega$  nominal.

**Monitor output:** in ac level mode provides scaled output of measured input signal. In SINAD, distortion, and distortion level modes provides scaled output of input signal with the fundamental removed.

##### General

**Input impedance:** 100 k $\Omega \pm 1\%$  shunted by  $< 300$  pF with low terminal grounded<sup>5,6</sup>.

**CMRR (@ 60 Hz):** 60 dB for differential input  $< 2$ V; 36 dB for differential input  $< 48$ V; 30 dB for differential input  $> 48$ V.

**Remote operation:** HP-IB, all functions except the line switch, low terminal ground switches, and the  $\times 10 \div 10$  increment keys.

**HP-IB compatibility, as defined in IEEE-488-1978, is:** SH1, AH1, T5, TE0, L3, LE0, SR1, RL1, PP0, DC1, DT1, C0.

**Temperature:** operating,  $0^\circ$  to  $55^\circ\text{C}$ ; storage,  $-55^\circ\text{C}$  to  $75^\circ\text{C}$ .

**Power requirements:** 100, 120, 220, or 240 volts (+5, -10%); 48-440 Hz; 100 VA maximum.

**Weight:** net, 12.3 kg (27 lb). Shipping, 16.4 kg (36 lb).

**Size:** 146 H x 425 W x 440 mm D (5.75 x 16.8 x 17.3 in.).

**HP System II module size:**  $5\frac{1}{4}$  H x 1 MW x 17 D. See pp. 682-685 for compatible accessories.

**EMI:** conducted and radiated interference is within the requirements of methods CE03 and RE02 of MIL STD 461A, VDE 0871, and CISPR publication 11. Conducted and radiated susceptibility meet the requirements of methods CS01, CS02, and RS03 (1 volt/meter) of MIL STD 461A dated 1968.

##### Ordering Information

###### HP 8903A Audio Analyzer

(Note: HP-IB cable not supplied. See page 675.)

**Option 001:** Rear panel connections instead of front panel for source output and analyzer input.

**Option 907:** Front panel handle kit

**Option 908:** Rack mount flange kit

**Option 909:** Front panel handle plus rack mount flange kit

**Option 910:** Extra Operating & Service Manual

<sup>3</sup>20 Hz to 100 kHz in SINAD and distortion.

<sup>4</sup>Resolution is limited to 0.01 Hz for input frequencies  $< 100$  Hz.

<sup>5</sup>In dc level mode input resistance is 101 k $\Omega \pm 1\%$ .

<sup>6</sup>Input capacitance is  $< 330$  pF for Option 001.

# TRANSCIVER TEST EQUIPMENT

## HP 8955A RF Test System

653



- High performance measurements of AM and FM transmitters, receivers, and their modules
- Frequency range from 150 kHz to 1000 MHz
- System calibration, verification and diagnostics

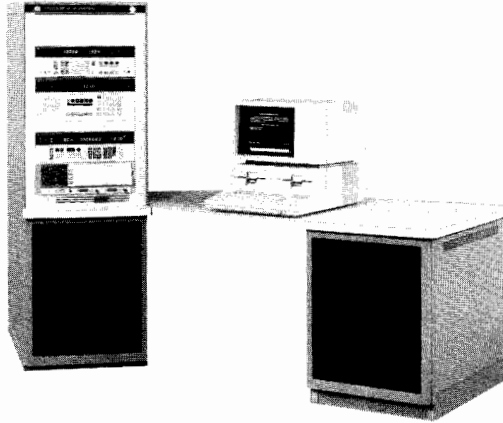

HP 8955A

### 8955A RF Test System

The HP 8955A RF Test System is a flexible combination of instrumentation and software used in the testing of transmitters, receivers, and subassemblies. The basic system consists of three measurement instruments: HP 8901B Modulation Analyzer, HP 8903A Audio Analyzer and HP 8656B Signal Generator. To these instruments is added the HP 8956A System Interface to provide flexibility and easy system integration. The system is automated with a powerful software package that is executed on the HP Series 200, Model 16 or 36 Computer System. All hardware is mounted in a HP 29402C cabinet and a desk is mounted off one side.

### HP 11791A Software Package

The HP 11791A Software Package for the HP 9816S or HP 9836S assure comprehensive transceiver testing on the same day the system is turned on. The software package is a powerful combination of operating system and measurement test routines. The operating system allows you to learn about system operation through its HELP command, verify system operation, reconfigure the system if new instruments are added or generate and execute a program from HP supplied test routines. While the test package is executing, you can interact with the system: halt execution to modify parameters, repeat certain tests, or learn more about system operation. There are over 60 measurement test routines which use the Electronic Industry Association (EIA) and Conference of European Postal and Telecommunications Administration (CEPT) standards for AM and FM receivers, transmitters, and their circuitry.

Additional software includes a powerful verification program, calibration program and configuration program which allows you to change the instrument configuration.

### Options

The system offers a variety of options to meet your needs. These options include instrumentation for SSB testing, out-of-channel testing, spurious response testing, power supplies, and cabinet hardware. All options are fully supported and integrated at the factory. Comprehensive documentation is included with every system and installation is offered as an option.

### Optional Instrumentation

HP 8662A Synthesized Signal Generator  
HP 8642A/B Synthesized Signal Generator  
HP 8568B Spectrum Analyzer  
HP 3325A Synthesizer/Function Generator  
Second HP 29402C Cabinet  
Sidebay  
Second Desk

- A fully automatic operating system with easy softkey interaction
- Automatic program generator
- Over 60 tests using EIA and CEPT standards

### HP 8955A SYSTEM SPECIFICATIONS (INCLUDES SOFTWARE CALIBRATION)

#### RF Signal Measurements (transmitter tests)

**Frequency range:** 150 kHz to 1000 MHz.

**Frequency measurement accuracy:** refer to HP 8901.

#### Power Measurement Range

With the 30 dB attenuator: 50 mW to 120 W.

Without the 30 dB attenuator: 100  $\mu$ W to 0.5 W.

#### Power Measurement Accuracy

##### With the 30 dB Attenuator

Within 2 MHz of calibration frequencies:  $< \pm 0.5$  dB ( $\pm 0.3$  dB typical).

1 MHz to 1000 MHz:  $< \pm 0.45$  dB typical.

#### Input VSWR

##### With the 30 dB attenuator

dc to 1000 MHz:  $\leq 1.2$ .

**Modulation measurements (AM, FM, PM):** refer to HP 8901.

#### RF Signal Source (receiver tests)

**Frequency range:** 100 kHz to 990 MHz.

Option 112 or 122: 10 kHz to 1280 MHz.

#### Output Level Range

With the 30 dB attenuator:  $-27$  dBm to  $-130$  dBm.

Without the 30 dB attenuator:  $+0$  dBm to  $-130$  dBm.

#### Output Level Accuracy

##### With the 30 dB Attenuator

Within 2 MHz of calibration frequencies:  $< \pm 1.8$  dB.

100 kHz to 990 MHz:  $< \pm 1.5$  dB typical.

##### Option 112 or 122

Within 2 MHz of calibration frequencies:  $< \pm 1.3$  dB.

10 kHz to 1000 MHz:  $< \pm 1.1$  dB typical.

#### Output VSWR

With the 30 dB attenuator:

dc to 1000 MHz:  $\leq 1.2$ .

**Modulation:** refer to signal generator specifications.

#### Audio Measurements

**Frequency range:** refer to HP 8903A.

**Voltage measurement range:** 50 mV to 30 V.

**Voltage measurement accuracy:** refer to HP 8903A.

**Distortion measurement:** refer to HP 8903A.

#### Audio Source

**Frequency range:** 20 Hz to 100 kHz.

**Output voltage range:** refer to HP 8903A.

**Output voltage accuracy:** refer to HP 8903A.

**Current drain measurement range:** 0 to 30 A.

#### Current Drain Measurement Accuracy

$I < 10$  A:  $\pm (2.5\%$  of reading + 12 mA).

$I > 10$  A:  $\pm (4\%$  of reading + 12 mA).

#### Timing Measurements

Closure of relay to half RF power (Carrier Attack Time).

Application of an RF signal to 90% rated audio power (Receiver Attack Time).

Removal of an RF signal to squelch closure (Receiver Squelch Closing Time).

**Timing accuracy:**  $\pm 5$  msec typical.

**Timing interval:** 500 msec maximum

**Timing resolution:** 0.1 msec.

#### General Specifications

**System operating temperature:**  $15^\circ$  to  $35^\circ$  C.

**System storage temperature:**  $-40^\circ$  to  $+75^\circ$  C.

**Ambient humidity:** 5% to 80%.

**Power:** 115 V, 60 Hz; Standard system less controller:

Approximately 600 VA worse case.

**Net weight (less controller):** 150 kg (330 lb).

**Shipping weight (less controller):** 212 kg (467 lb).

**Cabinet dimensions:** 163 cm H x 53 cm W x 70 cm D  
(64.25" x 21.0" x 27.6").

# TRANSCIVER TEST EQUIPMENT

## Transceiver Test Set

Model 8953A

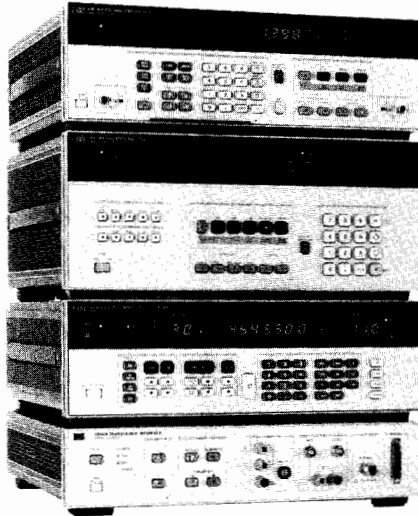

HP 8953A

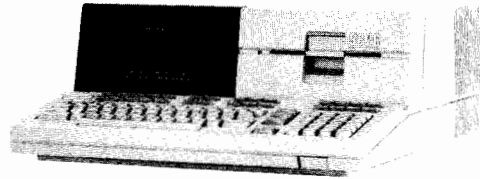

### Description

The HP 8953A Transceiver Test Set performs automatic and manual in-channel testing of AM and FM communication receivers and transmitters from 150 kHz to 990 MHz. It combines the measurement power of the HP 8901A Modulation Analyzer, HP 8903A Audio Analyzer and HP 8656B Synthesized Signal Generator with the HP 8954A Transceiver Interface, all necessary cables, accessories and software for a choice of controllers: the HP 85B, 9816S, 9826S or 9836S Computer Systems.

### Flexible and Expandable

Together these instruments and controllers provide a broad range of measurement capability from simple tests such as RF frequency and distortion through complex measurements including receiver usable sensitivity and audio frequency response. Basic in-channel testing of a radio using the test set's HP 11723B or HP 11790A Application Pac software typically takes less than a minute. These application pacs, the HP 11723B for the HP 85B and the HP 11790A for the HP 9816S, 9826S and 9836S, are comprehensive starter/demonstration software programs written in BASIC language. They are modular in structure and easily customized for specific applications.

For those requiring additional measurement capability such as out-of-channel or SSB testing, the test set's HP 8954A interface has connections for a second signal generator, a second RF monitor such as a power meter or a spectrum analyzer, and a d.c. power supply.

### Option 100

This option substitutes the more powerful HP 8956A System Interface for the standard HP 8954A Transceiver Interface, adding capabilities including current drain and transmitter and receiver attack time measurements. The HP 11790B Application Pac which takes advantage of the added capabilities of the HP 8956A can be executed on the HP Series 200 controllers.

### Easy to Operate

The HP 8953A test set is easy to use in both automatic and manual operation. Full front panel control, plus indicators for all functions, make test program development easy. Procedures can be developed manually and then translated to the controller's BASIC language by simply substituting one- or two-character program codes for key-strokes. For example, the keystroke sequence "Frequency 455 MHz" is equivalent to the program code "FR455MZ".

### Easy to Assemble

Assembling the test set is quick and easy. The HP 8953A Operating Manuals describe the simple setup procedure, provide a method for verifying setup, and describe how to use the supplied HP 11723B/11790A/11790B Application Pac software. You need to provide a power supply for the transceiver under test, and cables between the HP 8954A Transceiver Interface and the transceiver. Everything else is included.

Receiver In-channel	Transmitter	General
Sensitivity* Audio Power* Signal-to-Noise* Distortion* SINAD Quieting Audio Freq. Response* Hum and Noise	Power* Frequency* Frequency Error* AM, FM, $\theta$ M Squelch Frequency* Squelch Deviation* Residual AM, FM or $\theta$ M Incidental AM, FM or $\theta$ M Microphone Sensitivity* Distortion* Modulation Limiting* Audio Freq. Response Hum and Noise* Adjacent channel power (HP 8901B opt. 30)	AC Volts DC volts Frequency Distortion
Receiver Out-of-Channel Adjacent channel selectivity** Image rejection** IF rejection**		
*Tests performed and displayed by the HP 11723B/11790A/11790B Application Pac program. Additional subroutines are provided for all the measurements.		**Additional tests performed and displayed using the HP 11723B/11790A/11790B Application Pac program if an HP 8662A Signal Generator or HP 8642A/B Signal Generator is added to the test set for out-of-channel testing.

The HP 8953A can be configured with controllers and computer peripherals to form a complete system.

### Ordering Information

#### HP 8953A Transceiver Test Set

##### HP 8901A Modulation Analyzer

**Option 001** Rear Panel Connections

**Option 002** High Stability Time Base

##### HP 8656B Signal Generator

**Option 002** Rear Panel Connections

##### HP 8903A Audio Analyzer

**Option 001** Rear Panel Connections

##### HP 8954A Transceiver Interface

**HP 8498A** Option 030 Attenuator, 25 watt, 30 dB

**HP 10833A** Low-RFI HP-IB Cables (3)

**HP 11500B** 60 cm N Cables (2)

**HP 11170A** 30 cm BNC Cable

**HP 11170B** 60 cm BNC Cables (2)

**HP 11170C** 120 cm BNC Cables (2)

**HP 908A** 50-Ohm Termination

**Option 100:** adds HP 8956A System Interface; deletes HP 8954A Transceiver Interface, HP 8498A Attenuator, and HP 908A Termination

**Option 105:** replaces the HP 8901A opts. 001, 002 with the HP 8901B opts. 001, 002 and HP 11722A

**Option 106:** replaces the HP 8901A opts. 001, 002 with the HP 8902A opts. 001, 002 and HP 11722A

**Option 110:** deletes the HP 8656B opt. 002

**Option 111:** adds the HP 8642A opt. 002

**HP 11723B** Application Pac

**HP 11790A** Application Pac

**HP 11790B** Application Pac

# TRANSCEIVER TEST EQUIPMENT

RF Interfaces

Models 8954A, 8956A

655

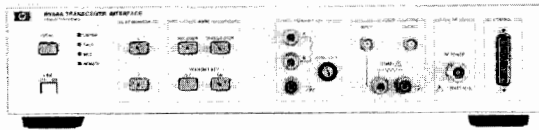

HP 8954A

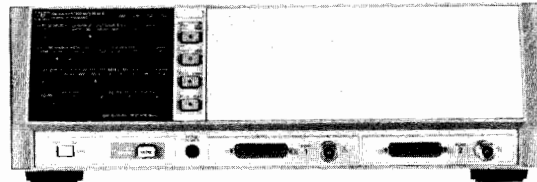

HP 8956A

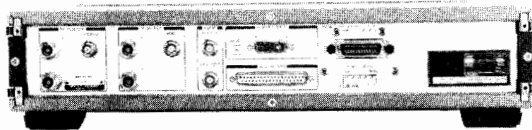

HP 8954A Rear View

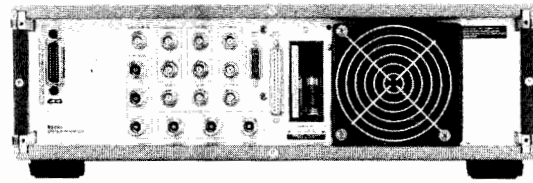

HP 8956A Rear View

## HP 8954A Transceiver Interface

The HP 8954A is Hewlett-Packard's lowest priced transceiver test interface. It is fully programmable and designed for dc to 18 GHz measurement applications.

The HP 8954A interface has connections for the three measurement instruments; the HP 8901A or HP 8901B Modulation Analyzers, HP 8903A Audio Analyzer and HP 8656B Signal Generator. You can add a second signal generator, a second RF monitor such as power meter or a spectrum analyzer, and route a power supply's output through the interface to the front panel transceiver connector. External devices may be controlled with the HP 8954A's sixteen programmable form-A contact relays.

Using the annunciated front panel keys, you can manually control the Receive/Transmit signal path, select either RF monitor, or key the transmitter. The HP 8954A Transceiver Interface provides the flexibility needed for most AM, FM and SSB receiver and transmitter testing.

## 8954A Specifications

**RF frequency range:** 100 kHz to 1300 MHz. (usable dc to 18 GHz.)

**VSWR (RF Port to RF Monitor):**  $\leq 1.15$

**VSWR (RF Source to RF Port):**  $\leq 1.15$

**RF insertion loss: (RF Port to RF Monitor)**  $\leq 0.5$  dB

**RF insertion loss: (RF Source to RF Port)** 6.0 dB +0.45 dB -0.35 dB

**Audio frequency range:** 20 Hz to 100 kHz. (dc coupled)

**Audio insertion loss:** 0.03 dB, 20 Hz to 20 kHz. 0.3 dB, 20 kHz to 100 kHz.

## Supplemental Characteristics

### DC Power Supply Circuit

**Current:** 30A (Voltage  $< 28$  Vdc)

**Voltage:** 50 Vdc (Current  $< 15$ A)

### Transmit Key Relay

**Current:** 1.5A (Voltage  $< 28$  Vdc)

**Voltage:** 50 Vdc (Current  $< 0.5$  A)

**Auxiliary Relays** (16 Form-A contact)

**Current:** 0.5A (Voltage  $< 20$  Vdc)

**Voltage:** 50 Vdc (Current  $< 0.2$  A)

**HP-IB interface functions:** SH1, AH1, T6, L4, SR1, RL1, PP0, DC1, DT0, C0 and E1.

## Ordering Information

HP 8954A Transceiver Interface

## HP 8956A System Interface

The HP 8956A System Interface, with its multiple paths and connections, provides flexibility in the designing of systems in the frequency range from dc to 1000 MHz. It can integrate up to 3 signal generators, 3 RF measurement instruments, 2 audio sources, 2 audio measurement instruments and a dc power supply.

A front panel keyboard makes it easy to control all switching operations making it a valuable component in system integration. Store/Recall keys of the front panel settings give extra versatility in manual operation.

The HP 8956A System Interface has 2 RF test ports for duplex testing, stimulus/response testing or for connect/unconnect of one unit under test while another is being tested. Next to each RF port is a control connector that contains all the audio and power signals.

Other additional functions of the HP 8956A include current drain and timing measurements.

## 8956A Specifications

**Frequency range:** dc to 1000 MHz

**Maximum Input Power to RF Ports**

With the 30 dB attenuator: 120 W CW

Without the 30 dB attenuator: 0.5 W CW

### VSWR

RF Ports: (Instrument connections terminated in 50 ohms):

With the 30 dB attenuator: dc to 1000 MHz:  $\leq 1.2$

### Audio

Frequency Range: dc to 100 kHz

## Supplemental Specifications

### Insertion Loss

Maximum variation of insertion loss with frequency:  $< 5$  dB.

Insertion loss of major RF source and monitor paths with the attenuator inserted can be characterized by:  $A(\text{dB}) = A_0 + k\sqrt{f}$   $A_0$  = Loss at dc,  $k$  = Constant,  $f$  = Frequency (MHz).

**HP-IB interface functions:** SH1, AH1, T6, L4, SR1, RL1, PP1, DC1, DT0, C0 and E2.

## Ordering Information

HP 8956A System Interface

Option 001 Rear Panel RF and Control Ports



# TRANSCEIVER TEST EQUIPMENT

## Cellular Radio Test Equipment

Models 8957S, 8958A



- Compatible with AMPS and TACS protocols
- Fully automatic operation
- Complete RF testing
- Over-the-air signalling simulation
- Up to six RF instruments - add a spectrum analyzer or signal generator for more complete measurements

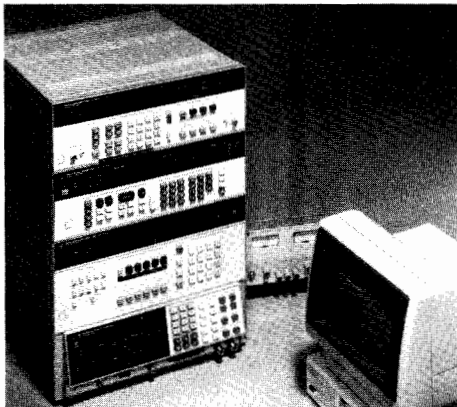

### HP 8957S Cellular Radio Test System

The HP 8957S Cellular Radio Test System helps save time and money by improving productivity and quality. A fully-automatic test system, the HP 8957S is the flexible, cost-effective answer needed in the highly-competitive cellular radio marketplace.

#### Simplifies Workflow

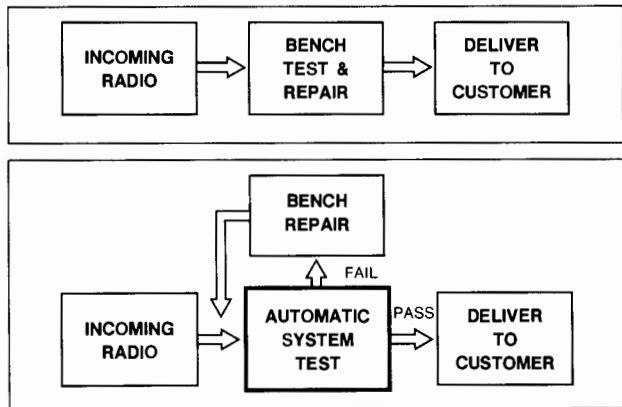

The top diagram shows a typical workflow using manual test equipment. In this case, a technician must manually test each radio and repair it if there is a problem. Then, he checks the radio again to verify that the fault was corrected. Because these tests are tedious and time-consuming, often only a cursory check is performed. In the second diagram, see the effect of an automatic test system. This system quickly and completely tests the radio. If a fault is found, the technician makes the necessary repairs and the system verifies proper operation. Often, the system quickly finds that an incoming radio is operating properly, saving valuable technician time.

#### Ensures Quality

An automatic test system can make a thorough test of every radio, helping to find latent problems. Its speed lets you make more measurements at more data points in less time than with manual testing. And, it follows the same exact procedure each time.

#### Improves Productivity

Time is saved with an automatic test system. This frees technicians for more productive work and allows for expansion to meet the growing demand for cellular products and services. Because it performs the tedious and repetitive tasks, the system helps to increase job satisfaction as well.

#### Maximizes Flexibility

With total control over the measurement parameters, you get the flexibility needed to optimize quality and productivity. The HP 8957S Cellular Radio Test System includes a wide selection of tests and you can easily modify or add to the test routines provided.

As your cellular business grows, you can add to your system. The HP 8958A Cellular Radio Interface includes connections for additional RF instrumentation, including extra signal generators and a spectrum analyzer—up to six RF instruments in all.

### HP 8958A Cellular Radio Interface

The HP 8958A Cellular Radio Interface gives your system the features needed to fully test a cellular radio. With its Channel Simulator's flexible operating modes, you can simulate cell-site operation, verify signalling protocol, or even perform highly complex and sophisticated tests by using an external controller to generate and analyze data message content.

#### Audio and Power Switching and Control

The HP 8958A Cellular Radio Interface controls the audio and dc paths between the test instrumentation and the unit under test. These functions include the audio source and analyzer paths, dc power to the Transceiver Unit (TU) and Control Unit (CU), access to the audio test points in the Test Bus Interface, and a programmer for the TU/CU power supply.

Keys are also provided to control vehicle ignition simulation and the audio compander. With the built-in loudspeaker, you can listen to the baseband signals being generated or analyzed by the system Audio Analyzer.

#### Channel Simulator

The channel simulator, used with an RF signal generator and modulation analyzer, simulates a base station for over-the-air RF and signalling tests. Built-in test routines and utility functions greatly simplify protocol testing.

Built-in tests include placing and receiving a call and checking the signalling protocols of a handoff. To make these tests, you set the signal generator and modulation analyzer to fixed states. For more comprehensive testing, like that performed by the HP 8957S Cellular Radio Test System, you can use an external controller to generate and interpret the data message content. For example, with an external controller, you can make tests such as full hand-off testing, which require interaction between RF and signalling protocols.

#### Test Bus Interface

The test bus interface (provided on AMPS-standard cellular telephones) lets you test the internal operation of the transceiver unit (TU) and control unit (CU). You can also use the test bus interface to suspend normal operation and set the transceiver unit to fixed states, which simplifies RF testing.

#### RF Interconnection

The HP 8958A Cellular Radio Interface simplifies interconnection with its built-in RF combiner. Connections are provided for up to six signal generators and analyzers (one of these ports is a low-SWR, controlled-loss path intended for high-accuracy power measurements) and the antenna port of the radio being tested. Option 002 adds a second antenna connection and RF switch for diversity testing.

#### Ordering Information

The HP 8957S Cellular Radio Test System consists of an HP 8958A Cellular Radio Interface, HP 8901B Modulation Analyzer, HP 8903A Audio Analyzer, HP 8656B Signal Generator, HP 8482A Power Sensor, HP 6024A Power Supply, any optional instrumentation, a controller and peripherals, an HP 11797A Software/Documentation Package, and cables and accessories. For complete ordering information, see the "HP 8957S Cellular Radio Test System Ordering Information" guide or contact your HP sales office.



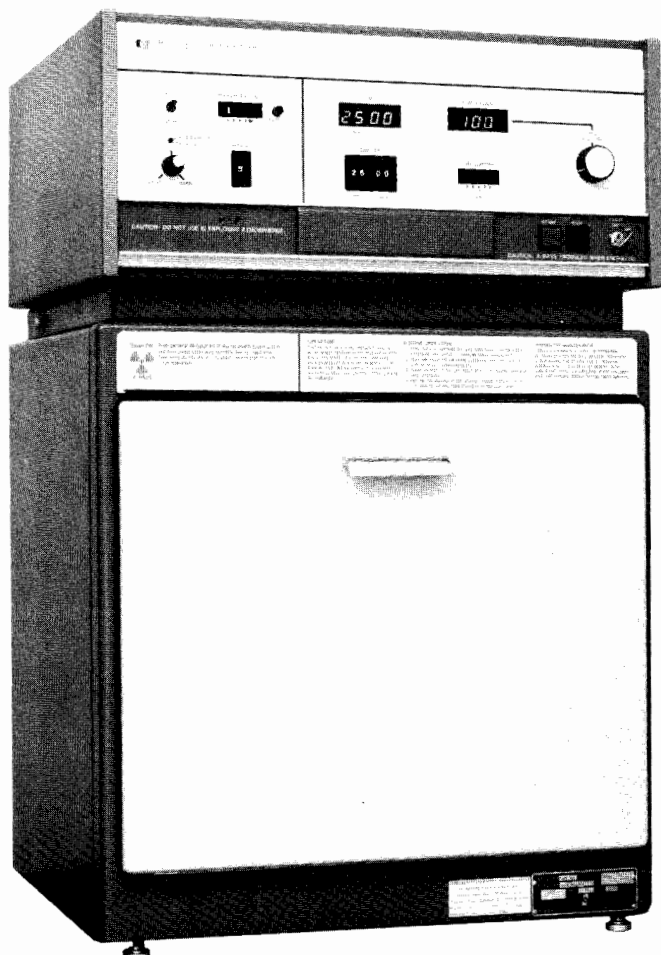

### Faxitron® Cabinet Systems

Radiography, the art and science of making pictures with X-rays, has an important place in modern technology. It is one of the major nondestructive test methods available to industry, provides an indispensable tool in scientific investigations and is a valuable aid to law enforcement agencies. Hewlett-Packard makes a major contribution to these activities with X-ray equipment that offers a "better way" through advanced technology and design. This equipment makes radiographs easier and safer to take.

### Industrial Inspection

Industrial quality control and inspection procedures, especially in the field of electronics, benefit from nondestructive testing by radiography. The advantages of a testing method which does not harm the test objects are obvious. Radiography, therefore, offers benefits in design engineering, incoming inspection, production quality control, product reliability and failure analysis. X-rays are used to detect misregistration or plate-thru problems in multi-layer P.C. boards; porosity, poor substrate bonding and wiring or lead location in transistors and integrated circuits; voids and other encapsulation problems in potted

components; and solder balls or other defects in sealed relays.

Die casting is another industry that benefits from the nondestructive aspects and ability to "see inside" provided by radiography. Porosity, gas voids, tramp metal inclusion and other common defects can be easily detected and the cause determined. Expensive machining time can be avoided for castings found to be defective through X-ray inspection. The integrity of welds, alignment of connectors, inspection for proper assembly and mechanical defects are further examples of tests which radiography performs for industry. The benefits of X-ray testing are reduced production costs, better quality assurance and product safety. The results are increased profits.

### Medical Applications

HP Faxitron Cabinet X-ray Systems are used by the medical profession for specimen radiography in support of diagnostic surgical procedures and in biological research. Specimen radiographs of biopsy samples are correlated with preoperative mammograms, for example, and in the evaluation of mastectomy specimens. Typical research applications include microradiography of thin bone specimens and microangiographic studies of vasculature.

### Scientific Applications

Oceanography, geology, marine biology, paleontology, pathology, botany, forestry and agricultural research are a few examples of scientific disciplines that use X-rays. Applications range from the study of the interior anatomy of fossils to determining the viability of seeds.

These are among the many applications served by HP Faxitron Cabinet X-ray Systems. They offer a unique combination of high quality radiographic capability, simplicity of operation and convenience of use which is expanding the capabilities of scientific and industrial concerns throughout the world.

### HP 43700 Series Flash X-Ray Systems

High-speed (flash) radiography is used to record and study dynamic events where interposed material, smoke, flame, debris, or pressure variations exclude the use of high-speed cameras. Typical events include ballistics, shaped charges, explosives, behind-armor studies, shock waves in solids, aerospace phenomena, and crash-injury studies.

The basic performance requirement of a flash X-ray system used for the study of transient mechanisms is to provide high resolution radiographs with exposure times short enough to eliminate motion blur. HP series 43700 flash X-ray systems produce X-ray pulses of sub-microsecond duration and are designed specifically for "stop motion" radiographic applications. All HP 43700 series systems utilize the same basic components, the same electrical theory, and are modular in concept. Standard systems include 150 kV, 300 kV, 450 kV, 1 MV, and 2.3 MV models.

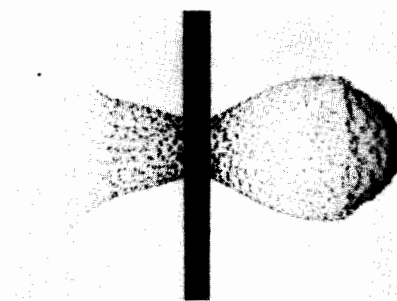

An HP basic single "channel" flash X-ray system, composed of a pulse generator, high-voltage power supply, cold-cathode field emission X-ray tube, and associated controls, provides a single radiograph per event. Additional pulser/X-ray tube sets (add-on channels) may be combined with the initial single-channel system to provide multiple-channel "systems." Multiple channel systems may be of identical output voltage or may use varied output voltage pulser/tube combinations.

For specific information and consultation regarding HP X-ray systems, contact Hewlett-Packard, 1700 S. Baker Street, McMinnville, Oregon 97128. Telephone (503) 472-5101.



#### Ultrasound Imaging

- Real-time phased array systems
- New HP 77020AC system configured specifically for the cardiologist—totally mobile—VCR and strip chart
- New HP 77020AR system configured specifically for economical abdominal, obstetrical and pelvic imaging
- Small lightweight transducers

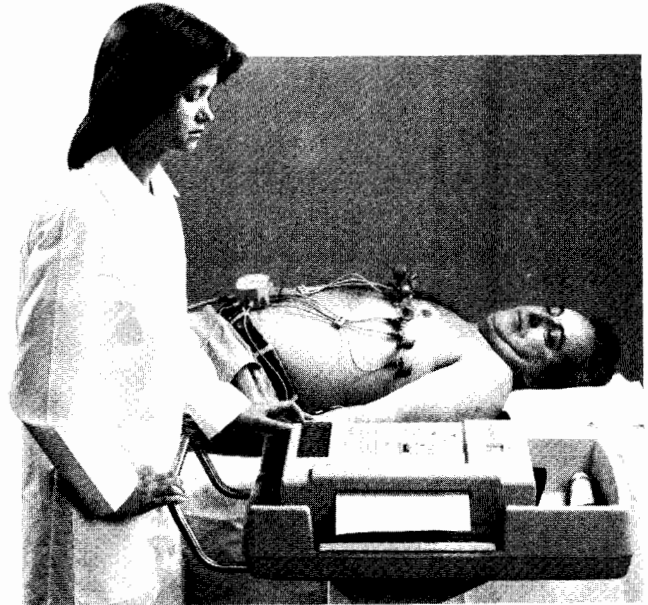

#### Cardiography Instrumentation

- New HP 4750A PageWriter Cardiograph
- ECG Management Systems for computer-aided interpretation of electrocardiograms
- ECG Stress Testing Systems

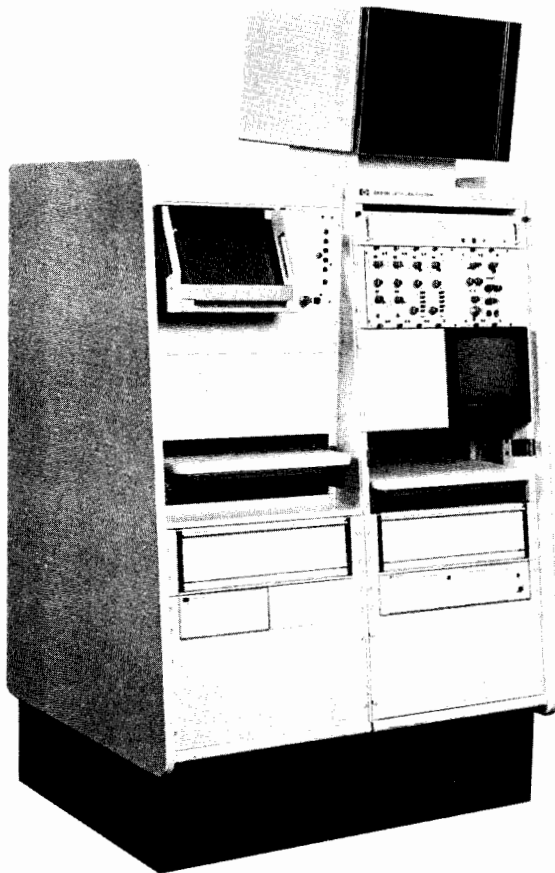

#### Cardiovascular Instrumentation

- Computerized catheterization data analysis system automates on-line data collection analysis
- Complete choice of plug-in signal conditioners and transducers



#### Perinatal Instrumentation

- Fetal/maternal monitoring equipment includes new HP 8040A Bedside Fetal Monitor, and central stations
- Telemetry for birthing centers
- Neonatal monitoring includes heart rate, temperature, respiration, ambient oxygen



**Arrhythmia Monitoring**

- Detection and classification by algorithm
- Advanced information management capabilities



**Resuscitation**

- Portable defibrillator/monitor with paddle contact indicator
- Battery/ac operating
- Digital heart rate display
- Mobile resuscitation systems

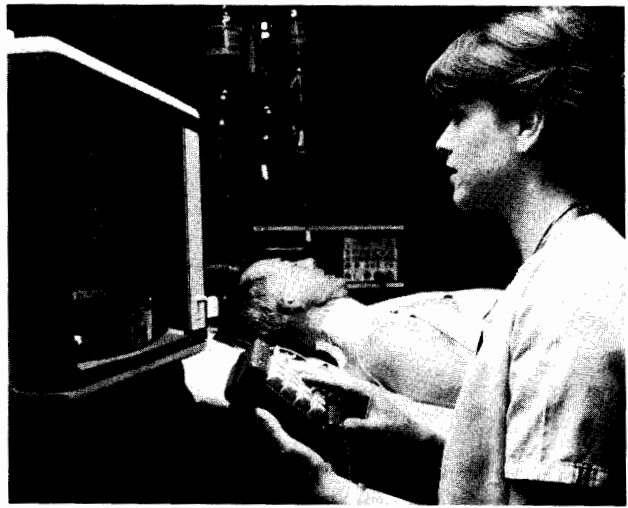

**Patient Data Management**

- Rapid access to progress notes, vital signs, intake/output, lab data and trends
- Organization and calculating data

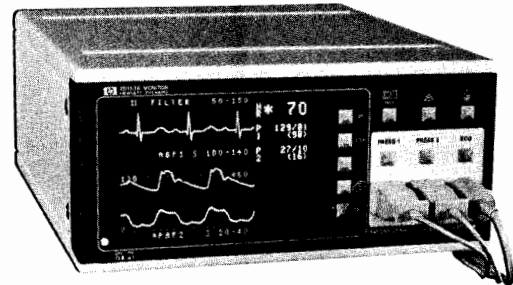

**OR Monitoring**

- New microprocessor based ECG monitor designed for the OR
- Software cardiotech improves ECG signal detection, provides multi-level alarm capability

**For Additional Information** on HP Medical instrumentation, request literature in one or more of the following categories:

- Patient Monitoring
  - Ultrasound Imaging
  - Cardiography Instrumentation
  - Cardiovascular Instrumentation
  - Perinatal Instrumentation
  - Arrhythmia Monitoring
  - Patient Data Management
  - OR Monitoring
  - Resuscitation
  - Healthcare Information Systems
  - Healthcare Personal Computers
  - Supplies, Consumables, Pressure Transducers
- Please use request card at back of catalog.

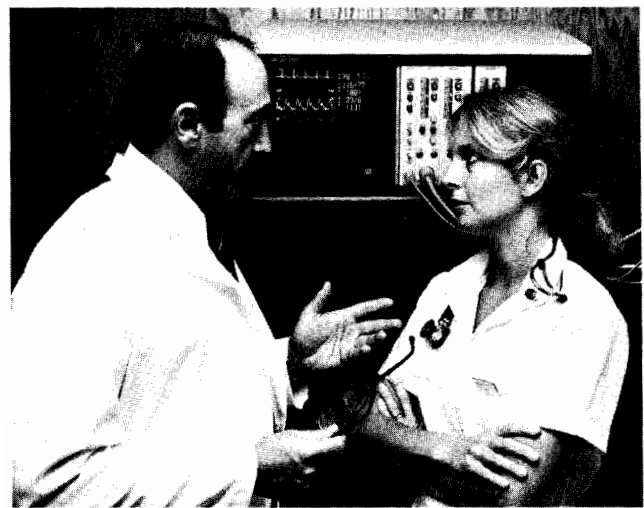

**Patient Monitoring**

- Monitor/Terminal with Overview feature
- Patient Information Centers
- Telemetry

**An Invitation** for you to become a subscriber to **ADVANCES FOR MEDICINE**, the Hewlett-Packard medical products magazine. To receive **ADVANCES** free of charge, simply fill in and return the request card at the back of this catalog.

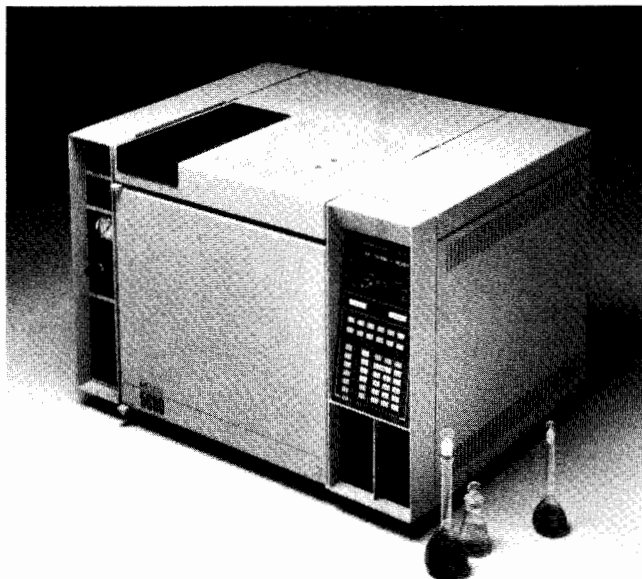

HP 5890A Gas Chromatograph

**Gas Chromatographs.** Choose a GC that offers the maximum in chromatographic and data handling capability such as the HP 5880; or the new HP 5890, a high performance, low cost GC ideal for the routine laboratory. Also available is a wide range of accessories, in-



HP 5880A Gas Chromatograph

cluding the new Series 530 $\mu$  columns, automatic samplers and detectors, including the powerful HP 5970 Mass Selective Detector, and a full line of consumables.

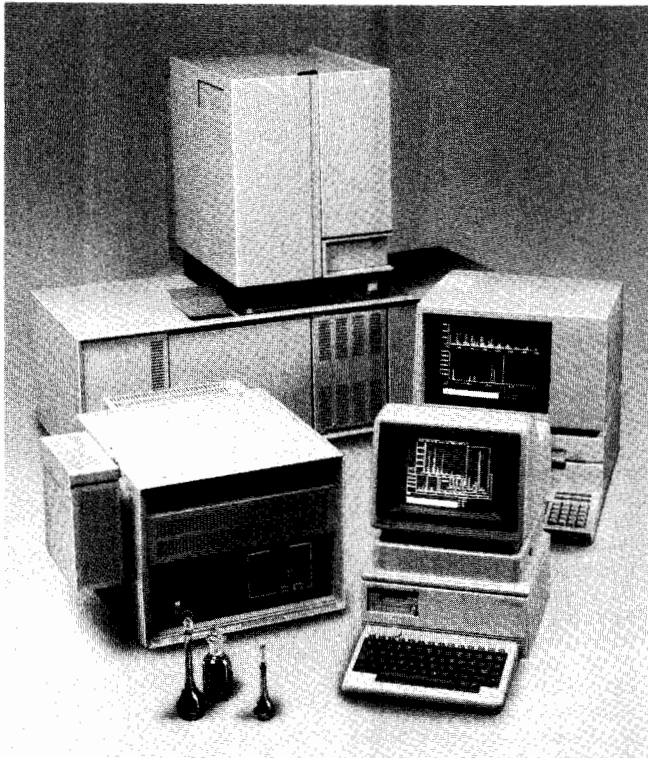

HP 5970B Mass Selective Detector (front row).  
HP 5995C Benchtop GC/MS (back row).

**Hewlett-Packard GC/MS products** include the HP 5970B Mass Selective Detector, which can be used with most gas chromatographs; the HP 5995C GC/MS, which offers many big-system features in a compact benchtop unit; and the HP 5987A, the most versatile and capable HP GC/MS system.

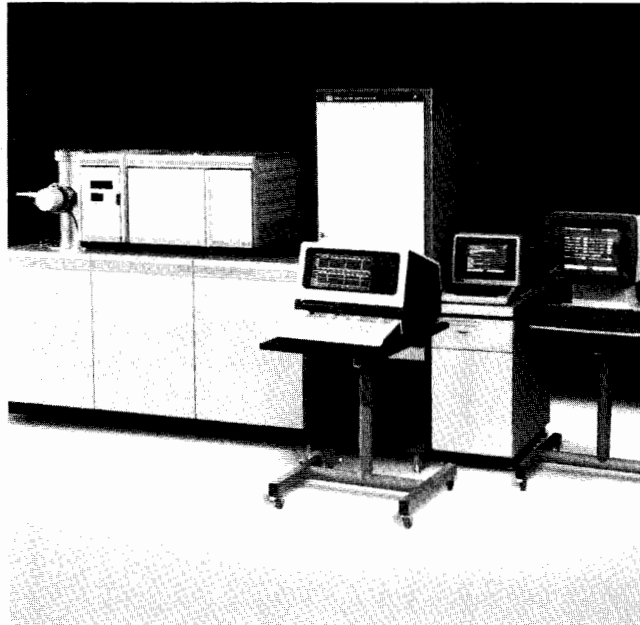

HP 5987A GC/Mass Spectrometer

Both the HP 5970B and the HP 5995C are offered with a choice of single-user GC/MS workstations for ease of control, automation and data handling. The HP 5987A uses the multi-user, multi-instrument HP 1000 RTE data system.

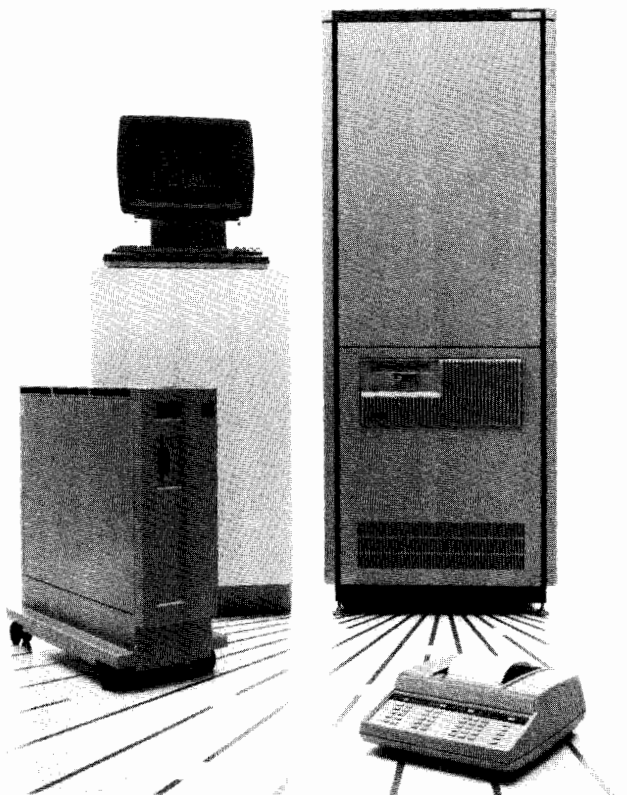

HP 3350A Lab Automation Systems Function in Analytical Networks

**Laboratory Automation Systems.** Whatever size your laboratory, HP integrators and systems for laboratory information and management can help you increase productivity. HP 3350A and X Series Systems can increase sample throughput by automating your analytical procedures, providing easy-to-use, yet sophisticated data reduction, and managing the flow of samples, information, and materials throughout the lab. The HP 3390 Integrator offers the first economical step in integration, and instrument control, as well as communication with HP 3350 Systems and other computers.

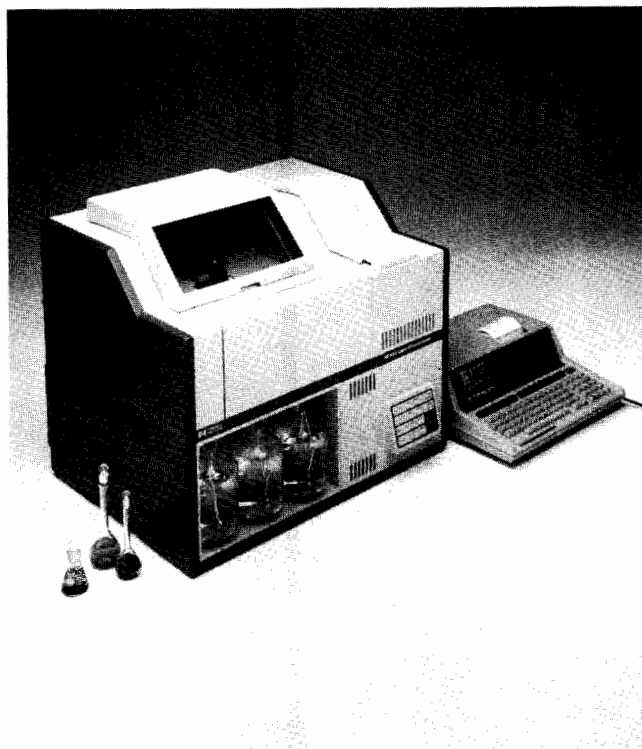

HP 1090 Liquid Chromatograph

**Liquid Chromatographs.** The HP 1090 Family of Integrated LC Modules provides flexibility, upgradability and total system performance whether you are using conventional, high-speed or microbore columns. Also available is a full line of LC columns and accessories, including detectors, data handling devices and consumables.

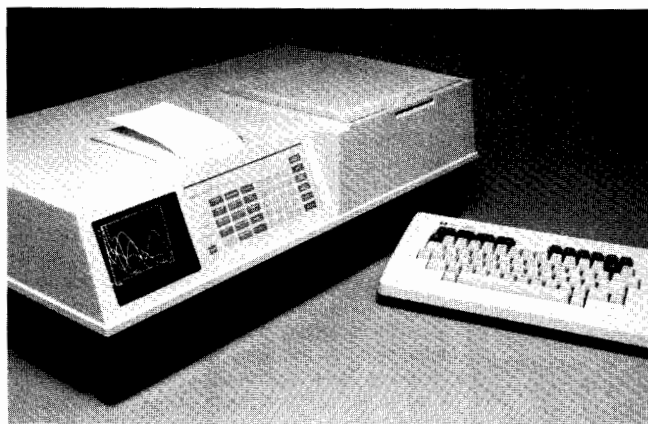

HP 8451A Diode Array Spectrophotometer

**Diode Array Spectrophotometers.** These powerful computer-controlled UV/VIS instruments utilize diode array technology to greatly speed complex analyses. They measure and display in *seconds*: multi-component analyses, a full spectrum, and lists of analysis conditions and concentration. Choose the more powerful HP 8450A, or the new HP 8451A with built-in printer/plotter and optional alphanumeric keyboard.

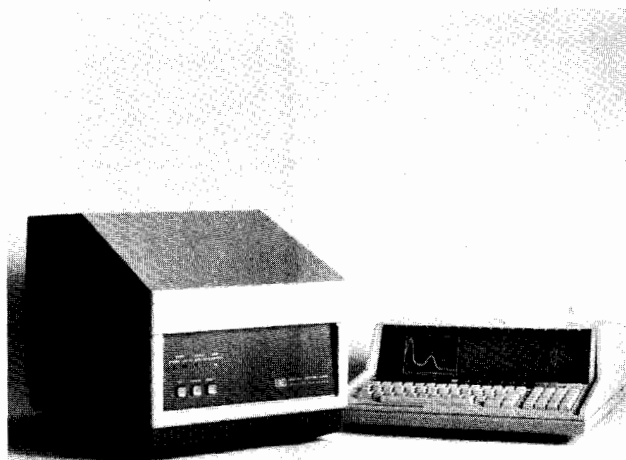

HP 1040A Spectrophotometric Detector

**Diode Array LC Detector.** The HP 1040A HPLC Detection System uses diode-array technology to capture the analytical information normally wasted by a Liquid Chromatograph, allowing you to fully optimize the sensitivity and selectivity of your analytical method. **For further information** on Hewlett-Packard instruments and computers for chemical analysis, call your local HP office listed in the white pages of your metropolitan telephone directory and ask for an analytical representative. Or write: Hewlett-Packard Analytical Group, 1820 Embarcadero Road, Palo Alto, CA 94303.



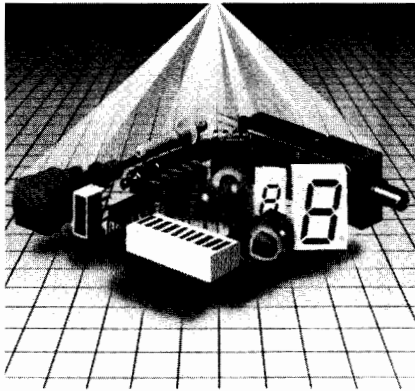

HP's Growing Optoelectronic Family

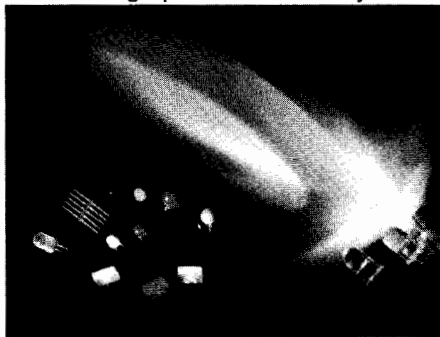

Led Lamps

### LED Solid State Lamps, Light Bars & Arrays

Hewlett-Packard is a world leader in the area of LED technology, and offers a broad variety of LED indicator products available in red, high efficiency red, yellow and high performance green. Emphasizing high brightness and superior reliability, Hewlett-Packard's most recent product introductions include a family of high-performance green indicators, ultrabright LED lamps (125 mcd at 20 mA), and LED bar graph arrays of 10- and 101-elements. Recent advancements in the fundamental semiconductor material have generated new areas of contribution, particularly in sunlight viewability, low power consumption, and brightness.

### Solid State Displays

Hewlett-Packard offers a complete line of seven-segment displays in red, high efficiency red, yellow and high performance green and in a wide variety of package sizes. The newest member is the micro-bright display which has a 0.3-inch character height in a 0.5-inch by 0.3-inch package.

LED alphanumeric displays in monolithic and dot matrix versions are also available. Some of these rugged displays are screened and tested for use in military applications and harsh environments.

The aesthetic appearance and reliable performance of LED displays make them appropriate for use in instruments, point-of-sale, appliance, automobile, telephone and other high-ambient light front-panel displays.

### Optocouplers

Hewlett-Packard's family of logic compatible, high-performance optocouplers provides solutions to problems caused by ground loops

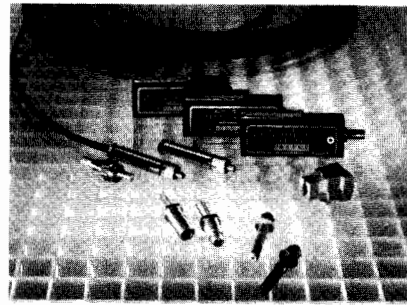

Fiber Optic Family

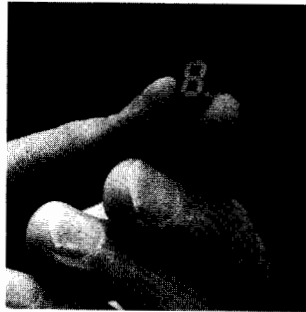

Seven Segment Displays

and induced common mode noise for both analog and digital applications in commercial, industrial and military products.

Types of optocouplers available include high-speed and high-gain devices, ac/dc to logic interface optocouplers, and optocouplers which interface directly with microprocessors.

### Fiber Optic Components

Hewlett-Packard offers three families of fiber optic components which include transmitters, receivers, cable, connectors and connector assembly tools. The snap-in link family offers low cost, plastic-fiber compatible components for high volume, OEM design. Higher speeds and greater distances are possible with the glass-fiber compatible components in the miniature link family. The high performance module family has an additional capability as a link monitor that is independent of data format. All families guarantee performance. Lifetime reliability is built into every system using HP fiber optic links.

The HP model 39301A Fiber Optic Multiplexer incorporates HP fiber optic components and cable. Up to 16 RS-232-C/V.24 data communication channels can be extended up to 1 km at data rates up to 19.2 kbytes over one pair of fiber optic cables. Other advantages include immunity to noise producing electromagnetic interference such as RFI, EMI, and EMP.

### Motion Control

Hewlett-Packard's high-reliability, yet easy-to-assemble optical encoders are motion sensors that provide a digital link between mechanical shaft rotation and the control

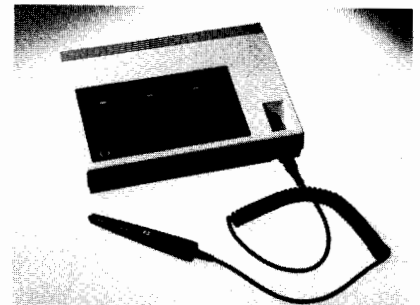

Bar Code Reader

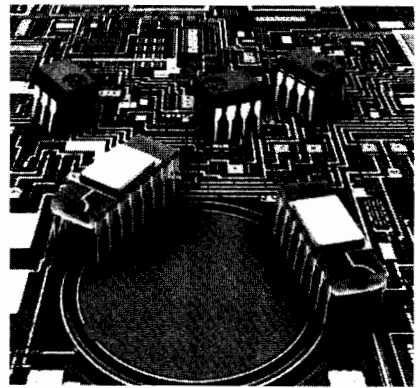

High Performance Optocouplers

electronics in a closed loop servo system. By combining precision lenses and custom ICs, Hewlett-Packard provides superior performance and high reliability in two compact package sizes.

Encoders are used in a wide variety of applications from computer peripherals to industrial and instrument applications where digital information is needed to monitor rotary motion.

### Bar Code Products

Bar code data entry is an effective alternative to the keyboard because it is faster and more accurate. HP's family of bar code products is continually growing to include rugged scanning wands in different resolutions, programmable and non-programmable readers and a new bar code decoding chip.

Ease-of-use is a benefit of all HP bar code products. All scanners provide digital output and can be used over a wide range of scan angles. HP's bar code reader provides the flexibility of interfacing with most all computers, either as a stand-alone unit or in conjunction with a CRT terminal. HP's newest addition, the decoding chip, frees designers who are implementing bar code reading capability from the need to develop decoding software. Both chip and reader can be used with a variety of standard industrial and commercial codes.

### Emitter/Detector Components

In addition to the complete bar code system, Hewlett-Packard also offers the designer the choice of both integrated and discrete emitter/detector components, such as a high-resolution optical sensor, high radiant intensity emitters in the near infrared range, and PIN photodiodes.



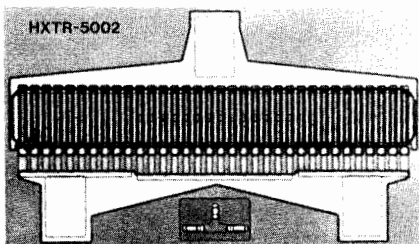
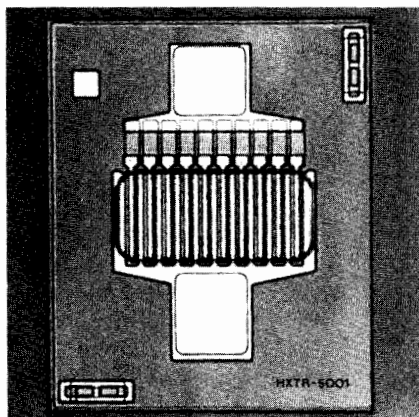

LINEAR POWER TRANSISTOR CHIPS

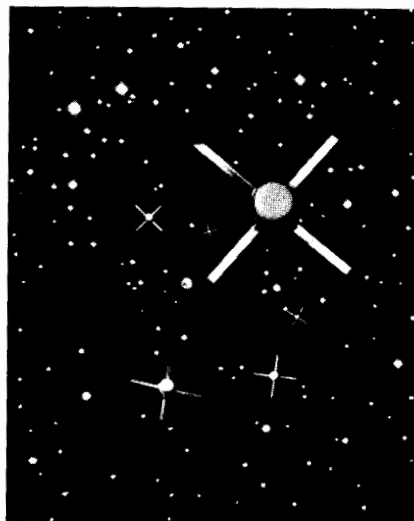

BIPOLAR TRANSISTORS



SCHOTTKY BEAM LEAD PAIR

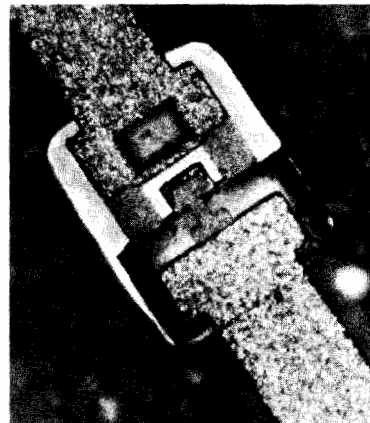

BEAM LEAD SINGLE

### Silicon Bipolar Transistors

Device-to-device uniformity and superior performance are combined in the HXTR series of microwave transistors which have been individually designed for low noise (HXTR-6000 series), high gain (HXTR-2000 series), low distortion linear power (HXTR-5000 series), or low cost (HXTR-3000 series). With guaranteed RF performance specifications from 1000 to 4000 MHz, these devices are well suited for high-reliability, space military, and industrial applications at frequencies up to 6000 MHz.

### Diodes

**Schottky Barrier Diodes:** Schottky diodes combine extremely high rectification efficiency with picosecond switching speeds, low series resistance, and low noise characteristics. This combination makes the Schottky an excellent mixer/detector diode.

At HF, VHF, and UHF frequencies, HP offers Schottky diodes in hybrid form as beam leads and chips, and in package styles suitable for microstrip, stripline, waveguide, and coaxial assemblies. These same diodes have many digital circuit applications such as clipping and clamping where switching speed is important. The most popular of the glass packaged diodes are available in JAN qualified types.

**PIN diodes:** PIN diodes function as variable resistors at microwave frequencies. By controlling the dc bias, the RF resistance of a PIN diode can be varied from 1  $\Omega$  to about 10  $\Omega$ . This property of the PIN diode makes it extremely useful as a switch, attenuator, modulator, phase shifter, limiter or AGC element at all frequencies from 1 MHz to 18 GHz and above. Package configurations include beam lead devices as well as conventional microstrip, ceramic and axial-lead packages.

**Step recovery diodes:** SRDs are intended for use as comb generators and harmonic frequency multipliers. When used as a comb generator, the abrupt termination of the diode's reverse recovery current generates voltage pulses up to tens of volts with pulse widths as narrow as 100 ps, giving useful power at frequencies in excess of 20 GHz. By optimizing the circuit around any specific harmonic, high efficiency multiplication can be accomplished.

**Diodes for Hybrid Integrated Circuits:** Hybrid Integrated Circuits are used to achieve circuits with light weight, small size, operation to high frequencies, repeatable characteristics and lower end-product costs. HP offers a wide range of PIN, Schottky and SRD single diodes in beam lead and chip configurations as well as Schottky beam lead pair and quad diodes.

### Integrated Products

Hewlett-Packard manufactures a broad line of components for the control, conversion, and generation of RF and microwave signals. This line of integrated products (combinations of chip and beam lead diodes with hybrid thin film circuit technology) includes SPST switches, absorptive modulators, attenuators, limiters, comb generators, double-balanced mixers, and mixer/detectors.

### High Reliability Testing

Many Hewlett-Packard components are space qualified. The reliability of these devices is established by one of the finest high reliability testing facilities in the microwave component industry. Hewlett-Packard's High Reliability Test Group maintains military approved JAN and JANTX parts in stock and can recommend HP standard screening programs, patterned after MIL-S-19500, for any HP component. Those who wish to design their own screening specifications can consult with and obtain quotations from Hewlett-Packard's staff of dedicated field sales engineers.

### Write for More Information

Specifications of Hewlett-Packard's component products are available in individual data sheets or complete designer catalogs. These are available free of charge from your local HP sales office or authorized distributor, or return the Information Request Card located at the back of this catalog.

# DIMENSIONAL MEASUREMENTS

## Laser Measurement System



Model 5528A



Magnetic disc research and development



Hewlett-Packard Laser Measurement Systems fundamentally measure distance. A patented two-frequency design uses a low power Helium-Neon laser to obtain resolutions up to 0.01 micrometre (1.0 microinch) — over distances up to 40 metres (130 feet). The same basic principles are used to measure pitch, yaw, flatness, straightness, squareness, parallelism and velocity.

The HP 5528A Laser Measurement System offers a combination of accuracy, versatility and ease of use unmatched by any other system or method. Application examples are found everywhere:

- in R&D (positioning of magnetic disc heads)
- in fabrication (calibration of machine tools and coordinate measuring machines)
- in metrology (calibration of scales, gages and surface plates).

The laser makes an ideal standard for lab applications because it is unaffected by wear or aging. Its rugged construction and portability make it equally attractive for shop environments.

### Metrology System

System capabilities are also enhanced by the addition of a personal computer and software. The HP 55288S Dimensional Metrology Analysis System automatically collects, analyzes and plots data from the HP 5528A system. Special features include statistical analysis (mean and standard deviation) and data collection "on the fly".

Hard copy output is available in several forms. Data can be printed and plotted on the HP 85B's thermal printer. Report quality plots can be made on the optional HP 7470A Graphics Plotter.

The time saved over manually recording and calculating the results is enormous. These savings are especially important to fabrication shops, where machine tool errors are quickly identified and downtime is kept to a minimum.

### Modular Design

The basic system consists of the HP 5508A Measurement Display, the HP 5518A Laser Head and the HP 10753A Laser Tripod. System capabilities are determined by adding the optical components for the desired measurements. Optical components and their mounting fixtures are available in five convenient kits:

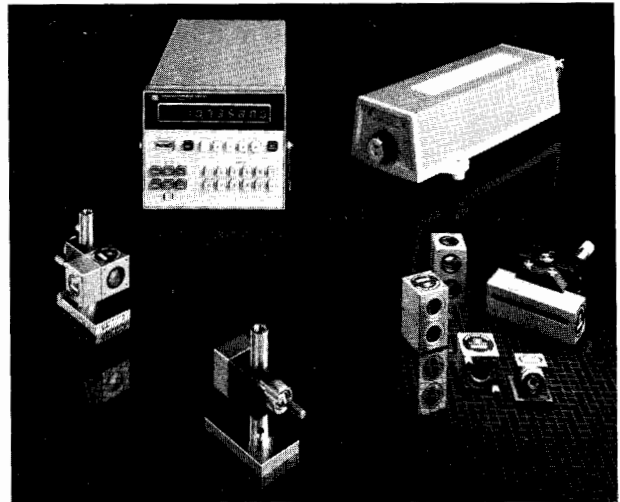

HP 5528A Laser Measurement System

- HP 55280A Linear Measurement Kit (distance and velocity)
- HP 55281A Angular Optics Kit (pitch and yaw)
- HP 55282A Flatness Accessory Kit (flatness)
- HP 55283A Straightness Measurement Kit (straightness and parallelism)
- HP 10777A Optical Square (squareness).

In this way, the HP 5528A system can be configured to meet the needs of the present while offering economical expansion in the future.

### Manual or Automatic Compensation

The absolute accuracy of distance measurements depends on the velocity of light in air. This is a function of temperature, pressure and relative humidity. Manual compensation consists of measuring these conditions, finding a compensation factor in a set of tables, and entering this number into the HP 5508A Measurement Display.

Automatic compensation is provided by the HP 10751A Air Sensor. This multi-purpose probe monitors air conditions and automatically updates the compensation factor. Automatic compensation is essential for continuously changing environments.

Distance measurements are also affected by the thermal expansion of the measured object. Its temperature can be manually entered into the HP 5508A Measurement Display, or automatically monitored and updated by one to three HP 10757A Material Temperature Sensors.

### Specifications

The following specifications are for distance measurements at 15-25 degrees Celsius. Please refer to the technical data sheet for complete specifications.

**Accuracy:**  $\pm 0.1$  part per million in a vacuum.  $\pm 1.7$  parts per million using the HP 10751A Air Sensor.

**Resolution:**  $0.01 \mu\text{m}$  (1.0  $\mu\text{in}$ ).

**Measurement Range:** 40m (130 ft).

**Measurement Velocity:** 18.3 m/min (720 ft/min) maximum.

**Display Update Rate:** 40/second nominal.

**Power:** 100, 120, 220, 240 Vac (+5%, -10%), 48-66 Hz, 175 VA maximum.

### Ordering Information

For complete specifications and ordering information, please contact any Hewlett-Packard Sales Office. System prices range from \$17,500 to \$49,500 depending on customer requirements.

# DIMENSIONAL MEASUREMENTS

Laser Transducer System

Model 5501A

665

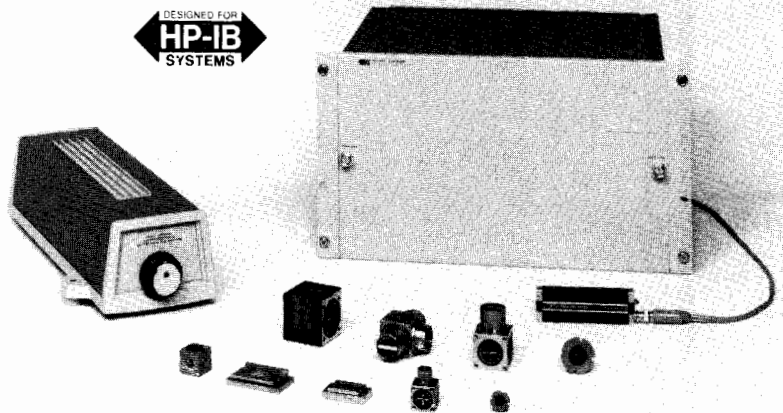

HP 5501A Laser Transducer System

The HP 5501A Laser Transducer System is a linear-displacement measuring system that delivers the accuracy of laser interferometry to builders and users of precision-positioning equipment. Customers can select from a variety of optics and electronics depending on application. This flexibility benefits both end users and original equipment manufacturers (OEMs). Applications can be found in three main areas:

- Integrated circuit manufacturing (wafer steppers, projection aligners, electron beam machines and reticle/mask inspection equipment)
- Disc manufacturing (magnetic and optical track writers)
- Precision machining (diamond turning and coordinate measuring machines)

## Laser Source

The HP 5517A Laser Head is a new high-stability laser source for the HP 5501A Laser Transducer System. This new laser head features improved performance and reliability over the previous laser transducer head. The wavelength of light from the laser is used as the length standard for this transducer system. The HP 5517A Laser Head is accurate to 0.1 part per million and this accuracy remains in calibration indefinitely. With a single laser head, up to 4 axes of motion may be monitored simultaneously.

## Optics

Three linear measurement techniques are available with the laser transducer, with one of three sets of optics:

- The HP 10702A Linear Interferometer and HP 10703A Linear Retroreflector are used in general applications.
- The HP 10705A Single Beam Interferometer and the HP 10704A Single Beam Retroreflector are used where space is severely limited, or for non-contact measurements.
- The HP 10706A Plane Mirror Interferometer is ideal for monitoring position of an x-y stage. It also provides twice the measurement resolution as the other interferometers and can be used for non-contact measurements.

Each axis requires an interferometer, a reflector and HP 10780A Receiver. Using the HP 10700A and HP 10701A Beam Splitters and the HP 10707A Beam Bender, a multiple axis system can be configured.

## Electronics

All signal processing and interfacing are performed by a series of printed circuit boards housed in the HP 10740A Coupler Box. The modular structure of the electronics provides the flexibility to tailor the HP 5501A Laser Transducer System to a specific measurement control application.

Customers can choose one of several output formats from the system electronics:

1. Binary Interface Open-Loop Electronics—provides binary information of position data to digital processors and controllers.  
HP 10740A Coupler  
HP 10746A Binary Interface  
HP 10755B Compensation Interface  
HP 10760A Counter

2. HP-IB Interface Open-Loop Electronics—outputs position data for use with HP personal and desktop computers.

HP 10740A Coupler  
HP 10745A HP-IB Interface  
HP 10755B Compensation Interface  
HP 10760A Counter

3. Closed-Loop Position Control Electronics—provides high-speed positioning feedback to closed-loop control systems.

HP 10740A Coupler  
HP 10746A Binary Interface  
HP 10755B Compensation Interface  
HP 10762A Comparator  
HP 10764C Fast Pulse Converter

4. English/Metric Output Electronics—provides microinch or micrometre pulses to machine tool numerical controllers.

HP 10740A Coupler  
HP 10755B Compensation Interface  
HP 10760A Counter  
HP 10761A Multiplier  
HP 10763A English/Metric Output

5. Pulse Converter—provides TTL or A-Quad-B format pulses of quarter-wavelength value.

HP 10781A Pulse Converter

Compensation is provided by the HP 10756A Manual Compensation, or the HP 5510A Automatic Compensator and one to three HP 10563A Material Temperature Sensors. Other components include the HP 10783A Numeric Display and cables for measurement, reference and power.

## Specifications

The following is a partial list of system specifications. Please refer to the technical data sheets for a complete list.

**Laser:** Helium-Neon. Continuous wave. Two-frequency. 1.0 mW output maximum.

**Accuracy:**  $\pm 0.1$  part per million in a vacuum.

**Resolution:** from 0.16  $\mu\text{m}$  (6.0  $\mu\text{in.}$ ) to .005  $\mu\text{m}$  (0.2  $\mu\text{in.}$ ) depending on electronics and optics being used.

**Measurement Range:** 40m (130 ft) maximum depending on system configuration and environment. Sum of axes for multi-axis system.

**Axes:** 4 maximum depending on system configuration and environment.

**Measurement Velocity:** 18.3 m/min. (720 in/min) maximum. The maximum measurement velocity depends on resolution extension and optics being used.

**Maximum Data Transfer Rate:** 700 Hz-500 kHz depending on number of axes and type of electronics.

**Power:** HP Model 63312F Power Supply is recommended for all configurations of HP 5501A Laser Transducer System.

**Ordering Information:** For complete ordering information, please contact any Hewlett-Packard Sales Office. System prices range from \$15,000 to \$45,000 depending on customer requirements.

# PRESSURE & TEMPERATURE

## Quartz Pressure Gauge, Pressure Signal Processor

Models 2813B, 2816A



- 0.01 psi resolution (69 Pa)
- 0.025% full scale accuracy
- Direct surface readout

- Simple operation
- Long term stability
- 200-11000 PSIA range

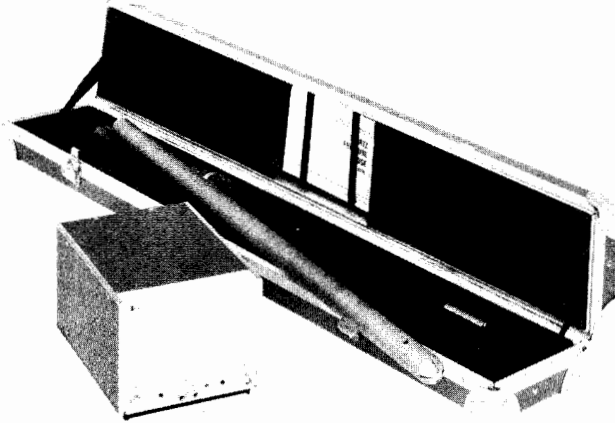

HP 2816A Pressure Signal Processor,  
HP 2813B Quartz Pressure Probe

### HP 2813B, 2816A Description

The gauge consists of an HP 2813B Quartz Pressure Probe and an HP 2816A Pressure Signal Processor. A frequency signal proportional to pressure is transmitted from the bottom-hole pressure probe to the signal processor on the surface. It travels through a single-conductor, armored electric line. The processor conditions the pressure-related signal to drive a separate electronic frequency counter for direct readout.

### 0.01 psi Resolution at 11,000 psi (69 Pa @ 76 MPa)

The HP quartz pressure gauge measures wellbore pressure with a resolution of 0.01 psi over a dynamic range in excess of 11,000 psi. This capability makes it possible to measure pressure changes that cannot be detected with conventional gauges using bourdon tube transducers.

This ability to detect and record small pressure changes allows sophisticated test techniques to be used economically. For example, since the super-sensitive HP quartz pressure gauge can detect small pressure transients at observation wells, pulse tests can be conducted with extremely short pulse cycle times at the stimulus well. Because the shut-in time is reduced, the permeability and formation thickness between wells can be determined at a substantially lower cost.

With the gauge, pressure transients can be observed and recorded on the surface while the test is in progress. When the surface readout indicates the test is completed, the gauge can be retrieved immediately.

The quartz pressure gauge was specifically designed for pressure measurement in oil and gas wells and it is used by many oil companies and well service companies. However, its high resolution pressure measuring capability and rugged construction also make it ideally suited for oceanographic research and subterranean hydrodynamic studies.

### Field Case Study

The following plot shows the results of a test designed by Calvin J. Strobel, Molhinder S. Gulati and Henry J. Ramey, Jr. Note that the test was completed after only a few tenths of a psi pressure change.

Diagram courtesy of and copyrighted by Society of Petroleum Engineers of AIME, Paper No. SPE 5596

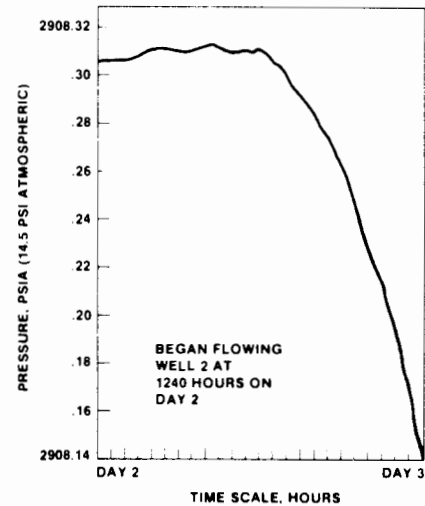

### System Specifications

**Sensitivity:** (105 Hz/psi) 105 Hz/6.9 kPa nominal output of signal processor.

**Probe operating pressure range:** 0–82.7 MPa (0–12,000 psia).

**Probe operating temperature range:** 0 to 150°C (32° to 302°F).

**Signal processor operating temperature range:** 0° to 55°C (32° to 131°F).

**Calibrated pressure range:** 1.4–75.8 MPa (200–11,000 psia).

**Resolution:** 69 Pa (0.01 psi) when sampling for a 1-second period.

**Repeatability:** ±2.76 kPa (±0.4 psi) over entire range.

**Accuracy (at thermal equilibrium) if Operating Temperature is Known**

**Within 1° C (1.8° F):** ±(3.45 kPa + 0.025% of reading) or ±(0.5 psi + 0.025% of reading).

**Within 10° C (18° F):** ±(6.89 kPa + 0.1% of reading) or ±(1 psi + 0.1% of reading).

**Within 20° C (36° F):** ±(34.5 kPa + 0.25% of reading) or ±(5 psi + 0.25% of reading).

### Dimensions and Weights

**HP 2813B Probe:** 36.5 mm (1.4 in.) OD by 1000 mm (39.4 in.) long.

Weight: 5.0 kg (11 lb.).

**HP 2816A Signal Processor:** 154 mm H x 197 mm W x 279 mm D (6.1" x 7.8" x 11").

HP 2813B Quartz Pressure Probe

HP 2816A Pressure Signal Processor

# PRESSURE & TEMPERATURE

## Quartz Thermometer

### Model 2804A

667



- $\pm 0.04^{\circ}\text{C}$  absolute accuracy
- $0.0001^{\circ}\text{C}$  or  $0.001^{\circ}\text{F}$  resolution
- $-80^{\circ}$  to  $+250^{\circ}\text{C}$  range
- Display of absolute or differential temperature
- Flexible HP-IB system interface
- Variable resolution analog output
- Easy ice-point or triple-point adjustment



HP 2804A

The HP 2804A Quartz Thermometer allows you to easily measure temperature with exceptionally high accuracy and resolution. Absolute accuracy is  $\pm 40$  millidegrees Celsius over the range of  $-50^{\circ}\text{C}$  to  $150^{\circ}\text{C}$ , NBS traceable to IPTS-68. The useable resolution of  $0.0001^{\circ}\text{C}$  allows you to measure temperature changes that could not be detected by other digital thermometers.

The HP 2804A can be used with one or two temperature sensing probes. The temperature of either probe, or their difference, can be measured and displayed under pushbutton control. Display resolution is selectable from  $0.01$  to  $0.0001^{\circ}\text{C}$  ( $0.1$  to  $0.001^{\circ}\text{F}$ ) by pushbuttons. An internal switch allows you to easily select measurement in the Celsius or Fahrenheit temperature scale.

Temperature is measured and displayed automatically with the microprocessor and electronics provided in the HP 2804A package. There is no need to balance a bridge, perform calculations using resistance- or voltage-temperature tables or curves, or to use calibration correction tables. The only adjustment necessary to remove effects of thermal history on the sensor is a simple ice point or triple point calibration adjustment using the front panel thumbwheel switches.

### How It Works

The HP 2804A temperature sensor is a quartz crystal whose precise angle of cut gives a stable and repeatable relationship between resonant frequency and temperature. Each quartz sensor is individually calibrated at the factory over the full temperature range. The calibration data for each sensor is processed and stored in a calibration module which is supplied with the probe.

In operation, a microprocessor in the thermometer performs the complex control and calculation operations to accurately measure temperature from the quartz sensor frequency and probe calibration information in the calibration module. The microprocessor also performs self-checks to detect fault conditions. If a problem occurs that would give an improper measurement, an error message is displayed to indicate the source of the problem.

### System Oriented Design

The HP-IB (standard) offers you a simple, yet flexible, way to connect the Quartz Thermometer to either an HP computing controller or printer. Temperature data can easily be sent to a calculator or computer for processing and recording. All front panel controls can be operated automatically by commands sent on the bus.

The analog output (standard) converts any three consecutive digits to a voltage between  $0$  and  $+10$  volts to drive a chart recorder. Front panel controls allow easy adjustment of pen zero and full scale as well as normal or offset (center-zero) operation. Any three digits can be selected for conversion, allowing you to change the full scale value on the recorder.

## HP 2804A Specifications

### Performance

**Range:**  $-80$  to  $250^{\circ}\text{C}$ .

**Absolute accuracy:** HP 2804A with HP 18110A, or HP 18111A

Quartz Probe —

$\pm 0.040^{\circ}\text{C}$  from  $-50$  to  $150^{\circ}\text{C}$

$\pm 0.075^{\circ}\text{C}$  from  $-80$  to  $250^{\circ}\text{C}$

NBS traceable to IPTS-68

**Resolution:** three levels can be selected:

Level of selection	Resolution		Nominal time between readings in seconds	
	$^{\circ}\text{C}$	$^{\circ}\text{F}$	T1 or T2	T1 - T2
Low	0.01	0.1	0.1	0.2
Medium	0.001	0.01	1	2
High	0.0001	0.001	10	20

### General

**Display:** 7-digit LED with polarity, decimal, and degree C or F annunciator.

**Probes:** laboratory probes are available for use with the HP 2804A. Refer to the data sheet for specifications and sheath configurations.

### Power Required

100, 120, 220, or 240 Vac,  $+5\%$ – $10\%$ , 48 to 66 Hz,  $<30$  VA.

### Accessories and Probes

HP 18107A External Oscillator

HP 18110A Laboratory Probe and cal module, 25 mm (1")

HP 18111A Laboratory Probe and cal module, 230 mm (9.1")

### HP 2804A Quartz Thermometer





# HEWLETT-PACKARD INTERFACE BUS

## Versatile Interconnect System for Instruments and Controllers



- The hardware, documentation and support that delivers the shortest path to a measurement system

There are many applications where the measurement power of interactive instruments can be further enhanced by coupling them to desktop or minicomputers. Operating in a remote mode can provide more exact, error-corrected results as compared with conventional manual operation techniques.

Presently, three major parameters combine to reduce significantly the engineering development costs of configuring measurement systems:

1. The Hewlett-Packard Interface Bus, also known as "HP-IB";
2. Distributed computing through the growing number of "smart" instruments with internal microprocessors;
3. The broad choice of computers ranging from "friendly", easy-to-program desktop computers to more sophisticated computer systems capable of managing multi-station instrument clusters and complex data bases.

### Relationship Between HP-IB and Other Interface Standards

Hewlett-Packard historically has been committed to the overall advancement of measurement technology, and has for some time been working on the problems of simplifying and standardizing means of instrumentation interfacing. An example of such an effort is the intimate involvement with the HP-IB from its conception at HP to its present status as a world instrumentation interface standard (IEEE 488-1978 and IEC 625-1).

In mid-1972, Hewlett-Packard began to participate in various international standardization bodies. The U.S. Advisory Committee, composed of diverse interests represented by both users and manufacturers, first established initial goals—and then adopted the interface concept utilized by the HP Interface Bus as an appropriate starting point. A draft document was subsequently written and evaluated by members of the Committee, and then submitted as the U.S. Proposal to the IEC (International Electrotechnical Commission) Working Group in the autumn of 1972. Since then, the interface definition has undergone a number of minor changes to accommodate various needs at the international level.

In September 1974, the parent technical committee, IEC TC76, approved the main interface draft document for a formal ballot among the member nations of the IEC. Balloting took place in 1976, and IEC recommendation 625-1 was adopted. The IEC recommendation, using a different connector, is totally compatible with the present definition of the HP-IB.

Meanwhile, the IEEE Standards Board approved IEEE Standard 488-1975 "Digital Interface for Programmable Instrumentation", first published in 1975 and again published in 1978 with minor editorial changes as IEEE Standard 488-1978. The IEEE standard is also fully compatible with

the HP-IB. In January 1976, the American National Standards Institute adopted the IEEE Standard and published it as ANSI Standard MC 1.1.

The standardized interface concept is now well accepted. More than 2000 products, including more than 200 from HP, that use the HP-IB concepts articulated in IEEE 488 are today available from more than 250 manufacturers in more than 14 countries. As additional instrumentation interface standards evolve from the HP-IB, we will clearly indicate the relationship of the Hewlett-Packard Interface Bus to those standards—just as we have done with IEEE Standard 488, ANSI Standard MC 1.1 and IEC Publication 625-1.

### Why the HP Interface Bus Name?

As the list of HP products available with the "new digital interface" grew, our customers sought a convenient way to identify those products having the interface capability. In response, in 1974 we adopted the name "Hewlett-Packard Interface Bus" or simply "HP-IB". We will continue to use the identifying name and this symbol:



Both are used with appropriate HP products so that their interface capabilities may be readily identified.

The Hewlett-Packard Interface Bus fully complies with IEEE Standard 488. As such, it incorporates the mechanical, electrical and functional specifications of the Standard. A fourth and vital element of any interface system is the operational aspect of a product at both the human-machine interface and machine-machine interface at the HP-IB port. HP-IB capability provides additional user benefits that are beyond the scope of IEEE Standard 488. Typical user conveniences include high-level language implementation of interface functions, underscored program codes on the front panel of the instruments for easy programming, convenient data output formats, and designed-in "Learn Mode" capabilities. In addition, we provide complete support documentation in the form of programming and interfacing guides, application notes and operation manuals that illustrate the added benefits for users of products with HP-IB capability.

### Single Source Systems Approach

The decision to use a "system" instead of conventional manual methods must be based on an engineering evaluation of benefits versus costs. Among the many benefits associated with a systems approach:

- More consistent results in repeated measurements—a system is not subject to operator fatigue.
- Greater throughput because systems are generally faster.
- More thorough testing because system speed allows more parameters to be measured in a shorter time.
- Results expressed in engineering or scientific units, since many systems controllers are capable of on-line data manipulation.

- Greater accuracy because system errors can be measured automatically, stored and accounted for in the results.
- "Adaptive" data acquisition wherein a system can be programmed to branch to other measurements to help pinpoint when it senses an abnormal condition.
- Measurement results can be stored in computer memory or on hard copy.

It is our objective to facilitate the integration of instrumentation systems by providing users with instruments and computers designed for systems applications. Computers are designed with HP-IB options that allow easy hook-up to the bus and incorporate easy-to-use bus commands in their software. HP's policy when designing HP-IB compatible instruments is to eliminate interfacing ambiguities associated with controllers and instruments operating per the IEEE, ANSI and IEC standards by adopting consistent interface design guidelines.

Proper training on system components is very important for efficient use of any interface system. Therefore, we offer training at sales and service offices worldwide on HP desktop computers, computer systems and instruments as they relate to the HP-IB. In the area of HP-IB support documentation, we offer general interface technical descriptions, Operating and Service Manuals with programming information, Instrument/Controller Introductory Operating Guides, Quick Reference Guides and Application Notes.

Technical assistance during system development is available at most local HP sales and service offices from resident systems engineers specialized in desktop computers, computer systems and instruments.

### How the HP Interface Bus Operates

All active interface circuitry is contained within the various HP-IB devices, and the interconnecting cable (containing 16 signal lines) is entirely passive. The cable's role is limited to that of interconnecting all devices in parallel so that any one device may transfer data to one or more other participating devices.

Every participating device (instrument, controller, accessory module) must be able to perform at least one of the roles of TALKER, LISTENER or CONTROLLER. A TALKER can transmit data to other devices via the bus, and a LISTENER can receive data from other devices via the bus. Some devices can perform both roles (e.g., a programmable instrument can LISTEN to receive its control instructions and TALK to send its measurement).

A CONTROLLER manages the operation of the bus system primarily by designating which devices are to send and receive data, and it may also command specific actions within other devices.

A minimum HP-IB system configuration consists of one TALKER and LISTENER, without a CONTROLLER. In this configuration, data transfer is limited to direct transfer between one device manually set to "talk only" and one or more devices manually set to "listen only" (e.g., a measuring instrument



talking to a printer for semi-automatic data logging).

The full flexibility and power of the HP-IB become more apparent, however, when one device that can serve as CONTROLLER/TALKER/LISTENER (e.g., calculator or computer) is interconnected with other devices that may be either TALKERS or LISTENERS, or both (e.g., frequency synthesizers, counters, power meters, relay actuators, displays, printers, etc.), depending on the application. An HP-IB controller participates in the measurement by being programmed to schedule measurement tasks, set up individual devices so that they can perform these tasks, monitor the progress of the measurement as it proceeds, and interpret the results of the measurement. HP offers controllers that can be programmed in high-level languages such as BASIC, FORTRAN, HPL, and Pascal.

**HP-IB Connections and Structure**

The HP-IB has a party line structure where all devices on the bus are connected in parallel. The 16 signal lines within the passive interconnecting HP-IB cable are grouped into three clusters according to their functions as follows:

1. Data Bus (8 signal lines)
2. Data Byte Transfer Control Bus (3 signal lines)
3. General Interface Management Bus (5 signal lines).

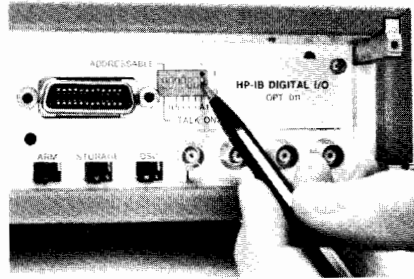

Rear panel switches are set so instrument will either be addressable by controller in a multi-device system, or will simply "talk only" to another device such as a printer.

The DATA BUS consists of eight signal lines that carry data in bit parallel, byte serial format across the interface. These signal lines carry addresses, program data, measurement data, universal commands and status bytes to and from devices interconnected in a system. Identification of the type of data present on the DIO signal lines is indicated by the ATN (attention) signal. When the ATN signal is true (asserted), either addresses or universal commands are present on the data bus and all connected devices are required to monitor the DIO lines. When the ATN message is false, device dependent data (e.g., programming data) is carried between devices previously addressed to talk and listen.

Transfer of each byte on the Data Bus is accomplished via a set of three signal lines: DAV (data valid), NRFD (not ready for data), and NDAC (not data accepted). These signals operate in an interlocked handshake mode. Two signal lines, NRFD and NDAC, are each connected in a logical AND (wired OR) to all devices connected to the interface. The DAV signal is sent by the talker and received by potential listeners whereas the NRFD and NDAC signals are sent by potential listeners and received by the talker.

The General Interface Management Lines manage the bus to effect an orderly flow of messages. The IFC (interface clear) message places the interface system in a known quiescent state. SRQ (service request) is used by a device to indicate the need for attention or service and to request an interruption of the current sequence of events. REN (remote enable) is used to select between two alternate sources of device program data. EOI (end or identify) is used to indicate the end of a multiple byte transfer sequence or, in conjunction with ATN, to execute a polling sequence.

It is not possible in this limited space to go into detail on each signal line's role. But you should note that every HP-IB device need not be able to respond to all the lines. As a practical and cost-effective matter, each HP-IB device usually responds only to those lines that are pertinent to its typical function on the bus. (Details appear in each device's operating manual.)

**HP-IB Training and Support**

Hewlett-Packard has field sales people trained in electronic instruments, desktop computers and computer systems to assist you in configuring HP-IB measurement systems. Also available for technical consultation are computing controller systems engineers and HP-IB instrumentation specialists.

HP-IB training courses on HP-IB controllers and instruments are listed below. Courses are conducted at a convenient HP location. Some courses can be taught at your site with special arrangements.

**Instrumentation Systems**

- HP-IB Instrument System Training With HP Model 26 Controllers\* 4 days
- HP-IB Instrument Programming With HP 1000E/F Series Controllers\* 4 days
- Instrument Interface with HP-IB 4 days

\*For more on these courses, see page 29.

**Desktop Computer Systems**

- HP BASIC Programming 4 days
- 9845 BASIC Operating and Programming 5 days
- BASIC Language I/O-Programming 4 days
- Series 200 Pascal Programming 5 days
- 9000 Family Basic Language Operating and Programming 5 days
- HPL Operating and Programming 5 days
- Series 80 Beginners Programming 2 days
- Series 80 General I/O Programming 3 days
- Series 80 Assembly Language 3 days

**Service and Warranty Considerations**

Hewlett-Packard has dedicated measurement system service people who perform on-site maintenance of HP instrumentation on customer-configured systems as well as HP-configured systems. Service contract coverage is available to meet your specific measurement system service needs and can be tailored to include extended warranty, calibration and extended hours of coverage. Contact your local sales and service office for further information on HP-IB service contract information.

Every HP-IB device and HP configured system carries a standard Hewlett-Packard warranty appropriate to that product. The warranty period for each product will be provided on request at the time of sale and is specified in documentation supplied with the product. HP takes responsibility for standard HP-IB systems performing as specified. However, software or interfacing which has not been provided by Hewlett-Packard as

*Continued on page 674.*

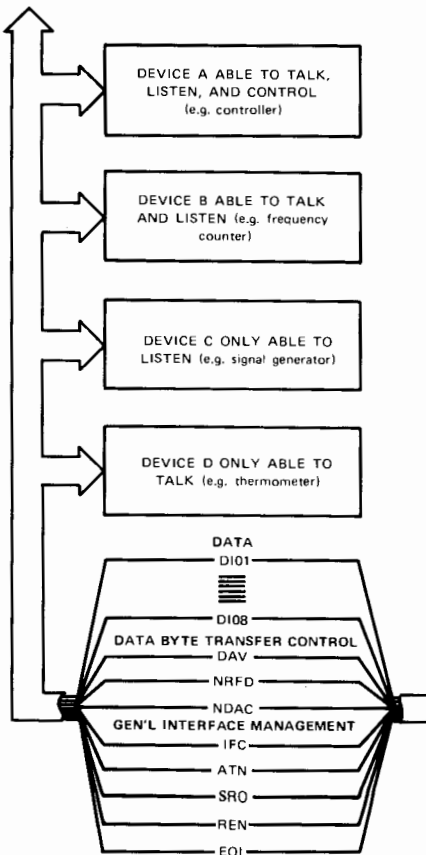

Interface connections and bus structure.



# HEWLETT-PACKARD INTERFACE BUS

Versatile Interconnect System for Instruments and Controllers



## Individual Hewlett-Packard Products Available with HP-IB Capability

Products Related to	HP Model	Product Name/Characteristics	Page
<b>Control and Computation</b>	85B	Personal Computer (uses HP 82937A Interface)	52
	86B	Personal Computer (HP 82937A interface built-in)	52
	HP 150	Touchscreen Personal Computer	44
	HP 150 MAX	Touchscreen MAX Personal Computer	44
	HP 1000 A600+	Computer (HP 2156B; uses HP 12009A Interface)	82
	HP 1000 A700	High Performance Computer (HP 2137A; uses HP 12009A Interface)	82
	HP 1000 A900	High Performance Computer (HP 2139A; uses HP 12009A interface)	82
	HP 1000 E-series	Computers (HP 2109E & 2113E use HP 59310B Interface)	82
	HP 1000 F-series	High-performance computers (HP 2117F uses HP 59310B Interface)	82
	9816A/S	Personal Technical Computer	74
	9817A/H	Technical Computer	74
	9826A/S	Technical Computer	74
	9836U/CU/T/CT	Technical Computer	74
	9837H	Technical Computer	74
	9920A/S	Modular Computer	74
	9020A/B/C/AS/AT	Computer	76
9030A	Computer	76	
9040A/AM/AT	Computer	76	
<b>Stimulus</b>	3314A	Function Generator: 0.01 Hz to 19.99 MHz	425
	3325A	Synthesizer/Function Generator/Sweeper: 1 $\mu$ Hz to 21 MHz	432
	3326A	Two-Channel Synthesizer: dc to 13 MHz	434
	3335A	Synthesizer/Level Generator: 200 Hz to 80 MHz	436
	3336A/B/C	Synthesizer/Level Generator: 10 Hz to 20.9 MHz	437
	4140B	PA Meter/DC Voltage Source	226
	5182A	Waveform Recorder/Generator: 20 MHz, 10 bits, 16K word memory	338
	5359A	Time Synthesizer: 1 ns accuracy; 50 ps increments, 100 ps jitter	415
	6002A Option 001	DC Power Supply: 200 W autoranging. Listen only	326
	6031A	System Power Supply: 1000W, 20 Vdc, 120A, autoranging with status readback	324
	6032A	System Power Supply: 1000W, 60 Vdc, 50A, autoranging with status readback	324
	6033A	System Power Supply: 200W, 20 Vdc, 30A, autoranging with status readback	324
	6038A	System Power Supply: 200W, 60 Vdc, 10A, autoranging with status readback	324
	6129C Opt. P05 or J99	Precision Voltage Sources: $\pm$ 50 Vdc at 5 A (requires HP 59301A)	328
	6130C Opt. P05 or J99	Precision Voltage Source: $\pm$ 50 Vdc at 1A (requires HP 59301A)	328
	6131C Opt. P05 or J99	Precision Voltage Source: $\pm$ 100 Vdc at 0.5 A (requires HP 59301A)	328
	6140A Opt. P05 or J99	Precision Current Source: $\pm$ 100 mA at 100 Vdc (requires HP 59301A)	328
	6940B	Multiprogrammer (requires HP 59500A)	199
	6942A	Multiprogrammer: automatic test, data acquisition and control	195
	8016A Option 001	Word Generator: 9 x 32 bit. Listen only	398
	8018A Option 001	Serial Data Generator: 50 MHz, 2048-bit memory. Listen only	400
	8112A	Programmable Low Cost Pulse Generator: 20 ns to 950 ms period	405
	8116A	Programmable Pulse/Function Generator: 1 mHz to 50 MHz	429
	8150A	Optical Signal Source: 850 nm, 250 MHz	512
	8160A	Programmable Pulse Generator: 20 ns to 999 ms period	406
	8161A	Programmable Pulse Generator: 10 ns to 980 ms period	406
	8165A	Programmable Signal Source: 0.001 Hz to 50 MHz	431
	8170A	Logic Pattern Generator: 8 x 1024/16 x 512 bit	399
	8180A	Data Generator: 50 MHz, 1024 bit/channel	394
	8181A	Data Generator Extender	394
	8340A	Synthesized Sweeper: 10 MHz–26.5 GHz	459
	8341A	Synthesized Sweeper: 10 MHz–20 GHz	459, 470
	8350B	Sweep Oscillator: 10 MHz to 40 GHz	474
	8620C Option 011	Sweep Oscillator: 10 MHz to 22 GHz	487
	8642A/B	Synthesized Signal Generator: 100 kHz - 2.115 GHz	442
	8656B	Signal Generator: 0.1 to 990 MHz	440
	8660A, C Option 005	Synthesized Signal Generators: 10 kHz to 2.6 GHz. Listen only	448
	8662A	Synthesized Signal Generator: 10 kHz to 1280 MHz.	445
	8663A	Synthesized Signal Generator: 100 kHz to 2560 MHz.	445
	8671A	Microwave Frequency Synthesizer: 2 to 6.2 GHz	463
8672A	Synthesized Signal Generator: 2 to 18 GHz	460	
8672S	Synthesized Signal Generator: 100 MHz to 18 GHz	463	
8673B	Synthesized Signal Generator: 2 to 26.5 GHz	460	
8673C/D	Synthesized Signal Generator: 50 MHz to 18, 26.5 GHz	462	
59501B	Power Supply Programmer: Isolated D-to-A Converter $\pm$ 10 Vdc at 10 mA	327	
<b>Measurement</b>	436A Option 022	Power Meter: -70 dBm to +44 dBm, to 26.5 GHz	518
	438A	Dual-channel Digital Power Meter: -70 dbm to +44 dbm, to 26.5 GHz	518
	853A	Spectrum Analyzer Display	604–609
	1630A/D/G	Logic Analyzer	270
	1726A	Time Interval Oscilloscope	352
	1950A	Two Channel Expansion Module for HP 1980 System	342
	1965A	Gated Universal Counter for HP 1980 System	344
	1980A/B	Oscilloscope Measurement System: fully programmable	344
	19860A	Digital Waveform Storage for HP 1980 System	344
	2250	Measurement & Control System	186
	2804A Option 010	Quartz Thermometer: 0.05°C accuracy	667
	3421A	Data Acquisition/Control Unit	176
	3437A	System Digital Voltmeter: high speed, 3½ digits	161
	3455A	Digital Voltmeter: 5½ or 6½ digits, auto calibration	160
	3456A	Digital Voltmeter: 3½ to 6½ digit voltmeter, 1 nV sensitivity	157
	3478A	Digital Multimeter: 3½ to 5½ digits; 5 functions	155
	3497A	Data Acquisition Control Unit	182

**Individual Hewlett-Packard Products Available with HP-IB Capability (cont.)**

Products Related to	HP Model	Product Name/Characteristics	Page
Measurement (cont.)	3561A	Dynamic Signal Analyzer: 125 $\mu$ Hz to 100 kHz	627
	3562A	Dynamic Signal Analyzer: dual channel, 64 $\mu$ Hz to 100 kHz	630
	3577A	Network Analyzer: 5 Hz to 200 MHz	544
	3582A	2-channel Real Time (FFT) Spectrum Analyzer	625
	3585A	Swept Spectrum Analyzer: 20 Hz to 40 MHz	585
	3586A/B/C	Selective Level Meter: 50 Hz to 32.5 MHz	141, 588
	3708A	Noise and Interference Test Set	140
	3717A	Wideband 70 MHz modem	146
	3746A	32.5 MHz Selective Level Measuring Set: CCITT and Bell FDM Systems	137
	3764A	Digital Transmission Analyzer	133
	3776A	PCM Terminal Test Set: CEPT/CCITT networks	118, 129
	3776B	PCM Terminal Test Set: Bell/Japanese/CCITT networks	118, 129
	3779C	Primary Multiplex Analyzer: CEPT 2 Mb/s PCM systems	130
	3779D	Primary Multiplex Analyzer: Bell 1.5 Mb/s PCM systems	130
	3781A/3782A	Pattern Generator/Error Detector: CEPT and CCITT PCM/TDM systems	132
	3781B/3782B	Pattern Generator/Error Detector: Bell PCM/TDM systems	132
	3785A	Jitter Generator and Receiver: CEPT PCM/TDM systems	134
	3785B	Jitter Generator and Receiver: Bell PCM/TDM systems	134
	4140B	PA Meter/dc Voltage Source	226
	4145A	Semiconductor Parameter Analyzer	228
	4191A	RF Impedance Analyzer	214
	4192A	LF Impedance Analyzer	216
	4193A	Vector Impedance Meter	218
	4262A Option 101	Automatic LCR Meter	220
	4274A	Multifrequency LCR Meter: 10 steps, 100 Hz to 100 kHz	206
	4275A	Multifrequency LCR Meter: 10 steps, 10 kHz to 10 MHz	206
	4276A	LCZ Meter	210
	4277A	LCZ Meter	210
	4280A	C Meter/CV Plotter	222
	4945A Option 010	Transmission Impairment Measurement System (TIMS)	124
	4955A	Protocol Analyzer	116
	5005B	System Signature Multimeter	240
	5006A	Signature Analyzer	243
	5180A	Waveform Recorder	336
	5328B	Universal Counter: to 512 MHz, 10 ns time interval	293
	5334A	Automatic Universal Counter: 100 MHz/1.3 GHz, 2 ns TI	288
	5335A	Automatic Universal Counter: 200 MHz/1.3 GHz, 2ns TI	284
	5340A Option 011	Automatic Microwave Counter: 10 Hz to 18 GHz	281
	5342A Option 011	Automatic Microwave Counter: 10 Hz to 18 GHz	278
	5343A Option 011	Microwave Frequency Counter: 10 Hz to 26.5 GHz	278
	5344S	Microwave Source Synchronizer 0.5 GHz to 18 GHz	280
	5345A Option 011,012	General Purpose Plug-In Counter	282
	5355A	Automatic Frequency Converter plug-in for HP 5345A	284
	5363B	Time Interval Probes	285
	5370B	Precision Time Interval Counter: $\pm$ 20 ps single-shot resolution	286
	5384A	225 MHz Frequency Counter	298
	5385A	1 GHz Frequency Counter	298
	5423A	Structural Dynamics Analyzer	633
	5501A	Laser Transducer	665
	5528A	Laser Measurement System	664
	6031A	System Power Supply: 1000 W, 20 Vdc, 120 A, autoranging with status readback	324
	6032A	System Power Supply: 1000 W, 60 Vdc, 30 A, autoranging with status readback	324
	6033A	System Power Supply: 200 W, 20 Vdc, 30 A, autoranging with status readback	324
	6038A	System Power Supply: 200 W, 60 Vdc, 10 A, autoranging with status readback	324
	6940B	Multiprogrammer (requires HP 59500A interface)	199
	6942A	Multiprogrammer: automatic test, data acquisition and control	195
	7090A	Measurement Plotting System: 3-channel A-D converter to 3 kHz	378
	8151A	Optical Pulse Power Meter: 250 MHz	514
	8182A	Data Analyzer: 50 MHz real-time capability; 1024 bit/channel	394
	8501A	Storage Normalizer for HP 8505A RF network analyzer	557
	8503A & 8503B	S-Parameter Test Set: 50 or 75 ohm, for HP 8505A	558
	8505A	RF Network Analyzer: 500 kHz to 1.3 GHz	554
	8507D	Network Analyzer Subsystem: 500 kHz to 1.3 GHz	560
	8510A	Network Analyzer	562
	8558B Option E98	EMI Measurement System	606
	8566B	Spectrum Analyzer: 100 Hz to 300 GHz	590, 595
	8568B	Spectrum Analyzer: 100 Hz to 1.5 GHz	590, 592
	8569B	Spectrum Analyzer: 10 MHz to 115 GHz	600
	8756A/8757A	Scalar Network Analyzer: 10 MHz to 40 GHz	535, 542
	8901A	Modulation Analyzer: 150 kHz to 1.3 GHz	648
	8901B	Modulation Analyzer: 150 kHz to 1.3 GHz	648
	8902A	Measuring Receiver: 150 kHz to 1.3 GHz	644
	8903A	Audio Analyzer: 20 Hz to 100 kHz	651
	8954A	Transceiver Interface	655
	8956A	System Interface	655
	8958A	Cellular Radio Interface	656
	8970A	Noise Figure Meter: 10 to 1500 MHz	526
	11729B	Carrier Noise Test Set: 5 MHz to 18 GHz	638
	54100A/D	Digitizing Oscilloscopes	340
	54300A	Probe Multiplexer	341
	85650A	Quasi-Peak Adapter	599

## Individual Hewlett-Packard Products Available with HP-IB Capability (cont.)

Products Related to	HP Model	Product Name/Characteristics	Page
Switching Scanning	2250	Measurement and Control Subsystem	186
	3421A	Scanner: to 30 channels; A/D converter	176
	3488A	Versatile switching for automated testing (VHF, matrix, general purpose)	190
Translation or Timing	3326A	Two-Channel Synthesizer/Sweeper: dc to 13 MHz	434
	3495A	Scanner: to 80 channels, low thermal; (to 40 relay channels)	189
	3497A	Data Acquisition Control Unit	182
	3754A	25 MHz Access Switch (requires HP 3755A switch controller)	138
	3756A	90 MHz Switch (requires HP 3755A)	138
	3757A	8.5 MHz Access Switch (requires HP 3755A)	138
	3777A	Telecommunications Channel Selector: up to 30 channels; dc to 110 kHz	130
	6940B	Multiprogrammer (requires HP 59500A interface)	199
	6942A	Multiprogrammer (no interface required)	195
	9411B	Switch Controller	203
	9412A	Modular Switch (requires HP 9411B switch controller)	203
	9413A	VHF Switch (requires HP 9411B)	203
	9414A	Matrix Switch (requires HP 9411B)	203
	11713A	Attenuator/Switch Driver (controls coax switches, step attenuators and microwave matrix switches)	499
	37201A	HP-IB Extender Twisted-Pair or Modems	679
	37203A/L	HP-IB Extender: Coax and Fiber Optics	678
	59301A	ASCII-to-Parallel Converter: string to 16 characters	676
	59303A	Digital-to-Analog Converter	676
	59306A	Relay Actuator: for programmable switches, attenuators	676
	59307A	VHF Switch: two 50 ohm, bidirectional, dc to 500 MHz	676
59309A	Digital Clock: month, day, hour, minute, second	677	
59313A	Analog-to-Digital Converter	677	
59501B	Power Supply Programmer: isolated D-to-A converter $\pm 10$ Vdc at 10 mA	327	
Storage	3964A Option 007	Instrumentation Tape Recorder: 4 channel, Listen only	390
	3968A Option 007	Instrumentation Tape Recorder: 8 channel, Listen only	390
	5180A	Waveform Recorder (digital oscilloscope): 20 MHz, 10 bits, 16K-word capacity	336
	7911P/R	Disc/Tape Drives: 28.1 Mb fixed disc drive, 67 Mb 1/4" tape cartridge drive	92
	7912P/R	Disc/Tape Drives: 65.6 Mb fixed disc drive, 67 Mb 1/4" tape cartridge drive	92
	7914P/R	Disc/Tape Drives: 132.1 Mb fixed disc drive, 67 Mb 1/4" tape cartridge drive	92
	7914ST/TD	Disc/Tape Drives: 132.1 Mb fixed disc drive, 1/2" reel-to-reel tape drive	92
	7933	Disc Drive: 404 Mb fixed	92
	7935	Disc Drive: 404 Mb removable	92
	7941A	Disc Drive: 24 Mb fixed disc drive	91
	7942A	Disc/Tape Drive: 24 Mb fixed disc drive, 67 Mb 1/4" tape cartridge drive	91
	7945A	Disc Drive: 55 Mb fixed disc drive	91
	7946A	Disc/Tape Drive: 55 Mb fixed disc drive, 67 Mb 1/4" tape cartridge drive	91
	7970E	1/2" Magnetic Tape Subsystem: 40 Mb formatted capacity	93
	7974A	1/2" Magnetic Tape Subsystem: 40 Mb formatted capacity	93
	7978A	1/2" Magnetic Tape Subsystem: 140 Mb formatted capacity	93
	9121D/S	Single-Sided 3 1/2" Disc Drives: 540 Kb dual (9121D), 270 Kb single (9121S) random access storage	59
	9122D/S	Double-Sided 3 1/2" Disc Drives: 1410 Kb dual (9122D), 710 Kb single (9122S) random access storage	59
	9125S	Single 5 1/4" Flexible Disc Drive: up to 360 Kb formatted, IBM/HP format compatible	59
	9133V/XV/D	Winchester/Microfloppy: 5 1/4" Winchester (4.6/14.6/14.6 Mb) plus 3 1/2" microfloppy (270/370/710 Kb)	60
9134XV/D	Standalone Winchester: 5 1/4", 14.6 Mb storage; 50 Kb/s (9134XV), 150 Kb/s (9134D) transfer rate	60	
9144A	1/4" Tape Cartridge Subsystem: 16 and 67 Mb formatted capacity	60	
9895A	8" Flexible Disc Dual Drive: 2.36 Mb mass storage	59	
Data Entry, Displays	1347A	HP-IB Display	371
	1351S	Graphics Display System	372
	2225A	ThinkJet ink-jet printer	57
	2563A	Line Printer: 300 lines/minute dot matrix	95
	2565A/66A	Line Printers: 600/900 lines per minute	95
	2602A	Daisywheel Printer	57
	2671A	Alphanumeric Thermal Printer: 80 columns	58
	2671G	Graphics Thermal Printer: 80 columns	58
	2673A	Intelligent Graphics Printer: 80 columns	58
	2680A, 2688A	Laser Page Printers	95
	2934A	Dual Mode Impact Printer	58
	5150A Option 001	Alphanumeric Thermal Printer: 20 Columns. Listen only	392
	7090A	Measurement Plotting System: 6 pen	378
	7470A	Graphics Plotter: 2-pen	98
	7475A	Graphics Plotter: 6-pen	98
	7550A	Automatic Sheet-Feed 8-Pen Plotter	100
	7580B, 7585B, 7586B	Large Format Drafting Plotters	102
	9111A	Graphics Tablet: graphics input	104
	9876A	Thermal Graphics Printer: 480 lines/minute	58
37461A	Display	137	
82906A	Impact Printer	57	
Interface Cabling	10833A-10833D	HP-IB Interconnection Cables	675
	10834A	HP-IB Interconnection Cable Adapter: 2.3 cm (.91 in)	675
HP-IB Extension	37201A	HP-IB Extender: Twisted Pair or modems	679
	37203A/L	HP-IB Extender: Coaxial or Fiber Optic Cable	678
Design/Serviceing	59401A	Bus System Analyzer	675



## Standard HP-IB Measurement Systems

Many application requirements can be satisfied with a standard HP-IB measurement system — a system assembled, tested, and

documented by Hewlett-Packard. Pre-configured systems save you design and setup time, and HP guarantees overall specified

system performance. Installation and service contracts are available from your local HP Sales and Service Office.

## Standard HP-IB Measurement Systems

Application	HP Model	HP Controller	System Name/Characteristics	Page
Data Logging, Acquisition, and Control	2250	1000	Industrial Data Acquisition & Control.	186
	3054A/S	85, Series 200	Fast, flexible, and precise data acquisition system with a wide choice of controllers.	178
	3054C	1000	Computer based automatic data acquisition/control system.	181
	3054DL	85	Complete data logger.	180
	3056DL	85	Complete data logger (HP-IB & HP-IL).	175
	6901S 6944S	Series 200 Series 200	Measurement and Analysis System: includes CAT software. HP Series 200 Multiprogrammer System	193 194
Network Analysis	8408B 8507D	85 Series 200	Automatic Microwave Network Analyzer: 500 MHz to 18 GHz.	575
	8510A	Series 200	Automatic RF Network Analyzer: measures complex impedance, transfer functions, group delay; 500 kHz to 1.3 GHz.	560
	8757S	Series 200	Microwave Network Analyzer: measures transmission and reflection parameters, 45 MHz to 26.5 GHz. Automatic Scalar Network Analyzer: measures insertion loss, gain, return loss, SWR, reflection coefficient & power.	562 534
Spectrum Analysis	8566S	Series 200	Automatic Spectrum Analyzer: covers 100 Hz to 22 GHz; exceptional frequency tuning accuracy and resolution.	598
	8568S	Series 200	Automatic Spectrum Analyzer: covers 100 Hz to 1.5 GHz; exceptional frequency tuning accuracy and resolution.	598
Frequency Stability Analysis	3047A	Model 236	Phase Noise Measurement System: high resolution and phase noise measurements.	636
	11740S	Model 236	Microwave Phase Noise Measurement System: automatic phase noise measurements on carriers from 5 MHz to 18 GHz.	640
Microwave Signal Analysis	8902S	Series 200	Microwave Measurement System for accurate modulation, frequency, and low-level power measurements to 26.5 GHz.	646
Waveform Analysis/Generation	5180S	Series 200	Waveform Measurement System: automatic time-domain measurements of captured waveforms.	336
	5182S	Series 200	Waveform Generation System: draw, trace, edit, and create arbitrary waveforms; modify captured waveforms for playback.	339
Signal Generator Calibration	8952A	Series 200	RF Signal Generator Test Set: Performance verification for HP 8640B, 8642A/B, 8656A/B, 8662A Signal Generators.	647
Transceiver Testing	8953A	85/Series 200	Transceiver Test Set for AM and FM transceivers, 150 kHz to 990 MHz.	654
	8955A	Series 200	RF Test System for AM and FM transceivers, to 1000 MHz, transmitters to 120 W.	653
	8957S	Series 200	Cellular Radio Test System: compatible with AMPS (U.S. system) and TACS (UK system) protocols; complete RF testing to 1000 MHz.	656
Circuit Testing	3061A/3062A	Series 200	In-circuit functional test system.	254
	3065C	Series 200	Analog Board Test System: Fast, accurate fault location on loaded printed circuit boards. Option 100 test microprocessors.	256
	55005S	85	Semiautomatic, at-speed functional testing of digital products.	239
Frequency Division Multiplex (FDM) Network Surveillance	3046A/B	85	Frequency Division Multiplex (FDM) network surveillance system: automates HP 3586A/B Selective Level Meters.	144
	37050S	1000	FDM Network Monitoring System: simultaneous control of multiple selective level measuring sets.	139
	37051S	Model 216	FDM Measurement System: sequential control of multiple selective level measuring sets.	139
Microwave Radio Performance Testing	3708S	Model 216	Noise and Interference Measurement System: automatic measurements of microwave radios under flat-fade conditions.	140
Semiconductor/Component Testing	4061A	Series 200	Semiconductor/Component Test System: evaluation of fundamental characteristics of semiconductor and electronic components (I-V, HF, C-V, + quasi static C-V).	230
	4062A	Model 236	AC/DC Parametric Test System; 48-pin matrix switch.	232
	4063A	Model 236	Semiconductor Parameter Analysis System: 1fA, 10 mV, 1 fF, 0.01 $\mu$ S, 0 to $\pm$ 100 V dc bias; C and G as functions of Vdc or time.	234
Power Sensor Calibration	436A-E40	85	Calibrates RF & MW power sensors; good for metrology labs.	516



# HEWLETT-PACKARD INTERFACE BUS

## Versatile Interconnect Systems for Instruments and Controllers



part of a standard system delivered by HP is not covered by this warranty.

In all cases, overall operational responsibility for those HP-IB systems assembled by a customer from individual HP-IB devices shall rest with the customer.

### HP-IB Specifications Summary

#### Interconnect Devices

Up to 15 maximum on one contiguous bus.

#### Interconnection Path

Star or linear bus network; total transmission path length 2 metres times number of devices or 20 metres, whichever is less. Operating distances can be extended; see pages 678 and 679.

#### Message Transfer Scheme

Byte-serial, bit-parallel asynchronous data transfer using locked 3-wire handshake technique.

#### Data Rate

One megabyte per second maximum over limited distance; 250-500 Kbytes per second typical over full transmission path (actual data rate depends on individual device characteristics).

#### Address Capability

Primary addresses, 31 TALK and 31 LISTEN; secondary (2-byte) addresses, 961 TALK and 961 LISTEN. Maximum of 1 TALKER and up to 14 LISTENERS at a time.

#### Control Shift

In systems with more than one controller, only one can be active at a time. A currently active controller can pass control to another, but only designated system controller can assume control over others.

#### Interface Circuits

Driver and receiver circuits are TTL-compatible.

#### HP-IB Interface Functions

HP-IB functions are the predefined capabilities that can be designed into an HP-IB device. These capabilities and their alphanumeric codes are summarized in the table. Because the codes completely describe interface capability and are therefore particularly useful to system designers and specifiers, they are more and more frequently appearing in technical data and on system components. On HP system-ready products they are listed near the HP-IB connector, and they are included in the specifications for most of the HP-IB products in this catalog.

#### Connector Lock Screw Compatibility

HP-IB products delivered now and in recent years are equipped with connectors having ISO metric-threaded lock screws, and stud mounts. (Very early HP-IB products have non-metric parts, but are readily distinguished from the metric by color: metric-threaded parts are black and stamped with the letter "M", whereas non-metric parts have a shiny nickel finish.) HP-IB Metric Conversion Kit (HP P/N 5060-0138) is available to convert these early instruments.

#### Reference Publications

- *Tutorial Description of the Hewlett-Packard Interface Bus*. This 94-page, easy-to-read reference chronicles the development of byte-serial, bit-parallel interface system standards, describes their relationship to HP-IB, and includes a working overview of HP-IB, and includes useful information such as suggestions for improving software performance, HP-IB verification programs, a glossary of HP-IB terms, and bibliographies. Free copies are available from your nearest HP office. Ask for publication number 5952-0156.
- *IEEE-488-1978, Digital Interface for Programmable Instrumentation*, published by the Institute of Electrical and Electronics Engineers, 345 East 47th Street, New York, NY 10017.
- *ANSI MCI.1, Digital Interface for Programmable Instrumentation*, published by the American National Standards Institute, 1430 Broadway, New York, NY 10018.
- *IEC 625-1, An Interface System for Programmable Measuring Apparatus (Byte Serial Bit Parallel)*, published by the International Electrotechnical Commission, 1 rue de Varembe, 1211 Geneva 20, Switzerland.
- *EIA RS-232-C, Interface Between Data Terminal Equipment and Communication Equipment Employing Serial Binary Data Interchange*, published by the Electronic Industries Association, 2001 Eye Street NW, Washington, DC 20006.

#### Interface Capability Codes for HP Products

Interface Function	Basic Code	Capability Code
Source Handshake	SH	SH0 No capability
		SH1 Full capability
Acceptor Handshake	AH	AH0 No capability
		AH1 Full capability
Talker (Extended Talker)	T(TE)	T(TE)0 No capability
		T(TE)1 Basic talker, serial poll, talk only
		T(TE)2 Basic talker, serial poll
		T(TE)3 Basic talker, talk only
		T(TE)4 Basic talker
		T(TE)5 Basic talker, serial poll, talk only, unaddresses if MLA <sup>1</sup>
		T(TE)6 Basic talker, serial poll, unaddresses if MLA <sup>1</sup>
		T(TE)7 Basic talker, talk only, unaddresses if MLA <sup>1</sup>
Listener (Extended Listener)	L(LE)	L(LE)0 No capability
		L(LE)1 Basic listener, listen only
		L(LE)2 Basic listener
		L(LE)3 Basic listener, listen only, unaddresses if MTA <sup>2</sup>
		L(LE)4 Basic listener, unaddresses if MTA <sup>2</sup>
Service Request	SR	SR0 No capability
		SR1 Full capability
Remote Local	RL	RL0 No capability
		RL1 Full capability
		RL2 No local lockout
Parallel Poll	PP	PP0 No capability
		PP1 Remote configuration
		PP2 Local configuration
Device Clear	DC	DC0 No capability
		DC1 Full capability
		DC2 Omit selective device clear
Device Trigger	DT	DT0 No capability
		DT1 Full capability
Driver Electronics	E	E1 Open collector (250kb/s max)
		E2 Tri state (1Mb/s max)
Controller <sup>3</sup>	C	C0 No capability
		C1 System controller
		C2 Send IFC and take charge
		C3 Send REN
		C4 Respond to SRQ
		C5 Send interface messages, receive control, pass control to self, parallel poll, take control synchronously

<sup>1</sup>MLA: My Listen Address

<sup>2</sup>MTA: My Talk Address

<sup>3</sup>There are 29 controller levels. These are the more significant levels.





# HEWLETT-PACKARD INTERFACE BUS

## Versatile Interconnect System for Instruments and Controllers

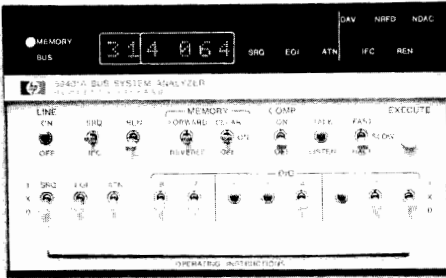

HP 59401A

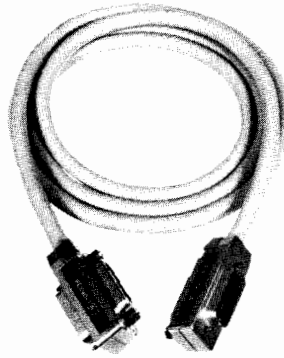

HP 10833A/B/C/D

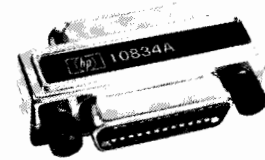

HP 10834A



### HP 59401A Bus System Analyzer

The HP-IB (IEEE 488) concept has greatly simplified many of those things which have in the past made instrument interfacing a burdensome task. Even so, software errors can occur if the system designer does not completely understand the bus system or the capabilities of the instruments and other devices being interfaced. Hardware problems can occur if the instruments/devices are not functioning properly, or if they are not completely compatible with the bus standard.

The HP 59401A Bus System Analyzer is especially useful in design and service work. It simplifies and speeds up the diagnosis of software and hardware problems by allowing the user to see the status of all bus lines, including the actual characters on the bus data lines. Because the HP 59401A can also drive all bus lines, it can completely exercise another Talker, Listener or Controller—which is especially useful in verifying compatibility of new or user-designed products with the HP-IB.

There are several choices of analyzer operating speed. It may be operated at one character at a time (useful for software debugging), at 2 characters per second, or at regular bus speed. It may also be operated at a variable rate as determined by the external clock input.

The analyzer's 32 character memory can be used to store bus characters in the Listen mode, or to output characters to the bus in the Talk mode. When the analyzer is in the Compare mode, a stream of bus traffic may be stopped on a pre-selected character—and at that time a trigger pulse is available, which is very useful when analyzing transient or timing problems related to the bus.

### HP 59401A Specifications

**Display:** monitors all bus lines. Represents data lines, any memory location, or DIO front panel switch settings; in octal code and ASCII character.

**Listen mode:** stores up to 32 characters of bus traffic in memory for real time and repetitive testing. In Compare mode, halts bus traffic when a selected character is present, and user can display any one of the previous 31 characters stored in memory.

**Timing:** accept <750 ns; ready <750 ns.

**Talk mode:** bus lines can be driven directly from front panel switches; memory can be loaded from front panel switches for driving bus with a 32 character sequence.

**Timing:** (1) data changed >500 ns before DAV pulled low; (2) ATN driven low >1  $\mu$ s before DAV pulled low; (3) DAV driven high <700 ns after NDAC is false; (4) DAV driven low <700 ns after NRFD is false, if conditions 1 and 2 are met.

**Operating speeds:** one character at a time, 2 characters per second, regular bus speed, or variable rate determined by external clock input; in either Listen or Talk mode.

**External clock input:** 1 standard power TTL gate input;  $\leq$ 10 MHz repetition rate.

**Compare output:** provides 1 standard power TTL gate output (LOW TRUE) sync pulse when bus character is same as front panel switches.

**HP-IB load:** 1 bus load (capable of driving 14 other bus devices).

### General

**Temperature ranges:** operating, 0 to 50°C; storage, -40 to +75°C.

**Humidity:** 95% relative, 0 to 40°C.

**Power requirements:** 100, 120, 220, or 240 V +5%, -10%; 48 to 66 Hz;  $\leq$ 42 VA.

**Size:** 145.5 H, 205.1 W, 495.3 mm D (5.730" x 8.075" x 19.500").

**Weight:** net, 5.64 kg (12.44 lb).

### Accessories

**HP 5061-0089** front handle kit

**HP 10833B** 2 m (6.6 ft) bus cable, furnished

### HP 59401A Bus System Analyzer

### HP-IB Interconnection Cables

Cables for interconnecting HP-IB devices are available in four different lengths. The connector block at both ends of each HP-IB cable (photo above) has a plug on one side and a matching receptacle on the other, so that several cables may be conveniently connected in parallel, thus simplifying system interconnection. Lock screws provide for secure mounting of each connector block to an HP-IB instrument, or to another cable connector block.

*SPECIAL NOTE: HP-IB cables are not always included with individual HP-IB devices, particularly those that normally connect directly to an HP computing controller. (The HP-IB interface for HP computing controllers contains the necessary cable and connector). Product listings in this catalog should be checked to see if HP-IB cables are furnished.*

The HP 10833 series of cables feature an improved shielding design to help improve RFI levels in systems. This series of cables, with the RFI shielding, exhibits significantly lower radiated emissions than previous HP-IB cables.

The HP 10834A adapter is a shielded HP-IB to HP-IB adapter. It provides additional clearance between the HP-IB cable and the rear panel of the instrument. This allows easier access to switches, cables, and other connectors that may be in close proximity to the HP-IB connector.

### Ordering Information

**HP 10833A** HP-IB Cable, 1m (3.3 ft)

**HP 10833B** HP-IB Cable, 2m (6.6 ft)

**HP 10833C** HP-IB Cable, 4m (13.2 ft)

**HP 10833D** HP-IB Cable, 0.5m (1.6 ft)

**HP 10834A** Adapter

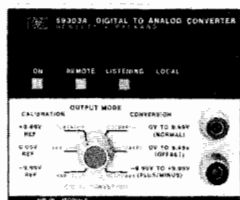

HP 59303A

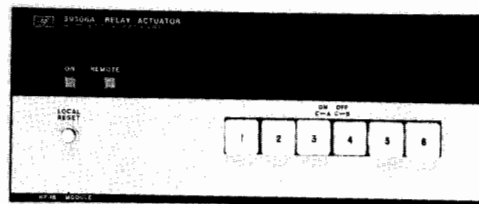

HP 59306A



HP 59301A

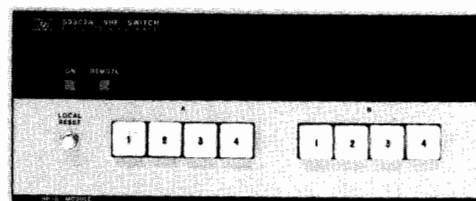

HP 59307A

## HP-IB Accessory Modules

Modules in the HP 59300, 59400 and 59500-series are ideal building blocks for use with instruments to extend measurement capabilities. Modules listed here can be interconnected via the HP-IB to HP measuring instruments, signal sources and recording devices capable of operating directly on the HP-IB. In addition, these modules frequently serve as useful ways to interconnect with devices which are not themselves capable of direct HP-IB operation.

Instrument requirements differ. Some only output or accept data on the HP-IB. Others can be remotely programmed by ASCII characters sent along the HP-IB. These modules can work with instruments on any of these levels with or without a controller. Each module having controls can be operated stand-alone from its front panel, or it can be placed in automatic operation under program control.

Module provision for stand-alone, local operation also has important system benefits. The operator can set up and check out the system under manual control, avoiding otherwise complex and time consuming error tracing. Each module has status indicator lights that make it easy to monitor operation.

### HP 59301A ASCII-to-Parallel Converter

Accepts byte-serial ASCII characters from the HP-IB and converts them to parallel output. In operation, ASCII characters transmitted serially along the bus are converted into 4-bit characters with the first ASCII character received being interpreted as the most significant digit. A string of up to 16 characters terminated by linefeed is converted and placed upon the output lines. The linefeed character causes the HP 59301A to output a print command (strobe).

With the HP 59301A, instruments controlled via BCD or binary can be operated using HP-IB. For example, the HP 59301A can be used with HP 6129C through 6131C and 6140A (Option J99 or P05) digitally-controlled power supplies for HP-IB programmable voltage and current. The HP 59301A can additionally be used to control other functions using its hexadecimal format.

#### General

**Size:** 101.6 mm H<sup>1</sup> x 212.9 mm W x 294.6 mm D (4" x 8.38" x 11.6").  
**Weight:** net 1.70 kg (3.78 lb). Shipping 2.33 kg (5.16 lb).

### HP 59301A ASCII-to-Parallel Converter

### HP 59303A Digital-to-Analog Converter

Accepts a string of serial ASCII characters and converts any three consecutive input digits to an analog output voltage, accurate to 0.1% in 30  $\mu$ s. Fully programmable via the HP-IB or manually operated from the front panel. A concentric control on the front panel makes it easy to select the digit group for conversion and the output mode. The

conversion switch is used to select the three digits of the character string that the DAC will change into analog voltage. The three output modes (NORMAL, OFFSET, and PLUS/MINUS) make the converter convenient for use directly with a variety of data logging devices, avoiding the need for auxiliary equipment to shift zero level or change polarity.

A primary application for the HP 59303A is to present on a logging device the data points being taken with a measuring instrument (like a frequency counter). A controller is not required for operation. Compatible logging devices include strip chart recorders, X-Y plotters, and displays.

#### General

**Size:** 101.6 mm H<sup>1</sup> x 105.9 mm W x 294.6 mm D (4" x 4.17" x 11.6").  
**Weight:** net 2.61 kg (5.80 lb). Shipping 3.17 kg (7.04 lb).

### HP 59303A Digital-to-Analog Converter

### HP 59306A Relay Actuator

Has six Form-C relays that provide for control of external devices either manually from front panel pushbuttons or remotely from the HP-IB. Relay contacts are specified to switch 24 V dc or 115 V ac at 0.5 A. Each relay can be programmed independently or multiple relays can be switched together. Front panel pushbuttons light to indicate the state of each relay.

The HP 59306A is ideal for providing control of microwave coaxial switches (HP 8761 A/B) as well as control of microwave programmable step attenuators (HP 8494 through 8496 G/H) using external dc power supplies.

#### General

**Size:** 101.6 mm H<sup>1</sup> x 212.9 mm W x 294.6 mm D (4" x 8.38" x 11.6").  
**Weight:** net 2.64 kg (5.87 lb). Shipping 3.23 kg (7.18 lb).

### HP 59306A Relay Actuator

### HP 59307A Dual VHF Switch

This module provides two single pole 4-throw switches controlled from front panel pushbuttons or remotely from the HP-IB. The HP 59307A is a dc to 500 MHz 50  $\Omega$  switch designed to maintain fast pulse transition times. The switches are independent and bidirectional for optimum use in multiplexing 50  $\Omega$  signal lines into measuring instruments. The HP 59307A is ideal to switch a standard delay, frequency, or voltage into a measurement loop for purposes of system calibration.

#### General

**Size:** 101.6 mm H<sup>1</sup> x 212.9 mm W x 294.6 mm D (4" x 8.38" x 11.6").  
**Weight:** net 2.64 kg (5.87 lb). Shipping 3.23 kg (7.18 lb).

### HP 59307A VHF Switch

<sup>1</sup>Height includes feet. With feet removed height is 88.1 mm (3.45").

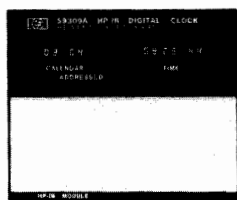

HP 59309A

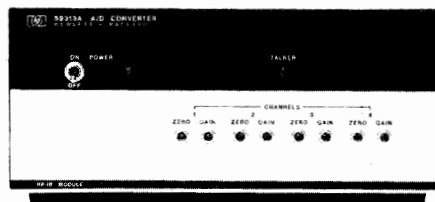

HP 59313A

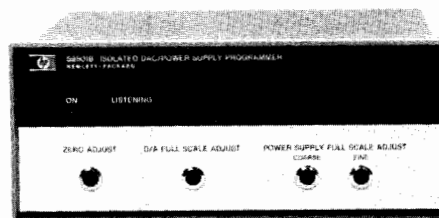

HP 59501B

## HP 59309A HP-IB Digital Clock

Displays month, day, hour, minute, and second, and upon command will output time via the interface bus. Time can be set into the clock by local control, or by remote commands received from the HP-IB. The clock accepts a small internal battery which can provide more than a day's standby in case of short power interruptions. Additionally, an auxiliary power supply such as the K10-59992 can sustain the clock for up to one year.

### General

**Size:** 101.6 mm H<sup>1</sup> x 105.9 mm W x 294.6 mm D (4" x 4.17" x 11.6").

**Weight:** net 1.70 kg (3.78 lb). Shipping 2.84 kg (6.31 lb).

## HP 59309A HP-IB Digital Clock

<sup>1</sup>Height includes feet. With feet removed height is 88.1 mm (3.45").

## HP 59313A Analog-to-Digital Converter

Four channel converter allows analog data with a full scale range of up to  $\pm 10$  V dc to be digitized and transmitted via HP-IB to a computing controller.

On command from the controller, the instrument can be programmed to perform a single conversion or a series of internally-paced conversions in six selectable rates of up to 200 per second on one channel, or up to 50 per second on each of four channels. Sampling can also be initiated externally by a TTL transition or contact closure to ground. Included is a program-controlled reverse channel capable of driving small lamps, relays or TTL devices.

### General

**Size:** 101.6 mm H<sup>1</sup> x 212.9 mm W x 345.4 mm D (4" x 8.38" x 13.6").

**Weight:** net 5.45 kg (12.0 lb). Shipping 6.36 kg (14.0 lb).

## HP 59313A Analog-to-Digital Converter

## HP 59501B Power Supply Programmer (isolated DAC)

This single-channel digital-to-analog converter can control a wide range of power supplies (output voltage, or current), as well as other analog programmable devices. It may also be used as a low level signal source, depending on the speed of the controller. It has two output ranges (0-1 and 0-10 V dc in unipolar mode; -1 to +1 and -10 to +10 V dc in bipolar mode), as well as photo-isolators which electrically separate HP-IB control and data lines from power supply circuitry by up to 600 V dc. (For additional details see page 327)

### General

**Size:** 101.6 mm H<sup>1</sup> x 212.9 mm W x 194.6 mm D (4" x 8.38" x 11.6").

**Weight:** net 2.61 kg (5.80 lb). Shipping 3.17 kg (7.04 lb).

## HP 59501B Power Supply Programmer

HP Model	Description	Dimensions—max. height x width x depth mm (inches)	Net Weight kg (lb)	Shipping Weight kg (lb)	
59301A	ASCII-to-Parallel Converter	101.6 x 212.9 x 294.6 (4 x 8.38 x 11.6)	1.70 (3.78)	2.32 (5.16)	
59303A	Digital-to-Analog Converter	101.6 x 105.9 x 294.6 (4 x 4.17 x 11.6)	2.61 (5.80)	3.17 (7.04)	
59306A	Relay Actuator	101.6 x 212.9 x 294.6 (4 x 8.38 x 11.6)	2.64 (5.87)	3.23 (7.18)	
59307A	VHF Switch	101.6 x 212.9 x 294.6 (4 x 8.38 x 11.6)	2.64 (5.87)	3.23 (7.18)	
59309A	HP-IB Digital Clock	101.6 x 105.9 x 294.6 (4 x 4.17 x 11.6)	1.70 (3.78)	2.84 (6.31)	
59313A	Analog-to-Digital Converter	101.6 x 212.9 x 345.4 (4 x 8.38 x 13.6)	5.45 (12.0)	6.36 (14.0)	
59401A	Bus System Analyzer	145.5 x 205.1 x 495.3 (5.73 x 8.08 x 19.5)	5.64 (12.44)	9.1 (20)	
59501B	Power Supply Programmer	101.6 x 212.9 x 294.6 (4 x 8.38 x 11.6)	2.61 (5.80)	3.17 (7.04)	



# HEWLETT-PACKARD INTERFACE BUS

Versatile Interconnect System for Instruments and Controllers

Models 37203A, 37203L

- Transparent HP-IB extension up to 1000 metres
- HP-IB transfer rate up to 50 k bytes/s
- Supports all HP-IB functions including pass control and parallel poll

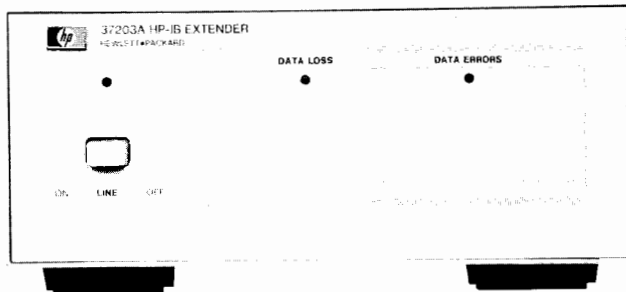

HP 37203A



- Electrical isolation plus error detection and correction protect HP-IB from transmission errors
- Transmission over single low-cost coaxial cable or, with option 001, dual optical fiber

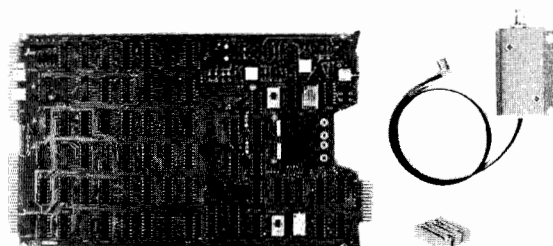

HP 37203L

## 37203A HP-IB Extender

The HP 37203A HP-IB Extender overcomes the range limitations imposed by the cabling rules of the Interface Bus and provides high-speed, low-cost extension up to 1000 metres.

HP 37203A's are used in pairs: each Extender serialises the normally parallel HP-IB information and transmits it to the other Extender where it is reconverted back to its original format. The transmission medium can be a single low-cost coaxial cable for both directions of transmission or, when Option 001 is fitted, dual optical fiber.

The HP 37203A is in general compliance with each of the following standards and supports their major capabilities

- IEEE Standard 488-1978
- ANSI Standard MC1.1
- IEC Standard 625-1

## HP 37203L HP-IB Extender

The HP 37203L is a repackaged version of the HP 37203A on an L-series computer card specifically designed for installation in the HP 2250A Measurement and Control Processor and HP 1000 L-series Computer. It operates in conjunction with a HP 37203A or another HP 37203L at the other end of the link. The transmission media and distances are the same as for the HP 37203A. The HP 37203L is supplied as a single circuit card together with two cable assemblies. Power is supplied from the HP 2250A or Computer mainframe. Operating characteristics are identical to those of the HP 37203A.

## Operating Characteristics (HP 37203A/L) Speed/Range

The table below shows the trade-off between maximum byte transfer rate and distance for coaxial cable and optical fiber.

Table 1. Nominal HP-IB Transfer Rates and Response Times

	Max HP-IB byte transfer rate (kbytes/sec)	Max SRQ propagation delay ( $\mu$ s)	Max Parallel Poll response time ( $\mu$ s)
Coaxial Cable			
Short* (at normal speed)	50	14	20
250m (max range at normal speed)	40	18	25
500m (max range at $1/4$ speed)	14.2	55	75
1000m (max range at $1/16$ speed)	2.75	200	270
Fiber Optics (opt 001)			
Short*	50	14	20
250m	39	20	25
1000m	25	30	40

\*For distances <250m, interpolate between Short and 250m.

## Parallel Poll Operation

The HP 37203A supports the Parallel Poll function but because of the absolute transmission delay, a guaranteed response cannot be delivered within 200 ns, as required by IEEE 488. Instead, the response from distant devices is returned as rapidly as possible to the polling controller.

## Error Detection and Correction

Data is transmitted across the link in frames. Each frame includes a cyclic redundancy check code which is rechecked when the frame is received. Any transmission errors which are detected cause the frame to be rejected. Data integrity is maintained by automatic retransmission of the rejected data frame. The presence of errors in the received data causes the DATA ERRORS indicator on the HP 37203A front panel to be illuminated. A break in the link, or loss of power at the remote Extender will cease all activity on the Bus until the link is re-established.

## Transmission Over Coaxial Cable

The standard serial link between Extenders is a single coaxial cable which is used for transmission in both directions. Coaxial cable was chosen for this link because it is relatively inexpensive, easy to handle, and easy to obtain. The use of Belden type 9248B cable (or equivalent) is recommended.

## Transmission Over Optical Fiber

Option 001 of the HP 37203A/L provides the capability of operation over duplex optical fiber as a user-selectable alternative to coaxial cable. The use of optical fiber removes the metallic path between the Extenders and, therefore, eliminates all risk of electromagnetic pick-up on the link. Option 001 is recommended for use in severe electrical environments or where the use of electrical signaling is not acceptable. A further advantage of optical fiber is that it enables a higher byte transfer rate to be attained for transmission distances greater than 250m than is possible with coaxial cable (see Table 1).

## Accessories

HP 39200B Duplex fiber optic cable  
HP 92179G Coaxial Cable  
HP 92226A BNC Connector, male

## Options (37203A/L)

001: Fiber Optic Interface  
010: Power Fail Option for use with HP 3000 Computer  
301: Rack Mount Adaptor (HP 37203A only)  
302: Dual Rack Mount Adaptor (HP 37203 only)

## Ordering Information

HP 37203A HP-IB Extender  
HP 37203L HP-IB Extender



# HEWLETT-PACKARD INTERFACE BUS

## Versatile Interconnect System for Instruments and Controllers

Model 37201A



- Transparent extension of HP-IB systems
- Operation over twin-pair cable or modems
- Automatic error detection and correction
- High immunity to electrical interference
- Multi-point (multi-drop) capability
- Auto-dialler interface

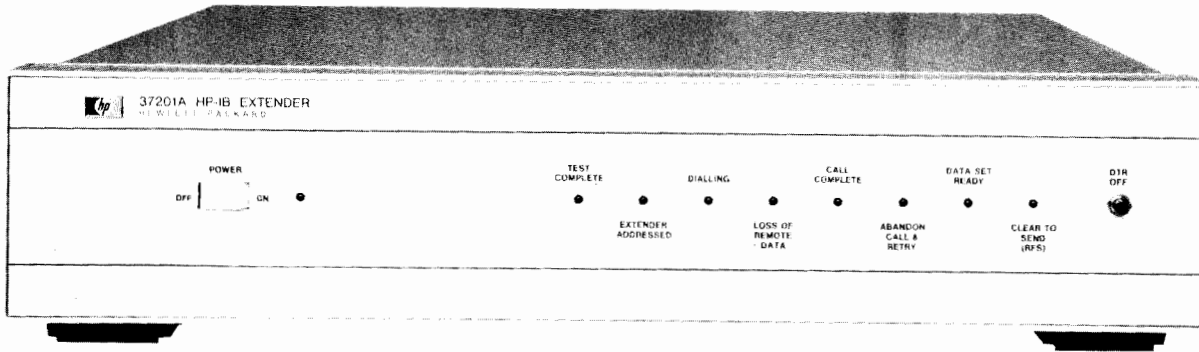

The 37201A HP-IB Extender overcomes the limited range available with direct HP-IB cable interconnections. Each 37201A converts parallel data from the interface bus into a serial bit stream, suitable for transmission to a remote site, and reconverts incoming serial data to bit-parallel HP-IB format. An HP-IB system can therefore be split into two or more discrete parts separated by HP-IB Extenders and a serial data link. A range of 1000 metres is obtainable if twin-pair cable is used for the transmission path, and virtually unlimited range is available if a modem link is used. Communication between Extenders is full duplex, allowing information to flow in both directions simultaneously.

Integrity of HP-IB data and control signals is assured by an automatic error-checking protocol, which retransmits any data corrupted in transmission. The 37201A is in general compliance with each of the following standards and supports their major capabilities:

- IEEE Standard 488-1978
- ANSI Standard MC1.1
- IEC Standard 625-1

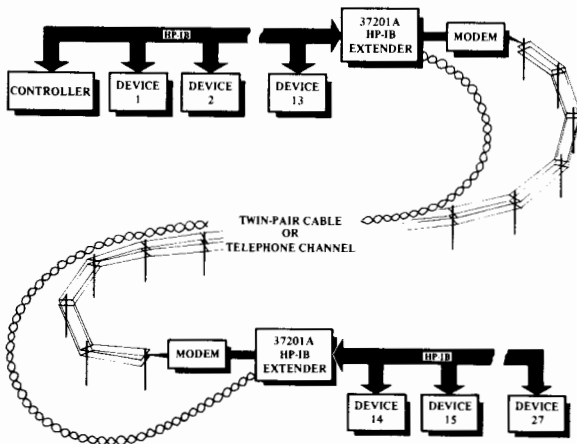

Point-to-point connection using twin twisted pair cable or full duplex modem link.

A pair of HP-IB Extenders provides a transparent interface between local and remote HP-IB devices. Program control of the 37201A is seldom necessary. Consequently, HP-IB Extenders can be added to an HP-IB system usually without any modification of software and without writing special routines to control the Extenders.

The 37201A supports the full range of HP-IB functions with the exception of Parallel Poll and Pass Control.

### Twin-Pair Cable Operation

Twin twisted-pair cable provides a simple inexpensive transmission medium for distances up to 1000 metres. The serial data rate is nominally 20 kbit/s. Suitable cable is available as an accessory (HP Part Number 8120-1187). Transformer coupling within the 37201A gives a high degree of immunity from the effects of common mode signals. This, combined with the automatic error correction capability, makes the 37201A suitable for use in an electrically hostile environment.

### Modem Link Operation

The 37201A is designed to operate with a wide range of synchronous and asynchronous modems over private lines, leased lines, or the public switched (dial-up) telephone network. The data interface is compatible with EIA RS-232C and CCITT V.24 and V.28 standards. Asynchronous data rates provided are: 150, 300, 600, and 1200 bit/s. For synchronous modems, operation at any bit rate up to 19.2 kbit/s is possible. Besides operating in point-to-point mode, the 37201A can be used with modems in a multi-point (multi-drop) leased line configuration involving up to 31 remote sites. When operating over the public switched telephone network, connections may be dialed manually. Alternatively, an external auto-dialler may be used to make connections under program control. The 37201A has an RS-366/V.25 interface to permit operation with an auto-dialler.

The error checking/correcting communications protocol used in the 37201A protects against errors introduced by poor quality data circuits. It even provides immunity to major interruptions in the data link, such as dropouts, line breaks and modem sync loss, and recovers automatically without loss of data.

### 37201A HP-IB Extender

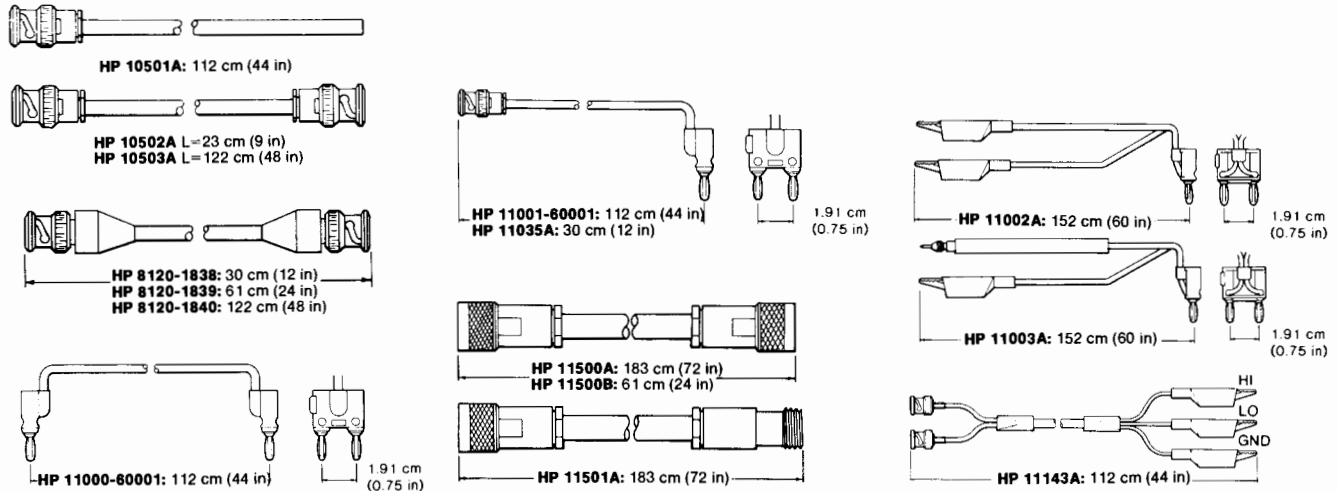

### Cable Assemblies

- HP 10501A:** 112 cm 50Ω coax with one UG-88C/U BNC (m) connector
- HP 10502A:** 23 cm 50Ω coax with UG-88C/U BNC (m) connectors
- HP 10503A:** like HP 10503A, but 122 cm
- HP 8120-1838:** 30 cm 50Ω coax with two BNC (m) connectors
- HP 8120-1839:** like HP 8120-1838, but 61 cm
- HP 8120-1840:** like HP 8120-1838, but 122 cm
- HP 11000-60001:** 112 cm 50Ω coax with dual banana plugs
- HP 11001-60001:** 112 cm 50Ω coax, UG-88C/U BNC (m) to dual banana plug

### Cable Assemblies

- HP 11035A:** like HP 11001-60001, but 30 cm
- HP 11500A:** 183 cm 50Ω coax with UG-21D/U Type N (m) connectors
- HP 11500B:** like HP 11500A, but 61 cm
- HP 11501A:** 183 cm 50Ω coax with UG-21D/U (m) and UG-23D (f) type N connectors
- HP 11002A Test Leads:** 152 cm, alligator clips to dual banana plug
- HP 11003A Test Leads:** 152 cm, probe and alligator clip to dual banana plug
- HP 11143A:** 112 cm, dual BNC (m) to alligator clips

### Coaxial Connector & Adapter Performance

The performance curves in the graph will help you in choosing and applying HP cables, connectors and adapters. SWR curves show design specifications for mated pairs of connectors of the type indicated. You can expect typical performance in that range.

For cross-series adapters, use the curve with the highest SWR in each case. For applications of Tee-adapters such as HP 1250-0559, 1250-0846 and 1250-0781, be sure to consider the extra shunt capacitance of the Tee.

Of course when HP mounts various connectors onto RF and microwave products, the product specification predominates and SWR is often far superior to that shown in these utility curves. For example, the HP "precision" Type-N adapters shown on the next page are for high accuracy use dc-1.3 GHz where SWR < 1.03.

For more information on history and performance of various coax connectors, see pages 90-91 in HP's 1984 *Coaxial & Waveguide Measurement Accessories Catalog*. (Lit # 5952-8262).

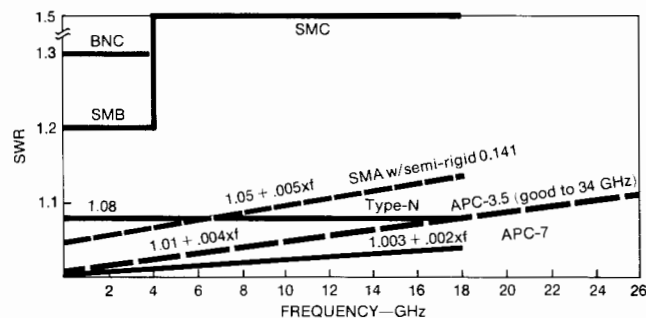

Typical SWR for connector pairs.





**HP 1250-0077**  
**HP 1250-1534**  
**HP 1250-1477**

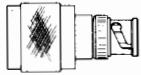

**HP 1250-0082**  
**HP 1250-1533**  
**HP 1250-1473**

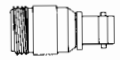

**HP 1250-1474**  
**HP 1250-1536**

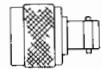

**HP 1250-0780**  
**HP 1250-1535**  
**HP 1250-1476**



**HP 1250-0176**

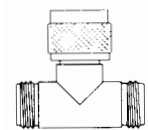

**HP 1250-0559**

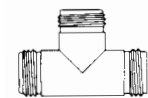

**HP 1250-0846**



**HP 1250-0777**  
**HP 1250-1529**  
**HP 1250-1472**

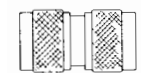

**HP 1250-0778**  
**HP 1250-1528**  
**HP 1250-1475**

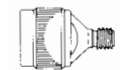

**HP 1250-1250**



**HP 1250-1158**



**HP 1250-1159**

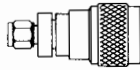

**HP 1250-1743**

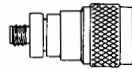

**HP 1250-1744**

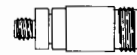

**HP 1250-1745**

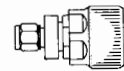

**HP 1250-1746**

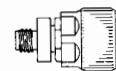

**HP 1250-1747**



**HP 1250-1748**



**HP 1250-1749**

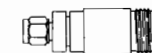

**HP 1250-1750**



**HP 1250-0831**

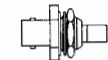

**HP 1250-1236**



**HP 1250-0832**



**HP 11524A**



**HP 11525A**



**HP 11533A**



**HP 11534A**



**HP 1250-0076**  
**HP 1250-1286**

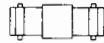

**HP 1250-0080**  
**HP 1250-1287**



**HP 1250-0216**  
**HP 1250-1288**

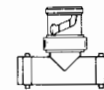

**HP 1250-0781**



**HP 1250-1263**

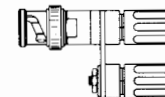

**HP 1250-1264**

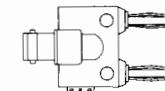

**HP 1251-2277**

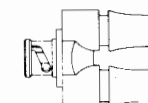

**HP 10110B**

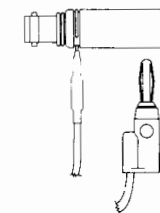

**HP 10111A**

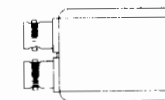

**HP 10113A**

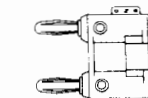

**HP 1251-2816**

### Adapters Type N, Standard 50 Ω

#### HP Part Number

1250-0077 N(f) to BNC(m)  
1250-0082 N(m) to BNC(m)  
1250-0176 N(m) to N(f) right angle (use below 12 GHz)  
1250-0559 N tee, (m)(f)(f)  
1250-0777 N(f) to N(f)  
1250-0778 N(m) to N(m)  
1250-0780 N(m) to BNC(f)  
1250-0846 N tee (f)(f)(f)  
1250-1250 N(m) to SMA(f)

### Adapters Type N, Precision 50 Ω<sup>[1]</sup>

1250-1472 N(f) to N(f)  
1250-1473 N(m) to BNC(m)  
1250-1474 N(f) to BNC(f)  
1250-1475 N(m) to N(m)  
1250-1476 N(m) to BNC(f)  
1250-1477 N(f) to BNC(m)

### Adapters Type N, Standard 75 Ω<sup>[2]</sup>

1250-1528 N(m) to N(m)  
1250-1529 N(f) to N(f)  
1250-1533 N(m) to BNC(m)  
1250-1534 N(f) to BNC(m)  
1250-1535 N(m) to BNC(f)  
1250-1536 N(f) to BNC(f)

### Adapters APC-3.5

1250-1743 APC-3.5(m) to N(m)  
1250-1744 APC-3.5(f) to N(m)  
1250-1745 APC-3.5(f) to N(f)  
1250-1746 APC-3.5(m) to APC-7  
1250-1747 APC-3.5(f) to APC-7  
1250-1748 APC-3.5(m) to APC-3.5(m)  
1250-1749 APC-3.5(f) to APC-3.5(f)  
1250-1750 APC-3.5(m) to N(f)

### Adapters SMA

1250-1158 SMA(f) to SMA(f)  
1250-1159 SMA(m) to SMA(m)

### Adapters SMB, SMC<sup>[4]</sup>

1250-0831 SMC(m) to BNC(m)  
1250-0832 SMC(f) to BNC(f)  
1250-1236 SMB(f) to BNC(f)

### Adapters APC-7<sup>®</sup>

11524A APC-7 to N(f)  
11525A APC-7 to N(m)  
11533A APC-7 to SMA (m)  
11534A APC-7 to SMA (f)

### Adapter Banana Plug

1251-2816 Dual banana plug

### Adapters BNC, Standard 50 Ω

1250-0076 Right angle BNC(UG-306/D)  
1250-0080 BNC(f) to BNC(f) (UG-914/U)  
1250-0216 BNC(m) to BNC(m)  
1250-0781 BNC tee(m)(f)(f)  
1250-1263 BNC(m) to single banana plug  
1250-1264 BNC(m) to dual banana plug  
1251-2277 BNC(f) to dual banana plug  
10110B BNC(m) to dual banana plug  
10111A BNC(f) to shielded banana plug  
10113A Dual BNC(f) to triple banana plug

### Adapters BNC, Standard 75 Ω<sup>[3]</sup>

1250-1286 Right angle BNC  
1250-1287 BNC(f) to BNC(f)  
1250-1288 BNC(m) to BNC(m)

<sup>[1]</sup> "Precision": typically ≥36 dB return loss to 1.3 GHz.

<sup>[2]</sup> Type N outer conductor; center pin sized for 75 Ω characteristic.

<sup>[3]</sup> BNC outer conductor; center pin sized for 75 Ω characteristic.

<sup>[4]</sup> SMB & SMC are used often inside HP instruments for inter-module connections.

<sup>®</sup> A registered trademark of the Bunker Ramo Corporation



# CABINET ACCESSORIES

## System II—Handles and Rack Flanges, Bail Handle Kit

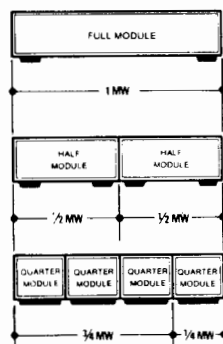
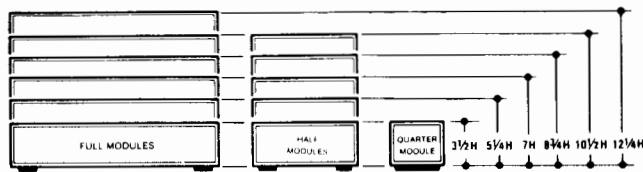

System II Cabinet Design

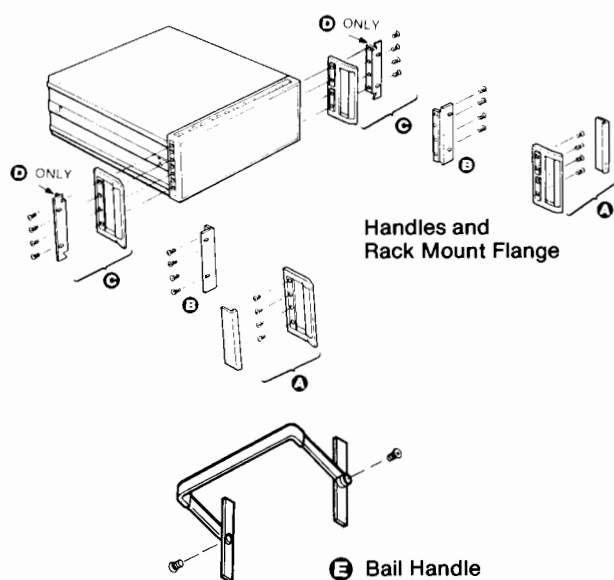
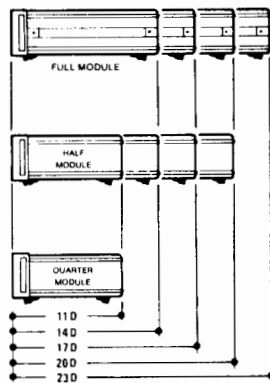

Handles and Rack Mount Flange

Bail Handle

NOTICE - Early in 1985, HP will begin shipping new instruments in the System II cabinets with metric fastening hardware. The cabinet accessories on this page use English standard fasteners and are compatible with all pre-1985 instruments.

If you wish to order cabinet accessories for a new (1985) instrument, we suggest you first refer to the accompanying instruction manual which will indicate whether it uses metric or English cabinet fasteners. Then reference the required accessory below, but be sure to specify if you need the *metric* equivalent.

### System II Cabinet Design

HP's modular cabinet system offers bench-stacking and rack mounting versatility. Many of HP's newer instruments are packaged in this System II frame, easily recognized by the cast aluminum front and rear frames. System II uses optional front corner handles characterized by a slight outward flare.

The family of System II modules is designed for compatibility with EIA and IEC racking standards, both in width and height. Each HP instrument specification contains dimensional information to tell you which module size is used.

### Handles and Rack Mount Flanges

Handles and rack flanges are available for all System II cabinets, although they find most use on full width modules or combinations of narrower modules locked together to form 1 MW (module width).

Certain instruments are supplied with front handles as part of the selling price. Handles and rack flanges can be supplied with any instrument by specifying the appropriate option from the following, at the time of order list. The extra cost of each option is usually specified on the instrument data sheet.

- Option 907 Front Handles
- Option 908 Rack Mount Flanges
- Option 909 Handles with Rack Flanges
- Option 913 Rack Mount Flanges (If handles already furnished) (HP 5061-2069 Version)

The table below describes kits available for use after receipt of equipment. Field installation is very straight-forward. A plastic trim strip is easily removed and the handle or flange attached with screws supplied in the kit. Before rack mounting, bottom feet must be removed.

### Bail Handle Kit

For 1/2 MW cabinets, you can attach this front bail handle for easy portability. Attaching hardware furnished.

HP Part No.	Name
5061-2001	Bail Handle Kit for 3 1/2 H Module
5061-2002	Bail Handle Kit for 5 1/4 H Module
5061-2003	Bail Handle Kit for 7 H Module

### Handle and Rack Flanges

Instrument Module Height	A Front Handle Kit		B Rack Mount Flange Kit [3]		C Rack Mount Flange Kits with Handles		D Rack Mount Flange Kit for Instruments With Previously Supplied Handles	
	HP Part No.		HP Part No.		HP Part No.		HP Part No.	
3 1/2 H	5061-0088		5061-0074[1]		5061-0075[1]		5061-2069[1]	
3 1/2 H	—		5061-0076[2]		5061-0082[2]		5061-2070[2]	
5 1/4 H	5061-0089		5061-0077		5061-0083		5061-2071	
7 H	5061-0090		5061-0078		5061-0084		5061-2072	
8 3/4 H	5061-0091		5061-0079		5061-0085		5061-2073	
10 1/2 H	5061-0092		5061-0080		5061-0086		5061-2074	
12 1/4 H	5061-0093		5061-0081		5061-0087		5061-2075	
<b>Kit includes</b>	2 Handles + 2 Trim Strips + Mtg. Screws		2 Flanges + Mtg. Screws		2 Handles + 2 Flanges + Mtg. Screws		2 Flanges + Mtg. Screws	

[1] HP 5061-0074/0075/2069 Kits use standard flanges with 1.75" hole spacing.  
 [2] HP 5061-0076/0082/2070 Kits use special flange with 3.00" hole spacing.

[3] Will not fit onto instruments with previously supplied handles.

[4] Option 913 ordered on instruments supplies HP 5061-2069. For 3.00" spacing order HP 5061-2070 instead of Opt. 913.

# CABINET ACCESSORIES

## System II—Support Shelves, Filler Panels

NOTICE - Early in 1985, HP will begin shipping new instruments in the System II cabinets with metric fastening hardware. The cabinet accessories on this page use English standard fasteners and are compatible with all pre-1985 instruments.

If you wish to order cabinet accessories for a new (1985) instrument, we suggest you first refer to the accompanying instruction manual which will indicate whether it uses metric or English cabinet fasteners. Then reference the required accessory below, but be sure to specify if you need the *metric* equivalent.

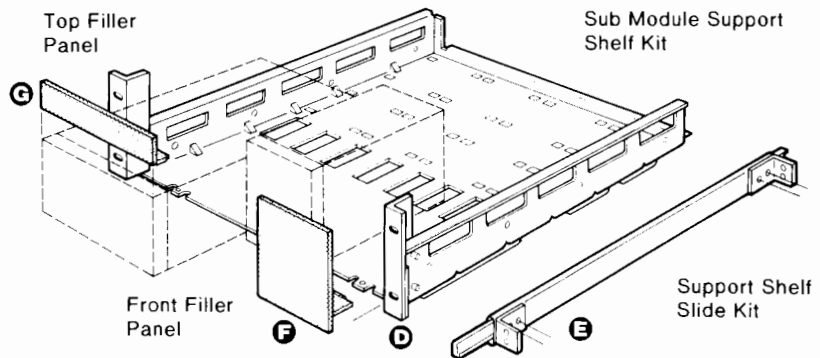
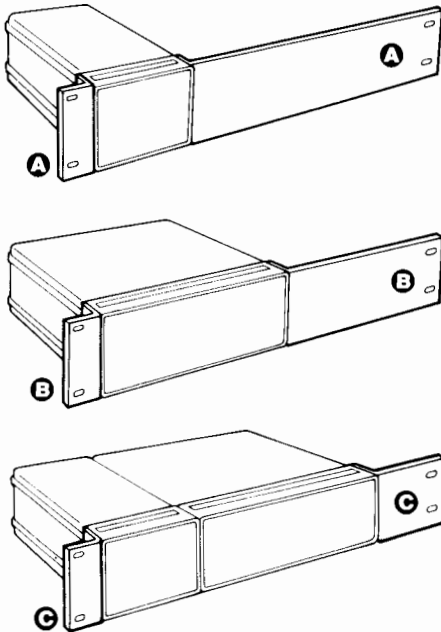

### Rack Mount Adapter Kits

Modules of less than 1 MW can be rack mounted using these kits. Individual 1/4 MW or 1/2 MW modules use the kits shown below directly. Combinations of 1/4 MW and 1/2 MW (of equal depth) are first joined side-by-side with the Lock Link Kit (HP 5061-0094) (following page), then have end flanges applied. Combinations adding to 1 MW use regular rack flange kit (previous page). Kits include attaching screws but not front panel rack mounting screws. Hole patterns conform to EIA and IEC standards.

### Rack Mount Adapter Kits

	<b>A</b> Mounts 1/4 MW Module	<b>B</b> Mounts 1/2 MW or 2 ea. 1/4 MW[2] Modules	<b>C</b> Mounts 3/4 MW (3 ea. 1/4 MW)[1] or 1/4 & 1/2 MW side-by-side[2]
	HP Part No.	HP Part No.	HP Part No.
3 1/2 H	5061-0073	5061-0072	5061-0071
5 1/4 H	—	5061-0057	5061-0058
7 H	—	5061-0060	5061-0061
10 1/2 H	—	5061-0066	5061-0067
<b>Kit includes</b>	1 ea. rack flange 1 ea. 1/4 MW extension adapter flange and screws	1 ea. rack flange 1 ea. 1/2 MW extension adapter flange and screws	1 ea. rack flange 1 ea. 1/4 MW extension adapter flange and screws

[1] 1/2 MW can be center mounted using 2 of these kits.  
[2] Side-by-side modules of equal depth require lock link kit (HP 5061-0094).

### Support Shelf, Slide, and Filler Panels

Submodules of differing heights, widths, and depths (up to 20 D) may be rack-mounted using these support shelves. Any combination of 1/4 MW and 1/2 MW will fit side-by-side up to 1 MW. Filler panels close up vacant spaces either on top of short modules or side-by-side. The slide kit provides ready access to internal shelf areas and is designed for HP racks with 24-inch depth vertical support rails. Slide kit includes brackets and mounting screws.

### HP Part No. Name

- 5061-0096 **D** Support Shelf for 3 1/2 H Modules
- 5061-0097 **D** Support Shelf for 5 1/4 H Modules
- 5061-0098 **D** Support Shelf for 7 H Modules
- 1494-0041 **E** Slide Kit (2 ea slides, brackets, hardware)

### Filler Panels

	Description	Size	HP Part No.
<b>F</b>	For 3 1/2 H support shelf partially filled with instruments, and having the following front panel space to fill:	1/4 MW to fill 1/2 MW to fill 3/4 MW to fill	5061-2021 5061-2022 5061-2023
<b>F</b>	For 5 1/4 H support shelf, and having the following front panel space to fill:	1/4 MW to fill 1/2 MW to fill	5061-2024 5061-2025
<b>F</b>	For 7 H support shelf, and having the following front panel space to fill:	1/4 MW to fill 1/2 MW to fill	5061-2066 5061-2027
<b>G</b>	For 1/4 MW and having the following vertical space to fill:	1 3/4 H 3 1/2 H	5061-2035 5061-2036
<b>G</b>	For 1/2 MW and having the following vertical space to fill:	1 3/4 H 3 1/2 H	5061-2037 5061-2038



# CABINET ACCESSORIES

## System II—Lock Link Kits, Rack Mount Slide Kits

NOTICE - Early in 1985, HP will begin shipping new instruments in the System II cabinets with metric fastening hardware. The cabinet accessories on this page use English standard fasteners and are compatible with all pre-1985 instruments.

If you wish to order cabinet accessories for a new (1985) instrument, we suggest you first refer to the accompanying instruction manual which will indicate whether it uses metric or English cabinet fasteners. Then reference the required accessory below, but be sure to specify if you need the *metric* equivalent.

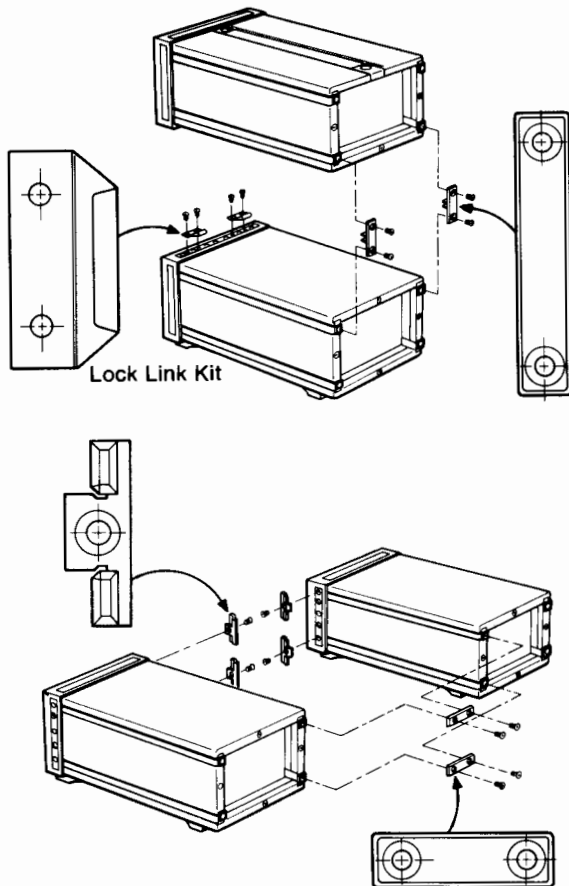

### Lock Link Kits HP 5061-0094

All sub-module cabinets of *equal depths* can be linked together over-under or side-by-side with hardware in the lock link kit. Cabinet frames are already pre-threaded to allow quick assembly. For side-by-side connections the kit contains 12 front hooks and six rear links, enough for 3 side-by-side joints. For vertical connections, the kit also contains four front hooks and four rear links enough for two over-under joints. Kit includes screws. Locking cabinets together horizontally in a configuration wider than 1 MW is not recommended.

If the over-under linked combination is to include rear standoff feet (HP 5061-2009), then the over-under locking feet kit HP 5061-0099 (next page) should be used for over-under connection.

The HP 5061-0094 Lock Link Kit is not recommended for full module over/under combinations. Use Kit HP 5061-0099 Locking Feet Kit (next page) to handle those larger weights.

### Slide Kits and Rack Brackets

Rack slides are available for full-width System II cabinets to permit easy access to internal spaces. Each kit consists of two slides which mount directly to System II cabinet side handle recess spaces (after removing side handles). The slides also mount directly to vertical support rails in HP-racks. HP 1494-0018 mounts 14D and 17D depth System II cabinets. HP 1494-0017; 20D and 23D.

Standard weight slides carry 38.6 kg (85 lbs) max. load. Tilting versions are available in standard duty only. (HP 1494-0025 and 1494-0026.)

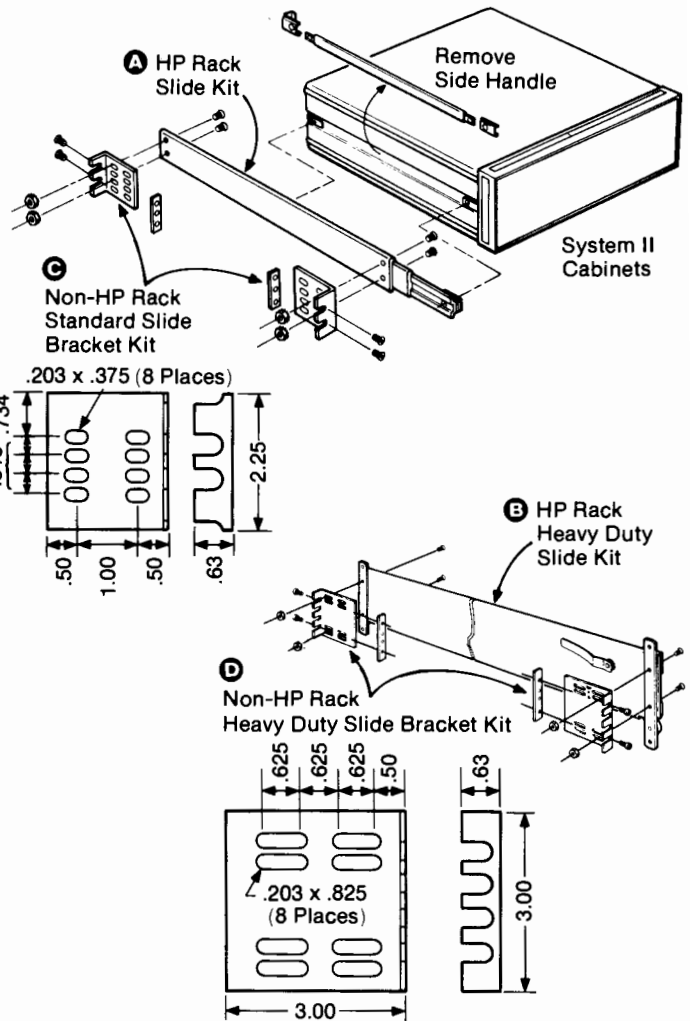

For non-HP-racks, end bracket kits are available for both standard and heavy duty slide kits. Slotted hole arrays in the brackets provide for front-to-back rack rail spacing of 24, 26, and 28-inch nominal centers. They also allow choice of two vertical positions. Each kit of four brackets includes screws and four bar nuts. These general purpose mounting brackets fit most common non-HP-racks such as GE, Honeywell, etc.

### HP Part No. Name

5061-0094	Lock Link Kit
1494-0018	A Non-Tilting, Std. Slide Kit, Fits 14D & 17D Cabinets
1494-0017	A Non-Tilting, Std. Slide Kit, Fits 20D & 23D Cabinets
1494-0025	Tilting, Std. Slide Kit, Fits 14D & 17D Cabinets
1494-0026	Tilting, Std. Slide Kit, Fits 20D & 23D Cabinets
1494-0016	B Non-Tilting, Heavy Duty Slide Kits (20D & 23D Cabinets Only)
1494-0023	C (4) End Brackets for Non-HP Racks, Std. Slides
1494-0042	D (4) End Brackets for Non-HP Racks, Heavy Duty Slides

**NOTICE** - Early in 1985, HP will begin shipping new instruments in the System II cabinets with metric fastening hardware. The cabinet accessories on this page use English standard fasteners and are compatible with all pre-1985 instruments.

If you wish to order cabinet accessories for a new (1985) instrument, we suggest you first refer to the accompanying instruction manual which will indicate whether it uses metric or English cabinet fasteners. Then reference the required accessory below, but be sure to specify if you need the *metric* equivalent.

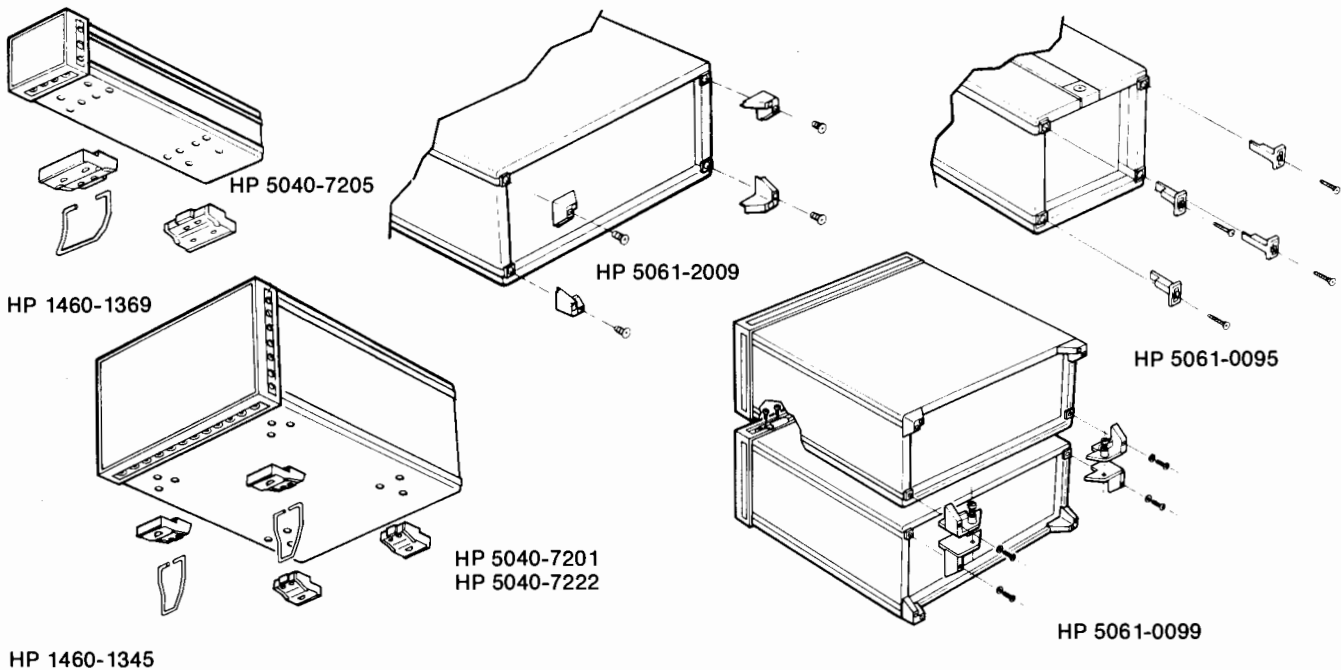

## Bottom and Rear Cabinet Feet

### Cabinet Rear Standoff Feet HP 5061-2009

Kit HP 5061-2009 provides four corner feet which give 25.4 mm (1-in.) stand-off protection to the rear panel of instruments. It is used when instruments are to be operated or stored vertically on their rear panels. (Fits all but 1/4 MW by 3½H). Includes mounting screws.

### Cord Wrap Feet Kit HP 5061-0095

Kit HP 5061-0095 contains four ribbed corner posts on which you can wrap power cords or signal cables for transport or storage. (Recommended for 1/4 MW and 1/2 MW cabinets weighing less than 11 kg, (24 lbs). Includes mounting screws.

### Cabinet Bottom Feet and Tilt Stands

The standard foot HP 5040-7201 fits the bottom of full width and 1/2 MW cabinets. It fits front or rear and four are required. HP 5040-7222 foot is a non-skid version. Used in pairs it can prevent bench-top creeping. Tilt-stand HP 1460-1345 fits into the standard or non-skid foot and is used in pairs (front or rear) to tilt the instrument up or down for better viewing.

For 1/4 MW cabinets, foot HP 5040-7205 fits front or rear (two required). Tilt stand HP 1460-1369 fits the standard 1/4 MW foot and can be used front or rear depending on whether you want an upward or downward display.

### Rear Panel Locking Foot Kit

When full module cabinets are to be linked vertically, and rear standoff feet are planned, use this kit. It consists of right and left foot linking pairs and 2 front hooks, enough for one over-under joint.

Also requires one HP 5061-2009 foot kit to supply the remaining 4 corner feet.

HP Part No.	Name
5061-2009	Rear Standoff Feet Kit (4 Feet)
5061-0095	Cord Wrap Feet Kit (4 Feet)
5040-7201	Standard Foot
5040-7222	Non-Skid Foot
1460-1345	Tilt Stand
5040-7205	1/4 MW Foot
1460-1369	1/4 MW Tilt Stand
5061-0099	1 MW Cabinet Lock-Foot Kit



# CABINET ACCESSORIES

## SYSTEM I—Rack Hardware and Accessories

### System I Cabinet Design

System I Cabinets are still used on older HP instruments. System I can be identified by its front handles being integral with the side casting frame. These two pages describe accessories for use with System I Cabinets and small modular instruments.

HP 1051A

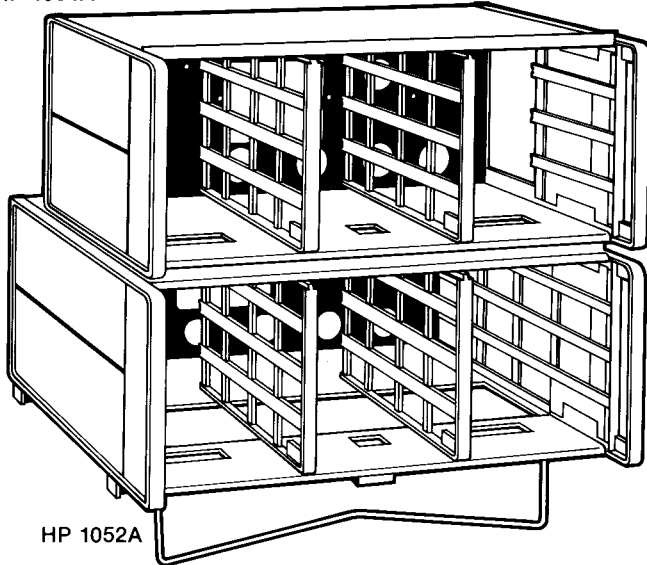

HP 1052A

### Combining Cases, HP 1051A, 1052A

HP 1051A and HP 1052A combining cases conveniently rack or bench mount combinations of small modular Hewlett-Packard SYSTEM I instruments. Both cases accept  $\frac{1}{2}$  or  $\frac{1}{3}$  instrument modules, 130mm or 198mm wide ( $5\frac{1}{8}$  or  $7\frac{25}{32}$  inches). The basic difference is that the HP 1052A is 130mm ( $5\frac{1}{8}$  in.) deeper and will accept modules up to 416mm deep ( $16\frac{3}{8}$  in.). The HP 1051A accepts instruments up to 286mm deep ( $11\frac{1}{4}$  in.). Each case is furnished with two dividers.

Accessory drawer HP 5060-8756 supplies storage space  $\frac{1}{2}$  width and 77mm ( $3\text{-}1\frac{3}{32}$ " high. Use an HP 5060-8758 filler panel above or below.

### HP 1051A, 1052A, 5060-8756 Specifications

#### Size

HP 1051A: 178 H x 482.6 W x 337 mm D ( $7''$  x  $19''$  x  $13\frac{1}{4}''$ ).

HP 1052A: 178 H x 482.6 W x 467 mm D ( $7''$  x  $19''$  x  $18\frac{3}{8}''$ ).

#### Weight

HP 1051A: net, 4.5 kg (10 lb). Shipping, 6.7 kg (15 lb).

HP 1052A: net, 5.4 kg (12 lb). Shipping, 8.1 kg (18 lb).

Opt 908: Rack Mount Kit

Opt 910: Extra Manual

HP 5060-8756 Accessory Drawer

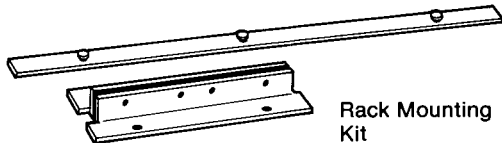

Rack Mounting Kit

### Rack Mounting Kits, HP 5060-8739 to 5060-8744

With these kits all Hewlett-Packard products in full rack-width cabinets of the integral side frame-handle style (see HP 1051A, 1052A, Combining Cases above) can be easily prepared for rack mounting. Each kit contains two flanges, a filler strip, and mounting screws.

### Rack Mounting Kit Ordering Information

HP Part Number	Nominal Cabinet Height	
	Millimetres	Inches
5060-8739	88.1	$3\frac{1}{2}$
5060-8740	132.6	$5\frac{1}{4}$
5060-8741*	177	7
5060-8742	221.5	$8\frac{3}{4}$
5060-8743	265.9	$10\frac{1}{2}$
5060-8744	310.4	$12\frac{1}{4}$

\*Also used to rack mount Combining Kits HP 1051A & 1052A shown above.

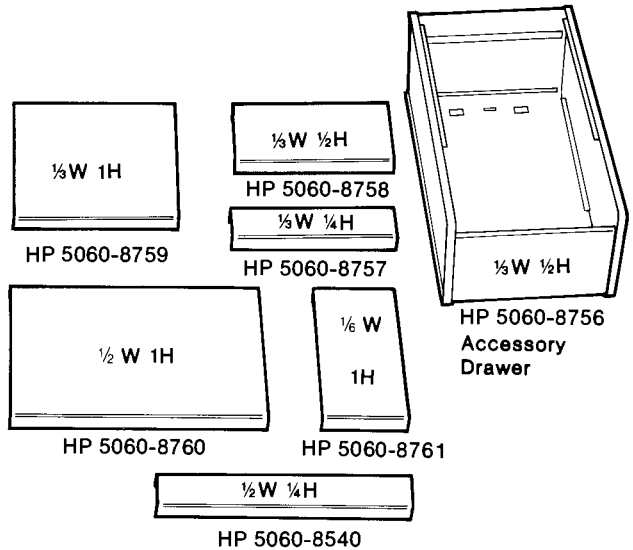

### Filler Panels, HP 5060-8540, 5060-8757 to 5060-8761

Filler panels can be used to close off any leftover space after instruments are mounted in combining cases (left) or adapter frames (below). Panels are available in a variety of widths and heights.

HP Part No.	Module Case Height x Width	Filter Panel Dimensions	
		Millimetres	Inches
5060-8540	$\frac{1}{4}$ x $\frac{1}{2}$	38 x 198	$1\frac{1}{2}$ x $7\frac{25}{32}$
5060-8757	$\frac{1}{4}$ x $\frac{1}{3}$	38 x 130	$1\frac{1}{2}$ x $5\frac{1}{8}$
5060-8758	$\frac{1}{2}$ x $\frac{1}{3}$	77 x 130	$3\frac{1}{32}$ x $5\frac{1}{8}$
5060-8759	full x $\frac{1}{3}$	155 x 130	$6\frac{3}{32}$ x $5\frac{1}{8}$
5060-8760	full x $\frac{1}{2}$	155 x 198	$6\frac{3}{32}$ x $7\frac{25}{32}$
5060-8761	full x $\frac{1}{6}$	155 x 63	$6\frac{3}{32}$ x $2\frac{31}{64}$

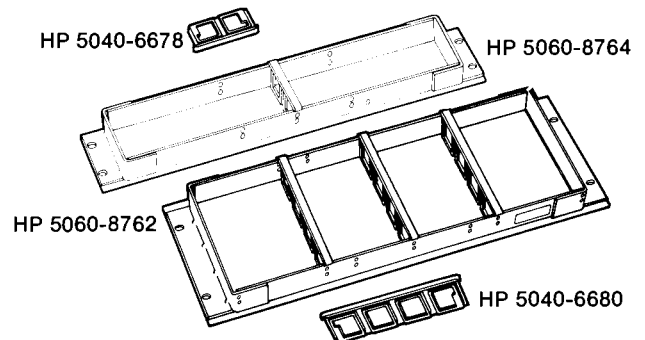

### Rack Adapter Frames, HP 5060-8762, 5060-8764

These frames can be used to hold combinations of  $\frac{1}{3}$  and  $\frac{1}{2}$  module-width HP instruments. Each frame is furnished with mounting hardware and three dividers. Two models are available for different instrument heights. Adapter frames are for permanent or semi-permanent rack mounting. Where quick removal and reinstallation of instruments is desirable, the HP 1015A and HP 10152A should be used.

HP 5060-8762 is 178mm (7 in.) high and accepts instruments heights of  $\frac{1}{4}$ H,  $\frac{1}{2}$ H, and 1H. HP 5060-8764 is 89mm ( $3\frac{1}{2}$  in.) high and accepts instruments of  $\frac{1}{4}$ H and  $\frac{1}{2}$ H.

### HP Part No. Name

5060-8762	Rack Adapter 178mm (7-in)
5060-8764	Rack Adapter 89mm ( $3\frac{1}{2}$ -in)
5040-6678	Extra Vertical Dividers for 5060-8764
5040-6680	Extra Vertical Dividers for 5060-8762



# CABINET ACCESSORIES

## System 1 - Slide Kits, Fans, Joining Brackets, Cases

687

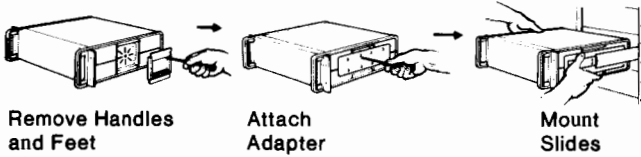

### Rack Mount Slide Kits and Cabinet Adapters

By removing the side handle of full width system 1 cabinets, rack mount slides can be attached for easy access to internal space. Both tilting and non-tilt are available, while max. load factor is 31.7 kg (70 lb). The cabinet adapter plate attaches to the handle recess then to the slide. Slide kits include four angle brackets which mount to rack rails with front-to-back nominal spacings of 24, 26 and 28-inches.

### Rack Mount Slide Kits, HP 1490-0713 to 1490-0720

HP Part Number <sup>1</sup>	Cabinet Depth	Extension Length
1490-0713*	All Sizes	482.6 (19) <sup>2</sup>
1490-0714*	All Sizes	635.0 (25) <sup>3</sup>
1490-0715#	279.4 (11)	482.6 (19) <sup>2</sup>
1490-0716#	406.4 (16)	482.6 (19) <sup>2</sup>
1490-0717#	279.4 (11)	533.4 (21) <sup>3</sup>
1490-0718#	406.4 (16)	558.8 (22) <sup>3</sup>
1490-0719#	482.6 (19)	635.0 (25) <sup>3</sup>
1490-0720#	558.8 (22)	635.0 (25) <sup>3</sup>

Notes: \*Fixed type slide; #Tilt type slide  
 1. Cabinet Adapters, below, must be added to slides  
 2. Slide's stationary mounting depth: 406.4 (16)  
 3. Slide's stationary mounting depth: 558.8 (22)

### Cabinet Adapters

HP Part No.	Name
1490-0722	Adapter plate for 88.9mm H(3½ in.) cabinets
1490-0721	Adapter plate for 133mm H(5¼ in.) and higher cabinets

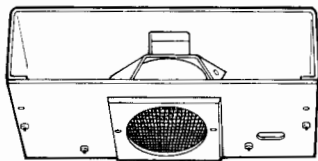

### Cooling Kits, HP 5060-0789 and 5060-0796

These cooling kits are designed to be easily installed in the rear of the HP 1052A Combining Case (only).

HP 5060-0789: 115 V, 50 to 60 Hz  
 HP 5060-0796: 230 V, 50 to 60 Hz

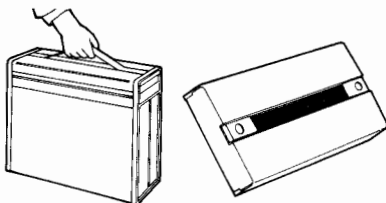

### Control Panel Covers, HP 5060-8766 to 5060-8771

A series of control panel covers equipped with carrying handles are available for full rack width instruments. These covers protect instrument front panels and make rack mounted instruments tamper-proof.

One of these covers, the HP 5060-8768, fits both the HP 1051A and the HP 1052A Combining Case (page 41.5). Other covers are available to fit the six modular enclosures with front panel heights ranging from 88.1 to 310.4 mm (3½ to 12¼ in.). Cover locks securely to front handles.

#### HP Part Number

- 5060-8766: 88.1 mm (3½ in.) EIA panel height
- 5060-8767: 132.6 mm (5¼ in.) EIA panel height
- 5060-8768: 177 mm (7 in.) EIA panel height
- 5060-8769: 221.5 mm (8 ¾ in.) EIA panel height
- 5060-8770: 265.9 mm (10½ in.) EIA panel height
- 5060-8771: 310.4 mm (12¼ in.) EIA panel height

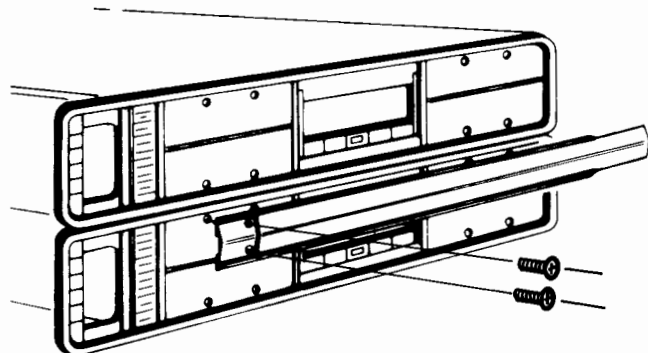

### Joining Bracket Kits, HP 5060-8541 to 5060-8545

These kits join HP System I instruments of the same width and length into easily handled single stacks. Each kit consists of two brackets, mounting hardware and trim. They are available to fit the three most common instrument depths:

#### HP Part Number

- 5060-8541: 279 mm (11 in.) EIA panel depth
- 5060-8543: 406 mm (16 in.) EIA panel depth
- 5060-8545: 480 mm (19 in.) EIA panel depth

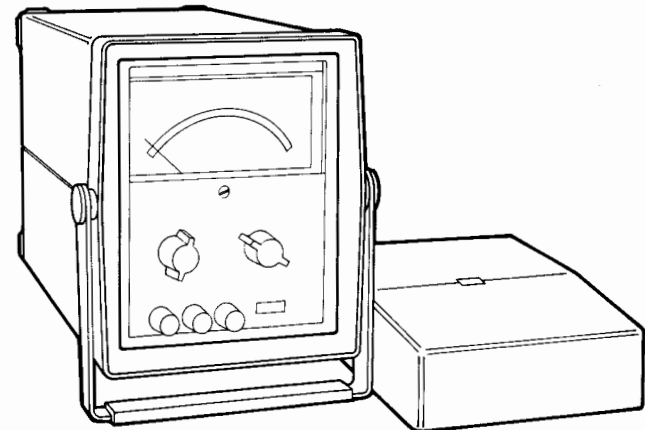

### Module Instrument Cases, HP 11075A, 11076A

Rugged, high impact plastic instrument cases for HP System I ½ module instruments. Instruments can be operated, stored or carried in this splashproof case. Storage compartment for power cord in rear of case is accessible through a removable hatch. Front lid contains adequate storage space for cables, test leads, etc. The dual purpose tilt stand also serves as a carrying case handle. The HP 11075A holds instruments 203 mm D (8 in.); HP 11076A carries modules up to 279 mm D (11 in.).

#### HP Part Number

- 11075A: Module Instrument Case
- 11076A: Module Instrument Case

# TRANSIT CASES

## Rugged Protection for Instruments

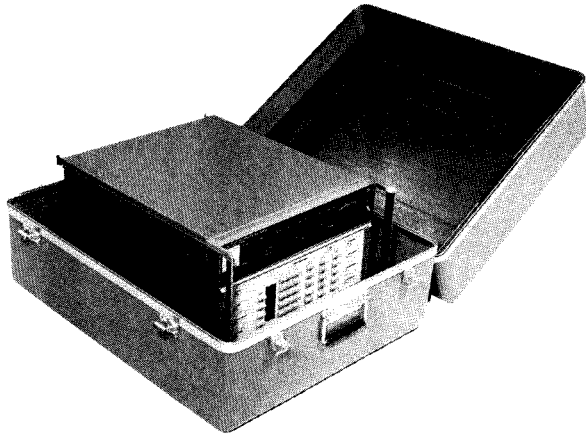

Typical System II Transit Case

Hewlett-Packard transit cases are rugged protective outer shells for use when instruments must be frequently transported or used away from laboratory conditions. HP cases protect your instruments from hostile environments, shock, vibration, moisture, and impact while providing a secure enclosure for shipping. The cases are molded from a structural composite which is 65% lighter than aluminum, yet which provides excellent strength and durability. Tests of the composite show tensile and compressive strength exceeding 33,000 PSI and flexural strength exceeding 45,000 PSI.

### Typical Uses

Transit cases are a necessity whenever equipment is frequently transported from one operating location or test site to another, or is shipped for testing and calibration. Transit cases are particularly valuable for instruments used by service and repair personnel. For example, telephone companies frequently use transit cases for the instruments they use to repair line faults. Transit cases are also valuable when instruments must be transported over rough roads, or are used in dusty environments or outdoors.

### Product Detail

HP transit cases are pressure molded of an extremely strong and light fiberglass and resin laminate which provides an excellent strength to weight ratio. All cases seal tightly with O-ring gaskets and clamping latches. They are rainproof under the test conditions of MIL-STD-108. Carrying handles are conveniently placed, and fold flat when not in use.

Transit cases are typically provided with foam cushions that are designed to cradle the instrument securely. Maximum protection is provided against damage from handling, dropping, or crushing. The cushion inserts are typically molded polyurethane, or are fabricated from slabs of polyurethane or polyethylene flexible foams. Each case/cushion unit is designed as its own shock and vibration damping system.

Hewlett-Packard's standard transit cases provide effective protection from all but the most abusive treatment. To ensure maximum protection for your instrument, transit cases are also available in versions that meet the specified requirements of MIL-STD-108, MIL-T-21 200, MIL-T-28800, MIL-T-4734, and MIL-C-4150.

Removable swivel casters are available as an option on certain HP transit cases. These cases are identified with a ★ on the case selection tables.

### How to Select the Proper Transit Case

Transit cases are available for almost all HP instruments. If you are ordering a case for one of HP's 80 most popular instruments and computation products, you can use the quick cross-reference table below. To order a case for any other instrument, please refer to "Accurate Measurements Assure Proper Fit" and use the tables for ordering System I and System II style cases.

HP Product Number to Transit Case Number Cross Reference

<b>Oscilloscopes</b>		<b>Voltmeters</b>		<b>Microwave Instruments</b>		<b>Communication Testing</b>	
1715A	9211-2459	3400A	9211-2667	432A/B	9211-1318	1645A	9211-1289
1725A	9211-2459	3455A	9211-2654	435B	9211-1318	3702B	9211-1294
1740A	9211-2459	3456A	9211-2654	436A	9211-2667	3710A	9211-1293
1741A	9211-2459	3466A	9211-2666	438A	9211-2676	3745A	9211-1297
1742A	9211-2459			8403A	9211-1292	4935A	9211-1289
1743A	9211-2459			8614A	9211-0839	4937A	9211-1289
				8616A	9211-0839	4945A	9211-2650
<b>Signal Generators</b>		<b>Signal Analyzers</b>		8671A	9211-2661	4951A	9211-1895
8640B	9211-0839	141T	9211-1294	8672A	9211-2661	4953A	9211-2644
8642A/B	9211-2661	334A	9211-1289	8673B	9211-2661	4955A	9211-2662
8654A	9211-2800	3325A	9211-2662	8673C/D	9211-2676		
8654B	9211-2644	339A	9211-2643	<b>Component Measurement</b>		<b>Function Generators</b>	
8656B	9211-2661	3561A	9211-2459	4145A	9211-2663	3325A	9211-2655
8660A/C	9211-2662	3562A	9211-2663	4191A	9211-2663	3330A	9211-1163
8662A	9211-2662	3582A	9211-2662	4192A	9211-2663	3336C	9211-2655
8663A	9211-2662	3585A	9211-2663	5345A	9211-2682		
<b>Recorders</b>		3586C	9211-2650	<b>Network Instruments</b>		<b>Computing Products/Terminals</b>	
3968A	9211-2557	5423A	9211-2661	3336A/B	9211-2655	262X series	9211-4677
<b>Counters</b>		8555A	9211-2671	3577A	9211-2663	264X series	9211-4676
5328A/B	9211-1292	8565A	9211-2656	3586A/B	9211-2650	82905B	9211-4684
5342A	9211-2682	8566A	9211-1297	8350B	9211-2649	85/86B	9211-4120
5340A	9211-1292	8568A	9211-2664	8405A	9211-1293	9134A	9211-0839
5343A	9211-2682	8569A	9211-2656	8505A	9211-2665	9826A	9211-2662
5345A	9211-1296			8620C	9211-1289		
				8754A	9211-2661		
				8756A	9211-2656		

### Instrument Cabinet System Styles

Hewlett-Packard produces two styles of cabinet systems: System I and System II. The most visible difference is handle configuration; the handles on System I instruments are a part of the instrument side frame, and project at 90 degrees from the instrument face. The handles on System II modules also project at 90 degrees from the instrument face, but are not a part of the instrument frame, are easily removable, and are turned outward at the handle grip. Each of the cabinet styles requires a different cushion insert configuration. This difference makes it important to order your case from the correct selection table.

### Transit Case Styles

Each transit case is coded according to its style in the following tables: Valise (V), hinged with the handle opposite the hinge; Transit (T), a completely removable cover with a handle at each end; and Valise Transit (VT), a hinged transit case with a handle opposite the hinge and a handle at each end. Each case is designed and manufactured in the style which best suits the configuration of its instrument. If a style other than the standard is more appropriate for your application, a special case can be ordered.

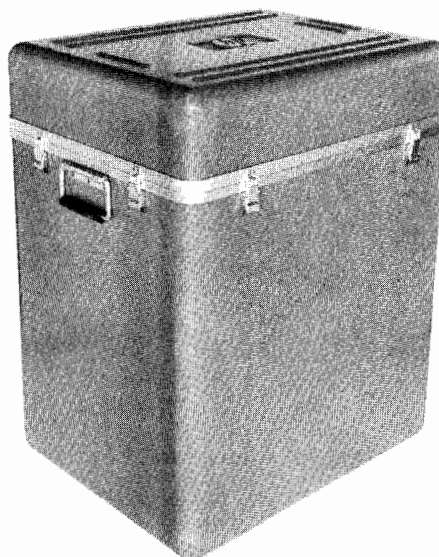

Typical transit (T) style case

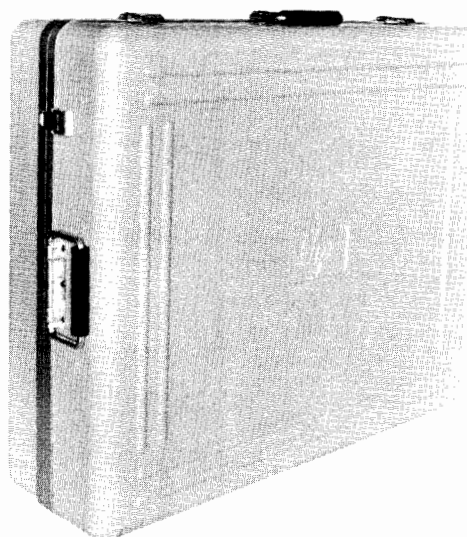

Typical valise transit (VT) style case



Typical valise (V) style case

### Special or Custom Transit Cases

When HP began providing standardized cases, it was understood that there would be certain instruments that would not fit into the standard cases. For that reason, special or custom cases are available.

Proper fit is very important in protecting your instrument, and the dimensional measurements of your instrument are critical. It is recommended that when ordering a custom case you provide your Hewlett-Packard sales office with the instrument's exact height, width, and depth, the serial and model number, and any other pertinent information that may affect the design of the case or cushions. In designing your own case, you may wish to have additional space available for the protected storage of materials necessary for your instrument's on-site operation. Space can be provided for storing power/data cables, operating supplies, accessories, additional printed circuit boards, and documentation or manuals. All specifications and measurements should be on hand when discussing your needs with a representative from your local HP sales office.

### Colors

HP transit cases are produced in "Hewlett-Packard Pearl Gray Cabinet," a standard color used in whole or in part on a majority of the instruments HP produces. Transit cases in any other color must be a special order at additional cost.

### Accurate Measurements Assure Proper Fit

To assure proper fit, each instrument must be measured carefully. The three measurements necessary are:

**WIDTH:** The distance across the entire body of the instrument, not including rack mounting accessories. Instruments set up to be rack mounted require special cushion designs (custom transit cases).

**DEPTH:** The depth of the instrument from the front panel face to the rearmost projection at the back of the instrument. On a System II instrument add two inches if the instrument has handles.

**HEIGHT:** The actual instrument height from the base to the top of the cabinet.

The selection tables include American standard and metric measurements. The addition of any options, accessories, or standoff devices will affect the instrument's overall configuration and must be taken into consideration when ordering a transit case.

# TRANSIT CASES

## Rugged Protection for Instruments

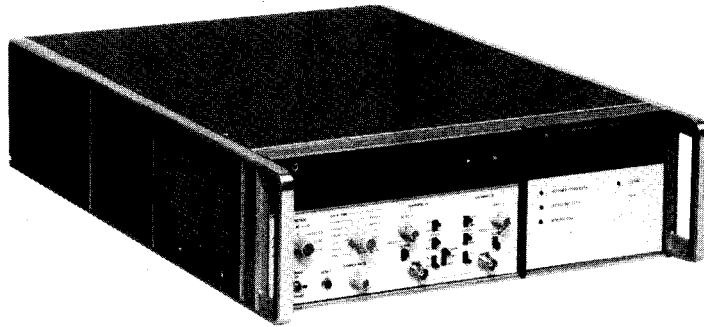

Typical full module System I style cabinet

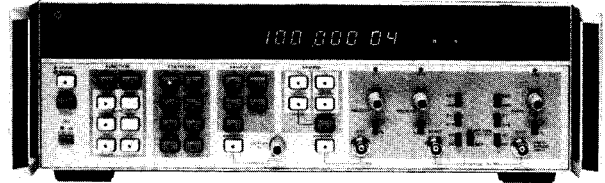

Typical full module System II style cabinet

### System I Cabinet Style Transit Cases

Full Module Width Instruments			
Instrument Width - 16.75 in. 425.5 mm			
Instrument Depth - 11.25 in. 285.8 mm			
Inst. Height	mm	Style	HP Part Number
3.50	88.9	VT*	9211-1288
5.25	133.4	VT*	9211-1289
7.00	177.8	VT*	9211-1290
8.75	222.3	T*	9211-1291
Instrument Depth - 16.25 in. 412.8 mm			
Inst. Height	mm	Style	HP Part Number
3.50	88.9	VT*	9211-1292
5.25	133.4	VT*	9211-0839
7.00	177.8	VT*	9211-1293
8.75	222.8	VT*	9211-1294
10.50	266.7	T*	9211-1295
12.25	311.2	T*	9211-1313
Instrument Depth - 19.25 in. 489.0 mm			
Inst. Height	mm	Style	HP Part Number
5.25	133.4	VT*	9211-1296
7.00	177.8	VT*	9211-1735
Instrument Depth - 22.25 in. 565.2 mm			
Inst. Height	mm	Style	HP Part Number
12.25	311.2	T	9211-1297

\*Removable casters are an option.

Two-thirds Module Width Instruments			
Instrument Width - 10.50 in. 266.7 mm			
Instrument Depth - 11.00 in. 270.4 mm			
Inst. Height	mm	Style	HP Part Number
6.5	165.1	V	9211-1895

Half Module Width Instruments			
Instrument Width - 7.75 in. 196.9 mm			
Instrument Depth - 8.00 in. 203.2 mm			
Inst. Height	mm	Style	HP Part Number
6.5	165.1	V	9211-1316
Instrument Depth - 11.00 in. 279.4 mm			
Inst. Height	mm	Style	HP Part Number
6.5	165.1	V	9211-1315
Instrument Depth - 16.00 in. 406.4 mm			
Inst. Height	mm	Style	HP Part Number
6.5	165.1	V	9211-1734

One-third Module Width Instruments			
Instrument Width - 5.125 in. 130.2 mm			
Instrument Depth - 8.00 in. 203.2 mm			
Inst. Height	mm	Style	HP Part Number
6.5	165.1	V	9211-1317
Instrument Depth - 11.00 in. 279.4 mm			
Inst. Height	mm	Style	HP Part Number
6.5	165.1	V	9211-1318

### System II Cabinet Style Transit Cases

Full Module Width Instruments			
Instrument Width - 16.75 in. 425.5 mm			
Instrument Depth - 15.25 in. 387.4 mm			
Inst. Height	mm	Style	HP Part Number
3.50	88.9	VT	9211-2642
5.25	133.4	VT	9211-2643
7.00	177.8	VT	9211-2644
8.75	222.3	VT	9211-2645
10.50	266.7	T*	9211-2646
12.25	311.2	T*	9211-2647
Instrument Depth - 18.25 in. 463.6 mm			
Inst. Height	mm	Style	HP Part Number
3.50	88.9	VT	9211-2648
5.25	133.4	VT	9211-2649
7.00	177.8	VT	9211-2650
8.75	222.3	T*	9211-2651
10.50	266.7	T*	9211-2652
12.25	311.2	T*	9211-2653
Instrument Depth - 21.50 in. 546.1 mm			
Inst. Height	mm	Style	HP Part Number
3.50	88.9	VT	9211-2654
5.25	133.4	VT	9211-2655
7.00	177.8	VT	9211-2656
8.75	222.3	T*	9211-2657
10.50	266.7	T*	9211-2658
12.25	311.2	T*	9211-2659
Instrument Depth - 24.50 in. 622.3 mm			
Inst. Height	mm	Style	HP Part Number
3.50	88.9	VT	9211-2660
5.25	133.4	VT	9211-2661
7.00	177.8	T*	9211-2662
8.75	222.3	T*	9211-2663
10.50	266.7	T*	9211-2664
12.25	311.2	T*	9211-2665

\*Removable casters are an option.

# TRANSIT CASES

Rugged Protection for Instruments



Typical System II half module instrument

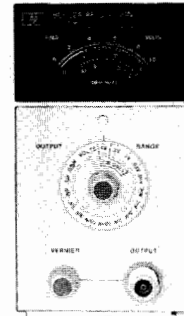

Typical System II quarter module instrument

## System II Cabinet Style Transit Cases (Continued)

Half Module Width Instruments			
Instrument Width – 8.50 in. 215.9 mm			
Instrument Depth – 9.75 in. 247.7 mm			
Inst. Height	Style	HP Part Number	
in. mm			
3.50 88.9	V	9211-2666	
5.25 133.4	V	9211-2667	
7.00 177.8	V	9211-2668	
8.75 222.3	V	9211-2669	
10.50 266.7	V*	9211-2670	
Instrument Depth – 12.75 in. 323.9 mm			
Inst. Height	Style	HP Part Number	
in. mm			
3.50 88.9	V	9211-2671	
5.25 133.4	V	9211-2672	
7.00 177.8	V	9211-2673	
8.75 222.3	V	9211-2674	
10.50 266.7	V	9211-2675	
Instrument Depth – 15.75 in. 400.1 mm			
Inst. Height	Style	HP Part Number	
in. mm			
3.50 88.9	V	9211-2676	
5.25 133.4	V	9211-2677	
7.00 177.8	V	9211-2678	
8.75 222.3	V	9211-2679	
10.50 266.7	V	9211-2680	
Instrument Depth – 18.75 in. 476.3 mm			
Inst. Height	Style	HP Part Number	
in. mm			
3.50 88.9	V	9211-2681	
5.25 133.4	V	9211-2682	
7.00 177.8	V	9211-2683	
8.75 222.3	V	9211-2684	
10.50 266.7	V	9211-2685	

\* Removable casters are an option.

Quarter Module Width Instruments			
Instrument Width – 4.125 in. 104.8 mm			
Instrument Depth – 9.75 in. 247.7 mm			
Inst. Height	Style	HP Part Number	
in. mm			
3.50 88.9	V	9211-2686	
5.25 133.4	V	9211-2687	
7.00 177.8	V	9211-2688	
Instrument Depth – 12.75 in. 323.9 mm			
Inst. Height	Style	HP Part Number	
in. mm			
3.50 88.9	V	9211-2689	
5.25 133.4	V	9211-2690	
7.00 177.8	V	9211-2691	
Instrument Depth – 15.75 in. 400.1 mm			
Inst. Height	Style	HP Part Number	
in. mm			
3.50 88.9	V	9211-2676	
5.25 133.4	V	9211-2677	
7.00 177.8	V	9211-2678	

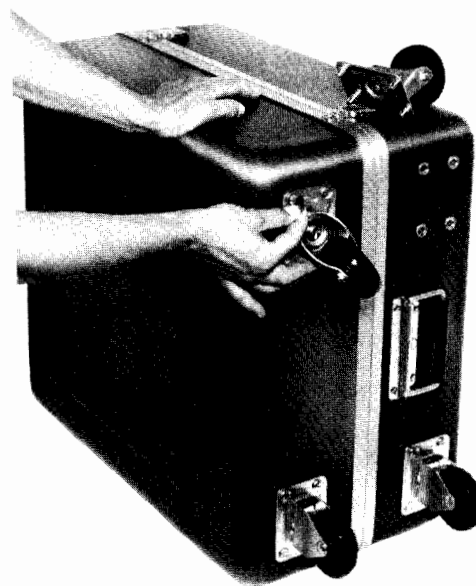

Field installed swivel caster kit. HP part number 1490-0913

# OPERATING CASES

## Rugged Protection for Instruments

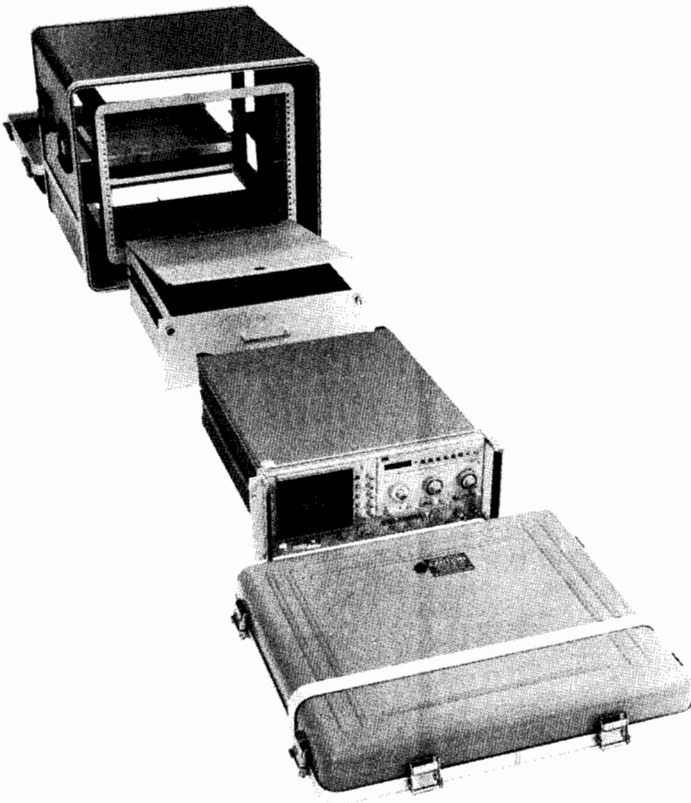

Exploded view of an Operating Case with an instrument and drawer ready for mounting.

### Operating Cases

Hewlett-Packard operating cases are rugged protective enclosures, used when instruments are transported and used on-site. They are constructed of the same pressure molded fiberglass/resin laminate as Hewlett-Packard transit cases. Hewlett-Packard's standard hardware provides excellent protection from damage and the elements. Conveniently placed handles fold flat when not in use. Front and back covers seal with O-ring gaskets and clamping latches. All transit cases are rainproof under MIL-STD-108.

### Interior Configuration

Operating cases are equipped with shock mounted aluminum frames that accept any standard 19-inch rack mounting instrument (EIA-RETMA standard), up to the height of the frames. Most full sized instruments and modular combinations of instruments can be rack mounted in one of our operating cases. The frame arrangement and the ability to remove the front and back covers allows the convenience of operation without removing the instrument. As a result, the instrument can be set up for operation with a minimum of delay. At the same time, environmental protection is afforded. Both Hewlett-Packard System I and System II cabinet styles can be mounted in operating cases (including System I module combining cases).

Rack mounting offers a number of conveniences. Total systems configured of individual instruments and accessories can be combined in one or more operating cases. Patch cable, HP-IB, and HP-IL connections can be left in place within the case, so that instruments are ready to be put into use with a minimum of delay.

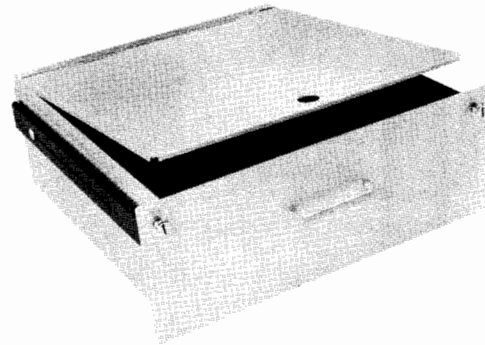

Sturdy drawers that accommodate various HP accessories and operating supplies are available in three sizes, and come with smooth operating ball bearing slides.

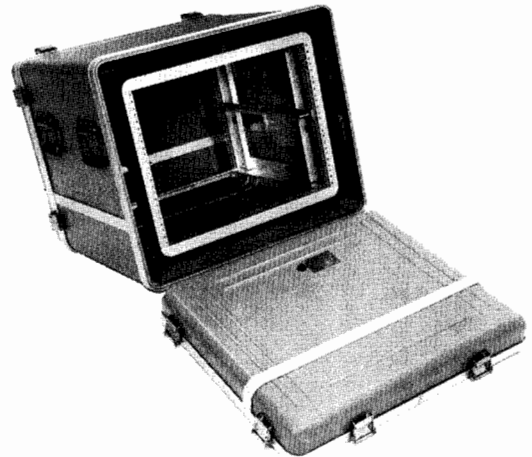

Elastomeric shock mounted frames provide outstanding shock and vibration attenuation. A set of standard shock mounts can be provided for any equipment weight and fragility.

### Accessories and Options

A number of accessories and options are available to provide maximum flexibility. Drawers are available in three heights so that small accessories, supplies, and tools can be kept inside the case with the instrument (cut foam cushions can be designed to accommodate any of these items). Aluminum skids, stacking feet, internal power receptacles, and many other items are available as options on special orders, or as accessories for customer installation when ordered separately.

### How to Order

Operating cases, like transit cases, are ordered through your local HP sales office. Because of the wide variety of options available and the number of configurations possible, it is recommended that you discuss your needs with an HP representative before you order.



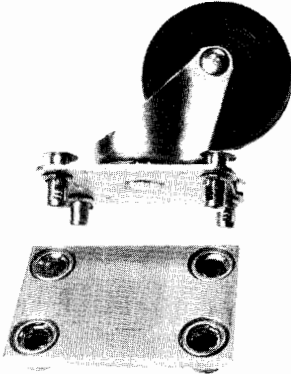

Heavy duty removable caster and mounting plate

### Operating Case Selection Guide

**Case Width = 24.00 in./609.6 mm (standard)**  
**Case Depth = 28.50 in./723.9 mm (standard)**

Nominal Rack Height in.	ISO	Instrument Weight				Case Height in.	mm	HP Part Number
		maximum lbs	kg	minimum lbs	kg			
5.25	3U	75	34.0	20	9.1	10.75	273.1	9211-1302
8.75	5U	75	34.0	20	9.1	15.20	386.1	9211-1303
10.50	6U	130	59.0	30	13.6	17.00	431.8	9211-2635
12.25	7U	130	59.0	30	13.6	18.87	479.3	9211-1163
14.00	8U	130	59.0	30	13.6	20.50	520.7	9211-1241
15.75	9U	130	59.0	30	13.6	22.25	565.2	9211-1242
17.50	10U	130	59.0	30	13.6	24.00	609.6	9211-1243
19.25	11U	130	59.0	30	13.6	25.75	654.1	9211-1244
21.00	12U	250	113.4	50	22.7	28.00	711.2	9211-1245
22.75	13U	250	113.4	50	22.7	29.75	755.7	9211-2636
24.50	14U	250	113.4	50	22.7	31.50	800.1	9211-1911
26.25	15U	250	113.4	50	22.7	33.25	844.6	9211-2637
28.00	16U	250	113.4	50	22.7	35.00	889.0	9211-2638
29.75	17U	250	113.4	50	22.7	36.75	933.5	9211-2639
31.50	18U	250	113.4	50	22.7	38.50	977.9	9211-2640
33.25	19U	250	113.4	50	22.7	40.25	1022.4	9211-1713
47.25	27U	320	145.2	70	31.8	53.88	1368.6	9211-2641

### Standard Features

Inner rack frame with provision for infinitely adjustable T-bar instrument support bracket. Standard 20" depth.

Inner rack frame with RETMA hole pattern drilled in rear rails.

Standard color: pearl grey cabinet.

Manual pressure relief valve.

### Special Features Available

- A. Mating feet for stacking one case on top of another.
- B. Special color. Please specify.
- C. Modified inner rack frame depth. Standard depth 20" from front panel mounting surface to rear surface of frame. This option includes an appropriate change in the overall depth of the enclosure. Please specify desired inner frame depth. Maximum 23", minimum 12".
- D. Chassis track C-300 instrument slide pair to mount on either side of inner frame using RETMA hole pattern drilled in front and rear rails.
- E. Special shock mounts for unusual instrument weights. Please specify weights.
- F. Increased front cover depth. Maximum depth 6". Please specify.
- G. Increased rear cover depth. Maximum depth 6". Please specify.
- H. Latches recessed into the surface of the case.
- I. Handles recessed into the surface of the case.
- J. Hermetically sealed case tested by the hot water method.
- K. MIL-C-4150 certification with the exception of design and preproduction testing. Case will have increased wall thickness, hardware anodized to military specification, and will be hermetically tested using the hot water method.
- L. Automatic pressure relief valve.
- M. Addition of four permanently mounted, 3/2" diameter swivel casters.
- N. Addition of four removable, 3/2" diameter swivel casters. Also available in kit form.
- O. Addition of two aluminum hat-section skids to the case bottom.
- P. Addition of lift rings to either side of the case.
- Q. 3 1/2 H (88.9 mm) Drawer with ball bearing slides.
- R. 5 1/4 H (133.4 mm) Drawer with ball bearing slides.
- S. 7 H (177.8 mm) Drawer with ball bearing slides.
- T. Pair of T-Bar instrument support brackets.
- U. AC power receptacle strip with four outlets mounted on bottom rear of inner rack frame. Power cord 1 meter (3' 3") long. NEMA connectors.

### Accessories (when ordered separately)

- 9211-1164** 3 1/2 H (88.9 mm) Drawer with ball bearing slides.
- 9211-1165** 5 1/4 H (133.4 mm) Drawer with ball bearing slides.
- 9211-1166** 7 H (177.8 mm) Drawer with ball bearing slides.
- 0950-0122** AC power receptacle strip with four outlets mounted on bottom rear of inner rack frame. Power cord 1 m (3.3') long, NEMA connectors.
- 9211-1173** Pair T-Bar instrument support brackets.
- 1490-0913** Caster kit, four removable 3/2" (88.9 mm) swivel casters. For transit cases only.
- 5081-5832** Aluminum hat section skids (2) for case bottom
- 5081-5834** Caster kit, four removable 3/2" (88.9 mm) swivel casters. Heavy duty for Operating Cases only.

On request, cases can be fabricated that meet the environmental requirements of Military Specifications. Specifications other than military are subject to change without notice.



### Communicating With HP

Hewlett-Packard is committed to providing convenient local support and the best possible attention to customer needs on a worldwide basis. There are more than 100 sales and support offices in the U.S. and some 220 sales and support offices and distributorships in 70 other countries; a listing of these offices starts on page 695.

Your entry point to the resources of Hewlett-Packard is through the local HP office nearest you. Our sales representatives and order support specialists there are well-equipped to provide you with pre-sale assistance in product selection, as well as related business information such as current product availability and price delivered to your location.

Many HP sales offices are tied into a sophisticated intra-company communications system. This not only means prompt transmission of orders to any HP product responsible division—it also speeds the flow of regular messages among HP sales offices and factories. The objective, of course, is to provide the fastest possible response to your product interests.

### Placing Your Order

Hewlett-Packard people at the sales office nearest you will be pleased to provide assistance in selecting the HP equipment most appropriate to your needs, and to help you prepare your order.

The information in this catalog will, in many cases, be sufficient for you to decide to buy a particular HP product. In those instances, a telephone call to the nearest HP office will provide you with (1) information

on product availability, and (2) the product's price.

HP wants to be sure the product delivered to you is exactly the one you want. Therefore, when placing your order, please specify the product's catalog (model, accessory, or part) number, as well as the product's name. Be as complete as possible in specifying exactly what you'd like, including standard options.

In the event you want special features or capabilities such as different color or a non-standard power line voltage, ask your HP sales representative about availability and cost of these "specials" first—and then, to prevent misunderstandings, include special instructions and specification details with your order.

### Shipping Methods

**Inside the USA:** shipments to destinations in the USA are made directly from factories or local warehouses. Unless specifically requested otherwise, express or truck transportation is used, whichever is less expensive and most serviceable to you. Small items are sent parcel post or UPS. If fast delivery is needed, we gladly ship by air freight, air express, or air parcel post, when specified on your order, at prevailing rates. In many parts of the USA, a consolidated air freight service provides the speed of air transport at surface rates. Ask your HP sales representative for details.

**Outside the USA:** shipments to destinations outside the USA are made from the appropriate Hewlett-Packard facility by either surface or air, as requested. Sea shipments usually require commercial export packaging at a nominal extra charge.

### Budgetary Prices

Price information which may be supplied with this catalog provides you with helpful budgetary guidance.

Please call your nearby Hewlett-Packard sales office to determine a product's delivered price.

Prices furnished with this catalog are net prices prevailing at the time of printing. Hewlett-Packard reserves the right to change prices, and those prices prevailing at the time an order is received will apply.

### Quotations and Pro Forma Invoices

Destination prices and other details you may need to know before ordering can be quickly obtained via telephone. Just call your nearest HP office.

If you are an international customer requiring formal paperwork such as pro forma invoices or quotations, please contact the Hewlett-Packard office or representative serving your area. Exportation or importation assistance is also available.

### Terms of Sale

**Inside the USA:** Hewlett-Packard's standard credit terms for established customers in the USA are net 30 days from invoice date.

Leasing and extended financial terms are available. However, the associated costs are not included in any product prices furnished with this catalog. Your nearby HP office will be pleased to discuss your requirements and work with you in setting up an appropriate program.

**Outside the USA:** terms for orders placed on Hewlett-Packard Company by customers outside the USA are irrevocable letters of credit or cash in advance—unless other terms have been previously arranged. Please contact authorized Hewlett-Packard international subsidiaries or distributors regarding terms for orders placed with them.

### U.S. Government Sales

Some products in this catalog are covered on GSA federal supply schedule multi-award contracts.

### Product Changes

Although product information and illustrations in this catalog were current at the time it was approved for printing, Hewlett-Packard, in a continuing effort to offer excellent products at a fair value, reserves the right to change specifications, designs, and models without notice.

# SALES & SUPPORT OFFICES

Arranged alphabetically by country

695



## Product Line Sales/Support Key

### Key Product Line

- A** Analytical
- CM** Components
- C** Computer Systems Sales only
- CH** Computer Systems Hardware Sales and Services
- CS** Computer Systems Software Sales and Services
- E** Electronic Instruments & Measurement Systems
- M** Medical Products
- P** Personal Computation Products
- \* Sales only for specific product line
- \*\* Support only for specific product line

**IMPORTANT:** These symbols designate general product line capability. They do not insure sales or support availability for all products within a line, at all locations. Contact your local sales office for information regarding locations where HP support is available for specific products.

*HP distributors are printed in italics.*

## HEADQUARTERS OFFICES

If there is no sales office listed for your area, contact one of these headquarters offices.

### AFRICA AND MIDDLE EAST

Hewlett-Packard S.A.  
Mediterranean and Middle East Operations  
Atrina Centre  
32 Kifissias Ave.  
Paradissos-Amarousion, **ATHENS**  
Greece  
Tel: 682 88 11  
Telex: 21-6588 HPAT GR  
Cable: HEWPACKSA Athens

### NORTH/CENTRAL AFRICA

Hewlett-Packard S.A.  
7, Rue du Bois-du-Lan  
CH-1217 **MEYRIN 2**, Switzerland  
Tel: (022) 83 12 12  
Telex: 27835 hpse  
Cable: HEWPACKSA Geneve

### ASIA

Hewlett-Packard Asia Ltd.  
47/F, 26 Harbour Rd.,  
Wanchai, **HONG KONG**  
G.P.O. Box 863, Hong Kong  
Tel: 5-8330833  
Telex: 76793 HPA HX  
Cable: HPASIAL TD

### CANADA

Hewlett-Packard (Canada) Ltd.  
6877 Goreway Drive  
**MISSISSAUGA**, Ontario L4V 1M8  
Tel: (416) 678-9430  
Telex: 610-492-4246

### EASTERN EUROPE

Hewlett-Packard Ges.m.b.h.  
Lieblgasse 1  
P.O. Box 72  
A-1222 **VIENNA**, Austria  
Tel: (222) 2365110  
Telex: 1 3 4425 HEPA A

### NORTHERN EUROPE

Hewlett-Packard S.A.  
Uilenstede 475  
P.O. Box 999  
NL-1180 **AZ AMSTELVEEN**  
The Netherlands  
Tel: 20 437771

### SOUTH EAST EUROPE

Hewlett-Packard S.A.  
World Trade Center  
110 Avenue Louis Carol  
1215 Cointrin, **GENEVA**, Switzerland  
Tel: (022) 98 96 51  
Telex: 27225 hpse.

### EASTERN USA

Hewlett-Packard Co.  
4 Choke Cherry Road  
**ROCKVILLE**, MD 20850  
Tel: (301) 258-2000

### MIDWESTERN USA

Hewlett-Packard Co.  
5201 Tollview Drive  
**ROLLING MEADOWS**, IL 60008  
Tel: (312) 255-9800

### SOUTHERN USA

Hewlett-Packard Co.  
2000 South Park Place  
P.O. Box 105005  
**ATLANTA**, GA 30348  
Tel: (404) 955-1500

### WESTERN USA

Hewlett-Packard Co.  
3939 Lankershim Blvd.  
P.O. Box 3919  
**LOS ANGELES**, CA 91604  
Tel: (213) 506-3700

### OTHER INTERNATIONAL AREAS

Hewlett-Packard Co.  
Intercontinental Headquarters  
3495 Deer Creek Road  
**PALO ALTO**, CA 94304  
Tel: (415) 857-1501  
Telex: 034-8300  
Cable: HEWPACK

### ANGOLA

*Telectra*  
Empresa TAEcnica de Equipamentos  
R. Barbosa Rodrigues, 41-I DT.  
Caixa Postal 6487

### LUANDA

Tel: 35515,35516  
E,P

### ARGENTINA

Hewlett-Packard Argentina S.A.  
Avenida Santa Fe 2035  
Martinez 1640 **BUENOS AIRES**  
Tel: 798-5735, 792-1293  
Cable: HEWPACKARG  
A,E,CH,CS,P

### AUSTRALIA

#### Adelaide, South Australia Office

Hewlett-Packard Australia Ltd.  
153 Greenhill Road  
**PARKSIDE**, S.A. 5063  
Tel: 272-5911  
Telex: 82536  
Cable: HEWPARD Adelaide  
A\*,CH,CM,CS,E,M,P

#### Brisbane, Queensland Office

Hewlett-Packard Australia Ltd.  
10 Payne Road  
**THE GAP**, Queensland 4061  
Tel: 30-4133  
Telex: 42133  
Cable: HEWPARD Brisbane  
A,CH,CS,CM,E,M,P

#### Canberra, Australia Capital Territory Office

Hewlett-Packard Australia Ltd.  
121 Wollongong Street  
**FYSHWICK**, A.C.T. 2609  
Tel: 80 4244  
Telex: 62650  
Cable: HEWPARD Canberra  
C,CH,CM,CS,E,P

#### Melbourne, Victoria Office

Hewlett-Packard Australia Ltd.  
31-41 Joseph Street  
**BLACKBURN**, Victoria 3130  
Tel: 895-2895  
Telex: 31-024  
Cable: HEWPARD Melbourne  
A,CH,CM,CS,E,M,P

#### Perth, Western Australia Office

Hewlett-Packard Australia Ltd.  
261 Stirling Highway  
**CLAREMONT**, W.A. 6010  
Tel: 383-2188  
Telex: 93859  
Cable: HEWPARD Perth  
A,CH,CM,CS,E,M,P

### Sydney, New South Wales Office

Hewlett-Packard Australia Ltd.  
17-23 Talavera Road  
P.O. Box 308  
**NORTH RYDE**, N.S.W. 2113  
Tel: 888-4444  
Telex: 21561  
Cable: HEWPARD Sydney  
A,CH,CM,CS,E,M,P

### AUSTRIA

Hewlett-Packard Ges.m.b.h.  
Grottenhofstrasse 94  
A-8052 **GRAZ**  
Tel: (0316) 291 5 66  
Telex: 32375  
CH,E

Hewlett-Packard Ges.m.b.h.

Lieblgasse 1  
P.O. Box 72  
A-1222 **VIENNA**  
Tel: (0222) 23 65 11-0  
Telex: 134425 HEPA A  
A,CH,CM,CS,E,M,P

### BAHRAIN

*Green Salon*  
P.O. Box 557  
*Manama*  
**BAHRAIN**  
Tel: 255503-255950  
Telex: 84419  
P

*Wael Pharmacy*  
P.O. Box 648

### BAHRAIN

Tel: 256123  
Telex: 8550 WAEI BN  
E,M

### BELGIUM

Hewlett-Packard Belgium S.A./N.V.  
Blvd de la Woluwe, 100  
Woluwedal  
B-1200 **BRUSSELS**  
Tel: (02) 762-32-00  
Telex: 23-494 paloben bru  
A,CH,CM,CS,E,M,P

### BERMUDA

Applied Computer Technologies  
Atlantic House Building  
Par-La-Ville Road  
Hamilton 5  
Tel: 295-1616  
P

### BRAZIL

Hewlett-Packard do Brasil  
I.e.C. Ltda.  
Alameda Rio Negro, 750  
Alphaville  
06400 **BARUERI SP**  
Tel: (011) 421.1311  
Telex: (011) 33872 HPBR-BR  
Cable: HEWPACK Sao Paulo  
A,CH,CM,CS,E,M,P



# SALES & SUPPORT OFFICES

Arranged alphabetically by country

## BRAZIL (Cont'd)

Hewlett-Packard do Brasil  
l.e.C. Ltda.  
Avenida Epitacio Pessoa, 4664  
22471 RIO DE JANEIRO-RJ  
Tel: (021) 286.0237  
Telex: 021-21905 HPBR-BR  
Cable: HEWPACK Rio de Janeiro  
A,CH,CM,E,M,P\*

*Convex/Van Den  
Rua Jose Bonifacio  
458 Todos Os Santos  
CEP 20771*

**RIO DE JANEIRO, RJ**  
Tel: 249-7121, 591-4946  
Telex: 33487

*ANAMED I.C.E.I. Ltda.  
Rua Bage, 103  
04012 SAO PAULO  
Tel: (011) 570-5726  
Telex: 021-21905 HPBR-BR  
M*

## CANADA

### Alberta

Hewlett-Packard (Canada) Ltd.  
3030 3rd Avenue N.E.  
**CALGARY**, Alberta T2A 6T7  
Tel: (403) 235-3100  
A,CH,CM,E\*,M,P\*

Hewlett-Packard (Canada) Ltd.  
11120-178th Street  
**EDMONTON**, Alberta T5S 1P2  
Tel: (403) 486-6666  
A,CH,CM,CS,E,M,P

### British Columbia

Hewlett-Packard (Canada) Ltd.  
10691 Shellbridge Way  
**RICHMOND**,  
British Columbia V6X 2W7  
Tel: (604) 270-2277  
Telex: 610-922-5059  
A,CH,CM,CS,E\*,M,P\*  
Hewlett-Packard (Canada) Ltd.  
121 - 3350 Douglas Street  
**VICTORIA**, British Columbia V8Z 3L1  
Tel: (604) 381-6616  
CH,CS

### Manitoba

Hewlett-Packard (Canada) Ltd.  
1825 Inkster Blvd.  
**WINNIPEG**, Manitoba R3H 0Y1  
Tel: (204) 786-6701  
A,CH,CM,E,M,P\*

### New Brunswick

Hewlett-Packard (Canada) Ltd.  
37 Shediac Road  
**MONCTON**, New Brunswick E1A 2R6  
Tel: (506) 855-2841  
CH,CS

### Nova Scotia

Hewlett-Packard (Canada) Ltd.  
Suite 111  
900 Windmill Road  
**DARTMOUTH**, Nova Scotia B2Y 3Z6  
Tel: (902) 469-7820  
CH,CM,CS,E\*,M,P\*

## Ontario

Hewlett-Packard (Canada) Ltd.  
3325 N. Service Rd., Unit 6  
**BURLINGTON**, Ontario P3A 2A3  
Tel: (416) 335-8644  
CS,M\*

Hewlett-Packard (Canada) Ltd.  
496 Days Road  
**KINGSTON**, Ontario K7M 5R4  
Tel: (613) 384-2088  
CH,CS

Hewlett-Packard (Canada) Ltd.  
552 Newbold Street  
**LONDON**, Ontario N6E 2S5  
Tel: (519) 686-9181  
A,CH,CM,E\*,M,P\*

Hewlett-Packard (Canada) Ltd.  
6877 Goreway Drive  
**MISSISSAUGA**, Ontario L4V 1M8  
Tel: (416) 678-9430  
A,CH,CM,CS,E,M,P

Hewlett-Packard (Canada) Ltd.  
2670 Queensview Dr.

**OTTAWA**, Ontario K2B 8K1  
Tel: (613) 820-6483  
A,CH,CM,CS,E\*,MS,P\*

Hewlett-Packard (Canada) Ltd.  
1855 Lasalle Boulevard  
**SUDBURY**, Ontario, P3A 2A3  
Tel: (705) 560-5450  
CH

Hewlett-Packard (Canada) Ltd.  
220 Yorkland Blvd. Unit #11  
**WILLOWDALE**, Ontario M2J 1R5  
Tel: (416) 499-9333  
CH

## Quebec

Hewlett-Packard (Canada) Ltd.  
17500 South Service Road  
Trans-Canada Highway  
**KIRKLAND**, Quebec H9J 2M5  
Tel: (514) 697-4232  
A,CH,CM,CS,E,M,P\*

Hewlett-Packard (Canada) Ltd.  
1150 Rue Claire Fontaine  
**QUEBEC CITY**, Quebec G1R 5G4  
Tel: (418) 648-0726  
CH,CS

Hewlett-Packard (Canada) Ltd.  
#7-130 Robin Crescent  
**SASKATOON**, Saskatchewan S7L 6M7  
Tel: (306) 242-3702  
CH,CS

## CHILE

*ASC Ltda.  
Austria 2041  
**SANTIAGO**  
Tel: 223-5946, 223-6148  
Telex: 340192 ASC CK  
P,C*

*Jorge Calcagni y Cia. Ltda.  
Av. Italia 634 Santiago  
Casilla 16475*

**SANTIAGO 9**  
Tel: 222-0222  
Telex: 440283 JCYCL CZ  
CM,E,M

## Metrolab S.A.

*Monjitas 454 of. 206  
**SANTIAGO**  
Tel: 395752, 398296  
Telex: 340866 METLAB CK  
A*

*Olympia (Chile) Ltda.  
Av. Rodrigo de Araya 1045  
Casilla 256-V*

**SANTIAGO 21**  
Tel: 225-5044  
Telex: 340892 OLYMP  
Cable: Olympiachile Santiagochile  
CH,CS,P

## CHINA, People's

**Republic of**  
China Hewlett-Packard Co., Ltd.  
6th Floor, Sun Hung Kai Centre  
30 Harbour Road

**HONG KONG**  
Tel: 5-8323211  
Telex: 36678 HEWPA HX  
A,C,CH,CS,E,M,P

*China Hewlett-Packard Rep. Office  
P.O. Box 418*

*1A Lane 2, Luchang St.  
Beiwei Rd., Xuanwu District  
**BEIJING***

*Tel: 33-1947, 33-7426  
Telex: 22601 CTSHP CN  
Cable: 1920  
A,CH,CM,CS,E,P*

## COLOMBIA

*Instrumentación  
H. A. Langebaek & Kier S.A.  
Carrera 4A No. 52A-26  
Apartado Aereo 6287  
**BOGOTA 1, D.E.***

*Tel: 212-1466  
Telex: 44400 INST CO  
Cable: AARIS Bogota  
CM,E,M*

*Nefromedicas Ltda.  
Calle 123 No. 9B-31  
Apartado Aereo 100-958  
**BOGOTA D.E., 10**  
Tel: 213-5267, 213-1615  
Telex: 43415 HEGAS CO  
A*

*Procesa, S.A.  
CRA 7 No. 24-89 Piso 25  
Torre Colpatría  
Apartado Aereo No. 49667  
**BOGOTA D.E.***

*Tel: 2344925, 2344958, 2344742  
Telex: 43127 COVER CO  
C,P*

*Compumundo  
Avenida 15 # 107-80  
**BOGOTA D.E.***

*Tel: 214-4458  
Telex: 45466 MARICO  
P*

## COSTA RICA

*Científica Costarricense S.A.  
Avenida 2, Calle 5  
San Pedro de Montes de Oca  
Apartado 10159*

**SAN JOSÉ**  
Tel: 24-38-20, 24-08-19  
Telex: 2367 GALGUR CR  
CM,E,M

## CYPRUS

*Telexera Ltd.  
P.O. Box 4809  
14C Stasinou Avenue  
**NICOSIA**  
Tel: 62698  
Telex: 2894 LEVIDO CY  
E,M,P*

## DENMARK

Hewlett-Packard A/S  
Datavej 52

**DK-3460 BIRKEROD**  
Tel: (02) 81-66-40  
Telex: 37409 hpas dk  
A,CH,CM,CS,E,M,P

Hewlett-Packard A/S  
Røllighedsvej 32  
**DK-8240 RISSKOV**, Aarhus  
Tel: (06) 17-60-00  
Telex: 37409 hpas dk  
CH,E

## DOMINICAN REPUBLIC

*Microprog S.A.  
Juan Tomás Mejía y Cotes No. 60  
Arroyo Hondo  
**SANTO DOMINGO**  
Tel: 565-6268  
Telex: 4510 ARENTA DR (RCA)  
P*

## ECUADOR

*CYEDE Cia. Ltda.  
Avenida Eloy Alfaro 1749  
y Belgica  
Casilla 6423 CCI*

**QUITO**  
Tel: 450-975, 243-052  
Telex: 2548 CYEDE ED  
CM,E,P

*Hospitalar S.A.*

*Robles 625  
Casilla 3590  
**QUITO**  
Tel: 545-250, 545-122  
Telex: 2485 HOSPTEL ED  
Cable: HOSPITALAR-Quito  
M*

**QUITO**  
Tel: 2-238-951  
Telex: 2298 ECUAME ED

## EGYPT

*Egyptian International  
Office for Foreign Trade  
P.O. Box 2558  
42 El-Zahraa Street  
Dokki, **CAIRO**,  
Tel: 712230  
Telex: 93337 EGPOR UN  
Cable: EGYPOR  
P,A*