

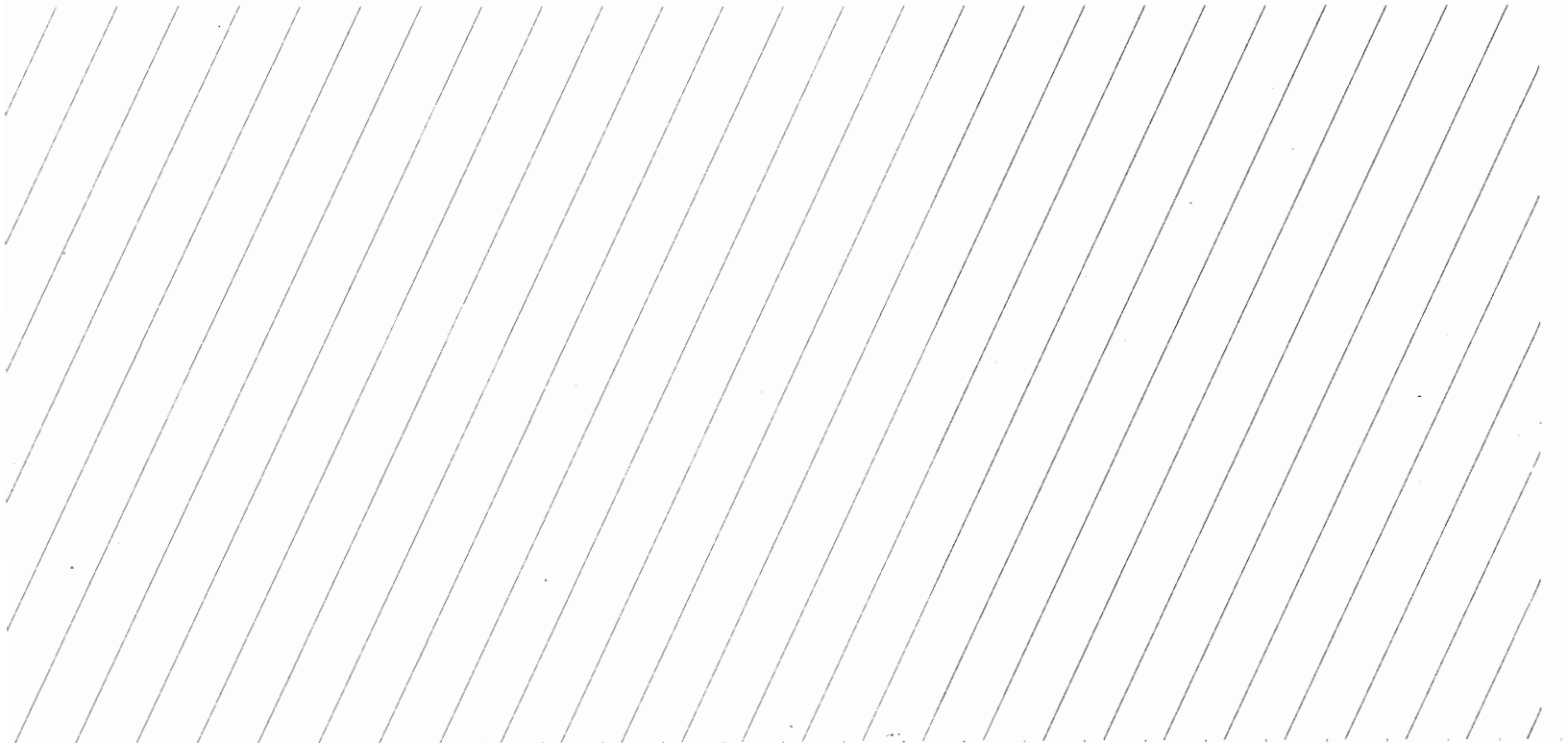

**Test &
Measurement
Catalog
1990**

ATE
Component Measurement
Controllers
Data Acquisition
Datacom Test
Digital Multimeters
EMC Test
Frequency Counters
Lightwave Test
Logic Analyzers
Logic Signal Sources
Measurement Accessories
Measurement Automation Software
Modular Measurement Systems
Network Analyzers
Noise Figure Measurement
Oscilloscopes
Phase Noise Test
Power Meters
Power Supplies/Loads
Pulse/Function Generators
Semiconductor Test
Signal Generators/Synthesizers
Spectrum Analyzers
Support
Sweep Oscillators
Telecom Test
Transceiver Test
VXI Instruments on a Card





In This Catalog

- New Product Highlights 1
- New Product Information Request Card Inside Back Cover

Finding The HP Product You Need

- Table of Contents II
- Indexes
 - General 46
 - Alphabetical 21
 - Model Number 33

Doing Business With Hewlett-Packard

- About Hewlett-Packard 17
- Ordering Information 737
- Leasing, Renting, Financing 736
- Office Addresses and Phone Numbers 739
- Warranty Information 738

HP Computer Museum
www.hpmuseum.net

For research and education purposes only.



PRODUCT GROUPS

HP Support

- Hardware 725
- Extended Repair Service 725
- Software 731
- Consulting Services 732
- Customer Education 728

Analyzers & Meters
Pages 48-303

Sources/Analyzers
Pages 304-353

Sources
Pages 354-495

HP Services

- Customer Information Center . . Inside Back Cover
- Fast-ship Service  734
- Leasing, Renting, Financing 736
- Free Publications 760
- Test & Measurement News 760
- Test & Measurement Accessories Catalog 735
- Application & Product Notes 748

Telecom/Datacom Test
Pages 496-523

Semiconductor Test & Board Test
Pages 524-553

Controllers & CAT
Pages 554-623

Hewlett-Packard Interface Bus



- General Information 564
- IEEE 488.2 566
- Capability Codes 568

Design Automation & Technical Computers
Pages 624-657

Computers, Peripherals & Other Key Products
Pages 658-707

Accessories, Support, Ordering & Offices
Pages 708-760

Prices Subject to Change

Prices in this catalog are subject to change. Prices prevailing at the time an order is received will apply. To determine a product's delivered price, just contact your nearest HP office. A listing of HP office locations starts on page 739. For more on shipping, prices and terms of sale, please refer to page 737.

CONTENTS

ALPHABETICAL INDEX	21	Information Request Card	Back of catalog
GENERAL INDEX	46	Instrument Financing	736
MODEL NUMBER INDEX	33	New Product Highlights	1
About Hewlett-Packard	17	Operating Environments & Warranty	738
Application & Product Notes	748	Ordering Information	737
Customer Support	724	Sales Offices	739
Free Publications	760		

PRODUCT SECTIONS

Amplifiers	408	Logic Analyzers	244
Analytical Instruments for Chemistry	660	Measurement System Architecture	562
Automatic Test	622	Medical Instrumentation	662
Board Test Systems	548	Microwave Test Accessories	330
Business Computer Systems	670	Network Analyzers	208
Cabinets & Cabinet Accessories	716	Noise Figure Meter	326
Cables & Adapters	708	Operating Cases	714
Calculator Products	666	Oscilloscopes & Waveform Analyzers	48
Component Measurement	282	Personal Computers & Terminals	674
Computer Aided Test	590	Plotters & Recorders	76
Computer Peripherals	678	Power Meters	200
Controllers	554	Power Supplies	452
Data Acquisition Systems	572	Pressure & Temperature	352
Data Communications Test Equipment	510	Pulse Generators	432
Data Generators & Data Analyzers	316	Signal Analyzers	96
DC Electronic Loads	448	Signal Generators	354
Design Automation	624	Solid State Devices	658
Digital Circuit Testers	276	Semiconductor Test Equipment	524
Digital Multimeters	78	Sweep Oscillators	394
Dimensional Measurements	348	Technical Computer Systems	650
Electronic Counters	158	Telecommunications Test Equipment	496
Frequency & Time Standards	488	Transceiver Test Equipment	322
Frequency, Function & Waveform Synthesizers	412	Transit Cases	710
Hewlett-Packard Interface Bus	564	X-Ray Equipment	664
Lightwave Test Equipment	304		



Identifies products having the Hewlett-Packard Interface Bus (HP-IB) capability. HP-IB is our implementation of ANSI/IEEE Standard 488, "Digital interface for programmable instrumentation." For the complete story, see pages 564-568.



Identifies products appearing for the first time in this catalog. New products are also indicated by **boldface** listings in the Model Number Index.



Identifies products available by **Fast-Ship Service**. **Fast-Ship Service** is the quick way for you to choose from thousands of HP products, order them by phone, and receive expedited delivery. For more information, see pages 734 and 735.

Specifications describe the product's performance. Parameters that are described as **typical**, **nominal**, or **approximately** (\approx) are supplemental characteristics intended to provide information useful to applying the product.

The Measurement Systems Architecture for the '90s

The increasing complexity of automated testing places new demands on test-system architectures. System designers and specifiers require more choices of standard, supportable hardware and software tools to meet industry's changing measurement needs.

Hewlett-Packard's Measurement Systems Architecture (MSA) meets this challenge with the widest array of hardware, software, controller, and support offerings available today. These HP products are based on industry standards for greater compatibility. With the Measurement Systems Architecture, you can create cost-effective systems that cover measurements from dc through lightwave.

Within the HP Measurement Systems Architecture you will find new modular product families that enhance our traditional HP-IB test equipment. All have measurement functions optimized for automated test systems. The HP 75000 family is part of the emerging VXIbus technology with particular strengths in digital and analog measurement. Hewlett-Packard is working to extend the offerings in this family from dc to microwave. For applications from RF through lightwave, the HP 70000 modular measurement system (MMS) offers a wide selection of rugged and reliable high-performance instrumentation.

The standard IEEE-448 bus links MMS, VXIbus, and HP-IB products together and to a variety of controllers. Software development tools such as the HP Interactive Test Generator and the HP Functional Test Manager are based on MS-DOS®, HP BASIC, and UNIX operating systems. These tools help get your system up and running quickly. Excellent HP support keeps it running at peak efficiency.

A new Test and Measurement Systems Language (TMSL) provides a single set of instrument commands designed for use in all types of instruments. Hewlett-Packard has begun to implement this language in its test instrumentation, including all the new HP 75000 VXI system products. TMSL has also been released for use by other manufacturers. For more information on Hewlett-Packard's Measurement Systems Architecture, see page 562.

MS-DOS is a U.S. registered trademark of Microsoft Corporation. UNIX is a registered trademark of AT&T in the U.S.A. and other countries.

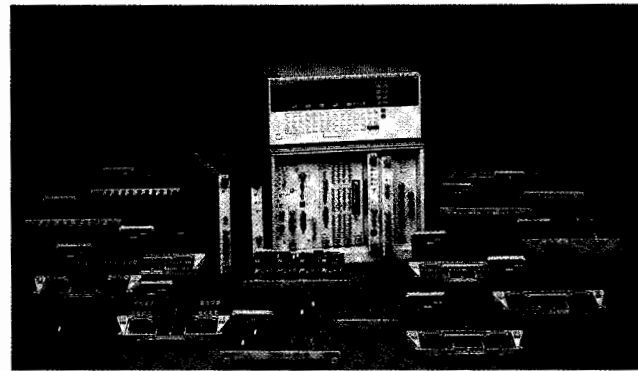
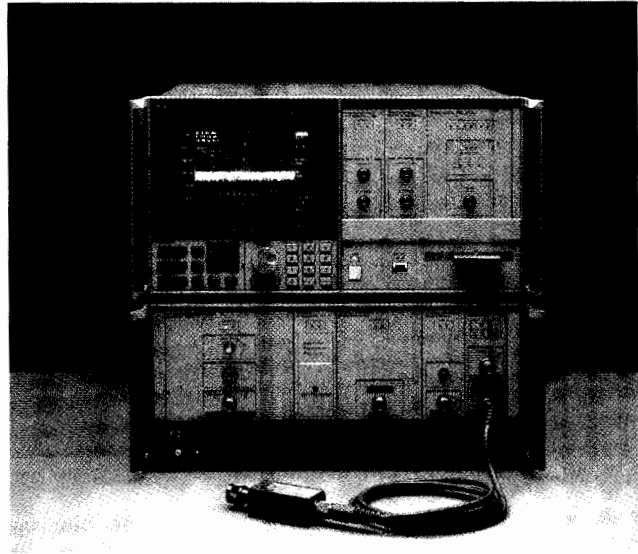

New MSA products for 1990 include mainframes and modules for both the HP 70000 modular measurement system (top) and the HP 75000 VXI system (bottom).

Measurement Systems Architecture

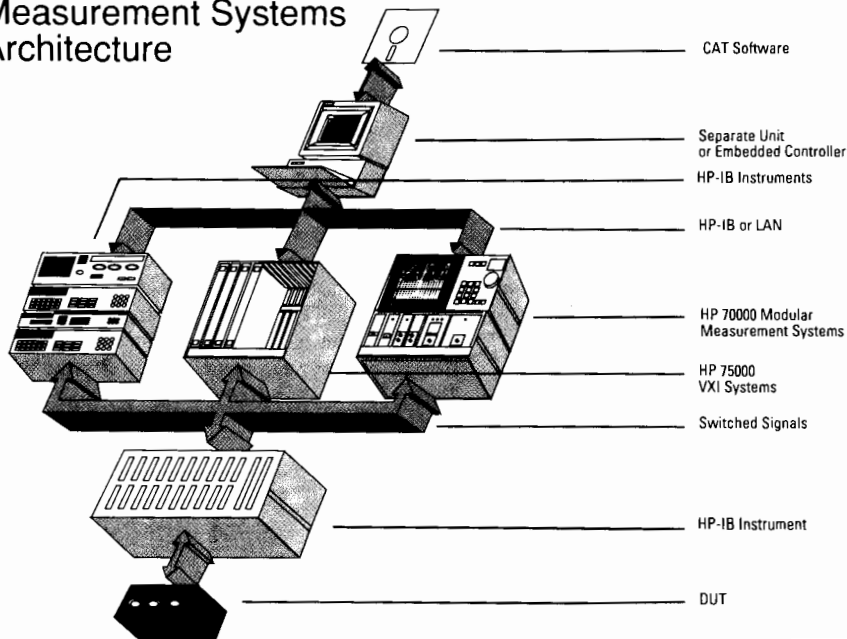

NEW PRODUCT HIGHLIGHTS

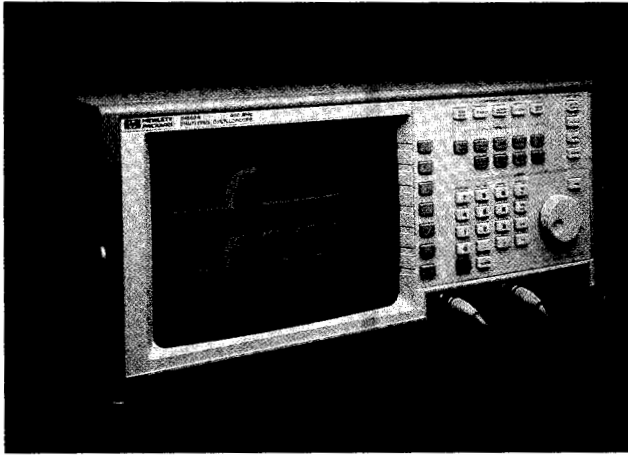

HP 54502A 400 MHz Digitizing Oscilloscope

The HP 54502A digitizing oscilloscope is a low-priced oscilloscope that provides 400 MHz bandwidth for repetitive signals and 100 MHz bandwidth for single-shot signals. Maximum sample rate is 400 megasamples per second. The HP 54502A maintains many of the features of our higher-priced scopes, including full programmability, direct hardcopy output, and full advanced logic triggering capability. New features include dual-time-base windowing and measurement limit testing. See page 52 or check 1 on the reply card.

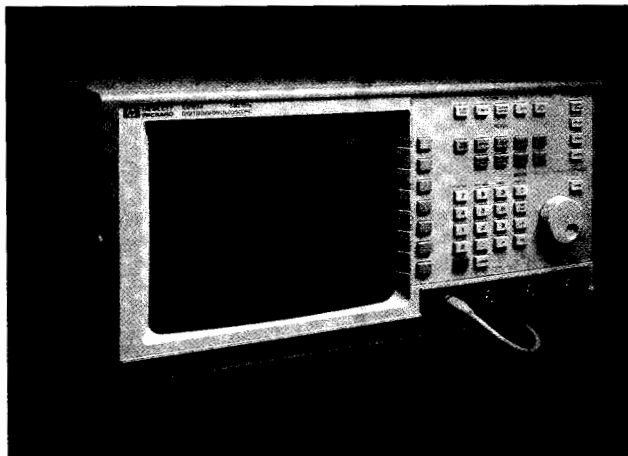

HP 54503A 500 MHz Digitizing Oscilloscope

The HP 54503A digitizing oscilloscope is a low-priced oscilloscope that provides 500 MHz repetitive signal bandwidth. The HP 54503A has four channels, each with a full-featured attenuator. The 54503A provides two-channel simultaneous sampling and has a complete set of features that are normally found only in higher-priced instruments. See page 52 or check 2 on the reply card.

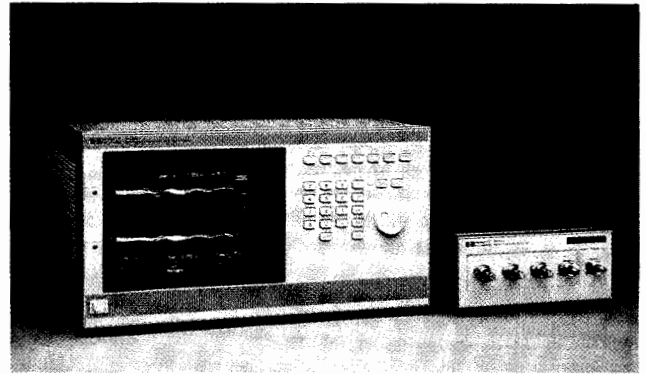

HP 54122T 12.4 GHz Digitizing Oscilloscope

The HP 54122T four-channel, 12.4 GHz digitizing oscilloscope is designed for use in the automated production test environment. A four-range, programmable step attenuator on each of the four channels allows an external controller to recognize that an attenuator is present in a given measurement. The controller can select any of the attenuator ranges on the input channels under program control and obtain calibrated measurement results. These attenuators allow the HP 54120 family of oscilloscopes to examine signals up to 2.4 V/div and provide wide dynamic input range. The HP 54210 family's digital feedback sampling architecture with software linearization ensures that the entire input dynamic range is linear. See page 60 or check 3 on the reply card.



HP 54123T 34 GHz Digitizing Oscilloscope

The HP 54123T digitizing oscilloscope provides the highest bandwidth available in a bench-top oscilloscope. The 34 GHz bandwidth is available in both the average and persistence acquisition modes and displays infinitely fast voltage steps in 10.3 ps. The HP 54123T is the third member in the HP 54120 family of digital sampling oscilloscopes, which offers 0.25 ps resolution time bases, 2.5 GHz edge triggers, and up to 32 μ V of vertical resolution. The HP 54123T offers time-domain reflectometry (TDR) and time-domain transmission (TDT), built-in histograms for statistical analysis, and push-button hardcopy for color documentation using the HP PaintJet printer. See page 60 or check 4 on the reply card.

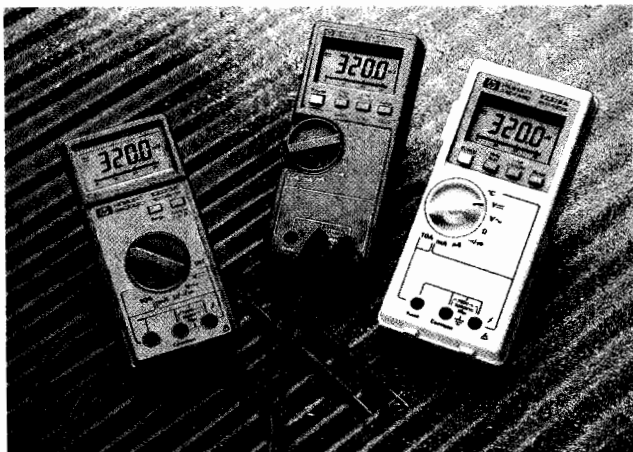

HP E2373A, E2377A, E2378A Handheld Multimeters

The HP E2300 series of handheld multimeters includes a basic model, a full-feature model, and a rugged model. All three models come with dc and ac volts, dc and ac currents, resistance, audible continuity, and diode test. All models have maximum dc voltage of 1000 V and current of 10 A. The 3200-count digital display is supplemented by a 32-segment analog bar. The basic model (E2373A) has a dc accuracy of 0.7%. The E2377A and the E2378A have built-in temperature function and data hold. Both have dc accuracy of 0.3%. The E2378A has a yellow splash-resistant rugged case. All meters have a 3-year warranty, and a 1-year calibration cycle. See page 94 or check 5 on the reply card.

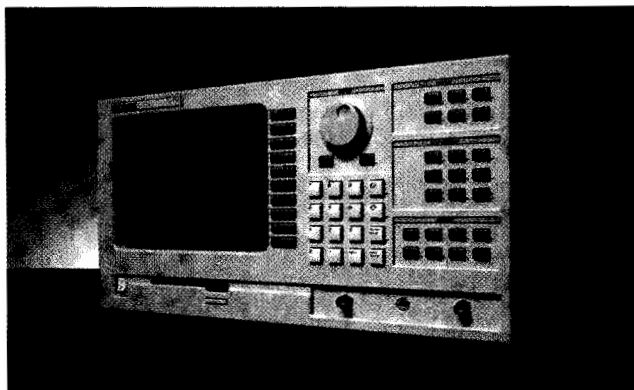

HP 3588A Spectrum Analyzer

The HP 3588A spectrum analyzer provides fast, high-performance spectrum and scalar network analysis from 10 Hz to 150 MHz. At home in both R&D and production-test environments, the analyzer is ideally suited for noise measurements, modulation analysis, and spectrum measurements of a wide range of communications equipment. The analyzer has two measurement modes: a traditional swept-tuned mode (enhanced for faster operation) and a narrowband mode for spans of 40 kHz or less. There is also a built-in disk drive and internal non-volatile memory for convenient storage of instrument states, trace data, and measurement programs. An HP Instrument BASIC option is available, allowing internal programming and controller capability for full measurement automation. See page 100 or check 6 on the reply card.

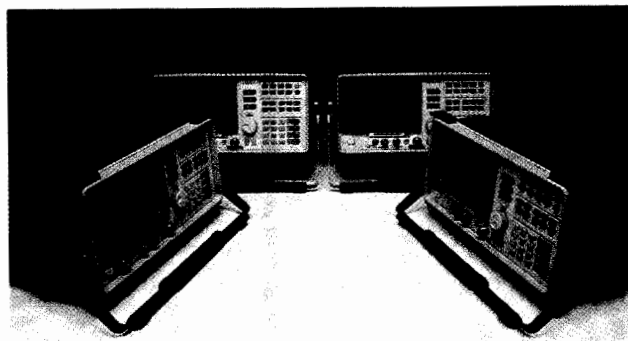

HP 8590 Series Portable Spectrum Analyzers

Four new models in the 8590 family of portable spectrum analyzers offer a wide range of performance, features, and prices designed to fit most any budget. The HP 8591A and 8593A signal analyzers are high-performance models with synthesizer accuracy, a built-in memory card reader, and expanded program memory. The HP 8590B and 8592B signal analyzers are lower-cost, basic-performance models that include the expanded program memory with the option to add a card reader. The memory-card reader can be used to load application-specific measurement personalities or your own custom programs. All models include a built-in clock/calendar that stamps plots and printouts with the time and date. See page 104 or check 7 on the reply card.

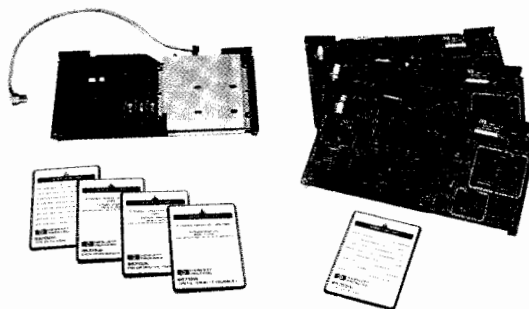

HP 85700A Series Application Measurement Cards

The 85700A series of application measurement cards adds custom personalities to any HP 8590-series portable spectrum analyzer with a memory-card reader. Application measurement cards offer an inexpensive option for adding dedicated functions for cable-television, digital-radio, and electromagnetic compatibility measurements. See page 106 or check 8 on the reply card.

NEW PRODUCT HIGHLIGHTS

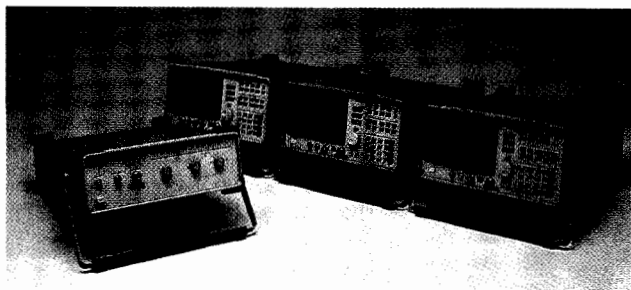

HP 8560A, 8561B Spectrum Analyzers, HP 85640A Portable Tracking Generator

The HP family of military-rugged portable test equipment has two new RF spectrum analyzers and a new tracking generator. The HP 8560A spectrum analyzer has a frequency range of 50 Hz to 2.9 GHz and includes an optional built-in tracking generator. The HP 8561B spectrum analyzer extends the upper range to 6.5 GHz. Both instruments feature high-performance, synthesized technology and include narrow digital bandwidths at 10, 30, and 100 Hz for sweep times up to 20 times faster than possible with comparable analog bandwidths. The new HP 85640A portable tracking generator adds capability for scalar network measurements to the rugged portable analyzers. A built-in attenuator, vernier, external leveling, and more are included. See page 110 or check 9 on the reply card.

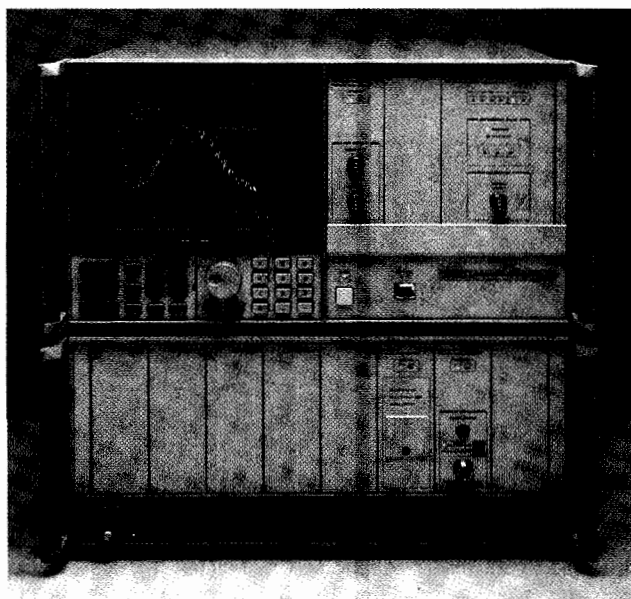

HP 70004A, 70900B Displays

The HP 70004A is a new, full-color display integrated with a 4-module-slot mainframe for the HP 70000 modular measurement system. Connected to a standard 8-slot mainframe, it gives you a modular system with enough space to add the measurement capabilities that your application demands. The display/mainframe also features a snap-on keypad for dedicated measurement functions, HP-IL interface, a built-in clock/calendar that stamps the time and date on plots and printouts, and a 32 Kbyte memory-card reader. The HP 70900B local oscillator adds greater speed and lower phase noise to the HP 70000 modular measurement system. Used with the new color display, it forms the basis for a new model C series of spectrum analyzer systems. A special digital persistence feature of this local oscillator simulates the variable intensities of an analog display without sacrificing the qualities of a digital display. See page 115 or check 10 on the reply card.

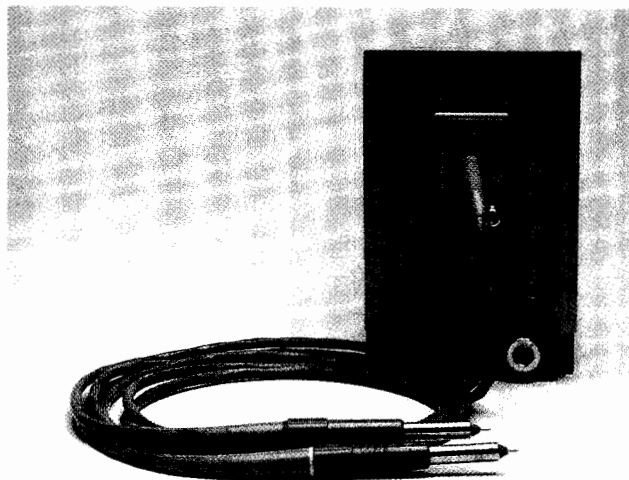

HP 70138A Vector Voltmeter for RF and Phase Measurements

This vector voltmeter module is a fully programmable, two-channel receiver that adds CW phase and magnitude measurement capability to the HP 70000 modular measurement system. You can make stimulus-response measurements by integrating this module with a spectrum analyzer and a tracking generator. Instruments can operate independently, with the vector-voltmeter's phase reading displayed simultaneously with the tracking generator's swept scalar display. Or, their functions can be combined to produce a display of phase and magnitude versus frequency. A component-test personality controls the instrument functions to enhance, yet simplify, these measurements. Complex impedance, reflection coefficient, electrical length, and group delay can be calculated automatically. For more information on HP 70000 modular measurement systems components, see page 117 or check 11 on the reply card.

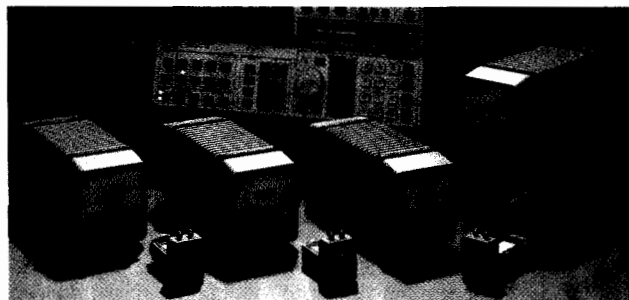

HP 11974A Series Preselected Millimeter Mixers

This HP 11974A series of preselected millimeter mixers eliminates the need for signal identification from 26.5 to 75 GHz for faster, easier testing of millimeter devices and systems. Preselection reduces mixer overload from broadband signals and reduces the radiation of local-oscillator harmonics back to the device under test. This greatly simplifies both the manual process of locating true signals and the development of software for automated measurements. See page 129 or check 12 on the reply card.



HP 3563A Control Systems Analyzer

The HP 3563A control systems analyzer is a development tool that simplifies test and analysis of analog, digital, and mixed analog/digital control systems. This control systems analyzer is a compatible superset of the popular HP 3562A dynamic signal analyzer. It performs network, spectrum, and waveform analysis from 64 μ Hz to 100 kHz with 80 dB dynamic range. Built-in modeling and analysis functions work in both the s- and z-domains to turn data into information and facilitate experimentation. See page 134 or check 13 on the reply card.



HP 3566A, 3567A PC Spectrum/Network Analyzers

The 12.8 kHz HP 3566A and 102.4 kHz HP 3567A are multichannel programmable analyzers that make time and frequency domain measurements. Each analyzer expands to 16 simultaneous data acquisition input channels that reduce measurement time in applications such as mechanical test, production test, and general-purpose signal analysis. Both analyzers contain a powerful hardware signal processor module that transforms time data to frequency data using the latest FFT fast fourier transform hardware technology. Linked to this module is an HP Vectra PC (or other IBM PC AT compatible) running MS-DOS®, Microsoft WINDOWS, and HP measurement software. For measurement automation, every HP 3566A and 3567A measurement feature is accessible by programs written in a variety of Microsoft-supported programming languages. Features also include waterfall and spectrogram displays, $\frac{1}{3}$ octave, correlation, and a new HP digital algorithm that improves order tracking measurements. See page 143 or check 14 on the reply card.

*MS-DOS is a U.S. registered trademark of Microsoft Corporation.

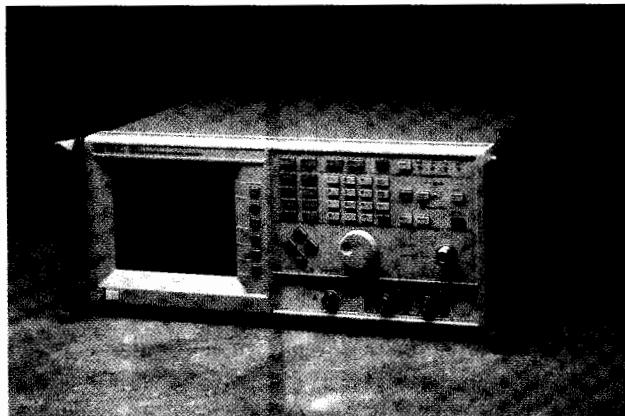

HP 5372A Frequency and Time Interval Analyzer

Hewlett-Packard improves modulation domain analysis with the HP 5372A frequency and time interval analyzer. As with the HP 5371A, the HP 5372A displays frequency, time interval, or phase versus time. This new analyzer improves jitter analysis with time-interval histogram results and processes the results faster than the HP 5371A. An optional 2 GHz Channel C extends measurement capability for communications and radar applications. Up to 8K measurements can be analyzed from the front panel. An optional FastPort interface is available to deliver data continuously to an external memory system for very large measurement sizes, such as those required for disk drive and communications test applications. Pre-trigger capability with trigger-on-time-interval-value makes this instrument valuable for analyzing transient timing effects. See page 162 or check 15 on the reply card.

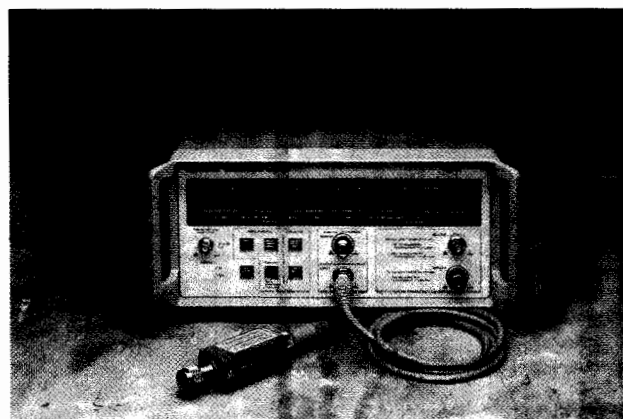

HP 5347A, 5348A Microwave Counter/Power Meters

Microwave frequency and true power measurements are combined in a single instrument with the HP 5347A and 5348A microwave counter/power meter. The HP 5347A allows CW frequency measurements to 20 GHz to 26.5 GHz. Both models offer high accuracy power measurements to 0.16 dB. The new counter/power meters are designed for portability with a rugged package, optional carrying strap, and optional internal battery for cordless operation in the field. Five function keys on the front panel simplify the data input. Power sensor calibration tables stored permanently in memory eliminate the need to individually enter calibration factors. The frequency counter function can be used to access the calibration factor. HP-IB and a rack mount kit are available. See page 174 or check 16 on the reply card.

NEW PRODUCT HIGHLIGHTS



HP 5361A 20 GHz Pulse/CW Microwave Counter

The HP 5361A microwave counter combines pulse and high-performance CW microwave frequency measurements in one instrument. The new counter is fully automatic and offers the CW performance typical of a dedicated CW-microwave counter. Pulse measurements are available from 500 MHz to 20 GHz with accuracy of 1 Hz in 1 second. The HP 5361A is an excellent tool for designing, testing, and servicing commercial and military radar systems. It is also well suited to electronic warfare, satellite communications and automatic/microwave landing system applications. The HP 5361A simplifies testing with automatic features that determine a signal's pulse width, pulse repetition frequency, pulse repetition interval, and pulse off-time. The scope-view output can be used with an oscilloscope to view the exact position of a measurement on an external gate. See page 180 or check 17 on the reply card.

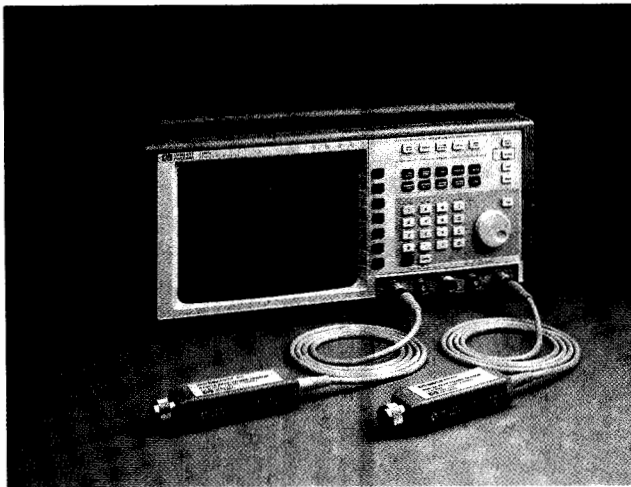

HP 8990A Peak Power Analyzer

The HP 8990A peak power analyzer is the first HP programmable peak power analyzer to provide comprehensive pulsed power characterization from 0.05 to 40 GHz. Powerful measurement firmware analyzes 8 time parameters and 5 amplitude parameters, then statistically processes the digitally sampled data for high measurement confidence. New PDB sensors have temperature, power level, and frequency data individually stored in EPROM, which allows wide operating ranges without requiring recalibration. Two video channels can be displayed in addition to the two sensor-detected waveforms of less than 10 ns rise/fall times. See page 200 or check 18 on the reply card.

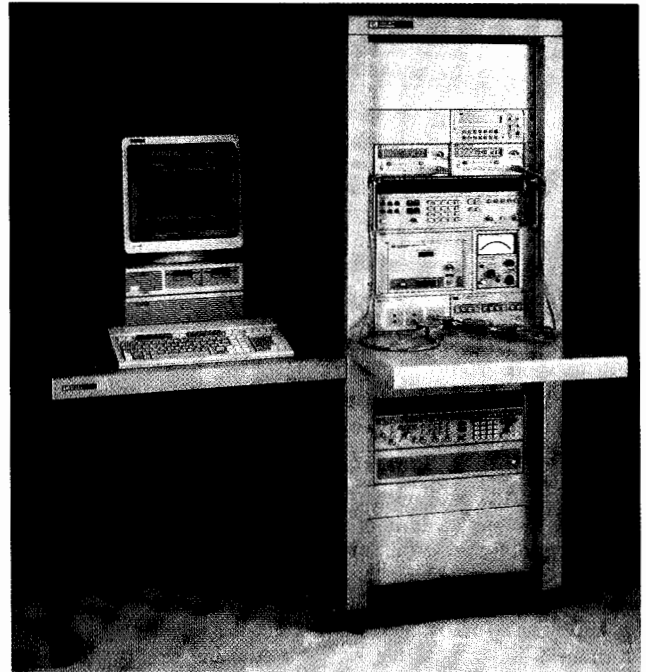

HP 11760S-E01 Automatic Power Sensor Calibration System

The HP 11760S-E01 automatic power sensor calibration system provides metrology laboratories with the means to support large workloads of HP thermocouple, thermistor, and diode power sensors. The system supplies test signals from 100 kHz to 26.5 GHz with standard reference sensors with traceability to the US NIST. In less than 4 minutes, the system measures Cal Factor, calculates uncertainties, and plots a new label for the sensor. See page 204 or check 19 on the reply card.

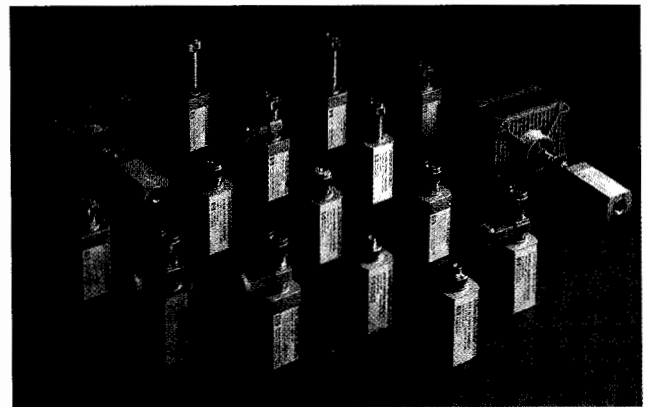

HP 8481D, 8487D Power Sensors

Two new high-sensitivity power sensors based on planar-doped-barrier technology now extend the HP 8480 family of 14 sensors. These are compatible with the HP 435/436/437/438/70100A power meters. HP 8481D replaces the popular HP 8484A for the 0.010 to 18 GHz and -70 to -20 dBm ranges. HP 8487D covers the range from 0.050 to 50 GHz and -70 to -20 dBm ranges. Both have better temperature stability than Schottky diodes. HP 8485A/D sensors, which previously covered up to 26.5 GHz, now have Option 033 with a range up to 33 GHz. See page 204 or check 20 on the reply card.

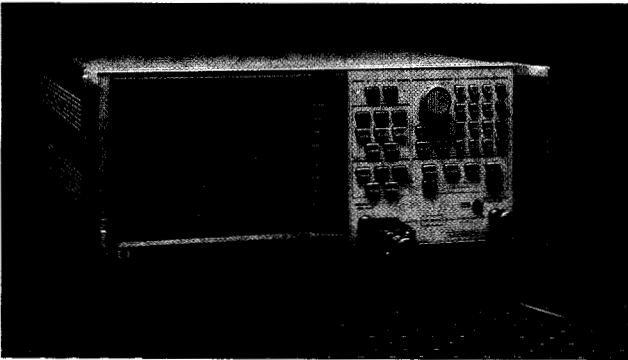

HP 8752A RF Network Analyzer

The HP 8752A RF network analyzer is a compact, fully integrated instrument capable of measuring the magnitude, phase, and group delay of RF components and networks over the 300 kHz to 1.3 GHz, or optionally 3 GHz, frequency range. The HP 8752A is a complete measurement system composed of a synthesized source, a sensitive receiver, a transmission/reflection test set, and a test port cable. The uncorrected performance of this instrument is excellent, allowing simple and accurate measurements of a device under test without the need for measurement calibration. Powerful productivity features, including limit testing and marker bandwidth functions, make this instrument ideal for service, incoming inspection, and production environment. See page 229 or check 21 on the reply card.

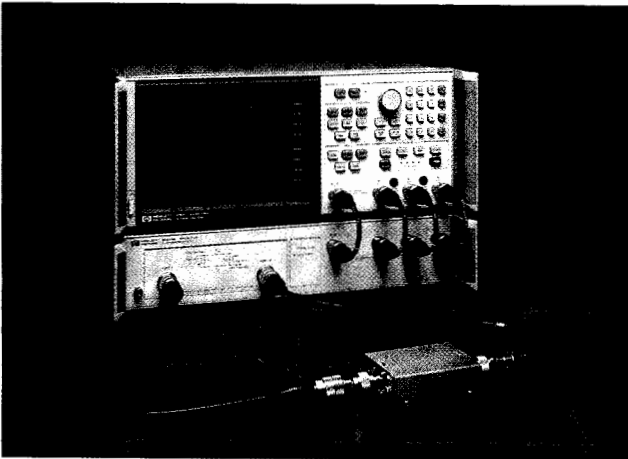

HP 8753C RF Network Analyzer

The HP 8753C RF network analyzer continues the tradition of affordable excellence in RF component measurements established by the HP 8753A/B. The HP 8753C offers wide frequency coverage (300 kHz to 3 or 6 GHz) to characterize RF components in both transmission and reflection. You can then view the measured magnitude, phase, and group delay response in your choice of formats on the crisp color display. Non-linear measurement capability allows you to characterize mixers and amplifier harmonics. Repetitive tests can be more easily performed with one-key sequencing.

The HP 8753C is a powerful, flexible automatic vector network analyzer ideal for use in the lab. It also incorporates many productivity features, including limit testing, while maintaining simplicity and speed for production test areas. See page 231 or check 22 on the reply card.

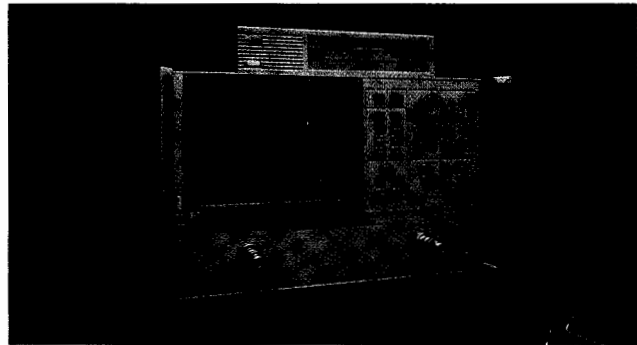

HP 8719A, 8720B Microwave Network Analyzers

The HP 8719A and 8720B microwave network analyzers provide economical, yet fully capable, measurements of microwave components and networks from 130 MHz to 13.5 GHz, or 20 GHz. Both offer a fast-sweeping synthesized source, switching S-parameter test set, and tuned receiver with vector error correction — all integrated in a compact, easy-to-use system. They display both reflection and transmission characteristics, in a variety of useful formats (including phase and group delay), on the large color display. Built-in productivity features make tuning or testing faster and more consistent: pass/fail limit test, external disk save/recall, and direct buffered hardcopy to plotter/printer. See page 235 or check 23 on the reply card.

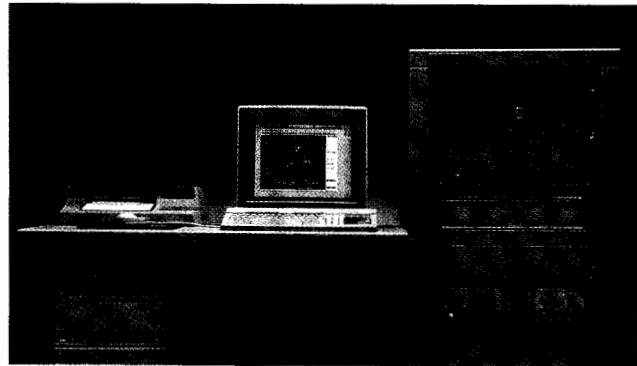

HP 85301A Antenna Measurement System

The HP 85301A antenna measurement system is an integrated system for far field antenna pattern measurements from 45 MHz to 26.5 GHz, extendable to 110 GHz. To provide the optimum configuration, each system is individually configured to meet range requirements. Systems include the transmit sources, HP 8510B receiver/signal processor, choice of RF frequency converters, cabling, system controller with data acquisition and presentation software, system integration, installation, training, and on-site support. See page 243 or check 24 on the reply card.

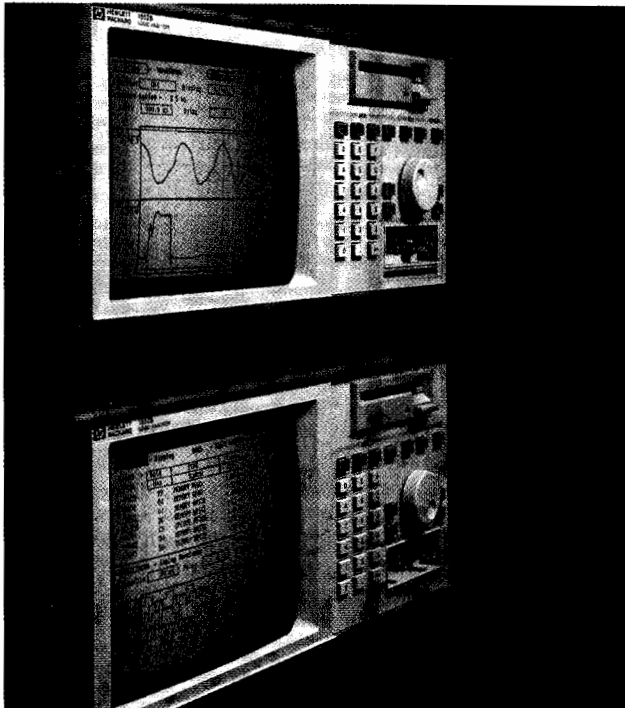

HP 1652B, 1653B Logic Analyzers

The HP 1652B and 1653B logic analyzers offer state, timing and oscilloscope measurement capabilities in a compact and portable package. Each model contains a two-channel 400 MSa/second full-featured digitizing oscilloscope. It correlates state listings, timing diagrams, and oscilloscope waveforms on the same menu, making the digital debug task easier. Each model includes a built-in disk drive for storing measurement results. HP-IB and RS-232 ports are standard. Each analyzer contains a full-featured state and timing analyzer. For more information, See page 254 or check 25 on the reply card.

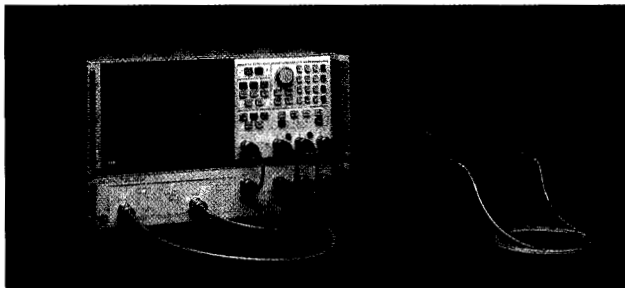

HP 8702B Lightwave Component Analyzer

The HP 8702B lightwave component analyzer is a calibrated 6 GHz measurement system for lightwave engineers and technicians who need to characterize the transmission and reflection responses of optical, electrical, and electro-optical devices and systems. These devices and systems include lasers, LEDs, photodiodes, optical attenuators, optical receiver-transmitter pairs, and electrical amplifiers and filters. Tests use swept intensity modulated lightwave and RF test signals. Optical wavelengths of 1300 nm, 1550 nm and 850 nm are available. Data can be displayed in magnitude, phase, and distance-time domain formats and directly output to a Hewlett-Packard plotter for reports, presentations, and data sheets. Measurement accuracy, speed, and convenience can be increased when testing lightwave devices operating under 6 GHz frequencies and bit rates. See page 312 or check 26 on the reply card.

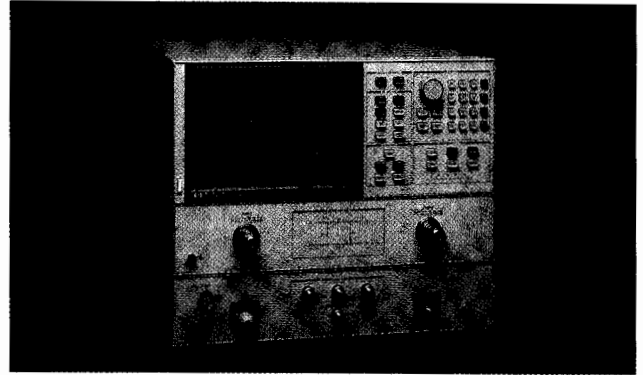

HP 8703A Lightwave Component Analyzer

The HP 8703A lightwave component analyzer delivers 20 GHz modulation bandwidth plus calibrated transmission and reflection measurements of optical, electrical, and electro-optical devices. It is an excellent measurement solution for lightwave scientists, engineers, and technicians who are characterizing high-speed lasers, LEDs, photodiodes, optical modulators, receiver-transmitter pairs and electrical amplifiers, and filters. Internal microwave and intensity modulated lightwave sources and receivers are automatically monitored and coordinated by an internal processor/controller. Possible lightwave sources include an internal 1300 Fabry-Perot laser or optional 1300 nm and 1550 nm distributed feedback lasers. An optional external lightwave source input provides additional source flexibility. Data can be displayed in magnitude, phase, and distance-time domain formats, and can be output directly to a Hewlett-Packard plotter for reports, presentations, and data sheets. Lightwave system devices operating under 20 GHz frequencies and bit rates can be tested with dramatic increases in accuracy, speed, and convenience. See page 313 or check 27 on the reply card.

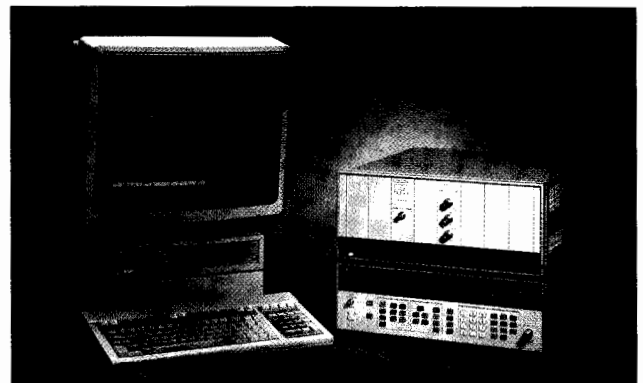

HP 11836A 0.3 GMSK Modulation Measurement Software

Pan-European Digital Cellular Radio transmitters use spectrally efficient, 0.3 GMSK modulation. The HP 11836A software permits designers and manufacturers to accurately evaluate the modulation performance of these Groupe Speciale Mobile (GSM) transmitters. It measures carrier frequency error, modulation phase error (peak and rms values), and amplitude envelope, and it recovers the data. By first down-converting the signal to a suitable IF, then digitizing the signal and performing mathematical calculations on the digital samples, the software measures these parameters. For production applications, efficient algorithms characterize a transmitter in less than one minute with approximately nine sample points per transmitted data bit. Graphical output is available with a zoom feature to examine results in more detail. See page 325 or check 28 on the reply card.

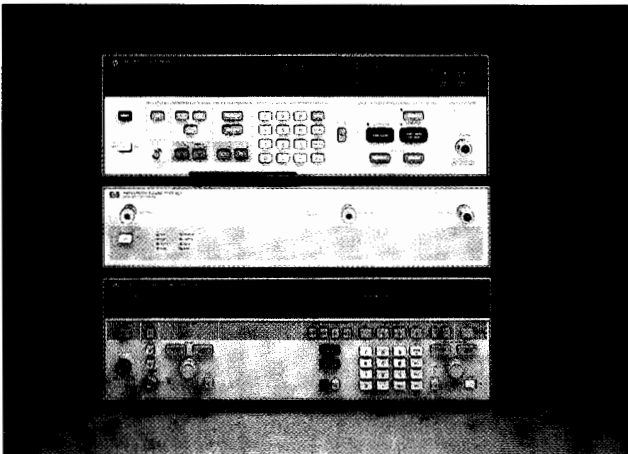

HP 8970U Microwave Noise Figure Measurement System

The HP 8970U microwave noise figure measurement system features a frequency range from 10 MHz to 26.5 GHz. This allows noise figure characterization from a single port, ideal for production applications. This test set also uses low-noise pre-amplifiers so that second-stage corrections for test set input noise are not required; and as a result, accuracy improves. Complete system includes programmable local oscillator. See page 328 or check 29 on the reply card.

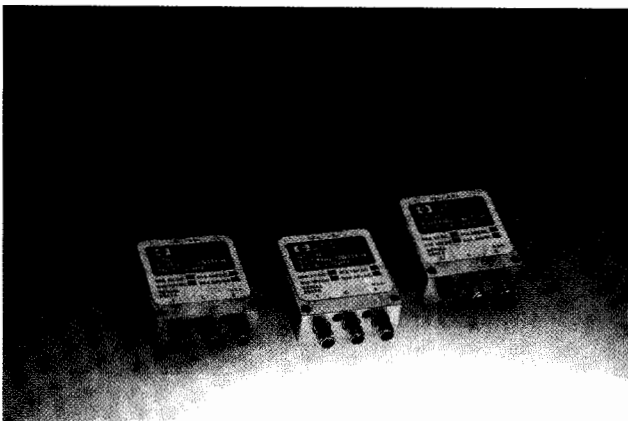

HP 8474, 8765, 84900 Series Coaxial Measurement Accessories

Hewlett-Packard continues to introduce new coaxial measurement accessories to provide better performance and higher frequency coverage. The line of PDB (planar-doped-barrier) detectors is expanded with the HP 8474 series. Mechanical switching advanced with the HP 8765 series SPDT switches that feature 5-million-cycle life. A completely new design of programmable step attenuators (HP 84904/06/07L) now covers dc to 40 GHz with 11, 70, and 90 dB ranges. See page 334 or check 30 on the reply card.

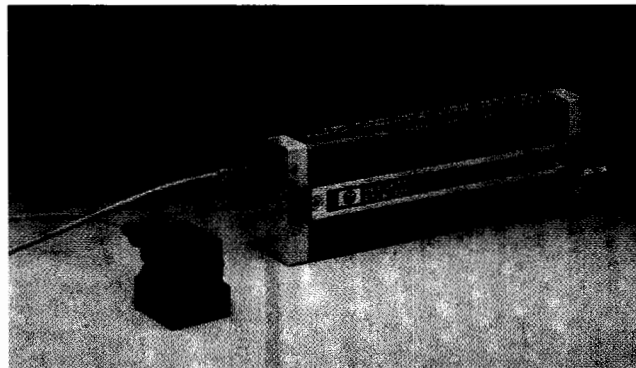

HP 10780F Remote Receiver

The HP 10780F remote receiver is a new addition to the HP family of laser-based precision products. It is a variation of proven HP measurement receivers with the sensor optics separated from the electronics module by a fiber-optic cable. This enables you to remove a heat source that is normally located near the measurement area, thereby improving measurement accuracy and stability. For most uses, the new design can replace the standard receiver and is much easier to install and adjust. The HP 10780F can be used with either the HP 5501A or HP 5527A laser position transducer systems, which are used in semiconductor manufacturing equipment, precision machine tools, disk drive manufacturing equipment, and other applications requiring high precision positioning. See page 348 or check 31 on the reply card.

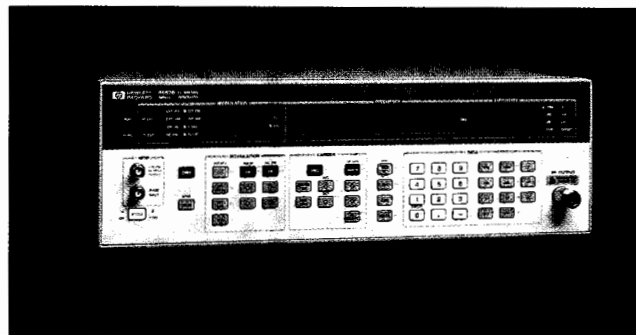

HP 8657B Synthesized Signal Generator

The HP 8657B synthesized signal generator offers economical RF frequency coverage to 2060 MHz with 1 Hz resolution. The HP 8657B has carrier phase adjustment capability for offsetting the carrier phase in precise offsets with respect to a reference time base. Carrier phase adjustment can be used in various testing applications of phase-sensitive devices and systems. Additionally, the HP 8657B offers AM, FM, and optional high-performance pulse modulation. The GaAs FET pulse modulator provides high isolation on/off ratios of 70 dB to 90 dB and fast rise/fall times of 35 ns to 50 ns. The HP 8657B also includes the same excellent spectral purity characteristics inherent in the HP 8657A 1040 MHz signal generator, making the HP 8657A and HP 8657B ideal companion 1- and 2-GHz economy signal generators. See page 360 or check 32 on the reply card.

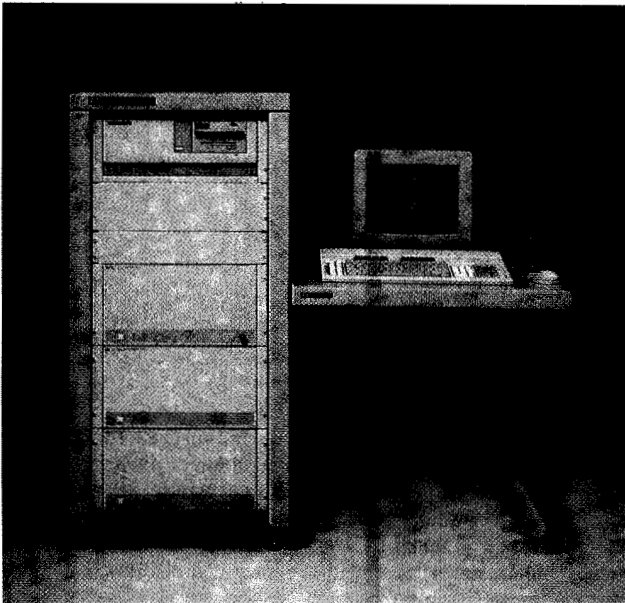

HP 8791 Frequency Agile Signal Simulator (FASS)

The HP 8791 FASS system provides exotic, agile test signals for advanced EW-threat simulation, radar-target simulation, and secure communications test. Covering 10 to 3000 MHz with 250 ns agility and a 40 MHz direct-digital instantaneous modulation BW, the system permits advanced spread-spectrum formats including chirp, Barker coded pulse, maximal-length pulse sequence, QAM, and FSK. Comprehensive applications software on a 20 Mbyte disk cover radar/EW simulations and modern signal generator formats of frequency hopping, intrapulse modulation, and a variety of antenna scans. An upconversion option extends coverage to 18 GHz. See page 380 or check 33 on the reply card.

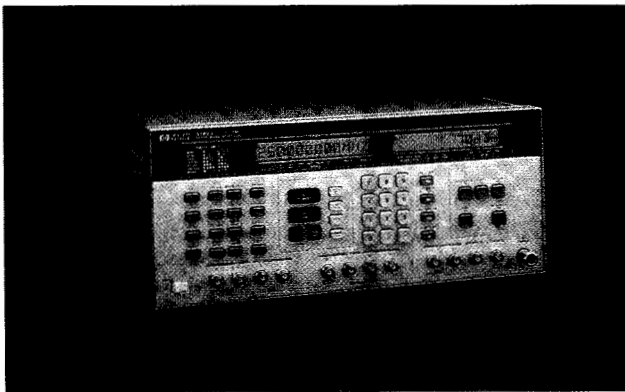

HP 8782A Vector Signal Generator

The low-cost HP 8782A vector signal generator provides precise digital modulations from 1 to 250 MHz, thus covering the IF ranges of most commercial receivers. Modulations range from BPSK to 256QAM to 81PRS formats for terrestrial and satellite communications testing. An internal PRBS generator with $2^{23}-1$ sequence length can generate modulation at rates to 50 MHz. This simulates TDMA systems while AM/scalar inputs permit flat fading. See page 383 or check 34 on the reply card.

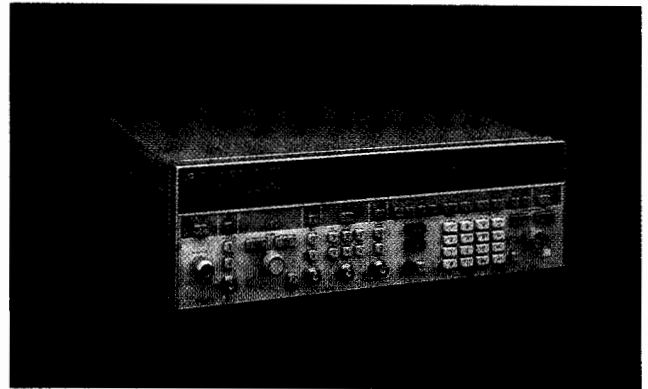

HP 8673H Synthesized Signal Generator

The HP 8673H is the lowest-cost, full-performance microwave synthesized signal generator offered by Hewlett-Packard because it is specifically designed for narrower-band coverage. You choose either HP 8673H Option 212 (2 to 12.4 GHz) or HP 8673H Option 618 (5.4 to 18.0 GHz). Full performance means -40 dBc harmonics, standard +8 dBm output power, AM, FM and pulse modulation, digital sweep and mm-wave capability. The HP 8673H mean time between failure (based on component warranty failure rates) is 20,000 hours. With this capability at this low price, the HP 8673H is ideal for all cost-sensitive applications. See page 384 or check 35 on the reply card.

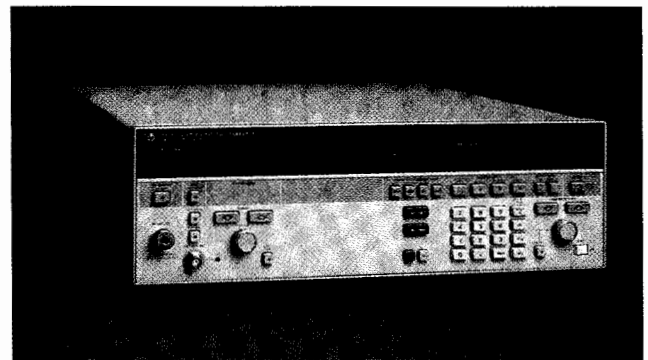

HP 8673G Synthesized CW Signal Generator

The HP 8673G synthesized CW generator provides a clean CW test source for unmodulated applications. Full 2 to 26 GHz frequency coverage, -40 dBc harmonics, and typical phase noise of -85 dBc (1 kHz offset at 6 GHz) combine with low cost to provide exceptional value for upconversion, downconversion, and component testing. Compatibility with the HP 83550 millimeter-wave source modules makes the HP 8673G one of the most economical methods to generate synthesized frequencies to 110 GHz. Also available with Option 088 is a +8 dBm output power to 26 GHz. See page 387 or check 36 on the reply card.

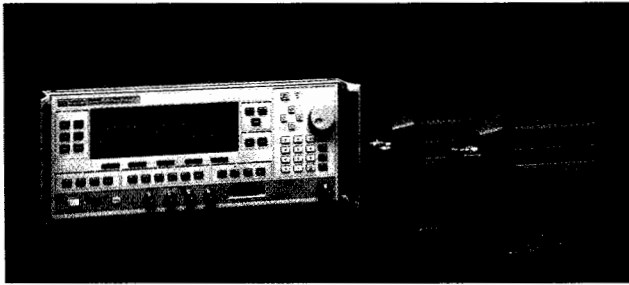

HP 8360 Series Synthesized Sweepers

The HP 8360 series synthesized sweepers are the standard of excellence for applications requiring both the high performance and accuracy of a synthesized source and the speed and versatility of a sweep oscillator.

The HP 8360 series synthesized sweepers generate signals up to 40 GHz in coax. They can be combined with the HP 83550 series mm-wave source modules for synthesized frequency coverage up to 110 GHz. The HP 8360 series synthesized sweepers provide an unprecedented combination of high performance features, including list, step, and analog sweeps and comprehensive modulation capability. This maximizes accuracy and versatility in signal simulation and device characterization applications.

These synthesized sweepers offer an unequalled commitment to quality and reliability. They only require calibration every 2 years, and they have over 250 guided internal diagnostic tests. See page 390 or check 37 on the reply card.

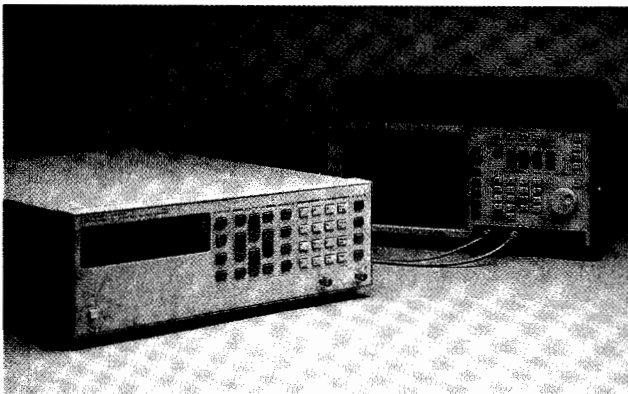

HP 3324A Synthesized Function/Sweep Generator

The HP 3324A synthesized function/sweep generator (1 MHz - 21 MHz wave sine) brings synthesizer accuracy to a variety of functions. It also provides a flexible cascaded sweep applications range from bench to ATE where a stable reference source or a versatile stimulus is required. See page 416 or check 38 on the reply card.

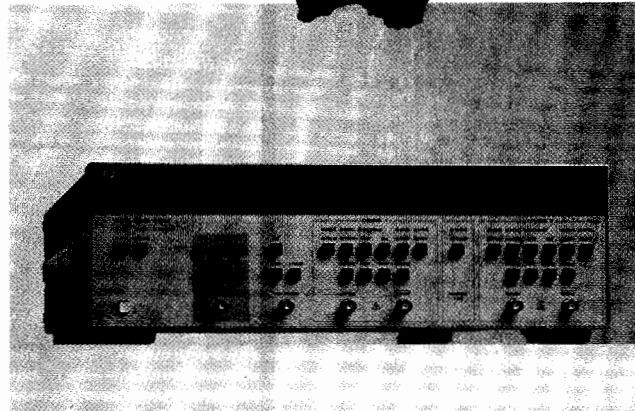

HP 8130A 300 MHz Pulse Generator

The HP 8130A 300 MHz programmable pulse generator is another member in the HP high-speed programmable pulse generator family. The HP 8130A is a one-channel instrument with differential outputs, offering 300 MHz repetition rate with variable transition times from 1 ns to 100 μ s (between 10% to 90% of amplitude) and 10 ps resolution on all programmable timing parameters. It features an output amplitude of 5 V p-p into 50 ohms in a ± 5 V amplitude window. The instrument is fully HP-IB programmable. An optional second channel is available. The HP 8130A is suitable for ATE system requirements. With its outstanding features, it can be used in a large number of applications throughout all industry segments. See page 436 or check 39 on the reply card.

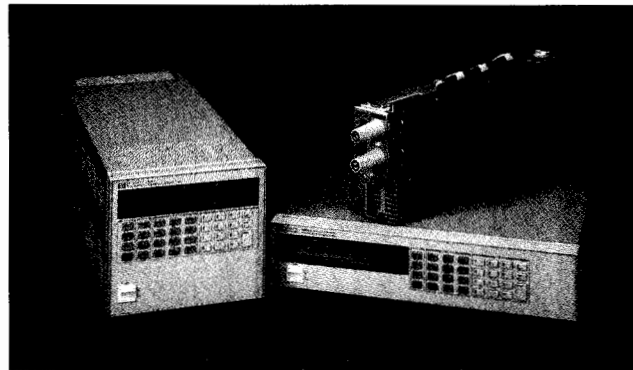

HP 6051A, 6063A, 60503A dc Electronic Loads

High performance and reliability are designed into the new HP 6051A 600 W electronic load mainframe, the HP 6063A 250 W, 240 V single input load, and the HP 60503A 250 W, 240 V load module. Power supplies, batteries, and power components can be tested in an automated or manual environment. These electronic loads include built-in HP-IB interface for full control and readback of all functions. The loads can be operated manually with the front-panel keypad and LCD display. These new products offer increased flexibility for loading solutions by providing 240 V input capability (for the HP 6063A and HP 60503A) and more efficient use of rack space (with the HP 6051A mainframe). High-performance features include a built-in transient generator, storage of settings, and an internal current monitor shunt and DVM. See page 450 or check 40 on the reply card.

NEW PRODUCT HIGHLIGHTS

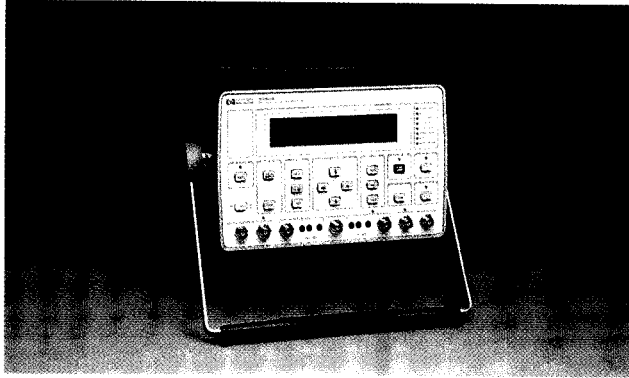

HP 3784A Digital Transmission Analyzer

The HP 3784A digital transmission analyzer is a powerful, multi-rate, error-performance test set for applications up to 50 Mbit/s, with optional jitter and 64 Kbit/s measurements. It is intended for use in the development, manufacture, installation and maintenance of digital transmission equipment operating at the standard CEPT telecom rates of 704 Kbit/s, 2, 8 and 24 Mbit/s. In addition, it makes 1 Kbit/s to 50 Mbit/s binary error measurements to address many different applications in digital testing.

Measurements of output jitter, jitter tolerance, and jitter transfer function are available. Tolerance and transfer function can be measured and plotted automatically for rapid, unattended operation in manufacturing. There are several ease-of-use features provided for increased productivity in the field. The HP 3784A is a compact unit that is easily transported or can be rack-mounted for automated production testing. See page 498 or check 41 on the reply card.

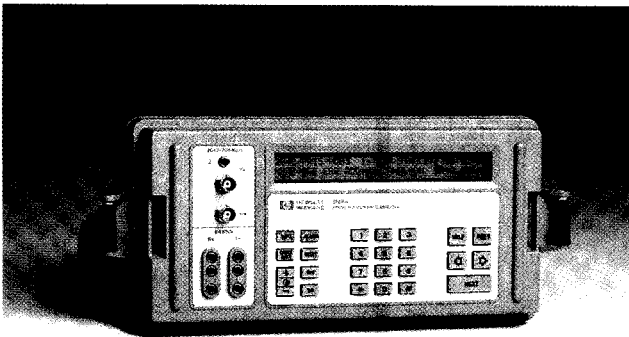

HP 3788A Error Performance Analyzer

The HP 3788A error performance analyzer is a low-cost test set for installation and maintenance of digital data circuits, lines, and multiplexers. It uses unframed test patterns to measure errors in CEPT-standard digital transmission equipment operating at 64, 704, and 2048 Kbit/s. In addition, it monitors live traffic for code errors. It not only measures basic error-rate results, but also carries out standard G.821 analysis for long-term circuit monitoring. Results can be stored internally and viewed or printed later. Battery-operated, lightweight, and portable, the HP 3788A is ideal for use in the field. See page 498 or check 42 on the reply card.

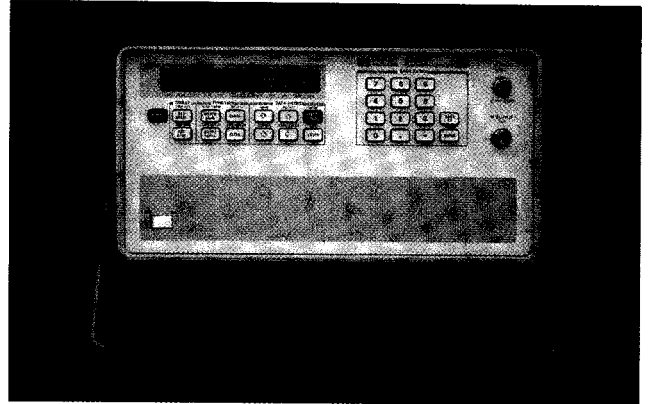

HP 11757A Multipath Fading Simulator

Digital microwave radios are subject to multipath fading effects that degrade transmission integrity by causing intersymbol interference. Simulating these effects in design, test, and maintenance phases assures that operational radios have enough margin for reliable transmissions. The HP 11757A multipath fading simulator provides the simplified 3-path model of fading at IFs of 70 and 140 MHz, with variable notch depth to 40 dB and resolution of 0.1 dB, variable gain to 12 dB and flat fade from 0 to 50 dB. Intermodulation caused by the insertion of the HP 11757A is less than -50 dBc. The 20-pound instrument is rugged and portable. See page 507 or check 43 on the reply card.

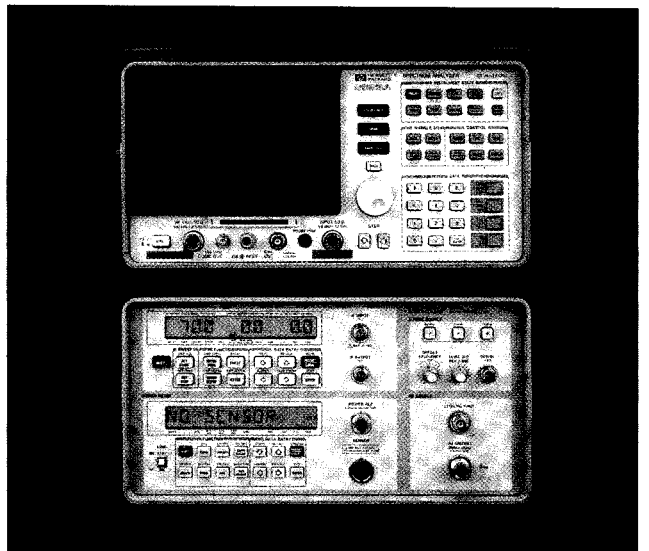

HP 11758T Digital Radio Test Set

The HP 11758T digital radio test set brings together the instruments most commonly used in testing digital microwave radios in production, installation and maintenance. The result is a portable solution adaptable to old as well as new radios. The capabilities include a microwave spectrum analyzer, frequency counter, 300 kHz to 3 GHz IF source, power meter, multipath fading simulator, three-tone IF source, 3.5 to 6.5 GHz source, and an optional 10.7 to 11.7 GHz source. See page 509 or check 44 on the reply card.

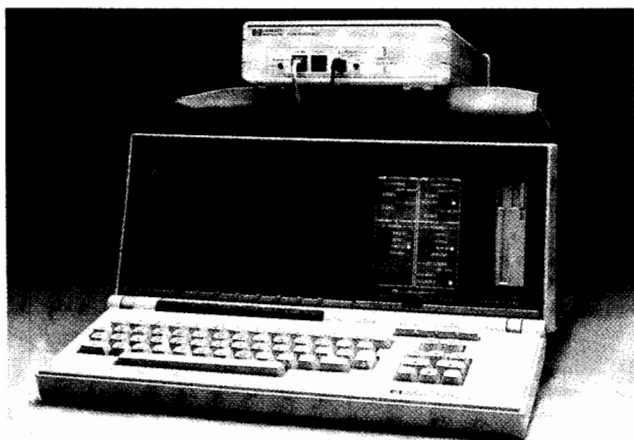

HP 4954I ISDN WAN Protocol Analyzer

The HP 4954I protocol analyzer addresses the emerging technology of ISDN as a protocol analyzer for the development engineer. The basic rate interface conforms to the CCITT I.430 specification. Two RJ-45 (ISO 887) 8-pin module connectors provide access to ISDN terminal equipment (TE), terminal adapters (TAs), PBX interfaces, network terminators (NTs), and digital switches. A handset is provided to allow full-duplex monitoring or voice communication over either of the B channels. The physical layer LED display provides continuous indications of the data traffic on the B and D channels, INFO STATE conditions, and dc power source status. Monitoring and simulation of Q.921 (I.331, LAPD) and Q.932 are specifically provided for the AT&T 5ESS, Northern Telecom DMS, Siemens EWSD, German PTT ITR6, and French PTT VN2 switches. LAPD emulation provides an additional advantage for upper level ISDN testing. The HP 4954I also includes the powerful DataCommC language platform for customized testing. See page 512 or check 45 on the reply card.

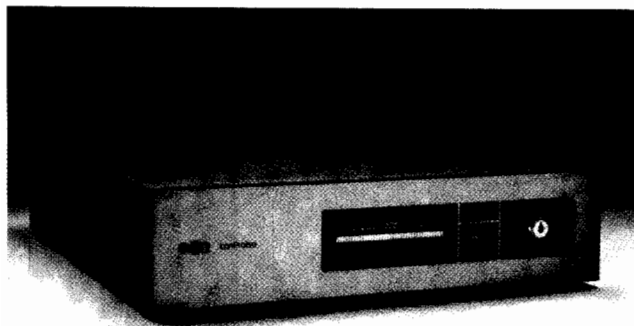

HP 4990S LanProbe Distributed Analysis System

The HP LanProbe distributed analysis system monitors Ethernet LANs. Completely independent of equipment or protocols, the system monitors, tests, and diagnoses the network. It presents its findings in color graphics. The system consists of one or more LanProbe segment monitors and ProbeView software running under Microsoft® Windows. The NodeLocator option automatically locates the position of nodes on coaxial networks. All three components work together to dynamically map and monitor the LAN. The HP 4990S LanProbe system is an integral part of the network. It provides a comprehensive and informative view that is key to confident network management. See page 515 or check 46 on the reply card.

*Microsoft is a U.S. registered trademark of Microsoft Corporation

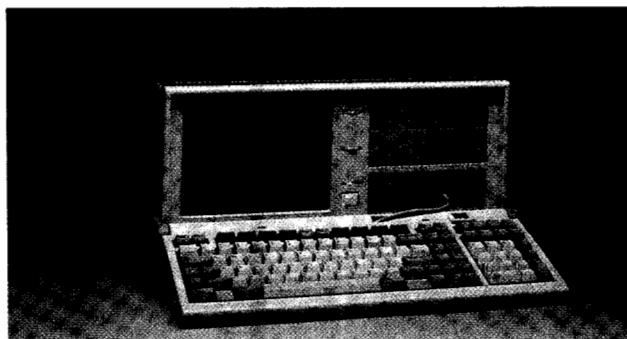

HP 37900C Signaling Test Set

The new Signaling System No. 7 (SS7) currently being introduced into telephone networks worldwide is the foundation for all new and enhanced services. The HP 37900C signaling test set is dedicated to SS7 test applications. These No. 7 specifications include ANSI/Bellcore SS7, CCITT #7, BTNR 167, GSM, and others. (Consult Hewlett-Packard for additional information.) The HP 37900C can monitor, with a choice of interfaces, both send and receive directions of up to two links. A full decode, at all levels, of captured data is provided down to individual octet level in an MSU. This decode gives a complete description in words and diagrams from the actual signaling specification. The HP 37900C, with optional software, also emulates certain parts of the signaling network. Applications include level 2 error tracing, signaling point processing time checks using the HP 37900C's advanced triggers and filters to capture and time specific messages, and 800 number data base checking using the advanced high level decode capability. See page 517 or check 47 on the reply card.

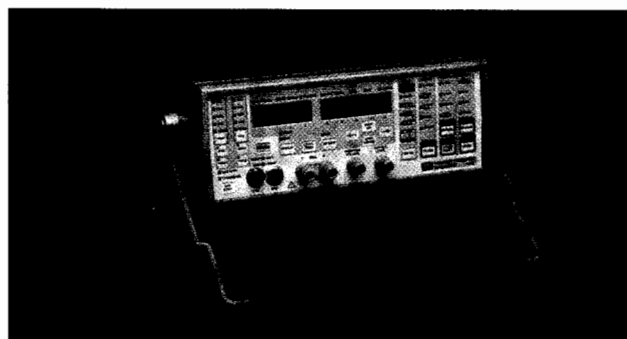

HP 4934A Transmission Impairment Measuring Set

The HP 4934A transmission impairment measuring set is designed for outstanding ease of use in testing analog and digital data circuits in the North American telephone network. It makes measurements using the methods of IEEE 743-1984, so datacom circuit users can rely on its line quality. Its heavy duty case, a button for each function, and large bright display offer excellent portability, ruggedness, and ease of use in telephone installation and maintenance environments. With 110 kHz bandwidth, and a choice of filters, the HP 4934A covers a wide range of analog circuits. See page 522 or check 48 on the reply card.

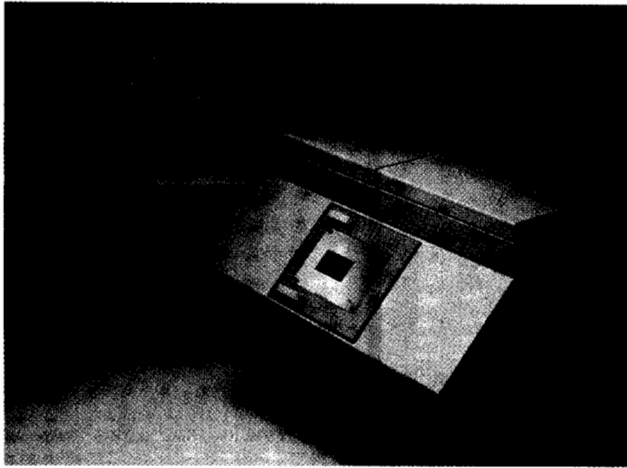

HP 82000 Model D50 IC Evaluation System

Designed for maximum data rate of 50 MHz, the HP 82000 model D50 extends the HP 82000 family of compatible IC evaluation systems. It is based on the same tester-per-pin architecture as the high-speed HP 82000 model D200, and test setups and user-written programs can be exchanged between systems. The HP 82000 model D50 is suitable for design verification and measurement software with ± 500 ps accuracy. Small batch production testing is also possible. The system is available in a benchtop version for up to 160 input/output channels and in a free-standing version for up to 512 channels. See page 526 or check 49 on the reply card.

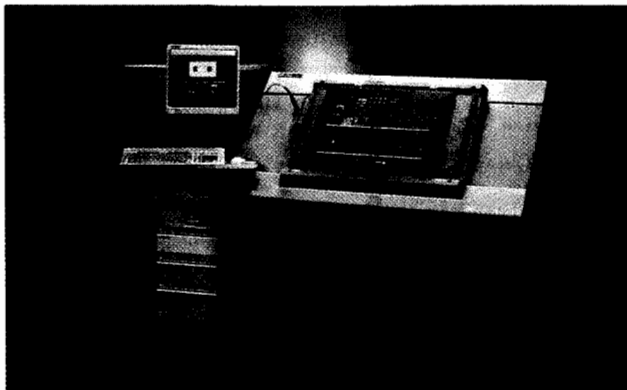

HP 3070 AT-Series Combinational Board Test Systems

The HP 3070 AT-Series combinational board test system combines high-performance functional and in-circuit capabilities into a single tester. Each system provides a completely integrated set of powerful resources for testing digital, analog, and mixed-signal circuits, using combinational testing techniques. The parallel modular architecture provides the flexibility and expansion capability to solve complex test problems well into the 21st century. The HP 3070 AT-Series features test development tools that automatically generate test programs, design test fixtures, manage the test development process, and assist in analog and digital test debugging. A total of 2,592 independently programmable HP HybridPlus pins for in-circuit, functional, digital, or analog testing are available. The in-circuit and functional pattern application rate is 12.5 million patterns per second. This system offers unsurpassed reliability with a mean time between failure (MTBF) of over 2300 hours and a mean time to repair (MTTR) of 2 hours. See page 550 or check 50 on the reply card.

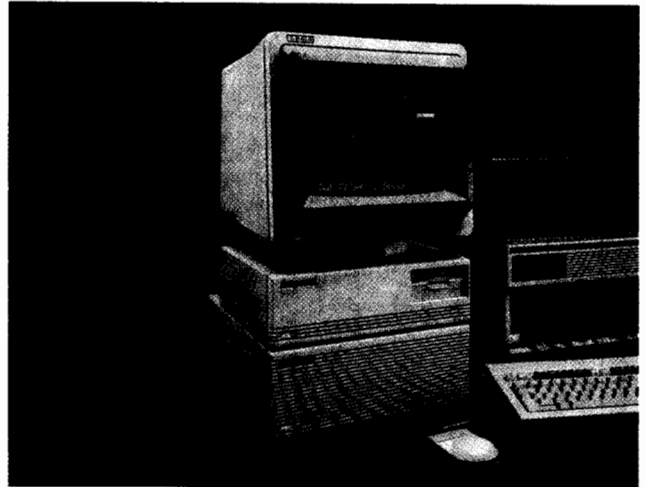

HP 16276A Interactive Measurement and Analysis (IMA) Software

HP interactive measurement and analysis (IMA) software accelerates semiconductor measurements and analysis through specially designed drivers in the HP 4142B dc source/monitor. The software makes the HP 4142B a fully automatic semiconductor dc parameter analyzer with on-screen interactive, softpanel, user interface, making it unnecessary (but still possible) to write HP BASIC program code. The menu- and mouse-driven operations simplify measurement setup and let you control all the graphical analysis routines, output formats, and file management of IMA. The analysis panel provides a digital readout of marker, cursor, line functions, and user-definable calculated results. The analysis instruction set (AIS), a sub-program library, offers a flexible interface to HP BASIC. See page 540 or check 51 on the reply card.

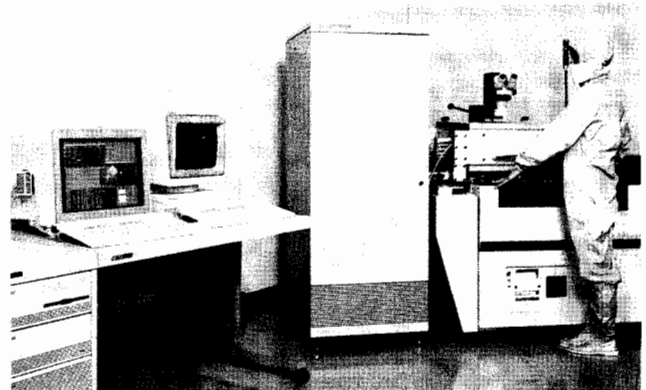

HP 4062UX Semiconductor Process Control System

The HP 4062UX semiconductor process control system is the newest model of the HP 4062 semiconductor test system family. It is a fully integrated system designed to satisfy the IC manufacturer's requirements of process monitoring and process development. It features high-speed dc testing and a wide measurement range of 20fA to 1A and 4 μ V to 200V. The superiority of the HP 4062C semiconductor parametric test system is maintained with the high accuracy and reliability of the HP 4062UX. The friendly and powerful HP BASIC/UX programming environment brings multi-tasking and windowing to process control, and adds to all the facilities of HP-UX, which opens up the world of computer networking. See page 530 or check 52 on the reply card.

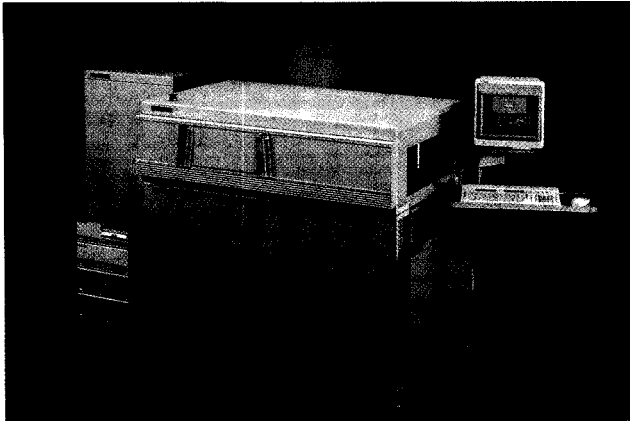

HP 3070 SMT-Series Board Test Systems

The HP 3070 SMT-Series board test system combines the innovative mechanical HP Express Fixturing System with the high performance of the HP 3070 hardware and software to provide a total solution for surface-mount technology (SMT) test problems. The HP Express Fixturing System provides mechanical accuracy and reliability for close-center, dual-sided, and dual-stage probing. HP Express Fixturing Software automates the design and construction of SMT fixtures. It minimizes wire lengths and close-center probes. The rugged design makes this system ideal for high-volume production areas and SMT processes. Automatic board handling requires only 6 seconds for in-line mode or 12 seconds for pass-back mode. With the interchangeable HP Express Cassettes, changing board types takes only 30 seconds. The single plane design of the cassettes facilitates automatic drilling, wiring, and probe receptical insertion. Average wire lengths are 75 mm, 25 mm for critical nodes. **See page 552 or check 53 on the reply card.**

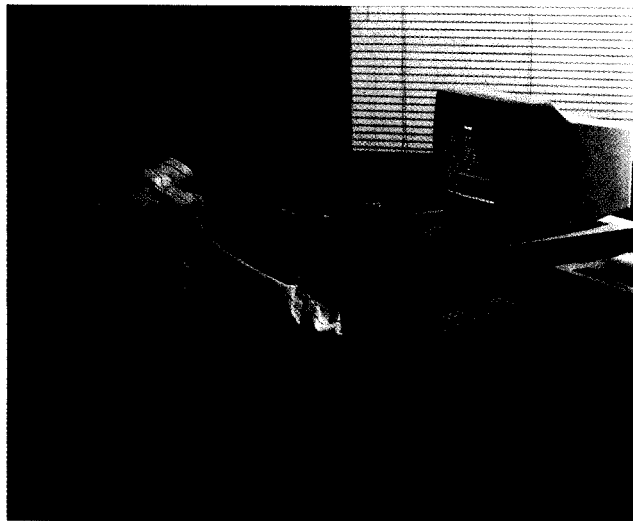

HP 75000 PC Data Acquisition System 10

HP 75000 PC Data Acquisition System 10 is a total data acquisition solution for professionals who don't have time to write programs. The System 10 includes an HP 75000 card cage, three measurement cards, and LABTECH® NOTEBOOK data acquisition software. Use the System 10 to monitor experiments, test materials, control environments, monitor a facility, or characterize an important process. The system is designed to easily collect reliable data and document the results without having to program your PC. **See page 588 or check 55 on the reply card.**

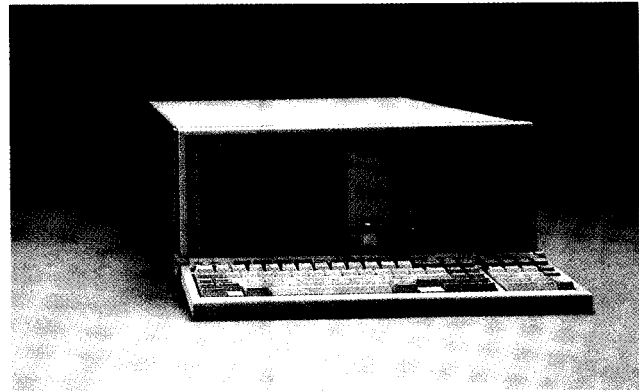

HP Model R/332 Rack-Mountable Series 300 Instrument Controller

The HP R/332 instrument controller provides the power and performance of the HP Model 332 BASIC instrument controller in a single, integrated, rack-mountable configuration. The HP R/332 has full language and enhancement compatibility with the HP 332 controller. The HP R/332 occupies only 7 inches of rack space, or it can be used as a compact, transportable field unit. With a touch-screen display and an adjustable, removable keyboard, it is designed for reliability in extreme environments. It has the high performance of an MC 68030 processor with DMA and cache memory. Its 9-inch monochrome monitor, disk drives, and keyboards are conveniently located on the front panel. The built-in interfaces, 8 DIO expansion slots, and customizable front panel allow the R/332 to be expanded and adapted to most controller requirements. **See page 558 or check 54 on the reply card.**

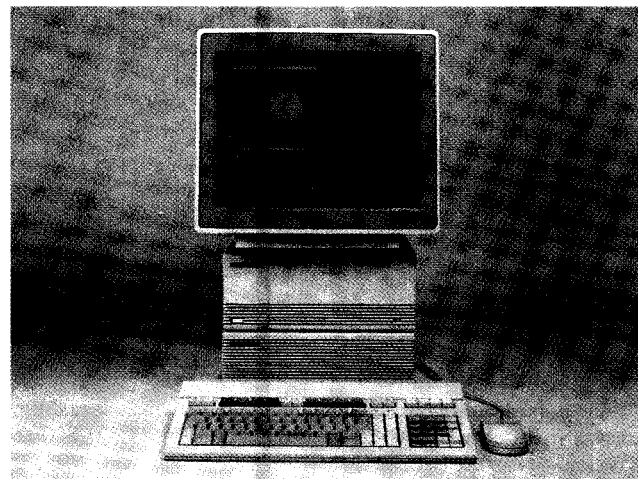

HP 9000 Model 332 HP BASIC/UX Instrument Controllers

The HP 9000 Model 332 MMAX/CMAX systems are specifically configured to provide an HP BASIC/UX platform combining low cost, expandability, and high performance. Based on the HP 332 instrument controller, these two systems provide the computational power and high-performance device I/O capabilities required for complex instrument-control applications. They are configured with HP BASIC/UX, which combines HP BASIC control with the flexibility and features of HP-UX. **See page 557 or check 56 on the reply card.**

NEW PRODUCT HIGHLIGHTS

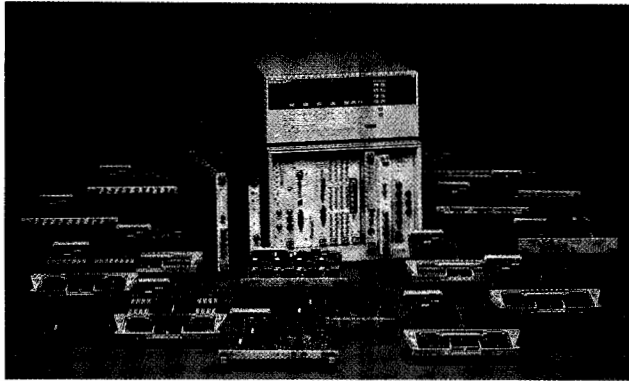

HP 75000 Family of VXI Products

The HP VXI family of products has been dramatically expanded with the introduction of the more powerful HP 75000 Series C mainframe and the new HP 75000 Series B mainframe. Over 25 modules are now available including a plug-in HP 9000 Model 360 computer, 5½ and 6½-digit multimeters, counter/totalizer, universal counter, high-performance function generator, power meter, D/A converters, digital I/O, switches, and multiplexers covering dc to microwave frequencies. All HP 75000 modules use the standard systems language, TMSL, and are supported by HP Interactive Test Generator (HP ITG) software, giving you compatibility, ease-of-use, and fast system development. See page 597 or check 57 on the reply card.

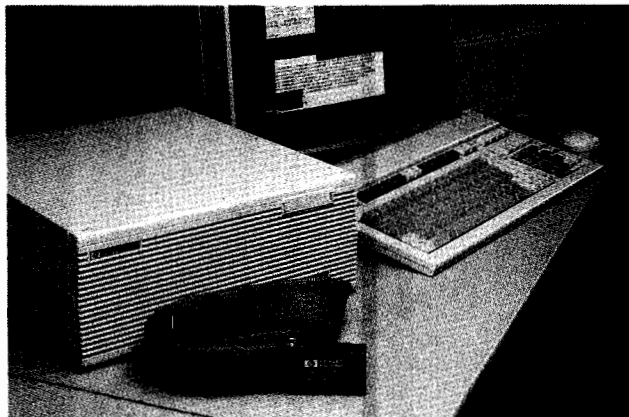

HP 64700 Series Emulators

Emulators in the HP 64700 series are expanded to include real-time, transparent, emulation, and analysis of AMD 80C521/80C321, Hitachi 647180X, Intel 8051, Motorola 68HC000, NEC V25, and NSC 32532/32GX32 processors. These self-contained analyzers can be controlled from a terminal, through an optional HP 9000 series 300-hosted softkey interface, or through a PC-hosted user interface. This choice of user interface plus high-speed program download provides efficient design and integration of embedded processor systems. These emulators include an emulation bus analyzer for tracing processor code flow to help solve complex system problems. An optional 100 MHz timing and 25 MHz state analyzer is available to integrate target system performance with emulator measurements. See page 630 or check 58 on the reply card.

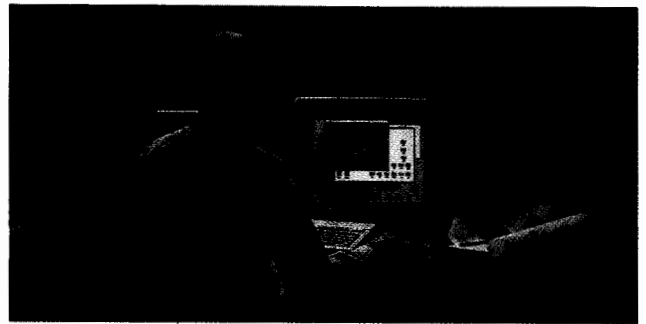

HP Electronic Design System, HP System HILO®

Logic simulation is the key design verification capability available on today's CAE systems. Benefits of HP System HILO for the HP DesignCenter include reductions in both the number of prototype cycles and design troubleshooting time. This results in substantial time-to-market and cost improvements. This broad appeal in both PCB and ASIC design verification makes it an ideal choice as part of the HP DesignCenter. Now, with the emergence of a new set of HILO simulation products, designers have at their fingertips an even more powerful set of simulation tools. See page 639 or check 59 on the reply card.

*HILO is a U.S. registered trademark of GenRad, Inc.

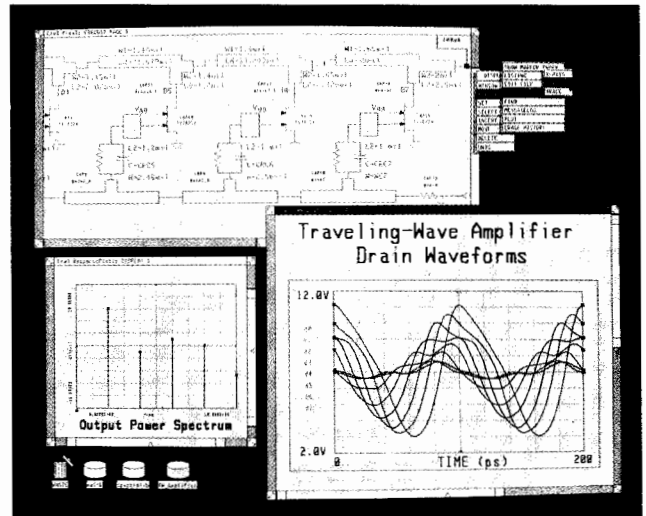

HP 85150B Microwave Design System

The HP 85150B Microwave Design System is a graphics-based CAE system for RF and microwave designers. It includes four integrated modules for design capture, linear and nonlinear circuit simulation, and artwork generation. Integrated into the program are extensive capabilities for documenting designs and provisions for networking several CAE stations for file sharing. See page 642 or check 60 on the reply card.

Hewlett-Packard Company develops, manufactures and markets measurement and computation products and systems for people in science, engineering, business, industry, education, and medicine. The over 10,000 HP products are known for high quality, reliability, and advanced technology.

Hewlett-Packard products include electronic test and measuring instruments, instruments for chemical analysis, medical instrumentation, computer systems, peripherals, integrated instrument and computer systems, handheld calculators, and electronic components.

Hewlett-Packard in Profile

Headquartered in Palo Alto, California, Hewlett-Packard employs approximately 95,000 people worldwide, of whom some 62,000 work in the U.S.A. Product research and manufacturing activity is highly decentralized, with facilities in the U.S.A., Europe, Japan, Southeast Asia, Latin America, and Canada. The worldwide sales organization includes sales and support offices in 140 cities in the U.S.A. and over 300 sales and support offices and distributorships in 92 other countries.

With a 1988 revenue of 9.8 billion dollars, Hewlett-Packard is ranked in the top 50 U.S. industrial corporations, and it is one of the top 15 American exporters. Approximately half of the revenue is generated outside the United States, with European sales accounting for 65 percent of international sales. Other principal markets include Japan, Canada, Australasia, the Far East, and Latin America.

Founded in 1939

Hewlett-Packard Company was founded in 1939 by Bill Hewlett and Dave Packard. The first product was an audio oscillator that improved on existing audio oscillators in size, price, and performance. The company focused on developing high-quality, innovative electronic instruments for broad applications.

Today, Hewlett-Packard has grown to be the world's leading manufacturer of electronic test and measuring instruments for engineers and scientists. HP instruments are used to evaluate the performance of electronic equipment as it is designed, manufactured, operated, or serviced.

Hewlett-Packard's 50 divisions allow the company to preserve the personal touch of a small operation. Each division has its own research and development, manufacturing, marketing, and support operations for its own family of products.

HP Laboratories

HP Laboratories is the central research facility for the company, and it is regarded as one of the leading scientific and technical research centers in the world. The basic research performed by HP Laboratories helps the company develop new technologies and new business areas so that HP instruments are at the forefront of technology.

Wide Range of Products

HP products serve the electronics industry, the telecommunications, aerospace, aircraft, and automotive industries, as well as scientific research programs.

Hewlett-Packard also manufactures other products, all related by basic electronics technology. The products include solid-state components, consisting primarily of microwave semiconductor and optoelectronic devices.

Hewlett-Packard has extended electronics technology to the fields of medicine and analytical chemistry. Hospitals and clinics use HP equipment for patient monitoring, diagnosis, and therapy, and for data management. Analytical instruments are widely used in the chemical, energy, pharmaceutical, biotechnology, environmental monitoring, and food industries, as well as in medical and chemical research.

Instruments often incorporate computer systems to provide additional automation and precision not available in competitive products.

HP handheld calculators have made the engineer's slide rule obsolete. They are known for their ruggedness and versatility.

Hewlett-Packard computers were originally designed to gather and analyze data from electronic instruments. Today, computers, computer systems, peripheral devices, and calculators are a major portion of the company's products.

HP Test and Measurement Systems

Customers use HP instruments in evaluating the performance of their own equipment, in developing new products, in controlling quality and manufacturing processes, and in field service applications. HP instruments are used in almost every industry where precise testing, measurement, and control are required.

Increasingly scarce and costly technical labor has accelerated the need for measurement systems, with their high speed, accuracy, repeatability, and productivity. HP instruments and computers are designed with systems in mind. Hewlett-Packard combines precision electronic equipment into interactive systems that provide customers with total

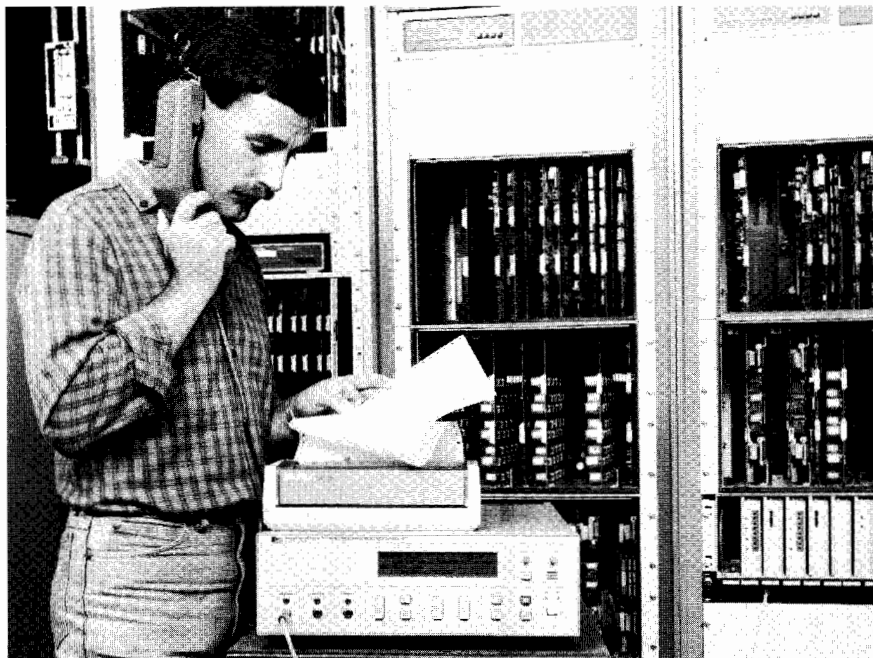

The HP 4948A transmission impairment measuring set (TIMS) tests the performance of leased analog data lines carrying voicegrade modem signals. The set improves circuit availability because it allows an operator to test lines at any point on a network while the lines are still in service carrying data traffic. Troubleshooting can begin immediately, and there is no need to take a line down.

ABOUT HEWLETT-PACKARD

solutions to information needs. This capability sets HP products apart from other companies that can provide either computers or instruments, but not both. These integrated systems allow customers to access essential information, to put it in meaningful form, and to improve their effectiveness.

A Leader in Open Industry Standards

In the early 1970's, Hewlett-Packard created its own internal standard for linking HP instruments and computers. The standard became a worldwide standard, IEEE 488-1978, and today it is used by several hundred manufacturers worldwide. We call this standard HP-IB, the Hewlett-Packard Interface Bus. In this catalog, system-ready products are marked with the HP-IB symbol.

Hewlett-Packard has built on the HP-IB standard to create the new HP Measurement Systems Architecture (MSA), an integrated approach to automatic testing. With MSA, Hewlett-Packard has taken a leading role to help establish fully open, modular standards that any manufacturer can build on. MSA will continue to evolve to keep pace with the changing measurement needs of automated testing.

HP Measurement Systems Architecture provides the easiest way for you to develop systems that will be technically viable and allow you to be competitive in the future. It minimizes the time, effort, risk, and expertise required for system development. MSA includes a wide selection of hardware, controllers, software, and support products that are based on open standards for increased compatibility in the industry. MSA is described in more detail on page 562.

New MSA hardware includes two modular product families that enhance traditional HP-IB test equipment. The HP 70000 modular measurement system and the HP 75000 VXIbus families offer test equipment and development tools for design and integration of computer-aided-test systems.

New HP controllers for MSA are available in rackmount and VXIbus configurations.

The MSA software includes the HP Interactive Test Generator for easy generation of code and the HP Functional Test Manager, a reusable framework that you customize for production-test systems.

MSA includes a new test and measurement systems language (TMSL), based on IEEE Standard 488.2-1987, which provides a single set of commands for all types of instruments. The common instrument language increases the compatibility of software between generations as hard-



VXIbus is an exciting new systems architecture, and the HP 75000 family is part of Hewlett-Packard's extensive line of VXIbus products. The HP 75000 family provides many benefits including standardization, downsizing, throughput, and support to speed test system development. When more capability is needed, users can easily add other components from Hewlett-Packard's Measurement Systems Architecture.

ware is upgraded. TMSL has been opened for use by other manufacturers.

In all cases, the goal of HP systems is to provide essential information in a useful form and in the most efficient and timely manner. The result is that customers can improve the productivity of their processes and organizations.

HP Computers

Hewlett-Packard's strength in engineering, scientific, and manufacturing applications has enabled it to make major contributions in key technical computer markets. Advanced data communications technology allows instrument systems to be linked with computers, giving customers tools for acquiring, analyzing, managing, and transmitting data. Powerful desktop workstations from Hewlett-Packard improve the productivity of engineers working on complex tasks.

Hewlett-Packard also is an important manufacturer of business computers, portable computers, personal computers, and minicomputers. The HP 3000 mini-

computer line is one of the most widely installed general-purpose business computers in the world, with more than 35,000 machines in use.

Hewlett-Packard's strong support of industry networking standards and open systems makes multi-vendor connectivity possible and provides the flexibility to solve customer problems using a variety of approaches, including software applications developed by third parties.

Since 1986, Hewlett-Packard has introduced a series of new, high-performance computers based on HP Precision Architecture. The simplicity of the new architecture ensures ease of manufacture and provides both business and technical customers with excellent price/performance compared with conventional designs. HP Precision Architecture promises superior future performance capabilities and allows Hewlett-Packard to develop a range of compatible computer systems, including personal computers, engineering workstations, and minicomputers. The unified architecture enables customers to leverage their

software investments because the same application can run on a wide range of machines within the same family.

Hewlett-Packard's family of personal computers includes portable computers and the HP Vectra personal computers, first introduced in 1985.

HP Innovation

Hewlett-Packard's continuing growth is based on a strong commitment to research and development. Each year the company invests about ten percent of its net revenue in R&D (\$1 billion in 1988). This heavy investment enables Hewlett-Packard to remain a leader in technological development and to maintain a steady flow of new and useful products. Well over half of the company's 1988 orders were for products introduced during the previous three years, a clear indication of the importance of product-development efforts.

About 85 percent of the company's yearly R&D budget is allocated to product development within some 50 separate divisions. The remaining 15 percent is invested in more basic, higher-risk, longer-term research by HP Laboratories. The scientific and technical research of HP Laboratories helps the company remain a leader in technology.

Hewlett-Packard believes that test and measurement is a dynamic market, with new technologies and opportunities driving the development of future products. In the future, there will be increasing emphasis on systems that take advantage of computer and instrument capabilities. Instrumentation will be programmable, have standard interfaces, and be easier to use and customize. Computer technologies will have an increasing impact. Instruments that use digital architectures have improved performance, lowered prices, and are changing the way analog measurements are made.

Improved performance has resulted in new measurement opportunities. New demands have emerged in digital, light-wave, and secure communications, chirped radar, and frequency-agile radios. HP customers also drive demand for test and measurement systems as they strive to become more competitive in global markets.

Hewlett-Packard looks forward to meeting the challenges and satisfying the needs of the future by continuing to advance the sciences of test and measurement.

HP Product Standards

All HP products are designed to operate under the environmental conditions expected for the product. All new hardware designs are tested to internal HP standards in typical operating environments before they are released for customer sales. Internal HP standards are derived from our experience with environmental conditions at customer installations and from industry standards such as IEC, ISO, ANSI, and MIL.

The classification codes used to identify expected environments range from A1 to C2. A1 corresponds to the severe environments found in heavy industrial areas that are unsuitable for operating personnel, and C2 corresponds to the controlled environments of dedicated computer rooms. Most HP hardware products are designed to meet Class B2, general-purpose applications in light industrial and commercial facilities.

HP Support

Hewlett-Packard's commitment to engineering excellence is equaled by its commitment to providing customers with high-quality support services. Hewlett-Packard's support organization consists of a worldwide sales and service network staffed by highly trained engineers and technicians. Our support starts before you purchase an HP product and continues long after the product has been delivered.

Before you purchase a product or system, HP sales representatives are available to help you assess your needs and choose the product or system that meets your immediate and longer term requirements. We offer applications and training support to help you obtain full use of your system, hardware support to help maximize system up time, and software support to keep your system software current and productive.

To help you plan your system and its use, we offer the consulting and training skills of experienced systems engineers. For the installation and maintenance of your system and its components, we offer the services of customer engineers. For the long-term support of your system, there is an extensive menu of options for services, including contract or as-needed calibration and repair on-site and at Hewlett-Packard. Update services are available for both software and hardware, and training is available for your own service personnel.

Hewlett-Packard also offers a full range of instrument rental and lease plans. Because of our low cost of funds, we offer finance plans at very competitive rates. From 12-month rentals to 5-year

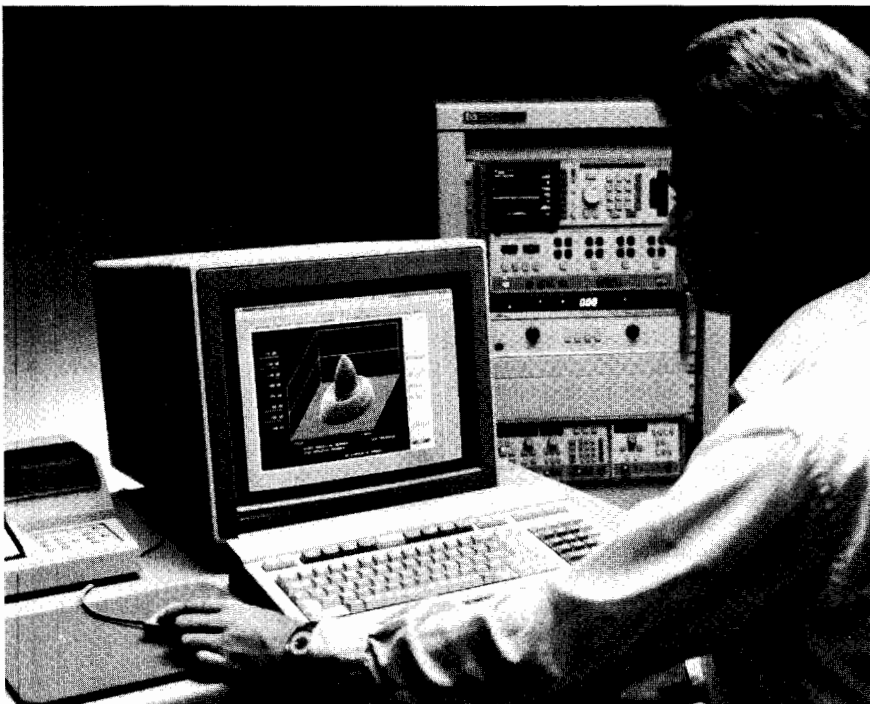

The HP 85301A is an integrated antenna-measurement system that simplifies far-field antenna-pattern measurements. The system includes RF-measurement instrumentation, a workstation controller, and system software. The user interface is a logical instrument-style front panel that appears on the workstation display. All instrument controls are manipulated by a controller mouse.

ABOUT HEWLETT-PACKARD

leases and purchase plans, an HP finance representative can help you tailor a plan to meet your financial requirements.

Rental and lease plans provide an answer for short-term project needs, a hedge against obsolescence, a way to finance "off balance sheet," and a way to smooth out your cash flow by avoiding large cash outlays. See page 736 for more details about financing, rental, and leasing.

Hewlett-Packard's worldwide support network ensures prompt availability of replacement parts throughout the service life of products and beyond. Replacement parts services also include parts stocking recommendations based on extensive component reliability histories and the numbers and mix of HP products to be supported.

For products requiring consumable supplies, such as recording paper, ribbons, and magnetic media, we offer fast, convenient service from well-stocked supply centers. These centers also offer personal computers and software, peripherals and terminals, cables and connectors, workstation furniture, books and learning aids. The support services outlined above are described in more detail beginning on page 724.

HP's comprehensive support extends to information services, including excellent hardware and software manuals, and a wide variety of free publications. These publications help you choose the HP products that best fill your needs, allow you to benefit from applications knowledge acquired by users inside and outside of Hewlett-Packard, and help you maintain your HP products. This literature includes new-product announcements, catalogs, product family brochures, single-product data sheets, application notes, programming aids, service notes, and maintenance periodicals. More details on these publications can be found on page 760.

The HP Test & Measurement Catalog

The growth of Hewlett-Packard over 50 years has been reflected in this catalog. The first catalog, published in 1943, described 12 products on 24 pages. This 1989 edition describes about 1,700 of more than 10,000 products on 760 pages.

This catalog is divided into sections based on broad product groups, including sources and analyzers, design automation and technical computers, semiconductor test and board test, etc. Many of the sections begin with descriptions of basic kinds of measurements and the techniques of measurement that are associated with the featured products.

Products described in this catalog are indexed three ways: alphabetically,

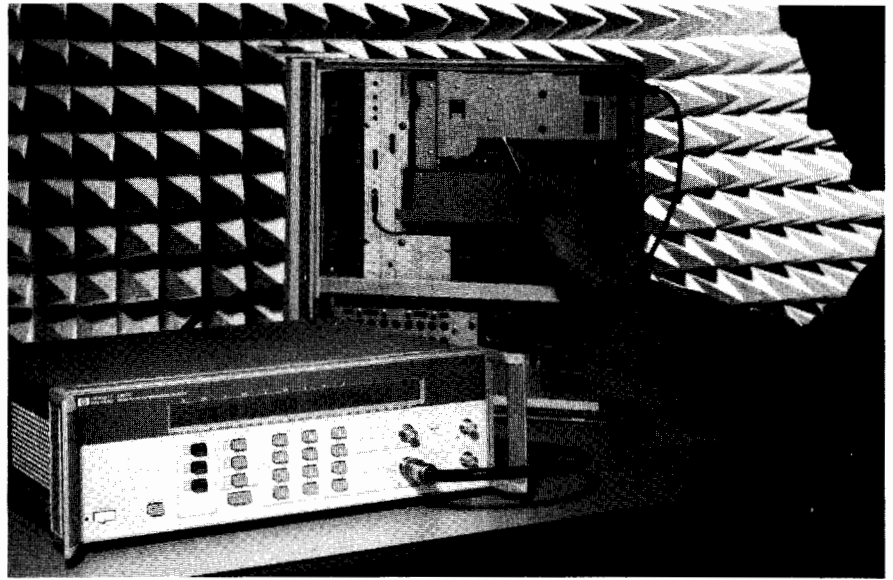

The HP 5361A 20 GHz pulse/CW-microwave counter is an excellent tool for designing, testing, manufacturing, and servicing commercial and military radar systems. It combines pulse and CW microwave frequency measurements in a single instrument, and its automatic features simplify measurements. The scope-view output shows the exact position of a measurement during frequency profiling. The counter is also well-suited for electronic warfare, satellite communications, and automatic/microwave landing systems.

numerically by HP model number, and by product type or application. In addition, blue page tabs allow you to readily locate a particular product group. The alphabetical index begins on page 21, the numerical index begins on page 33, and the general index begins on page 46.

For some products you might want a data sheet for a full set of specifications. Data sheets are available on request at local HP sales offices.

Contacting Hewlett-Packard

Locations of HP sales and service offices are listed on pages 739 through 746. Calls to your local HP office will be routed to the person best qualified to assist you. Just give the HP operator your specific product interest: test and measurement, computers, medical, analytical, or components. Our sales force is made up of specialists in those major product areas.

Staff engineers are always available during business hours. Our sales representatives are supported by the HP systems engineering organization, which has specialists in measurement and computation systems.

Information on product availability, prices, and order status is immediately available through our worldwide order processing network.

You can also contact Hewlett-Packard through toll-free phone numbers at a growing number of Customer Information

Centers (CICs) worldwide. These centers can provide pre-sale assistance with product selection and information on product availability and price. In addition, CICs can arrange for you to receive some free publications. CIC locations and phone numbers are included in the listing of HP offices that starts on page 739.

Suggestions Welcomed

The purpose of this catalog is to give you useful information about HP products, along with some company background that might help you reach decisions on products and systems that will fill your needs. The catalog emphasizes test and measurement products and systems, but it also includes representatives of Hewlett-Packard's other product categories. For additional literature describing the other products, contact your local sales office.

If you have any comments and suggestions about how we can make this catalog more useful to you, please let us know by writing to us at the following address:

Hewlett-Packard Company
Max Trescott
T&M Literature Manager
3200 Hillview Avenue
Palo Alto, CA 94304-1298
U.S.A.

- A**
- AC**
- Power Source 109
 - Probes 93
 - True RMS Voltmeters 92
 - Voltmeters 78–93
- Accessories**
- Adapters 309, 708–709
 - Board Test Systems 553
 - Cabinet 723
 - Cables/Connectors 215, 233, 309, 569, 708–709
 - Catalogs 737
 - Coaxial & Waveguide 330
 - Component Measurement 283
 - Computer 734
 - Connectors 309, 708–709
 - Digital Multimeter 93
 - EMI Measurement 128
 - Fiber-Optic Lenses 309
 - Fixtures 553
 - HP Touch 676
 - Network Analyzer ... 208, 213–216, 224, 232–234, 236, 277
 - Operating Cases 714, 715
 - Optical 309
 - Oscilloscope 64–66
 - Pulse Generator 446
 - Signal Generator 393
 - Spectrum Analyzer 126, 128, 130, 131, 227
 - Test & Measurement 734
 - Transit Cases 710–713
 - Voltmeter 93
 - Waveguide 241, 341, 345–346, 347
- Active Probes** 64, 227, 279
- A/D Converters** 48, 68–76, 611, 613, 615, 618
- Adapters**
- 50-75 Ω 234, 393, 709
 - APC-3.5 708
 - APC-7[®] 708
 - Bends, Twists, Waveguide 347
 - Coaxial 347
 - Optical 309
 - Quasi-Peak 126
 - Waveguide 347
- Agile Signal Generator** 364, 380–381
- Agile Signal Simulator** 380–381
- Agile Up-Converter** 380–381
- Air Line Extensions** 342
- Alphanumeric LED Displays** 658
- AM/FM Signal Generators** 356–360, 362–377, 385, 388–389, 391–392
- AM/FM Test Source** 152
- AM/FM/ ϕ M Modulation Analyzers** 151, 162–167
- AM/FM/ ϕ M Signal Generators** 362, 363, 364–375, 382–383
- Ammeters** 78–93, 542
- Amplifiers**
- Broadband Power 408
 - Broadband Preamp 409
 - Distribution 494
 - Microwave 409–410
 - Power Supply 482
 - RF 408, 411
- Analog**
- Circuit Test Systems 548–552
 - Converters, A-D 48, 68–76, 611, 613, 615, 618
 - Input/Output Cards For HP-1000 A-Series 615
 - LSI Test System 528
 - Voltmeter 92
- Analyzers**
- Accessories 264
 - Amino Acid 661
 - Audio 144, 149
 - Audio Spectrum 132–133, 136–139, 141–142, 144, 224
 - Automatic Network 221, 237
 - Automatic Spectrum 104–131, 144, 224
 - Chemical 676
 - Constellation 508
 - Customer Support 729–730, 732
 - Data 316, 320
 - Data Line 497
 - Digital Microwave Radio 508
 - Digital Transmission 148, 498–499, 508
 - Distortion 145, 149–157
 - Error Performance 498
 - Fourier (FFT) 132–133, 136–139, 141–142, 144
 - Frequency Stability 146–147, 162–167
 - Frequency and Time Domain 68–73, 132–133, 136–139, 141–142, 144
 - Frequency and Time Interval 162
 - Gain-Phase 221, 223, 284
 - Impedance 282–286, 288–289
 - Impedance/Gain-Phase 284, 286
 - Jitter 162, 498
 - LAN Protocol 513
 - Logic 244–245, 256, 258, 260–262, 264, 273
 - Microwave Modulation 148, 162, 165–167, 508
 - Modulation 148, 151, 162
 - Network 132–133, 136, 208–220
 - Phase 148, 162
 - Phase Noise 146–147, 162
 - Portable Logic 252–255
 - Primary Multiplex 497
 - Protocol 510–513
 - Pulsed Phase 148
 - RF Impedance 288
 - RF Signal Modulation 148, 151
 - Scalar Network 211–220
 - Selective Level 144, 504–505
 - Semiconductor Parameter 536
 - Signature 276–278
 - Spectrum 96–99, 102–131, 144
 - State/timing 258
 - Time Interval 162
 - Time and Frequency Domain 132–133, 136–139, 141–142, 144
 - Training 729–730
 - Upgrade Kits 273
 - Vector Modulation 148
 - Vibration 139
 - WAN Protocol 511–512
 - Wave 144, 420, 504–505
 - Waveform 48, 56, 68–76, 115–119, 132–133, 139, 141, 148
- Antenna Measurements** 243
- APC-3.5 series Adapters** 708
- APC-7[®] series Adapters** 708
- Application Notes** 747
- Arbitrary Waveform Generators** .. 74, 318, 378, 414, 421, 427
- Arbitrary Waveform Synthesizer** 378
- Architecture, Measurement Systems** 562–563
- ASIC Test System** 526
- Atomic Clock/Frequency Standard** 488
- ATS 2000 Automatic Test System** 622
- Attenuator/Switch Driver** 339

ALPHABETICAL INDEX

- Attenuators
 Calibration 155
 Coaxial 332-335, 336
 Optical 308
 Step, Programmable 334
 Test System 155
 Waveguide, Fixed, Variable 346
 Audio Synthesizer 414, 418, 420, 429, 504-505
 Automatic Test Systems 622
- B**
 Balanced 2/4 Wire Audio Channel Selector 497
 Bar Code
 Identification System 660
 Printers 691
 Readers 659
 Wand 659
 Bar Graph Array, LED 658
 BASIC Language Processor System
 Bundled Systems 557
 Controllers 555
 Upgrade Kit-Release II 560, 561
 BasicLine Software Support Service 731
 Basic System Maintenance Service 727
 Basis Branch Analyzer 630
 Battery Operated
 Calculators 666
 Counters 186, 196-198
 Disk Drive 680
 DMM 80-92
 Error Performance Analyzer 498
 Microwave Power Meter 203
 Portable AC Power Source 109
 Printers 690
 Standby Power Supplies 495
 Beam Lead Diodes 659
 Bias Current Source 293
 Bias Networks 240
 Bias Supply, Transistor 240
 Bipolar Transistors 659
 Bit Error Rate Test Sets 497-498, 500
 BNC Series Adapters 709
 Board Test Fixtures 553
 Board Testers 548-552
 Breadboard Cards, Multiprogrammer 611, 613
 Bridges, Directional 213-214, 331
 Broadband Amplifiers 408-411
 Business Computer Systems 670-673, 675
- C**
 Cabinet Accessories 716, 718
 Cabinets, Rack 722-723
 Cable Assemblies 215, 233, 309, 708
 Cable Kit, Scalar Analyzer 215
 Cables
 Microwave 243
 HP-IB 569
 Network Analyzer 215, 231, 241
 Optical 309
 Cables/Connectors 708
 CAD Software 624-627, 637-649
 CAE Links 263
 CAE Software 546, 638
 Calculator Interfaces, Accessories, Software 669
 Calculators 666
 Calculators, Enhancements and Peripherals 668
 Calculators, Handheld Computers & Peripherals 668, 694
 Calibration Agreements 726
 Calibration Data, Attenuators 332-333
 Calibration Kits (Network Analyzer) 215, 233, 241
 Calibrators
 AM/FM (HP 8901A/B) 151
 Power Meter, for HP 432 Series 206
 Range, for HP 435B Power Meter 203
 Scalar, for HP 8756A & 8757A 216
 Time Interval 155
 Calibration Service 725
 Calibration System, Attenuator 155
 Capacitance Meters 296, 298-300, 544
 Capacitor, Blocking 26.5 GHz 342
 Capacitor Sets 303
 Cardiology Instrumentation 662
 Cardiovascular Instrumentation 662
 Carrier Modulation Analyzers 148
 Carrier Testing 506
 CASE 634-636
 CASEdge 634-636
 Cases, Combining 720-721
 Cases, Transit 710-713
 Catalog
 Coaxial/Waveguide Measurement Accessories 330
 Computer Users Supplies and Accessories 734
 DC Power Supply 760
 Software 627
 Summary 760
 Test and Measurement Accessories 734
 Cavity Frequency Meters 345
 Cellular Radio Test System 322
 Cellular Radio Transmitter Measurement 325
 Cesium Beam Frequency Standard 489
 ChemStations 660
 Chromatographs, Gas 660
 Chromatographs, Liquid 661
 Circuit Test Systems 548-553
 Circuit Testers, Digital 276-281, 548-553
 Circuit Testers, SMT 550-551
 Clinical Information Systems 663
 Clip, Logic 280
 Clock, Atomic 489
 Clock, Digital 570
 C Meters 296, 298-300, 544
 Coaxial
 Accessories 330-335, 337-346, 708
 Adapters 347, 709
 Air Lines 342
 Attenuators 332-335, 336
 Blocking Capacitor 342
 Connector Gages 342
 Couplers 345
 Crystal Detectors 340
 Detectors 341
 Directional Couplers 344
 Dual Directional Coupler 344
 Fixed Attenuators 332-333, 346
 Frequency Meters 345
 Low-Pass Filters 346
 Matrix Switches 337-339
 Noise Sources 329
 Open-Short Circuits 343
 Pad Attenuators 332-333

- Power Sensors 204, 207
 Programmable Step Attenuators 336
 Shorts 343
 Sliding Loads 343
 Step Attenuators 334-335
 Switches 337-339, 591
 Terminations 342-343
 Thermistor Mounts 207
 Thermocouple Mounts 204
 Waveguide Adapters 347
 Combining Cases 720-721
 Command Module 603
 Communications, Data 162, 510-514, 517, 519-523
 Communications, Signaling 414, 418-420, 429
 Communications Test Equipment 68, 144, 148, 322,
 382-383, 414, 496-502, 504-508,
 510-514, 517-523, 548-552
 Comparator, Logic 280
 Comparator, Phase 223, 493
 Component & Semiconductor Measurement
 Digital IC Test System 526, 536
 Digital IC Testers 320, 526, 536
 Impedance, LCR Meters 282-286, 288-292, 294,
 296, 298-300
 Semiconductor Parametric Test 530-534, 536,
 538-543, 545, 547
 Components, Solid State 658-659
 Computer-Aided Design (CAD) 546, 624-627,
 637-649, 686, 695-699, 700
 Computer-Aided Engineering (CAE) 546, 624-627,
 637-649, 686, 695-699
 Computer-Aided Software Engineering (CASE) 624-625,
 634-636
 Computer Peripherals 678
 Computers and Peripherals
 Automatic Test Systems 548-552, 622
 BASIC Language Processor System 560, 561
 Board Computers 656
 Business Computer Systems 670-673
 Computer Users Catalog 734
 Digitizing Tablets 687
 Disk Drives 680, 681, 682-683
 Flexible Disk Drives 680
 Furniture 704
 Graphics 673, 676, 688, 690-692, 694-700
 Modems 679
 Monitors 676
 Networking and Data Communications 638
 Optical Drives 684
 Personal Computers 674, 676-677
 Plotters 694-700
 Printers 688, 690-692
 Real-Time Systems 656
 Software Catalogs 627
 Supplies and Accessories 693, 734
 Support 724
 Tape Drives 685
 Technical Computers 560-561, 653, 655-656
 Terminals 677
 X-Window Software 655
 Connector Adapters 708
 Connector Gage, 2.4mm and 3.5mm 342
 Connectors, Microwave Precision 708
 Connectors, Optical 309
 Constellation Analyzer 508
 Consulting Services
 HP ASSIST 733
 Installation Services 733
 Project Services 733
 Support 724
 Time and Material Service 733
 Controllers 557-561, 607
 Converter, Frequency 243
 Converters
 A-to-D 48, 68-76, 611, 613, 618
 D-to-A 570, 578, 611, 613, 618
 Counter/Power Meter 203
 Counters, Electronic
 Counter/Analyzer 162
 Counter/Timers 168, 188-199
 Digital Multimeter/Counters 277, 574, 578, 611
 DVM/DMMs 192-195
 Low Cost 163-170, 186-191, 196-199
 Microwave 162, 171-173, 177-180, 183-187
 Multiprogrammer Card 611
 Portable, Battery Operated 186, 196-199
 Pulsed RF 162, 180, 183
 Reciprocal 171-173, 177-180, 183-194,
 196-198, 574, 578
 Time Interval Probes 170
 Time Interval 162-169, 188-199
 Universal 168, 188-199
 Counter/Totalizer Cards 611, 613
 Counter/Totalizer 600
 Couplers, Directional (Coax and Waveguide) 344-345
 Crystal Detectors 340-341
 Crystal Oscillator 491
 Current Tracer, Digital 279
 Custom MW Matrixes 339
 Customer Education 724
 Customer Support 724-734
 C-V Meter 299
 C-V Plotter 544
D
 D/A Converter Cards, Multiprogrammer 611, 613
 D/A Converters 570, 578, 601, 611, 613, 618
 Data
 Acquisition System Training 729
 Acquisition Systems 50, 68, 76, 572-584
 Analyzer 316, 320
 Communications 162, 510-514, 517, 519-523
 Generators 316, 320
 Pulse Pattern Generator 317
 Time Interval Analyzer 162
 Data Acquisition
 Measurement and Control Unit 572
 Systems 68, 76, 572-584, 586-589
 System Training 729
 Voltmeters/Counters 78-93, 188-198, 572-584
 Data Communications Test Equipment
 Data Line Analyzers 500
 General Information 510, 518
 LAN Protocol Analyzer 513-514
 Network Circuit Access Test Set 521
 Protocol Analyzers 510-514
 Selective Level Meter 144, 504-505
 Spectrum Analyzers 144, 96
 Time Interval Analyzer 162
 Transmission Impairment Test Sets 518-523
 Vector Modulation Generator/Analyzer 508
 Waveform Analyzer 68
 DC Electronic Loads 448-451

ALPHABETICAL INDEX

- DC Power Supplies
 Amplifier/Power Supply 482
 Autoranging 468, 471, 476
 Condensed Listing 482-486
 Constant-Current Sources 487
 Digitally Controlled 472
 Dual Tracking 464, 474, 483
 General Information 452
 General Purpose: 10-30 W Output 483
 General Purpose: 100-2000 W Output 476, 478
 General Purpose: 25-200 W Output 474
 General Purpose: 300-11,000 W Output 480
 HP-IB Programmable 456, 460-473
 Precision Voltage Sources 472, 486
 Programmable 448-473
 Source/Monitors 466, 538, 541
 Specifications, Definitions 459
 Test Loads 448-451
 Transistor Bias 240
- DC Source/Monitor 466, 538, 540, 541
 DC Voltmeters 78-93, 192-195, 574, 578-584
 Decade Capacitor 303
 Degaussers 493
 Delay Generators 432-435, 436, 438-447
 Design Automation
 Electronic Design System 638
 Overview 624-626
 Software Catalog 627
 DesignCenter Products 624, 626-627, 637-647
 Design Interfaces 638
- Detectors
 Adapter 217
 Atomic Emission 661
 Coaxial, Microwave, OEM 340
 Crystal, Coaxial and Waveguide 340-341
 Diode Array 661
 Error 498, 500
 Scalar 213-214
- Development Systems, Logic 628
 Diagnostic Cardiology 662
 Dial-Up Modem 679
- Digital
 AC Voltmeters 78-93
 Ammeter 542
 Analyzers, Logic 628
 Analyzers, Signature 276-278
 Audio Synthesizer 414
 Bar Code Wand 659
 Board Testers 548-553
 Capacitance Meters 296, 298-300, 544
 Circuit Test 276-281, 548-553
 Circuit Test, SMT 550-551
 Combinational Board Tester 548-552
 Communications Board Tester 548-549, 552
 Constellation Analyzer 508
 Current Tracer 279
 D/A Current Converter Cards 578, 611, 613
 D/A Voltage Converter Cards 578, 611
 DC Voltmeter/Counters 192-195
 DC Voltmeters 78-93, 574, 578-584
 IC Testers 276-280, 320, 528-529, 542, 548-553
 IC Test Systems 320, 526, 528-529
 Impedance Analyzers 282-286, 288-289
 In-Circuit Board Test Systems 548-553
 Input Cards, Multiprogrammer 611, 613
 Input/Output 601
- LCR Meters 290-292, 294, 296, 298-300
 Microprocessor Troubleshooting 276-278
 Modulation Analyzer 148
 Modulation Signal Generator 382-383
 Modulation Test 503
 Multimeters 78-93, 599
 Multimeters, Multiprogrammer 610
 Multimeters, Signature 276
 Noise Figure Meter 327
 Oscilloscopes 48-59, 68-73, 260
 PC Board Test Systems 548-553
 Power Meters 200-202
 Pressure Gauge 352
 Programmable Power Supplies 448-473
 Signal Analyzers 148
 Signal Generators 262, 382-383
 Signature Analyzers 276-278
 Stimuli 316-321, 432-436, 438-447
 Thermometers 574, 578
 Time Interval Analyzer 162
 Transmission Analyzer 498-499
 Troubleshooting 276-281
 Voltmeters 78-93
- Digital Data Test Equipment 496, 502
 Digital Microwave Radio Test 507
 Digital MW Radio Test 503
 Digital Radio Test System 503, 509
 Digitizer, MMS Module 115-119
 Digitizing Oscilloscopes 48-59, 68-73
 Digitizing Tablets 687
 Dimensional Measurements 350
 Diode Array Spectrophotometers 661
 Directional Bridges 213-214
 Directional Couplers 344-345
 Disk/Tape Drives 685
 Disk Drives 680, 682-683
 Disk Drives - SCSI 681
 Distortion Analyzers 145, 149-150
 Distribution Amplifier 494
 Double Balanced Mixer PDB 341
 Doubler, Frequency 393
 Down Converters 129, 393, 506
 Drafting Plotters 698-700, 702
 Drafting, Mechanical Engineering 646-649
 Driver, Attenuator/Switch 339
 DS3 Transmission Test Set 501
 Dual Arbitrary Waveform Generator 318, 421
 Dual Tracking Power Supplies 464, 474, 483-484
 Dual VHF Switch Module 595
 Dynamic Signal Analyzers 132-133, 139, 144, 148
- E**
 Echocardiography 662
 Education Support 728-730
 Eight-Pen Plotters 694, 696-700
 Electronic Clocks 488-489, 492
 Electronic Counters 158, 160, 162-173, 177-180, 183-199
 Electronic Loads 448-451
 Electronic Mail 672
 Electronic Warfare Simulation 380-381
 Electrostatic Plotters 702
 Embedded Microprocessor System Development 628
 EMI Measurement Software and Accessories 126-128
 EMI Measurement Systems 125
 Emulators, Microprocessor 632, 633
 Encapsulator 634-636
 Enclosure, Weatherproof 243
 Engineering Graphics 637, 643, 645

Environment, Software Development	634-636
Environments, Operating	738
Error Rate Measurements	
Generators	500
Jitter	500
PRBS	500
Pattern	500
Error	
Performance Analyzer	498
EW Receiver Test Simulation	380-381
Express Fixturing System	553
Extenders, HP-IB	571
F	
FDM Measurement Systems	504-506
FDM Network Monitoring Systems	503-506
Fiber Optic Cable	312
Fiber Optics	
Adapters	309
Attenuators	308
Average Power Meter	306
Cables	309, 658
Connectors	309, 658
Heads	305-306
Laser Diode Source	307
LED Source	307
Lightwave Signal Analyzer	314
Optical Time Domain Reflectometer	310
Pulse Power Meter	305
Signal Sources	307
Test Equipment	304, 311
Transmitters/Receivers	658
Fiber Test Equipment	312
Filters	
High Pass	216
Low Pass	216, 346
Waveguide	346
Financing	736
Fixtures	
Automatic	553
Board Test System	553
Vacuum Actuated	553
Mechanical	553
FM Modulation Analyzers	151, 162
FM Signal Generators	382-383, 385, 388-389, 391
Form C Switch	601
Fourier Analyzers	132-133, 139, 141, 144
Frequency	
Analyzer	162
Counters	83-85, 158, 160, 162-173, 177-180, 183-199, 574, 83-85
Doublers	393
Meters, Coaxial and Waveguide	345
Sources	488-492
Stability Analyzer	146-147, 162
Synthesizers	356-359, 362-375, 386, 388-389, 391-392, 414, 418-420, 429, 431, 488-492
Frequency Agile Signal Simulation	380-381
Frequency and Time Domain Analyzers	132-134, 136-139, 141-142, 144
Frequency and Time Standards	488-495
Frequency Selective Meter and Tracking Oscillator	144, 504-505
Frequency, Synthesizers	360
Function Generators	413-416, 418-429, 431
Functional Test Manager Software	562-563
Functional Test Software	620

G	
Gage, Connector, 2.4mm and 3.5mm	342
Gas Chromatographs	660
GC/Mass Spectrometer Systems	661
General-Purpose Electronic Measurement	628
Generators	
AM-FM-Pulse	388
Arbitrary Waveform	74, 318, 378, 414, 421, 427
AWS Baseband Signal Simulation	378
Cavity-tuned	385
CW	386
Data	262, 316-317
Delay	432-436, 438-447
Digital Modulation	382-383
Digital Signal	421
Frequency and Time	488-490, 492
Function	413-415, 418-429
Noise	414
Pattern	316-317, 498, 499
Phase Modulation	382-383
PRBS	318, 498, 499
Pulse/Function	378, 413-415, 418-419, 421-429, 433
Pulse/Pattern	317
Pulse	427, 432-436, 438-446
Signal	354-359, 360, 362-379, 382-383, 385-386, 388-389, 391-393, 509
Square Wave	413-415, 418-429
Sweep	394-395, 398-407, 418-420, 427, 429
Synthesized Signal	384
Synthesized	386, 388-389, 391-392
Timing	447
Vector Modulation	382-383, 509
Vector	318, 382-383
Waveform	378, 414, 418-420, 427, 429
Word	318, 320, 446, 498, 502, 526
Graphics	
Displays	676
Plotters	76, 694-700, 702
Printers	688, 690-692
Software	76, 627, 645, 673, 676
Supplies	693
Technical Computers	560-561, 624, 655
Terminals	677
H	
Hardware Support	724-727
Harmonic Mixers (Coaxial and Waveguide)	129, 341
Hewlett-Packard Interface Bus (HP-IB)	564, 566-571
High-Sensitivity Power Sensors	204
HP BASIC	
HP-IB Instrument Control	560
HP-IB Instrument Control Self-Study Course	561
HP Basic System Maintenance Service	727
HP BasicLine Software Support Service	731
HP Customer Return Repair Service	725
HP Customer Service Centers	725
HP-IB	
Cables	569
Channel Selector	497
Digital Clock	570
Electronic Loads	448-451
Extenders	571
Frequency Counters	158, 160, 162-173, 177-180, 183-198
General Information	564, 566-568
Instrument Control-BASIC Self-Study Course	560-561
Interface and Command Library	560
Logic Analyzers	244

ALPHABETICAL INDEX

- Oscilloscopes 260, 48
 Power Meters 154, 200–202
 Power Supplies 466–467
 Relay Actuators 570, 578, 591
 Signal Sources 414–415, 418–425, 427, 429
 Spectrum Analyzers 96, 104–109, 111–133,
 136–139, 141–142, 144
 Spectrum 110
 Switch Controller 506, 595
 Switch Driver 339
 Switch Test Unit 591
 Switch/Control Unit 595
 Switches 337–338
 Time Synthesizer 447
 VHF Switches 570, 595
- I**
 IC Design Analysis Software 525
 IC Design Verification System 320, 526
 IC Prototype Verification System 526
 IC Testers, Digital 276–280, 320, 528, 529, 542, 548–553
 IC Test Systems, Analog 528
 IC Test Systems, Digital 320, 526
 Impedance Analyzers 282–286, 288–289
 Impedance Meter 284
 Impedance Transformers, 50–75 Ω 130
 Impedance/Gain-Phase Analyzer 284, 286
 Indicators, LED 658
 Industrial Touch Display Terminal 678
 Infrared Detector 661
 Inkjet Printers 688, 690, 692
 Installation Services 727, 732
 Integrators 660
 Interactive Test Generator 562–563, 597
 Interface Bus (HP-IB) 570–571
 Interface Kits Multiprogrammer 609, 613
 Interference & Noise Test Set 507
 Interference Test Set, Radio 507
 Interferometers, Laser 348–349, 350, 351
 Interferometers, Lightwave Accessory 315
 Interrupt Card, Multiprogrammer 611, 613
 I/Q Tutor Digital Training Program 508
 I/Q Vector-Modulated Generator (VAWS) 380–381
 I/Q Vector Modulation Analyzer 148
 Isolators, Waveguide 345
- J**
 Jitter Generation & Measurement 227, 498–502
 Jitter, Time Interval Analyzer 162
- K**
 Kits, Fiber Optic Link 658
 Kits, Interface 609, 613, 680
 Kits, Rack Mounting 716–717, 720
- L**
 Laboratory Automation Systems 660
 Laboratory Information Management 660
 LAN Protocol 514
 LAN Protocol Analyzer 513–514
 Laser
 Diode Source 307
 Interferometers 348–349, 350, 351
 Machine Tool Calibration 351
 Position Measurement 351
 Position Transducer 348–349
 Printers 691–692
 Transducer System 348–349
- LC/MS Systems 661
 LCR Meters 290–292, 294, 296, 298–299
 LCZ Meters 298
 Leasing 736
 LED Displays 658
 LED Indicators 658
 LED Source 307
 LF Impedance Analyzer 286
 Light Bar Modules, LED 658
 Light Emitting Diodes 658
 Lightwave
 Component Analyzer 312
 Directional Coupler 312
 Instruments 305–310
 Signal Analyzer 314
 Test Equipment 312
 Limiters 128, 130
 Liquid Chromatographs 661
 Loads, DC Electronic 448–451
 Logic
 Analyzer Training Courses 730
 Analyzers 256, 260–262
 Clip 280
 Current Tracer 279
 Pattern Generators 262
 Probes 262, 279
 Pulser 279
 Signal Sources 316, 432
 Troubleshooting Kits 281
 Logic Analyzers
 Accessories 251
 Bus Support 250
 HP-IB Bus Support 250
 Microprocessor Emulation 628
 Microprocessor Support 248
 Preprocessors 251
 RS-232 Bus Support 250
 SCSI Bus Support 250
 User-definable Interfaces 251
 VME Bus Support 250
 Logic Development Systems 628
 LSI Test System 528
- M**
 Mail, Electronic 672
 Maintenance Service 727
 Mass Selective Detectors 661
 Mass Spectrometers 661
 MATE Power Meter 202
 Matrix Switch (HP-IB) 337–339, 535, 591–596
 Matrix Switch, Custom 339
 Matrix Switch, Microwave 337–339
 Matrix Switch, VXI 601
 Measurement Graphics Software 76
 Measurement Plotting System 76
 Measurement System Calibration Service 727
 Measurement Systems Architecture 562–563
 Measuring Receiver 153
 Mechanical Engineering
 Design 646, 648
 DesignCenter 646
 Drafting 646, 648
 Drafting Plotters 698–700
 Solids Modeling 646, 648
 Test 132–133, 136–139, 141, 144, 646, 648
 Medical Instrumentation 662–663
 Memory Card, Multiprogrammer 611

Meters	
AC	78–93
Capacitance	298, 544
Carrier Noise	147
Distortion	144–145, 149–157
Frequency	83, 160, 162–173, 177–180, 183–199, 347, 574
Impedance	226, 284, 288–290
LCR	290, 294
Low Resistance	88
Modulation	148, 162
Multifunction	78–93
Multimeter	78–93
Noise Figure	327
Ohmmeter	78–93
pA Meter	542
Peak Power	207
Phase	132–133, 144, 162, 221
Picoampere	542
Power/Counter	203
Power	154, 200–207, 305–306
Signature	276–278
Susceptance	288, 290
Time Interval	162, 168, 188–199
True RMS	78–93
Vector Impedance	289
Microfloppy	680
Microprocessor Development Environment	628–633
Microprocessor Emulation	628
Microprocessor Software Performance Analyzer	630
Microprocessor Support	
AMD Microprocessors	248
GTE Microprocessors	248
Hitachi Microprocessors	248
Intel Microprocessors	248
Motorola Microprocessors	248
Rockwell Microprocessors	248
Zilog Microprocessors	248
Microprocessor Troubleshooting	276, 278, 628
Microwave	
Amplifiers	409–410
Attenuator Calibration	155
Counters	171–173, 177–180, 183–187
Design System (CAE)	642
Diodes	659
Down-Converter	157, 164–167
Measurement System	157
Modulators	157, 392
Network Analyzers	208–217
Noise Figure Meter	327
Noise Figure Test Set	328
Power Measuring Equipment	153, 200–207
Preamplifiers	115–119, 409
Radio Testing	506
Semiconductors	659
Signal Generator Calibration	156
Signal Generators	382–386, 388–389, 391–392
Spectrum Analyzers	104, 107–108, 110–122
Sweep Oscillators	394–395, 398–407
Switches	602
Synthesizers	362–375, 386, 388–389, 391–392
Test Accessories	334, 337–339
Test Equipment	330–333, 340–343, 345–347
Transistors	659
Microwave Digital Radio Test	503, 508–509
Microwave Linear Simulator (CAE)	642
Microwave Nonlinear Simulator	642
Microwave Radio	
Fading Test	507
Noise and Interference Test Set	507
Military Standard Agreements	726
Millimeter Wave Instrumentation	
Spectrum Analyzers	110–114
Millimeter Wave Instrumentation	
Adapters	347
Attenuators	346
Bends	347
Counters	171, 183
Detectors	341
Directional Couplers	345
Frequency Meters	345
Harmonic Mixers	129, 341
Isolators	345
Mismatches, Waveguide	347
Network Analyzer	213, 239
Power Sensors	204
Preselected Mixers	129
Shorts	343
Spectrum Analyzers	110–114, 120–121
Straight Sections	347
Sweep Oscillator	405
Synthesized Sweeper	388
Terminations	343
Twists	347
Milliohmmeters	88, 302
Miniature Link Components	658
Mismatches, Coaxial Sliding	343
Mixers, Coaxial and Waveguide	129, 341
Mixers, Double-Balanced	341
MM-Wave Signal Generators	384
MMS Modular Power Meter	201
Modems	382
Modular DC Source Monitor	538, 540
Modular Measurement System	115–119, 228, 562–563
Modular Measurement System Vector Voltmeter	228
Modular Power Meter	201
Modulation Analyzers	148, 151, 162
Modulation Analyzers, Vector I/Q	148
Modulation Domain Analyzers	162–167
Modulation Test Source	152, 382–383, 508
Modulation, Vector Signal Generator	509
Modulator/Demodulator	382–383, 506
Modulators, Absorptive	392
Modulators, I/Q, Vector	382–383
Modulators, PIN	392
Module, Mixer	243
Monitors	676
MOTIF	655
Multichannel Measurement System	141
Multimeters	78–93, 276, 599
Multimeters, Digital	599
Multimeter, Signature	276
Multipath Fading Simulator, Radio	507
Multiplex (Primary) Analyzer	497
Multiplexers	83, 574–584, 591–596, 602
Multiprogrammers	607, 610–613
N	
Network Analyzers	
Automatic	221, 237
Frequency and Time Domain	136
General Information	208
Impedance/Gain-Phase	284
Millimeter-Wave	240
Scalar	211–220

ALPHABETICAL INDEX

- Vector 132-133, 144, 221-225, 228, 231-241, 284
- NewWave 670, 671
- Noise
 - Generator 329, 414
 - Measurements 146-147
 - Microwave Noise Figure Test Set 326-328
- Noise and Interference Test Set 507
- Noise Figure/Gain Circles 326
- Noise Figure, Measurement System 326, 328
- Noise Figure, Microwave 326-328
- O**
- Obstetrical Information Management System 663
- OEM
 - Computers 656, 675
 - Displays, CRT 676-677
 - Graphics Plotters 694-700, 702
 - Measurement Plotting System 76
 - Microwave Attenuators 332-334
 - Microwave Components 659
 - Microwave Crystal Detectors 340-341
 - Microwave Switches 337-339
 - Optoelectronic Components 658
 - Power Supplies 452
 - Printers 688, 690-692
- Offices, Sales and Support 739
- Ohmmeters 78-93, 302
- Opens, Coaxial 343
- Operating Environments 738
- Optical
 - Accessories 309
 - Adapters 309
 - Average Power Meter 306
 - Cables 309
 - Connectors 309
 - Drives 684
 - Heads 305-306
 - LED Source 307
 - Laser Diode Source 307
 - Pulse Power Meter 305
 - Signal Source 307
 - Time Domain Reflectometer 310
- Optocouplers 658
- Optoelectronics 658
- Oscillators
 - Function 413-415, 418-429
 - General Information 394
 - Low Frequency 414-415, 418-419, 427, 429, 504-505
 - Sinewave 414-415, 418-420, 429, 504-505
 - Squarewave 414-415, 418-429
 - Sweep 149, 370, 388, 391, 394-395, 398-407, 414-415, 418-420, 427-429, 504-505
 - Synthesized Sweep 388, 391, 414-415, 418-420, 429
- Oscilloscopes
 - Accessories 64-66
 - Digital Waveform Storage 56-59
 - Digitizing 48-59, 60-63, 70
 - General Information 48
 - HP-IB 60-63
 - Precision 60-63, 68-75
 - Sampling 60-63
- P**
- Parameter Extraction Software 525
- Parts Libraries, Electronic Design System 638
- Pattern Generator & Error Detector 500
- Pattern Generator, Digital 262, 318, 320
- Pattern Generator/Error Detector 499
- Pattern Generator/Pulse Capability 317
- PC Applications 673
- PC BASIC Controllers 560-561
- PC Board Design/Test Link 643
- PC Board Testers 547-553
- PCM Test Equipment 227, 496-497, 499-500, 501
- Peak Power Analyzer 200
- Peak Power Meters 200, 207
- Peripherals, Computer 685
- Personal Computers 674, 676-677
- Phase Comparator 223, 493
- Phase Meters 132-133, 144, 162, 221, 223
- Phase Modulation Analyzers 148, 151, 162
- Phase Modulation Generator 382-383
- Phase Noise Measurement 146-147
- PIN Diodes 659
- Planar-doped-barrier detectors 341
- Planar-doped-barrier
 - Detectors 340, 341
 - Waveguide 340
- Plotter Accessories and Supplies 693
- Plotters, Drafting 698-700, 702
- Plotters, Graphics 76, 694-700, 702
- Portable
 - AC Power Source 109
 - Error Performance Analyzer 498
 - Spectrum Analyzers 104-114, 129
- Position Measurement, Laser 348-349
- Power Amplifiers 409-411
- Power Dividers 216
- Power Meter Calibrators 203, 206
- Power Meter/Counter 203
- Power Meter/Measuring Receiver 153
- Power Meter, MMS Module 115-119, 201
- Power Meter, Optical 305-306
- Power Meters 603
- Power Meters, RF & Microwave 153, 200-206
- Power Products 466-467
- Power Sensors, RF & Microwave 154, 204, 207
- Power Source, Portable AC 109
- Power Splitters, Coaxial 216, 218, 233
- Power Splitters, Optical 309
- Power Supplies
 - Amplifier/Power Supplies 456
 - Atomic Clock 495
 - Condensed Listing 452-458
 - Constant Current Sources 487
 - Digitally Controlled 448-451, 454-455, 460-461, 466-468, 470
 - Dual Tracking 464
 - Frequency Standards 495
 - HP-IB Programmable 448-473
 - Laboratory 448-474, 477, 479, 482, 485
 - Multiprogrammer Control 454-458
 - Output Isolation Relays 470
 - Polarity Reversal Relays 470
 - Precision Current, Voltage Sources 431, 486-487
 - Programmable 448-473
 - Specifications, Definitions 459
 - Standby 495
- PRBS Generators 318
- Preamplifiers 115-119, 170, 409
- Precision Coaxial Connectors 708
- Precision DC Voltage or Current Source 431
- Precision Digitizing Oscilloscopes 68-75
- Precision Frequency Sources 488-495
- Precision Oscillator 491

- Precision Time Interval Counters 162, 168
 Preprocessor, Logic Development System 628
 Preprocessors 251
 Preselectors 126
 Pressure Probes, Quartz 352
 Primary Multiplex Analyzer 497
 Printed Circuit Design 643–644
Printers
 Bar Code 691
 Color 688
 Desktop Publishing 690–691
 Dot Matrix 690–692
 Graphics 690–692
 Impact 690–691
 Inkjet 690
 Laser 691–692
 Page 691–692
 Personal 690
 Supplies 734
 Tempest 691
 Probe, High Frequency 508
 Probe, High Impedance 508
Probes
 Accessories 93, 279
 Close-Field 128
 Close-field 131
 Digital Multimeter 93
 High Frequency 93
 High Voltage 93
 Impedance 284
 Logic 279
 Oscilloscope 64
 Pressure Quartz 352
 Spectrum/Network 224
 Temperature 353
 Voltage Divider 93
 Processor-Based Circuit Analysis 628
 Product Notes 747
 Programmer Starter Kit 378
 Programmable Logic Device Design System (PLDDS) ... 641
 Protocol Analyzers 511–514
 Publications 747
 Pulse Adder, Splitter, Inverter 446
Pulse Generators
 Configurable 446
 High Power 443
 Programmable 428, 434–436, 438–442
 Pulse Generators 427–428, 432–436, 438–447
 Pulse Width/Duty Cycle Analyzer 162
 Pulse/Function Generators 378, 413–415, 418–419,
 421–429, 433
Pulsers, Logic 279
- Q**
 Quartz Frequency Standard 491
 Quartz Pressure Probe 352
 Quartz Thermometer 353
 Quasi-Peak Adapter 126
- R**
 R/332 Controller 558–559
 Rack Cabinets 722–723
 Rack Mount Kits 558–559, 716–717, 720
 Rack Slides 717–718, 720–721
 Rack-Mountable Controller 558–559
 Radar Cross Section (RCS) Measurements 243
 Radar Signal Simulator 380–381
 Radio System Testing 162, 503
 Radio Test, Microwave Digital 509
 Radio Test, Microwave
 Fading Simulator 507
 Noise and Interference Test 507
 Radio Test Systems 322
 Range Calibrator (for HP 435B Power Meter) 203
 Receiver, Measuring 153
Recorders
 Measurement Plotting System 76
 Waveform 68–76
 X-Y 76
 Reflection/Transmission Test Sets 231–232
 Reflectometer, Optical Time Domain 310
 Relay Accessories, Power Supply Output 470
 Relay Actuators (HP-IB) 570, 578, 591, 595
 Relay Multiplexers 602
 Relay Output Card, Multiprogrammer 611, 613
 Remote Terminal Unit 576
 Repair Agreements 725, 726
 Resistance Meters 78–93
 ResponseLine Software Support 731
RF
 Amplifiers 411
 Impedance Analyzer 228
 Network Analyzer 221, 228, 231–234
 Preselector 126
 Signal Generators 354–355
 Spectrum Analyzers 104–106, 110–113, 120, 123
 Switch 337–339, 591
 Time and Frequency Analyzers 68–75, 162
 Transceiver Test Systems 322
 RF Multiplexers 602
 RMS Voltmeters 78–93
 Rotary Vane Attenuators, Waveguide 346
 Rubidium Frequency Standard 490
- S**
 Sales Offices 739
 S-Parameter Test Sets 231–232, 238
 Sampler, Automatic 660
 Scalar Network Analyzers 211–220
 Scanner Cards, Multiprogrammer 611, 613
 Scanners 611, 613
 Schottky Diodes 659
 Selective Level Measurement Set (SLMS) 503, 506
 Selective Level Voltmeters 144, 504–505
 Semiconductor/Component Test Systems .. 320, 526, 528–534
 Semiconductor Parameter Analyzer 536
 Semiconductor Parameter Extraction Software 525
 Semiconductor Parametric Test System
 CAE Software 546
 Capacitance Meters 544
 Test System 530–533
 Semiconductor Test Equipment 466–467, 524–526,
 528–535, 542
 Sensor Module 154, 204
 Sensors, Power 154, 204, 207
 Sensors, Thermistor 207
 Service Agreements 725–727
 Servo Electronics 349
 Shorts, Coaxial 343
 Shorts, Waveguide 343
Signal Analyzers
 Audio 100–101, 132–133 136–139, 141–142, 144, 149
 Distortion 145, 149, 151, 153, 155–157
 Frequency and Time Interval 162
 General Information 96

ALPHABETICAL INDEX

- Modulation..... 148, 151, 162, 325
 Phase Noise..... 146-147, 162
 Spectrum Analyzers..... 108
 Spectrum.. 100-101, 104-107, 109-131, 144, 146-147, 224
 Time Interval..... 162
 Waveform..... 76, 115-119, 132-133, 139, 141, 148
- Signal Generators**
 AM-FM-Pulsed..... 389
 Calibration..... 156
 Cavity-tuned..... 385
 CW..... 386
 Digital..... 421
 General Information..... 354-355
 Generator/Recorder..... 74
 HF, VHF, UHF, SHF... 356-359, 362-378, 382-384, 386, 388-389, 391-392, 418-420, 429
 Microwave..... 386, 388-389, 391-392
 Modular..... 115-119
 Programmable.. 356-359, 362-375, 386, 388-389, 391-392
 Pulse Modulator..... 392
 Pulsed..... 388
 Service Kits..... 369, 372, 389, 392
 Sweep..... 388, 391, 394-395, 398-407, 418-420, 427, 429
 Synthesized..... 356-359, 362-375, 386, 388-389, 391-392, 413-415, 418-429
 Vector, I/Q..... 382-383
 VOR Modulator..... 414
- Vector Modulation**..... 509
- Signal Simulation System**..... 378
- Signal Simulation, Radar/EW**..... 380-381
- Signal Sources**..... 305-307, 316-321, 356-360, 362-375, 394-395, 398-407, 413-416, 418-423, 425-429, 432-436, 438-443
- Signal Sources, Optical**..... 307
- Signal Sources, Programmable**.. 316-317, 356-360, 362-375, 413-416, 418-425, 429, 434-436, 438-442
- Signaling, RF Radio**..... 414
- Signature Analysis**..... 276, 278
- SimPlate Fixture Series**..... 553
- Simulation, Signal**..... 378
- Simulator**
 Radar Threat..... 380-381
 Signal..... 380-381
- Single Sideband Phase Noise Test Set**..... 147
- Single Sideband Phase Noise Test System**..... 146
- Slides for Rack Mounting**..... 717-718, 720-721
- Sliding Loads (Coaxial and Waveguide)**..... 343
- SoftBench**..... 634-636
- Softpanel Interactive Measurement and Analysis Software**..... 540
- Software**
 0.3 GMSK Modulation Measurement..... 325
 Active Device Measurement..... 240
 Antenna Measurement..... 243
 Applications Solutions..... 624-627, 637-649, 673
 Basic Network Measurement..... 236, 241
 Business..... 670, 673
 CAD..... 624-627, 637-649
 CAE..... 638
 CASE..... 625
 Catalog..... 627
 Cellular Radio Test..... 323
 Computer-aided Test (CAT)..... 616
 Datacom..... 672-673
 Electronic Design..... 624, 638
 EMI Measurement..... 127
 Engineering Documentation..... 637, 645
- Engineering Graphics Systems (EGS)**..... 645
- Engineering System**..... 634-636
- Graphics**..... 645, 673
- IGES Translator**..... 645
- Mechanical Design & Drafting**..... 646, 648
- Mechanical Engineering**..... 646, 648
- Microprocessor Development**..... 628
- MSA**..... 562-563
- NC Drill**..... 645
- Network Measurement**..... 236, 241
- Parameter Extraction (TECAP)**..... 525
- Photoplotter/NC Drill**..... 645
- Printed Circuit Design**..... 643
- Scalar Network Analyzer**..... 219
- Signal Generator Test**..... 156
- Spectrum Analyzer System**..... 127
- Spreadsheets**..... 673
- Support Options W30, W31, W32**..... 725
- Support Service**..... 724, 731
- Terminal Emulation**..... 673
- Tools**..... 634-636
- Transceiver Test**..... 323
- Translator (IGES)**..... 645
- Transmission Line Test System**..... 220
- Vector Network Analyzer**..... 236, 241
- Waveform Generator**..... 378, 75
- Waveform Measurement**..... 73
- Word Processing**..... 673
- Solid State**
 Diodes, Transistors, Integrated Products..... 659
 Displays, Lamps, Optocouplers, Fiber Optics..... 658
- Source, AM/FM Test**..... 151
- Source, Avionic**..... 414
- Source, DC**..... 431
- Source, Optical**..... 307
- Source, Signal**..... 318, 320-321, 356-360, 362-375, 394-395, 398-407, 413-415, 418-429, 431, 439, 446
- Spectrum Analyzer Preselector**..... 126
- Spectrum Analyzers**..... 100-101, 104-107, 109, 111-113, 115-128, 131, 144
- Stability Analyzer, Frequency**..... 146-147, 162
- Standards, Frequency and Time**..... 488-495
- Standby Power Supply**..... 495
- Step Attenuators, Coaxial**..... 336
- Stepping Motor Control Card (Multiprogrammer)**..... 613
- Support, Customer**..... 724, 728-731
- Sweep Oscillators**..... 370, 388, 391, 394-395, 398-407, 414-415, 418-420, 427-429, 504-505
- Sweep Signal Generators**..... 388, 391, 394-395, 398-407, 418-420, 427, 429
- Sweeper Synthesizers**..... 418, 420, 429, 504-505
- Switch Controller, HP-IB**..... 595
- Switch, Driver**..... 339
- Switches**
 Access, Distribution and Bi-directional..... 506
 AC Power Controller..... 580
 Actuators..... 83, 574, 580
 Coaxial, Five-Port..... 337-339, 574
 Coaxial, Microwave OEM..... 337-339
 Matrix (HP-IB)..... 591, 595
 Microwave..... 602
 SPDT..... 337-339
 SP-Multi-Throw..... 339
 Switch/Test Unit..... 591
 VHF, HP-IB..... 570, 591, 595
- Synthesized Function Generators**..... 378, 414, 427
- Synthesized Function/Sweep Generator**..... 601

- Synthesized Signal Generators .. 356–359, 362–375, 384, 386, 388–389, 391–392, 414, 418, 420–421, 427, 429
- Synthesized Signal Sources 386, 388–389, 391–392, 414, 418–420, 429
- Synthesized Sweep Oscillators 394–395, 407
- Synthesizer, Arbitrary Waveform 378, 427
- Synthesizer, Audio Complex 414
- Synthesizer, Frequency 392
- Synthesizer, Time 447
- Systems
- Analog LSI Test 528
 - Attenuator Calibration 157
 - Automatic Test 622
 - Board Test 548–553
 - CAD 643, 646, 648
 - Combinational Test 548–552
 - Communications Test 548–552
 - Computer-Aided Engineering (CAE/CAD) 624, 626–627, 637–649
 - Computer-Aided Software Engineering 628
 - DC Electronic Load 448–451
 - Data Acquisition 574, 578, 580
 - Digital IC Test 320, 526
 - EMI Measurement 125
 - IC Prototype Verification 320, 526
 - In-Circuit Test 548–552
 - Laser Measurement 350
 - Logic Analysis 628
 - LSI Test 528
 - Microprocessor Development 628
 - Modular Measurement 115–119
 - Real-Time Computer 656
 - Semiconductor Test 526, 528
 - Signal Generator Calibration 156
 - Surface Mount Technology Test 550–551
 - Transceiver Test 322
 - Transmission Line Test 220
 - Waveform Generation 75, 378
 - Waveform Measurement 72
- T**
- Teamwork Environment 628
- TECAP Parameter Extraction Software 525
- Technical Computers and Peripherals
- DesignCenter 648–649
 - Engineering Workstations 624–627, 637, 642, 645
 - Multiprogrammer: I/O Expander & Converter 613
- Technical Documentation Software 645
- Telecommunications Test Equipment
- Access Switch 506
 - Audio Channel Selector: HP-IB Controlled 497
 - Balanced 2/4-wire Audio Channel Selector 497
 - Bidirectional Switch 506
 - Bit Error Measurements 500
 - Bit Error Rate Measurements 498
 - Carrier Testing 503, 506
 - Cellular Radio Test Equipment 322
 - Constellation Analyzer 148, 508
 - Controller, Switch 506
 - Digital Data Test Set 502
 - Digital Modulation Analyzer 148
 - Digital Modulation Generator/Analyzer 382–383
 - Digital Radio Test Set 503
 - Digital Transmission Analyzer 498, 499
 - Digitizing Oscilloscopes 72
 - Down Converter 506
 - Error Performance Analyzer 498
 - Error Rate Measurements 498–500
 - FDM Measurements 503–506
 - FDM Surveillance Software 506
 - Frequency Analyzer 162
 - HP-IB Controlled Channel Selector 497
 - Impairment Tests 503
 - Jitter Generator and Receiver 498, 500
 - Jitter, Time Interval Analyzer 162
 - LAN Protocol 515–516
 - Microwave Counters 183
 - Microwave Network Analyzers 219–225, 228, 231–241
 - Microwave Radio Testing 506, 508
 - Modulation Analyzers 151, 162
 - Modulator/Demodulator 382–383, 506
 - Noise and Interference Test Set 507
 - Optical Time Domain Reflectometer 310
 - PCM Terminal Test Set 497
 - PCM Testing 162, 497, 499, 502
 - Pattern Generator/Error Detector 499
 - Power Meters 200–204, 207
 - Primary Multiplex Analyzer 497
 - RF Radio Testing 322
 - Remote Automatic Surveillance Systems 506
 - Selective Level Measuring Sets 506
 - Selective Level Meters 144, 504–506
 - Spectrum Analyzers 100, 106, 114–119, 128, 131–133, 136–139, 141, 144
 - Switch, Access 506
 - Time Interval Analyzer 162
 - Transmission Impairment Measuring Sets 519–523
 - Transmission Line Test Sets 220
 - Vector Modulation Analyzer 148
 - Vector Modulation Generator/Analyzer 382–383
 - Voice & Data Testing 518
 - Waveform Analyzers 68–76, 115–119, 132–133, 139, 141, 148, 162
- Temperature Measurement 353, 574, 578, 580
- Terminals - Rugged 678
- Termination Panel, Multiprogrammer 613
- Test Systems
- Automatic 622
 - Board 548–552
 - IC 320, 526, 528
- Thermistor - Sensor 206
- Thermistor Assemblies 207
- Thermistor Sensors, Coaxial and Waveguide 207
- Thermocouple Scanning Cards 611
- Thermometer, Quartz 353
- Threat Simulator, Radar 380–381
- Time Interval Analyzer 162
- Time Interval Calibrator 168
- Time Interval Counters 162, 164
- Time Standards 488–492, 495
- Time Synthesizer 447
- Time, Frequency Domain Analyzers 68–75
- TNC Adapters 708
- Tracking Generators 420
- Transceiver Test Systems 323
- Transducer, Laser Position 349
- Transfer Function Analyzer 144
- Transient Digitizers 75, 132–133, 136–139, 141, 144
- Transient Generators 74, 378
- Transient Recorders 132–133, 136–139, 141, 144
- Transistor Bias Supply 240
- Transistor Characterization (TECAP) 731
- Transistor Test Fixtures 240
- Transmission Impairment Measuring Sets 518, 521–523
- Transmission Line Test System 220

ALPHABETICAL INDEX

True RMS Voltmeters 78-93
 Type N Short 343

U

UHF Signal Generators 356-359, 362-375, 382-383
 Universal Counter 600

V

Vector Analyzer 148
 Vector Generator 382-383
 Vector Modulation Analyzer 148
 Vector Modulation, Signal Generator 509
 Vector Network Analyzers 132-133, 144, 239, 241
 Vector Signal Generator 509
 Vector Voltmeter, MMS Module 115-119
 Vector/Arbitrary Waveform Synthesizer 380-381
 Vectra PC 674
 Vibration Analyzers 139, 144
 Voltmeters
 Digital 80-83, 85-93
 Vector, MMS Module 115-119
 VXIbus Family 597-599

W

Warranty 738

Waveform

Adapters 347
 Analyzers 76, 132-133
 Attenuators 346
 Digitizers 75, 132-133, 139, 141, 144
 Generator, Arbitrary 74, 318, 378, 414, 427, 431
 Recorders 68-76

Waveguide

Bends, Twists 347
 Coaxial Adapters 347
 Directional Couplers 345
 Frequency Meters 345
 Harmonic Mixers 341
 Holders 346
 Isolators 345
 Low-Pass Filters 346
 Sliding Loads 343
 Sliding Shorts 343
 Stands 346
 Terminations 343
 Variable Attenuators 346
 Wideband Amplifiers 409-411

X

X Window Software 655
 X-Y Recorders 76

MODEL NUMBER INDEX

New product listings are printed in bold face type

33

A1005A HP 9000 Model 825SRX Workstation.....	652
A1008A HP 9000 Model 825CHX Workstation.....	652
A1045A HP 9000 Model 835SRX Workstation.....	652
A1050A HP 9000 Model 835CHX Workstation.....	652
A1055A HP 9000 Model 835 TurboSRX Workstation.....	652
A1055A Opt. 747 HP 9000 Model 835 TurboSRX Animation Workstation.....	652
A1056A HP 9000 Model 834CH.....	652
A1303A Model R/332 Controller w/3.5-inch Flexible disk.....	558
A1305A Model R/332 Controller w/3.5-inch Flexible disk and 20 mB hard disk.....	558-559
A1307A Model R/332 Controller w/3.5-inch Flexible disk and 40 mB hard disk.....	558-559
A1309A Rack Mount Flange Kit.....	558-559
ATS 2000 Automatic Test System.....	622
B1155A X Window System Version 11 for Model 825, 835.....	655
B1156A Right to Copy B 1155A.....	655
B1157A X Window System Version 11 for Model 840.....	655
B1158A Right to Copy B1157A.....	655
B1159A X Window System Version 11 for Model 850, 855.....	655
B1160A Right to Copy B1159A.....	655
B1161A User Documentation for Series 300 and 800.....	655
B1162A Programmer Documentation for Series 300 and 800.....	655
B1621A HP SoftBench, License to use for Series 300.....	634-636
B1623A HP SoftBench, License to use for Series 800.....	634-636
B1625A HP Encapsulator, License to use for Series 300.....	634-636
C1602A PaintJet XL Color Graphics Printer.....	688
D1024A HP Vectra 15/12 Laptop Model 24 PC.....	675
D1044A HP Vectra 15/12 Laptop Model 44 PC.....	675
D1180A Video Graphics Adapter.....	676
D1181A/G/W Monochrome Monitor.....	676
D1182A/B VGA Color Monitor.....	676
D1183A HP Touch Accessory.....	676
D1184A VGA Cable.....	676
D1187A 20" Color Display.....	676
D1188A 16" Color Display.....	676
D1210A HP Vectra ES Model 10 PC.....	675
D1215A HP Vectra ES Model 15 PC.....	675
D1220A HP Vectra ES Model 20 PC.....	675
D1226A HP Vectra ES Model 26 PC.....	675
D1227A HP Vectra ES Model 27 PC.....	675
D1310A HP Vectra ES/12 Model 10 PC.....	675
D1315A HP Vectra ES/12 Model 15 PC.....	675
D1320A HP Vectra ES/12 Model 20 PC.....	675
D1326A HP Vectra ES/12 Model 26 PC.....	675
D1327A HP Vectra ES/12 Model 27 PC.....	675
D1340A HP Vectra ES/12 Model 40 PC.....	675
D1346A HP Vectra ES/12 Model 46 PC.....	675
D1347A HP Vectra ES/12 Model 47 PC.....	675
D1420A HP Vectra QS/20 Model 10e PC.....	675
D1422A HP Vectra QS/20 Model 46 PC.....	675
D1424A HP Vectra QS/20 Model 47 PC.....	675
D1425A HP Vectra QS/20 Model 100e PC.....	675
D1427A HP Vectra QS/20 Model 15e PC.....	675
D1460A HP Vectra QS/16S Model 10 PC.....	675
D1462A HP Vectra QS/16S Model 46 PC.....	675
D1464A HP Vectra QS/16S Model 47 PC.....	675
D1600A HP Vectra RS/20 Model 40 PC.....	653
D1602A HP Vectra RS/20 Model 100 PC.....	653
D1603A HP Vectra RS/20 Model 150 PC.....	653
D1604A HP Vectra RS/20 Model 300 PC.....	653
D2001A HP Vectra RS/20C Model 10e PC.....	675
D2002A HP Vectra RS/20C Model 100e PC.....	675
D2003A HP Vectra RS/20C Model 150e PC.....	675
D2004A HP Vectra RS/20C Model 154e PC.....	675
D2021A HP Vectra RS/25C Model 10e PC.....	675
D2022A HP Vectra RS/25C Model 100e PC.....	675
D2023A HP Vectra RS/25C Model 150e PC.....	675
D2024A HP Vectra RS/25C Model 154e PC.....	675
D2025A HP Vectra RS/25C Model 304e PC.....	675
D2300A AXDS/PC.....	655
E1022A HP 3070 User's Fundamentals Class.....	730
E1024A HP 3070 Advanced Digital Class.....	730
E1025A HP 3070 Training for Experienced HP 3065 Users.....	730
E1300A HP 75000 Series B Mainframe.....	598
E1326A 5 1/2-Digit Multimeter.....	599
E1328A 4-Channel D/A Converter.....	601
E1330A Quad 8-Bit Digital Input/Output.....	601
E1332A 4-Channel Counter/Totalizer.....	589, 604
E1333A 3-Channel Universal Counter.....	600
E1345A 16-Channel Relay Multiplexer.....	602
E1346A 48-Channel Single Ended Relay Multiplexer.....	602
E1347A 16-Channel Thermocouple Relay Mux.....	602
E1361A 4x4 Matrix Switch.....	601
E1364A 16-Channel Form C Switch.....	601
E1366A 50-Ohm RF Multiplexer (2X4:1).....	602
E1367A 75-Ohm RF Multiplexer (2X4:1).....	602
E1368A 18 GHz Microwave Switch.....	602
E1369A Microwave Switch Driver.....	602
E1390A HP 75000 System 10.....	589
E1400B HP 75000 Series C Mainframe.....	598
E1405A Command Module.....	603
E1410A 6 1/2-Digit Multimeter.....	599
E1411A 5 1/2-Digit Multimeter.....	599
E1416A Power Meter.....	603
E1440A 21 MHz Synthesized Function/Sweep Generator.....	601
E1460A 64-Channel Relay Multiplexer.....	602
E1472A 50-Ohm RF Multiplexer (6X4:1).....	602
E1473A 50-Ohm RF Multiplexer Expander (6X4:1).....	602
E1480A V/360 Controller.....	603
E2000A Interactive Test Generator Software.....	616
E2001A Instrument Driver Software.....	616
E2301A Surface Thermocouple Probe.....	94
E2302A Airflow Thermocouple Probe.....	94
E2303A Thermocouple Probe Adapter.....	94
E2304A Handheld Multimeter Carrying Case.....	94
E2305A Replacement Test Leads.....	94
E2373A Multimeter.....	94
E2377A Multimeter.....	94
E2378A Multimeter.....	94
E21-5061B Flying Clock (Cesium).....	489
E21-5065A Portable Rubidium Time Standard.....	490
10	
10B Business Calculator.....	666, 669
12C RPN Programmable Financial Calculator.....	666, 669
14B Business Calculator.....	666, 669
17B Business Calculator.....	666, 669
19B HP Business Consultant II Professional Calculator.....	666, 669
20	
20GB/A Optical Disk Library System.....	684
20S Scientific Calculator.....	669
21S Stat/Math Calculator.....	667, 669
22S Scientific Calculator.....	667, 669
27S Scientific Calculator.....	667, 669
28S Advanced Scientific Calculator.....	668-669
30	
32S RPN Scientific Calculator.....	667, 669
40	
41CV RPN Advanced Programmable Calculator.....	668-669
41CX RPN Advanced Programmable Calculator.....	668-669
42S RPN Scientific Calculator.....	669
100	
105B Quartz Oscillator.....	491

MODEL NUMBER INDEX

New product listings are printed in bold face type

200

214B Pulse Generator.....	443
281 Series Coaxial-Waveguide Adapters.....	347
292 Series Waveguide-Waveguide Adapters.....	347

300

334A Distortion Analyzer.....	145
339A Distortion Measuring Set.....	145
346A/B/C Noise Sources.....	329
346C OPT K01 Noise Source.....	329
347B Series Waveguide Noise Sources.....	329
355 Series Coaxial Step Attenuators.....	334-335
362A Series Waveguide Low-pass Filters.....	346
365 Series mm-Wave Waveguide Isolators.....	345
370 Series mm-Wave Fixed Attenuators.....	346
373 Series mm-Wave Fixed Attenuators.....	346
382 Series Waveguide Precision Variable Attenuators.....	346

400

415E SWR Meter.....	217
422A/C Series Waveguard Crystal Detectors.....	340
422A/C Series Waveguide Crystal Detectors.....	341
423B Coaxial Crystal Detector.....	340
432 Series Power Meters.....	206
435B Power Meter.....	203
436A Power Meter.....	200
437B Power Meter.....	201
438A Dual Channel Power Meter.....	202
438A Option 700 MATE - Programmed Power Meter.....	202
478A Coaxial Thermistor Mount.....	207
486A Series Waveguide Thermistor Mounts.....	207

500

532 Series Waveguide Frequency Meters.....	345
537A Coaxial Frequency Meter.....	345
545A Logic Probe.....	279
546A Logic Pulser.....	279
547A Digital Current Tracer.....	279
548A Logic Clip.....	280

600

650/A Rewritable Optical Disk Drive.....	684
---	------------

700

700/22 Display Terminal.....	677
700/32 Display Terminal.....	677
700/41 Display Terminal.....	677
700/43 Display Terminal.....	677
700/44 Display Terminal.....	677
700/71 Display Terminal.....	677
700/92 Display Terminal.....	677
700/94 Display Terminal.....	677
752 Series Waveguide Directional Couplers.....	345
772-773D Directional Couplers.....	344
774-777D Coaxial Dual Directional Couplers.....	344
778D Coaxial Dual Directional Coupler.....	344
779D Coaxial Directional Coupler.....	344

800

894 Series Waveguide Mismatches.....	347
896 Series Waveguide Precision Straights.....	347
897 Series E-, H-Plane Waveguide Bends.....	347
898 Series Waveguide Twists.....	347
899 Series Waveguide Straight Sections.....	347

900

905A Coaxial Sliding Load.....	343
--------------------------------	-----

908A Coaxial 50-Ohm Termination.....	342
909A/C/D/E/F Coaxial 50-Ohm Terminations.....	342
910 Series Waveguide Terminations.....	343
911C Coaxial Sliding Loads.....	343
911D/E Sliding Loads.....	343
911F/G Sliding Mismatches.....	343
914 Series Waveguide Sliding Loads.....	343
920 Series Waveguide Moving Shorts.....	343
921 Waveguide Fixed Shorts.....	343

1000

1000 Computers and Systems.....	656
1008A Testmobile.....	66
1040A Series HPCL Detectors.....	661
1050 Series HPLC Modules.....	661
1051A & 1052A Combining Cases.....	720
1090 Liquid Chromatograph Systems.....	661
1122A Probe Power Supply.....	65-66
1124A Active Divider Probe.....	65-66
1133A TV Video Sync Pod.....	67
1180A Testmobile.....	66
1631D + 24D HP 1631A/D Logic Analysis Measurement Techniques Course.....	729
1650B 80-Channel Logic Analyzer.....	252
1651B 32-Channel Logic Analyzer.....	252
1652B Logic Analyzer with Oscilloscope.....	254
1653B Logic Analyzer with Oscilloscope.....	254

2000

2106CK/DK Board Computer.....	656
2134A Computer.....	656
2139B Computer.....	656
2156C/D Computer.....	656
2196G/H Model 26 Computer Systems.....	656
2199E Model 29 Computer Systems.....	656
2225A/B/C/D/P ThinkJet Personal Printer.....	690
2227A/B QuietJet PLUS Printer.....	690
2228A QuietJet Printer.....	690
2235A/B/C/D RuggedWriter 480 Printer.....	690
2276A DeskJet Printer.....	690
2277A DeskJet PLUS Printer.....	690
2278A DeskWriter Printer.....	690
2393A Graphics Terminal.....	677
2397A Color Graphics Terminal.....	677
2424A Micro 14 Computer.....	656
2426G/H Micro 16 Computers.....	656
2434A Micro 24 Computer.....	656
2436G/H Micro 26 Computer.....	656
2439B Micro 29 Computer.....	656
2484B Micro 24 Computer.....	656
2486B/C Micro 26 Computer System.....	656
2487B Micro 27 Computer System.....	656
2489B Micro 29 Computer System.....	656
2562C Dot Matrix Printer.....	692
2563B Line Printer.....	691
2564B Line Printer.....	691
2566B Line Printer.....	691
2567B Line Printer.....	691
2680A Laser Printing System.....	691
2685C Laser Print Station.....	691
2804A Quartz Thermometer.....	353
2813D Quartz Pressure Set.....	352
2813E Quartz Pressure Probe.....	352
2816A Pressure Signal Processor.....	352
2934A Business Printer.....	690

3000

3048A Phase Noise Measurement System.....	146, 731
3048A + 24A HP 3048A Phase Noise Measurement System.....	729
3065 Board Test Family (HP-IB).....	548-549, 552

3065AT Combinational Board Test System.....	548–549, 552	3782A Error Detector (CEPT, CCITT).....	500
3065CT Communications Technologies Board Test System.....	548–549, 552	3782B Error Detector (Bell).....	500
3065ST Standard Technologies Board Test System.....	548–549, 552	3784A Digital Transmission Analyzer	498
3070 Board Test Family (HP-IB)	548, 550–552	3785A Jitter Generator & Receiver (CEPT).....	500
3070 SMT-Series Board Test System	548, 550–552	3785B Jitter Generator & Receiver (Bell).....	500
3070AT-Series Board Test System	548, 552	3787B Digital Data Test Set.....	502
3070AT-Series Combinational Board Test System	550–551	3788A Error Performance Analyzer	498
3082B Industrial Touch Terminal.....	678	3789A DS3 Transmission Test Set.....	501
3235A Switch/Test Unit.....	591, 731	3789B DS3 Transmission Test Set.....	501
3245A Universal Source.....	430	3852A Data Acquisition/Control Unit.....	580, 731
3312A Function Generator.....	427	3852A + 24D HP 3852S User Training Course.....	729
3314A Function Generator.....	427	3852S Data Acquisition/Control System.....	580
3324A Synthesized Function/Sweep Generator	416		
3325B Synthesizer/Function Generator.....	418	4000	
3326A Two-Channel Synthesizer.....	429	4061A Semiconductor/Component Test System.....	534
3335A Synthesizer/Level Generator.....	420	4062B Semiconductor Parametric Test System.....	533, 731
3336A/B/C Synthesizer/Level Generators.....	504–505	4062C Semiconductor Parametric Test System.....	532, 731
3365 ChemStation.....	660	4062C + 24A HP 4062C Operating and Programming Training.....	730
3396A Integrator	660	4062UX Semiconductor Process Control System	530, 731
3400A RMS Voltmeter.....	92	4085M Switching Matrix.....	535
3421A Data Acquisition/Control Unit.....	574	4140B pA Meter/DC Voltage Source.....	542
3437A System Voltmeter.....	89	4141B DC Source/Monitor.....	541
3455A Digital Voltmeter.....	89	4142B Modular DC Source/Monitor.....	538
3456A Systems DVM.....	88	4145B Semiconductor Parameter Analyzer.....	536
3457A Multimeter.....	83	4191A RF Impedance Analyzer.....	288
3458A Multimeter.....	80	4192A LF Impedance Analyzer.....	286
3466A Digital Multimeter.....	92	4193A Vector Impedance Meter.....	289
3468A/B Digital Multimeter.....	90	4194A Impedance/Gain - Phase Analyzer.....	284
3478A Multimeter.....	86	4195A Network/Spectrum Analyzer.....	224
3488A Switch/Control Unit.....	595	4261A Digital LCR Meter.....	300
3497A Data Acquisition/Control Unit.....	578	4262A Digital LCR Meter.....	300
3498A Extender.....	578	4274A Multifrequency LCR Meter.....	294
3551A Transmission Test Set.....	521	4275A Multifrequency LCR Meter.....	294
3552A Transmission Test Set.....	521	4276A LCZ Meter.....	298
3561A Dynamic Signal Analyzer.....	139	4277A LCZ Meter.....	298
3562A Dynamic Signal Analyzer.....	133	4278A 1 kHz/1 MHz Capacitance Meter.....	296
3563A Control Systems Analyzer	132	4279A 1 MHz C-V Meter.....	299
3565S Signal Processing System.....	141	4280A 1 MHz C Meter/C-V Plotter.....	544
3566A Spectrum/Network Analyzer.....	143	4284A Precision LCR Meter.....	290
3567A Spectrum/Network Analyzer.....	143	4328A Milliohmeter.....	302
3575A Gain/Phase Meter.....	223	4329A High Resistance Meter.....	302
3577A Network Analyzer.....	221	4342A Q Meter.....	301
3581A Wave Analyzer.....	144	4440B Decade Capacitor.....	303
3581C Selective Voltmeter.....	144	4925B Bit Error Rate Test Set.....	523
3582A Spectrum Analyzer.....	144	4934A Transmission Impairment Measuring Set	522
3585B Spectrum Analyzer.....	101	4935A Transmission Impairment Measuring Set.....	523
3586A/B Selective Level Meter.....	504–505	4936A Transmission Impairment Measuring Set.....	523
3586C Selective Level Meter.....	144	4937A Transmission Impairment Measuring Set.....	521
3588A Spectrum Analyzer	100	4938A Network Circuit Access Test Set.....	521
3630A PaintJet Color Graphics Printer.....	688	4945A Transmission Impairment Measuring Set.....	519
3708A Noise and Interference Test Set.....	507	4947A Transmission Impairment Measuring Set.....	519
3709B Constellation Analyzer.....	508	4948A In-Service Transmission Impairment Measuring Set.....	520
3717A 70 MHz Modulator-Demodulator.....	506	4951C Protocol Analyzer.....	511
3730B Down Converter: RF to IF.....	506	4952A Protocol Analyzer.....	511
3736B RF Module: 1.7 to 4.2 GHz.....	506	4954I ISDN WAN Protocol Analyzer	512
3737B RF Module: 3.7 to 8.5 GHz.....	506	4954A Protocol Analyzer.....	512, 731
3738B RF Module: 5.9 to 11.7 GHz.....	506	4972A LAN Protocol Analyzer.....	513, 731
3739B RF Module: 10.7 to 14.5 GHz.....	506	4974S MAP Protocol Analyzer System.....	514
3746A Selective Level Measuring Set (32 MHz).....	506	4990S LanProbe Distributed Analysis System	515, 731
3754A 25 MHz Access Switch.....	506		
3755A Switch Controller.....	506		
3756A 90 MHz Bi-directional Switch.....	506		
3757A 8.5 MHz Access Switch.....	506		
3764A Digital Transmission Analyzer.....	499	5000	
3776A PCM Terminal Test Set.....	497	5005B Signature Multimeter.....	276
3776B PCM Terminal Test Set.....	497	5006A Signature Analyzer.....	278
3777A HP-IB-Controlled Channel Selector.....	497	5011T Logic Troubleshooting Kit.....	281
3779C Primary Multiplex Analyzer (CEPT).....	497	5021A Logic Troubleshooting Kit.....	281
3779D Primary Multiplex Analyzer (Bell).....	497	5022A Logic Troubleshooting Kit.....	281
3780A Pattern Generator/Error Detector.....	499	5023A Logic Troubleshooting Kit.....	281
3781A Pattern Generator (CEPT, CCITT).....	500	5024A Logic Troubleshooting Kit.....	281
3781B Pattern Generator (Bell).....	500	5061B Cesium Beam Frequency Standard.....	489
		5065A Rubidium Frequency Standard.....	490

MODEL NUMBER INDEX

New product listings are printed in bold face type

5087A Distribution Amplifier.....	494
5089A Standby Power Supply.....	495
5180A Waveform Recorder.....	72
5180S Waveform Measurement System.....	73
5180T waveform recorder.....	731
5180T,U Precision Digitizing Oscilloscopes.....	68, 72
5182A Waveform Recorder/Generator.....	74
5182S Waveform Generation System.....	75
5183A Waveform Recorder.....	71, 731
5183T,U Precision Digitizing Oscilloscopes.....	70
5314A Universal Counter.....	199
5315A Universal Counter.....	196-198
5316B Universal Counter.....	196-198
5328B Universal Counter.....	195
5334B Universal Counter.....	190, 191
5335A Universal Counter.....	192-194
5340A Microwave Frequency Counter.....	179
5342A Microwave Frequency Counter.....	177
5343A Microwave Frequency Counter.....	177
5345A Electronic Counter.....	183, 188
5347A Counter/Power Meter.....	174, 203
5348A Counter/Power Meter.....	174, 203
5350B Microwave Frequency Counter.....	171
5351B Microwave Frequency Counter.....	171
5352B Microwave Frequency Counter.....	171
5355A Automatic Frequency Converter.....	183
5356A, B, C, D Frequency Converter Heads.....	183
5359A Time Synthesizer.....	447
5361A 20 GHz Pulse/CW Microwave Counter.....	180
5363B Time Interval Probes.....	170
5364A Microwave Mixer/Detector.....	165
5370B Universal Time Interval Counter.....	168
5371A Frequency & Time Interval Analyzer.....	162
5372A Frequency and Time Interval Analyzer.....	162
5384A Frequency Counter.....	186
5385A Frequency Counter.....	186
5386A Frequency Counter.....	186
5501A Laser Transducer System.....	348-349
5507A Laser Position Transducer Electronics.....	348-349
5508A Measurement Display.....	351
5517A Laser Head.....	348
5517B High Slew Rate Laser Head.....	348
5518A Laser Head.....	351
5527A Laser Position Transducer System.....	348-350
5528A Laser Measurement System.....	348, 351
5890A Series II Gas Chromatograph.....	660
5921A Atomic Emission Detector.....	660
5965A Infrared Detector.....	661
5970B Mass Selective Detector.....	661
5988A GC/Mass Spectrometer.....	661
5988A LC/Mass Spectrometer.....	661
6000	
6002A Autoranging DC Power Supply.....	471
6010A 1000 Watt Autoranging Power Supply.....	476
6011A 1000 Watt Autoranging Power Supply.....	476
6012B 200 Watt Autoranging Power Supply.....	476
6023A 200 Watt Autoranging Power Supply.....	476
6024A 200 Watt Autoranging DC Power Supply.....	476
6030A 1000 Watt Autoranging System Power Supply.....	468
6031A 1000 Watt Autoranging System Power Supply.....	468
6032A 1000 Watt Autoranging System Power Supply.....	468
6033A 200 Watt Autoranging System Power Supply.....	468
6038A 200 Watt Autoranging System Power Supply.....	468
6050A 1800W Load Mainframe.....	449
6051A 600W Load Mainframe.....	450
6060A Single Input Load.....	448
6063A 250W, 240V Single Input Load.....	451
6114A & 6115A Precision DC Power Supplies.....	486
6129C-6131C Digitally Controlled Voltage Sources.....	472
6140A Digital Current Source.....	472
6177C Precision DC Current Source.....	487
6181C Precision DC Current Source.....	487
6186C Precision DC Current Source.....	487
6200B-6209B DC Power Supplies.....	483-485
6212C-6218C DC Power Supplies.....	483-485
6227B Dual Tracking DC Power Supply.....	474
6228B Dual Tracking DC Power Supply.....	474
6234A Dual Output Power Supply.....	483, 485
6235A Triple Output Power Supply.....	484
6236B Triple Output DC Power Supply.....	484
6237B Triple Output DC Power Supply.....	484
6253A Dual Output DC Power Supply.....	474
6255A Dual Output DC Power Supply.....	474
6259B DC Power Supply.....	478
6260B DC Power Supply.....	478
6261B DC Power Supply.....	478
6263B DC Power Supply.....	478
6264B DC Power Supply.....	478
6266B DC Power Supply.....	478
6267B DC Power Supply.....	478
6268B DC Power Supply.....	478
6269B DC Power Supply.....	478
6274B DC Power Supply.....	478
6281A DC Power Supply.....	474
6282A DC Power Supply.....	474
6284A DC Power Supply.....	474
6286A DC Power Supply.....	474
6289A DC Power Supply.....	474
6291A DC Power Supply.....	474
6294A DC Power Supply.....	474
6296A DC Power Supply.....	474
6299A DC Power Supply.....	474
6434B DC Power Supply.....	480
6443B DC Power Supply.....	480
6448B DC Power Supply.....	480
6453A DC Power Supply.....	480
6456B DC Power Supply.....	480
6459A DC Power Supply.....	480
6464C DC Power Supply.....	480
6466C DC Power Supply.....	480
6469C DC Power Supply.....	480
6472C DC Power Supply.....	480
6475C DC Power Supply.....	480
6477C DC Power Supply.....	480
6479C DC Power Supply.....	480
6483C DC Power Supply.....	480
6621A System Power Supply.....	464
6622A System Power Supply.....	464
6623A System Power Supply.....	464
6624A System Power Supply.....	464
6625A Precision System Power Supply.....	466
6626A Precision System Power Supply.....	466
6627A System Power Supply.....	464
6628A Precision System Power Supply.....	466
6629A Precision System Power Supply.....	466
6632A System Power Supply.....	462
6633A System Power Supply.....	462
6634A System Power Supply.....	462
6824A DC Power Supply/Amplifier.....	482
6825A DC Power Supply/Amplifier.....	482
6826A DC Power Supply/Amplifier.....	482
6827A DC Power Supply/Amplifier.....	482
6940B Multiprogrammer.....	613
6941B Multiprogrammer Extender.....	613
6942A Multiprogrammer.....	609
6943A Multiprogrammer Extender.....	609
6944A Multiprogrammer.....	608
6944S + 24D Multiprogrammer System User's Course.....	729
6954A Multiprogrammer.....	607
7000	
7060A HP SketchPro Graphics Tablet.....	686
7090A Measurement Plotting System.....	76

7440A ColorPro Plotter	694
7475A 6-Pen Graphics Plotter	695
7550A 8-Pen Graphics Plotter	696
7570A DraftPro Plotter	698
7575 DraftPro DXL Plotter	698
7576 DraftPro EXL Plotter	698
7595A DraftMaster I Plotter	700
7596A DraftMaster II Rollfeed Plotter	700
7600 Series Model 240D Electrostatic Plotter	702
7600 Series Model 240E Electrostatic Plotter	702
7673A Automatic Sampler	660
7936H/XP Disk Drive	683
7937H/XP Disk Drive	683
7957B Disk Drive	682
7957S Disk Drive	681
7958B Disk Drive	682
7958S Disk Drive	681
7959B Disk Drive	682
7959S Disk Drive	681
7962B Disk Drive	682
7963B Disk Drive	682
7979A ½" Tape Drive	685
7980A ½" Tape Drive	685
7980XC ½" Tape Drive	685

8000

8011A Pulse Generator	444
8012B Pulse Generator	444
8013B Pulse Generator	444
8080A Pulse Generator Mainframe	446
8081A Repetition Rate Generator, 300 MHz	446
8082A Pulse Generator	445
8083A Output Amplifier, 300 MHz	446
8084A Word Generator, 300 MHz	446
8091A Rate Generator, 1 GHz	446
8092A Delay Generator	446
8093A Output Amplifier, 1 GHz	446
8111A Pulse/Function Generator	426
8112A Pulse Generator	434
8115A 50-MHz Dual-Channel Pulse Generator	435
8116A Pulse/Function Generator	424
8118A 100 MBit/s Pulse Pattern Generator	317
8130A 300-MHz Pulse Generator	436
8131A 500-MHz Pulse Generator	438
8145A Optical Time Domain Reflectometer	310
8151A Optical Pulse Power Meter	305
8152A Optical Average Power Meter	306
8154B LED Source 1300 nm	307
8155A LD Source	307
8157A Optical Attenuator	308
8158B Optical Attenuator	308
8160A Programmable Pulse Generator	440
8161A Programmable Pulse Generator	440
8165A Programmable Signal Source	423
8175A Digital Signal Generator	318, 421
8180B Data Generator	320
8181B Data Generator Extender	320
8182B Data Analyzer	320
8328A/S Transmission Line Test Set	220
8347A RF Amplifier	408
8349B Microwave Amplifier	410
8350B Sweep Oscillator Family	398-407
8360 Series Synthesized Sweepers	396
8444A Option 059 Tracking Generator	130
8447 Series Amplifiers	131, 411
8449A Preamplifier	131, 409
8452A Diode Array Spectrophotometer	661
8470B Coaxial Crystal Detectors	340
8471D	340
8472B Coaxial Crystal Detector	340
8473 Series Coaxial Detectors	340
8474 Series Coaxial Detectors	340

8477A Power Meter Calibrator	206
8478B Coaxial Thermistor Mount	207
8481A/B/D/H Power Sensors	204
8482A/B/H Power Sensors	204
8483A Power Sensor	204
8484A Power Sensor	204
8485A/D Power Sensors	204
8487A/D Power Sensors	204
8490D 2.4mm Coaxial Fixed Attenuator	332-333
8491A Coaxial Fixed Attenuator	333
8491A/B Coaxial Fixed Attenuators	332
8492A Coaxial Fixed Attenuator	332-333
8493A/B/C Coaxial Fixed Attenuators	332-333
8494A/B/G/H Coaxial Step Attenuators	334-335
8495A/B/D/G/H/K Coaxial Step Attenuators	334-335
8496A/B/G/H Coaxial Step Attenuators	334-335
8497K Coaxial Step Attenuators	334
8498A Coaxial Fixed Attenuator	332-333
8508A Vector Voltmeter	228
8510B Network Analyzer	237
8510B Series Millimeter-Wave Measurement System	239
8510B + 24D Basic Measurements Using HP 8510 Network Analyzer System	729
8511A Frequency Converter	238, 243
8514B S-Parameter Test Set (45 MHz-20 GHz)	238
8515A S-Parameter Test Set (45 MHz-26.5 GHz)	238
8516A S-Parameter Test Set (45 MHz-40 GHz)	238
8560A Spectrum Analyzer	110
8561B Spectrum Analyzer	110
8562A Spectrum Analyzer	110
8566B Spectrum Analyzer	120-121
8567A Spectrum Analyzer	120, 123
8568B Spectrum Analyzer	120, 123
8573A CISPR EMI Receiver	125
8574A CISPR EMI Receiver	125
8590B Portable RF Spectrum Analyzer	105-106
8591A Portable RF Spectrum Analyzer	105-106
8592B Spectrum Analyzer	107-108
8593A Spectrum Analyzer	107-108
8640B AM/FM Signal Generator	376
8642A/B Synthesized Signal Generators	368
8644A Synthesized Signal Generator	362
8645A Agile Signal Generator	364
8656B Synthesized Signal Generator	356
8657A Synthesized Signal Generator	358
8657B Synthesized Signal Generator	360
8660D Synthesized Signal Generator	373
8662A Synthesized Signal Generator	370
8663A Synthesized Signal Generator	370
8665A Synthesized Signal Generator	366
8671B Synthesized CW Generator	386
8672A Synthesized Signal Generator	392
8672S Synthesized Signal Generator	392
8673B Synthesized Signal Generator	388
8673C/D Synthesized Signal Generators	388
8673E Synthesized Signal Generator	391
8673G Synthesized CW Generator	387
8673H Synthesized Signal Generator	384
8683B/D Signal Generators	385
8684B/D Signal Generators	385
8702B Lightwave Component Analyzer	312
8703A Lightwave Component Analyzer	312
8717B Transistor Bias Supply	240
8719A Network Analyzer	235
8720B Network Analyzer	235
8721A Directional Bridge	130, 331
8752A RF Network Analyzer	229
8753B + 24A HP 8753A RF Network Analyzer Course	729
8753C Network Analyzer	231
8757C/E Scalar Network Analyzer	211
8761 SPDT Coaxial Switch	337-339
8762 SPDT Coaxial Switch	337-339
8763 4-Port Coaxial Switch	337-339

MODEL NUMBER INDEX

New product listings are printed in bold face type

8764 5-Port Coaxial Switch	337-339	10315G Microprocessor Interface	248
8765 SPDT Coaxial Switch	337	10315H Microprocessor Interface	248
8766-69 SP - Multi-throw Coaxial Switch	337	10316G Microprocessor Interface	248
8770A Arbitrary Waveform Synthesizer.....	378	10320C Preprocessor	251
8770S Signal Simulator System.....	378	10321C Preprocessor	251
8780A Vector Signal Generator	382, 508	10322A Preprocessor	251
8782A Vector Signal Generator	383, 509	10323A Preprocessor	251
8791 Model 10 Frequency Agile Signal Simulator	380-381	10324A Preprocessor	251
8791 Model 100 Precision Signal Generator	380-381	10335G Microprocessor Interface	248
8791 Model 200 Radar Simulator	380-381	10336G Microprocessor Interface	248
8791 Model 2000 Advanced Agile Threat Simulator	380-381	10336H Microprocessor Interface	248
8900C/D Peak Power Meters.....	207	10341B 1553 Interface	250
8901A Modulation Analyzer	151	10342B Bus Interface.....	250
8901B Modulation Analyzer	151	10342G HP-IB Preprocessor.....	250
8902A Measuring Receiver.....	153	10343B SCSI Bus Interface.....	250
8902AT Attenuator Calibration System	155	10344A VME Bus Interface	250
8902S Microwave Measurement System.....	157	10344B VME Bus Interface.....	250
8902SG Signal Generator Test System.....	156	10349B Upgrade Kit	273
8903B Audio Analyzer	149	10390A System Performance Analysis Software.....	265
8903E Distortion Analyzer	149	10430A 10:1 Passive Oscilloscope Probe.....	64
8904A Multifunction Synthesizer.....	414	10431A 10:1 Passive Oscilloscope Probe.....	64
8953A Transceiver Test Set.....	322	10432A 10:1 Passive Oscilloscope Probe.....	64
8953A-J45 Agile Transceiver	322	10433A 10:1 Passive Oscilloscope Probe.....	64
8954A Transceiver Interface.....	324	10434A 10:1 Passive Oscilloscope Probe.....	64
8955A RF Test System.....	322	10435A 10:1 Passive Oscilloscope Probe.....	64
8956A System Interface.....	324	10436A 10:1 Passive Oscilloscope Probe.....	64
8957S Cellular Radio Test System.....	322	10437A 50 Ohm Probe.....	64
8958A Cellular Radio Interface	324	10438A 1:1 Passive Oscilloscope Probe	64
8970B Noise Figure Meter.....	327	10439A 1:1 Passive Oscilloscope Probe	64
8970S/T/U Microwave Noise Figure Measurement Systems	328	10440A 100:1 Passive Oscilloscope Probe.....	64
8970U Noise Figure Measurement System	329	10448A Upgrade Kit.....	273
8971C Noise Figure Test Set.....	328	10449A Upgrade Kit.....	273
8980A Vector Analyzer.....	148, 508	10501A Cable Assembly.....	708
8981A Vector Modulation Analyzer	148	10502A Cable Assembly	708
8990A Peak Power Analyzer	200	10503A Cable Assembly.....	708
9000		10514A Double-Balanced Mixer	341
9000 Series 300 Computers.....	555	10529A Logic Comparator	280
9000 Series 332 Computer	555	10534A Double-Balanced Mixer	341
9000 Series 360 Computer	555	10541A Reference Boards.....	280
9000 Series 370 Computer	555	10541B Preprogrammed Reference Boards.....	280
9000 Series R332 Controllor	558	10595A Board Extender Kit (HP 5345A).....	189
9000 Series 800 Computers.....	650	10638A Degausser	493
9122C 3½" Microfloppy Disk Drive	680	10717A Wavelength Tracker	348-349
9127A Single-Sided 5¼" Flexible Disk Drive	680	10751A Air Sensor	349, 351
9144A ¼" Cartridge Tape Drive	685	10754A Metrology Software.....	351
9145A ¼" High Performance Cartridge Tape Drive	685	10757A Material Temperature Sensor.....	349, 351
9153C Disk Drive	680	10777A Optical Square.....	351
9153M Upgrade Kit.....	680	10780C Receiver	348-349
9480 Analog LSI Test System	528	10780F Remote Receiver	348
10000		10793A Laser Head Cable.....	351
10002A 50:1 Voltage Divider Probe	65-66	10821A Probe Accessory Kit (HP 5363B).....	170
10020A Resistive Divider Probe Kit.....	65-66	10833A/B/C/D HP-IB Cables	569
10024A IC Test Clip.....	65-66	10834A HP-IB Cable Adapter	569
10062A Protective Cover	319	10842A Extender Board Kit (HP 5342/5343/5344S)	178
10100C 50-ohm BNC Feedthrough.....	65-66	10855A Broadband Preamplifier	170
10229A Hook Tip Adapter	65-66	10870A Service Kit (HP 5370B).....	169
10275A Interface.....	250	10871B Service Kit (HP 5180A).....	73
10276A Interface.....	250	10873A Rack Mount Kit	73
10300B Microprocessor Interface.....	248	10874A Slide Mount Kit.....	73
10303B Microprocessor Interface.....	248	10875A/B DMA Cables.....	73
10304B Microprocessor Interface.....	248	10895A VME Laser Axis Board	349
10305B Microprocessor Interface.....	248	10932A Axis Board	349
10306B Microprocessor Interface.....	248	10936A Servo-Axis Board.....	349
10307B Microprocessor Interface.....	248	10941A Prototyping Kit	349
10311B Microprocessor Interface.....	248	10946B Automatic Compensation Board	349
10311G Microprocessor Interface	248	11000	
10312B Microprocessor Interface	248	11002A Test Leads.....	93, 708
10313G Microprocessor Interface	248	11003A Test Leads.....	93, 708
10314B Microprocessor Interface.....	248	11053A Low Thermal Lug-Lug Jumper Set	93
		11058A Low Thermal Banana-Banana Jumper Set	93
		11059A Kelvin Probe Set	93

11060A Surface Mount Device Probe Set.....	93
11062A Kelvin Clip Set	93
11096B High Frequency Probe.....	93
11174A Low Thermal Lug-Banana Jumper Set.....	93
11340A/B/C HP-IL Cable Assemblies	575
11500A/B/C/D/E/F Precision Cables	708
11501A Cable Assembly.....	708
11509A Fuseholder.....	393
11511A Coaxial Short.....	343
11512A Coaxial Short.....	343
11515A Waveguide Adapter.....	347
11516A Waveguide Adapter.....	347
11524A APC-7 to N (female) Adapter.....	708
11525A APC-7 to N (male) Adapter.....	708
11533A APC-7 to SMA (male) Adapter.....	708
11534A APC-7 to SMA (female) Adapter.....	708
11536A Probe Tee for HP 8508A.....	228
11540A Waveguide Stand.....	346
11545A-11548A Waveguide Holders.....	346
11549A Power Splitter for HP 8508A.....	228
11565A Coaxial Short.....	343
11566A Air Line Extension	342
11567A Air Line Extension	342
11570A Accessory Kit for HP 8508A	228
11581A Attenuator Set	332-333
11582A Attenuator Set	332-333
11583A/C Attenuator Sets.....	332-333
11590B Bias Network	240
11608A Transistor Fixture.....	240
11612A/B Bias Network	240
11613B Calibrator for HP 8756A, 8757A	216
11614A Firmware Enhancement for HP 8757A.....	215
11635A Bias Decoupling Network	240
11636A/B Power Dividers.....	216, 331
11644A Series Calibration Kits	239
11644A Series Millimeter-Wave Calibration Kits.....	241
11645A Series Verification Kits.....	239
11661B Frequency Extension Module.....	373
11664A/D/E Detector for HP 8755, 8756 and 8757	213
11664C Detector Adapter for HP 8755, 8756 and 8757	213
11665B Modulator for HP 8755, 8756 and 8757.....	216
11667A/B/C Power Splitters.....	217, 331
11668A High Pass Filter for HP 8755, 8756, 8757	216
11672A Service Accessory Kit for HP 8660A/C/D.....	375
11678A Low Pass Filter Kit.....	216
11679A/B Extension Cables for HP 8755, 8756 and 8757	215
11683A Range Calibrator.....	203
11684/5/6/8/9A Low Pass Filters.....	216
11687A Adapter, 50 to 75 Ω	393
11690A Frequency Doubler.....	393
11691D Coaxial Directional Coupler	344
11692D Coaxial Dual Directional Coupler	344
11693A Microwave Limiter.....	130
11694A Matching Transformer, 50-75 Ω	130
11707A Test Plug-in.....	375
11708A Attenuator (30dB, 50 MHz).....	204
11710B Down Converter.....	393
11712A Service Support Kit (for HP 8671A, 8672A/S)	392
11713A Attenuator/Switch Driver.....	339
11714A Service Support Kit (for HP 8662A, 8663A).....	372
11715A AM/FM Test Source	152
11716 A Option K10, Waveform Generation Language	380-381
11716 C/D Attenuator Interconnection Kit (for HP 84900 Attenuators).....	336
11716A/B Interconnection Kits.....	334
11717A Attenuator/Switch Rack Mount Support Kit	339
11720A Pulse Modulator	392
11721A Frequency Doubler	393
11722A Sensor Module.....	154
11726A Support Kit for HP 8673B/C/D	389
11727A Support Kit (For HP 8683/84)	385
11729C Carrier Noise Test Set.....	147
11731A Frequency Extension Retrofit Kit.....	392

11732A Frequency Extension Retrofit Kit.....	392
11742A/B Coaxial Blocking Capacitor.....	342
11748A High-Impedance Probe Set (HP 8980/81A)	148
11752C/D/E 2.4, 3.5-mm Connector Gages.....	342
11757A Multipath Fading Simulator	507
11758T Digital Radio Test System	509
11760S-E01 Automatic Power Sensor Calibration System.....	204
11761-64 Adapter Cables for HP 11713A	339
11764 A-D Interconnect Cable (for HP 84900 Attenuators)	336
11776A Waveform Generation Software	378, 731
11776A + 24D Waveform Generation Language User's Course.....	729
11792A Sensor Module.....	157
11793A Microwave Converter.....	157
11794A Software Pac for HP 8902S	157
11798A Software Application Pac for Cellular Radio Test.....	323
11799A Signaling Unit.....	324
11801A/B/C On-Site Service Kits for HP 8642A/B.....	369
11804A Accessory Kit for HP 8957S.....	322
11805A Software Application Pac for HP 8953A	323, 731
11806B Attenuator Test Software for HP 8902AT, HP 8902S	155, 731
11808A Signal Generator Performance Test Software for HP 8902SG, HP 8902S.....	156
11808A Signal Generator Test System	731
11816A Retrofit Kit for HP 8904A Opt. 001.....	415
11817A Retrofit Kit for HP 8904A Opt. 002.....	415
11818A Retrofit Kit for HP 8904A Opt. 003.....	415
11823A/B Attenuator Accessory Kits for HP 8902AT.....	155
11823C SWR Accessory Kit for HP 8902AT.....	155
11836A 0.3 GMSK Modulation Measurement Software.....	325
11845A 2-GHz Retrofit Kit for HP 8645A.....	364
11848A Phase Noise Interface.....	146
11850C/D Power Splitters.....	233
11851B RF Cable Kit.....	233
11852B 50-75 Ω Minimum Loss Pad	233
11853A 50 Ω Type N Accessory Kit.....	233
11854A 50 Ω BNC Accessory Kit.....	233
11855A 75 Ω Type N Accessory Kit.....	233
11856A 75 Ω BNC Accessory Kit.....	233
11857B/D Test Port Extension Cables for HP 85046A/B.....	233
11858A Transistor Fixture Adapter	233
11867A RF Limiter.....	130
11869A Adapter for HP 86200 Series Sweeper Plug-ins.....	400
11871A/B/C Fiber Cables	313
11876A Upgrade Kit.....	312
11886A Interconnect Cable Kit.....	313
11887A Interconnect Cable Kit.....	313
11889A RF Interface Kit.....	312
11890A Lightwave Coupler	312
11891A Lightwave Coupler	312
11940A Close-Field Probe	128, 131
11941A Close-Field Probe	128, 131
11945A Close-Field Probe Set	128, 131
11949A EMC Design Course.....	127
11970 Series Harmonic Mixers.....	129, 341
11971 Series Harmonic Mixers.....	341
11974 Series Preselected Millimeter Mixers	129
11975A Microwave Power Amplifier.....	131, 409
11980 Lightwave Interferometer	315

12000

12060B 8-Channel Analog Input Card.....	615
12061A 32-Channel Analog Input Expansion Card	615
12062A 4-Channel Analog Output Card.....	615
12063A 32-Channel Digital Multifunction Card.....	615
12100A A400 Single-Board Computer.....	656

14000

14513A Rack Kit (for one unit, 3½ in. H).....	475, 485
---	----------

MODEL NUMBER INDEX

New product listings are printed in bold face type

14515A Rack Kit (for one unit, 5/4 in. H)	475	16061A Test Fixture	283, 300
14521C Rack Kit (for Bench Series)	485	16062A Test Leads	283, 300
14523A Rack Kit (for two units, 3 1/2 in. H)	475, 485	16063A Test Leads	283, 300
14525A Rack Kit (for two units, 5/4 in. H)	475	16064A Retrofit Kit for Comparator	298
14533B Pocket Programmer	472	16065A External DC Bias Test Fixture	283
14534A Pocket Programmer Extension Cable	472	16066A Test Fixture Adapter	531
14535A Interface Kit, DCPS-to-HP 1000 Computers	472	16067A 24-pin DIP Low Leakage Fixture	531
14536A Chaining Cable	472	16068A 48-pin DIP Low Leakage Fixture	531
14540A Input Cable Assembly, Multiprogrammer-to-HP 1000 Computers	613	16069A Universal Low Leakage Fixture	531
14541A Chaining Cable, HP 6940B or 6941B to HP 6941B	613	16070A General Purpose DIP Fixture	531
14545A Casters for HP 6464C - 6483C	481	16071A Universal Fixture	531
14550B Interface Kit, Multiprogrammer-to-HP 1000 Computers	613	16071B Universal Fixture	531
14551A Multiprogrammer Service Kit	613	16072A Personality Board	531
14555A Connector Kit	613	16072B Personality Board	531
14556A Software Library for HP 9825A	613	16075A Relay Test Adapter	531
14557A Power Supply Interconnect Cable	613	16076A System Test Module	531
14558A Termination Panel	613	16077A Extension Cable Fixture	531
14560A Cable Assembly	613	16080A Direct Coupled Test Fixture	545
14561A Cable Assembly	613	16081A Test Leads	545
14562A Cable Assembly	613	16082A Test Leads	545
14704A/B/C Multiprogrammer Interface Cables	608	16083A Pulse Bias Noise Clipper	545
14753A Computer Aided Test Programming Package	608, 612	16085A Terminal Adapter	283
14753R Right to Reproduce CAT Program Pkg	608, 612	16091A Coaxial Fixture Set	283
14852A Bias Cable	467	16092A Spring Clip Fixture	283
		16093A/B Binding Post Fixture	283
		16094A Probe Fixture	283
		16095A Probe Fixture	283, 287
		16096A 2-Port Component Test Fixture	283, 287
		16099A Test Fixture Adapter	283
15000		16117A Low Noise Test Leads	302
15104A Pulse Adder/Splitter	446	16143A Probe Cable	302
15115A Pulse Splitter/Inverter	446	16269A Test Management Shell/TekBase	731
15116A Pulse Inverter	446	16276A Interactive Measurement & Analysis Software	540
15179A Rack Adapter Frame	444	16320B Pin Board	531
15408A-15411A HP 8175A Accessories	319	16320C Pin Board	531
15415A Plug-on Miniprobe	319	16334A Test Fixture for Chip Components	283
15429A Solder-in Receptacles	319	16355A Relay Test Adapter	531
15430A Cable for Master-Slave Operation	319	16356A System Test Module	531
15461A ECL Pod	319	16370A Test Fixture Adapter	531
15462A TTL/CMOS Pod	319	16371A 24-pin DIP Low Leakage Fixture	531
15463A Trigger Pod	319	16372A 48-pin DIP Low Leakage Fixture	531
15464A TTL Pod	319	16373A 64-pin DIP Low Leakage Fixture	531
15475A Optical Cleaning Kit	309	16374A Universal Low Leakage Fixture	531
15512A Cable	497, 523	16375A General Purpose DIP Fixture	531
15513A 1m Audio Cable	522	16376A Universal Fixture	531
15513A Cable	497, 523	16376B Universal Fixture	531
15515B Loop Holding Unit	497	16377A Personality Board	531
15518A/B/C Loop Holding Accessories	497	16377B Personality Board	531
15677A Ladder Bracket	522	16378A Extension Cable Fixture	531
15678A 19-inch Rack Mount	522	16380A/C Standard Capacitor Sets	303
15709A High Impedance Probe	508	16451A Dielectric Test Adapter	301
		16451B Dielectric Test Fixture	283
		16462A Auxiliary Capacitor	301
		16470A/B/C Reference Inductors	301
		16500A Logic Analysis System	244-245, 256
16000		16510B State/Timing Analysis Module	258
16005A Probe	302	16511B State/Timing Analysis Module	258
16006A Probe	302	16515A 1 GHz Timing Card	261
16007A/B Test Leads	302	16516A 1 GHz Timing Card	261
16008A Resistivity Cell	302	16520A 50 Mb Pattern Generator Master Card	262
16014A Series Loss Test Adapter	301	16521A 50 Mb Pattern Generator Expansion Card	262
16034E Test Fixture for Chip Components	283	16530A 400 Msample Digitizing Oscilloscope Card	260
16047A Direct Coupled Test Fixture	283	16531A 400 Msample Digitizing Oscilloscope Card	260
16047B Test Fixture with Safety Cover	283		
16047C Test Fixture for High Frequencies	283		
16047D Direct Coupled Test Fixture	283		
16048A Test Leads, BNC	283		
16048B Test Leads, RF Miniature	283		
16048C Test Leads, Alligator Clips	283		
16048D Test Leads, BNC (2m)	283		
16048E Test Leads	283		
16053A Test Leads	543		
16054A Connection Selector	543		
16055A Test Fixture	543		
16056A Current Divider	543		
16058A Test Fixture	537, 539		
		17000	
		17090B Measurement Graphics Software	76
		18000	
		18064A Noise-to-ground Adapter for HP 4935A	523
		18107A External Oscillator (HP 2804A)	353
		18110A Laboratory Probe and Cal Module (HP 2804A)	353

18111A Laboratory Probe and Cal Module (HP 2804A)	353
18132A Rack Mount	523
18134A Carrying Case	522-523
18160A Interface Pod	511
18161A Ladder Bracket for HP 4935A, 4937A	523
18174A Interface Pod	511
18176A Rack Mount Kit	519
18179A RS-232C/V.24 Interface Pod	511
18180A RS-232C/V.24, RS-449/422A/423A Interface	511
18182A Audio Cable	522, 523
18183A RS-232-C/V.24 Interface	523
18184A V.35 Interface	523
18185A 115V Power Module	523
18190A Soft Vinyl Carrying Case	511
18191A Rack Mount (19-inch)	523
18192A Carrying Case	523
18194A 220V Power Module	523
18263A 3270 Installation, Maintenance Software	511
18264A X.25, SNA Link Level Analysis	511
18265A DDCMP Analysis	511
18266A Enhanced X.25 Analysis	511
18267A X.25 Test Library and Emulator	511
18331D SNA, DDCMP, X.25 Analysis	511
18332D 3270 Installation & Maintenance	511
18347A HP 4951C Protocol Analyzer User's Course	729
18352A X.21 State Simulator	512
18353A Password Security	512
18355A CCITT #7/CCS7 Analysis	512
18360A SNA Emulation Language	512
18361A 3270 Device Exerciser	512
18362A LU6.2 Node Exerciser	512
18369A Asynchronous Terminal Emulator	512
18370A X.25 Network Performance Analysis	512
18371A SNA/BSC Network Performance Analysis	512
18587A Bar Code Identification System	660
19000	
19500B Rack Kit	681, 682
19511A Cabinet for 2 7936/7937 disk drives	683
19512A Cabinet Mounting Kit	683
19514A Cabinet for 8 7936/7937 disk drives	683
19521FL 2 7937FL drives with cabinet	683
19521H 2 7937H drives with cabinet	683
19521XP 2 7937XP drives with cabinet	683
19522FL 4 7937FL drives with cabinet	683
19522H 4 7937H drives with cabinet	683
19522XP 4 7937XP drives with cabinet	683
19524FL 8 7937FL drives with cabinet	683
19524H 8 7937H drives with cabinet	683
19524XP 8 7937XP drives with cabinet	683
19560B Rack kit for mounting 7962B/63B in EIA Rack	682
20000	
22861B ARPA/Berkeley Services for Series 300, Series 800	730
22862A Administration of NFS and Yellow Pages	730
25650 Signal Analyzer Mainframe	141
30000	
31112A Introduction to Pascal	729
31113A HP Pascal for Advanced and System Programming	729
31124A Introduction to Ada/300 DS	729
33311 SPDT Coaxial Switch (OEM)	338
33312 4-Port Coaxial Switch (OEM)	338
33313 5-Port Coaxial Switch (OEM)	338
33314 SPDT Coaxial Switch (OEM)	338
33320 Series OEM Coaxial Step Attenuators	334
33330B/C/D/E Coaxial Crystal Detectors	340
33330D/E OEM Coaxial Detector	341
33334 Series OEM Coaxial Detectors	341
33340A/B/C/D OEM Coaxial Attenuators	332
33363-69 SP-Multi-throw Coaxial Switch (OEM)	338
33440A LaserJet Series II Printer	691
33447A LaserJet IID Printer	691
33471A LaserJet IIP Printer	691
34110A Carrying Case	93
34111A High Voltage Probe	93
34118A Test Lead Kit	85, 93
34119A High Voltage Probe	85, 93
34300A 40 kV AC/DC High Voltage Probe	93
34301A RF Detector Probe	93
34302A Clamp-on AC/DC Current Probe	93
34303A Temperature Probe	93
34530T MW Switch Terminal Block for HP 3235A	339
34800A Functional Test Manager	731
34806D/E Functional Test Manager	620
35073A HP-UX System Administration for Series 200	730
35129B HP-UX System Administration for Series 500	730
35130B Programming in C Language	729
35401A ¼" Cartridge Autochanger Tape Drive	685
35629A HP 3562A User's Course	729
35630 VISTA signal processing	731
35630B HP VISTA Signal Processing Software	142
35630A + 42B HP Signal Processing System Installation	732
35631B HP SINE	142
35650A Mainframe	141
35651B Signal Analyzer Processing Module	141
35652A Signal Analyzer Input Module	141
35652B Signal Input Module	141
35653A Signal Analyzer Source Module	141
35654A Signal Analyzer Processing Module	141
35655A Signal Analyzer Input Module	141
35656A Programmable DAC	141
35660A Dynamic Signal Analyzer	136
35680A HP Instrument BASIC	137
35681A Analysis Pack	137, 731
35723A Touchscreen Bezel	676
35731D 12-Inch Monochrome Plus Video Display	653
35732A Monochrome Plus Video Adapter	653
35741A 12-inch Color Monitor	653
37011A Telecom System Software	731
37050S FDM Network Monitoring System	506
37050S + 24A HP 37050S User and System Manager Course ...	730
37051S FDM Measurement System	506
37190A HP 37100S Operator and Management Course	730
37191A HP 37100S Operator Training	730
37201A HP-IB Extender	571
37204A Multipoint HP-IB Extender	571
37204B Multipoint HP-IB Extender	571
37212B Error Correcting Modem	679
37900B Signaling Test Set	517
37900C Signaling Test Set	517
40000	
41420A Source/Monitor Unit	538
41421B Source/Monitor Unit	538
41424A Voltage Source/Voltage Monitor Unit	538
41425A Analog Feedback Unit	538
41800A Active Probe	227
41941A/B Impedance Probe Kits	284
41951A Impedance Test Kit	226
41952A/B Transmission/Reflection Test Sets	227
42841A Bias Current Source	293
42842A/B Bias Current Test Fixture	293
42843A Bias Current Cable	293
43855 Cabinet X-Ray Systems	664
44200S/L SimPlate Express Fixture Kit	553
44201S Express Cassette	553
44202S/L SimPlate 3070 Fixture Kit	553
44203S/D/L SimPlate Fixture Kit	553
44458A DAC manager	731
44458A/B/R Data Acquisition Manager	619
44461A HP-IB Interface	575

MODEL NUMBER INDEX

New product listings are printed in bold face type

44462A 8 Channel Multiplexer Assembly.....	575
44463A Extra Connector Block.....	575
44464A Breadboard Assembly.....	575
44465A 8-Bit In, 8-Bit Out Digital I/O Assembly.....	575
44466A Extra Connector Block.....	575
44469A Seven 10:1 Dividers.....	575
44476B Microwave Switch Module for HP 3488A.....	339
44531A HP 3060A/61A/62A User's Course.....	730
44584 + 24A 1/2 day HP 3060 Enhancement Training.....	730
44672A + 60A HP Q-STATS II/HP PR PLUS ASSIST.....	733
44672A + 65Z HP Q-STATS II ASSIST Additional Service Units.....	733
44850A HP 3065 Advanced User's Course.....	730
44851A HP 3065AT User's Course.....	730
44852A HP 3065 Board Test System User's Course.....	730
44853A HP 3065 AT Training.....	730
44990A Express Fixturing System.....	553
45911C Graphics Tablet.....	687
45981A Multimode Video Adapter.....	653
45984A Multimode Color Adapter.....	653
46298 Series Rack Cabinets.....	722
48000 Remote Terminal Unit.....	576
48050 Remote Terminal Unit.....	576
48060 Remote Terminal Unit.....	576
50000	
50011C HP-IB Instrument Programming Using Series 200/300 BASIC.....	729
50015A Data Acquisition and Control Fundamentals.....	729
50698A Programming in FORTRAN 77.....	729
50710A Programming with HP-UX System Calls.....	729
50722A HP-UX System Administration for Application Users.....	730
50740B Microwave Fundamentals Course.....	729
50959A Using SRM from BASIC and Pascal.....	730
50963A SRM Interface.....	561
51409A HP-IB Theory.....	729
51412A HP-IB with MS-DOS®.....	729
51414A Additional Time and Materials Consulting.....	732
51432A HP-UX Fundamentals for General Users.....	729
51433A Shell Programming for General Users.....	729
51434B HP-UX for Programmers.....	729
51435A Advanced HP-UX Tools.....	729
51436B HP-UX System Administration for Series 300.....	730
51438A SCS and make.....	729
51439A Advanced Editing with VI.....	729
51440A Document Preparation.....	729
51473A Architecture for Test, Measurement Software.....	729
51482A HP-UX System Administration for Series 800.....	730
51489A HP-UX Basics for Application Users.....	729
51820A Waveform Generation Software.....	75
52126A Interface.....	250
54001A 1-GHz Miniature Active Probe Pod.....	56
54002A 50Ω BNC Input Pod.....	56
54003A 1-MΩ 10:1 Probe Pod.....	56
54100A 1-GHz Digitizing Oscilloscope.....	56
54100D 1-GHz Logic Triggering Digitizing Oscilloscope.....	56
54110D 1-GHz Color Digitizing Oscilloscope.....	56
54111D 500-MHz Logic Triggering Digitizing Oscilloscope.....	57
54112D 100-MHz, 4-Channel Digitizing Oscilloscope.....	59
54120B Digitizing Oscilloscope Mainframe.....	60-63
54121A Four Channel Test Set.....	60-63
54121T 20 GHz Digitizing Oscilloscope.....	60-63
54122A Four Channel Test Set.....	60-63
54122T 12.4 GHz Digitizing Oscilloscope.....	60-63
54123A Four channel Test Set.....	60-63
54123T 34 GHz Digitizing Oscilloscope.....	60-63
54300A Probe Multiplexer.....	67
54501A - 100 MHz Digitizing Oscilloscope.....	52
54502A - 400 MHz Digitizing Oscilloscope.....	52
54503A - 500 MHz Digitizing Oscilloscope.....	52
55280A Linear Measurement Kit.....	351
55280A + 24A Basic Laser Measurement Training.....	729
55281A Angular Optics Kit.....	351
55282A Flatness Accessory Kit.....	351
55283A Straightness Measurement Kit.....	351
55283A + 24A Advanced Laser Measmnt Sys. Training.....	729
59306A Relay Actuator.....	570
59307A Dual VHF Switch.....	570
59309A HP-IB Digital Clock.....	570
59401A Bus System Analyzer.....	569
59500A Multiprogrammer HP-IB Interface.....	613
59501B HP-IB Power Supply Programmer.....	473, 570
59510A Relay Accessory for Power Supplies.....	470
59511A Relay Accessory for Power Supplies.....	470
59991A-K34 Broadband Linear Phase Comparator.....	493
59992A-J06 Time Interval Calibrator.....	168
59992A-K70 Rack Mount Adapter Kit (HP 5342A, 5343A).....	178
60000	
60501A Electronic Load Module.....	449
60502A Electronic Load Module.....	449
60503A 250W, 240V Load Module.....	451
60504A Electronic Load Module.....	449
64000 Logic Development System.....	628
64000 Series Emulators.....	630
64000-UX Microprocessor Development.....	628
64100A + 24D HP 64000 System Concepts and Measurements.....	730
64120T HP DesignCenter 64000-UX User's Course.....	730
64121T HP-UX for HP 64000-UX User's Course.....	730
64310A Software Performance Analyzer.....	630
64310A + 24D Software Performance Analysis.....	730
64600S + 24D Timing/Hardware Analysis.....	730
64610S Timing/State Analyzer.....	631
64620S + 24D State/Software Analysis.....	730
64700 Series Emulators.....	632
64710S + 42A HP Teamwork Products Installation.....	732
64801S + 42A HP 64000-UX Microprocessor Development Environment Installation.....	732
64810A + 24D Pascal/64000 on 8080/8085.....	730
64812A + 24D HP 64000/Pascal on Z80.....	730
64814A + 24D Pascal on 8086/8088.....	730
64815A + 24F HP 64000/Pascal on 68000.....	730
64817A + 24F HP 64000 System HOST Pascal.....	730
69280A Breadboard Card.....	613
69321B D/A Voltage Converter.....	613
69322A Quad D/A Voltage Converter Card.....	613
69331B Digital Output Card.....	613
69332A Open Collector Output Card.....	613
69335A Stepping Motor Control Card.....	613
69336B High Speed Scanner Card.....	613
69351C Voltage Regulator Card.....	613
69380A Breadboard Output Card.....	613
69422A High Speed A/D Converter Card.....	613
69423A Low Level A/D and Scanner Card.....	613
69430A Isolated Digital Input Card.....	613
69431A Digital Input Card.....	613
69433A Relay Output With Readback Card.....	613
69434A Event Sense Card.....	613
69435A Pulse Counter Card.....	613
69436A Process Interrupt Card.....	613
69480A Breadboard Input Card.....	613
69500A Unloaded Resistance Programming Card.....	613
69501A-69513A Power Supply Control Cards.....	613
69520A Power Supply Programming Card.....	613
69602A Timer/Pacer Card.....	613
69700A-69706A Resistance Output Cards.....	611
69709A Power Supply Control Card.....	611
69720A D/A Voltage Converter Card.....	611
69721A D/A Current Converter Card.....	611
69730A Relay Output Card.....	611
69731B Digital Output Card.....	611
69734A Timebase Card.....	611

69735A Pulse Train Output/Stepping Motor Control Card.....	611	74240A HP EDS/16500A CAE Link.....	640
69736A Timer/Pacer Card.....	611	74240B Simulation Data File Comparator.....	640
69750A Scan Control/Pacer Card.....	611	74300A Introduction to HP EGS.....	730
69751A Analog-to-Digital Converter Card.....	611	74301A PCB Design with HP EGS.....	730
69752A 64 Channel FET Scanner Card.....	611	74302A Customizing HP EGS.....	730
69753A Temperature Scanner Card.....	611	74305A Standard, Modular HP EGS.....	645
69754A 32 Channel Relay Scanner Card.....	611	74306A HP EGS, Add-on Modules.....	645
69755A 16 Channel FET Scanner Card.....	611	74307A Hybrid Circuit Design Module.....	645
69759A 500 kHz A/D Converter Card.....	611	74308A High Performance HP EGS.....	645
69761A Integrating Digital Multimeter Card.....	611	74309A Vectra HP EGS.....	645
69770A Isolated Digital Input Card.....	611	74400A/R HP Printed Circuit Design System.....	644
69771A Digital Input/Analog Comparator Card.....	611	74400A+42A HP PC Design System Installation.....	732
69774A Universal Counter Card.....	611	74400A+65Z HP PCDS-ASSIST Additional Service Unit.....	733
69775A Counter/Totalizer Card.....	611	74492A PCB Design with PCDS.....	730
69776A Interrupt Card.....	611	74610A Analog Workbench.....	640
69790B Memory Card.....	611	74836A + 60A ME-30 ASSIST Base Unit (1st workstation).....	733
69791A/69792A Memory Cards.....	611	74836A + 60B ME-30 ASSIST Two Additional Workstations.....	733
69793A Breadboard Card.....	611	74836A + 60C SRX-ASSIST.....	733
70000		74836A + 65Z ME-30 ASSIST Additional Service Units.....	733
70000 Modular Measurement System.....	562-563	74836T HP DesignCenter ME 30 Users Course.....	730
70001A System Mainframe.....	117	75000 VXIbus System.....	562, 597
70004A Color Display/Mainframe.....	117	75000 System 10 Data Acquisition System.....	588
70100A Power Meter.....	117, 201	80000	
70138A Vector Voltmeter.....	117, 228	81000AS Optical Power Splitter, 600 - 1200 nm.....	309
70205A Monochrome Graphic Display Module.....	117	81000BS Optical Power Splitter, 1200 - 1650 nm.....	309
70206A Monochrome Graphic Display.....	117	81511A Optical Head, 550 - 950 nm.....	305
70300A RF Tracking Generator.....	117	81512A Optical Head, 900 - 1725 nm.....	305
70301A Microwave Tracking Generator.....	117	81520A Optical Head, 450 - 1020 nm.....	306, 309
70310A Precision Frequency Reference.....	117	81521B Optical Head, 900 - 1700 nm.....	306, 309
70320A Synthesized Signal Generator.....	117	81522A Optical Head, 1000-1650 nm.....	306
70322A Synthesized Signal Generator.....	117	82000 IC Evaluation System.....	526, 731
70325A Agile Signal Generator.....	117	82160A HP-IL Interface Module.....	668-669
70591A 1/8-width Module Part Kit.....	117	82161A Digital Cassette Drive.....	669
70592A 2/8-width Module Part Kit.....	117	82164A HP-IL/RS-232C Interface.....	669
70593A 3/8-width Module Part Kit.....	117	82169A HP-IL/HP-IB Interface.....	669
70594A 4/8-width Module Part Kit.....	117	81280A Extended Functions/Memory Module.....	669
70595A Module Development Design Guides.....	117	81281A Extended Memory Module.....	669
70596A Module Communication Design Guides.....	117	82182A Time Module.....	668-669
70600A Preselector.....	117	82183A Extended I/O Module.....	668-669
70601A Preselector.....	117	82240B Infrared Printer.....	668-669
70620A Preamplifier (2 - 22 GHz).....	117	82242A Infrared Printer Interface Module.....	669
70700A Digitizer.....	117	82300C BASIC Language Processor-Release II.....	560
70900B Local Oscillator.....	117	82302A Using HP BASIC for Instrument Control, A Self-Study Course.....	561
70902A IF Section.....	117	82302AA Using HP BASIC for Instrument.....	560
70903A IF Section.....	117	82303A 512K Ram Expansion Kit.....	561
70904A RF Section.....	117	82305A Ram Expansion Board.....	561
70905A RF Section.....	117	82306A GPIO Interface.....	561
70905B RF Section.....	117	82307A GPIO Cable.....	561
70906A RF Section.....	117	82312A HP BASIC - HP Pascal Language Processor Board with Right-To-Execute.....	561
70906B RF Section.....	117	82313A Hierarchical File System.....	561
70907A External Mixer Interface.....	117	82314E PC-308ML HP BASIC Controller.....	561
70908A RF Section.....	117	82315 E PC-308 CL HP BASIC Controller.....	561
71100C Modular Spectrum Analyzer.....	115	82319E PC-308CM HP BASIC Controller.....	561
71200C Microwave Spectrum Analyzer.....	117	82323A Release II Upgrade Kit.....	561
71210C Modular Spectrum Analyzer.....	115	82328A Intelligent Graphics Controller.....	653
71400C Lightwave Signal Analyzer.....	117, 314	82329A EGA Emulation Module.....	653
74001A HP EE DesignCenter System Administration.....	730	82332E PC-312CL HP BASIC Controller.....	561
74150A Programmable Logic Device Design System.....	641	82333E PC-312CM HP BASIC Controller.....	561
74153A Advanced Programmable Logic Device Utilities.....	641	82334E PC-315CN HP BASIC Controller.....	561
74201A HP Design Capture System Overview.....	730	82335A HP-IB Interface & Command Library.....	560
74202A HP Design Verification Interface User's Course.....	730	83400A Lightwave Source Module.....	312
74203A Introduction to HILO Modeling.....	730	83401A Lightwave Source Module.....	312
74210A Design Capture System.....	640	83402A Lightwave Source Module.....	312
74210A + 42A HP Electronic Design System Installation.....	732	83403A Lightwave Source Module.....	312
74230A Design Verification Interface.....	640	83404A Lightwave Source Module.....	312
74230B System HILO Logic Simulator.....	640	83410B Lightwave Receiver Module.....	312
74230C System HILO Simulator Models.....	640	83411A Lightwave Receiver Module.....	312
74230D System HILO Fault Simulator.....	640	83411B Lightwave Receiver Module.....	312
74230S HP Design Verification Sub-System.....	640		
74231A HICHP Hardware Modeling System.....	640		

MODEL NUMBER INDEX

New product listings are printed in bold face type

83412A Lightwave Receiver Module.....	312	85301A Antenna Measurement System	243
83420A Lightwave Test Set.....	313	85310A Distributed Frequency Converter	243
83421A Lightwave Source.....	313	85320A Test Mixer Module	243
83422A Lightwave Modulator.....	313	85320B Reference Mixer Module	243
83423A Lightwave Receiver.....	313	85360A Antenna Measurement Software	243
83522A 0.01-2.4 GHz RF Plug-in.....	400, 404	85380A Weatherproof Enclosure	243
83525A/B 0.01-8.4 GHz RF Plug-ins.....	400, 404	85381A Microwave Cable.....	243
83540A/B 2-8.4 GHz RF Plug-ins.....	400, 404	85381B Microwave Cable.....	243
83545A 5.9-12.4 GHz RF Plug-in.....	400, 404	85381C Microwave Cable.....	243
83550A 8-20 GHz RF Plug-in.....	400, 404	85640A Portable Tracking Generator	130
83554A 26.5-40 GHz Millimeter-Wave Source Module.....	405	85650A Quasi-Peak Adapter.....	126
83555A 33-50 GHz Millimeter-Wave Source Module.....	405	85668A Spectrum Analyzer Operation Course.....	729
83556A 40-60 GHz Millimeter-Wave Source Module.....	405	85685A RF Preselector.....	126
83557A 50-75 GHz Millimeter-Wave Source Module.....	405	85700A 32-Kbyte Blank Memory Card	104
83558A 75-110 GHz Millimeter-Wave Source Module.....	405	85711A CATV Measurement Card	104
83570A 18-26.5 GHz RF Plug-in.....	400, 404	85712A EMI Diagnostic Measurement Card	104
83572A/B 26.5-40 GHz RF Plug-in.....	400, 404	85713A Digital Radio Measurement Card	104
83590A 2-20 GHz RF Plug-in.....	401	85867A EMI Receiver Functions.....	126
83592A/B/C 0.01-20 GHz RF Plug-in.....	401	85869A EMI Measurement Software.....	127
83594A 2-26.5 GHz RF Plug-in.....	401	85870A Open-Site EMI Measurement System Software.....	127
83595A 0.01-26.5 GHz RF Plug-in.....	401	85901A Portable AC Power Source.....	109, 130
83596A 2.4-40 GHz RF Plug-In.....	400, 403	86200 Series RF Plug-ins.....	407
83597A 0.01-40 GHz RF Plug-In.....	400, 403	86222A/B RF Plug-ins.....	407
84811A Peak Power Sensor.....	207	86235A RF Plug-in.....	407
84900 Series Coaxial Step Attenuators	336	86240A/B/C RF Plug-ins.....	407
85014B Active Device Measurements Application Pac.....	240	86241A 3.2-6.5 GHz RF Plug-in.....	407
85015B System Software for HP 8756S and 8757S.....	219	86242D 5.9-9 GHz RF Plug-in.....	407
85016B Transmission Line Test Software.....	219	86245A 5.9-12.4 GHz RF Plug-in.....	407
85020A/B RF Directional Bridges.....	213	86250D 8-12.4 GHz RF Plug-in.....	407
85022A System Cable Kit.....	215	86251A 7.5-18.6 GHz RF Plug-in.....	407
85023A/B/C/D/F System Verification Kit.....	215	86260A 12.4-18 GHz RF Plug-in.....	407
85024A High-frequency Probe.....	131	86260B 10-15.5 GHz RF Plug-in.....	407
85025A/B/D/E AC/DC Detectors.....	213	86260C 17-22 GHz RF Plug-in.....	407
85025C Detector Adapter.....	213	86290B/C RF Plug-ins.....	407
85026A Waveguide Detectors.....	213	86601A 0.01-110 MHz RF Section.....	373
85027A/B/C/D/E Microwave Directional Bridges.....	213	86602B 1-1300 MHz RF Section.....	373
85028A Directivity Verification Kits.....	215	86603A 1-2600 MHz RF Section.....	373
85029B 7mm Verification Kit.....	234	86607A 8660D Upgrade Kit.....	373
85031B APC-7 Calibration Kit for HP 8753C.....	233	86631B Auxiliary Section.....	373
85032B 50 Ω Type-N Calibration Kit.....	234	86632B AM/FM Modulation Section.....	373
85033C 3.5mm Calibration Kit.....	234	86633B AM/FM Modulation Section.....	373
85036B 75 Ω Type-N Calibration Kit.....	234	86634A \emptyset M Modulation Section.....	373
85041A Transistor Test Fixture Kit.....	240	86635A \emptyset M/FM Modulation Section.....	373
85043B Systems Cabinet.....	233	86720A Frequency Extension Unit.....	392
85044A/B Transmission/Reflection Test Sets.....	232	88500A IBM Disk/Tape Interface.....	680
85046A/B S-Parameter Test Sets for HP 8753C.....	232	88703A HP 979A to 7980A Field Upgrade Kit.....	685
85047A 6-GHz S-Parameter Test Set for 8753C	233	88705A HP 7980A to 7980XC Field Upgrade Kit.....	685
85050B/C/D 7mm Calibration Kits.....	241		
85051B 7mm Verification Kit.....	241	90000	
85052B/D 3.5mm Calibration Kits.....	241	91290A 5/4" HP Qualified Media.....	680
85053B 3.5mm Verification Kit.....	241	92192A 3/2" 1-Mbyte Doublesided Microfloppy Disks.....	680
85054B Type N Calibration Kit.....	241	92192X 3/2" 2-Mbyte Doublesided Microfloppy Disks.....	680
85055A Type N Verification Kit.....	241	92208 Series Chairs.....	704
85101B + 24D Advanced Programming for HP 8510 Network Analyzer.....	729	92210 Series Tables, Desks, Accessories.....	706, 707
85104A Series Test Set Modules.....	239	92211 Series Cabinets.....	705
85106B Millimeter-Wave Network Analyzer Subsystem.....	239	92211R Desk-high Cabinet.....	681
85138A/B 2.4 mm 50 Ω Terminations.....	343	92213 Series Work Stations.....	705
85140A/B 2.4mm Short Circuits.....	343	92214 Series Tables.....	705
85141A/B 2.4mm Open Circuits.....	343	92222A 0.5 m SCSI Peripheral Interface Cable.....	681
85150A + 24D Discovering the HP Microwave Design System.....	729	92222B 1 m SCSI Peripheral Interface Cable.....	681
85150A + 42A 85150A Microwave Design System Installation Service.....	732	92222C 2 m SCSI Peripheral Interface Cable.....	681
85150B Microwave Design System (CAE)	642	92222D 1 m SCSI Extender Cable.....	681
85153A GDS-II Translator.....	642	97522FL HP-FL Controller Upgrade.....	683
85160A Measurement Automation Software.....	234	97962B 152 Megabyte Upgrade Kit with Controller.....	682
85161A Measurement Automation Software.....	237	97963B 304 Megabytes Upgrade Kit with Controller.....	682
85162A Measurement Automation Software.....	236	98310A HP EGS Photoplotter/NC Drill Utility.....	645
		98365A+60A ME-5/10 ASSIST Base Unit (1st workstation).....	733
		98365A+60B ME-5/10 ASSIST Two Additional Workstation.....	733
		98365A+60C ME-ASSIST Network.....	733
		98365A+60D ME-ASSIST Add to Network.....	733

98365A+65Z ME-5/10 ASSIST Additional Service Units.....	733
98366A + 42A HP ME- 5, 10, 30 CAD System Installation.....	732
98501B Introduction to Workstation BASIC.....	729
98510D Series 200/300 BASIC Operating and Advanced Programming Course.....	729
98511C Series 200/300 Pascal Operating and Advanced Programming Course.....	729
98563E HP 9000 Model 340M.....	652
98563G HP 9000 Model 340MH.....	652
98564C HP 9000 Model 340C+.....	652
98564G HP 9000 Model 340CH.....	652
98564G Opt. 556 HP 9000 Model 340CHX.....	652
98573C HP 9000 Model 340SRX.....	652
98580C HP 9000 Model 332 MMA.....	557
98580CX HP 9000 Model 332MMAX	557
98580W HP 9000 Model 360MMA.....	557
98580WX HP 9000 Model 360MMAX	557
98581C HP 9000 Model 332CMA.....	557
98581CX HP 9000 Model 332CMAX	557
98581W HP 9000 Model 360CMA.....	557
98581WX HP 9000 Model 360CMAX	557
98583G HP 9000 Model 370C+.....	652
98583W HP 9000 Model 360C+.....	652
98587G HP 9000 Model 370SRX.....	652
98587H HP 9000 Model 370 TurboSRX.....	652
98587T HP 9000 Model 360 TurboSRX.....	652
98587W HP 9000 Model 360SRX.....	652
98588G HP 9000 Model 370CH.....	652
98588G Opt. 556 HP 9000 Model 370CHX.....	652
98588W HP 9000 Model 360CH.....	652
98588W Opt. 556 HP 9000 Model 360CHX.....	652
98589G HP 9000 Model 370MH.....	652
98595A + 42A HP-UX Application Execution Environmental Installation.....	732
98597B + 42A HP-UX Programming Environment Installation.....	732
98751A 19-Inch Color Monitor (1024 x 768).....	653
98785A 16-Inch Color Monitor (1024 x 768).....	653
98796A + 42A HP-UX BASIC Installation.....	732
98880A HP BASIC/UX Programming and Operating.....	729
00014-90021 Business Student.....	669
00017-90019 Real Estate, Banking, and Leasing.....	669
00017-90020 Business Finance and Accounting.....	669
00017-90021 Marketing and Sales.....	669
00017-90022 Personal Investment and Tax Planning.....	669
00027-90044 Technical Applications.....	669
00028-90101 Algebra and College Math (HP 28C/S).....	669
00028-90102 Calculus (HP 28C/S).....	669
00028-90104 Probability and Statistics (HP 28C/S).....	669
00028-90105 Vectors and Matrices (HP 28C/S).....	669
00028-90111 Mathematical Applications (HP 28S).....	669
00032-90057 Engineering Applications.....	669
00041-15001 Standard Applications.....	669
00041-15004 Financial Decisions.....	669
00041-15005 Surveying.....	669
00041-15006 Circuit Analysis.....	669
00041-15016 Real Estate.....	669
00041-15019 Thermal & Transport Science.....	669
00041-15020 Machine Design.....	669
00041-15021 Structural Analysis-Civil Engineering.....	669
00041-15022 Games.....	669
00041-15027 Stress Analysis-Mechanical Engineering.....	669
00041-15039 Petroleum Fluids.....	669
00041-15049 Math/Statistics.....	669
00041-15055 HP 41 Advantage.....	669
00041-90082 Test Statistics.....	669
00041-90083 High-Level Math.....	669
00041-90084 Geometry.....	669
00041-90086 Lending, Savings, & Leasing.....	669
00041-90088 Electrical Engineering.....	669
00041-90089 Civil Engineering.....	669
00041-90090 Mechanical Engineering.....	669
00041-90092 Control Systems.....	669
00041-90093 Antennas.....	669
00041-90094 Business Statistics/Marketing/Sales.....	669
00041-90096 Home Construction Estimating.....	669
00041-90099 Games I.....	669
00041-90100 Chemical Engineering.....	669
00041-90102 Chemistry.....	669
00041-90136 Real Estate.....	669
00041-90137 Small Business.....	669
00041-90138 Solar Engineering.....	669
00041-90139 Fluid Dynamics & Hydraulics.....	669
00041-90140 Heating, Ventilating & Air Conditioning.....	669
00041-90141 Surveying.....	669
00041-90142 Physics.....	669
00041-90395 Time Module Solutions I.....	669
00041-90441 Structural Design (cassette-based).....	669
00041-90443 Games II.....	669
00042-90020 Programming Examples and Techniques.....	669
00042-90021 Electrical Engineering.....	669
00042-90022 Mechanical Engineering.....	669
05096A SA/SD for Test, Measurement Software.....	729
0960-0054 SMA-Female Short (50 Ohm).....	343
0960-0055 SMA-Male Short (50 Ohm).....	343
1250-1530 N(m) Short (75 Ohm).....	343
1250-1531 N(f) Short (75 Ohm).....	343
1250-XXXX Series Adapters and Connectors.....	708
1251-2277 Dual Banana Plug to BNC Female.....	708
1251-2816 Dual Banana Plug (for Cable).....	708
1252-2297 SCSI Terminator.....	681
1460-XXXX Series Cabinet Parts.....	719
1490-XXXX Series Slide Kits, Casters.....	720
1494-XXXX Series Slide Kits.....	718
5040-XXXX Series Rack Frames.....	720
5060-XXXX Control Panel Covers.....	720
5060-XXXX Filler Panels.....	720
5060-XXXX Rack Adapter Frames.....	720
5060-XXXX Rack Mounting Kits.....	720
5060-XXXX Series Racking Accessories, Covers.....	720
5062-XXXX Series System II Cabinet Parts.....	720
8120-XXXX Cables and Adapters.....	708
9211-XXXX Series Operating Cases.....	714
9211-XXXX Series Transit Cases.....	710
11000-60001 Dual Banana-Dual Banana Cable.....	708
11000-60001 Dual Banana-BNC Cable.....	708
11652-60001 BNC (m) 50-ohm Termination.....	343

GENERAL INDEX

General-Purpose Electronic Measurement

Amplifiers	408
Automatic Test Systems	622
Board Test Systems	548
Component Measurement	282
Computer-Aided Test	590
Data Analyzers/Generators	320
Digital Circuit Testers	276
Digital IC Tester	320, 524
Electronic Counters	158
Electronic Loads	448
Frequency & Time Standards	488
Frequency & Time Interval Analyzers	162
Frequency Synthesizers	354, 412
Function Generators	378, 412
HP-IB	564
Impedance Analyzers	282
LCR Meters	282
Lightwave Test	304
Logic Analyzers	244
Modulation Domain Analyzers	162
Multimeters	78
Network Analyzers	208
Oscilloscopes	48
Plotters	76, 694
Power Supplies	452
Pulse Generators	432
Recorders, Printers	76, 688
Semiconductor Testers	320, 524
Signal Analyzers	96
Signal Sources	316, 354, 394, 412, 432
Support	724
VXI Instruments on a Card	597
Waveform Analyzers	68
Waveform Synthesizers	412

CAT/HP-IB

Automatic Test Systems	622
Board Test Systems	548
Computer-Aided Test	590
Computer Peripherals	678
Controllers	554
Data Acquisition Systems	572
Digital IC & Circuit Testers	276, 320, 524
Electronic Counters	158
Electronic Loads	448
HP-IB Cables	569
HP-IB Extenders	571
HP-IB Overview	564
Lightwave Test	304
Multimeters	78
Multiprogrammers	605
Network Analyzers	208
Noise Figure Meter	326
Oscilloscopes	48
Plotters & Recorders	76, 694
Power Meters	200
Power Supplies	452
Semiconductor Testers	320, 524
Signal Analyzers	96
Signal Sources	316, 354, 394, 412, 432
Support	724
Switches, Switch Driver	337, 591
Telecommunications Test	496
Transceiver Test	322
Waveform Analyzers	68

Telecommunications & Data Communications

Amplifiers	408
Communications Board Test System	548
Data Generators	316
Data & Voice Testing	518
Data Communications Test	510
Digital Communications Measurements	496
Digital Radio Testing	503
Frequency Synthesizers	354, 412
Lightwave Test	304
Microwave Counters	162, 171
Microwave Radio Testing	496
Microwave Accessories	330
Network Analyzers	208
Noise Figure Meter	326
Operational Support Systems	506
Optical TDR	310
PCM Testing	496
Plotters	76, 694
Power Meters	200
Protocol Analyzers	510
Pulse Generators	432
Radio & FDM Carrier Testing	322, 503, 506
Signal Analyzers	96
Signal Sources	316, 354, 394, 412, 432
Support	724
Telecommunications Test	496
Transceiver Test	322

RF & Microwave Measurement

Amplifiers	408
Automatic Test Systems	622
Coaxial Test Equipment	332
Digital Radio Testing	503
Electronic Counters	158
Frequency Synthesizers	354, 394, 412
Microwave Counters	162, 171
Microwave Design System (CAE)	642
Microwave Link Analyzers	506
Microwave Semiconductors	659
Microwave Accessories	330
Millimeter-Wave Equipment	129, 183, 239, 341, 405
Modulation Domain Analyzers	162
Network Analyzers	208
Noise Figure Meter	326
Oscilloscopes	48
Plotters	76, 694
Power Meters	200
RF Impedance Analyzer	288
Signal Analyzers	96
Signal Generators	354
Support	724
Sweep Oscillators	394
Time Domain Reflectometry	66
Transceiver Test Equipment	322
Waveform Analyzers	68
Waveguide Test Equipment	330



Data Acquisition & Control

Automatic Test Systems	622
Board Test Systems	548
Component Testers	282
Computers	554, 650, 670, 674
Computer-Aided Test	590
Data Acquisition Systems	572
Digital Circuit Testers	276
Digital IC Tester	320, 524
Disc Drives	680
Electronic Counters	158
Fourier Analyzers	132
HP-IB	564
HP-IB Extenders	571
Multimeters	78
Multiprogrammers	605
Recorders, Plotters, & Printers	76, 688, 694
Signal Analyzers	96
Semiconductor Testers	320, 524
Support	724
Switches	591
Waveform Analyzers	68

Computers, Peripherals & Calculators

BASIC Controllers	554
Business Computers	670, 674
Calculators	666
Computers	554, 650, 670, 674
Data Acquisition Systems	572
Digitizing Tablet	686
Drafting Plotters	698
Electrostatic Plotter	702
Engineering Workstations	616, 650
Furniture	704
HP-IB	564
HP-IB Extenders	571
IBM PC Compatible Computers	674
Mass Storage	680
Modems	679
Multiprogrammers	605
Networking	654
Network Testing	510
Peripherals	76, 678
Personal Computers	674
Portable Computers	674
Precision Architecture Computers	650, 670
Printers	688
Supplies & Accessories	693, 734
Support	724
Technical Computers	634, 650
Terminals	674
Terminals, Rugged	678

CAE/CAD

Digital IC Prototype Verification	320, 526
Digital Oscilloscopes	48
Drafting Plotters	698
Electronic Design System (CAE)	634
Electrostatic Plotter	702
Engineering Graphics System	645
Fourier Analyzers	132
Logic Analyzers	244
ME/CAD Systems	646
Microprocessor Development Systems	628
Microwave Design System (CAE)	642
Overview	624
Personal Computers	674
Plotters	76, 694
Printed Circuit Design System	643
Printers	688
Programmable Logic Device Design System	641
Signal Analyzers	96
Support	724
Third-Party Software	627
Workstations	624, 650

Logic & Processor-Based Circuit Analysis

Board Test Systems	548
Data Generators/Analyzers	320
Digital Circuit Testers	276
Digital IC Tester	320, 524
IC Troubleshooters	276
Logic Analyzers	244
Microprocessor Development Systems	628
Plotters	76, 694
Signature Analyzers	276
Support	724

Other Products

Adapters	708
Analytical Instruments for Chemistry	660
Cabinet Accessories	716
Cabinets	722
Cables	569, 708
Dimensional Measurement	348
Frequency & Time Standards	488
Laser Interferometers	348
Medical Instrumentation	662
Microwave Semiconductors	659
Operating Cases	714
Optoelectronics Devices	658
Pressure & Temperature	352
Support	724
Transit Cases	710
X-Ray Systems	664

OSCILLOSCOPES & WAVEFORM ANALYZERS

HP Digitizing Oscilloscopes

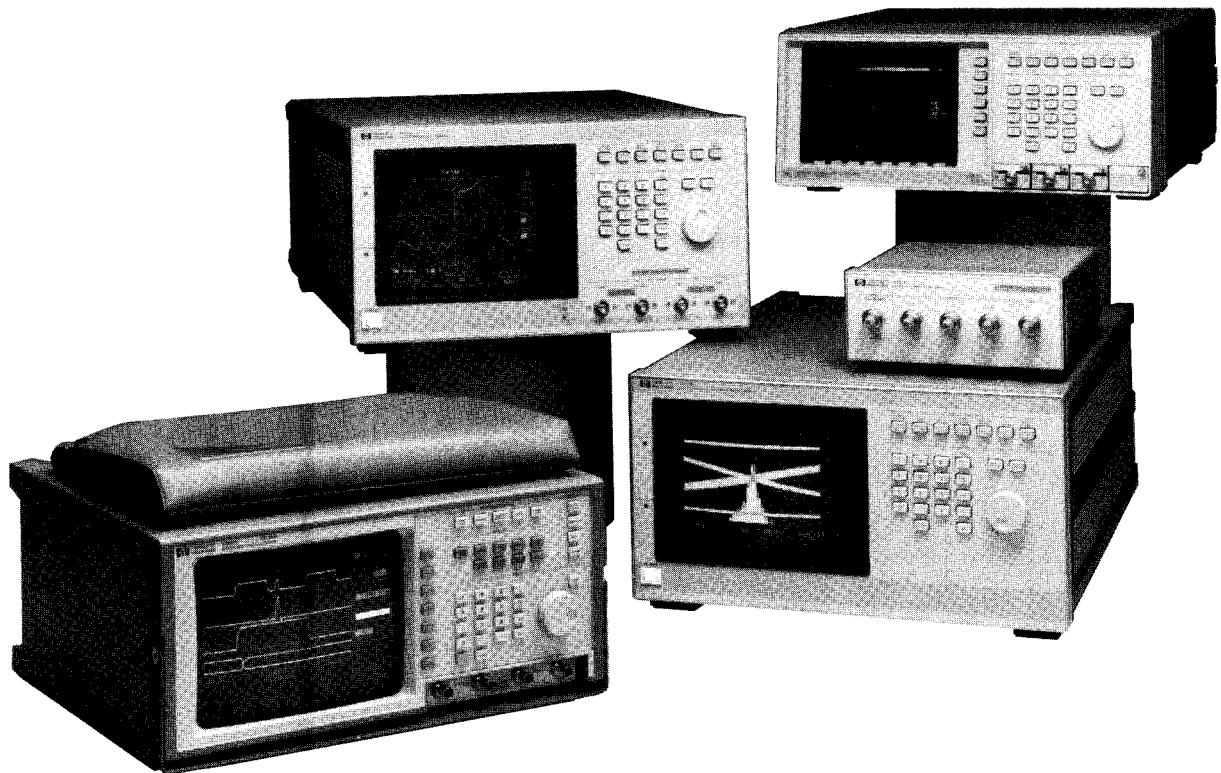

The HP 54100 and HP 54500 Series Digitizing Oscilloscopes . . . combining high bandwidth with high digitizing rates makes these general-purpose oscilloscopes useful for both analog and digital measurements.

Choose the Right Scope for Your Application

Selecting a digitizing oscilloscope is similar to selecting a conventional one; it involves asking whether the instrument can capture the waveform of interest, and, after storage, whether the data can be recalled and analyzed in the desired way.

Selection Criteria

Digitizing rate: for single-shot transient capture, digitizing rate is the key criteria for determining whether the oscilloscope can capture a one-time event. It is suggested that your scope have a digitizing rate of at least two and a half to four times the bandwidth of the waveform you wish to capture for single-shot measurements. For repetitive waveforms, some scopes use repetitive sampling, for which digitizing rate is a less important criterion than bandwidth and vertical resolution.

Bandwidth: bandwidth is another fundamental selection criterion. It affects the accuracy of amplitude and timing measurements. The bandwidth of an oscilloscope should exceed that of the signal; how much it exceeds it depends on the measurement accuracy needed. In general, the instrument's bandwidth should be three times the highest frequency component of the signal.

For pulse applications, the rise time is related to the maximum frequency content by:

$$\text{frequency} = 0.35/\text{rise time}$$

This guideline suggests that you should choose an oscilloscope with a rise time less than one-third the rise time of your signals.

Resolution: voltage resolution and timing resolution are also important criteria when choosing an oscilloscope. Your particular application helps determine how much resolution you need. For single-shot acquisition, there is an inherent trade-off between timing resolution and vertical resolution. Obtaining higher vertical resolution means sacrificing digitizing rate.

The timing resolution of the scope is more important to the digital designer who measures propagation delay and setup and hold times.

If, however, the signal being measured is a complex, modulated-analog signal where frequency-domain analysis is desired in addition to time-domain analysis, then increased voltage resolution results in greater signal-to-noise measurement capability. A guideline is 6 dB signal-to-noise measurement capability per bit of resolution (ten bits gives you 60 dB). Bits of resolution are related to percentage resolution by:

$$\% = 100/2^n$$

where n is the number of bits.

Memory: the fourth selection criterion is the memory length of the oscilloscope. Memory length simply describes how long an event (i.e., how many samples can be captured, although there are a variety of techniques to capture long waveforms or non-continuous events using burst timebase or adaptive sample rate.

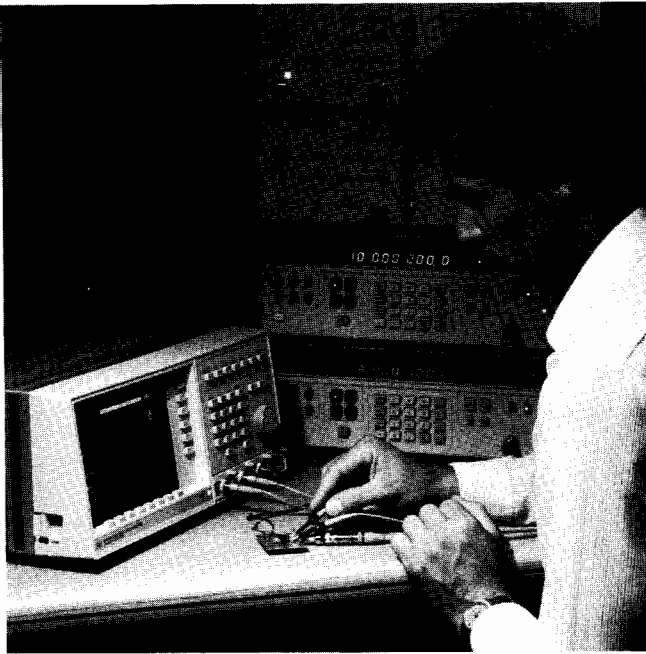

Digital Storage

- Bright, stable display of low duty-cycle signals.
- Retain waveforms as long as desired for worst-case analysis.
- Fade-free, non-blooming display.
- Store as many waveforms as needed for comparison or reference.
- Make measurements after signal is acquired. This is especially useful on single-shot signals or infrequent error conditions.
- Waveform data available over the HP-IB.
- Signal averaging for noise rejection and increased resolution.

Automatic Measurements

- Automatic edge finders save time, eliminate uncertainty, and reduce operator error in time-interval measurements.
- Measure pulse parameters automatically, without a controller.
- Markers indicate where the measurement was made, providing confidence in measurement results.

Pre-trigger Display

- Find causes of events.
- Displayed time can be any time before or after the trigger, and is not limited to one screen width before the trigger. Time intervals can be measured with a resolution of parts per million, before and after the trigger.

Store Waveforms for Comparison and Reference

- Pixel memories for overlaying multiple waveforms.
- Waveform memories for measurements and comparison of stored signals.

Easy-to-Use

- Pressing the Autoscale button automatically sets up the time base, sensitivity, offset, and trigger for a stable display over a wide range of input signals.
- Save up to ten front panel setups in non-volatile memory; simplify a sequence of repeated measurements quickly.
- Instant hardcopy with either a pen plotter or a graphics printer eliminates time-consuming, expensive photography.
- ECL and TTL presets scale the vertical gain, offset, and trigger levels for the selected logic family. This saves time in setting up for a measurement.

Triggering on Complex Digital Waveforms

- Logic pattern triggering allows you to trigger on the complex events found in typical digital systems.
- Trigger holdoff can be specified by events or by time for stable triggering on long, complex sequences of events.
- Independent trigger threshold adjustments for each channel. No need to reset the trigger level each time you switch from one trigger source to another.

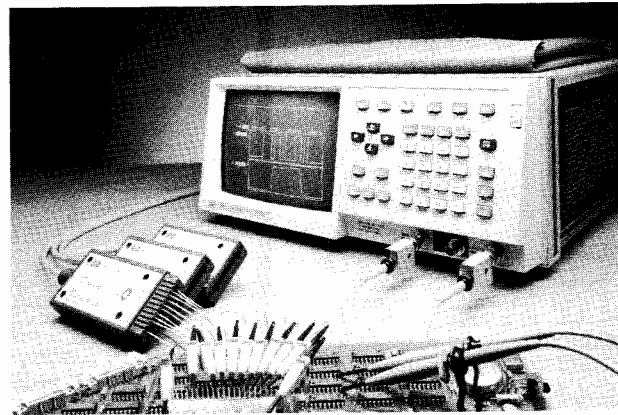

Simplified Programming

- Simple, logical, structured programming mnemonics make programs easy to edit, easy to understand, and easy to modify for new applications.
- Measurement-oriented, English-like mnemonics.

Document Results

Active as well as stored waveforms, setup conditions, and measurement results can be printed or plotted for instant, low-cost documentation. HP printers provide report-quality hardcopy for articles or printed reports at minimal cost, and without the delay of photographic reproduction.

Color as a Measurement Tool

The addition of color to an oscilloscope can make productivity improvements in applications performed manually as well as those involving automated measurements. Color can be combined with intensity, line types, and modulation to create easier, faster measurements with fewer errors than with a monochrome oscilloscope.

The HP 54110/111D/112D/120T can display a high-resolution, flicker-free color representation of rapidly changing data. With the nine-inch raster display, the user can work with as many as nine colors at one time, selecting these nine from a total of 4096 available. For convenience, a default nine-color palette was designed to provide optimum viewing for users in standard laboratory environments.

Adding color to an instrument such as an oscilloscope aids the user in four ways:

- it helps in differentiating between overlapping, superimposed, or similar waveforms;
- it helps in associating displayed information with corresponding data or waveforms;
- it can be used to emphasize displayed information; and
- the user can choose colors and their use to compensate for color blindness, ambient conditions, or special test requirements.

OSCILLOSCOPES & WAVEFORM ANALYZERS

HP Digitizing Oscilloscopes (cont'd)

Model	HP 54100A/D & HP 54110D	HP 54111D	HP 54112D	HP 54121T	HP 54122T	HP 54123T
Bandwidth -Repetitive -Single-shot	1 GHz 4 MHz**	500 MHz 500 MHz	100 MHz 100 MHz	20/12.4 GHz N/A	12.4/10.0 GHz N/A	34/18 GHz N/A
Time Interval Accuracy	100 ps 300 ps	100 ps 300 ps	300 ps 300 ps	10 ps N/A	10 ps N/A	10 ps N/A
Channels	2	2	4	4	4	4
Digitizing Rate	40 Msa/s	1 Gsa/s	400Msa/s	N/A	N/A	N/A
Memory/Channel	1 ksa	8 ksa	64 ksa	501	501	501
Vertical Resolution	7 bits, 10 with avg	8 bits to 25 MHz 7 bits to 100MHz 6 bits to 500 MHz	6 bits	12 bits, 14 with avg	12 bits, 14 with avg	12 bits, 14 with avg
Input Voltage Ranges	7 ranges 80mV-8V full scale	Cont. Var 8mV-40V full scale	Cont. Var 40mV-40V full scale	Cont. Var. 1mV-80mV per division	Cont. Var. 1mV-2.4V per division	Cont. Var. 1mV-80mV per division
Input Coupling	50,10K 1M pods	50,1M ac,dc internal	50,1M ac,dc internal	50	50	50
Effective Bits	—	5.5-7.2	5.0-5.5	N/A	N/A	N/A
Pulse Parameter Measurements	yes	yes	yes	yes	yes	yes
Waveform Math	A+B, A-B AvsB, Invert	A+B, A-B Invert	A+B, A-B Invert	A+B, A-B AvsB, Min, Max Invert, Only	A+B, A-B AvsB, Min, Max Invert, Only	A+B, A-B AvsB, Min, Max Invert, Only
Other Analysis Functions	Infinite Persistence, Averaging Magnify	Infinite Persistence, Averaging	Infinite Persistence, Averaging	Infinite Persistence, Averaging	Infinite Persistence, Averaging	Infinite Persistence, Averaging
Waveform Storage	2 Pixel, 4 Waveforms	2 Pixel 4 Repet. Wft 4 SS Wft	2 Pixel 4 Repet Wft 4 SS Wft	2 Pixel 4 Waveforms	2 Pixel 4 Waveforms	2 Pixel 4 Waveforms
Trigger Enhancements	* Edge, Pattern State, Digital Delay by Event and Time, Time Qualified Pattern	Edge, Pattern State, Digital Delay by Event and Time, Time Qualified Pattern	Edge, Pattern State, Digital Delay by Event and Time Time Qualified	2.5 GHz Edge Trigger to 18 GHz with HP 54118A	2.5 GHz Edge Trigger to 18 GHz with HP 54118A	2.5 GHz Edge Trigger to 18 GHz with HP 54118A
Timebase Enhancements				N/A	N/A	N/A
Instant Hardcopy & Disk Support		HP Printers HP Plotters		HP graphic printers, plotters including PaintJet	HP graphic printers, plotters including PaintJet	HP graphic printer, plotters including PaintJet
Other	Color Display & Color Hardcopy	Color Display & Color Hardcopy	Color Display & Color Hardcopy	Built-in Histograms TDR/TDT	Built-in Histograms TDR/TDT	Built-in Histograms TDR/TDT
Page Reference	56	57	57	60	60	60
Price	\$13,900 \$18,500 \$22,900	\$26,900	\$22,900	\$28,800	\$28,800	\$34,800

*D Models only

**10 pts per period without reconstruction

Compare the Features . . .

Whether you need pinpoint vertical resolution or lightning-fast signal capture, Hewlett-Packard's digitizing oscilloscopes provide a powerful set of features and capabilities in an easy-to-use interface.

Here's a look at how the various models compare in terms of features, capabilities, and price.

Model	HP 54201A/D	HP 54501A	HP 54502A	HP 54503A	HP 16500A Mainframe with 16530A/16531A	HP 70700A
Bandwidth -Repetitive -Single-shot	300 MHz 50 MHz	100 MHz 1 MHz**	400 MHz 100 MHz	500 MHz 2 MHz	100 MHz 100 MHz	10 MHz 10 MHz
Time (rep) Interval (s-s) Accuracy	200 ps 2 ns	1 ns 100 ns	270 ps 520 ps	104 ps 50 ns	1 ns 1 ns	50 ns 50 ns
Channels	2	4 (2+2)	2	4	2 - 8	1-8
Digitizing Rate	200Msa/s	10 Msa/s	400 Msa/s	20 Msa/s	400 Msa/s	20 Msa/s
Memory/Channel	1 ksa	500 sa (display) 1 ksa (HP-IB)	501 sa (normal) 2001 sa (extended)	501 sa (display) 1 ksa (HP-IB)	4 ksa	256 ksa
Vertical Resolution	6 bits, 8 with avg	8 bits, 10 bits with averaging	6 bits, 8 with avg	8 bits, 10 with avg	6 bits, 8 bits with averaging	10 bits
Input Voltage Ranges	Continuously variable 40mV-16V full scale	Continuously variable 40mV-40V full scale	Continuously Variable 16 mV-40V full scale	Continuously Variable 8 mV-40V full scale	continuously variable 40 mV-16V full scale	4 ranges 600 mV-20V full scale
Input Coupling	1M, 50, ac,dc internal	1M, 50 ac, dc internal	1M, 50 ac, dc internal	1M, 50 ac, dc internal	1M, 50 ac, dc Internal	1M, 50 ac,dc internal
Effective Bits	—	—	—	—	—	7.0 eff bits
Pulse Parameter Measurements	yes	yes	yes	yes	yes	yes
Waveform Math	A+B, A-B,	A+B, A-B, A×B, AvsB, Invert, magnify	A+B, A-B A×B, AvsB Invert, Magnify	A+B, A-B A×B, AvsB Invert, Magnify	A+B, A-B	A+B, A-B, A*B A vs B, Invert
Other Analysis Functions	Accumulate, Envelope, Averaging	Infinite Persistence, Averaging, Envelope	Infinite Persistence, Averaging, Envelope	Infinite Persistence Averaging Envelope	Infinite Persistence, Averaging	Averaging, Magnify, FFT Random Event Capture 4 Waveforms
Waveform Storage	4 Waveforms	2 Pixel, 4 Waveforms,	2 Pixel, 4 Waveforms	2 Pixel, 4 Waveforms	store to built-in disk	
Trigger Enhancements	* 27Bit state Trigger, Missing/Extra bit, Digital Delay	Edge, Pattern, State, Digital Delay by Event and Time, Time-Qualified Pattern	Edge, Pattern State, Digital Delay by Events and Time, Time-qualified Pattern	Edge, Pattern State, Digital Delay by Events and Time, Time-qualified Pattern	Edge, Pattern, Delay by Event, Immediate	Interpolated digital trigger, Edge, Level, Range
Timebase Enhancements		Dual Timebase Windowing	Dual Timebase Windowing	Dual Timebase Windowing	Dual timebase	
Instant Hardcopy & Disc Support	HP Printers HP Plotters	HP Graphic Printers	HP Graphic Printers, Plotters	HP Graphic Printers, Plotters	HP printers HP Paintjet® printer 2 built-in disk drives	HP Plotters HP Printers
Other	—	Measurement Statistics, Measurement Limit Test,	Measurement Statistics, Measurement Limit Test	Measurement Statistics, Measurement Limit Test	logic analysis, high speed timing, pattern generation	Modular
Page Reference	48	53	54	52	256	115
Price	\$8,450/10,450	\$3,465 (List)	\$6,450	\$4,950	\$13,050 to \$25,350	\$7,800/Channel plus Mainframe

OSCILLOSCOPES & WAVEFORM ANALYZERS

Digitizing Oscilloscopes

HP 54501A, 54502A, 54503A

- Choice of 100 MHz, 400 MHz, 500 MHz bandwidth
- Single-shot and repetitive signal performance
- Up to 4 channels
- Fully programmable
- 16 automatic pulse parameter measurements
- Dual-time-base windowing
- Automatic limit testing
- Three-year warranty
- Affordable

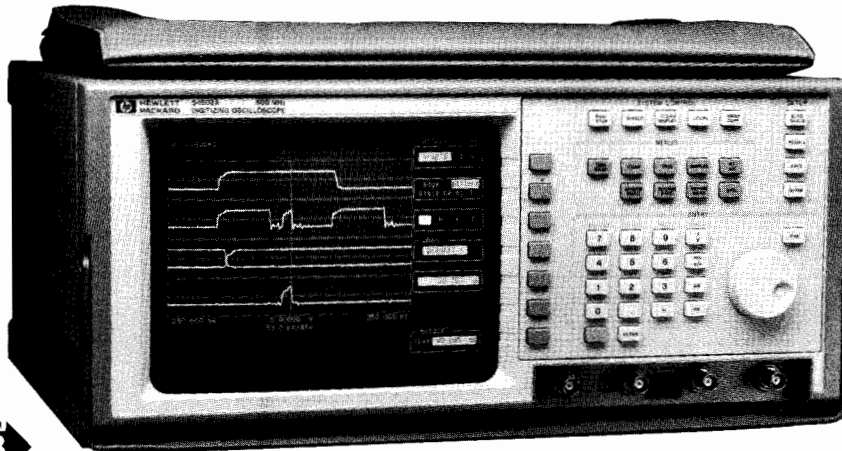

DESIGNED FOR
HP-IB
SYSTEMS
HP 54503A

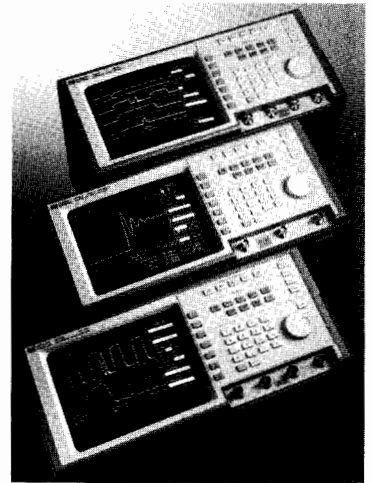

HP 54501A, 54502A, 54503A

The HP 54500 Family of Digitizing Oscilloscopes

A Family of Affordable Digitizing Oscilloscopes

Last year's introduction of the HP 54501A 100 MHz oscilloscope is joined this year by two new family members: the HP 54502A, a 400 MHz repetitive signal/100 MHz single-shot bandwidth model, and the HP 54503A, a 500 MHz 4-channel model. The addition of 400 MSa/s digitizing in the 54502A brings true single-shot capability to the family at a price significantly below that previously available. The 500 MHz/4-channel HP 54503A increases the family's bandwidth performance for repetitive signal measurements at a price competing favorably with both digital and even analog oscilloscopes having many fewer features.

Get the Digitizing Advantage

The HP 54500 family of oscilloscopes has features and functions that were previously available only on considerably higher priced instruments. Like the HP 54100 and 54200 series digitizing oscilloscopes, these instruments include all of the digitizing advantages, such as autoscale, pushbutton hard-copy output, 16 automatic measurements, non-volatile setup and waveform memories, and full HP-IB programmability.

Affordable Automation

The HP 54500 family's fully-programmable setup and data acquisition capabilities can be used with your HP Vectra PC, IBM PC, or other compatible personal computer. The built-in HP-IB interface, simplified, self-documenting programming language, and high data throughput rate provide a modestly-priced, yet powerful automated test system.

Easy-to-Use

All three members of the HP 54500 family have a new simplified user interface that makes them the easiest to operate of any HP oscilloscopes. Adjustments are made with a single, front-panel knob or numeric keypad. Automatic measurements, hard-copy output, or instrument setup are performed with a single keystroke. Operation is intuitive and straightforward.

Advanced Logic and TV Triggering

Hewlett-Packard's advanced logic triggering is a standard feature in the HP 54500 family. Use it to trigger on a wide variety of user-specified conditions. Trigger on edge, pattern, state, or trigger-after-delay to capture such elusive events as timing violations or transient bus phenomena.

Select line and field for a variety of video waveforms. The 54500 family makes it easy to focus on the video information that you need to capture.

Measurement Limit Test

Using measurement limit test, the HP 54500 family can automatically characterize a circuit or device over temperature or time—without human supervision. Specify upper and lower limits for any three of the instrument's automatic measurements, and leave it running unattended. If a measurement exceeds the predefined limits, the violating waveform, measurements and other display data can be automatically stored or transferred to an external printer or controller.

These instruments can automatically calculate maximum, minimum, average, and most-recent values for all measurements, making device or circuit characterization even more accurate.

Dual-time-base Windowing

Dual-time-base windowing lets you zoom in on fine details of the waveform that you are measuring. Similar to the dual-delayed sweep feature found on some analog oscilloscopes, dual-time-base windowing gives you a time-expanded view of a smaller portion of the waveform that is defined by you with the instrument's easy-to-use cursors.

Lightweight and Portable

Members of the HP 54500 family weigh only 22 pounds and are easily transported. Their small size allows them to fit easily in the trunk of a car, making them ideal for field applications. An optional soft carrying case is also available, as well as a sturdy transit case for safe shipment.

HP 54501A 100 MHz, 4 Channel Digitizing Oscilloscope

The HP 54501A is a 100 MHz, 4 channel digitizing oscilloscope designed primarily for repetitive signal applications. It has all of the digitizing advantages of oscilloscopes much higher in price. Ease of use and general purpose features such as TV trigger, Dual-time-base windowing, advanced logic triggering, automatic measurements and full HP-IB programmability make it a powerful tool for both manual and automated test applications.

HP 54501A Specifications and Characteristics

Vertical (Voltage)

Bandwidth

dc-coupled:

Repetitive dc to 100 MHz (-3dB)

Single Shot dc to 1 MHz

(Based on 10 points per period of input signal.)

ac-coupled:

Repetitive 10 Hz to 100MHz (-3dB)

Single Shot 10 Hz to 1 MHz (Based on 10 points per period of input signal.)

Risetime: 3.5 ns

(calculated from:

$$\text{Risetime} = \frac{0.35}{\text{bandwidth}}$$

Number Of Channels 4 (2+2)

(Channels 2 and 3 are limited attenuator inputs, optimized for digital signals.)

Simultaneous Channels 2+2

Channels 1 and 4 are acquired simultaneously. If four channels are used, data is acquired alternately by channels 1 and 4, then 2 and 3.

Vertical Sensitivity Maximum 5 mV/div
Minimum 5 V/div

Vertical Gain

Accuracy (dc) $\pm 1.5\%$

Vertical Resolution $\pm 0.4\%$ — 8 bit A/D

(Since expansion is used for 5 mV/div range, A/D resolution is 7 bits 0.8% in that range.)
 $\pm 0.1\%$ — 10 bits via HP-IB (with averaging)

Maximum Sample Rate 10 Megasamples/second

Memory Depth 501 points (display)

1024 points (via HP-IB)

For single-shot via HP-IB, maximum memory depth is 501 points.

For 2ns/div time base range, memory depth is 200 points.

For 5ns/div time base range, maximum memory depth via HP-IB is 501 points.

Input RC (nominal) 1 M Ω , 16 pF

Input Coupling ac, dc

Max Input Voltage ± 250 V DC + peak AC (<10KHz)

Offset Range Sensitivity range Available offset

5 - 50 mV/div ± 2 V

0.1 - 1 V/div ± 20 V

1 - 5 V/div ± 200 V

Offset Accuracy $\pm 2\%$ of offset ± 0.2 X (V/div)

± 0.075 division/ Δ° C from calibration temperature

Dynamic Range ± 16 divisions from center

Operating range for dc + peak AC input.

Channel-to-channel 40 dB dc to 20 MHz

Isolation 30 dB 20 MHz to 100 MHz

(with channels at equal sensitivity)

Voltage Measurement Accuracy

Single Cursor: Gain Accuracy + offset accuracy + A/D resolution

Dual Cursor: Gain Accuracy + (2 x A/D resolution)
(single channel)

Horizontal (Time)

Time Base Range Minimum 2 ns/div
Maximum 5 s/div

Time Base Accuracy .005%

Maximum Time Base

Resolution 100 ps

Delta t Accuracy $1 \text{ ns} \pm (5E-5) \times \text{delta } t \pm .02 \times (t/\text{div})$

Delta-t accuracy for dual-cursor, single-channel measurement, or for channel-to-channel measurement after visual time null calibration has been performed.

Delay Range (post-trigger)	Time Base Setting	Available Delay
	50 ms - 5 s	40 x (s/div)
	100 μ s - 20 ms	1 s
	2 ns - 50 μ s	10,000 x (s/div)

Delay Range (pre-trigger)

	10 μ s - 5 s	-40 x (s/div)
	20 ns - 5 μ s	-200 μ s
	2 ns - 10 ns	-10,000 x (s/div)

Triggering

Trigger Sensitivity

5mV/div dc-20MHz, 0.1 x full-scale

20MHz-100MHz, 0.25 x full-scale

All Other dc-20MHz, 0.05 x full-scale

20MHz-100MHz, 0.125 x full-scale

Trigger Pulse Width 7 ns

(minimum)

Trigger Level Range ± 6 div from center

(Specifications valid for temperature range $\pm 10^\circ$ C from calibration temperature with 8 averages selected and channel (s) in sensitivity range 1, 2 or 5)

Ordering Information

The HP 54501A digitizing oscilloscope comes complete with two HP 10432A 10:1 10 M Ω probes, an Operating and Programming Manual, a Service Manual, one miniature-probe-to-BNC male adapter, a power cord and a three-year warranty.

HP 54501A Digitizing Oscilloscope QTY 1 \$3,465

QTY ≥ 2 \$3,362

Opt 908 Rackmount Kit (5061-6175) \$250

Opt 910 One additional Operating/Programming manual (54501-90901) and one additional Service manual (54501-90902) \$75

Opt 090 Delete Probes -\$200

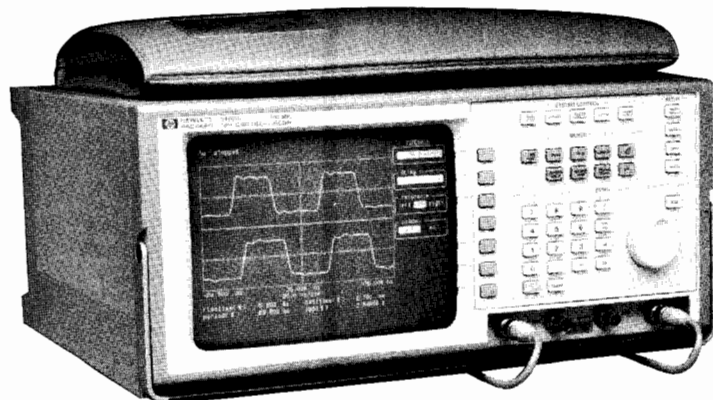

HP 54501A

OSCILLOSCOPES & WAVEFORM ANALYZERS

Digitizing Oscilloscopes (cont'd)

HP 54502A

HP 54502A 400 MHz, 400 MSa/s Digitizing Oscilloscope

The HP 54502A is a 400 MHz, 400 MSa/s sample rate, 2-channel digitizing oscilloscope designed for both repetitive and single-shot signals. In repetitive mode, the HP 54502A has 400 MHz bandwidth. In real-time mode, its 400 MSa/s sample rate provides a single-shot bandwidth of 100 MHz. Like other members of the HP 54500 family, the HP 54502A has all of the digitizing advantages of oscilloscopes that are much higher in price. Its high repetitive/single-shot bandwidth, ease of use, HP-IB programmability, and HP 54500 family general-purpose features make it a powerful tool for both manual and automated test applications.

HP 54502A Specifications and Characteristics

	Real-time	Repetitive
Bandwidth: (-3 dB) dc-coupled	dc to 100 MHz	dc to 400 MHz ¹
Switchable bandwidth limits	ac-coupled lower -3 dB freq.: 90 Hz LF reject lower -3 dB freq.: 450 Hz Bandwidth limit: dc to 30 MHz	
Rise time ²	3.5 ns	875 ps
Number of channels	2 (simultaneous)	
Vertical sensitivity range	2 mV/div to 5 V/div	
Vertical gain accuracy (dc) ^{3,4}	±2.0% of full scale	
Vertical resolution ^{4,5}	±0.4% of full scale	
Maximum sample rate	400 MSa/s	25 MSa/s
Waveform record length ⁶	normal: 501 points extended: 2001 points	time/div 5 ns - 5 s/div 2 ns/div ins/div Rec length 501 pts 401 pts 201 pts
Input R (selectable)	1 MΩ ±1% or 50Ω ±1%	±1%
Input C	7 pF nominal	
Input coupling	ac, dc	
Maximum input voltage	1 MΩ: ±250 V dc + peak ac (<10 kHz) 50 Ω: 5 V rms	
Offset range	vertical sensitivity 2 mV - 50 mV/div >50 mV - 250 mV/div >250 mV - 1.25 V/div >1.25 V - 5 V/div	available offset ±2 V ±10 V ±50 V ±250 V
Offset accuracy ⁴	±(2 mV+2% of ch. offset+2.5% of full scale)	
Dynamic range	±1.5 x full scale from center of screen	
Channel-to-channel Isolation (with channels at equal sensitivity)	40 dB: dc to 50 MHz 30 dB: 50 to 100 MHz	40 dB: dc to 50 MHz 30 dB: 50 to 400 MHz
Voltage measurement accuracy (dc) ^{3,4}	±(2.0% of full scale + 0.032 x V/div)	
Dual cursor	±(2.0% of full scale + offset accuracy +0.016 x V/div)	
Single cursor		
Time base range	1 ns/div to 5 s/div	

	Real-time	Repetitive
Time base reference accuracy	0.01%	
Time base resolution	50 ps	
Delta-t accuracy	±(2% x s/div + 0.01% x delta t + 500 ps)	±(2% x s/div + 0.01% x delta t + 250 ps)
Delay range (post-trigger)	Time/div setting 50 ms - 5 s/div 100 μs - 20 ms/div 1 ns - 50 μs/div	Available delay 40 x (s/div) 1s 10 000 x (s/div)
Delay range (pre-trigger)	All time/div settings 40 x (s/div)	Time/div setting 2 μs-5 μs/div 10 ns-1 μs/div 1 ns-5 ns/div
Trigger sensitivity ⁴		
Internal	dc to 100 MHz 100 MHz to 400 MHz	0.063 x full scale N/A
External	dc - 250 MHz	100 mVp-p into 50 Ω 0.125 x full scale
Trigger pulse width (minimum)		
Internal	7.0 ns	1.75 ns
External	2.8 ns	2.8 ns
Trigger level range	Internal: ±1.5 x full scale from center of screen External: ± 2V	

Specifications valid for temperature range ±10°C from software calibration temperature with eight or more averages selected.

¹Upper bandwidth reduces by 2.5 MHz for each °C above +35°C.

²Rise times are calculated from:

$$tr = \frac{0.35}{\text{bandwidth}}$$

³Vertical gain accuracy decreases 0.08% per °C from software calibration temperature.

⁴Expansion is used below 7 mV/div range so vertical resolution and accuracies are correspondingly reduced. Below 7mV/div full scale is defined as 56 mV.

⁵With < 8 averages vertical resolution becomes 1.6% of full scale.

⁶Available over HP-IB waveform record length is:

Real-time -normal: 500 points, extended: 2000 points

10 ns - 5 s/div: 1024 pts

Repetitive -5 ns/div: 1000 pts

2 ns/div: 400 pts

1 ns/div: 200 pts

Ordering Information

The HP 54502A digitizing oscilloscope comes complete with two HP 10430A 10:1 10 MΩ probes, a front panel manual, a programming manual, a service manual, a miniature probe to BNC male adapter, a power cord, and three-year warranty.

	Price
HP 54502A Digitizing Oscilloscope qty 1	\$6450
qty ≥ 2 (each)	\$6257
Opt 908 Rackmount Kit	+\$250
Opt 910 Additional Front-Panel, Programming and Service manual	+\$75
Opt 090 Delete Probes	-\$200

HP 54503A 500 MHz 4 Channel Digitizing Oscilloscope

The HP 54503A is a 500 MHz, 4 channel digitizing oscilloscope designed primarily for repetitive signal applications. All four channels have full-featured attenuators. Like all of the HP 54500 family oscilloscopes, the 54503A features 2-channel simultaneous sampling and has the digitizing advantages of oscilloscopes much higher in price. Its four channels, 500 MHz repetitive signal bandwidth, ease of use, HP-IB programmability, and HP 54500 family general-purpose features make it a powerful tool for both manual and automated test applications.

HP 54503A Specifications and Characteristics

Bandwidth (-3 dB) dc-coupled

Repetitive¹ dc to 500 MHz

Single-shot dc to 2 MHz (based on 10 points per period of input signal)

Switchable ac-coupled lower -3 dB frequency : 90 Hz

bandwidth LF reject lower -3 dB frequency : 450 Hz

limits Bandwidth limit upper -3 dB frequency : 30 MHz

Rise time 700 ps (calculated from: rise time = 0.35/BW)

Number of channels² 4

Vertical sensitivity range (all channels) 1 mV/div to 5 V/div

Vertical gain^{3,4} **accuracy dc:** ±1.25%

Vertical resolution⁴ ± 0.4% (8 bit A/D)

± 0.1% (10 bits via HP-IB with averaging)

Maximum sample rate 20 MSa/s

Waveform record length⁵ 501 points (display)

1024 points (via HP-IB)

Input R (selectable) 1 MΩ ± 1% or 50 Ω ± 1%

Input C 7pF nominal

Input coupling ac, dc

Maximum input voltage 1MΩ: ± 250V, (dc + peak ac <10 KHz)

50 Ω: 5V rms

Offset range	Vertical Sensitivity	Available Offset
	1mV to 50 mV/div	± 2V
	> 50 mV to 250 mV/div	± 10V
	> 250 mV to 1.25 V/div	± 50V
	> 1.25 V to 5 V/div	± 250V

Offset accuracy⁴ ± (2% of full scale + 0.5% of offset)

Dynamic range (dc + peak ac) ± 1.5 X full scale from center of screen

Channel-to-channel 40 dB: dc to 100 MHz

Isolation 30 dB: 100 MHz to 500 MHz

(with channels at equal sensitivity)

Voltage measurement accuracy

Dual cursor^{3,4} ± (1.25% of full scale + .032 div)

Single cursor ± (1.25% of full scale + offset accuracy +0.16 div)

Time base range 200 ps/div to 5 s/div

Time base reference accuracy 0.005%

Time base resolution 20 ps

Delta t accuracy ± 2% of s/div ± 0.005% X delta t ± 100 ps

Delay range (posttrigger)	Time/div Setting	Available Delay
	50 ms - 5 s/div	40 X (s/div)
	100µs- 20 ms/div	1 s
	200 ps - 50 µs/div	10,000 X (s/div)

Delay range (pretrigger) 5µs- 5s -39.96 X (s/div)

10 ns - 2µs -99.9 µs

200 ps - 5 ns -10,000 X (s/div)

Trigger Sensitivity

≥ 5 mV/div dc-100MHz 0.063 of full-scale

100 MHz-500 MHz 0.156 of full scale

< 5 mV/div dc-100 MHz 2.5 mV

100 MHz-500 MHz 6 mV

Trigger pulse width (minimum) 1.5 ns

Trigger level range ± 1.5 X full scale from center of screen

Specifications valid for temperature range ± 10°C from software calibration temperature with 8 averages selected and channel(s) in sensitivity range 1, 2 or 5.

¹Upper bandwidth reduces by 2.5 MHz for each degree centigrade above +35°C.

²Simultaneous acquisition on two channels. Channels 1 and 4 are acquired simultaneously. If four channels are used, data is acquired alternately by channels 1 and 4, then 2 and 3.

³Accuracy reduces by ±0.08% for each degree centigrade away from software calibration temperature.

⁴Expansion is used below 7 mV/div range so vertical resolution and accuracies are correspondingly reduced.

⁵For single-shot via HP-IB, waveform record length is 500 points In repetitive mode: 200 ps/div time base range, waveform record length is 100 points. 500 ps/div time base range, waveform record length is 250 points. 1 ns/div time base range, waveform record length is 500 points. ≥ 2 ns/div time base range, waveform record length is 1000 points.

Ordering Information

The HP 54503A digitizing oscilloscope comes complete with two HP 10430A 10:1 10 MΩ probes, a front-panel manual, a programming manual, a service manual, a miniature probe to BNC male adapter, a power cord, and three-year warranty.

	Price
HP 54503A Digitizing Oscilloscope qty 1	\$4950
qty ≥ 2 (each)	\$4802
Opt 908 Rackmount Kit	+\$250
Opt 910 Additional Front-Panel, Programming and Service manual	+\$75
Opt 090 Delete Probes	-\$200

OSCILLOSCOPES & WAVEFORM ANALYZERS

Digitizing Oscilloscopes

Models 54100A/D, 54110D

- 1 GHz bandwidth
- Auto pulse parameter and time interval measurements
- Digital storage
- Available with color or monochrome display
- Pre-trigger viewing
- Logic triggering capability

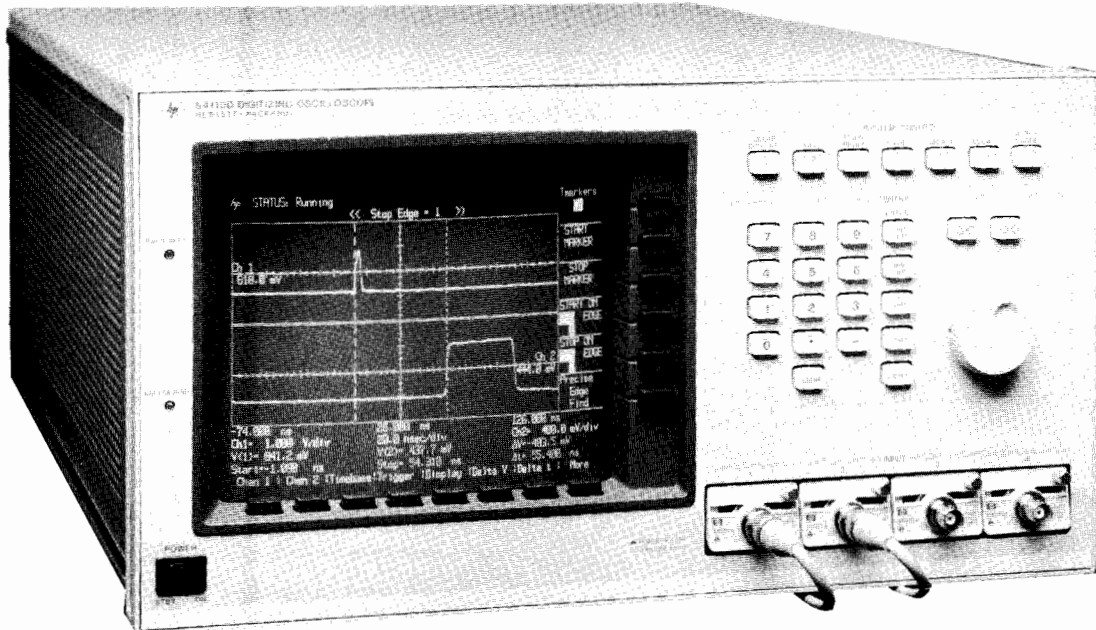

HP 54110D



HP 54100A/D and HP 54110D

As the speeds of analog and digital logic continue to increase, board and system designers need to pay even closer attention to high-frequency and transmission-line characteristics of their circuits. Design requirements are rigorous. Subnanosecond technology creates narrow and elusive pulses.

High Bandwidth

The HP 54100/110 unite a powerful 1 GHz bandwidth with a random repetitive sampling technique for viewing rarely occurring narrow waveforms. These oscilloscopes have 0.002% time base accuracy, 50 ps aperture jitter, and 10 ps resolution for confident measurements of critical timing parameters in high-speed circuitry.

With random repetitive sampling, you can capture waveforms that occur thousands of screen diameters before the trigger event. This gives an effective memory depth of millions of bytes for finding causes of failures that occur long before the trigger.

High Resolution

Analyze perturbations within a waveform with high resolution. With vertical magnification and waveform averaging, small signal details can be viewed and measured with 10 bits of effective resolution.

Flexible Analysis

Only the HP 54100A/D and HP 54110D allow the display of either vertical channel versus the other. The 1 GHz bandwidth makes this feature valuable in measuring high-speed I-V device characteristics and transfer functions high-speed converters.

The HP 54100A/D

When a monochrome display is preferred, for example in a totally automatic test application, choose the HP 54100A or HP 54100D oscilloscope. These units require less rack height (7") than the HP

54110D (8.75") and have all of the same measurement features and specifications. The HP 54100A has one external trigger input, while the HP 54100D and HP 54110D have two.

Ordering Information

HP 54100A 1GHz Digitizing Oscilloscope	\$13,900
Opt W30 Service Extension	\$325
HP 54100D 1GHz Digitizing Oscilloscope	\$18,500
Opt W30 Service Extension	\$440
HP 54110D 1GHz Digitizing Oscilloscope with color display	\$22,900
Opt W30 Service Extension	\$550

Input Pods and Probes

	Price
HP 54001A 1 GHz miniature active probe pod	\$765
HP 54002A 50 ohm BNC input pod	\$130
HP 54003A 1-megohm, 10:1 probe pod	\$665

A Choice of Input Pods and Probes

The HP 54100/110 inputs are configured with removable pods that can be chosen according to the application. Pods can be changed quickly and easily, and they occupy a minimum of storage space.

- 50 ohm inputs and probes for a wide variety of environments, without the expense of amplifier plug-ins.
- 1 GHz miniature active probes for densely packed, high-speed logic circuits.
- 1 Mohm probes for circuits sensitive to resistive loading.
- 50 ohm BNC inputs for measurements where terminated lines are important.
- 100:1 probes for extended dynamic range.

For more information on the HP 54100/110's probing system, please refer to page 64.

- 2 Gigasample/second, one channel when used with HP 54114A
- 500 MHz repetitive bandwidth
- 8k memory depth
- PaintJet color hardcopy output

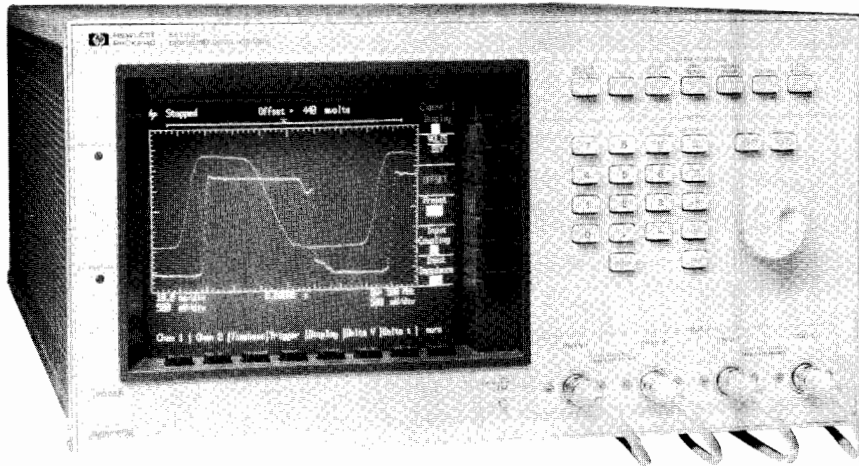

The HP 54111D features a 2 gigasample/second digitizing rate and a 500 MHz bandwidth.

HP 54111D: High-speed General-Purpose Scope

The HP 54111D is a 2 gigasample/second, one channel digitizing oscilloscope with a memory depth of 8k samples per channel. The HP 54111D retains all of the key features and user friendliness of the HP 54100/110 oscilloscopes . . . such as automatic measurements, autoscaling, cursors, and a color display. Plus, the HP 54111D adds features necessary for controlling and managing the added memory depth, such as scroll, zoom, and memory bar.

Key Contributions

- 2 gigasamples/second digitizing rate (maximum)
- 500 MHz bandwidth
- 8k memory per channel
- Up to eight bits of vertical resolution with bandwidth limits
- Two channels of simultaneous capture at up to 1 GSa/s
- Pre-trigger information
- Automatic measurements
- Fully HP-IB programmable
- Advanced Logic triggering capabilities
- Instant hardcopy output

General-purpose to Special Applications

With a 2 gigasample/second digitizing rate, the HP 54111D gives you the fastest sampling rate available in a general-purpose digitizing oscilloscope. However, the HP 54111D is much more than an instrument for capturing fast single-shot transients. With random repetitive sampling, this instrument provides a bandwidth of 500 MHz for high-speed circuit design and test.

In addition to its single-shot and repetitive capabilities, the HP 54111D provides flexible input coupling with a side dynamic range for viewing and analyzing a variety of signals. Use this scope for just about any general-purpose application from very slow to very high-speed repetitive or non-repetitive waveforms.

Memory Bar Simplifies Data Viewing

The HP 54111D provides 8k samples of memory per channel. This results in 16 screens of waveform information in each real-time or single-shot acquisition cycle. To simplify management of all this data,

the HP 54111D displays a memory bar. The memory bar is displayed along the top edge of the graticule and shows the portion of memory being viewed relative to the entire memory record. In addition, the trigger point is also shown along the memory bar.

Ultra High Digitizing Rate

No longer do you need a manual analog storage oscilloscope to capture high-speed single-shot phenomena found in:

- high-speed pulse analysis
- nuclear test studies
- plasma discharge
- high voltage arcing
- high frequency bursts

All these single-shot events can be captured easily at 2 GSa/s, with 4 μ s of data stored for review and analysis. (8 μ s over HPIB).

High-speed ECL Design

Non-repetitive glitches appearing on the clock signal can be captured easily with the 500 MHz single-shot performance of the HP 54111D with the HP 54114A two gigasample/second test set. Four μ s of pre-trigger data is invaluable for determining the cause of the glitch.

High-speed Semiconductor Design

Single-shot performance of 500 MHz permits you to measure the outputs from latches (i.e., one-time events for multiple clock periods in ECL circuits).

Laser and High Energy Research

Photo detector pulses can be measured via single-shot capture using the 2 GHz sampling rate and built-in automatic measurements. Infinite persistence can also be used to show and measure maximum variations of the waveform to the 500 MHz bandwidth.

The HP 54111D's two simultaneous 1 gigasample/second channels give you the single-shot performance of the most advanced analog storage oscilloscopes, but with all the advantages and ease of use of a digitizing oscilloscope. And with a staggered over-sampling technique, the HP 54111D provides this single-shot performance with up to eight bits of non-blooming vertical resolution.

OSCILLOSCOPES & WAVEFORM ANALYZERS

Digitizing Oscilloscopes (cont'd)

Models 54100A/D, 54110D

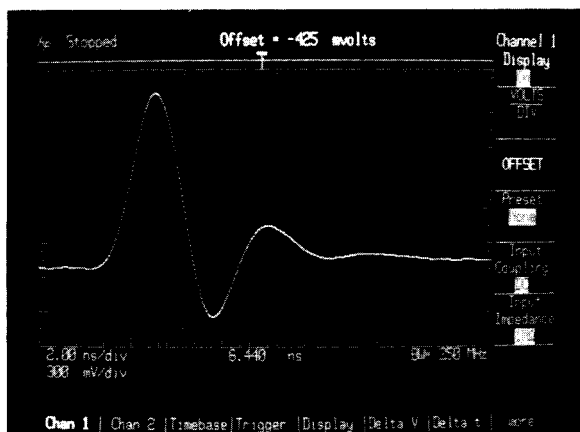

With its 1 gigasample/second digitizing rate, the HP 54111D was able to capture this laser pulse single-shot.

Data Communications

Combine 1 gigasample/second digitizing rate with eight kbytes of memory depth per channel, and you have an invaluable tool for analyzing high-speed serial waveforms such as data communications or radar testing.

High Bandwidth Applications

Not only is the HP 54111D digitizing oscilloscope useful for single-shot phenomena, but it also samples repetitively, giving you 500 MHz bandwidth with high signal fidelity. Use this scope for just about any general-purpose application from very slow to very high-speed repetitive or non-repetitive waveforms.

Computer-aided Test

The HP 54111D has many features that make it an excellent tool in computer-aided test. Its repetitive bandwidth and digitizing rate allow it to cover a wide range of automatic measurement applications. In addition, this instrument has many features that enhance test throughput time, such as built-in automatic measurements, fast acquisition cycles, and deep memory.

Input Range and Conditioning

The HP 54111D has the widest input dynamic range and coupling capabilities of any of our digitizing oscilloscopes. The input sensitivity can be set from 1 mV/div to 5 V/div. In addition, all input coupling is internal and programmable. The selections include: ac, dc, 1 megohm, 50 ohms, and GND. These input signal conditioning features make the HP 54111D more general-purpose for the circuit designer and test engineer.

HP 54111D Specifications

Vertical (Voltage)

Channels: 2

	Single-shot		Repetitive
	two channel	one channel with HP 54114A	
Bandwidth	250 MHz	500 MHz	500 MHz
Transition Time	1.4 ns	700 ps	700 ps
Resolution/BW	8 bits/25 MHz, 7 bits/100 MHz, 6 bits/250 MHz	8 bits/50 MHz, 7 bits/200 MHz, 6 bits/500 MHz#	6 bits, 8 bits with averaging

Gain Accuracy: $\pm 2\%$ of full-scale**

Dc Offset Accuracy: $\pm 1.5\%$ of setting

Measurement Accuracy

Single data point: \pm gain acc \pm offset acc \pm resolution

Between data points on the same waveform: \pm gain acc $\pm 2 \times$ resolution

Dc Offset Range: ± 200 mV (1 mV/div to 4.9 mV/div)

± 1 V (5 mV/div to 49 mV/div)

± 10 V (50 mV/div to .49 V/div)

± 100 V (.5 V/div to 5 V/div)

Input Coupling: ac/dc/dc-50 ohms/Gnd

Input Impedance: 1 Mohm at 6.5 pF or 50 ohm (dc)

Maximum Safe Input Voltage: ± 40 V at 1 Mohm (dc + peak ac), 5 V rms at 50 ohms

Horizontal (Time)

Digitizing Rate: 1 gigasamples/second to 50 samples/second

Deflection Factor: 500 ps/div to 1 s/div

Memory Depth Per Channel: 8k (8 μ s at 1 gigasample/second), single-shot only.

Pre-trigger Delay Range: -8μ s at timebase settings 50 μ s/div and less, increasing to -160 seconds at 1 s/div.

Post-trigger Delay Range: .16 seconds at timebase settings .5 μ s/div and less, increasing to 10k seconds at 1 s/div.

	Single-shot	Repetitive
Time Measurement Accuracy		
single channel	± 300 ps $\pm .03\%$ of reading	± 100 ps $\pm .03\%$ of reading
dual channel	± 600 ps $\pm .03\%$ of reading	± 200 ps $\pm .03\%$ of reading
Triggering		
Sources	Internal Chan 1,2	Ext. Inputs 3,4
Sensitivity		
single-shot	0.1 of full scale, dc to 200 MHz***	15 mV (1:1), dc to 200 MHz
repetitive	0.2 of full scale, 200 MHz to 500 MHz ***	45 mV (1:1), 200 MHz to 500 MHz
Trigger Level Range	$\pm 3 \times$ full scale	± 1 V (1:1)
Input Resistance	NA	1 Mohm
Maximum Input Safe Voltage	NA	± 10 V, dc + peak ac
Input Operating Range	NA	± 1 V(1:1), dc + peak ac

*Bandwidth for settings 1 mV/div to 4.9 mV/div is reduced to 150 MHz.

**When calibrated to probe tip using front panel calibration source. Applies to major ranges (5 mV/div, 10 mV/div, 20 mV/div, 50 mV/div, 100 mV/div, 200 mV/div, 500 mV/div, 1 V/div, and 2 V/div). All continuous settings between these ranges are $\pm 3\%$ of full-scale.

***Applies to settings 5 mV/div and above.

#Raw Data

Ordering Information

HP 54111D 1 gigasample/second digitizing oscilloscope

Opt W30 Service Extension

Price

\$26,900

\$675

OSCILLOSCOPES & WAVEFORM ANALYZERS

Digitizing Oscilloscopes (cont'd)

Model 54112D

59

- 64k memory depth per channel
- Quad 400 megasamples per second digitizers
- Four channels.

- 100 MHz bandwidth (single-shot and repetitive)
- PaintJet color hardcopy output

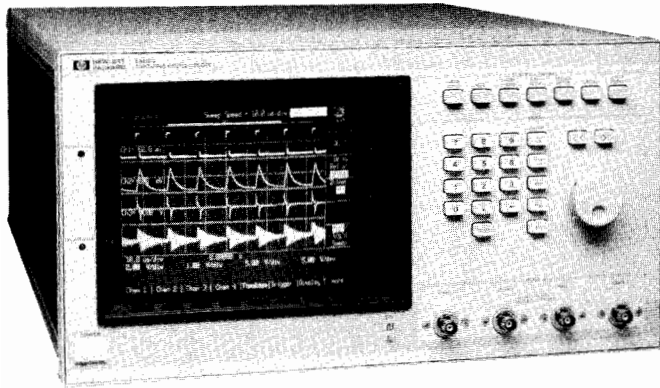

HP 54112D



HP 54112D Specifications

Vertical (Voltage)

Channels: 4		
Bandwidth	Single-shot	Repetitive
dc-coupled	dc to 100 MHz	dc to 100 MHz
ac-coupled	10 Hz to 100 MHz	10 Hz to 100 MHz
Transition Time (10% to 90%)	3.5 ns (nominal)	3.5 ns (nominal)
Deflection Factor (full scale=8 div)	5 mV/div to 5 V/div continuous	
Resolution	6 bits	6 bits, 8 bits with averaging

Gain Accuracy: $\pm 2\%$ of full-scale*

Dc Offset Accuracy: $\pm 1.5\%$ of setting

Measurement Accuracy

single data point: \pm gain acc \pm offset acc \pm resolution.

between data points on same waveform: \pm gain acc $\pm 2 \times$ resolution.

Dc Offset Range: ± 1 V (5 mV/div to 49 mV/div)
 ± 10 V (50 mV/div to .49 V/div)
 ± 40 V (.5 V/div to 5 V/div)

Input Coupling: ac/dc/dc-50 ohms

Input Impedance: 1 Mohms at 6.5 pf or 50 ohms

Maximum Safe Input Voltage: ± 40 V at 1 Mohm (dc + peak ac)
 5 V rms at 50 ohms

* When calibrated to probe tip using front panel calibration source. Applies to major ranges (5 mV, 10 mV, 20 mV, 50 mV, 100 mV, 200 mV, 500 mV, 1 V and 2 V). All continuous settings between these ranges are $\pm 3\%$ of full scale.

Horizontal (Time)

Digitizing Rate: 400 Megasamples/second to 50 samples/second.

Memory Depth Per Channel: selectable either 64k or 8k in single-shot only.

Pre-trigger Delay Range: -160μ sec at timebase settings of 125 ns/div and less, increasing to -1200 seconds at 1 second/div.

Post-trigger Delay Range: .16 sec at timebase settings .5 μ sec/div and less, increasing to 10,000 seconds at 1 s/div.

Time Measurement Accuracy	
single channel	± 500 ps $\pm .002\%$ of reading
dual channel	± 1 ns $\pm .002\%$ of reading

Triggering

Sources: internal chan. 1,2,3,4 and external input.

Sensitivity

Internal: 0.1 of full-scale

External: 10 mV (1:1)

Trigger level range:

Internal: $\pm 3 \times$ full scale

External: ± 5 V (1:1)

External trigger input

Input resistance: 200k ohms

Maximum input safe voltage: ± 40 V dc + peak ac.

Input operating range: ± 5 V (1:1) dc + peak ac.

HP 54112D: Four Channel Deep Memory Scope

The HP 54112D is a 400 megasample per second, four channel digitizing oscilloscope with 64k samples of memory depth per channel. The HP 54112D retains all the key features and the user friendliness of the HP 54100 series scopes. These features include automatic measurements, autoscaling, cursors, functional color display, scroll, zoom, and memory bar.

Key Contributions

- 400 megasamples per second digitizing rate
- 100 MHz repetitive and single-shot bandwidth
- 64k memory per channel
- Four channels of simultaneous capture at the full digitizing rate
- 160 μ s of pre- or post-trigger information minimum
- Automatic measurements
- Fully programmable
- Advanced Logic triggering capabilities
- Instant hardcopy output

Automatic Test Environment

The English-like commands and logical structure of HPOL (Hewlett-Packard Oscilloscope Language) make programming the 54100 series scopes in computer aided test a much easier task. The learning curve is greatly reduced.

The four channels, built-in automatic measurements and very deep memory of the 54112D improve the throughput of ATE systems. Data that used to take many acquisitions passes can now be captured in one.

General Purpose Inputs

The fully programmable input impedance and coupling of the four channels allow the user to choose 1 megohm impedance AC or DC coupled or 50 ohm DC coupled on each channel.

Ordering Information

HP 54112D 4 channel 64k memory/channel digitizing oscilloscope.

Opt W30 Service Extension

Price

\$22,900

\$575

OSCILLOSCOPES & WAVEFORM ANALYZERS

Digitizing Oscilloscopes (cont'd)

HP 54121T, 54122T, 54123T

- 12.4 GHz, 20 GHz, 34 GHz bandwidth
- 0.25 ps timing resolution
- Built-in histograms
- 2.5 GHz edge trigger
- Time domain reflectometry
- HP PaintJet printer output

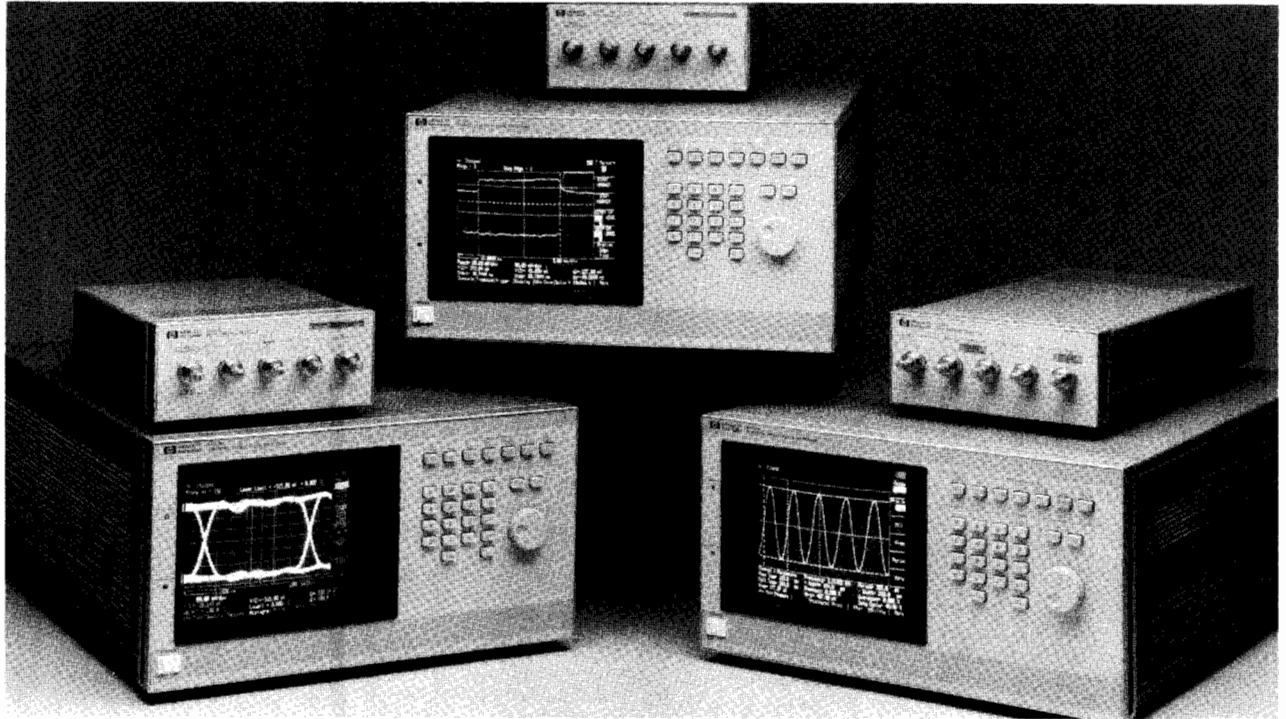

The HP 54120-series of high bandwidth digitizing oscilloscopes featuring digital feedback sampling for repeatable, accurate, and operator-independent measurement results.

HP 54120-series High Bandwidth Digitizing Oscilloscopes

The HP 54120-series of digitizing oscilloscopes combines high bandwidth, a time domain reflectometer (HP 54121T and HP 54123T only), four input channels, and superb stability in an easy-to-use, fully programmable oscilloscope that needs no manual loop gain adjustment. Whether your application involves high-speed device and circuit characterization, high-speed telecom analysis, or microwave design, the HP 54120-series of digitizing oscilloscopes give you a new confidence in state-of-the-art measurements.

Key Contributions

- dc - 12.4 GHz bandwidth (HP 54122T) - 28.2 ps risetime
- dc - 20 GHz bandwidth (HP 54121T) - 17.5 ps risetime
- dc - 34 GHz bandwidth (HP 54123T) - 10.3 ps risetime
- 10 ps time interval accuracy
- 0.25 ps time interval resolution
- 10 ps/div to 1 s/div
- 0.4 % vertical accuracy
- 32 microvolt resolution
- 1 mV/div to 80 mV/div (HP 54121T and HP 54123T)
- 1 mV/div to 2.4 V/div (HP 54122T)
- Automatic pulse parameter measurements
- Fully HP-IB programmable
- Pushbutton hardcopy documentation

- Four input channels
- Step generator with 35 ps risetime and 1% flatness (HP 54121T and HP 54123T)
- Reflection (TDR)/transmission (TDT) normalization¹ (HP 54121T and HP 54123T)
- Time and voltage histograms

Picosecond measurements

The 0.25 ps time interval resolution and typically 1 ps time interval accuracy of the HP 54120 family reduce the oscilloscope's contribution to errors in digital pulse parameter measurements in semiconductors and computers.

Quantify Noise and Jitter

Time and voltage histograms, which quantify noise and jitter measurements, characterize the eye patterns in telecommunications applications. Eye height and width, location of one and zero, are easily found with histograms. With no loop gain control, you can obtain repeatable results that do not vary between operators or between oscilloscopes over the entire input dynamic range.

Eliminate Reflections with TDR

Ringings and waveform distortion can be eliminated by using time domain reflectometry on the HP 54121T and the HP 54123T to locate and remove discontinuities in transmission line systems.

NOTE 1: Normalization uses the Bracewell transform, which is under license from Stanford University.

HP 54120-Series Specifications Channels

(Vertical) ¹	HP 54121T	HP 54122T	HP 54123T
Bandwidth (-3 dB)			
High Bandwidth²	dc to 20 GHz chs 2,3,4 (ch 1 is -3.5 dB @ 20 GHz)	dc to 12.4 GHz	dc to 34 GHz chs 2,3,4 dc to 20 GHz, ch 1
Low Bandwidth	dc to 18 GHz, ch 1 dc to 12.4 GHz	dc to 10 GHz	dc to 18 GHz, chs 2,3,4 dc to 12.4 GHz, ch 1
Transition Time (10% to 90%) (calculated from Tr = .35/BW)			
High bandwidth	<17.5 ps, Chs 2,3,4 <19.4 ps, Ch 1	<28.2 ps	<10.3 ps Chs 2,3,4 <17.5 ps, Ch 1
Low bandwidth	<28.2 ps	<35.0 ps	<19.4 ps, Chs 2,3,4 <28.2 ps, Ch 1
Noise (rms)			
High bandwidth	<2 mV	<2 mV (1:1 attenuation)	<2 mV
Low bandwidth	<1 mV	<1 mV (1:1 attenuation)	<1 mV
Scale factor (full-scale is 8 divisions)			
Minimum	1 mV/div	1 mV/div	1 mV/div
Maximum	80 mV/div	2.4 V/div	80 mV/div
Atten. factors	N/A	X1, X3, X10, X30	N/A
Programmable dc Offset³	± 500 mV	± 500 mV x atten. factor	± 500 mV
dc Accuracy Single Voltage Marker⁴	Average mode : ± 0.4% of full-scale or marker reading (whichever is greater) ± 2 mV x attenuation factor ⁵ ± 3.0% of ⁶ (reading - channel offset)		
	High bandwidth Persistence mode : ± 0.4% of full-scale or marker reading (whichever is greater) ± 2 mV x attenuation factor ⁵ ± 3.0% of ⁶ (reading - channel offset)		
	Low bandwidth Persistence mode : ± 0.4% of full-scale or marker reading (whichever is greater) ± 2 mV x attenuation factor ⁵ ± 1.5% of ⁶ (reading - channel offset)		
Inputs			
Number	Four	Four	Four
Dynamic range	± 320 mV relative to channel offset	± 320 mV x attenuation factor	± 320 mV relative to channel offset
Maximum safe input voltage	± 2 V dc + peak ac (+16 dBm)	± 5 V dc + peak ac (+24 dBm)	± 2 V dc + peak ac (+16 dBm)
Nominal impedance	50 Ω	50 Ω	50 Ω
Percent reflection	<5% for 30 ps risetime	<5% for 30 ps risetime	<5% for 30 ps risetime
Connectors	3.5 mm (m)	3.5 mm (m)	3.5 mm (m)

- When operated within ± 5 C (± 9 F) of the temperature of the last front panel calibration.
- The input samplers are biased differently for increased bandwidth in the high bandwidth mode.
- An effective offset of ± 820 mV x attenuation factor can be achieved by using the ± 500 x attenuation factor mV of channel offset and adding ± 320 mV x attenuation factor of offset with the waveform math offset scaling function.⁵
- When driven from a 0 Ω source.
- The attenuation factor of the HP 54121T and the HP 54123T is 1.
- For the HP 54123T, the 3% changes to 5% and the 1.5% changes to 2%.

TDR System (HP 54121T and HP 54123T only)

	Combined Oscilloscope and TDR Performance	Normalized Characteristics ¹
Risetime^{2,3}	<45 ps	Adjustable: allowable values based on time-base setting Minimum: 10 ps or 0.08 X time/div, whichever is greater Maximum: 5 X time/div
Flatness²	<+ 1% after 1 ns from edge; <+ 5%, - 3% to 1 ns from edge	< 0.1%
Levels:	Low 0 V ± 2 mV High + 200 mV ± 2 mV	0 V ± 2 mV + 200 mV ± 2 mV

- Normalized information is a characteristic, not a specification. The information is presented here for comparison purposes only. Normalization characteristics are achieved only with the use of the normalization calibrations and firmware routines.
- Measured in the low bandwidth and average display modes.
- The risetime of the generator is less than 35 ps, as calculated by (Tr system)² = (Tr generator)² + (Tr scope)²

Time base (Horizontal)

Scale factor (full-scale is 10 divisions)

Minimum	10 ps/division
Maximum	1 s/division

Delay (time offset relative to trigger)

Minimum	16 ns
Maximum	1000 screen diameters or 10 seconds, whichever is smaller.

Time Interval Accuracy

(Dual marker measurement)

Time Interval Resolution

< 10 ps ± 0.1% of reading

0.25 ps¹ or .02 division, whichever is larger

At 10 ps/division, data points are plotted at 0.2 ps intervals to match the display pixel resolution.

Trigger-External Input Only

Sensitivity

dc - 100 MHz
100 MHz to 2.5 GHz

40 mV peak-to-peak
Increasing linearly from 40 mV at 100 MHz to 200 mV at 2.5 GHz.

Pulse width

High frequency reject

< 200 ps, > 200 mV
Trigger bandwidth reduced to approximately 100 MHz.

Trigger level range

Jitter

(Trigger and time base combined one standard deviation)

± 1 V

< 2.5 ps + 5E-5 X delay setting
(Tested using 2 GHz synthesized source at 200 mV peak-to-peak with High Frequency Sensitivity ON and High Frequency Reject OFF.)

Trigger Input

Maximum Safe Input Voltage

Nominal Impedance

Percent Reflection

Connector

± 2 V dc ac peak (+16 dBm)
50 Ω
<10% for 100 ps risetime
3.5 mm (m)

OSCILLOSCOPES & WAVEFORM ANALYZERS

Accessories For The HP 54120 Series Digitizing Oscilloscopes

HP 54006A, 54007A, 54008A, 54118A, 10086A

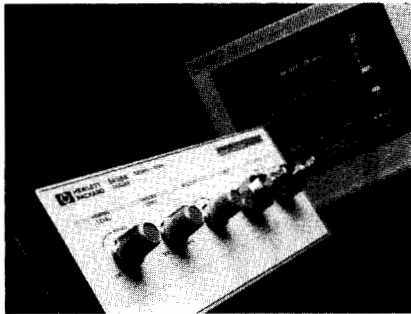

HP 54118A

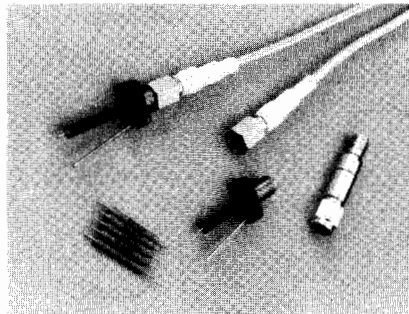

HP 54006A

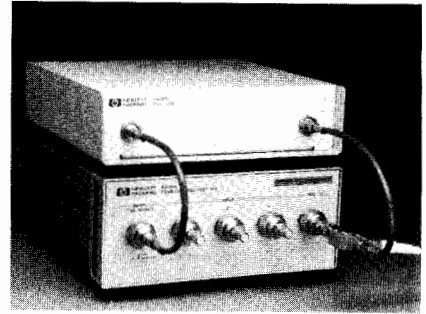

HP 54008A

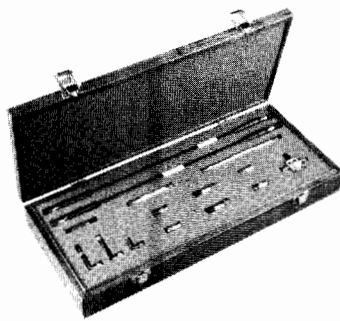

HP 54007A

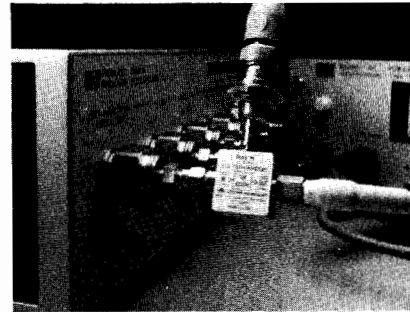

HP 10086A

Hewlett-Packard has a large number of accessories for use with wideband digital sampling oscilloscopes that will help you build a multi-gigahertz system that is tailored to your unique needs.

The HP 54118A, 500 MHz to 18 GHz Trigger Simple/Stable Triggering at Microwave Frequencies

For applications requiring more than 2.5 GHz trigger bandwidth, use the HP 54118A 18 GHz Trigger. The HP 54118A gives your HP 54120-series oscilloscope true event triggering from 500 MHz to 18 GHz with less than 1.7 ps of rms jitter at 18 GHz. This powerful and versatile accessory extends the oscilloscope's measurement capabilities to applications in lightwave communications, pulsed RF, gigabit logic, pseudo random bit stream eye patterns, and other microwave signals.

True event triggering is not possible with countdown synchronizers, but with the event triggering capability of the HP 54118A, you are no longer restricted to the limitations of countdown synchronizers. An HP microwave thinfilm IC locks onto your input signal and holds it, even if the signal has frequency drift or large deviations in FM modulation.

Independent control of arming and triggering levels let you make measurements that simply were not possible before, such as triggering on a carrier of a radar pulse or CW signals with large noise components. And the trigger's variable holdoff feature makes it a snap to trigger on the carrier of a burst RF signal.

The HP 54006A 6 GHz Probe High Frequency Hand-held Probing

Probing multi-GHz systems with the HP 54006A, 10:1, 500 Ω and 20:1, 1 k Ω resistive divider probes lets you access circuit nodes that do not have a 50 Ω connector. These probes let you see the signal at specific points, such as the input to a gate. You can also use them to probe circuits that are not nominally 50 Ω .

The HP 54008A 22 ns Delay Line Viewing the Trigger Signal

The HP 54008A delay line provides 22 ns of delay with a usable frequency response of 20 GHz. By adding this accessory to your HP 54120 oscilloscope system, you will be able to view the trigger event. The HP 54008A has enough delay to view the trigger event with the HP 54118A Trigger installed in the trigger path also.

The HP 54007A Accessory Kit Low-loss Measurements For the HP 54120 Oscilloscope Systems

The HP 54007A Accessory Kit provides an assortment of parts with 3.5 mm connectors for low-loss measurements. This kit is highly recommended for low-loss reflection and transmission measurements. It also includes semi-rigid coax, formed for use with the HP 11667B power splitter.

Contents of HP 54007A Accessory Kit:

17-inch cable, APC 3.5 (f-f)	17-inch cable, APC 3.5 (m-f)
Coaxial short, APC 3.5 (f)	Coaxial short, APC 3.5 mm (m)
50 Ω termination, APC 3.5 (m)	50 Ω termination, APC 3.5 (f)
7.5 cm airline, APC 3.5 (m-f)	Power splitter, APC 3.5 mm (f)
6 cm. semi-rigid "L", SMA (m-m)	3 cm. semi-rigid "L", SMA (m-m)
6 dB attenuator, APC 3.5 (m-f)	40 dB attenuator, APC 3.5 (m-f)
Adapter, APC 3.5 mm (m-m)	

HP 10086A ECL Terminator

Safe, Reliable Termination For Measuring ECL Devices

Create a simple high-performance 10 GHz interface between an ECL-compatible output and a 50 Ω instrument input. The ECL terminator provides bias and termination for your device under test, while presenting an undistorted and level-shifted signal to your measurement equipment. It also provides proper termination to ECL output devices, thereby reducing the risk of destroying sensitive output devices.

HP 54120B includes:

- Color mainframe
- Interface cable
- Service manual for the HP 54120B
- Power cord

HP 54121A includes:

- Operating and programming manuals for the HP 54121T
- Service manual for the HP 54121A
- Four vertical channels, switchable step generator, and a trigger input
- Five adapters, APC-3.5 (f-f) (HP P/N 5061-5311)
- Five coaxial shorts, SMA (m) (HP P/N 0960-0055)
- One anti-static mat with wrist strap (HP 9300-1484)
- RF accessories (HP P/N 54121-68701):
 - Five 20 dB attenuators, APC-3.5 (f-m) (HP 33340C opt 020)
 - Three 50 Ω cables, SMA (m-m) (HP P/N 8120-4948)
 - Two SMA (m) to BNC (f) adapters (HP P/N 1250-1200)
 - One 50 Ω termination, SMA (m) (HP P/N 1250-2153)
 - One 50 Ω termination, SMA (f) (HP P/N 1250-2151)
 - One coaxial short, SMA (f) (HP P/N 1250-2152)

HP 54121T Documentation

- HP 54121T Front Panel Reference Manual (HP P/N 54121-90903)
- HP 54121T Programming Manual (HP P/N 54121-90904)
- HP 54120 Family Getting Started Guide (HP P/N 5952-4239)
- HP 54120B Mainframe Service Manual (HP P/N 54120-90907)
- HP 54121A Service Manual (HP P/N 54121-90902)

HP 54122A includes:

- Operating and programming manuals for the HP 54122T
- Service manual for the HP 54122A
- Four vertical channels, internal attenuators, and a trigger input.
- Five adapters, APC-3.5 (f-f) (HP P/N 5061-5311)
- Five coaxial shorts, SMA (m) (HP P/N 0960-0055)
- One anti-static mat with wrist strap (HP 9300-1484)
- RF accessories (HP P/N 54122-68701):
 - One 20 dB attenuator, APC 3.5 (f-m) (HP P/N 33340C opt. 020)
 - Three 50 Ω cables, SMA (m-m) (HP P/N 8120-4948)
 - Five SMA (m) to BNC (f) adapters (HP P/N 1250-1200)

HP 54122T Documentation

- HP 54122T Front Panel Reference Manual (HP P/N 54122-90903)
- HP 54122T Programming Manual (HP P/N 54122-90904)
- HP 54120 Family Getting Started Guide (HP P/N 5952-4239)
- HP 54120B Mainframe Service Manual (HP P/N 54120-90907)
- HP 54122A Service Manual (HP P/N 54122-90901)

HP 54123A includes:

- Operating and programming manuals for the HP 54123T
- Service manual for the HP 54123A
- Four vertical channels, switchable step generator, and a trigger input.
- Five adapters, APC-3.5 (f-f) (HP P/N 5061-5311)
- Five coaxial shorts, SMA (m) (HP P/N 0960-0055)
- One anti-static mat with wrist strap (HP 9300-1484)
- RF accessories (HP P/N 54121-68701):
 - Five 20 dB attenuators, APC-3.5 (f-m) (HP 33340C opt 020)
 - Three 50 Ω cables, SMA (m-m) (HP P/N 8120-4948)
 - Two SMA (m) to BNC (f) adapters (HP P/N 1250-1200)
 - One 50 Ω termination, SMA (m) (HP P/N 1250-2153)
 - One 50 Ω termination, SMA (f) (HP P/N 1250-2151)
 - One coaxial short, SMA (f) (HP P/N 1250-2152)

HP 54123T Documentation

- HP 54123T Front Panel Reference Manual (HP P/N 54123-90902)
- HP 54123T Programming Manual (HP P/N 54123-90903)
- HP 54120 Family Getting Started Guide (HP P/N 5952-4239)
- HP 54120B Mainframe Service Manual (HP P/N 54120-90907)
- HP 54123A Service Manual (HP P/N 54123-90901)

Ordering Information

HP 54120B Digitizing Oscilloscope Mainframe	\$11,900
Opt 908 Rackmount Kit (HP P/N 5061-9679)	+\$40
Opt 910 One additional set of manuals	+\$20
Opt W30 Extended Repair Service. See page 725	+\$290
Opt W32 Calibration Service. See page 725.	+\$230

HP 54121T 20 GHz Digitizing Oscilloscope

The HP 54121T 20 GHz Digitizing Oscilloscope consists of two model numbers, the HP 54120B Digitizing Oscilloscope Mainframe and the HP 54121A Four Channel Test Set. The HP 54121T is the recommended ordering configuration.

HP 54121T 20 GHz Digitizing Oscilloscope	\$28,800
Opt 090 Deletes RF accessories	-\$1,800
Opt 908 Rackmount Kits (HP P/N 5061-9672)	+\$89
Opt 910 One additional set of manuals	+\$120
Opt W30 Extended Repair Service. See page 725.	+\$560
HP 54121A Four Channel Test Set	\$16,900
Opt 090 Deletes RF accessories	-\$1,800
Opt 908 Rackmount Kit (HP P/N 5061-9672)	+\$49
Opt 910 One additional set of manuals	\$100
Opt W30 Extended Repair Service. See page 725.	+\$410

HP 54122T 12.4 GHz Digitizing Oscilloscope

The HP 54122T 12.4 GHz Digitizing Oscilloscope consists of two model numbers, the HP 54120B Digitizing Oscilloscope Mainframe and the HP 54122A Four Channel Test Set. The HP 54122T is the recommended ordering configuration.

HP 54122T 12.4 GHz Digitizing Oscilloscope	\$28,800
Opt 090 Deletes RF accessories	-\$700
Opt 908 Rackmount kits (1 ea HP P/N 5061-9672)	+\$89
Opt 910 One additional set of manuals	+\$120
Opt W30 Extended Repair Service. See page 725.	\$695
HP 54122A Four Channel Test Set	\$16,900
Opt 090 Deletes RF Accessories	-\$700
Opt 908 Rackmount Kit (HP P/N 5061-9672)	+\$49
Opt 910 One additional set of manuals	\$100
Opt W30 Extended Repair Service. See page 725.	+\$410
Opt W32 Calibration Service. See page 725.	+\$650

HP 54123T 34 GHz Digitizing Oscilloscope

The HP 54123T 34 GHz Digitizing Oscilloscope consists of two model numbers, the HP 54120B Digitizing Oscilloscope Mainframe and the HP 54123A Four Channel Test Set. The HP 54123T is the recommended ordering configuration.

HP 54123T 34 GHz Digitizing Oscilloscope	\$34,800
Opt 090 Deletes RF accessories	-\$1,800
Opt 908 Rackmount kits (1 ea HP P/N 5061-9672)	+\$89
Opt 910 One additional operating and programming manual	+\$120
Opt W30 Extended Repair Service. See page 725.	+\$870
HP 54123A Four Channel Test Set	\$22,900
Opt 090 Deletes RF Accessories	-\$1,800
Opt 908 Rackmount Kit (HP P/N 5061-9672)	\$49
Opt 910 One additional set of manuals	\$100
Opt W30 Extended Repair Service. See page 725.	+\$572.50

Accessories

HP 54006A 6 GHz resistive divider probe kit	\$895
HP 54007A Accessory kit	\$5,225
HP 54008A 22 ns Delay line	\$2,600
HP 54118A 18 GHz Trigger	\$8,925
Opt 090 Deletes RF accessories	+\$1,250
Opt 908 Rackmount kit (HP 5061-9672)	+\$49
Opt 910 One additional Manual	+\$15
Opt W30 Extended Repair Service. See page 725.	+\$180
HP 10086A ECL Terminator	\$637

For additional information concerning any high bandwidth oscilloscope or high bandwidth oscilloscope accessory see HP publication number 5952-7084.

OSCILLOSCOPES & WAVEFORM ANALYZERS

Probes and Other Oscilloscope Accessories

A Family of Miniature Oscilloscope Probes

- Modular construction
- Improved electrical performance
- Accessories

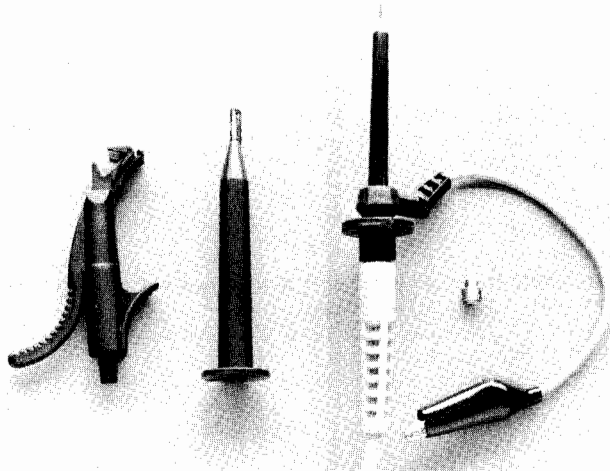

The HP 10400A Miniature Probe Family

The HP 10400A miniature probe family offers modular construction, improved reliability, and superior electrical performance over our previous mini-probes. Modular construction allows individual replacement of probe tips, cables, and chassis assemblies cutting down on probe replacement and repair costs. Improved cable and strain relief design increase reliability. Electrical performance is also improved by reducing the probe shunt capacitance and increasing the input resistance that load the circuit under test.

The HP 10400A mini-probe family also features accessories (see below) including a ground lead utilizing a ferrite bead for reduced ringing on pulse tops, and an IC grabber that allows easy connection of a single probe to many IC packages without fear of shorting adjacent pins.

OSCILLOSCOPE/MINIATURE PROBE COMPATIBILITY AND PROBE CHARACTERISTICS

HP Oscilloscope/ Logic Analyzer	HP Probe Model No.	Approx Overall Length in Metres (ft)	Division Ratio	Input R	Approx Shunt Capacitance	Compensates Oscilloscope Input	Max dc Volts	U.S. list Price	
Same as 10431A but without probe identification 54502A, 54503A	10430A	1m (3.3)	10:1	10M Ω	6.5 pF	1M 6-9 pF	450	\$115	☎
54111D, 54112D	10431A*	1m (3.3)	10:1	10M Ω	6.5 pF	1M 6-9 pF	450	\$120	☎
1631A/D, 1715A, 1722A, 1725A 1726A, 1727A, 1805/09A 54200/201, 54501A, 5185	10432A**	1m (3.3)	10:1	10M Ω	7.5 pF	1M 10-16 pF	450	\$105	☎
1631A/D, 16530/31, 5185 54003A, 54200/201, 54501A	10433A	2m (6.6)	10:1	10M Ω	10 pF	1M 10-16 pF	450	\$105	☎
1740A, 1741A, 1742A, 1743A 1744A, 1745A, 1746A	10434A	1m (3.3)	10:1	10M Ω	8.5 pF	1M 18-22 pF	450	\$105	☎
1631A/D, 1715/22/25/26/27 1805/09, 54200/201, 5185	10435A	1m (3.3)	10:1	1M Ω	7.5 pF	1M 10-16 pF	450	\$115	☎
1740/41/42/43/44/45/46	10436A	2m (6.6)	10:1	10M Ω	11 pF	1M 18-22 pF	450	\$110	☎
For oscilloscopes with 50 Ω inputs	10437A	2m (6.6)	1:1	50 Ω				\$80	☎
All scopes with high Z inputs (may reduce bandwidth)	10438A 10439A	1m (3.3) 2m (6.6)	1:1 1:1		40 pF 64 pF		450 450	\$85 \$90	☎
1631A/D, 1715A, 1722A, 1725A 1726A, 1727A, 1805/09A 1950A, 54112D†, 54003A, 54111D†, 54200/201A/D†, 54502A, 54503A	10440A	2m (6.6)	100:1	10M Ω	2.5 pF	1M 6-14 pF	450	\$115	☎

Note 1: Maximum input voltage may be limited by scope input maximum volt.

*Has probe identification pin.

**The 54201A/D can use the HP 10432A or HP 10435A probes for the vertical inputs, but the HP 10435A probe must be used for trigger inputs.

†For vertical inputs only

☎ Fast ship product see page 734

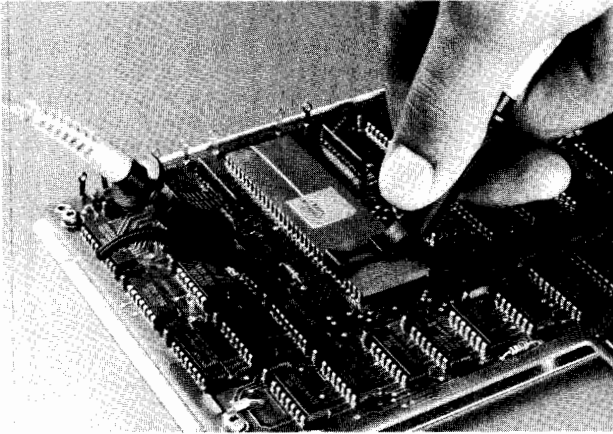

HP 10400A Family Accessories

Each 10400A family probe is shipped with one general purpose grabber, one IC grabber, and one ground lead. An accessory package is also included which contains 4 grounding spanners (for close grounds at the probe tip), 1 probe barrel insulator, 1 adjustment screwdriver, and 8 colored cable markers.

The photo above illustrates use of the IC grabber. This device fits DIPs with 0.1 inch pin spacing (standard) and up to 0.9 inch package width. It is handy for connecting the mini-probe tip to a single DIP pin. Construction prevents shorting adjacent pins during hook-up. For applications where several adjacent DIP pins must be probed, the 10024A accessory can be used (see page 66).

HP 10002A 1000V 50:1 Voltage Divider Probe

The HP 10002A voltage divider probe is a general purpose probe for use with instruments that have a bandwidth of less than 40 MHz with an input impedance of 1 megohm shunted by approximately 15 to 55 pF. The probe is rated at 1000V peak.

HP 10020A Resistive Divider Probe Kit

The HP 10020A Resistive Divider Kit is a signal probing system for measuring fast transition signals in high impedance systems. It is designed for use with 50 ohm input oscilloscopes, but may be used with other than 50 ohm systems if a 50 ohm feedthrough termination (HP 10100C) is used. The extremely low input RC of the 10020A provides high fidelity measurements of fast transition signals.

HP 10020A Resistive Dividers

Division Ratio	Input R* (ohms)	Division Accuracy	Max V** (rms)	Input C (pF)
1:1	50	—	6	—
5:1	250	±3%	9	<0.7
10:1	500	±3%	12	<0.7
20:1	1000	±3%	15	<0.7
50:1	2500	±3%	25	<0.7
100:1	5000	±3%	35	<0.7

*When terminated in 50 ohms.

**Limited by power dissipation of resistive element.

Probe length (overall): 1.2 m (4 ft).

Weight: net, 0.45 kg (1 lb); shipping, 1.4 kg (3 lb).

Accessories supplied: blocking capacitor, BNC adapter tip, 6-32 adapter tip, alligator tip, probe handle, cable assy's 5.1 cm (2 in) & 15.2 cm (6 in) ground, spanner tip, insulating caps, colored sleeves.

HP 1124A 100 MHz Active Divider Probe

The HP 1124A active divider probe provides high voltage, general-purpose probing capabilities for instruments having 50 ohm inputs without selectable high impedance inputs. This 10 Mohm 10 pF probe allows direct measurements of 100 V, in the 100:1 division ratio mode, from dc to 100 MHz. In the 10:1 division ratio mode, input voltage range is ±10 V. Power is supplied by instruments with probe power jacks or the HP 1122A probe power supply.

HP 1124A Specifications

(Measured when connected to a 50 ohm load)

Bandwidth: (measured from a terminated 50 ohm source) dc-coupled, dc to 100 MHz; ac-coupled, 2 Hz to 100 MHz.

Pulse response: (measured from a terminated 50 ohm source) transition time, <3.5 ns; perturbations, 5% p-p. Measured with pulse transition time of >2.5 ns.

Attenuation ratio: 10:1 ±5%; 100:1 ±5%.

Dynamic range: x10, ±10 V; x100, ±100 V.

Input RC: 10 Mohm shunted by ≈ 10 pF.

Maximum safe input

dc-coupled: x10, ±300 V (dc + peak ac) ≤100 MHz; x100, ±500 V (dc + peak ac) ≤100 MHz.

ac-coupled: x10, ±300 V (dc + peak ac) ≤100 MHz; dc component must not exceed ±200 V; x100, ±500 V (dc + peak ac) ≤100 MHz; dc component must not exceed ±200 V.

Accessories supplied: one 20.3 cm (8 in) ground lead, one retractable hook tip, and two probe tip insulating caps.

Power: supplied by instruments with probe power jacks or the HP 1122A probe power supply.

Weight: net, 0.2 kg (5 oz); shipping, 0.91 kg (2 lb).

Length: 1.5 m (5 ft) overall.

HP 1122A Probe Power Supply

The HP 1122A is a regulated power supply that provides all power requirements for simultaneous operation of up to four active probes.

HP 1122A Specifications

Probe driving capability: up to four HP active probes.

Power output: -12.6 V and +15 V, ±3%.

Power input: 115 V or 230 V ±10%, 48 to 440 Hz, 40 W (with four probes).

Weight: net, 2.7 kg (6 lb); shipping 3.6 kg (8 lb).

Ordering Information

	Price
HP 10002A 1000V 50:1 Voltage Divider Probe	\$230
HP 10020A resistive divider probe kit	\$495
HP 1124A 100 MHz active probe	\$350
HP 1122A probe power supply	\$1235

OSCILLOSCOPES & WAVEFORM ANALYZERS

Probes and Other Oscilloscope Accessories (cont'd)

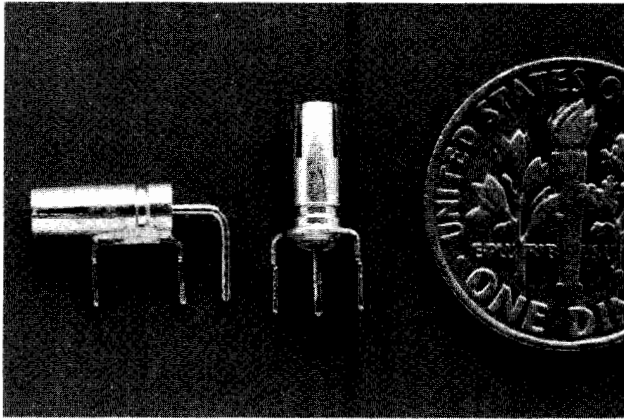

HP 1250-1737 PC Board Mini Probe Socket

The HP 1250-1737 PC board mini probe socket is ideal for breadboard circuit applications where it is desirable to make a reliable circuit connection between the mini probe tip and a test circuit (Soldering the tip itself into place is not recommended.) The HP 1250-1737 is also useful in production PC board applications as an oscilloscope test point. The probe plugs into the socket parallel to the PC board.

HP 1250-1918 PC Board Vertical Mini Probe Socket

The HP 1250-1918 is similar to the 1250-1737 (above) except that it is designed for attaching the probe vertically to the board rather than horizontally.

HP 10024A IC Test Clip

The HP 10024A IC test clip provides easy probing of dual in-line packages and includes four insulated circuit interface pins. Additional circuit interface pins are available (see Ordering Information) in packages of twelve pins. Each pin has a tip on each end so that probes such as those on HP logic analyzers can be connected for fast, functional checks of circuit operation.

Probe Accessories

Terminations

HP 10100C: 50 ohm $\pm 1\%$ BNC male to BNC female feedthrough termination.

Standard Probe Tip Adapters

HP 10229A hook tip adapter: retractable pincer tip provides firm connection to circuit nodes. Recommended accessory for HP 10020A resistive divider kit.

Ordering Information

	Price
HP 1250-1737 PC board mini probe socket	\$6.75
HP 1250-1918 PC board mini probe socket (vertical)	\$8.75
HP 10024A IC test clip (with 4 circuit interface pins)	\$20.00
HP 10024-69501 interface pin kit for HP 10024A; includes 12 interface pins.	\$39.00
HP 1250-1454 BNC-to-mini probe adapter	\$13.50
HP 10229A retractable hook tip adapter	\$20.00
HP 10100C 50 ohm feedthrough termination	\$40.00

Testmobiles

The low-priced HP 1180A Scope cart is designed for HP 545XX, HP 542XX Digitizing Oscilloscopes and HP 163X, HP 165X Logic Analyzers. A quick-connect strap enables users to easily remove or replace the scope on the cart. The large casters give excellent stability and smooth maneuverability. The top shelf tilt angle is adjustable to optimize the oscilloscope's viewing angle. The back of the cart has power cord storage and mounting provisions for a five outlet U.S. power strip (not included, order part number HP 92199B). FOR LARGER, HEAVIER INSTRUMENTS, USE THE HP 1008A (SEE SPECIFICATIONS BELOW)

Testmobile Specifications

	HP 1008A	HP 1180A
Height	930 mm (36.6 in)	890 mm (35.0 in)
Overall width	759 mm (29.8 in)	475 mm (18.7 in)
Width of tray	473 mm (18.6 in)	456 mm (18.0 in)
Tilt tray angle	$\pm 30^\circ$	$+30^\circ$
Weight	net	13 kg (28 lb)
	shipping	22 kg (48 lb)
Max load on tilt tray		22 kg (48 lb)
		30 kg (66 lb)
Max load below tilt tray		20.5 kg (45 lb)
	see option 006 description	25 kg (55 lb)

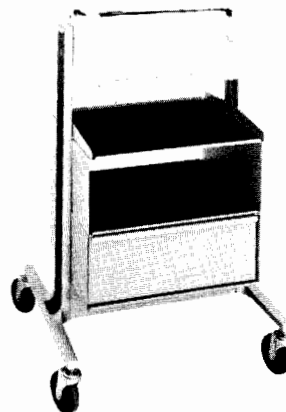

Opt 006: storage cabinet with shelf on top and drawer in lower position; load limit 18 (40 lb) each on shelf and in cabinet, 11 kg (25 lb) in drawer.

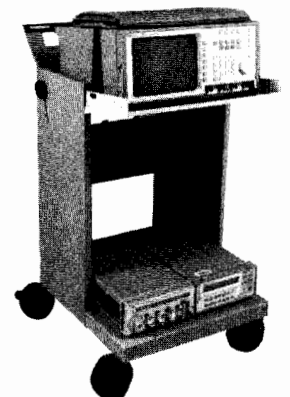

HP 1180A: New low-priced testmobile for the HP 54501A, HP 542XX, HP 163X, and HP 165X.

Ordering Information

HP 1180A Testmobile	\$290.00 ☒
HP 1008A Testmobile	\$970.00 ☒
HP 1008A Opt 006 Added shelf and cabinet for 1008A	\$270.00 ☒
HP 92199B U.S. Power Strip for HP 1180A	\$36.00 ☒

☒ Fast-ship product - see page 734.



HP 1133A TV/Video Sync Pod

- Clamped or unclamped video output.
- Trigger output for line and frame.
- For most standard broadcast composite video systems
- Compatible with most analog & digitizing scopes

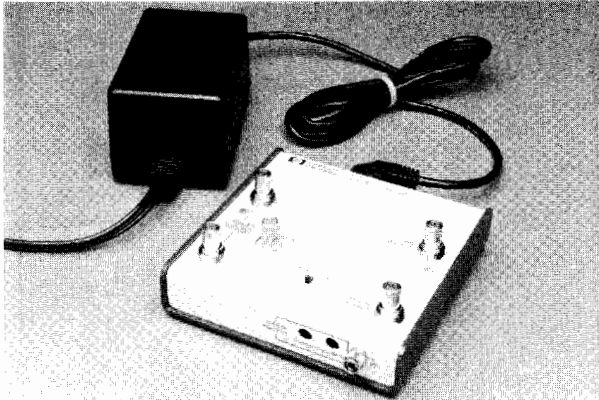

The HP 1133A TV/Video Sync Pod is an accessory that provides users with TV sync triggering for most analog or digitizing oscilloscopes. It features clamped or unclamped video outputs that can be viewed on the oscilloscope's vertical channels and trigger outputs that can synchronize the oscilloscope to video frame and individual lines.

The pod itself is packaged in a case approximately 14x14x4.5 cm (5.5x5.5x1.75") and is powered by a separate ac power module. The pod features a loop-thru input (two female BNC) which can be driven from a 75 ohm source, or for probing high impedance circuits, from a 1-10 megohm probe. The loop-thru feature allows 75 ohm signal to be looped through the TV/Video pod then connected to a video monitor or other 75 ohm device. Clamped or unclamped video outputs are designed to drive a high impedance probe (1-10 megohm) connected to the oscilloscope input.

The HP 1133A is compatible with broadcast standards M, N, C, B, G, H, I, D, K, K1, and L systems.

Characteristics

Video input: AC coupled with an RC of 1 megohm shunted by approximately 10 pF.

Bandwidth: Approximately 10 MHz

Maximum input voltage: 40 Volts (DC plus peak AC)

Frame output is phase locked to the leading edge of the third field synchronizing pulse on field one, to the leading edge of the second pulse on field two. Frame output goes high on field one, and low on field two.

A switch is provided for positive or negative sync pulse polarity.

A gain control is provided to adjust for signal amplitude at BNC input.

Gain from input BNC to unclamped output is approximately 2.5 to 50.

Ordering Information

Note: The 1133A must be ordered with a power supply option.

HP 1133A TV/Video Sync Pod	\$275.00
Opt ABA Power supply for U.S.A., 120V, nema 515P plug	N/C
Opt ABB Power supply for Europe, 220V CEE7-VII plug	N/C
Opt ABJ Power supply for Japan, 100V nema 515P plug	N/C
Opt ABU Power supply for United Kingdom, 240V BS1363 plug	N/C

HP 54300A PROBE MULTIPLEXER

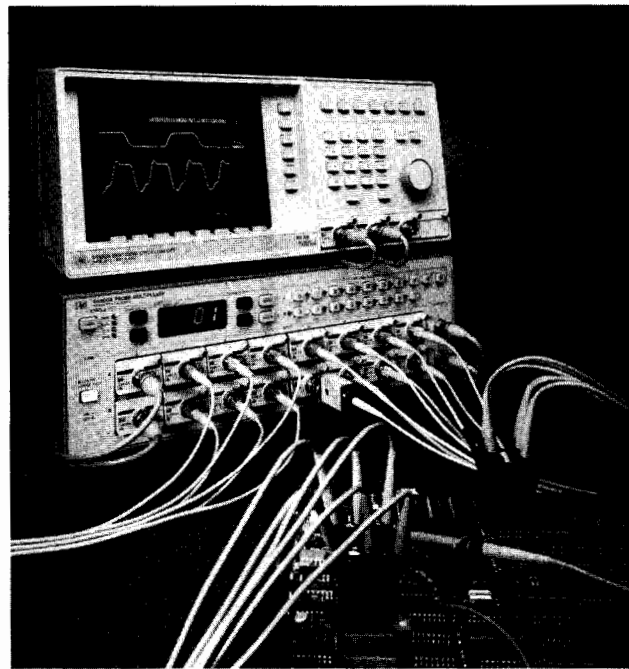

The Multi-input Tool For 50Ω Instrumentation

The HP 54300A is a programmable, dual eight-to-one probe multiplexer designed to expand the input capability of instrumentation with 50Ω inputs. The unique strength of this multiplexer is its configurability. The user may select from three different input pods: two high-frequency, high-impedance probes, or a 50Ω BNC input for terminated line applications.

The HP 54300A features full HP-IB programmability as well as simple front-panel control. It has internal non-volatile memory for storing lists of switching steps. Switch lists can be advanced step-by-step from a front-panel button, over the HP-IB (i.e., IEEE-488) or for data logging applications, through a TTL pulse entered at the rear panel.

HP 54001A 1 GHz Active Mini-probe Pod

This pod, with its built-in probe, offers 1 GHz bandwidth with 10kΩ/2 pF input loading. It uses HP's mini-tip probe for easy access in compact circuits, and features both high-bandwidth and high-impedance at the probe tip.

HP 54002A 50Ω BNC Pod

This pod should be used with terminated 50Ω systems. Output from the multiplexer using this pod is <2 dB down at >1 GHz. The 54002A is also useful with divider probes such as the HP 10020A.

HP 54003A 300 MHz 1 MΩ Probe Pod

This pod, with a 10:1 detachable mini-tip probe, has 1 MΩ resistive and 8 pF capacitive loading. It is valuable when resistance is a more significant loading factor than capacitance, such as in operational amplifier measurements. If desired, the probe may be removed from its pod to provide a 1 MΩ approximately 10 pF BNC input.

Ordering Information

	Price
HP 54300A dual 8:1 probe multiplexer	\$7900
Includes one operating and programming manual. Each HP 54300 accepts up to 16 input pods in any combination. Pods must be ordered separately.	
Opt. 908 Rackmount flange kit	\$35
HP 54001A 1 GHz miniature active probe pod	\$765
HP 54002A 50Ω BNC input pod	\$130
HP 54003A 1MΩ 10:1 probe pod	\$665

OSCILLOSCOPES & WAVEFORM ANALYZERS

Precision Digitizing Oscilloscopes

Models 5180T/U, 5183T/U

- HP 5183T/U: 12-bit resolution, 4 Msamples/s, up to 512-ksample memory
- HP 5180T/U: 10-bit resolution, 20 Msamples/s, 16-ksample memory
- 2 channel operation (4 channels for HP 5183U and HP 5180U)

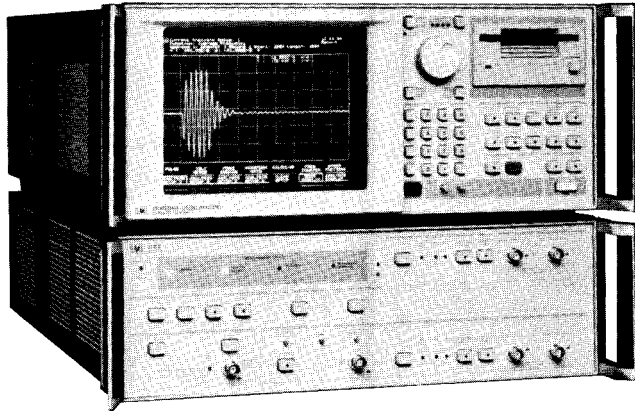

HP 5183T (5183U, 4 channels—not shown), see page 70 for more information.



Precision Digitizing Oscilloscope

The oscilloscope has been one of the fundamental engineering tools for many decades. It is a general purpose instrument, which provides the same measurement answers as racks of instrumentation. Voltage, frequency, phase and many more parameters can be measured using an oscilloscope, but it usually involves laborious human intervention to count graticules and interpret data. Also, until the storage scope, most transient measurements could not be performed.

With the advent of digitizing oscilloscopes, the tedium involved in taking data from a waveform has been vanquished. The production line no longer needs the single, dedicated instruments, customized to take a voltage or time measurement. The digitizing scope can “capture” the waveform, and preprocess the signal to provide single number answers so that the technician or computer can make simple “go” or “no go” decisions. Waveforms can be stored enabling characterization and correlation between runs.

Accuracy unrealized by oscilloscopes is obtained by this new series of precision digitizing oscilloscopes. Measurements with standard analog oscilloscopes produce approximately 30 dB of dynamic range; the HP 5183T/U and 5180T/U precision digitizing oscilloscopes have 72 dB and 60 dB of dynamic range respectively.

Built-in Analysis Package

HP precision digitizing oscilloscopes provide many analysis features. These features give the designer or technician the information he needs in real time without resorting to the use of sophisticated external software to manipulate the data.

Precision Pulse Measurements

These oscilloscopes provide pulse measurements according to the IEEE-194 standard. The designers can also define their own pulse characterization environment. Risettime or falltime are provided with the touch of a finger in the analysis menu. Positive and negative

- Dual domain analysis
- High-quality 2048 x 2048-point vector display
- Complete HP-IB programmability
- 60 dB or 72 dB of dynamic range



HP 5180U (5180T, 2 channels—not shown), see page 72 for more information.



pulse widths along with duty cycle and amplitude are other statistics available. Also included at a single touch are overshoot and undershoot.

Real Time Conversion to Frequency Domain

With the introduction of the precision digitizing oscilloscope, the designer can now do some frequency domain analysis with the same instrument that does the time domain analysis. Both domains can be observed and characterized simultaneously. An FFT is performed on the time record using either a Hann, Uniform, Flat Top or user defined window. The magnitude and the phase spectrums can then be computed and displayed independently using the flexibility of the instruments.

Waveform Math and Calculus

Two waveforms can be manipulated mathematically by adding, subtracting or multiplying them together. This gives the designer the ability to experiment quickly with modulation, performing experiments on raw data before breadboarding is done. Afterwards, the data can be gathered from the actual circuit and compared against the theoretical data. All this is accomplished without the aid of external computational equipment.

Incoming signals, or waveforms in memory can be integrated or differentiated, resulting in a waveform that lets the designer bypass special purpose hardware or computer programming. The DC drift of a circuit is easily quantifiable using integration in the analysis feature set. High frequency components of a signal are easily identifiable by integrating an incoming signal and placing it either underneath the signal, or combining the two traces into one display.

Waveform Reconstruction means Readable Displays

A common complaint when using digitizing oscilloscopes, is that the representation of the data is not always optimum. The following two figures show the same waveform; the top waveform has used the waveform reconstruction algorithm, built into the HP 5183T/U and 5180T/U, and the bottom waveform shows the data with the reconstruction

feature turned off. The top graph is also the representation that would be viewed on a storage oscilloscope.

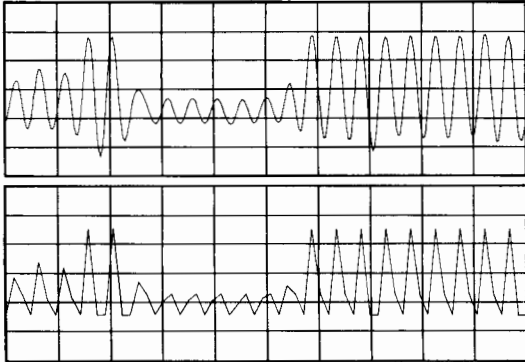

Reconstruction gives designers a truer representation of the data, allowing them to continue thinking in the analog time domain.

Flexibility in Data Presentation

These digitizing oscilloscopes are extremely friendly as bench top instruments. One to four traces can be displayed, with the designer determining what the traces consist of and how they are displayed. As with analog oscilloscopes, continuous or single-shot waveforms can be displayed. Here the similarity with analog scopes ends; the precision digitizing oscilloscope can also display waveforms stored in memory, or signals that have been processed using the analysis functions inside the scope. These oscilloscopes can display analyzed data and the original measurement continuously as the signals are digitized. Once the waveform has been digitized, the display can be manipulated by zooming in on an interesting section, or changing the gain and offset to show more fine details.

Permanent Copies of Waveforms

The HP 5183T/U and 5180T/U provide two ways to create permanent copies of waveforms or processed signals. With the optional

internal floppy disc, up to 250 1K records can be stored. In addition to storing captured and processed waveforms, the entire state of the instrument can be stored so that complex series of instrument setups can be recalled at a touch, leaving the designer or technician to concentrate on the device under test, and not setting up instruments. The waveforms are formatted in Hewlett-Packard's LIF directory, permitting the recorded disc to be used with any of the HP 9000 series 200 and 300 computers. In addition to storing the binary waveform, each file is time stamped.

Hardcopies of the display can also be created without the aid of a controller. This series of precision digitizing oscilloscopes operates most HP plotters (see the data sheet for a complete list of the supported plotters).

Precision Measurements with Cursors

Two cursors are provided for making accurate measurements. A reference level, settable by the operator, is used to make voltage measurements; timing measurements are taken with respect to the trigger point. The difference between two cursors is also available for voltage, timing, frequency and decibels. Measurements using the delta cursors feature can be made on a single trace, or between two different traces being displayed.

Quick timing, frequency, voltage and power analysis can be accomplished using a single cursor. Once the cursor is placed on the desired waveform, the minimum and maximum can be determined with a single touch. A single keystroke places the cursor on the next minimum, maximum, or zero crossing which reveals waveform details without the user having to perform a tedious search.

Battery Backed up Instrument Settings

Four instrument settings may be stored, but five can be recalled. The fifth memory location contains the instrument environment that was present before the last recall, which means that a complex instrument setting won't be overwritten by accident. This gives the designer or technician the ability to determine the exact instrument settings, and then auto-sequence through five different test setups. The ram that stores the front panel settings along with the internal clock is backed up by a lithium battery.

Common Analysis Features

Pulse characterization

Rise time, fall time, baseline, topline
+ width, - width, overshoot, period
frequency and duty cycle

Voltmeter

Peak to peak, rms and period rms

Frequency Domain

Power spectrum, phase spectrum and magnitude spectrum

Available windows

Uniform, Hann and Flat Top

Waveform math

Add, subtract and multiply

Calculus

Integrate and differentiate

Frequency Counter

Average frequency and event crossing

Miscellaneous functions

Minimum hold, maximum hold and extract

Cursor functions

Waveform maximum, waveform minimum, next maximum, next minimum, next crossing, next positive crossing and next negative crossing

Display functions

X zoom, X position, Y gain, Y offset,
reconstruction and dot or line mode

Plotting

Plot waveforms with most HP plotters

Mass storage

Using 3.5 inch floppy discs, when option 035 is installed

See pages 70 and 71 for more information on the 5183A/T/U.
See page 72 and 73 for more information on the HP 5180T/U.

OSCILLOSCOPES & WAVEFORM ANALYZERS

Precision Digitizing Oscilloscope

Model 5183T/U

- Differential inputs
- Adaptive Sample Rate
- Dropout trigger
- 256K word per channel optional memory
- Complete calibration to probe tip
- Configurable as two or four channels

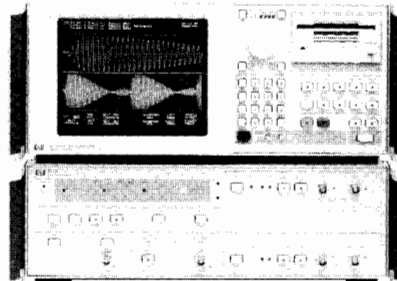

HP 5183T

Unbeatable measurement resolution & accuracy

The HP 5183T/U provides many features unavailable from any other digitizing oscilloscope. Trigger features allow data acquisition that was previously either impossible, or required complex external trigger circuitry. The optional 512K word memory allows long continuous records to be acquired. In one channel operation, channel one can be configured to have 512K samples with option 512 installed. Adaptive Sample Rate gives the benefit of catching glitches that would ordinarily escape detection. The burst timebase feature allows samples to be gathered in packets of samples as small as 1 sample per trigger point. Calibration is now possible out to the probe tip providing greater absolute accuracy.

Enhanced trigger capability

As with the other Hewlett-Packard waveform recorders, post- and pre-triggering are available. This permits viewing of the trigger point, the events leading up to the trigger point, or events that occur long after the trigger has occurred. Dropout trigger provides the capability to trigger on the absence of a signal. This means that the HP 5183T/U can be used to monitor a signal source such as a power main. The recorder can be configured with auto advance to capture up to 256 1K records showing dropouts, when Option 512 is installed.

Delay trigger is used in the following manner. A trigger event occurs at the external trigger input. Then, when a user defined delay elapses, the recorder will wait for the proper internal trigger and record in the operator defined environment. This can be used for recording signals such as a specific sector on a magnetic disc, using the index pulse as the external trigger, and the approximate delay to the proper sector.

Trigger-on-all allows the trigger circuitry to be or'ed together internally. This trigger scheme is also available in four channel operation, with two recorder sections being used together. This allows the designer to set up triggering conditions for the channels, and whichever event occurs first, will cause synchronous triggering and sampling in all channels.

High frequency trigger will cause the recorder to trigger on a glitch of sufficient amplitude or other large high frequency components in the waveform. This is only available with the optional Adaptive Sample Rate.

ASR (Adaptive Sample Rate - Option 301)

ASR provides rapid sampling only when it is needed, conserving memory where possible. With this option, the recorder samples at a slow speed until high-frequency energy is detected. When this occurs, the timebase switches to a higher speed to capture the high-frequency signal, returning to the slower speed when the high-frequency component ceases. For some signals, particularly those with low duty cycles, the maximum effective memory length can be increased (by a factor approaching 64) to approximately 30 million words.

HP 5183T/U Specifications*

Channel 1 and 2 inputs

- Maximum sensitivity (nominal):** 50 μ V.
- Input attenuator ranges:** \pm 100 mV to \pm 50 V (full scale).
- Input offset voltage:** \pm 200% of input attenuator range.
- Input bandwidth (nominal):** ($-$ 1 dB) 1 MHz, ($-$ 2 dB) 3 MHz with filter (10 pole), ($-$ 4 dB) 1 MHz, ($-$ 6 dB) 3 MHz.
- Input impedance (nominal):** 1 M Ω in parallel with 45 pF.
- CMRR at 10 kHz:** 60 dB on 100 mV to 1 V ranges.
- Damage level:** \pm 5 V (dc plus peak ac) on 100 mV to 1 V ranges. 400% of range (dc plus peak ac) on 2 V to 50 V ranges.

Dynamic performance after calibration

- Harmonic and spurious distortion:** \leq $-$ 65 dBc.
- Effective bits:** 10.0 at 95% of full scale range.

Triggering

- Internal trigger:** level and sensitivity selectable over input voltage range.
- External trigger:** level selectable over \pm 5 V range, in mV increments.
- Internal source:** channel 1, channel 2, drop-out, delay, trigger-on-all, or high frequency trigger (with Option 301).
- Measurement control:** auto, normal, single, manual trigger.
- Settable:** level, hysteresis, position, drop out delay, delay from external trigger (sequential trigger).
- Slope:** +, $-$, or bi-trigger (internal only).
- Trigger position:** $-$ 100% to + 6400% of record length

Timebase

- Internal timebase:** 4 MHz reference, sample intervals are between 250 ns and 4 s, in 250 ns increments.
- Aging rate:** \pm 3 \times 10 $^{-6}$ /year after 10 days of power.
- Temperature:** \pm 2 \times 10 $^{-3}$, 0 to 50 C.
- External timebase:** 1, 4 or 10 MHz.
- External encode:** 1 μ Hz to 2.1 MHz or 1.9 MHz to 4 MHz.
- Option 010**
 - Timebase:** 4 MHz is locked to high-stability 10 MHz reference.
 - Aging rate:** 2 \times 10 $^{-7}$ /year after 10 days of power.
 - Temperature:** 7 \times 10 $^{-9}$, 0 to 50°C.

Memory

- Size:** 64k words per channel standard. With Option 512 installed, 256k words per channel, also configurable as a single 512k word record for channel 1.
- Segmentation:** memory can be configured as a single 131,072 word record for channel A, or between 1 to 64 equal length records for channel A and B.
- When Option 512 is installed, memory can be configured as a single 524,288 word record for channel A, or between 1 and 256 equal length records for channel A and B.
- ASR (Adaptive Sample Rate):** Slows timebase by a 1:64 rate when high frequency energy is not present; Option 301.

*See HP 5183T/U Data Sheet for more information. See page 24 for ordering information.

OSCILLOSCOPES & WAVEFORM ANALYZERS

Waveform Recorder and Ordering Information

Models 5183A/T/U

71

- 72 dB of dynamic range for analysis
- New high measurement throughput BASIC driver software
- Systems of up to 64 channels
- Adaptive sample rate

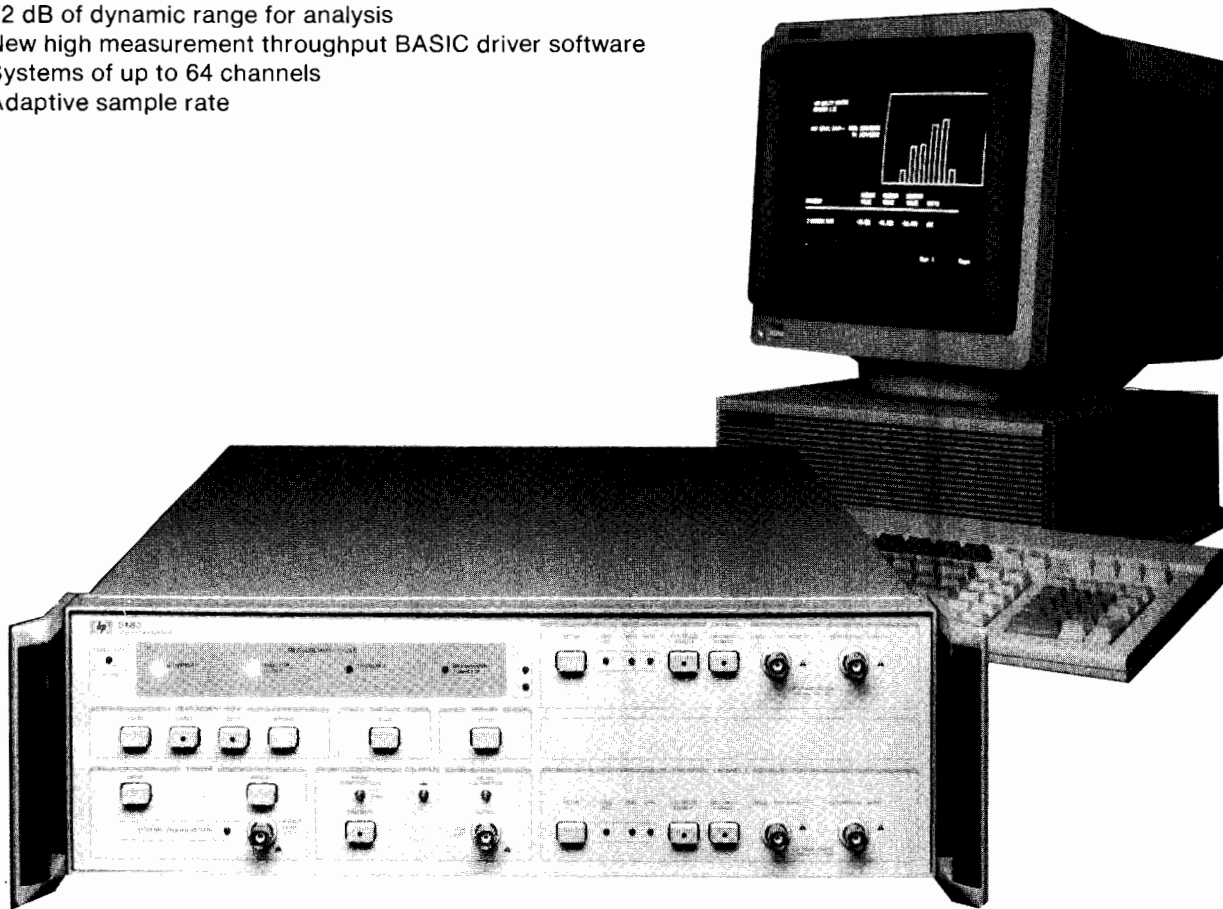

HP 5183A

HP 5183A Waveform Recorder

High Throughput for Automated Measurements

For those applications that require the superb fidelity of the HP 5183T, but not the analysis, display or real time control, the HP 5183A is an excellent solution. The HP 5183A is not a stand-alone instrument, but functions as a digitizing front end to a computer. New HP BASIC driver software, optimized for speed, helps to set up, take measurements, and transfer data at high speeds to an HP 9000 Series 200/300 workstation or HP Vectra PC. The HP 5183A's auto-advance feature can yield up to 70 measurements (1K words) per second with re-arm time as short as 13 ms.

HP 5183A Condensed Specifications*

Channel 1 and 2 inputs

Maximum sensitivity (nominal): 50 μ V.

Input attenuator ranges: \pm 100 mV to \pm 50 V (full scale).

Input offset voltage: \pm 200% of input attenuator range.

Input bandwidth (nominal): (-1 dB) 1 MHz, (-2 dB) 3 MHz with filter (10 pole), (-4 dB) 1 MHz, (-65 dB) 3 MHz.

Input impedance (nominal): 1M Ω in parallel with 45 pF.

CMRR at 10 kHz: 60 dB on 100 mV to 1 V ranges.

Damage level: \pm 5 V (dc plus peak ac) on 100 mV to 1 V ranges. 400% of range (dc plus peak ac) on 2 V to 50 V ranges.

Dynamic Performance at 1 MHz Signal Input after Calibration

Harmonic and spurious distortion: \leq 65 dBc.

Effective bits: 10.0 at 95% of full scale range.

Triggering Characteristics

Internal trigger: level and sensitivity selectable over input voltage range.

External trigger: level selectable over \pm 5V range, in mV increments.

Internal source: Channel 1, Channel 2.

Measurement control: auto, normal, single, manual trigger.

*See HP 5183A Recorder Data Sheet (Pub 5952-7933D) for more information.

Settable: level, hysteresis, position.

Slope: +, -, or bi-trigger (internal only).

Trigger position: -100% to +6400% of record length.

Time Base

Internal time base: 4 MHz internal time base allows sample rates between 250 ns and 4 s, in 250 ns increments.

External time base: 1, 4 or 10 MHz.

External encode: 1 μ Hz to 2.1 MHz or 1.9 MHz to 4 MHz.

Memory

Size: 64k words per channel standard. With Option 512 installed, 256k words per channel, also configurable as a single 512k word record for channel 1.

Ordering Information

	Price
HP 5183A Waveform Recorder 2-Channel (includes an interconnect cable and software for control and data transfer on the HP 200 and 300 series computers). Requires host computer for operation.	\$14,500
HP 5183T Digitizing Oscilloscope 2-Channel (includes waveform analyzer, 2-channel recorder section, and interconnect cables)	\$25,300
HP 5183U Digitizing Oscilloscope 4-Channel includes waveform analyzer, 2 two-channel recorder sections, and interconnect cables.	\$37,900
Options for HP 5183A/5183T	
Opt 301 Adaptive Sample Rate	+\$3,450
Opt 512 512K Word Memory	+\$5,750
Options for HP 5183T	
Opt 010 Oven Oscillator	+\$1,325
Opt 035 Floppy Disc Drive	+\$1,100
Options for HP 5183U	
Opt 010 Oven Oscillator	+\$1,275
Opt 035 Floppy Disc Drive	+\$1,050
Opt 301 Adaptive Sample Rate	+\$6,500
Opt 512 512K Word Memory	+\$10,950

OSCILLOSCOPES & WAVEFORM ANALYZERS

Digitizing Oscilloscope and Waveform Recorder/Measurement System

Models 5180T/U, 5180A, 5180S, 5180A

- High quality display
- Built-in analysis provides answer and raw data
- Utilizes the HP 5180A for quality digitization
- 16K memory records up to 32 waveforms
- High-speed signal acquisition
- Accurately digitizes transient signals
- Up to 1 million words/s data transfer

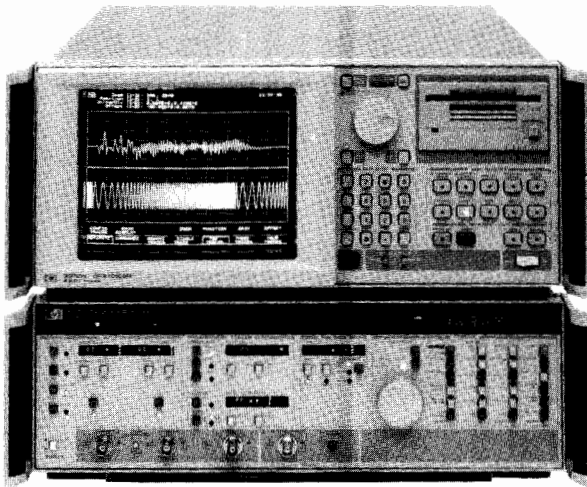

HP 5180T (HP 5180U not shown)

HP 5180T/U

Automatic Analysis

The HP 5180T/U delivers answers normally associated with other instruments such as time interval counters, voltmeters, spectrum analyzers, and storage oscilloscopes. Unlike other instruments, these digitizing oscilloscopes require only one waveform capture to get results. After you capture your signal, you can view it as you would with a storage oscilloscope; you can zoom in to view details, analyze pulses, view its frequency spectrum, and measure its rms or peak-to-peak amplitude - all using the same signal.

Dynamic Performance

Dynamic (ac) performance can mean the difference between just looking at a waveform or completely analyzing it. To help you analyze your signals thoroughly, the HP 5180T/U provides 10-bit resolution for waveform data while delivering fully specified, high-fidelity dynamic performance.

Automatic Setup

The display provides many convenient features that enhance the system's waveform capture. For example, the AUTOSCOPE function acquires repetitive waveforms and automatically sets the input amplifier, trigger level, and time base to the appropriate values for optimum signal viewing. Existing front-panel settings are automatically saved in non-volatile RAM when AUTOSCOPE is pressed. You can also save up to four additional front-panel setups for recall at your convenience. An optional built-in floppy disc, which is compatible with those for the HP 9000 Series 200 and 300 Computers, lets you store both front-panel settings and captured waveforms. See page 26 for condensed specifications and ordering information.

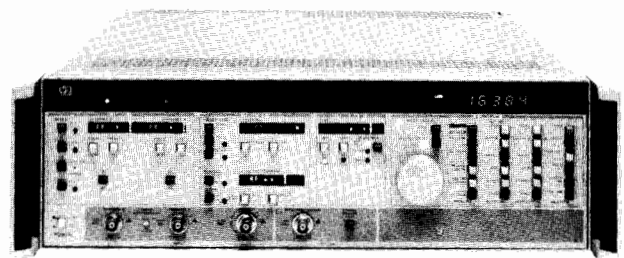

HP 5180A

HP 5180A

High Quality Samples Every 50 Nanoseconds

Signal processing requires high quality input data. Hewlett-Packard's 5180A Waveform Recorder digitizes and stores single-shot or repetitive signals. Voltage waveforms are digitized at sampling rates up to 20 M sa/s (50 ns/sample). Each voltage sample is encoded into a 10-bit word and stored into the memory. These precise voltages (and times) can be read from the front panel with cursors.

Excellent dynamic performance (please read HP Product Note 5180-2) means the ADC does not break up for higher input frequencies. Therefore, your signal is accurately represented for analysis (and replay; see the next pages for description of the HP 5182A Waveform Recorder/Generator).

Accurately Digitize Transients - The shape of fast attack and decay single-shot waveforms is preserved because the higher frequency components are accurately digitized. The digital trigger is precisely settable ensuring reliable triggering with no drift. Selectable hysteresis eliminates false triggering due to noise.

View Single-shot or Repetitive Signals Quickly

The HP 5180A controls external XYZ displays and hardcopy devices to show the contents of memory records without the need for a computer. Zoom and Gain features expand displayed waveforms horizontally or vertically to look in detail at a selected portion of a waveform. Dual trace capability puts two waveforms on an external display for visual comparison. Digital plotters and printers are controlled by HP-IB. There are two methods of transferring data from the HP 5180A to a computer for analysis: HP-IB and DMA. Direct Memory Access (DMA) can transfer data at a rate up to 1 million words/second, depending on the computer.

The HP 5180A can begin recording a signal at one sampling rate and then switch to another. The switch point is selectable. Set one timebase at a faster sample rate to record more detail, and set the other at a slower rate to conserve memory space. Two transients may be recorded simultaneously using the HP 5180A's input CHOP mode.

The HP 5180A is fully programmable over HP-IB for automated operations. See page 26 for condensed specifications and ordering information.

- Automatic measurements
- Universal measurement solutions
- Modular software

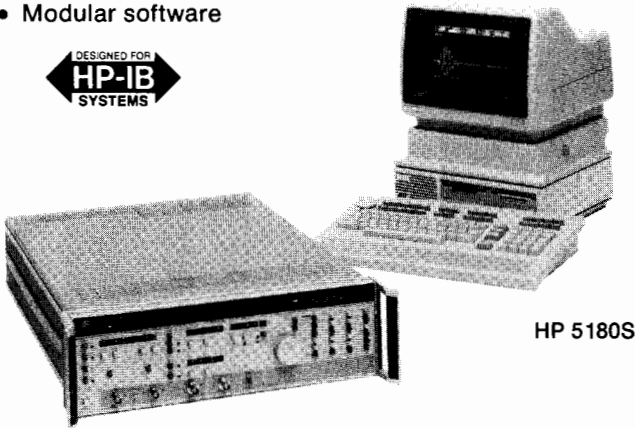

HP 5180S

HP 5180S and HP 51800A

Automatic Time Domain Measurements

Make time domain measurements on single-shot or repetitive waveforms with the HP Model 51800A Waveform Measurement Library. The library is a collection of programs designed to make measurements on signals captured by the HP 5180A Waveform Recorder and HP 5182A Waveform Recorder/Generator. Instruments are controlled by sub-programs. All you do is chain them together to make the measurements you need.

Realize the Power of a Waveform Recorder by Interfacing it to an HP Series 200 or 300 Technical Computer

The HP 5180S Waveform Measurement System allows you to configure a computer-controlled system based on the HP 5180A Waveform Controller. Because the signal has been digitized and stored, it can now be sent to a computer for analysis and then to a disc for permanent storage. Frequency, Period, Pulse Width, Rise/Fall Time, Volts rms and Volts p-p are some of the many standard measurement programs.

HP 5180A/T/U Specifications

See HP 5180A Waveform Recorder or HP 5180 T/U Digitizing Oscilloscope Data Sheet (Pub 5952-7722D & 5952-7835D) for more information.

Channel A and B Inputs

Maximum sensitivity: 200 μ V.

Input attenuator range: \pm 100 mV to \pm 10 V (full scale).

Input offset voltage: \pm selected Voltage Range.

Amplifier bandwidth (-3 dB): dc to 40 MHz (dc coupling).
10 Hz to 40 MHz (ac coupling).

Input impedance (NOMINAL): 1 M Ω || 40 pF (10 V range).
1 M Ω || 35 pF (other ranges).

Damage level: \pm 12 V above 1 kHz.

Dynamic Performance (at 1 MHz)

Harmonic and spurious distortion: -50 dBc

Effective bits: 7.8

Triggering

Internal trigger: level and sensitivity selectable over input voltage range.

External trigger: level selectable over \pm 2.5 V range.

Trigger position: -100% to +9999% of memory.

Timebase

Internal timebase: 20 MHz internal timebase allows sample rates between 50 ns and 50 ms in a 1-2-5 sequence.

External timebase: external timebase signals between 1 MHz and 20 MHz may be used. Internal divide ratio between 1 and 10⁶ in a 1, 2, 5 sequence.

- Increase test design productivity
- Choose standard measurements
- Add custom tests

Memory

Size: 16,384 10-bit words.

Segmentation: memory may be divided into 1, 2, 4, 8, 16, or 32 equal-length records.

Outputs

XYZ CRT monitor outputs: X, Y deflection voltages (NOMINAL) -1 to 0V into 50 Ω . X requires 1 MHz bandwidth input; Y requires 5 MHz bandwidth input. Z voltage (NOMINAL) is 0 to 2 V into 1 k Ω (0 to 1V into 50 Ω), selectable positive or negative going blanking pulse. Z requires 1.25 MHz bandwidth input.

HP-IB: all front panel function values selectable via HP-IB. Data I/O in ASCII or binary; maximum 3 Kbyte/second rate, depending on controller. "Talk only" to HP-GL plotters available even if no controller is used.

DMA: direct memory access allows fast parallel data transfer; maximum 1M word/second, depending on controller.

General

Operating temperature: 0°C to 55°C.

Power requirements: 100/120/220/240 volts +5%, -10%; 48 to 66 Hz. Max power dissipation 500 VA.

Weight: 22 kg (48 lb) net; 25 kg (53 lb) shipping.

Size: 142 mm H x 426 mm W x 574 mm D (5⁵/₈" x 16³/₄" x 23").

Ordering Information

HP 5180A Waveform Recorder

Price

\$27,200

HP 5180S Waveform Measurement System

N/C

To ensure coordination of shipments and compatibility of instruments, computers and software, use the system model number when ordering the individual components, including peripherals such as printers and plotters. Obtain an HP 51800A Data Sheet and HP 5180S Ordering Guide from your local sales office. See page 00.00.

HP 51800A Waveform Measurement Library

\$1,525

HP 5180T Digitizing Oscilloscope (2 Channel) includes waveform analyzer, two-channel recorder section, and interconnect cables

\$41,800

HP 5180U Digitizing Oscilloscope (4 Channel) includes waveform analyzer, 2 two-channel recorder sections, and interconnect cables

\$68,900

Accessories for HP 5180A

HP 10871B Service Kit

\$6,350

HP 10873A Rack Mount Kit

\$210

HP 10874A Slide Mount Kit

\$265

HP 10875A 4.8 m DMA Cable

\$255

HP 10875B 1.0 m DMA Cable

\$255

Options for HP 5180A

Opt 910 Additional Manuals

+\$360

Option for HP 5180T/U

Opt 035 Floppy Disc

+\$1,150

Accessories for HP 5180U

HP 1008A Testmobile

\$970

Opt 006 Storage Shelf and Lower Cabinet

+\$270

To ensure coordination of shipments and compatibility of instruments and peripherals such as printers, plotters, and disc drives, it is important that you request the appropriate Data Sheets and Ordering Guides from your local sales office.

OSCILLOSCOPES & WAVEFORM ANALYZERS

Waveform Recorder/Generator, 20 MHz, 10 Bits, 16K Word Memory
Model 5182A

- 16K nonvolatile waveform memory
- Fully programmable via HP-IB
- Quickly transfer waveforms to/from computer
- Easily simulate complex, real signals
- Record single-shot, replay repetitively

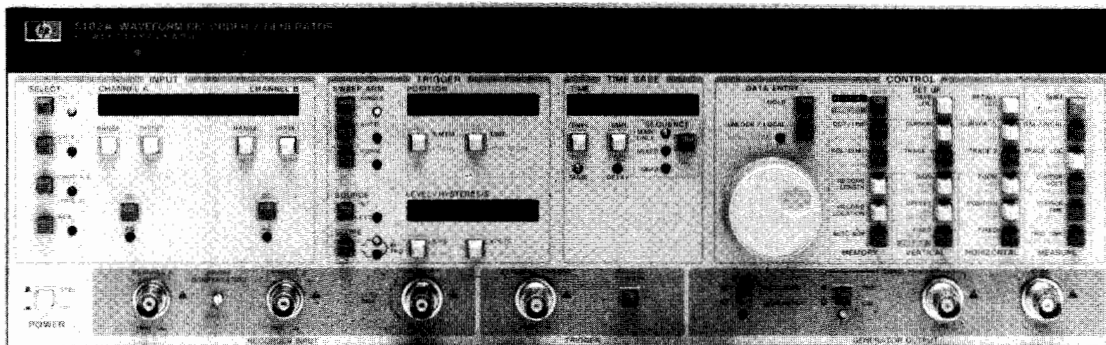

Duplicate Infrequent Waveforms Whenever You Need Them

Get an "instant replay" of your single shot signal when you buy a HP 5182A Waveform Recorder/Generator. Also create repetitive signals by playing back a single recording over and over again with no time gap between replays.

Now you can test your circuits with the actual signal you record rather than a theoretical one. "What if" testing can be done by adding a computer to modify and store the waveforms. An HP Series 200/300 Technical Computer, HP 9111A Graphics Tablet and an HP 5182A comprise the HP 5182S Waveform Generation System.

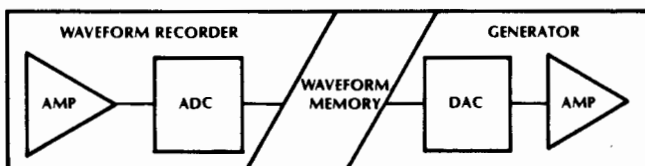

A Waveform Recorder/Generator is a High Speed Digital "Tape" Recorder

The "tape" is silicon memory. At 20 M samples per second, it can store 819 μ s, 819 seconds at 20 samples per second. This digitized waveform can be played back once, or over and over again with no time gap. For example, you can accurately store 16 separate lines of video, or a single sector of data from a floppy disc drive. The video signal can generate color bar patterns to test video circuits. The disc signal can be used to test read-recovery circuits.

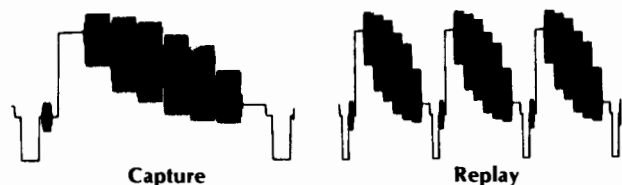

Capture and Save in the Field, Replay on the Bench

Continuous (battery backed up) waveform memory allows you to record up to 32 waveforms on site. Remove the power and carry the HP 5182A back to the lab. Now you can play them back to test your circuits or for further analysis. Attach the HP 5182A to an HP Series 200/300 Technical Computer and you can store the waveforms on disc, process them further and modify them for "what if" testing.

Simulate Expensive, Single-Shot Experiments

Some experiments can be very time consuming and expensive to repeat, for example: biomedical experiments, measurements of explosions, and propagation experiments such as radar and sonar. With the HP 5182A you can capture the signal accurately, when it occurs. Then, switch to generator mode, and you're ready to replay it, any time you need it.

A sync pulse is generated once per playback cycle for synchronizing other equipment.

Generator Section Specifications

For accessories and specifications of the recorder section, please see page 00.00.

Peak output voltage (for full-scale waveform) into 50 ohms

Range	Vernier Range		Vernier Step Size
	Min	Max	
5.12 V	520 mV	5.12 V	40 mV
512 mV	52 mV	512 mV	4 mV
51.2 mV	5.2 mV	51.2 mV	0.4 mV

Max. output voltage into open circuit: 10 V (NOMINAL).

Output offset: -5.12 V to +5.11 V in 10 mV steps into 50 ohms.

AC Performance: Noise: -65 dBc.

Harmonic distortion (dc to 1 MHz): -48 dBc.

Spurious (sample rate related): -40 dBc TYPICAL.

Output risetime: 100 ns max. (10% to 90%).

Amplifier bandwidth (-3dB): 10 MHz (NOMINAL)

DC performance (10 bits resolution per sample)

Differential nonlinearity: <1 LSB (Monotonic).

Integral nonlinearity: <3 LSB.

Offset accuracy: 100 mV (20-30°C).

Absolute accuracy: 1% of p-p full scale range (20-30°C).

Internal trigger: Output automatically triggered when armed.

External trigger: Slope, level, hysteresis, width, impedance, coupling and maximum input same as for Recorder. (See page 00.00).

Insertion delay: 250 ns max.

Time base modes

Main only: Available in Single, Auto, and Normal Sweep Arm modes.

Mixed (main, delay): Available in Single and Normal Sweep Arm modes.

Memory size: 16384 10-bit words; Segmentation: 1,2,4,8,16 or 32 equal length blocks. Generation: Data may be generated from any memory block. Within any one block, a portion of the waveform may be generated by setting the starting point and stopping point. An even number of points is always output.

Sync output: Voltage: 0 to -0.75 V NOMINAL into 50 ohms, Pulse Width: One sample interval with the falling (first) edge active (or approximately 100 μ s when the sync pulse is past the stop position, and Sweep Arm is Single or Normal). Position: Settable from first point in the record to the last point. If the sync position is set outside the limits of the Start and Stop Position markers, the output record is extended to include the Sync Position by assigning a dc voltage (equal to the nearest Start/Stop Position marker) to the waveform between the Start/Stop Position marker and the sync position.

Ordering Information

HP 5182A Waveform Recorder/Generator

\$31,700

OSCILLOSCOPES & WAVEFORM ANALYZERS

Waveform Generation System

Models 5182S, 51820A

75

- Save time storing and recalling waveforms
- Quickly modify and utilize waveforms
- Save time when generating arbitrary waveforms
- No programming necessary

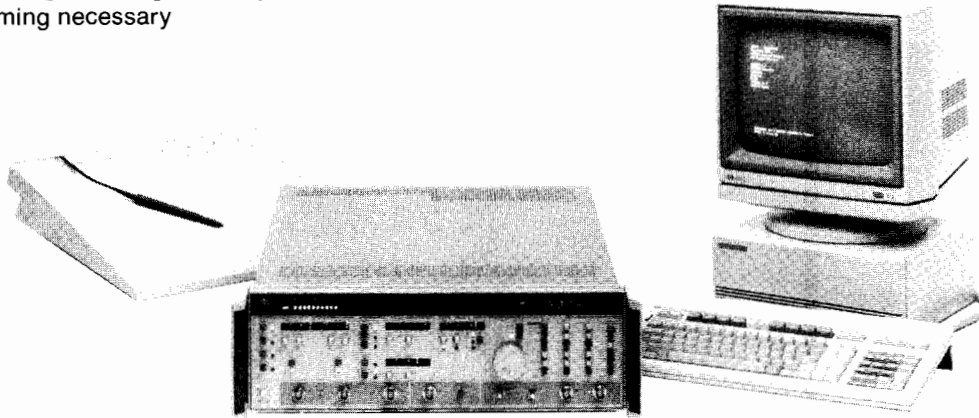

The 5182S waveform capture and playback system.

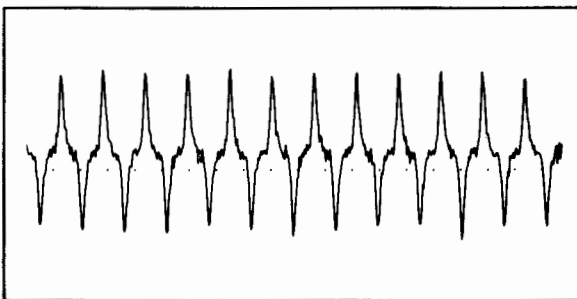

This signal was recorded from a floppy disc read head.

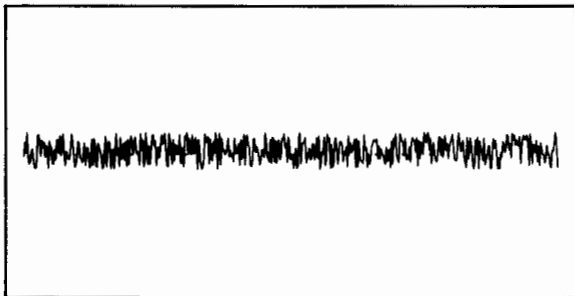

Combined with noise generated from built-in function . . .

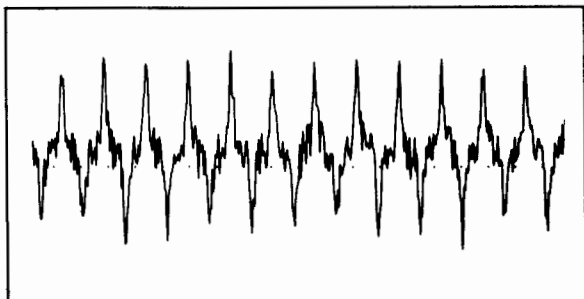

It is used to test the sensitivity of read recovery circuits.

Save Time Generating Specialized Waveforms

The HP 51820A Software is a powerful set of tools for creating specialized waveforms. Modify captured waveforms or define new ones with the HP 46087A graphics tablet (part of the HP 5182S system). Simply press a SOFTKEY to send waveforms to the HP 5182A for replay or disc for storage. Since the HP 51820A is a complete package (no programming is required), you are productive immediately.

The software is driven by a main menu and three submenus: draw, process and I/O. Because it's only two levels deep, you won't get lost in multiple levels of menus.

Waveform Capture, Modification and Playback

Modify waveforms you've captured and play them back into the device you are testing. Rather than waiting for a glitch to occur randomly, you can draw one and see the circuit response immediately.

Waveforms can also be modified by processing. Simple functions like offset and gain are built into the SOFTKEY MENU. There are also SOFTKEYS for adding or multiplying two waveforms together.

More complicated processing like calculus and convolution can be accomplished by modifying the user-equation subroutines. Four SOFTKEYS are reserved for your own equations. The Software comes with the equations programmed to generate sine waves, triangle waves, square waves and random noise.

Arbitrary Waveform Generation

There are three ways to create the waveforms you need. You can recall waveforms from the library, including sine waves, square waves, SIN (X)/X, Gaussian pulses, exponentials and more. You can calculate waveform samples with equations. Third, you can draw or trace waveforms with the graphics tablet. Choose the method that will get you the signal you need in the shortest time.

Ordering Information

HP 5182S Waveform Generation System

Price
N/C

To ensure coordination of shipments and compatibility of instruments, computers and software, use the system model number when ordering individual components including peripherals such as printers and plotters. Obtain HP 51820A and HP 51800A Data Sheets and a HP 5182S Ordering Guide from your local sales office. See page 739.

HP 51820A Waveform Generation Software

\$1,525

PLOTTERS & RECORDERS

Measurement Plotting System

Model 7090A

- Floating and guarded inputs
- DC to 3 kHz bandwidth, 33.3 kHz sampling rate
- 3 channels with simultaneous sampling

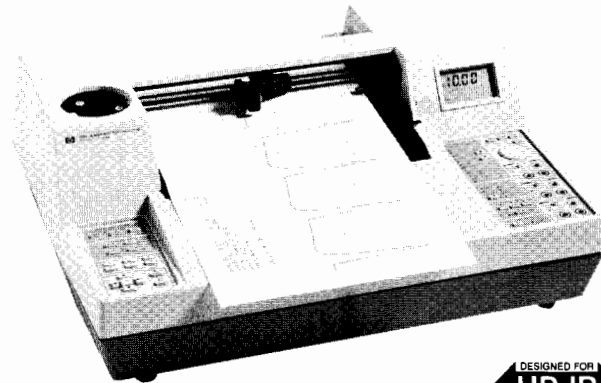

HP 7090A



The HP 7090A is designed for low-frequency (< 3 kHz) measurement, analysis, and documentation. The 7090A merges several technologies - waveform recording, digital plotting, analog recording, and automated measurement - to provide a powerful solution to a broad range of measurement applications. It significantly increases the ability to measure and display low-frequency phenomena and substantially improves real-time recording and digital plotting ... all in one low-cost system.

Signal Capture

Simultaneous sampling on each of three channels, 12-bit resolution, bandwidth of dc to 3 kHz (33.3 k samples/s maximum), and 1000 word memory per channel allow high resolution measurement, storage, and display.

Flexible Triggering

The HP 7090A has six trigger modes which allow virtually any signal change to initiate signal capture, even decaying repetitive signals such as faults in a power line voltage, or in a transducer's carrier. Combined with pre-trigger capability, these trigger modes make the HP 7090A Measurement Plotting System ideal for turn-on/off characterization, fault monitoring and mechanical motion analysis.

A System Component

All panel functions are programmable via the HP-IB interface. Data can be transferred from the internal 1 k-buffers or streamed in real time from the analog-to-digital converters at up to 500 points/s. In addition, the menu-driven HP 17090B Measurement Graphics Software package is available for HP 9000 Series 200 computers (BASIC 3.0 only). The software allows easy data manipulation, storage and retrieval, and system integration.

Versatile Capabilities

As the name implies, the HP 7090A Measurement Plotting System is also a high performance digital plotter. It is ideal for a graphics dump from a smart instrument (e.g. from an HP 8569B Spectrum Analyzer) or as part of an HP-IB system; you can also use the HP 7090A to take an X-Y dump from an analog instrument (e.g. from an HP 141T Spectrum Analyzer System). With the HP 7090A, hand annotation is unnecessary. The 7090A annotates setup conditions, date and time, selected data points from memory, and trigger information. It draws user-defined axes and grids, eliminating the need for pre-printed graph paper. The HP 7090A even lets you plot overhead transparencies for technical presentations.

- 12-bit resolution, 1 k buffer/channel
- 6 trigger modes with up to 100% pre-trigger capture
- Full programmability and data transfer over HP-IB

Applications

Analog Recording: Electrical, chemical, mechanical and medical fields all benefit from recording real-time X-Y and Y-T relationships. As an analog recorder, the HP 7090A has sensitivity to 5 mV full scale and 41,000 calibrated ranges for easy and quick calibration to measurement units. The HP 7090A's superior dynamic performance and high sensitivity provide users the versatility and accuracy required in laboratory environments.

Capturing Low Frequency Electrical Transients: General diagnostic monitoring (such as looking for relative timing sequences) and fault monitoring (capturing pre-trigger data for intermittent failure analysis) are natural applications for the HP 7090A.

Measuring Phase Relationships: The simultaneous sampling on all channels is ideal for measuring current/voltage phase relationships in power systems.

Analog Instrument/Digital System Link: The HP 7090A can integrate an analog instrument into an HP-IB system; the HP 7090A, with a controller can digitize output voltages from analog instruments for HP-IB system data entry.

Mechanical and Electromechanical Testing: Applications in which transducers convert velocity, acceleration, force, temperature or torque to voltage are a good fit for the HP 7090A. These applications have a maximum output frequency below 3 kHz. The HP 7090A's flexible trigger capabilities make it useful for one-shot electromechanical events such as clutch and mechanism engagements.

Electromechanical Control Systems: The HP 7090A can measure the response of a system to a stimulus; a typical use would be exciting the system with a step function and using the measured response to determine damping ratio and the natural frequency of the control system.

Material Testing: The HP 7090A can record classic stress-strain curves, particularly those obtained from destructive testing. The data is stored in a buffer, so even though the sample has been destroyed, the data can be viewed and rescaled in several different ways.

Automatic Test: When linked to an HP 9000 Series 200 computer, the HP 7090A is a good, inexpensive learning tool for small companies considering automatic test systems. Applications include environmental and production line testing and proof of performance records.

Measurement Graphics Software

HP 17090 Measurement Graphics Software is designed to access the full capabilities of the HP 7090A Measurement Plotting System and integrate it into computer system applications. This software is compatible with properly configured Series 200 and Series 300 computers. The computer system must have ten softkeys, a knob, and separate displays for alpha characters and graphics. The main user interface with this software is through 10 softkeys on the computer's keyboard and a knob.

Program Capabilities: There are six main functional areas of Measurement Graphics Software:

- measurement setup
- measurement
- display
- annotation
- storage and retrieval
- data manipulation

Measurement Graphics Software helps you use the HP 7090A's features easily and efficiently, and it provides storage, annotation and data transformation capabilities not available on the HP 7090A unit alone.

Friendly, Menu-driven Interface: Each menu allows the user to view several parameters simultaneously. Series 200 and 300 softkeys and cursor-control knob minimize keyboard input, and the "help" softkey displays the available choices and ranges for each parameter setting.

Specifications

Inputs

Number of channels	3
Type of input	floating, guarded
Sensitivity	5 mV to 100 V full scale
Sensitivity ranges	41,000
Zero offset	±2 full scale or ±100 V maximum
Zero offset ranges	approximately 5% or range steps
Input impedance	1 Mohm, shunted by 45 pf (Nominal)
Maximum input voltage	200 V, dc or peak
Maximum source resistance	10 kohm
Common mode rejection ratio	140 dB dc; 100 dB ac @ 60 Hz with 1 kohm unbalance in LOW terminal and most sensitive range (at 25 C)

Electrical accuracy (@ 25 C, ±1 scale offset maximum):

Constant inaccuracy	
1 V to 100 V range	±0.15% of range
5 mV to 500 mV range	increases from ±0.15% of range @ 500 mV to ±0.26% of range @ 5 mV
Reading inaccuracy	±0.055% of reading
Temperature coefficient	
Constant inaccuracy	
1 V to 100 V range	±0.012% of range/degree C
5 mV to 500 V range	increases from ±0.012% or range/degree C @ 500 mV to ±0.044% of range/degree C @ 5 mV
Reading inaccuracy	±0.01% of reading/degree C

Timebase

Buffer mode	
Range	30 milliseconds to 24 hours
Number of ranges	4,700
Direct mode	
Range	1 second to 24 hours
Number of ranges	3,700
Accuracy	±0.1%

Dynamic Performance

Slewing Speed (Nominal)	
Direct mode	127 cm/s (50 in./s)
Plotting mode	75 cm/s (30 in./s)
Acceleration (Nominal)	2 g constant
Bandwidth (≥3dB)	3 kHz for all full scale ranges ≥ 20 mV 2.6 kHz for all full-scale ranges <20 mV
Peak capture	250 μs at fastest timebase range

Memory per Channel

Size	1000 words
Resolution	12-bits

Trigger Characteristics

Internal Trigger	Inside or outside window to capture decaying repetitive signals, inside resets with each reverse transition; Above or below level, selectable over the full-scale range in 1.0% of range increments (NOMINAL); Source, channel 1
External Trigger	BNC connector, TTL level or contact closure to ground
Manual Trigger	Available from front-panel controls
Display	Up to 100% pre-trigger capture, up to 24 hour post-trigger delay before measurement start

Supplemental Characteristics

Writing System	6-pen carousel with automatic pen capping Fiber-tip pens for paper or transparencies
Digital Plotting	Intelligence: over 40 HP-GL instructions; five built in character sets including ANSI ASCII, HP 9825, French/German, Scandinavian,

Spanish/Latin America

Front-panel controls: P1, P2; pen position cursors; pen selection
Interface modes (user selectable): listen only; listen/talk
Types: paper, overhead transparency film
Sizes (switch-selectable): A4/A (210 x 297 mm, 8.5 x 11 in.); A3/B (297 x 420 mm, 11 x 17 in.)

Media

Programming

Scope Output

Digital Voltmeter (DVM) Mode

Pen Position Data Display

External Pen Lift Control

Analog-to-digital

Real-time Clock

Environmental Power Requirement

Size

Weight

HP-IB control of all recorder and plotter functions
Software lockable front panel
Allows use of X-Y oscilloscope to preview buffer contents
Connectors: 2 BNC, vertical and horizontal
Output: -10 V to 10 V (0 V corresponds to origin on chart); refreshed every 15 ms
Resolution: 10-bit
Allows panel display of dc voltage levels on selected channel input
Sampling rate: 1/sec (NOMINAL)
Allows cursor to move pen along plotted buffer data on selected channel, value shown on display, and coordinate pair can be printed at selected points.

BNC connector, TTL level or contact closure to ground
Max. sampling rate: 33.3 k samples/s
Max. streaming rate over HP-IB:

	ASCII	Binary
1 channel	167/s	500/s
1 channel plus trigger	143/s	333/s
3 channels	59/s	167/s
3 channels plus trigger	59/s	167/s

Functions: second, minute, hour, day, year
Controls: front-panel set, battery (lithium) backup
Accuracy: ±4 sec/day @ 25 C
Operating temperature: 0-55 C
Source: 100, 120, 220, 240 V ac -10%, +5%

Frequency: 48-66 Hz
Consumption: 140 W
Height: 205.5 mm (8.1 in.)
Weight: 575.0 (22.6 in.)
Depth: 465.0 (18.3 in.)
Net: 15.7 kg (34.5 lbs)
Shipping: 23.6 kg (18.3 lbs)

Accessories Supplied

Accessories Supplied	Part Number
Interfacing and Programming Manual	07090-90001
Operator's Manual	07090-90002
Pocket Guide	07090-90004

An assortment of pens and media are also shipped with each HP 7090A unit sold. Paper size and power cord are determined by destination.

Ordering Information

Ordering Information	Price
HP 10833A or 45529A HP-IB (IEEE-488) 1-meter cable	\$80.00
HP 10833B or 45529B HP-IB (IEEE-488) 2-meter cable	\$90.00
HP 7090A Measurement Plotting System	\$5200.00
Option 910 (duplicate set of manuals)	\$100.00
HP 17090A/B/C Measurement Graphics Software	
Option 630 (3.5 in. disc size)	\$700.00
Option 655 (5.25 in. disc size)	\$700.00

DIGITAL MULTIMETERS

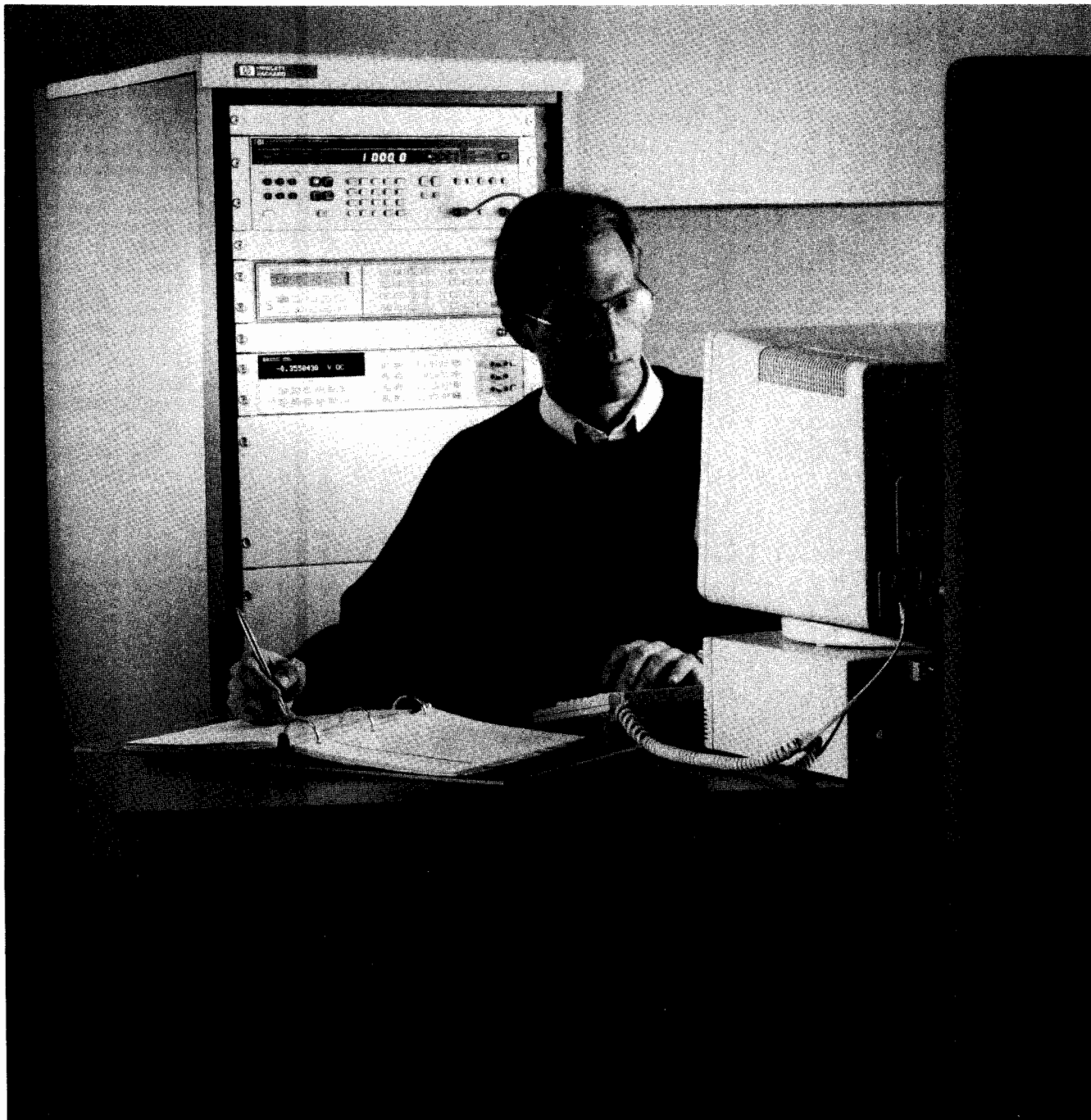

Optimize Measurements for Your Application Needs

Hewlett-Packard offers multimeters to satisfy a wide range of measurement requirements. Your selection depends primarily on the accuracy you need. In many cases, these multimeters are significantly faster than other solutions at the accuracy needed.

All these multimeter solutions provide measurements of DC and AC voltage, resistance, and DC and AC current. Low cost frequency and period measurements are also available.

Aimed at computer-aided test, the HP 3458A multimeter also has the accuracy to address metrology/standards lab applications, and the digitizing speed to address high-resolution digitizing. The HP 3457A

multimeter handles most application needs in computer-aided test systems. For low-cost HP-IB systems, the 3½ to 5½-digit HP 3478A satisfies many measurement requirements without putting a big dent in your instrumentation budget. For portable troubleshooting, the HP E2300 Series offers you HP quality in a 3½-digit handheld.

Increase Test Throughput

Increase your test capacity by reducing the time for each test.

In most system applications, interactions with the computer and other HP-IB instruments have just as much impact on test throughput as reading rates of the multimeter. Most functional tests are a series of tests that require function changes, and voltage or

resistance range changes. Also, transfer rates of data must be fast to reduce traffic on HP-IB. With all these factors taken into consideration, you will find that the HP 3458A multimeter increases your test capacity without having to increase the number of test systems.

HP multimeters also provide math, storage of entire test sequences, reading memory, interrupts, and limit testing to increase test throughput. Finally, HP's system multimeters have a "Voltmeter Complete" pulse output to increment channels on external scanners or switches, without the delay of a computer command. Flexible triggering gives you the ability to ensure that measurements are properly synchronized with the device under test.

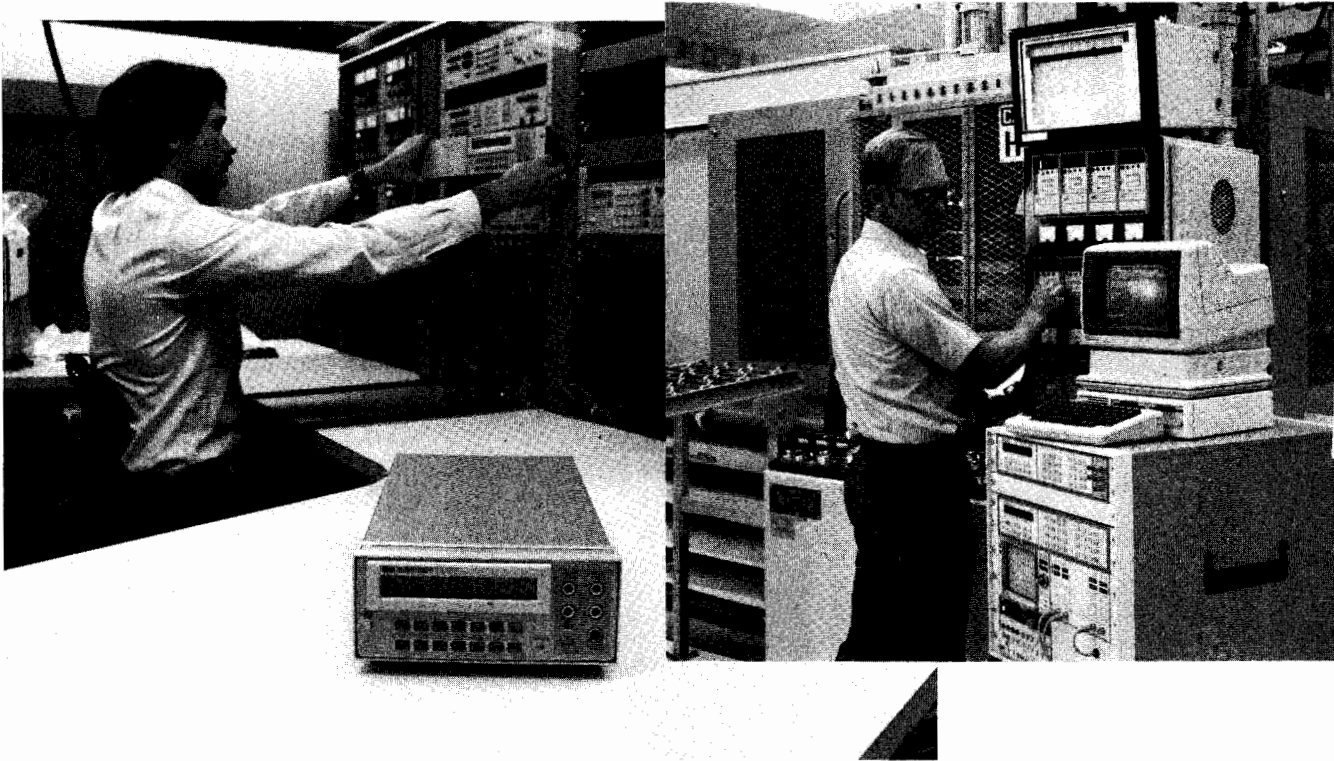

Increase Up-time

Hewlett-Packard's quality philosophy focuses on continuous process improvement. Although we continue to improve, perfection is the goal. To achieve this goal, we apply scientific methods and data to all processes, where everything is considered a process.

This philosophy requires participation by everyone working together toward a common goal. Improvements in quality result from better designs and careful attention to improvements in production. The anticipated result is that we continue to satisfy our customers by exceeding their needs and expectations.

HP's field-proven multimeters are already living up to such ideals. The HP 3478A, the HP 3457A, 3458A, and HP E2300 Series multimeters include quality and reliability with the performance you need. As one way of demonstrating this reliability, HP offers three years of hardware support. You can expect HP reliability that keeps your test system up and running for a long time.

HP Model	3458A page 80	3457A 83	3478A 86	E2377A/ E2378A 94
DC VOLTAGE				
Accuracy 1 Yr Best Full Scale (parts per million)	5.1 (Opt 002)	27	197	3667
Resolution (nanovolts)	10	10	100	100,000
Maximum Reading Rate at 5½ digits (readings per second)	50,000	360	4.4	
Maximum Range (volts)	1000	1000 (HP 44497A)	300	1000
RESISTANCE				
Accuracy 1 Yr Best Full Scale (parts per million)	10.5	52	167	7333
Resolution (microhms)	10	10	100	100,000
AC VOLTAGE				
Bandwidth	1 Hz to 10 MHz	20 Hz to 1 MHz	20 Hz to 300 kHz	40 Hz to 1 kHz
FUNCTIONS	DC & AC V, 2- and 4-w Ω, Offset-compensated Ω, DC & AC I, Frequency, Period, Math, Test sequence storage, Ratio, 20 kbytes reading memory, Digitizing, & HP-IB	DC & AC V, 2- and 4-w Ω, Offset-compensated Ω, DC & AC I, Frequency, Period, Math, Test sequence storage, 1 kbyte reading memory, & HP- HP-IB	DC & AC V, 2- and 4- wΩ, DC & AC I, & HP-IB	DC & AC V, DC & AC I 2wΩ, Diode Test, Audio Continuity, Temp (K-Type), & Data Hold
OPTIONS	Opt 001 Expanded reading memory to 148 kbytes, Opt 002 High stability (4 ppm/yr), Opt 005 Waveform analysis library Opt 700 CIIIL Language Opt W30 3 yr hardware support	Opt 700 CIIIL Opt W30 3 yr hardware support 44497A 1000 V attenuator 44491A Armature relay mux 44492A Reed relay mux	Opt W30 3 yr hardware support	E2301A Surface thermocouple probe K-Type E2302A Airflow thermocouple probe K-Type E2303A thermocouple probe adapter E2305A Replacement test leads
BASE PRICE	\$5900	\$2950	\$995	\$169/189

DIGITAL MULTIMETERS

A System Multimeter with Both High Speed and High Accuracy

Model 3458A

DESIGNED FOR
MATE
SYSTEMS

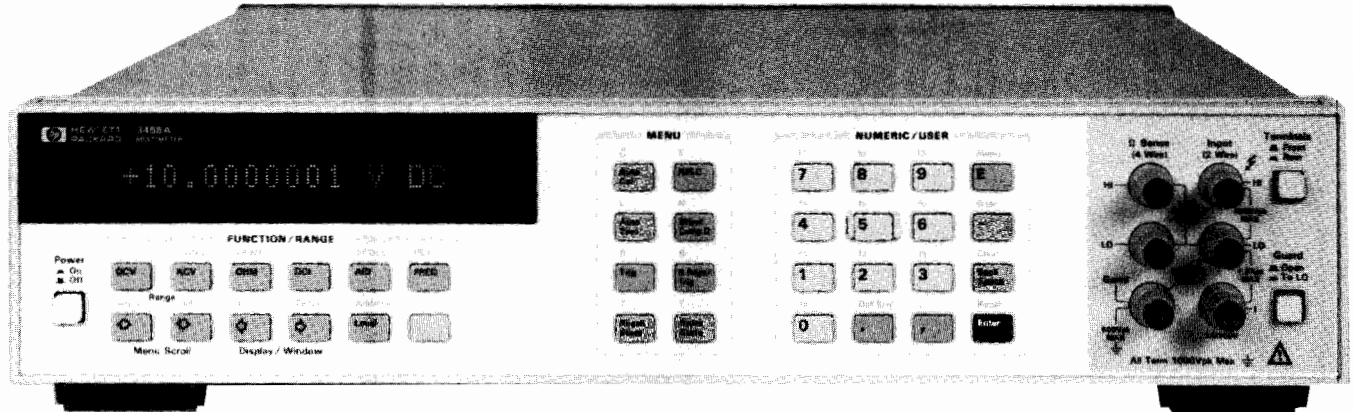

Model 3458A

The HP 3458A multimeter shatters long-standing performance barriers of speed and accuracy on the production test floor, in R&D, and in the calibration lab. The HP 3458A is simply the fastest, most flexible, and most accurate multimeter ever offered by Hewlett-Packard. In your system or on the bench, the HP 3458A saves you time and money with unprecedented test system throughput and accuracy, seven function measurement flexibility, and low cost of ownership.

Select a reading rate of 100,000 readings per second for maximal test throughput. Or achieve highest levels of precision with up to 8½ digits of measurement resolution and 0.1 part per million transfer accuracy. Add to this, programming compatibility through the Hewlett-Packard Multimeter Language (HPML) and the HP 3458A's simplicity of operation and you have the ideal multimeter for your most demanding applications.

High Test System Throughput

Faster Testing

- Up to 100,000 readings/sec
- Internal test setups >200/sec
- Programmable integration times from 500 ns to 1 sec

Greater Test Yield

- More accuracy for tighter test margins
- Up to 8½ digits resolution

Longer Up-Time

- Two-source (10V, 100kΩ) calibration, including ac
- Self-adjusting, self-verifying auto-calibration for all functions and ranges, including ac

High Resolution Digitizing

Greater Waveform Resolution and Accuracy

- 16 bits at 100,000 samples/sec
- 18 bits at 50,000 samples/sec
- 12 MHz bandwidth
- Timing resolution to 10 ns
- Less than 100 ps time jitter
- Over 75,000 reading internal memory

Flexible Digitizing Software

- Powerful, easy-to-use analysis software for HP 9000 Series 200/300 Computers
- Subprograms for waveform acquisition, data transfer, FFT, IFT, and data presentation

Calibration Lab Precision

Superb Transfer Measurements

- 8½ digits resolution
- 0.1 ppm dc Volts linearity
- 0.1 ppm dc Volts transfer capability
- 0.01 ppm rms internal noise

Extraordinary Accuracy

- 0.6 ppm for 24 hours in dc Volts
- 2.2 ppm for 24 hours in Ohms
- 100 ppm mid-band ac Volts
- 8 ppm (4 ppm optional) per year voltage reference stability

HP 3458A Multimeter Performance Features

DC Volts

- 5 ranges: 0.1 V to 1000 V
- 8½ to 4½ digit resolution
- Up to 100,000 readings/sec (4½ digits)
- Maximum sensitivity: 10 nV
- 0.6 ppm 24 hour accuracy
- 8 ppm (4 ppm optional)/year voltage reference stability

Ohms

- 9 ranges: 10Ω to 1GΩ
- Two-wire and four-wire Ohms with off-set compensation
- Up to 50,000 readings/sec (5½ digits)
- Maximum Sensitivity: 10μΩ
- 2.2 ppm 24 hour accuracy

AC Volts

- 6 ranges: 10 mV to 1000 V
- 1 Hz to 10 MHz bandwidth
- Up to 50 readings/sec with all readings to specified accuracy
- Choice of sampling or analog true rms techniques
- 100 ppm best accuracy

DC Current

- 8 ranges: 100 nA to 1 A
- Up to 3,500 readings/sec (5½ digits)
- Maximum sensitivity: 1 pA
- 13 ppm 24 hour accuracy

AC Current

- 5 ranges: 100 μA to 1 A
- 10 Hz to 100 kHz bandwidth
- Up to 50 readings/sec
- 500 ppm 24 hour accuracy

Frequency and Period

- Voltage or current ranges
- Frequency: 1 Hz to 10 MHz
- Period: 100 ns to 1 sec
- 0.01% accuracy
- ac or dc coupled



DC Voltage				Accuracy		Transfer Accuracy	
Range	Full Scale	Maximum Resolution	Input Impedance	1 Year (ppm of Reading + ppm of Range)	Conditions	10 Min Tref $\pm 0.5^\circ\text{C}$ (ppm of Reading + ppm of Range)	Conditions
100 mV	120.000000	10 nV	10 G Ω	9 + 10	<ul style="list-style-type: none"> Specifications for NPLC 100 within 24 hours and $\pm 1^\circ\text{C}$ of last ACAL; TCAL $+5^\circ\text{C}$. For High stability (Option 002) subtract 1.5 ppm of Reading from 90 day, and 4 ppm of Reading from 1 or 2 year accuracy. Add 2 ppm of reading additional error for HP factory traceability of 10 V dc to US NBS. Traceability error is the absolute error relative to National Standards associated with the source of last external calibration. 	0.5 + 0.5	<ul style="list-style-type: none"> NPLC = 100 Following 4 hour warm-up. Full scale to 10% of full scale. Measurements on the 1000 V range are within 5% of the initial measurement value and following measurement setting. Tref is the starting ambient temperature. Measurements are made on a fixed range using accepted metrology practices.
1 V	1.20000000	10 nV	10 G Ω	8 + 1		0.3 + 0.1	
10 V	12.00000000	100 nV	10 G Ω	8 + 0.2		0.05 + 0.05	
100 V	120.00000000	1 μV	10 M Ω $\pm 1\%$	10 + 0.3		0.5 + 0.1	
1000 V	1050.00000000	10 μV	10 M Ω $\pm 1\%$	10 + 0.1		1.5 + 0.05	

Noise Rejection (dB)¹

	AC NMR ²	AC ECRM	DC ECRM
NPLC <1	0	90	140
NPLC ≥ 1	60	150	140
NPLC ≥ 10	60	150	140
NPLC ≥ 100	70	160	140
NPLC = 1000	80	170	140

¹Applies for 1 k Ω unbalance in the LO lead and $\pm 0.1\%$ of the line frequency currently set for LFREQ.

²For line frequency $\pm 1\%$, ACNMR is 40 dB for NPLC ≥ 1 , or 80 dB for NPLC ≥ 100 . For line frequency $\pm 5\%$, ACNMR is 65 dB for NPLC ≥ 100 .



Maximum Input

	Rated Input	Non-Destructive
HI to LO	± 1000 V pk	± 1200 V pk
LO to Guard	± 100 V pk	± 350 V pk
Guard to Earth	± 500 V pk	± 1000 V pk

Resistance

Range	Accuracy Four-Wire Ohms ¹		Conditions
	One Year (ppm of Reading + ppm of Range)		
10 Ω	15 + 5		<ul style="list-style-type: none"> 100 power line cycle integration, offset compensation on. Within 24 hours and $\pm 1^\circ\text{C}$ of last ACAL; Tcal $\pm 5^\circ\text{C}$. Add 3 ppm of reading additional error for HP factory traceability of 10 kΩ to US NBS. Traceability is the absolute error relative to National Standards associated with the source of last external calibration.
100 Ω	12 + 5		
1 k Ω	10 + 0.5		
10 k Ω	10 + 0.5		
100 k Ω	10 + 0.5		
1 M Ω	15 + 2		<ul style="list-style-type: none"> Add 3 ppm of reading additional error for HP factory traceability of 10 kΩ to US NBS. Traceability is the absolute error relative to National Standards associated with the source of last external calibration.
10 M Ω	50 + 10		
100 M Ω	500 + 10		
1 G Ω	0.5% + 10		

¹Two-Wire Ohms Accuracy
Add 250 m Ω to the four-wire ohms accuracy.

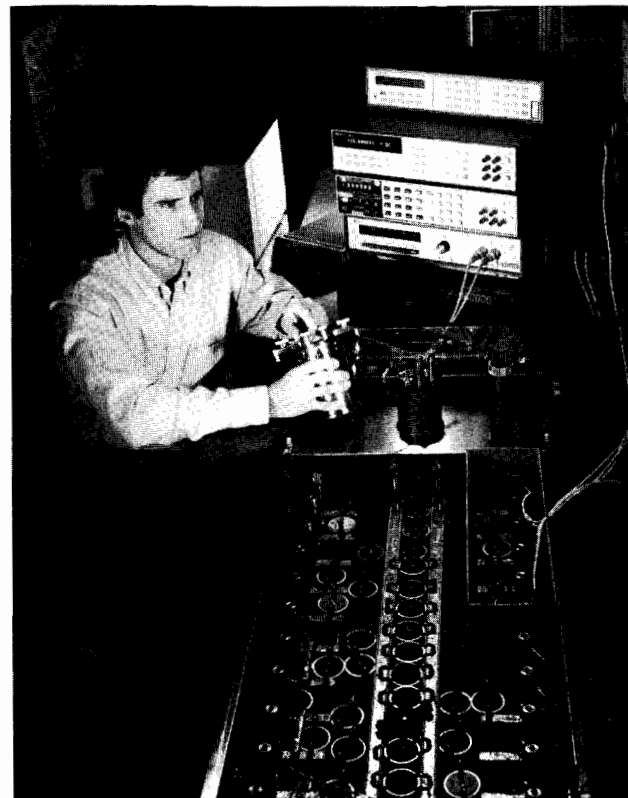

DIGITAL MULTIMETERS

A System Multimeter with Both High Speed and Accuracy (Cont'd)

Model 3458A

AC Voltage

(Synchronously Sub-sampled Mode)

Accuracy

Range	Full Scale	Maximum Resolution	Input Impedance	24 hr to 2 Year 40 Hz to 1 kHz (% of Reading + % of Range)	Conditions
10 mV	12.00000	10 nV	1 MΩ ±15% with <140 pF	0.02 + 0.011	<ul style="list-style-type: none"> Specifications apply full scale to 10% of full scale, DC <10% of AC, sine wave input, crest factor = 1.4. Within 24 hours and ±1°C of last ACAL. Peak (AC + DC) input limited to 5 x full scale for all ranges in ACV function. Add 2 ppm of reading additional error for HP factory traceability of 10 V DC to US NBS.
100 mV	120.0000	100 nV	1 MΩ ±15% with <140 pF	0.007 + 0.002	
1 V	1.200000	1 μV	1 MΩ ±15% with <140 pF	0.007 + 0.002	
10 V	12.000000	10 μV	1 MΩ ±2% with <140 pF	0.007 + 0.002	
100 V	120.00000	100 μV	1 MΩ ±2% with <140 pF	0.02 + 0.002	
1000 V	1050.000	1 mV	1 MΩ ±2% with <140 pF	0.04 + 0.002	

Maximum Input

	Rated Input	Non-Destructive
HI to LO	±1000 V pk	±1200 V pk
LO to Guard	±200 V pk	±350 V pk
Guard to Earth	±500 V pk	±1000 V pk
Volt-Hz Product	1 x 10 ⁶	

Front/Rear Panel Description

Display

- Bright, easy-to-read, vacuum fluorescent display
- 16 character alpha-numeric display to easily read data, messages, and commands

Standard Function/Range Keys

- Simple to use, for bench measurements of dcV, acV, Ohms, current frequency and period
- Select autorange or manual ranging

Menu Command Keys

- Immediate access to eight common commands
- Shifted keys allow simple access to complete command menu

Numeric/User Keys

- Numeric entry for constants and measurement parameters
- Shifted keys (f0 through f9) access up to ten user-defined setups.

Volts/Ohms/Ratio Terminals

- Gold-plated tellurium copper for minimum thermal emf
- 2-wire or 4-wire Ohms measurements
- dc/dc or ac/dc ratio inputs

Current Measurement Terminals

- Easy fuse replacement with fuseholder built into terminal

Guard Terminal and Switch

- For maximum common mode noise rejection

Front-Rear Terminal Switch

- Position selects front or rear measurement terminals

External Output

- Programmable TTL output pulse with 5 modes for flexible system interface

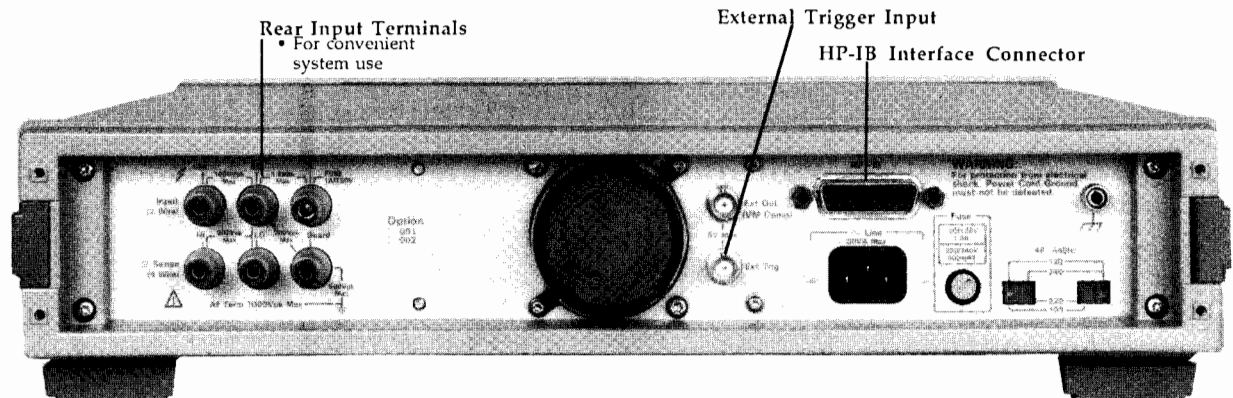

Throughput

Maximum Reading Rates

- 100,000 readings/sec at 4½ digits (16 bits)
- 50,000 readings/sec at 5½ digits
- 6,000 readings/sec at 6½ digits
- 60 readings/sec at 7½ digits
- 6 readings/sec at 8½ digits

Measurement System Speed

- 100,000 readings/sec over HP-IB or with internal memory
- 110 autoranges/sec
- 200 function or range changes/sec
- Post-processed math from internal memory

Ordering Information

HP 3458A Multimeter (with HP-IB, 20k bytes reading memory, and 8 ppm stability)

Price
\$5900

Option 001 Extended Reading Memory (Expands total to 148k bytes)

\$500

Option 002 High Stability (4 ppm/year) Reference

\$800

Option 005 Waveform Analysis Library for HP Series 300 Computers with BASIC 4.0 or greater

\$400

Option W30 Two additional years Return-to-HP hardware support

\$160

Option 700 CIIL Language

\$990

Option 907 Front Handle Kit

\$51

Option 908 Rack Flange Kit

\$31

Option 909 Rack Flange Kit (with handles)

\$73

- Over 1350 Readings/sec at 3 1/2 Digits
- Seven Functions—DCV, ACV, DCI, ACI, Ohms, Frequency and Period

- Three Plug-in Multiplexer Options
- DC Sensitivity to 10 Nanovolts
- Outstanding Combination of Performance and Price

DESIGNED FOR
MATE
SYSTEMS

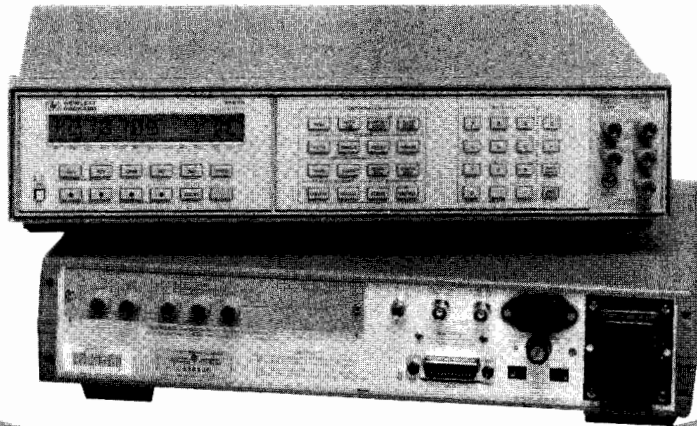

HP 3457A

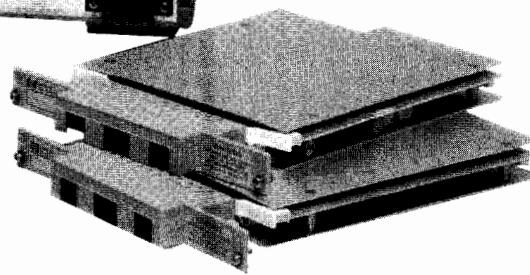
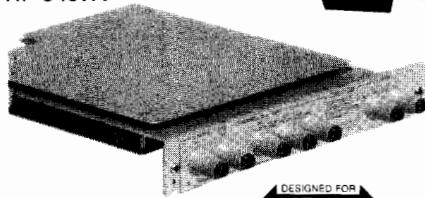

Description

The HP 3457A has seven functions with 3 1/2 to 6 1/2 digits of resolution extendable to 7 1/2 digits at reading rates from 1 reading every 2 seconds to 1350 rds/s and basic DC volts accuracy as good as 5 ppm. In addition, the input of the HP 3457A can be expanded up to ten channels with either of the optional plug-in multiplexer assemblies. On the bench, the front panel operation is extremely flexible and comprehensive. In systems, the Hewlett-Packard Interface Bus (HP-IB) is standard.

Powerful Measurement Management

The HP 3457A combines superb analog measuring capability with equally powerful measurement management. More than 1000 readings or whole measurement sequences can be stored in the HP 3457A for convenient and fast measurement throughput. The present dmm setup can be stored in the non-volatile state memory for convenient reconfiguration of the dmm.

Additional power from math functions can be obtained by using PASS/FAIL limit testing, NULL, SCALE, THERMISTOR linearization, and others. The power of total electronic calibration, including AC volts, makes it easy to maintain instrument performance.

System Features

Keeping with HP's long tradition of systems oriented digital multimeters, the HP 3457A has all the systems features you've come to expect plus more to make interfacing to your computer even easier—features like flexible formatting of ASCII, 16 bit binary, or 32 bit binary data and buffer memory so that you can take measurements with the HP 3457A at its highest speed. In addition, you'll find the VOLTMETER COMPLETE output and EXTERNAL TRIGGER input signals ideal for synchronizing other instrumentation with the HP 3457A. Finally, programmable front-rear terminal switching lets you measure two separate inputs without a scanner.

Hewlett-Packard Multimeter Language (HPML)

Another first for the HP 3457A DMM is an easy-to-use dmm language—HPML. Designed so that software written for today's multimeter will fit tomorrow's, HPML only asks you to define the parameters necessary to accomplish your measurement. For example, if you want to make a measurement on a 9 volt DC signal with 0.01% resolution, the command sequence is "DCV,9,.01".

Control Interface Intermediate Language (CIIL)

With Option 700, the HP 3457A responds to standardized DMM CIIL commands via HP-IB. Physically and functionally identical to the standard HP 3457A, Option 700 adds the CIIL command set with a built-in Test Module Adapter (TMA) to the DMM's standard HPML. The HP 3457A is further enhanced by adding the functions of AC and DC current measurement through CIIL through HP-IB.

Three Rear Panel Plug-In Options

Either one of three different optional assemblies may be used with the HP 3457A for different measurement capabilities. Using the multiplexer assemblies will enable up to ten signal channels to be scanned either sequentially or randomly. All of the functional capability offered through the normal front and rear input terminals is available for multiple inputs. Using the high voltage assembly allows single channel measurement of either AC or DC voltages at the rear panel.

For measurement flexibility, the HP 44491A Armature Relay Multiplexer Assembly offers eight two-wire channels and two current/actuator channels. Under software control, the eight two-wire channels can be reconfigured to four 4-wire ohm channels. The two current channels offer automatic make-before-break switching so that the path for current as high as 1.5 A is never broken. In addition, these two channels can be used as external device actuator channels. Each channel can switch up to 150 V. The general purpose multiplexer can close a channel and make a measurement at a maximum rate of 33 channels per second.

For higher speed scanning, the HP 44492A Reed Relay Multiplexer Assembly offers ten two-wire channels. The HP 44492A is useful for switching dcV, acV, ac+dcV, two wire ohms, frequency and period measurement signals with a maximum amplitude of 125 V. The Reed Relay Multiplexer can close a relay and make a measurement at a maximum rate of 300 channels per second.

For measurement of voltages up to 1414 V peak, the HP 44497A High Voltage Assembly offers a 1000:1 attenuator input (channel 1) for the high voltage measurements. In addition, the other rear terminal input (channel 0) can be utilized to perform conventional VDC, VAC, Two-wire and Four-wire Ohms, Period, Frequency, DCI, and ACI measurements. Using the HP 44497A with HP 3457A in the 6 1/2 digit mode will yield a resolution of 1 mV for a 1000 V input. Implementing the MATH Scale function will have the HP 3457A LCD display the measurement results in the correct units of kilovolts.

DIGITAL MULTIMETERS

3¹/₂ to 6¹/₂ Digit DMM with Extended Resolution to 7¹/₂ Digits (cont'd)

HP Model 3457A

Abbreviated Technical Specifications

90 day, Tcal ± 5 deg. C

DC Voltage

Range	Maximum Reading	Best 6 ¹ / ₂ Digit Accuracy ¹ ± (% Rdg + Cnts)		Input Resistance
		% of Reading	Count Error	
30 mV	30.03000 mV	0.0040	365	10 GΩ
300 mV	303.0000 mV	0.0025	39	10 GΩ
3.0 V	3.030000 V	0.0017	6	10 GΩ
30.0 V	30.30000 V	0.0035	19	10 MΩ
300.0 V	303.0000 V	0.0050	6	10 MΩ

- After 1 hr warm-up, integration time 100 PLC. Tcal is the temperature of the calibration environment between 18 and 28 deg C.

DC Current

Range	Maximum Reading	Best 6 ¹ / ₂ Digit Accuracy ¹ ± (% Rdg + Cnts)		Input Resistance
		% of Reading	Count Error	
300 μA	303.0000μA	0.02	104	1000Ω
3 mA	3.030000 mA	0.02	104	100Ω
30 mA	30.30000 mA	0.02	104	10Ω
300 mA	303.0000 mA	0.07	204	1Ω
1.0A	1.000000 A	0.07	604	0.1Ω

- After 1 hr warm-up, integration time 100 PLC. Tcal is the temperature of the calibration environment between 18 and 28 deg C.

Resistance (2 and 4 wire ohms)²

Range	Maximum Reading	Best 6 ¹ / ₂ Digit Accuracy ¹ ± (% Rdg + Cnts)		
		% of Reading	Count Error	Current Output
30 Ohm	30.30000 Ohm	0.0065	315	1 mA
300 Ohm	303.0000 Ohm	0.0045	34	1 mA
3 kOhm	3.030000 kOhm	0.0035	6	1 mA
30 kOhm	30.30000 kOhm	0.0035	6	100 μA
300 kOhm	303.0000 kOhm	0.0040	7	10 μA
3 MOhm	3.030000 MOhm	0.0055	12	1 μA
30 MOhm	30.30000 MOhm	0.0250	80	100nA
300 MOhm ³	303.0000 MOhm	1.6	1000	100nA
3.0 GOhm ³	3.030000 GOhm	16.0	1000	100nA

- After 1 hr warm up, integration time 100 PLC. Tcal is the temperature of the calibration environment between 18 and 28 deg C.
- For two-wire ohms, add 200m Ohms to count error specifications.
- For two-wire ohms only, Accuracy is specified following autocal (ACAL), under stable conditions (±1 deg C).

Maximum Reading Rates (DCV, DCI, and Resistance up to 30 kOhm)²

Power Line Cycles ³	Maximum # of Digits	Readings per Second-60Hz (50Hz)		
		Auto Zero On	Auto Zero Off	NMR
.0005	3 ¹ / ₂	300	1350	0
.005	4 ¹ / ₂	280	1250	0
.1	5 ¹ / ₂	140 (128)	360 (312)	0
1.0	6 ¹ / ₂	26 (22)	53 (45)	60dB
10	7 ¹ / ₂ ⁴	2.5 (2.0)	4.8 (4.0)	80dB
100	7 ¹ / ₂ ⁴	.25 (0.2)	0.5 (0.4)	90dB

- Using Math HIRSES mode.
- Reading rates are specified with zero delay, fixed range, display off, and front panel off. The output is to internal reading memory using single integer format and internal timer.
- Integration Time in Power Line Cycles (PLC).

Common Mode Rejection (dB): (1 kOhm unbalance in low lead) DC ECMR 140 dB; AC ECMR: <1 PLC, 76 dB; AC ECMR >1 PLC 156 dB, for 50, 60 Hz ±.08%.

True RMS ACV and (AC+DC)V

Bandwidth: 20 Hz to 1 MHz

Crest Factor: 3.5 to 1 at full scale

Common Mode Rejection: (1 kOhm unbalance in LO): >76 dB, DC to 60 Hz

Accuracy: (90 day)

Accuracy specified for sine wave inputs, >10% of range. DC component <10% of AC component after 1 hr warm-up and within one week of autocal. Integration time = 10 PLC. AC Band set to <400 Hz. DC coupled mode requires 2 hour warm-up.

Range	Maximum Reading	(100 Hz to 20 kHz) Best 5 ¹ / ₂ Digit Accuracy ± (% Rdg + Cnts)				Input Impedance
		AC Coupled % of Reading	Count Error	DC Coupled % of Reading	Count Error	
30mV	32.50000mV	0.13	116	0.17	364	1MΩhm ±1% shunted by <90pf
300mV	325.0000mV	0.13	116	0.17	364	
3.0V	3.250000 V	0.13	116	0.17	364	
30.V	32.50000 V	0.13	116	0.17	364	
300V	303.0000 V	0.19	116	0.23	364	

True RMS ACI and (AC+DC)I

Bandwidth: 20 Hz to 100 kHz Crest Factor: 3.5 to full scale

Accuracy: (90 day)

Accuracy specified for sine wave inputs, >10% of range. DC component <10% of AC component after 1 hr warm-up and within one week of autocal. Integration time = 10 PLC. AC Band set to <400 Hz. DC coupled mode requires 2 hour warm-up.

Range	Maximum Reading	(100 Hz to 20 kHz) Best 5 ¹ / ₂ Digit Accuracy ± (% Rdg + Cnts)			
		AC Coupled		DC Coupled	
		% of Reading	Count Error	% of Reading	Count Error
30mA	32.50000mA	0.25	290	0.3	1600
300mA	325.0000mA	0.25	290	0.3	1600
1.0A	1.000000 A	0.35	290	0.4	1600

Reading Rates (ACV and ACI)¹

Power Line Cycles	Maximum # of Digits	Readings per Second .60 Hz (50 Hz)	
		Input <400 Hz (Slow Response)	Input >400 Hz (Fast Response)
.0005	3 ¹ / ₂	1	9.5
.005	4 ¹ / ₂	1	9.5
.1	5 ¹ / ₂	1 (1)	9.25 (9.2)
1	6 ¹ / ₂	1 (1)	7.25 (6.9)
10	6 ¹ / ₂	0.7 (0.65)	2.0 (1.7)
100	6 ¹ / ₂	0.2 (0.17)	0.25 (0.2)

- Reading rates are specified with preprogrammed delays, fixed range, and Auto Zero on.

Frequency and Period: Measures the frequency or period of the ac component of the ac or dc coupled voltage or current input. The counter uses a reciprocal counting technique to give constant resolution independent of input frequency.

Input Impedance: Refer to AC voltage and current specifications.

Frequency Range: 10 Hz to 1.5 MHz (voltage input)

10 Hz to 100 KHz (current input)

Period Range: .1 s to 667 ns (voltage input)

.1 s to 3.33 us (current input)

Sensitivity: 10 mV or 100 μA (sinewave)

Triggering: Triggers and counts on zero crossings

Accuracy: (1 year)

Frequency	Period	±% of Reading
10 Hz to 400 Hz	.1 s to .025 s	0.05
400 Hz to 1.5 MHz	.025 s to 667 ns	0.01

Maximum Reading Rate: 2.0 rdgs/s for integration time of 1 PLC, AC Band >400 Hz, delay zero and math off, and fixed range.

Memory: 2139 available bytes that can be partitioned into 3 segments, one devoted to storing measurements, one devoted to storing measurement subprograms, and one devoted to storing instrument states.

Math Functions: The HP 3457A performs the following math functions on the measurements—NULL, SCALE, OFFSET, RMS FILTER, SINGLE POLE FILTER, THERMISTOR LINEARIZATION, DB, DBM, % ERROR, PASS?FAIL LIMIT TESTING, and STATISTICS. Two math functions may be used at one time.

General Specifications

- Operating Temperature:** 0 to 55° C
- Warmup Time:** one hour to all specifications except where noted
- Humidity Range:** 95% R.H., 0 to 40° C
- Storage Temperature:** -40 to +75° C
- Power:** 100/120/220/240 V ±10%, 48 Hz - 66 Hz, 220 V, ±10%, 48 Hz to 66 Hz. Fused at .2A (115 V) or 0.08 A (230 V). <30 VA.
- Size:** 89 mm H (without removable feet) x 425mm W x 292mm D (3.5" x 16.75" x 11.5"). Height (with removable feet): 100 mm (4"). Allow 76mm (3") additional depth for wiring.
- Net Weight:** 5.05 kgm (11.1 lbs)
- Shipping Weight:** 9.3 kgm (20.5 lbs)

Plug-in Options

HP 44491A Armature Relay Multiplexer Assembly Input Characteristics: Eight two-wire armature relay channels and two current/actuator channels. Maximum voltage (terminal-to-terminal or terminal to chassis) 250 Vrms. Maximum current (per channel) - 1.0 A DC or AC. Thermal Offset - 3µ V. Closed channel resistance (end of relay life) - <2 Ohms. Maximum switching and measurement speed - 33 channels/second.

HP 44492A Reed Relay Multiplexer Assembly Input Characteristics: Ten two-wire reed relay channels. Maximum voltage (terminal-to-terminal or terminal-to-chassis) - 125 V peak. Thermal offset - 3 µV. Closed channel resistance (end of relay life) - <4 Ohms. Specified for <100 kHz ac volts and frequency operation. Maximum switching and measurement speed - 300 channels/second.

HP 44497A High Voltage Attenuator Assembly Input Characteristics: Two relay channels, channel 1 devoted to high voltage measurements. Maximum High-to-Low voltage of 1000 Volts DC or AC rms. Maximum Low-to-Earth voltage of 350 V Peak Non-destructive Overload voltage of 1700 V Peak, 1200 Volts DC. Attenuator accuracy to be added to HP 3457A range and function accuracy for total accuracy.

DC	0.030% of reading
20 Hz - 1 KHz	2.8% of reading
1 KHz - 10 KHz	10.0% of reading

Note: One year accuracy applies to Tcal ±5%, NPLC=1 or greater. Specifications are for low-to-earth voltage less than 0.1 times the High-to-Earth voltage.

Model 3457A Multimeter

	Price
*HP 44491A Armature Relay Multiplexer Assembly	\$2950
*HP 44492A Reed Relay Multiplexer Assembly	\$470
*HP 44497A High Voltage Attenuator Assembly	\$470
Option 401: Side Handle Kit (P/N 5061-1171)	\$390
Option 700: CIIL Language	\$40
Option 907: Front Handle Kit (P/N 5061-1170)	\$990
Option 908: Rack Flange Kit (P/N 5061-1168)	\$51
Option 909: Rack Flange and Front Handle Kit (P/N 5061-1169)	\$32
Option 910: Extra Operating and Service Manual	\$75
Option W30: Two years of additional hardware support	\$110

Accessories:

HP 44490A Rack Slide Kit for 30 inch depth racks	\$230
HP 44493A Screw Terminal Connector for HP 44491A includes strain relief and housing	\$63
HP 44494A Screw Terminal Connector for HP 44492A includes strain relief and housing	\$63
HP 34118A Test Lead Kit	\$27 ☎
HP 34301A RF Detector Probe, 100 KHz to 700 MHz	\$80 ☎
HP 34300A 40 Kv ac/dc Probe, dc to 300 Hz	\$90 ☎
HP 34119A High Voltage Probe, 1000:1, AC & DC Voltage Divider for up to 5000V	\$130 ☎
HP 44414A: Four Thermistor Pack	\$63 ☎

*Plug-in options may be ordered and shipped separately without a HP 3457A mainframe. Unless otherwise specified, the optional plug-in accessories will be shipped with the HP 3457A mainframe.

☎ Fast Ship Product—see page 734.

Armature Relay (44491A)

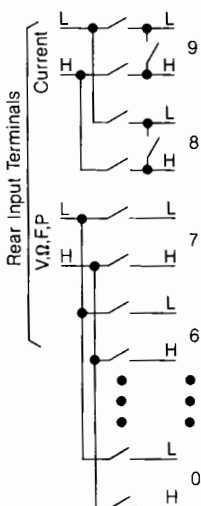

Reed Relay (44492A)

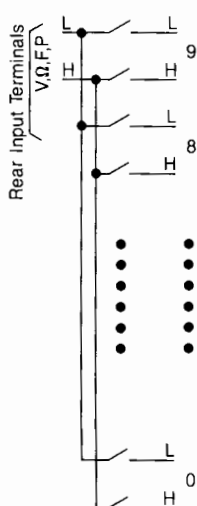

DIGITAL MULTIMETERS

Low Cost 3½ to 5½ Digit HP-IB Multimeter

Model 3478A

- 5 measurement functions
- Up to 90 readings/s
- Electronic calibration
- 100 nanovolt resolution

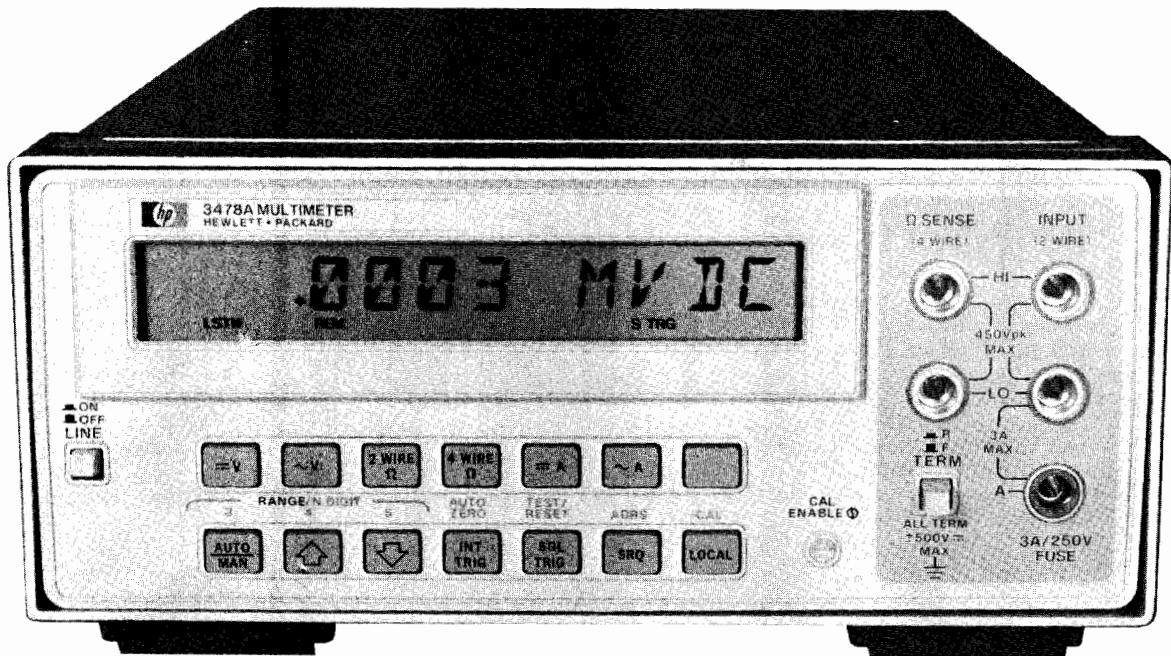

HP 3478A

Description

The HP 3478A is a low cost, full function, reliable DMM for system measurements. Selectable 3½ to 5½ digit resolution and 5 autoranging functions offer flexibility in automated testing. The HP 3478A measures dcV, true rms acV, 2- and 4-wire resistance, and dc and ac current. Simple, fast electronic calibration eliminates all adjustments to provide a lower cost of ownership.

Low Cost of Ownership

The combination of an extremely reliable DMM with complete electronic calibration and self-test gives you low cost of ownership. The proven reliability of the HP 3478A is so good that Hewlett-Packard offers you two additional years of hardware service (Option W30) for less than four percent of the purchase price of the DMM.

Performance

Selectable speed and resolution provide the right capability for your measurement. The HP 3478A can perform production tests or acquire experimental data at 90 readings/s with 3½ digit resolution, or take 35 readings/s with 130 dB of noise rejection using 4½ digits. The 5½ digit mode offers 100 nVdc and 100 μΩ resolution for precise measurements. True rms with 300 kHz bandwidth and 4:1 crest factor provides reliable measurements of ac signals. Fast autoranging makes the first reading useful and accurate.

Designed for Systems

Switchable front/rear inputs permit flexible system connections. The Voltmeter Complete output and External Trigger input allow synchronization of the HP 3478A with a scanner for fast multiplexed measurements without the delay of software commands. The test program can write prompt messages or results on the alphanumeric display. The operator can respond by pressing the HP 3478A's SRQ key to interrupt the controller and start the next test. Built-in self-test capability assures proper operation.

Electronic Calibration

Complete calibration of the HP 3478A is accomplished without any internal adjustment or removing the instrument's covers. Either manually, from the front panel, or automatically over HP-IB, calibration is fast and easy. Connect your standards to the HP 3478A and during calibration, the calibration constants are stored in the H

3478A's non-volatile memory. The result is less calibration error and lower calibration costs.

Specifications

DC Voltage

Input Characteristics

Range	Maximum Reading (5½ digit)	Resolution		
		5½ digit	4½ digit	3½ digit
30 mV	±30.3099 mV	100 nV	1 μV	10 μV
300 mV	±303.099 mV	1 μV	10 μV	100 μV
3 V	±3.03099 V	10 μV	100 μV	1 mV
30 V	±30.3099 V	100 μV	1 mV	10 mV
300 V	±303.099 V	1 mV	10 mV	100 mV

Input resistance: 30 mV, 300 mV, 3 V ranges: $>10^{10} \Omega$
30 V, 300 V ranges: $10 \text{ M}\Omega \pm 1\%$

Maximum input voltage (non-destructive): Hi to Lo: 303 Vrms or 450 V peak; Hi or Lo to Earth Ground: $\pm 500 \text{ V peak}$

Measurement accuracy: $\pm(\%$ of reading + number of counts). Auto zero ON.

5½ Digit Mode

Range	$T_{\text{Cal}} \pm 1^\circ \text{C}$		$T_{\text{Cal}} \pm 5^\circ \text{C}$	
	24 Hour	90 Day	90 Day	1 Year
30 mV	0.025 + 40	0.0275 + 40	0.0275 + 40	0.035 + 40
300 mV	0.004 + 4	0.005 + 5	0.005 + 5	0.007 + 5
3 V	0.003 + 2	0.004 + 2	0.004 + 2	0.006 + 2
30 V	0.004 + 3	0.005 + 4	0.005 + 4	0.007 + 4
300 V	0.004 + 2	0.005 + 2	0.005 + 2	0.007 + 2

* T_{Cal} is the temperature of the environment where the HP 3478A was calibrated. Calibration should be performed with the temperature of the environment between 20°C and 30°C . 24 hour accuracy relative to calibration standards.

4½ and 3½ digit mode: accuracy is the same as 5½ digit mode for % of reading; use 1 count for number of counts on all ranges except 30 mV, use 4 counts.

Temperature coefficient: 0° to 55°C, 5½ digits, auto zero ON. ±(% of reading + number of counts)/°C

Range	Temperature Coefficient
30 mV	0.0028 + 5.0
300 mV	0.0005 + 0.5
3 V	0.0004 + 0.05
30 V	0.0006 + 0.5
300 V	0.0004 + 0.05

Noise rejection: in dB with 1 kΩ imbalance in Lo lead. AC rejection for 50, 60 Hz ± 0.1%. Auto zero ON.

Display	AC NMR	AC ECRM	DC CMR
5½ digits	80	150	140
4½ digits	59	130	140
3½ digits	0	70	140

Maximum Reading Rates (readings/s.)

Line Frequency	Auto Zero and Display	Resolution		
		3½ digits	4½ digits	5½ digits
60 Hz	Off	90	35	4.4
	On	60	20	2.3
50 Hz	Off	85	30	3.7
	On	50	17	1.9

AC Voltage (true rms)

Input Characteristics

Range	Maximum Reading (5½ Digit)	Resolution		
		5½ Digit	4½ Digit	3½ Digit
300 mV	303.099 mV	1 µV	10 µV	100 µV
3 V	3.03099 V	10 µV	100 µV	1 mV
30 V	30.3099 V	100 µV	1 mV	10 mV
300 V	303.009 V	1 mV	10 mV	100 mV

Input impedance: 1 MΩ ± 1% shunted by <60 pF

Maximum Input Voltage (non-destructive):

Hi to Lo: 303 Vrms or 450 V peak

Hi or Lo to Earth Ground: ±500 V peak

Measurement accuracy: ±(% of reading + number of counts). Auto zero ON. 5½ digit display. Accuracy is specified for sinewave inputs only, >10% full scale.

1 Year, T_{Cal}* ±5°C

Frequency	Ranges		
	300 mV	3 V, 30 V	300 V
20-50 Hz	1.14 + 163	1.14 + 102	1.18 + 102
50-100 Hz	0.46 + 163	0.46 + 103	0.50 + 102
100 Hz-20 kHz	0.20 + 120	0.20 + 70	0.24 + 70
20-50 kHz	0.38 + 205	0.26 + 140	0.42 + 140
50-100 kHz	1.20 + 840	0.87 + 780	0.98 + 780
100-300 kHz	10.1 + 3720 (30 V range only)		

Crest factor: >4:1 at full scale

Common mode rejection: with 1 kΩ imbalance in Lo lead, >70 dB, at 60 Hz

Maximum reading rates: 3½ or 4½ digits, 1.4 readings/s; 5½ digits, 1.0 readings/s. First reading is correct within 70 counts of final value when triggered coincident with step input. Add 0.6 seconds for each range change.

Resistance (2-wire Ω, 4-wire Ω)

Input Characteristics

Range	Maximum Reading (5½ Digit)	Resolution		
		5½ Digit	4½ Digit	3½ Digit
30 Ω	30.3099 Ω	100 µΩ	1 mΩ	10 mΩ
300 Ω	303.099 Ω	1 mΩ	10 mΩ	100 mΩ
3 kΩ	3.03099 kΩ	10 mΩ	100 mΩ	1 Ω
30 kΩ	30.3099 kΩ	100 mΩ	1 Ω	10 Ω
300 kΩ	303.099 kΩ	1 Ω	10 Ω	100 Ω
3 MΩ	3.03099 MΩ	10 Ω	100 Ω	1 kΩ
30 MΩ	30.3099 MΩ	100 Ω	1 kΩ	10 kΩ

Input protection (non destructive): Hi to Lo: ±350 V peak; Hi or Lo to Earth Ground: ±500 V peak.

Measurement accuracy: ±(% of reading + number of counts). Auto zero ON. 5½ digit display. 4-wire ohms.

Range	T _{Cal} * ± 1°C			T _{Cal} * ± 5°C		
	24 Hour			90 Day		
30 Ω	0.023 + 35	0.027 + 41	0.034 + 41			
300 Ω	0.0045 + 4	0.012 + 5	0.017 + 5			
3 k-300 kΩ	0.0035 + 2	0.011 + 2	0.016 + 2			
3 MΩ	0.0052 + 2	0.011 + 2	0.016 + 2			
30 MΩ	0.036 + 2	0.066 + 2	0.078 + 2			

Current Through Unknown

Range	30 Ω	300 Ω	3 kΩ	30 kΩ	300 kΩ	3 MΩ	30 MΩ
Current	1 mA	1 mA	1 mA	100 µA	10 µA	1 µA	100 nA

DC Current

Input Characteristics

Range	Maximum Reading (5½ Digit)	Resolution		
		5½ Digit	4½ Digit	3½ Digit
300 mA	± 303.099 mA	1 µA	10 µA	100 µA
3 A	± 3.03099 A	10 µA	100 µA	1 mA

Maximum input (non-destructive): 3 A from <250 V source; fuse protected.

Measurement accuracy: ±(% of reading + number of counts). Auto zero ON. 5½ digit display.

Range	T _{Cal} * ± 5°C	
	90 Days	1 Year
300 mA	0.11 + 40	0.15 + 40
3 A (<1 A)	0.14 + 6	0.17 + 6
3 A (>1 A)	1.0 + 30	1.0 + 30

Maximum burden at full scale: 1 V (3 A range), 0.1 V (0.3 A range)

AC Current (true rms responding)

Input Characteristics

Range	Maximum Reading (5½ Digit)	Resolution		
		5½ Digit	4½ Digit	3½ Digit
300 mA	303.099 mA	1 µA	10 µA	100 µA
3 A	3.03099 A	10 µA	100 µA	1 mA

Maximum input: (non-destructive): 3 A from <250 V source; fuse protected.

Measurement accuracy: ±(% of reading + number of counts). Auto zero ON. 5½ digit display. Accuracy is specified for sinewave inputs only, >10% of full scale.

1 Year, T_{Cal}* ±5°C

Frequency	Ranges	
	300 mA	3 A
20-50 Hz	1.54 + 163	2.24 + 163
50-1 kHz	0.81 + 163	1.50 + 163
1 k-10 kHz	0.72 + 163	1.42 + 163
10 k-20 kHz	0.86 + 163	1.56 + 163

Maximum burden at full scale: 1 V RMS (3A range)

General

Operating temperature: 0 to 55°C

Humidity range: 95% R.H., 0 to 40°C

Power: ac line 48 to 440 Hz; 86 to 250 V, 25 VA max.

Size: 102 mm H x 215 mm W x 356 mm D (4" x 8" x 14"); 3½ in. H without feet.

Weight: 3 kg (6.5 lb)

HP-IB Interface Functions: SH1, AH1, T5, TE0, L4, LE0, SR1, RL1, PP0, DC1, DT1, C0

Ordering Information

Choose one N/C power option:

Opt 315: 100 V, 50 Hz; **Opt 335:** 220 V, 50 Hz

Opt 316: 100 V, 60 Hz; **Opt 336:** 220 V, 60 Hz

Opt 325: 120 V, 50 Hz; **Opt 345:** 240 V, 50 Hz

Opt 326: 120 V, 60 Hz; **Opt 346:** 240 V, 60 Hz

Opt W30: Three year extended hardware support

Opt 907: Front Handle Kit (HP P/N 5061-0088)

Opt 908: Rack Mount Kit (HP P/N 5061-0072)

Opt 910: Extra Manuals (HP P/N 03478-90005 and (HP P/N 03478-90006)

Price

HP 3478A Multimeter

\$995

☎ Fast Ship Product—see page 734.

DIGITAL MULTIMETERS

6½ to 3½ Digit HP-IB DMM with High Stability

Model 3456A

- Up to 330 readings per second
- 100 nanovolt resolution

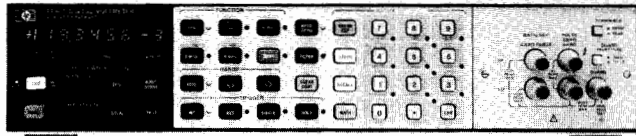

Description

This fully guarded, integrating Digital Multimeter is designed for bench or systems. The HP Model 3456A measures DC, true RMS AC voltage and resistance.

Measurement speed and accuracy can be enhanced for a specific application, using the HP 3456A's selectable integration time (up to 100 power line cycles). An operator can select up to 330 readings/second for high speed bursts or one reading every fifteen minutes for periodic measurements. Resolution of 100 nanovolts at 48 readings/second (6½ digits) to 10 microvolt resolution at 330 readings per second (3½ or 4½ digits) can be selected.

With good repeatability and 100 nanovolt sensitivity, accuracy on the ten volt range is $\pm 0.0008\% + 2$ counts over a 24-hour period at $23^\circ\text{C} \pm 1^\circ\text{C}$.

Four full-scale, true RMS AC voltage ranges are provided, with reading speeds up to 12 readings per second over a 10 Hz to 250 kHz frequency range. Best accuracy is 0.05%. Crest factor is greater than seven at full scale.

With the HP 3456A's program memory and reading storage capability, the HP 3456A can take measurements and store them while a computer performs some other task.

Another system feature of the HP 3456A is its hardware scanner advance capability for scanned or multiplexed system applications. As soon as the HP 3456A's measurement cycle is complete, a TTL signal is available to trigger a variety of switching instruments.

Specifications

DC Voltage

RANGE	MAXIMUM READING (5½ digit)	RESOLUTION 6½ digit	RESOLUTION 5½ digit	RESOLUTION 4½ digit	INPUT RESISTANCE	MAXIMUM INPUT VOLTAGE
0.1 V	11.9999 V	100 nV	1 μV	10 μV	$>10^{10} \Omega$	± 1000 V peak
1.0 V	1.9999 V	1 μV	10 μV	100 μV	$>10^{10} \Omega$	
10.0 V	11.9999 V	10 μV	100 μV	1 mV	$>10^{10} \Omega$	
100.0 V	119.999 V	100 μV	1 mV	10 mV	10 M $\Omega \pm 5\%$	
1000.0 V	1000.00 V	1 mV	10 mV	100 mV	10 M $\Omega \pm 5\%$	

Measurement accuracy: \pm (% of reading + number of counts).

RANGE	24 hour: $23^\circ\text{C} \pm 1^\circ\text{C}$		90 days: $23^\circ\text{C} \pm 5^\circ\text{C}$		1 year: $23^\circ\text{C} \pm 5^\circ\text{C}$	
	6½ digit (≥ 10 PLC)	6½ digit (1 PLC)	6½ digit (≥ 10 PLC)	6½ digit (1 PLC)	6½ digit (≥ 10 PLC)	6½ digit (1 PLC)
0.1 V	.0022 + 24	0.0024 + 32	0.0026 + 24	0.0027 + 32	0.0034 + 24	0.0035 + 32
1.0 V	0.0009 + 4	0.0012 + 5	0.0016 + 4	0.0017 + 5	0.0024 + 4	0.0025 + 5
10.0 V	0.0008 + 2	0.0011 + 3	0.0015 + 2	0.0016 + 3	0.0023 + 2	0.0024 + 3
100.0 V	0.0011 + 3	0.0014 + 4	0.0018 + 3	0.0019 + 4	0.0026 + 3	0.0027 + 4
1000.0 V	0.0011 + 2	0.0013 + 3	0.0016 + 2	0.0017 + 3	0.0024 + 2	0.0025 + 3

¹Add .02 $\left(\frac{\text{Input Voltage}}{1000}\right)^2$ % to % of reading.

AC RMS Voltage (AC, AC + DC)

RANGE	MAXIMUM READING (5½ digit)	RESOLUTION 6½ digit	RESOLUTION 5½ digit	RESOLUTION 4½ digit	INPUT IMPEDANCE	MAXIMUM INPUT VOLTAGE
1.0 V	1.9999 V	1 μV	10 μV	100 μV	1 M $\Omega \pm 5\%$ shunted by <90 pF	± 1000 V peak (700 V rms) 10 ⁹ VHZ
10.0 V	11.9999 V	10 μV	100 μV	1 mV		
100.00 V	119.999 V	100 μV	1 mV	10 mV		
1000.0 V	700.00 V	1 mV	10 mV	100 mV		

Measurement accuracy: \pm (% of reading + number of counts).

- 100 micro-ohm to 1.0 gigaohm

90 days: $23^\circ\text{C} \pm 5^\circ\text{C}$

Integration Time	Frequency In Hz					
	10 to 20	Filter Off → 20 to 30	400-20k 30-20k	20k to 50k 20k to 50k	50k to 100k 50k to 100k	100k to 250k 100k to 250k
$>1^*$ (6 Digit) ²	.47 + 450	.35 + 500	.07 + 730	.17 + 1700	.55 ± 2900	5.0 + 6500
.1~ (5 Digit)	.48 + 90	.36 + 53	.08 + 73	.18 + 173	.56 ± 293	5.0 + 653
.01~ (4 Digit)	.56 + 10	.41 + 7	.13 + 9	.23 + 19	.61 + 31	5.1 + 67

*Frequencies > 100 kHz are specified for 1.0 V and 10 V ranges only.

²Integration Time in Power Line Cycles (PLC). For 5½ digits, multiply counts by 0.1. For 4½ digits, multiply counts by 0.01.

Resistance (2 W Ω , 4 W Ω , 2 WOC Ω , 4 WOC Ω)

RANGE	MAXIMUM READING (5½ digit)	RESOLUTION 6½ digit	RESOLUTION 5½ digit	RESOLUTION 4½ digit	CURRENT THROUGH UNKNOWN
100 Ω	119.999 Ω	100 $\mu\Omega$	1 m Ω	10 m Ω	1 mA
1 k Ω	1199.99 Ω	1 m Ω	10 m Ω	100 m Ω	1 mA
10 k Ω	11.9999 k Ω	10 m Ω	100 m Ω	1 Ω	100 μA
100 k Ω	119.999 k Ω	100 m Ω	1 Ω	10 Ω	50 μA
1 M Ω	1199.99 k Ω	1 Ω	10 Ω	100 Ω	5 μA
10 M Ω	11.9999 M Ω	10 Ω	100 Ω	1 k Ω	500 nA
100 M Ω	119.999 M Ω	100 Ω	1 k Ω	10 k Ω	≤ 500 nA ¹
1 G Ω	1000.00 M Ω	1 k Ω	10 k Ω	100 k Ω	≤ 500 nA ¹

¹Ohms source is a 500 nA current source in parallel with a 10 M Ω resistance.

Measurement accuracy: \pm (% of reading + number of counts).

RANGE	24 hour: $23^\circ\text{C} \pm 1^\circ\text{C}$		90 days: $23^\circ\text{C} \pm 5^\circ\text{C}$	
	6½ digit (≥ 10 PLC)	6½ digit (1 PLC)	6½ digit (≥ 10 PLC)	6½ digit (1 PLC)
100 Ω	0.003 + 24	0.003 + 32	0.004 + 24	0.004 + 32
1 k Ω	0.002 + 4	0.003 + 5	0.003 + 4	0.004 + 5
10 k Ω	0.002 + 4	0.003 + 5	0.003 + 4	0.004 + 5
100 k Ω	0.002 + 2	0.003 + 3	0.003 + 2	0.004 + 3
1 M Ω	0.006 + 2	0.006 + 3	0.007 + 2	0.007 + 3
10 M Ω	0.041 + 2	0.041 + 3	0.042 + 2	0.042 + 3
100 M Ω	1.3 + 1	1.3 + 1	1.8 + 1	1.8 + 1
1 G Ω	11 + 1	11 + 1	16 + 1	16 + 1

Ratio

Type: DC/DC, AC/DC, or (AC + DC)/DC

Method: 4-wire with Volts Lo input common

$$\text{Ratio} = \frac{\text{Signal Voltage}}{\text{Ref. Hi Voltage} - \text{Ref. Lo Voltage}}$$

Reading Rate

INTEGRATION TIME IN POWER LINE CYCLES (PLC)	RATES (rdgs/second)			
	Auto Zero OFF		Auto Zero ON	
	60 Hz	50 Hz	60 Hz	50 Hz
0.01 (4½ digit)	330	290	210	180
0.10 (5½ digit)	210	180	120	100
1.00 (6½ digit)	48	40	25	20
10.00 (6½ digit)	5.8	4.8	2.9	2.4
100.00 (6½ digit)	.57	.47	.29	.24

Memory

Reading store: Store up to 350 readings.

Program memory: can execute an internal program which controls instrument configuration and measurement sequence.

General

Operating temperature: 0 to 50°C

Humidity Range: 95% R.H., 0 to 40°C

Power: 100/120/220/240 V +5%, -10%, 48 Hz to 400 Hz line operation, 45 VA max.

Size: 88.9 mm H x 425.5 mm W x 527.1 mm D (3½" x 16¾" x 20¾")

Weight: net, 10.49 kg (23.13 lb.); shipping, 13.35 kg (29.38 lb.)

Ordering Information

Opt 050: Noise rejection for 50 Hz

Opt 060: Noise rejection for 60 Hz

Opt W30: 3 year hardware support

HP 3456A Digital Voltmeter

Price

N/C

N/C

+ \$120

\$4600

- 5½/6½-Digit DVM with Auto Cal
- High Speed 3½ Digit System Voltmeter

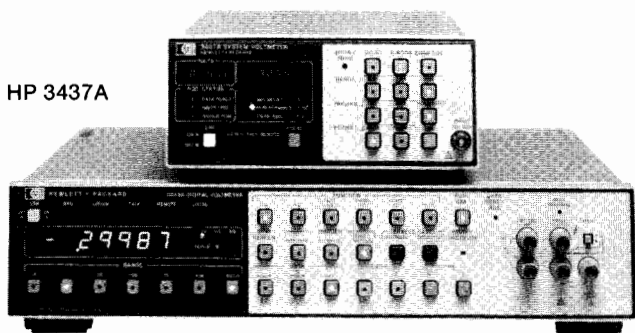

HP 3437A

HP 3455A

HP 3437A Description

The Hewlett-Packard 3437A System Voltmeter is designed for systems. It is a 3½-digit, high-speed dc voltmeter with sample and hold. The standard unit measures dc volts, provides trigger delay, burst reading capability and Hewlett-Packard Interface Bus (HP-IB).

There are three dc floating input ranges: 0.1V, 1.0V and 10.0V full scale with a maximum display of "1998." Sample and Hold allow the HP 3437A to be an instantaneous reading voltmeter. The trigger delay can be set from 0.1µs to 1.0 second and the number of readings can be set from 0 to 9999 readings.

Specifications

Static Accuracy (90 days, 23°C ± 5°C)

10 V range: ±(0.05% of reading + 1.6 counts).

Static accuracy temperature coefficient (0°C–50°C):

±(0.002% reading + 0.05 counts) / °C.

Input Characteristics

10 V range: R = 1 MΩ ± 20%; C < 75 pF.

Maximum input voltage high to low on all ranges: < ±30 V peak.

Maximum voltage low to chassis: ±42 V peak.

Maximum reading rate (remote, N Rdgs. > 1, and a zero delay listener)

ASCII: 3600 readings/s.

Packed: 5700 readings/s.

Input Bandwidth (3 dB)

1 V and 10 V range: 1.0 MHz.

General

Operating temperature: 0 to 55°C.

Storage temperature: -40°C to 75°C.

Humidity range: < 95% R.H., 0°C to 40°C.

Power: 100 V, 120 V, 220 V, 240 V +5%, -10%, 48 Hz to 440 Hz line operation, < 42 VA.

Size: 88.9 mm H x 212.7 mm W x 527.1 mm D (3½" x 8¾" x 20¾").

Weight: net, 5.6 kg (12 lb 4 oz). Shipping, 7.6 kg (16 lb 12 oz).

HP 3437A System Voltmeter
Opt W30 extended warranty

\$3600
\$95

HP 3455A Description

Hewlett-Packard's 3455A Digital Voltmeter is a 5½ to 6½-digit integrating voltmeter for bench or systems applications. The standard instrument measures dc volts, ac volts, and resistance. HP-IB and auto or manual ranging are also standard.

DC measurements can be made with up to 1µV sensitivity. Ohms measurements are made with either a 2-wire and 4-wire mode. The high resolution (6½-digit) mode gives dc and ohms measurements with greater than 1 part per million resolution. The standard true rms ac to dc converter measures sinusoid and complex signals with crest factors up to 7:1 at full scale from 30 Hz to 1 MHz.

Specifications

DC Voltage

Accuracy ± (% of reading + counts), 6½ digit mode

24 hrs: 23°C ± 1°C		
Range	24 Hrs.	90 Days
1 V	0.003 + 4	0.006 + 4
10 V	0.002 + 3	0.005 + 3
100 & 1000 V	0.004 + 3	0.007 + 3

Input resistance: 0.1 V through 10 V range: > 10¹⁰ ohms. 100 V and 1000 V range: 10 megohm ± 0.1% with Auto Cal. "off."

Maximum Input Voltage: High to low input terminals: ±1000 V peak; Guard to chassis: ±500 V peak; Guard to low terminal: ±200 V peak.

NMR at 50 or 60 Hz ± 0.1%: > 60 dB.

ECMR with 1 kΩ Unbalance in low lead at DC: > 160dB

AC Voltage (rms converter)

Input Impedance

Front terminals: 2 MΩ ± 1% shunted by less than 100 pF.

Rear terminals: 2 MΩ ± 1% shunted by less than 75 pF.

Maximum Input Voltage

High to low terminals: ±1000 volts peak; 10⁷ VHz max.

Guard to chassis: ±500 V peak; Guard to low terminal: ±200 V peak.

Crest factor: 7:1 at full scale.

Accuracy: [± % of reading + counts] (ac coupled)

Fast ACV	300 Hz to 20 kHz	20 kHz to 100 kHz	100 kHz to 250 kHz	250 kHz to 500 kHz	500 kHz to 1 MHz
	ACV				
90 days					
23°C ± 5°C	0.05 + 50	0.50 + 100	2.00 + 250	5.00 + 500	6.00 + 3100

Resistance

Accuracy ± (% of reading + counts) 4-wire, 6½ digit mode

24 hours: 23°C ± 1°C		
Range	24 Hours	90 Days
1 kΩ	0.0025 + 4	0.0035 + 5
10 kΩ	0.0045 + 4	0.0060 + 5
100 kΩ	0.0020 + 5	0.0035 + 6
1000 kΩ	0.0120 + 4	0.0135 + 5
10,000 kΩ	0.1000 + 4	0.1000 + 5

Maximum Reading Rates for Remote Operations. (Rdgs/s)

Function	50 Hz	60 Hz
DCV	22	24
Ohms	11	12
ACV (rms)	1.1	1.3
Fast ACV (rms)	12	13

General

Power: 100 V, 120 V, 240 V +5% -10%, 48-400 Hz; < 60 VA.

Size: 88.9 mm H x 425.5 mm W x 527.1 mm D (3.5" x 16.75" x 20.75").

Weight: net, 9.38 kg (20.7 lb); shipping, 11.8 kg (26 lb).

HP 3455A Digital Voltmeter
Opt 001 average converter

\$5950
-\$100

DIGITAL MULTIMETERS

High Performance 5½ to 3½ Digit Bench DMM
HP Models 3468A/B

- Five functions
- Electronic calibration
- 5½ to 3½ digits

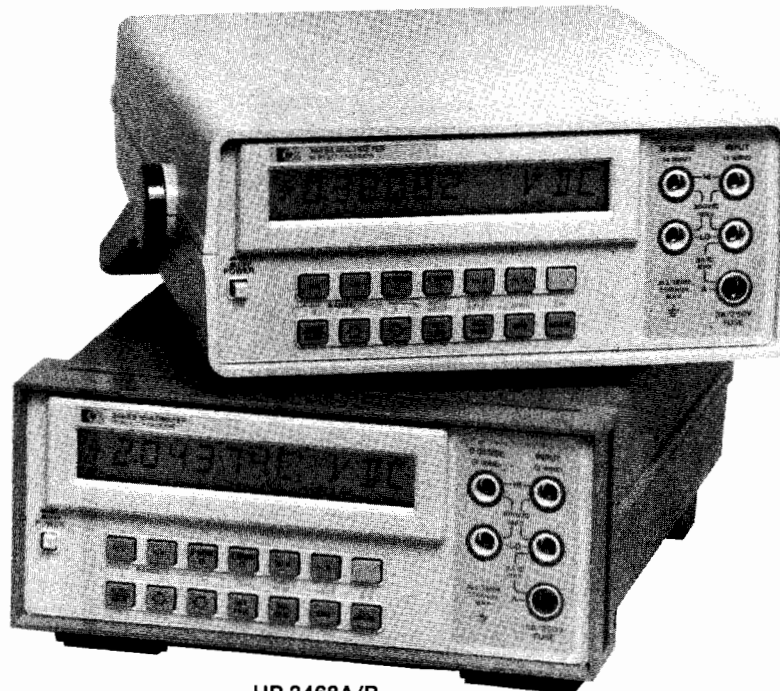

HP 3468A/B

Description

The HP Models 3468A/B are autoranging 5½ to 3½ digit DMMs, with the five functions of dc volts, true RMS ac volts, 2- and 4-wire ohms, dc current and true RMS ac current. They are low-cost, highly reliable DMMs which can be completely calibrated electronically, either manually from the front panel or remotely in an automatic calibration system. Remote calibration is made possible by the built-in HP-IL (Hewlett-Packard Interface Loop) interface which provides complete programmability of functions, ranges and modifiers.

The HP 3468A comes in a streamlined portable package with a handle for convenient carrying, whereas the HP 3468B comes in a plastic system case for easy rack mounting. Both are available with a rechargeable battery and battery charging circuitry for portable measurements.

High Performance

The HP 3468A/B have 5 functions with selectable 5½, 4½ or 3½ digit resolution. DC and true RMS ac voltage measurements are provided from 0.3 volt full scale range with 1 µV sensitivity up to 300 volts. The bandwidth of the true RMS ac converter is from 20 Hz to 100 kHz on all ranges and up to 300 kHz on the 30 V range. Either 2 or 4-wire ohms measurements can be selected with a maximum range of 30 MΩ. Both dc and true RMS ac current capability is provided up to 3 A. All functions on the HP 3468A/B incorporate fast autoranging. The HP 3468A/B use an integrating analog to digital conversion technique for high noise rejection. The selectable 3½, 4½ or 5½ digits of resolution allows flexibility for choosing speed or noise rejection.

Electronic Calibration

Complete calibration of the HP 3468A/B is done electronically, either manually from the front panel or remotely in an automatic calibration system. There are no internal adjustments necessary. Complete calibration of all functions is done without removal of the instrument's covers, thus saving valuable time and reducing cost. The calibration procedure for the HP 3468A/B involves connecting a calibration standard to the input, then pressing three keystrokes to store

one calibration constant in CMOS RAM for each range and function. When the HP 3468A/B make a measurement, each reading is corrected according to the calibration constants that have been stored. The internal CMOS RAM used in the HP 3468A/B is powered by a lithium battery to create a non-volatile memory capable of holding the calibration constants for more than ten years.

Battery

The optional battery pack includes a rechargeable battery and the battery charger circuitry for up to five hours of continuous measurements.

DC Voltage Input Characteristics

Range	Maximum Reading (5½ digit)	Resolution		
		5½ digit	4½ digit	3½ digit
0.3 V	±0.301000 V	1 µV	10 µV	100 µV
3 V	± 3.01000 V	10 µV	100 µV	1 mV
30 V	± 30.1000 V	100 µV	1 mV	10 mV
300 V	± 301.000 V	1 mV	10 mV	100 mV

Input resistance: 0.3 V, 3 V ranges: $>10^{10} \Omega$
30 V, 300 V ranges: $10 \text{ M}\Omega \pm 1\%$

Maximum Input Voltage (non-destructive)

Hi to Lo: 301 Vrms or 450 V peak

Hi or Lo to Earth Ground: $\pm 500 \text{ V peak}$

Measurement accuracy: $\pm(\% \text{ of reading} + \text{number of counts})$.
Auto zero ON. 5½ digits.

Range	TCal $\pm 1^\circ\text{C}$ 24 Hour	TCal $\pm 5^\circ\text{C}$	
		90 Day	1 Year
0.3 V	0.005 + 4	0.009 + 5	0.02 + 5
3 V	0.0035 + 2	0.0072 + 2	0.0181 + 2
30 V	0.005 + 3	0.009 + 3	0.02 + 3
300 V	0.0055 + 2	0.009 + 2	0.02 + 2

*TCal is the temperature of the environment where the 3468A/B was calibrated. Calibration should be performed with the temperature of the environment between 20°C and 30°C.

Temperature coefficient: 0°C to 55°C, 5½ digits, auto zero ON. ± (% of reading + number of counts)/°C.

Range	Temperature Coefficient
0.3 V, 30 V	0.0008 + 0.5
3 V, 300 V	0.0007 + .05

Noise rejection: in dB, with 1 kΩ imbalance in Lo lead. AC rejection for 50, 60 Hz ±0.1%. Auto zero ON.

Display	AC NMR	AC ECMR	DC CMR
5½ digits	80	150	140
4½ digits	59	130	140
3½ digits	0	70	140

Maximum reading rate with HP-41CV: 2 readings/second.

Resistance (2-wire Ω, 4-wire Ω)

Input Characteristics

Range	Maximum Reading (5½ digit)	Resolution		
		5½ digit	4½ digit	3½ digit
300 Ω	301.000 Ω	1 mΩ	10 mΩ	100 mΩ
3 kΩ	3.01000 kΩ	10 mΩ	100 mΩ	1 Ω
30 kΩ	30.1000 kΩ	100 mΩ	1 Ω	10 Ω
300 kΩ	301.000 kΩ	1 Ω	10 Ω	100 Ω
3 MΩ	3.01000 MΩ	10 Ω	100 Ω	1 kΩ
30 MΩ	30.1000 MΩ	100 Ω	1 kΩ	10 kΩ

Input protection (non-destructive): ± 350 V peak.

Measurement accuracy: ± (% of reading + number of counts). Auto zero ON. 5½ digit display. 4-wire ohms.

Range	TCal ±1°C 24 Hour	TCal ±5°C	
		90 Day	1 Year
300 Ω	.0045 + 4	.012 + 4	.017 + 5
3 kΩ-300 kΩ	.0035 + 2	.011 + 2	.016 + 2
3 MΩ	.0052 + 2	.011 + 2	.016 + 2
30 MΩ	.036 + 2	.066 + 2	.078 + 2

Current Through Unknown

Range	300 Ω	3 kΩ	30 kΩ	300 kΩ	3 MΩ	30 MΩ
Current	1 mA	1 mA	100 μA	10 μA	1 μA	100 nA

Maximum open circuit voltage: 6.5 V

AC Voltage (true RMS responding)

Input Characteristics

Range	Maximum Reading (5½ digit)	Resolution		
		5½ digit	4½ digit	3½ digit
0.3 V	0.301000 V	1 μV	10 μV	100 μV
3 V	3.01000 V	10 μV	100 μV	1 mV
30 V	30.1000 V	100 μV	1 mV	10 mV
300 V	301.000 V	1 mV	10 mV	100 mV

Input impedance: 1 MΩ ±1% shunted by <60 pF.

Maximum input voltage (non-destructive): 301 Vrms or 450 V peak.

Measurement accuracy: ± (% of reading + number of counts) Auto zero ON. 5½ digit display. Accuracy is specified for sinewave inputs only, >10% of full scale.

1 Year, TCal ±5°C

Frequency	Ranges		
	0.3V	3 V, 30 V	300 V
20-50 Hz	1.14 + 163	1.14 + 102	1.18 + 102
50-100 Hz	0.46 + 163	0.46 + 103	0.5 + 102
100 Hz-20 kHz	0.29 + 163	0.26 + 102	0.33 + 102
20-50 kHz	0.56 + 247	0.41 + 180	0.55 + 180
50-100 kHz	1.74 + 882	1.05 + 825	1.26 + 825
100 k-300 kHz	10.1 + 3720 (30 V range only)		

Crest factor: >4:1 at full scale.

DC Current

Input Characteristics

Range	Maximum Reading (5½ digit)	Resolution		
		5½ digit	4½ digit	3½ digit
3 A	± 3.01000 A	10 μA	100 μA	1 mA

Maximum input (non-destructive): 3 A from <250 V source; fuse protected.

Measurement accuracy: ± (% of reading + number of counts). Auto zero ON. 5½ digit display.

Range	TCal ±5°C	
	90 Days	1 Year
3 A, <1 A input	0.14 + 6	0.17 + 6
3 A, >1 A input	1.0 + 30	1.0 + 30

AC Current (true RMS responding)

Input Characteristics

Range	Maximum Reading (5½ digit)	Resolution		
		5½ digit	4½ digit	3½ digit
3 A	0.301000 A	1 μA	10 μA	100 μA
3 A	3.01000 A	10 μA	100 μA	1 mA

Maximum input (non-destructive): 3 A from <250 V source; fuse protected.

Measurement accuracy: ± (% of reading + number of counts). Auto zero ON. 5½ digit display. Accuracy specified for sinewave inputs only, >10% of full scale.

1 Year, TCal ±5°C

Frequency	Ranges	
	0.3 A	3 A
20-50 Hz	1.77 + 163	2.5 + 163
50-1 kHz	1.1 + 163	1.8 + 163
1 k-10 kHz	1.0 + 163	1.7 + 163
10 k-20 kHz	1.14 + 163	1.84 + 163

General Information

Operating temperature: 0 to 55°C

Humidity range: 95% R.H., 0 to 40°C

Power: AC line 48 to 440 Hz, 86 to 250 V, (see configuration)

Battery: (Opt 001) Rechargeable lead-acid; minimum continuous operation for 5 hours at 25°C; recharge time is 16 hours with HP 3468A/B off and 36 hours with HP 3468A/B on.

Size: HP 3468A: 98.4 mm H x 238.1 mm W x 276.2 mm D (3.88 in. H x 9.38 in. W x 10.88 in. D). 3468B: 89 mm H x 213 mm W x 275 mm D (without feet), 3.5 in. H x 8.38 in. W x 10.83 in. D.

Weight: HP 3468A/B—2.1 kg (4.63 lb); HP 3468A/B with Opt 001—3.1 kg (6.83 lb).

Configuration: order one power and frequency option at no charge from below.

Opt 315: 100 V, 50 Hz; **Opt 335:** 220 V, 50 Hz

Opt 316: 100 V, 60 Hz; **Opt 336:** 220 V, 60 Hz

Opt 325: 120 V, 50 Hz; **Opt 345:** 240 V, 50 Hz

Opt 326: 120 V, 60 Hz; **Opt 346:** 240 V, 60 Hz

Ordering Information

HP 3468A DMM in Streamlined Portable Case with HP-IL and test probes. **Price** \$765 ☞

HP 3468B DMM in Rack and Stack Case with HP-IL and test probes. \$765 ☞

Options and Accessories

HP 3468A/B Option W30, add 3 year Extended Hardware Support \$25

HP 3468A/B Option 001, add Rechargeable Battery Pack \$155

HP 3468B Option 401, add Side Handle Kit (HP P/N 5061-1171) \$40

HP 3468B Option 907, add Front Handle Kit (HP P/N 5061-1170) \$52

HP 3468B Option 908, add Rack Mount Kit for a Single Instrument (HP P/N 5060-0173) \$55

HP P/N 5060-0174 Rack Mount Kit for rack mounting two instruments side-by-side \$87.50

☞ Fast-Ship product - See page 734

DIGITAL MULTIMETERS

Bench, General Purpose and Wide Bandwidth
HP Models 3466A/3400A

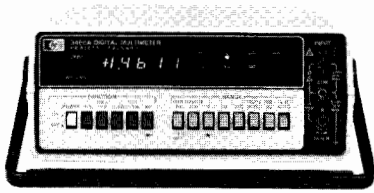

HP 3466A

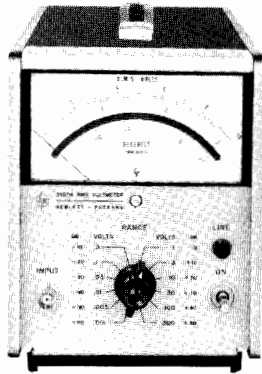

HP 3400A

HP Model 3466A

The HP 3466A is a 4 1/2 digit autoranging multimeter offering six functions ACV, DCV, ACI, DCI, Ohms, and Diode Test. ACV and ACI measurements are true rms with selectable ac or dc coupling. Available with rechargeable batteries or ac power only, it offers 1 μ V and 1 mOhm sensitivity with zero adjustment on the lowest ranges to compensate for external offsets.

Specifications

Voltage

DC V

Range	Maximum Display	Accuracy: 1 year. 15 to 30 deg. C \pm (% of reading + # of counts)
20 mV	\pm 19.999	0.05 + 3
200 mV	\pm 199.99	0.04 + 2
2 V	\pm 1.9999	0.03 + 1
20 V	\pm 19.999	0.03 + 1
200 V	\pm 199.99	0.035 + 1
1200 V	\pm 1199.9	0.035 + 1, <700 V input
1200 V	\pm 1199.9	0.055 + 1 >700 V input

AC V (true-rms responding, true-rms calibrated)

Frequency Range	Accuracy: 1 year. 15 to 30 deg. C \pm (% of reading + # counts)
20 to 30 Hz	2 + 50
30 to 50 Hz	1 + 30
50 Hz to 10 kHz	0.3 + 20
10 to 20 kHz	1 + 40
20 to 100 kHz	2 + 150

Maximum input: (ac+dc)V: \pm 1200 Vdc, 1700 V (dc + peak ac); acV: \pm 600 V dc, 1700V(peak ac + dc); 10^7 volt-Hz max.

Crest Factor: 4:1 at full scale.

Resistance

Ranges: 20 Ohm to 20 MOhm in 7 ranges

Input Protection: 250V or 350V (dc + peak ac).

Range	Accuracy: 1 year. 15 to 30 deg. C \pm (% of reading + # counts)
20 to 200 Ohm	0.08 + 2
2 kOhm to 200 kOhm	0.03 + 1
2000 kOhm	0.04 + 1
20 MOhm	0.15 + 1

Current

Maximum Input: current: 2 A (fused protected). Voltage: 250 V

DC I

Range	Accuracy: 1 year. 15 to 30 deg. C \pm (% reading + # counts)
200 μ A, 2mA, 20mA	0.07 + 2
200 mA	0.15 + 2
2000 mA	0.5 + 2

AC I

Range	Frequency	Accuracy: 1 year. 15 to 30 deg.C \pm (% reading + # counts)
200 μ A to 200 mA	20 to 30 Hz	2.0 + 50
	30 Hz to 10 kHz	0.9 + 35
2000 mA	20 to 30 Hz	2.0 + 50
	30 Hz to 10 kHz	1.2 + 20

Ordering Information

HP 3466A Opt. 001, streamlined portable case, ac line power only

Price

-\$75

HP 3466A Opt. 002, Rack and Stack case, ac line power only. (Rack mount kit not included.)

-\$10

HP 3466A Digital Multimeter. Standard configuration in a streamlined portable case with handle, ac line power, batteries and charger, and test leads.

\$1290

☎ Fast-Ship product. See page 734.

HP Model 3400A

The HP 3400A is a true rms analog voltmeter. Six-decade frequency coverage makes the HP 3400A extremely flexible for audio and RF measurements up to 10 MHz and permits the measurement of broadband noise and fast risetime pulses.

Pulses or other non-sinusoids with crest factors up to 10:1 can be measured full scale. Plots of measured data and higher resolution measurements can be produced by connecting a dmm to the convenient rear-panel dc output which produces a linear 0 to 1 volt output proportional to the meter deflection.

Specifications

Voltage Range: 1 mV to 300 V full scale, 12 ranges.

dB Range: -72 to + 52 dBm (0 dBm = 1 mW into 600 Ohm).

Frequency range: 10 Hz to 10 MHz.

Response: responds the rms value (heating value) of the input signal for all waveforms.

Meter accuracy: % of full scale (20 to 30 deg. C)*

10 Hz	50 Hz	1 MHz	2 MHz	3 MHz	10 MHz
5%	1%	2%	3%	5%	

AC to DC converter accuracy: % of full scale (20 to 30 deg. C)

10 Hz	50 Hz	1 MHz	2 MHz	3 MHz	10 MHz
5%	0.75%	2%	3%	5%	

* TC: 0.1% from 0 to 20 and 30 to 55 deg.C

Crest Factor: (ratio of peak to rms amplitude of input signal): 10:1 at full scale.

Input impedance: from 0.001 to 0.3V range: 10 MOhm shunted by <50 pF. 1.0 to 300 V range: 10 MOhm shunted by < 20 pF, ac coupled input.

Output: negative 1 V dc into open circuit at full scale deflection, proportional to meter deflection from 10 to 100% of full scale. 1 mA maximum; nominal source impedance is 1 kOhm. Output noise is <1mV rms.

Accessories furnished: 10110A adapter, BNC to dual banana jack.

Ordering Information

HP 3400A Opt. 001 expands the dB scale by placing it on the top of the meter.

Price

\$42

Rear terminals in parallel with front terminals and linear log scale uppermost on the meter face are available on special order.

HP 3400A RMS Voltmeter

\$1850

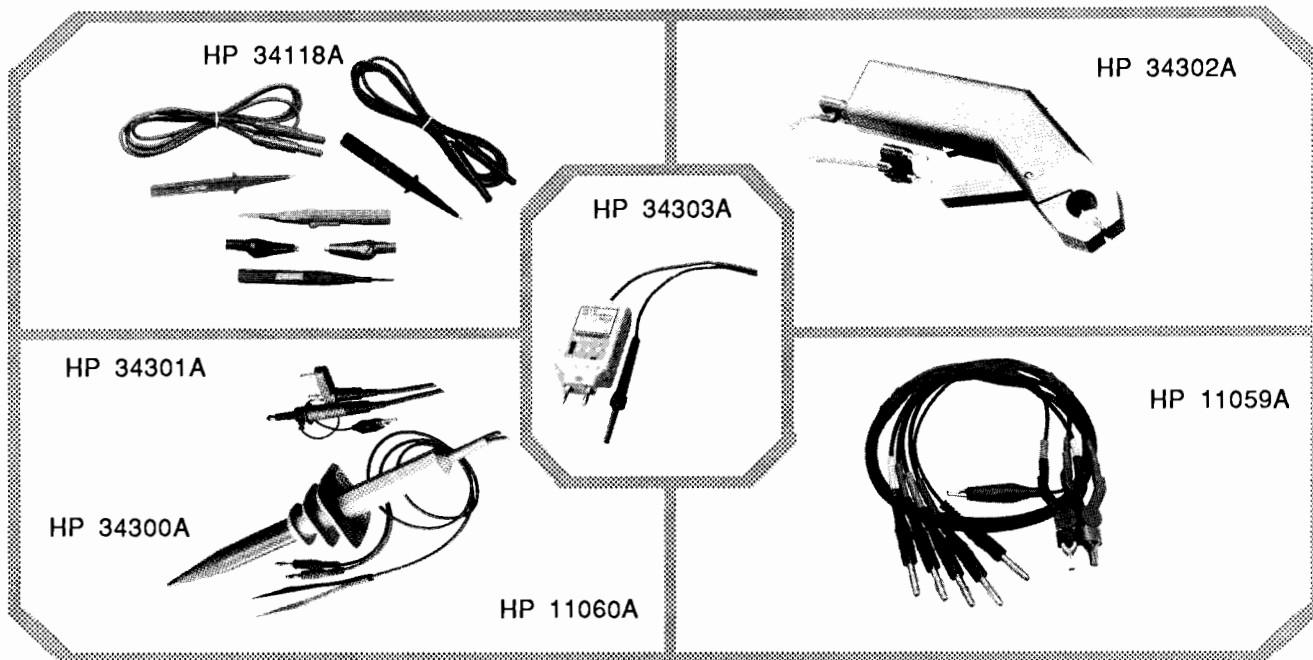

HP 34301A RF Detector Probe

This probe detects high frequency signals for voltage measurements. The probe can be used with any dmm having a 10 m Ω input.

Bandwidth: 100 kHz - 700 MHz

Accuracy: 100 kHz - 500 MHz, ± 1 dB
100 kHz - 700 MHz, ± 3 dB

Input Capacitance: approx. 5 pF

Maximum ac Input: 50 Vrms

Transfer Ratio: 1 Vdc output for 1 Vrms input

HP 34302A Clamp-on AC/DC Current Probe

A clamp-on probe used for measuring ground currents, power supply ripple, or current distribution in systems. This probe allows you to measure ac, dc and ac+dc currents without breaking the circuit.

Ranges: ± 10 A dc or 10 A ac

± 100 A dc or 100 A ac

Frequency Response: dc to 1 kHz

Recommended Load: >3.0 k Ω

Rated Output: ± 1.0 V dc at 10 A

± 1.0 V dc at 100 A

Aperture Size: 19 mm

Accuracy: $\pm 2\%$ or rated output

HP 34300A 40 kV AC/DC High Voltage Probe

A probe for use with any dmm having an input resistance of 10 M Ω . Maximum input (at sea level): 40 kV (dc + peak ac), derated 1% of voltage rating per 100 meters in rise from sea level.

Voltage Division Ratio: 1000:1

Bandwidth: dc to 300 Hz

Input Resistance: 1 G Ω

Division Ratio Accuracy: $\pm 2\%$

HP 11060A Surface Mount Device Test Probe

Designed for SMD testing, this probe provides an easy method to access and measure SMD resistive networks. Not to be used over 42 volts peak.

HP 34303A Temperature Probe

Temperature measurements are read directly in degrees C or F on dmm's having a minimum input impedance of 10 k Ω . The probe is a temperature-to-voltage transducer with a forward-biased diode providing calibrated linear output. A standard dual banana plug output connector provides universal connection to dmm's. A 9 volt battery is required for operation and is not included.

Temperature Range: -58° to 302° F;
 -50° to 150° C

Output: 10 mV/ $^{\circ}$ C or $^{\circ}$ F

Resolution: 0.01 $^{\circ}$ C or $^{\circ}$ F

Accuracy: $\pm 3.0^{\circ}$ F; $\pm 1.7^{\circ}$ C

HP 11059A Kelvin Probe Set

Works with any dmm with 4-wire ohms. Circuit connection is performed with two gold-plated flat tweezers with special gripping surfaces to ensure precise contact to the components being measured. An alligator clip and lead are provided for either grounding or guarding. Instrument connection is through banana plugs. Not to be used over 42 volts peak.

Ordering Information

	Price
HP 11002A Test Lead	\$20
HP 11003A Test Lead	\$20
HP 11053A Low Thermal Lug-Lug Jumper Set	\$29
HP 11058A Low Thermal Banana-Banana Jumper Set	\$29
HP 11059A Kelvin Probe Set	\$135
HP 11060A Surface Mount Device Test Probe	\$24
HP 11062A Kelvin Clip Set	\$26
HP 11096B High Frequency Probe	\$225
HP 11174A Low Thermal Lug-Banana Jumper Set	\$29
HP 34110A Carrying Case for 1/2 Rack Size Instruments	\$75
HP 34111A DC High Voltage Probe	\$225
HP 34118A Test Lead Kit	\$27
HP 34119A High Voltage Probe	\$130
HP 34300A 40 kV AC/DC High Voltage Probe	\$90
HP 34301A RF Detector Probe	\$80
HP 34302A Clamp-on AC/DC Current Probe	\$250
HP 34303A Temperature Probe	\$120

☎ Fast ship product. See page 734.

DIGITAL MULTIMETERS

3¹/₂ Digit Handheld Multimeters

HP Models E2373A, E2377A, E2378A

- Excellent standard feature set
- Choice of general purpose or rugged model
- 0.3% or 0.7% basic DCV accuracy
- 3-year standard warranty on all models
- 3200 count analog/digital display
- All models in stock

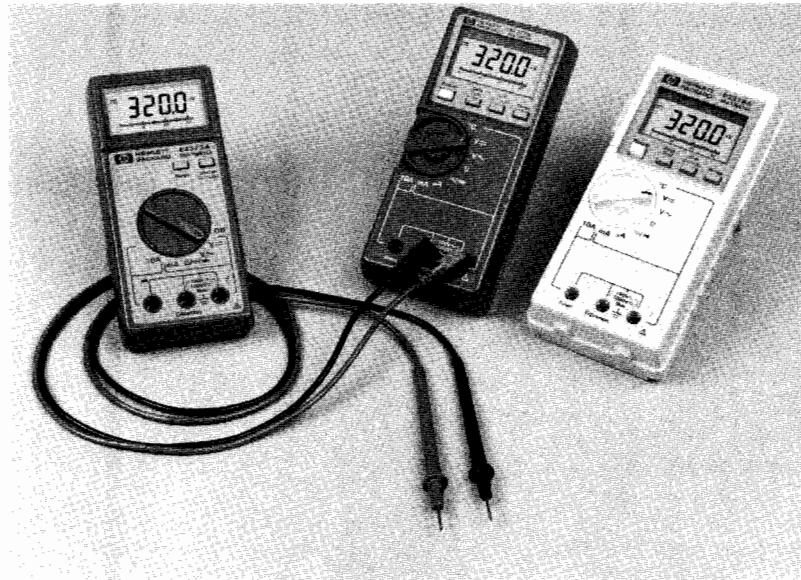

HP E2373A, E2377A, and E2378A



E2300 Series Handheld Multimeters

The HP E2300 Series of handheld multimeters meet the requirements of your portable basic measurement applications. Standard features on all three models include the following features:

- dc and ac volts, dc and ac current, resistance, audible continuity and diode test
- Maximum 1 kV dc, 750V rms, 10A
- Selection of auto-ranging or manual range hold
- Large 3200 count digital display (samples approx. 2 times/sec.) with 32-segment analog bar (samples approx. 12 times/sec.)
- Display annunciators for all functions (except temperature on E2377A and E2378A), also for low-battery indication, overload, range hold and data hold (E2377A and E2378A)
- Built-in tilt stand and three terminal input jacks
- One-year calibration cycle
- Three-year warranty

Three Models to Choose From

The basic HP E2373A multimeter is ideal for troubleshooting applications. It offers all the standard features listed above, along with a basic DCV accuracy of 0.7%. Audible continuity and a choice of autoranging or manual ranging make this low-cost meter an excellent and economical choice.

For more exacting tasks on the bench or in the field, the HP E2377A has a basic DCV accuracy of 0.3% and a 1kHz bandwidth. It also adds a data hold function and a temperature function to the solid feature set of the HP E2373A. The temperature function is built-in and can be used with any K-type thermocouple probe.

For outside use and rougher applications, the HP E2378A adds a rugged case to the feature set and accuracy of the HP E2377A. It has all of the same functions and accuracy as the HP E2377A, and is encased in a yellow, splash-proof case.

Refer to the comparison chart in the next column to determine which of the three models best suits your needs.

	E2373A	E2377A	E2378A
Basic dc accuracy	0.7%	0.3%	0.3%
Basic ac accuracy	2%	1%	1%
Maximum ac bandwidth	500 Hz	1 kHz	1 kHz
Audible continuity and diode test	Yes	Yes	Yes
Data hold function	No	Yes	Yes
Temperature function	No	Yes	Yes
Input protection up to 300 mA range	0.5A/250V	0.5A/250V	0.5A/250V
10A range	unfused	15A/250V	15A/250V
Power supply (alkaline batteries)	AA(1.5V)x2	AAA(1.5V)x2	AAA(1.5V)x2
Battery life (minimum)	2500h	1000h	1000h

Standard Accessories are Included

All three meters come with alkaline batteries, spare fuse(s), operating manual and test leads.

Always in Stock

All three meter models and their accessories are always in stock. Please contact HP for information on quantity price breaks on orders of two or more.

Additional Accessories

To extend the measurement capability of your handheld multimeter, a variety of accessories are available. These are described below:

HP E2301A Surface Thermocouple Probe, K-type (-130°C to 260°C; accuracy is greater of +2.2°C or 0.75% of reading.) Note: must also order E2303A, Thermocouple Probe Adapter.

HP E2302A Airflow Thermocouple Probe, K-type (for range and accuracy, see E2301A.) Note: must also order E2303A, Thermocouple Probe Adapter.

HP E2303A Thermocouple Probe Adapter (Uncompensated, banana to K-type connector.) For use with E2377A or E2378A multimeters and any K-type thermocouple probe.

HP E2304A Handheld Multimeter Carrying Case (padded, water-resistant nylon case with 2-zipper closing and inside pocket)

HP E2305A Replacement test leads (right angle), 2 pair
For additional multimeter accessories, refer to page 93.

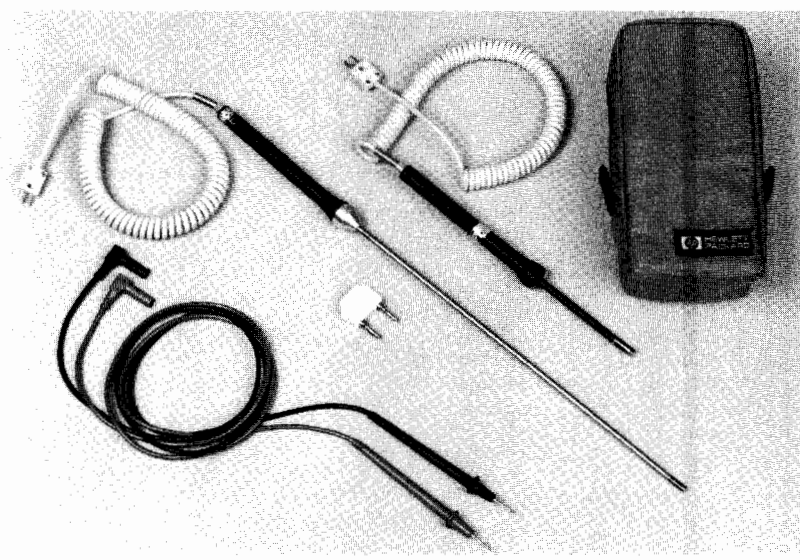

Accessories for handheld multimeters

Specifications

23°C ±5°C, <80%RH

Function	Range	Resolution	Accuracy ¹ ±(%rdg + number of digits)	
			E2373A	E2377A E2378A
dc voltage	300 mV	100 μV	0.5%+2	0.3%+2
	3V	1 mV	0.7%+1	0.3%+2
	30V	10 mV	0.7%+1	0.4%+1
	300V	100 mV	0.7%+1	0.4%+1
	1000V	1V	0.7%+1	0.4%+1
ac Voltage	3V	1 mV	1.2%+4	1.0%+3 ²
	30V	10 mV	1.2%+4	1.0%+3 ²
	300V	100 mV	1.2%+4	1.0%+3 ²
	750V	1V	1.2%+4	1.0%+3 ²
	300 μA	100 nA	...	1.0%+2
dc current	3 mA	1 μA	...	1.0%+2
	30 mA	10 μA	1.0%+2	1.0%+2
	300 mA	100 μA	1.5%+2	1.5%+2
	10A	10 mA	1.5%+2	1.5%+2
	ac current	300 μA	100 nA	...
3 mA		1 μA	...	2.0%+5
30 mA		10 μA	2.0%+5	2.0%+5
300 mA		100 μA	2.0%+5	2.0%+5
10A		10 mA	2.0%+5	2.0%+5
Resistance	300Ω	100MΩ	0.7%+2	0.7%+2
	3 k Ω	1 Ω	0.7%+1	0.7%+1
	30 k Ω	10 Ω	0.7%+1	0.7%+1
	300 k Ω	100 Ω	0.7% ^f 1	0.7%+1
	3 M Ω	1 k Ω	1.5%+1	0.7%+1
	30 M Ω	10 k Ω	3.0%+1	2.0%+1

Maximum input 1,000V dc or 750V ac rms
 Continuity check 300Ωapprox. 20Ωhold
 Temperature test -20°C to 700°C with 1° resolution
 (not E2373A)
 Diode test 0.6 mA test current, ±3%+2 mV

	E2373A	E2377A	E2378A
Size			
Height	164mm (6.5")	176mm (6.95")	186mm (7.4")
Width	76mm (3.0")	80mm (3.15")	89mm (3.4")
Depth	33mm (1.3")	45mm (1.4")	45mm (1.4")
Net weight	0.24kg (0.53lb)	0.31kg (0.68lb)	0.45kg (0.99lb)

1) One digit corresponds to the range's resolution
 2) 40-500Hz range

Ordering Information

HP E2373A Multimeter	(1 ea.) \$99 📦
	(2-5) \$96 📦
	(6-9) \$94 📦
	(10+) \$93 📦
HP E2377A Multimeter	(1 ea.) \$169 📦
	(2-5) \$164 📦
	(6-9) \$161 📦
	(10+) \$159 📦
HP E2378A Multimeter	(1 ea.) \$189 📦
	(2-5) \$183 📦
	(6-9) \$180 📦
	(10+) \$178 📦
HP E2301A Surface Thermocouple Probe	\$120 📦
HP E2302A Airflow Thermocouple Probe	\$75 📦
HP E2303A Thermocouple Probe Adapter	(1 ea.) \$12 📦
	(2+) \$10 📦
HP E2304A Handheld Multimeter Carrying Case	\$19 📦
HP E2305A Replacement Test Leads, 2 pair	\$15 📦

📦 - Fast Ship Product - see page 734.

SIGNAL ANALYZERS

Wave, Distortion, Modulation, Spectrum, and Fourier Analyzers

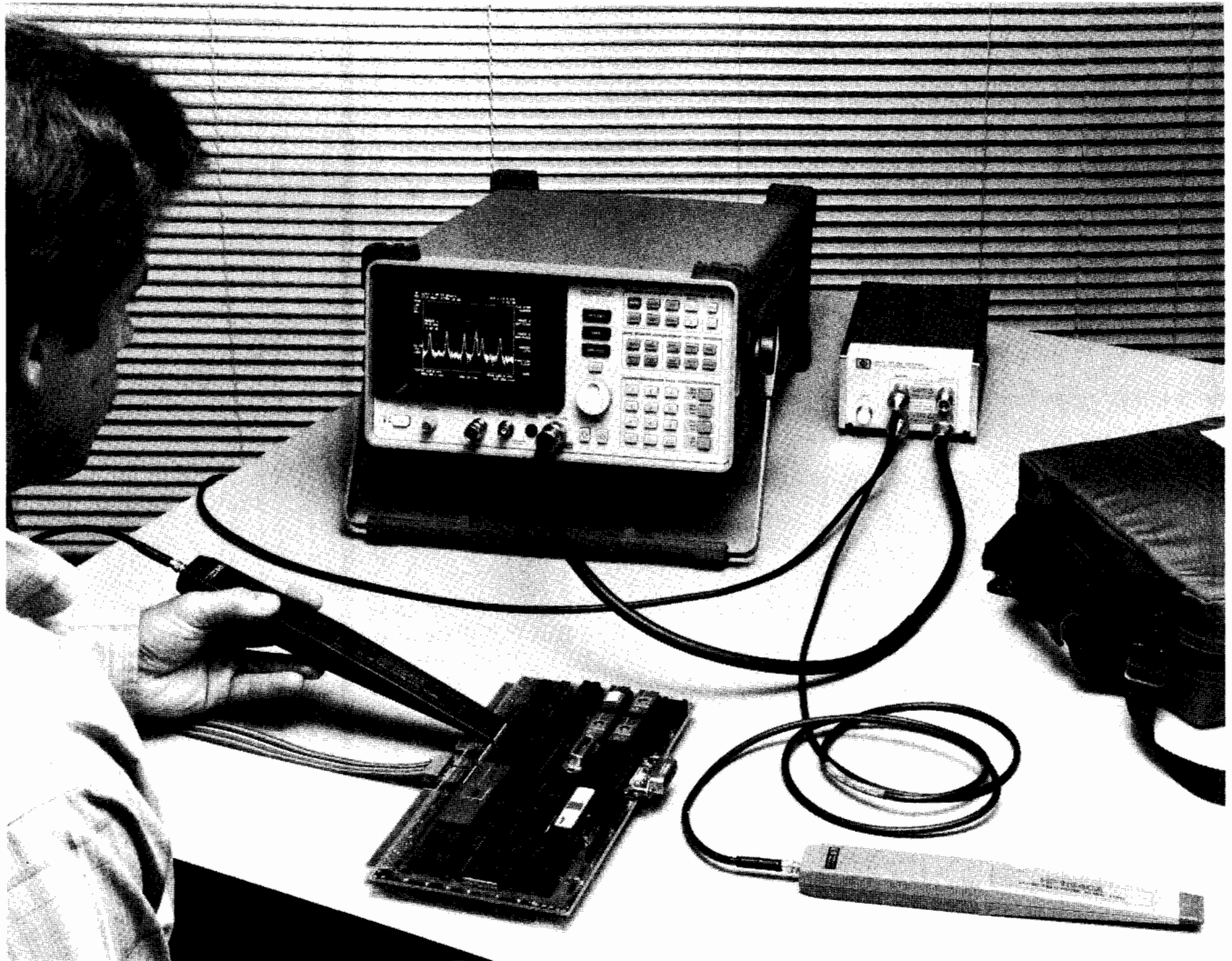

Signal Analyzers

Several different types of signal analyzers provide frequency domain measurement capability. Spectrum analyzers, distortion analyzers, audio analyzers, modulation analyzers, and measuring receivers are all offered by HP. Each of these instruments has capabilities that make it the preferred instrument for particular measurement applications.

The spectrum analyzer is a swept-tuned, superheterodyne receiver that provides a CRT display of amplitude versus frequency. It is essentially a frequency-selective, peak-responding voltmeter calibrated to display the RMS value of a sine wave. The spectrum analyzer can show the individual frequency components that make up a complex signal. (It does not provide phase information about a signal, however). The swept receiver technique used in Hewlett-Packard spectrum analyzers enables frequency domain measurements to be made over a large dynamic range and a wide frequency range of 5 Hz to 325 GHz.

The Fourier analyzer uses digital sampling and mathematical transformation techniques to form a Fourier spectrum of a signal. This

method is presently useful for measuring signals from a few μHz to 100 kHz and provides frequency, amplitude, and phase information. Like the spectrum analyzer, all information is presented on a CRT display. With its real-time signal analysis capability, the Fourier analyzer is able to capture periodic as well as random and transient events.

The wave analyzer uses a tunable filter, which can be visualized as a movable frequency window, to measure both the amplitude and frequency of individual spectral components. This measurement technique essentially makes the instrument a frequency-selective voltmeter. The wave analyzer employs meters and digital displays to show both the amplitude and frequency of the signal within the window. HP wave analyzers provide accurate results from 15 Hz to 32.5 MHz.

Distortion analyzers and audio analyzers employ broadband detectors and notch filters to measure signal properties such as total harmonic distortion. These tunable filters enable the analyzer to selectively display the level and frequency of harmonic and distortion products. Measurement results are shown on a meter or digital display. Audio analyzers include a signal source, making

possible measurements such as SINAD that include signal and distortion levels. The frequency range covered by HP distortion and audio analyzers extends from 5 Hz to 600 kHz.

Modulation analyzers are designed to capture and analyze a fundamental signal and its entire modulation envelope. These analyzers use independent AM and FM detection circuits for simultaneous analysis of complex modulated signals. When a modulation analyzer is combined with a measuring receiver, accurate measurements of frequency, power, and modulation characteristics can be made on signals from 150 kHz to 26.5 GHz. All measurement results are presented on a digital display.

Spectrum Analyzers

Spectrum analyzers take advantage of the frequency-conversion properties of the swept-tuned heterodyne receiver to make significant contributions to frequency-domain signal analysis. The following are some of the measurements that can be made with spectrum analyzers:

- 1) Absolute and relative frequency.
- 2) Absolute and relative amplitude.

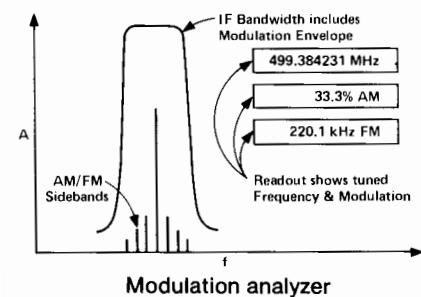
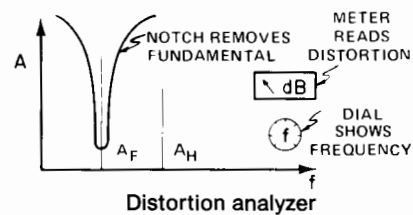
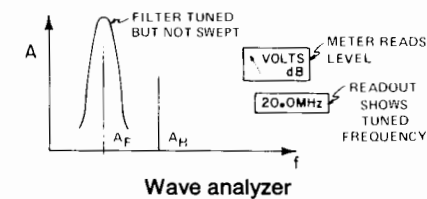
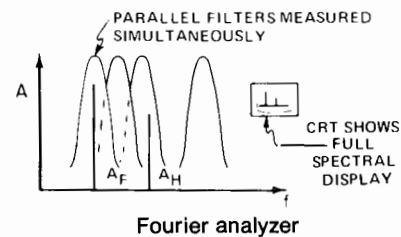
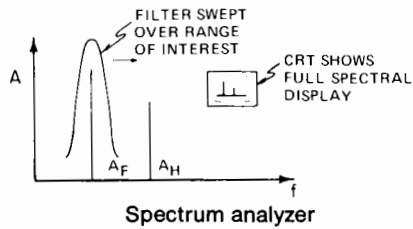
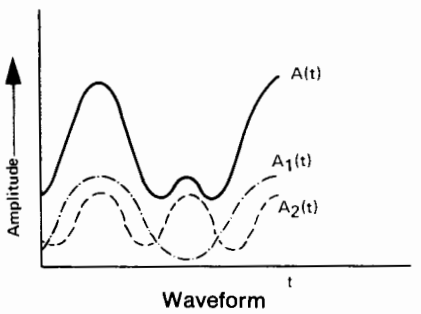

These measurements are possible because spectrum analyzers have the following characteristics:

- 1) Broad frequency coverage from 5 Hz to 325 GHz.
- 2) Wide amplitude range from -138 dBm to $+30$ dBm.
- 3) Excellent sensitivity for low-signal detection.
- 4) Excellent frequency stability.
- 5) High resolution of frequency and amplitude.

These capabilities allow spectrum analyzers to provide frequency-domain signal analysis for numerous applications, including the manufacture and maintenance of microwave communication links, radar, telecom equipment, CATV systems, and broadcast equipment; EMI diagnostic testing; and signal surveillance.

In addition to the swept-tuned frequency mode, spectrum analyzers can also be used in the fixed-tuned mode (zero span) to provide time-domain measurement capability much like that of an oscilloscope.

With the addition of desktop technical computers, the capability of spectrum analyzers can be greatly enhanced. Computers can be used to directly control the operation of spectrum analyzers over HP-IB. Computers can also be used to develop downloadable programs (DLPs) for those spectrum analyzers with the capability to store such programs in non-volatile memory. These custom measurement routines are then as easy to use as any of the standard instrument features.

In addition, spectrum analyzers with HP-IB capability can directly control a plotter or printer, enabling a hard copy of the CRT display to be made without the use of a computer. Application areas that require accurate, high speed, repetitive routines; physical separation of the operator and the analyzer; unattended operation or operation by personnel with limited technical skills—all are candidates for automation.

Areas that benefit significantly from automated spectrum analysis include

- 1) EMC testing,
- 2) frequency spectrum monitoring,
- 3) production testing of RF or microwave components, subsystems, or systems, and
- 4) remote site testing.

The basic measurement capabilities of the spectrum analyzer, combined with its ability to automate and to interface with other HP-IB instruments and peripherals, make this instrument ideal for many general-purpose and specialized applications.

Fourier Analyzers

Fourier analyzers offer fast, high-resolution spectrum and network analysis. Unlike conventional swept analyzers, Fourier-based analyzers can measure dynamic signals because they measure all frequencies simultaneously, not one at a time.

Fourier analyzers characterize signals using digital signal processing techniques based on the Discrete Fourier Transform. For a complete description of these techniques, see Application Note 243, "The Fundamentals of Signal Analysis."

Fourier analyzers are especially useful on low frequency signals (<100 kHz) or where very fast measurements are desired. They can improve measurement speed by a factor of 10 to 100 and allow accurate measurements on frequencies as low as a few microHertz. Signal components as closely spaced as 20 microHertz can be clearly resolved and accurately measured.

Since both magnitude and phase of each frequency component are measured, the Fourier analyzer can measure the statistical properties of signals or the joint properties or relationships of two or more signals. Applications include acoustic, modal, vibration or rotating machine analysis. In addition, various types of modulation can be detected and measured.

Simultaneous measurement of magnitude and phase on two or more channels provides high quality network measurements. Transfer functions or frequency response can be easily measured and the use of band-limited or band-translated random noise as the stimulus allows the entire frequency span of interest to be measured at once. Measurement of the coherence function can provide an indication of the validity of many network measurements.

Wave Analyzers/SLMs

Wave analyzers are known by several different names: frequency selective voltmeters, carrier frequency voltmeters, and selective level meters. A wave analyzer can be thought of as a finite bandwidth filter which can be tuned throughout a particular frequency range. Signals will be selectively measured as they are isolated within the bandwidth of the filter. For a particular signal, the wave analyzer will indicate both its frequency and amplitude.

The uses of wave analyzers can be categorized into three broad areas: (1) amplitude measurement of a single component of a complex frequency system, (2) amplitude measurement in the presence of noise and interfering signals, and (3) measurement of signal energy appearing in a specified, well-defined bandwidth.

Wave analyzers are most commonly used in communication systems and have input configurations and measurement bandwidths optimized for these applications. Both balanced and unbalanced inputs are available and impedances range from 50 Ohms to 600 Ohms.

Distortion, Audio Analyzers

The Hewlett-Packard distortion and audio analyzers consist of a narrow band rejection filter and broadband detector. Before the fundamental is rejected, the analyzer first measures the amplitude of the fundamental, all the harmonic components, and noise. Then the rejection filter is employed to remove the fundamental. The ratio of the two measurements is total harmonic distortion plus noise.

- 3) Noise.
- 4) Distortion products.
- 5) AM, FM & pulsed RF modulation.
- 6) Stimulus response.
- 7) Electromagnetic compatibility (EMC).

SIGNAL ANALYZERS

Wave, Distortion, Modulation, Spectrum and Fourier Analyzers (cont'd)

Audio Analyzers

The audio analyzer performs several basic low frequency measurements in addition to distortion, making it a general purpose audio test set. The audio analyzer includes the SINAD function for testing mobile radio receiver sensitivity. It contains a low distortion audio oscillator for stimulus response testing in combination with its distortion analyzer. It contains a true rms voltmeter and dc voltmeter for accurate measurement of complex waveform levels. Swept ac level and swept distortion measurements can be made using the internal source and rms voltmeter. A reciprocal frequency counter is also included that continuously counts the frequency of the input signal.

True Harmonic Distortion Measurements

Computer-controlled spectrum analyzers provide a rapid means of measuring true harmonic distortion levels. The fundamental and its harmonic components are rapidly measured one at a time and the distortion is computed and either stored or printed.

Modulation Analyzers/Measuring Receivers

A modulation analyzer is a precision receiver designed to detect the entire modulation envelope of a signal under test. It can

measure and display the carrier characteristics of RF frequency and power as well as AM, FM and phase modulation characteristics such as AM depth, peak deviation, residual modulation, and various ratios associated with them. The modulation analyzer faithfully recovers the actual modulation signal for further analysis such as distortion testing.

In addition to all the capabilities of the modulation analyzer, the measuring receiver can measure power down to -127 dBm. With very high accuracy, the measuring receiver can look at signals up to millimeter-wave frequencies. This makes it ideal for calibration of signal generators and attenuators.

Microwave Modulation Analyzers

Most modern microwave communication and radar/EW system designs are now turning to the use of complex modulations to improve performance and make them less susceptible to dense signal environments. This typically involves the use of quadrature or "vector" modulation formats, such as QPSK, 16QAM, etc., in the case of communication systems and complex, coded formats in the case of radar/EW systems.

In all of these receivers, the signal processing is not handled in the traditional one-

channel, amplitude-only mode, but instead is demodulated into in-phase and quadrature-phase signals that provide dynamic phase and amplitude information about the carrier's modulation, and thus enhances system performance.

The high bandwidth requirements of those modulations combined with the need to measure and characterize both the amplitude and phase of the signals has led to the introduction of the HP 8980A Vector Analyzer and the HP 8981A Vector Modulation Analyzer. Both instruments contain a matched dual channel, sampling oscilloscope with dc to 350 MHz baseband capability. Powerful measurement routines and tailored screens make modulation measurements simple and fast. Routines will measure such parameters as quadrature error, lock angle, constellation closure, gain matching, and dc offsets.

The HP 8981A contains an internal I/Q demodulator which takes an IF signal from 50 MHz to 200 MHz and demodulates it into I and Q signals for display and analysis. A user-configured down-converter can be used for analyzing microwave signals. Extensive application information is available. Ask for Application Notes 343-2, 343-3, and 343-4, as well as related data sheets and product notes.

Signal Analyzers Selection Guide

Spectrum Analyzers

Frequency Range	Amplitude Calibration Range	Bandwidths		HP Model Description	HP Companion Instruments	Page
		Min	Max			
0.02 Hz-40 MHz (Offset from Carrier) 5 MHz to 18 GHz (Carrier Range)	0 to -170 dBc	0.01 Hz	30 kHz	3048A Phase Noise Measurement System	8662A/8663A Synthesized Signal Generator 8642A/B Synthesized Signal Generator 11729C Carrier Noise Test Set	146
5 Hz-50 kHz	-150 to $+30$ dBm	1 Hz	300 Hz	3580A Spectrum Analyzer		144
20 Hz-40.1 MHz	-137 dB to $+30$ dBm	3 Hz	30 kHz	3585B Spectrum Analyzer		101
10 Hz - 150 MHz	-132 to $+20$ dBm	1.14 Hz	18.6 kHz	3588A Spectrum Analyzer		100
9 kHz-1.8 GHz	-115 to $+30$ dBm	1 kHz	5 MHz	8590B Spectrum Analyzer	85700A Series Application Measurement Card/Personality	104
9 kHz-1.8 GHz	-115 to $+30$ dBm	1 kHz	5 MHz	8591A Spectrum Analyzer	85901A PAC Power Supply	104
50 Hz-2.9 GHz	-130 to $+30$ dBm	10 Hz	2 MHz	8560A Spectrum Analyzer	85640A Tracking Generator 85629A Test & Adj. Module	110
50 Hz-6.5 GHz	-131 to $+30$ dBm	10 Hz	2 MHz	8561B Spectrum Analyzer	85620A Mass Memory Module 11970 and 11974A mm Mixers	110
100 Hz-2.9 GHz	-134 to $+30$ dBm	10 Hz	3 MHz	71100C Spectrum Analyzer	70300A Tracking Generator, 70700A Digitizer 70100A Power Meter 70138A Vector Voltmeter	115
10 kHz-1.5 GHz	-115 to $+30$ dBm	1 kHz	3 MHz	8567A Spectrum Analyzer	8444A Opt 059 Tracking Generator, 85650A Quasi-peak Adapter, 85685A RF Preselector	123
100 Hz-1.5 GHz	-135 to $+30$ dBm	10 Hz	3 MHz	8568B Spectrum Analyzer		123
9 kHz-22 GHz	-114 to $+30$ dBm	1 kHz	5 MHz	8592B Spectrum Analyzer	85700A Series Application Measurement Card/Personality	107
9 kHz-26.5 GHz	-114 to $+30$ dBm	1 kHz	5 MHz	8593A Spectrum Analyzer	85901A PAC Power Source	107
9 kHz-26.5 GHz	-121 to $+30$ dBm	100 Hz	2 MHz	8562A Spectrum Analyzer	11970 & 11974 mm Mixers 85629A Test&Adj Module 85620A Mass Memory Module 85640A Tracking Generator	110
100 Hz-22 GHz	-134 to $+30$ dBm	10 Hz	3 MHz	8566B Spectrum Analyzer	85650A Quasi-peak Adapter 85865A RF Preselector 11970 & 11974 mm Mixers	121
100 Hz-26.5 GHz	-132 to $+30$ dBm	10 Hz	3 MHz	71200C Spectrum Analyzer	11970 & 11974 mm Mixers 70300A & 70301A Tracking Generators, 70100A Power Meter, 70138A Vector Voltmeter	115
100 Hz-22 GHz	-139 to $+30$ dBm	10 Hz	3 MHz	71210C Spectrum Analyzer		115
1200-1600 nm (optical)	-60 to $+15$ dBm (optical)	10 Hz	3 MHz	71400C Lightwave Signal Analyzer	70620A Preamplifier 70700A Digitizer 70810A Lightwave Module	314

Modulation Analyzers/Measuring Receivers

Frequency Range	Modulation Measurements	Amplitude Measurement Range	Audio Frequency Count + Distortion Measurement	HP Model Number	Page
dc to 350 MHz	Baseband AM, ϕ M	5mV to 5V	No	8980A	148
dc to 350 MHz 50 to 200 MHz	Baseband IF	5mV to 5V -5 to -20 dBm	No	8981A	148
150 kHz-1300 MHz	AM, FM, ϕ M	+30 to 0 dBm	No	8901A	151
150 kHz-1300 MHz	AM, FM, ϕ M	+30 to -20 dBm	Yes	8901B	151
150 kHz-1300 MHz	AM, FM, ϕ M	+30 to -127 dBm	Yes	8902A	154
150 kHz - 18 GHz or 26.5 GHz	AM, FM, ϕ M	+30 to -100 dBm	Yes	8902S	157

Dynamic Signal Analyzers

Frequency Range	Number Of Input Channels	Resolution Points Max	HP Model No.	Special Features	Page
.02 Hz to 25.6 kHz	2	256	3582A Spectrum Analyzer	Digital Averaging Coherence function Internal noise source	144
125 μ Hz to 100 kHz	1	401	3561A Dynamic Signal Analyzer	1/3 and 1/1 octave analysis Internal mass storage Spectral map display Waveform recording Internal noise source	139
64 μ Hz to 100 kHz	2	801	3562A Dynamic Signal Analyzer 3563A Dynamic Signal Analyzer	Data throughput to disc Internal sine, noise sources Waveform recording Curve fitter Direct digital and analog measurements Autosequence programming	134
488 μ Hz to 102.4 kHz	2	401	35660A Dynamic Signal Analyzer	Internal disc drive Waveform recording Internal sine, noise sources Pass/fail limit testing	136
61 μ Hz to 51.2 kHz	1-63	3200	3566A/3567A Spectrum Network Analyzers	PC based, MSDOS, MS windows, HP measure software Multi-channel time and frequency measurements 25.6 KHz real time bandwidth PC programmability	141

Distortion/Audio Analyzers

Fundamental Frequency Range	Minimum Distortion	Auto Set Level	Auto Nulling	True RMS	AM Detector	Filters	HP Model No.	Internal Source	HP-IB	Page
5 Hz to 600 kHz	0.03% (-70 dB)		•	•	•	•	334A			145
10 Hz-110 kHz	0.0018% (-95 dB)	•	•	•	•	•	334A Opt 002			145
20 Hz-100 kHz	0.01% (-80 dB)	•	•	•	Note 1	•	8903B*	•	•	149
20 Hz-100 kHz	0.01% (-80dB)	•	•	•	Note 1	•	8903E**		•	149

*The HP 8903B also performs Frequency Count, Signal/Noise, SINAD, watts, ac/dc voltage measurements.
NOTE 1: The HP 8901A Modulation Analyzer (page 151) provides complete demodulation of AM, FM, and ϕ M signals. **The HP 8903E also performs Frequency Count, SINAD, and ac/dc voltage measurements.

Wave Analyzers/Selective Level Meters

Frequency Range	Selective Bandpass	Dynamic Range		Freq. Readouts	Type of Inputs	Type of Outputs	Modes of Operation	HP Model Number	Page
		Absolute	Relative						
15 Hz to 50 kHz	3 Hz 10 Hz 30 Hz 100 Hz 300 Hz	0.1 μ V-300 V full scale	>85 dB	5-place digital	Banana Jacks	rec: 5 V full scale, with pen lift BFO, Local Oscillator, tuning loudspeaker, and headphone jack	AFC, normal, BFO	3581A/ 3581C	144
50 Hz to 32.5 MHz	20 Hz 400 Hz 3100 Hz	-130 to +20 dBm	>80 dB	LED, 0.1 Hz Resolution	50/75 Ω , BNC 600 Ω Banana Jacks	Tracking Generator Audio/Loud Speaker 1 MHz Ref.	Wideband Selective USB/LSB	3586C (3336C*)	144
50 Hz to 32.5 MHz	20 Hz 400 Hz 1740/2000 Hz Optional 3100 Hz WTD	-130 to +20 dBm	>70 dB	LED 0.1 Hz Resolution	75 Ω BNC/WECO 124 Ω WECO 135 Ω WECO 150 Ω Siemens 600 Ω WECO/ Siemens	Tracking Generator Audio/Loud Speaker 1 MHz Ref.	Wideband Selective SSB	3586A/B (3336A/B*) (3335A)	

*Tracking Synthesizers.

Carrier Phase Noise Analysis

Frequency Range	HP Model Number	Maximum Sensitivity dBc/Hz (depends on offset & method)	Functions Available	Page
5 MHz-18 GHz	3048A Phase Noise Measurement System	-170 dBc/Hz (Requires external reference source of equivalent performance)	Fully documented Software with specified Phase Detector, Frequency Discriminator, AM and Two Port Measurements	146
5 MHz-18 GHz	11729C Carrier Noise Test Set	-126 dBc/Hz (Including HP 8662A Reference Source)	Phase Detector Mode Frequency Discriminator Mode AM Noise Option, Pulsed Carrier	147

SIGNAL ANALYZERS

Spectrum Analyzer 10 Hz to 150 MHz

HP 3588A

- 1 Hz resolution
- ± 0.4 dB typical level accuracy
- Very fast narrow band measurements

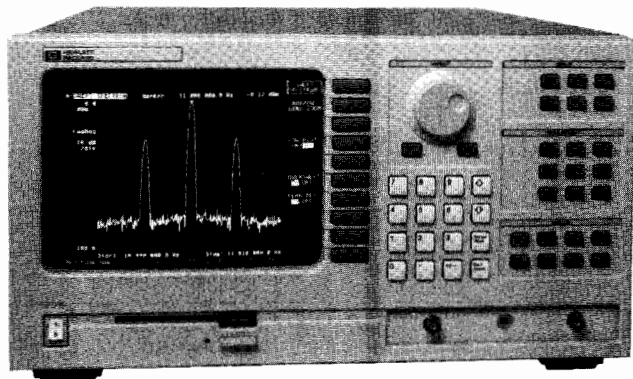

HP 3588A



High Performance Signal Characterization

The HP 3588A spectrum analyzer provides high-performance spectrum analysis from 10 Hz to 150 MHz, with outstanding frequency and amplitude accuracy. A wide range of frequency spans and resolution bandwidths accommodates many types of measurements. A built-in tracking generator with programmable amplitude allows easy scalar network measurements for passive and active networks. The HP 3588A offers swept spectrum mode and narrowband zoom mode. Both modes provide excellent speed and greater resolution than conventional analyzers. Swept spectrum mode provides the performance and features of traditional swept-tuned analyzers but adds very sharp digital IF filters for improved frequency resolution (to 1.14 Hz). Narrowband zoom uses an implementation of the Fast Fourier Transform to provide faster measurements with even greater resolving power.

Built-in autocalibration allows amplitude accuracies better than ± 0.4 dB (typical), including all absolute, temperature, and frequency response errors (200 kHz to 150 MHz). This amplitude accuracy, combined with the frequency stability and accuracy of a synthesized receiver, provides the high performance needed for the most demanding measurement situations. Maximum signal-to-noise dynamic range is 112 dB. Low-distortion mode measurements are optimized to provide 80 dB of distortion-free dynamic range.

Faster Narrowband Analysis

Narrow resolution measurements with conventional swept-tuned analyzers typically require long measurement times, which can drive up development time and test costs. In contrast, the HP 3588A sets new standards in speed with no loss of resolution.

Faster measurements are possible in swept spectrum mode because of the analyzer digital IF filters have nearly twice the selectivity of analog filters and offer faster measurements while still resolving low-level carrier sidebands. The predictability of digital filters also permits the analyzer to sweep faster, using a built-in correction algorithm. This provides measurement speed up to four times faster than conventional swept-tuned analyzers with no additional amplitude error or resolution loss.

Narrowband zoom provides the fastest spectrum measurements (more than fifty times faster than swept-tuned analyzers for comparable measurements), with resolution unequalled by traditional technologies. Narrowband zoom can be used for spans of 40 kHz and less,

- Scalar network analysis with built-in tracking generator
- Built-in 3.5 inch flexible disk drive
- Internal instrument BASIC and controller option

and it is ideal for both phase noise measurement and close-in modulation sideband analysis.

Extensive Features Offer a Complete Solution

It is easy to design custom measurements with the HP 3588A because it supports the HP BASIC instrument programming language, which also lets you control other instruments through HP-IB. You can use the built-in disk drive or non-volatile memory to store and retrieve traces, instrument states, or programs. Other features include autoranging input, limit lines with go/no-go indication, direct plotter or printer output, and HP-IB operation — all of which allow faster setup and documentation of results.

Noise and Modulation Analysis Applications

With the HP 3588A, a broad range of communication equipment can be quickly characterized to demanding standards. Direct noise and discrete sideband measurements of signals below 150 MHz are possible with the narrow resolution and low internal phase noise. Narrowband zoom mode provides power line frequency, voice channel, and audio-band modulation sideband analysis at speeds untouched by conventional swept-tuned spectrum analyzers.

Specifications

The following summary specifications describe warranted performance at temperatures from 0°C to 55°C. Refer to the technical data sheet for full performance specifications. Specifications are preliminary and are subject to change.

Frequency

Range: 10 Hz to 150 MHz

Span:

Swept spectrum full span range: 10 Hz to 150 MHz

Narrowband zoom span range: 1.22 Hz to 40 kHz in divide by 2 steps

Resolution bandwidth:

Swept sizes: 1.14 Hz to 18.6 kHz in divide by 2 steps

Bandwidth selectivity: selectable to be less than 4:1

Frequency accuracy: $\pm 1 \times 10^{-7}$ /mo. of frequency (with optional temperature-controlled reference oven)

Phase noise: -105 dBc/Hz at 1 kHz offset

Amplitude

Measurement range: -132 dBm to $+20$ dBm in 50 Ω input

Input range settings: -20 dBm to $+20$ dBm in 10 dB steps

Amplitude accuracy: $< \pm 0.6$ dB for 200 kHz to 150 MHz full scale signal when reference level = range (typical ± 0.4 dB)

Dynamic range

Maximum dynamic range of 80 dB for signal to distortion, 112 dB for full scale signal to noise (50 Ω input)

Tracking generator

Frequency range: 10 Hz to 150 MHz

Amplitude range: -59.9 dBm to $+10$ dBm, off. Programmable level

Impedance: 50 Ω

Signal inputs and outputs

Input:

Impedance: 50 Ω or 1 M Ω selectable, 75 Ω with adapter barrel

Other: probe power, external frequency reference input, frequency reference output, external trigger input, trigger output, HP-IB

Accessories available

Active probe HP 41800A

Ordering Information

HP 3588A Spectrum Analyzer

Available First Quarter 1990.

Contact your HP sales office for information.

See page 739.

Price

TBA

SIGNAL ANALYZERS

Spectrum Analyzer 20 Hz to 40 MHz

HP 3585B

101

- New sweep gating option
- 80-100 dB dynamic range
- ± 0.25 dB typical level accuracy
- 50, 75, 1 M Ω inputs
- 3 Hz resolution bandwidth
- Automatic limit testing

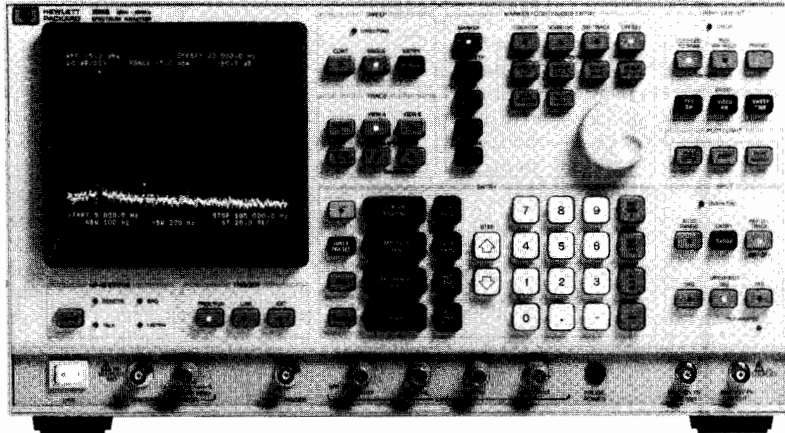

DESIGNED FOR
HP-IB
SYSTEMS
HP 3585B

Uncompromising Baseband Signal Analysis

The HP 3585B spectrum analyzer delivers high performance where it counts – at baseband frequencies. With unmatched accuracy, resolution, and dynamic range, the HP 3585B is the best solution for signal analysis at the critical frequencies comprising voice, picture, or digital information.

In today's high-speed, high-density information processing systems, maintaining the integrity of data signals requires more measurement performance than ever before. The HP 3585B provides 80-100 dB of spurious-free dynamic range, a sharp 3 Hz resolution bandwidth, and a 20 Hz–40.1 MHz frequency range to easily cover most information bandwidths. Fully synthesized tuning (including sweeps) and typical amplitude accuracy to ± 0.25 dB are unique in this frequency range and ensure complete measurement confidence.

Measurement performance is critically important at baseband frequencies because signal degradation occurring here is typically not recoverable elsewhere in the system. As a result, test requirements for baseband signals and circuits often demand a level of performance that only a high-performance, low-frequency signal analyzer such as the HP 3585B can provide.

Carefully Chosen Features for Better Measurements

Measurements are faster and easier with the optimized featured set. The automatic limit test function checks all 1000 measurement points against user-defined upper and lower limits in a fraction of a second. Pass/fail results are shown in the display and are available over HP-IB for improved productivity in automated applications.

The automatic peak search and signal track functions speed signal identification and analysis and make examination of drifting signals more convenient. In addition to locating the strongest signal in a display, the peak search function can also find successively smaller signals, or search to the right or left for peaks above a user-defined threshold.

Fast, Flexible Frequency Sweeps

Well-designed filters and a phase-continuous, synthesized local oscillator team up with exceptional dynamic range to give the HP 3585B very fast measurement speeds. A 40 MHz sweep using the 30 kHz resolution bandwidth takes only 200 milliseconds, fast enough for high resolution spectrum surveillance. A 1 MHz sweep using a 1 kHz bandwidth takes only 2 seconds, yet yields an average noise floor of -85 dBc.

Powerful Marker Functions

The tunable marker readout of frequency and amplitude can be expressed as an absolute or relative (offset) value. For offset measurements, a reference point is selected and all measurements are displayed relative to this value. Offset measurements are especially useful when comparing various spectral component levels to a carrier in modulation analysis or when determining signal-to-noise ratio.

With a single keystroke, the marker value can be entered as the center frequency, reference level, frequency span, or center frequency step size. This improves accuracy and efficiency in manual testing and reduces setup errors.

The built-in frequency counter provides additional accuracy when measuring the frequency of a signal in the display. Results are provided in 0.3 seconds to 0.1 Hz resolution. Because the counter function is combined with the selectivity of the analyzer, it is possible to accurately measure small signals in the vicinity of much larger ones.

For noise measurements, the noise level marker function displays averaged rms noise density at the marker position, normalized to a standard 1 Hz bandwidth and corrected for the analyzer's characteristics. This function can be combined with the relative measurement mode for fast, easy signal-to-noise ratio measurements.

Measurement Hard Copy

Copying a complete display to a printer or plotter is as easy as pressing a button. The HP 3585B directly controls HP-GL compatible HP-IB plotters and graphics printers such as the HP Thinkjet printer.

Tracking Generator

The standard 50 Ω tracking generator covers the full 40 MHz frequency range of the HP 3585B to provide easy scalar (amplitude-only) network analysis. The signal is fully synthesized in CW measurements and sweeps and level is adjustable from 0 dBm to -11 dBm on the front panel.

Flexible Inputs with Autoranging

50, 75, and 1 M Ω input impedances are all standard and are electronically selectable to match your system. For sensitive circuits, the 50 Ω and 1 M Ω inputs and provided probe power offer maximum compatibility with a variety of passive and active probes. With input autoranging, the HP 3585B automatically chooses the optimum input range for maximum dynamic range and lowest distortion. This eliminates the need to manually adjust attenuation and IF gain.

Compatibility

Hewlett-Packard protects your investment in measurement solutions. The HP 3585B can directly replace the HP 3585A in virtually every application. The HP 3585B meets all HP 3585A specifications and uses an expanded version of the HP 3585A programming codes. Physical dimensions are identical, and input and output are in the same location, serving the same functions.

SIGNAL ANALYZERS

Spectrum Analyzer 20 Hz to 40 MHz (cont'd)
HP 3585B

Distortion Measurements

The dynamic range, resolution, and level accuracy of the HP 3585B make harmonic and intermodulation distortion measurements a straightforward task. The peak search function quickly locates the fundamental and each distortion product, and the automatic limit test function can be used for immediate pass/fail results. Resolve and measure closely-spaced intermodulation products with resolution bandwidths as narrow as 3 Hz. The fully synthesized local oscillator provides the frequency accuracy and stability necessary to make dependable measurements on closely-spaced signals, and to measure distortion products directly with the narrowest bandwidths.

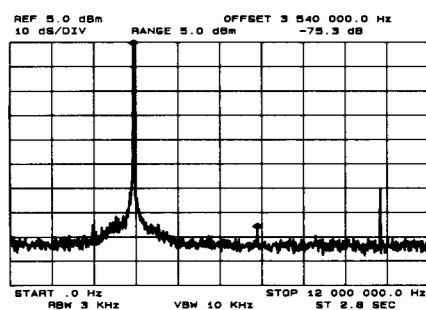

Network Analysis

Gain, loss, and frequency response measurements are dependable and automatic with the built-in synthesized tracking generator. Superb amplitude accuracy, resolution, and flatness contribute to high-quality measurements. The HP 3585B has multiple input impedances to match the network under test and a broad selection of receiver bandwidths to provide the best balance of measurement speed and dynamic range. Use the limit test function to save analysis time and effort with its immediate, automatic, pass/fail results. For narrowband devices such as crystal filters, the synthesized local oscillator yields stable, repeatable measurements. For devices such as mixers that perform frequency conversion, swept measurements can be synchronized with separate sources for complete characterization in one pass.

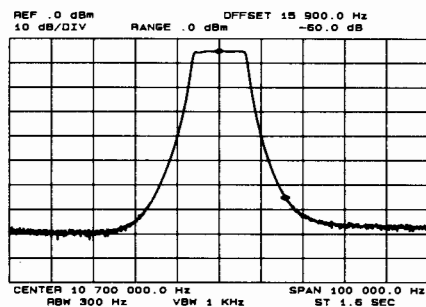

Noise Level Measurements

The HP 3585B makes fully calibrated noise level measurements automatically. Just select the frequency and press the Noise Level key. The HP 3585B calculates averaged rms noise density and displays the results normalized to a 1 Hz bandwidth. The extremely low internal noise level makes repeatable, accurate measurements possible below -137 dBm. For convenience, the marker can provide both absolute and relative (signal-to-noise) measurements directly.

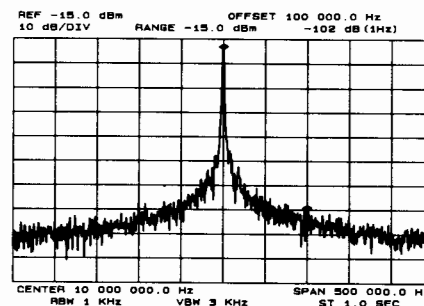

Burst Signal Analysis

Spectrum analysis results from traditional swept measurements on burst signals include not only the signal of interest, but also the c signal from the burst repetition period. The noise floor is higher in burst measurements, which masks the signal of interest. Accurate signal-to-noise and carrier-to-noise measurements are impossible. The new sweep gating option 001 reveals the signals you have missed.

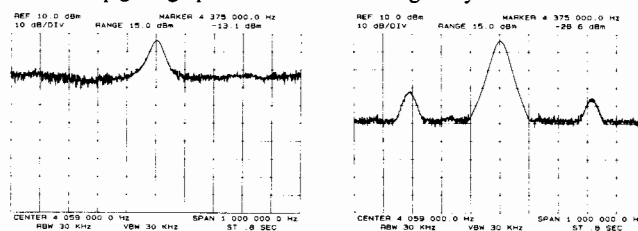

Before sweep gating

After sweep gating.

Specifications

Specifications describe the warranted performance of the HP 3585B over the temperature range 0°C to 55°C, except where noted. Supplemental characteristics describe typical but non-warranted performance; they are described as "typical" or "approximate" and apply over the temperature range 25 ± 5°C.

Frequency

Measurement range: specifications apply 20 Hz-40.1 MHz

Start/stop, center, manual frequency range: 0 Hz-40.1 MHz

Accuracy: (same as frequency ref. accuracy)

Frequency span: 0 Hz-40.1 MHz

Frequency reference accuracy: ± 1 × 10⁻⁷/mo. of frequency

Marker frequency:

Readout accuracy: ± 0.2% of frequency span ± resolution bandwidth.

Resolution: 0.1 Hz

Resolution bandwidth:

Bandwidth: 3 Hz-30 kHz (3 dB bandwidth) in 1, 3, 10 sequence.

Selectivity: 60 dB / 3 dB < 11:1

Video bandwidth: 1 Hz-30 kHz in 1,3,10 sequence

Amplitude

Display scale: 10 vertical division graticule with reference level (0dB) at top graticule line

Calibration: 1, 2, 5, 10 dB/division

Measurement range:

50/75Ω input: -137 dBm to +30 dBm or equivalent level in dBV or volts

1MΩ input: 31 n Vrms to 7.08 Vrms

Input range settings: autoranging, -25 dBm to +30 dBm in 5dB steps

Amplitude accuracy

Accuracy note: measurement accuracy is determined by the sum of reference level accuracy, amplitude linearity (if the signal is not at the reference level) and frequency response across the measurement span (if the signal is not at the center or manual frequency). In measurements where the signal is at the reference level and/or at the center or manual frequency, the amplitude linearity and/or flatness uncertainties will not apply.

Reference level

Range: -100 dB to +10 dB (relative to input range)

Accuracy: 50/75 Ω input (using 1 or 2 dB/div., measured at manual frequency or with sweep rate reduced by a factor of 4):

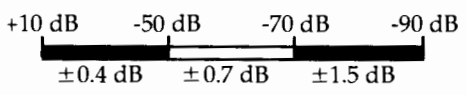

Typical accuracy, +10 dB to -50 dB: ± 0.25 dB For 5 or 10 dB/div. add 0.1 dB to the figures above
For 1M Ω input: Add to above specification ± 0.7 dB for 20 Hz-10 MHz; ± 1.5 dB for 10 MHz-40.1 MHz

Amplitude linearity

50/75 Ω input (relative to reference level):

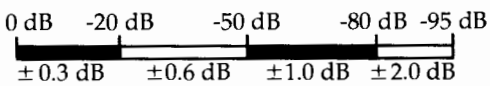

Typical linearity 0 dB to -20 dB: ± 0.2 dB

Frequency response

50/75 Ω input (relative to center frequency): ± 0.5 dB

Typical frequency response: ± 0.3 dB

For 1M Ω input: add to above specification ± 0.7 dB for 20 Hz-10 MHz, ± 1.5 dB for 10 MHz-40.1 MHz

Marker amplitude:

Accuracy:

Center or manual frequency at the reference level: Use reference level accuracy from 30 dBm to -115 dBm; add amplitude linearity below -115 dBm.

Anywhere on screen: Add amplitude linearity and frequency response (same as display accuracy)

Dynamic range

Spurious responses: (image, out-of-band, and harmonic distortion)

50/75 Ω input: < -80 dB relative to a single signal at or below the input range setting.

Typical performance: -84 dB - (1 dB/dB below input range setting)

Example: For a -8 dB signal on the 0 dBm input range, the spurious responses would be -92 dB.

1M Ω input: < -80 dB, except 2nd harmonic distortion < -70 dB

Intermodulation distortion

50/75 Ω input: $\geq < -80$ dB relative to the larger of two signals, each ≥ 6 dB below input range setting except 2nd order IM from 10 MHz to 40 MHz < -70 dB

1M Ω input: < -70 dB for 2nd order, < -80 dB for 3rd order

Residual responses (no signal at input): < -120 dBm using -25 dBm range, or 95 dB below input range setting

Residual phase noise (typical at 40 MHz, -10 dBm input): 5 kHz offset: -112 dBc/Hz

100 kHz offset: -120 dBc/Hz

Maximum dynamic range (typical): 92 dB spurious, harmonic and 3rd order IM; 115 dB signal to noise.

Average noise level

50/75 Ω input:

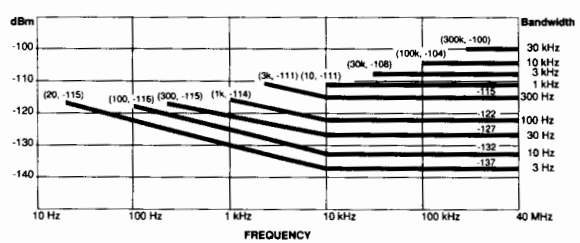

1M Ω input: below 500 kHz add 12 dB to above

Sweep:

Modes: continuous, single, manual (CW, direct or knob entry)

Trigger: free run, external, line

Time: 0.2s to 200s/Hz of frequency span, excluding calibration cycles (autocalibration may be disabled)

Tracking generator

Level: 0 dBm to -11 dBm, manual control from front panel

Frequency accuracy: ± 1 Hz relative to analyzer tuning

Frequency response: ± 0.7 db; Typically: ± 0.5 dB

Impedance: 50 Ω , > 14 dB return loss

Signal input

50/75 Ω : > 26 dB return loss, BNC connectors

1M Ω : $\pm 3\%$ shunted by < 30 pF, BNC connector

Maximum input level

50/75 Ω : 13V peak ac plus dc, relay protected for overloads to 42V peak.

1M Ω : 42V peak ac plus dc (derated by factor of two for each octave above 5 MHz)

External trigger: negative-going TTL level or contact closure initiates sweep

External frequency reference: 10 MHz or subharmonic to 1 MHz, 0 dBm minimum level

Signal output

Frequency reference: 10.00 MHz $\pm 1 \times 10^{-7}$ /mo., +10 dBm into 50 Ω

IF: 350 kHz, -11 dBV to -15 dBV at the reference level

Video: 10V at the reference level

Probe power: +15 Vdc, -13 Vdc; 150 mA max., suitable for HP active probes

HP-IB interface functions: SH1 AH1 T5 L4 SR1 RL1 PP0 DC1 DT1 C0 E1

General

Environmental

Temperature, operating: 0 $^{\circ}$ C to 55 $^{\circ}$ C

Humidity: $< 95\%$ RH

Warm up time: 20 min. at ambient room temperature

Power

115V (11% -25%), 48-440 Hz

230V (11% -18%), 48-66 Hz

180 W, 3A max.

Weight: 36.7kg (81lb)

Size: 229H x 426W x 635mmD cm (9" x 16.75" x 25")

Ordering Information

HP 3585B spectrum analyzer

Opt W30 Extended Repair Service. See page 725.

Opt 001 Sweep Gating

Opt 002 Field Installable Sweep Gating Kit

Price

\$24,690

+ \$605

+ \$1,500

+ \$2,000

SIGNAL ANALYZERS

Spectrum Analyzers, Low-cost Portable

HP 8590 Series

- New family of portable spectrum analyzers
- Full range of price and performance options

- Expanded memory and trace-storage capability
- Custom measurement personalities

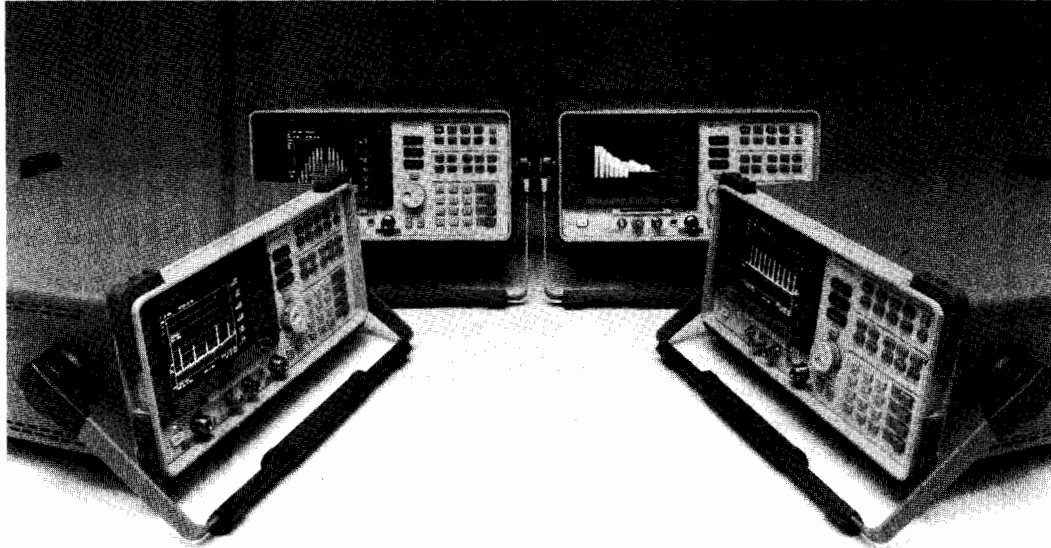

HP 8590 Series

The new HP 8590 family of portable spectrum analyzers offers a wide range of performance, features, and prices designed to fit your budget. Choose from two new low-cost, basic-performance analyzers or two higher performance models with synthesizer accuracy. Whatever your choice, the expandable feature set of your new HP 8590-series spectrum analyzer will allow it to be easily configured to meet your growing measurement needs.

The many new options that are available for the portable spectrum analyzers can be added at the time of instrument purchase or any time thereafter. You can also choose from a wide array of printers, plotters, and accessories that will help make your job easier.

Measurement Personalities for New HP 8590-series Spectrum Analyzers

The HP 8591A and 8593A high-performance portable analyzers include a built-in memory-card reader and expanded program memory for storing measurements. The HP 8590B and 8592B include the expanded program memory and can be configured with the memory-card reader as an option.

The memory-card reader can be used to load application-specific measurement personalities or your own custom programs. HP offers several application-personality cards to customize your spectrum analyzer for cable-television, electromagnetic-compatibility, and digital-radio testing.

HP 85711A CATV Measurement Card

This measurement personality card customizes your new HP 8590-series spectrum analyzer for headend testing, proof-of-performance measurements, trunk maintenance, and (with a microwave analyzer) CARs band testing.

One-button measurements include channel selection, carrier level, carrier-to-noise ratio, power-line hum, cross modulation, composite triple beat, video-modulation depth, and non-intrusive frequency response.

HP 85712A Electromagnetic-interference Diagnostics Measurement Card

This card for your HP 8590B or 8591A RF spectrum analyzer has applications that include field-strength testing in close fields, peak response weighted for broadband emissions, and identification of narrowband and impulse (broadband) signals. Accessories such as a preamplifier and close-field-probe set complement the EMI measurement capabilities. See page 10.33 for more information on EMI-test products.

HP 85713A Digital-radio Measurement Card

This custom measurement card for your microwave portable analyzer includes four major agency masks for testing to US FCC, UK, and FRG digital-radio specifications. Automatic mean-power-level measurements are made using the modulated spectrum of the digital-radio signal. Measurement functions include transient-analysis monitoring and frequency-response measurement. Custom user-created masks can also be stored and recalled.

Ordering

Application Measurement Cards/Personalities

	Price
HP 85700A 32-Kbyte Blank Memory Card	\$95
HP 85711A CATV Measurement Card	\$500
HP 85712A EMI Diagnostics Measurement Card	\$560
HP 85713A Digital Radio Measurement Card	\$750

Selected Accessories

HP 85901A Portable AC Power Source	\$1,095
HP C1405A Option ABA Keyboard	\$240
HP 10855A Broadband Preamplifier	\$700
HP 2225A/D ThinkJet Printer	\$495
HP 3630A PaintJet Printer	\$1,395
HP 7440A ColorPro Plotter	\$1,295

SIGNAL ANALYZERS

Spectrum Analyzers, Low-cost RF Portable

Models 8590B and 8591A

105

- Affordable new RF spectrum analyzers
- General-purpose or high performance capabilities

- 32-plus Kbytes of user memory
- Wide range of add-on features
- Custom measurement personalities

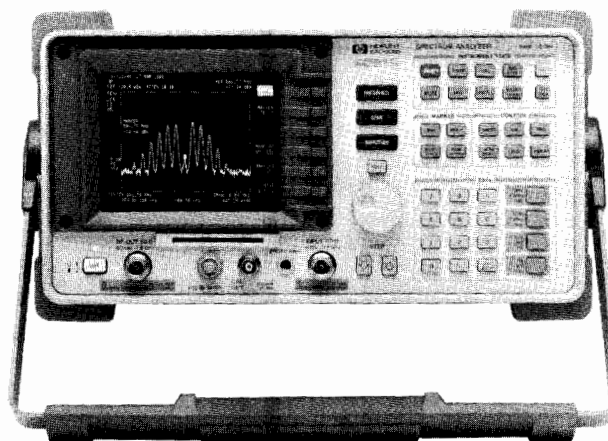
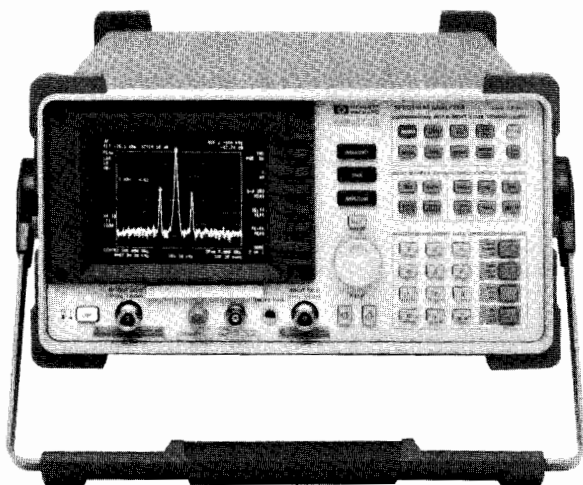

HP 8590B



HP 8591A

This very affordable model offers general-purpose measurement capabilities from 9 kHz to 1.8 GHz. Its wide amplitude range extends from -115 dBm to $+30$ dBm, and it has a 50- or optional 75-ohm input. Compact, weighing only 30 pounds, this analyzer goes anywhere. If ac power is not available, the analyzer can be run for approximately one and one half hours using the HP 85901A portable ac power source (see page 109). Display data can be sent to a printer or plotter.

More Standard Features at an Economical Price

The HP 8590B has more standard features than ever before offered in our lowest-priced RF spectrum analyzer. These features include 32 Kbytes of non-volatile program memory and the ability to incorporate custom programs or HP measurement personalities. You can store 50 traces without using program memory. A built-in clock/calendar stamps your trace data with the time and date. And, you can add titles to your stored traces through the front-panel keys, with a controller over the bus, or with an optional keyboard.

Add-on Features

As your measurement needs grow, a many options are available to increase the performance of the spectrum analyzer. HP-IB or RS-232 computer-interface options (including an external keyboard) automate the many functions of this instrument. A built-in, 1.8-GHz tracking-generator option turns the analyzer into a stimulus-response system for frequency-response and insertion-loss measurements. A memory-card reader can also be added, and optional measurement personalities customize the HP 8590B for cable-television and electromagnetic-interference (EMI) applications (see page 104).

Easy Signal Analysis

Operating this signal analyzer does not require an expert. With three clearly labeled keys—FREQUENCY, SPAN, and AMPLITUDE—and the data-entry knob or keypad, you can measure any signal. Built-in calibration routines guarantee the accuracy of your tests, and built-in service routines reduce down time and repair costs.

HP 8591A Frequency-accurate RF Spectrum Analyzer

For applications that require higher performance, the HP 8591A has frequency-counter resolution for frequency-synthesized accuracy from 9 kHz to 1.8 GHz. This model offers all of the portability and convenience features of the HP 8590B RF spectrum analyzer with even better specifications and more customizing features and options.

Greater Versatility for RF Measurements

Standard features of this high-performance analyzer include a built-in memory-card reader for use with 32-Kbyte memory cards. Fifty traces and states can be stored, and HP measurement personalities as well as your custom programs can be loaded in seconds. The built-in frequency counter, internal clock/calendar, and a de-blocked input are also standard. Built-in calibration and service routines are included.

The many options can be added in any combination to customize the spectrum analyzer for the lowest cost. Optional features include fast time-domain sweep, AM/FM demodulator with speaker, TV trigger sync, precision frequency reference, and HP-IB or RS-232 interfaces. A built-in tracking generator is available for stimulus-response measurements, and HP measurement personalities for cable-television and EMI testing can be added (see page 104). Four internal slots allow certain options to be configured at any time.

SIGNAL ANALYZERS

Spectrum Analyzers, Low-cost RF Portable (Cont'd)

Models 8590B and 8591A

General Specifications

Temperature range

Operating: 0° to +55° C

Storage: -40° to +75° C

EMI compatibility: CISPR pub 11 and FTZ 526/527/79

Audible noise: <37.5 dBA pressure, <5.0 Bels power (ISODP7779)

Power requirements: 86 to 127 or 195 to 250 Vrms, 47 to 66 Hz; 103 to 126 Vrms, 400 Hz $\pm 10\%$; <300 VA power consumption

HP 8590B Specifications

Frequency

Frequency range: 9 kHz to 1.8 GHz; 1 MHz to 1.8 GHz (75 ohm)

Frequency accuracy readout: $\pm(5 \text{ MHz} + 1\% \text{ of freq span})$

Frequency span

Range: 0 Hz (zero span), 50 kHz to 1.8 GHz

Accuracy: $\pm 3\%$ of indicated span

Sweep time

Range: 20 ms to 100 s

Accuracy: $\pm 3\%$ of indicated sweep time

Sweep trigger: free run, single, line, video, external

Stability

Drift: <75 kHz/5 min after 2-hr warmup, 5 min after center freq set

Noise sidebands: <-95 dBc/Hz at >30 kHz offset from CW

System related sidebands: <-65 dBc at >30 kHz offset from CW signal

Amplitude

Amplitude range: -115 to +30 dBm (50 ohm); -63 to +75 dBmV (75 ohm)

Maximum safe input: +30 dBm (1 watt) and +25 Vdc for 50 ohm; +75 dBmV (0.4 watt) and 100 Vdc for 75 ohm

Gain compression: $\leq 0.5 \text{ dB}$ for -10 dBm total power at input mixer

Displayed average noise level: -115 dBm at 1 GHz (50 ohm)

Spurious responses, 5 MHz to 1.8 GHz

Second harmonic distortion: <-70 dBc for -45 dBm tone at input mixer

Third-order intermodulation distortion: <-70 dBc for two -30 dBm tones at input mixer and >50 kHz separation

Other input-related spurious: <-65 dBc for $\geq 30 \text{ kHz}$ offset from CW

Display range

Log scale: calibrated 0 to -70 dB from reference level; 1 to 20 dB/division in 1 dB steps; 8 divisions displayed

Linear scale: 8 divisions

Scale units: dBm, dBmV, dBmicroV, volts, watts

Reference level

Range: -115 to +30 dBm (50 ohm); -63 to +75 dBmV (75 ohm)

Resolution: 0.01 dB, log scale; 0.12% of ref level for linear scale

Accuracy, -20 dBm reference level: $\pm(0.5 \text{ dB} + \text{input atten acc @ } 50 \text{ MHz})$ for 0 to -59.9 dBm; $\pm(1.25 \text{ dB} + \text{input atten acc @ } 50 \text{ MHz})$ for -60 to -115 dBm

Absolute frequency response: $\pm 1.5 \text{ dB}$, ref to 300 MHz CAL OUT

Relative flatness: $\pm 1.0 \text{ dB}$

Calibrator output

Frequency: 300 MHz $\pm 30 \text{ kHz}$

Amplitude: -20 dBm $\pm 0.4 \text{ dB}$ (50 ohm); +28.75 dBmV $\pm 0.4 \text{ dB}$ (75 ohm)

Input attenuator

Range: 0 to 60 dB, 10 dB steps

Accuracy: $\pm 0.5 \text{ dB}$ at 50 MHz, ref 10 dB attenuation, 0 to 50 dB; $\pm 0.75 \text{ dB}$ at 50 MHz, ref 10 dB attenuation, 60 dB

Resolution BW switching: $\pm 0.4 \text{ dB}$, 3 kHz to 3 MHz RBW; $\pm 0.5 \text{ dB}$, 1 kHz

Log to linear switching: $\pm 0.25 \text{ dB}$ at reference level

Log scale fidelity: $\pm 0.2 \text{ dB}/2 \text{ dB}$, 0 to -70 dB from ref lev, incremental; $\pm 0.75 \text{ dB}$, 0 to -60 dB from ref lev, maximum cumulative

Linear accuracy: $\pm 3\%$ of reference level

HP 8591A Specifications

Frequency

Frequency range: 9 kHz to 1.8 GHz; 1 MHz to 1.8 GHz (75 ohm)

Frequency reference

Aging: $\pm 1 \times 10^{-7}/\text{day}$, $\pm 2 \times 10^{-6}/\text{year}$

Settability: $\pm 0.5 \times 10^{-6}$

Temperature stability: $\pm 5 \times 10^{-6}$

Precision frequency reference (Opt 004)

Aging: $\pm 1 \times 10^{-7}/\text{year}$

Settability: $\pm 1 \times 10^{-8}$

Temperature stability: $\pm 1 \times 10^{-8}$

Frequency readout accuracy: $\pm(\text{frequency} \times \text{frequency reference error} + 3\% \text{ of span} + 20\% \text{ of RBW} + 1.5 \text{ kHz})$

Marker count accuracy (signal to noise ratio $\geq 25 \text{ dB}$, RBW/span ≥ 0.01)

Frequency span $\leq 10 \text{ MHz}$: $\pm(\text{marker freq} \times \text{freq ref error} + \text{counter resolution} + 100 \text{ Hz})$

Frequency span > 10 MHz: $\pm(\text{marker freq} \times \text{freq ref error} + \text{counter resolution} + 1 \text{ kHz})$

Counter resolution: selectable from 10 Hz to 100 kHz

Frequency span

Range: 0 Hz (zero span), 10 kHz to 1.8 GHz

Accuracy: $\pm 2\%$ of span, span $\leq 10 \text{ MHz}$; $\pm 3\%$ of span, span > 10 MHz

Sweep time

Range: 20 ms to 100 s, span = 0 Hz or > 10 kHz; 20 micros to 100 s, span = 0 Hz (option 101)

Accuracy: $\pm 3\%$ of indicated sweep time; $\pm 2\%$ for option 101

Sweep trigger: Free run, single, line, video, external

Stability

Noise sidebands: $\leq -95 \text{ dBc}/\text{Hz}$ at >30 kHz offset from CW signal (1 kHz RBW, 30 Hz VBW, sample detector)

Residual FM: <250 Hz pk-pk in 100 ms (1 kHz RBW, 1 kHz VBW)

System-related sidebands: <-65 dBc at >30 kHz offset from CW signal

Amplitude

Amplitude range: -115 to +30 dBm (50 ohm); -63 to +75 dBmV (75 ohm)

Maximum safe input: +30 dBm (1 watt), +25 Vdc for 50 ohm; +75 dBmV (0.4 watt), 100 Vdc for 75 ohm

Gain compression: $\leq 0.5 \text{ dB}$ for -10 dBm total power at input mixer

Displayed average noise level: <-115 dBm, 400 kHz to 1.5 GHz; <-113 dBm, 1.5 GHz to 1.8 GHz (50 ohm)

Spurious responses, 5 MHz to 1.8 GHz

Second harmonic distortion: <-70 dBc for -45 dBm tone at input mixer

Third-order intermodulation distortion: <-70 dBc for two -30 dBm tones at input mixer and >50 kHz separation

Other input-related spurious: <-65 dBc for $\geq 30 \text{ kHz}$ offset from CW

Display range

Log scale: calibrated 0 to -70 dB from ref lev; 1 to 20 dB/division in 1 dB steps; 8 divisions displayed

Linear scale: 8 divisions

Scale units: dBm, dBmV, dBmicroV, volts, watts

Reference level

Range: -115 to +30 dBm (50 ohm), -63 to +75 dBmV (75 ohm)

Resolution: 0.01 dB for log scale; 0.12% of ref level for linear

Accuracy: $\pm(0.5 \text{ dB} + \text{input atten acc @ } 50 \text{ MHz})$, 0 to -59.9 dBm; $\pm(1.25 \text{ dB} + \text{input atten acc @ } 50 \text{ MHz})$, -60 to -115 dBm

Absolute frequency response: $\pm 1.5 \text{ dB}$ referred to 300 MHz CAL OUT

Relative flatness: $\pm 1.0 \text{ dB}$

Calibrator output

Frequency: 300 MHz $\pm(300 \text{ MHz} \times \text{freq ref error})$

Amplitude: -20 dBm $\pm 0.4 \text{ dB}$ (50 ohm); +28.75 dBmV $\pm 0.4 \text{ dB}$ (75 ohm)

Input attenuator

Range: 0 to 60 dB in 10 dB steps

Accuracy at 50 MHz, 10 dB atten: $\pm 0.5 \text{ dB}$ for 0 to 50 dB; $\pm 0.75 \text{ dB}$ for 60 dB

Resolution BW switching: $\pm 0.4 \text{ dB}$, 3 kHz to 3 MHz RBW; $\pm 0.5 \text{ dB}$, 1 kHz

Log to linear switching: $\pm 0.25 \text{ dB}$ at reference level

Log scale fidelity: $\pm 0.2 \text{ dB}/2 \text{ dB}$, 0 to -70 dB from ref lev, incremental; $\pm 0.75 \text{ dB}$, 0 to -60 dB from ref lev and $\pm 1.0 \text{ dB}$, 0 to -70 dB from ref lev, maximum cumulative

Linear accuracy: $\pm 3\%$ of reference level

Ordering Information

	Price
HP 8590B Portable RF Spectrum Analyzer	\$8,895
Opt 001 75-ohm Input Impedance	\$0
Opt 003 Card Reader	+\$600
Opt 010 Tracking Generator 50 Ohms	+\$3,200
Opt 011 Tracking Generator 75 Ohms	+\$3,200
Opt 021 HP-IB Interface	+\$600
Opt 023 RS-232 Interface	+\$600
Opt W30 Extended Repair Service. See page 725.	+\$225
HP 8591A Portable RF Spectrum Analyzer	\$12,000
Opt 001 75-ohm Input Impedance	\$0
Opt 004 Precision Frequency Reference	+\$2,000
Opt 010 Tracking Generator 50 Ohms	+\$3,600
Opt 011 Tracking Generator 75 Ohms	+\$3,600
Opt 021 HP-IB Interface	+\$600
Opt 023 RS-232 Interface	+\$600
Opt 101 Fast Time Domain Sweep	+\$1,000
Opt 102 AM/FM Demodulator & TV Synch Trigger	+\$1,500
Opt W30 Extended Repair Service. See page 725.	+\$300

SIGNAL ANALYZERS

Spectrum Analyzers, Low-cost Portable

HP 8592B, 8593A

107

- General-purpose or high performance microwave capabilities
- Built-in comb generator and internal preselection
- Optional 26.5 GHz operation

- 32-plus Kbytes of user memory
- Wide range of add-on features
- Custom measurement personalities

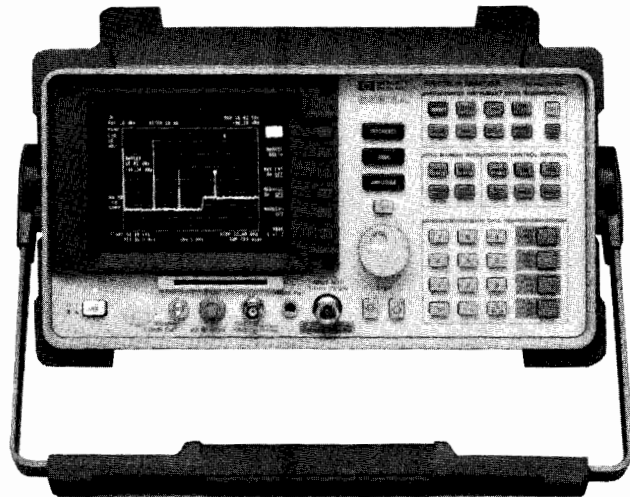
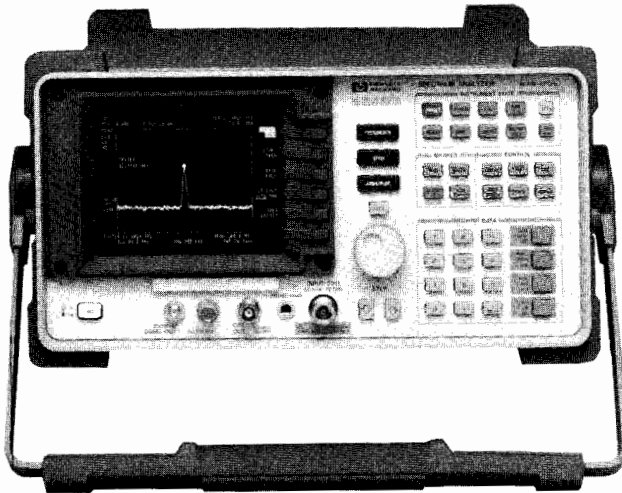

HP 8592B



HP 8593A

HP 8592B Low-cost Microwave Spectrum Analyzer

Our lowest-priced microwave spectrum analyzer offers basic performance and features similar to those of the HP 8590B. This 35-pound, portable analyzer has a frequency range of 9 kHz to 22 GHz with optional coverage to 26.5 GHz. Amplitude range is -114 dBm to $+30$ dBm. An internal preselector facilitates signal identification. And, as with all models in the portable spectrum analyzer family, this instrument can be operated approximately one hour using the HP 85901A portable ac power source (see page 109).

Easy-to-use Features

Whether you are a first-time user or an experienced professional, this microwave analyzer is one of the easiest you will ever operate. Three clearly marked keys and the data-entry knob or keypad are used to measure any signal. Internal parameters such as resolution bandwidth, video bandwidth, sweep time, IF gain, and input attenuation are adjusted automatically.

This model also has 32 Kbytes of programmable memory, and an optional card reader. Dedicated measurement personalities for cable-television and digital-radio testing can be downloaded using application measurement cards (see page 104). A built-in clock/calendar is standard, and HP-IB or RS-232 interfaces are optional. Data can be sent directly from the analyzer to a printer or plotter.

To ensure the continued accuracy of your tests, internal calibration routines are included along with service routines.

HP 8593A Frequency-accurate Microwave Spectrum Analyzer

High performance spectrum analysis in the field or on the bench is now available with the HP 8593A. This model has synthesizer frequency accuracy from 9 kHz to 22 GHz, extendable to 26.5 GHz. Marker-count accuracy is 11 kHz at 18 GHz. All the portability and convenience features of the HP 8592B are found in this microwave spectrum analyzer, along with additional features for improved performance and more customizing options.

Better Performance and More Features at Microwave

New standard features of this spectrum analyzer include a frequency counter and more than 32 Kbytes of non-volatile program memory as well as capability for storing up to 50 traces. With the built-in memory-card reader, you can load custom programs or HP measurement personalities in seconds. An internal clock/calendar stamps stored traces with the time and date. The many options can be added in any combination to customize this analyzer for the lowest cost. Optional features include 26.5-GHz frequency coverage, fast time-domain sweep, AM/FM demodulator with speaker, TV trigger sync, a precision frequency reference, and HP-IB or RS-232 interfaces. HP measurement personalities for cable-television and digital-radio testing can be added (see page 104), and four internal card slots permit certain options to be configured at any time.

SIGNAL ANALYZERS

Portable AC Power Source

Model 85901A

109

- 200 Watts Continuous
- 115 Vrms or 230 Vrms
- Internal 17AH Battery

- Built-In Charger
- Lightweight and Portable
- Small With Briefcase-style Handle

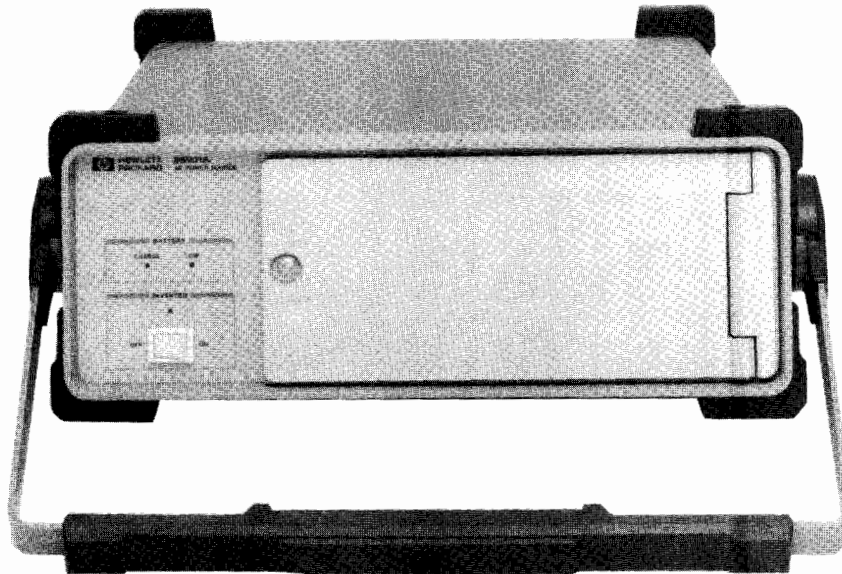

HP 85901A



Remote Power Where You Need It

Take the guesswork out of field measurements! Use your test equipment with the HP 85901A Portable AC Power Source to provide the power you need. The power source is small and has briefcase handle that makes it easy to carry. It fits into tight spots, even under an airline seat. You can use it as a stand-alone battery or connect it to an external 12 Vdc source for even longer operating times.

Easy to Use

Just plug your piece of test equipment into the HP 85901A AC Power Source and turn them both on. You'll get more than an hour of operation at 100 Watts continuous load. When the battery charge gets low, the power source automatically shuts off. This prevents any deep discharge battery degradation. You can charge the battery in six hours or less.

Designed for Reliability

No compromises were made in designing the HP 85901A Portable AC Power Source. Portable and reliable, its gel-cell battery, control circuitry, and charger all fit into a briefcase-sized package similar to our HP 8590 Series Portable Spectrum Analyzers. The internal battery, in its own rugged box, is accessible through a front panel door and can be replaced by removing just two screws.

Built-in Protection

The HP 85901A AC Power Source protects itself and your test equipment. It has over-voltage, short-circuit, and over-load protection on the inverter output. The power source also has over-voltage protection on the inverter input and over-charge and over-discharge protection for the internal battery.

Specifications

Input

Inverter Voltage: 10.8 to 14.5 Vdc

Charger

Voltage: 90 to 250 Vac Auto Selected

Frequency: 47 to 66 Hz

Power Consumption: 122 VA Maximum

Output

Voltage: 135 or 270 Vpeak +5% Rectangular Waveform with 25% Dead Zone (115 or 230 Vrms \pm 5%)

Frequency: 60 Hz \pm 0.1%, Crystal Ref

Max. Power: 200 Watts Continuous

Connectors: Two CEE22-V type; female

General Specifications

Environmental

Temperature¹

Operating: 0° to 55°C

Storage: With Battery -20° to 40°C, without Battery -40° to 70°C

EMI

Conducted VDE 0871 Level B

Radiated VDE 0871 Level B

Battery²

Type: Sealed Lead Acid

Voltage: 12 Vdc (Nominal)

Capacity: 17 AMP-HR (Nominal)

Mechanical (Nominal)

Dimensions: 337(W) x 125(H) x 461(D) mm

Weight: (With Battery) 14.2 Kg (31.3 lbs.); (Without Battery) 8.0 Kg (17.7 lbs.)

Shipping Weight: 16.3 Kg (36.0 lbs.)

Ordering Information

HP 85901A AC Power Source

Price

\$1,095.00 ☎

Extra HP Power Cord Adapter

\$17.00

8120-5220 (For Powering HP Instruments)

General Purpose Power Cord Adapters

(For connecting country specific line cords)

European 8120-5210

\$55.00

USA 8120-5211

\$55.00

UK 8120-5212

\$55.00

☎ Fast-Ship product — see page 734.

¹Shelf life of battery decreases with either extended operation or storage at higher than 40°C.

²Battery cyclic life (charging-discharging) is nominally more than 200 cycles.

SIGNAL ANALYZERS

Spectrum Analyzers, 50 Hz to 325 GHz

HP 8560A, 8561B, 8562A, 85620A, 85640A

- Synthesized tuning
- Optional precision frequency reference
- Frequency counter
- AM/FM demodulator
- Advanced markers
- Mass memory module
- Test and adjustment module
- One-year calibration cycle
- MIL-T-28800C rugged
- Lightweight and portable

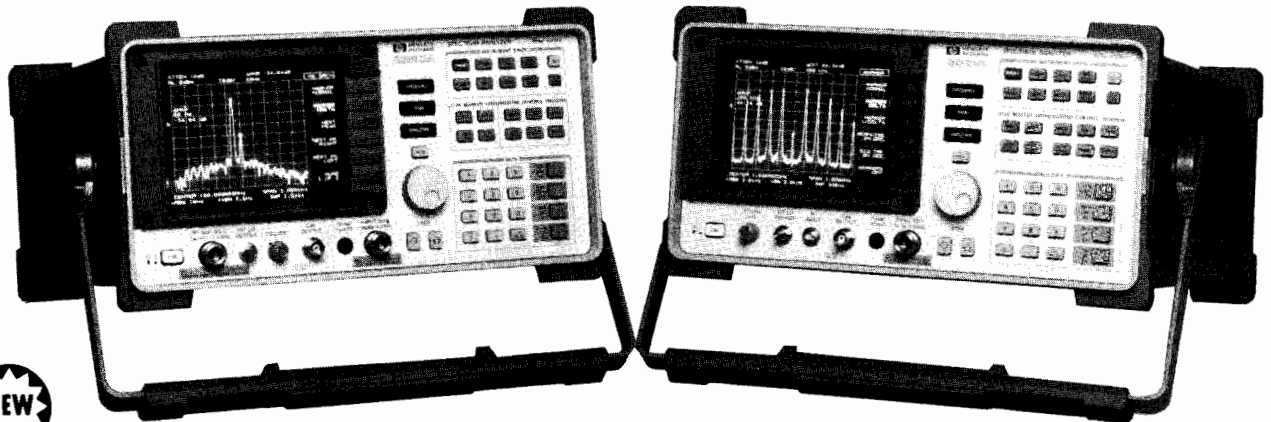

HP 8560A and 8561B

Rugged Spectrum Analyzers

The HP 8560A, 8561B, and 8562A spectrum analyzers put high-performance, synthesized technology into a lightweight, portable package. Ruggedized to military specifications, these analyzers are engineered to survive harsh field conditions. They perform a wide variety of jobs from communication-system and component testing to radar and millimeter measurement. These models are packed with advanced HP technology, and HP-IB is standard.

Frequency Coverage From RF Through Millimeter

The new HP 8560A spectrum analyzer has a frequency range of 50 Hz to 2.9 GHz and includes an optional built-in tracking generator. The new HP 8561B extends the upper range to 6.5 GHz. For higher frequency applications, the HP 8562A operates from 9 kHz to 22 GHz with an option to extend the frequency range to 26.5 GHz. Using HP millimeter mixers, frequency coverage reaches 110 GHz. With mixers from other manufacturers, frequency can be extended to 325 GHz.

Use Them Anywhere

The compact size and shape of the HP 8560 series spectrum analyzers makes them easy to transport to remote sites. With the HP 85901A portable ac power source, you can operate them anywhere. In the laboratory and on the production line, they fit easily onto crowded workbenches or instrument racks. If there is no room on your bench, you can operate these analyzers upright on the floor.

Rugged and Dependable

The HP 8560A, 8561B, and 8562A are built to perform in adverse conditions. They meet MIL-T-28800C requirements for temperature, pulse shock, and transit drop. Climate is not a problem; these models warm up in five minutes in ambient temperatures from -10°C to $+55^{\circ}\text{C}$. These analyzers withstand 30 g's of shock, so there is no need to worry if they are knocked around.

A removable impact cover fits over the front panel for maximum protection during transit. Inside the cover there are several convenient compartments for small accessories such as adapters, BNC cables, and external mixers. You will also find a handy, pocket-sized operating guide inside the cover.

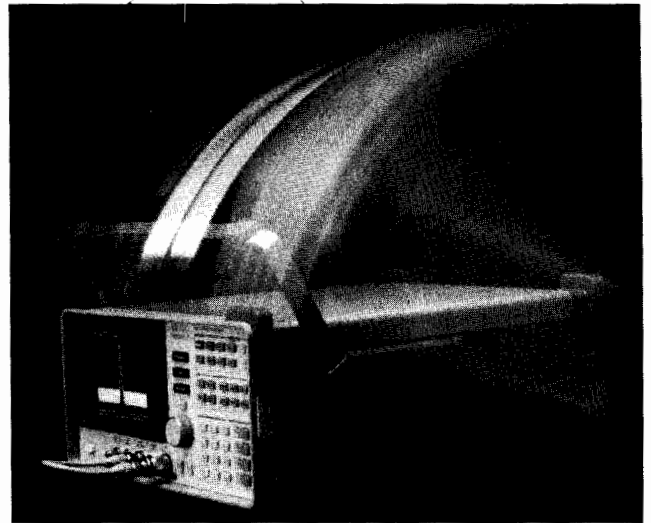

The portable spectrum analyzers meet MIL-T-28000C requirements for temperature, pulse shock, and transit drop.

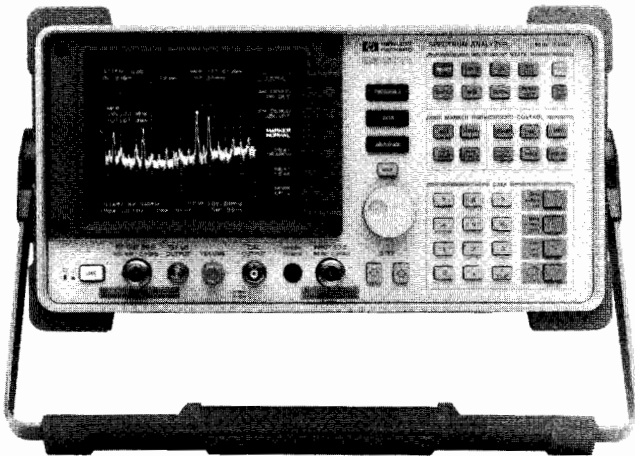

HP8560

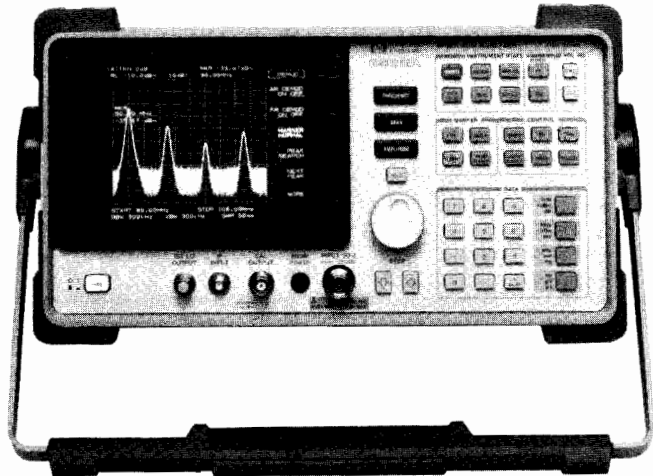

HP8562A

High-performance RF Measurements

Two new RF spectrum analyzers are ideal for RF design and service applications. The synthesized tuning in the HP 8560A and 8561B result in drift-free, accurate frequency measurements that are necessary for transmitter testing. With excellent sensitivity of -130 dBm, they make distortion measurements easily.

Fast Sweeps With Digital Bandwidths

Fast, accurate resolution of closely spaced signals is possible using the narrow 10-Hz resolution bandwidth of the new HP 8560A and 8561B spectrum analyzers. The digital technology used to implement the 10, 30, and 100 Hz narrow bandwidths results in sweep times up to 20 times faster than those using comparable analog bandwidths.

Built-in Tracking Generator

For scalar network measurements, a built-in tracking generator option for the HP 8560A, option 002, provides a built-in attenuator, vernier, external leveling, and much more. Similar performance is possible using the HP 8561B and new HP 85640A portable tracking generator.

Precise Measurements

Option 003 for the HP 8560A, 8561B, and 8562A adds frequency reference accuracy of 0.13 ppm after a 15-minute warmup (1 year aging, -10° to $+55^{\circ}$ C).

High-performance Microwave Measurements

The synthesized HP 8562A microwave spectrum analyzer gives speedy, accurate tuning after only 5 minutes of warmup. The optional precision frequency reference ensures a frequency accuracy of 2.3 kHz at 18 GHz after a 15-minute warmup (1 year aging, -10° to $+55^{\circ}$ C). And after only 30 minutes at room temperature, the preselector in this model needs no adjustment. This means faster measurements, which can be especially useful in automatic testing.

Ease of Use

The front panels of all HP 8560 series spectrum analyzers are clean, uncluttered, and inviting to use. You do not need to be an expert operator to begin taking measurements. You will find that easy access to frequently used functions makes the process simpler and faster.

Ten non-volatile memory registers allow you to save measurement settings and data in the field or in the factory. Up to 8 traces can also be stored in the analyzer's non-volatile memory, and up to 100 traces can be saved in the battery-backed RAM of the HP 85620A mass memory module. This module also stores more data on 32-Kbyte memory cards that plug into the module.

Advanced marker capability, built-in AM and FM demodulators for use in wide spans, and direct printing and plotting with or without a computer are a few more of the powerful features of this portable spectrum analyzer family.

SIGNAL ANALYZERS

Spectrum Analyzers, 50 Hz to 325 GHz (cont'd)

HP 8560A, 8561B, 8562A, 85620A, 85640A

Applications

Communication Measurements

The portable spectrum analyzers are ideal tools for bench measurements and field maintenance of digital radios, CATV/broadcast measurements, terrestrial point-to-point microwave-link maintenance, troubleshooting the interference problems of devices and systems, and measuring low-level signals in the presence of high-level ambients. Eliminate external mixers to analyze K-band signals by using the HP 8562A option 026, preselected to 26.5 GHz.

The HP 8560A is ideal for tests of broadband LAN systems or field measurements of mobile and cellular radios. The built-in AM/FM demodulator and speaker indicate over-modulation, clipping, synch buzz, and troublesome birdies in CATV systems. The built-in frequency counter accurately measures the frequency of the carrier. Direct carrier-to-noise measurements can be made with delta markers. Use the MAX HOLD function to capture elusive transient signals.

Radar Measurements

Some analyzers with digital displays have difficulty capturing short-duration pulses. With such analyzers it is not certain whether variations from sweep to sweep are due to equipment under test or to the analyzer itself. Because the HP 8560A, 8561B, and 8562A have a digitization uncertainty specification of ± 1.25 dB and typical repeatability of 0.2 dB, you can be sure that observed amplitude variations—those caused by magnetron moding, misfiring, or rotary joint problems—are due to the equipment under test, not to the analyzer.

Component Testing

The HP 8560A option 002 is an excellent choice for scalar network analysis. The combination of a built-in tracking generator and rugged, portable spectrum analyzer results in a compact scalar system that is perfect for testing and adjusting amplifiers, antennas, and other transceiver components in the field.

The HP 85640A tracking generator, used with the HP 8561B or 8562A, offers similar scalar performance while meeting your requirements for higher-frequency signal-analysis coverage.

Easy Troubleshooting

Intelligent design and exhaustive testing ensure that the HP 8560A, 8561B, and 8562A spectrum analyzers will remain reliable for many years. Fewer parts and selected low-failure components reduce random failures, and ac coupling provides the input mixer with extra protection against damaging signals. A continuously self-aligning IF section maintains the proper adjustment of step gains, log amplifiers, and resolution bandwidths, even in extreme environmental conditions. And a plug-in test-and-adjustment module makes diagnostic testing and troubleshooting easy.

Accessories to Enhance Measurements

Mass Memory Module

The HP 85620A mass memory module provides the portable spectrum analyzers with built-in computer capability plus a large memory. Simply plug the module onto the rear panel for exceptional measurement power at your fingertips. Create one-button measurement routines with downloadable programs (DLPs) to simplify operation and increase throughput. Store your programs in the 128 Kbytes of battery-backed RAM, which can also be used to store up to 100 traces with instrument-state information. Easy-to-use 32-Kbyte RAM memory cards are also available for additional storage.

The mass memory module simplifies your tasks in many ways. Limit lines can be created and stored for easier pass/fail testing. A built-in clock and automatic save and execute functions let you make measurements at specified times and under specified conditions.



HP 8562 with HP 85620A and 32 Kbyte memory cards

New Portable Tracking Generator

Even if your spectrum-analyzer measurements extend beyond 2.9 GHz, you can make swept stimulus-response measurements to 2.9 GHz with the HP 85640A portable tracking generator. This instrument is similar in performance to the HP 8560A option 002 built-in tracking generator, and it is compatible with all three analyzers in this family. The HP 85640A also incorporates an output attenuator.

Test and Adjustment Module

The HP 85629B test and adjustment module (TAM) makes it easy to service the HP 8560A, 8561B, and 8562A spectrum analyzers. It plugs onto the rear panel of the analyzer and automates high-level diagnostics, self tests, and other procedures. Automatic fault isolation checks the operation of the CPU, ADC, IF, LO, and RF sections. With minimal equipment, more than 1,000 measurements can be made using the 8-input voltmeter of the TAM and the twenty-six 16-pin test connectors located throughout the analyzer. Once the repair is complete, readjustment is fast and easy because the TAM controls both internal analyzer settings and external equipment. After readjustment, the functional tests of the TAM give immediate assurance of the success of the repair.

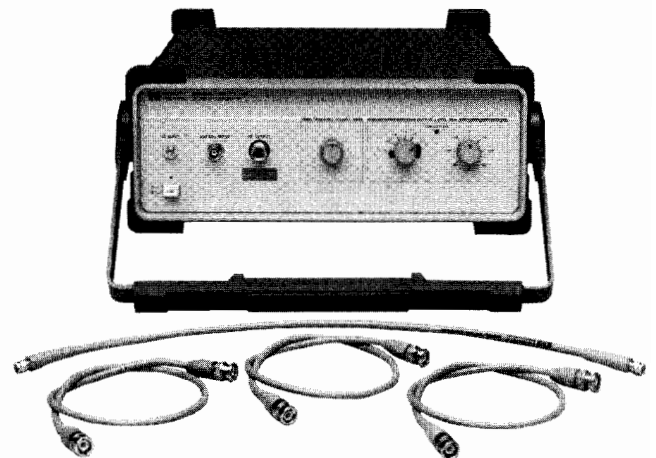

HP 85640A RF Tracking Generator

Specifications

Frequency

Frequency range

- HP 8560A:** 50 Hz to 2.9 GHz (dc-coupled); 100 kHz to 2.9 GHz (ac-coupled)
HP 8561B: 50 Hz to 6.5 GHz (dc-coupled); 100 kHz to 6.5 GHz (ac-coupled)
HP 8562A: 9 kHz to 22 GHz; 9 kHz to 26.5 GHz (option 026)

Harmonic mode (n)	Center frequency
1	9 kHz - 2.9 GHz
1	2.75 GHz - 6.46 GHz
2	5.86 GHz - 13.0 GHz
3	12.4 GHz - 19.7 GHz
4	19.1 GHz - 22 GHz
4	19 GHz - 26.5 GHz (opt 026)

Frequency readout accuracy (start, stop, center, or marker)

- HP 8560A and 8561B:** $\pm(\text{freq readout} \times \text{freq ref acc'y} + 5\% \times \text{span} + 15\% \times \text{RBW} + 350 \text{ Hz})$
HP 8562A: $\pm(\text{freq readout} \times \text{freq ref acc'y} + 5\% \times \text{span} + 15\% \times \text{RBW} + 250 \text{ Hz})$

Counter resolution: 10 Hz - 1 MHz (HP8562A, selectable); 1 Hz - 1 MHz (HP8560A and 8561B, selectable)

Marker counter accuracy (S/N \geq 25 dB)

- HP 8560A and 8561B:** $\pm(\text{marker freq} \times \text{freq ref acc'y} + 50 \text{ Hz} \times n + 1 \text{ LSD})$
HP 8562A: $\pm(\text{marker freq} \times \text{freq ref acc'y} + 50 \text{ Hz} \times n + 2 \text{ LSD})$

Delta counter accuracy: $\pm(\text{delta freq} \times \text{freq ref acc'y} + 100 \text{ Hz} \times n + 2 \text{ LSD})$ for S/N \geq 25 dB

Frequency reference accuracy

- Standard:** $< 4 \times 10^{-7}$ /yr (includes aging, temp drift, settability)
Option 003 (precision frequency reference): $< 0.13 \times 10^{-7}$ /yr (includes aging, temp drift, settability, warmup)

Residual FM (zero span)

- HP 8560A and 8561B:** $< 10 \text{ Hz p-p}$ in 20 ms
HP 8562A: $< 50 \text{ Hz} \times n \text{ p-p}$ in 100 ms

Spectral purity

Noise sidebands: $< (-100 + 20 \log n) \text{ dBc/Hz}$ at 30 kHz offset

Frequency span

Range

- HP 8560A:** 0 Hz, 100 Hz to 2.9 GHz
HP 8561B: 0 Hz, 100 Hz to 6.5 GHz
HP 8562A: 0 Hz, 2.5 kHz x n to 23.75 GHz (opt 026)

Accuracy: $< 5\%$

Resolution bandwidth (-3 dB)

Range

- HP 8560A and 8561B:** 10 Hz - 1 MHz in a 1,3,10 sequence, and 2 MHz
HP 8562A: 100 Hz - 1 MHz in a 1,3,10 sequence, and 2 MHz

Accuracy

- HP 8560A and 8561B:** $\pm 10\%$ (10 Hz to 300 kHz); $\pm 25\%$ (1 MHz, 2 MHz)
HP 8562A: $\pm 30\%$ (100 Hz); $\pm 10\%$ (300 Hz to 300 kHz); $\pm 25\%$ (1 MHz, 2 MHz)

Selectivity ($-60 \text{ dB}/-3 \text{ dB}$)

- HP 8560A and 8561B:** $< 5:1$ (RBW \leq 100 Hz); $< 15:1$ (RBW $>$ 100 Hz)

HP 8562A: $< 15:1$

Video bandwidth

Range: 1 Hz - 3 MHz in a 1,3,10 sequence

Amplitude Range

Amplitude range: +30 dBm to displayed average noise level

Maximum safe input

Average continuous power: +30 dBm (1 W) with input atten $>$ 10 dB

Peak pulse power: +50 dBm (100 W) with input atten \geq 30 dB for $< 10 \mu\text{s}$ pulse width and $< 1\%$ duty cycle

dc: 0 Volts

Display range

Display: 10 x 10 division graticule

Calibration: log = 10,5,2, and 1 dB per division; linear = 10% of reference level/division

Reference level range: log = -120 to +30 dBm in 0.1 dB steps; linear = 2.2 μVolts to 7.07 Volts in 1% steps

Input attenuation range: 0 to 70 dB in 10 dB steps

Dynamic Range

Maximum dynamic range

Compression to noise

HP 8560A: 125 dB

HP 8561B: 128 dB

HP 8562A: 118 dB

Signal to distortion, harmonic

HP 8560A: 81 dB

HP 8561B: 81 dB ($<$ 2.9 GHz), 110 dB (\geq 2.9 GHz)

HP 8562A: 76 dB ($<$ 2.9 GHz), 105.5 dB (\geq 2.9 GHz)

Signal to distortion, intermodulation

HP 8560A: 90 dB

HP 8561B: 90 dB ($<$ 2.9 GHz), 92 dB (\geq 2.9 GHz)

HP 8562A: 83 dB ($<$ 2.9 GHz), 86 dB (\geq 2.9 GHz)

Displayed average noise level (minimum RBW, 0 dB input attenuation, 1 Hz video BW, no signal at input)

Frequency	HP 8560A	HP 8561B	HP 8562A
10 kHz	-103 dBm	-103 dBm	-90 dBm
100 kHz	-110 dBm	-110 dBm	-100 dBm
1 MHz - 2.9 GHz	-130 dBm	-130 dBm	-120 dBm
2.75 GHz - 6.46 GHz		-131 dBm	-121 dBm
5.86 GHz - 13.0 GHz			-110 dBm
12.4 GHz - 19.7 GHz			-105 dBm
19.1 GHz - 22.0 GHz			-100 dBm

1 dB gain compression: -5 dBm at input mixer (10 MHz - 2.9 GHz); -3 dBm at input mixer ($>$ 2.75 GHz)

Spurious responses (signals generated by analyzer due to input signals): for mixer level $<$ -40 dBm, $>$ 60 dB below input signal for frequencies $<$ 6.46 GHz

Second harmonic distortion

Frequency	Mixer Level	HP 8560A	HP 8561B	HP 8562A
50 Hz - 10 MHz	-40 dBm	-60 dBc	-60 dBc	
10 MHz - 2.9 GHz	-40 dBm	-72 dBc	-72 dBc	-72 dBc
$>$ 2.75 GHz	-10 dBm		-100 dBc	-100 dBc

Third-order intermodulation (two -30 dBm signals at mixer):

-64 dBc, 50 Hz - 10 MHz (HP 8560A and 8561B); -70 dBc, 10 MHz - 2.9 GHz; -75 dBc, $>$ 2.75 GHz (HP 8561B and 8562A)

Image, multiple, and out-of-band responses: $<$ -70 dBc, 10 MHz - 22 GHz; $<$ -60 dBc, 10 MHz - 22 GHz

Residual responses (no signal at input, 0 dB input atten): $<$ -90 dBm, $>$ 200 kHz

Amplitude Accuracy

Frequency response (relative)

HP 8560A: +1.0 dB (dc-coupled)

HP 8561B: +1.0 dB (dc-coupled, 50 Hz - 2.9 GHz); +1.5 dB (dc-coupled, 2.75 - 6.5 GHz)

HP 8562A:

Frequency Range	HP 8562A
9 kHz - 2.9 GHz	$\pm 1.0 \text{ dB}$
2.75 - 6.46 GHz	$\pm 1.5 \text{ dB}$
5.86 - 13.0 GHz	$\pm 2.0 \text{ dB}$
12.4 - 19.7 GHz	$\pm 3.0 \text{ dB}$
19.1 - 22.0 GHz	$\pm 3.0 \text{ dB}$
19.1 - 26.5 GHz (opt 026)	$\pm 3.0 \text{ dB}$

SIGNAL ANALYZERS

Spectrum Analyzers, 50 Hz to 325 GHz (cont'd.)

Calibrator accuracy: ± 0.3 dB
IF gain uncertainty: ± 1 dB for 0 dBm to -80 dBm reference level
Scale fidelity: 0.4 dB/4 dB to a maximum of ± 1.5 dB over 0 - 90 dB range; linear, $\pm 3\%$ of reference level
Input attenuator switching accuracy (with 20 - 70 dB settings referenced to 10 dB): < 2.9 GHz ± 0.6 dB/10 dB step, 1.8 dB max
Resolution bandwidth switching uncertainty: ± 0.5 dB referenced to 300 kHz BW
Pulse digitization uncertainty (pulse-response mode, PRF > 720/sweeptime)
Log (peak to peak): 1.25 dB (RBW ≤ 1 MHz), 3 dB (RBW = 2 MHz)
Linear (peak to peak): 4% of ref level (RBW ≤ 1 MHz); 12% of ref level, nominal standard deviation 0.2 dB

Sweep

Sweep time

Range: 50 μ s to 60 s for zero span; 50 ms to 100 s (HP 8560A and 8561B, span > 100 Hz; HP 8562A, span > 2.5 kHz x n)

Sweep trigger: free run, line, single, video, external

Demodulation

Modulation type: AM and FM

Audio output: speaker and phone jack with volume control

Inputs and Outputs

Front-panel connectors

RF input: Precision type-N female, nominal impedance 50 ohms
VSWR: $< 1.5:1$ for < 2.9 GHz and ≥ 10 dB input atten (nominal); $< 2.3:1$ for > 2.9 GHz and ≥ 10 dB input atten (nominal)
LO emission level (average): with 10 dB input atten, < -80 dBm (nominal)

Second IF input (not available on HP 8560A opt 002): SMA female, nominal frequency 310.7 MHz; NF 7 dB, nominal

First LO output: SMA female, nominal impedance 50 ohms; nominal freq range 3.0000 - 6.8107 GHz; amplitude $+16.5$ dBm ± 2 dB ($20^\circ - 30^\circ$ C); $+14.5$ dBm ± 3 dB (HP 8560A opt 002)

Calibrator output: BNC female, nominal impedance 50 ohms

Rear-panel connectors

10 MHz reference (input/output): BNC female, nominal impedance 50 ohms; nominal input range -2 to $+10$ dBm

Video output: BNC female, nominal impedance 50 ohms (dc-coupled)

LO sweep/0.5 V per GHz output: shared BNC female, nominal impedance 2,000 ohms (dc-coupled); nominal LO sweep output 0 to $+10$ V (no load)

External trigger input: BNC female, nominal impedance $> 10,000$ ohms; trigger level, rising edge of TTL level

HP-IB

Interface functions: SH1, AH1, T6, TE0, L4, LE0, SR1, RL1, PP1, PC1, DT1, C1, C28

Direct plotter outputs: HP 7440A, 7470A, 7475A, 7550A

Printers: HP 3630A PaintJet, HP 2225A ThinkJet; other printers with IEEE 488 interface may work

General Specifications

Environmental

Military specifications: meets MIL-T-28800C, Type III, Class 3, Style C

Calibration interval: 1 year

Warmup: 5 minutes from ambient conditions

Temperature: -10° to $+55^\circ$ C, operating; -62° to $+85^\circ$ C, not operating

Humidity: 95% at 40° C for 5 days

Altitude: 15,000 ft, operating; 50,000 ft, not operating

Rain resistance: drip-proof at 16 liters/hour/square foot

Vibration: 0.059 inch p-p excursion (5 - 15 Hz); 0.039 inch p-p excursion (15 - 25 Hz); 0.020 inch p-p excursion (25 - 55 Hz)

Pulse shock: half sine, 30 g's for 11 ms duration

Transit drop: 8-inch drop on 6 faces and 8 corners

Electromagnetic compatibility: conducted and radiated interference in compliance with CISPR publication 11 (1985) and FTZ 526/527/79. Meets MIL-STD 461B, Part 4, with exceptions noted below

Conducted emissions: CE01 (narrowband), 1 - 15 kHz only; CE03 (narrowband), full limits; CE03 (broadband), 20 dB relaxation from 15 - 100 kHz

Conducted susceptibility: CS01, full limits; CS02, full limits; CS06, full limits

Radiated emissions: RE01, 15 db relaxation to 28 kHz and exceptioned from 28 - 50 kHz; RE02, full limits < 1 GHz

Radiated susceptibility: RS01, full limits; RS02, exceptioned; RS03, limited to 1 V/meter from 14 kHz - 1 GHz with 20 dB relaxation at IF frequencies

Power requirements

115 VAC operation: voltage 90 - 140 V RMS; current 3.2 A RMS Max; frequency, 47 - 440 Hz

230 VAC operation: voltage 180 - 250 V RMS; current 1.8 A RMS Max; frequency 47 - 66 Hz

Maximum power dissipation: 180 Watts

Nominal audible noise: 5.0 Bels power at room temp (ISO DP7779)

Nominal weight

HP 8560A: 18.2kg (40lb)

HP 8561B and 8562A: 20 kg (44 lb)

Size: 163H x 325W x 427mmD (nominal, without handle, feet, or cover)

Option 002 Built-in Tracking Generator (HP 8560A only)

Frequency

Frequency range: 300 kHz - 2.9 GHz

Tracking drift: useable in 1 kHz RBW after 5-minute warmup; useable in 300 Hz after 30-minute warmup

Minimum RBW: 300 Hz

Amplitude

Output level: -10 to $+1$ dBm

Resolution: 0.1 dB

Accuracy

Vernier: ± 0.20 dB/dB, ± 0.5 dB max (25° C + 10° C)

Absolute: ± 0.75 dB

Level flatness: ± 2.0 dB

Return loss: 10 dB

Dynamic range: 96 dB at 300 kHz - 1 MHz; 116 dB at 1 Hz - 2.0GHz; 111 dB at 2.0 - 2.9 GHz

Power sweep: 10 dB range, 0.1 dB resolution

Input/output

RF output (front panel): type-N, 50-ohm nominal

Ext ALC input (rear panel): BNC female; use with negative detector

Ordering Information

	Price
HP 8560A RF Spectrum Analyzer	\$23,900
HP 8561B RF Spectrum Analyzer	\$29,000
HP 8562A Microwave Spectrum Analyzer	\$36,000
Opt 001 Second IF Output	+\$850
Opt 002 Built-in Tracking Generator (HP 8560A only)	+\$6,000
Opt 003 Precision Frequency Reference	+\$2,000
Opt 026 Extended Frequency Coverage to 26.5 GHz (HP 8562A only)	+\$3,200
Opt 908 Rackmount Kit Without Handles	+\$400
Opt 909 Rackmount Kit With Handles	+\$450
Opt 915 Support Documentation Package	+\$360
Opt 916 Extra Quick Reference Guide (HP 8560A and 8561B) or Extra Pocket Operating Guide (HP 8562A)	+\$25
Opt W30 Extended Repair Service. See page 725.	
for HP 8560A	+\$625
for HP 8561B	+\$735
for HP 8562A	+\$900
Opt W32 Calibration Service. See page 725.	
for HP 8560A	+\$965
for HP 8561B	+\$1,075
for HP 8562A	+\$1,230
HP 85620A Mass Memory Module	\$2,150
HP 85629B Test and Adjustment Module	\$2,150
HP 85640A Tracking Generator	\$7,500
HP 85901A Portable ac Power Source	\$1,095
☛ Fast-Ship product—see page 734.	

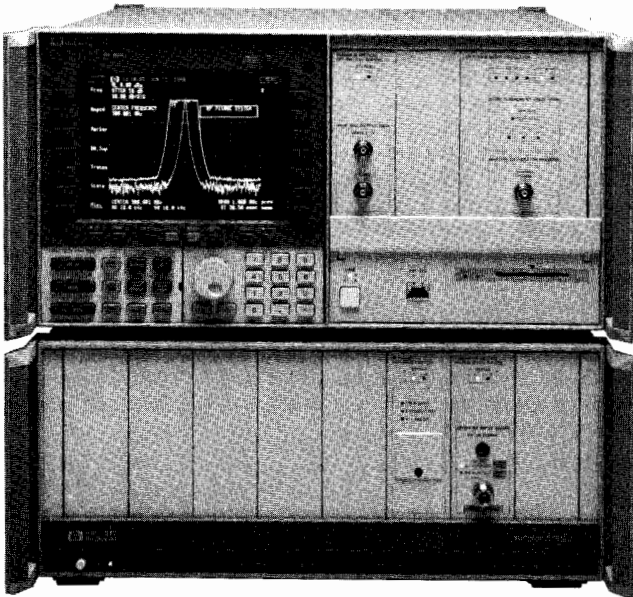

HP 71100C

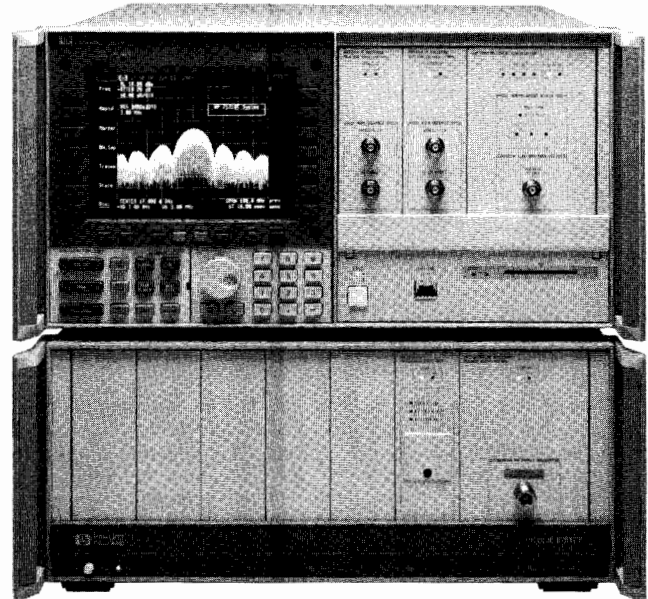

HP 71210C



The HP 70000 modular measurement system has a new look for 1990. A new full-color display comes integrated with a 4-module-slot mainframe. Connected to a standard 8-slot mainframe, it gives you a modular system with enough room to add the measurement capabilities that your application demands. A new local oscillator module adds greater speed and lower phase noise. Now, making measurements is easier than ever before.

An Exciting New Family of Full-color Systems

Four new standard systems featuring the HP 70004A color display meet all of your high-performance spectrum analysis needs, from basic RF measurement through lightwave signal analysis. Each standard model has extra slots for system expansion, and a precision frequency reference is included.

But the modular measurement system is far more than just a spectrum analyzer. You can add a modular power meter, vector voltmeter, digitizer, preamplifier, signal generators, and much more. The new display makes it simple to build multiple windows, and you can switch control from one instrument to another in just two keystrokes.

Valuable New Features for Greater Efficiency

Other new ease-of-use features include a dedicated keypad for spectrum analyzer operation and a save-and-recall menu that allows you to store traces, states, limit lines, or custom programs in internal

memory, on a memory card, or directly to an external disk. You can continue making measurements while plotting with the new buffered output.

A color editor allows you to customize the display, choosing the colors that best enable you to easily distinguish markers from noise, or different limit lines and traces. You can change the color of traces, background, annotation, graticule lines, and other display elements. Up to four custom-designed color palettes can be saved. A set of special palettes includes one for applications using laser light that require protective eyewear.

The new system models in the HP 70000 modular family feature an HP-IL interface on the front panel of the display. Plug in a full keyboard and enter data for display titles, instrument commands, or short- to medium-length programs. An external monitor can be connected to the rear panel. The display has a built-in clock/ calendar that stamps prints and plots with the time and date. And data can be sent directly to a color printer using either high or low resolution.

Digital Persistence Benefits

New firmware adds digital persistence to the HP 70004A color display. Digital persistence simulates the variable intensities of an analog display without sacrificing the storage and plotting capabilities of a digital display. This allows you to extract information from complex modulated signals such as TV, pulsed RF, and FM.

SIGNAL ANALYZERS

HP 70000 Modular Measurement System (cont'd)

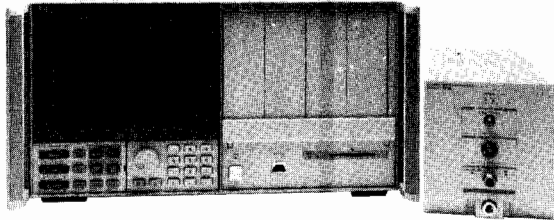

An Open, Modular System

The HP 70000 modular measurement system combines the latest technology with all the benefits of modularity. Its fully automated, modular architecture has been optimized for test instrumentation. Its rugged, reliable mainframes and display/control units combine with an expanding variety of modules from Hewlett-Packard, or you can design your own modular instrumentation. Hewlett-Packard has transferred the patent rights of the modular measurement system, including the modular system interface bus (MSIB), to the public domain. To aid the development of custom modules, HP offers design guides and part kits.

The elements required to configure a basic modular spectrum analyzer are a display, the HP 70900B local oscillator, an RF or external-mixer-interface module, and an IF section. For more demanding applications, HP offers the HP 71100C RF system, the HP 71200C and 71210C microwave systems, and the HP 71400C lightwave signal analyzer system. You can also configure a custom system; for example, in automated applications where space is at a premium, you can configure a system without a display. See pages 118 and 119 for configuration options.

Expanding Measurement Capabilities

A growing variety of new modules makes it easy to increase or modify your measurement capability. Make RF-voltage and phase measurements with the new HP 70138A vector voltmeter module. Improve sensitivity at microwave frequencies by adding the HP 70602A preamplifier module. Or add stimulus-response capabilities with the HP 70300A RF and 70301A microwave tracking generators.

The new HP 70320A and 70322A synthesized signal generators offer spectral purity at RF and microwave frequencies, and the HP 70325A agile signal generator gives frequency agility from 252 kHz to 2060 MHz. The HP 70700A digitizer module enhances spectrum analyzer time-domain measurements or acts as a stand-alone, programmable waveform recorder. Additional mainframes can be added as your system grows, with system control residing in a single display.

Custom Functions

Specific measurement routines can be created as downloadable programs (DLPs) and assigned to softkeys in the HP 70000 modular measurement system. These custom routines can then be used like any other system function.

Multisystem Control and Management

One modular system can include many instruments, with up to 255 modules. System architecture manages communication between

modules. Instrument control is handled over HP-IB when no display is present; adding a display allows you to manually control the instruments in the system. Up to four instruments can be viewed simultaneously on the display while all of the instruments are making measurements. This flexibility is unsurpassed in the microwave industry.

Product Support

Every HP 70000 modular measurement system now comes with a standard two-year warranty.

In addition, the HP 11990A software package provides complete electrical-test capability to data-sheet specifications and is available for any standard system.

A one-day, lab-intensive user's course demonstrates techniques for using the HP 70000 system most effectively. Topics cover connecting and configuring modules, becoming familiar with menus that control system operation, and unique features of the HP 70000 modular measurement system. For more information, call your local HP sales office listed on page 739.

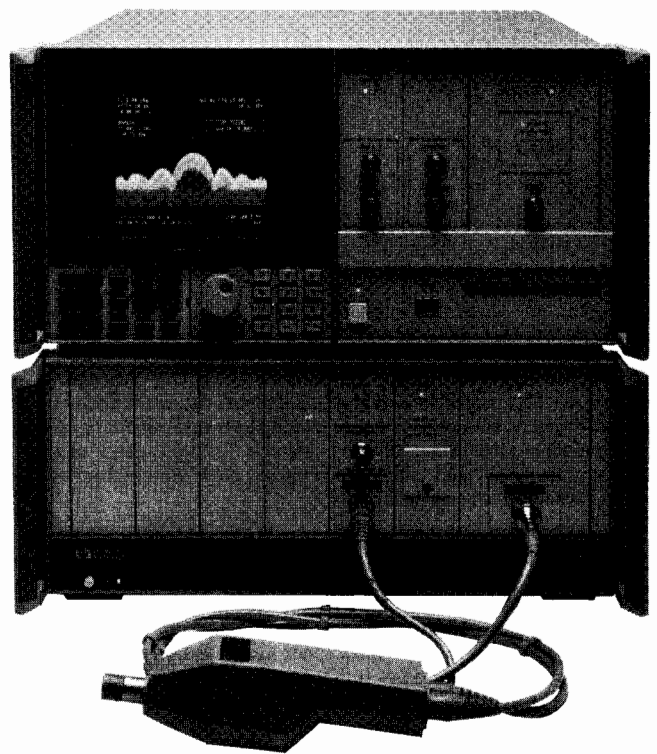

Specifications

Complete specifications for the many HP 70000 systems and modules are available from your local HP sales office. See page 739 for locations.

Upgrade Kits

The new HP 70860A high-speed controller board approximately doubles the speed of any RF, microwave, or millimeter-wave spectrum analyzer containing the HP 70900A local oscillator. This board also has new firmware (sold separately as the HP 70861A RAM/ROM upgrade kit). These upgrades give your local oscillator the same firmware features found in the new HP 70900B, the master control unit of the HP 70000 C series modular spectrum analyzers.

Ordering Information

Standard Spectrum Analyzer Systems

HP 71100C RF Spectrum Analyzer, 100 Hz to 2.9 GHz \$45,000

Precise RF measurement. Features color display with color editor, hardkeys for spectrum analyzer functions, data transfer to disk or memory card, HP PaintJet dump. Seven module slots open. Capability to add scalar-analysis, CW-phase, and power-meter measurement.

10 Hz minimum resolution bandwidth, -108 dBc/Hz phase noise 10 kHz offset, -133 dBm sensitivity, +117 Hz/GHz/year frequency accuracy.

HP 71200C Microwave Spectrum Analyzer, 100 Hz to 22 or 26.5 GHz \$50,000

Preselection and 26.5 GHz frequency options. Features color display with color editor, hardkeys for spectrum analyzer functions, data transfer to disk or memory card, HP PaintJet printer dump. Supports HP 11970 harmonic and 11974 preselected millimeter mixers when used with interface module. Seven module slots open. Capability to add scalar-analysis, CW-phase, and power-meter measurement.

10 Hz minimum resolution bandwidth, -108 dBc/Hz phase noise @ 30 kHz offset, -133 dBm sensitivity, ±117 Hz/GHz/year frequency accuracy.

HP 71210C Microwave Spectrum Analyzer, 100 Hz to 22 GHz \$78,000

Highest performance. Fundamentally mixed front end. Continuously tracking preselector always peaked. Receiver-quality noise floor and -154 dBm sensitivity with HP 70602A preamplifier. Features color display with color editor, hardkeys for spectrum analyzer functions, data transfer to disk or memory cards, HP PaintJet printer dump. Supports HP 11970 harmonic and 11974 preselected millimeter mixers when used with interface module. Five module slots open. Capability to add scalar-analysis and power-meter measurement.

10 Hz minimum resolution bandwidth, -108 dBc/Hz phase noise @ 30 kHz offset, ±117 Hz/GHz/year frequency accuracy.

HP 71400C Lightwave Signal Analyzer, 1200 to 1600 nm \$98,325

First off-the-shelf analyzer to measure intensity modulation. Has bandwidth of 100 Hz to 22 GHz and all the spectrum-analyzer capabilities and features of the HP 71210C. Four module slots open. See page 314 for more details.

Basic Components

HP 70001A System Mainframe \$6,600
HP 70004A Color Display/Mainframe \$9,750
HP 70205A Monochrome Graphic Display Module \$5,600
HP 70206A Monochrome Graphic Display \$8,140

HP 70310A Precision Frequency Reference \$4,980
Opt 001 Add Distribution Amplifier +\$1,560
Opt 002 Delete Ovenized Oscillator -\$2,450
HP 70600A Preselector (2.7 GHz - 22 GHz) \$10,550
HP 70601A Preselector (2.7 GHz - 26.5 GHz) \$12,850
HP 70900B Local Oscillator \$18,750
HP 70902A IF Section (RBW 10 Hz - 300 kHz) \$4,880
HP 70903A IF Section (RBW 100 kHz - 3 MHz) \$3,810
HP 70904A RF Section (100 Hz - 2.9 GHz) \$8,800
HP 70905A RF Section (50 kHz - 22 GHz) \$10,900
HP 70905B RF Section (50 kHz - 22 GHz, no attenuator) \$9,940
HP 70906A RF Section (50 kHz - 26.5 GHz) \$12,750
HP 70906B RF Section (50 kHz - 26.5 GHz, no attenuator) \$11,750
HP 70907A External Mixer Interface \$8,850
HP 70908A RF Section (100 Hz - 22 GHz, fundamentally mixed) \$36,600

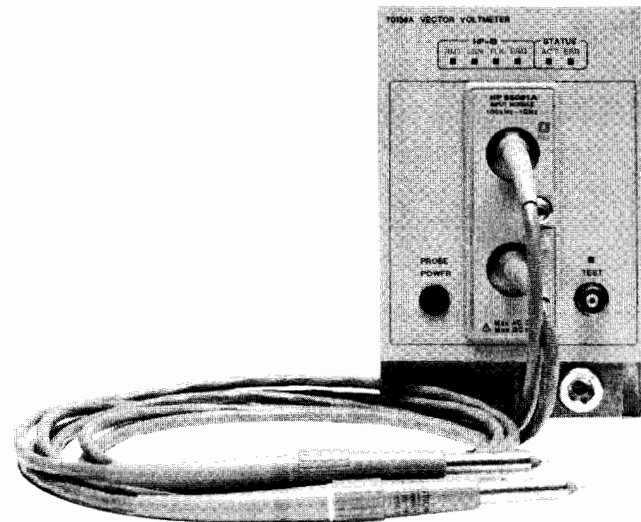

HP 70138A Vector Voltmeter

Other Components

HP 70100A Power Meter (100 kHz - 50 GHz) \$2,900
HP 70138A Vector Voltmeter (100 kHz - 2 GHz) \$5,800
HP 70300A RF Tracking Generator (20 Hz - 2.9 GHz) \$11,950
HP 70301A Microwave Tracking Generator (10 MHz - 18 GHz) \$25,000
HP 70320A Synthesized Signal Generator (252 Hz - 2,060 MHz) \$17,000
HP 70322A Synthesized Signal Generator (100 kHz - 4.2 GHz) \$35,000
HP 70325A Agile Signal Generator (252 kHz - 2,060 MHz) \$32,000
HP 70591A 1/8-width Module Part Kit \$765
HP 70592A 2/8-width Module Part Kit \$815
HP 70593A 3/8-width Module Part Kit \$1,430
HP 70594A 4/8-width Module Part Kit \$2,500
HP 70595A Module Development Design Guides \$600
HP 70596A Module Communication Design Guides \$600
HP 70620A Preamplifier (2 - 22 GHz) \$10,700
HP 70700A Digitizer \$7,800

SIGNAL ANALYZERS

HP 70000 Modular Measurement System (cont'd)

HP 70000 MODULAR MEASUREMENT SYSTEM Configuration Guide

		1 Choose Base System										2 <input checked="" type="checkbox"/> Check desired capabilities			
		Module Slots Available		FRONT ENDS						FREQUENCY ACCURACY		IF BANDWIDTH			
		2.9 GHz	22 GHz	26.5 GHz	Preselection	Ext. Mixer Interface to > 110 GHz	Lightwave 1200 - 1800 nm	±13 kHz/GHz (W)	±117 Hz/GHz (W)	Distribution Amplifier	External Reference (Delete Owen)	10 Hz - 300 kHz	100 kHz - 3 MHz	Delete 10 Hz - 300 kHz	Delete 100 kHz - 3 MHz
Module/ Mainframe Icons		<input type="checkbox"/>	<input type="checkbox"/>	<input type="checkbox"/>	<input type="checkbox"/>	<input type="checkbox"/>	<input type="checkbox"/>	<input type="checkbox"/>	<input type="checkbox"/>	Internal	Internal	<input type="checkbox"/>	<input type="checkbox"/>	<input type="checkbox"/>	<input type="checkbox"/>
Module Slots Used			0	+1	+1	+1	-1			0	0	+1	-1	-1	
RF Spectrum Analyzer HP 71100C \$45,000	7	●						●			●				
Microwave Spectrum Analyzer HP 71200C \$50,000	7		●					●			●				
High Sensitivity Microwave Spectrum Analyzer HP 71210C \$78,000	5		FUNDAMENTAL MARKING		DYNAMIC TRACKING			●			●	●			
Lightwave Signal Analyzer HP 71400C \$98,325	4		FUNDAMENTAL MARKING		DYNAMIC TRACKING		●	●			●	●			
HP model numbers, system options, and prices		70904A	70905A or 70908A	#001 26.5GHz (70906A) \$1,850	#002 Preselect (70905B 70600A) \$8,090	70907A	70810A	#110 Deletes 70310A	70310A	#121 70310A (option 001)	#122 70310A (option 002)	70902A	70903A	#006 Deletes 70902A	#007 Deletes 70903A
				#003 26.5GHz Preselected (70906B 70601A) \$13,700		\$6,850	\$18,350	\$2,500		\$1,560	-\$2,450		\$3,810	\$4,880	\$3,810

- Standard in Base System
- Selectable Option
- Not Available

Your system will come fully configured.
If you want any modules shipped separately, please make note on order form.

Example 1:

1 Choose base system		3 Add mainframe?	
	Model number	Module count	
RF Spectrum Analyzer	HP 71100C	Module Slots Available = 7	
2 <input checked="" type="checkbox"/> Check desired capabilities	Tracking Generator	+2	} = 5 Optional Module Slots Used.
	CW Phase Measurement	+2	
	Power Meter	+1	
	+ Sensors		
		2 module slots are available, additional mainframe not required.	

HP 70000 MODULAR MEASUREMENT SYSTEM

Configuration Guide

② <input checked="" type="checkbox"/> Check desired capabilities											③ Add mainframe ?*			
TRACKING GENERATORS					TEST AND MEASUREMENT CAPABILITIES						MONOCHROME DISPLAYS		MAINFRAME	
100 Hz - 2.9 GHz	2.7 GHz - 18 GHz	Vector Voltmeter CW Mag. & Phase	Power Meter	Digitizer	2-220-Hz Preamplifier	Synthesized Sig. Gen. 252 MHz-2360 MHz	Synthesized Sig. Gen. 100 Hz-4.2 GHz	Agile Sig. Gen. 252 MHz-2360 MHz	5.5 Inch Display Module	8 Inch Display Full Rack	Optional Module Slots Used	Add	Delete	
+ <input type="checkbox"/>	+ <input type="checkbox"/>	+ <input type="checkbox"/>	+ <input type="checkbox"/>	+ <input type="checkbox"/>	+ <input type="checkbox"/>	Full Rack		+ <input type="checkbox"/>	+ <input type="checkbox"/>	Full Rack	+/-			
+2	+3	+2	+1	+1	+1				+7	+4		-8	+8	
	Preselection Recommended													
70300A	70301A	70138A	70100A	70700A	70620A	70320A	70322A	70325A	#205 Substitute 70205A for 70004A	#206 Substitute 70206A for 70004A		70001A	#201	
\$11,950	\$25,000	\$5,900	\$2,900	\$7,800	\$10,700	\$17,000	\$35,000	\$32,000	\$4,150	\$1,600		\$6,600	\$3,500	

* Module Slots Used must be ≤ Module Slots Available. If not, add a mainframe.

Only count modules checked (✓) as part of Optional Module Slots Used.

Example 2:

① Choose base system Lightwave Signal Analyzer	③ Add mainframe? Model numbers Module count
② <input checked="" type="checkbox"/> Check desired capabilities 100 Hz-18 GHz Tracking Generators	HP 71400A Module Slots Available = 4 HP 70300A +2 } 5 Optional Module HP 70301A +3 } Slots Used Add mainframe or delete capability.

SIGNAL ANALYZERS

Spectrum Analyzers, 100 Hz to 325 GHz
Models 8566B, 8567A & 8568B

- 100 Hz to 325 GHz coverage with synthesizer accuracy
- 10 kHz to 1.5 GHz coverage at a lower price
- 100 Hz to 1.5 GHz coverage with counter accuracy
- 2 to 22 GHz preselected range
- Trace markers with amplitude and frequency readout
- 16K bytes of user RAM for trace data or custom routines



HP 8566B

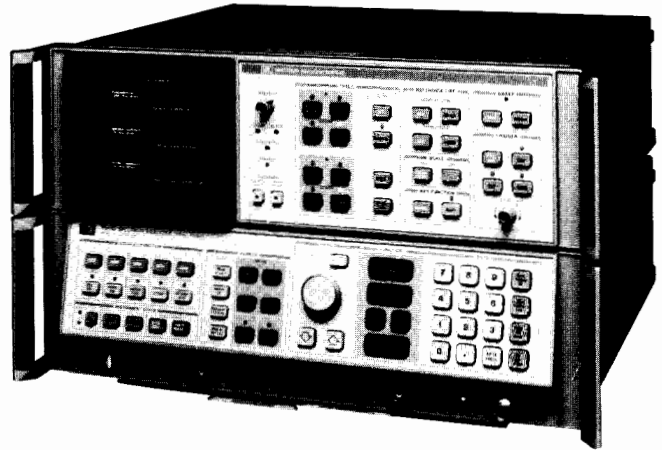

HP 8568B

The HP 8566B, HP 8567A, and HP 8568B are high-performance spectrum analyzers for bench and ATE system use. The HP 8566B is the highest performance analyzer of the three, with extendable frequency range from 100 Hz to 325 GHz. The HP 8567A is identical to the HP 8568B in many respects, but has reduced performance in some areas and a lower price. See pages 122 and 124 for specification summaries on all three analyzers.

Each analyzer is designed around its own internal bus and controlled by its own microcomputer to yield significant improvements in operational and data processing features, as well as flexibility under computer control. Each analyzer has 16K bytes of user RAM for storing trace data, instrument states, or custom downloadable programs (DLPs).

Performance

The exceptional frequency stability of both the HP 8566B and the HP 8568B makes measurements with 10 Hz resolution bandwidths possible. This narrow resolution bandwidth yields sensitivities to -135 dBm in both instruments. Excellent frequency stability, sensitivity, and frequency-reference accuracy combine to allow very accurate measurement of small signals in the presence of large ones.

For applications that don't require the high performance of the HP 8568B, the HP 8567A offers the same speed, versatility, and automatic operation capability at a lower price. Resolution bandwidths as narrow as 1 kHz yield sensitivities as low as -115 dBm.

Usability

The instrument control settings are conveniently notated on the CRT for easy reference. Functions are activated by pressing a front-panel key, then selecting the function value using the knob, step keys, or numeric keyboard. To maintain a calibrated display, certain functions are automatically coupled in the analyzer. For example, resolution bandwidth, video bandwidth, and sweep time are automatically adjusted by the instrument when the frequency span is reduced.

Up to four tunable display markers are available to aid in measuring and analyzing signals. Two markers can be used to make relative measurements by displaying their amplitude and frequency difference. Marker information allows you to step between evenly spaced portions of a spectral display (such as signal harmonics) or "zoom-in" on a selected portion of the spectrum.

Analyzer control settings can also be saved in the non-volatile memory of the analyzer. Different operators can recall these settings to make consistent, repeatable measurements.

Versatile CRT Display and Plotting Capabilities

All displayed information resides in the analyzer's digital memory, which refreshes the CRT at a flicker-free rate. Multiple traces can be displayed to measure residual FM or drift, or to conduct real-time surveillance over a wide frequency range.

By adding an HP-IB plotter, hard copy of all information on the display of the analyzer can be made for analysis, documentation, or presentation. Plots can be produced directly or with the aid of a controller.

Custom Programming of Softkeys

Custom measurement routines can be created to meet your specific requirements. These programs can be created on an external controller or from the front-panel controls of the instrument and then stored in the non-volatile memory of the analyzer. Custom programming allows you to create complex measurement routines that can be stored and executed using a single softkey. This capability makes the analyzer a custom instrument that is more efficient for your specific tasks.

System Software

BASIC system software for the HP 8566B, 8567A, and 8568B spectrum analyzers provides high-level routines to aid in developing custom programs for specific measurement applications. Capabilities include automatic computation and setting of analyzer functions to insure optimum measurement performance.

SIGNAL ANALYZERS

Spectrum Analyzer, 100 Hz to 325 GHz

Model 8566B

121

- 100 Hz to 22 GHz, external mixing to 325 GHz
- Synthesizer frequency accuracy
- Direct plot capability

- Expanded firmware feature set
- Enhanced signal-processing power
- 16K bytes of user RAM

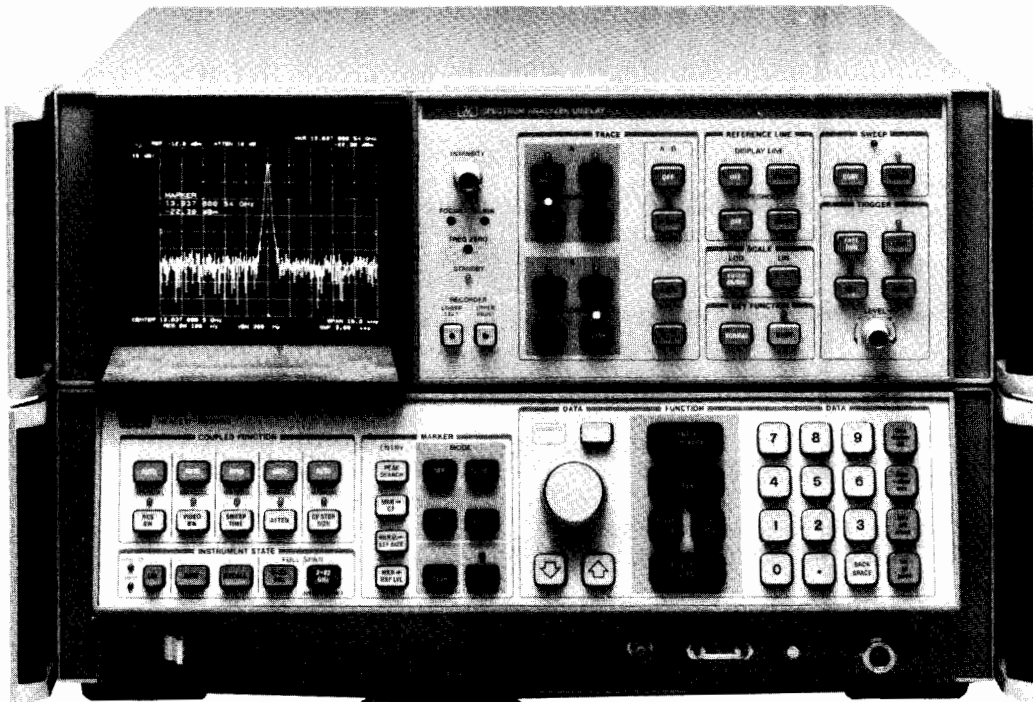

HP 8566B



The HP 8566B Microwave Spectrum Analyzer is a high-performance instrument, ideal for bench or ATE applications. The frequency range of 100 Hz to 22 GHz, using internal mixing, can be extended to 110 GHz with HP 11970 external mixers and HP 11974 series preselected mixers (see page 129), or to 325 GHz with mixers from other suppliers. A synthesized local oscillator produces counter-like accuracy at microwave and millimeter-wave frequencies. A 10-Hz resolution bandwidth and excellent frequency stability allow difficult measurements such as line-related sideband characterization at 22 GHz.

The HP 8566B offers 16K bytes of RAM for user-defined routines, which can be developed for complex measurements that are made routinely. Using the downloadable programming capability of the HP 8566B, measurement routines can be created on a computer and then downloaded into the non-volatile memory of the analyzer. Custom routines can also be defined and saved using the front-panel controls of the analyzer.

The ability to create and store downloadable programs (DLPs) makes the instrument more efficient for your specific measurement tasks. Custom DLPs can be executed via the HP-IB or user-defined

front panel softkeys. Instrument settings can also be saved for future recall to insure that repeatable measurements can be made by different operators. You can control other HP-IB devices such as plotters, printers, signal generators, and power meters with user-defined softkeys on the HP 8566B. And CRT information can be plotted directly without the use of a controller.

All HP 8566B functions are remotely programmable via HP-IB. Many high-level functions are available that produce results instead of just more data. This enables the controller to move on to other tasks, thereby reducing the total execution time. Friendly programming codes and easily recognizable mnemonics facilitate learning the analyzer's language.

A unique, integrated preselector/mixer provides high sensitivity with preselection from 2 GHz to 22 GHz. Coupled functions insure that a calibrated display and a specific input-mixer-drive level are maintained. Functions can be uncoupled and set manually if you wish.

SIGNAL ANALYZERS

Spectrum Analyzer, 100 Hz to 325 GHz (cont'd)

Model 8566B

HP 8566B Specification Summary

Frequency

Frequency Range: 100 Hz to 22 GHz with internal mixer; extendable to 110 GHz with HP 11970 external mixers and HP 11974 series preselected mixers, and to 325 GHz with mixers from other suppliers

Frequency Span: 0 to 2.5 GHz, 2 to 22 GHz, plus 0 Hz (zero span)

Frequency Reference Accuracy: Aging rate; $< 1 \times 10^{-9}/\text{day}$, $< 2.5 \times 10^{-7}/\text{year}$

Temperature Stability: $< 7 \times 10^{-9}$, 0 to 55° C

Resolution Bandwidth: 3 dB bandwidths of 10 Hz to 3 MHz in a 1, 3, 10 sequence

Bandwidth Selectivity, 60 dB/3 dB ratio: $< 11:1$, 30 Hz to 3 kHz; $< 13:1$, 10 kHz & 30 kHz; $< 15:1$, 100 kHz to 3 MHz

Bandwidth Shape: synchronously tuned, 4- or 5-pole filters, approximately Gaussian shape

Video Bandwidth: 1 Hz to 3 MHz in a 1, 3, 10 sequence

Residual FM (typical peak to peak, fundamental mixing mode): < 0.2 Hz, frequency span < 5 kHz; < 5 Hz, frequency span < 100 kHz; < 200 Hz, frequency span < 5 MHz

Drift (typical, after one hour warm-up at stabilized temperature): < 10 Hz/minute of sweep time, frequency span ≤ 100 kHz; < 500 Hz/minute of sweep time, frequency span 100 kHz to 5 MHz, < 5 kHz/minute of sweep time, frequency span ≥ 5 MHz

Spectral Purity

Noise sidebands (center frequency 100 Hz to 5.8 GHz): 320 Hz offset, < -80 dBc/Hz; 1 kHz offset, < -85 dBc/Hz; 10 kHz offset, < -90 dBc/Hz; 100 kHz offset, < -105 dBc/Hz

Amplitude

Amplitude Range (dBm): -134 to $+30$, 1 MHz-2.5 GHz; -132 to $+30$, 2.5-5.8 GHz; -125 to $+30$, 5.8-12.5 GHz; -119 to $+30$, 12.5-18.6 GHz; -114 to $+30$, 18.6-22 GHz

Log Display Range: 1, 2, 5, or 10 dB/division for 10, 20, 50, & 90 dB displays, respectively

Scale Fidelity: ± 0.1 dB/dB over 0 to 80 dB display; ± 1.0 dB max over 0 to 80 dB display; ± 1.5 dB max over 0 to 90 dB display

Calibrator Uncertainty: ± 0.3 dB

Frequency Response (10 dB input atten): 100 Hz to 2.5 GHz, ± 0.6 dB; 2 to 12.5 GHz, ± 1.7 dB; 12.5 to 20 GHz, ± 2.2 dB; 20 to 22 GHz, ± 3.0 dB

Dynamic Range

Spurious Responses: < -70 dBc for mixer levels ≤ -40 dBm

Second Harmonic Distortion

Unpreselected, mixer levels ≤ -40 dBm: < -70 dBc, 100 Hz to 2.5 GHz; < -80 dBc, 50 to 700 MHz.

Preselected, mixer levels ≤ -10 dBm: < -100 dBc, 2 to 22 GHz

Third Order Intercept (TOI): $> +5$ dBm, 100 Hz to 5 MHz; $> +7$ dBm, 5 MHz to 5.8 GHz; $> +5$ dBm, 5.8 to 18.6 GHz

Image Responses: < -70 dBc, 100 Hz to 18.6 GHz; < -60 dBc, 18.6 to 22 GHz

Multiple Responses: < -70 dBc, 100 Hz to 22 GHz

Out-Of-Band Responses: < -60 dBc, 2 to 22 GHz

Residual Responses (0 dB input atten, no input signal): < -100 dBm, 100 Hz to 5.8 GHz; < -95 dBm, 5.8 to 12.5 GHz; < -85 dBm, 12.5 to 18.6 GHz; < -80 dBm, 18.6 to 22 GHz

Gain Compression (≤ -5 dBm at mixer): < 1.0 dB, 100 Hz to 22 GHz

Displayed Average Noise Level (0 dB input atten, 10 Hz Res BW)

Unpreselected: < -95 dBm, 100 Hz to 50 kHz; < -112 dBm, 50 kHz to 1 MHz; < -134 dBm, 1 MHz to 2.5 GHz

Preselected: < -132 dBm, 2 to 5.8 GHz; < -125 , 5.8 to 12.5 GHz; < -119 dBm, 12.5 to 18.6 GHz; < -114 dBm, 18.6 to 22 GHz

Sweeptime

Zero Span: 1 μsec to 1500 seconds

Swept: 20 msec to 1500 seconds

Accuracy: $\pm 10\% \leq 200$ second sweeptimes; $\pm 30\% > 200$ second sweeptimes

Trigger: Free run, line, video, external, continuous, and single

General Specifications

Environmental

Temperature: Operation; 0 to 55° C Storage; -40 to $+75$ ° C

Humidity: Operating $< 95\%$ RH, 0 to 40° C

EMI: Conducted and radiated interference is within the requirements of MIL-STD-461B, CEO3/part 2, and REO2/part 7, and the requirements of CISPR pub. 11, and FTZ 526/1979

Power Requirements: 100, 120, 220, or 240 VAC (+5%, -10%), 50 to 60 Hz or 400 Hz with Option 400

Warm-up Time Operation: 30 minutes from cold start (0 to 55° C)

Frequency Reference: frequency within 1×10^{-8} of final stab frequency within 30 minutes

Size (w/out handles), mm (inches): 279.2 (11) H, 425.5 (16.75) W, 598.5 (23.56) L

Weight: 50 kg (112 lb)

Inputs

RF in (Type N), Ext Freq Ref in, Ext Sweep Trig in

Quasi-Peak: Video in, IF in

Outputs

Cal out, 1st LO out, IF out, Sweep + Tune out, Display X, Y, Z out, Horiz Sweep out, Video out, Penlift out, 21.4 MHz IF out, Freq Ref, 10 MHz

Quasi-Peak: Video out, IF out

Ordering Information

Ordering Information	Price
HP 8566B Spectrum Analyzer	\$58,800
Option 016: Installed EMI receiver functions	+\$255
Option 400: 400 Hz power-line frequency operation	+\$410
Option W30: Extended repair service, see page 725	+\$950
Option 462: Impulse bandwidths for EMI measurements	+\$2,400
Option 655: 5.25" operation verification disks instead of 3.5" disks	\$0
Option 010: Rack mount slide kit	+\$460
Option 908: Rack flange kit (instrument w/out handles)	+\$66
Option 913: Rack flange kit (instrument w/handles)	+\$71
Option 910: Extra operating and test and adjustment manuals	+\$355
Option 915: Troubleshooting and repair manual	+\$204
Option 031: German operating manual	\$0
Option 080: Information card in Japanese	\$0
Option 081: Information card in French	\$0
Option E69: Internal MATE test module adapter	\$4,500

SIGNAL ANALYZERS

Spectrum Analyzers, 100 Hz to 1500 MHz

Models 8568B & 8567A

123

- 100 Hz or 10 kHz to 1500 MHz frequency range
- Powerful firmware feature set
- Direct plot capability
- 16K bytes of user RAM for custom routines

- Powerful signal- and trace-processing functions
- EMI measurement capability
- Stimulus-response test capability
- Frequency counter accuracy

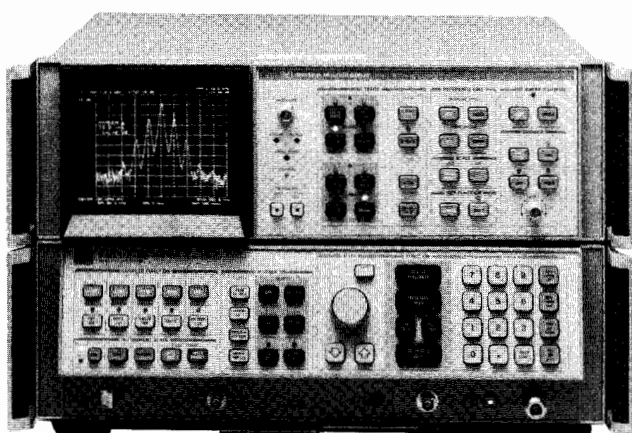

HP 8568B

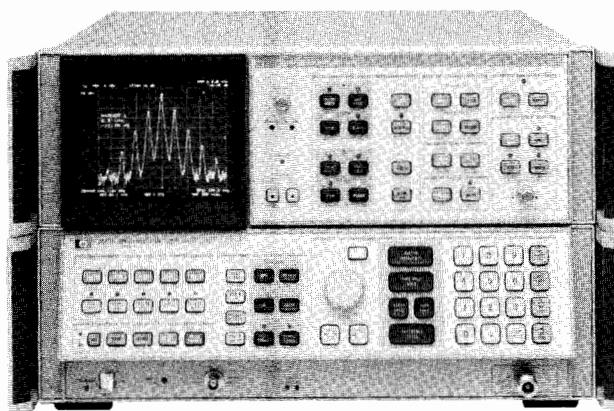

HP 8567A



The HP 8568B and HP 8567A RF Spectrum Analyzers offer a choice in high performance instruments for bench and ATE use. The HP 8568B covers the 100 Hz to 1500 MHz frequency range while the HP 8567A goes from 10 kHz to 1500 MHz. The HP 8568B has superior performance in several areas, including better frequency accuracy, narrower resolution bandwidths, and greater sensitivity (see following page for specification summary). If the higher performance of the HP 8568B is not required, the HP 8567A offers the same powerful feature set and capabilities at a very cost-effective price.

Both instruments offer 16K bytes of RAM for custom user-defined measurement routines. Custom measurement programs can be created, either on an external controller or using the front-panel controls of the spectrum analyzer, and then stored in the non-volatile memory of the instrument. These stored programs can be executed with a single

softkey, making them as easy to use as any other function of the analyzer. This capability facilitates customization of either the HP 8568B or the HP 8567A to better suit your particular measurement requirements. In addition, instrument control settings can also be saved for future recall, to insure repeatable measurements even by different operators.

The HP 8568B and 8567A fit into many RF application areas including EMI testing, component stimulus-response testing, and broadband signal surveillance. Add the HP 85650A Quasi-Peak Adapter, HP 85685A RF Preselector, and HP EMI Measurement Software for complete CISPR and MIL-STD EMI measurement capability. (See page 125 for EMI system details.) Stimulus-response measurement capability can be obtained at a minimal cost with the addition of the HP 8444A Option 059 Tracking Generator.

SIGNAL ANALYZERS

Spectrum Analyzers, 100 Hz to 1500 MHz (cont'd)

Models 8568B & 8567A

Specification Summary

FREQUENCY	8568B	8567A
Frequency Range	100Hz - 1500MHz - DC coupled 100kHz - 1500MHz - AC coupled	10kHz - 1500MHz
Frequency Span	100Hz to 1500MHz + zero span	100Hz to 1500MHz + zero span
Frequency Reference Accuracy		
Aging Rate	$<2.5 \times 10^{-7}$ /year	$<5 \times 10^{-6}$ /year
Temperature Stability	$<7 \times 10^{-9}$ (0-55°C)	$<1 \times 10^{-8}$ (5-55°C)
Resolution Bandwidth (-3dB) 10Hz - 3MHz in 1,3,10 sequence	10Hz - 3MHz in 1,3,10 sequence	1kHz-3MHz in 1,3,10 sequence
Video Bandwidth	1Hz - 3MHz in 1,3,10 sequence	1Hz - 3MHz in 1,3,10 sequence
Residual FM (pk to pk, <100kHz span)	<3Hz (Res BW \leq 30Hz)	<100Hz (Res BW 1kHz)
Drift (per minute of sweep time) (after one hour warm-up)	<10Hz (freq span \leq 100kHz)	<100Hz (freq span \leq 100kHz)
Phase Noise (30kHz offset, 1Hz Res BW)	-107dBc	-105dBc
AMPLITUDE		
Amplitude Range	-135 to +30dBm	-115 to +30dBm
Log Display Range	1,2,5, or 10dB/div for 10,20,50 or 90dB display	1,2,5, or 10dB/div for 10,20,50 or 90dB display
Scale Fidelity - incremental cumulative (20-30°C)	± 0.1 dB/dB; 0-90dB $\leq \pm 1.0$ dB; 0-80dB $\leq \pm 1.5$ dB; 0-90dB	± 0.1 dB/dB; 0-80dB $\leq \pm 1.0$ dB; 0-80dB $\leq \pm 1.5$ dB; 0-90dB
Calibrator Uncertainty	± 0.3 dB	± 0.3 dB
Frequency Response (input atten \geq 10dB)	± 1.5 dB, 100Hz - 1500MHz	± 1 dB, 10kHz - 1500MHz
Spurious Responses (<-40dBm at mixer)	<-70dBc (<10MHz input sig) <-75dBc (>10MHz input sig)	<-70dBc
Second Harmonic Distortion (-30dBm at mixer)	<-70dBc (sig \geq 10MHz) <-60dBc (sig <10MHz)	<-70dBc (sig \geq 10MHz) <-60dBc (sig < 10MHz)
Third Order Intercept (TOI)	+10dBm (sig > 10MHz)	+10dBm (sig >10MHz)
Residual Responses (at 1MHz) (0dB attn, no input signal)	<-105dBm	<-100dBm
Gain Compression (\leq 10dBm at mixer)	<0.5dB	<1.0dB
Displayed Average Noise Level (0dB attn, 1Hz Video BW)	<-112dBm, 500Hz-1MHz (10Hz Res BW) <-135dBm, >1MHz (10Hz Res BW)	<-92dBm, 50kHz-1MHz (1kHz Res BW) <-115dBm, >1MHz (1kHz Res BW)
Sweptime - Zero Span	1 μ sec to 1500 sec	1 μ sec to 1500 sec
Swept	20 msec to 1500 sec	20 msec to 1500 sec

General Specifications (Pertain to both 8568B and 8567A unless noted)

Environmental

Temperature: Operation, 8568B, 0 to 55° C; 8567A, 5° to 55° C
Storage, -40° to +75° C

EMI: Conducted and radiated interference is within the requirements of MIL-STD-461B, CE03/part 2 and RE02/part 7, and the requirements of CISPR pub. 11 and FTZ 526/1979

Power Requirements: 100, 120, 220, or 240 VAC (+ 5%, - 10%), 50-60 Hz or 400 Hz with Option 400

Warm-up Time

Operation: 30 minutes from cold start

Frequency Reference

8568B: frequency within 1×10^{-8} of final stab freq within 30 minutes

8567A: frequency within 5×10^{-5} of final stab freq within 30 minutes

Size (w/out handles), mm (inches): 279.2 (11) H, 425.5 (16.75) W, 558.8 (22) L

Weight: 45 kg (100 lb)

Inputs

RF in (Type N), RF in (BNC, 8568B only), Ext Freq Ref in, Ext Sweep Trig in

Quasi-Peak: Video in, IF in

Outputs

Cal out, Display X, Y, & Z out, Horiz Sweep out, Video out, Penlift out, 21.4 MHz IF, 1st LO, Freq Ref, Probe Power out (8568B only)

Quasi-Peak: Video out, IF out

Ordering Information

HP 8568B Spectrum Analyzer

\$36,000

HP 8567A Spectrum Analyzer

\$28,100

Option 001: 75 ohm (BNC) RF input

+\$204

Option 016: Installed EMI receiver functions

+\$255

Option 044: Add HP 8444A Opt 059 Tracking Generator (8567A only)

+\$5,200

Option W30: Extended repair service. See page 725

8568B

+\$690

8567A

+\$540

Option 400: 400 Hz power line frequency operation

8568B

+\$410

8567A

+\$715

Option 655: 5.25" operation verification disks instead of 3.5" disks

\$0

Option 010: Rack mount slide kit

+\$460

Option 908: Rack flange kit (instrument w/out handles)

8568B

+\$66

8567A

+\$153

Option 913: Rack flange kit (instrument w/handles)

8568B

+\$71

8567A

+\$153

Option 910: Extra operating and test and adjustment manuals

+\$355

Option 915: Troubleshooting and repair manual

8568B

+\$204

8567A

+\$225

Option 462: Impulse bandwidths for EMI measurements (8568B only)

+\$2,040

Option 080: 8568B information card in Japanese

\$0

Option 081: 8568B information card in French

\$0

SIGNAL ANALYZERS

CISPR EMI Receivers, 9kHz to 1.5GHz

Models 8573A, 8574A

125

- Meets CISPR Publication 16* requirements
- Performs VDE, FCC, VCCI Compliance Tests

- Makes diagnostic EMI measurements
- Automates VDE, FCC, VCCI and MIL-STD EMI tests

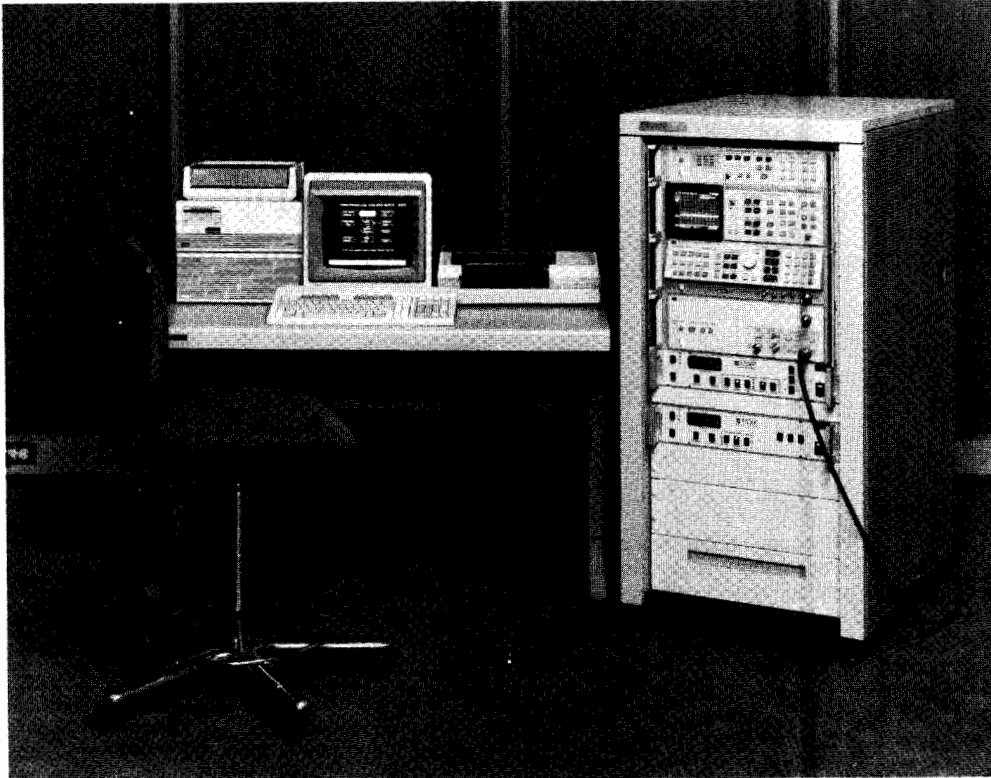

Typical HP 8573A Configuration with additional Controller and optional accessories.



The HP 8573A and 8574A EMI Receivers are designed for making fast, accurate EMI measurements. With improved sensitivity and overload protection, these powerful receivers meet CISPR Publication 16* recommendations as well as requirements of the FCC, VDE, and VCCI. And, because a versatile HP 8567A or 8568B Spectrum Analyzer forms the heart of each system, full EMI diagnostic capabilities aid you throughout a product's evolution, from design stages to completion of final commercial and MIL-STD qualification tests.

CISPR/EMI Receiver Features and More

To meet CISPR Publication 16 specifications, the HP 85650A Quasi-Peak Adapter provides the CISPR EMI Receivers with required bandwidths and quasi-peak detection. Each system comes with the HP 85867A EMI Receiver Functions, a set of downloaded programs that make possible speedy "one-button" manual quasi-peak measurements. The HP 85685A RF Preselector adds input overload protection and increased measurement sensitivity, and its built-in absolute amplitude calibration ensures ± 2 dB amplitude accuracy. The preselector automatically tracks the spectrum analyzer during manual and remote operation. A low-frequency RF input withstands large impulses and Line Impedance Stabilization Network (LISN) transients. Both the low-frequency and high-frequency inputs allow the use of CISPR calibration pulses.

Automatic Control for Remote Operations

The HP 8573A and 8574A CISPR EMI Receivers let you automate emission measurements via the HP-IB for conducted or radiated tests using a variety of compatible system controllers, EMI

accessories, and peripherals. You can write your own programs or elect HP software: the HP 85869A EMI Measurement software or HP 85870A Open-Site EMI Measurement System Software. Both feature easy-to-use menu structures that lead you through EMI measurements from initial setup to final results. Choose from libraries of FCC, and VDE emission tests, or design your own. Results can be annotated and notes generated as part of your test documentation, and subroutines can be added to the software for automatic control of your EMI accessories.

EMI accessories available for FCC, VDE, VCCI and MIL-STD tests feature a LISN for commercial conducted measurements and current probes for MIL-STD conducted emission requirements. Transducer kits contain magnetic and electric field antennas for radiated emission testing from 9 kHz to 18 GHz. Other EMI accessories include preamplifiers, printers, plotters, and a system cabinet. See page 128.

Ordering Information

HP 8573A CISPR EMI Receiver	\$54,750
HP 8574A CISPR EMI Receiver	\$62,700
Option 001 HP 85900 System Cabinet (includes Option 913)	+ \$2,980
Option 908 Rack mounting kit without handles	+ \$125
Option 910 Extra set of operating manuals	+ \$420
Option 913 Rack mounting kit with handles	+ \$138

*CISPR Publication 16 is the Comite International Special des Perturbations Radioelectrique specification for radio interference measuring apparatus and measurement methods.

SIGNAL ANALYZERS

RF Preselector, 20 Hz to 2 GHz/Quasi-Peak Adapter

Models 85685A, 85650A

- Automatic filter tracking
- Input overload protection
- Low system noise

- Quasi-peak detection
- CISPR-specified bandwidths
- Bypass for regular spectrum analyzer operation

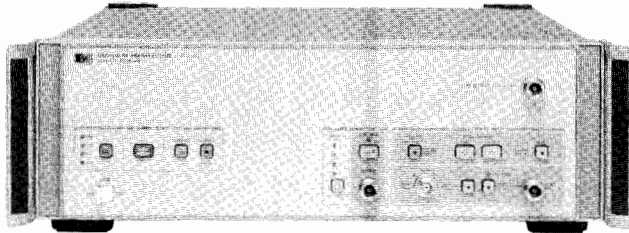

HP 85685A

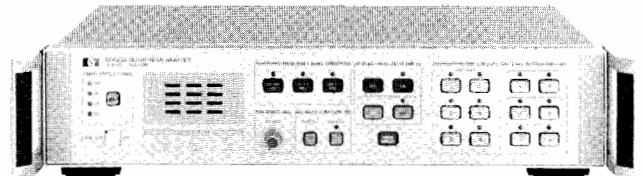

HP 85650A



HP 85685A RF Preselector

The HP 85685A RF Preselector makes a multi-purpose test receiver of an HP 8566B, 8567A, or 8568B Spectrum Analyzer. In addition to an instrument for general-purpose spectrum analysis, you now have a test receiver for specialized applications. The RF preselector, with tracking filters and preamplifiers covering the 20 Hz to 2 GHz range, improves spectrum analyzer measurement sensitivity while providing overload protection from out-of-band signals. The resulting test receiver system operating in the presence of high-level interference, has a measurement range 30 dB greater than that of a spectrum analyzer alone.

The test receiver/spectrum analyzer measures signals within the preselector filter passband and rejects out-of-band interference by 40 dB. This enables low-level signals to be monitored in the presence of high-level ambients. The preselector decreases input overload from out-of-band signals, thereby increasing the range for measuring low-level signals. Fast, wideband measurements mean a reduction in measurement time.

Combining the HP 85685A RF Preselector with an HP 8566B, 8567A, or 8568B Spectrum Analyzer and the HP 85650A Quasi-Peak Adapter gives you an EMI receiver that meets the recommendations of CISPR Publication 16*.

The RF preselector adds the measurement sensitivity and overload protection needed for FCC, VDE, and VCCI radiated emission testing at open sites. For commercial and MIL-STD conducted EMI tests, the low-frequency input withstands large impulses and Line Impedance Stabilization Network (LISN) transients. A built-in calibrator ensures ± 2.0 dB absolute-amplitude accuracy as required by the FCC, VDE, and VCCI and a convenient linearity check tests for system overload.

Operating the test receiver is easy. Use only the spectrum analyzer controls—the RF preselector automatically adjusts input-filter tracking, and the spectrum analyzer reports preselector operating conditions on the CRT. The receiver system is fully HP-IB programmable, and the HP 85685A comes equipped with the hardware needed to connect it to any compatible spectrum analyzer.

HP 85650A Quasi-peak Adapter

The HP 85650A Quasi-peak Adapter works with the HP 8566B, 8567A, and 8568B Spectrum Analyzers and with the 85685A RF Preselector to complete an EMI test receiver system. The quasi-peak adapter adds the special bandwidth filters and quasi-peak detection capability specified in CISPR Publication 16*. These bandwidth filters (200 Hz, 9 kHz, and 120 kHz) have 6 dB resolution and may be selected using either peak or quasi-peak detection.

A bypass switch enables the spectrum analyzer to bypass the quasi-peak adapter, and a Normal mode allows use of the three CISPR bandwidths whether or not the quasi-peak detector is being used. The HP 85650A is fully programmable over the HP-IB for automated measurements, and it has both an internal speaker and an audio output jack (for external headphones) for monitoring signals.

HP 85867A EMI Receiver Functions

This set of softkey programs simplifies commercial EMI measurements performed manually using HP EMI receiver/spectrum analyzers (see page 125). An external computer is not needed after the softkeys are downloaded into spectrum analyzer non-volatile RAM. You can select a CISPR* band, make automatic quasi-peak measurements at up to six discrete frequencies, and directly print or plot measurement data using front-panel softkeys.

Features of the EMI Receiver Functions include a quasi-peak softkey that automatically chooses resolution bandwidths, video bandwidths, CISPR bandwidths, and sweep times for fast, accurate quasi-peak measurements. Up to six quasi-peak markers and numeric values can be displayed at the same time. This lets you simultaneously view a wide frequency span and the quasi-peak values of up to six signals. A numeric keypad overlay for the spectrum analyzer is included to help you select the right softkey, and a help function gives the purpose of each softkey. Spectrum analyzer options are available for factory installation of this product.

Ordering Information

	Price
HP 85685A RF Preselector	\$21,465
Option 010, Rack mount slide kit	+ \$395
Option 908, Rack flange kit without handles	+ \$33
Option 910, Extra manual	+ \$51
Option 913, Rack flange kit with handles	+ \$36
HP 85650A Quasi-peak Adapter	\$5,370
Option 908, Rack flange kit without handles	+ \$26
Option 910, Extra manual	+ \$10
Option 913, Rack flange kit with handles	+ \$31
HP 85867A EMI Receiver Functions	
Option 630 3 1/2-inch media	\$300
Option 655 5 1/2-inch media	\$300

*CISPR Publication 16 is the Comité International Spécial des Perturbations Radioélectrique specification for radio interference measuring apparatus and measurement methods.

- Locate EMI "hot spots" quickly
- Increase EMI measurement repeatability
- Utilize powerful analysis aids

HP 11949A EMC Design Course

"Designing for Electromagnetic Compatibility" is a new, two-day course for engineers who face issues of electromagnetic compatibility. Emphasis is on evaluating and solving EMC problems early in the design phase, rather than during final EMC-compliance testing. Instruction and demonstrations provide EMC fundamentals, methods of measuring EMC, and principles of incorporating proven EMC design into products. Topics include radiation from digital circuits, non-conductive coupling, diagnosing EMI problems, shielding, common-impedance coupling, susceptibility, cables, and electrostatic discharge. An 11-chapter handbook used in the class serves as a permanent reference. For locations and dates near you, call your local HP sales office listed on page 739.

HP 85870A Open-Site EMI Measurement System Software

The HP 85870A Open-site EMI Measurement System (OEMS) Software is specially designed to automate and simplify commercial EMI, radiated-emission compliance measurements. EMI measurements made at open sites, due to ambient signals present in the measurement environment, are inherently more complex than measurements made in shielded enclosures. The HP 85870A helps EMI engineers and technicians quickly obtain repeatable, accurate, and completely documented measurement results using the HP 8573A and 8574A EMI Receivers.

Identify and record ambients

The OEMS Software allows you to identify and categorize ambients by automatically (or manually) generating a list of the frequencies and amplitudes of ambient signals that are present when the equipment under test (EUT) is off. The ambient list is incorporated into a user-defined frequency-band table, which allows you to segment the entire range of interest and categorize the ambients in each band. For example, you can specify and label the 6-meter ham, FM radio, and land mobile bands in the frequency-band table. Methods are provided to generate and maintain complex ambient signal lists for repeated use. The spectrum analyzer screen is marked where the ambient signals occur for simplified identification of suspect EUT emissions.

Identify and maximize EUT emissions

With a complete ambient list and a remote AC power switch, the software can automatically turn on the EUT and find suspect emissions, even in the presence of impulsive or noisy environments. The EMC engineer or technician can then select from a number of features such as Tune & Listen, EUT On/Off, and Zoom Local to determine which signals are coming from the EUT. Confirmed emissions are assigned to a final list of signals. Each emission's amplitude is then determined by automatically controlling a turntable and antenna mast using a signal characterization routine of your choice. EUT emissions can be manually maximized using the SIG PEAK function, which controls an HP-IB antenna mast and turntable or allows manual positioning. The OEMS software records information on each signal such as frequency and amplitude deviation from the limit, as well as the antenna height, turntable position, and user comments.

Generate complete reports in desired formats

Complete measurement results are documented in the format of your choice using the OEMS Software Report Generator. You can design your own test report using combinations of fixed text and updateable variable fields for the date and time of test, equipment name and serial number, or any other information. Ambient, suspect, or final signal lists and log frequency plots of the final data can be integrated with your text for concise, professional-looking reports. A library is provided to store these report formats. CRT data and signal lists can also be sent to a printer or plotter from virtually any point in the software.

- Begin testing at system turn-on
- Test to standard or internal limits
- Automatically correct data for transducer and system gain/loss

HP 85869A EMI Measurement Software

The HP 85869A EMI Measurement Software is a general-purpose program for making automatic commercial and military emission measurements using an HP 8566B, 8567A, or 8568B Spectrum Analyzer. The friendly menu structure of the program leads you through an EMI measurement from initial setup to the final plotting of the test results. The HP 85869A has an easy start-up procedure, so you are "ready to run" even if you have never programmed before.

Automate MIL-STD and commercial EMI measurements

The HP 85869A EMI Measurement Software automates military and commercial EMI emission measurements. It is designed to automate EMI measurements made in a shielded enclosure. The HP 85869A takes advantage of the spectrum analyzer's ability to quickly measure wide frequency spans and locate EMI "hot spots" using peak detection. For commercial measurements, quasi-peak data need be taken only at these "hot spots." Save time and effort in your MIL-STD measurements by letting the software automatically discriminate between narrowband and broadband signals.

Design your own tests

Design your own tests or choose from the examples given in the software. These examples reside in the test library and include MIL-STD, FCC, and VDE/FTZ emission tests. Transducer factors, test limits, and receiver parameters are easily changed and stored in libraries. Once your test is designed, it is stored away and can be executed repeatedly at the push of a key.

Compatibility

The HP 85869A and 85870A are compatible with the following equipment:

Spectrum Analyzer*	HP 8566B, 8567A, 8568B
RF Preselector	HP 85685A
Quasi-Peak Adapter	HP 85650A
EMI Receiver	HP 8573A, 8574A
Computer*	HP 9000 Series 300 Model 310, 319, 320, 330, 332, 340, 350, 360, 370 HP 9000 Series 200 Model 216, 236

Memory Requirements*

Mass Storage*	2 Mbytes
Plotters	HP 9122C, 9153C
Printers	HP 7440A, 7475A, 7550A HP 2225A, 2227B, LaserJet Series II, Deskjet
DMA Controller	HP 98620B
Floating Point Card	HP 98635A
SRM Interface	HP 50962A

*Minimum equipment required

Ordering Information

	Price
HP 11949A "Designing for EMC" Course	\$750
HP 85869A EMI Measurement Software	\$0
Opt. 630 3½-inch media	\$5,000
Opt. 655 5¼-inch media	\$5,000
Opt. 830 Upgrade kit for HP 85864A/B/C software, 3½-inch media	\$500
Opt. 855 Upgrade Kit for HP 85864A/B/C software, 5¼-inch media	\$500
HP 85870A OEMS Software	\$0
Opt. 630 3½-inch media	\$5,200
Opt. 655 5¼-inch media	\$5,200
HP 85874A Bundled EMI Software	
Includes HP 85869A and 85870A	\$0
Opt. 630 3½-inch media	\$7,280
Opt. 655 5¼-inch media	\$7,280

SIGNAL ANALYZERS

Impulse Bandwidth/EMI Diagnostic Measurement Card/EMI Accessories

HP 8566B/68B Option 462

Option 462 for HP 8566B and 8568B spectrum analyzers provides impulse bandwidths for making MIL-STD and DEF STAN EMI measurements. Standard HP 8566B and 8568B models have 12 resolution bandwidth filters (10 Hz to 3 MHz in a 1, 3, 10 sequence) specified in terms of their 3 dB bandwidth. Option 462 modifies the 1 kHz to 3 MHz resolution bandwidth filters to correspond to their impulse bandwidth instead.

In addition to enhancing instrument capability for MIL-STD 461A/B/C and 462 EMI measurements, spectrum analyzers with Option 462 can still make all commercial EMI and general-purpose measurements. Option 462 spectrum analyzers are compatible with the HP 85650A Quasi-peak Adapter, HP 85685A RF Preselector, HP 85864C EMI Measurement Software, HP 85870A Open-site Measurement Software and the HP 85867A EMI Receiver Functions program. Existing HP 8566B and 8568B spectrum analyzers can be modified to include Option 462. For more information, contact your local sales office listed on page 739.

HP 85712A EMC Diagnostic Measurement Card

This memory card customizes the new HP 8590B and 8591A, 8592B, and 8593A spectrum analyzers for electromagnetic-compatibility testing. When you use these EMC-evaluation analyzers with the HP 11945A close-field probe set, you have capability for comprehensive diagnostic electromagnetic-interface measurements. (For more information on the portable spectrum analyzers, see page 104.)

HP 11940A and 11941A Close-field Probes

These small, hand-held electromagnetic-field sensors are used with a spectrum analyzer for EMI diagnostic and troubleshooting applications. A dual-loop configuration and balun structure enable them to make repeatable, absolute magnetic-field measurements. The HP 11941A operates from 9 kHz to 30 MHz; the HP 11940A, from 30 MHz to 1 GHz.

Designed to measure radiation from surface currents, slots, and cables, these probes are ideal for diagnostic testing of printed circuit boards, cabling, and shielded enclosures. Five antenna factor points appear on the back of each probe for calculating absolute magnetic-field strength (dBuA/m) from the spectrum analyzer's dBuV reading.

Double-shielded cables and adapters are included with the HP 11945A Close-field Probe Set, which includes both probes. Option E51 adds the HP 8447F Option H64 Preamp and a convenient carrying bag.

HP 11947A Transient Limiter

The model HP 11947A Transient Limiter protects a spectrum analyzer input from the damage caused by high level transients from line impedance stabilization networks (LISNs) during EMI testing for conducted emissions.

A high-pass filter and a 10 dB attenuator are incorporated into the HP 11947A Transient Limiter, which is capable of withstanding inputs as high as 10 kW for 10 μ sec, or 2.5 W of average power. The built-in high pass filter helps reduce 60 Hz line feedthrough that might impede conducted emission measurements.



HP EMC Design Support Tools

Ordering Information

	Price
HP 8566B/68B Option 462	\$2,040
HP 85712A EMI Diagnostic Measurement Card	\$560
Recommended EMC Configurations	
HP 8590B RF Spectrum Analyzer	\$8,995
Opt 010 Tracking Generator, 50 Ohms	\$3,200
Opt 021 HP-IB Interface	\$600
HP 8591A RF Spectrum Analyzer	\$12,000
Opt 010 Tracking Generator, 50 Ohms	\$3,600
Opt 021 HP-IB Interface	\$600
HP 11945A Close-field Probe Set	\$1,100
Option E51 adds preamplifier, accessory-carrying bag, and 36-inch, Type N cable	\$2,510
HP 11941A Close-field Probe (9 kHz-30 MHz)	\$650
HP 11940A Close-field Probe (30 MHz-1 GHz)	\$650
Option 001 Rotary Joint	\$385
HP 11947A Transient Limiter	\$470

EMI Accessories

	Price
Turntable for Radiated Emission Testing	
Equipment Testing Turntable with HP-IB control.	
HP 85685A Option K40: 50-60 Hz, 100-120 volts	\$9,725
HP 85685A Option K41: 50-60 Hz, 220-240 volts	\$9,725
Tower for Radiated Emission Testing.	
Antenna Positioning Tower with HP-IB and polarization control.	
HP 85685A Option K42: 50-60 Hz, 100-120 volts	\$15,315
HP 85685A Option K43: 50-60 Hz, 220-240 volts	\$15,315

Recommended EMI Transducer Kits

Commercial				
Test	Freq. Range	Transducer Kit	Price	
VDE 0871 FCC Part 15J	Radiated	9 kHz-30 MHz	HP 11965A (100-120 volt) Opt. 001 (220-240 volt) Opt. 002 Tripod Opt. 003 BNC cable, 25 ft.	\$2,295 N/C 710 143
		9 kHz-1 GHz	HP 11965B (100-120 volt) Opt. 001 (220-240 volt) Opt. 002 Tripod Opt. 003 BNC cable, 25 ft. Opt. 004 Type N cable, 25 ft.	\$5,430 N/C 710 143 173
		Conducted	10 kHz-30 MHz	HP 11965C (LISN)
	FCC Part 15J (only)	Radiated	30 MHz-1 GHz	HP 11965D Opt. 001 Tripod Opt. 002 BNC cable, 25 ft. Opt. 003 Type N cable, 25 ft.
			HP 85685A Opt. K09 Dipole antennas	\$3,935
Conducted		10 kHz-30 MHz	HP 11965C (LISN)	\$1,945

MIL-STD				
Test	Freq. Range	Transducer Kit	Price	
MIL-STD 461A/B/C 462	Radiated RE-02	14 kHz-1 GHz	HP 11965M (Circularly polarized) or HP 11965N (Linearly polarized)	\$4,965 5,185
			Opt. 001 (220-240 volt) Opt. 002 Tripod Opt. 003 BNC cable, 10m Opt. 004 Type N cable, 10m	N/C 710 143 173
			HP 85685A Opt. K32 (Circularly polarized antenna) or HP 85685A Opt. K33 (Linearly polarized antenna)	\$10,150 12,020
	Conducted CE-03	10 kHz-50 MHz	HP 11965R (Current Probe)	\$1,615

SIGNAL ANALYZERS

Millimeter Mixers

HP 11970 Series and 11974 Series

129

- Preselected mixers to eliminate signal identification
- State-of-the-art technology
- Easier automated measurements

- Low conversion loss
- Individually amplitude-calibrated
- No bias or tuning adjustments
- High 100 mW safe input level

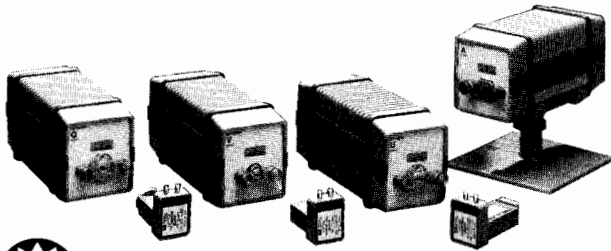

HP 11970, 11974 series mixers

HP 11974 Series Preselected Millimeter Mixers

Eliminate the need for signal identification at millimeter frequencies. The new HP 11974 series mixers are preselected from 26.5 GHz to 75 GHz for faster, easier testing of millimeter devices and systems. Preselection reduces mixer overload from broadband signals as well as reducing radiation of local oscillator harmonics back to the device under test. Equipment operators can quickly locate true signals, and software development for automated measurements is greatly simplified.

HP 11974 series preselected mixers are available in four bands.

HP Model ¹	Frequency range (GHz)	Sensitivity (displayed Avg. noise level/10 Hz) (dBm)	Frequency ² response (uncorrected) (dB)	Image rejection (dB)	1 dB gain compression (dBm)
HP 11974A	26.5-40	≤115	<±4.5	≤59	+5
HP 11974Q	33-50	≤113	<±4.0	≤55	+0
HP 11974U	40-60	≤116	+±4.0	≤55	-1
HP 11974V	50-75	≤100	<±4.0	≤55	+2

¹Specifications apply when connected to the following spectrum analyzers: HP 8566B (date code TBD or later), HP 70907B after peaking preselector. Consult with your field engineer for conversion kits available for other analyzers.

²Corrected frequency response available using calibration table supplied with unit.

These mixers feature advanced barium-ferrite technology and come with a stand-alone power supply. They are particularly useful for broadband millimeter signal analysis, millimeter electromagnetic-interference (EMI) measurements, and unattended monitoring of millimeter signals.

Compatibility

The HP 11974 series is compatible with the HP 8566B spectrum analyzer, the HP 85620A series portable spectrum analyzer, and the HP 70907B external millimeter interface module for the HP 70000 modular measurement system. (A retrofit kit is required for HP 8566B & spectrum analyzers shipped before November 1, 1989.)

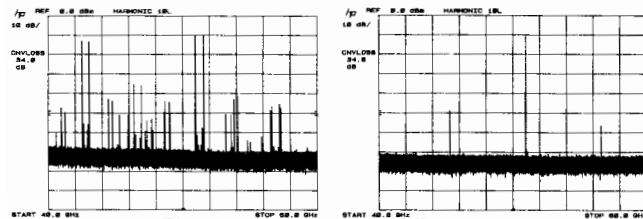

40-60 GHz sweep without preselection

40-60 GHz sweep using new HP 11974 series mixer

HP 11970 Series Harmonic Mixers

The HP 11970 series waveguide mixers are general-purpose harmonic mixers that employ a dual-diode design to achieve flat frequency response and low conversion loss. These are achieved without external dc bias or tuning stubs. Manual operation and computer-controlled hardware operation is simplified because mixer bias and tuning adjustment are not required.

HP 11970 series harmonic mixers are available in six bands:

HP model	Frequency range (GHz)	LO harm number	Conversion loss (dB)	Noise level (dB) 1 kHz RBW	Freq ¹ response (dB)	Gain compression (dBm)
HP 11970K	18-26.5	6+	24	-110	±1.9	-3
HP 11970A	26.5-40	8+	26	-108	±1.9	-5
HP 11970Q	33-50	10+	28	-104	±1.9	-7
HP 11970U	40-60	10+	28	-104	±1.9	-7
HP 11970V	50-75	14+	40	-92	±2.1	-3
HP 11970W	75-110	18+	46	-85	±3.0	-1

¹Frequency of the mixers is reduced by 1 dB for LO range of 14 to 18 dBm.

Compatibility

The HP 11970 series mixers extend the frequency range of the HP 8561B, 8562A, and 8563A portable spectrum analyzers; of the HP 8566B spectrum analyzer (used with the HP 11975A amplifier); and of the HP 70000 modular measurement system (used with the HP 70907A external mixer interface module).

HP 11970 and 11974 Series Specifications

IF range: dc to 1.3 GHz

LO amplitude range: +14 to +18 dB; +18 optimum

Calibration accuracy: +2.0 dB with optimum LO amplitude (+2.2 for HP 11974 series)

Typical RF input SWR: <2.2:1

Bias requirements: none

Typical odd-order harmonic suppression: >20 dB (does not apply to HP 11974 series)

Maximum CW RF input level: +20 dBm (100 mW), +25 dBm for HP 11974 series

Maximum peak pulse power: 24 dBm (250 mW) with < 1 μsec pulse (avg. power = +20 dBm)

Bandwidth: 100 MHz minimum (HP 11974 series only)

Environmental: meets MIL-T-28800C, Type III, Class 3, Style C

IF/LO connectors: SMA female

TUNE IN Connector: BNC

LO range: 3.0 to 6.1 GHz

Ordering Information

HP 11974A 26.5 TO 40 GHz Preselected Mixer	\$14,000
HP 11974Q 33 to 50 GHz Preselected Mixer	\$14,500
HP 11974U 40 to 60 GHz Preselected Mixer	\$15,000
HP 11974V 50 to 75 GHz Preselected Mixer	\$16,000
Opt 003 Delete Power Supply	-\$500
HP 11970K 18 to 26.5 GHz Mixer	\$1,750
HP 11970A 26.5 to 40 GHz Mixer	\$1,800
HP 11970Q 33 to 50 GHz Mixer	\$1,950
HP 11970T 18 to 40 GHz Mixers and Case	\$3,600
Opt 001 Add 40 to 60 GHz Mixers (HP 11970 series only)	+\$2,200
Opt 002 Add 33 to 50 GHz Mixers (HP 11970 series only)	+\$1,950
HP 11970U 40 to 60 GHz Mixers	\$2,200
HP 11970V 50 to 75 GHz Mixers	\$2,650
HP 11970W 75 to 110 GHz Mixers	\$3,000
HP 11970	

Opt 009 Mixer Connection Set adds three 1-meter low-loss SMA cables, wrench, allen driver for any HP 11970 series mixer. Carrying case with storage space for cables and tools included. +\$475

HP 11969A Carrying Case for one to five HP 11970-series mixers, SMA cables, and tools \$600

HP 11975A 2 to 8 GHz Amplifier \$4,700

HP 281A/B Coaxial to Waveguide Adapters

R281A 26.5-40 GHz, 2.4 mm (f)	\$850
R281B 26.5-40 GHz, 2.4 mm (m)	\$800
Q281A 33-50 GHz, 2.4 mm (f)	\$850
Q281B 33-50 GHz, 2.4 mm (m)	\$800

SIGNAL ANALYZERS

Spectrum Analyzer Accessories

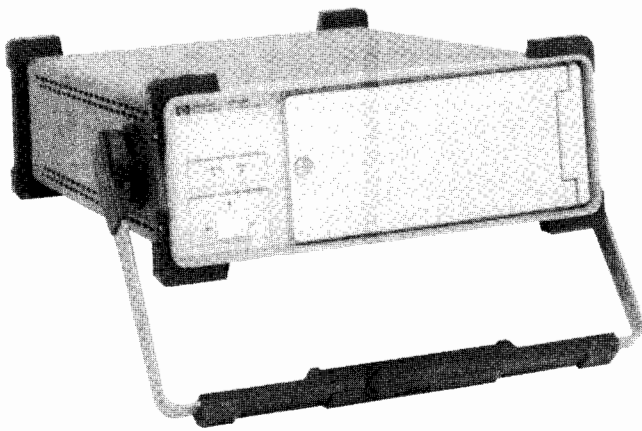

HP 85901A

HP 85640A Portable Tracking Generator

This portable, MIL-rugged tracking generator adds scalar-analysis capability from 300 kHz to 2.9 GHz to an HP 8560A, 8561A/B, or 8562A portable spectrum analyzer. It allows measurements of gain, frequency response, compression, flatness, and return loss on components and subsystems. A built-in attenuator gives an output power range of -80 dBm to 0 dBm.

HP 8444A Opt 059 Tracking Generator

Used with the HP 8568B RF spectrum analyzer, this tracking generator adds stimulus-response measurement capability for a minimal cost. It allows swept-frequency testing of components and subsystems. Frequency range is 500 Hz to 1.5 GHz.

HP 85901A Portable ac Power Source

This is Hewlett-Packard's first portable battery pack for test instruments. It provides 200 watts of continuous power using an internal battery, external battery, or other 12 Vdc source. See page 109.

HP 11867A and 11693A Limiters

Protect the input circuits of spectrum analyzers, counters, amplifiers, and other instruments from high power levels with minimal effect on measurement performance. The HP 11867A RF limiter (dc to 1.8 GHz) reflects signals up to 10 watts average power and 100 watts peak power. Insertion loss is less than 0.75 dB. The HP 11693A microwave limiter (100 MHz to 12.4 GHz, usable to 18 GHz) guards against input signals over 1 milliwatt up to 1 watt average power and 10 watts peak power.

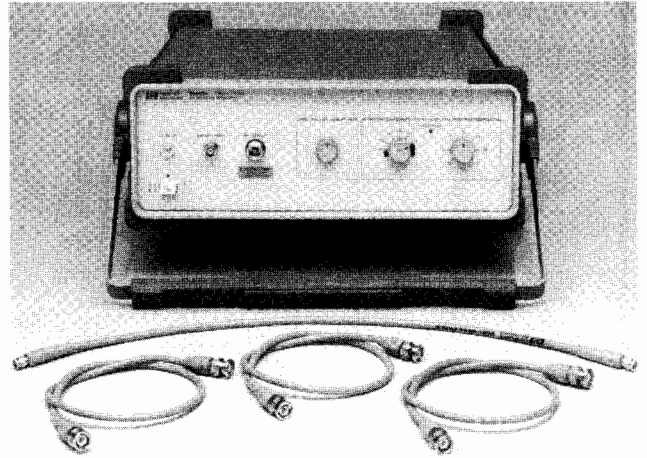

HP 85640A

HP 11694A 75Ω Matching Transformer

From 3 MHz to 500 MHz, this allows measurements in 75-Ω systems while retaining amplitude calibration with a 50-Ω spectrum analyzer input. VSWRs are less than 1.2; insertion loss is less than 0.75 dB. See page 105 for 75-Ω versions of the HP 8590B and 8591A RF spectrum analyzers.

HP 8721A Directional Bridge

Frequency range is 100 kHz to 100 MHz. This bridge is used in return-loss measurements made with a swept source such as a tracking generator and spectrum analyzer. It has 6-dB insertion loss and is 6-dB coupled to the auxiliary arm. Frequency response is ± 0.5 dB (0.1 to 110 MHz); directivity is greater than 40 dB (1 to 110 MHz); load-part return loss is less than 0.03; maximum input power is +20 dBm. Standard model is 50Ω with a 75Ω option.

Ordering Information

	Price
HP 85640A Portable Tracking Generator	\$7,500
Opt 908 Rackmount kit	+\$400
Opt 909 Rackmount kit with handles	+\$450
Opt 910 Extra Operation/Service Manual	+\$50
Opt W30 Extended Repair Service. See page 725	+\$195
Opt W32 Calibration Service. See page 725	+\$360
HP 8444 Opt 059 Tracking Generator	\$6,000
HP 85901A Portable ac Power Source	\$1,095 ☎
HP 11867A RF Limiter	\$475
HP 11693A Microwave Limiter	\$600
HP 11694A 75-Ω Matching Transformer	\$205
HP 8721A Directional Bridge	\$325

☎ Fast-Ship product. See page 734.

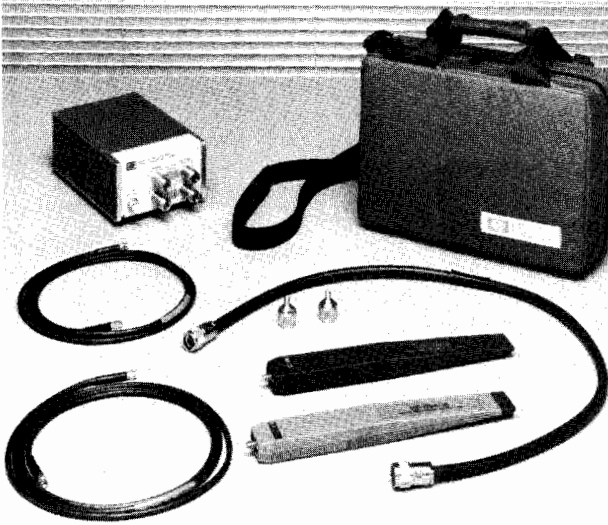

HP 11945A with HP 8447F Option H64

HP 8447 Series RF Amplifiers

These amplifiers with a frequency range of 9 kHz to 1.3 GHz feature low noise and wide bandwidths. They are ideal for improving spectrum-analyzer sensitivity and noise figure while providing input isolation. Broad frequency coverage, flat frequency response, and low distortion assure accurate measurements. See page 411.

HP 11975A Microwave Amplifier

This amplifier has a frequency range of 2 to 8 GHz. Used in stimulus-response systems, it allows a wide variety of sources to be leveled to ± 1 dB and amplitude-calibrated up to 16 dBm. As a preamplifier, its small signal gain varies between 0 and 15 dB, depending upon frequency. For measurements above 18 GHz, it amplifies the local oscillator signal from a spectrum or network analyzer. See page 409.

HP 8449A Microwave Preamplifier

This high gain, low noise preamplifier has a frequency range of 2 to 22 GHz. It increases the sensitivity of any microwave spectrum analyzer for detection and analysis of very low level signals. The improved sensitivity can also dramatically reduce measurement time. See page 409.

HP 11947A Transient Limiter

This limiter protects a spectrum analyzer or receiver from the damage caused by high-level transients from line-impedance-stabilization networks (LISNs) during EMI testing for conducted emissions. See page 128.

HP 11940A and 11941A Close-field Probes

These small, hand-held, electromagnetic-field sensors are used with a spectrum analyzer for EMI diagnostic and troubleshooting applications. They make repeatable, absolute magnetic-field measurements from 9 kHz to 1 GHz. See page 128.





HP 11945A Close-field Probe Set

This set contains both the HP 11940A and 11941A close-field probes and double-shielded cables and adapters. Option E51 adds the HP 8447F option H64 RF preamplifier and a convenient carrying bag. See page 128.

HP 85024A High Frequency Probe

In-circuit measurements are easy with this probe. Input capacitance of only 0.7 pF shunted by 1 M Ω resistance permits high-frequency probing without adverse loading of the circuit under test. Excellent frequency response and unity gain guarantee highly accurate swept measurements. High sensitivity and low distortion levels allow measurements taking advantage of full analyzer dynamic range. This probe is directly compatible with many HP RF spectrum and network analyzers. See page 312.

Order Information

	Price
HP 8447A 100 kHz to 400 MHz Preamplifier	\$1,400
Opt 001 Dual Channel	+\$610
HP 8447D 100 kHz to 1.3 GHz Preamplifier	\$1,500
Opt 001 Dual Channel	+\$665
HP 8447E 100 kHz to 1.3 GHz Preamplifier	\$1,700
Opt 010 Type N Connectors	+\$102
HP 8447F 100 kHz to 1.3 GHz Preamplifier and Power Amplifier	\$2,550
Opt H64 9 kHz to 1.3 GHz Preamplifier	\$0
HP 11975A 2 to 8 GHz Amplifier	\$4,700
HP 8449A 2 to 22 GHz Preamplifier	\$7,650
HP 11947A Transient Limiter	\$470 
HP 11940A Close-field Probe	\$650 
HP 11941A Close-field	\$650 
HP 11945A Close-field Probe Set	\$1,100 
HP 85024A High Frequency Probe	\$1,900

 Fast-Ship product. See page 734.

SIGNAL ANALYZERS

Dual-channel, Control Systems Analyzer 65 μ Hz to 100 kHz

HP 3563A

- Measure analog and digital signals
- Apply analog and digital stimulus
- Make swept sine and FFT frequency response measurements
- Measure spectra, waveforms, and transients
- Extract models with s- and z-domain curve fitting
- Model systems using frequency response synthesis

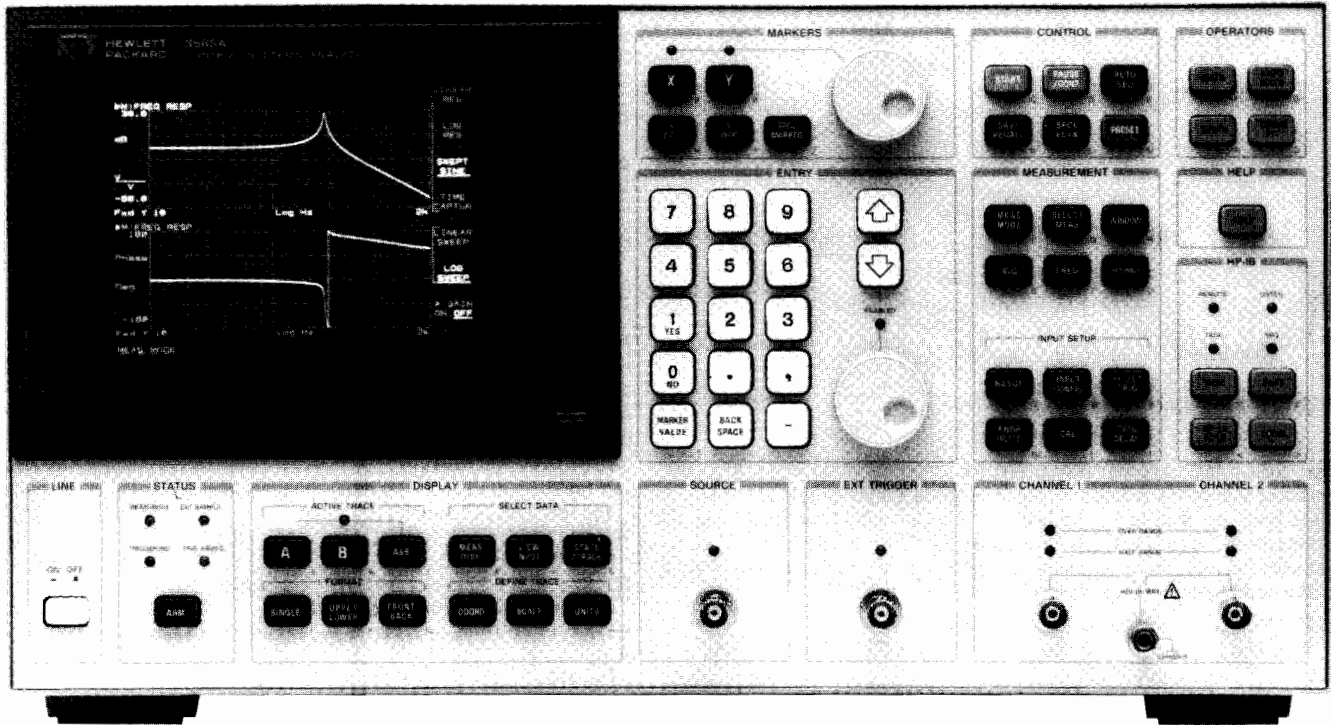

HP 3563A

Direct Measurement of Dynamic Analog and Digital Signals

The HP 3563A control systems analyzer is the development tool that provides test and analysis of analog, digital, and mixed analog/digital systems. In the world of electronics and control systems, designs are shifting from analog to digital. Products ranging from disk drives to robots to spacecraft use closed-loop control systems containing digital filters and microprocessors rather than analog circuitry.

Hewlett-Packard helps you analyze next generation systems with the HP 3563A control systems analyzer. A compatible superset of the popular HP 3562A dynamic signal analyzer, this FFT-based analyzer offers the versatility required to make the most difficult spectrum, network and waveform measurements in both the time and frequency domain. For analog measurements, the analyzer has two differential input channels, a 26.5 μ Hz-to-100 kHz frequency range, 150 dB measurement range, 80 dB dynamic range, flexible triggering, and a versatile signal source. The digital inputs accept TTL-level parallel data up to 16-bits wide with data rates as high as 256 kHz and clock rates up to 10 MHz.

Protect Your HP 3562A Investment

If you develop, design, or test control systems, chances are you own an HP 3562A dynamic signal analyzer. If your designs now call for digital measurements, you can protect your investment in the HP 3562A by converting it to the functionality of the HP 3563A. Because the control systems analyzer is compatible with auto sequence and computer programs written for the HP 3562A, your programming

investment is also protected. For more information regarding HP 3562A, Option 063, please contact your local HP sales representative.

Test the Performance of Control Systems

Whether a control system is analog, digital, or mixed, you still need to characterize its stability and performance. Characterization of system stability begins with an accurate frequency response measurement. Measure frequency response magnitude and phase quickly using the linear or logarithmic resolution FFT modes. Get a detailed look at the response with the swept sine mode. Linear or logarithmic swept sine frequency response measurements can be made with up to 140 dB dynamic range. With FFT or swept sine tests, frequency response measurements are as accurate as ± 0.1 dB and $\pm 0.5^\circ$ (see specifications for details).

Display measurement results in familiar formats such as Bode, Nyquist, and Nichols. Use waveform math to compute the open-loop response from a closed-loop measurement. Activate the special marker function to calculate and display the gain and phase margins.

Key measures of time domain performance such as rise time, overshoot, steady state deviation, and settling time are derived from the system step response. By providing a step stimulus, pre- and post-trigger delay, trace scaling, and separate x- and y-axis markers, the HP 3563A simplifies the measurement of time domain parameters.

The built-in signal source produces the stimuli commonly needed to fully characterize closed-loop control systems. In analog or 16-bit parallel format, the source will output swept sine, fixed sine, sine chirp, step, pulse, ramp, random noise, and arbitrary signals. Data editing combined with waveform math simplifies the creation of arbitrary waveforms such as sine chirps with shaped amplitude.

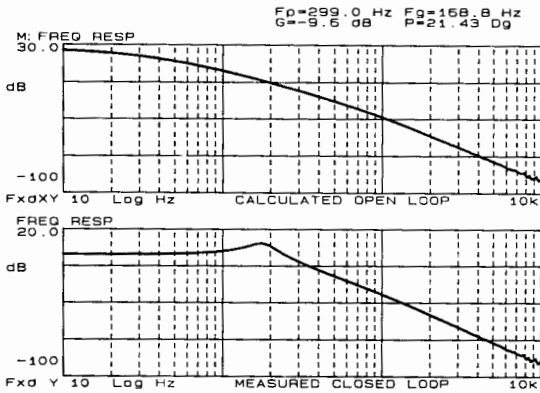

Turning Data into Information

Plots of the frequency response or step response might not be enough to describe a control system. To quickly develop a proper compensation scheme, you need to know the location of system poles and zeros. If a compensator is being added to the system, its pole/zero model should be added to the system simulation to predict its effect. The HP 3563A addresses these problems with two powerful features: curve fitting and frequency response synthesis.

Identify system poles and zeros by applying the HP 3563A curve fitter to a measured frequency response. Separate s- and z-domain curve fitters are included to handle analog and digital systems. The frequency domain multiple degree of freedom (MDOF) algorithm used in the curve fitters accounts for the interaction of adjacent poles more accurately than single degree of freedom (SDOF) methods. The HP 3563A can fit up to 40 poles and 40 zeros simultaneously. Results are displayed in a table showing the real and imaginary parts of system poles and zeros. If needed, a pole/zero table can be converted to polynomial or pole/residue formats.

Use frequency response synthesis to model s- or z-domain control elements, actuators, and compensators. To create more accurate models, enter a time delay to simulate computational delays. Include a zero-order hold in a z-domain synthesis table to model the effect of a digital-to-analog converter in the control system. Synthesis plus waveform math lets you try a compensator design before it is built. Use waveform math to combine a synthesized response with a measured frequency response and predict the compensator's effect on system stability. If the predicted stability margins do not meet the design criteria, revise the model as many times as needed before building the compensation network.

To handle systems with a mixture of analog and digital subsystems, curve fit and synthesis tables can be transformed between the s- and z-domains. A choice of impulse invariant, step invariant, and bilinear transformations lets you use the method that matches the characteristics of your system.

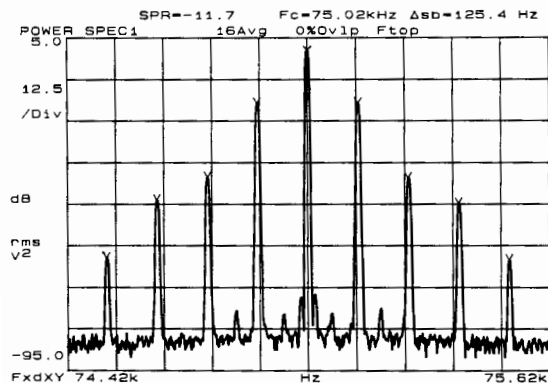

Characterize Electronic Networks and Signals

Whether you develop digital signal processing ICs and data conversion devices or analyze the processed signals, the HP 3563A can simplify the task. Two inputs that accept analog and digital signals make

the HP 3563A a powerful spectrum and waveform analyzer. Measure frequency spectra with 801 lines of resolution, ± 0.15 dB accuracy, and 80 dB dynamic range. Special trace markers simplify analysis of distortion, sidebands, and band power. The built-in demodulation capability helps you analyze complex modulated signals in the time and frequency domains.

Perform waveform analysis by capturing signals in the internal 20K-sample capture buffer, or use time throughput to save longer events in an external HP-IB disk drive. Data scrolling and trace expansion help you locate and analyze the important parts of captured waveforms.

With a built-in signal source that generates analog and digital stimulus signals, the HP 3563A is also a versatile network analyzer. Measure the response of analog filters and devices. Test the frequency response of digital filters with a digital-in/digital-out measurement. Test the accuracy of analog-to-digital converters by applying analog stimulus and measuring the digital output directly.

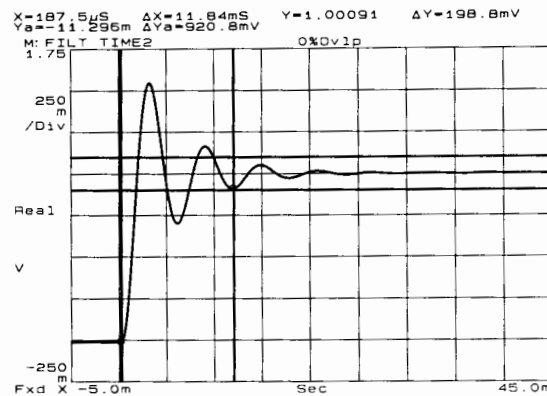

Troubleshoot Noise and Vibration Problems

Mechanical resonance problems often appear in electromechanical control system designs. The HP 3563A provides the measurements you need to identify structural resonances, analyze motor vibration, and locate noise sources. Improve the quality of frequency response impact testing with functions such as data previewing and automatic overload rejection. Simplify interpretation of vibration measurements by selecting RPM or orders as the frequency axis and by using engineering units scaling to display amplitude in appropriate units such as displacement or velocity.

Test accessories such as impact hammers and accelerometers are available through the HP test & measurement accessories catalog, and from third-party vendors. For detailed noise and vibration analysis, software solutions are available from third-party software suppliers.

Automation Makes it Easy

Increase your productivity when automating testing or documenting results with versatile automation capabilities such as auto sequence programming and direct control of HP-IB disk drives and plotters. Auto sequence programming (ASP) lets you reduce a series of front-panel operations to a single keystroke. In addition to automating analyzer functions, an ASP can send commands over the HP-IB to control external devices such as programmable switch banks and programmable loads. With ASP and a sheet-fed plotter such as the HP 7550A plotter, the HP 3563A can perform batch plotting of files saved on disk.

For computer-aided testing, the HP 3563A is also HP-IB programmable. If you use a personal computer, the PC file conversion option (Option 921) is useful. This set of utilities runs on a PC and converts HP 3563A and 3562A files to MS-DOS® format. Conversion utilities are also included to make analyzer files compatible with MATRIX_X from Integrated Systems, and PC-Matlab from The Mathworks.

Note: See page 137 for specifications. A data sheet with complete specifications is available from your HP sales representative. MS-DOS is a U.S. registered trademark of Microsoft Corporation.

SIGNAL ANALYZERS

Dual-channel, Control Systems Analyzer 64 μ Hz to 100 kHz

HP 3562A

- Network, spectrum, waveform, transient analysis
- Linear, logarithmic, swept sine modes

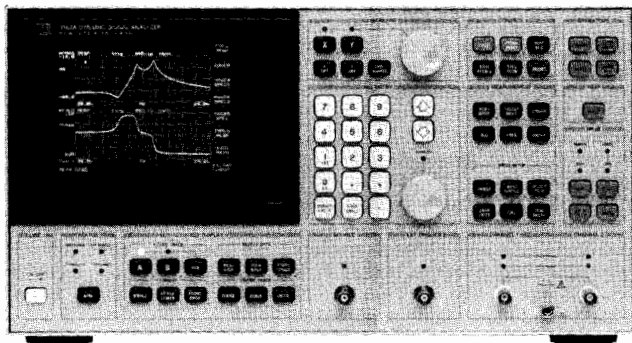

HP 3562A

HP 3562A Dynamic Signal Analyzer

The HP 3562A dynamic signal analyzer is well suited for design test and analysis of electronics, mechanical systems, and electromechanical control systems. Two input channels, 26.5 μ Hz-to-100 kHz frequency range, 150 dB measurement range, and 80 dB dynamic range on this FFT-based analyzer offer versatility and performance for even the most difficult network, spectrum, and waveform measurements, in both time and frequency domains.

The two high-performance input channels and a built-in signal source (noise and sine signals) address network analysis needs on the bench or in a test system. Vector averaging, waveform math, 40-pole/40-zero curve fitter, and frequency response synthesis enhance network measurements with a full range of analysis and modeling capabilities. Zoom analysis with frequency resolution to 26.5 μ Hz plus a powerful AM, FM, and PM demodulation function make the HP 3562A a versatile spectrum analyzer. For transient or waveform analysis, signals can be sampled, digitized, then stored in internal memory, or sent via HP-IB to an external disk drive (without a computer). Stored waveforms can be recalled and analyzed in the time, frequency and amplitude domains (baseband and zoom analysis).

Frequency Response Measurements

You can make accurate, high-resolution frequency response measurements of electronic and mechanical systems with linear resolution FFT, logarithmic resolution and swept sine analysis. A built-in signal source provides a variety of random noise and sine wave signals to meet the requirements of the system under test.

Linear resolution is the measurement technique common to all dynamic signal analyzers. In the HP 3562A, 2048-point time records are Fourier-transformed into 801-line frequency spectra. For network analysis, frequency response magnitude and phase, as well as input and output power spectra, can be measured with 801 lines of resolution. Accuracy for the frequency response magnitude and phase is ± 0.1 dB and $\pm 0.5^\circ$.

The swept sine mode configures the HP 3562A as a powerful swept sine frequency response analyzer. The source can generate linear or logarithmic sweeps with increasing or decreasing frequency; user-selectable sweep rate and resolution are also standard source functions. Input channel functions include user-selectable averaging and integration time; automatic input ranging can be activated to provide over 140 dB of dynamic range for measurements of high performance systems.

Spectrum Analysis

On-line analysis of distortion, drift, modulation, and phase noise can benefit from the speed and accuracy of the HP 3562A. High resolution measurements are typically 100 times faster than tuned spectrum analyzers. Because the HP 3562A is an FFT-based analyzer, you can see transient events a tuned analyzer would probably miss.

The HP 3562A is essentially a dual-channel spectrum analyzer that provides resolution to 26.5 Hz anywhere within the 64 μ Hz-to-

- 80 dB dynamic range with full alias protection
- High accuracy (± 0.15 dB)

100 kHz measurement range. Single-channel accuracy is ± 0.15 dB with 80 dB of dynamic range. Modulation analysis can be performed on either or both channels with harmonic and sideband markers as well as with the built-in demodulation capability: zoom measurement can be AM, FM, or PM demodulated with carrier frequencies up to 99.9 kHz.

Waveform and Transient Analysis

Perform complete analysis of waveforms and transients in the time and frequency domains. Store sampled and digitized waveforms in internal memory (single-channel time capture) or on disk in an external disk drive (single- or dual-channel time throughput). Recall data for time domain analysis as single time records or as a compressed display of up to 10 time records (time capture mode). Data can also be recalled for baseband and zoom analysis in the frequency domain, with vector averaging if needed.

The array of triggering capabilities enhances both waveform recording modes. Pre- and post-trigger delays can be specified to capture the rising edge of a transient or to compensate for delays in the system under test.

Hardcopy and Mass Storage

When access to prototypes is limited, make your test time more efficient with the time throughput capability; through direct control of external disk drives, the HP 3562A stores time data directly to disk without a computer.

HP-IB is a standard feature to speed and simplify documentation of results with direct control of plotters and disk drives. Anything displayed on the analyzer screen can be plotted or saved on disk: measurement results, setup state table, synthesis tables, curve fit tables, and auto sequence or auto math program listing.

Automation for Improved Productivity

As a stand-alone solution, the analyzer can "learn" a series of key-strokes and then perform them on command (auto sequence programming). Up to five auto sequence programs can be stored internally, with additional programs stored on an external disk drive. For networked HP-IB systems, the HP 3562A provides complete HP-IB programmability. Custom display graphics messages can be created with direct programming of the display, and user-defined softkey menus can be created to simplify interactive testing.

Specifications (HP 3562A, 3563A)

Contact your local HP sales office for more information, including a data sheet with complete specifications.

Frequency

Measurement range: 64 μ Hz to 100 kHz. Both channels, single- or dual-channel operation.

Resolution: span/800. Both channels, single- or dual-channel operation, linear resolution mode.

Spans	Baseband	Zoom
# of spans	66	64
min span	10.24 mHz	20.48 mHz
max span	100 kHz	100 kHz
time record (sec)	800/span	800/span

Window functions: flat top, hann, uniform, force, exponential, user-defined

Typical real-time bandwidths:

Single-channel, fast averaging 10 kHz

Throughput to CS/80 disk

Single-channel 12.5 kHz

Dual-channel 6.25 kHz

Amplitude

Accuracy: defined as full scale accuracy at any of the calculated frequency points. Overall accuracy for the linear or logarithmic resolution modes is the sum of the absolute accuracy, window flatness and noise level. Overall accuracy for swept sine mode is the sum of absolute accuracy and noise level.

SIGNAL ANALYZERS

Dual-channel, Control Systems Analyzer 64 μ Hz to 100 kHz

HP 3563A, 3562A

135

Absolute accuracy: single channel (channel 1 or 2)
 ± 0.15 dB $\pm 0.015\%$ of input range (+27 dBV to -40 dBV)
 ± 0.25 dB $\pm 0.025\%$ of input range (-41 dBV to -51 dBV)

Window flatness:

Flat top +0, -0.01 dB
 Hann +0, -1.5 dB

Noise floor: with flat top window, 50 Ω source impedance and input set to -51 dBV range

20 Hz to 1 kHz (1 kHz span) < -126 dBV (-134 dBV/ Ω Hz)
 1 kHz to 100 kHz (100 kHz span) < -115 dBV (-144 dBV/ Ω Hz)

Frequency response channel match:

Analog/analog: input signals at full scale on any pair of ranges, accuracy is ± 0.1 dB, ± 0.5 degree.

Digital/digital: for simultaneous sampling on channels 1 and 2, accuracy is ± 0.1 dB, ± 0.5 degree. If sampling is not simultaneous, the HP 3563A can partially correct for skew in the system under test. With skew correction activated, nominal accuracy is ± 0.1 dB, ± 1.0 degree from 320 mHz to 10 kHz and ± 0.1 dB, ± 4.0 degrees from 10 kHz to 100kHz.

Mixed analog/digital: With full-scale inputs on both channels, no skew between the analog and digital inputs, 1:1 sampling ratio, and 8 averages, nominal accuracy is ± 0.2 dB, ± 2.0 degrees from 320 mHz to 20 kHz and ± 0.4 dB, ± 6.0 degrees from 20 kHz to 100 kHz

Dynamic range: All distortion (intermodulation and harmonic), spurious, and alias products are ≥ 80 dB below full scale input range (16 averages)

Output level: between +10 and -10 V_{peak} (ac + dc) into a ≥ 10 k Ω , < 1000 pF load. Maximum current is 20 mA.

ac level: ± 5 V_{peak} (≥ 10 k Ω , < 1000 pF load)

dc offset: ± 10 V_{peak} in 100 mV steps. Residual offset at 0V offset ≤ 10 mV

Distortion: including subharmonics

26.5 μ Hz to 10 kHz -55 dB

10 kHz to 100 kHz -40 dB

Pulse: nominally 1 sample wide and bandlimited

Digital source (HP 3563A)

All analog signal types can be output from the digital source connector. Data format is 16-bit parallel in either two's complement or offset binary. Output level is TTL compatible.

Maximum load: 8 LSTTL

Maximum output rate: 256 kHz

General

Specifications apply when AUTO CAL is enabled or within 5°C and 2 hours of last internal calibration

Ambient temperature: 0 to 55C

Relative humidity: $\leq 95\%$ at 40C

Altitude: ≤ 4570 m (15,000 ft)

Storage:

Temperature: -40 to +75C

Altitude: ≤ 15240 m (50,000 ft)

Power: 90-132 V ac, 48 to 66 Hz

198-264 V ac, 48 to 66 Hz

450 VA maximum

Weight: net, 27kg (58lb); shipping, 36kg (79lb)

Size: 222H x 426W x 578mmD (8.75" x 16.75" x 22.75")

Accessories Included

HP 3563A: HP 01650-61607 16-bit probe cable: 3 each
 HP 03563-61605 16-bit probe pod: 3 each
 HP 03563-61604 8-bit probe cable: 3 each
 HP 10347A pattern generator probe lead set: 3 each
 HP 9599-0288 grabber (package of 20): 80 each (4 packages)
 Pouch for cables and probes

HP 3563A/HP 3562A: getting started guide, operating manual, programming reference

Accessories Available

HP 3563A: HP 10346A 8-Channel TTL tristate buffer pod
 HP 01650-63201 termination adapter
HP 3563A/HP 3562A: transit case for one HP 3563A: HP p/n 9211-2663

Ordering Information

	Price
HP 3563A Control Systems Analyzer	\$24,900
Opt 907 Front Handle kit	+\$77
Opt 908 Rack Mount kit	+\$41
Opt 909 Rack Mount and Front Handle kit	+\$102
Opt 910 extra Getting Started, Operating, Programming manuals	+\$179
Option 915 add Service manual and kit	+\$100
Opt 921 PC File Utilities	+\$150
Opt 922 delete cables, pods, and pouch	-\$1,400
Opt W30 Extended Repair Service. See page 725.	625
HP 3562A Dynamic Signal Analyzer	\$19,900
Opt 907 Front Handle kit	+\$77
Opt 908 Rack Mount kit	+\$41
Opt 909 Rack Mount add Front Handle kit	+\$102
Opt 910 Extra Operating manuals	+\$179
Opt 914 Delete Service manuals	-\$100
Opt W30 Extended Repair Service. See page 725.	+\$500

Analog input (HP 3563A and 3562A)

Input impedance: 1M Ω $\pm 5\%$ shunted by < 100 pF

Input coupling: inputs can be ac or dc coupled — ac rolloff in <3 dB at 1 Hz

Crosstalk: -140 dB (50 Ω source, 50 Ω input termination, input connectors shielded)

Common mode rejection:

0 Hz to 66 Hz 80 dB

66 Hz to 500 Hz 65 dB

External sampling input: TTL compatible input for signals ≤ 256 kHz (nominal maximum sampling rate)

Digital input (HP 3563A)

Measurement data signals can be up to 16 bits wide and must be parallel data in two's complement or offset-binary format. (User selects truncation of unused upper bits or rounding of the three lowest bits for data more than 13 bits wide.) The data qualifier input accepts 8 qualifier lines, a trigger, and 1 clock signal.

Trigger

Trigger modes: free run, input channel 1, input channel 2, source and external trigger. Free run applies to all measurement modes. Input channel 1, input channel 2, source and external trigger apply to the linear resolution, time capture, and time throughput measurement modes.

Trigger delay: pre- and post-trigger delay resolution is 1 sample (1/2048 of a time record)

Pre-trigger: a measurement can be based on data that starts from 1 to 4096 samples (1/2048 to 2 time records) before trigger conditions are met

Post-trigger: a measurement is initiated from 1 to 65,536 samples (1/2048 to 32 time records) after the trigger conditions are met

Analog source (HP 3563A and 3562A)

Random noise, burst random, sine chirp, burst chirp, fixed sine, and swept sine are available from the front panel source of the HP 3562A and HP 3563A. The HP 3563A also provides step, pulse, ramp and arbitrary signals from the same front panel source output. Users can select dc offset.

Output impedance: 50 Ω (nominal)

SIGNAL ANALYZERS

Dual-Channel, Dynamic Signal Analyzer 244 μ Hz to 102.4 kHz

Model 35660A

- Network and spectrum analysis
- 102.4 kHz single channel measurements
- 51.2 kHz dual channel measurements
- 401 line resolution
- 70 dB dynamic range
- ± 0.5 dB amplitude accuracy
- ± 0.4 dB and ± 1.0 degree channel match
- Frequency accuracy of ± 30 ppm

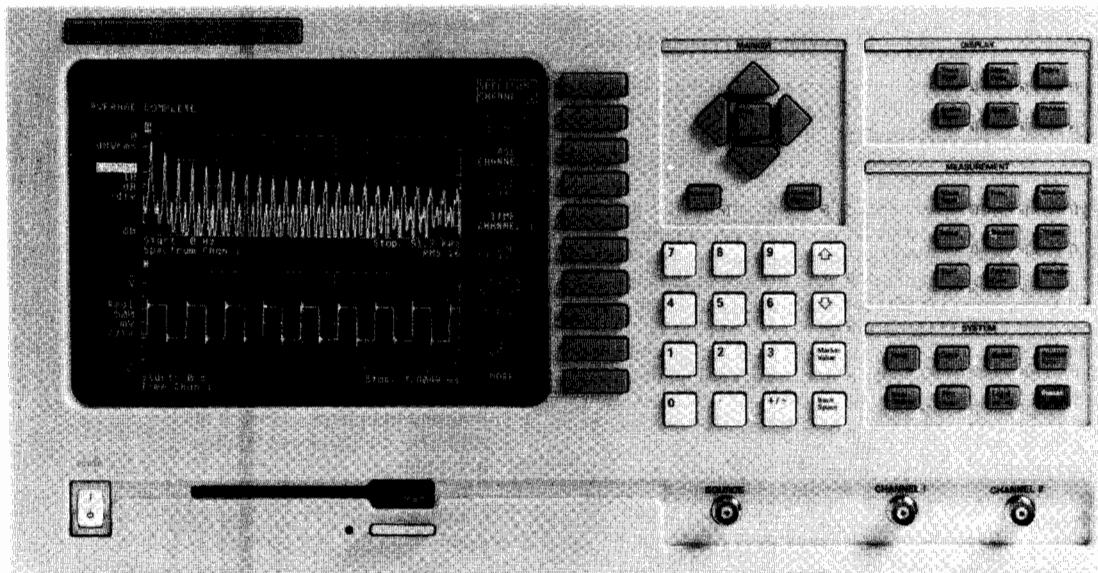

HP 35660A

HP 35660A Dual-channel Dynamic Signal Analyzer

The HP 35660A Dynamic Signal Analyzer is an FFT-based instrument that provides spectrum and network measurements in electronics, mechanical test, acoustics, and other low frequency application areas. The analyzer also offers built-in test and automation features, traditionally available only with a computer. These features include an internal programming language (HP 35680A Instrument BASIC), a built in disc drive, limit testing and data tables. With automation built in, the HP 35660A can save you both time and money.

The HP 35660A performs spectrum analysis from 488 μ Hz to 102.4 kHz and network analysis from 244 μ Hz to 51.2 kHz. The FFT provides 401 lines of resolution in both one- and two-channel modes. Complete alias protection and digital zoom ensure high resolution measurements with warranted accuracy. Measurements include linear spectrum, power spectrum, frequency response, gain/phase, group delay, time history, and power spectral density. A built-in 3.5 inch disc drive, compatible with HP Series 200/300 workstations, stores traces, tables, states, and application programs.

Electrical Spectrum Analysis

The HP 35660A is typically 10 to 100 times faster than swept spectrum analyzers for equivalent measurements, and provides higher resolution (244 μ Hz throughout the 102.4 kHz frequency range). This speed and resolution contribute to the quality of HP 35660A tests for distortion, spur level, frequency drift, intermodulation, and other signal parameters. Amplitude accuracy of ± 0.5 dB and frequency accuracy of ± 30 ppm guarantee precision in tests of such devices as headsets, modems, telephone components, speakers, transducers, and electrical motors.

Electrical Network Analysis

With two input channels and a built-in source, the HP 35660A can quickly measure the response of low-frequency filters and networks. Source signals provided are random noise, periodic chirp, and fixed sine. Periodic chirp is useful for testing non-linear responses such as output clipping of amplifiers. Random noise is ideal to get a linear approximation of a non-linear network. Fixed sine lets you test response at a specific frequency.

The HP 35660A is also a good choice for low-frequency transmission measurements in telecommunications and other areas. To ensure highly accurate magnitude and phase measurements, the HP 35660A offers ± 0.4 dB gain and ± 1.0 degree input channel phase match. For custom analysis of these measurements, the HP 35660A provides waveform math, including conjugation, FFT, inverse FFT, square root, and frequency domain integration and differentiation.

Machinery Vibration

The HP 35660A is an excellent fit for applications that require vibration monitoring at full load. With the analyzer's built-in limit tables, users can implement vibration and health monitoring of engines, machine tools, and other equipment, without an external computer and without programming. The analyzer's internal disc drive makes it easy to record, store, and recall limits for production or maintenance testing.

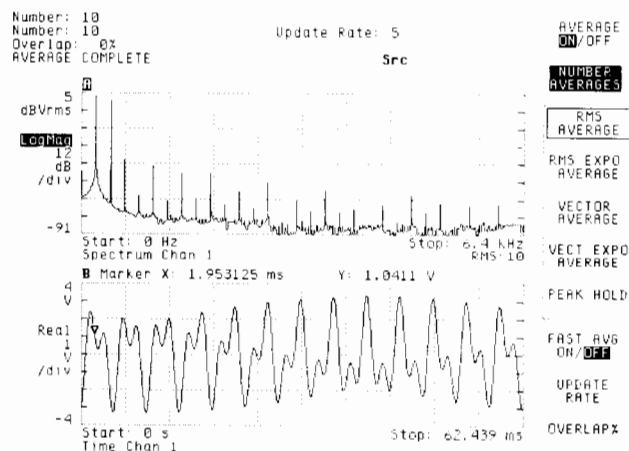

Structural Analysis

The HP 35660A uses force and exponential windows to perform frequency response testing of mechanical devices and structures. Using HP Instrument BASIC, the analyzer can simplify data collection for your modal surveys. For complete modal analysis, you can choose from several third party modal packages.

Acoustics

Another major application area for the HP 35660A is acoustics and noise measurements. This includes testing for room and device responses, noise identification and level, and underwater acoustic tests such as sono-buoy and sonar transducer testing. Acoustic intensity measurements are available with third party software.

Limit and Data tables for fast, consistent results

Spectrum and network analyzers are frequently used to test signals and device response against certain specifications. The HP 35660A improves this process by providing built-in limit testing. A limit line defines acceptable minimum and maximum values at specific X-axis points (in both time and frequency domains). Users can specify an upper and lower limit for every point in the trace, as well as specifying acceptable bands and slopes. During a test, the HP 35660A checks the trace level against the limit lines, then displays PASS or FAIL on the screen. Limit testing is especially powerful when used with HP Instrument BASIC. For example, a program can quickly pull limit lines off disc and use them as a reference against a series of traces.

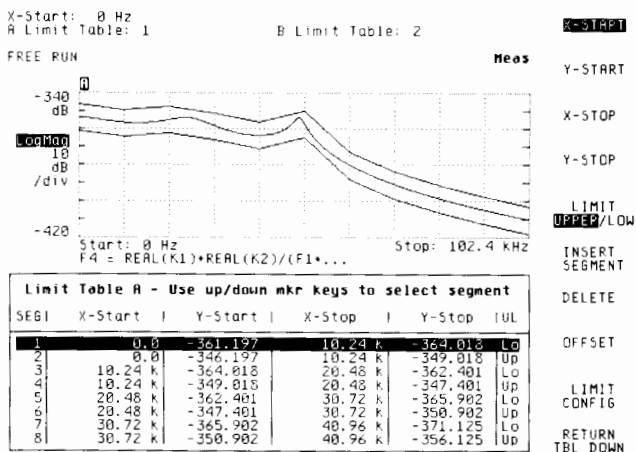

Data tables are another key feature of the HP 35660A. A data table eliminates the need to move markers along a trace to read multiple values. This is particularly useful for such applications as noise level monitoring at multiple frequencies. Enter up to 400 X-axis locations in a data table, and the HP 35660A fills in the table with a Y-axis value for each X entry. You can display, print, or store a completed table. For repeated measurements, you can create a unique table for each test and quickly recall each table from disc.

In addition to data tables and limit testing, the analyzer includes extensive markers to highlight harmonics and sidebands and to search for minimum, maximum, and target values.

HP-IB System Control

When used with HP Instrument BASIC, the HP 35660A can serve as a test system controller. A system might include peripherals such as hard discs, printers and plotters, as well as other instruments such as switch matrices, voltmeters and signal generators. You can automate smaller systems without the cost of an external computer, while conserving rack or bench space.

HP 35680A Instrument BASIC

To simplify automation and test analysis, the HP 35660A includes a powerful new feature: a subset of HP Series 200/300 BASIC running inside the analyzer. HP 35680A Instrument BASIC adds decision-making, branching, I/O including control of other instruments, and custom user interfaces. HP Instrument BASIC is fully syntax-compatible with HP BASIC, so current HP workstation owners can easily merge the HP 35660A and HP Instrument BASIC into their test systems.



A Language for Programmers and Non-Programmers

With over 150 BASIC commands, HP Instrument BASIC is a powerful tool for programmers. But it also includes a feature that makes it easy for non-programmers to automate analyzer functions. Keystroke recording automatically creates a program as the user makes measurements from the front panel. An entire test sequence can be recorded and saved with no programming required.

HP Instrument BASIC programs can be developed on an HP 9000 Series 200/300 BASIC workstation and then transferred to the analyzer via a 3.5 inch floppy disc (files must be saved in LIF format). Programs developed on the HP 35660A will also run on a workstation. If desired, the analyzer portion of a computer-aided test (CAT) can be created with keystroke recording, then merged with the main program written on an external computer. The HP 35660A is also fully HP-IB programmable from an external computer, using any language you choose.

Custom solutions with the HP 35660A

Applications that involve long and repetitive testing can benefit significantly from custom solutions available with the HP 35660A. For example, in a production environment, HP Instrument BASIC programs can automatically recall test setups and prompt a technician for date, time, and other important information. Limit testing can quickly indicate the presence of spurs or undesired harmonics. Operator interaction is further reduced with routines that automatically catalog results to a printer/plotter or to disc.

The HP 35681A Analysis Pack provides examples of how to customize the HP 35660A for specific applications. The Analysis Pack is a set of network and spectrum application programs that enhance the power of the HP 35660A analyzer.

Written in HP Instrument BASIC, the Analysis Pack provides several ready-to-use application tests, including distortion testing, filter parameter testing, and modulation and peak analysis. The Analysis Pack shows how easy it is to customize tests and provides a set of tested, documented routines you can re-use in your own custom applications.

SIGNAL ANALYZERS

Dual-channel, Dynamic Signal Analyzer 244 μHz to 102 kHz

HP 35660A

HP 35660A Specifications

Frequency

Measurement Range: Channel 1: 488 μHz to 102.4 kHz, single channel mode. Channel 1 and 2: 244 μHz to 51.2 kHz, dual channel mode.

Accuracy: $\pm 0.003\%$ of frequency reading

Resolution: Span/400, both channels, single or dual channel operation.

Spans:	Single Channel	Dual Channel
# of spans available	20 (x2 sequence)	20 (x2 sequence)
min span	195.3 mHz	97.6 mHz
max span	102.4 kHz	51.2 kHz
time record length	400/span	400/span

Window Functions: Flat Top, Hann, Uniform, Force, Exponential

Window Shape Parameters:

	Noise Equiv. BW (% of span)	-3dB BW (% of span)	Shape Factor (-60dB BW/ -3dB BW)	Window Flatness (dB)*
Uniform	0.25	0.25	716	+0, -4.0
Hann	0.375	0.37	9.1	+0, -1.5
Flat Top	0.955	0.9	2.6	± 0.005

*relative to analyzer's 401 calculated frequency points

Typical Realtime Bandwidth: (random noise source off)

	Single Channel	Dual Channel
Averaging Off	800 Hz	400 Hz
Fast Averaging	3.2 kHz	1.6 kHz

Amplitude

Input Range: The calibrated input range is +27 dBV (31.7 Vpk) to -51 dBV (3.99 mVpk). Range is adjustable in 2 dB increments.

Dynamic Range: All distortion (intermodulation and harmonic) spurious and alias products < -70 dB relative to full scale input range.

Noise: (-51 dBV range, $R_s = 50$ ohms, 16 RMS Averages)

160 Hz to 1.28 kHz < -130 dBV/sqrt Hz (.316 μV /sqrt Hz)

1.28 kHz to 102.4 kHz < -140 dBV/sqrt Hz (.100 μV /sqrt Hz)

Common Mode Rejection: (Frequency ≤ 1 kHz)

-51 to -11 dBV Ranges > 80 dB (typical)

(3.99 mVpk to 399 mVpk)

-9 to +9 dBV Ranges > 60 dB (typical)

(502 mVpk to 3.99 Vpk)

+11 to +27 dBV Ranges > 40 dB (typical)

(5.02 Vpk to 31.7 Vpk)

Crosstalk: < -130 dB relative to the transmitting signal, or < -70 dB relative to the receiving channel range, whichever is greater. (Receiving channel input termination = 50 Ω)

Absolute Amplitude Accuracy: ± 0.5 dB ± 0.03 % of input range (488 μHz to 102.4 kHz, DC coupled)

Phase

Single Channel Phase Accuracy:

488 μHz to 10.24 kHz ± 4.0 degrees

(relative to external trigger, 16 vector averages, DC coupled, amplitude ≥ -50 dB relative to full scale)

Frequency Response

Gain Accuracy: ± 0.4 dB

Phase Accuracy: 488 μHz to 10.24 kHz ± 1 degree

10.24 kHz to 51.2 kHz ± 1.8 degree

(DC coupled, 16 RMS averages, 488 μHz to 51.2 kHz, Ch1 range = Ch2 Range, full scale periodic chirp input, Uniform window)

Inputs

Connection: Grounded or Floating

Input Impedance: 1 M Ω $\pm 10\%$ shunted by < 100 pF.

Low to chassis in floating mode:

1 M Ω shunted by < 0.01 μF (Typical)

Low to chassis in grounded mode: 50 Ω (Typical)

Input Coupling: AC or DC coupling;

AC roll-off is < 3 dB at 1 Hz

Common Mode Range: (floating mode) $\pm 4\text{V}$ peak

Trigger

Internal: Positive or negative slope

Level: $\pm 100\%$ of input range

External: TTL, positive or negative slope

Source

Source types: Random, periodic chirp, fixed sine

Output Impedance: < 5 Ω

Max. Output Level: ± 5 Vpk

Maximum current: ± 20 mA

Maximum capacitive load: 1000 pF

Sine:

Frequency range: 15.63 mHz to 102.4 kHz

Amplitude Accuracy: $\pm 4\%$ Vpk (at 1 kHz, Vpk = .1V to 5V)

Flatness: ± 1.0 dB (relative to 1 kHz, Vpk = .1V to 5V)

Harmonic, subharmonic, and other spurious responses:

488 μHz to 10 kHz: < -60 dB relative to source level

10 kHz to 102.4 kHz: < -40 dB relative to source level

(Vpk = 0.1V to 5V)

Residual DC offset: ± 8.0 mV, $\pm 6.0\%$ Vpk

Random:

Flatness: < 5.0 dB (typical)

(passband, relative to minimum amplitude in the frequency domain, Vpk = .1V to 5V, full span)

General

Power: 90 - 132 VAC, 48 to 440 Hz

198 - 264 VAC, 48 to 66 Hz

280 VA maximum

Weight: 22 kg (47 lbs) net

24 kg (52 lbs) shipping

Dimensions: 222mm (8.75") high
425.5mm (16.75") wide
538mm (21.19") deep

HP-IB

Implementation of IEEE Std 488.1 and 488.2

SH1 AH1 T6 TE0 L4 LE0 SR1 RL1 PP0 DC1 DT1 C1,C2,C3,C12 E2

Compatible Peripherals

Disc Drives: HP SS/80 Protocol Disc Drives (These include the 9122C,D,S; 9133D,H,L; and HP 9153A,C)

Plotters: Hewlett-Packard Graphics Language (HP-GL) digital plotters

Printers: HP-IB printers, alpha and raster dumps.

Ordering Information

HP 35660A Dynamic Signal Analyzer	Price
Option 001 Add 2 Mbyte RAM	\$12,500
Option 002 Delete disc drive	\$1500
Option 908 Rack mount kit	-\$100
Option 910 Extra Operating Manual Set and HP-IB Programming Reference	\$85
Option 915 Service Manual and Kit	\$75
Option W30 Extended repair service. See page 725.	\$150
HP 35680A Instrument BASIC	\$200
HP 35681A Analysis Pack	\$500
	\$250

Accessories Supplied

Operating and Programming Manuals, HP 35660A performance tests

SIGNAL ANALYZERS

Single-channel, Dynamic Signal Analyzer 0.000125 Hz to 100 kHz
HP 3561A

139

- Spectrum analysis, $1/3$ and $1/1$ octave analysis
- Time capture (40 k sample)
- High speed (7.5 kHz real time rate)

- High accuracy, $\pm .15$ dB
- 80 dB dynamic range, to 640 μ Hz resolution bandwidth
- Non-volatile memory option stores 127 measurements

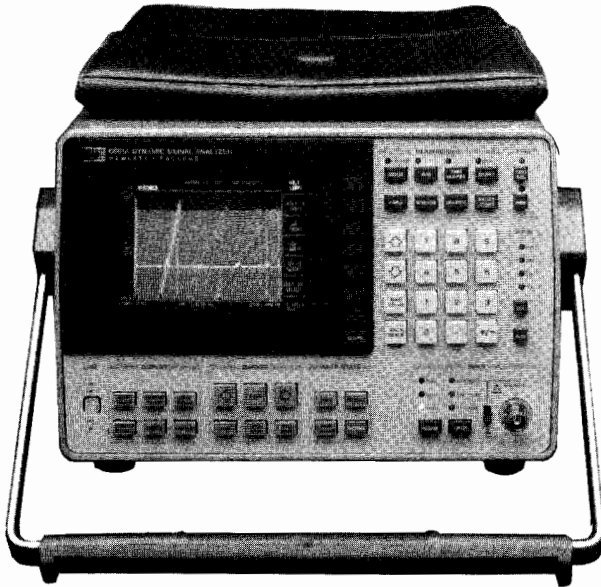

DESIGNED FOR
HP-IB
SYSTEMS
HP 3561A

HP 3561A Dynamic Signal Analyzer

The HP 3561A is a versatile real-time spectrum analyzer for analysis of electronic, acoustic, and vibration signals up to 100 kHz. The patented design of the input provides outstanding measurement performance, $\pm .15$ dB amplitude accuracy, 80 dB dynamic range and $\pm 0.003\%$ frequency accuracy. The analyzer also has a built-in tracking generator for stimulus-response measurements. With built-in waveform math, magnitude and phase measurements are possible. Digital processing is used to provide ultra-narrow resolution bandwidths up to 640 μ Hz. Digital processing also speeds up measurements; a measurement with 1 Hz resolution bandwidth requires only a 1.5 second sweep.

In addition to spectrum measurements, the HP 3561A displays time waveforms similar to oscilloscope displays. A 40 k sample time buffer captures transients for examination in the time domain or analysis in the frequency domain. The HP 3561A is also an excellent analyzer for acoustic testing. It offers $1/3$ and $1/1$ octave measurements and an analog A weighted filter.

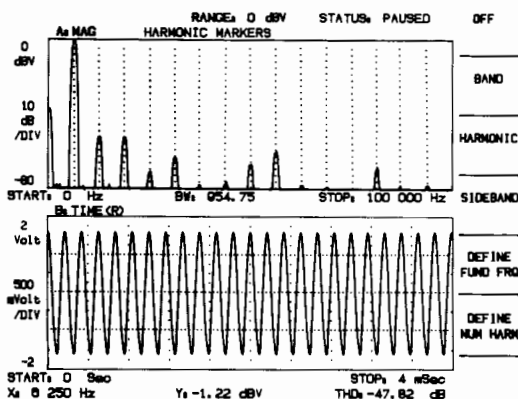

Harmonic marker function computes total harmonic distortion (THD) directly in dB or percent.

Spectrum Analysis

The HP 3561A uses digital processing to achieve high performance and increase measurement speed (up to two orders of magnitude for resolution bandwidths 1 Hz or less). Results can be displayed in rms volts, volts squared, milliwatts, dBV, and dBm. Other engineering units can be displayed by entering a calibration factor and a label.

In addition to standard marker features like marker to peak and peak track, the HP 3561A provides advanced marker features. Harmonic markers aid analysis and automatically compute total harmonic distortion (THD). Band markers automatically compute rms band level or average band power, depending on the display units selected. Sideband markers make it easy to identify the frequency spacing of modulation sidebands and automatically compute the power.

Waveform Recording

The HP 3561A is well-suited for transient capture and analysis because it has a high-performance, 13-bit analog-to-digital converter with exceptional linearity. The A-to-D sampling rate is 256 kHz, and the analog anti-alias filter at the input prevents signals above 100 kHz from corrupting measurements. Lower sampling rate can be selected by changing the analysis span. To control transient capture measurements, the analyzer triggers on the analog level at the input, and it can be set to trigger on positive or negative slope. Trigger delays of 40 k samples pre-trigger and 1023 k samples post-trigger can be selected.

The HP 3561A signal analyzer lets you capture long transients with its 40 K sample time buffer. Segments of the time buffer (1024 samples) can be expanded for easy viewing or can be transformed into spectrums so you can see the spectral content.

Figure 3: Up to 40,000 samples of a transient waveform can be captured, with analysis in either the time domain or the frequency domain.

Acoustic Analysis

Calibrated sound pressure level (SPL) measurements are possible using the Engineering Units feature of the analyzer. The sensitivity of the microphone can be measured and entered into the analyzer so the display directly reads out calibrated dBA. The built-in analog A weight filter is selectable for sound level measurements.

The HP 3561A makes $1/3$ and $1/1$ octave measurements by digitally synthesizing the 'proportional to bandwidth' filters in custom VLSI ICs. This custom processing allows the display to update quickly and indicates any short-term changes in noise level. Both the $1/3$ and $1/1$ octave displays show the total sound level of the band on the right of the display. This eliminates the need for a separate sound level meter.

Vibration Analysis

When used with an accelerometer or other motion transducer, the HP 3561A is an excellent diagnostic tool for vibration analysis. The cause of vibration problems can often be deduced by analyzing the spectral components of the vibration signal, and analysis is easy with HP 3561A harmonic, band, and sideband marker functions. The analyzer also has a built-in power source for ICP-type quartz accelerometers.

SIGNAL ANALYZERS

Single-channel, Dynamic Signal Analyzer 0.000125 Hz to 100 kHz (cont'd)

HP 3561A

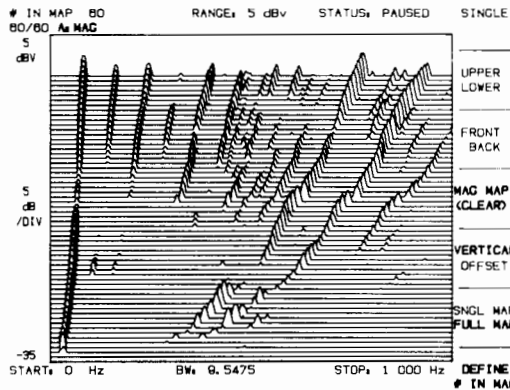

Figure 5: Spectral maps greatly reduce the time required to analyze changes in up to 60 successive measurements.

Internal Storage

The HP 3561A comes standard with non-volatile memory for 2 measurement traces and 6 setup states. Option 001 increases non-volatile memory so that 127 measurement traces (or any combination of measurement traces and setup states) can be saved; an entire 40 k sample time capture can be saved.

Display Formats

The HP 3561A comes with the standard single-trace format as well as the upper/lower and front/back dual trace formats. These formats are very flexible; a spectrum can be displayed in an upper trace while the time waveform can be displayed in the lower one. For trend analysis, the HP 3561A has a spectral map display format that displays up to 60 successive spectra. This display format is extremely useful for analyzing transients and vibrations in rotating machinery.

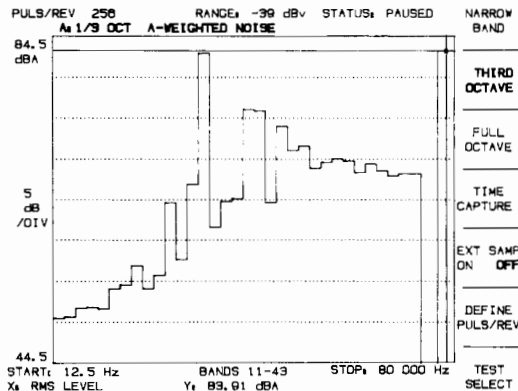

Figure 4: The combination of octave and narrowband analysis makes the HP 3561A a powerful instrument for noise and vibration analysis.

Portable Operation

The HP 3561A can run for over one hour with the HP 85901A portable ac power source.

Specifications

Frequency

Range: 0.000125 Hz to 100 kHz.

Spans: 0.01024 Hz to 100 kHz in a 1, 2, 2.5, 5, 10 sequence. Other spans are available but are too numerous to list here.

Accuracy: $\pm 0.003\%$ of display center frequency.

Resolution: 0.25% of frequency span.

Window: flat top, hann, uniform, and exponential

Bandwidth

	Flat	Hann	Uniform
3 dB Bandwidth (% of frequency span)	0.90%	0.36%	0.22%

Real-time bandwidth: (typical) single display, 3 kHz. Fast average display, 7.5 kHz.

Amplitude

Measurement range: +27 to -120 dBV noise floor (22.4 VRMS to 1 μ V noise floor). Input range selected in 1-dB steps from +27 to -51 dBV. Optimum range determined automatically in autorange mode.

Dynamic range: 80 dB

Accuracy at the passband center

± 0.15 dB +27 to -40 dBV input ranges

± 0.25 dB -41 to -51 dBV input ranges

Flat top window: +0, -0.01 dB

Hann window: +0, -1.5 dB

Uniform window: +10, -4.0 dB

Note: overall accuracy is the sum of the accuracy at the passband center plus the selected window accuracy

Resolution: Log 0.01 dB

Linear: 4 digits

Phase

Accuracy: ± 2 degrees, dc-10 kHz; ± 10 degrees, 10-100 kHz (signals no more than 40 dB below full range).

Resolution: 0.1 degree

Input

Impedance: $1 \times 10^6 \Omega \pm 5\%$ shunted by 95 pF maximum

Isolation: input low may be connected to chassis ground or floated up to 30 volts rms (42 volts peak) above ground

Coupling: signal may be ac or dc coupled. Low frequency 3-dB point < 1 Hz in ac mode.

A-weighting: hardware A-weighting filter conforms to ANSI standard S1.4-1971 (R1976)

ICP current: nominal 4 mA current source provided, compatible with integrated circuit piezoelectric accelerometers

Output

Source: band-limited, band-translated, pseudo-random, random, or impulse, or TTL "synch" signals are available on rear panel. Level is selectable between 0.7 and 0.007 volts rms, nominal. Impedance $50 \Omega \pm 5\%$

Print/plot: controls HP-GL plotters and HP raster dump printers directly

Display

General: magnitude, phase, time and math traces can be selected. Units available are:

Horizontal: Hz, seconds, RPM, orders; linear, or log spacing

Vertical: dBV, dBm (selectable Z), volts, volts squared, and user-defined units

Scale: Linear or log magnitude scales may be selected. Full scale, dB/division, and degrees/division are user definable. Center scale user definable in phase or time traces.

Math: Arithmetic operations can be performed on new or recalled frequency spectra. Add, subtract, multiply, divide, integrate, differentiate and user-defined constants are provided. 1/BW is provided for Power Spectral Density (PSD) computations.

Internal Memory

	Non-volatile	Volatile
Standard	2 traces, 6 states	40 time records
Optional	traces + states + (1+2 time records) = 127	40 time records

Marker

Single, relative, harmonic, sideband, and power cursors are provided. THD can be calculated from up to 20 harmonics. Sideband power relative to specified carrier can be calculated from up to 10 sidebands. MKR to peak, MKR to center, MKR to full scale and marker peak track are provided.

General

Power: 100/120 V ac +5%, -10%, 48-440 Hz; 220/240 V ac +5%, -10%, 48-66 Hz

Weight: net, 15kg (33lb); shipping, 21.6kg (47.5lb)

Size: 197H x 335W x 595mmD (7.8" x 13.2" x 23.4")

HP-IB interface functions: implementation of IEEE Std. 488-1978 SH1, AH1, T5, TE0, L4, LE0, SR1, RL1, PP0, DC1, DT1, C0

Ordering Information

HP 3561A Dynamic Signal Analyzer	Price
HP 3561A Dynamic Signal Analyzer	\$12,000
Opt 001 Extended Non-volatile Memory	+\$1,595
Opt W30 Extended Repair Service. See page 725.	+\$290

SIGNAL ANALYZERS

Multichannel Measurement System, 64 μ Hz to 102.4 kHz

HP 3565S

141

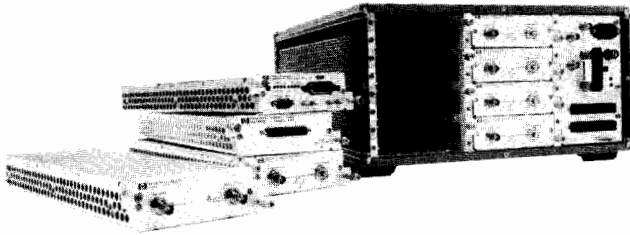

HP 3565S

HP 3565S Multichannel Measurement System

The HP 3565S multichannel measurement system is a computer-based signal acquisition and analysis system. The hardware consists of a mainframe and plug-in modules. The mainframe can hold 8 modules. Up to 8 mainframes can be chained together to permit a maximum of 64 modules in a single system.

There are three types of modules: signal processing, input, and source. A system (one or more mainframes) must have one and only one signal processing module, which acts as the interface to the host computer and the controller of all the other modules in the system. The signal processing module also performs digital signal processing on time data from the input modules.

Application Software

System performance depends on the application software used to access the hardware. Software for the HP 3565S includes HP VISTA (for HP 9000 series 300 workstations) and HP 3566 and 3567 (for HP Vectra PCs or other IBM AT compatibles). (See catalog pages 10.50 and 10.51 for details on HP 3565S application software.) Additional solutions can be created with the HP Programmers Toolkit (HP 35635R) or purchased from independent vendors. For more information on the HP 35635R or third party solutions, contact your HP sales representative.

HP 35650A Mainframe

The HP 35650A mainframe provides power and cooling for up to 8 modules. A special cable is used to connect mainframes together to create larger systems.

Signal Processing Modules

- The signal processing module performs the following functions:
- Controls all system operations, including commands to the other modules and flow of data between the modules
 - Transfers measurement data to the host computer via HP-IB
 - Controls direct throughput to disk
 - Generates time records to send to the HP 35656A source
 - Processes time data from the input modules

HP 35651B Signal Processing Module

The 35651B signal processing module uses a MC 68020 main processor and a MC 56001 DSP processor for computing spectrums. Most application software for the HP 3565S uses this module. It includes 1 Mbyte RAM (additional RAM is available as an option).

HP 35654A Signal Processing Module

The 35654A signal processing module is a higher performance version of the HP 35651B, used for computation-intensive applications

such as high-speed waterfall displays. The added capability is accessed through custom programming (as taught in the HP 35635R Programmers Toolkit course).

Input Modules

There are three input modules. All use analog-to-digital converters to digitize signals. In each channel, the A/D converter is preceded by an analog antialias filter and followed by a digital filter (with zoom capability) and an 8K FIFO buffer. Time data from the FIFO buffers is sent to the signal processing module to be converted into spectrums.

HP 35652A Input Module

The HP 35652A is a single-channel input module with dc to 51.2 kHz bandwidth and 80 dB of dynamic range. Signal conditioning for piezoelectric and ICP transducers are built-in. The ICP mode provides 4 mA of constant current. The HP 35652A module also has an option for buffered analog output. Option 001 provides 2 volts peak (full scale) analog output.

HP 35652B Input Module

The HP 35652B input module is similar to the HP 35652A but has increased measurement bandwidth to 102.4 kHz. The HP 35652B has 80 dB of dynamic range at frequencies below 50 kHz. From 50 kHz to 100 kHz, dynamic range is 75 dB.

HP 35655A Input Module

The HP 35655A is an 8-channel input module, with dc to 12.8 kHz bandwidth for each channel and a dynamic range of 72 dB. Each channel has its own filtering and trigger detection. Channels sample and hold simultaneously to maintain phase match across channels. Each channel includes buffered analog output.

HP 35653A Source Module

The HP 35653A source module provides the following excitation signals for frequency response measurements:

- Continuous sine wave
- Band limited random noise
- Burst random noise of variable duration

This module also includes a reference signal for system calibration of input modules.

HP 35656A Programmable DAC

The 35656A module uses a programmable digital-to-analog converter with 16 bits of resolution to generate arbitrary stimulus signals up to 100 kHz bandwidth. The data buffer size is selectable from 1 to 32768 words.

Ordering/Configuration Information

	Price
HP 35605A System Rack (for 2 mainframes)	\$1,600
HP 35606A System Rack (for 4 mainframes)	\$2,100
HP 35650A Mainframe	\$3,100
HP 35651B Signal Processing Module	\$6,629
HP 35652A 51.2 kHz Input Module	\$3,300
HP 35652B 102.4 kHz Input Module	\$3,500
HP 35653A Source Module	\$1,850
HP 35654A Signal Processing Module	\$14,000
HP 35655A 8 channel Input Module	\$12,000
HP 35656A Programmable DAC	\$6,000

SIGNAL ANALYZERS

Multichannel Measurement Software, 64 μ Hz to 102.4 kHz

HP 35630, 35631B, 35632B

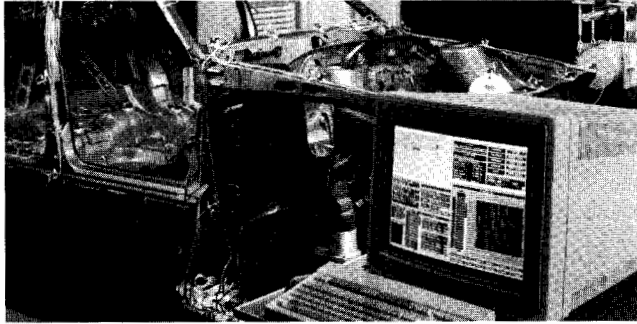

HP VISTA - HP 35630B

HP VISTA software controls up to 256 channels for broadband PSD and frequency response measurements. Time data from input modules is converted to spectral data through the signal processing module. Results can be baseband or zoom. Resolution ranges from 400 lines for fast measurements to 3200 lines for demanding applications. Features include the following:

- Engineering units for calibrated vibration and acoustic measurements
- Advanced display marker features that include THD and band power computation
- Windowed interface for organization of large measurements
- Direct digital throughput to disk for high-speed data acquisition for transient events
- MIMO (multiple input multiple output) frequency response measurements for multi-shaker testing of large, complex structures for modal analysis.

HP SINE - HP 35631B

HP SINE software adds sine-based measurements to HP VISTA software. Special features include the following:

- Sine dwell frequency response measurements
- Sine reduction of sine dwell vibration tests
- Transmissibility from sine dwell vibration test
- Dynamic impedance to tune multiple shakers in normal mode test
- Time measurements to capture time waveforms
- 16-channel monitor displays on-line time waveforms

HP Modal Data Manager (MDM) - HP 35632B

HP MDM software organizes and stores large sets of frequency response and coherence functions for modal analysis. It accepts HP VISTA and HP SINE measurements. You can do the following:

- Attach coordinates and direction to each measurement
- Connect multiple data sets into a single matrix
- Attach adjacent zoom measurements for a single measurement with ultra high resolution
- Store data in space-efficient formats that are recognized by industry-standard modal analysis software

Environmental Testing

For broadband random noise testing of up to 256 channels, HP VISTA can make PSD measurements and compute overall Grms. Use the special fast average feature for tests with less than 50 channels. For swept sine environmental testing, HP Sine locks onto the excitation signal driving the shaker and computes THD, relative phase, and transmissibility in all channels.

Structural Measurements For Modal Analysis

HP VISTA software measures broadband frequency response functions required for modal analysis. It supports continuous and burst random excitation signals. For large, complex structures that require multiple shakers to distribute vibration energy evenly over the structure, the MIMO feature computes the entire matrix of frequency response functions for each stimulus/response pair. Any number of shakers can be used. MIMO measurements a highly reliable way to identify two different modes with the same natural frequency.

Add HP SINE to HP VISTA software when you need swept sine frequency response measurements. HP SINE is ideal for normal

mode method analysis. A special 'dynamic impedance' display provides valuable feedback during tuning of the forcing pattern. The 'decay mode' feature captures time data at turn off of the excitation signal to allow damping estimation and to confirm that only one mode was excited. After testing, HP MDM software organizes all results and stores the data in formats recognized by modal analysis software.

Ordering Information Software

Software	Price
HP 35630B HP VISTA Software	\$11,048
HP 35631B HP SINE Software	\$7,000
HP 35632B HP Modal Data Manager Software	\$3,000

Measurement hardware

See the HP 3565S multichannel measurement hardware system description on page 141.

Host Computer

Please contact HP for the recommended list of HP 9000 series 300 workstations using the HP-UX operating system.

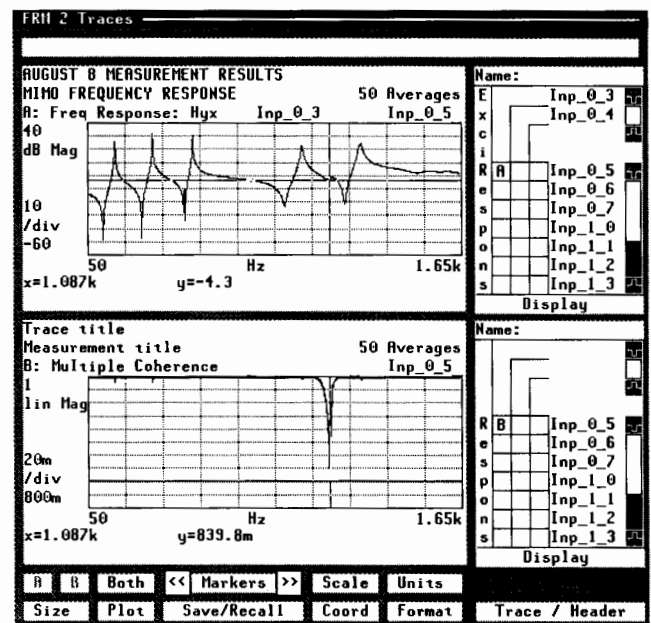
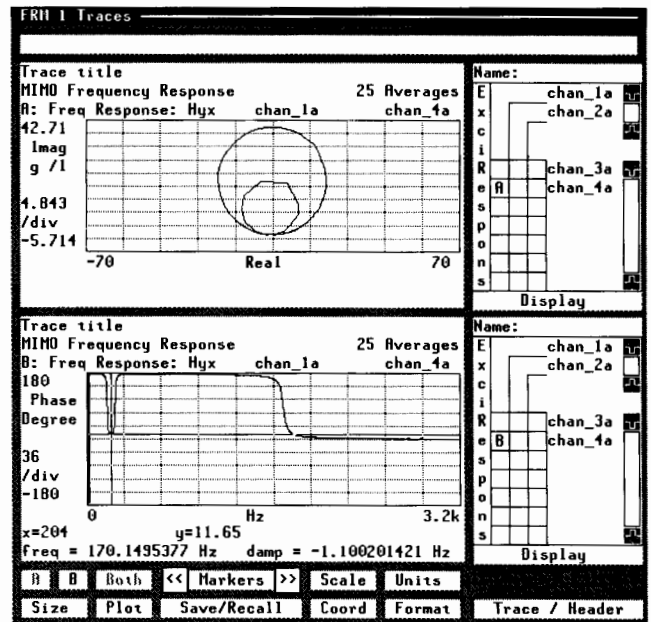

SIGNAL ANALYZERS

Multichannel, Spectrum/Network Analyzers 64 μ Hz to 102.4 kHz

HP 3566A, 3567A

143

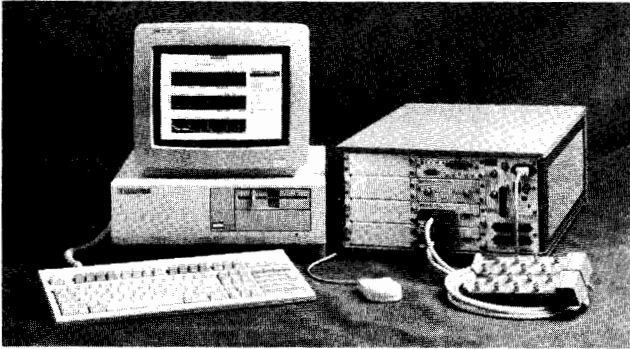

HP 3566A

Powerful Time and Frequency Measurements with a PC Analyzer

The 12.8 kHz HP 3566A and 102.4 kHz HP 3567A are PC-based spectrum/network analyzers that link high-performance measurement hardware (see page 10.49) to an HP Vectra PC (or other IBM-AT compatible computer) to provide flexible turnkey solutions in mechanical test, signal characterization, and production test.

The HP 3566A and 3567A analyzers have the same measurement feature set, but differ in maximum frequency span and hardware configuration (see table 1). Both analyzers can expand to 16 channels that can acquire data simultaneously. For fast measurement processing, a powerful hardware signal processor module converts time data to frequency data using the latest FFT (Fast Fourier Transform) technology. Linked to this module is an HP Vectra PC (or IBM PC-AT compatible) running MS-DOS[®], Microsoft WINDOWS, and HP measurement software.

	HP 3566A	HP 3567A
channel count	8 or 16	2 to 16
cross channel accuracy	± 2 dB	± 1 dB
phase	$\pm 1^\circ$	$\pm 5^\circ$
dynamic range	72 dB	80 dB
maximum frequency span		
spectrum measurements	12.8 kHz	102.4 kHz
network measurements	12.8 kHz	51.2 kHz ¹
realtime bandwidth ²		
display off	12.8 kHz	26.5 kHz
display on	3.2 kHz	3.2 kHz
transient capture rates		
max samples/s per channel	32,768	262,144
Max samples/s to RAM	1.5 million	1.5 million
max time samples in RAM	1.0 million	1.0 million
signal conditioning	ICP - 2mA	Charge amp, ICP - 4mA
waterfall display update ³	5/s	5/s
max. samples/s per channel	32,768	262,144

¹102.4 kHz using an external source

²One channel

³Rate applies to eight traces, updated simultaneously

HP 3566A and 3567A Measurement Capability

- Transient capture to RAM
- Time record
- RPM spectral map
- 1/3 and 1/1 octave
- Convolution
- Auto correlation
- Frequency response gain phase
- Power spectrum
- Nyquist
- Histogram, PDF, CDF
- Order tracking
- Order ratio map
- Cross spectrum
- Orbit diagram
- Cross correlation
- Impulse response
- Coherence

An Expandable Analyzer for Mechanical Testing

The HP 3566A and 3567A offer features for all types of mechanical testing, including rotating machinery analysis, vibration test,

structural analysis, and acoustic noise testing. With an expandable channel count, these analyzers are a solution for applications requiring as many as 16 channels. Display up to 8 traces of time or frequency data to quickly view accelerometer conditions or input channel ranges. Quickly distinguish between order-related and non-order-related rotating machinery signals. Spectral maps and order ratio maps provide an overall picture of machinery behavior during run-up or coast down, and allow you to identify important orders of vibration.

Analyzer applications also include sound pressure testing, spatial characterization of radiated noise, and noise source identification. Both analyzers provide 1/3 and 1/1 octave displays with a software A-weighting filter.

New Order Tracking Algorithm

The HP 3566A and 3567A can measure an accurate order spectrum independent of constant speed. Using new HP technology, this technique eliminates the need for ratio synthesizers, tracking filters, and RPM counters required by other FFT analyzers.

Multichannel Characterization of Moving Signals

Use the HP 3566A or HP 3567A to accurately measure fast-moving signals. Applications like speech analysis, underwater acoustic testing, or surveillance require multichannel analyzers to process data in real time. Real-time measurement features, ensure that transient events are captured and processed quickly. High-speed waterfall and spectrogram displays allow you to monitor changes. The analyzers also provide network analysis (to 12.8 kHz for the HP 3566A, and 51.2 kHz for the 3567A). Built-in source signals such as impulse, random, and burst random, are available for convenient network testing.

Ordering Information

HP 3566A Spectrum/Network Analyzer Price \$22,000
includes 1 mainframe, 1 8-channel 12.8 kHz input module, 1 source module, 1 signal processor module with 1 Mbyte RAM, 1 HP-IB cable, 90-day onsite hardware warranty,

HP time/frequency domain measurement software

- Opt 010** add 1 eight channel 12.8 kHz input module — (2 eight channel modules is maximum configuration) +\$12,000
- Opt 020** add Order Tracking Software +\$2,500
- Opt 104** convert signal processor module RAM to 4 Mbyte (required for order tracking software or 1 Mbyte time sample time capture buffer) +\$2,000
- Opt D01** delete HP 3566A measurement hardware — measurement software ONLY -\$18,000
- Opt Q16** HP Vectra QS16 with software installed on disk +\$5,950

HP 3567A Spectrum/Network Analyzer Price \$18,000
includes 1 mainframe, 2 102.4 kHz input modules, 1 source module, 1 signal processor module with 1 Mbyte RAM, 1 HP-IB cable, 90-day onsite hardware warranty, HP time/frequency domain measurement software

- Opt 005** add 1 mainframe (3 mainframes is maximum configuration) +\$3,100
- Opt 010** add 1 102.4 kHz input module (16 input modules is maximum configuration) +\$3,500
- Opt 020** add Order Tracking Software +\$2,500
- Opt 104** convert signal processor RAM to 4 Mbyte (required for order tracking software or 1 Mbyte time sample time capture buffer) +\$2,000
- Opt D01** delete HP 3567A measurement hardware — measurement software ONLY -\$14,000
- Opt Q16** HP Vectra QS16 PC with software installed on disk +\$5,950

MS-DOS[®] is a U.S. registered trademark of Microsoft Corp.

SIGNAL ANALYZERS

Low Frequency Spectrum and Wave Analyzers, 0.02 Hz to 32.5 MHz

HP 3580A, 3581A, 3581C, 3582A, 3586C

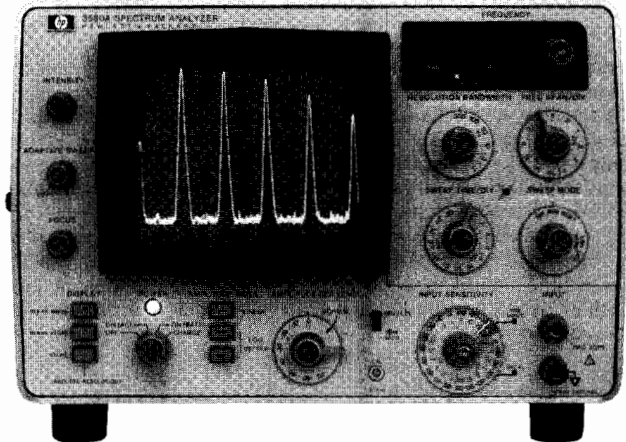

HP 3580A



DESIGNED FOR
HP-IB
SYSTEMS
HP 3581C

HP 3580A Spectrum Analyzer

The HP 3580A spectrum analyzer covers the 5 Hz to 50 kHz frequency range with 1 Hz-300 Hz resolution and 3.5 Hz accuracy. Dynamic range is up to 80 dB, with a measurement range of 100 nV to 20 V.

The HP 3580A has a digital frequency display for setting analysis range and determining tuned frequency. The digital storage display allows two measurement traces to be displayed simultaneously for easy comparison. An optional internal rechargeable battery allows up to 5 hours operation independent of an AC power source. For detailed information, please consult the HP 3580A technical data sheet.

HP 3581A Wave Analyzer, HP 3581C Selective Voltmeter

The HP 3581A wave analyzer and HP 3581C selective voltmeter cover the 15 Hz to 50 kHz frequency range and are optimized for general-purpose and telecommunications measurements, respectively. Both instruments offer similar measurement capability to the 3580A (above), but display results on a meter rather than a CRT.

Features include a digital readout of tuned frequency, linear, and logarithmic amplitude scales, and optional internal rechargeable battery power. The HP 3581C also offers balanced/bridged and 600/900 Ω balanced/terminated inputs to test service circuits in both inside and outside plant maintenance. For detailed information, please consult the HP 3581A or HP 3581C technical data sheet.

Ordering Information

HP 3580A Spectrum Analyzer
Opt 001 Internal Rechargeable Battery
Opt 002 Balanced input

Price

\$9,370
+\$720
+\$270

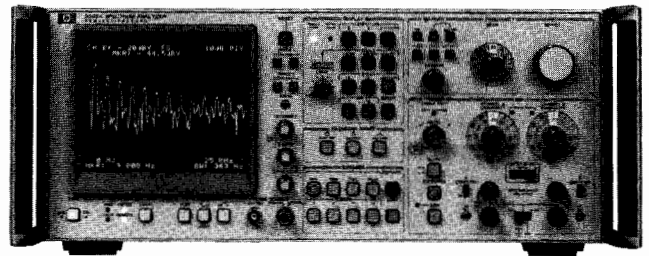

HP 3582A

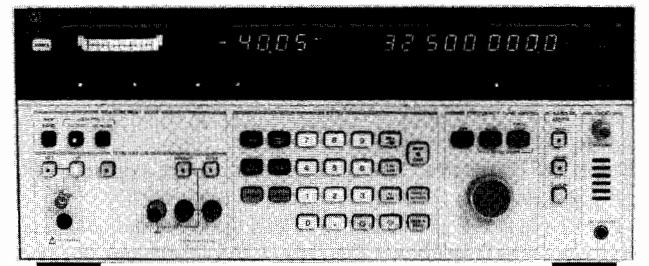

DESIGNED FOR
HP-IB
SYSTEMS
HP 3586C

HP 3581A Wave Analyzer

Opt 001 Internal Rechargeable Battery +\$720
Opt 003 Rackmount +\$345

HP 3581C Selective Voltmeter

Opt 001 Int. Rechargeable Battery, Dust Cover +\$720
Opt 003 Rackmount +\$345

HP 3582A Spectrum Analyzer

The HP 3582A spectrum analyzer provides network and spectrum analysis with excellent speed and good resolution over the frequency range 0.02 Hz to 25.6 kHz. Dynamic range is 70 dB and amplitude accuracy is up to ± 0.5 dB. Frequency spans from 1 Hz to 25 kHz are available anywhere in the HP 3582A frequency range, with frequency resolution as narrow as 0.02 Hz.

The HP 3582A dual input and FFT signal processing offer fast spectrum analysis along with transfer function magnitude and phase, and transient capture. The built-in periodic and random noise source is band-limited to concentrate all stimulus energy in the analysis range. All major front-panel controls are fully programmable over HP-IB. For detailed information, please consult the HP 3582A technical data sheet.

HP 3586C Selective Level Meter

The HP 3586C selective level meter is designed for general-purpose wave analysis applications in the design, manufacture, and maintenance of electronic systems. The HP 3586C is fully HP-IB programmable and covers the frequency range of 50 Hz to 32.5 MHz for measurement of audio, sonar and other low frequency systems, as well as high frequency communications and subsystems.

Input impedances of 50, 75 and 600 Ω are provided with 10 k Ω bridging for maximum measurement flexibility. Signal levels can be measured with up to 0.02 dB accuracy and 0.01 dB resolution. The built-in frequency counter and narrow resolution bandwidths to 20 Hz allow harmonic and intermodulation measurements to be made with ease. For detailed information, please consult the HP 3586C technical data sheet.

Ordering Information

HP 3582A Spectrum Analyzer
HP 3586C Selective Level Meter
Opt 004 High Stability Frequency Reference

Price

\$14,400
\$11,250
+\$775

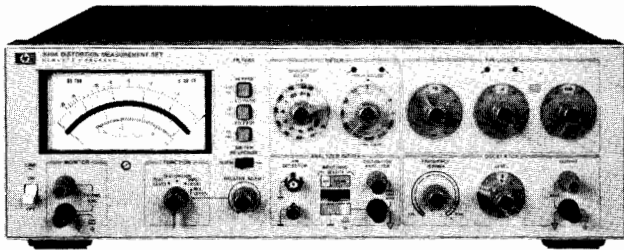

HP 339A

HP 339A Distortion Measurement Set

The HP 339A Distortion Measurement Set is an ultralow distortion measuring system complete with total harmonic distortion (THD) analyzer, true rms voltmeter, and sinewave oscillator. This lightweight bench instrument allows you to make THD measurements over the 10 Hz to 110 kHz frequency band, including harmonics to 330 kHz.

With the built-in tracking oscillator in the HP 339A, you only need to tune one instrument instead of two. Input filters are included to speed test time. The 30 kHz low pass filter provides the band limiting required by FCC proof-of-performance broadcast testing. An 80 kHz low pass filter and 400 Hz high pass filter reduce high frequency noise and line frequency hum.

Distortion Measurements

The fundamental frequency range is 10 Hz to 110 kHz with continuous frequency coverage with 2 digit resolution. The distortion analyzer and oscillator are tuned simultaneously. Distortion measurement range is 100% to 0.01%, (0 dB to -80 dB).

Specifications

Distortion measurement accuracy

20 Hz to 20 kHz: ± 1 dB
 10 Hz to 50 kHz: +1, -2 dB
 50 kHz to 110 kHz: +1.5, -4 dB

Distortion introduced by instrument (input > 1V rms)

10 Hz to 10 kHz <-95 dB (0.0018%) THD
 10 kHz to 20 kHz <-92 dB (0.0035%) THD
 20 kHz to 30 kHz <-90 dB (0.0056%) THD
 30 kHz to 50 kHz <-85 dB (0.01%) THD
 50 kHz to 110 kHz <-70 dB (0.032%) THD

Oscillator

Frequency range is 10 Hz to 100 kHz with 2 digit resolution. Output level is variable from 4V rms to 1 mV rms.

Oscillator distortion (>600 ohm load, <3 Vrms)

10 Hz to 20 kHz <-93 dB (0.0022%) THD
 20 kHz to 30 kHz <-85 dB (0.0056%) THD
 30 kHz to 50 kHz <-80 dB (0.01%) THD
 50 kHz to 80 kHz <-70 dB (0.032%) THD
 80 kHz to 110 kHz <-65 dB (0.056%) THD

Voltmeter

Range is 1 mV rms full scale to 300 V rms full scale (-60 dB to +50 dB with the meter calibrated in dBV to 600 ohms). Option 001 provides increased sensitivity to 0.1 mV rms (-80 dBV).

Voltmeter accuracy

1 mV to 300 V Ranges
 20 Hz to 20 kHz: $\pm 2\%$
 10 Hz to 110 kHz: $\pm 4\%$
 .1 mV and .3 mV ranges
 20 Hz to 20 kHz: $\pm 2\%$
 10 Hz to 30 kHz: $\pm 4\%$
 30 kHz to 80 kHz: +10% to -30%

General

Power: 100/120/220/240 V +5%, -10%, 48 Hz to 66 Hz line operation, 200 mA maximum.
Size: 146H x 426W x 375mmD (5.75" x 16.75" x 14.75")
Weight: net, 8.2kg (18lb); shipping, 11.3kg (25lb)

Ordering Information

HP 339A Distortion Measurement Set	\$4225
Opt 001 Increased Sensitivity	\$290
Opt W30 Extended Repair Service. See page 725.	\$105

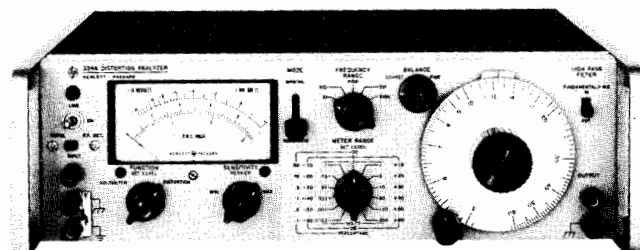

HP 334A

HP 334A Distortion Analyzer

The HP 334A Distortion Analyzer measures total distortion down to 0.1% full scale at any fundamental frequency between 5 Hz and 600 kHz; harmonics are indicated up to 3 MHz. Noise levels as low as 25 microvolts can be measured. The HP 334A includes automatic fundamental nulling and amplitude modulation detector. A meter with VU ballistic characteristics and a 30 kHz low pass filter are optional.

Specifications

Input level for distortion measurements: 0.3 V rms for 100% set level or 0.245 V for 0 dB set level (up to 300 V may be attenuated to set level reference).

Harmonic measurement accuracy (full scale) Fundamental input less than 30 V

Range	$\pm 3\%$	$\pm 6\%$	$\pm 12\%$
100%-0.3%	10 Hz-1 MHz	10 Hz-3 MHz	
0.1%	30 Hz-300 kHz	20 Hz-500 kHz	10 Hz-600 kHz

Fundamental rejection: >80 dB

Residual distortion: >-70 dB (0.003%) from 5 Hz to 200 kHz; >-64 dB (0.06%) from 200 kHz to 600 kHz. Meter indication is proportional to average value of a sine wave.

Frequency calibration accuracy: Better than $\pm 5\%$ from 5 Hz to 300 kHz. Better than $\pm 10\%$ from 300 to 600 kHz.

Input impedance: Distortion mode: 1 M Ω $\pm 5\%$ shunted by <70 pF
DC isolation: Signal ground may be ± 400 V dc from external chassis

Voltmeter range: 300 μ V to 300 V rms full scale (13 ranges) 10 dB per range. Average responding calibrated in rms.

Noise measurements: Voltmeter residual noise on the 300 μ V range: <25 μ V rms, when terminated in 600 (shielded) ohms.

Output: 0.1 ± 0.01 V rms open circuit

Output impedance: 2k Ω

Automatic nulling mode: Set level: at least 0.2 V rms

Frequency ranges: X1, manual null tuned to less than 3% set level; total frequency hold-in $\pm 0.5\%$ about true manual null. X10 through X10k, manual null tuned to less than 10% of set level; total frequency hold-in $\pm 1\%$ about true manual null.

Automatic null accuracy: 5 Hz to 100 Hz: meter reading within 0 to +3 dB of manual null. 100 Hz to 600 kHz: meter reading within 0 to +1.5 dB of manual null.

High pass filter: 3 dB point at 400 Hz with 18 dB per octave roll off. AM detector: 550 kHz to 65 MHz; 40 Vp-p max input.

Distortion introduced by detector: Carrier frequency: 550 kHz-1.6 MHz: <50 dB (0.3%) for 3-8 V rms carriers modulated 30%.

General

Power: 100V/120V/240V -10% +5%, 48-66 Hz
Size: 426W x 126H x 337mmD (16.75" x 5" x 13.25")
Weight: net, 7.89kg (17.75lb); shipping, 10.35kg (23lb)

Ordering Information

HP 334A Distortion Analyzer	\$3,810
Opt 001 VU Characteristics	+\$26
Opt 002 30 kHz Low Pass Filter	+\$134
Opt 003 (combined 001 and 002)	+\$155
Opt W30 Extended Repair Service See page 725.	+\$95

Price

SIGNAL ANALYZERS

Automated Spectrum Analysis

Model 3048A

Calibrated, Automated Phase Noise Measurements with

- Specified amplitude accuracy of ± 2 dB
- Offset frequency range of 0.01 Hz to 40 MHz

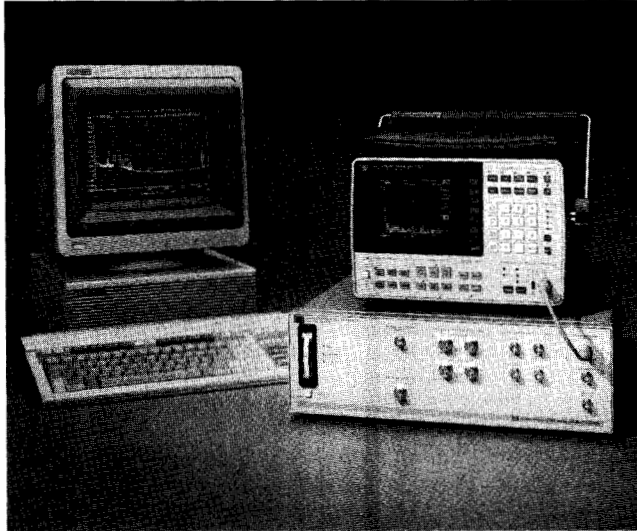

HP 3048A Phase Noise Measurement System controlled by an HP 98580C Desktop Computer.

The HP 3048A Phase Noise Measurement System uses the power of a flexible software program to automate phase noise carrier measurements. The basic HP 3048A system includes the HP 11848A Phase Noise Interface containing the phase detectors and phase lock loop circuitry, the HP 3561A Dynamic Signal Analyzer, measurement software, and a comprehensive operator training course. Using an HP 98580B Desktop Computer, this basic system will measure carrier frequencies from 5 MHz to 1.6 GHz (to 18 GHz with Option 201) and characterize the demodulated phase noise over an offset range of 0.01 Hz to 100 kHz. Adding other HP spectrum analyzers such as the HP 8566A/B, 8567A, 8568A/B, 8562A/B, 3585A/B, or 71000S, provides automated measurements to offsets of 40 MHz. A variety of signal generators such as the HP 8662A, 8663A, or 8642A/B can also be added to the system to provide a low-noise reference signal up to a frequency of 2.56 GHz. Adding an HP 11729C Carrier Noise Test Set in combination with an HP 8662A or HP 8663A provides a low-noise reference signal for measuring carrier signals up to 18 GHz.

The HP 3048A system software uses the HP 11848A interface to demodulate the phase noise of a carrier in the frequency range of 5 MHz to 18 GHz (and beyond with external, user-supplied mixers) and measures the resulting baseband signal with the analyzers. Measurement menus allow the operator to specify the measurement to be made and the system software controls the measurement process, including the calibration of the system. Several output formats are available to the user, including plots of the single sideband phase noise power of a signal, integrated noise power, or the calculated Allan variance. A real-time measurement mode is available to monitor the level of phase noise and discrete spurs as changes are made to the device under test.

As measured by the HP 3048A, the term "phase noise" includes all forms of a signal's frequency and phase instabilities. Randomly occurring frequency and phase noise modulation, as well as discrete sidebands resulting from power-line phase modulation and phase jitter, are detected and accurately measured. Coherent signals are displayed at the power level that was detected while random phase signals are normalized for a 1 Hz bandwidth. The HP 3048A system is optimized for several measurement techniques that are chosen based on the stability and tuning capability of the signal to be measured and the availability of comparable reference oscillators. The two primary techniques for demodulating the phase noise of a signal use either a phase detector or a frequency discriminator.

- Carrier frequency range from 5 MHz to beyond 18 GHz
- Spurs separated from noise spectra
- Optimization for several measurement techniques

Specifications Summary

Sensitivity:

The system's sensitivity is a function of the measurement technique that is used. The following graph indicates the sensitivity of the system as limited by its own internally-generated noise for a signal under test of +15 dBm. Also plotted is the phase noise that would limit the measurement sensitivity for a 1 GHz signal using HP signal generators as reference sources.

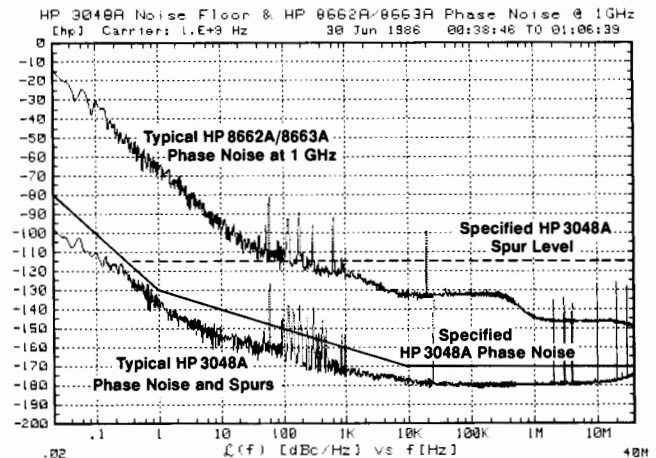

Carrier Frequency Range

Internal mixer: 5 MHz to 1.6 GHz, optional to 18 GHz.

External (user-supplied) mixer: The frequency range of the carrier is limited only by the frequency range of the external mixer or the frequency discriminator that is used.

Offset frequency range: 0.01 Hz to 100 kHz, extended to 40 MHz with an optional spectrum analyzer such as the HP 3585A/B.

Amplitude accuracy: ± 2 dB to 1 MHz offset; ± 4 dB for offsets greater than 1 MHz. This accuracy is verified by the system at the time of the measurement. The system advises the user of any potential accuracy degradations detected during measurement set-up.

Ordering Information

HP 3048A Phase Noise Measurement System **Price** \$34,000

Includes the HP 11848A Phase Noise Interface, HP 3561A Dynamic Signal Analyzer, measurement software and operator training

Reference oscillator options

Opt 001 Adds HP 8662A Opt. 003 Synthesized Signal Generator (0.01 to 1280 MHz) + \$37,650

Opt 002 Adds HP 8663A Opt. 003 Synthesized Signal Generator (0.01 to 2560 MHz) + \$57,750

Opt 003 Adds HP 11729C Carrier Noise Test Set (5 MHz to 18 GHz) + \$24,700

Opt 005 Adds HP 8642A Opt. 001 Synthesized Signal Generator (0.1 to 1057 MHz) + \$29,300

Opt 006 Adds HP 8642B Opt. 001 Synthesized Signal Generator (0.1 to 2114 MHz) + \$39,300

System Computer: HP 98580C Opt. 008 and Opt. 104, and HP-HIL Knob (HP 46083A) \$9,500

For full details on available system options and ordering information, see the HP 3048A Phase Noise Measurement System Technical Data (5953-8462).

- 10 MHz to 18 GHz
- Phase noise and AM noise measurements
- Low system noise floor

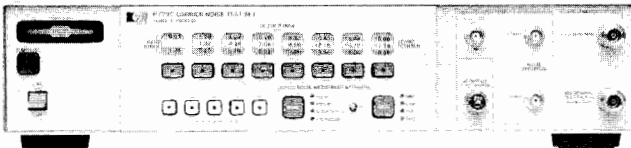

HP 11729C



HP 11729C Carrier Noise Test Set Versatile Phase and AM Noise Measurements

The HP 11729C, combined with an HP 8662A Synthesized Signal Generator and a baseband spectrum analyzer, provides a broadband measurement system for phase noise and AM noise measurements on microwave oscillators, 10 MHz to 18 GHz. The HP 11729C may be ordered with either full frequency coverage, or in a number of bands to specifically match the application. The HP 11729C supports both the phase detector and frequency discriminator phase noise measurement techniques, as well as AM noise measurements (with Opt. 130), at offsets from the carrier <math><1\text{ Hz}</math> to 10 MHz. The HP 11729C also supports pulsed AM and phase noise measurements.

The HP 11729C Carrier Noise Test Set is a fully programmable instrument. All functions can be automatically controlled via the HP Interface Bus. With an appropriate programmable baseband spectrum analyzer, the HP 11729C can be integrated into your own automatic system. By adding the HP 11729C and an HP 8662A or HP 8663A to the HP 3048A Phase Noise Measurement System automated, specified phase noise measurements can be made to 18 GHz.

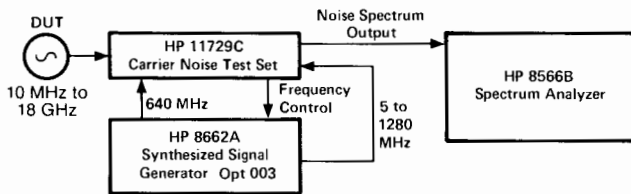

Complete carrier noise characterization system can be assembled from standard instruments.

Typical System Noise

The HP 11729C/8662A combination includes the critical low noise microwave reference signal (which determines the system noise floor). The HP 11729C also features a new Surface-Acoustic-Wave (SAW) filter which can be configured into an internal SAW oscillator. This built-in oscillator allows the HP 11729C to be used as a low-cost frequency discriminator system for measurements on free-running oscillators. This discriminator mode uses the HP 11729C in a "stand-alone" configuration, combined with a simple length of external delay line (such as RG 223 cable) and an available baseband analyzer.

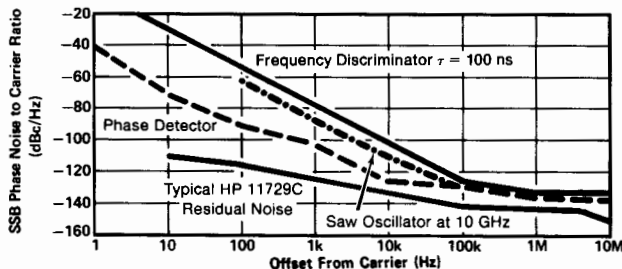

Figure 1. Typical HP 11729C/8662A and HP 11729C self-oscillator mode system sensitivity using the phase detector and frequency discriminator methods at X-Band. Typical HP 11729C residual noise.

Abbreviated HP 11729C/8662A Specifications

Frequency range: 10 MHz to 18 GHz in 8 bands.

Absolute system noise floor, phase detector method:

System noise is specified only when the HP 11729C is used with an HP 8662A or HP 8663A Option 003. See the HP 11729C data sheet for more information.

Test Signal Requirements

Amplitude: +7 dBm minimum to +18 dBm maximum (typically useable to -15 dBm with noise floor degradation).

HP 11729C Outputs

IF output

Bandwidth: 5 to 1280 MHz.

Level: +7 dBm minimum.

Noise spectrum outputs

1) Noise spectrum output <math><1\text{ MHz}</math>: dc coupled, 600 Ω nominal.

2) Noise spectrum output <math><10\text{ MHz}</math>: 10 Hz to 10 MHz, 50 Ω nominal, nominal 40 dB of gain over <math><1\text{ MHz}</math> output.

3) Auxiliary noise spectrum output: dc coupled, 600 Ω nominal.

Phase Lock Loop Function

Frequency control outputs

To crystal oscillator: $\pm 10\text{V}$.

To dc FM: $\pm 1\text{V}$.

Lock bandwidth factor: nominal 1, 10, 100, 1k, 10k selectable.

Remote Programming

All front panel functions are HP-IB programmable. In addition, the HP 11729C can output current settings and out-of-lock indication.

AM Noise Detection (Option 130)

Frequency: 10 MHz to 18 GHz.

Input level: 0 dBm minimum to +18 dBm maximum.

AM noise floor (at +10 dBm input level, dBc/Hz):

Offset from Carrier (Hz)	Typical	Specified
1k	-147	-138
10k	-152	-145
100k	-161	-155
1M	-165	-160

General

Operating temperature range: 0° to +55°C.

Power: 100, 120, 220, 240 V, +5%, -10%; 48 to 66 Hz; <math><75\text{ VA}</math> max.

Weight: net, 10.4 kg (23 lb); shipping, 13.6 kg (30 lb).

Size: 425 W x 99 H x 551 mm D (21.7" x 16.8" x 3.9"). 1 MW x 3 1/2 H x 20 D System II module.

Ordering Information

HP 11729C Carrier Noise Test Set (10 MHz to 18 GHz)¹

Price

\$24,700

Note: Each of options 003 to 027 (only one may be ordered) also includes 0.005 to 1.28 GHz coverage

Opt 003 (1.28 to 3.2 GHz) - \$8,500

Opt 007 (3.2 to 5.76 GHz) - \$8,500

Opt 011 (5.76 to 8.32 GHz) - \$8,500

Opt 015 (8.32 to 10.88 GHz) - \$8,500

Opt 019 (10.88 to 13.44 GHz) - \$8,500

Opt 023 (13.44 to 16.0 GHz) - \$8,500

Opt 027 (16.0 to 18.0 GHz) - \$8,500

Opt 130 AM noise detection + \$1,805

Opt 140 Rear panel connectors + \$515

Opt 907 Front handle kit (5061-9688) + \$57

Opt 908 Rack flange kit (5061-9674) + \$36

Opt 909 Rack flange kit with front handles (5061-9675) + \$82

Opt 910 A total of two sets of operation and service manuals (11729-90017) + \$36

¹ HP-IB cables not supplied. For description and prices, see page 569.

SIGNAL ANALYZERS

Vector Modulation Analysis, dc-350MHz, 50-200MHz
HP 8980A, 8981A

HP 8980A, HP 8981A

- Analyzes coherent phase and amplitude modulation
- 350 MHz Q vs. I bandwidth
- Markers for measuring phase, amplitude, and time
- 12 bit digitizing for HP-IB measurements.

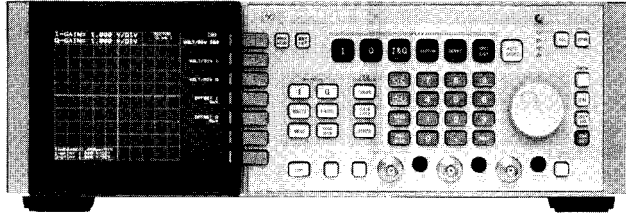

HP 8980A

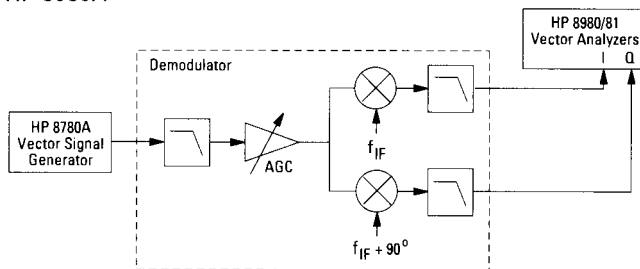

The HP 8980A Vector Analyzer and the HP 8780A Vector Signal Generator can be used to adjust and troubleshoot an I/Q demodulator directly. The I/Q outputs of the demodulator are connected directly to the HP 8980A. The HP 8980A Vector Analyzer can display the constellations of high-rate modulation schemes such as QPSK, 16QAM, 49PRS, 64QAM, and 56QAM. It also makes statistical measures of system quality like closure, lock angle error and quadrature error.

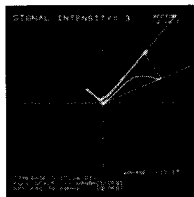

UMOP (Unintentional-Modulation-on-Pulse) is identified by quantitatively measuring the phase transients on a radar pulse with the delta-phase measurement marker.



Display of vector demodulated SAW chirp signals. The spiraling phase response indicates the changing chirp frequency and amplitude.

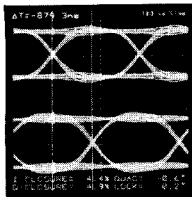

I & Q display: each I and Q channel is displayed vs. time on a separate grid, one above the other.

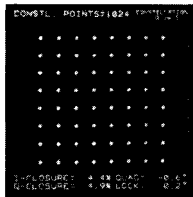

Constellation display: displays Q vs. I at the time instant defined by the time marker.

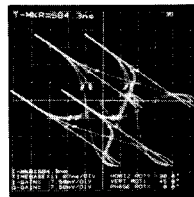

3D display: useful for visual, or intuitive, analysis of Q vs. I vs. time waveforms. Signal can be rotated about any of three axes for optimal viewing.

HP 8981A adds built-in I/Q demodulator with:

- 50 - 200 MHz modulated IF input frequency range
- 100 MHz baseband bandwidth with external I/Q filters and 35 MHz with internal filters
- Automatic internal/external demodulator calibration

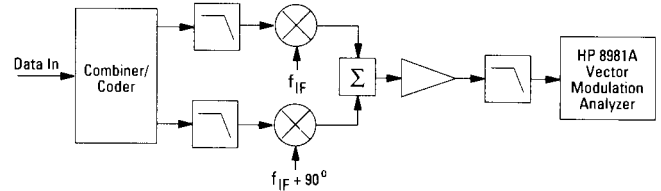

HP 8980/81A Vector Modulation Analyzer

The HP 8981A Vector Analyzer is a superset of the HP 8980A. It also analyzes the analog I and Q signals, but because it contains a calibrated demodulator it can be connected to the IF of the modulator. This gives the user the flexibility to examine the changes in modulation down through the receiver chain and isolate faults quickly.

Specifications

HP 8980A, 8981A

I and Q channels

Bandwidth (-3dB): 350 MHz dc coupled; approximately 1 KHz to 350 MHz, ac coupled

dc vector accuracy using internal ADC: $\pm 1\%$ of full scale (or 2mV if greater) $\pm 1\%$ of offset

Input termination: 50 ohms or 75 ohms

Input coupling: each channel independently; ac,dc, or ground (input disconnected)

Power Requirements

Voltage: 100, 120, 220, 240V ac, -10% to 10% ; 48-66Hz

Power: 245 Watts, 320 VA maximum

Dimensions: Package is 5/4 inch rack height, one module width 23D HP System II cabinet

Weight: net, approximately 20kg (45lb); shipping, approximately 24kg (53lb)

Demodulator Correction (HP 8981A only)

A powerful routine in the HP 8981A measures and corrects demodulator errors. This routine measures the internal demodulator or external demodulator quadrature error, I/Q gain imbalance, and DC offsets. The display and digitized outputs can then be automatically adjusted to correct for these errors.

HP 8981A Demod Mode Specifications

Modulated IF input frequency range: 50 MHz to 200 MHz.

Modulated IF input level range: -5 dBm to -20 dBm.

Coherent reference input frequency range: 50 MHz to 200 MHz.

Coherent reference input level range: $+10$ dBm to -20 dBm.

Baseband bandwidth (3 dB): 100 MHz with external filters. Supplemental characteristic of 35 MHz with internal filters.

Corrected vector dc accuracy at 70 MHz: (typical from 50 to 200 MHz) $< 2\%$ of full scale IF input.

Supplemental characteristics

Quadrature Error: Corrected: $\leq \pm 5^\circ$ Uncorrected: $\leq \pm 1^\circ$.

I/Q gain imbalance (dc to 10 kHz): Corrected: $\leq \pm 0.1$ dB. Uncorrected: $\leq \pm 0.25$ dB.

Ordering Information

HP 8980A Vector Analyzer

HP 8981A Vector Modulation Analyzer

HP 11748A Active probe system

Price

\$25,000

\$30,000

\$3,200

SIGNAL ANALYZERS

Audio Analyzer, 20 Hz to 100 kHz; Distortion Analyzer, 20 Hz to 100 kHz

Models 8903B, 8903E

149

- Measures distortion, SINAD, signal-to-noise
- Measures true-RMS ac volts, dc volts, frequency
- Low-distortion programmable source
- RMS, average and quasi-peak detection

- Measures distortion, SINAD
- Measures true-RMS ac volts, dc volts, frequency
- RMS, average and quasi-peak detection

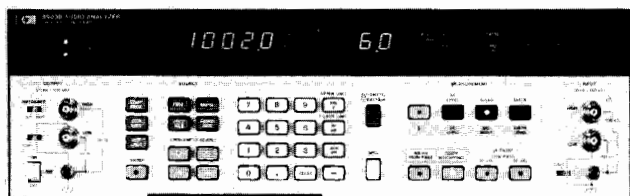

HP 8903B



HP 8903E



HP 8903B Audio Analyzer and HP 8903E Distortion Analyzer

The HP 8903B Audio Analyzer and HP 8903E Distortion Analyzer provide unparalleled versatility and performance for audio measurements from 20 Hz to 100 kHz. The HP 8903B combines the functionality of a low-distortion audio source, high-performance distortion analyzer, frequency counter, ac voltmeter, dc voltmeter and SINAD meter into one compact package. With microprocessor control of source and analyzer, the HP 8903B can perform stimulus-response measurements, such as signal-to-noise ratio and swept distortion, automatically with no additional equipment. The HP 8903E Distortion Analyzer is the analyzer portion of the HP 8903B Audio Analyzer. (The HP 8903E has no source.)

For ease of use, most measurements on the HP 8903B and HP 8903E are made with only one or two keystrokes. Both instruments automatically tune and autorange for maximum accuracy and resolution. For quick identification of input signals, the analyzer counts and displays the input frequency in all ac measurement modes.

Low Frequency Applications

The HP 8903B/E have many features which make difficult audio measurements easy. These include flexible data display formats, a selectable balanced or unbalanced input, plug-in filters, and automatic notch filter tuning. With the ratio key, you can establish a reference in % or dB and directly make frequency response and 3 dB bandwidth measurements without computation. A fully balanced analyzer input allows testing of bridged power amplifiers found in many radios and car stereos as well as professional balanced audio equipment.

With two internal plug-in filter slots and six optional filters to choose from, we simplify your audio measurements by providing the filter networks required by international standards. (See the next page for a complete list of filters.) The HP 8903B and HP 8903E both use true-RMS detection (for all signals with crest factor 3) for accurate measurement of complex waveforms and noise. Average and quasi-peak detectors are also available. (Quasi-peak is selectable only via HP-IB on the HP 8903E.) Accurate distortion measurements typically can be made down to less than -90 dB (0.003%) from 20 Hz to 20 kHz.

For receiver testing, both instruments have a tunable SINAD notch filter. On the HP 8903B, the filter is automatically tuned to the source frequency. With the HP 8903E, a front-panel key allows the operator to lock the notch filter at any given input frequency.

HP 8903B and HP 8903E Specifications

System Specifications

(HP 8903B only, source and analyzer combined)

Distortion

Residual distortion and noise (the higher of):

80 kHz BW: -80 dB (0.01%) or $17 \mu\text{V}$, 20 Hz to 20 kHz.

500 kHz BW: -70 dB (0.032%) or $50 \mu\text{V}$, 20 Hz to 50 kHz.

-65 dB (0.056%) or $50 \mu\text{V}$, 50 kHz to 100 kHz.

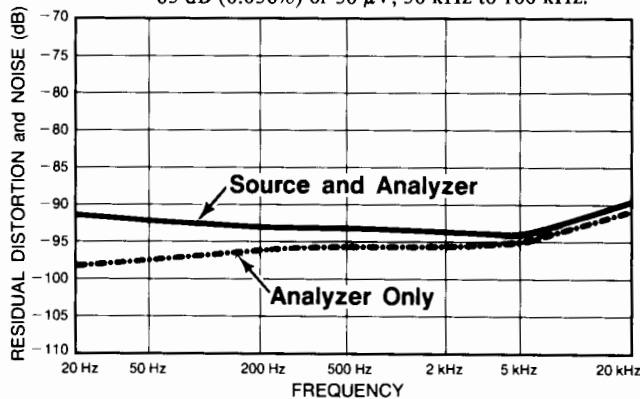

Typical residual THD + noise of source and analyzer combined (source voltage set to 1.5V, 80 kHz BW). Dashed line represents typical residual THD + noise for the analyzer only.

Signal-to-Noise

Frequency range: 50 Hz to 100 kHz.

Display range: 0 to 99.99 dB.

Accuracy: ± 1 dB.

Input voltage range: 50 mV to 300V.

Residual noise (the higher of): -85 dB or $17 \mu\text{V}$, 80 kHz BW; -70 dB or $50 \mu\text{V}$, 500 kHz BW.

Source Specifications (HP 8903B only)

Frequency

Range: 20 Hz to 100 kHz.

Resolution: 0.3%.

Accuracy: 0.3% of setting.

Output Level

Range: 0.6 mV to 6V open circuit.

Resolution: 0.3% or better.

Accuracy (open circuit): 2% of setting 60 mV to 6V, 20 Hz to 50 kHz; 3% of setting 6 mV to 6V, 20 Hz to 100 kHz; 5% of setting 0.6 mV to 6 mV, 20 Hz to 100 kHz.

Flatness (1 kHz reference): $\pm 0.7\%$ (± 0.06 dB), 20 Hz to 20 kHz; $\pm 2.5\%$ (± 0.22 dB), 20 Hz to 100 kHz.

Distortion and noise (the higher of):

80 kHz BW: -80 dB (0.01%) or $15 \mu\text{V}$, 20 Hz to 20 kHz.

500 kHz BW: -70 dB (0.032%) or $38 \mu\text{V}$, 20 Hz to 50 kHz.

-65 dB (0.056%) or $38 \mu\text{V}$, 50 kHz to 100 kHz.

Impedance: $600\Omega \pm 1\%$ or $50\Omega \pm 2\%$, Front panel selectable. (HP-IB programmable.)

Sweep mode: log sweep with up to 500 points per decade or 255 points total between entered start and stop frequencies.

HP 8903B and HP 8903E Analyzer Specifications

Distortion

Fundamental frequency range: 20 Hz to 100 kHz.

Display range: 0.001% to 100% (-99.99 to 0 dB).

Accuracy: ± 1 dB, 20 Hz to 20 kHz; ± 2 dB, 20 kHz to 100 kHz.

Input voltage range: 50 mV to 300V.

Residual distortion and noise (the higher of):

80 kHz BW: -80 dB (0.01%) or $15 \mu\text{V}$, 20 Hz to 20 kHz.

500 kHz BW: -70 dB (0.032%) or $45 \mu\text{V}$, 20 Hz to 50 kHz.

-65 dB (0.056%) or $45 \mu\text{V}$, 50 kHz to 100 kHz.

Supplemental Characteristics

3 dB measurement bandwidth: 10 Hz to 500 kHz.

Detection: true rms or rms calibrated average.

SINAD

Fundamental frequency range: 20 Hz to 100 kHz.

Display range: 0 to 99.99 dB.

Residual distortion and noise: same as listed under Distortion.

Accuracy: ± 1 dB, 20 Hz to 20 kHz; ± 2 dB, 20 kHz to 100 kHz.

Input voltage range: 50 mV to 300V.

Supplemental Characteristics

Detection: true rms or rms-calibrated average.

Tuning: HP 8903B: notch filter is tuned to the internal source frequency. HP 8903E: notch filter is tuned to the counted input frequency. Notch filter hold function available on front panel.

AC Level

Full range display: 300.0V, 30.00V, 3.000V, .3000V, 30.00 mV, 3.000 mV, 0.3000 mV.

Overrange: 33%, except on 300V range.

Accuracy: $\pm 2\%$, 50 mV to 300V, 20 Hz to 20 kHz; $\pm 4\%$, 0.3 mV to 50 mV, 20 Hz to 100 kHz; $\pm 4\%$, 50 mV to 300V, 20 kHz to 100 kHz.

Supplemental Characteristics

AC converter: true-rms responding for signals with crest factor up to 3, rms-calibrated average detection and quasi-peak.

3 dB measurement bandwidth: > 500 kHz.

DC Level

Full range display: 300.0V, 48.00V, 16.00V, 4.000V.

Overrange: 33%, except on 300V range.

Accuracy: $\pm 1.0\%$ of reading, 600 mV to 300V.
 ± 6 mV, $V_{in} < 600$ mV.

Frequency Measurement

Measurement range: 20 Hz to 150 kHz. (20 Hz to 100 kHz in distortion and SINAD modes.)

Resolution: 5 digits (0.01 Hz for input frequencies < 100 Hz).

Accuracy: $\pm (0.004\% + 1 \text{ digit})$.

Sensitivity: 50 mV in distortion and SINAD modes, 5.0 mV in ac level and signal-to-noise (HP 8903B only) modes.

Standard Audio Filters

30 kHz Low-Pass Filter

3 dB cutoff frequency: 30 kHz ± 2 kHz.

Rolloff: third-order Butterworth; 18 dB/octave or 60 dB/decade.

80 kHz Low-Pass Filter

3 dB cutoff frequency: 80 kHz ± 4 kHz.

Rolloff: third-order Butterworth; 18 dB/octave or 60 dB/decade.

Internal Plug-in Filter Options

Both the HP 8903B and HP 8903E have TWO internal plug-in filter slots, each of which will accept one of six optional filters. The standard HP 8903B and HP 8903E come with 30 kHz and 80 kHz low-pass filters, but with NO PLUG-IN FILTERS. The appropriate filter options must be ORDERED for the analyzers to have any of the filters listed below. Each filter option has TWO option numbers: the 010 series for the left filter slot and the 050 series for the right filter slot. Each filter option ordered (maximum of two) adds additional cost to the instrument.

Filters	Option Numbers Filter Position	
	Left Slot	Right slot
400 Hz High-Pass	010	050
CCITT Weighting Filter	011	051
CCIR Weighting Filter	012	052
C-MESSAGE Weighting Filter	013	053
CCIR/ARM Weighting Filter	014	054
"A" Weighting Filter	015	055

Analyzer Input

Input type: Balanced (full differential).

Input impedance: $100 \text{ k}\Omega \pm 1\%$ shunted by < 300 pF, each side to ground. (In dc-level mode the input resistance is $101 \text{ k}\Omega \pm 1\%$).

Max input (maximum peak input voltage, any combination of ac/dc):

HP 8903B: 425 volts peak, applied differentially or between either input to ground.

HP 8903E: 42 volts peak, Low side to ground.

425 volts peak, differentially or High side to ground.

CMRR: > 60 dB, 20 Hz to 1 kHz, $V_{in} < 2\text{V}$; > 45 dB, 20 Hz to 1 kHz; > 30 dB, 20 Hz to 20 kHz.

General

Temperature: operating, 0°C to 55°C ; storage, -55°C to 75°C .

Power: 100, 120, 220, or 240V (+5, -10%); 48-66 Hz. 100 or 120V +5, -10% ; 48-440 Hz. 100 VA maximum.

Weight: HP 8903B: net 12.3 kg (27 lb.); shipping 16.4 kg (36 lb.) HP 8903E: net 11.8 kg (26 lb.); shipping 15.9 kg (35 lb.)

Dimensions: 146 mm H x 425 mm W x 462 mm D. (5.75 x 16.8 x 18.2 in.)

Ordering Information

Analyzer Mainframes

	Price
HP 8903B Audio Analyzer¹	\$6,250
Opt 001 Input/output connectors on rear panel only	+ \$100
Opt 910 2 sets of operation/calibration (08903-90079) and service manuals (08903-90062)	+ \$285
Opt 915 service manual (08903-90062) supplied with instrument	+ \$120
Opt W30 Extended repair service. See page 725.	+ \$150
Opt W32 Calibration service. See page 725.	+ \$885

HP 8903E Distortion Analyzer¹

	\$4,235
Opt 001 Input/output connectors on rear panel only	+ \$210
Opt 910 Provides an additional operation and calibration manual (08903-90053) and two service manuals (08903-90065)	+ \$295
Opt 915 Add service manual (08903-90065)	+ \$132
Opt W30 Extended repair service. See page 725.	+ \$105

Options for both HP 8903B and HP 8903E

Opt 010 or 050 400 Hz High-Pass filter	+ \$210
Opt 011 or 051 CCITT Weighting filter	+ \$210
Opt 012 or 052 CCIR Weighting filter	+ \$210
Opt 013 or 053 C-Message Weighting filter	+ \$210
Opt 014 or 054 CCIR/ARM Weighting filter	+ \$210
Opt 015 or 055 "A" Weighting filter	+ \$210
Opt 907 Front handle kit (5061-9689)	+ \$55
Opt 908 Rack flange kit (5061-9677)	+ \$32.50
Opt 909 Rack flange kit (5061-9683) with front handles	+ \$80

¹HP-IB cables not included. For description and price, see page 569.

SIGNAL ANALYZERS

Modulation Analyzer, 150 kHz to 1300 MHz

Models 8901A, 8901B

151

- Measures AM and FM to 1% accuracy
- Measures RF frequency
- Measures RF power

- Low internal noise
- Completely automatic

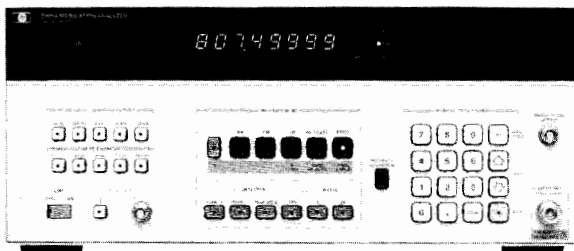

HP 8901A

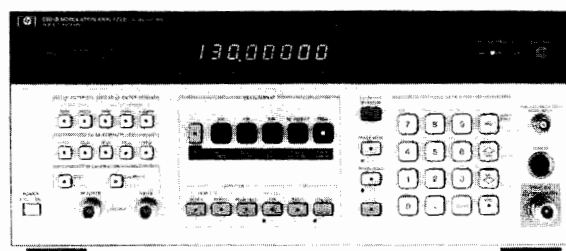

HP 8901B



HP 8901A and HP 8901B Modulation Analyzers

The HP 8901A and HP 8901B modulation analyzers combine the capabilities of several RF instruments to give complete, accurate characterization of modulated signals in the 150 kHz to 1300 MHz frequency range. Both instruments very accurately measure modulation and recover the modulation signal. They determine RF frequency and measure RF power. The major additional capabilities of the HP 8901B are its improved power meter accuracy, its ability to use external power sensors, to make adjacent channel power measurements or carrier noise measurements (with options 030-037) and its ability to count audio frequencies and measure distortion on 400 Hz and 1 kHz signals. Both instruments are fully automatic and make all major measurements with the push of a key or under HP-IB control.

Transmitter Testing

The HP 8901A/B has the features required to perform standard transmitter measurements. It measures transmitter power, counts frequency, and measures the signal modulation very accurately. The HP 8901B also characterizes the demodulated audio signal's frequency, level, and distortion. With Option 030 the HP 8901B can quickly and accurately make adjacent channel power measurements to CEPT standards.

RF Signal Characterization

The HP 8901A/B is an excellent lab & production tool for accurately characterizing RF signals.

Use the HP 8901A/B to make accurate AM/ØM and FM/AM conversion measurements of phase and amplitude sensitive devices such as bandpass filters and multiple channel receivers. Excellent isolation between AM and FM make it simple to separate the AM and ØM of AM stereo, incidental AM of FM transmitters and the AM, FM, and ØM components of complex signals.

Automatic Test Systems

The HP 8901A/B is an important component of automatic RF test systems. All functions are fully automatic and easily programmed. With these measurements combined into one instrument, interfacing requirements, hardware costs, and software development time are reduced.

HP 8901A and HP 8901B Specifications

RF Input

Frequency range: 150 kHz to 1300 MHz
Operating level: 12 mVrms to 7 Vrms.
Input impedance: 50Ω nominal.
Tuning: manual frequency entry, automatic, or track.
Acquisition time (automatic operation): ~1.5 seconds.
Maximum safe input level (typical): 35 Vrms (25W for source SWR <4), ac; 40V, dc.

Frequency Modulation

Rates: 20 Hz to 200 kHz.
Deviations: to 400 kHz.

Accuracy:

±2% of reading ±1 digit, 20 Hz to 10 kHz rates, 250 kHz to 10 MHz.
 ±1% of reading ±1 digit, 50 Hz to 100 kHz rates, 10 MHz to 1300 MHz.

Demodulated output distortion: <0.1% THD.

AM rejection (for 50% AM at 400 Hz and 1 kHz rates): <20 Hz peak deviation measured in a 50 Hz to 3 kHz BW.

Residual FM (50 Hz to 3 kHz BW): <8 Hz rms @ 1300 MHz, decreasing linearly with frequency to <1 Hz rms for 100 MHz and below.

Maximum deviation resolution: 1 Hz.

Stereo separation (50 Hz to 15 kHz): >47 dB typical.

Phase Modulation

Carrier frequency: 10 MHz to 1300 MHz.

Rates: 200 Hz to 20 kHz; typically usable from 20 Hz to 100 kHz with degraded performance.

Deviation: to 400 radians.

Maximum deviation resolution: 0.001 radian.

Accuracy: ±3% of reading ±1 digit.

Demodulated output distortion: <0.1% THD.

AM rejection (for 50% AM at 1 kHz rate): <0.03 radian peak deviation (50 Hz to 3 kHz BW).

Amplitude Modulation

Rates: 20 Hz to 100 kHz.

Depth: to 99%.

Accuracy:

±2% of reading ±1 digit, 50 Hz to 10 kHz rates, 150 kHz to 10 MHz.
 ±1% of reading ±1 digit, 50 Hz to 50 kHz rates, 10 MHz to 1300 MHz.

Flatness (variation in indicated AM depth for constant depth on input signal): ±0.3% of reading ±1 digit.

Demodulated output distortion: <0.3% THD.

FM rejection (at 400 Hz and 1 kHz rates, 50 Hz to 3 kHz BW): <0.2% AM.

Residual AM (50 Hz to 3 kHz BW): <0.01% rms.

Maximum depth resolution: 0.01%.

Frequency Counter

Range: 150 kHz to 1300 MHz.

Accuracy: ±3 counts of least significant digit ± reference accuracy.

Internal reference:

Frequency: 10 MHz.

Aging rate: <1x10⁻⁶/month (optional: 1x10⁻⁹/day).

Maximum resolution:

HP 8901A: 10 Hz for frequencies <1 GHz; 100 Hz for frequencies ≥1 GHz.

HP 8901B: 1 Hz.

HP 8901A RF Level (Peak Voltage Responding, RMS Sine Wave Power Calibrated)

Range: 1 mW to 1W.

Instrumentation accuracy: ±1.5 dB; 0.7 dB typical.

SWR: ≤1.3, 150 kHz to 650 MHz; ≤1.5, 650 MHz to 1300 MHz.

Maximum resolution: 0.001 mW for levels <0.01W.

HP 8901B RF Level (True RMS)**Frequency range with HP 11722A:** 100 kHz to 2.6 GHz.**Power range:** -20 dBm to +30 dBm.**RF range-to-range change error:**

±0.02 dB/RF range change from reference range.

Input SWR: <1.15, using HP 11722A Sensor Module.**Zero set (digital settability of zero):**

±0.5% ±1 digit of full scale on lowest range.

Decrease by a factor of 10 for each high range.

RF power resolution:

0.1% of full scale in watts or volts mode.

0.001 in dBm or dB relative mode.

HP 8901B Selective Power Measurements (Options 030-037)**Frequency range:** 10 MHz to 1.3 GHz.**Carrier power range:** +30 dBm to -20 dBm, 12.5, 25 and 30 kHz filters; +30 dBm to -10 dBm, Carrier Noise Filter.**Dynamic range:** 115 dB.**Carrier rejection (temp. ≤35° C):** >90 dB, for offsets ≥1 channel spacing or 5 kHz, whichever is larger.**Relative accuracy:** ±0.5 dB, levels ≥-95 dBc or levels ≥-129 dBc/Hz.**Power Reference****Power output:** 1.00 mW. Factory set to ±0.7%, traceable to the U.S. National Bureau of Standards.**Accuracy:** ±1.2% worst case (±0.9% rss) for one year (0°C to 55°C).**Audio Filters****High pass (3 dB cutoff frequency):** 50 Hz and 300 Hz**Low pass (3 dB cutoff frequency except >20 kHz filter):** 3 kHz, 15 kHz, >20 kHz.**De-emphasis filters:** 25 μs, 50 μs, 75 μs, and 750 μs.**Calibrators (Standard HP 8901B, Option 010 HP 8901A)****AM calibrator depth and accuracy:** 33.33% depth, nominal; internally calibrated to an accuracy of ±0.1%.**FM calibrator deviation and accuracy:** 34 kHz peak deviation, nominal; internally calibrated to an accuracy of ±0.1%.**General Characteristics****Operating temperature range:** 0° to 55°C.**Power requirements:** 100, 120, 220, or 240V (+5%, -10%); 48-66 Hz; 200 VA max.**Weight:** HP 8901A—net 20 kg (44 lb), shipping 25 kg (55 lb);

HP 8901B—net 23 kg (52 lb), shipping 31 kg (69 lb).

Size: HP 8901A, 190 mm H x 425 mm W x 468 mm D (7.5 in. x 16.8 in. x 18.4 in.); HP 8901B, 190 mm H x 425 mm W x 551 mm D (7.5 in. x 16.8 in. x 21.7 in.)**Ordering Information**

	Price
HP 8901A Modulation Analyzer¹	\$10,200
Opt 001 RF connectors on rear panel only	+\$113
Opt 002 1x10 ⁻⁹ /day internal reference	+\$825
Opt 003 Connections for external local oscillator	+\$440
Opt 004 Operation from 48 to 440 Hz power (Temp. <40°C)	+\$290
Opt 010 AM and FM calibrators	+\$670
Opt 910 A total of 2 sets of operating (08901-90031) and service manuals (08901-90032)	+\$255
Opt W30 Extended repair service. See page 725.	+\$200
HP 8901B Modulation Analyzer¹	\$14,400
Opt 001 RF connectors on rear panel only	+\$232
Opt 002 1x10 ⁻⁹ /day internal reference	+\$800
Opt 003 Connections for external local oscillator	+\$410
Opt 004 Operation from 48 to 440 Hz power (Temp. <40°C)	+\$310
Opt 021 Add HP 11722A Sensor Module	+\$2,210
Opt 030 High selectivity (select only 2 filter options) (Options 032-037 require Option 030; Option 030 includes Option 003 connections for external local oscillators.)	+\$2,625
Opt 032 12.5 kHz filter	\$0
Opt 033 20.0/25.0 kHz filter	\$0
Opt 035 Cellular Radio Filter	\$0
Opt 037 Carrier Noise Filter	\$0

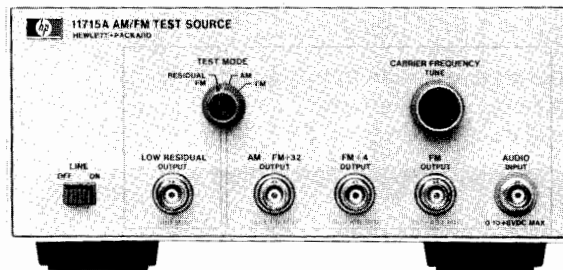
¹HP-IB cables not included. For description and prices, see page 569**HP 11715A****Opt 910** 2 sets of operation/calibration (08901-90113) and service manuals (08901-90114) +\$360**Opt 915** Service manual (08901-90114) supplied with instrument +\$150**Opt W30** 2 years additional hardware service +\$260**HP 11715A AM/FM Test Source**

The HP 11715A AM/FM Test Source provides very flat, wide-bandwidth, and low distortion amplitude or frequency modulated RF signals. Designed primarily for performance tests and adjustments of the HP 8901A/B Modulation Analyzer and HP 8902A Measuring Receiver, it will also serve as a high quality modulated test oscillator where its frequency ranges apply.

The major components of the HP 11715A are a low-noise voltage controlled oscillator (VCO), two digital dividers, and a double-balanced mixer. The VCO is the primary signal source, with a typical frequency range of 330 to 470 MHz at the FM OUTPUT. FM is produced by directly coupling the external modulation source to the VCO's tune input, providing very wide bandwidth modulation with low phase shift. This design also ensures very little incidental AM.

The HP 11715A can also be used in conjunction with an HP 8901A/B and an HP 8902A as a calibrated signal source for special applications. In particular, the U.S. commercial FM broadcast band of 88 to 108 MHz is covered by the FM ÷ 4 OUTPUT of the HP 11715A.

HP 11715A Specifications**FM Outputs****Frequency range:**

11 to 13.5 MHz, AM FM ÷ 32 output.

88 to 108 MHz, FM ÷ 4 output.

352 to 432 MHz, FM output.

Peak deviation:

>12.5 kHz, 11 to 13.15 MHz carrier.

>100 kHz, 88 to 108 MHz carrier.

>400 kHz, 352 to 432 MHz carrier.

Distortion:

<0.025% THD (<-72 dB) for

Carrier frequency	Peak deviation	Modulation rate
12.5 MHz	12.5 kHz	<10 kHz
100 MHz	100 kHz	<100 kHz
400 MHz	400 kHz	<100 kHz

Flatness:

±0.1%, dc to 100 kHz rates.

±0.25%, dc to 200 kHz rates.

Stereo separation (88 to 108 MHz carrier, 75 kHz peak deviation, 1 kHz rate): >60 dB typical.**AM Output****Frequency range (AM FM ÷ 32 output):** 11 to 13.5 MHz.**Depth:** to 99%.**Distortion:**

<0.05% THD (<-66 dB), 50% AM, 20 Hz to 100 kHz rates.

<0.1% THD (<-60 dB), 95% AM, 20 Hz to 100 kHz rates.

Flatness: ±0.1%, 50 Hz to 50 kHz rates;

±0.25%, 20 Hz to 100 kHz rates.

Linearity: ±0.1%, <95% AM; ±0.2%, <99%.**Ordering Information****HP 11715A AM/FM Test Source** \$2,730**Opt 910** A total of 2 sets of operating and service manuals (11715-90004) +\$25

SIGNAL ANALYZERS

Measuring Receiver, 150 kHz to 1300 MHz

Model 8902A

153

- RF power: digital power meter accuracy
- Tuned RF level: 0 dBm to -127 dBm dynamic range
- Carrier Noise: AM and phase noise measurements to -140 dBc/Hz

- AM and FM, 1% accuracy; \emptyset M, 3% accuracy
- RF frequency: 1 Hz resolution
- Audio: frequency, level and distortion

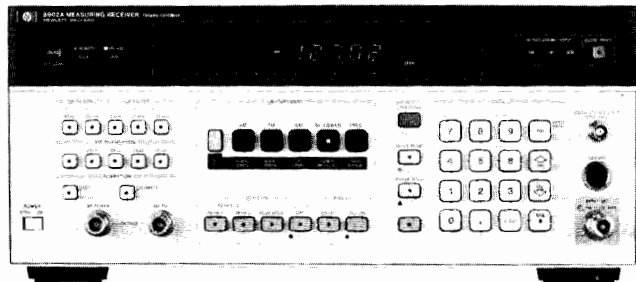

HP 8902A 

HP 8902A Measuring Receiver

The HP 8902A Measuring Receiver combines six precise measurement functions into one fully automatic, HP-IB programmable instrument. It accurately measures RF power, tuned RF level, carrier noise/adjacent channel power, modulation and RF frequency, and characterizes audio signals. For precise signal analysis, the HP 8902A Measuring Receiver provides the performance you need.

Metrology and Calibration

The HP 8902A Measuring Receiver makes signal generator and attenuator calibration easier than ever before. As the main component in the HP 8902AT Attenuator Calibration System and the HP 8902SG Signal Generator Test System, the HP 8902A provides exceptional accuracy, wide dynamic range and a broad range of measurements.

The HP 8902A quickly and accurately measures your signal generator's RF frequency, RF level flatness, output level accuracy to -127 dBm, AM and FM with 1% accuracy, incidental and residual AM, FM and phase modulation, carrier noise down to -140 dBc/Hz and characterizes the demodulated audio signals.

For attenuator calibration and other relative measurements, the HP 8902A gives you the accuracy and dynamic range you need. Option 050 gives $\pm(0.015 \text{ dB} + 0.005 \text{ dB}/10 \text{ dB})$ relative power accuracy to test attenuators to the most stringent specifications.

RF Signal Characterization

The HP 8902A Measuring Receiver is an excellent lab and production tool for accurately characterizing RF signals from 150 kHz to 1300 MHz.

Level measurements down to -127 dBm with superb accuracy make the HP 8902A ideal for testing devices such as antennas, multiplexers, log/linear amplifiers, filters and mixers. Unlike diode detectors, the HP 8902A's power meter accurately measures signals with harmonics and spurious.

The HP 8902A makes accurate AM to \emptyset M and FM to AM conversion measurements of phase and amplitude sensitive devices such as bandpass filters and multiple channel receivers. Excellent isolation between AM and FM makes it simple to separate the AM and \emptyset M of AM stereo, incidental AM of FM transmitters and the AM, FM and \emptyset M components of complex signals.

Automatic Test Systems

The HP 8902A is an important component of automatic RF test systems. All functions — power, level, frequency count, carrier noise, modulation, audio analysis — are fully automatic and easily programmed. With these measurements combined into one instrument, interfacing requirements, hardware costs, and software development time are reduced.

HP 8902A Specifications

RF Power (with HP 11722A Sensor Module)

Range: +30 dBm (1W) to -20 dBm (10 μ W).

Frequency range: 0.1 MHz to 2.6 GHz.

Linearity: $\pm 0.02 \text{ dB}$ (within range) $\pm 0.02 \text{ dB}$ per range change from reference range ± 1 count LSD.

Input SWR: < 1.15.

Tuned RF Level

Range: 0 dBm to -127 dBm.

Frequency range: 2.5 MHz to 1300 MHz.

Relative accuracy: $\pm 0.02 \text{ dB} \pm 0.02 \text{ dB}$ per IF range change $\pm 0.04 \text{ dB}$ per RF range change ± 1 digit.

Worst case cumulative relative power accuracy (with Opt 050)^{1,2}:

$\pm 0.005 \text{ dB}/10 \text{ dB}$ step (0 to -100 dBm).

$\pm 0.050 \text{ dB}/10 \text{ dB}$ step (-100 to -120 dBm).

$\pm 0.015 \text{ dB} \pm 1$ digit.

Selective Power Measurements (Carrier Noise, Options 030-037)

Frequency range: 10 MHz to 1300 MHz.

Carrier power range:

+30 dBm to -20 dBm; 12.5 kHz, 25 kHz and 30 kHz filters.

+30 dBm to -10 dBm; Carrier Noise filter.

Relative measurement accuracy:

$\pm 0.5 \text{ dB}$; levels > -95 dBc; 12.5 kHz, 25 kHz and 30 kHz filters.

$\pm 0.5 \text{ dB}$; levels > -129 dBc/Hz; Carrier Noise filter.

Filter bandwidths: 2.5 kHz, Carrier Noise filter; 8.0 kHz, 12.5 kHz filter; 16.0 kHz, 25 kHz filter; 30.0 kHz, Cellular Radio filter.

RF Frequency

Range: 150 kHz to 1300 MHz.

Maximum resolution: 1 Hz.

Amplitude Modulation

Rates: 20 Hz to 100 kHz.

Depths: to 99%.

Accuracy: $\pm 1\%$ of reading ± 1 digit, for rates 50 Hz to 50 kHz and depths $\geq 5\%$.

Frequency Modulation

Rates: 20 Hz to 200 kHz.

Deviations: to 400 kHz.

Accuracy: $\pm 1\%$ of reading ± 1 digit, for rates 50 Hz to 100 kHz.

Phase Modulation

Rates: 200 Hz to 20 kHz.

Deviations: to 400 radians.

Accuracy: $\pm 3\%$ of reading ± 1 digit.

Audio Level, Frequency and Distortion Capability

Audio Level

Accuracy: $\pm 4\%$ of reading, 100 mV to 3V.

Audio Frequency

Display resolution: 6 digits, to 250 kHz.

Audio Distortion

Accuracy: $\pm 1 \text{ dB}$, 400 Hz and 1 kHz.

¹Specifications are warranted when using a Hewlett-Packard synthesized source with less than 100 Hz peak residual FM measured in a 3 kHz post detection bandwidth over a 30-second period.

²Accuracy specifications do not include mismatch uncertainty.

SIGNAL ANALYZERS

Measuring Receiver, Sensor Module, Verification Kit

Models 8902A, 11722A, 11812A

Ordering Information

HP 8902A Measuring Receiver¹	Price
Opt 001 Rear panel instead of front panel connections for input, modulation output, and calibrators	\$25,550
Opt 002 1×10^{-9} /day internal reference oscillator	+ \$232
Opt 003 RF connectors on rear panel only	+ \$800
Opt 004 Operation from 48 Hz to 400 Hz power line (temp. $<40^{\circ}\text{C}$)	+ \$410
Opt 021 Add HP 11722A Sensor Module	+ \$310
Opt 030 High selectivity (select only two filter options)	+ \$2,210
(Options 032-037 require Option 030. Option 030 includes Option 003 connections for external local oscillator.)	+ \$2,625
Opt 032 12.5 kHz Filter	\$0
Opt 033 25.0 kHz Filter	\$0
Opt 035 Cellular Radio Filter	\$0
Opt 037 Carrier Noise Filter	\$0
Opt 050 Increased power measurement accuracy	+ \$3,710
Opt 907 Front handle kit (5061-9690)	+ \$67
Opt 908 Rack flange kit (5061-9678)	+ \$36
Opt 909 Rack flange kit (5061-9684) with front handles	+ \$93
Opt 910 Provides an additional operation and calibration manual (08902-90029) and two service manuals (08902-90031)	+ \$370
Opt 915 Add service manual (08902-90031)	+ \$155

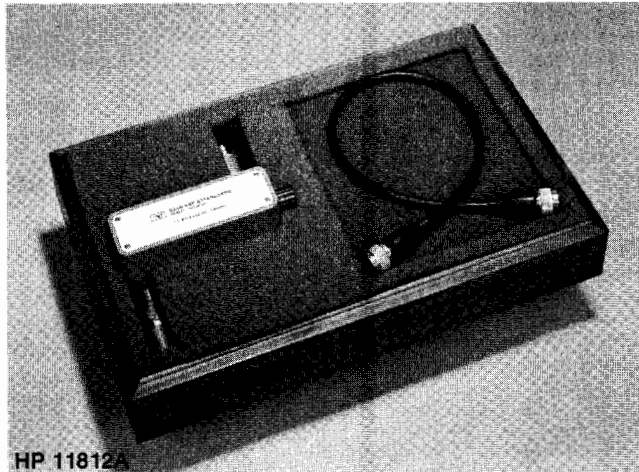

HP 11812A

HP 11812A Verification Kit

The HP 11812A Verification Kit is available to verify the performance of the HP 8902A Option 050 tuned RF level function to $\pm(0.015 \text{ dB} + 0.010 \text{ dB}/10 \text{ dB step})$. The kit consists of a step attenuator, two 10 dB pads semi-permanently attached, a cable, and a case.

HP 11812A Specifications

Frequency: 30 MHz.

HP 11812A accuracy: $\pm(0.003 \text{ dB} + 0.003 \text{ dB}/10 \text{ dB step})$.

Option 050 worst case cumulative tuned RF level accuracy verified with the HP 11812A:

$\pm 0.010 \text{ dB}/10 \text{ dB step}$ (0 to -100 dBm)

$\pm 0.050 \text{ dB}/10 \text{ dB step}$ (-100 to -120 dBm)

$\pm 0.015 \text{ dB} \pm 1 \text{ digit}$.

Ordering Information

HP 11812A Verification Kit

¹HP-IB cables not included. For description and prices, see page 569

Price

\$2,110

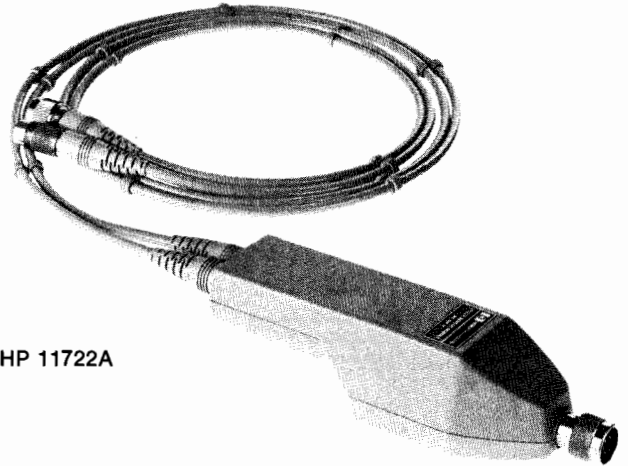

HP 11722A

HP 11722A Sensor Module

The HP 11722A Sensor Module was designed for use with the HP 8901B Modulation Analyzer and HP 8902A Measuring Receiver. The HP 11722A contains a silicon monolithic thermocouple as a power sensing element.

With the HP 11722A Sensor Module, you get all the performance of the HP 8901B or HP 8902A, plus superb power measurement accuracy, at a single connector. You can characterize a signal without switching back and forth between the power sensor and the analyzer's RF input.

Each HP 11722A Sensor Module is individually calibrated, traceable to the U.S. National Bureau of Standards. The calibration factors are printed on the sensor module for easy reference. Enter these factors into the HP 8901B or HP 8902A's non-volatile memory and the instrument automatically compensates for the power sensor's efficiency and mismatch loss at each frequency.

HP 11722A Specifications

Frequency range: 100 kHz to 2.6 GHz.

Power range: +30 dBm (1 watt) to -20 dBm ($10 \mu\text{W}$).

Input SWR (connected to an HP 8901B or 8902A): <1.15 , for RF power measurements.

Power sensor linearity: +2%, -4%; +30 dBm to +20 dBm. Negligible deviation, levels $<+20 \text{ dBm}$.

Calibration factors: Each HP 11722A Sensor Module is individually calibrated. The calibration factors are printed on the HP 11722A Sensor Module for easy reference.

Cal Factor Uncertainty

Frequency	RSS Uncertainty	Worst Case Uncertainty
0.1 MHz	0.7%	1.6%
0.3 MHz	0.7%	1.6%
1.0 MHz	0.8%	1.7%
3.0 MHz	0.8%	1.7%
10.0 MHz	0.9%	2.0%
30.0 MHz	0.9%	2.0%
50.0 MHz	0.0% (ref.)	0.0% (ref.)
100.0 MHz	1.1%	2.2%
300.0 MHz	1.1%	2.2%
1000.0 MHz	1.1%	2.2%
2600.0 MHz	1.2%	2.3%

Ordering Information

HP 11722A Sensor Module

Opt 910 Additional operating and service manual

Price

\$2,215

+ \$10

SIGNAL ANALYZERS

Attenuator Calibration System

Models 8902AT, 11806B, 11823A/B/C

155

- Exceptional accuracy: ± 0.015 dB ± 0.005 dB/10 dB
- 100 dB dynamic range

- Tests fixed, manual, and programmable attenuators
- 10 MHz to 26.5 GHz

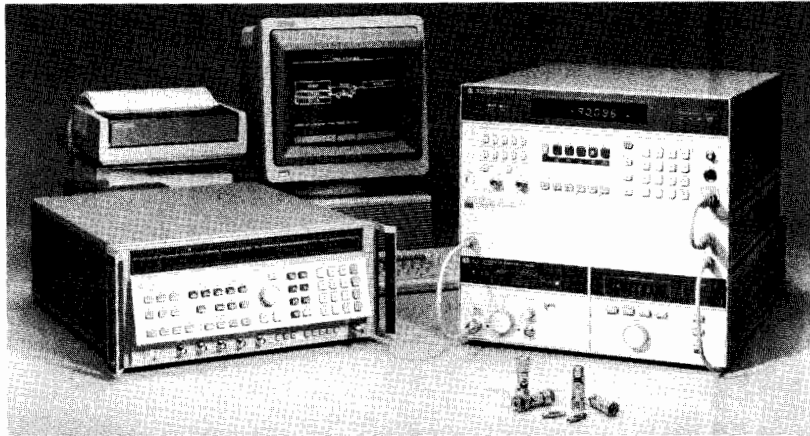

HP 8902AT

HP 8902AT Attenuator Calibration System

The HP 8902AT offers the total solution for attenuator calibration. It is configured for optimal performance from 10 MHz to 18 GHz. Option 026 extends the superb performance to 26.5 GHz. The HP 8902AT combines the exceptional accuracy of the HP 8902A Option 050 with the HP 11806B Attenuator Test Software to give you precise results with the speed of automation.

The HP 8902AT minimizes measurement uncertainty by specifying 0.005 dB/10 dB attenuation accuracy, monitoring the output power of the attenuator source, and automatically adjusting for any amplitude instabilities. This provides you with state-of-the-art accuracy, simply and repeatably.

The HP 8902AT includes the HP 11806B Attenuator Test Software, HP 8902A Option 050 Measuring Receiver, HP 11793A Microwave Converter, local oscillator, attenuator source, power splitter, power sensor, attenuator accessory kit, and SWR accessory kit. For a detailed list of equipment see the HP 8902S Ordering Guide.

Accessory Kits

The HP 8902AT Attenuator Calibration System includes an attenuator accessory kit and an SWR accessory kit. The HP 11823A/B Attenuator Accessory Kit includes 10 dB matching attenuators and adapters to test attenuators with Type-N, APC-3.5, and APC-7 connectors. The HP 11823C SWR Accessory Kit includes precision SWR bridges, opens, shorts, and terminations.

HP 11806B Attenuator Test Software

The HP 11806B provides the efficiency and repeatability of automation for attenuator calibration. By entering a table of frequencies, levels and specification limits, you can test any RF or microwave attenuator - fixed, manual or programmable - quickly and accurately.

The HP 11806B offers flexibility and ease of use with user-selectable averaging, various output formats, and flexible hardware configurations. With additional features such as statistical analysis, multiple test frequencies, and supporting multiple attenuator sources the HP 11806B is the ideal software pac for all your attenuator calibration needs.

HP 8902AT Specifications

Frequency Range:

10 MHz to 18 GHz,
10 MHz to 26.5 GHz, Option 026.

Dynamic Range:

+10 dBm to -117 dBm, 10 MHz to 1300 MHz,
0 dBm to -100 dBm, 1300 MHz to 18 GHz,
0 dBm to -95 dBm, 18 GHz to 26.5 GHz.

Attenuation Accuracy:¹

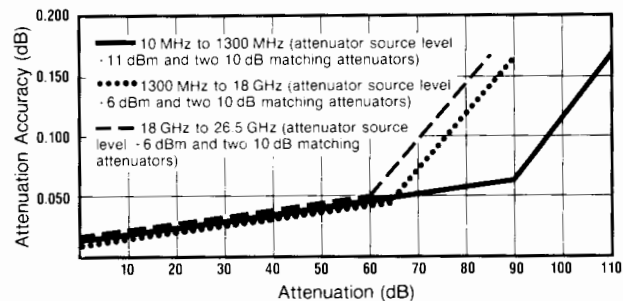

For optimal dynamic range the attenuator source level can be increased to -11 dBm and smaller matching attenuators can be used. This results in an additional 0.1 dB uncertainty for frequencies 1300 MHz to 26.5 GHz.

Ordering Information

	Price
HP 8902AT Attenuator Calibration System	\$121,550
Opt 026 26.5 GHz coverage	+\$45,300
HP 11806B Attenuator Test Software	\$3,090
HP 11823A Attenuator Accessory Kit	\$5,660
HP 11823B Attenuator Accessory Kit	\$6,690
HP 11823C SWR Accessory Kit	\$20,100

¹Accuracy specifications do not include mismatch uncertainty.

SIGNAL ANALYZERS

Signal Generator Test System

Models 8902SG, 11808A

- Frequency coverage to 26.5 GHz
- Powerful software offers simple test modifications

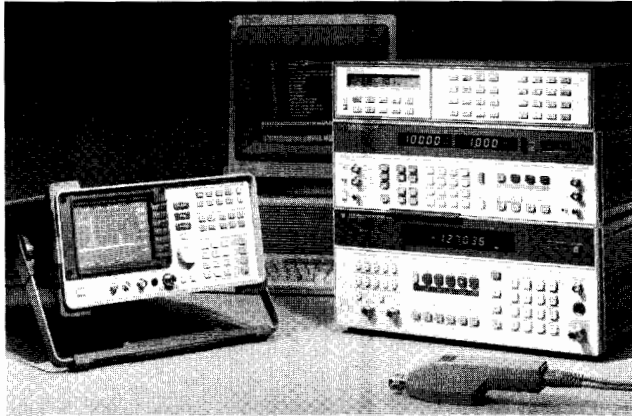

HP 8902SG

HP 8902SG Signal Generator Test System

The HP 8902SG Signal Generator Test System provides a versatile and powerful solution for testing RF and microwave signal generators. System hardware provides accurate measurements and complete automation; the dedicated software adds flexibility, speed, and ease-of-use.

The standard system includes the HP 8902A Measuring Receiver, the HP 8903B Audio Analyzer, an HP 8562B Spectrum Analyzer, and the HP 3488A Switch Control Unit to provide complete automation. The HP 11808A Signal Generator Performance Test Software is included, as are all cables and adapters required to complete the system. Options 018 and 026 add the HP 11793A Microwave Converter and a synthesized local oscillator to extend measurement capabilities to microwave frequencies.

Many common signal generator performance tests can be run with the 8902SG. Tests such as Output Level Accuracy, Output Flatness, AM and FM Accuracy are but a few of those available. The system can be expanded to offer additional tests such as Pulse Rise/Fall time and third order intermodulation distortion. The system software is easily updated to reflect changes in the test equipment used.

HP 8902SG Specifications

RF Frequency

Range: 150 kHz to 1300 MHz, standard system.
150 kHz to 18 GHz, Opt 018.
150 kHz to 26.5 GHz, Opt 026.

RF Power

Range: +30 dBm to -20 dBm, standard system.
+30 dBm to -20 dBm, options 018 and 026.
Frequency range: 100 kHz to 2600 MHz, standard system,
50 MHz to 18 GHz, Option 018,
50 MHz to 26.5 GHz, Option 026.

Tuned RF Level

Frequency range: 2.5 MHz to 1300 MHz, standard system,
2.5 MHz to 18 GHz, Option 018,
2.5 MHz to 26.5 GHz, Option 026.
Range: +10 dBm to -117 dBm, 2.5 MHz to 1300 MHz,
0 dBm to -100 dBm, 1300 MHz to 18 GHz (Options 018 & 026),
0 dBm to -95 dBm, 18 GHz to 26.5 GHz, (Option 026).
Relative accuracy: ± 0.02 dB ± 0.02 dB per IF range change ± 0.04 dB per RF range change ± 1 digit.

- Fully automated system: more thorough testing in less time
- Fast, accurate, and repeatable measurements

Amplitude Modulation

Rates: 20 Hz to 100 kHz.

Depths: to 99%.

Accuracy: $\pm 1\%$ of reading ± 1 digit, for rates 50 Hz to 50 kHz and depths $\geq 5\%$.

Frequency Modulation

Rates: 20 Hz to 200 kHz.

Deviations: to 400 kHz.

Accuracy: $\pm 1\%$ of reading ± 1 digit, rates 50 Hz to 100 kHz.

Phase Modulation

Rates: 200 Hz to 20 kHz.

Deviations: to 400 radians.

Accuracy: $\pm 3\%$ of reading ± 1 digit.

Audio Source

Frequency range: 20 Hz to 100 kHz.

Frequency accuracy: 0.3% of setting.

Audio Analyzer

Distortion frequency range: 20 Hz to 100 kHz fundamentals.

Distortion accuracy: ± 1 dB, 20 Hz to 20 kHz.

General

Temperature: Operating, 0°C to 55°C; Storage, -25°C to 75°C.

Power: 100, 120, 220, or 240V (+5%, -10%); 48-66 Hz.

HP 11808A Signal Generator Performance Test Software

The HP 11808A software provides 29 common performance tests for RF and microwave signal generators. The software is structured so that tests are defined by data files; data files for HP signal generators are included with the software - others can be created easily through simple screen entries.

The software supports the equipment in the HP 8902SG configurations, as well as other types such as digital scopes, digital voltmeters, and function generators. Instruments in the system can be indicated quickly in the program through the use of soft-keys and the configuration can be stored for later use.

Ordering Information

Ordering Information	Price
HP 8902SG Signal Generator Test System	\$79,400
Opt 018 Extension to 18 GHz operation	+ \$37,100
Opt 026 Extension to 26.5 GHz operation	+ \$61,800
HP 11808A Signal Generator Performance Test Software	\$5,660

SIGNAL ANALYZERS

150 kHz to 26.5 GHz

Models 8902S, 11792A, 11793A, 11794A

157

- RF power: digital power meter accuracy
- Tuned RF level: 0 dBm to -100 dBm dynamic range
- AM and FM: 1% accuracy, Φ M: 3% accuracy



- Carrier Noise (AM and phase noise measurements): ± 0.5 dB accuracy
- RF frequency: 10 Hz resolution
- Audio: frequency, level and distortion

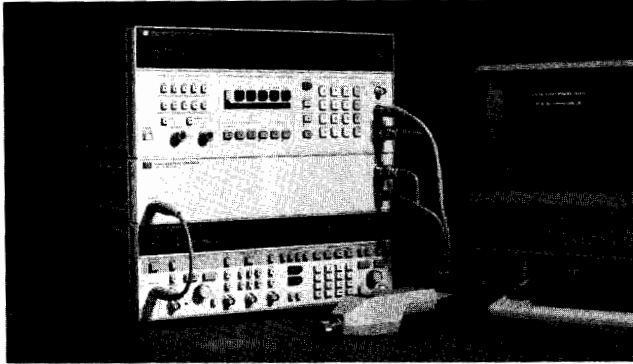

HP 8902S

HP 8902S Measurement System

The HP 8902S Measurement System extends the superb measurement performance of the HP 8902A Measuring Receiver to microwave frequencies. The frequency is extended by adding an HP 11793A Microwave Converter and a local oscillator. With the HP 11792A Sensor Module the system delivers the accuracy and resolution of a high performance power meter to 26.5 GHz from +30 dBm to -100 dBm. It accurately measures AM, FM, and Φ M (including residuals and incidentals) with a single keystroke. Adding options 030-037 to the HP 8902A extends the system's capability to include carrier noise measurements. The HP 8902S counts signals to 26.5 GHz with 10 Hz resolution and excellent long-term frequency stability.

The HP 8902S provides flexibility in specifying a solution that meets your exact needs. It can be configured for attenuator calibration, signal generator performance testing, and general signal characterization. For dedicated, preconfigured systems the HP 8902AT Attenuator Calibration System and the HP 8902SG Signal Generator Test System are available.

System Software

Under the control of the HP 11794A Software Pac, the HP 8902S Measurement System functions as a single instrument. You select the frequency and measurement from the front panel of the HP 8902A. The software then calculates and sets the local oscillator frequency, then releases the HP 8902A to make the measurement and display the results.

For a fully automated system the HP 8902S is supported by the HP 11806B Attenuator Test Software and HP 11808A Signal Generator Performance Test Software.

HP 11793A Microwave Converter

The HP 11793A Microwave Converter down converts microwave signals to the frequency range of the HP 8902A Measuring Receiver. For signals above 1.3 GHz, the HP 11793A routes the signal through its internal mixer. Below 1.3 GHz, signals are routed directly to the input of the HP 8902A.

The HP 11793A requires +8 dBm leveled output from the local oscillator. For LOs with insufficient power above 18 GHz, the HP 11793A offers an optional 18 to 26.5 GHz amplifier.

HP 11792A Sensor Module (50 MHz to 26.5 GHz)

The HP 11792A Sensor Module gives you all the performance of the HP 8902S system, plus superb power measurement accuracy, at a single connector. You can characterize a signal without manually switching between the power sensor and the receiver input.

Each HP 11792A Sensor Module is individually calibrated, traceable to the U.S. National Bureau of Standards. The calibration factors are printed on the sensor module for easy reference. Enter these factors into the HP 8902A's non-volatile memory and the instrument automatically compensates for the power sensor's efficiency and mismatch loss at each frequency.

RF Power (with HP 11792A Sensor Module)

Range: +30 dBm (1W) to -20 dBm (10 μ W).

Frequency range: 50 MHz to 26.5 GHz.

Linearity: ± 0.02 dB (within range) ± 0.02 dB per range change from reference range ± 1 digit.

Input SWR: < 1.10 , $f_c \leq 2.0$ GHz.

< 1.28 , 2.0 GHz $< f_c \leq 18$ GHz.

< 1.40 , 18.0 GHz $< f_c \leq 26.5$ GHz.

Tuned RF Level¹

Frequency range²: 2.5 MHz to 26.5 GHz.

Dynamic range:

+10 dBm to -117 dBm, 2.5 MHz $\leq f_c \leq 1300$ MHz.

0 dBm to -100 dBm, 1300 MHz $< f_c \leq 18.0$ GHz.

0 dBm to -95 dBm, 18.0 GHz $< f_c \leq 26.5$ GHz.

Relative accuracy: ± 0.02 dB ± 0.02 dB per 1F range change ± 0.04 dB per RF range change ± 1 digit.

RF Frequency

Range²: 150 kHz to 26.5 GHz.

Maximum resolution: 10 Hz.

Time base aging rate: $< 5 \times 10^{-10}$ /day, for HP 8672A, HP 8673B/D/E; $< 1 \times 10^{-9}$ /day, for HP 8340A/B, HP 8341A/B.

Amplitude Modulation

Frequency range²: 150 kHz to 26.5 GHz.

Rates: 20 Hz to 100 kHz.

Depths: to 99%.

Accuracy: $\pm 1\%$ of reading ± 1 digit, for rates 50 Hz to 50 kHz and depths $\geq 5\%$.

Frequency Modulation

Frequency range²: 150 kHz to 26.5 GHz.

Rates: 20 Hz to 200 kHz.

Deviations: to 400 kHz.

Accuracy: $\pm 1\%$ of reading ± 1 digit, for rates 50 Hz to 100 kHz.

Phase Modulation

Frequency range²: 150 kHz to 26.5 GHz.

Rates: 200 Hz to 20 kHz.

Deviations: to 400 radians.

Accuracy: $\pm 3\%$ of reading ± 1 digit.

General

Temperature: Operating, 15° C to 35° C; storage, -25° C to 60° C.

Power: 100, 120, 220, or 240V (+5%, -10%); 48-66 Hz; 1300 VA maximum (worst case).

Weight: Net 122.3 kg (270 lb); shipping, 153.3 kg (338.3 lb) worst case.

Ordering Information

HP 8902S Measurement System

For complete ordering information, see the "HP 8902S Measurement System Ordering Information" guide, or call your HP sales office.

HP 11794A Software Pac

\$255

¹An HP 11722A Sensor Module may be used with the HP 8902S to make tuned RF level measurements from 2.5 MHz to 1300 MHz at levels from 0 dBm to -127 dBm.

²Frequency range may be limited by the frequency range of the LO.

ELECTRONIC COUNTERS

General Information

Introducing Modulation Domain Measurement and Analysis

A New Way to View Complex Signals

The modulation domain is a view of frequency, phase and time interval variations of a signal as a function of time.

This powerful technique complements and extends the familiar time and frequency domain analyses of complex signals.

Today's complex analog and digital signals have intended and unintended frequency and phase modulation. Analysis of this modulation requires the insight offered by the modulation domain.

With modulation domain analysis you can now better characterize the following:

- Jitter statistics, spectrum, and transfer function
- VCO and YIG frequency and phase dynamics
- Phase-locked loop capture dynamics, bandwidth and jitter
- Radar signal frequency, phase, and timing
- Agile communications signal transient and modulation performance
- Disk drive margin
- Frequency stability
- Electromechanical device frequency and phase dynamics

Introducing the HP 5372A Frequency and Time Interval Analyzer

New this year, the HP 5372A joins the already well established HP 5371A, adding many powerful new capabilities.

The HP 5372A enhances the analysis capability of the HP 5371A with frequency extension to 2 GHz, the ability to build histograms with up to 14 million measurements per second, measurements as frequently as every 70 ns, 8k internal memory, and a real-time direct output of results to extend memory virtually without limit. Enhancements have also been made in the analysis of phase and jitter.

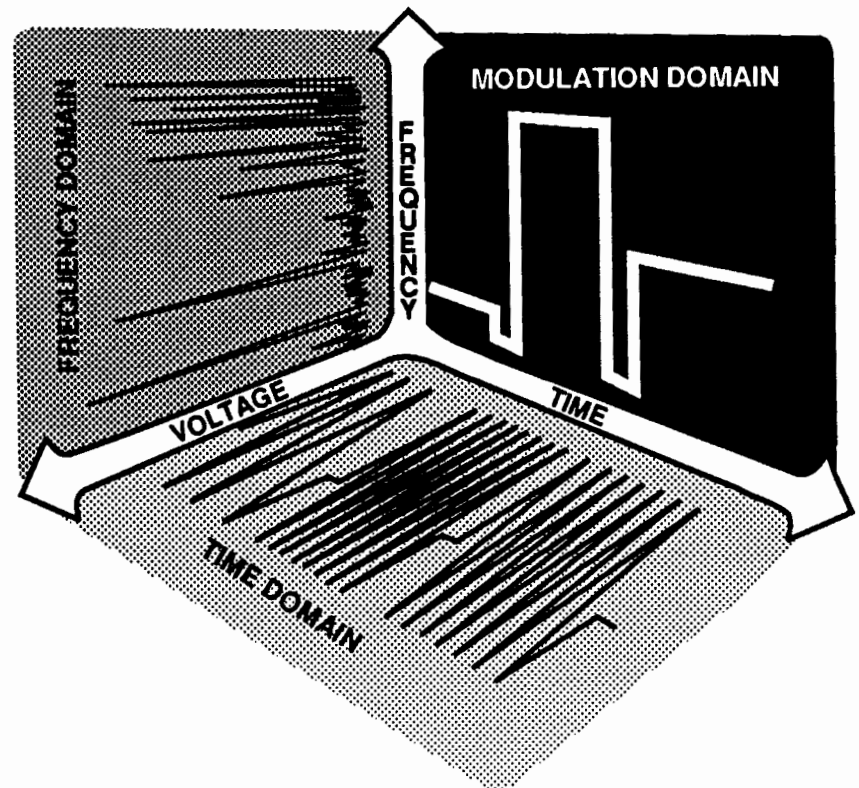

The HP 5371A analyzes signals to 500 MHz, providing 150 ps rms timing resolution, 10 digits/s frequency resolution, measurements as often as every 100 ns (a 10 MHz rate) with a 1000 internal measurement memory. Analysis of frequency, phase, and timing dynamics is provided in the modulation domain. Statistical analyses, such as histograms and Allan Variance, are also provided.

Microwave Modulation Domain Measurements

The HP 5364A Microwave Mixer/Detector allows this analysis to be extended to the microwave frequency range, from 2 to 18 GHz.

Turn to pages 162 through 167 for a more detailed description.

Traditional Counters

Counters Provide Fast, Inexpensive, and Accurate Time and Frequency Measurements

When you buy a counter from Hewlett-Packard, you can be sure you will get the quality you need. HP counters deliver:

- High measurement accuracy
- Fast system throughput/HP-IB capability
- Low cost of ownership
- Ease of use
- Data reduction on many models
- Triggering simplicity

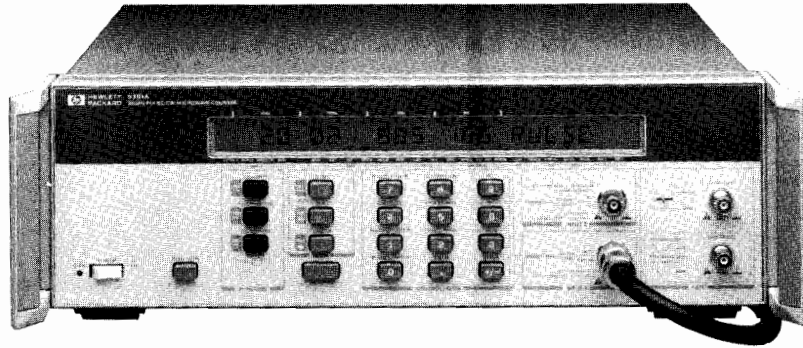

HP 5361A

A Wide Selection of Counters to Meet your Needs

Basic Universal Counters

- HP value at a low price
- Time measurements down to 100 ns single shot, 1 ns repetitive
- Frequency measurements up to 1 GHz

Performance Universal Counters

- Designed for systems
- Time interval measurements down to 2 ns single shot, 100 ps repetitive
- Frequency measurements up to 1.3 GHz

Precision Time Interval Products*

- NBS traceable time interval measurements
- Optimized for systems throughput

Basic RF Counters

- Frequency measurement up to 3 GHz
- Easy to use

Microwave and Millimeter CW Counters

- Measurements to 110 GHz
- MTBF of over 20 years on the HP 5350 series (based on actual use)

Microwave and Millimeter Pulse Counters

- Modular expandability via interchangeable heads

* For companion time synthesizer see page 447

For More Information

Hewlett-Packard offers the most complete set of application and product notes available. This literature gives you detailed information to help you make your measurements with confidence every time. For more information, fill out the card at the back of this catalog, or call your local HP sales office listed in your telephone directory. Ask for the electronic instrument department.

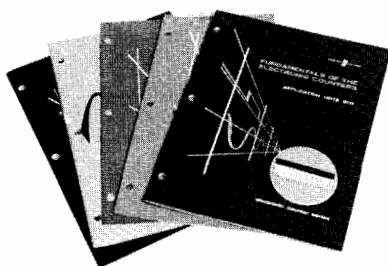

New Pulse/CW Microwave Counter Sets a New Standard

The new HP 5361A 20 GHz Pulse/CW Microwave Counter provides functionality and performance that make it your best choice for microwave frequency measurements. The counter directly makes measurements of frequency, pulse width, pulse repetition interval (PRI), pulse repetition frequency (PRF), and pulse offtime, each at the touch of a button.

The HP 5361A offers an unprecedented 1 Hz resolution in both pulse and CW frequency measurements. In fact, in addition to a

powerful pulse counter, you get a high performance CW counter for no additional cost. Fast signal tracking, low FM rate, and high resolution are some of the CW features that have not been compromised in the HP 5361A. No other pulse counter offers the CW capability of the HP 5361A.

Simplify chirp profiling and VCO characterization with the HP 5361A. This counter introduces new features like Auto-suite and scope-view, which make these measurements trouble free.

See pages 180 through 182 for details on the HP 5361A.



HP 5348A

Portable Microwave Frequency and Power Measurements in One Instrument

Now you have the convenience of a single instrument that meets both your frequency and your power measurement needs. The HP 5347A Microwave Counter/Power Meter combines frequency and power measurements up to 20 GHz in one package. The HP 5348A extends this capability to 26.5 GHz.

The HP 5347A and HP 5348A feature high-performance frequency measurement and true power meter accuracy. They use industry-standard power sensors to make accu-

rate power measurements. Other counters with power measurement capability merely indicate power rather than measure it to 0.1 dB. No other product packs such power in combined frequency and power measurements.

Measurements could not get easier. With only five function keys, the HP 5347A and 5348A are designed for ease of use. They are also rugged, lightweight, and battery powered. They provide measurement power in a portable frame. You can take them anywhere.

See pages 174 through 176 for details on the HP 5347A and 5348A.

ELECTRONIC COUNTERS

Modulation Domain Analyzer Selection Guide

Model	Frequency Range (Extension)	Single-Shot Freq. Res. (1s Gate)	Time-Interval Resolution (Single-Shot/Averaging)	Maximum Continuous Meas. Rate (Meas/s)	Memory Size	Output Result/s	Analysis and Display	Page	Price
-------	-----------------------------	----------------------------------	--	--	-------------	-----------------	----------------------	------	-------

Modulation Domain Analyzers

HP 5371A	500 MHz (18GHz ¹)	10 digits	150 ps/1 ps	10x10 ⁶	1000	HP-IB: to 20,000	Frequency and Time vs. Time Graph Software Histogram Event Timing Graph Numeric Display	162	\$23,000
HP 5372A	500 MHz (2 GHz) (18 GHz ¹)	10 digits	150 ps/1 ps	14x10 ⁶	8000	HP-IB: to 20,000 Fastport: to 14x10 ⁶	As 5371A plus: Hardware Histogram Frequency and Time vs. Time Avg. Pre-Triggering Time Dev. (Jitter) Phase Deviation	162	\$28,000

Accessories

HP 5363B	Time-Interval Probes	Provides signal conditioning to maximize accuracy, improve dynamic range and minimize circuit loading in time-interval measurements.	170	\$5,400
HP J06-59992A	Time-Interval Calibrator	Allows time-interval calibration to remove systematic errors from a measurement system.	168	\$3,000
HP 5364A	Microwave Mixer/Detector	Extends measurement range to include 2 to 18 GHz.	162	\$13,000

¹Requires HP 5364A

Counter Selection Guide

Model	Frequency Range (Extension)	Freq. Resolution (1s Gate Time)	Sensitivity	Time-Interval Res. (Single-Shot/Averaging)	Additional Features	Page	Price
-------	-----------------------------	---------------------------------	-------------	--	---------------------	------	-------

Basic Universal Counters

HP 5314A	100 MHz (-)	1 Hz	25 mV	100 ns/-	battery optional	199	\$600
HP 5315A	100 MHz (1 GHz)	7 digits	10 mV	100 ns/10 ps	battery optional	196	\$1,250
HP 5316B	100 MHz (1 GHz)	7 digits	10 mV	100 ns/10 ps	HP-IB standard	196	\$1,475

Performance Universal Counters

HP 5328B	100 MHz (1.3 GHz)	1 Hz	25 mV	10 ns/10 ps	HP-IB standard, dc DVM optional	195	\$5,900
HP 5334B	100 MHz (1.3 GHz)	9 digits	15 mV	2 ns/200 ps	HP-IB standard, MATE optional auto pulse characterization	190	\$1,995
HP 5335A	200 MHz (1.3 GHz)	9 digits	25 mV	2 ns/100 ps	HP-IB standard, dc DVM optional, auto pulse characterization	192	\$4,400
HP 5345A	500 MHz (see HP 5355A/ HP 5356A below)	9 digits	25 mV	2 ns/2 ps	HP-IB optional, MATE optional, microwave measurements via HP 5355A/HP 5356A/B/C/D	188	\$12,000

Precision Time-Interval Counters

HP 5370B	100 MHz (-)	11 Digits	35 mV	100 ps/0.3 ps	HP-IB standard, statistics	168	\$12,100
----------	-------------	-----------	-------	---------------	----------------------------	-----	----------

Counter Selection Guide (Continued)

Model	Frequency Range (Extension)	Freq. Resolution (1s Gate Time)	Sensitivity	Time-Interval Res. (Single-Shot/Averaging)	Additional Features	Page	Price
-------	-----------------------------	---------------------------------	-------------	--	---------------------	------	-------

RF Counters

HP 5384A	225 MHz (-)	9 digits	15 mV	-/-	HP-IB standard, battery optional, HP-IL optional	186	\$1,500
HP 5385A	1 GHz (-)	9 digits	15 mV	-/-	HP-IB standard, battery optional, HP-IL optional	186	\$1,995

CW Microwave Counters

HP 5386A	3 GHz (-)	9 digits	-33 dBm	-/-	HP-IB standard	186	\$3,600
HP 5340A	18 GHz (23.6 GHz)	1 Hz	-35 dBm	-/-	HP-IB optional	179	\$16,500
HP 5343A	26.5 GHz (-)	1 Hz	-33 dBm	-/-	HP-IB optional	177	\$9,900
HP 5350B	20 GHz (-)	1 Hz	-40 dBm	-/-	HP-IB standard, MATE optional	171	\$5,200
HP 5351B	26.5 GHz (-)	1 Hz	-40 dBm	-/-	HP-IB standard, MATE optional	171	\$6,300
HP 5352B	40 GHz (46 GHz)	1 Hz	-30 dBm	-/-	HP-IB standard, MATE optional	171	\$10,000

Power Meter/CW Microwave Counters

HP 5347A	20 GHz (-)	1 Hz	-32 dBm	-/-	HP-IB optional, battery optional, -70 dBm to +20 dBm power range	174	\$7,500
HP 5348A	26.5 GHz (-)	1 Hz	-32 dBm	-/-	HP-IB optional, battery optional, -70 dBm to +20 dBm power range	174	\$8,500
HP 5342A	18 GHz (24.5 GHz)	1 Hz	-25 dBm	-/-	HP-IB optional, -25 dBm to +22 dBm amplitude measurement optional	177	\$8,400

Pulsed/CW Microwave Counters

HP 5361A	20 GHz (-)	1 Hz	-32 dBm	-/-	HP-IB standard, MATE optional, full microwave pulse measurements	180	\$11,900
HP 5355A ²	1.6 GHz (110 GHz)	see HP 5345A specifications above	-25 dBm	see HP 5345A specifications above	see HP 5345A specifications above	183	\$7,900
HP 5356A ³	18 GHz (-)		-20 dBm			183	\$2,400
HP 5356B ³	26.5 GHz (-)		-20 dBm			183	\$2,400
HP 5356C ³	40 GHz (-)		-25 dBm			183	\$2,950
HP 5356D ³	110 GHz (-)		-20 dBm			183	\$7,000

Accessories

HP 5363B	Time-Interval Probes	Provides signal conditioning for universal counters to maximize accuracy, improve dynamic range and minimize circuit loading in time-interval measurements.	170	\$5,400
HP J06-59992A	Time-Interval Calibrator	Allows time-interval calibration to remove systematic errors from a measurement system.	168	\$3,000

²Requires HP 5345A³Requires HP 5345A and HP 5355A

ELECTRONIC COUNTERS

Frequency and Time Interval Analyzers

HP 5371A, 5372A

- dc to 18 GHz continuous frequency profiling capability
- Built-in statistical and graphical analysis
- Characterize frequency, phase, and time-interval versus time
- Fast time-interval histogram analysis
- Pre-trigger display and time-interval detect
- 150 ps rms single-shot resolution, 2 ps resolution with averaging



HP 5371A and 5372A The HP 5371A and HP 5372A Frequency and Time Interval Analyzers measure and analyze your signals in the Modulation Domain.

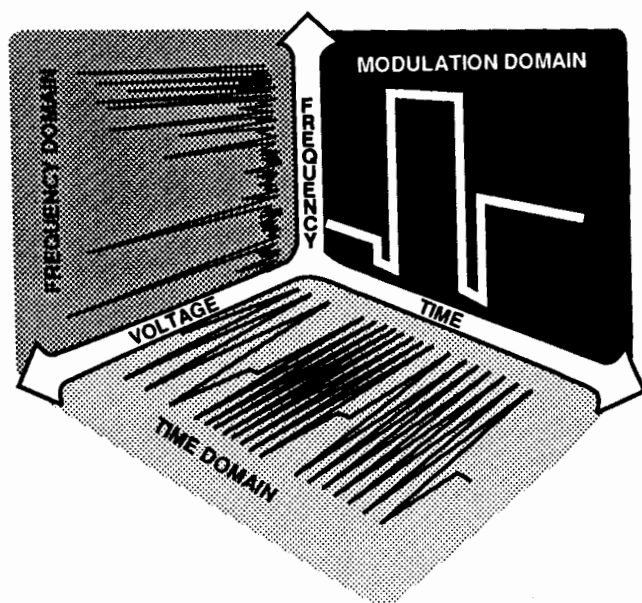

Powerful Insight into Frequency, Phase, or Time Interval Performance

If you need to characterize:

- Data Storage Products
- Radar Systems
- Communication Systems
- Electromechanical Systems
- Frequency Stability
- VCO's

Hewlett-Packard's frequency and time interval analyzers can show you frequency and timing information that traditional techniques miss.

Window Margin Analysis for Disk and Tape Drive Characterization

The HP 5372A features hardware data reduction to sort time interval measurements into histograms as fast as 13.3 million measurements per second. You can analyze data as a histogram, or you can have the HP 5372A display window margin information directly. This gives you a fast and accurate method of viewing a drive's overall timing performance in R&D or in production.

You can use the time interval detect capability of the HP 5372A to monitor for timing errors. An inhibit input allows you to gate out sector header, ECC, and servo fields to measure only in data fields.

The HP 5372A can be configured to measure data-to-data as fast as every 75 ns. For faster systems, a random event sampling mode ensures that histogram information is equally sampled across all code spacings.

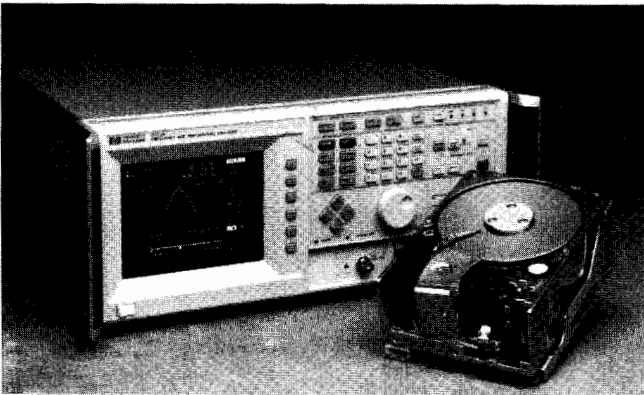

The HP 5372A displays window margin information directly for disk and tape drive testing.

Direct VCO Characterization With Frequency vs Time Displays

Voltage-controlled oscillators are a key component in many electronic systems. VCO switching and settling characteristics directly affect total system performance. Switching and settling measurements have traditionally been made using discriminators and a storage oscilloscope, but the modulation domain simplifies this characterization by directly showing frequency or phase settling versus time. You can view the step response and easily characterize ringing and overshoot, settling time, and post-tuning drift. The optional 2 GHz Channel C on the HP 5372A extends VCO analysis to cover 100 MHz to 2 GHz frequency steps. The HP 5364A Microwave Mixer/Detector lets you analyze VCO's operating between 2 GHz and 18 GHz.

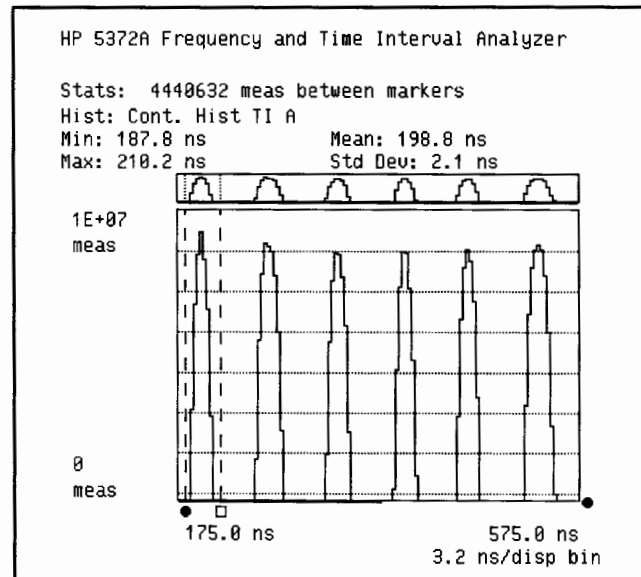

Flexible graphic capabilities let you retrieve statistical information for any single distribution of this RLL (2,7) histogram.

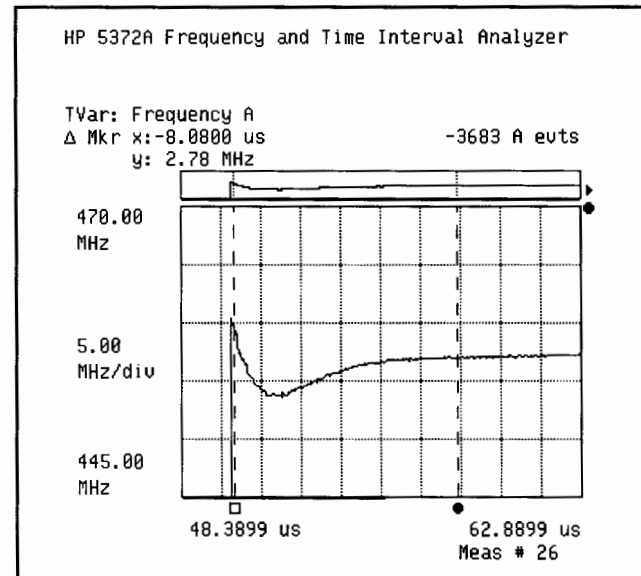

A plot of frequency vs time simplifies VCO switching and post-tuning drift analysis.

ELECTRONIC COUNTERS

Frequency and Time Interval Analyzers (cont'd.)

HP 5371A, 5372A

Flexible Jitter Spectrum Analysis for Digital Communications

The HP 5371A or the HP 5372A frequency and time interval analyzer can be used to characterize jitter or phase noise in digital communications and other serial data systems. When you add a computer and analysis, you can make jitter spectrum measurements at any clock rate (including non-standard rates) with higher resolution than current jitter test sets. The jitter bandwidth to be examined can be in excess of 2 MHz. (Analysis software is available from Data Physics Corporation.)

In addition to jitter spectrum, jitter transfer function and adjustable weighting filters can be added to processing software to extend system performance. The HP 5371A measures and displays the variation of period jitter with time or in a histogram. The HP 5372A adds the capability to display jitter as the variation of the significant instants from the ideal timing position (time deviation function).

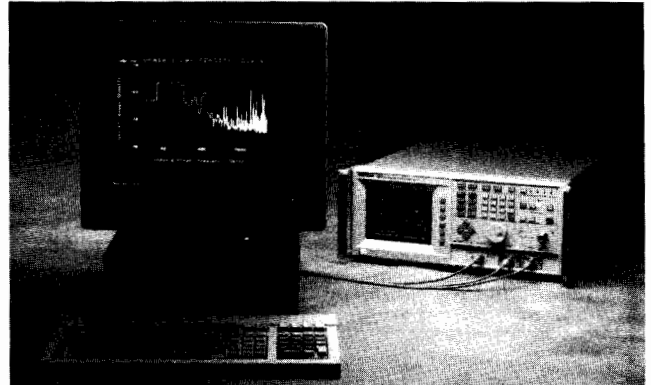

Software available from Data Physics Corporation gives you jitter spectrum and transfer function computations from HP 5371A or HP 5372A data. Weighting filters are also available.

A Clear Picture of Agile Signals

Characterization of agile transmitters is difficult in the time or frequency domains. Pseudorandom selection of the carrier means repetitive techniques are inadequate to properly characterize an agile radio's performance. 'Golden receiver' or back-to-back testing, where transmitters and receivers are tested in pairs, give little quantitative information about the radio's performance.

The modulation domain provides a clear view of these agile signals. Parameters such as dwell time, hop rate, and carrier settling time can be obtained from the graphic display. Modulation parameters such as peak-to-peak deviation, center frequency, and modulation rate can easily be displayed as well.

A histogram of frequencies is a clear measure of random usage of the frequency spectrum. Flat histogram characteristics indicate that channels are used with equal probability, providing the highest resistance to jamming and communication security.

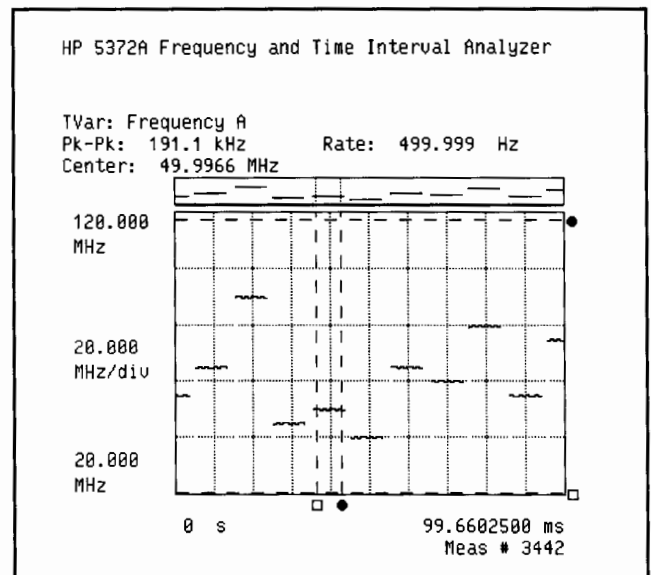

In addition to dwell time and hop sequence, the modulation characteristics on the agile carrier can easily be examined using the HP 5371A or HP 5372A time variation graph.

Powerful Radar Signal Characterization

Combining the HP 5364A microwave mixer/detector with the HP 5371A or HP 5372A frequency and time interval analyzers, and a local oscillator gives you the ability to extend the modulation domain to 18 GHz.

The HP 5364A microwave mixer/detector is designed to ensure downconversion with minimal distortion and group delay over its 500 MHz IF bandwidth. You can provide your own local oscillator, or you can use an HP source such as the HP 8671A synthesized CW generator, the HP 8673C synthesized signal generator, or the HP 8673E synthesized signal generator. In addition to the IF channel, the HP 5364A provides a video detector output to trigger the HP 5371A or HP 5372A. The video output can also be used to directly measure pulse width, rise and fall time, and PRF/PRI.

Radar chirp-linearity is easily characterized in the modulation domain. The HP 5364A microwave mixer/detector can be used to downconvert the chirp to baseband, maximizing measurement resolution. A frequency vs time display clearly shows deviation from linearity. The HP 5372A features display-averaging, which can dramatically improve the resolution of measurements on repetitive signals.

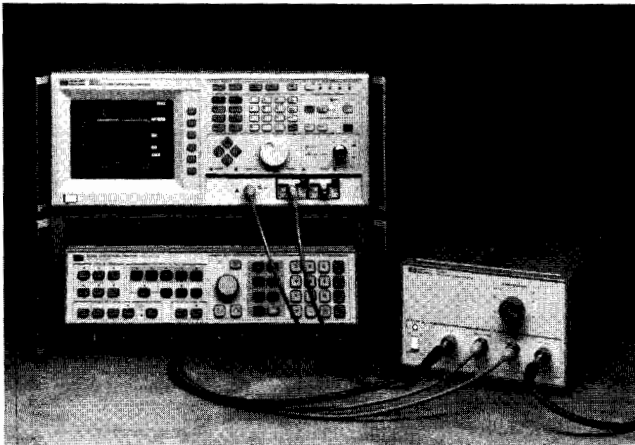

Use the HP 5364A microwave mixer/detector (shown right) with the HP 5371A or HP 5372A to bring the modulation domain to microwave frequencies between 2 and 18 GHz.

Characterize Motion Control Systems

Pulse encoders used in motion control systems deliver pulse streams that correspond to position - either linear or rotary. Position and velocity analysis can be done by characterizing the timing of pulses delivered by the encoder.

Continuous time-interval and frequency measurements with the HP 5371A or HP 5372A give you new insight into positioning system performance. Variations in velocity or rotational non-linearities can easily be analyzed by viewing the time variation display; a plot of velocity versus time. For closed-loop systems, factors such as system dampening, overshoot, and response time can be quickly verified - independent of the system's control.

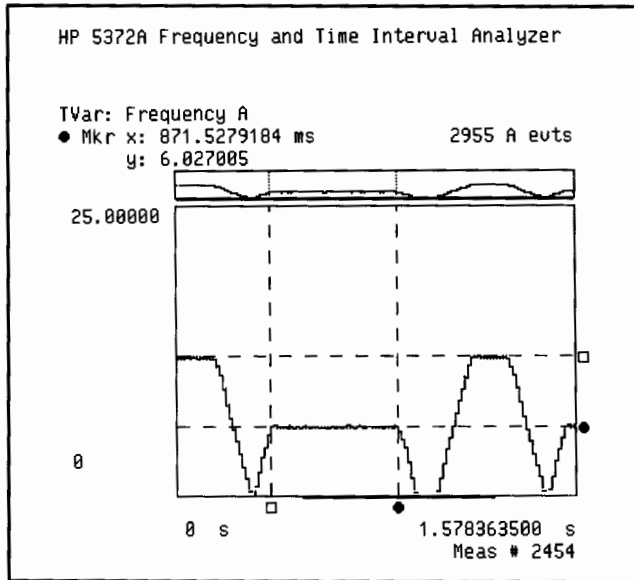

The velocity (frequency) vs time graph allows easy analysis of the print sweep and double-speed return of a motion-control servo used in a graphics printer.

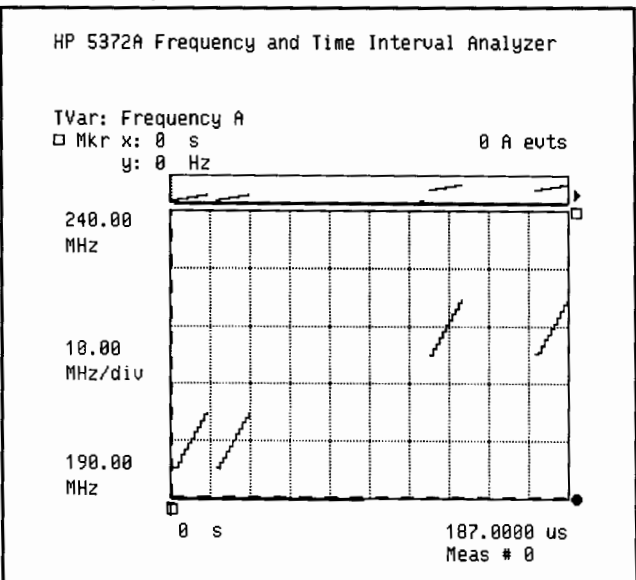

The power of modulation domain analysis can be seen with this HP 5372A frequency vs time graph of a frequency chirp on an agile carrier with a varying PRI.

ELECTRONIC COUNTERS

Frequency and Time Interval Analyzers (Cont'd)

HP 5371A, 5372A

Select the Frequency and Time Interval Analyzer Which Best Fits Your Needs

	HP 5371A	HP 5372A
Measurement Memory	1K front panel 4K HP-IB binary mode	up to 8K front panel and HP-IB
Max measurement rate	10 MHz (100 ns)	10 MHz (100 ns) 13.3 MHz (75 ns)*
Histogram display	X	X
Fast time-interval histogram	N/A	X
Time variation display (measurements vs time)	X	X
Event timing display	X	X
2 GHz channel C input	N/A	optional
Averaged time-variation display	single-shot only	averaged or single-shot
FastPort (direct output of measurement data)	N/A	optional
Pre-trigger measurement	N/A	X
Trigger on time-interval value	N/A	X
Window margin analysis	N/A	X
Phase deviation	N/A	X
Time deviation (timing jitter for communications applications)	N/A	X
Modulation parameters (pk-pk deviation, center frequency, modulation rate)	X	X
Full statistics, math, limit test	X	X
Direct output to HP-IB printer/plotter	X	X
Adjustable input sensitivity	N/A	X
Multiple blocks displayed on time variation graph	N/A	X
Measurements referenced to external trigger	N/A	X
400 Hz power	Contact Hewlett-Packard	X

*HP 5372A features a fast measurement mode that limits the maximum time-interval value, but increases measurement speed to 13.3 MHz (75 ns).

HP 5371A and HP 5372A Performance Summary

Basic Performance

- Continuous measurements to a 10 MHz Rate (13.3 MHz rate using the HP 5372A fast measurement mode)
- 125 mHz to 500 MHz frequency range. 100 MHz to 2 GHz Channel C (HP 5372A only)
- -4.0 to +4.0 second time interval range, including 0 seconds.
- 150 ps rms single-shot time interval resolution, 10 digits per second frequency resolution.
- 1 ns minimum input pulsewidth
- 2 mV trigger level resolution
- Auto-trigger capabilities
- Selection of input pods: 50 Ω , 1 M Ω , or 10 K Ω active.

Arming and Triggering Capabilities

- Measurement holdoff by time, events, or signal edge.
- Measurement sample by time, events, signal edge, or parity.
- Arm on any of three input channels: external arm, input A, or input B.

Measurements

Function	Range
Frequency A¹,B¹	125 MHz to 500 MHz 7.6 kHz to 500 MHz ³
Frequency C¹ (HP 5372A only)	100 MHz to 2 GHz
Frequency A&B,A&C,B&C,A+B, A+C,B-A,C-A,B+C,C-B, A/B,B/A, A/C,C/A,B/C,C/B	250 mHz to 500 MHz (A and B) 15.3 kHz to 500 MHz (A and B) ³ 100 MHz to 2 GHz (C)
Period A¹,B¹	2 ns to 8 seconds 2 ns to 131 usec ³
Period C¹ (HP 5372A only)	500 ps to 10 ns
Period A&B,A&C,B&C,A+B, A+C,B-A,C-A,B+C,C-B, A/B,B/A, A/C,C/A,B/C,C/B	2 ns to 4.0 seconds (A and B) 2 ns to 65.5 usec (A and B) ³ 500 ps to 10 ns (C)
Totalize A,B,A&B,A+B A-B,B-A,A/B,B/A	0 to 2 ³² -1 events, each channel
Time Interval A,B,A->B,B->A	10 ns to 8.0 seconds 10 ns to 131 us ³
Continuous Time Interval A¹,B¹	100 ns to 8.0 seconds 75 ns to 131 us ³
+ Time Interval A->B,B->A,A,B	-4.0 seconds to +4.0 seconds including 0 seconds -65.5 us to +65.5 us including 0 seconds ³
Rise and Fall Time A² Positive and Negative Pulsewidth A² Duty Cycle A²	1 ns to 100 us (auto-trigger) 1 ns to 1 ms (auto-trigger) 0% to 100 % for pulsewidths > 1ns and periods < 1ms (auto-trigger)
Phase A rel B, B rel A Peak Amplitudes A,B	>+ 360 degrees 1 kHz to 200 MHz, 200 mV pk-pk to 2V pk-pk.

¹ Maximum sample rate for these measurements is 10 MHz (100 ns), and up to 13.3 MHz (75 ns) using the HP 5372A fast measurement mode. For all other measurements, maximum sample rate is 5 MHz (200 ns) in the normal measurement mode and 7.7 MHz (135 ns) in the fast measurement mode.

² Requires 8 ns setup time between each measurement.

³ Fast Measurement Mode values

Analysis Features

- Time variation of measurements: frequency vs time, time interval vs time, and phase vs time. Averaged plots of time variation to improve vertical resolution are obtainable using the HP 5372A.
- Histogram
- Fast Time-interval histogram (HP 5372A only, histograms computed at measurement rate)

- Event timing plots
- Limit test
- Statistics: mean, minimum, maximum, standard deviation, variance, rms.
- Allan variance, root Allan variance.
- Window margin analysis (HP 5372A only)
- Modulation parameters: center frequency, pk-pk deviation, modulation rate.

HP-IB Performance

- Up to 20,000 measurements/second throughput (HP 5371A), 40,000 for HP 5372A (binary format)
- Three output formats: ASCII, floating point, or binary
- English-like HP-IB commands
- Full programmability
- Direct graphics output to printer or plotter

HP 5364A Microwave Mixer/Downconverter

Performance Summary

- 2 GHz to 18 GHz input frequency range
- 10 MHz to 500 MHz IF output range
- 2.2 GHz to 18 GHz local oscillator input range
- Built-in manual attenuator
- 73 dB rf input dynamic range for pulse signals, 53 dB for CW signals
- APC 3.5(m) connectors for rf and LO inputs
- <7.5 ns video output risetime
- Less than 1 ns group delay over 500 MHz IF output range

HP 53700A Continuous Measurement Software

This software consists of compiled subroutines that simplify and-speed binary programming with the HP 5371A and HP Series 300 computers. Sample programs demonstrating these routines are included on disk. Software is supported with the HP 5371A only.

Ordering Information

	Price
HP 5371A Frequency and Time Interval Analyzer	\$23,000
HP 5372A Frequency and Time Interval Analyzer	\$28,000

Both the HP 5371A and HP 5372A include 2 HP 54002A 50 Ω input pods. The HP 5372A also includes 1/2 day application consulting.

Options

Opt 060 Rear Panel Inputs (50 Ω BNC) for channels A and B. 1 M Ω BNC for external arm. Deletes front panel inputs.	\$0
Opt 0KP Service Kit	+\$3,350
Opt W30 Extended Repair Service. See page 725.	\$750
Opt W32 Calibration Service. See page 725.	\$580

Additional options for HP 5372A only

Opt 001 Delete 1/2 Day Application Consulting	-\$600
Opt 020 FastPort Data Output	\$1,500
Opt 030 2 GHz Channel C (if rear panel input is desired, order opt 090).	\$2,000
Opt 090 Rear Panel Inputs for channels A,B, and C. 1 M Ω BNC for External Arm, 50 Ω BNC for channels A and B, type N connector for C. Deletes front panel inputs.	\$2,000

HP 5364A Microwave Mixer/Detector	\$13,000
HP 53700A Continuous Measurement Software (Supported with HP 5371A only.)	\$1,200

Accessories

HP 54001A 1 GHz Miniature Active Probe/Pod (10:1, 10 K Ω)	\$765
HP 54003A 1 M Ω Pod (with 10:1 scope probe)	\$665
HP 54003A Pod Multiplexer	\$7900
HP J06-59992A Time Interval Calibrator	\$3000

ELECTRONIC COUNTERS

Universal Time Interval Counter

Model 5370B

- 20 ps single shot LSD
- ± 100 ps accuracy achievable
- 8000 measurements/s possible
- Built-in statistics functions
- Positive, zero and negative time
- Frequency and period to 100 MHz

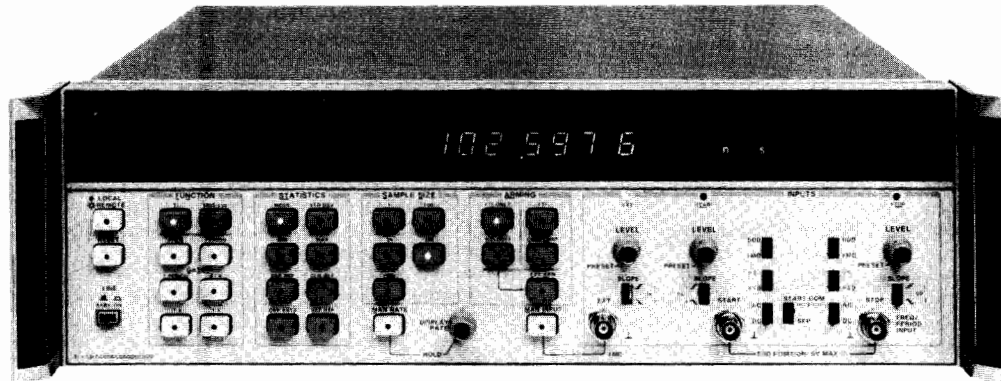

With the HP 5370B, you can make high-precision, time-interval measurements at up to 8000 measurements/second, making it ideal for your production applications.

Increase Productivity with the HP 5370B's Precision and Measurement Speed

- IC Tester performance verification
- Fast IC characterization
- Disk drive manufacture
- Digital communications - jitter analysis
- Radar/laser ranging calibration
- Nuclear systems
- Calibration Labs

Use the full range of functions

Time Interval: you can get 20 ps single shot LSD on time intervals from zero to 10 s, including negative time (where the STOP channel event occurs before the START channel event).

Frequency: measure up to 100 MHz with 11 digits of resolution in one second. Choose gate times down to one period: use one period with average mode and access the powerful STATISTICS capabilities.

Period: measure period average from one to 100k samples and use STATISTICS.

Statistics: will reduce your external computations, reduce random errors and improve measurement throughput.

Sample size: you can select 1, 10, 1k, 10k or 100k samples from the front panel, or 1 to 16,777,215 samples over HP-IB. For the selected sample size you can compute:

- Mean
- Standard Deviation
- Minimum
- Maximum

Select the time interval you want from complex waveforms:

use the extremely flexible arming and gating to select:
+TI or \pm TI with internal arming, external arming - no hold-off, or with external arming - external hold-off.

Program all major capabilities of the HP 5370B over HP-IB:

Data output rates:

- up to 8000 readings/second in fast binary mode - 125 μ s dead time.
- 10 to 20 readings/second fully formatted - 330 μ s dead time.

Time Interval Measurement Characteristics

Range:

- \pm TI: -10 to +10 seconds, including zero.
- +TI: 10 ns to 10 seconds.

Resolution: measurement resolution will depend on input signal noise and slew rate. Refer to Graph 3 for characteristic curves.

Accuracy:

Time interval measurement accuracy is influenced by internal systematic uncertainties, trigger level timing error for each trigger edge, and timebase aging in addition to resolution or random uncertainties. Graphs 1 and 2 show characteristic systematic uncertainties for the HP 5370B. These uncertainties may be reduced to less than 10 ps by calibration with the HP J06-59992A Time Interval Calibrator. Careful calibration and averaging will result in accuracies to ± 100 ps.

Frequency and Period Measurement Characteristics

Range:

- Frequency: 0.1 Hz to 100 MHz
- Period: 10 ns to 10 seconds

Resolution: measurement resolution will depend on input signal noise as well as measurement gate time. Refer to Graph 6 for characteristic curves.

Accuracy:

Accuracy is influenced by internal uncertainties, timebase aging, and noise on the input signal. Graphs 4 and 5 show the contributions of timebase aging and internal uncertainties to measurement accuracy. Periodic timebase calibration will minimize uncertainty due to timebase aging. Internal uncertainties and noise effects may be reduced by selecting longer gate times, or averaging results.

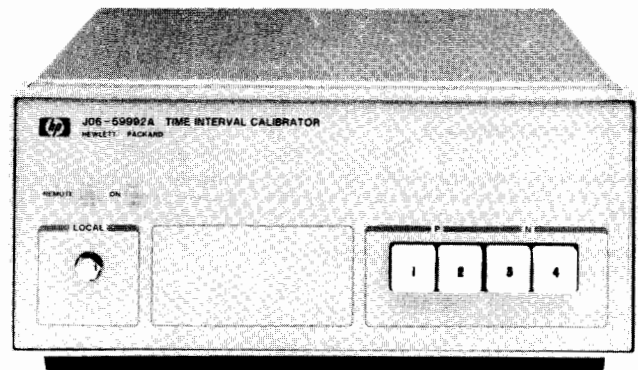

The J06-59992A Time Interval Calibrator gives you the ability to remove systematic errors from your measurement system, so that the 5370B can measure with uncertainties of $< \pm 100$ ps.

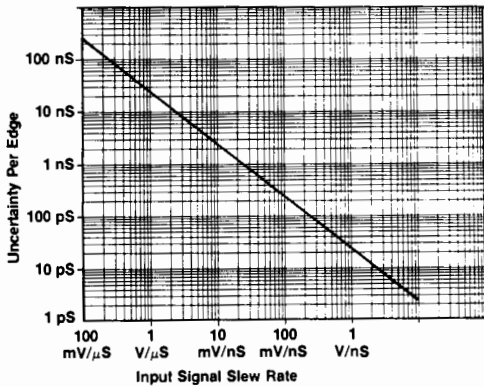

Graph 1. Trigger level timing error varies with input signal slew rate. Uncertainty is associated with both start and stop edges.

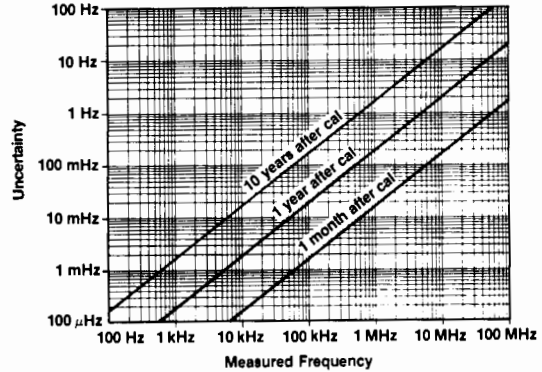

Graph 4. Time base crystal aging affects Frequency and Period measurements. You can further reduce the uncertainty by using an atomic frequency standard.

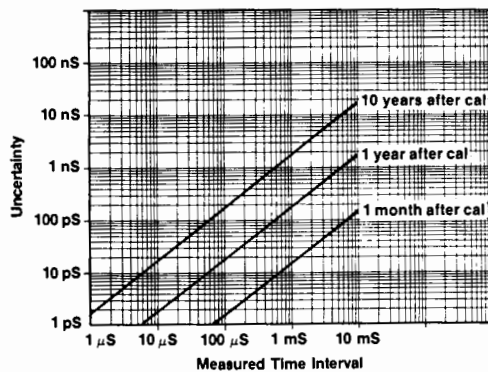

Graph 2. Time base crystal aging affects a time interval or pulse width measurement.

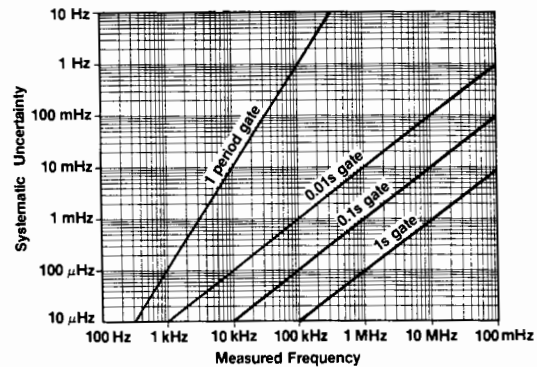

Graph 5. Internal uncertainties affect Frequency and Period measurements.

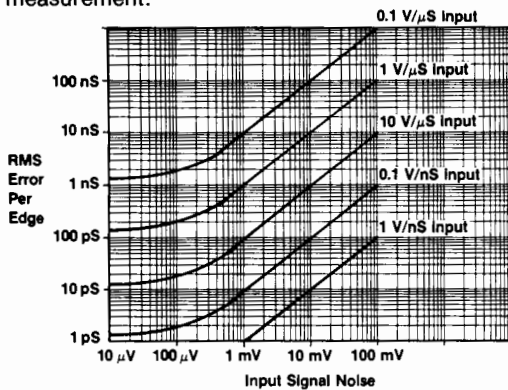

Graph 3. Noise on the input signal will add uncertainty to a time interval measurement. Averaging will reduce the effects of random noise.

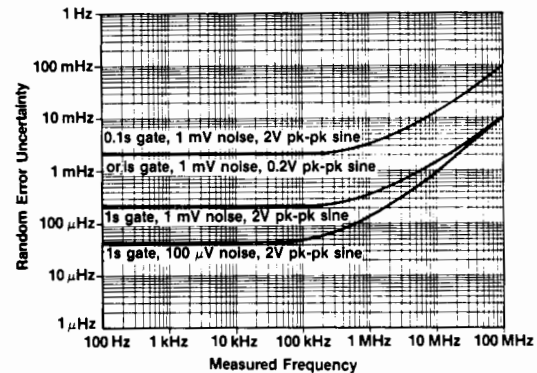

Graph 6. Noise on the input signal will add uncertainty to a Frequency or Period measurement. Longer gate times and averaging will reduce the effects of random noise.

For more information . . .

Ask your local HP sales representative for the following literature for more details on the HP 5370B Time Interval Counter and the HP J06-59992A Time Interval Calibrator. See page 739 for your local HP sales office.

HP 5370B Technical Data Sheet Literature Number 5952-7915
 HP J06-59992A Technical Data Sheet Literature Number 5952-7837

Product Note 5370B-2 "Better than 100 ps Accuracy in HP 5370B Time Interval Measurements Through Bias Error Reduction" Literature Number 5952-7834.

Product Note 5370B-3 "High Throughput Picosecond Characterization of Pulse Parameters" Literature Number 5952-7769

Application Note 191-7 "High-Speed Timing Acquisition and Statistical Jitter Analysis" Literature Number 5952-7908.

Ordering Information

	Price
HP 5370B Time Interval Counter	\$12,100
Opt 913 (5370B Rack Flange Kit - use with supplied front handles)	+ \$30
Opt 908 (5370B Rack Flange Kit - without supplied front handles)	+ \$32.50
HP 10870A HP 5370B Service Kit Accessory	+ \$930
HP J06-59992A Time Interval Calibrator	+ \$3,000

ELECTRONIC COUNTERS

Accessories

Models 5363B & 10855A

- Precise trigger level setting
- Wide input dynamic range



HP 5363B



HP 5363B Time Interval Probes

Enhanced Counter Measurements

The HP 5363B provides the necessary input signal conditioning to allow a universal counter to make highly accurate and repeatable time interval measurements. Counters such as the HP 5345A, 5370B, 5335A, 5334A, 5334B, and 5328B when teamed up with the HP 5363B can now make more accurate rise time, fall time, slew rate, propagation delay, and other complex measurements.

Wide Dynamic Range, Fine Trigger Level Settablity

Greatly improved dynamic range allows the trigger point to be selected in 10 mV increments from -9.99 V to +9.99 V.

Minimized Circuit Loading

High impedance, low capacitance active probes minimize circuit loading and pulse distortion. Each probe contains two measurement channels, start and stop, so timing measurements on one waveform are possible. As an example, the input/output rise (propagation delay) of a device can be measured between the probes.

Eliminate Systematic Timing Errors

Delays through probes, cables and inherent differential delays between a counter's input channels limit the absolute accuracy of time interval measurements.

A calibration procedure using the HP 5363B can equalize such systematic delays to set the counter to read 0.0 ns. This is possible with counters that can measure down to 0 ns like the HP 5370B, 5334A, 5334B, and 5335A. For counters with a minimum time interval specification (HP 5345A and 5328B have 10 ns minimum capability), the HP 5363B can add a fixed offset of 10 ns to permit measurements of zero time interval.

Condensed Specifications

Operating range: ± 10 V.

Minimum input voltage: ± 100 mV about trigger point.

Damage level: ± 30 V.

Voltage resolution: 10 mV.

Impedance: 1 M Ω shunted by <20 pF.

Effective bandwidth: 350 MHz (1 ns rise time).

Minimum pulse width: 5 ns at ± 100 mV about trigger point.

Output to counter: separate start/stop outputs; -0.5 V to +0.5 V into 50 Ω , slew rate through zero volts exceeds 0.25 V/ns.

Delay compensation range: 2 ns adjustable about 0 ns, or 10 ns fixed.

Power: 100, 120, 220, 240 Vac (+5-10%), 48-440 Hz; 40 VA max.

Weight: net 3.0 kg (6.5 lb). Shipping 5.5 kg (12 lb).

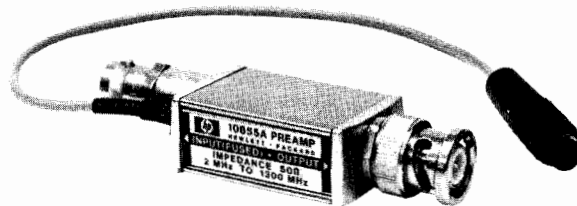

HP 10855A

Dimensions: 88.1 H x 212 W x 295 mm D (3.5 in. x 8.4 in. x 11.6 in.).

Absolute Accuracy

$$\pm 1 \text{ ns} \pm \frac{\text{START TLA} + \text{START NTE}}{\text{START slew rate}} \pm \frac{\text{STOP TLA} + \text{STOP NTE}}{\text{STOP slew rate}}$$

where TLA denotes trigger accuracy and NTE denotes noise trigger error.

Noise trigger error: $\sqrt{(125 \mu\text{V})^2 + e_n^2}$ volts where 125 μV is the typical input noise on the HP 5363B and e_n is the input signal noise for a 350 MHz bandwidth.

Accessories Available

HP 10821A Probe Accessory Kit including 2 of each of the following: HP 10229A Hook Tip; HP 10218A BNC to Probe Adapter; HP 10100C 50 ohm Feedthrough termination; HP 1250-0655 BNC Tee to Probe Adapter; and HP 8710-0661 HP Probe tips (extra).

HP 10855A 2-1300 MHz Preamp

The HP 10855A Preamp provides a minimum of 22 dB gain from 2 MHz to 1300 MHz to enhance measurements of very low-level signals. The ± 1.5 dB flat response reduces distortion in non-sinusoidal waveforms. The HP 10855A operates conveniently with a variety of HP measuring instruments having probe power outlets, or will work with the HP 1122A Probe Power Supply. The HP 5334A/5335A Option 030 and HP 5328B Option 031 counters all measure frequency to 1300 MHz and are compatible for use with the HP 10855A.

HP 10855A Specifications

Frequency range: 2 MHz-1300 MHz.

Gain (minimum): 22 dB; 24 dB typical.

Gain flatness across full frequency range: ± 1.5 dB.

Noise figure: <8.5 dB typical.

Output power for 1 dB gain compression: 0 dBm.

Harmonic distortion: -30 dB for -15 dBm output, typical.

Output for <-66 dB harmonic distortion: -25 dBm, typical.

VSWR: <2.9, typical.

Impedance: 50 Ω nominal.

Reverse isolation: >45 dB.

Maximum input: 3.5 V rms (+24 dBm), fuse protected.

Ordering Information

HP 5363B Time Interval Probes

HP 10855A 2-1300 MHz Preamp

HP 10821A Probe Accessory Kit

☎ Fast-Ship product — see page 734.

Price

\$5400

\$800 ☎

\$360

ELECTRONIC COUNTERS

Our Newest, High-Performance CW Microwave Frequency Counters

Models 5350B, 5351B, 5352B

171

- Frequency coverage from 10 Hz to 46 GHz, without an external mixer
- 2.4 mm connector available with Option 005
- Exceptional sensitivity to -40 dBm
- 1 GHz/second tracking speed
- 60-millisecond acquisition time
- 100 measurements/second over HP-IB in automatic mode
- Two years of extended hardware support with Option W30

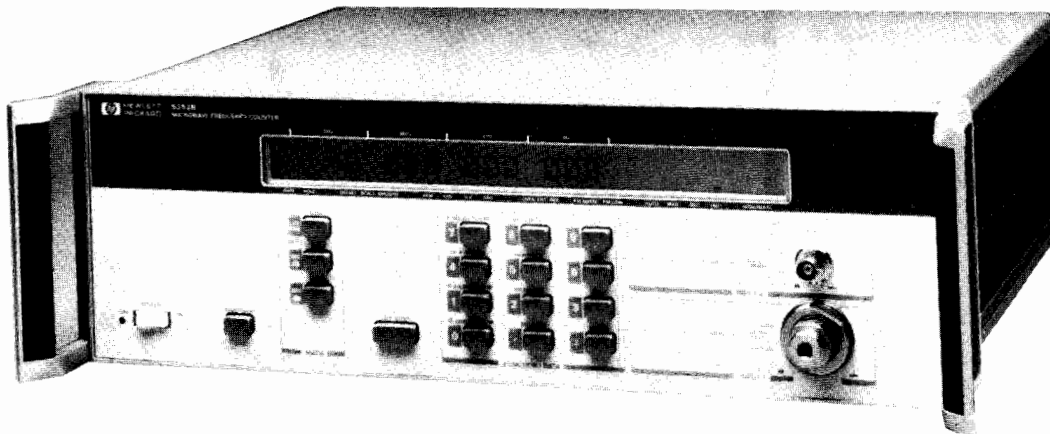

The HP 5352B, shown above, is a member of the new HP 5350 CW microwave counter family

HP 5350B/5351B/5352B Microwave Frequency Counters

The HP 5350B/5351B/5352B are automatic CW Microwave Frequency Counters that measure to 20, 26.5, and 46 GHz respectively. With resolution as fine as 1 Hz, these counters provide you with fast and precise frequency measurements.

By integrating all microwave components onto a single hybrid GaAs circuit, these counters offer you high performance at low prices. Wide frequency coverage, exceptional sensitivity, fast tracking speed, high measurement throughput, and wide FM tolerance are but a few of the high-performance features that you get with these low-cost counters.

With a built-in microprocessor, the HP 5350B/5351B/5352B also have math capabilities such as measurement scaling and offset. These functions are useful when you need indirect measurement results. Also, automatic amplitude discrimination automatically measures frequency of the highest-amplitude signal in a multi-signal environment. Other convenience features include diagnostic routines that let you perform tests on the counter for general information and troubleshooting.

The HP 5350B/5351B/5352B are ideal components for test systems. They are easy to program and their English-like commands simplify systems integration by reducing your programming effort. Their high measurement throughput also saves you money by reducing test time. In automatic test systems, the programmable alphanumeric liquid-crystal display (LCD) can serve as a message center; and if operational security is a concern, keyboard and display lockout can be activated. In noise-sensitive environments, you can put these counters in the SLEEP mode to reduce kickback noise to as low as -70 dBm.

Direct Inputs to 46 GHz, Providing Low-cost Solutions for your Expanding Needs

The HP 5350B/5351B/5352B provide a full range of high-performance, low-cost products to meet your expanding measurement needs. The HP 5350B and HP 5351B measure frequency from 10 Hz to 20 GHz and 26.5 GHz respectively. The HP 5352B, which extends input capability to 40 GHz (46 GHz with Option 005), now lets you make measurements in the millimeter-wave range directly – without having to purchase expensive mixers.

Exceptional Sensitivity, Making Direct Measurement of Low-Level Signals Possible

As these counters have input sensitivity to -40 dBm (-30 dBm for HP 5352B), accurately measuring your low-energy signals becomes a simple task. For example, you no longer need expensive microwave amplifiers to make low-level measurements. Also, you no longer have to worry about signal attenuation by the probe when you make frequency measurements at different nodes within your circuit. These conveniences simplify measurements in applications such as receiver front-end testing.

Reduced Acquisition Time, Significantly Improving Your Measurement Throughput

With acquisition time reduced to 60 milliseconds in automatic, fast-acquisition tracking mode (20 milliseconds in manual mode), these high-speed microwave counters can significantly improve your measurement throughput.

In bench-top applications, this high-speed throughput gives you fast measurement response. The liquid-crystal display (LCD) will update measurements rapidly to shorten your evaluation time. For applications that require fast measurement response to source tuning, these counters are ideal solutions.

In systems environments, the counters' fast measurement throughput also contributes to your overall system efficiency. Delivering more than 100 measurements/second over HP-IB in automatic mode, the counters' systems performance saves you money by reducing test time.

1 GHz/second Tracking Speed, Accurately Measuring Your Fast-Moving Signals

Fast acquisition also offers you fast tracking speed. With acquisition time below 60 milliseconds, these counters can track source drift to 1 GHz/second effortlessly. For example, in measuring the response of a voltage-controlled oscillator (VCO) to voltage-source tuning, these counters will track the changing frequency rapidly to measure the transfer characteristics.

Option W30 Provides you with Convenient Service and Support For the Second and Third Year of Ownership

In addition to the one-year service that HP normally provides for all of its instruments, Option W30 gives you two additional years of support at the time of purchase. This optional support reflects HP's commitment to product reliability and customer satisfaction.

HP 5350B/5351B/5352B Specifications

Input 1

Frequency range: HP 5350B: 500 MHz to 20 GHz
 HP 5351B: 500 MHz to 26.5 GHz
 HP 5352B: 500 MHz to 40 GHz
 Option 005: 500 MHz to 46 GHz

Sensitivity, in dBm (specification/typical performance @ 25°C)
HP 5350B/5351B: 500 MHz to 12.4 GHz: -32/-40; Option 002: -31/-39; Option 006: -29/-37.
HP 5350B/5351B: 12.4 GHz to 20 GHz: -27/-35; Option 002: -25/-33; Option 006: -23/-31.
HP 5351B: 20 GHz to 26.5 GHz: -16/-28; Option 002: -13/-25; Option 006: -11/-23.
HP 5352B: 500 MHz to 26.5 GHz: -25/-30; 26.5 GHz to 46 GHz, linear decrease to -10/-15.

Maximum input: +7 dBm.

Damage level: +25 dBm; HP 5350B/5351B Option 006: 500 MHz to 6 GHz + 39 dBm; 6 GHz to 18 GHz + 36 dBm; 18 GHz to 26.5 GHz + 34.8 dBm.

SWR (typical): 500 MHz to 10 GHz 2:1; Option 002/006 2.5:1.
 10 GHz to 26.5 GHz 3:1; Option 002/006 3.5:1.
 26.5 GHz to 46 GHz 3.5:1.

Coupling: dc to 50Ω termination, ac to instrument.

Connector:

Precision Type N female (HP 5350B)
 APC-3.5 male with collar (HP 5351B/HP 5352A)
 APC-2.4 male with collar (Option 005)

Accuracy: ± 1 LSD ± time-base error × frequency. (See Graphs 3 & 5).

Residual stability: when counter and source use common 10 MHz time base or counter uses external higher stability time base, .3 LSD rms typical for resolution 1 Hz - 1 kHz at 25°C; HP 5352B .7 LSD typical 26.5 - 40 GHz; LSD = least significant digit.

Resolution: selectable 1 Hz to 1 MHz.

FM Tolerance (see Graph 2: FM Rate Tolerance)

Maximum deviation: Auto 20 MHz p-p (HP 5350B/HP 5351A)
 12 MHz p-p (HP 5352B)
 9 MHz p-p (Option 005)
 Manual: 60 MHz p-p (HP 5350B/HP 5351B)
 55 MHz p-p (HP 5352B)
 55 MHz p-p (Option 005)

Maximum FM rate: 10 MHz.

Tracking Speed

Fast-acquisition track: 1 GHz/s.

Normal FM rate: 1 MHz/s.

Low FM rate: 80 kHz/s.

AM tolerance: any modulation index provided the minimum signal level is not less than the sensitivity specification.

Modes of Operation

Automatic: counter automatically acquires and displays highest level signal within sensitivity range.

Manual: center frequency must be entered to within ± 20 MHz or input frequency; ± 3 MHz worst case below 1 GHz; increases measurement and data output rate.

Automatic amplitude discrimination: automatically measures the largest of all signals present, providing that signal is >6 dB (typical) above any signal within 500 MHz; >20 dB (typical) above any signal within 500 MHz to 20 (46) GHz.

Acquisition time

Automatic mode: fast-acquisition track: <60 ms.
 normal FM rate: <125 ms.
 low RM rate: <1.25 s

Manual mode: <20 ms.

	TCX0	Option 001	Option 010
Aging Rate	1 X 10 ⁻⁷ per month	5 X 10 ⁻¹⁰ per day	2 X 10 ⁻⁸ per year
Short Term	1 X 10 ⁻⁹ per s	1 X 10 ⁻¹⁰ per s	1 X 10 ⁻¹⁰ per s
Temperature 0 - 50	1 X 10 ⁻⁹	1 X 10 ⁻⁹	1 X 10 ⁻⁹
Line 10% change	1 X 10 ⁻⁷	1 X 10 ⁻¹⁰	1 X 10 ⁻¹⁰
Warm up to <5 X 10 ⁻⁹ @ 25°C		10 minutes	10 minutes

Figure 1. Time Base (10 MHz).

Input 2

Frequency range: 10 Hz to 525 MHz.

Mode of Operation

50 Ω: 10 MHz to 525 MHz.

1M Ω: 10 Hz to 80 MHz.

Sensitivity: full operating environment:

50 Ω: 10 MHz to 525 MHz, 25 mV rms: 15 mV typical @ 25°C;

1M Ω: 10 Hz to 80 MHz, 25 mV rms: 15 mV typical @ 25°C;

Gate Time = 1/resolution: 1 ms minimum.

Resolution: selectable 1 Hz to 1 MHz.

High resolution: 1M Ω mode: 0.001 Hz for <100 kHz input; 0.01 Hz for <1 MHz input; 0.1 Hz for <10 MHz input; 1 Hz for >10MHz input: 1 second gate.

Accuracy: (See Graphs 4 & 5). ± 1 LSD

$$\left(\frac{\pm 1.4 \times \text{Trigger Error}^{(1)} \pm \text{Time Base}}{\text{Gate Time}} \right) \times \text{Frequency}$$

Impedance: selectable 1M Ω nominal shunted by <70 pF or 50 Ω nominal.

Coupling: ac.

Connector: replaceable fuse, type BNC female.

Maximum input: 50 Ω: +10 dBm; 1M Ω: 1V rms.

Damage level: 50 Ω or 1M Ω dc - 5 kHz: 250 V (dc + ac peak); >5 kHz: 5.5 V rms (+ 28 dBm) + 1.25 X 10⁶ V rms/FREQ.

Panel label: 5.5 V rms (+ 28 dBm).

Time base output: 10 MHz and 1 MHz, 2.4 V square wave AC coupled into 1k Ω: 1.5V p-p into 50 Ω; available from rear panel BNC connectors whenever the instrument has AC power connected.

External time base: 1, 2, 5 or 10 MHz, 0.7 V min to 8 V max. p-p sine wave or square wave into > 1K Ω shunted by < 30 pF, via rear-panel BNC connector. External reference automatically selected when signal is present.

General

Display: segmented 24-character alphanumeric LCD (backlighted).

Keyboard: set-up stored in STBY mode.

Self-check: tests for correct circuit operation.

Diagnostics: front-panel or HP-IB selectable, Display and Keyboard Lockout, Service Diagnostics and User Information.

Data output: over HP-IB bus; varies with Frequency and Resolution.

Auto mode: >100 readings/s, 10 kHz resolution, no math functions, "DUMP" mode.

Manual mode: >120 readings per second formatted at 10 kHz resolution, no math functions "DUMP MODE".

Math functions: result = measurement x scale + offset.

Offset: measurement is offset by entered value.

Scale: measurement is multiplied by entered value.

Smooth: displayed resolution is determined using exponential averaging; displays only stable digits.

Sample rate: variable from less than 50 ms between measurements to HOLD, which holds the display indefinitely or until trigger occurs.

Display rate: 5/s, variable over HP-IB.

Overload indication: "OVRLOAD" A user message.

Sleep mode: input 1 emissions reduced to <-70 dBm typical when sleep mode or input 2 is selected.

IF output: rear panel BNC provides 30 - 110 MHz down-converted microwave signal at >-20 dBm into 50 Ω, ac coupled.

HP-IB interface functions: functions and diagnostics are programmable; address-set at front panel, default switches on rear panel; teach/learn programming; IEEE 728 compatible command structure; function subset SH1, AH1, T5, RF1, RL1, PP0, DC1, DT1, C0, E1 (see page 00.00).

Reset/local: returns to local control.

Operation temperature: 0° C to 50° C.

Power requirements: 100 VA max.

Line select: 100 V (90-105 VAC rms; 47.5 - 440 Hz).

115/120 V (104/126 VAC rms; 47.5 - 440 Hz).

220 V (198-231 VAC rms; 47.5 - 66 Hz).

230/240 V (207-252 VAC rms; 47.5 - 66 Hz).

Accessories furnished: power cord, manual.

Size: 33mmH × 425 mmW × 358 mmD (5¼ in. H × 16¾ in. W × 14 in. D)

Weight: 11 kg (24 lb).

$$^{(1)} \text{Trigger Error} \sqrt{e_f^2 + e_n^2} \quad \text{s rms}$$

Input Slew Rate in V/s at Trigger Point

Where e_f = effective rms noise of counter's input channel (100 μV typical)

e_n = rms noise of the input signal for a 500 MHz bandwidth

ELECTRONIC COUNTERS

Low-Cost, High-Performance CW Microwave Frequency Counters (cont'd)

Models 5350B, 5351B, 5352B

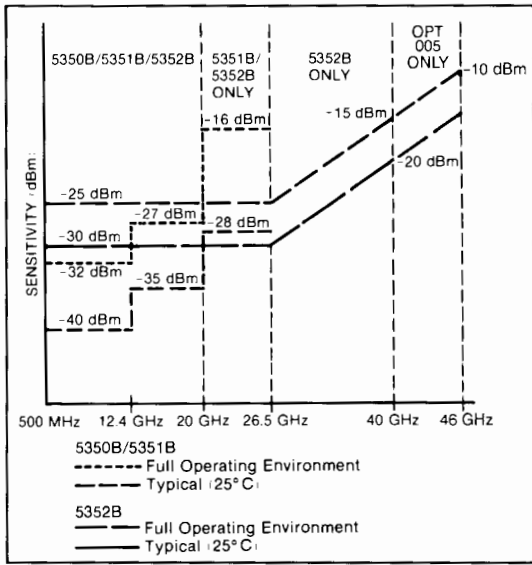

Graph 1. Sensitivity

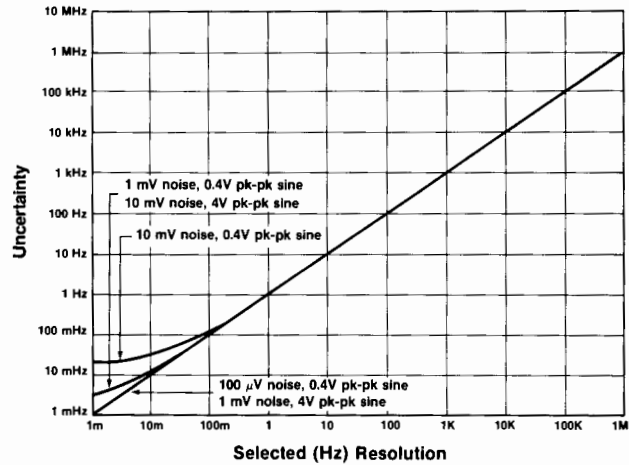

Graph 4. Input 2 uncertainty due to selected resolution and trigger error.

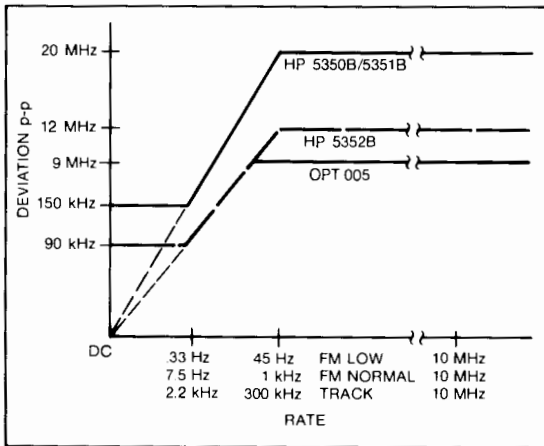

Graph 2. FM Rate Tolerance

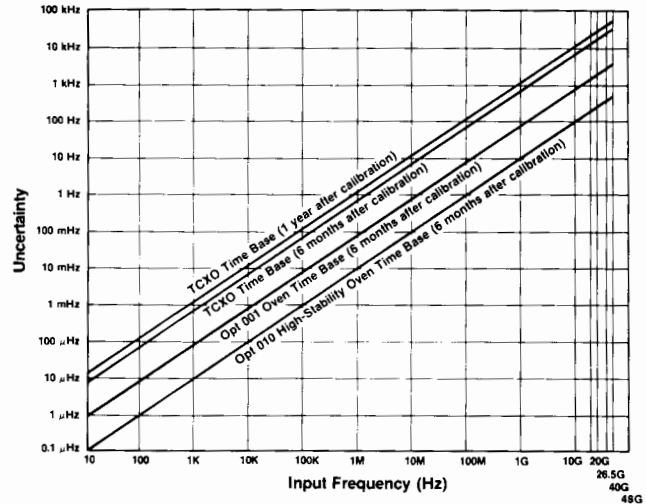

Graph 5. Uncertainty due to time-base error. Time-base error can be reduced by calibrating the time base more frequently, or by using a time base with a slower aging rate.

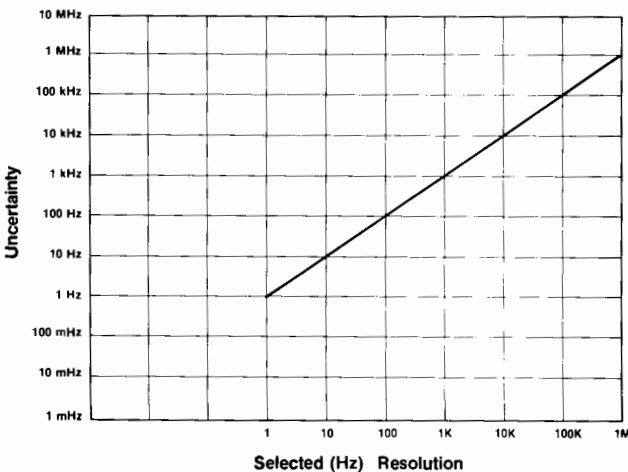

Graph 3. Input 1 uncertainty due to selected resolution

Ordering Information

Item	Price
HP 5350B 20 GHz Microwave Frequency Counter	\$5,200
HP 5351B 26.5 GHz Microwave Frequency Counter	\$6,300
HP 5352B 40 GHz Microwave Frequency Counter	\$10,000
Opt 001 Oven Time Base	+\$750
Opt 002 Rear Panel Inputs (HP 5350B/51B only)	+\$300
Opt 005 Frequency Extension to 46 GHz (HP 5352B only)	\$3900
Opt 006 Microwave Level Limiter (HP 5350B/51B only)	+\$580
Opt 010 High Stability Oven Time Base	+\$1,500
Opt 700 MATE Programming	\$500
Opt 910 Additional Operating & Service Manual	+\$75
Opt 908 Rack Mount Kit for use with front handles removed	+\$32.50
Opt 913 Rack Mount Kit for use with supplied front handles	+\$35
Opt W30 2-year extended hardware support	+\$160
Additional Equipment Available:	
Transit Case	9211-2643
Waveguide (3" straight) adapter WR28-APC3.5	05356-20217
Waveguide (3" straight) to coaxial adapter WR42-APC3.5	05356-20216
Adapter - In series APC 3.5 Male to Male	1250-1748
Adapter - In series APC 3.5 Female to Female	1250-1749

ELECTRONIC COUNTERS

Microwave Counter/Power Meter

HP 5347A, 5348A

- Quick and easy power and frequency measurements
- Portable
- Battery operation
- Built-in sensor calibration tables
- Supports HP's power sensors



HP 5348A with optional carrying strap and HP 8481A power sensor

HP 5347A and HP 5348A Microwave Counter/Power Meter

The HP 5347A and HP 5348A microwave counter/power meters offer the convenience of a single instrument that meets both your frequency and power measurement needs. The HP 5347A counter/power meter makes these measurements to 20 GHz, and the HP 5348A to 26.5 GHz. Both counter/power meters offer the accuracy and resolution that previously required a stand-alone counter and a separate power meter.

Measurements are easy. With only five function keys, the HP 5347A and 5348A are designed for ease of use. They are rugged, lightweight, and battery powered.

True Power Meter Performance

As a power meter, the HP 5347A and 5348A offer excellent dynamic range, linearity, and accuracy. They use the same proven power sensors used with Hewlett-Packard's stand-alone power meters. Power sensors and accurate, wide range measurements go hand in hand.

Power measurements can be made from -70 dBm to $+20$ dBm over a 10 MHz to 26.5 GHz frequency range, depending on the sensors used. Exceptional power meter linearity and low sensor SWR combine to give you outstanding measurement accuracy. The instrumentation accuracy is $\pm 0.5\%$ in linear mode or ± 0.02 dB in logarithmic mode, making power meter uncertainty a negligible part of your total measurement error.

Outstanding Frequency Measurements

The frequency counter offers performance that rivals Hewlett-Packard's highest performance, stand-alone CW microwave counters. The HP 5347A measures frequency from 10 Hz to 20 GHz, and the HP 5348A from 10 Hz to 26.5 GHz. You can select either 1 Hz or 10 kHz resolution while measuring signals down to -35 dBm.

Portable, Easy-to-Use

The HP 5347A and 5348A come in a rugged, lightweight, and portable package. Several features have been designed-in for quick and easy, portable measurements. An internal battery option, for example, provides up to two hours of cordless measurements.

Designed for Measurement Ease

How many times have you purchased test equipment only to find that you never use most of the available functionality? The excess functionality only clutters the front panel and makes measurements difficult. Hewlett-Packard recognizes the importance of quick and easy measurements to field service personnel. The HP 5347A and HP 5348A are designed for ease of use.

Five Function Keys Simplify Operation

Extra functions that can get in the way of making quick and easy power and frequency measurements, were designed out of the HP 5347A and HP 5348A counter/power meters. As a result, only five function keys are required to make accurate frequency and power measurements. With only five keys, the chances of getting an incorrect reading due to instrument set-up is almost eliminated.

You will find that little or no time is required to learn how to use these instruments. And, in case it is needed, a one-page guide for getting started is shipped with every instrument.

No Need for Calibration Tables

Average calibration tables have already been entered for you in the HP 5347A and HP 5348A. They are permanently stored in memory. You no longer need to spend valuable time trying to correctly enter power sensor calibration tables. Using average calibration tables results in only a slight reduction in overall measurement accuracy.

With the HP 5347A and 5348A, you do not need to enter the frequency used to make a power measurement. Simply take advantage of the built-in frequency counter to measure frequency. With the press of a single key, the frequency measurement is stored for use in the power measurement. The stored frequency is then used to access the power sensor calibration factor in the permanently stored calibration factor versus frequency tables.

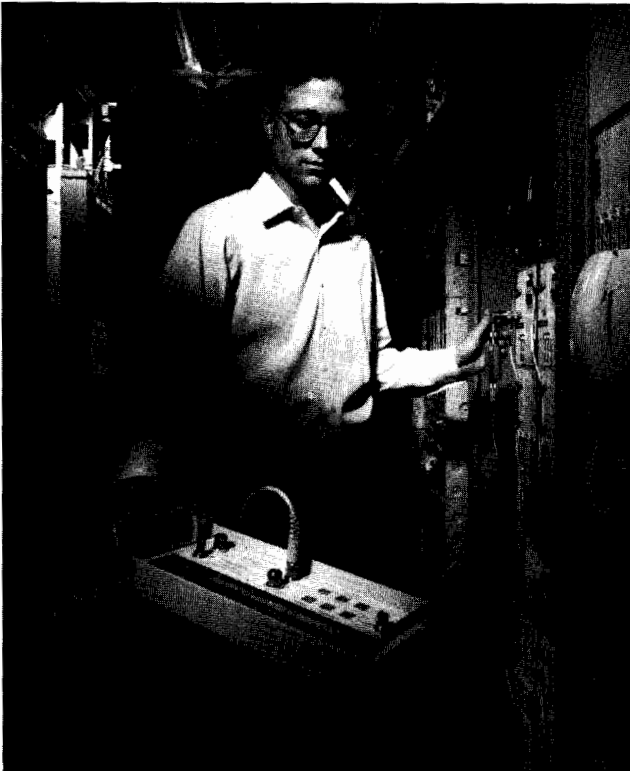

One easy-to-use instrument makes the job quicker and more convenient.

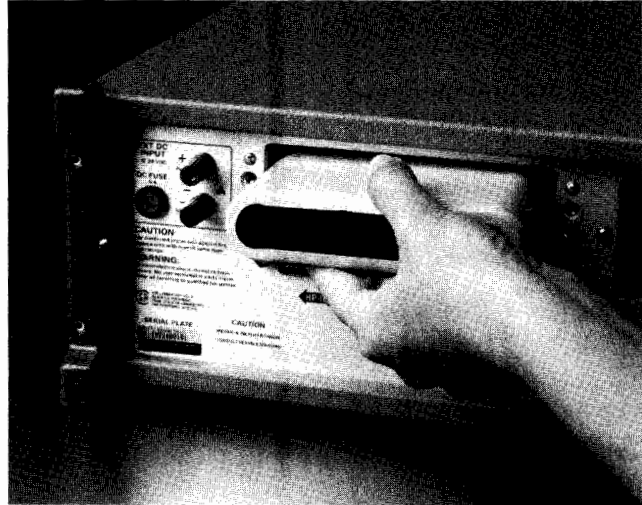

The internal battery allows measurements without cumbersome electrical cords.

Internal Battery for Cordless Measurements

An optional internal battery allows you to make cordless measurements for up to two hours. When you are in the field, you do not need a power cord. Just walk right up to the output port and make your measurement.

An external dc input is available for even greater flexibility in choosing a power source. At times it might be more convenient to operate the instrument from a dc supply.

A Rugged Package for Tough Environments

These instruments are designed to survive the harsh transportation and operation environments common to portable applications. Their membrane front panels keep dirt and moisture from entering the instruments, and an optional front cover protects the front panel and connectors during transit.

For Benchtop and ATE Systems Too

You will find that having frequency and true power measurements in a single portable package saves valuable bench space in a manufacturing environment. The ease-of-use features will also be greatly appreciated.

A rackmount kit and HP-IB option are available for using the HP 5347A HP 5348A in an ATE system.

ELECTRONIC COUNTERS

Microwave Counter/Power Meter (Cont'd.)

Counter Specifications

Input 1

Frequency range: HP 5347A: 500 MHz - 20.0 GHz
HP 5348A: 500 MHz - 26.5 GHz

Sensitivity:

HP 5347A/48A: 500 MHz - 12.4 GHz: -32 dBm
(-35 dBm typical)
12.4 GHz - 20.0 GHz: -27 dBm
(-32 dBm typical)

HP 5348A: 20.0 GHz - 26.5 GHz: -20 dBm (-27 dBm typical)

Maximum input: +7 dBm

Damage level: +25 dBm, peak

Connector: HP 5347A: N(f)
HP 5348A: APC 3.5(m)

Coupling: ac

Accuracy: \pm LSD \pm time base error x frequency
Accuracy specification applies from 0°C to 50°C when using internal time base, 0°C to 55°C with external time base.

Resolution: 1 Hz or 10 kHz, selectable

Tracking speed: resolution = 1 Hz, speed = 1 MHz/s
resolution = 10 kHz, Speed = 1 GHz/s

Acquisition time: resolution = 1 Hz, Time < 125 ms
resolution = 10 kHz, Time < 60 ms

Maximum deviation: 20 MHz p-p, automatic mode

Maximum FM rate: 10 MHz

AM tolerance: any modulation index provided the minimum signal level is not less than the sensitivity specification.

TCXO time base: see page 172 for specifications

External time base: 10 MHz, 0.7 V min. to 8 V max p-p sine wave or square wave into >1 K Ω shunted by < 30 pF, via front panel BNC connector.

Input 2

Frequency range: 10 Hz - 525 MHz

Sensitivity: 25 mV rms (15 mV rms typical)

Impedance: 1 M Ω nominal shunted by < 70 pF (10 Hz - 80 MHz) or 50 Ω nominal (10 MHz - 525 MHz)

Maximum input: +10 dBm (50 Ω input), 1 V rms (1 M Ω input)

Connector: BNC (f)

Coupling: ac

Resolution: 1 Hz or 10 kHz, selectable

Power Meter Specifications

Frequency range: 10 - 26.5 GHz, sensor dependent

Power range: -70 dBm - +20 dBm (100 pW - 100 mW), sensor-dependent

Power sensors: HP 8481A, HP 8481D, HP 8484A, HP 8485A
The HP 8481D is a direct replacement for the HP 8484A

Dynamic range: 50 dB in 10 dB steps

Display units: Watts, dBm

Resolution: 0.01 dB in logarithmic mode, 0.1 % of full scale in linear mode.

Accuracy

Instrumentation: \pm 0.02 dB or \pm 0.5%

Zero Set (digital setability of zero): \pm 0.5 % of full scale on most sensitive range

Power reference

Power output: 1.00 mW. Factory set to \pm 0.7 % traceable to U.S. National Institute of Standards.

Accuracy: \pm 1.2% worst case (\pm 0.9% RSS) for one year.

General

Diagnostics: rear panel or HP-IB selectable, service diagnostics and user information

Data output: 90 meas/s, counter -varies with frequency
(10 kHz resolution, DUMP MODE)
18 meas/s, power meter

HP-IB codes: SH1, AH1, T5, L4, SR1, RL1, DC1, DT1, E1

Operating temperature: 0°C to 55°C

Power requirements: 50 VA maximum

Line select: 100V (90 - 105VAC rms; 47.5 440 Hz);
115/120V (104 - 126VAC rms; 47.5 -440 Hz);
220V (198 - 231VAC rms; 47.5 - 66 Hz);
230/240V (207 -252VAC rms; 47.5 -66 Hz)

External dc: 14 to 26VDC, 40 W, binding post

Battery (Option 002): 1-2 hours of operation (typical), 12 hours to charge (typical)

Accessories supplied: power cord, Operating/Programming Manual, power sensor cable (HP 11730)

Size: 144mm H x 325mm W x 456mm D (5.66" x 12.8" x 18.0")

Weight: 9.1kg (20lb); with battery, 10.4kg (23lb)

Ordering Information

HP 5347A 20 GHz Counter/Power Meter \$7,500

HP 5348A 26.5 GHz Counter/Power Meter \$8,500

Options for HP 5347A and HP 5348A

Opt 002 Battery Pack +\$400

Opt 011 HP-IB Interface +\$300

Opt 060 Front Panel Cover and Carrying Strap +\$50

Opt 913 Rack Mount Kit +\$390

Opt 915 Service Manual +\$75

Opt 916 Addition Operating/Programming Manual +\$75

Opt W30 (HP 5347A) Extended Repair Service.
See page 725. +\$190

Opt W30 (HP 5348A) Extended Repair Service.
See page 725. +\$215

Opt W32 (HP 5347A/48A) Calibration service.
See page 725. +\$870

Power sensors

HP 8481A Power sensor \$650

HP 8481D Power sensor \$900

HP 8484A Power sensor \$1,000

HP 8485A Power sensor \$950

HP Power Sensor Cables

HP 11730A 1.5 meters (5 ft) sensor cable \$90

HP 11730B 3.0 meters (10 ft) sensor cable \$100

HP 11730C 6.1 meters (20 ft) sensor cable \$140

HP 11730D 15.2 meters (50 ft) sensor cable \$200

HP 11730E 30.5 meters (100 ft) sensor cable \$265

HP 11730F 61.0 meters (200 ft) sensor cable \$425

ELECTRONIC COUNTERS

CW Microwave Frequency Counters

Models 5342A & 5343A

177

- Automatic measurements to 18 GHz/26.5 GHz
- Portability
- Wide FM tolerance

- Amplitude measurement in dBm (HP 5342A Option 002)
- High input sensitivity
- Digital-to-analog converter (Option 004)

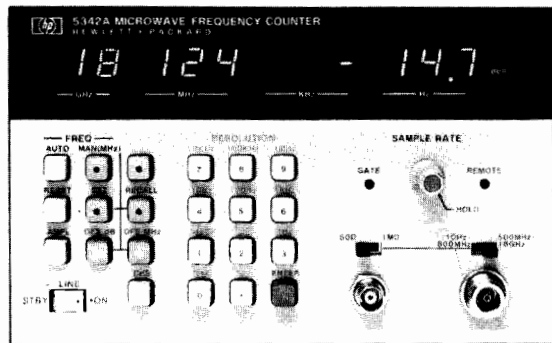

HP 5342A

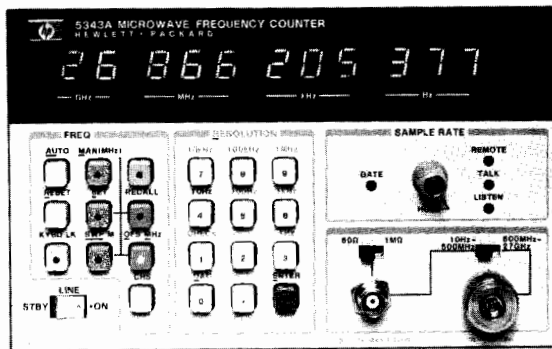

HP 5343A



HP 5342A & 5343A Microwave Counters

Portability

The HP 5342A and HP 5343A Microwave Counters provide automatic frequency measurement to 18 or 26.5 GHz in highly portable packages. The operating range of the HP 5342A can be extended to 24 GHz with Option 005.

Amplitude Measurements (Option 002, HP 5342A only)

Option 002 adds the ability to measure and display the power level of the input in dBm. The 11-digit LED display presents amplitude measurement to 0.1 dBm resolution. Also, the same option extends the instrument's dynamic range to enable frequency measurements to +22 dBm.

FM Tolerance

Measuring a carrier frequency while it is being frequency modulated has broad appeal in the communication industry and elsewhere. Both the HP 5342A and HP 5343A can tolerate peak-to-peak FM deviation to 50 MHz.

Option 004 lets you convert any three consecutive displayed digits (frequency or amplitude) into an analog voltage output on the rear panel. This makes the monitoring of microwave-oscillator-frequency drift easy to make with only a stripchart recorder.

Scaling and Offset Functions

The versatility of the microprocessor-controlled keyboard allows you to perform math functions by means of a few key strokes. Frequency values to 1 Hz resolution can be added to or subtracted from the measured frequency for IF offset application. The HP 5343A also offers an $mx \pm b$ mode for both scaling and offset functions.

HP 5342A Specifications

Signal Input

Input 1

Frequency range: HP 5342A: 500 MHz to 18 GHz.

HP 5343A: 500 MHz to 26.5 GHz.

Sensitivity: HP 5342A: 500 MHz to 12.4 GHz: -25 dBm.
12.4 GHz to 18 GHz: -20 dBm.

HP 5343A: 500 MHz to 12.4 GHz: -33 dBm.
12.4 GHz to 18 GHz: -28 dBm.
18.0 GHz to 26.5 GHz: -23 dBm.

Maximum input: +7 dBm (See Option 002, 003 for higher levels).

Impedance: 50, nominal.

Connector: HP 5342A: Precision Type N female.

HP 5343A: APC 3.5 male with collar.

Damage level: +25 dBm, peak (See Option 006 for +39 dBm protection).

Coupling: dc to load, ac to instrument.

SWR: < 2:1, 500 MHz-10 GHz.

< 3:1, 10 GHz-18 GHz/26.5 GHz.

FM tolerance: switch selectable (rear panel)

Wide: 50 MHz p-p worst case.

Normal: 20 MHz p-p worst case.

Narrow: (HP 5343A only) 6 MHz p-p worst case.

For Modulation Rates from dc to 10 MHz.

AM tolerance: any modulation index provided the minimum signal level is not less than the sensitivity specification.

Automatic amplitude discrimination: automatically measures the largest of all signals present, providing that signal is 6 dB above any signal within 500 MHz; 20 dB above any signal, 500 MHz-18 / 26.5 GHz.

Modes of Operation

Automatic: counter automatically acquires and displays highest level signal within sensitivity range.

Manual: center frequency entered to within ± 40 MHz of true value.

Acquisition Time

Automatic Mode

Narrow FM 200 ms worst case (HP 5343A only)

Normal FM 530 ms worst case

Wide FM 2.4 s worst case

Manual mode: 80 ms after frequency entered.

Input 2

Frequency range: 10 Hz to 520 MHz direct count.

Sensitivity: 50 Ω : 10 Hz to 520 MHz: 25 mV rms. 1 M Ω : 10 Hz to 25 MHz: 50 mV rms.

Impedance: selectable 1 M Ω , <50 pF or 50 Ω nominal.

Coupling: ac.

Connector: type BNC female.

Maximum input 50 Ω : 3.5 V rms (+24 dBm) or 5 V dc, fuse protected

1 M Ω : 200 V dc + 5 V rms.

Time Base

Crystal frequency: 10 MHz.

Stability

Aging rate: $< 1 \times 10^{-7}$ /month.

Temperature: $< \pm 1 \times 10^{-6}$ over the range 0°C to 50°C.

Short term: $< 1 \times 10^{-9}$ for 1 second averaging time.

Line variation: $< \pm 1 \times 10^{-7}$ for 10% change from nominal.

Output frequency: 10 MHz, ≥ 2.4 V square wave (TTL compatible) 1.5 p-p V into 50 Ω available from rear panel BNC.

External time base: requires 10 MHz, 3.0 V p-p sine wave or square wave into 1 k Ω via rear panel BNC connector. Switch selects either internal or external time base.

ELECTRONIC COUNTERS

Automatic Microwave Counters

Models 5342A & 5343A

Optional Time Base (option 001)

Crystal frequency: 10 MHz.

Stability

Aging rate: $<5 \times 10^{-10}$ /day after 24-hour warmup.

Temperature: $<7 \times 10^{-9}$ over the range 0°C to 50°C.

Short term: $<1 \times 10^{-10}$ for 1 second averaging time.

Line variation: $<1 \times 10^{-10}$ for 10% change from nominal.

Warm-up: $<5 \times 10^{-9}$ of final value 20 minutes after turn-on, at 25°C.

Amplitude Measurement (opt 002) (HP 5342A only)

Input 1

Frequency range: 500 MHz–18 GHz.

Dynamic range (frequency and level)

–22 dBm to +22 dBm 500 MHz to 12.4 GHz

–15 dBm to +22 dBm 12.4 GHz to 18 GHz

Maximum operating level: +22 dBm.

Damage level: +25 dBm, peak.

Resolution: 0.1 dBm.

Accuracy: ± 1.5 dB (excluding mismatch uncertainty).

SWR: $<2:1$ (amplitude measurement).

$<5:1$ (frequency measurement).

Measurement time: 100 ms + frequency measurement time.

Display: simultaneously displays frequency to 1 MHz resolution and level. (Option 011 provides full frequency resolution on HP-IB).

Input 2 (50 Ω impedance only)

Frequency range: 10 MHz–520 MHz.

Dynamic range (frequency and level): –17 dBm to +20 dBm.

Damage level: +24 dBm.

Accuracy: ± 1.5 dB (excluding mismatch uncertainty).

SWR: $<1.8:1$.

Measurement time: 100 ms + frequency measurement time.

Display: simultaneously displays frequency and input level.

Extended Dynamic Range (opt 003) (HP 5342A only)

Frequency range: 500 MHz to 18 GHz.

Sensitivity: 500 MHz to 12.4 GHz: –22 dBm.

12.4 GHz to 18 GHz: –15 dBm.

Maximum operating level: +22 dBm.

Dynamic range: 500 MHz to 12.4 GHz: 44 dB.

12.4 GHz to 18 GHz: 37 dB.

Damage level: +25 dBm, peak.

SWR: $<5:1$.

Microwave Limiter (option 006)

Input 1

Frequency range: HP 5342A: 500 MHz – 18 GHz.

HP 5343A: 500 MHz – 26.5 GHz.

Sensitivity: HP 5342A: 500 MHz – 12.4 GHz: –21 dBm.

12.4 GHz – 18 GHz: –15 dBm.

HP 5343A: 500 MHz – 12.4 GHz: –30 dBm.

12.4 GHz – 18 GHz: –24 dBm.

18 GHz – 26.5 GHz: –18 dBm.

Maximum operating level: +7 dBm.

Damage level: 500 MHz – 6 GHz: +39 dBm (8W).

6 GHz – 18 GHz: +36 dBm (4W).

(HP 5343A only) 18 GHz – 26.5 GHz: +34.8 dBm (3W).

SWR: 2.5:1, 500 MHz – 10 GHz.

3.5:1, 10 GHz – 18 GHz/26.5 GHz.

Note: Option 006 is incompatible with Option 002, Option 003, and Option 005 for HP 5342A. Please consult factory special to combine Options 005 and 006.

General

Accuracy: ± 1 LSD \pm time-base error.

Resolution: front panel push buttons select 1 Hz to 1 MHz.

Display: 11 digit LED display, sectionalized to read GHz, MHz, kHz, and Hz.

Self-check: selected from front panel pushbuttons displays 75 MHz for resolution chosen.

Frequency offset: selected from front panel pushbuttons. Displayed frequency is offset by entered value to 1 Hz resolution.

Frequency multiply: (HP 5343A only) (mx \pm b) measured data is multiplied by any integer up to 99. Offset can then be added or subtracted. Front-panel selectable.

Totalize (HP 5343A only): input 2 can totalize at rates up to 520 MHz. Readout on the fly is controlled by front panel or HP-IB.

Sample rate: variable from less than 20 ms between measurements to HOLD which holds display indefinitely.

IF out: rear panel BNC connector provides 25 MHz to 125 MHz output of down-converted microwave signal.

Power requirements: 100/120/220/240 V rms, +5%, –10%, 48–66 Hz; 100 VA max.

Weight: net 9.1 kg (20 lb). Shipping 12.7 kg (28 lb).

Size: 133 mm H x 213 W x 498 mm D (5.25 in. H x 8.38 in. W x 19.6 in. D).

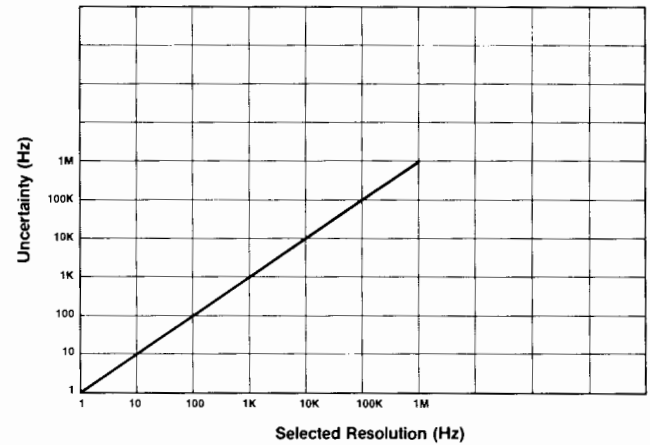

Graph 1. Uncertainty due to selected resolution.

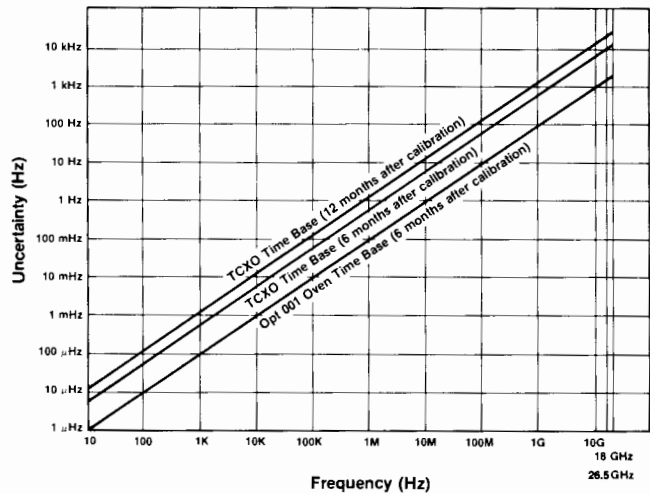

Graph 2. Uncertainty due to timebase error can be reduced by calibrating the timebase more frequently, or by using a timebase with a lower aging rate.

Ordering Information

HP 5342A Frequency Counter

Price

\$8400

HP 5343A Frequency Counter

\$9900

Options and Accessories (both models)

Opt 001 High Stability Time Base

+ \$750

Opt 002 Amplitude Measurement (HP 5342A Only)

+ \$1900

Opt 003 Extended Dynamic Range (HP 5342A Only)

+ \$720

Opt 004 Digital-To-Analog Converter

+ \$400

Opt 005 Frequency Extension to 24 GHz (HP 5342A Only)

+ \$500

Opt 006 Limiter Input Protection (+39 dBm)

+ \$630

Opt 011 Digital Input/Output (HP-IB) (Cable Not Incl)

+ \$550

Opt 908 Rack Mounting Adapter Kit

+ \$65

HP K70-59992A: Rack Mounting Adapter Kit With Slot for access to front connectors from rear.

HP 10842A: Extender Board Kit

\$800

ELECTRONIC COUNTERS

Automatic Microwave Counters (cont'd)

Model 5340A

179

- Single input 10 Hz to 18 GHz
- Automatic amplitude discrimination
- High sensitivity -35 dBm

- Optional extension to 23 GHz
- High AM and FM tolerance
- Exceptional reliability



HP 5340A



HP 5340A Frequency Counter

The HP 5340A Frequency Counter is an easily used, versatile instrument for direct measurement of frequencies from 10 Hz through 18 GHz via a single input connector.

The exceptional sensitivity of this instrument enhances measurement in the microwave field, where signals are commonly low-level and connected via directional coupler or lossy devices.

Access to the HP Interface Bus via Option 011 provides a flexible systems interface. The ability to program octave range through this input reduces acquisition time to less than 40 ms (typical).

HP 5340A Specifications

Signal Input

Input 1

Range: 10 Hz to 18 GHz.

Symmetry: sinewave or squarewave input (40% duty factor, worst case).

Sensitivity: -30 dBm, 10 Hz to 500 MHz; -35 dBm, 500 MHz to 10 GHz; -25 dBm, 10 to 18 GHz.

Dynamic range: 37 dB, 10 Hz to 500 MHz; 42 dB, 500 MHz to 10 GHz; 32 dB, 10 GHz to 18 GHz.

Impedance: 50 Ω.

VSWR: <2:1, 10 Hz-12.4 GHz; <3:1, 12.4-18 GHz.

Connector: precision Type N.

Coupling: dc to load, ac to instrument.

Damage level: +30 dBm.

Total power (ac + dc) not to exceed 1 watt. See Option 006 for up to +39 dBm protection.

Acquisition time: <150 ms mean typical.

Input 2

Range: 10 Hz-250 MHz direct count.

Sensitivity: 50 mV rms. 150 mV p-p pulses to 0.1% duty factor; minimum pulse width 2 ns.

Impedance: 1 MΩ shunted by <25 pF.

Connector: type BNC female.

Coupling: ac.

Maximum input: 200 V rms, 10 Hz to 100 Hz; 20 V rms, 100 Hz to 100 kHz; 2 V rms, 100 kHz to 250 MHz.

Automatic amplitude discrimination: automatically selects the strongest of all signals present (within 250 MHz to 18 GHz phase-lock range), providing signal level is: 6 dB above any signal within 200 MHz; 10 dB above any signal within 500 MHz; 20 dB above any signal, 250 MHz-18 GHz (typical performance).

Maximum AM modulation: any modulation index as long as the minimum voltage of the signal is not less than the sensitivity specification.

Time Base

Crystal frequency: 10 MHz.

Stability

Aging rate: <3 × 10⁻⁷ per month.

Short term: <5 × 10⁻¹⁰ rms for 1 second averaging time.

Temperature: <±2 × 10⁻⁶ over the range of 0°C to 50°C.

Line variation: <±1 × 10⁻⁷ for 10% line variation from nominal.

Output frequency: 10 MHz, ≥2.4 V square wave (TTL compatible) available from rear panel BNC.

External time base: requires 10 MHz approximately 1.5 V p-p sine wave or square wave into 1 kΩ via rear panel BNC. Switch selects either internal or external time base.

Optional time base (opt 001) aging rate: <5 × 10⁻¹⁰ per day after 24-hour warm-up for less than 24 hour off-time.

General

Accuracy: ±1 LSD ± time-base error.

Resolution: front-panel switch selects 1 Hz to 1 MHz.

Display: eight digit LED with positioned decimal point and appropriate measurement units of kHz, MHz, or GHz.

Self check: counts and displays 10 MHz for resolution chosen.

Sample rate: controls time between measurements. Continuously adjustable from 50 ms typical to 5 seconds. HOLD position holds display indefinitely. RESET button resets display to zero and activates a new measurement.

HP-IB interface functions: SH1, AH1, T1, L2, SL1, RL2, PP0, DC1, DT1, C0, E1 (see page 568).

Operating temperature: 0°C to 50°C.

Power: 115 V or 230 V +5%, -10%, 48-66 Hz, 100 VA.

Weight: net, 11.3 kg (25 lb). Shipping, 14.1 kg (31 lb).

Size: 88.2 mm H x 425 mm W x 467 mm D (3.47 in. x 16.75 in. x 18.39 in.).

Ordering Information

Ordering Information	Price
HP 5340A Frequency Counter	\$16,500
Opt 001 High Stability Time Base	+ \$825
Opt 002 Rear Panel Connectors	+ \$230
Incompatible with Option 006. Consult factory special to combine these Options.	
Opt 005 Frequency Extension to 23 GHz	+ \$690
Incompatible with Option 006. Consult factory special to combine these Options.	
Opt 006 Limiter Input Protection (+39 dBm)	+ \$690
Incompatible with Option 002 & Option 005. Consult factory special to combine these Options.	
Opt 011 Remote Programming-Digital Output (HP-IB)	+ \$630
Opt 908 Rack Flange Kit	+ \$65

ELECTRONIC COUNTERS

Pulse/CW Microwave Frequency Counter

HP 5361A

- 1 Hz resolution on pulsed and CW signals
- Measure frequency (pulsed or CW), PRI, PRF, pulse width and offtime directly
- Up to +50 dBm pulse level protection (optional)
- 60 ns minimum pulse width
- 20 ns minimum external gate
- Measurements down to 1 Hz PRF

DESIGNED
FOR
MATE
SYSTEMS



DESIGNED FOR
HP-IB
SYSTEMS
HP 5361A

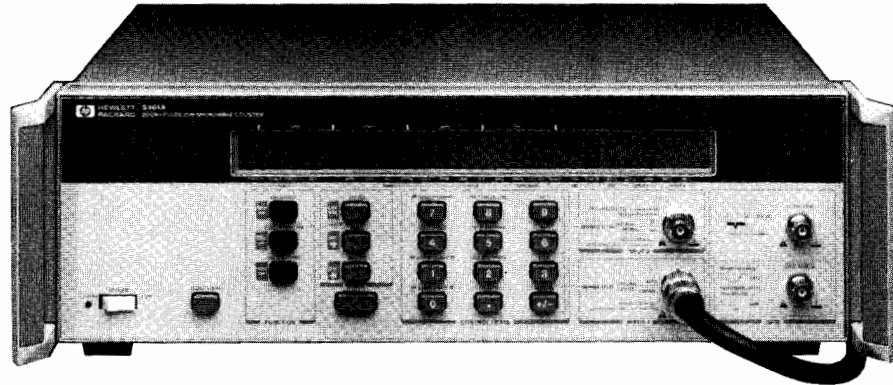

Precision Pulse and CW Measurements in One Microwave Counter

The HP 5361A is designed for both high precision pulse and CW performance. Measure radar pulses, VCO step responses, or stable local oscillators (STALOs) with one counter. For the price of a pulse microwave counter you receive a high performance CW counter at no extra cost.

A High Precision Pulse Counter

The HP 5361A measures 20 GHz pulsed microwave signals with up to 1 Hz resolution. Five separate pulse microwave measurements are available to characterize signals. And, you can profile with external gate widths as narrow as 20 ns.

True CW Performance

Count CW signals from 20 GHz to 10 Hz with 1 Hz resolution. Resolution improves to 0.001 Hz at 100 kHz. Other CW counter features include fast track and low FM rate. Fast track enables the counter to measure a signal that is sweeping at up to 800 MHz per second which is useful when characterizing a VCOs. Low FM rate allows measurements on a signal that is varying slowly in frequency.

Automatic Measurements Simplify Testing

The "suite" of automatic features for the HP 5361A are designed to make your testing easier. The counter performs many different automatic operations that must be performed manually in other counters.

Measurements are simple with this instrument; all you need to do is connect your signal and choose the function. The counter automatically makes the measurement and displays the result. Automatic features include the following:

Auto-calibration - A major calibration is performed internally at power up, or on command. No external connections are needed.

Auto-assess - Determines if the signal is pulsed or CW and shifts to the correct measurement routines.

Auto-acquire - Automatically acquires a signal from 500 MHz to 20 GHz, without the need to switch bands.

Auto-gate - Sets the required gate width for CW signals, depending on the resolution you select. For pulses, auto-gate measures the width of the microwave pulse and sets a gate width that is slightly smaller than the pulse.

Auto-PRF - Allows you to measure the carrier frequency of signals with stable or changing PRIs, from 2 MHz to 50 Hz. A low-PRF mode enables measurements to 1 Hz PRF.

Auto-position - Positions the gate inside the microwave pulse so that turn-on and turn-off transients do not corrupt the measurement.

Auto-track - After a CW signal has been acquired, the HP 5361A automatically tracks a signal sweeping up to 800 MHz per second in Fast Track.

Auto-resolution - You set the resolution, and the counter determines the gate width for CW signals and the number of pulses to average for the true resolution. Smoothing typically provides a factor of 10 improvement on this resolution.

Auto-indicate - Displays the measurement and indicates whether the signal is pulse or CW.

Increase Your Confidence in Pulse Profiling with Scope-View

Complex measurements such as profiling radar chirps are now easier. You can see precisely where the gate is positioned inside the pulse by connecting the scope-view output to a 100 MHz oscilloscope (see figure 1). This signal is a composite of the actual gate (internal or external) and the downconverted signal.

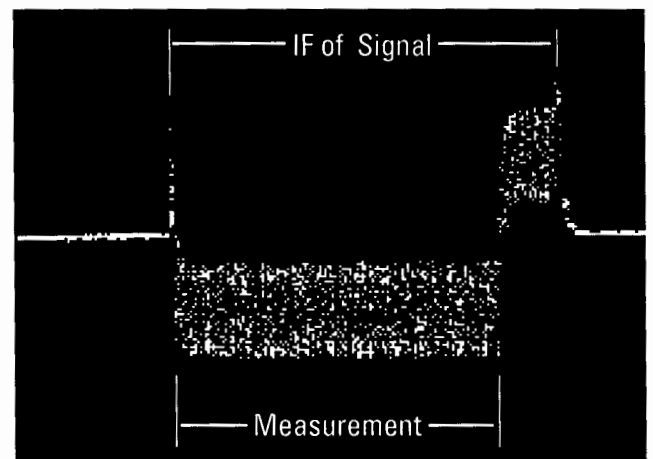

Figure 1. Scope-view (IF + gate) output, as seen on an HP 54501A 100 MHz oscilloscope.

The Capability Required For R&D On Tomorrow's Radar

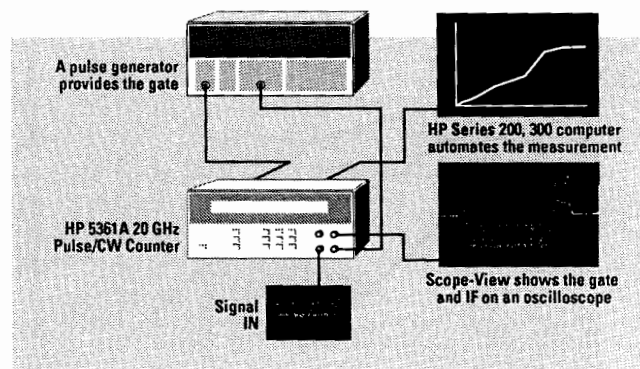

Figure 2. Simplify frequency profiling using HP 5361A Scope-View.

Measure Simple Parameters Easily

The HP 5361A counter makes standard frequency and timing measurements at the touch of a button. Frequency within the burst, pulse width, PRI, PRF and offtime are measured directly. The counter is also flexible enough to make more complex measurements. Carrier frequency measurements on signals with jittered PRIs or varying pulse widths are easy.

Profile Frequency Easily and Inexpensively

Profiling a radar chirp to determine linearity or characterizing the droop when turning on a high power stage is relatively easy with built-in features on the HP 5361A. The "Pulse Out" output provides a TTL pulse that matches the signal envelope width. This can be used to trigger a pulse generator that can supply a measurement gate as small as 20 ns. This gate is used to profile the microwave pulse.

Scope-View Gives You Visual Feedback during Frequency Profiles

Scope-view enables you to see the pulse directly (downconverted to 45 to 95 MHz) with a dc offset at the actual measurement interval. When frequency profiling with a frequency counter, there is always a concern that the external gating signal might not coincide with the microwave pulse. This can be due to internal delays of the counter or pulse generator or to cable lengths that add too much delay. Scope-view eliminates the concern by showing you the location of the measurement interval.

Application Notes Provide Measurement Assistance

"Automatic Frequency Profiling of Chirped Radar Pulses," Application Note 377-1, shows you how to measure FMOP (frequency modulation on the pulse) using the HP 5361A as illustrated in figure 2.

Resist Burnout with a High Damage Level

Option 006 extends the damage level to +50 dBm for pulses of 1 micro-second and less (with a duty cycle of 0.001), or approximately +40 dBm for CW signals. Outstanding sensitivity of -25 dBm is still achieved with option 006. The standard damage level is +25 dBm, more than enough for low power applications.

The Features To Meet Those Tough Military Applications

The HP 5361A offers built-in and optional features to meet special military requirements.

Security Mode (standard)-Many applications require measurement of secure parameters such as particular frequencies and PRIs. To ensure that secure data remains secure, the HP 5361A can make measurements over HP-IB while keeping the display blank.

47.5 Hz to 440 Hz Operation (standard)-Many military operations require more than the standard 50 to 60 Hz frequency power source operation. This counter accepts 47.5 Hz to 440 Hz power without requiring a special option.

MATE (Option 700)-Modular Automatic Test Equipment compatibility is required for all automatic test equipment sold to the U. S. Airforce. This provides the means of making instruments from various manufacturers appear identical to the system controller.

Low Emissions/Susceptibility (Option 461)-Provides the capability to operate in low noise environments without interfering with the measurement, per MIL-STD-461C, part 7.

The Optimum Tool For Both Manufacturing And Service

An Excellent Solution for ATE

Easy programming for automated test stations is ensured with the HP 5361A by its simple English-like commands. The counter can also produce results at rates up to 100 measurements/second. The improved efficiency saves you time and money by letting you test more devices in a given amount of time.

Easy System Integration with Timebase Flexibility

The counter can be locked to an external reference or source its own high performance timebase. Both 1 MHz and 10 MHz references are available at the rear panel of the instrument. Two options (Options 001 and 010) provide even higher stability timebases. A higher stability timebase extends the calibration cycle. The timebase is the only periodic calibration. Option 010 can extend the calibration cycle to 5 years, and still provide kHz measurement accuracy on a 20 GHz frequency measurement.

The Right Mix of Features Simplifies VCO Testing.

The HP 5361A has features to accurately and easily test VCOs. External gating lets you profile the step response with gate widths as narrow as 20 ns. Post-tuning drift and settling time can also be measured in this way. Fast track is also useful for measuring tuning linearity because it is able to track a signal that is moving at up to 800 MHz per second. The counter can output results at up to 100 readings per second.

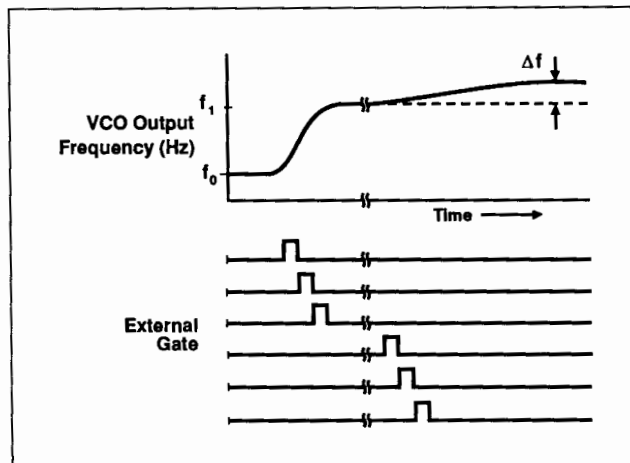

Figure 3. Measure VCO step response, settling time, and post tuning drift with the HP 5361A (see Application Note 377-2, "Automatic Characterization of Microwave VCOs").

ELECTRONIC COUNTERS

Pulse/CW Microwave Frequency Counter (cont'd)

HP 5361A

Specifications

Functions

Frequency (pulse or CW), PRF, PRI, pulse width, and offtime

Input Characteristics

	Input 1 (50 Ω)	Input 2 (1 M Ω)	Input 2 (50 Ω)
Freq. Range	500 MHz - 20 GHz	10 Hz - 80 MHz	10 MHz - 525 MHz
Sensitivity		25 mV _{rms} (20 mV _{rms})	25 mV _{rms} (20 mV _{rms})
0.5 - 12.4 GHz	-28 dBm (-32 dBm)		
12.4 - 20 GHz	-23 dBm (-27 dBm)		

The sensitivities in parentheses relate the mean of 10 HP 5361As at 25°C

Frequency (INPUT 1)

Automatic & manual acquisition: 500 MHz - 20 GHz

least significant digit: 1 MHz to 1 Hz for frequency, 0.001 Hz for PRF

Pulse frequency measurements

Pulse width (minimum)

Manual mode- 60 ns

Auto mode- 100 ns

Pulse rep frequency

Minimum - 1 Hz

Maximum - 2 MHz

External gate width (minimum): 20 ns

Resolution: 1 MHz to 1 Hz

Accuracy (mean): 1 MHz to 30 Hz

Acquisition time (auto mode): >360 ms

Measurement time: \geq 100 ms

CW measurements

FM tolerance (manual mode) 50 MHz p-p

Tracking speed (fast acquisition): 800 MHz/s

Resolution: 1 Hz

Accuracy (mean): 1 Hz

Acquisition time

Manual mode- <40 ms

Auto mode, Fast Acq.- <100 ms

Gate time (1 Hz Resolution): 200 - 800 ms

Measurement time: \geq 8.5 ms

Frequency (INPUT 2)

Range 10 Hz - 525 MHz

Resolution/LSD 1 Hz to 0.001 Hz

Accuracy 1 Hz to 0.001 Hz

Pulse parameters (INPUT 1)

	Pulse Width	PRI	Offtime	PRF
Min/max	60 ns/10 ms	500 ns/1 s	400 ns/1 s	1 Hz/2 MHz
LSD	(PW < 1 ms) - 1 ns; (PW \geq 1ms) - 100 ns			to 0.001 Hz
Accuracy (100 ave.)	$\pm(20 \text{ ns} + \text{timebase error} \times \text{measurement}) \pm \text{LSD}$			$\pm(20 \text{ ns}) \times (\text{PRF})^2$ $\pm \text{LSD} \pm \text{timebase uncertainty}$

Measurements approx. 6 dB below signal peak.

Optional increased damage level

Option 006 Damage Level: Pulsed - +50 dBm (100 watts) peak;
CW - +39 dBm (8 watts)

Resolution &
Gate Error

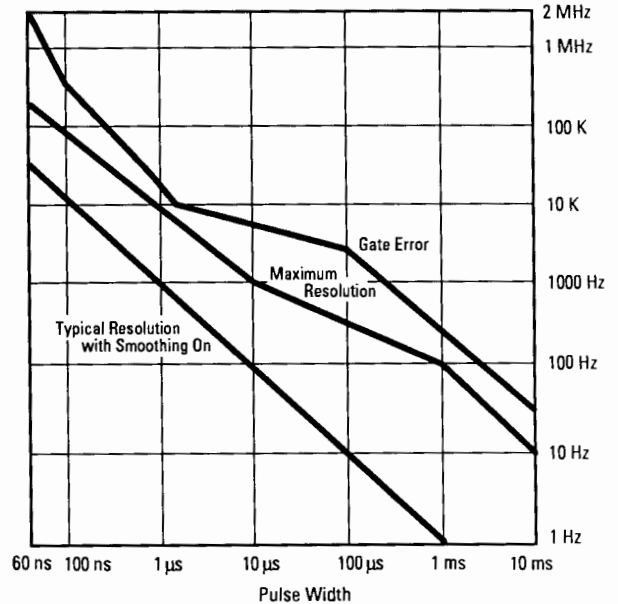

Graph 1. Resolution and Gate Error

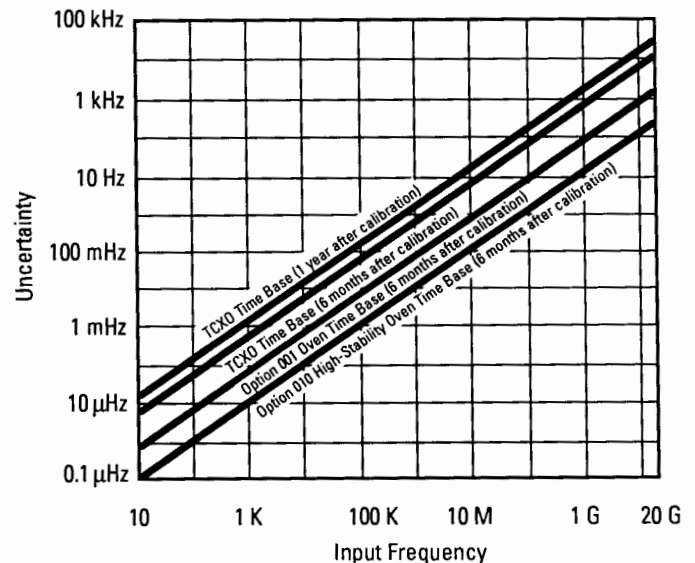

Graph 2. Time Base Uncertainty

Ordering Information

HP 5361A 20 GHz Pulse/CW Microwave Counter

Price \$11,900

Opt 001 Oven timebase +\$950

Opt 006 Microwave limiter +\$950

Opt 010 High stability timebase +\$1,500

Opt 461 Low emissions/susceptibility +\$950

Opt 700 MATE interface +\$750

Opt 908 Rack mount kit for use with front handles removed +\$33

Opt 910 Additional operating and programming manual +\$65

Opt 913 Rack mount kit for use with supplied front handles +\$82

Opt W30 Extended Repair Service. See page 725. +\$325

Opt W32 Calibration Service. See page 725. +\$875

ELECTRONIC COUNTERS

Pulse and CW Microwave Frequency Counters

Models 5345A/5355A/5356A,B,C,D

183

- -25 dBm sensitivity
- 100 Hz measurement resolution
- 75 nanoseconds minimum pulse width

- 20 nanoseconds minimum external gate
- CHIRP profile or VCO post-tuning drift

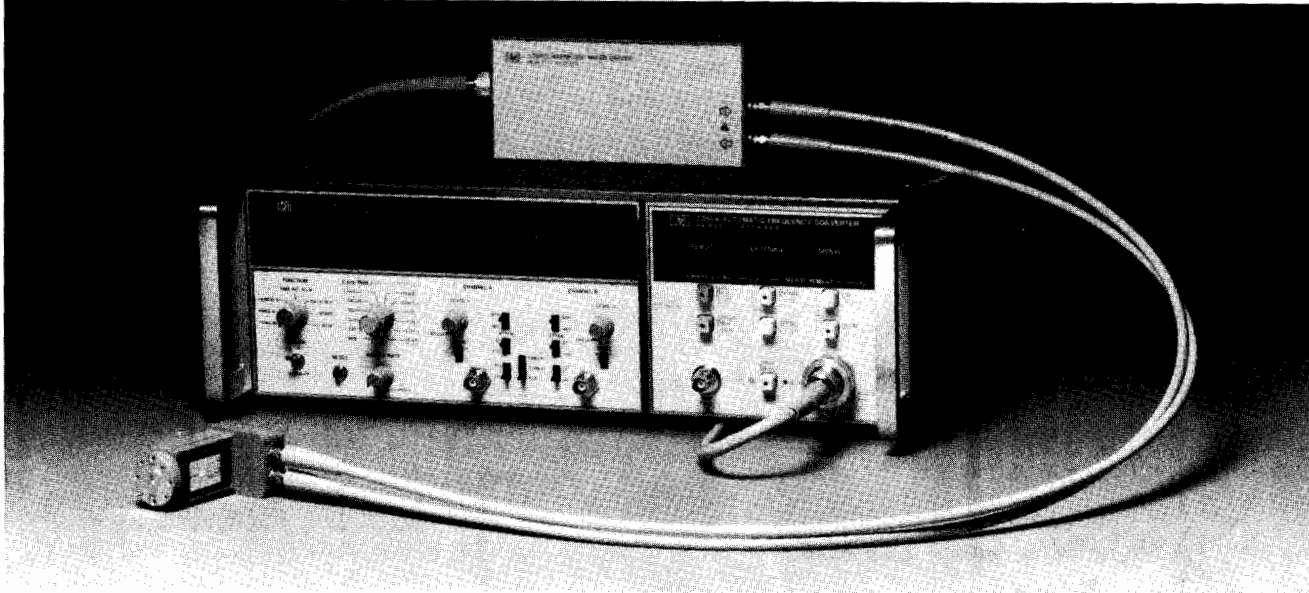

Extending the frequency range of CW and pulse measurements to 100 GHz.



DESIGNED FOR
MATE
SYSTEMS

Pulse and CW Measurements to 110 GHz

HP 5355A Automatic Frequency Converter/5345A Counter, together with the HP 5356A, 5356B, 5356C, 5356D Frequency Converter Heads, provide pulse and CW frequency measurement capability to 18, 26.5, 40, and 110 GHz respectively. The HP 5355A's internal microprocessor controls the measurement algorithm, computes the input microwave frequency, and displays the result on the HP 5345A with 11 digits of resolution.

Automatic Pulse Detection

This 110 GHz counter is a versatile tool for characterizing pulsed signals. Internal pulse-detection circuitry (Figure 1) can detect incoming RF bursts as short as 75 nanoseconds and generate a measurement gate for the counter. With this internally-generated detection gate, the counter can then measure the average frequency of the RF burst.

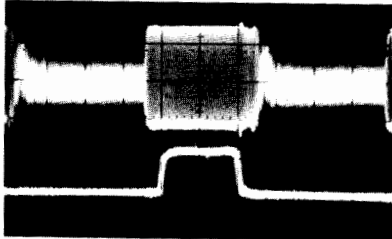

Figure 1. Automatic Pulse Detection

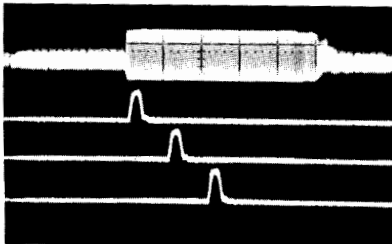

Figure 2. External gates as short as 20 ns

Pulse Frequency Profiling

If there is FM on the burst carrier, the counter can also accept external measurement gates as short as 20 nanoseconds (Figure 2) to perform dynamic frequency profilings. This external gating capability is useful in applications such as radar CHIRP characterization. (Figure 3) It can also help VCO manufacturers measure oscillator's post-tuning drift (Figure 4).

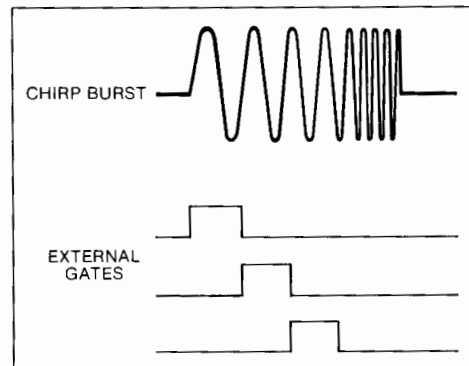

Figure 3. CHIRP radar characterization

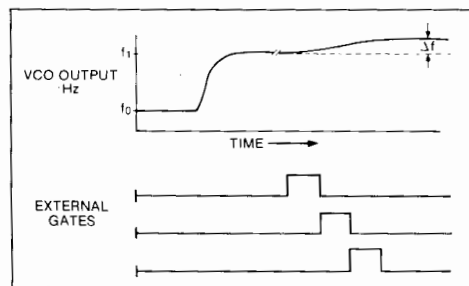

Figure 4. VCO post-tuning drift characterization

Exceptional Resolution, High Accuracy

You can select the measurement gate time of this counter from 50 nanoseconds to 1000 seconds. Increasing the measurement gate time increases the resolution of measurement results. In fact, this counter can measure a 110 GHz signal with 100 Hz resolution and 3 kHz accuracy in pulse mode. This performance improves to 1 Hz in CW mode.

Even if your application requires narrow external gates, the counter can still achieve fine resolution through an automatic frequency averaging scheme (Figure 5). When the measurement gate is longer than the external gate, the counter will automatically take several measurements of the repetitive signal. It will then average the results to yield better resolution. The measurement process is completely automatic—making the counter easy to work with.

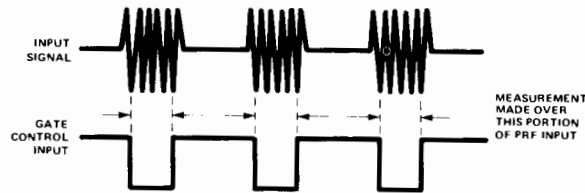

Figure 5. Frequency averaging to increase resolution

Sensitivity, FM Tolerance, Automatic Amplitude Discrimination

HP's pulse counters have sensitivity performance to -25 dBm, making measurement of low-level microwave and millimeter-wave signals reliable and accurate. For signals with frequency modulation, these counters also offer high peak-to-peak amplitude discrimination automatically measures the signal with the highest amplitude.

Systems Performance, 9000 Measurements/Second

These counters are fully programmable over HP-IB. Measurement throughput of 9000 measurements/second saves you money by reducing test time.

Input Specifications (pulse and CW mode)

	HP 5356A	HP 5356B	HP 5356C	HP 5356D
Frequency Range	1.5-18 GHz	1.5-26.5 GHz	1.5-40 GHz	36-110 GHz
Sensitivity				
1.5-12.4 GHz	-20 dBm	-20 dBm	-25 dBm	---
12.4-18 GHz	+5 dBm	-15 dBm	-20 dBm	---
18-26.5 GHz	---	-15 dBm	-20 dBm	---
26.5-34 GHz	---	---	-15 dBm	---
34-40 GHz	---	---	-10 dBm	---
36-50 GHz	---	---	---	-20 dBm
40-60 GHz	---	---	---	-15 dBm
50-75 GHz	---	---	---	-10 dBm
75-95 GHz	---	---	---	-7 dBm
95-105 GHz	---	---	---	-5 dBm
105-110 GHz	---	---	---	-3 dBm
① Maximum Input				
1.5-12.4 GHz	+5 dBm	+5 dBm	+5 dBm	---
12.4-18 GHz	+5 dBm	+5 dBm	+15 dBm	---
18-26.5 GHz	---	+5 dBm	+15 dBm	---
26.5-40 GHz	---	---	+15 dBm	---
36-110 GHz	---	---	---	+5 dBm
① Damage Level	+25 dBm peak	+25 dBm peak	+25 dBm peak	+24 dBm peak +20 dBm CW
Impedance	50 Ω NOMINAL	50 Ω NOMINAL	50 Ω NOMINAL	Waveguide
SWR (TYPICAL)				
1.5-10 GHz	< 2.1	< 2.1	< 2.1	---
10-18 GHz	< 3.1	< 3.1	< 3.1	---
18-26.5 GHz	---	< 3.1	< 3.1	---
26.5-34 GHz	---	---	< 3.1	---
34-40 GHz	---	---	< 5.1	---
36-110 GHz	---	---	---	< 3.1
Connector	N Male	SMA Male	APC 3.5 Male	Waveguide

① HP 5356A/B. See Option 006 for higher damage protection to +39 dBm.
 ② 1.5-6 GHz: +0 dBm (+5 dBm, TYPICAL)
 6-12.4 GHz: +5 dBm

CW Mode

	HP 5356A/B/C Auto Mode	HP 5356A/B/C/D Man Mode	HP 5356D Auto Mode
FM Tolerance	5356A/B: 15 MHz p-p (60 MHz p-p in special FM mode); rate: dc - 10 MHz 5356C: 60 MHz p-p; rate: dc - 10 MHz	80 MHz p-p rate: dc - 10 MHz	Fig. 6
AM Tolerance	Any modulation index provided the minimum signal level is greater than the counter sensitivity.		50
Multiple Signal Discrimination	Automatic Amplitude Discrimination (AAD): Automatically measures largest signal provided signal is 8 dB (TYPICAL) greater than any signal within 500 MHz and 20 dB (TYPICAL) greater than any signal over the full frequency range of the head.		15 dB TYP
Acquisition Time (TYPICAL)	HP 5356A/B = 400 ms HP 5356C = 1.4 s	15 ms	① 100 ms
Measurement Time (TYPICAL)	Gate Time ≤ 100 ms: Acquisition time + 4 × HP 5345A GATE TIME + 5345A Sample Rate + 125 ms Gate Time > 100 ms: Acquisition time + HP 5345A GATE TIME + HP 5345A Sample Rate + 35 ms		
Tracking Rate			100 MHz/s (TYPICAL)
LSD Displayed	1 Hz : HP 5345A Gate Time		
Resolution	±2 × LSD ± 10 ⁻¹⁰ rms × FREQ		
Accuracy	±2 × LSD × 1 × 10 ⁻¹⁰ rms × FREQ - time base error × FREQ		

① 100 ms (input level -5 to +5 dBm)
 300 ms (input level -15 to -5 dBm)
 400 ms (input level -20 to -15 dBm)

Pulse Mode

	HP 5356A/B/C/D Input Auto Mode	HP 5356A/B/C/D Input Man Mode
FM Tolerance (TYPICAL)	50 MHz p-p Chirp	80 MHz p-p Chirp
Acquisition Time (TYPICAL)	<ul style="list-style-type: none"> HP 5356A/B/C Input Man Mode: 0 HP 5356A/B Input Auto Mode: 100 μs + (EXT GATE WIDTH × PRF) + 650 ms for EXT GATE ≤ 100 μs (2 - PRF) + 650 ms for EXT GATE > 100 μs HP 5356C Input Auto Mode: (8 × PRF) + 1.55s + 100 μs + (EXT GATE WIDTH × PRF) for EXT GATE ≤ 100s (10 + PRF) + 1.55s for EXT GATE > 100 μs HP 5356D -5 to +5 dBm (X) = 2.5 HP 5356D -15 to -5 dBm (X) = 3.5 HP 5356D -20 to -15 dBm (X) = 4.5 $(X)s + 2 \left(\frac{100 \mu s}{EXT GATE WIDTH \times PRF} \right) \text{ For EXT GATE } < 100 \mu s$ $(X)s + \frac{2}{PRF} \text{ For EXT GATE } > 100 \mu s$ <ul style="list-style-type: none"> HP 5356D Limited Search: (X) = 1, Range: 1 to 6 GHz or +3 GHz from center frequency 	
Calibration Time	$\left(\frac{HP 5345A GATE TIME}{EXT GATE WIDTH \times PRF} \right) + 75 \text{ ms}$ Performed during 10 consecutive measurements when PULSE Mode is selected; after any front panel change; or when the EXTERNAL GATE width changes by more than 12%. Only calibrates if External Gate is < 100 μs	
Measurement Time (TYPICAL)	Acquisition Time + Calibration Time + HP 5345A SAMPLE RATE + HP 5345A GATE TIME or 100 μs (whichever is greater)	Acquisition Time + Calibration Time + HP 5345A SAMPLE RATE + 60 ms + (1 μs + HP 5345A GATE TIME) / EXT GATE WIDTH × PRF
Pulse Width Min.	100 ns (150 ns, HP 5356D with Opt. 110)	75 ns
Max.	20 ms	20 ms
Pulse Repetition Frequency Min.	50 Hz	50 Hz
Min. (HP 5356D only)	500 Hz	500 Hz
Max.	2 MHz	2 MHz
Minimum On/Off RATIO	25 dB TYPICAL	
Maximum Video Feed-Through	15 mV p-p TYPICAL for r.f. burst rise and fall times > 10 ns for HP 5356A/B/C. No limitation for HP 5356D (Waveguide beyond cutoff)	
Minimum EXT GATE WIDTH	20 ns	
LSD Displayed	1 Hz + HP 5345A GATE TIME	
Resolution	±2 × LSD ± 100 Hz rms + (1 : √ HP 5345 GATE TIME × EXT GATE TIME WIDTH) ①	
Accuracy	$(1 + \sqrt{HP 5345 GATE TIME \times EXT GATE TIME WIDTH}) \times \left(\pm 2 \times LSD \pm 100 \text{ Hz rms} + \frac{0.4}{EXT GATE WIDTH} \pm 3 \text{ kHz} \right) \pm \text{time base error} \times \text{FREQ}$ ①	

① For (HP 5345 GATE TIME) ≥ 10 ms and PULSE WIDTH > 10 μs, use

$$A = \sqrt{HP 5345 GATE TIME \times EXT GATE TIME WIDTH}$$

A=3, except for W band, where A=7

For EXT GATE signals generated by the HP 5355A the EXT GATE WIDTH equals the input PULSE WIDTH minus 30 ns (TYPICAL) for the HP 5356A/B/C/D input and equals input PULSE width minus 65 ns (TYPICAL) for the HP 5355A 0.4-1.5 GHz input

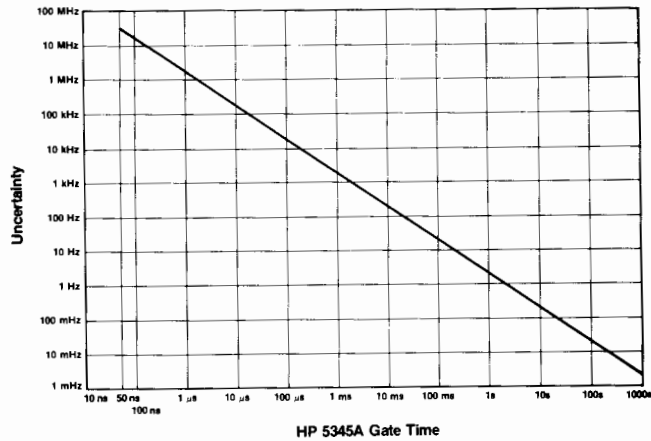

Graph 1. Uncertainty ($2 \times \text{LSD}$) due to selected 5345A gate time.

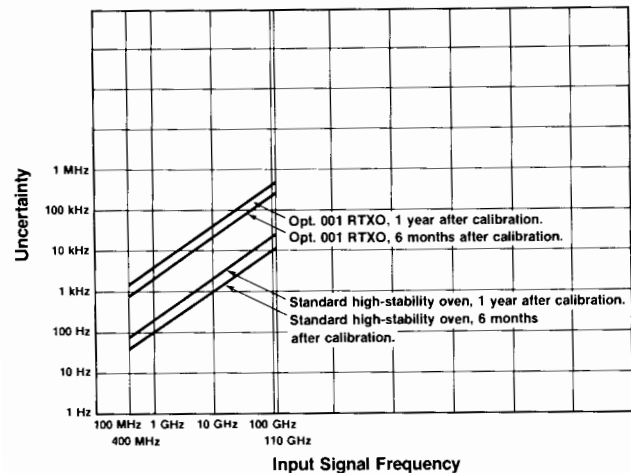

Graph 2. Uncertainty, due to time-base error. Time-base error can be reduced by calibrating the time base more frequently

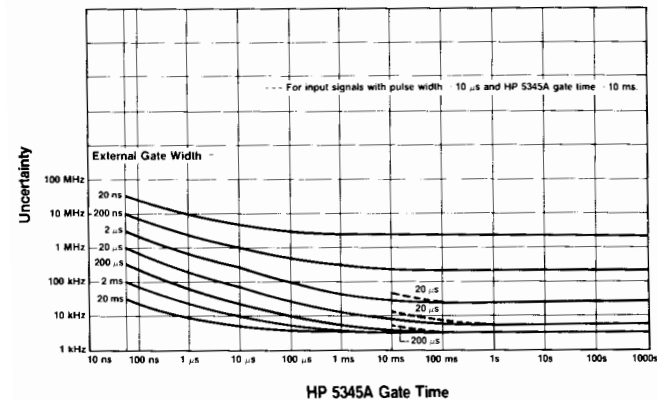

Graph 3. Uncertainty due to jitter (rms jitter) and gate error

$$\left(\frac{.04}{\text{EXT GATE WIDTH}} \pm 3 \text{ kHz} \right)$$

Input Specifications

- 5355A 0.4 - 1.6 GHz (condensed)
- Sensitivity:** -15 dBm.
- Maximum input:** +5 dBm.
- Impedance:** 50 Ω nominal.
- Damage level:** +24 dBm peak (fuse in BNC connector).
- Pulse width:** 150 ns to 1 s
- Pulse repetition rate:** 100 Hz to 2 MHz.

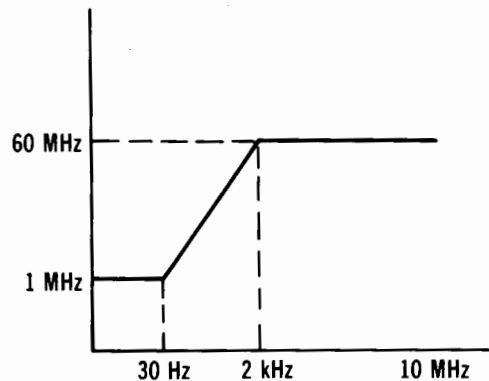

Figure 6 HP 5356D FM Tolerance

Ordering Information

	Price
HP 5345A Electronic Frequency Counter	\$12,000
HP 5355A Automatic Frequency Converter	\$7,900
HP 5356A 18 GHz Frequency Converter	\$2,400
HP 5356B 26.5 GHz Frequency Converter	\$2,400
HP 5356C 40 GHz Frequency Converter	\$2,950
HP 5356D 36-110 GHz Harmonic Mixer Driver	\$7,000

Options for HP 5345A

Opt 011 HP-IB includes remote programming	+\$1,500
Opt 012 HP-IB similar to Opt 011, but also includes slope and trigger level controls	+\$1,600
Opt 700* Test Module Adapter (TMA) for MATE System	+\$5,000
Opt 908 Rack Flange Kit, HP 5060-8740	+\$65

Options for HP 5356A

Opt 001 High Pass Filter	+\$240
Opt 006 Limiter	+\$500

Options for HP 5356B

Opt 001 18-26.5 GHz Waveguide (WR-42)	+\$1,050
Opt 006 Limiter	+\$450

Option for HP 5356C

Opt 001 26.5-40 GHz Waveguide (WR-28)	+\$940
--	--------

Options for HP 5356D (requires an HP 5355A with S/N prefix greater than 2620 - xxxxx and one of the following mixer options)

Opt 005 (two HP 5061-5458 parts) 2 cables to connect HP 5356D to HP 1197Q/U/V or W	+\$230
Opt 050 (HP 11970Q) 36-50 GHz Harmonic Mixer	+\$1,700
Opt 060 (HP 11970U) 40-60 GHz Harmonic Mixer	+\$1,850
Opt 075 (HP 11970V) 50-75 GHz Harmonic Mixer	+\$2,250
Opt 110 (HP 11970W) 75-110 GHz Harmonic Mixer	+\$2,500

Fast-Ship Product — see page 734.

* Must be ordered with Opt 12 and an HP 5355A

ELECTRONIC COUNTERS

Low Cost Counters for Frequency Measurements

Models 5384A, 5385A, 5386A

- Frequency measurements to 3 GHz (HP 5386A)
- Up to 11 digits of resolution, 9 digits per second
- -23.5 dBm sensitivity



HP 5386A: 10 Hz to 3 GHz (pictured above).
 HP 5385A: 10 Hz to 1 GHz (not shown).
 HP 5384A: 10 Hz to 225 MHz (not shown).

HP 5384A/5385A/5386A Frequency Counters

The HP 5384A/85A/86A are HP's lowest priced system counters. They provide outstanding measurement performance for bench, field, and systems applications. Combining wide frequency range, high resolution, high sensitivity, and HP-IB compatibility, these counters compare with instruments which cost much more.

Portable: The half-rack-width package makes the HP 5384A/85A/86A portable and saves rack or bench space.

Versatile Display: The twelve-digit, liquid-crystal display has larger characters than other LED displays and is easier to read in sunlight. The added feature of remote display extends the usefulness of these counters beyond that of simply making and displaying frequency measurements. User-friendly messages, prompts and measurement units can now be displayed.

Low Cost Of Ownership: Integrated design and extensive self-tests result in greater reliability, easier serviceability, and ultimately lower cost of ownership.

Performance

If your frequency measurement needs are below 3 GHz, the HP 5386A will provide you with the basic performance of traditional microwave counters, at about half the price. The HP 5386A measures frequencies from 10 Hz to 3 GHz with only two input ports, instead of the three ports found with other counters. The high-frequency input measures frequencies from 100 MHz to 3 GHz with -23.5 dBm sensitivity (15 mV rms). In addition, prescaling techniques offer peak-to-peak FM tolerance of at least 100 MHz for your communications applications. You can select the number of digits displayed from 3-to-11 to blank meaningless digits from an unstable signal source. The HP 5386A also solves your systems problems with full remote programmability (via HP-IB standard feature) and remote display capabilities. The high-stability timebase option will lengthen the required calibration period (for kHz accuracy at 3 GHz) from six months to a full year.

Applications

The HP 5386A fits well in the following application areas for local oscillator, IF, and radio transmitter frequency measurements:

- Military and private communications
- TACAN, DME, and Identify Friend or Foe
- Global Positioning System
- MDS Television

- HP-IB standard
- Systems performance and portability

Condensed Specifications

Input Channel A (HP 5384A/85A/86A): 1 M ohm // 25 pF.

Range: 10 Hz to 100 MHz.

Sensitivity: 15 mV rms sine wave 50 Hz (10 Hz for HP 5386A) to 100 MHz; 45 mV peak-to-peak 5 ns minimum pulse width; HP 5384A/85A only: 25 mV rms sine wave 10 Hz to 50 Hz.

Dynamic Range: 45 mV to 4 V peak-to-peak X attenuator setting.

Attenuator: $\times 1$ or $\times 20$ nominal above 50 Hz input.

Low Pass Filter: 100 kHz nominal 3 dB point.

Manual Trigger Level: variable, -0.1 V to +0.1 V \times attenuator.

Damage Level $\times 1$: 10 - 200 Hz 350 V (dc + ac peak).

0.2 - 420 kHz 170 V (dc + ac peak).

0.42 - 10 MHz (5 $\times 10^7$ V rms Hz)/FREQ.

>10 MHz 5 V rms.

$\times 20$: <1 MHz, Same as $\times 1$: >1 MHz, 50 V rms.

Input Channel B (HP 5384A): 50 ohm.

Range: 50 to 225 MHz.

Sensitivity: 10 mV rms 50 to 200 MHz; 15 mV rms 200 to 225 MHz.

Dynamic Range: 10 mV to 1 V rms.

Manual Attenuator: variable, $\times 1$ to $\times 5$ (0 to 14 dB) nominal.

Damage Level: 350 V dc + 5 V rms ac.

Input Channel B (HP 5385A): 50 ohm, fused.

Range: 90 to 1000 MHz.

Sensitivity: 10 mV rms (-27 dBm) 100-1000 MHz; 15 mV rms (-23.5 dBm) 90 - 100 MHz.

Dynamic Range: 10 mV to 7 V rms (-27 to +30 dBm).

Manual Attenuator: variable, $\times 1$ to $\times 18$ (0 to 25 dB) nominal.

Damage Level: ac >1 MHz + 30 dBm (7 V rms).

ac <1 MHz 2 V rms, dc ± 5 V.

Input Channel B (HP 5386A): 50 ohm nominal, VSWR 2.5, typical.

Range: 100 MHz to 3 GHz, prescaled; (100 MHz to 3.5 GHz, typical).

Coupling: ac.

Sensitivity: 15 mV rms (-23.5 dBm); 5 mV rms (-33.0 dBm) typical.

Dynamic Range: 15 mV rms to .5 V rms (-23.5 dBm to +7 dBm); 5 mV rms to .5 V rms (-33.0 dBm to +7 dBm), typical.

NOTE: Manual attenuator not active for channel B.

Frequency A and B

Range Channel A: 10 Hz - 100 MHz.

Range Channel B: (HP 5384A) 50 MHz - 225 MHz; (HP 5385A) 90 MHz - 1.0 GHz; (HP 5386A) 100 MHz - 3 GHz.

LSD Displayed: 10 Hz to 1 nHz.

Accuracy: \pm Resolution \pm Timebase Error \times Frequency (see Graphs 1 and 3).

Period A

Range: 10 ns to 0.1 s.

LSD Displayed: .001 fs to 10 ns.

Accuracy: \pm Resolution \pm Timebase Error \times Period (see Graphs 2 and 3).

Timebase

Standard HP 5384A: 10 MHz.

Aging Rate: $< 3 \times 10^{-7}$ /mo.

Temperature: $< 5 \times 10^{-6}$, 0° to 50°C, ref. 25°C.

Line Voltage: $< 1 \times 10^{-7}$ for $\pm 10\%$ variation.

Standard HP 5385A/86A, Option 001 (HP 5384A): TCXO, 10 MHz.

Aging Rate: $< 1 \times 10^{-7}$ /mo.

Temperature: $< 2 \times 10^{-6}$, 0° to 40°C, ref. 25°C.

Line Voltage: $< 5 \times 10^{-8}$ for $\pm 10\%$ variation.

Oven Timebase (Option 004)

Frequency: 10 MHz.

Aging Rate: $< 3 \times 10^{-8}$ /mo. after 30 days continuous operation.

Temperature: $< 1 \times 10^{-7}$, 0° to 50°C, ref. 25°C.

Line Voltage: $< 2 \times 10^{-9}$ for $\pm 10\%$ variation.

Battery Operation (HP 5384A/85A Only): the instrument operates for 3 hours (typ.) with Option 004. In STBY, the oven will operate continuously for 24 hours (typ.).

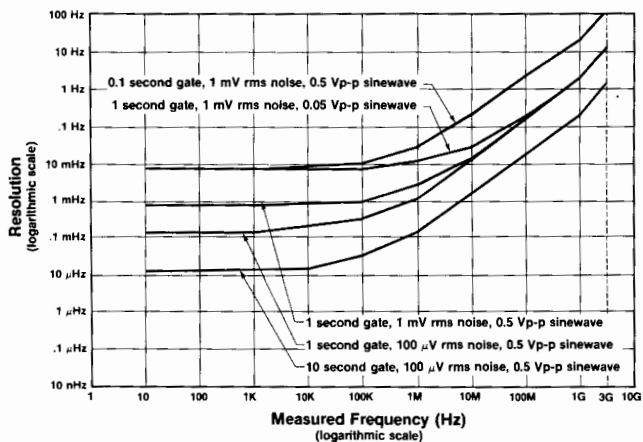

Graph 1. Frequency Resolution. Uncertainties which limit resolution can be reduced by increasing the gate time, reducing the noise on the input signal, or increasing the input signal amplitude.

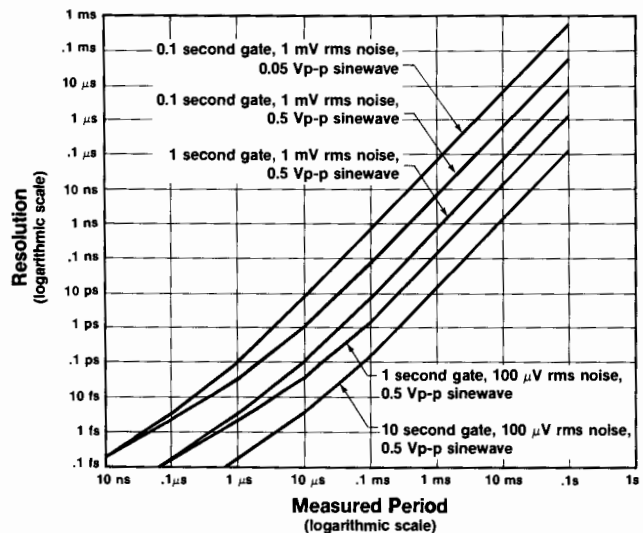

Graph 2. Period Resolution. Uncertainties which limit resolution can be reduced by increasing the gate time, reducing the noise on the input signal, or increasing the input signal amplitude.

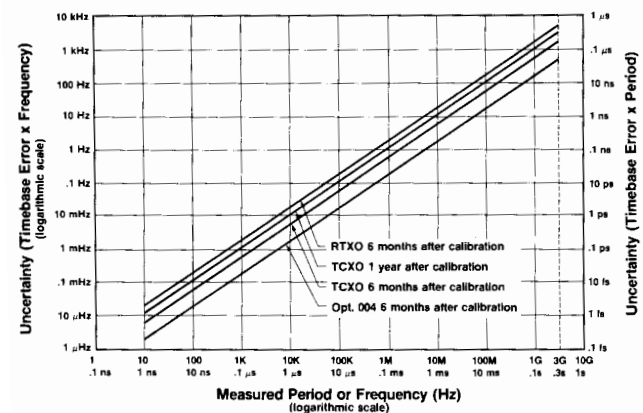

Graph 3. Frequency and Period Uncertainty due to Timebase Error. Timebase error can be reduced by calibrating the timebase more frequently, or by using a timebase with a better aging rate.

I/O Interface

HP-IB Standard

Programmable Functions: Frequency A, Frequency B, Period A.
Programmable Controls: ATTN A, FILTER A, MAN LEVEL A, MAN LEVEL A/B (HP 5384A/85A Only), Gate Time.
Display: Normal, Increment, Decrement (digits displayed); Remote, Local; any 12-character message can be displayed on the LCD via a system controller.
Data Output: output will be maximum resolution/gate time.
Format: 17 characters plus CR and LF.
Rate: 4 readings/s maximum at 0.1 s gate.
HP-IB Interface Functions: SH1, AH1, T5, TE0, L4, LE0, SR1, RL1, PP0, DC1, DT1, C0, E1 (see page 564).
Talk Only: Set with address switch = 31.

Battery Pack (Option 005 - HP 5384A/85A Only)

Battery Type: sealed lead-acid.
Capacity: 4 hours (typ.) at 25°C without Option 004.
Recharge Time: 16 hours (typ.) in the standby mode.
Battery Low Annunciator: enabled 20 minutes prior to instrument shutdown nominally.
Battery Save Switch (rear panel): prevents discharge of interval battery by the oven timebase, Option 004, during instrument standby (STBY).
Line Failure Protection: instrument automatically switches to battery in case of line failure.
Weight: Option 005 adds 1.4 kg (3 lb) to instrument weight.

General

Check: 10 MHz self-test.
Gate Times: 0.1, 1, or 10 seconds (nominal).
Display: 12-digit alphanumeric liquid crystal.
Display Digits (variable): frequency 3 to 11; period 3 to 8.
Timebase Output: 10 MHz, 25 mV p-p (nominal) into 50 ohm.
External Timebase Input: 10 MHz, 0.5 V rms into 500 ohm; 15 V (dc + ac peak) maximum.
Operating Temperature: 0° to 50°C.
Power Requirements
AC: selectable, 18 VA max. (30 VA max., HP 5386A) 115 V + 10%, -25%; 230 V + 10%, -15%; 48 - 66 Hz; 115 V ± 10%: 380 - 420 Hz.
DC: (HP 5384A/85A Only): 9 - 15 V dc, 1.0 A maximum.

Weight

HP 5384A/85A: net, 2.2 kg (4.8 lb). Shipping, 4.1 kg (9 lb).
HP 5386A: net, 3.4 kg (7.8 lb). Shipping 5.3 kg (11.9 lb).

Size:

HP 5384A/85A: 212 mmW x 98 mmH x 276 mmD (8 3/8 in. x 3 7/8 in. x 10 7/8 in.); **HP 5386A:** 212.3 mmW x 88.1 mmH x 421.6 mmD (8 3/8 in. x 3 1/2 in. x 16 1/2 in.).

Ordering Information

HP 5384A Frequency Counter 225 MHz	\$1500 ☎
HP 5385A Frequency Counter 1.0 GHz	\$1995 ☎
HP 5386A Frequency Counter 3.0 GHz	\$3600
Opt 004 High Stability Ovenized Timebase	+ \$550
Opt 910 Additional Operating/Service Manual	+ \$20
HP 5384A/85A only:	
Opt 001 High Stability TCXO (HP 5384A)*	+ \$150
Opt 005 Battery Pack	+ \$300
Side Handle Kit: HP 5061-1171	\$19
Rack Mount Kit (single): HP 5060-0173	\$64
Rack Mount Kit (dual): HP 5060-0174	\$62.50
Vinyl Carrying/Operating Case: HP 34110A	\$40 ☎
*TCXO time base is standard with HP 5385A/86A	

HP 5386A only:

Front Handle Kit: HP 5061-9688	\$50 ☎
Rack Mount Kit (single): HP 5061-9672	\$50 ☎
Rack Mount Kit (dual): HP 5061-9674 and 5061-9694	\$55 ☎

☎ Fast-Ship product — see page 734.

ELECTRONIC COUNTERS

Our Fastest Universal Systems Counter

Model 5345A

- 500 MHz Direct Count, Conversion Plug-Ins to 110 GHz
- 2 ns Single Shot Resolution, 2 ps Averaged
- 25 mV Sensitivity to 500 MHz
- Up to 9000 readings/second over HP-IB

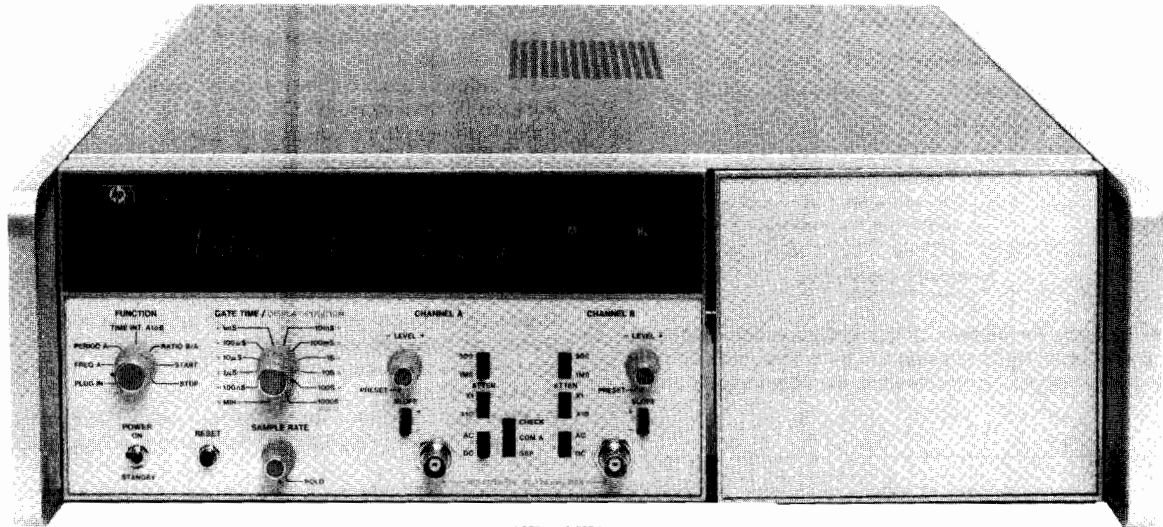

HP 5345A



Versatile, High-Speed Measurement Power

- High resolution pulsed Frequency measurements and pulse profiling to 110 GHz with the HP 5355A and HP 5356A/B/C/D.
- Rapid 2 ns resolution Time Interval measurements for jitter characterization.
- High throughput Frequency, Period, Ratio, Totalize, and Scale measurements to 500 MHz.

HP 5345A Condensed Specifications

Input Channels A and B

Range: 0 to 500 MHz dc coupled 50 Ω and 1 M Ω ; 4 MHz to 500 MHz ac coupled, 50 Ω ; 200 Hz to 500 MHz ac coupled, 1 M Ω .

Impedance: selectable, 1 M Ω shunted by less than 45 pF or 50 Ω (nominal).

Sensitivity (X1): 50 Ω , 25 mV rms sine wave and 75 mV p-p pulse. 1M Ω , 25 mV rms sine wave and 75mV p-p pulse to 300 MHz; 50 mV rms sine wave and 150 mV p-p pulse to 500 MHz.

Trigger level: adjustable over ± 2.0 V dc.

Output: rear-panel BNC connectors bring out CHAN A TRIG LEVEL and CHAN B TRIG LEVEL for convenient DVM monitoring.

Common Input

Range: ac coupled 50 Ω , 4 MHz to 400 MHz; ac coupled 1 M Ω , 300 Hz to 400 MHz; dc coupled, 0 to 400 MHz.

Impedance: 50 Ω remains 50 Ω ; 1 M Ω becomes 500 k Ω shunted by <80 pF.

Sensitivity (X1): 50 Ω , 50 mV rms sine wave and 150 mV p-p pulse. 1M Ω , 25 mV rms sine wave and 75 mV p-p pulse to 50 MHz; 75 mV rms sine wave and 150 mV p-p pulse to 200 MHz; 120 mV rms sine wave and 360 mV p-p pulse to 400 MHz.

Frequency A

Range: 0.00005 Hz to 500 MHz.

Resolution: See Graph 1.

Accuracy: \pm Resolution \pm Time-Base Error (Graph 2).

Period A

Range: 2 ns to 20,000 s.

Resolution and Accuracy: Δ Freq [Per]/Freq (Graphs 1 and 2).

Time Interval/Time Interval Average

Range: 10 ns to 20,000 s.

Minimum Dead Time: 10 ns.

Trigger Pulse Width: 1 ns (typical) minimum width input at minimum voltage input.

Resolution

Time Interval: 2 ns \pm Noise Trigger Error (Graph 3).

Time Interval Average: \pm T.I. Resolution \pm 2 picoseconds.

$\sqrt{\text{intervals averaged}}$

Accuracy: \pm Resolution \pm Time Base Error (Graph 2) \pm Trigger Level Timing Error (Graph 4) \pm 700 ps.

Ratio B/A

Range: both channels accept dc to 500 MHz.

LSD: Ratio/[Freq B x Gate Time].

Resolution and Accuracy: \pm LSD \pm [A Trigger Error (Graph 3)/Gate time] x Ratio.

Start/Stop

Range: both inputs dc to 500 MHz.

Modes: A, A \pm B determined by rear-panel switch.

Scaling

Range: dc to 500 MHz.

Scaling Factor: selectable by GATE TIME setting. Scaling factor equals GATE TIME setting/ 10^{-9} seconds.

Input: input signal through channel A.

Output: output frequency equals input frequency divided by scaling factor.

Time Base

Standard High Stability Oven

Frequency: 10 MHz.

Aging rate: $< 5 \times 10^{-10}$ per day.

Short term: $< 1 \times 10^{-11}$ for 1 s average.

Temperature: $< 7 \times 10^{-9}$, 0°C to 55°C.

Opt 001

Frequency: 10 MHz.

Aging rate: $< 3 \times 10^{-7}$ per month.

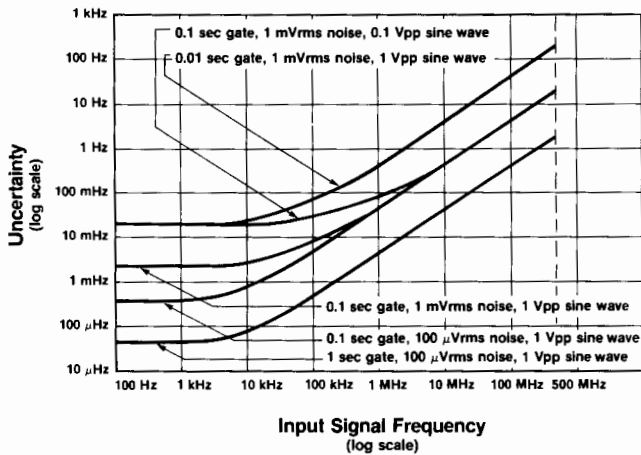

Graph 1, Frequency Resolution Error: Noise on the input signal and internal uncertainties affect Frequency and Period measurements. Longer gate times will reduce this error. (For Period, invert and find the $\Delta F/F$, then multiply by the Period. This yields Period Uncertainty (ΔP .)

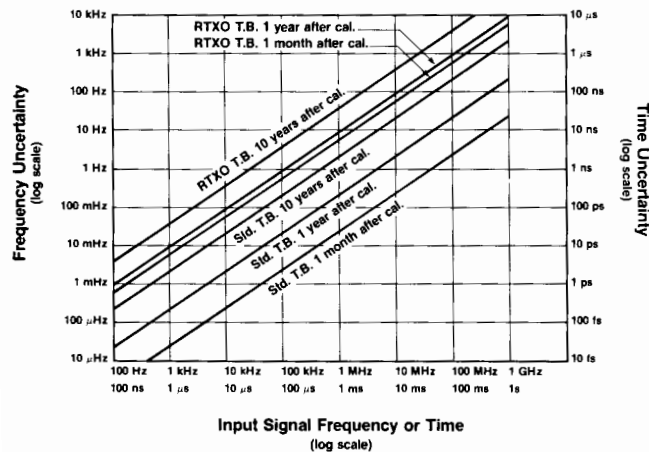

Graph 2, Time-Base Error: Environment and aging of the crystal affects all measurements. Frequent calibration and a better time base will reduce this error.

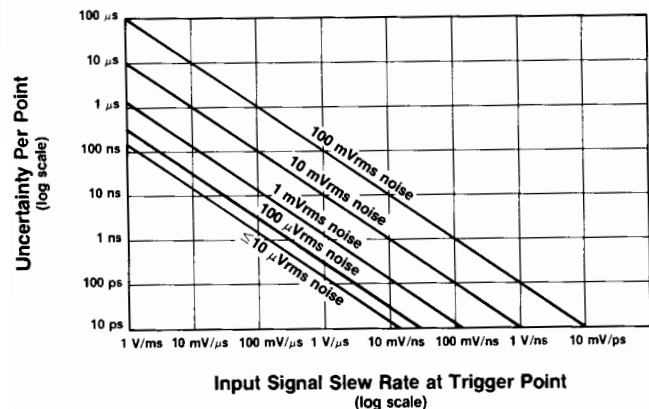

Graph 3, Input Noise Trigger Error: Noise on the input signal affects both the Start and Stop points of all time interval measurements. Averaging will reduce this error.

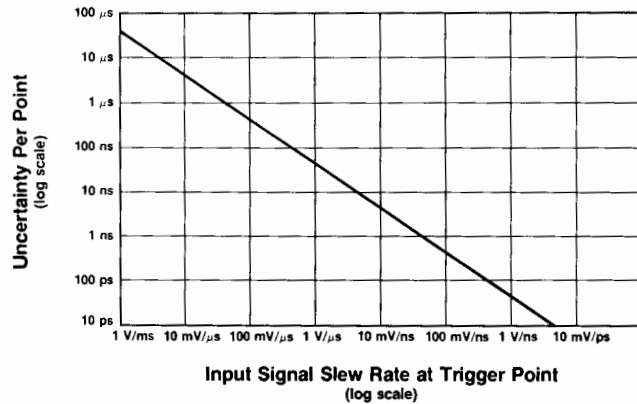

Graph 4, Trigger Level Timing Error: Affects the Start and Stop points, total error is the larger of the two. Input calibration will reduce this error.

Opt 001 (cont.)

Short term: $< 2 \times 10^{-9}$ rms for 1 s.

Temperature: $< 2 \times 10^{-6}$, 25°C to 35°C.

$< 5 \times 10^{-6}$, 0°C to 55°C.

Line voltage: $< 1 \times 10^{-8}$, $\pm 10\%$ from nominal.

External frequency standard input: input voltage > 1.0 V rms into 1 k Ω required from source of 1, 2, 2.5, 5 or 10 MHz $\pm 5 \times 10^{-8}$ ($\pm 5 \times 10^{-6}$ for option 001).

Frequency standard output: > 1 V rms into 50 Ω at 10.0 MHz sine wave.

General

Display: 11-digit LED display and sign.

Gate time: 1000 s to 100 ns in decade steps; < 50 ns in MIN position.

Measurement speed

Mode of Operation	Readings per Second
Normal Operation (Max sample rate)	10
Externally armed	500
Externally gated	500
Computer dump	9,000

Overflow: asterisk is illuminated when display is overflowed.

Sample rate: continuously variable from < 0.1 s to > 5 s with front-panel control. In HOLD position the last reading is maintained until the counter is reset.

External arm input: counter can be armed by a -1.0 V signal applied to the rear panel 50 Ω input.

External gate input: same conditions as for EXT ARM.

Gate output: > 1 V into 50 Ω .

Operating temperature: 0°C to 55°C.

Power requirements: 100/120/220/240 V rms $+5\% -10\%$ 48 to 66 Hz, maximum power 250 VA.

Weight: 17 kg (37 lb).

Size: 132.6 mmH x 425 mmW x 495 mmD (5.22 in x 16.75 in x 19.5 in).

Ordering Information

HP 5345A* Plug-In Counter

Price

\$12,000

Opt 011 HP-IB includes remote programming

+ \$1,500

Opt 012 HP-IB similar to Opt 011, but also includes slope and trigger level controls

+ \$1,600

Opt 908 Rack Flange Kit, HP 5060-8740

+ \$65

HP 10595A Board Extender Kit: For troubleshooting

\$1,100

Fast-Ship product — see page 734.

*See page 179 for Microwave extensions.

ELECTRONIC COUNTERS

100 MHz Universal Counters

Model 5334B

- Two matched 100 MHz input channels; optional C Channel to 1.3 GHz
- 9 digits per second resolution from 1 Hz to 1.3 GHz
- 2 ns time interval resolution, 200 ps with averaging
- Automatic rise/fall time, pulse width and ac/dc voltage measurements
- Complete HP-IB programmability standard
- MATE interface optional

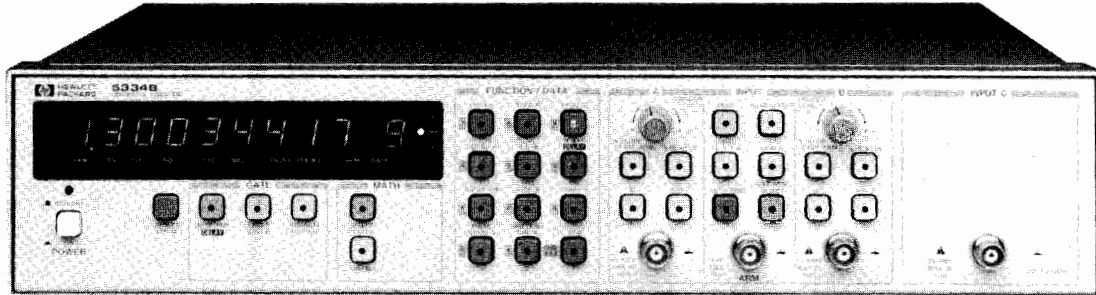

HP 5334B



DESIGNED FOR
MATE
SYSTEMS

Expanded Universal Counter Capability for Bench or System

- Rise/Fall Time and Pulse Width measurements at the push of a button.
- Measure the AC/DC voltage of the input signal.
- Offset, Normalize, and Average measurements for greater use ability of results.
- Auto Triggering and Auto Attenuation for user convenience.

As well as

- 100 MHz Frequency and Period measurements with resolution of 9 digits per second of gate time.
- Time Interval and Time Interval Delay to 2 ns resolution, 200 ps with averaging.
- Full HP-IB programmability standard with optional rear inputs for system applications. Make up to 140 readings per second.
- 1.3 GHz C Channel, MATE Interface, and High Stability Oven Time Base options.
- External Arming/Gating for synchronizing measurements to external events.

Condensed Specifications

Input Characteristics (channels A and B)

Range

DC coupled: 0 to 100 MHz.

AC coupled: 1 M Ω , 30 Hz to 100 MHz; 50 Ω , 1 MHz to 100 MHz.

Sensitivity

15 mV rms sine wave to 20 MHz, 35 mV rms sine wave to 100 MHz.

100 mV peak-to-peak at a minimum pulse width of 5 ns.

Dynamic Range (X1)

45 mV to 5 V peak-to-peak, to 20 MHz.

100 mV to 2.5 V peak-to-peak, to 100 MHz.

Trigger Level Range

Manual (auto trigger off): continuously adjustable over ± 5.1 V (\times ATTN), displayed in 20 mV steps (\times ATTN).

Preset: 0V NOMINAL in Sensitivity Mode.

Auto Trigger

DC coupled: 100 Hz to 100 MHz.

AC coupled: 1 M Ω , 100 Hz to 100 MHz; 50 Ω , 1 MHz to 100 MHz.

Trigger Slope: independent selection of + or - slope.

Impedance: 1 M Ω or 50 Ω , NOMINAL, switch selectable.

Attenuator

Manual: $\times 1$ or $\times 10$ NOMINAL, switch selectable.

Auto: attenuator automatically switched when in Auto Trigger.

Low Pass Filter: 100 kHz NOMINAL, Channel A, switchable.

External Arm

Sensitivity: 500 mV peak-to-peak at Min. pulse width of 50 ns.

Signal Operating Range: -5 V dc to +5 V dc.

Slope: independent selection of START and STOP ARM slopes: +, -, or OFF.

Frequency A and Frequency B

Range: .001 Hz to 100 MHz.

Resolution: See Graph 1.

Accuracy: \pm Resolution \pm Time Base Error (Graph 2).

Period A

Range: 10 ns to 10^3 s (single gate), 10 s (100 GATE AVERAGE)

Resolution and Accuracy: Δ FREQ [PER]/FREQ (Graph 1 and 2)

Time Interval A to B

Range: -1 ns to 10^3 (single shot), 10 s (100 GATE AVERAGE).

LSD: 1 ns (100 ps using 100 GATE AVERAGE).

Resolution: \pm LSD \pm Noise Trigger Error (Graph 3) \pm 1 ns rms.

Accuracy: \pm Resolution \pm Time Base Error (Graph 2) \pm Trig Level

Timing Error (Graph 4) \pm Trig Level Setting Error (Graph 5) \pm 2 ns.

Time Interval Delay

Selectable delay can be inserted between START and STOP of Time Interval A to B. Inputs during delay are ignored. Delay Range is 1 ms to 99,999 s.

Ratio A/B

Range: .001 Hz to 100 MHz both channels.

LSD: $4 \times$ RATIO/ [FREQ A \times GATE TIME].

Resolution and Accuracy: \pm LSD \pm [B Trig Error (Graph 3)/GATE TIME].

Totalize

Range: 0 to $10^{12} - 1$.

Resolution and Accuracy: 1 count of input signal.

Pulse Width A

Range: 5 ns to 10 ms.

LSD, Resolution, Accuracy: same as Time Interval A to B except ± 2 ns in Accuracy deleted.

Rise/Fall Time A

Range: 30 ns to 10 ms.

Minimum Amplitude: 500 mV peak-to-peak.

Dynamic Range: 500 mV to 40 V peak-to-peak.

LSD, Resolution, Accuracy: same as Time Interval A to B.

AC/DC Voltage

Max. and Min. peaks or dc level of Channel A or Channel B input are displayed.

Frequency Range: dc, 100 Hz to 20 MHz.

Dynamic Range: 0-40 V peak-to-peak; ± 51 Vdc.

Resolution: $\times 1$: 20 mV $\times 10$: 200 mV

Time Base

Frequency: 10 MHz.

Aging Rate: $< 3 \times 10^{-7}$ per month.

Math

Display = (Measurement/Normalize) + Offset.

Entry Range: $\pm 1 \times 10^{-10}$ to $\pm 9.99999999999 \times 10^9$.

Single Cycle: one measurement per push of RESET.

100 Gate Average: 100 measurements accumulated and average value displayed. Adds one digit of resolution to measurements and reduces resolution error by 10.

Hewlett-Packard Interface Bus

Programmable Controls: all front-panel controls and functions, except power on/stby switch.

Trigger Level: set Channel A or B in 20 mV steps (\times ATTN).

Data Output

Normal Operation: ten readings/second, formatted.

High Speed Mode: up to 140 readings/second (55 readings/second with Option 700), unformatted.

HP-IB Interface Functions: SH1, AH1, T5, TE0, L4, LE0, SR1, RL1, PP0, DC1, C0, E2 (see page 564).

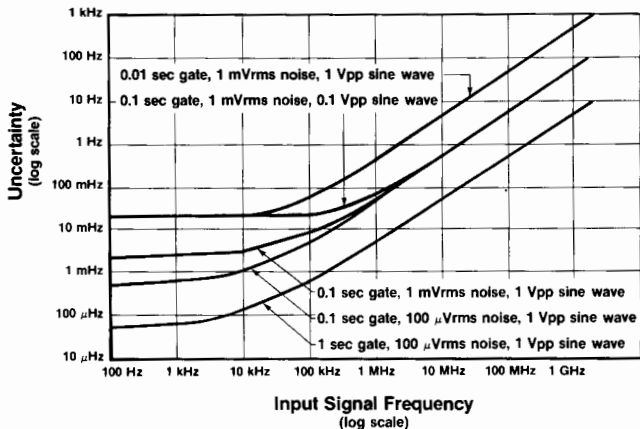

Graph 1, Frequency Resolution Error: Noise on the input signal and internal uncertainties affect Frequency and Period measurements.

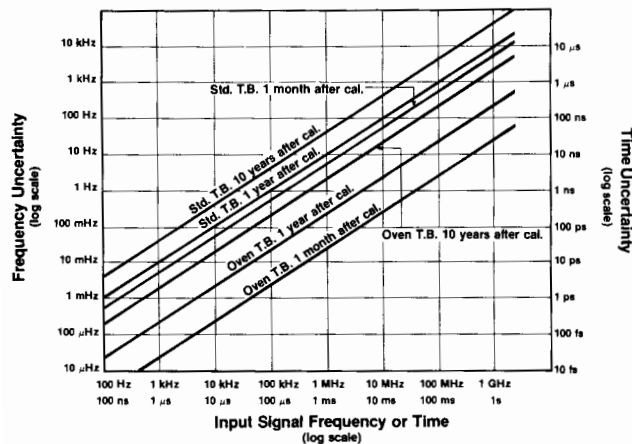

Graph 2, Time Base Error: Crystal environment and aging affects all measurements.

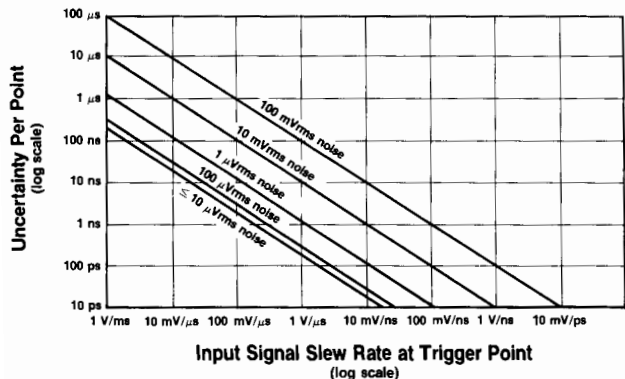

Graph 3, Input Noise Trigger Error: Noise on the input signal affects both the Start and Stop points of all time interval measurements.

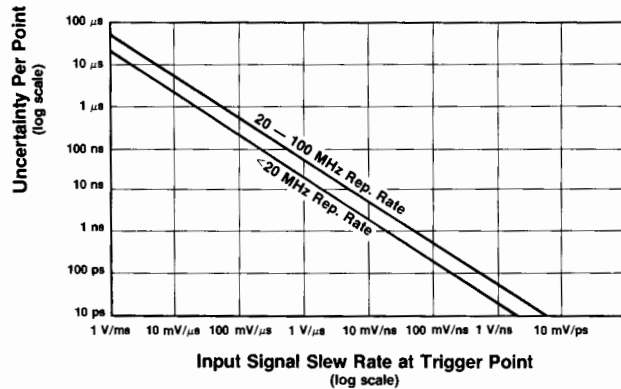

Graph 4, Trigger Level Timing Error: Affects the Start and Stop points of all time-interval measurements. Total error is the larger of the two trigger point errors.

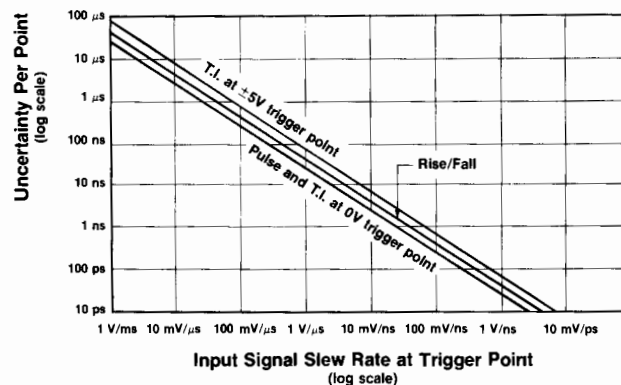

Graph 5, Trigger Level Setting Error: Affects both the Start and Stop points of all time interval measurements.

Options

Option 010 High Stability Time Base (Oven)

Frequency: 10 MHz.

Aging Rate: 5×10^{-10} /day after 24-hour warm up.

Option 030 1300 MHz C Channel

Range: 90 MHz to 1300 MHz.

Sensitivity: 15 mV rms (-23.5 dBm) sine wave, 90 MHz to 1000 MHz. 75 mV rms (-9.5 dBm) sine wave, 1000 MHz to 1300 MHz.

Resolution and Accuracy: same as Frequency A and B.

Option 700 Internal CIIIL Interface (MATE)

Measurement Functions Provided:

Frequency A, B, and C; Period A, Time Interval A to B, Ratio A/B, Totalize A, Rise/Fall Time A, Pulse Width A, Read Levels A and B (AC/DC Voltage and Trigger).

Programmable Controls:

Channel A and B: Trigger Level, Auto Trigger, Coupling, Trigger, Slope, Impedance, Attenuator, Common.

External Arm: External Arm Select, Slope.

General: Gate Time

Measurement Data Output Rate: 2.5 readings/second.

Ordering Information

HP 5334B Universal Counter

Opt 010 Oven Oscillator

Opt 030 Channel C

Opt 060 Rear Terminals

Channel A,B and ARM in parallel with front inputs.

Option 030 at rear panel only.

Opt 700 Internal MATE programming

☎ Fast-Ship product — see page 734.

Price

\$1995 ☎

+\$800

+\$550

+\$125

+\$450

ELECTRONIC COUNTERS

Our Highest Performance Universal Systems Counter

Model 5335A

- A high performance 200 MHz/2 ns Universal Counter
- Built-in automatic rise time, duty cycle, pulse width, slew rate and phase measurements
- Advanced automatic triggering capabilities
- HP-IB plus math and statistics functions standard



HP 5335A



Remarkable Automatic Measurement Power

The HP 5335A is an advanced universal counter with automatic measurement power built in. Designed either for bench or systems applications, the counter has 16 front-panel measurement functions, plus four "phantom" functions, all automatically selected by push button or by HP-IB. These twenty functions, plus greatly expanded arming and triggering capability, make the HP 5335A a most powerful universal counter. In addition, math and statistics features, matched Channel A and B input amplifiers, and HP-IB are all included in the standard unit, making the HP 5335A easily the most advanced universal counter available at its price.

Pulse Characterization Measurements

The HP 5335A possesses the expected universal measurements, and does them better than ever before. Beyond the expected measurement set, the HP 5335A has the ability to automatically measure waveform characteristics for various applications. Op amp characterization is one area where a number of measurements are needed to define the amplifier's performance. Using the HP 5335A and a signal source, rise and fall times, output slew rate, and propagation times can be measured with one test set-up. Also, duty cycle can be measured to see the distortion on a square wave through the amplifier due to different rising and falling slew rates. Phase measurements are also push-button selectable and automatically performed by the counter.

Complete Triggering Capability

To get good measurement results, a counter must properly trigger on the input signal. The HP 5335A employs both manual and automatic trigger modes to quickly and easily set the right trigger points.

Manual Triggering

The counter has a ± 5 Vdc range to help reduce input attenuator use for most input signals, including TTL.

Automatic Triggering

Two auto trigger modes help you trigger automatically. Just press *auto trig* or select auto trig on the HP-IB and the counter automatically selects 10%-90% rise/fall time trigger points, 50% phase trigger points, or the preset value of your choice. Then it tracks the signal's dc offset continuously to stay on the right trigger point. Option 040 allows programmability of trigger levels via HP-IB.

Trigger Level DVM

Built into the basic counter. Just press TRG LVL to see both input channel trigger levels displayed.

A Full Set of Universal Measurement Functions

In addition to waveform characterization features, the HP 5335A has an extremely wide set of measurement functions covering frequency, time, events and volts. These functions let you characterize signals quicker and more thoroughly than ever before possible.

Frequency

Frequency is the most common measurement performed by counters. The HP 5335A measures to 200 MHz in Channel A, 100 MHz in Channel B, and 1.3 GHz in its optional Channel C. Due to the counter's advanced design and reciprocal measurement technique, resolution is a constant 9 digits per second of gate time across its entire measurement range.

Time

In a universal counter, a time interval measurement equates to a stopwatch measurement started and stopped by unique events. Precision is dependent on the counter's circuitry.

To ensure precision, the HP 5335A has matched custom input amplifiers to greatly reduce trigger errors that might be produced if the start and stop signals were amplified differently. Further, the counter employs an analog interpolation technique that turns its 10 MHz clock into the equivalent of a 1 GHz time base. The HP 5335A is thus able to resolve single shot time interval measurements to better than 2 nanoseconds (100 ps with averaging). This analog interpolation eliminates the need found in some counters for a phase-modulated (jittered) time base for time interval average measurements.

Math and Statistics

Averaging techniques are often used to extend the resolution of a counter. For averaging, the HP 5335A provides sample sizes of $N = 100$ or $N = 1,000$. Best of all, averaging can be employed for all measurements except phase. In addition to mean, and selection of sample size, the counter takes standard deviations of the current measurement for the sample size selected.

Math functions are another built-in feature that provide operator convenience. These functions let you convert the display into direct indications of parameters like flow, speed, pressure, and temperature. Additionally, the counter remembers the offset, scale, and normalize factors for each measurement function.

Condensed Specifications

Input Characteristics (channel A and B)

Range

DC coupled, 0 to 100 MHz.

AC 1 M Ω , 30 Hz to 100 MHz.

AC 50 Ω , 200 kHz to 100 MHz.

NOTE: Channel A range 200 MHz when in Frequency A and Ratio modes.

Sensitivity (X1)

25 mV rms sinewave.

75 mV peak-to-peak pulse at minimum pulse width of 5 ns.

Dynamic Range (X1)

75 mV to 5 V peak-to-peak, to 100 MHz.

75 mV to 2.5 V peak-to-peak, >100 MHz.

Signal Operating Range (X1, DC)

-5 V dc to +5 V dc.

Trigger Level Range (X1)

Auto Trigger OFF

Preset: set to 0 V dc NOMINAL.

Adjustable: -5 V dc to +5 V dc.

Auto Trigger ON

Preset: set to nominal 50% point of input signal.

Adjustable: nominally between + and - peaks of input signal.

Auto Trigger (X1)

Range (50% duty cycle)

DC coupled, 30 Hz to 200 MHz.

AC 1 M Ω , 30 Hz to 200 MHz.

AC 50 Ω , 200 kHz to 200 MHz.

Minimum signal: 100 mV rms.

Duty cycle range: 10% to 90%.

Response time: 3 seconds, typical.

NOTE: Auto Trigger requires a repetitive signal.

Coupling: ac or dc, switchable.

Impedance: 1 M Ω , nominal, shunted by <35 pF or 50 Ω nominal, switchable. In COMMON A, 1 M Ω is shunted by <50 pF.

Attenuator: X1 or X10 nominal, switchable.

Slope: independent selection of + or - slope.

Channel input: SEPARATE or COMMON A, switchable.

Frequency A

Range: 0 to 200 MHz, prescaled by 2.

LSD Displayed

$\frac{1 \text{ ns}}{\text{Gate Time}} \times \text{FREQ.}$ (e.g. 9 digits in a second).

Resolution

$\pm (2 \times \text{LSD}) \pm 1.4 \times \frac{\text{Trigger Error}}{\text{Gate Time}} \times \text{FREQ.}$

Accuracy: $\pm (\text{Resolution}) \pm (\text{Time Base Error}) \times \text{FREQ.}$

Period A

Range: 10 ns to 10^7 s.

LSD Displayed

$\frac{1 \text{ ns}}{\text{Gate Time}} \times \text{PER.}$ (e.g. 9 digits in a second).

Period average: user selects MEAN function, and n = 100, or n = 1,000.

Time Interval A \rightarrow B

Range: 0 ns to 10^7 s.

LSD displayed: 1 ns (100 ps using MEAN).

Resolution: $\pm (2 \times \text{LSD}) \pm (\text{START Trigger Error}) \pm (\text{STOP Trigger Error})$.

Accuracy: $\pm (\text{Resolution}) \pm (\text{Time Base Error}) \times \text{TI} \pm (\text{Trigger Level Timing Error}) \pm (2 \text{ ns})$.

Gate mode: MIN only.

Time interval average: user selects MEAN function, and n = 100, or n = 1,000.

Time Interval Delay (holdoff)

Front panel Gate Adjust control inserts a variable delay between START and enabling of STOP. Electrical inputs during delay are ignored. Delay ranges are same as gate time ranges (100 μ s, to 4 s NOMINAL) for gate modes of Fast, Norm, and Manual.

Inverse Time Interval A \rightarrow B

Range: 10^{-7} to 10^9 units/second.

LSD Displayed, Resolution, and Accuracy are inverse of Time Interval A \rightarrow B specifications.

Rise and Fall Time A

Range: 20 ns to 10 ms transition with 50 Hz to 25 MHz repetition rates (50% duty cycle).

Minimum pulse height: 500 mV peak-to-peak.

Minimum pulse width: 20 ns.

Duty cycle range: 20% to 80%.

LSD Displayed and Resolution are same as Time Interval A \rightarrow B Specifications.

Pulse Width A

Range: 5 ns to 10^7 s.

Trigger point range: 40% to 60% of pulse height.

LSD Displayed and Resolution are same as Time Interval A \rightarrow B specifications.

Duty Cycle A

Range: 1% to 99%, 0 to 100 MHz.

Trigger point range: 40% to 60% of pulse height.

LSD displayed: $\frac{1 \text{ ns}}{\text{PER}} \times 100\%$

NOTE: Constant duty cycle required during measurement.

Slew Rate A

Range: 50 V/s to 10^8 V/s slew rate with 50 Hz to 25 MHz repetition rates (50% duty cycle). Minimum Pulse Height, Width, and Duty Cycle Range are same as Rise and Fall Time A.

Input mode: automatically set to COMMON A with 10% and 90% trigger levels.

Ratio A/B

Range: Channel A, 0 to 200 MHz (prescaled by 2).
Channel B, 0 to 100 MHz.

LSD displayed: $\frac{\text{RATIO}}{\text{FREQ} \times \text{Gate Time}}$ where FREQ is higher frequency after prescaling.

Totalize A

Range: 0 to 100 MHz.

LSD displayed: 1 count of input.

HP-IB output: at end of gate.

Manual

Count reset: via RESET key.

HP-IB output: totalize data on-the-fly sent if Cycle mode set to Single. Input frequency range in this mode is 0 to 50 Hz nominal.

Gated

Count reset: automatic after measurement.

Phase A Rel B

Range: -180 $^\circ$ to 360 $^\circ$, Range Hold off, or 0 $^\circ$ to 360 $^\circ$, Range Hold on, with signal repetition rates of 30 Hz to 1 MHz.

Minimum signal: 100 mV rms.

LSD displayed: 0.1 $^\circ$.

Gate Time

Range: 100 ns to 10^7 s.

LSD displayed: up to three digits with Ext. Arm Enable OFF, 100 ns when ON. MIN Gate Mode display zero.

ELECTRONIC COUNTERS

Our Highest Performance Universal Systems Counter (cont'd)

Model 5335A

Trigger Level

Range: $\times 1$, +5 to -5 V; $\times 10$, +50 to -50 V.

Resolution: $\times 1$, 10 mV; $\times 10$, 100 mV.

Accuracy ($\times 1$): ± 20 mV, $\pm 0.5\%$ of reading.

Time Base

Standard Crystal

Frequency: 10 MHz.

Aging rate: $< 3 \times 10^{-7}$ /month.

Temperature: $< 4 \times 10^{-6}$, 0 to 50°C.

Line voltage: $< 1 \times 10^{-7}$ for 10% change.

High stability crystal: see Option 010.

External time base input: rear panel BNC accepts 5 or 10 MHz, 200 mV rms into 1 k Ω ; 5 V rms maximum.

Time base out: 10 MHz, > 1 V p-p into 50 Ω via rear panel.

Statistics

Sample size: selectable between either $n = 100$ or $n = 1,000$ samples.

Std. dev.: displays a standard deviation of selected sample size.

Mean: displays mean estimate of selected sample size.

Smooth: performs a weighted running average and truncates unstable least significant digits from display.

Math

All measurement functions, with exception of GATE TIME, Totalize in Scale Mode, and TRIG LVL, may be operated upon by Math functions. Offset, Normalize, and Scale may be used independently or together as follows:

$$\text{Display} = \frac{\text{Measurement} + \text{Offset}}{\text{Normalize}} \times \text{Scale}.$$

Number value range: $\pm 1 \times 10^{-9}$ to $\pm 9 \times 10^9$.

Last display: causes value of previous display to Offset (negative value), Normalize, or Scale all subsequent measurements.

Measurement t-1: causes each new measurement to be Offset (negative value), Normalized, or Scaled by each immediately preceding measurement.

Hewlett-Packard Interface Bus

Programmable controls: all measurement functions, Math, Statistics, Reset, Range Hold, Ext. Arm Enable/Slope, Check, Gate Adj. (~ 1 ms to 1 s), Gate Open/Close (gate times to ∞), Gate Mode, Cycle, Preset, Slope, Common A, Auto Trigger.

Special functions: FREQ B, PULSE B, TIME B \rightarrow A, TOT A-B, LEARN, MIN, MAX, all internal diagnostic routines.

Interface functions: SH1, AH1, TS, TEQ, L4, SL1, RL1, PP0, DC1, DT1, C0, E1 (see page 40.00.).

Data output: fixed output format consisting of 19 characters plus CR and LF output is typically 8 ms.

Option 040: adds complete systems programmability; see column at right.

General

Gate: minimum, manual, or continuously variable (NORM/FAST) via Gate Adj. control.

NORM: 20 ms to 4 s NOMINAL.

FAST: 100 μ s to 20 ms NOMINAL.

MIN: minimum gate time. Actual time depends on function.

MANUAL: each press opens or closes gate.

Cycle: determines delay between measurements.

NORM: no more than 4 readings per second, nominal.

MIN: updates display as rapidly as possible (~ 15 readings per second, depending on function).

SINGLE: one measurement taken with each press of button.

Arming: Ext. Arm Enable key allows rear panel input to determine Start and/or Stop point of a measurement. External gate defined by both Start and Stop armed. All measurements are armable except Manual Totalize, Phase, and Trigger Level.

Start arm: + or - slope of arm input signal starts measurement.

Stop arm: + or - slope of arm input signal stops measurement. When used, Start Arm must occur before Stop Arm.

Ext. arm input: rear panel BNC accepts TTL into 20 k Ω . Minimum Start To Stop Time: 200 ns.

Trigger level out: dc output into 1 M Ω via rear panel BNCs for Channel A and B; not adjusted for attenuators.

Accuracy at dc ($\times 1$): ± 15 mV $\pm 0.5\%$ of TRIG LVL reading.

Gate out: TTL level into 50 Ω ; goes low when gate open; rear panel BNC.

Range hold: freezes decimal point and exponent of display.

Reset: starts a new measurement cycle when pressed.

Check: performs internal self test and lamp test.

Display: 12-digit LED display in engineering format; exponent range of +18 to -18.

Operating temperature: 0 to 50°C.

Power requirements: 100, 120, 220, 240 VAC (+5%, -10%), 48-66 Hz; 130 VA max.

Weight: net, 8.8 kg (19 lb 8 oz). Shipping, 13.6 kg (30 lb).

Dimensions: 425.5 mm W x 132.6 mm H x 345.4 mm D (16 $\frac{1}{4}$ in. x 5 $\frac{1}{4}$ in. x 13 $\frac{1}{2}$ in.), not including removable handles.

Options

Option 010: High Stability Time Base (oven)

Frequency: 10 MHz.

Aging rate: $< 5 \times 10^{-10}$ /day after 24-hour warm up.

Short term: $< 1 \times 10^{-10}$ rms for 1s average.

Temperature: $< 7 \times 10^{-9}$, 0 to 50°C.

Line voltage: $< 1 \times 10^{-10}$ for 10% change.

Warm-up: within 5×10^{-9} of final value in 20 minutes.

Option 020: DC Digital Voltmeter

Range: 4 digits, autoranging, autopolarity, in ± 10 , ± 100 , ± 1000 V ranges.

Sensitivity: 100 μ V, 1 mV, 10 mV, 100 mV for ± 1 V, ± 10 V, ± 100 V, ± 1000 V readings.

LSD displayed: same as sensitivity.

Input type: floating pair.

Input impedance: 10 M Ω $\pm 1\%$.

Option 030: 1.3 GHz C Channel

Input Characteristics

Range: 150 MHz to 1.3 GHz.

Sensitivity: 10 mV rms sinewave (-27 dBm) to 1 GHz. 100 mV rms sinewave (-7 dBm) to 1.3 GHz.

Frequency C

Range: 150 MHz to 1.3 GHz, prescaled by 20. LSD Displayed, Resolution, and Accuracy are same as Frequency A.

Ratio C/A

Range: channel A, 0 to 200 MHz.
channel C, 150 to 1300 MHz.

Option 040: Complete Systems Programmability

Adds remote selection of low pass filter, ac/dc coupling, $\times 1$ - $\times 10$ attenuation, dc trigger level and input impedance for both Channel A and B.

Definitions

Duty cycle: percentage of time a signal is high or low, depending on Slope A setting. Trigger point is high/low dividing point.

$$\text{DUTY CY} = \frac{\text{PULSE}}{\text{PER}} \times 100\%.$$

Slew rate: effective slope between 10% and 90% points of rising or falling signal depending on Slope A setting.

$$\text{SLEW} = \frac{V_B - V_A}{T_I}$$

Phase: angle, with respect to B signal, between 50% points of channel A and B signals, trigger slopes selected by Channel A and B slope switches.

$$\text{PHASE} = \frac{(T_{I1} + T_{I2}) 360^\circ}{2 \text{ PER}}$$

T_{I1} is time between 50% points of A then B signals using slopes defined during Phase measurement.

T_{I2} is time between 50% points of A then B signals using complement slopes to T_{I1} .

Front handles: supplied with instrument.

Ordering Information

HP 5335A Universal Counter

Opt 010 Oven Oscillator

Opt 020 DVM

Opt 030 C Channel

Opt 040 Expanded HP-IB Control

Opt 908 Rack Flange Kit for use without handles.

Opt 913 Rack Flange Kit for use with supplied front handles.

Price

\$4400

+ \$800

+ \$550

+ \$800

+ \$800

+ \$32.50

+ \$65

ELECTRONIC COUNTERS

100 MHz Universal Counters

Model 5328B

195

- 100 MHz and 1300 MHz
- 10 ns Time Interval
- T.I. Averaging to 10 ps resolution

- "Armed" measurements
- DVM option
- HP-IB Interface standard

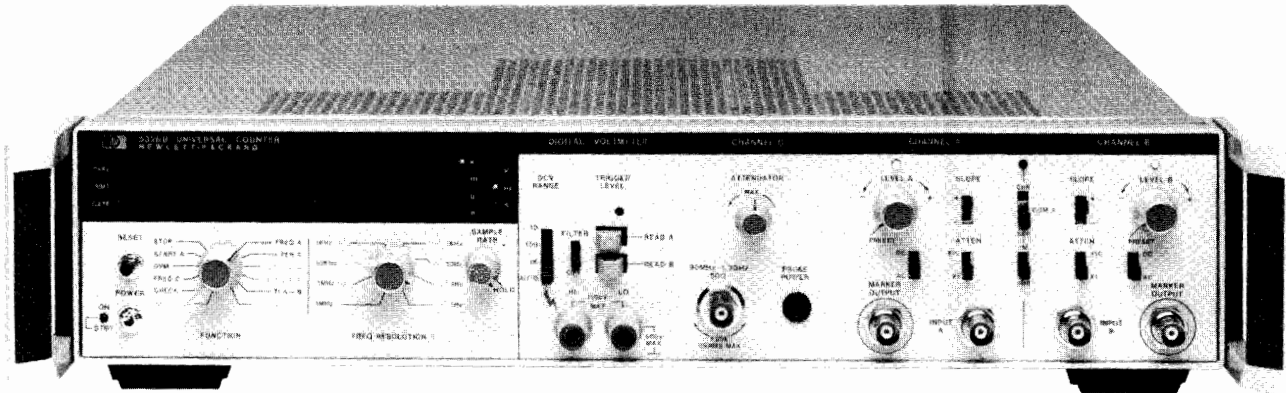

HP 5328B



Solid Universal Counter Performance for Bench or System

- Frequency measurements to 100 MHz, 1.3 GHz optional.
- 10 ns Time Interval resolution, 10 ps with averaging.
- 10 ns Period resolution, 1 fs with averaging.
- ± 1000 V dc DVM and High Stability Oven Time Base options.
- HP-IB programming and External Arming standard.

Condensed Specifications

Input Characteristics

Sensitivity: 25 mV rms, to 40 MHz; 50 mV rms, 40 MHz-100 MHz. Attenuators (nominal): $\times 1$, $\times 10$ switch selectable.

Frequency A

Range: 0 to 100 MHz.

Period A

Range: 100 ns to 10^7 s with resolution to 10 ns.

Period Average A

Range: 100 ns to 10^7 s with resolution to 1 fs.

Time Interval A \rightarrow B

Range: 10 ns to 10^7 s with resolution to 10 ns.

Time Interval Average A \rightarrow B

Range: 0.1 ns to 1 s with resolution to 10 ps.

Minimum Dead Time: 40 ns.

Ratio B/A

Range: Channel A, 0 to 10 MHz; Channel B, 0 to 100 MHz.

HP-IB Interface Bus

Programmable functions: Functions, resolution, sample rate, (maximum or manual control), arming, display modes, measurement modes, output mode, and reset commands. Trigger level, trigger slope, input impedance, coupling, separate/common/check, invert A and B, Trigger level is programmable in 10 mV steps in $\times 1$; 100 mV in $\times 10$. Trigger level accuracy under remote control in $\times 1$: ± 35 mV.

Interface functions: SH1, AH1, T1, L2, SR1, RL1, PP0, DC1, DT1, C0, E1. (See page 00.00).

Service request (SRQ): if enabled, indicates end of measurement.

Maximum data output rate: 500 readings/s.

General

Display: 9-digit LED display.

Sample Rate: Variable from less than 2 ms between measurements to HOLD, which holds display indefinitely.

Gate Output: rear panel output; TTL levels.

Time Base Output: rear panel output; TTL levels.

Operating Temperature: 0° to 50° C.

Power Requirements: 100/120/240 V rms, +5%, -10% (switch selectable), 48-66 Hz; 150 VA max.

Time Base Oscillators

Standard Crystal Oscillator

Frequency: 10 MHz.

Aging Rate: $< 3 \times 10^{-7}$ /month.

Temperature: $< 2.5 \times 10^{-6}$, 0° to 50° C.

Line Voltage: $< 1 \times 10^{-7}$ for 10% change.

Option 010: Oven Oscillator

Frequency: 10 MHz.

Aging Rate: $< 5 \times 10^{-10}$ /day after 24-hour warm-up.

Short Term: $< 1 \times 10^{-10}$ rms/s.

Temperature: $< 7 \times 10^{-9}$, 0° to 50° C.

Line Voltage: $< 5 \times 10^{-9}$ for 10% variation.

Warm-Up: within 5×10^{-9} of final value in 20 minutes.

Option 021: High Performance Digital Voltmeter

Range: ± 10 , ± 100 , ± 1000 V dc and Autorange.

Sensitivity: 10 μ V, 100 μ V, 1 mV, 10 mV, 100 mV for measurement times of 10 s, 1 s 0.1 s, 10 ms, 1 ms respectively.

Input: floating pair, 10 M Ω nominal.

Maximum Input: hi to low: ± 1100 V all ranges; low to chassis ground: ± 500 V.

Trigger Level Measurements: 1 mV display resolution.

Option 031: 1300 MHz C-Channel

Input Characteristics

Sensitivity: 20 mV rms sine wave (-21 dBm).

Maximum Input: 5 V rms, ± 5 Vdc, fuse protected.

Frequency C

Range: 90 MHz to 1300 MHz, prescaled by 4 with resolution to 0.1 Hz.

Ratio C/A

Range: channel A, 0 to 10 MHz; channel C, 90 to 1300 MHz

Attenuation: continuously variable for optimum noise suppression.

Ordering Information

HP 5328B Universal Counter

Opt 010 High Stability Time Base

Opt 021 High Performance DVM

Opt 031 1300 MHz Channel C

Opt 050 DVM and Channel C

Opt 908 No Handles Rack Flange Kit

Opt 913 With Handles Rack Flange Kit

Price

\$5900

+\$880

+\$900

+\$1200

+\$2100

+\$30

+\$30



ELECTRONIC COUNTERS

Universal Counters

Models 5315A, 5316B

- Frequency, period, ratio, and totalize to 100 MHz
- Portable, and HP-IB models
- 1 GHz capability available

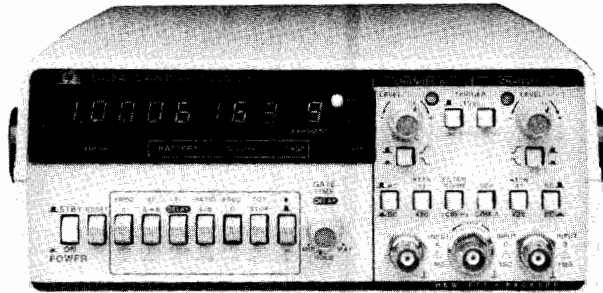

HP 5315A

- Uses reciprocal technique for full low-frequency resolution
- 100 ns time interval, 10 ps T.I. averaging
- Oven option for increased accuracy

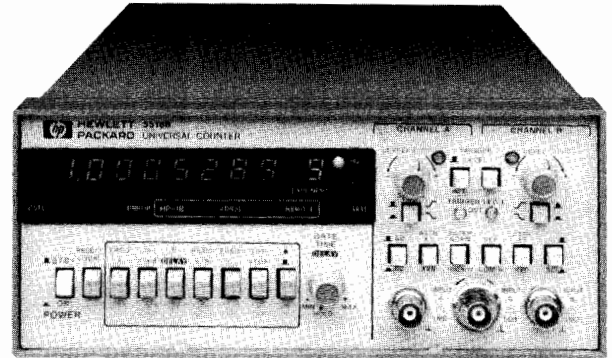

HP 5316B



HP 5315A and HP 5316B Universal Counters

A Quiet Revolution in Capability . . .

HP's economical HP 5315A and HP 5316B counters provide all the universal counter capability you've come to expect at much higher prices. That's because they use a unique custom circuit called the MRC (Multiple Register Counter) which packs counting and computing power into this popular counter series. To a user, the differences in operation from conventional direct models can be listed quickly: low frequency resolution is an outstanding 7 digits per second of gate time and reliability is extremely good due to the counter's low chip count. Also, the continuously adjustable gate time allows automatic selection of sample size for easy trade-offs between measurement time and resolution.

Much of the counter's performance is based on reciprocal counting techniques first pioneered in HP's high-performance HP 5360A computing counter, and the current HP 5345A Universal Counter. The use of these techniques coupled with HP's MRC and a microprocessor provides a quiet but powerful revolution in counter performance within the HP 5315A and HP 5316B. For example, this counter gives you its full 7-digits/second resolution over the range from 1 Hz to 100 MHz. This, simply stated, shows the power of the MRC and reciprocal counting.

High Performance, Low Price

In addition to its economy, the MRC counter offers a full set of universal counter measurements, and there are very few limitations to this capability. Increased accuracy in low-cost portable and system counters is also available with the oven oscillator option through improved temperature stability and lower aging rates.

Frequency to 100 MHz, C-Channel to 1.0 GHz

The MRC counter measures frequency to 100 MHz. Additionally the optional C-Channel measures to 1.0 GHz for both CW and pulsed RF signals as narrow as 60 ms. The C-Channel option is particularly useful in navigation and communications equipment testing due to this pulsed RF measurement feature.

Time Interval to 100 ns, T.I. Averaging to 10 ps

The MRC counter provides three time measurement modes. Single-shot time interval allows measurements over a range of 100 ns to 100,000 seconds. This capability can be used to measure pulse width. Time interval averaging provides greater resolution for repetitive events. Finally, time interval delay avoids measurement of spurious signals by holding off the counter's trigger point by a precise, operator-selectable amount of time.

A Full Set of Measurements

Besides the frequency and time functions mentioned above, the MRC counter has other measurement functions that make it a truly impressive value:

- Period A**—allows single period measurements via Channel A.
- Ratio A/B**—allows frequencies to 100 MHz into both Channel A and B.
- A By B**—totalizes the A input between 2 events on B channel.
- Totalize**—a manually gated totalize mode of operation.

Input Signal Conditioning Versatility

A full complement of input signal conditioning controls are provided for both channels. These include \pm slope, ± 2.5 Vdc trigger level, and ac/dc coupling. Other controls are a Separate/Common switch, and a 100 kHz low-pass filter for Channel A.

A Choice of Portable or System Models

HP 5315A: a portable, light-weight unit best suited for field applications. This unit has a convenient carrying handle and optional battery power is available for up to 4 hours continuous operation.

HP 5316B: this model possesses all the characteristics of the HP 5315A, and it has HP-IB capability built-in as standard equipment. It has low RFI, it is rackable, and it is functionally identical to the HP 5315A. In addition to programmable measurement functions, the user can also select dc trigger level and \pm slope under HP-IB control. Channel A and B trigger levels are brought out to the front panel on this unit for easy measurement with a DVM.

HP 5315A, 5316B Condensed Specifications

Input Characteristics (channel A and channel B)

Range: dc coupled, 0 to 100 MHz.
ac coupled, 30 Hz to 100 MHz.

Sensitivity: 10 mV rms sine wave to 10 MHz. 25 mV rms sine wave to 100 MHz. 75 mV peak-to-peak pulse at minimum pulse width of 5 ns.

Sensitivity can be varied continuously up to 500 mV rms *NOMINALLY* by adjusting sensitivity control. In sensitivity mode, trigger level is automatically set to 0 V *NOMINAL*.

Dynamic Range

30 mV to 5 V peak-to-peak, 0 to 10 MHz.
75 mV to 5 V peak-to-peak, 10 to 100 MHz.

Coupling: ac or dc, switchable.

Filter: low pass, switchable in or out of Channel A. 3 dB point of 100 kHz *NOMINALLY*.

Impedance: 1 M Ω *NOMINAL* shunted by less than 40 pF.

Signal operating range: +2.5 Vdc to -2.5 Vdc.

Attenuator: $\times 1$ or $\times 20$ *NOMINAL*.

Trigger level: variable between +2.5 Vdc and -2.5 Vdc.

Slope: independent selection of + or - slope.

Common input: all specifications are the same for Common A except the following:

Sensitivity: 20 mV rms sine wave to 10 MHz; 50 mV rms to 100 MHz; 150 mV peak-to-peak at a minimum pulse width of 5 ns.

Dynamic range: 60 mV to 5 V peak-to-peak to 10 MHz; 150 mV to 5 V peak-to-peak, 10-100 MHz.

Impedance: 500 k Ω *NOMINAL* shunted by less than 70 pF.

Frequency (channel A)

Range: 0.1 Hz to 100 MHz.

Resolution: See Graph 1

Accuracy: \pm Resolution \pm Time Base Error (Graph 2)

Period

Range: 10 ns to 10^5 s.

Resolution: See Graph 1

Accuracy: \pm Resolution \pm Time Base Error (Graph 2)

Time Interval

Range: 100 ns to 10^5 s.

LSD displayed: 100 ns.

Resolution: \pm LSD \pm Noise Trigger Error (Graph 3)

Accuracy: \pm Resolution \pm Time Base Error (Graph 2)

Time Interval Average

Range: 0 ns to 10^5 s.

LSD displayed: $100 \text{ ns}/\sqrt{N}$, 10 ps maximum.

Number of intervals averaged (N): $N = \text{Gate Time} \times \text{FREQ.}$

Minimum dead time (stop to start): 200 ns.

Resolution: \pm LSD \pm [Noise Trigger Error (Graph 3)]/ \sqrt{N}

Accuracy: \pm Resolution \pm Time Base Error (Graph 2) ± 4 ns

Time Interval Delay (holdoff)

Front panel gate time knob inserts a variable delay of *NOMINALLY* 500 μ s to 20 ms between START (Channel A) and enabling of STOP (Channel B). Electrical inputs during delay time are ignored. Delay time may be digitally measured by simultaneously pressing T.I. Averaging, T.I. Delay and blue key. Other specifications are identical to Time Interval

Ratio

Range: 0.1 Hz to 100 MHz, both channels.

LSD: [(2.5 x Period A)/Gate Time] x Ratio.

Totalize

Manual

Range: 0 to 100 MHz.

A gated by B

Totalizes input A between two events of B. Instrument must be reset to make new measurement. Gate opens on A slope, closes on B slope. Range: 0 to 100 MHz.

General

Standard Time Base

Frequency: 10 MHz.

Aging rate: $< 3 \times 10^{-7}$ /mo.

Temperature: $\pm 5 \times 10^{-6}$, 0° to 50°C.

Line voltage: $< 1 \times 10^{-7}$ for a $\pm 10\%$ variation.

Check: counts internal 10 MHz reference frequency.

Error light: LED warning light activated if logic error is found during instrument turn-on self-check.

Display: 8-digit LED display, with engineering units annunciator.

Overflow: only frequency and totalize measurements will overflow. In case of overflow, eight least significant digits will be displayed and front panel overflow LED will be actuated. All other measurements which would theoretically cause a display of more than 8 digits will result in the display of the 8 most significant digits.

Gate time: continuously variable, *NOMINALLY* from 60 ms to 10 s or 1 period of the input, whichever is longer.

Sample rate: up to 7 readings per second *NOMINALLY* except in time interval mode, where it is continuously variable *NOMINALLY* from 250 ms to 10 s via Gate Time Control.

Operating temperature: 0° to 50°C.

Power requirements: 100, 120, 220, 240 V (+5%, -10%) 48-66 Hz; 15 VA maximum or 30 VA maximum (HP 5316B).

Weight: net, 2.2 kg (4 lb 12 oz). Shipping, 4.1 kg (9 lb).

Dimensions: 238 mm W x 98 mm H x 276 mm D (9 $\frac{3}{8}$ in. x 3 $\frac{7}{8}$ in. x 10 $\frac{7}{8}$ in.).

Additional HP 5316B Specifications

Rack and stack metal case with rear panel, switchable ac power line module. Specifications same as HP 5315A except as follows:

Rack mount kit: HP 5061-9672 recommended.

Oscillator output: 10 MHz, 50 mV p-p into 50 Ω load on rear panel.

External frequency standard input: 1, 5, 10 MHz, 1 V rms into 500 Ω , or rear panel.

Trigger level output: $\pm 5\%$, ± 15 mV, over ± 2.0 Vdc range at front panel connectors.

Dimensions: 212 mm W x 88 mm H x 415 mm D (8 $\frac{3}{8}$ in. x 3 $\frac{1}{2}$ in. x 16 $\frac{1}{2}$ in.).

Weight: net, 3.7 kg (8 lb 2 oz). Shipping, 6.3 kg (14 lb).

Hewlett-Packard Interface Bus

Programmable functions: Frequency A and C, Frequency A Armed by B, Period A, Totalize A Gated by B, Ratio A/B, Time Interval A \rightarrow B, Time Interval Average A \rightarrow B, Time Int. Delay, Read Gate Time.

Programmable controls: Gate Time Command which sets long (60 ms to 10 s) or short (500 μ s to 30 ms) range; Trigger Level Commands which set Channel A and/or B slope (\pm) and Channel A and/or B trigger from -2.50 Vdc to +2.50 Vdc in steps of .01V.

HP-IB Interface Functions: SH1, AH1, T1, L2, SR1, RL1, PP0, DC1, DT1, C0, E1 (see page 564).

Options

Opt. 001: High Stability Time Base (TCXO).

Frequency: 10 MHz.

Aging rate: $< 1 \times 10^{-7}$ /mo.

Temperature: $\pm 1 \times 10^{-6}$, 0° to 40°C.

Line voltage: $< 1 \times 10^{-8}$ for $\pm 10\%$ variation.

ELECTRONIC COUNTERS

Universal Counters (cont'd)

Models 5315A, 5316B

Opt. 002: Battery (HP 5315A only).

Type: rechargeable lead-acid (sealed).

Capacity: TYPICALLY 4 hours of continuous operation at 25 °C.

Recharging time: TYPICALLY 16 hours to 98% of full charge, instrument non-operating. Charging circuitry included with Option. Batteries not charged during instrument operation.

Low voltage indicator: instrument turns itself off automatically when low battery condition exists. *Discharge* LED flashes slowly when this happens. *Discharge* LED is on whenever battery is supplying power to instrument. *Charge* LED indicates state of charge of battery during charging only and is on whenever battery is charged to 95% *NOMINAL* of capacity. *Charge* LED flashes when 90% *NOMINAL* of charge taken out is replaced. *Charge* LED is off if charge is less than 70% *NOMINAL* of capacity.

Line failure protection: instrument automatically switches to battery in case of line failure.

Weight: Opt 002 adds 1.4 kg (3 lb) to weight of instrument.

Option 003: C Channel.

Input Characteristics

Range: 50 to 1000 MHz, prescaled by 10.

Sensitivity: 15 mV rms sinewave (-23.5 dBm) to 650 MHz. 75 mV rms sinewave (-9.5 dBm) to 1000 MHz. Sensitivity can be decreased continuously by up to 20 dB *NOMINAL*, 50 to 500 MHz and 10 dB *NOMINAL*, 500 to 1000 MHz by adjusting sensitivity control. Trigger level is fixed at 0 V *NOMINAL*.

Dynamic range: 15 mV to 1 V rms (36 dB), 50 to 650 MHz. 75 mV to 1 V rms (20 dB), 650 to 1000 MHz.

Signal operating range: +5 Vdc to -5 Vdc.

Coupling: ac.

Impedance: 50 Ω *NOMINAL* (VSWR, < 2.5:1 TYPICAL).

Damage level: ±8 V (dc + ac peak), fuse protected. Fuse located in BNC connector.

Resolution and Accuracy: same as Frequency A.

Option 004: High Stability OVEN Time Base (HP 5315A only).

Frequency: 10 MHz.

Aging rate: $< 3 \times 10^{-8} / \text{mo}^*$.

Temperature: $\pm 1 \times 10^{-7}$, 0° to 50°C.

Line voltage: $< 1 \times 10^{-8}$, for a 10% variation.

Oven will operate continuously off of a fully charged battery for > 24 hours, typically, when in standby mode (no power applied, instrument OFF, and Freq. A button depressed).

(HP 5316B)

Frequency: 10 MHz.

Aging rate: $< 3 \times 10^{-8} / \text{mo}^{**}$.

Temperature: $\pm 2 \times 10^{-8}$, 0° to 50°C.

Line Voltage: $< 1 \times 10^{-9}$, for a 10% variation.

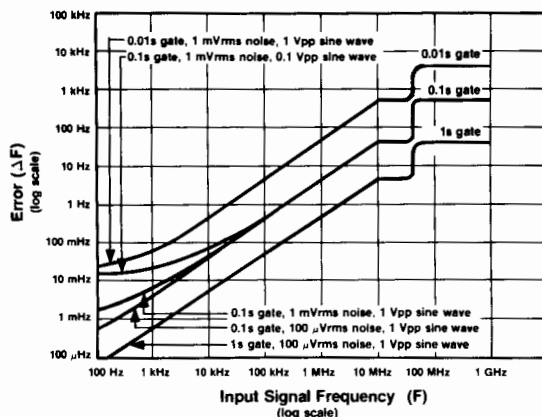

Graph 1. Frequency Resolution Error: Noise on the input signal and internal uncertainties affect Frequency and Period measurements. For Period, invert the period (P) of the input signal, and find frequency uncertainty (ΔF). Period uncertainty (ΔP) = (ΔF/F) x P.

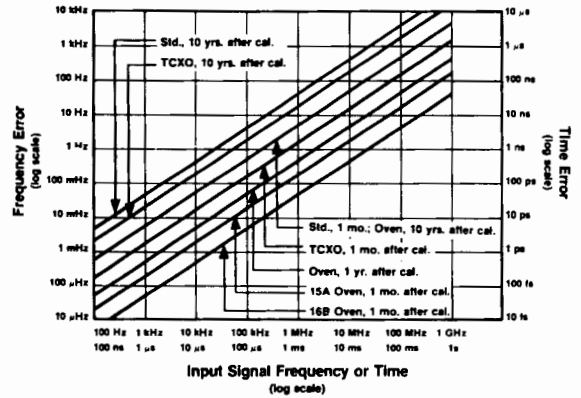

Graph 2. Time Base Error: Environment and aging of the crystal affects all measurements.

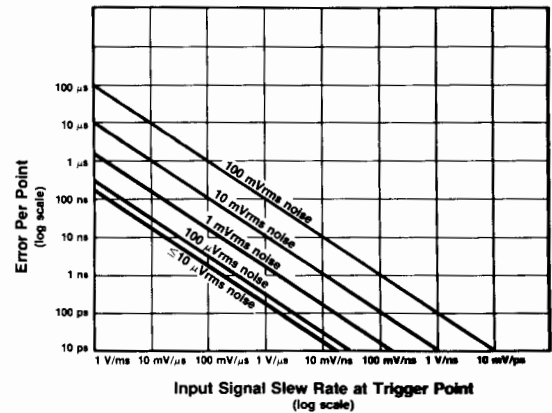

Graph 3. Input Noise Trigger Error: Noise on the input signal affects both the Start and Stop points of all Time Interval measurements.

*After 30 days continuous operation (ac power applied, in OFF or ON position).

**After 30 days continuous operation. $< 5 \times 10^{-8} / \text{mo}.$, after 7 days continuous operation.

Ordering Information

HP 5315A Universal Counter

\$1250 ☛

HP 5316B Universal Counter

\$1475 ☛

		HP 5315A	HP 5316B	Price
Opt 001	TCXO Time Base	X	X	+ \$180
Opt 002	Battery Pack	X		+ \$300
Opt 003	C-Channel (1.0 GHz)	X	X	+ \$400
Opt 004	High Stability Time Base	X	X	+ \$600

All HP 5315A orders must include one (1) of these line power options:

- Opt 100 90-105 VAC
- Opt 120 108-126 VAC
- Opt 220 198-231 VAC
- Opt 240 216-252 VAC

Price
N/C
N/C
N/C
N/C

ELECTRONIC COUNTERS

Low Cost Universal

Model 5314A

199

- 100 MHz
- 100 ns time interval
- Portable

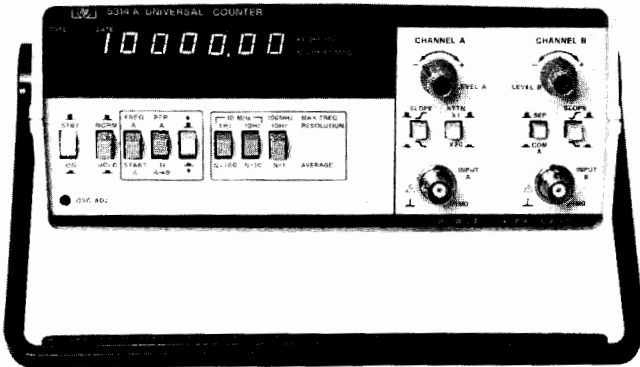

HP 5314A

HP 5314A Universal Counter

The HP 5314A Universal Counter combines excellent performance and traditional HP quality at a very attractive price. This counter is designed to deliver reliable, high quality operation in such areas as: Production Test, Frequency Monitoring, Education, Training, Service and Calibration. Additionally, the optional battery (option 002) makes the HP 5314A especially attractive for field and portable applications.

Input Characteristics (channels A and B)

Range: CHANNEL A: 10 Hz to 10 MHz Direct.

1 MHz to 100 MHz Prescaled.

CHANNEL B: 10 Hz to 2.5 MHz.

Sensitivity: CHANNEL A: 25 mV rms to 100 MHz.

75 mV peak-to-peak at minimum pulse width of 5 ns (100 MHz range).

CHANNEL B: 25 mV rms to 2.5 MHz.

75 mV peak-to-peak at minimum pulse width of 200 ns.

Coupling: ac.

Impedance: 1 MΩ NOMINAL shunted by less than 30 pF.

Attenuator: ×1 or ×20 NOMINAL (A channel only).

Trigger level: continuously variable ± 350 mV times attenuator setting around average value of signal.

Slope: independent selection of + or - slope.

Channel input: selectable SEPARATE OR COMMON A.

Dynamic range: 75 mV p-p to 4 V p-p.

Frequency

Range: 10 Hz to 10 MHz direct count.

1 MHz to 100 MHz prescaled by 10.

Least significant digit (LSD) displayed: direct count 0.1 Hz, 1 Hz, 10 Hz switch selectable. Prescaled 10 Hz, 100 Hz, 1 kHz switch selectable.

Resolution: ± LSD.

Accuracy: ± LSD ± (time base error) x Freq.

Period

Range: 10 Hz to 2.5 MHz.

LSD displayed: $\frac{100 \text{ ns}}{N}$ for N=1 to 1000 in decade steps of N.

Resolution: ± LSD ± $\frac{(1.4 \times \text{TRIGGER ERROR})}{N}$

Accuracy: ± LSD ± $\frac{(1.4 \times \text{TRIGGER ERROR})}{N}$

± (time base error) x Period.

Time Interval

Range: 250 ns to 1 s.

LSD displayed: 100 ns.

Resolution: ± LSD ± START trigger error ± STOP trigger error.

Accuracy: ± LSD ± START trigger error

± STOP trigger error ± (time base error) x TI.

External arming required for START/STOP channels.

Ratio (A to B)

Range: 10 Hz to 10 MHz CHANNEL A.

10 Hz to 2.5 MHz CHANNEL B.

LSD displayed: 1/N in decade steps of N for N = 1 to 1000.

Resolution: ± LSD ± (B trigger error x Frequency A)/N.

Accuracy: ± LSD ± (B trigger error x Frequency A)/N.

Totalize

Range: 10 Hz to 10 MHz.

Resolution: ± 1 count of input.

Totalize controlled by front panel switch.

General

Check: counts internal 10 MHz oscillator.

Display: 7 digit amber LED display with gate and overflow indication.

Max sample rate: 5 readings per second.

Operating temperature: 0° to 50 °C.

Power requirement: 115, +10%, -25%; 230 V, +9%, -17%; 48-66 Hz; 10 VA max.

Weight: 2.0 kg (4.4 lb).

Dimension: 238 mm W x 98 mm H x 276 mm D (9 $\frac{3}{8}$ in. x 3 $\frac{7}{8}$ in. x 10 $\frac{7}{8}$ in.).

Time Base

Frequency: 10 MHz.

Aging rate: < 3 parts in 10⁷ per month.

Temperature: < ± 1 part in 10⁵, 0 to 50°C.

Line voltage: < ± 1 part in 10⁷ for ± 10% variation.

Options

Option 001 TCXO

Frequency: 10 MHz.

Aging rate: < 1 part in 10⁷ per month.

Temperature: < ± 1 part in 10⁶, 0 to 40°C.

Line voltage: < ± 1 part in 10⁸ for ± 10% variation.

Option 002 Battery

Type: rechargeable lead-acid (sealed).

Capacity: typically 8 hours of continuous operation at 25 °C.

Recharging time: typically 16 hours to 98% of full charge, instrument non-operating. Charging circuitry included with option. Batteries not charged during instrument operation.

Battery voltage sensor: automatically shuts instrument off when low battery condition exists.

Line failure protection: instrument automatically switches to batteries in case of line failure.

Weight: Option 002 adds typically 1.5 kg (3.3 lb) to weight of instrument.

Definitions

Resolution: smallest discernible change of measurement result due to a minimum change in the input.

Accuracy: deviation from the actual value as fixed by universally accepted standards of frequency and time.

Trigger error:

$$\frac{\sqrt{(80 \mu\text{V})^2 + e_n^2}}{\text{input slew rate at trigger point } (\mu\text{V/s})} \text{ (rms)}$$

Where e_n is the RMS noise of the input for a 100 MHz bandwidth in CHANNEL A and 10 MHz bandwidth in CHANNEL B.

Ordering Information

HP 5314A 100 MHz/100 ns Universal Counter

Opt 001 High Stability Time Base

Opt 002 Battery

All orders must include one (1) of these line power options:

Opt 115 86-127 V

Opt 230 190-250 V

☎ Fast-Ship product — see page 734.

Price

\$600 ☎

+ \$180

+ \$180

N/C

N/C

POWER METERS

Peak Power Analyzer, Power Meter

Models 8990A, 436A

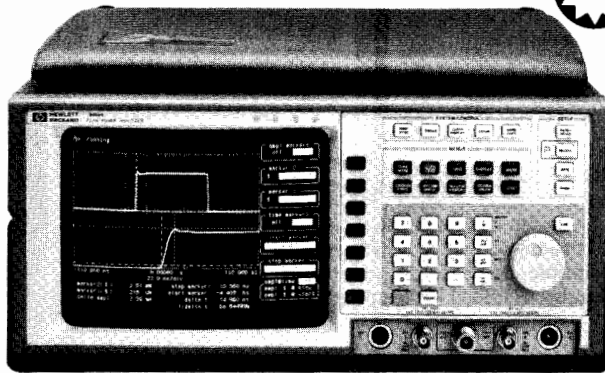

HP 8990A

The Accurate and Easy-To-Use Solution For Complete Pulse Power Characterization

The HP 8990A Peak Power Analyzer delivers state-of-the-art pulse characterization, with thirteen automatic measurements (peak power, power at top/base, risetime, falltime, PRF, overshoot, PRI, pulsewidth, offtime, duty cycle, delay, average power). With powerful measurement and display routines, the HP 8990A also features measurement statistics, high speed/high sensitivity triggering, amplitude and time markers, dual-timebase windowing, waveform storage and waveform math. You take control of your most demanding pulse measurements. The intuitive front panel operation enables you to quickly harness the power of this analyzer for your specific application.

HP 8990A Specifications

(With New HP 84812A/3A/4A Sensors):

Frequency Coverage: 500 MHz - 40 GHz

Power Range: -40 to +20 dBm

2 Power Channels

2 Ext. Triggering/Scope Channels

Sensor SWR: $1.22 \leq 18$ GHz

$1.35 \leq 26.5$ GHz

$1.7 \leq 40$ GHz

Risetime: < 7 ns

Contact HP for technical and ordering information.

HP 436A Power Meter

The HP 436A Power Meter is a general purpose digital power meter intended for manual and automatic RF and microwave power measurements. It is compatible with the entire series of HP 8480 Power Sensors. Depending on which power sensor is used, the HP 436A can measure power from -70 dBm (100 pW) to +44 dBm (25W) at frequencies up to 50 GHz.

The HP 436A measures either absolute or relative power. It displays absolute power in either watts or dBm, and relative power in dB.

HP 436A Specifications

Frequency range: 100 kHz to 50 GHz, sensor dependent.

Power Range (display calibrated in watts, dBm, and dB relative to reference power level). -70 to +44 dBm (100 pW to 25W), sensor dependent.

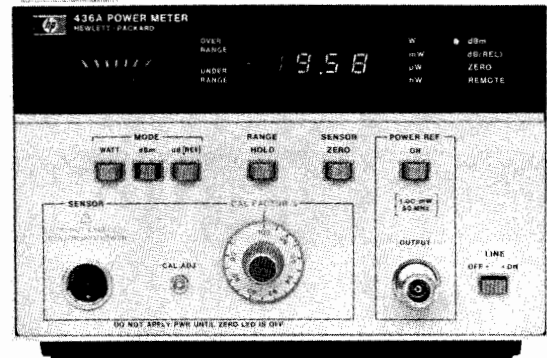

HP 436A



Accuracy Instrumentation

Watt mode: $\pm 0.5\%$.

dBm mode: ± 0.02 dB ± 0.001 dB/°C.

Zero: automatic, operated by a front-panel switch.

Zero set: $\pm 0.5\%$ of full scale on most sensitive range, typical.

Zero carry over: $\pm 0.2\%$ of full scale when zeroed on the most sensitive range.

Power reference: internal 50 MHz oscillator with Type N female connector on front panel (or rear panel, Option 003 only).

Power output: 1.0 mW. Factory set to $\pm 0.7\%$ traceable to the U.S. National Institute of Standards and Technology.

Accuracy: $\pm 1.2\%$ worst case ($\pm 0.9\%$ rss) for one year.

Supplemental Characteristics

Recorder output: linearly proportional to indicated power with 1 volt corresponding to full scale and 0.316 volts to -5 dB; 1 k Ω output impedance, BNC connector.

Power consumption: 100, 120, 220, or 240 V (+5%, -10%), 48 to 66 Hz, and 360 to 440 Hz; < 20 V · A (< 23 V · A with option 022).

HP-IB Function codes: AH1, C0, DC2, DT0, LEO, PP0, RL2, SH1, SR0, T3, TE0.

Weight: net, 4.5 kg (10 lb). Shipping, 5.5 kg (12 lb).

Size: 134 H x 213 W x 279 mm D (5.2" x 8.4" x 11.0").

Accessories

Furnished: HP 11730A, 1.5 m (5 ft) cable for power sensor; 2.3 m (7.5 ft) power cable. Mains plug shipped to match destination requirements.

Available: To select or substitute non-standard lengths for power sensor cables, see page 202. HP 5061-9657 Rack Mount Adapter Kit (One HP 436A by itself).

Ordering Information

HP 436A Power Meter

Price

\$2900

Option 003: Reference oscillator output on rear panel only.

N/C

Option 004: Delete power sensor cable
Option 022: Digital input/output, fully compatible with HP Interface Bus (HP-IB)

Less \$75

N/C

Option 908: Kit for rack mounting one HP 436A

\$35

Option 910: Extra operating and service manual

Add \$25

Option W30: Two additional years of return-to-HP warranty

Add \$60

☎ Fast-ship product - see page 734.

Average Power Measurements

At microwave frequencies, power is the best measure of signal amplitude because, unlike voltage and current, power remains constant along a lossless transmission line. For this reason, power meters are almost indispensable for microwave measurements. Typical applications include monitoring transmitter power levels, calibrating signal generators, leveling signal sources, and measuring transmission characteristics of unknown devices.

To satisfy the requirements of this broad range of applications Hewlett-Packard has developed a family of general purpose microwave power meters and power sensors. The power sensors use a

diode, thermocouple, or thermistor as the power sensing element, and it is important to understand the merits of each of these sensors before choosing a particular power meter.

Literature

Application Note 64-1, Fundamentals of RF and Microwave Power Measurements, deals with the general theory of microwave power measurements. It covers the basic principals of measurement, calculation of measurement uncertainty, traceability, etc.

POWER METERS

Power Meter

Model HP 437B, 70100A

201

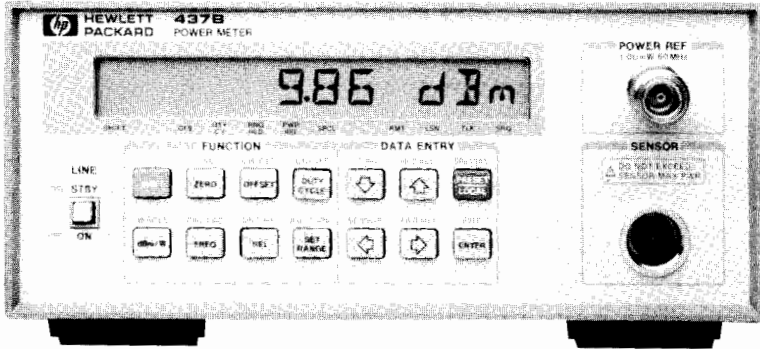

HP 437B

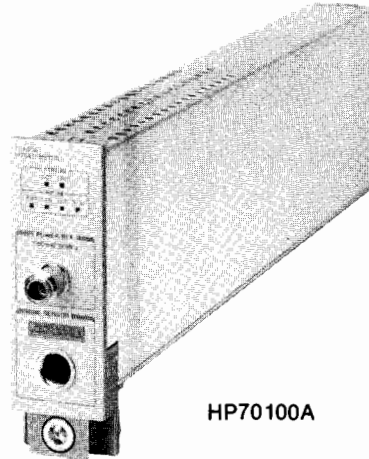

HP70100A

HP 437B Power Meter

The HP 437B is a low-cost, high performance, single-channel, programmable, average Power Meter compatible with the HP 8480 family of thermocouple and diode power sensors. Depending on which Power Sensor is used, the HP 437B can measure from -70 dBm (100pW) to +44 dBm (25W) at frequencies ranging from 100 KHz to 50 GHz.

Designed for ATE systems and demanding benchtop measurements, the HP 437B Power Meter makes fast, accurate and reliable average power measurements. Only 3½ inches high and half rack wide, the HP 437B minimizes the use of critical rack space in ATE systems. The advanced plastics technology used in the HP 437B cabinet combines the light weight of plastic with the shielding effectiveness of metal, making the HP 437B the only power meter to meet MIL-STD-461C EMI specifications.

A modern and flexible feature set makes this meter easy to use in any application:

- Automatic calibration and zeroing.
- Frequency entry instead of Cal Factor.
- Ten pre-loaded sensor Cal Factor versus frequency tables.
- Selectable resolution to 0.001 dB.
- Offset entry in dB.
- Duty cycle entry for a convenient peak power representation of the measured average power.
- Ten store/recall registers.
- HP-IB is standard.
- Optional analog meter (H36).

With a measurement speed twice as fast as that of the industry-standard HP 436A, powerful programming capability, state-of-the-art accuracy and exceptional reliability, the HP 437B lets you measure your test signal with speed, precision and confidence.

HP 437B Specifications

Frequency Range: 100 kHz to 50 GHz, sensor dependent.
Power Range: -70 to +44 dBm (100pW to 25W), sensor dependent.
Power Sensors: Compatible with all HP 8480 series Power Sensors.
Dynamic Range: 50 dB in 10 dB steps.
Display Units: Absolute: Watts, dBm.
 Relative: percent, dB.
Resolution: Selectable resolution of 0.1, 0.01 and 0.001 dB in logarithmic mode; or 1%, 0.1% and 0.01% of full scale in linear mode.

Accuracy

Instrumentation: ±0.02 dB or ±0.5%.
In REL mode: ±0.02 dB or ±0.5% within measurement range; ±0.04 dB or 1% outside measurement range.
Zero Set: ±0.5% of full scale on most sensitive range.

EMI: Radiated and Conducted Emissions and Radiated and Conducted Susceptibility are within the requirements of RE02, CE03, RS01/03 and CS01/03 called out in MIL-STD-461C, and within the requirements of VDE 0871 and CISPR Publication 11.

Power Reference

Power Output: 1.00mW, Factory set to ±0.7% traceable to US National Bureau of Standards.

Accuracy: ±1.2% worst case (±0.9% RSS) for one year.

General

Rear Panel Output: Analog 0-1 volt without digital filtering or Cal Factor correction, 1 kohm output impedance, BNC connector.

Line Voltage: 100 and 120 Vac, +5%-10%, 48-66 Hz, 360-440 Hz; 220 and 240 Vac, +5%-10%, 48-66 Hz.

Power Requirement: 8 Watts maximum (10 VA max).

Weight: Net 2.6 kg (5.9 lbs); shipping 4.5 kg (10 lbs).

HP-IB Codes: SH1, AH1, T5, TE0, L4, LE0, SR1, RL1, PP1, DC1, DT1, C0.

Dimensions: 88m H x 212mm W x 273mm D (3.46" H x 8.35" W x 10.75" D).

Accessories

Furnished: HP 11730A, 1.5m (5 ft.) cable for power sensors; 2.4m (7.5 ft.) power cable. Main plug shipped to match destination requirements.

Available: To select or substitute non-standard lengths for power sensor cable, see page 210. To rack mount one HP 437B order part number 5060-0174.

HP 70100A Power Meter Module (Modular Measurement System)

The HP 70100A is a full-feature single channel power meter module for the Modular Measurement System (see page 115). It has all the capability of the HP 437B Power Meter in an 1/8th rack-width module. The HP 70100A features the same modern and flexible feature set as the HP 437B, the same state-of-the-art accuracy and is also fully compatible with the HP 8480 series of power sensors.

Ordering Information

	Price
HP 437B Power Meter	\$2500
Option 002: Supplies a parallel rear panel sensor input	+\$75
Option 003: Supplies a parallel rear panel sensor input and moves reference oscillator to rear panel	+\$75
Option 004: Delete the HP 11730A sensor cable	-\$75
Option 401: Provides side-carrying handle and standoff feet	+\$25
Option 915: Service Manual	+\$25
Option 918: Extra Operating Manual	+\$65
Option W30: Two additional years of return-to-HP warranty	+\$100
Option H36: Additional analog meter	\$2900
HP 70100A Power Meter Module	\$0
Option 003: Moves reference oscillator from front to rear panel	-\$75
Option 004: Delete the HP 11730A Power Sensor Cable	-\$250
Option 005: Delete reference oscillator	+\$70
Option W30: Two additional years of return-to-HP warranty	

Fast-ship product - see page 734

POWER METERS

Power Meter Model HP 438A

- Ideal for ATE applications
- Dual power sensors
- Innovative ratio & difference measurements

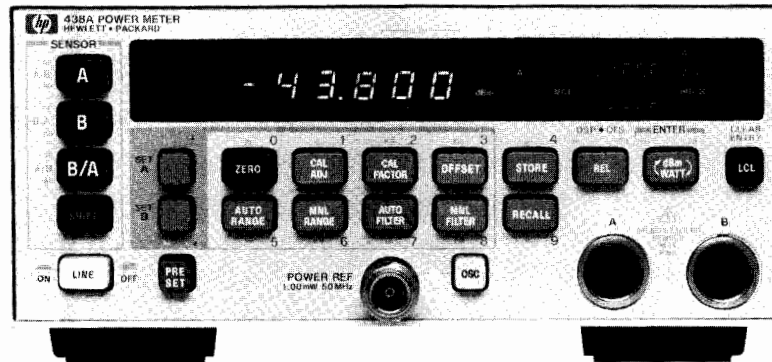

HP 438A

DESIGNED FOR
MATE
SYSTEMS

DESIGNED FOR
HP-IB
SYSTEMS

The HP 438A Power Meter is a dual channel power meter designed specifically for ATE systems. The compact front panel is designed to save space in rack mounted systems, while the dual channel design allows simple measurements of the ratio and difference of power levels from two separate sensors. Compatible with the HP 8480 series of thermocouple and diode sensors, the power and frequency range of the meter extends from -70 dBm to 44 dBm and from 100 kHz to 50 GHz.

Important measurement contributions are a programmable digital filter for optimizing resolution and measurement speed, independent offset (in dB) values for each channel, 0.001 dB resolution available, and a power difference mode for displaying absorbed power in transmission lines. Up to 19 different operating states of the meter can be stored into non-volatile memory for later recall.

The programmable digital averaging filter gives the user control over the inherent tradeoff between speed and accuracy. The AUTO filter mode is usually adequate for fully settled readings with 0.01 dB resolution. Less digital averaging leads to faster but noisier readings, if speed is the critical issue.

The Hewlett-Packard Interface Bus (HP-IB) capability is standard on the HP 438A with programming codes printed on the front panel for easy reference. For U.S. Air Force MATE (Modular Automatic Test Equipment) system applications, Option 700 provides the HP 438A with the internal capability to be controlled by the MATE language CIIL (Control Interface Intermediate Language). All measurement modes are programmable including zeroing, calibration, and Cal Factor. Complete interrupt capability with flexible SRQ operation optimizes the efficiency of program execution in automatic systems.

HP 438A Specifications

Frequency range: 100 kHz to 50 GHz (depending on power sensor used).

Power range: -70 dBm to $+44$ dBm (100 pW to 25 W), sensor dependent. Uses HP 8480 series power sensors; see sensor specs for details.

Operating temperature range: 0 -55° C.

Instrumentation Accuracy

Single channel, linear mode: $\pm 0.5\%$.

Log mode: ± 0.02 dB.

Dual channel, linear mode: $\pm 1\%$.

Log mode: ± 0.04 dB.

Zeroing: automatic, $\pm 0.5\%$ full scale on most sensitive range.

Power Reference

Power output: 1.00 mW. Factory set to $\pm 0.7\%$, traceable to the U.S. National Institute of Standards and Technology.

Accuracy: $\pm 1.2\%$ worst case ($\pm 0.9\%$ rss) for 1 year.

Connector: front panel type N female (also on rear panel, Opt 002).

Meter Adjustments

Cal factor: values from 1% to 150% in 0.1% steps can be entered to account for sensor frequency response. Sensor calibration: automatic self calibration to 1.00 mW.

General

Display: four digit display (five digits in high resolution mode) with 20% over-range capability on all ranges. Annunciators to indicate measurement mode, Cal Factor, offset value, fixed or automatic range and filter values, and error conditions.

Recorder output: linearly proportional to power in watts. One volt corresponds to full scale; 1k Ω output impedance, BNC rear panel female connector.

Line voltage: 100, 120, 220 or 240 Vac $+5\%$ -10% . 100 and 120 volts, 48 to 66 Hz and 300 to 440 Hz. 220 and 240 volts, 48 to 66 Hz only.

Power requirements: 65 VA, 35 watts, maximum.

Weight: net, 5.9 kg (13 lb). Shipping, 9.1 kg (20 lb).

Dimensions: 89 mmH x 213 mmW x 418 mmD (3.5 x 8.4 x 16.8 in).

HP-IB interface codes: SH1, AH1, T5, TE0, L4, LE0, SR1, RL1, PP1, DC1, DT1, C0.

Accessories

Furnished: HP 11730A, 2 each, 1.5 metre (5 ft) power sensor cables. Power cable, 1 each, 2.4 metres (7.5 ft). Mains plug matches destination requirements.

Available: To select or substitute non-standard lengths for power sensor cables, see below.

HP 11730A-F Power Sensor Cables

The HP 11730 series power sensor cables are for use with the HP 435B, 436A, 437B, 438A and 70100A power meters and the HP 8480 series thermocouple and diode power sensors. These cables are designed to reduce RFI effects on low power readings with an improved shielding design in the cable itself. Cables may be ordered individually or in pairs in any combination desired for single and dual channel measurements.

The HP 11730A cable is the standard cable for the HP 435B, 436A, 437B, 438A (2 cables shipped) and 70100A meters. To order a non-standard cable, select Option 004 for the meter in question, and order the desired cable from below.

Ordering Information

	Price
HP 438A Dual Channel Power Meter	\$5,100
Option 002: Rear panel sensor connectors (in parallel with front panel) and additional reference oscillator with rear panel output.	+\$325
Option 700: Internal MATE programming	+1000
Option 004: Delete power sensor cables	-\$150
Option 910: Additional manual	\$25
Option W30: Two additional years of return-to-HP warranty	+\$130
HP 11730A 1.5 metre (5 ft) sensor cable	\$90
HP 11730B 3.0 metre (10 ft) sensor cable	\$100
HP 11730C 6.1 metre (20 ft) sensor cable	\$140
HP 11730D 15.2 metre (50 ft) sensor cable	\$200
HP 11730E 30.5 metre (100 ft) sensor cable	\$265
HP 11730F 61.0 metre (200 ft) sensor cable	\$425

☎ Fast-ship product—see page 734.

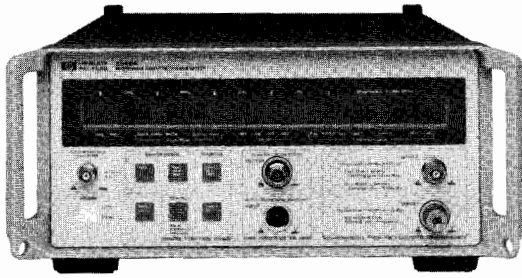

HP 5348A

Frequency and True Power Measurements in One Instrument

The HP 5347A 20 GHz Counter/Power Meter and HP 5348A 26.5 GHz Counter/Power combine a microwave counter and true power meter in a single portable instrument. They offer several ease-of-use features and an internal battery for making cordless measurements anywhere.

Both the HP 5347A and HP 5348A are compatible with a subset of HP 8480 series of power sensors. Depending on the sensor used, the HP 5347A and HP 5348A measure power from -70 dBm (100 pW) to $+20$ dBm (100 mW) at frequencies from 10 MHz to 20 GHz/26.5 GHz. They also measure frequency from 10 Hz to 20 GHz/26.5 GHz. For a detailed description and ordering information, see the Electronic Counters section, pages 167-169.

HP 435B Power Meter

The HP 435B Power Meter is an analog power meter, compatible with the entire series of HP 8480 Power Sensors. Depending on which sensor is used, the HP 435B can measure power from -65 dBm to $+44$ dBm, full scale, at frequencies from 100 kHz to 50 GHz. This versatile instrument also features $<1\%$ instrumentation uncertainty, low noise and drift, auto-zero, recorder output, optional battery operation, and long cable options up to 61 m (200 ft).

HP 11683A Range Calibrator

The HP 11683A Calibrator is specifically designed for use with the HP 435B, 436A, 437B, 438A and 70100A Power Meters. It allows verification of full-scale meter readings on all ranges, as well as meter tracking. Simply connect the cable between the power meter and calibrator. The CAL ADJ control on the power meter is used to set the meter to full scale on the 1 mW range. The calibrator and meter are then stepped through the other ranges verifying accuracy within $\pm 1\%$ plus noise and drift. The HP 11683A also has a polarity switch which tests the Auto-Zero circuit.

HP 435B Specifications

Frequency range: 100 kHz to 50 GHz (sensor dependent).

Temperature range: 0 -55° C.

Power Range (calibrated in watts and dB in 5 dB steps).

With HP 848xB: $+5$ dBm (3 mW) to $+44$ dBm (25 W) full scale.

With HP 848xH: -5 dBm (0.3 mW) to $+35$ dBm (3 W) full scale.

With HP 848xA: -25 dBm (3 μ W) to $+20$ dBm (100 mW) full scale.

With HP 848xD: -65 dBm (300 pW) to -20 dBm (10 μ W) full scale.

Accuracy

Instrumentation: $\pm 1\%$ of full scale on all ranges.

Zero: automatic, operated by front-panel switch.

Zero set: $\pm 0.5\%$ of full scale on most sensitive range, typical.

Zero carryover: $\pm 0.5\%$ of full scale when zeroed on the most sensitive range.

Power reference: internal 50 MHz oscillator with Type N female connector on front panel (or rear panel, Option 003 only).

Power output: 1.00 mW. Factory set to $\pm 0.7\%$ traceable to the U.S. National Institute of Standards and Technology.

Accuracy: $\pm 1.2\%$ worst case ($\pm 0.9\%$ rss) for one year.

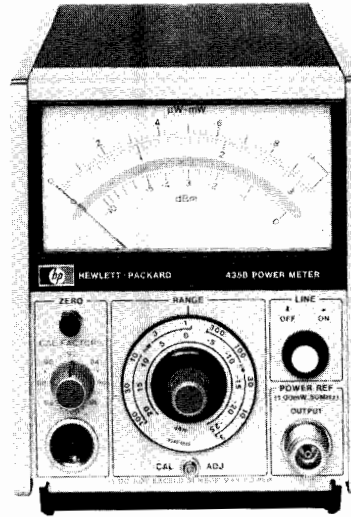

HP 435B

Supplemental Characteristics

Recorder output: linearly proportional to indicated power with 1 volt corresponding to full scale: 1 k Ω output impedance, BNC connector.

RF blanking output: provides a contact closure to ground. Used for turning off RF input to sensor during auto-zeroing. BNC connector.

Power consumption: 110 or 120 V ($+5\%$, -10%), 48 to 66 Hz and 360 to 440 Hz; also 220 or 240 V ($+5\%$, -10%), 48 to 66 Hz only: <20 V \cdot A.

Weight: net, 2.7 kg (5.9 lb). Shipping, 4.2 kg (9.2 lb).

Size: 155 H x 130 W x 279 mm D (6.3" x 5.1" x 11").

Accessories

Furnished: HP 11730A, 1.52 m (5 ft) cable for the power sensor; 2.3 m (7.5 ft) power cable (mains plug shipped to match destination requirements).

Available

To select or substitute non-standard lengths for power sensor cables see page 202.

HP 5060-8762: Rack adapter frame (holds three instruments the size of the HP 435B).

HP 11683A Range Calibrator

Calibration functions: outputs corresponding to meter readings of 3, 10, 30, 100 and 300 μ W; 1, 3, 10, 30, and 100 mW.

Calibration uncertainty: $\pm 0.25\%$ in all ranges.

Power: 100, 120, 220, or 240 Vac $+5\%$, -10% , 48-440 Hz, less than 10 V \cdot A.

Weight: net, 1.13 kg (2.5 lb). Shipping, 1.9 kg (4.2 lb).

Size: 89 H x 133 W x 216 mm D (3.5" x 5.25" x 8.5").

Ordering Information

HP 11683A Range Calibrator

Price

\$950

HP 435B Power Meter

\$1500 ☎

HP 435B Options

001: Rechargeable battery installed provides up to 16 hours of continuous operation +\$100

002: Input connector placed on rear panel in parallel with front +\$25

003: Parallel sensor inputs front and rear panels, reference oscillator output on rear panel. +\$25

004: Delete power sensor cable -\$75

910: Extra operating and service manual +\$7.50

W30: Two additional years of return-to-HP warranty +\$50

☎ Fast-Ship product—see page 734.

POWER METERS

Power Sensors

HP 8481A/B/D, 8481H, 8482A/B, 8482H, 8483A, 8485A/D, R/Q 8486A/D, 8487A/D, 11708A

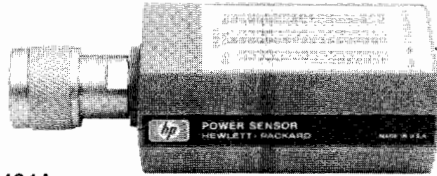

HP 8481A

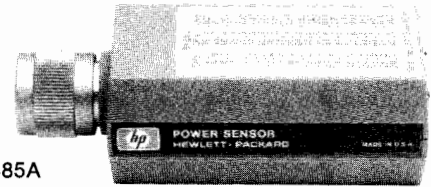

HP 8485A

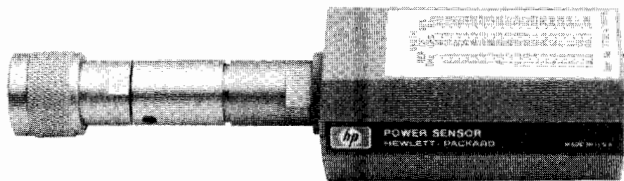

HP 8481H

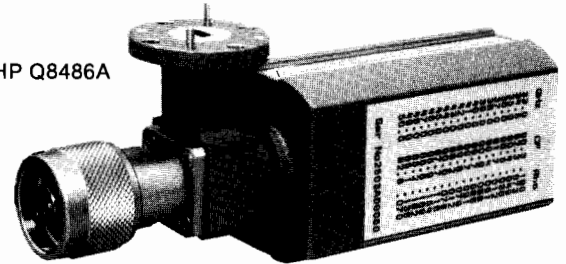

HP Q8486A

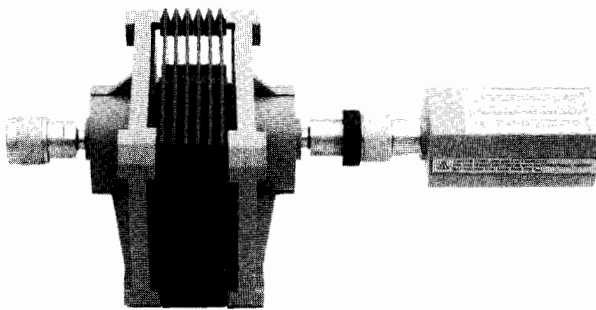

HP 8481B

HP 8480 Power Sensor Family

The HP 8480 power sensors are designed for use with the HP 435B, 436A, 437B, 438A, and 70100A Power Meters. These thermocouple and diode power sensors provide extraordinary accuracy, stability and SWR over a wide range of frequencies (100 kHz to 50 GHz) and power levels (-70 to +44 dBm).

Best SWR in the Industry

Mismatch uncertainty is usually the largest single source of error in power measurements. The HP 8480 power sensor family gives you extremely low SWR even at mm-wave frequencies. For example, the new HP 8485D high sensitivity power sensor has a specified SWR of less than 1.29:1 over its entire 50 MHz to 26.5 GHz frequency range. This low SWR translates into minimum mismatch uncertainty and optimum measurement accuracy.

Accurate Calibration and Traceability

Each power sensor in the HP 8480 family is individually calibrated and traceable to the U.S. National Institute of Standards and Technology (NIST, formerly NBS). The uncertainty in this calibration factor is your link to NIST. The Cal Factor measurement system used by HP Standards Lab provides you with minimum Cal Factor uncertainty.

True-RMS Reading Sensors

HP high-sensitivity diode power sensors (HP 8481D/5D/6D/7D) are always operated inside the square-law region. This means that the sensor will act as a true-RMS reading device over its entire -70 to -20 dBm dynamic range. The benefit to you: HP sensors provide you with accurate readings even if your test signal is subjected to multitone environments, modulated carriers, or carriers with high harmonics.

mm-Wave Sensor Calibration

A 50 MHz calibration port is included in HP waveguide power sensors for calibration with the power meter. This calibration provides traceability to NIST at millimeter-wave frequencies, and it eliminates the uncertainties due to temperature changes and the variance in making measurements with different meter/sensor combinations.

Accurate Accessories Included

With HP power sensors, you can start making measurements right away. No more hunting around for attenuators or adapters. HP sensors include all the accessories you need to optimize accuracy and save time.

In-House Power Sensor Calibration

Power sensor calibration is now easier than ever with the new HP 11760S-E01 calibration system, designed specifically for Metrology and Cal Lab engineers. In less than four minutes, this complete sensor calibration system can measure your sensor's Cal Factor, calculate all measurement uncertainties, generate a permanent record for your files, and plot a new replacement Cal Factor label.

For more information on the HP 11760S-E01 Power Sensor Calibration System, please contact your HP Field Engineer.

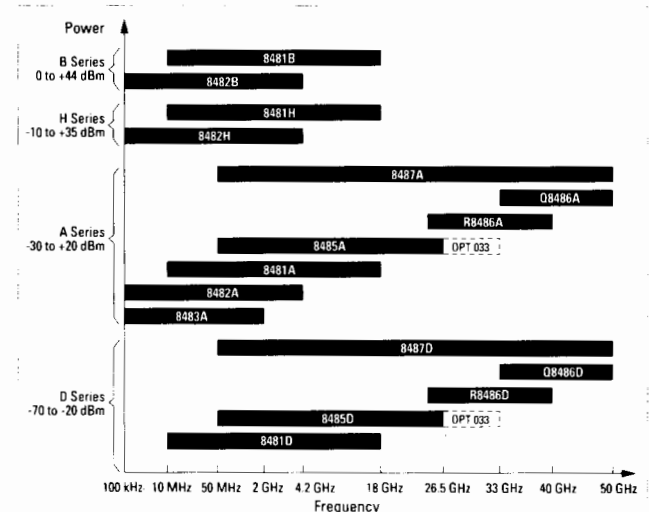

Figure 1. HP 8480 Power Sensor Family frequency and power range coverage.

HP 8480 Series Specifications

25 Watt Sensors 1 mW to 25W (0 to +44 dBm)

HP Model	Frequency Range	Maximum SWR	Power Linearity	Maximum Power ¹	Connector Type	Weight	
8481B	10 MHz-18 GHz	10 MHz-2 GHz: 1.10 2-12.4 GHz: 1.18 12.4-18 GHz: 1.28	+35 to +44 dBm ±4%	0-35°C: 30W avg 35-55°C: 25W avg 0.01-5.8 GHz: 500W pk 5.8-18 GHz: 125W pk 500W-µs per pulse	N(m)	Net 0.8 kg (1.75 lb) Shipping 1.5 kg (3.25 lb)	\$1,600
8482B	100 kHz-4.2 GHz	100 kHz-2 GHz: 1.10 2-4.2 GHz: 1.18			N(m)		

3 Watt Sensors 100 µW to 3W (-10 to +35 dBm)

8481	10 MHz-18 GHz	10 MHz-8 GHz: 1.20 8-12.4 GHz: 1.25 12.4-18 GHz: 1.30	+25 to +35 dBm ±5%	3.5W avg, 100W pk 100W-µs per pulse	N(m)	Net 0.2 kg (0.38 lb) Shipping 0.5 kg (1 lb)	\$825
8482H	100 kHz-4.2 GHz	100kHz-4.2GHz: 1.20			N(m)		\$800

100 mW Sensors 1 µW to 100 mW (-30 to +20 dBm)

8485A	50 MHz-26.5 GHz	50-100 MHz: 1.15 100 MHz-2 GHz: 1.10 2-12.4 GHz: 1.15 12.4-18 GHz: 1.20 18-26.5 GHz: 1.25	+10 to +20 dBm +2, -4%	300 mW avg, 15W pk 30W-µs per pulse	APC-3.5mm (m)	Net 0.2 kg (0.38 lb) Shipping 0.5 kg (1 lb)	\$950
Opt. 033	50 MHz-33 GHz	26.5-33 GHz: 1.40					+\$350
8481A	10 MHz-18GHz	10-30 MHz: 1.40 30-50 MHz: 1.18 50 MHz-2 GHz: 1.10 2-12.4 GHz: 1.18 12.4-18 GHz: 1.28			N(m)		\$650
8482A	100 kHz-4.2 GHz	100-300 kHz: 1.60 0.3-1 MHz: 1.20 1 MHz-2 GHz: 1.10 2-4.2 GHz: 1.30			N(m)		\$650
8483A (75Ω)	100 kHz-2 GHz	100-600 kHz: 1.80 600kHz-2 GHz: 1.18		300 mW avg, 10W pk	N(m) 75Ω		\$650
R8486A	26.5-40 GHz	1.4	+10 to +20 dBm +2, -4%	300 mW avg, 15W pk 30W-µs per pulse	Waveguide Flange UG-599/U	Net 0.26 kg (0.53 lb) Shipping 0.66 kg (1.3lb)	\$2,000
Q8486A	33-50 GHz	1.5			Waveguide Flange UG-383/U		\$2,600
8487A	50 MHz-50 GHz	50-100 MHz: 1.15 100 MHz-2 GHz: 1.10 2-12.4 GHz: 1.15 12.4-18 GHz: 1.20 18-26.5 GHz: 1.25 26.5-40 GHz: 1.30 40-50 GHz: 1.50	+10 to +20 dBm +2, -4%	300 mW avg, 15W pk 30W-µs per pulse	2.4 mm (m)	Net 0.14 kg (0.28 lb) Shipping 0.5 kg (1 lb)	\$2,000

High Sensitivity Sensors 100 pW to 10 µW (-70 to -20 dBm)

8481D ^{3,4}	10 MHz-18 GHz	10-30 MHz: 1.40 30 MHz-4 GHz: 1.15 4-10 GHz: 1.20 10-15 GHz: 1.30 15-18 GHz: 1.35	-30 to -20 dBm ±1%	100 mW avg 100 mW pk	N(m)	Net 0.18 kg (0.41 lb) Shipping 0.9 kg (2 lb)	\$900
8485D ³	50 MHz-26.5 GHz	0.05-0.1 GHz: 1.19 0.1-4 GHz: 1.15 4-12 GHz: 1.19 12-18 GHz: 1.25 18-26.5 GHz: 1.29	-30 to -20 dBm ±2%	100 mW avg 100 mW pk	APC-3.5 mm (m)	Net 0.2 kg (0.38 lb) Shipping 0.5 kg (1 lb)	\$1,350
Opt. 033	50 MHz-33 GHz	26.5-33 GHz: 1.35					+\$350
8487D ³	50 MHz-50 GHz	0.05-0.1 GHz: 1.19 0.1-2 GHz: 1.15 2-12.4 GHz: 1.20 12.4-18 GHz: 1.29 18-34 GHz: 1.37 34-40 GHz: 1.61 40-50 GHz: 1.86	-30 to -20 dBm ±2%	100 mW avg 100 mW pk	2.4 mm (m)	Net 0.2 kg (0.38 lb) Shipping 0.5 kg (1 lb)	\$2,600
R8486D ³	26.5-40 GHz	1.4	-30 dB to -25 dBm ±3%	100 mW avg or pk 40 Vdc max	Waveguide Flange UG-599/U	Net 0.26 kg (0.53 lb) Shipping 0.66 kg (1.3 lb)	\$2,700
Q8486D ³	33-50 GHz	1.4	-25 dB to -20 dBm ±5%		Waveguide Flange UG-383/U		\$3,400

¹ Negligible deviation except for those power ranges noted.

² For pulses greater than 30W the maximum average power (P_a) is limited by the energy per pulse (E) in W-µs according to $P_a = 30-0.02E$.

³ Includes HP 11708A 30 dB attenuator for calibrating against a 0 dBm, 50 MHz power reference. HP 11708A is factory set to 30 dB ±0.05 dB at 50 MHz, traceable to NIST. SWR <1.05 at 50 MHz.

⁴ This sensor directly replaces the popular HP 8484A Power Sensor.

 Fast-Ship product—see page 734.

POWER METERS

Thermistor Power Meters & Power Meter Calibrator

Models 432A/B, 8477A

- Automatic zero
- High accuracy

- Recorder outputs, analog & digital
- Long cable options

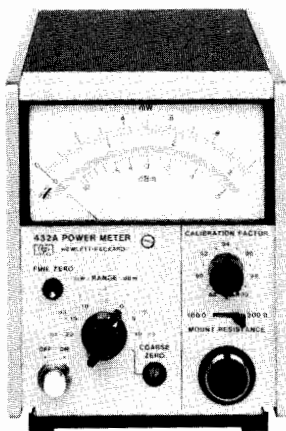

HP 432A

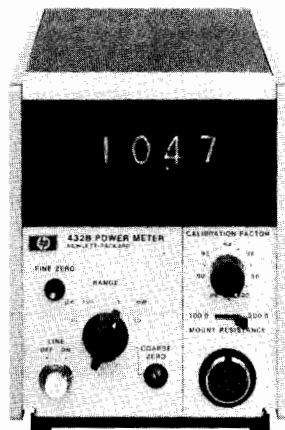

HP 432B

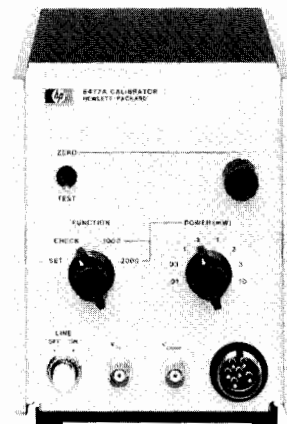

HP 8477A

HP 432A/B Power Meters

High accuracy—no thermoelectric error: high accuracy over a wide temperature range is featured on the HP 432 Power Meters. By measuring the output voltage of the thermistor bridges, and computing the corresponding power, even higher accuracy of $\pm 0.2\% \pm 0.5 \mu\text{W}$ can be obtained.

Accuracy can be maintained on even the most sensitive range because the error due to thermoelectric effect is reduced to a negligible level.

Calibrated mounts: each thermistor mount is furnished with data stating the Calibration Factor* and Effective Efficiency* at various frequencies across the operating range. For easy and accurate power measurements, the front panel of the HP 432 contains a calibration factor control, calibrated in 1% steps from 88% to 100%, that compensates for losses in the mount and eliminates the need for calculation.

Instrument type: automatic, self-balancing power meter for use with temperature-compensated thermistor sensor.

*"Calibration Factor" and "Effective Efficiency" are figures of merit expressing the ratio of the substituted signal measured by the power meter to the microwave power incident on and absorbed by the sensor.

Specifications (partial)

Power Range

HP 432A: seven ranges with full-scale readings of 10, 30, 100, and 300 μW , 1, 3, and 10 mW; also calibrated in dBm from -20 dBm to $+10$ dBm full scale in 5 dB steps.

HP 432B: four ranges with full-scale readings of 10 and 100 μW , and 1 and 10 mW.

Noise: less than 0.25% of full scale peak (typical).

Response time: at recorder output, 35 ms time constant (typical).

Fine zero: automatic, operated by front panel switch.

Zero carryover: less than 0.50% of full scale when zeroed on most sensitive range.

Meter

HP 432A: taut-band suspension, individually calibrated, mirror-backed scales. Milliwatt scale more than 108 mm (4.25 in.) long.

HP 432B: three digits with one digit overrange. 20% overrange capability on all ranges.

Calibration factor control: 13-position switch normalizes meter reading to account for thermistor sensor calibration factor. Range 100% to 88% in 1% steps.

Thermistor sensor: thermistor sensors are required for operation of the HP 432A/B. For microwave sensors HP 478B, 8478B and 486 series see page 207.

Recorder output: proportional to indicated power with 1 volt corresponding to full scale. 1 k Ω output impedance.

BCD output: 8, 4, 2, 1 code: "1" positive. TTL compatible logic. Operates with HP 5150A, Opt 002 (BCD) Digital Recorder. "Print" and "Inhibit" lines available. (HP 432B only.)

Power Consumption

HP 432A: 115 or 230 Vac $\pm 10\%$, 50 to 400 Hz, 1.5 watts.

HP 432B: 115 or 230 Vac $\pm 10\%$, 50 to 400 Hz, 10 watts.

Weight

HP 432A: net, 2.3 kg (5.5 lb). Shipping, 4.6 kg (10 lb).

HP 432B: net, 3 kg (6.5 lb). Shipping, 4.8 kg (10.5 lb).

Size: 130 W x 155 H x 279 mm D (5.2" x 6.1" x 11.0").

HP 8477A Power Meter Calibrator

The HP 8477A Calibrator is specifically designed for use with the HP 432 Power Meter. It allows you to verify full-scale meter readings on all ranges, and meter tracking. Simply connect three cables between the power meter and calibrator; no charts or additional instruments are required.

Power: 115 or 230 Vac $\pm 10\%$, 50 to 400 Hz, 3 watts.

Ordering Information

Item	Price
HP 432A Power meter	\$1550
HP 432B Power meter	\$2350

HP 432A/B Options

001: rechargeable battery installed, provides up to 20 hours continuous operation (HP 432A only)	+ \$105
002: input connector placed on rear panel in parallel with front	+ \$25
003: input connector on rear panel only	+ \$10
009: 3.1 m (10 ft) cable for 110- Ω or 200- Ω sensor	+ \$30
010: 6.1 m (20 ft) cable for 100- Ω or 200- Ω sensor	+ \$55
011: 15.2 m (50 ft) cable for 100- Ω or 200- Ω sensor	+ \$105
012: 30.5 m (100 ft) cable for 100- Ω or 200- Ω sensor	+ \$155
013: 61 m (200 ft) cable for 100- Ω or 200- Ω sensor	+ \$260
100: 100 Vac operation, 48–66 Hz	no charge
910: extra operating and service manual	+ \$5
W30: Two additional years of return-to-HP warranty	+ \$60
HP 8477A Power Meter Calibrator	\$1200
Opt W30 Two additional years of return-to-HP warranty	+ \$50

Thermistor Mounts, Peak Power Sensor & Peak Power Meters Models 478A, 8478B, 486 Series, 8900C/D, 84811A

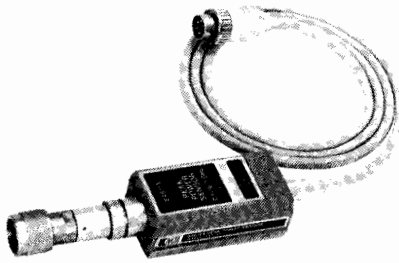

HP 84811A



HP 478A



HP 8478B

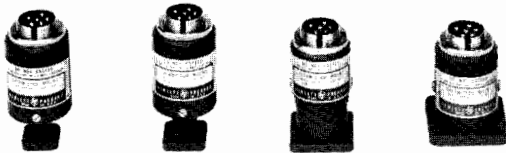

HP 486 Series

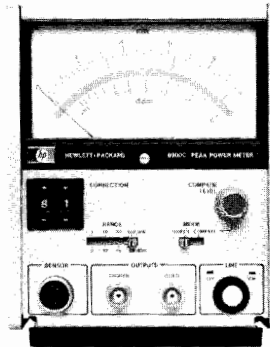

HP 8900C



HP 8900D

HP 8900C/D Peak Power Meters

The HP 8900C and 8900D Peak Power Meters directly display the peak power of RF pulses over a 100 MHz to 18 GHz frequency range. Measurements can be made on pulses with widths from 1 μ s (100 ns in Compare mode) to CW, and repetition rates from 100 Hz (0 Hz in Compare mode) to 100 kHz.

The HP 8900C is an economical analog meter calibrated in watts and dBm. The analog display with its large, easy-to-read scale makes it simple to peak or null pulsed power systems. The HP 8900D has a high resolution 3 1/2 digit digital display calibrated in watts. The direct reading display and range annunciators make the digital version a good choice for production and field applications where unambiguous or frequent readings are required.

HP 8900C/D Peak Power Meters Specifications

Frequency range: 100 MHz to 18 GHz.

Dynamic range: 20 dB (0 to +20 dBm).

HP 8900C: 4 ranges of 3, 10, 30 and 100 mW full scale.

HP 8900D: 2 ranges of 10 and 100 mW full scale.

Pulse Response:

Direct Mode

Pulse width: 1 μ s to CW.

Repetition rate: 100 Hz to 100 kHz.

Compare Mode

Pulse width: 100 ns (typical) limited by rise time specification.

Repetition rate: 0 to 100 kHz.

Rise time: 75 ns.

Fall time: 125 ns (as measured on video output).

Power consumption: 100 and 120 Vac +5, -10%, 48-66 Hz and 360-440 Hz; 220 and 240 Vac +5, -10%, 48-66 Hz.

Meter Accuracy	CW	Pulse	Transfer Accuracy CW to Pulse
Direct	± 0.2 dB	± 0.35 dB	± 0.2 dB
Compare	± 0.2 dB	± 0.25 dB	± 0.1 dB

HP 84811A Peak Power Sensor Specifications

Power range: 0 to +20 dBm (1 mW to 100 mW).

Frequency range: 100 MHz to 18 GHz.

SWR: 100 MHz to 12 GHz < 1.5. 12 GHz to 18 GHz < 2.0.

Maximum peak power: +24 dBm (250 mW) for 5 minutes.

Connector type: N (male).

Calibration: every 2 GHz from 2 to 10 GHz. Every 1 GHz from 11 to 18 GHz.

Operating temperature: 0 to +55°C.

Calibration accuracy: (+10 to +40°C), ± 0.7 dB 0.1 to 12 GHz. ± 1.0 dB to 18 GHz. 0-10°C and 40-55°C: add ± 0.2 dB.

Ordering Information

HP 8900C Analog peak power meter

HP 8900D Digital peak power meter

Option W30: Two additional years of return-to-HP warranty (for HP 8900C/D)

HP 84811A Peak power sensor

☎ Fast-Ship product—see page 734.

Price

\$2450

\$2900

+ \$50

\$900 ☎

Temperature Compensated Thermistor Mounts

High efficiency and good RF match are characteristic of the HP 478A and 8478B coaxial and 486A series waveguide Thermistor Mounts. Used in conjunction with the HP 432 Power Meter they provide high accuracy even in routine power measurements. These thermistor mounts are temperature-compensated for low drift, even in the presence of thermal shocks, permitting measurement of microwave power as low as one microwatt. Each mount contains data showing Calibration Factor and Effective Efficiency at six frequencies, directly traceable to the U.S. National Institute Standards and Technology at those frequencies where NIST provides calibration service.

HP 486, 478, 8478B Specifications

HP Model	Frequency range, GHz	Maximum SWR	Operating Resistance (Ohms)	Price
478A	10 MHz to 10 GHz	1.75, 10 to 25 MHz 1.3, 25 MHz to 7 GHz 1.5, 7 to 10 GHz	200	\$435
8478B ¹	10 MHz to 18 GHz	1.75, 10 to 30 MHz 1.35, 30 to 100 MHz 1.1, 0.1 to 1 GHz 1.35, 1 to 12.4 GHz 1.6, 12.4 to 18 GHz	200	\$600
X486A	8.20 to 12.4	1.5	100	\$600
P486A	12.4 to 18.0	1.5	100	\$800
K486A ²	18.0 to 26.5	2.0	200	\$800
R486A ²	26.5 to 40.0	2.0	200	\$850

¹Option 011: furnished with APC-7 RF connector +\$25
²Circular flange adapters:
 K-band (UG-425/U) HP 11515A \$250
 R-band (UG-381/U) HP 11516A \$250

HP 84811A Peak Power Sensor

The HP 84811A Peak Power Sensor works with the HP 8900C/D Peak Power Meters to measure the peak power of RF pulses. It is supplied with a 4 foot flexible cable to easily reach the pulse source being measured. The HP 84811A also conveniently detaches from the meter for storage, recalibration or replacement.

NETWORK ANALYZERS

Complete Characterization of Linear Networks

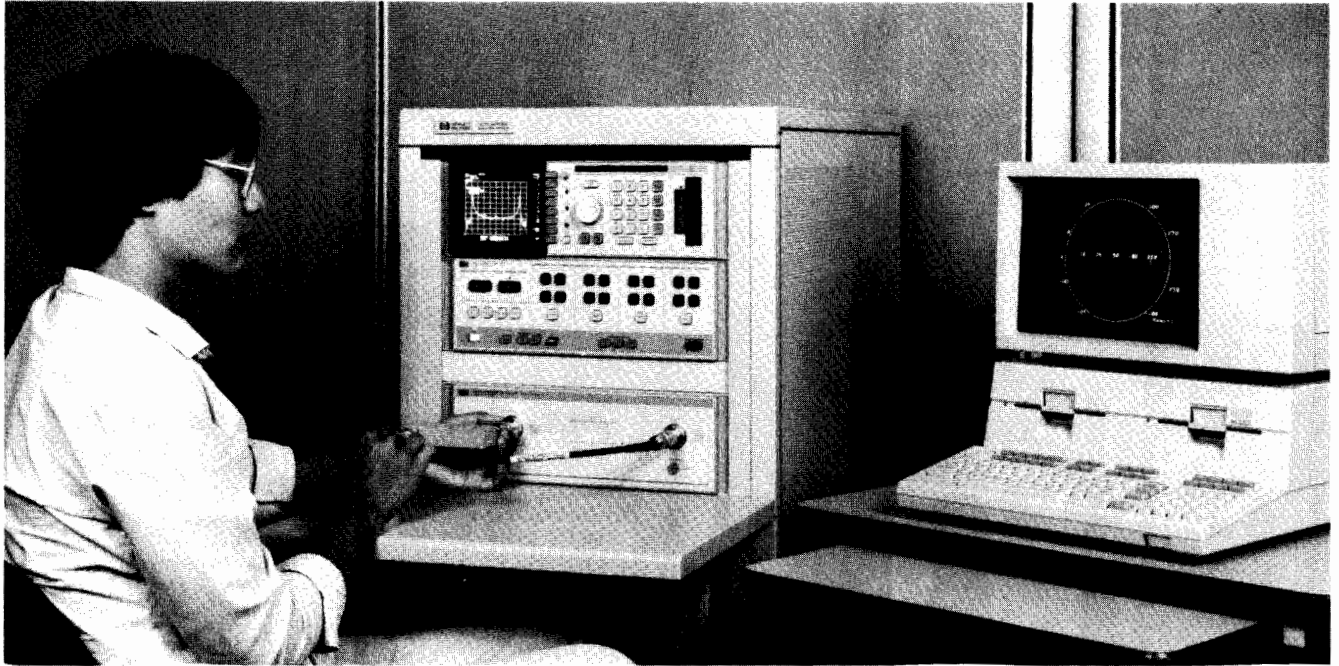

Why Network Analysis?

Characterizing the behavior of linear networks that will be stimulated by arbitrary signals and interfaced with a variety of other networks is a fundamental problem in both synthesis and test processes. For example, the engineer designing a multi-component network must predict with some certainty the final network performances from knowledge of the individual components. Similarly, a production manager must know allowable tolerances on the products manufactured and whether the final products meet the specified tolerances. Network analysis offers a solution to these problems through complete description of linear network behavior in the frequency domain. Additionally, some network analyzers offer the capability to transform measurement data, taken in the frequency domain, to the time domain providing further insight into the behavior of linear networks.

Network analysis accomplishes the description of both active and passive networks by creating a data model of such component parameters as impedances and transfer functions. However, these parameters not only vary as a function of frequency but are also complex variables in that they have both magnitude and phase. Swept network analyzers now measure magnitude and phase (the total complex quantity) as a function of frequency with less difficulty than conventional CW measurements. Impedance and transfer functions can then be conveniently displayed on a swept CRT, as in Figure 1, X-Y recorder, or peripherals such as a printer and/or a plotter.

Thus, network analysis satisfies the engineering need to characterize the behavior of linear networks quickly, accurately, and completely over broad frequency ranges. Hewlett-Packard manufactures a full line of scalar network analyzers (magnitude only) and vector network analyzers (both magnitude and phase).

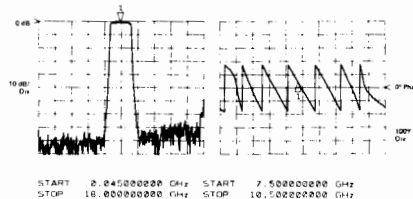

Figure 1. 45 MHz to 18 GHz measurement of magnitude and phase in a single sweep.

What Is Network Analysis?

Network analysis is the process of creating a data model of the transfer and/or impedance characteristics of a linear network through stimulus-response testing over the frequency range of interest. All network analyzers in the HP product line operate according to this definition.

At frequencies above 1 MHz lumped elements actually become "circuits" consisting of the basic elements plus parasitics like stray capacitance, lead inductance, and unknown absorptive losses. Since parasitics depend on the individual device and its construction they are almost impossible to predict. Above 1 GHz component geometries are comparable to a signal wavelength, intensifying the variance in circuit behavior due to device construction.

Network analysis is generally limited to the definition of linear networks. Since linearity constrains networks stimulated by a sine wave to produce a sine wave output, sine wave testing is an ideal method for characterizing magnitude and phase response as a function of frequency. For non-linear measurements, refer to the sections on spectrum analyzers, wave analyzers (signal analyzers) and vector modulation products in this catalog.

Network Analyzers

Hewlett-Packard network analyzers are instruments that measure transfer and/or impedance functions of linear networks through sine wave testing. A network analyzer system accomplishes these measurements by configuring its various components around the device under test. The first requirement of the measurement system is a sine wave signal source to stimulate the device under test. Since transfer and impedance functions are ratios of various voltages and currents, a means of separating the appropriate signals from the measurement ports of the device under test is required. Finally, the network analyzer itself must detect the separated signals, form the desired signal ratios, and display the results.

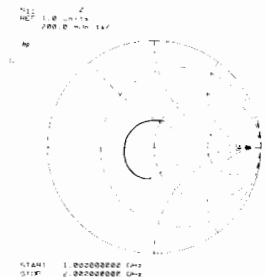

Figure 2. Input impedance of microcircuit amplifier is read directly with Smith Chart overlay for Polar Display.

Signal Sources and Signal Separation

In the general case, any sine wave source meeting the network analyzer's specifications can be used to stimulate the device under test. If the analyzer is capable of swept measure-

ments, great economies in time can be achieved by stimulating the device under test with a sweep oscillator or synthesized sweeper. This allows quick and easy characterization of devices over broad frequency ranges.

At high frequencies the problem of signal separation usually involves traveling waves on transmission lines and becomes correspondingly more difficult. Hewlett-Packard manufactures test sets applicable for separating the appropriate traveling waves in a variety of high frequency measurements.

Broadband and Narrowband Detection

After the desired signals have been obtained from the test set they must be detected by the network analyzer; HP network analyzers can use one of two detection methods. Broadband detection accepts the full frequency spectrum of the input signal while narrowband detection involves tuned receivers that convert CW or swept RF signals to a constant IF signal. There are certain advantages to each detection scheme.

Scalar analyzers usually employ broadband detection techniques. Broadband detection reduces instrument cost by eliminating the IF section required by narrowband analyzers but sacrifices noise and harmonic rejection. However, noise is not a factor in many applications. Finally, broadband systems can make measurements where the input and output signals are not of the same frequency, as in the measurement of the insertion loss of mixers and frequency doublers. Narrowband systems cannot make these measurements.

Vector network analyzers normally employ narrowband detection techniques. Narrowband detection makes a more sensitive low noise detection of the constant IF possible. This allows increased accuracy and dynamic range for frequency selective measurements (as compared to broadband systems).

Signal Processing and Display

Once the RF has been detected, the network analyzer must process the detected signals and display the measured quantities. All HP network analyzers are multi-channel receivers utilizing a reference channel and at least one test channel; absolute signal levels in the channels, relative signal levels (ratios) between the channels, or relative phase difference between channels can be measured depending on the analyzer.

Relative ratio measurements are usually made in dB, which is the log ratio of an unknown signal (Test Channel) with a chosen reference signal (Reference Channel). This allows the full dynamic range of the instrumentation to be used in measuring variations of both high and low level circuit responses. For example, 0 dB implies the two signal levels have a ratio of unity while ±20 dB implies a 10:1 voltage ratio between two signals.

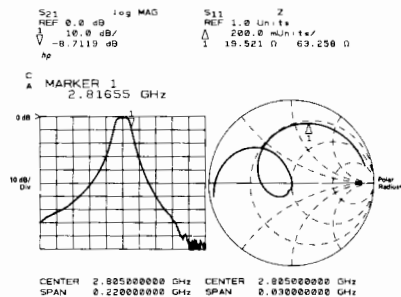

Figure 3. Simultaneous measurement of transmission response and passband reflection coefficient.

All network analyzer phase measurements are relative measurements with the reference channel signal considered to have zero phase. The analyzer then measures the phase difference of the test channel with respect to the reference channel.

Phase information complements amplitude data in the measurement of low frequency parameters. Phase is more sensitive to network behavior and it is a required component of complex impedance and transfer functions.

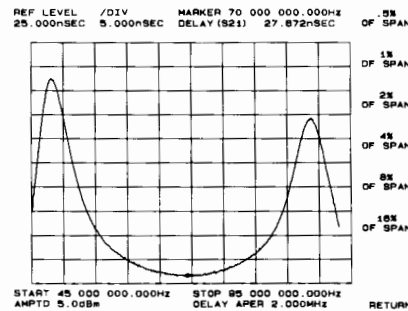

Figure 4. Direct measurement of group delay with digital readout at marker.

Phase data is also required to measure delay distortion or group delay of networks. Delay distortion occurs when different frequency components of a complex waveform experience nonlinear phase shifts as they are transmitted through a network. Group delay is a measure of this distortion and is defined as:

$$T_g = - \frac{d\theta}{d\omega}$$

An alternative method for measuring phase distortion is deviation from linear phase or differential phase. Deviations from linear phase can be measured by introducing enough electrical length in the network analyzer's reference channel to linearize a device's phase shift.

Scattering parameters or S-parameters were developed to characterize linear networks at high frequencies. S-parameters de-

fine the ratios of reflected and transmitted traveling waves measured at the network ports. A two-port device is modeled with S-parameters in Figure 5. S_{11} is the complex re-

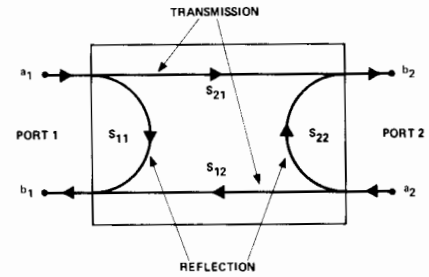

Figure 5. S-parameter model for a two-port linear network.

flexion coefficient at port 1 and is the ratio of b_1/a_1 , if $a_2 = 0$ (port 2 terminated in its characteristic impedance). S_{21} is the complex transmission coefficient from port 1 to port 2, b_2/a_1 , if $a_2 = 0$. The "a" and "b" signals represent the amplitude and phase of the incident and emerging or reflected traveling waves. By reversing the ports and terminating port 1 in its characteristic impedance, S_{22} and S_{12} can be similarly defined.

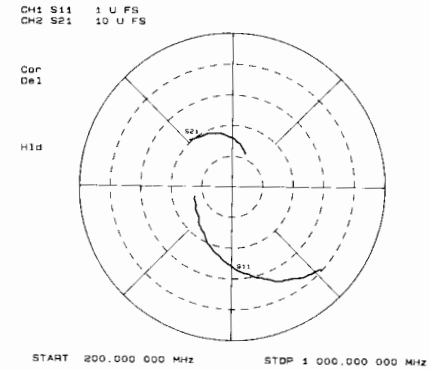

Figure 6. Simultaneous measurement of transistor S-parameters.

Additional Capabilities

Precision design work and manufacturing tolerances demand highly accurate measurements, but most errors in network measurements are complex quantities that vary as a function of frequency. By characterizing and virtually removing these systematic errors, measurement accuracies are improved by several orders of magnitude. Hewlett-Packard now offers network analyzers with built-in, high-speed computational hardware that can perform the complex mathematics required for sophisticated error correction.

Computer controlled network analyzers can be programmed to set up and make many measurements automatically. The measurement process is further accelerated by the computer's ability to store, transform, summarize, and output data in a variety of formats to a number of peripherals. These capabilities make the computer controlled network analyzer ideal for both computer aided design or automatic production testing.

NETWORK ANALYZERS

Complete Characterization of Linear Networks (cont'd)

Network Analyzer Product Line Summary

Network Analyzer			
HP Model	Frequency Range	Source	Measurement Capabilities
3562A Dual Channel Dynamic Signal Analyzer Page 134	64 uHz-100 kHz	Swept and fixed sine, chirp, burst, random noise and burst random noise	Transfer functions, magnitude/phase, 40-pole curve fitter, frequency response synthesis, time domain functions, and spectrum analysis HP-IB programmable
3577A Network Analyzer Page 221	5 Hz to 200 MHz	Integrated Synthesized Source	Transfer functions, magnitude/phase, insertion loss/gain, attenuation, electrical length, gain compression, Group Delay, Deviation from Linear Phase HP-IB Programmable
4195A network/spectrum/impedance analyzer Page 224	10 Hz-500 MHz	Integrated Synthesized source	Transfer functions, magnitude/phase, insertion loss, gain, attenuation, group delay, s-parameters, return loss, SWR, complex impedance, accuracy enhancement, HP-IB programmable
8752A Network Analyzer Page 229	300kHz-1.3/3.0 GHz	Integrated synthesized source, test set and receiver	Transfer functions - magnitude/phase, insertion loss/gain, attenuation, gain compression, s-parameters, electrical length, group delay, deviation from linear phase. Impedance-magnitude/phase, return loss, r + jx accuracy enhancement time domain capability HP-IB programmable
8753B Network Analyzer Page 231	300 kHz-3 GHz/6 GHz	Integrated Synthesized Source	Transfer functions - magnitude/phase insertion loss/gain, attenuation, gain compression, s-parameters, electrical length, group delay, deviation from linear phase. Impedance - magnitude/phase - Return Loss, r+jx Full Accuracy Enhancement Time Domain Capability Harmonic Measurement Capability HP-IB programmable
8719A/8720B Network Analyzers Page 235	130 MHz-13.5 GHz (8719A) 130 MHz-20 GHz (8720B)	Integrated Synthesized Source (1 Hz Resolution Optional)	Transfer functions - magnitude/phase insertion loss/gain, attenuation, s-parameters, electrical length, group delay, deviation from linear phase. Impedance - magnitude/phase - Return Loss, r + jx Full Accuracy Enhancement Time Domain Capability HP-IB programmable
8510 Series Network Analyzer Page 237	45 MHz to 110 GHz	HP 8350 Series Sweep Oscillators HP 8340B, 8341B Synthesized Sweepers HP 8360 Synthesized Sweepers	Transmission/Reflection Characteristics S-parameters Active device characterization Full Accuracy Enhancement Time Domain Capability HP-IB programmable

Vector Voltmeter

HP Model	Frequency Range	Source	Measurement Capabilities
3575A Gain Phase Meter Page 222	1 Hz-13 MHz	None	Gain, Phase and Amplitude
8508A Vector Voltmeter Page 228	.1 MHz-1 GHz .3 MHz-2 GHz	None	Voltage, Impedance Transfer Functions, phase and amplitude HP-IB programmable

Scalar Analyzer

HP Model	Frequency Range	Source	Measurement Capabilities
8757C/E Scalar Network Analyzer page 218	10 MHz-110 GHz	HP 8350 Series Sweep Oscillator, HP 8340B or 8341B HP 8360 series, Synthesized Sweepers	Scalar Transmission/Reflection Measurements 50Ω Coax Measurements 10 MHz-50 GHz 75Ω Coax Measurements 10 MHz-2.4 GHz Waveguide Measurements 26.5 GHz-110 GHz Open/Short Averaging, Normalization, Averaging, Limit Testing Storage Registers, HP-IB Programmable

NETWORK ANALYZERS

Scalar Network Analyzers, 10 MHz to 110 GHz

HP 8757C/E

211

- 76 dB dynamic range
- Accurate swept power measurements
- 40 dB directivity bridges
- 40 GHz in coax, 110 GHz in waveguide

- Buffered plotter/printer output
- External disk and internal register save/recall
- Limit testing built in
- Precision color display

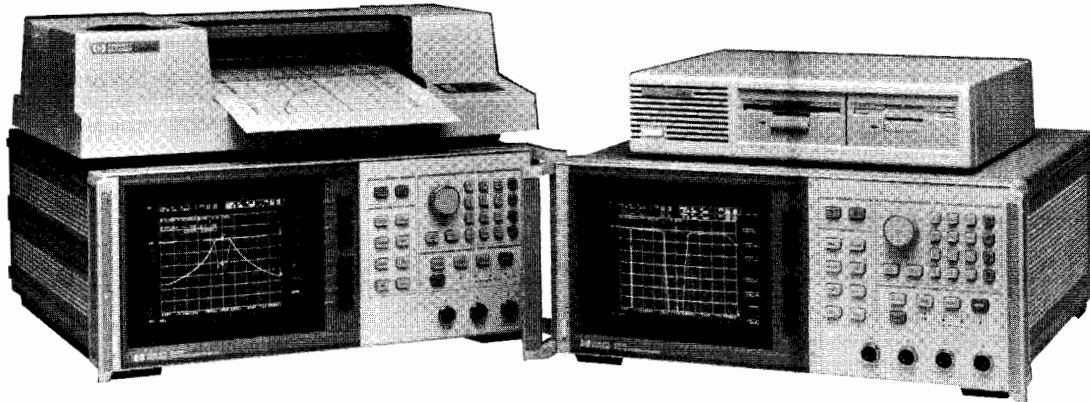

HP 8757E and HP 8757C option 001

Measure insertion loss, gain, return loss, SWR, and power quickly and accurately with either the HP 8757C or HP 8757E Scalar Network Analyzers. With high-performance detectors and directional bridges, and a companion HP source and digital plotter, the HP 8757C and 8757E become the basis of a complete measurement system with superb performance.

A Choice of Two Analyzers

For an economical measurement solution, choose the HP 8757E Scalar Network Analyzer. The HP 8757E features three detector inputs and two independent display channels, allowing simultaneous ratioed or non-ratioed measurement of your device's transmission and reflection characteristics, 76 dB dynamic range (+16 to -60 dBm) for measuring high rejection devices, and a choice between AC (square wave modulated) or DC detection techniques. The internal plotter/printer buffer allows you to send your measurement data directly to a plotter and then proceed to the next measurement, typically in less than 5 seconds. The HP 8757E includes a user-friendly interface, and menu-driven, direct-access softkeys, which simplify its operation.

When your application demands maximum system versatility, choose the HP 8757C Scalar Network Analyzer. It offers all of the performance of the HP 8757E, plus more features, limit testing, external disk save/recall, and a color display. Limit testing reduces test time by letting the analyzer make quick and objective pass/fail decisions. External disk save/recall allows your measurement state to be preconfigured by an engineer or skilled specialist and then automatically recalled by production technicians. The result is reduced setup time and greater test integrity at each production station. The precision color display simplifies the separation of measurement information while providing a pleasant display for the technician.

Systems from 10 MHz to 110 GHz

You can conveniently obtain a 20 GHz or 40 GHz coaxial measurement system by ordering the HP 8757XA (10 MHz to 20 GHz) or HP 8757XB (10 MHz to 40 GHz) scalar measurement system. Or, you can configure your own system to 50 GHz in coax or 110 GHz in waveguide.

The HP 8350B sweep oscillator family offers the benefits of a modular system with choices in source frequency range and output power. When testing narrowband, frequency-selective devices, choose a synthesized sweeper from the HP 8360 series or an HP 8340B or 8341B. The HP 8360 series, 8340B, and 8341B provide excellent frequency stability and up to 1 Hz frequency resolution.

Accessories Ensure Measurement Accuracy

Minimize transmission measurement uncertainty by using detectors with an unrivaled match (HP 85025E: >25 dB return loss to 25 GHz). Maximize your reflection measurement accuracy with high directivity directional bridges (HP 85027A,B,D: >40 dB to 20 GHz, HP 85027D: >25 dB to 47 GHz). The HP 8757C/E are compatible with a broad line of high-performance detectors, directional bridges, and other accessories that help reduce your measurement errors.

Feature	HP 8757C	HP 8757E
Display	Color	Monochrome
Display channels	4	2
Detector inputs	3 standard 4 with option 001	3
Dynamic range	76 dB	76 dB
AC/DC detection mode	Yes	Yes
Measurement points: Selectable values	101, 201, 401, 801, 1601	101, 201, 401
Channels Displayed	3 or 4	2
Max Points per channel	401	801, 1601
Plotter/printer buffer	Yes	Yes
Noise figure display capability	Yes	Yes
External disk save/recall	Yes	No
Internal save/recall registers	9	9
Limit testing (channels 1 and 2)	Yes	No
Adaptive normalization	Yes	No
Cursor search functions	Max, Min, bandwidth, n dB	Max, min
SWR display mode	Yes	Yes
Non-standard sweep mode	Yes	Yes
Auxiliary voltage display mode	Yes	Yes

NETWORK ANALYZERS

System Specifications

Model 8757

System Specifications

ACCURACY

Transmission Loss or Gain Measurement Accuracy: Transmission loss or gain measurements are made relative to a 0 dB reference point established at calibration. The measurement accuracy is equal to the uncertainty due to the change in power level, called dynamic accuracy, plus mismatch uncertainty. The frequency response errors of the source, detectors, bridge and power splitter may be removed via calibration.

Dynamic Power Accuracy (25 ±5°C, 0 dBm reference):

Coax Detectors* (50 MHz)

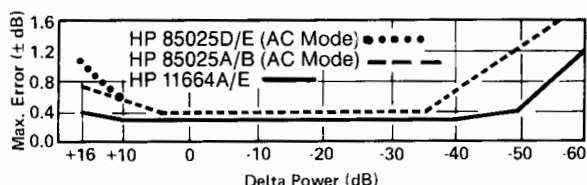

*For ≤20 dB change of power within +10 to -40 dBm, the specification for the HP 8757 with the HP 11664A/E is ±(0.1 dB + 0.01 dB/dB).

Waveguide Detectors

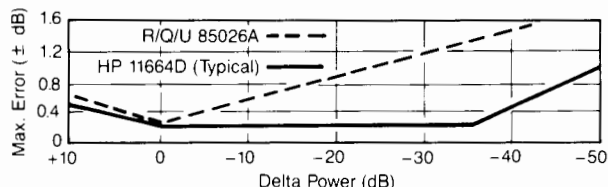

Absolute Power Measurement Accuracy: This specification is useful for determining the accuracy of power measurements in dBm when using the HP 85025A/B/D/E detectors in the DC mode. The total uncertainty is the sum of the detector frequency response, power accuracy, and mismatch uncertainties.

Absolute Power Accuracy (HP 85025A/B/D/E detectors in DC mode, detector offsets removed via power meter cal, 25 ±5°C):

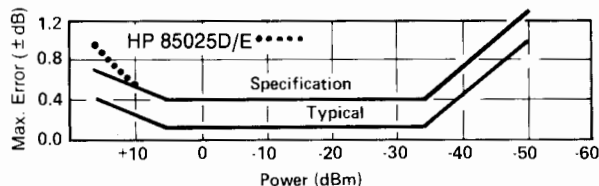

Detector Frequency Response (HP 85025A/B detectors, -10 dBm, 25 ±5°C):

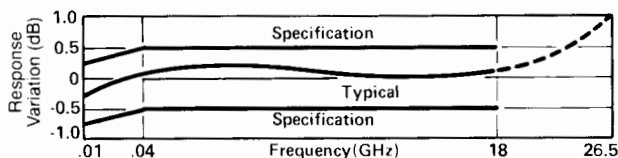

DYNAMIC RANGE (on all HP 8757 detector inputs):

Detector	AC Mode	DC Mode
HP 11664A/E	+16 to -60 dBm	
HP 11664D	+10 to -50 dBm	
HP 85025A/B/D/E	+16 to -55 dBm	+16 to -50 dBm
HP R/Q/U85026A	+10 to -50 dBm	+10 to -45 dBm

Reflection Measurement Accuracy: Uncertainties due to calibration error and the frequency response of the source, detectors and bridge are removed via open/short averaging. The remaining uncertainties are primarily the sum of directivity uncertainty, effective source match uncertainty, and dynamic power accuracy. As shown in the graphs below, directivity is the dominant error term when measuring small reflected signals (high return loss) and source match is dominant when measuring large reflected signals (low return loss).

The Effect of Effective Source Match on Reflection Uncertainty:

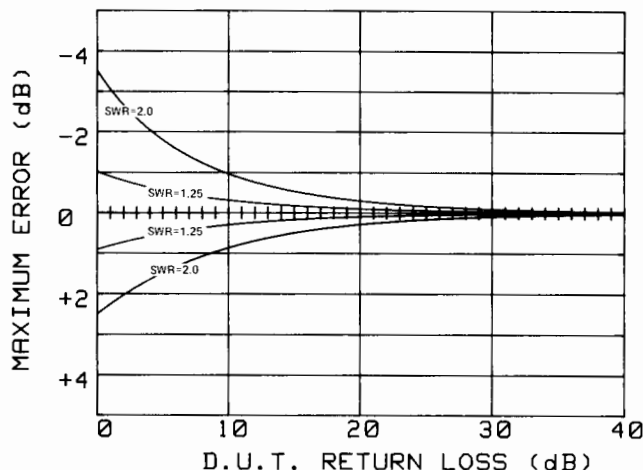

The Effect of Directivity on Reflection Uncertainty:

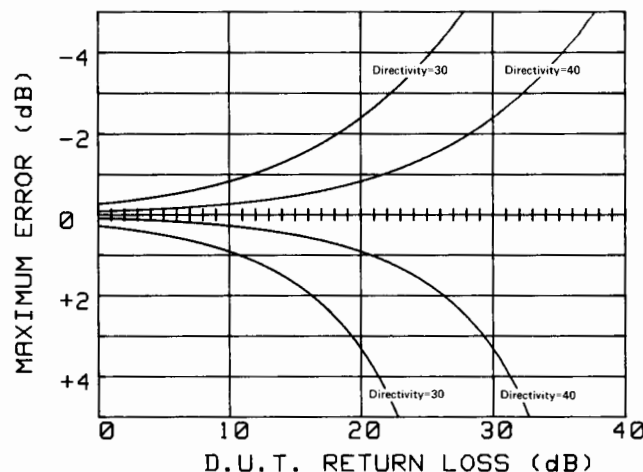

Dynamic Power Accuracy (HP 85027/20 bridges, 50 MHz, 25 ±5°C, +7 dBm input):

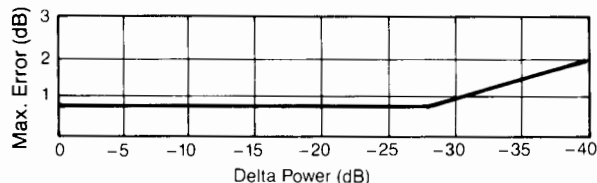

Models 85027A/B/C/D/E, 85020A/B, 85025A/B/C/D/E, 11664A/C/D/E, R/Q/U 85026A

Directional Bridges

The HP 85020 series and HP 85027 series are directional bridges designed especially for the HP 8757, 8756 and 8755 scalar network analyzers. Each bridge features outstanding directivity and test port match in a compact, rugged package.

Within each bridge, one zero-bias Schottky diode detector measures the return loss of the test device. Ratio measurements can be made by adding a power splitter (HP 11667A/B/C) and detector (HP 11664 series or HP 85025 series).

HP 85027A/B/C/D/E Directional Bridges

The HP 85027 series directional bridges are designed to operate with the HP 8757, 8756 and 8755 scalar network analyzers for reflection measurements from 10 MHz to 47 GHz. A switch on the HP 85027 series bridges allows the user to configure them for operation with the HP 8757 or the HP 8756 and 8755 scalar network analyzers.

When used with the HP 8757 scalar network analyzer, the HP 85027 series bridges allow the user to choose the measurement mode that best suits the application. Use the bridge's AC mode (modulated RF) for measurements in the presence of undesired signals such as broadband noise or electromagnetic interference. Or choose the bridge's DC mode (unmodulated RF) to measure the return loss of modulation sensitive devices such as amplifiers with gain control circuits. Use the companion HP 85025 series detectors for AC and DC measurement versatility or the HP 11664 series detectors for AC only measurements.

High (40 dB) directivity and excellent test port match ensure accurate reflection measurements over a broad swept frequency range. The HP 85027B bridge operates from 10 MHz to 26.5 GHz and has an SMA compatible, precision female 3.5mm test port connector. The HP 85027A/C bridges operate from 10 MHz to 18 GHz. The HP 85027A has a rugged 7mm test port connector and the HP 85027C has a precision Type-N connector. The HP 85027E operates from 10 MHz to 26.5 GHz and has an SMA compatible, precision male 3.5mm test port connector. Reflection measurements from 10 MHz to 47 GHz are possible using the HP 85027D directional bridge.

Measuring SMA devices

Hewlett-Packard recommends using the HP 85027A bridge and an 7mm to 3.5mm adapter for measuring SMA devices from 10 MHz to 18 GHz. For SMA measurements to 26.5 GHz, HP recommends using 3.5mm to 3.5mm adapters (included with the HP 85027B/E bridge) to preserve the HP 85027B/E output connector.

HP 85020A/B Directional Bridges

The economical HP 85020A/B directional bridges also offer high (40 dB) directivity and excellent port match at RF (to 4.3 GHz) frequencies. For 50 ohm measurements choose the HP 85020A. The HP 85020B is designed for 75 ohm environments. Both RF bridges have Type-N connectors.

Detectors

Two types of detectors are available for use with HP scalar network analyzers for measurements up to 60 GHz. All detectors provide excellent impedance match, and therefore minimize mismatch uncertainty in scalar measurements.

HP 85025 and 85026 Series Detectors (AC/DC)

The HP 85025 and 85026 series detectors are designed specifically for operation with the HP 8757 Scalar Network Analyzer and are not compatible with either the HP 8756 or the 8755. The HP 85025/26 detectors detect either a modulated (AC) or an unmodulated (DC) microwave signal. In AC mode, the HP 85025/26 series detect the envelope of the 27.8 kHz modulated microwave signal, provided internally by the HP 8350B Sweep Oscillator with RF plug-in and the HP 8360 series synthesized sweepers (AC) or externally with the HP 8340/41 synthesized sweepers. In DC mode, the HP 85025/26 series detectors measure the microwave power directly without modulation. The user can change detection modes from the HP 8757 front panel.

HP 11664 Series Detectors (AC Only)

The HP 11664 series detectors are designed to operate with the HP 8757, 8756 and 8755 scalar analyzers in AC mode only. The HP 11664A/E cover the 10 MHz to 26.5 GHz range, and the HP 11664D covers from 26.5 to 40 GHz.

Detector Adapters

The HP 85025C and the HP 11664C Detector Adapters match the scalar analyzer display to most standard crystal, silicon, and gallium arsenide detectors. This enables the user to operate up to 110 GHz with the HP 8757 and the HP 8756.

The HP 85025C Detector Adapter is designed for use with the HP 8757 only, and can operate in either AC or DC detection modes. A softkey calibration sequence calibrates the HP 8757 display to your particular detector for an accurate display of power level. The analyzer can then account for the voltage versus input power characteristics of the detector in use. This calibration requires two known calibration inputs, one at a high level (linear operating region, above 0 dBm) and one at a low level (square law region, below -20 dBm).

The HP 11664C Detector Adapter is designed for use with the HP 8757, 8756, and 8755 scalar analyzers. The HP 11664C is matched to the particular diode used via two screwdriver adjustments. One adjustment sets the adapter's amplifier gain to the correct power level indication on the scalar network analyzer. The second adjustment matches the input impedance of the adapter to the load impedance of the detector. Together, the voltage versus power characteristics of the detector are calibrated for the scalar analyzer display.

Detector Summary

For use with the HP 8757, 8756, or 8755 in AC detection mode only:

Detector	Freq. Range (GHz)	Connector Type	Return Loss (dB)	Dynamic Range		Weight	
				8757	8756	Net	Shipping
11664A ¹	.01-18	Type-N (m)	.01-.04 GHz: 10 dB .04-4 GHz: 20 dB 4-12 GHz: 18 dB 12-18 GHz: 16 dB	+16 to -60 dBm	+10 to -50 dBm	0.17 kg (0.4 lb)	0.9 kg (2 lb)
11664E	.01-26.5	3.5 mm (m)	.01-.04 GHz: 10 dB .04-6 GHz: 20 dB 6-20 GHz: 16 dB 20-26.5 GHz: 12 dB	+16 to -60 dBm	+10 to -50 dBm	"	"
11664D	26.5-40	WR-28	12 dB	+10 to -50 dBm	+10 to -50 dBm	0.24 kg (0.5 lb)	1.0 kg (2.2 lb)
11664C	³	SMA (m)	³	³	³	0.17 kg (0.4 lb)	0.9 kg (2 lb)

NETWORK ANALYZERS

8757 System Accessories (cont'd)

Models 85027A/B/C/D/E, 85020A/B, 85025A/B/C/D/E, R/Q/U85026A, 11664A/C/D/E

Detector Summary (cont'd)

For use with HP 8757 only in either AC or DC detection modes:

					AC mode		DC mode	
85025A ^{1, 2}	.01-18	Type-N (m)	.01-.04 GHz: 10 dB .04-4 GHz: 20 dB 4-18 GHz: 17 dB		+16 to -55 dBm	+16 to -50 dBm	0.24 kg (0.5 lb)	1.0 kg (2.2 kg)
85025B ²	.01-26.5	3.5mm (m)	.01-18 GHz: Same as 85025A 18-26.5 GHz: 12 dB		+16 to -55 dBm	+16 to -50 dBm	"	"
85025D	.01-50 GHz	2.4mm (m)	10-40 MHz: 10 dB 40-100 MHz: 20 dB .1-14 GHz: 23 dB 14-34 GHz: 20 dB 34-40 GHz: 15 dB 40-50 GHz: 9 dB		+16 to -55 dBm	+16 to -50 dBm	"	"
85025E	.01-26.5 GHz	3.5mm (m)	10-40 MHz: 10 dB 40-100 MHz: 20 dB .1-25 GHz: 25 dB 25-26.5 GHz: 23 dB		+16 to -55 dBm	+16 to -50 dBm	"	"
R85026A ² Q85026A ² U85026A ²	26.5-40 33-50 40-60	WR-28 WR-22 WR-19	12 dB 12 dB 12 dB		+10 to -50 dBm +10 to -50 dBm +10 to -50 dBm	+10 to -45 dBm +10 to -45 dBm +10 to -45 dBm	"	"
85025C K57	55-65 GHz	WR-15			-10 to -50 dBm (typical)	-10 to -45 dBm (typical)	"	"
85025C K71	90-110 GHz	WR-18			-10 to -50 dBm (typical)	-10 to -45 dBm (typical)	"	"
85025C ²	³	SMA (m)	³	³	³	³	"	"

Directional Bridge Summary

For use with the HP 8757, 8756, or 8755 in AC detection mode only:

Bridge	Freq. Range (GHz)	Nominal Impedance	Connector		Directivity (dB)	Test Port Match (SWR)	Weight	
			Input	Test port			Net	Shipping
85020A	.01-4.3 GHz	50 ohms	Type-N (f)	Type-N (f)	.01-3 GHz: 40 dB 3-4.3 GHz: 34 dB	.01-3 GHz: <1.22 3-4.3 GHz: <1.25	0.5 kg (1.2 lb)	2.3 kg (5 lb)
85020B	.01-2.4 GHz	75 ohms	Type-N (f)	Type-N (f)	40 dB	.01-1.3 GHz: <1.25 1.3-2.4 GHz: <1.43	"	"

For use with the HP 8756, or 8755 in AC detection mode or with the HP 8757 in either AC or DC detection modes

85027A	.01-18 GHz	50 ohms	Type-N (f)	7mm	40 dB	.01-8.4 GHz: <1.15 8.4-12.4 GHz: <1.25 12.4-18 GHz: <1.43	0.5 kg (1.2 lb)	2.3 kg (5 lb)
85027B	.01-26.5 GHz	50 ohms	3.5mm (f)	3.5mm (f)	.01-20 GHz: 40 dB 20-26.5 GHz: 36 dB	.01-8.4 GHz: <1.15 8.4-20 GHz: <1.43 20-26.5 GHz: <1.78	"	"
85027C	.01-18 GHz	50 ohms	Type-N (f)	Type-N (f)	.01-12.4 GHz: 36 dB 12.4-18 GHz: 34 dB	.01-8.4 GHz: <1.15 8.4-12.4 GHz: <1.25 12.4-18 GHz: <1.43	"	"
85027D	.01-47 GHz	50 ohms	2.4mm (f)	2.4mm (m)	.01-20 GHz: 36 dB 20-26.5 GHz: 32 dB 26.5-40 GHz: 30 dB 40-47 GHz: 25 dB	.01-16 GHz: <1.15 16-30 GHz: <1.25 30-40 GHz: <1.40 40-47 GHz: <2.20 (typical)	"	"
85027E	.01-26.5 GHz	50 ohms	3.5mm (f)	3.5mm (m)	.01-20 GHz: 40 dB 20-26.5 GHz: 36 dB	.01-8.4 GHz: <1.15 8.4-20 GHz: <1.43 20-26.5 GHz: <1.75	"	"

1. Option 001 changes to 7mm connector.

2. The HP 85025 and 85026 series detectors and the HP 85025C require HP 8757A firmware revision 2.0 or higher.

To upgrade previous revisions order the HP 11614A Firmware Enhancement.

3. Depends on the particular external detector used.

NETWORK ANALYZERS

8757 System Accessories (con't)

Models 11679A/B, 85023A/B/C/D/F, 85022A, 85028A, 11614A

215

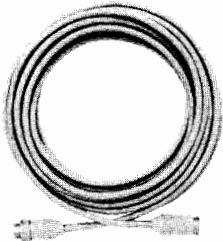

HP 11679A

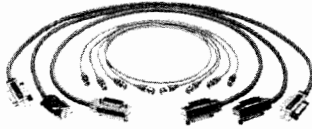

HP 85022A

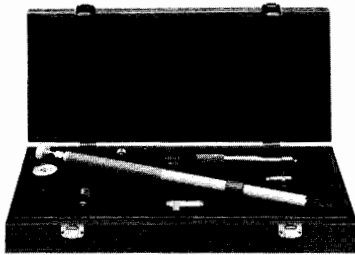

HP 85028A



HP 85023C



HP 11668A

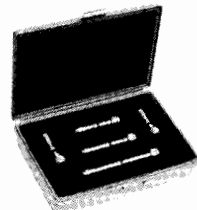

HP 11678A

HP 11679A/B Extension Cables

Function: These cables extend the distance between the scalar network analyzer and the detector or bridge to a maximum of 200 feet without degradation of performance.

HP 11679A: 7.6 m (25 ft) extension cable

HP 11679B: 61 m (200 ft) extension cable

HP 85023A/B/C/D/F Verification Kits

The HP 85023 Series system verification kits each contain a set of precision components used to perform a system verification procedure for the HP 8757 scalar network analyzer system. This procedure, which is in the HP 8757/56 Operating and Service Manuals, checks system installation and can be used as a daily functional test.

Choose a system verification kit to match your device under test. For 7mm applications, select the HP 85023A. If you are measuring SMA or 3.5mm devices, choose the HP 85023B. For 50 ohm, Type-N applications, select the HP 85023C. These kits (HP 85023A/B/C) all include an open, short, 10 dB fixed attenuator, 50 ohm termination, and a source to directional bridge adapter of the corresponding connector type. The HP 85023D verification kit, for 75 ohm Type-N measurements, consists of a short, a 75 ohm termination, a 50 ohm 10 dB fixed attenuator and two HP 11852B 50 to 75 ohm minimum loss pads (for 50/75 ohm impedance conversion).

The HP 85023F verification kit includes 2.4mm standards for verifying performance of the HP 8757 system to 50 GHz. Included are a 2.4mm female open, short and 50 ohm load, a 10 dB attenuator, and female to female adapter.

Frequency range: HP 85023A/C, dc to 18 GHz.

HP 85023D, dc to 1.3 GHz.

HP 85023B, dc to 26.5 GHz.

HP 85023F, dc to 50 GHz.

Connector type: HP 85023A, 7mm.

HP 85023B, 3.5mm.

HP 85023C, Type-N, 50 ohm.

HP 85023D, Type-N, 75 ohm.

HP 85023F, 2.4mm, 50 ohm.

Characteristic impedance: HP 85023A/B/C/F, 50 ohm.

HP 85023D, 75 ohm.

Weight: net, 0.5 kg (1.2 lb); shipping, 1.2 kg (2.9 lb).

HP 85022A System Cable Kit

The HP 85022A contains all the BNC and HP-IB cables to connect an HP 8350B sweep oscillator (or the HP 8360 series, HP 8340B/41B synthesized sweepers), an HP Series 200 or 300 computer, and a printer to the HP 8757 or 8756. This kit contains 3 one-meter HP-IB cables (HP 10833A), 3 two-foot BNC cables (HP 11170B), and 1 four-foot BNC cable (HP 11170C).

BNC connectors: N-Male, N-Male.

BNC impedance: 50 ohm.

Weight: net, 0.5 kg (1.2 lb); shipping, 1.2 kg (2.9 lb).

HP 85028A 7mm Directivity Verification Standards for HP 85021A/85027A

The HP 85028A allows on-site verification of the 40 dB directivity of the HP 85021A and 85027A directional bridges. For frequencies below 2 GHz, a precision 52 dB return loss load is used. For frequencies from 2 to 18 GHz, a sliding mismatch is used to establish a ripple pattern from which the directivity can be calculated. The HP 85028A includes a precision 50 ohm termination, a high-performance sliding mismatch, a 7mm open/short, a 7mm connector gage kit, and a torque wrench.

Weight: net, 2.0 kg (4.5 lb); shipping, 3.5 kg (8.0 lb).

HP 11614A Firmware Enhancement

The HP 11614A firmware enhancement updates the HP 8757A scalar network analyzer to firmware revision 2.1. (HP 8757As with serial number prefix 2802A or higher already have revision 2.1 firmware). Firmware revision 2.1 added several new features to previous versions of the HP 8757A. These include the ability to display and plot reflection traces in units of standing wave ratio (SWR), tabular listings of numerical data on an HP ThinkJet printer, full calibration and operation with the HP 85025C detector adapter and R/Q/U85026A waveguide detectors, and the ability to display and plot an external voltage applied to a rear panel input. All revision 2.1 features are HP-IB programmable.

NETWORK ANALYZERS

8757 System Accessories (cont'd)

Models 11613B, 11636A/B, 11665B, 11668A, 11852B

HP 11668A High Pass Filter

The HP 11668A high pass filter accessory is recommended when making measurements on active devices that have gain below 50 MHz. Use of the HP 11668A, placed after the HP 11665B, reduces the modulator drive feedthrough from 8 mV to 1 mV and prevents possible amplifier saturation. Use of the HP 11668A filter is not necessary for passive measurements since the feedthrough from the HP 11665B is -65 dBm and causes no degradation in system performance.

Frequency range: 50 MHz to 18 GHz.

	Insertion Loss	Return Loss
50-100 MHz	≤ 2.5 dB	≥ 12 dB
100 MHz-8 GHz	≤ 1.0 dB	≥ 16 dB
8-12 GHz	≤ 1.0 dB	≥ 14 dB
12-18 GHz	≤ 1.5 dB	≥ 14 dB

Maximum input: +27 dBm.

Connectors: N-female, N-male.

Weight: net, 0.13 kg (5 oz); shipping, 0.28 kg (10 oz.).

HP 11678A Low Pass Filter Kit

Description: the HP 11678A low pass filter kit contains five filters. Low pass filters reduce harmonics generated by the RF source when making precision measurements.

Frequency Range (low pass filters, cutoff frequency fc)

HP 11688A: 2.8 GHz.

HP 11689A: 4.4 GHz.

HP 11684A: 6.8 GHz.

HP 11685A: 9.5 GHz.

HP 11686A: 13.0 GHz.

Insertion loss: < 1.1 dB at 0.95 fc.

Rejection (at 1.25 fc): greater than 40 dB.

Impedance: 50 ohm normal.

Connectors: N-Female, N-Male.

Weight: net, 0.44 kg (1 lb); shipping, 1.2 kg (2.9 lb).

HP 11613B Calibrator

HP 8757 and 8756 verification/calibration is recommended every 12 months. This can be accomplished at an HP service center or on-site using the HP 11613B calibrator and an HP 9000 series 200 or series 300 computer.

The HP 11613B is a dedicated transfer standard for calibration of the HP 8757 and 8756. The HP 11613B provides the standard a 27.778 kHz source and a series of precision attenuators. The calibrator includes software (both 3.5 and 5.25 inch formats) that operates on an HP 9000 series 200 or series 300 computer, the BASIC operating system (BASIC 2.0, and above) and a GP-IO cable for use when calibrating the HP 8756. The software verifies (and adjusts if necessary) the internal calibration parameters stored in the non-volatile memory of the HP 8757 and 8756. All HP 8757 and 8756 detector inputs can be calibrated in a matter of minutes. Re-calibration of the HP 11613B is recommended every two years.

Memory Requirement: 1/2M byte, including BASIC.

Hardware Requirement: HP 98622A 16-bit GP-IO interface card for use with HP 8756.

Dimensions: 40 H x 185 W x 203 mm D (1.5 x 7.3 x 8.0 in).

Cable length: 1.22 m (48 in).

Weight: Net 0.91 kg (2 lbs). Shipping 1.4 kg (3 lbs).

HP 11665B

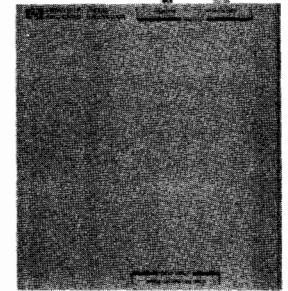
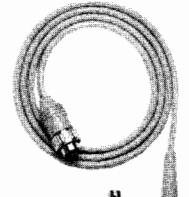

HP 11613B

HP 11636A/B Power Dividers

The HP 11636A/B power dividers/combiners are recommended when making wideband comparison measurements without ratioing, and in fault location measurements with the HP 8757/85016. Detailed specifications are on page 331.

Other Signal Separation Devices

Many other signal separation devices are available from HP for use with the HP 8757, 8756 and 8755. Coaxial couplers from 0.1 to 18 GHz are available with the HP 770 series, the 790 series, and the HP 11692. Higher directivity HP 752 series waveguide couplers can also be used with the HP 8757, 8756 or 8755 with the addition of appropriate HP 281 series waveguide-to-coax adapters.

11665B Modulator

Function: absorptive on-off modulator designed for and powered by the HP 8757, 8756 or 8755 scalar network analyzers.

Frequency Range	Return Loss On and Off	Insertion Loss On Off
15-40 MHz	≥ 10 dB	≤ 7.0 dB ≥ 35 dB
40 MHz-4 GHz	≥ 15 dB	≤ 3.2 dB ≥ 35 dB
4-8 GHz	≥ 12 dB	≤ 3.8 dB ≥ 40 dB
8-12.4 GHz	≥ 8 dB	≤ 4.3 dB ≥ 45 dB
12.4-18 GHz	≥ 8 dB	≤ 5.0 dB ≥ 45 dB

Modulator drive feedthrough: ≤ 8 mV (peak) at 27.8 kHz at either port when powered by the HP 8757, 8756 or 8755. Reduced to ≤ 1 mV (peak) using the HP 11668A. (See HP 11668A High Pass Filter).

Drive current: nominally +50 mA in On condition, -50 mA Off condition.

Weight: net, 0.17 kg (6 oz); shipping, 0.9 kg (2 lb).

HP 11852B 50 ohm/75 ohm Minimum Loss Pad

The HP 11852B is a low SWR minimum loss pad required between 75 ohm devices and 50 ohm sources and detectors. For more information, see page 233.

NETWORK ANALYZERS

8757 System Accessories (con't)

Models 415E, 11667A/B/C

217

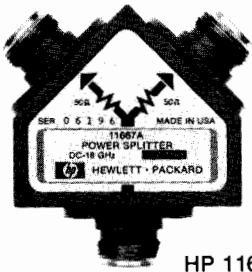

HP 11667A

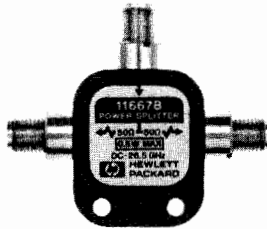

HP 11667B

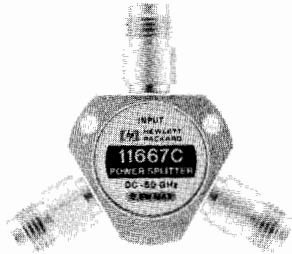

HP 11667C

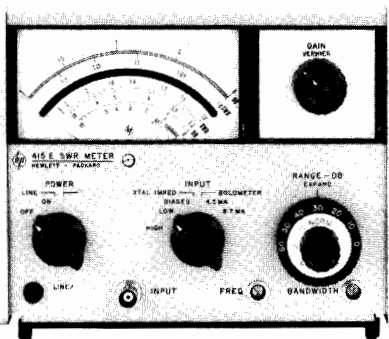

HP 415E

HP 415E SWR Meter

HP 415E SWR Meter is a low noise, 1000 Hz tuned amplifier and voltmeter, calibrated in dB and SWR. Designed for use with square law detectors, it measures SWR, attenuation, and gain directly from metered scales, or drives an X-Y recorder for RF substitution measurements. Front panel INPUT switch selects unbiased low (50-200 Ω) or high (2500-10,000 Ω) impedance crystal, biased crystal (1 V into 1 kΩ), or low or high current bolometer (4.5 or 8.7 mA ± 3% into 200 Ω).

An internal precision 60 dB attenuator allows the HP 415E to operate over a 70 dB range in 10 or 2 dB steps, with ±0.05 dB accuracy for a 10 dB step; maximum cumulative error between any two 10 dB steps is ±0.1 dB. Sensitivity is 0.15 μV rms for full scale deflection at maximum bandwidth (1 μV rms on high impedance crystal input).

Continuously adjustable bandwidth can be adjusted from 15 Hz for maximum sensitivity at CW frequencies to 130 Hz for swept frequency uses. An optional rechargeable battery pack provides up to 36 hours of continuous operation for portable use.

Weight: Net 4 kg (9 lb); shipping 5.8 kg (13 lb).

Power: 115-230 V ±10%, 50-400 Hz, 1 VA.

Dimensions: 155Hx190Wx279mm D(6⁷/₃₂x7²/₃₂x11 in.)

HP 11667A/B/C Power Splitters

The HP 11667A/B/C power splitters are recommended when making wideband ratio measurements using the HP 8757, 8756, or 8755 scalar network analyzer. These two-resistor type splitters provide excellent output SWR at the auxiliary arm when used for source leveling or ratio measurement applications. The tracking between output arms over a frequency range from dc to 50 GHz allows wideband measurements to be made with a minimum of uncertainty.

Frequency Range:

HP 11667A: DC to 18 GHz.

HP 11667B: DC to 26.5 GHz.

HP 11667C: DC to 50 GHz.

Impedance: 50 ohms nominal.

Insertion Loss:

HP 11667A/B: 6 dB nominal.

HP 11667A	DC to 4 GHz	DC to 8 GHz	DC to 18 GHz
Input SWR:	≤1.15	≤1.25	≤1.45
Equivalent Output SWR: (leveling or ratio measurements)	≤1.10	≤1.20	≤1.33
Output Tracking (dB): (between output arms)	≤0.15	≤0.20	≤0.25
Typical Phase Tracking (deg): (between output arms)	0.5	1.5	3.0

HP 11667B/C	DC to 18 GHz	DC to 26.5 GHz	DC to 40 GHz	DC to 50 GHz
Input SWR: HP 11667B HP 11667C	≤1.22 ≤1.22	≤1.29 ≤1.38	≤1.50	≤1.65
Equivalent Output SWR: (leveling or ratio measurements) HP 11667B HP 11667C	≤1.22 ≤1.29	≤1.22 ≤1.29	≤1.50	≤1.65
Output Tracking (dB): (between output arms) HP 11667B HP 11667C	≤0.25 ≤0.30	≤0.40 ≤0.35	≤0.40	≤0.40
Typical Phase Tracking (deg): (between output arms) HP 11667B HP 11667C	1.5 2.0	2.5 2.5	3.0	3.0
Typical Insertion Loss(dB): HP 11667C	6.0	7.0	8.0	8.5

Maximum Input Power: +27 dBm

Connectors:

HP 11667A: N-female on all ports.

HP 11667B: APC-3.5 female on all ports.

HP 11667C: 2.4 mm female on all ports.

Dimensions:

HP 11667A: 46 H x 52 W x 19 mm D (1.8 x 2.0 x 0.7 in.).

HP 11667B: 40 H x 47 W x 10 mm D (1.6 x 1.9 x 0.4 in.).

HP 11667C: 36 H x 36 W x 10 mm D (1.4 x 1.4 x 0.4 in.).

Weight:

HP 11667A: net, 0.14 kg (0.31 lb); shipping 0.22 kg (0.5 lb).

HP 11667B: net, 0.06 kg (0.13 lb); shipping 0.14 kg (0.3 lb).

HP 11667C: net, 0.06 kg (0.13 lb); shipping 0.14 kg (0.3 lb).

NETWORK ANALYZERS

Ordering Information

Model 8757

Ordering Information

The HP 8757 Scalar Network Analyzer is ordered with multiple line items to give you maximum flexibility in specifying a system that meets your needs. This ordering guide lists the HP 8757 line items required for software compatibility. It is not necessary to order any line item you already own. Consult your local HP Sales Office if you would like assistance.

	Price		
Complete Measurement Systems			
HP 8757XA 20 GHz Coaxial Scalar System	\$38,740		
Includes:			
HP 8757C Scalar Network Analyzer			
HP 8350B Sweep Oscillator			
HP 83592C RF Plug-in (0.01 - 20 GHz)			
HP 85027E Directional Bridge (3.5 mm)			
HP 85025E Detector (3.5 mm)			
HP 85022A Cable Kit			
HP 8757XB 40 GHz Coaxial Scalar System	\$53,205		
Includes:			
HP 8757C Scalar Network Analyzer			
HP 8350B Sweep Oscillator			
HP 83597A RF Plug-in (0.01 - 40 GHz)			
HP 85027D Directional Bridge (2.4 mm)			
HP 85025D Detector (2.4 mm)			
HP 85022A Cable Kit			
Analyzer			
HP 8757C Scalar Network Analyzer	\$9,000		
Opt. 001 Fourth detector input	\$1,500		
Opt. 802 HP 9122C Disk Drive and an HP 10833A HP-IB cable	\$1,495		
Opt. W03* 90 day on-site warranty conversion	N/C		
Opt. W30 2 year extended service	\$225		
HP 8757E Scalar Network Analyzer	\$7,500		
Opt. W03* 90 day on-site warranty conversion	N/C		
Opt. W30 2 year extended service	\$190		
Sweep Oscillators (choose either HP 8350B with an RF Plug-in, 8360 Series, 8340B, or 8341B)			
Directional Bridges (choose at least one)			
HP 85027A 0.01-18 GHz, 7mm, 50 ohm	\$2,550		
HP 85027B 0.01-26.5 GHz, 3.5mm female, 50 ohm	\$3,050		
HP 85027C 0.01-18 GHz, Type-N female, 50 ohm	\$2,550		
HP 85027D 0.01-47 GHz, 2.4mm male, 50 ohm	\$3,500		
HP 85027E 0.01-26.5 GHz, 3.5mm male, 50 ohm	\$2,950		
HP 85020A 0.01-4.3 GHz, Type-N female, 50 ohm	\$1,150		
HP 85020B 0.01-2.4 GHz, Type-N female, 75 ohm	\$1,300		
Detectors (choose at least one)			
HP11664A 0.01-18 GHz, Type-N male	\$525		
Opt. 001 7mm connector	add \$50		
HP 11664E 0.01-26.5 GHz, 3.5mm male	\$700		
HP 11664D 26.5-40 GHz, WR-28 waveguide	\$1,200		
HP 11664C Detector Adapter	\$300		
HP 85025A 0.01-18 GHz, Type-N male	\$900		
Opt. 001 7mm connector	add \$50		
HP 85025B 0.01-26.5 GHz, 3.5mm male	\$950		
HP 85025D 0.01-50 GHz, 2.4mm male	\$1,500		
HP 85025E 0.01-26.5 GHz, 3.5mm male	\$1,200		
HP R85026A 26.5-40 GHz, WR-28 waveguide			
	\$1,500		
HP Q85026A 33-50 GHz, WR-22 waveguide			
	\$1,700		
HP U85026A 40-60 GHz, WR-19 waveguide			
	\$1,700		
HP 85025C Detector Adapter			
	\$600		
System Verification Kits (choose at least one)			
HP 85028A 7mm directivity verification standards	\$5,000		
HP 85023A 7mm, 50 ohm	\$625		
HP 85023B 3.5mm, 50 ohm	\$850		
HP 85023C Type-N, 50 ohm	\$550		
HP 85023D Type-N, 75 ohm	\$900		
HP 85023F 2.4mm, 50 ohm	\$2,100		
Filter Kits			
HP 11668 High Pass Filter Kit	\$600		
HP 11678 Low Pass Filter Kit	\$1,875		
System Cable Kit			
HP 85022A System Cable Kit	\$355		
Computer			
HP 98580C Option 102 Series 300, Model 332	\$6,780		
Disc Drive			
HP 9122 3.5 inch Dual Flexible Disc Drive	\$1,465		
Software (choose one option)			
HP 85015B System Software for HP 8757	\$2,000		
Opt. 630 for Computer with HP 9121/22 Disc Drive	N/C		
Opt. 655 for either HP 9826 or 9836 Computer	N/C		
HP 85016B Transmission Line Test Software for HP 8757	\$4,500		
Opt. 630: for Computer with HP 9121/22 Disc Drive	N/C		
Opt. 655: for either HP 9826 or 9836 Computer	N/C		
Recommended Accessories			
Printer (choose at least one)			
HP 2225A ThinkJet Printer	\$495		
HP 2227B QuietJet Printer	\$799		
HP 3630A Option 002 PaintJet Color Graphics Printer	\$1,395		
Plotter (choose at least one)			
HP 7440A Opt. 002 Eight-pen Graphics Plotter (8.5" x 11")	\$1,295		
HP 7550 Eight-pen Vector Plotter (11" x 17")	\$3,995		
Optional Accessories (for ratio and/or modulation measurements)			
HP 11636A Power Divider DC to 18 GHz	\$500		
HP 11636B Power Divider DC to 26.5 GHz	\$995		
HP 11665B Modulator	\$900		
HP 11667A Power Splitter DC to 18 GHz	\$930		
Opt. 001 N-male on input port; N-female on output ports:	N/C		
Opt. 002 N-female on input port; 7mm on output ports:	add \$75		
HP 11667B Power Splitter DC to 26.5 GHz	\$995		
HP 11667C Power Splitter DC to 50 GHz	\$1,500		
HP 11852B 50 to 75 ohm Minimum Loss Pad	\$350		
Service and Support Products			
HP 11613B Calibrator	\$995		
HP 415E SWR Meter	\$2300		
Opt. 001: rechargeable battery installed	add \$105		
Opt. 002: rear panel output connector	add \$25		

* Only where available

NETWORK ANALYZERS

Scalar Network Analyzer Software for the HP 8757/8756

Models 85015B, 85016B, 86399-10001

219

- Custom tests without programming
- Friendly menu operation
- Measure insertion and return loss

- Plot or store data
- Test coax and waveguide
- Locate faults in transmission lines

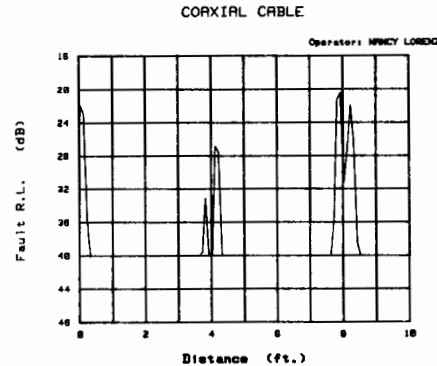

HP 85015B System Software

Using the HP 85015B system software for the HP 8757/8756, you can create and run complete scalar measurements without programming. The software guides you all the way from setup to output. Just make your selections using the computer's knob and softkeys. The software makes all the necessary settings on the scalar analyzer and source to provide fast, accurate measurements that can be stored for later reference.

Easy To Learn

Use the BASIC mode to get up to speed quickly on the software's operation. It prompts you with a few simple questions, then sets up your source and analyzer automatically. The software prompts you to make all the connections necessary for calibration and measurement sequences, then automatically plots the data on the CRT display. For a permanent record, send the plot to a graphics plotter with a single keystroke.

Use The Analyzer CRT

With the HP 8757, use the scalar analyzer as the control center for your measurements. The analyzer knob and softkeys control the software menus which appear on the CRT of the HP 8757, instead of the computer's.

Customized Measurement Setups

Use the GENERAL and ADVANCED modes to access more of the software's powerful features. Define up to 4 measurements in one sequence. Specify particular power levels for your test device and enter your specification limits as point, line, or sloped limits. These limit lines allow simple pass/fail testing, or real time adjustment to within the spec limits.

Then output the data using your own customized format with labels, limit lines and "out-of spec" indicators. Make up to 4 plots on a single page. Store the data on computer disc for archival purposes, then recall it later for further analysis.

The software makes it easy to save your configuration, complete with all the parameters you've specified and the calibration data. When you want to run this test later, just recall the configuration and connect the device. The software recalls cal data, plot formats, labels, limit lines . . . everything you need to run complete automated tests.

Test Transmission Lines

The HP 85016B transmission line test software provides all the capability of the HP 85015B plus fault location for complete testing of coax and waveguide transmission lines. Test frequency response (insertion and return loss), then find faults (mismatches) that affect the signals in your frequency range. Troubleshoot your ECM, radar or communication system quickly and without guesswork.

Fault location is accomplished using frequency domain reflectometry, a technique that uses frequency domain reflection data and the inverse Fast Fourier Transform to characterize reflection as a function of distance. This enables you to locate impedance mismatches resulting from bad connections or faulty cables.

MISMATCH SUMMARY

Cable or Waveguide Type: Coax
 Relative Velocity: .695
 Loss/100 ft: 50
 Length (Range): 10 ft
 Center Frequency: 5 GHz
 Distance Resolution: .1 ft
 Current Window is: Normal

Measurement 1:

Operator: NANCY LORENZ

Distance (ft)	FLT. R.L. A (dB)	COAXIAL CABLE % OF TOTAL MISMATCH
.020	21.91	36.347
4.120	26.84	20.607
7.920	20.44	43.046

Ordering Information

Each software package comes with 5 discs, including a data disc. Order the option that corresponds to your computer configuration. The HP 85015B/16B can run on BASIC 3.0 or greater and requires 1 1/2 Mbytes of RAM memory.

HP 85015B system software

Opt. 630: 3.5 inch discs

Opt. 655: 5.25 inch discs

HP 85016B transmission line test software

Opt. 630: 3.5 inch discs

Opt. 655: 5.25 inch discs

Price

\$2000

N/C

N/C

\$4500

N/C

N/C

Amplifier Test Software

Tailored for Amplifier Testing

The Amplifier Test Software (HP Part No. 86399-10001) allows rapid and systematic characterization of amplifier gain compression. Specifically, the software automates measurements of amplifier output power at the 1-dB compression point at frequencies of interest. The software runs with the HP 8757A/HP 8757A/C and 8756A, and the HP 8350B sweep oscillator or HP 8340B/41B synthesized sweepers. Besides compression testing, the software also allows measurements of gain and return loss/SWR.

Easy to Operate and Modify

The Amplifier Test Software's menu-driven, friendly user interface is designed so that measurements can be configured and run soon after the system is set up. Its limited feature set allows for a short program, which can be easily modified by the user to suit his needs. The documentation provided with the software includes a complete program listing, flow diagram, and variable dictionary.

Ordering Information

Each software package comes with the software on both 3-1/2" and 5-1/4" formats, and Product Note 8757-6, which documents operation of the software. The Amplifier Test Software can run on BASIC 3.0 or higher on HP 9000 series 200 or 300 computers with at least 1 Mbyte of RAM memory.

HP 86399-10001 Amplifier Test Software

\$250

Automate your measurements with a PC

Access popular DOS programs and control your measurement system with a personal computer. Run the HP 85015B, 85016B or your own HP BASIC measurement program on the HP Vectra personal computer by adding an HP 82300B HP BASIC Language Processor.

NETWORK ANALYZERS

Transmission Line Test System

Model HP 8328A

- High resolution - 0.25%
- Fast computation
- Three user levels

- Automatic data correction
- Completely self-contained
- Pass/fail and limit testing

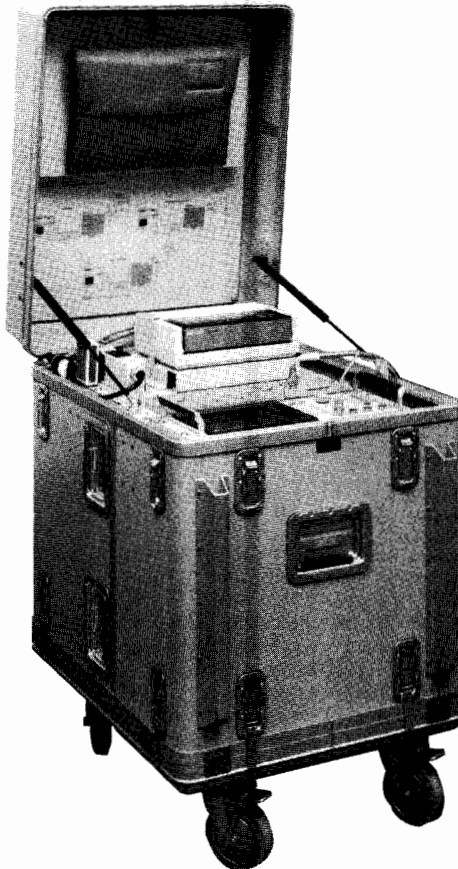

HP 8328A

The HP 8328A Transmission Line Test System tests the performance of waveguide runs and coaxial cables with swept frequency measurements of insertion loss and return loss. Additionally, the HP 8328A system can make fault location tests to find impedance mismatches as a function of distance, quickly and without guesswork.

The HP 8328A is a dedicated transmission line test system for tests from 10 MHz to 18 GHz. It is configured in a rugged, transportable container. The system is self-contained for ease of use and is ideal for accessing transmission lines in difficult-to-reach installations such as aircraft. Although all testing can be done automatically, full manual capability is retained.

The HP 8328A contains the HP 8757C Scalar Network Analyzer, the HP 8350B Sweep Oscillator with the HP 83592A RF Plug-In for coverage from 10 MHz to 18 GHz, the powerful HP 9000 Model 310 computer, the HP 85016B Transmission Line Test Software, and scalar analyzer accessories. The software is accessed from the front panel softkeys and knob of the HP 8757C. Complete measurements including pass/fail and limit testing can be configured and run easily like the HP 85016B software.

It is recommended that the HP 8328A Option 100, an HP 35731A monitor, an HP 46021A keyboard, and an HP 9122C dual disc drive be included for system diagnostics and disc backup for long-term data storage and retrieval.

Swept Distance Capability

Measurements vs. distance: Return loss (dB), SWR, or reflection coefficient.

Resolution (distance between data points as a percentage of the transmission line length):

1% (101 pts), 0.5% (201 pts), 0.25% (401 pts).

Data correction: Data is normalized to the response with a 50 ohm load at the test port. Data is also completely corrected for line losses and preceding mismatches. If waveguide is tested, the effects of phase dispersion are automatically removed from the response. The correction data for the coaxial cable or waveguide run is contained in a lookup table with over 100 entries stored in the program. This table can be modified to improve entries or updated with new cables.

Range and resolution (vs. frequency): The standard RF plug-in for the system is an HP 83592A, with a span from 10 MHz to 18 GHz. This span allows a minimum test range of 2 ft. and a resolution of 0.01 ft. (for 201 distance points and 0.5% resolution). Maximum test range is 500 ft. with a resolution of 2.5 ft.

Swept Frequency Capability

Measurements vs. frequency: Insertion loss, gain, return loss, VSWR, reflection coefficient, and power in dBm, dBW, or mW.

Frequency range: 10 MHz to 18 GHz with HP 83592A plug-in; Option 001, 10 MHz to 8.4 GHz with HP 83525B plug-in

Resolution: User selectable up to 1024 pts. for swept measurements, or stepped CW measurements.

Dynamic range (HP 11664A detectors and HP 8757C): 76 dB (+16 to -60 dBm)

General

User modes: BASIC, GENERAL, and ADVANCED. These user levels vary the level of sophistication to match the experience level of the user and the requirements of the measurement.

Measurement and data storage:

Configurations per data volume (typical): 99

Measurements per configuration: 4

Measurement data sets per data volume: 99

Additional storage can be obtained with the HP 8328A option 100 and the recommended optional equipment.

Ordering Information

	Price
HP 8328A Transmission Line Test System	\$64,000
Opt 001: 10 MHz to 8.4 GHz only	less \$7,000
Opt 100: Adds support software	add \$250
Opt W30: Two years extended Service	add \$1500
Opt 043: Add floppy disk drive	add \$500

NETWORK ANALYZERS

Audio/Video/Baseband/IF Network Analyzer, 5 Hz to 200 MHz

HP 3577A

221

- High-speed/high-accuracy measurements
- .001 dB, .005 degree, 1 ps, .001 Hz resolution

- Built-in three-term error correction plus normalization

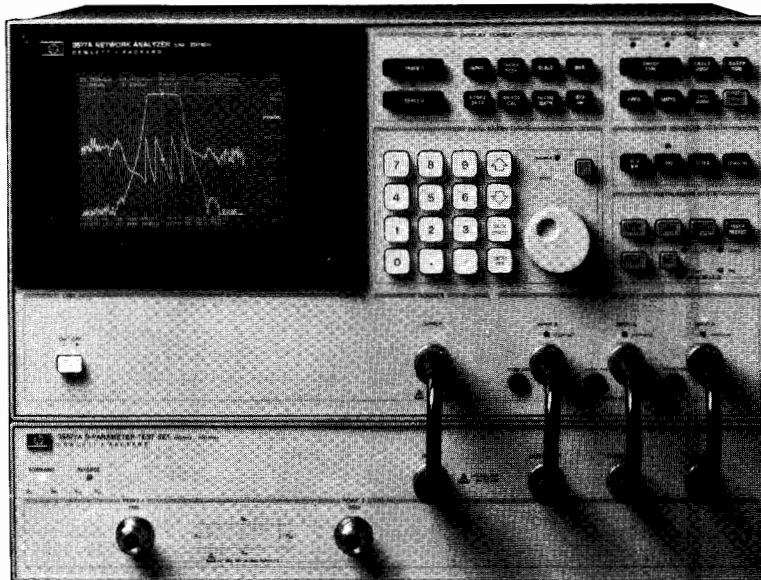

HP 3577A with HP 35677A

HP 3577A Network Analyzer

The HP 3577A Network Analyzer is a high-performance network analyzer for measuring magnitude/phase, insertion loss, electrical length, gain compression, and group delay from 5 Hz to 200 MHz. Math functions facilitate direct calculation and display of user-defined parameters, if desired. When used with the HP 35677A/B S-Parameter Test Set or the HP 35676A/B Reflection/Transmission Kit, the 3577A can also measure return loss, reflection coefficients, and impedance in 50 ohm or 75 ohm systems.

The 3577A is fully programmable with the Hewlett-Packard Interface Bus (HP-IB). With the addition of an HP 9000 Series 200 or 300 computer and HP 35675A Accuracy Enhancement Software, the instrument becomes an HP 3577S Network Analyzer System. The HP 3577S contains the core utilities and components you need to build your custom network analyzer system.

Unprecedented Measurement Precision

This network analyzer has the accuracy and resolution required to characterize the most demanding narrowband device, and the flexibility to quickly characterize wideband devices. Dynamic magnitude and phase accuracy is 0.02 dB and 0.2 deg, respectively. Device response can be examined in fine detail with 0.001 dB, 0.005 deg, and 1 ps resolution. A built-in synthesized LO and tracking generator provide superb frequency accuracy with 0.001 Hz resolution. The 100 dB dynamic range and -130 dBm noise floor meet the needs of the most demanding measurements.

Built-in three-term error correction removes errors due to directivity, frequency response, and source mismatch for one-port measurements. Similarly, vector normalization enhances the accuracy of two-port measurements.

Specifications

Source

Frequency

Range: 5 Hz to 200 MHz

Resolution: 0.001 Hz

Stability: $\pm 5 \times 10^{-8}$ g/day, 0 to 55°C.

Amplitude:

Range: +15 dBm to -49 dBm (1.26 V_{rms} to 793 μ V_{rms}: 2 dBV to -62 dBV) into a 50 Ω load

Resolution: 0.1 dB

Accuracy: ± 1 dB at +15 dBm and 100 kHz. Below +15 dBm, add the greater of ± 0.02 dB/dB or 0.2 dB.

Flatness: 1.5 dBp-p from 5 Hz to 200 MHz

Impedance: 50 Ω ; >20 dB return loss at all levels

RF output connector: 50 Ω Type N female

Sweep types: linear, alternate, cw and log frequency; log amplitude.

Sweep time: 100 ms/span to 6553 sec/span for frequency sweep; 1 ms/step to 16 s/step for amplitude sweep

Sweep modes: continuous, single, manual

Trigger modes: free run, immediate, line, external

Input characteristics

Frequency range: 5 Hz to 200 MHz

Inputs: three receiver inputs (A, B, and R)

Input impedance: selectable 50 Ω with > 25 dB return loss, or 1 M Ω in parallel with approximately 30 pF

Input connectors: 50 Ω type N female

Full scale input level: -13 dBV from 10 kHz to 200 MHz with internal 20 dB attenuators ON (0 dBm at 50 Ω).

Resolution bandwidth: selectable 1 kHz, 100 Hz, 10 Hz, or 1 Hz

Sensitivity (due to noise and internal crosstalk between source and receiver inputs):

Resolution Bandwidth	30 kHz - 200 MHz (50 Ω)	
	Internal 20 dB Attenuator ON	Internal 20 dB Attenuator OFF
10 Hz	-110 dBm	-130 dBm
100 Hz	-105 dBm	-125 dBm
1 kHz	-95 dBm	-115 dBm

Crosstalk: > 100 dB isolation between inputs

Magnitude characteristics

Range: full scale input to sensitivity

Display units: dB, dBm, dBV, V, and linear ratio

Accuracy (at 100-kHz, 25°C, and full scale input)

Absolute (A, B, R): ± 0.2 dB

Ratio (A/R, B/R, A/B): ± 0.15 dB (50 Ω); ± 0.2 dB (1 Ω).

Dynamic accuracy:

Error Resolution Bandwidth	Input Level Relative to Full Scale Input	
	1 kHz, 100 Hz, 10 Hz	1 Hz
± 0.04 dB	± 0.04 dB	0 dB to -10 dB
± 0.02 dB	± 0.02 dB	-10 dB to -50 dB
± 0.05 dB	± 0.05 dB	-50 dB to -60 dB
± 0.15 dB	± 0.25 dB	-60 dB to -80 dB
± 0.75 dB	± 0.75 dB	-80 dB to -90 dB
± 0.75 dB	± 3.00 dB	-90 dB to -100 dB

Frequency response (when driven from a 50 Ω source and with 50 Ω receiver input impedance)

Absolute (A,B,R): 0.3 dBpp from 20 Hz to 20 MHz; 0.6 dBpp from 5 Hz to 200 MHz.

Ratio (A/R, B/R, A/B): 0.3 dBpp from 20 Hz to 20 MHz; 0.4 dB from 5 Hz to 200 MHz.

NETWORK ANALYZERS

Audio/Video/Baseband/IF Network Analyzer, 5Hz to 200 MHz

HP 3577A

Stability

Temperature: typically $< \pm 0.02$ dB/°C.

Time: typically ± 0.05 dB/hour at 25°C.

Phase characteristics (A/R, B/R, A/B)

Range: ± 180 deg

Accuracy: At 100 kHz, 25°C, and Full Scale Input: $\pm 2.0^\circ$

Dynamic accuracy:

Error	Input Level relative to Full Scale Input
± 4 deg	0 dB to -10 dB
± 2 deg	-10 dB to -50 dB
± 5 deg	-50 dB to -60 dB
± 1.5 deg	-60 dB to -80 dB
± 7.5 deg	-80 dB to -100 dB

Temperature stability: typically $< \pm 0.05$ deg/°C

Time stability: typically $< \pm 0.05$ deg/hr at 25°C

Delay characteristics

Range: 1 ps to 20,000s

Resolution: .01 ns/div to 1000s/div

Normalized accuracy: $\frac{\text{dynamic phase accuracy}}{360 \times \text{aperture [Hz]}} + 2\text{ns}$

Aperture range: 0.05% to 16% of frequency span

Reference level: $\pm 10_{\frac{3}{s}}$

General characteristics

Traces

No. Traces: two simultaneous traces may be present with a rectangular graticule. One trace with polar or Smith graticules.

Markers: each trace has one main marker and an offset marker.

Graticules

Rectangular graticule: 0% to 100% full scale deflection in 0.05% increments. Logarithmic and Linear.

Polar/Smith chart graticule: ± 500 deg in 0.001 deg increments.

Noise averaging

Type: exponentially weighted vector averaging on successive sweep data.

Averaging factor: selectable 1 (off), 4, 8, 16, 32, 64, 128, 256.

Linear phase slope compensation: provides linear phase slope offset of $-72,000$ deg/span to $+72,000$ deg/span

Calibration

Transmission: both traces can be normalized to measured data with full accuracy and resolution.

Reflection: corrects for directivity, frequency response and source match errors.

Programming

Remote programming with the Hewlett-Packard Interface Bus (HP-IB). The HP 35677A/B S-Parameter Test Sets are programmable through the HP 3577A interface only.

Plotter control: directly compatible with HP-IB graphics plotters that use Hewlett-Packard Graphics Language (HP-GL) with listen only capability.

Save/recall: front-panel setups can be stored in non-volatile memory locations 1 through 5. Last state is saved when power is removed.

Operating conditions

Temperature: 0°C to +55°C

Relative humidity: $< 95\%$ at 40°C

Altitude: $< 4,572\text{m}$ (15,000 ft)

Non-operating conditions

Temperature: -40°C to $+75^\circ\text{C}$

Altitude: $< 15,240\text{m}$ (50,000 ft)

Power: 115V + 10%, -25% (47 Hz to 440 Hz), or 230 V + 10%, -15% (47 Hz to 66 Hz), 450 VA maximum

Weight: net, 31kg (67lb); shipping, 41kg (90lb)

Size: 22H x 426W x 578mmD (8.7" x 16.75" x 22.75")

HP 35677A/B S-Parameter Test Set

The HP 35677A/B test set is used to make transmission and reflection measurements in both the forward and reverse directions. The

only setup required is to connect the device under test to the two measurement ports. Even reverse measurements can be made without changing device connections. The HP 35677A is used for 50 ohm systems, and the HP 35677B is used for 75 ohm systems.

Specifications

Frequency range: 100 kHz to 200 MHz

Test port impedance

HP 35677A: 50Ω

HP 35677B: 75Ω

Directivity: > 40 dB

Frequency response

Transmission (S21, S12): ± 1 dB, ± 5 degrees

Reflection (S11, S22): ± 1 dB, ± 5 degrees

Port match

Test ports 1, 2: HP 35677A, > 25 dB; HP 35677B, > 24 dB

Test ports 1, 2 open/short ratio: HP 35677A, $< \pm 0.75$ dB magnitude and $< \pm 5$ degrees phase; HP 35677B, $< \pm 1$ dB magnitude and $< \pm 7.5$ degrees phase.

Input port: > 20 dB return loss

Output ports A, B, and R: > 26 dB return loss

Test port isolation: > 100 dB

Connectors

Input port and output ports A, B, and R: 50Ω type N female

Test ports 1 and 2: HP 35677A, 50Ω type N female; HP 35677B, 75Ω type N female

dc bias inputs: BNC female, rear panel

dc bias range: typically ± 30 Vdc and ± 20 mA with some degradation of RF specifications; 200 mA damage level

Accessories supplied

4 ca. 190 mm (7.5 in.) 50Ω cables with type N male connectors for connection to HP 3577A (HP Part No. 8120-4387)

1 ea. Test Set interconnect cable to HP 3577A (HP Part No. 35677-61620)

1 ea. Rear Panel Lock Foot Kit (HP Part No. 5061-0099)

1 ea. Service Manual (HP Part No. 35677-90010)

General characteristics

Power: all power is obtained through the HP 35677A interconnect cable

Weight: net, 6kg (13lb); shipping, 122kg (251lb)

Size: 90H x 425W x 584mmD (3.5" x 16.75" x 22.75"). Add 1½ inch to depth to include front panel connectors.

HP 35676A/B Reflection/Transmission Test Kits

Operating with internal calibration routines in the HP 3577A, the 35676A/B test kit provides measurements of reflection, transmission and impedance from 5 Hz to 200 MHz. Each test kit contains a precision resistive divider, a reference load, a coaxial short, a carrying case and miscellaneous cables and hardware.

Operating Characteristics*

Frequency range: 5 Hz to 200 MHz

Test port impedance: 50 \pm 2% typical (HP 35676A) 75 \pm 2% typical (HP 35676B)

Equivalent directivity: 40 dB typical

Equivalent source match: 30 dB typical (HP 35676A) 25 dB typical (HP 35676B)

*Typical, assuming proper calibration with accessories supplied.

HP 3577S Network Analyzer System

The HP 3577S Network Analyzer System combines the HP 3577A network analyzer, HP 9000 Series 200 or 300 computer, HP 35677A/B S-Parameter test set, HP 35678A/B calibration kit, and HP 35675A accuracy enhancement software to form a powerful automated network measurement solution. Using HP-IB programming, HP 3577S can be integrated with other Hewlett-Packard instruments to solve difficult measurement problems.

HP 35675A Accuracy Enhancement Software

At the heart of the system, the HP 35675A Accuracy Enhancement Software expands the measurement capabilities of the 3577A Network Analyzer. It adds two ports, twelve-term error correction, conversion from s parameters to h, y, or z parameters and auto sequence instrument operation. The HP 35675A software is an excellent core to your custom software for automated network analysis measurements.

Contact your local HP sales office for more information, including a data sheet with complete specifications.

Ordering Information

HP 3577S Network Analyzer System

Specify this system reference number to ensure coordination of shipments and guarantee compatibility of instruments and software. It is not necessary to order components already owned.

HP 3577A Network Analyzer

Opt 907 Front Handle Kit	\$25,750
Opt 908 Rack Mount Kit	+ \$79
Opt 909 Rack Mount and Front Handle Kit	+ \$42
Opt 910 Extra Operating and Service Manuals	+ \$105
Opt W30 Extended Repair Service. See page 725.	+ \$250
HP 03577-84401 Service Accessory Kit for HP 3577A	\$625
HP 35675A Accuracy Enhancement Software	\$725
Opt 042 software on 5.25" disks	\$1,660
Opt 044 software on 3.5" disks	\$0
HP 35676A 50Ω Reflection/Transmission Test Kit	\$0
HP 35676B 75Ω Reflection/Transmission Test Kit	\$1,390
HP 35677A 50Ω S-Parameter Test Set	\$1,660
HP 35677B 75Ω S-Parameter Test Set	\$4,100
Opt 907 Front Handle Kit	+ \$52
Opt 908 Rack Mount Kit	+ \$27
Opt 909 Rack Mount and Front Handle Kit	+ \$63
Opt 910 Extra Operating and Service Manuals	+ \$47
HP 35678A 50Ω Type N Calibration Kit	\$805
HP 35678B 75Ω Type N Calibration Kit	\$1,555
HP 35679A 50Ω Type N Port Extension Cables	\$535
HP 35679B 75Ω Type N Port Extension Cables	\$1,825
HP 85024A High Frequency Probe	\$1,900

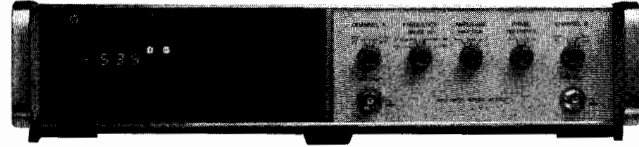

HP 3575A

HP 3575A

The HP 3575A Gain-Phase Meter is a broadband two-channel analyzer typically used to measure transfer functions such as amplifier gain/loss or the frequency response of filters. It can be used to measure the ratio and relative phase of any two signals on its two channel inputs and for absolute measurements of signals on each channel. A wide range of input waveforms can be measured including sine, square and triangular waveforms.

A three-digit display may be selected to read amplitude level/ratio or phase of the input signals. An optional three-digit readout and analog output is available for simultaneous amplitude and phase measurements.

Specifications Summary

Frequency:	1 Hz to 13 MHz
Level:	200μV rms to 20 V rms
No. Channels:	2
Impedance:	1 MΩ/30 pF
Protection:	±40 V dc, 20 V rms
Nominal Amplitude Accuracy:	±1 dB (see data sheet for complete accuracy specifications)
Amplitude Functions:	A dBV, B dBV or B/A dB
Range:	A dBV, B dBV: -74 dBV to +26 dBV (in two ranges)
	B/A dB: -100 to +100dB
Resolution:	0.1 dB
Nominal Phase Accuracy:	±0.5 degrees (see data sheet for complete accuracy specifications)
Range:	±180° with 12° of overrange
Resolution:	0.1°

General

Power: 115 V / 230 V ±10%, 48 Hz to 440 Hz, 40 VA
 Weight: net, 8.3 kg (18.4 lb); shipping, 11.3kg (25.8lb)
 Size: 88H x 425W x 337mm D (3.47" x 16.75" x 13.25")
 Contact your local HP sales office for more information including a Data Sheet containing complete specifications.

Ordering Information

Ordering Information	Price
HP 3575A Gain/Phase Meter	\$6,050
Opt 001 Dual Readouts/Dual Outputs	+\$670
Opt *002 BCD Programming (Negative true)	+\$1135
Opt *003 BCD Programming (Positive true)	+\$1135
Opt 908 Rack Flange Kit	+\$37
Opt 910 Extra Manual	+\$53
Opt W30 Extended Repair Service. See page 725.	+\$145

*Note: Includes option 001

NETWORK ANALYZERS

Combined Network/Spectrum Analysis, 10Hz to 500MHz

Model 4195A

- Linear and non-linear device measurement and analysis
- High accuracy and resolution
- User functions
- Color graphics, graphics analysis and direct copy capability
- Direct save/recall with internal disc drive

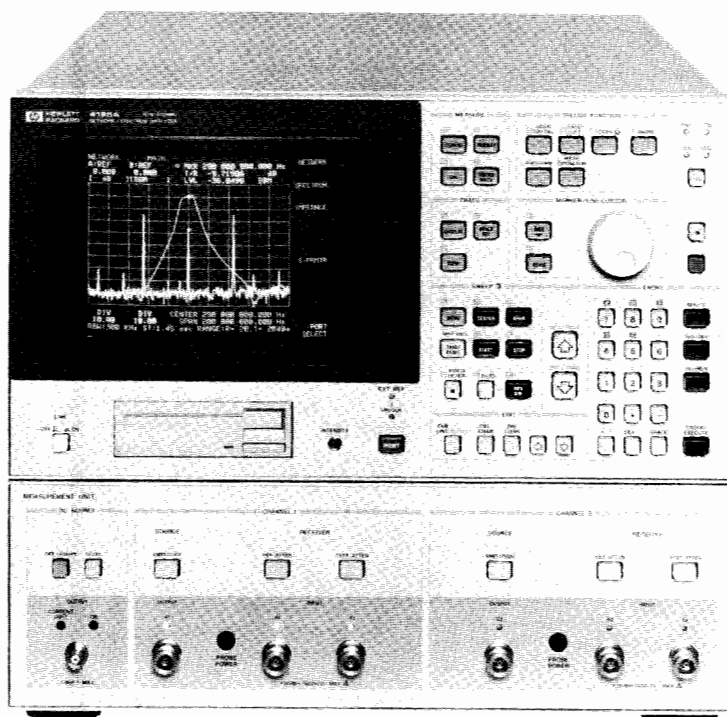

HP 4195A



Description

The HP 4195A is a high performance, cost effective and intelligent analyzer with combined vector network and spectrum analysis capabilities. The frequency is covered from 10Hz through 500MHz with an excellent 0.001Hz resolution for audio, baseband, HF, VHF and IF applications. It directly measures amplitude ratio, phase, group delay and spectrum level needed for characterizing linear/non-linear analog circuits or components used in communications, telecommunications, consumer electronics and other equipment.

The HP 4195A's excellent accuracy and resolution meets the severe measurement requirements for developing advanced equipment. A color display allows you to readily differentiate between multiple traces. Convenient softkey operation and marker functions make deriving device parameters quick and easy. Measurement results can be directly copied to printer or plotter without an external computer. Furthermore, the HP 4195A has internal user functions for computing and self controlling capability. User Program, User Defined Function and User Math allows you to quickly customize the setups most suited to your application without using an external computer. A built-in 3.5 inch disc drive can save the instrument state, data and user functions.

Combined Vector Network and Spectrum Analysis

Network analyzers and spectrum analyzers have become essential tools for evaluating subsystems or components used in electronic equipment. Especially, the importance of phase and group delay measurements is rapidly increasing. The HP 4195A offers full network and spectrum analysis from 10Hz to 500MHz at half the price. It has very wide applications. Network analysis functions include characterizing the gain/group delay ripple of filters and amplifiers. Spectrum

analysis functions include the harmonic, intermodulation distortion of amplifiers or IF subsystems in communications and telecommunications. S-parameters can also be measured by using 2 transmission/reflection test sets, without changing direction of the device.

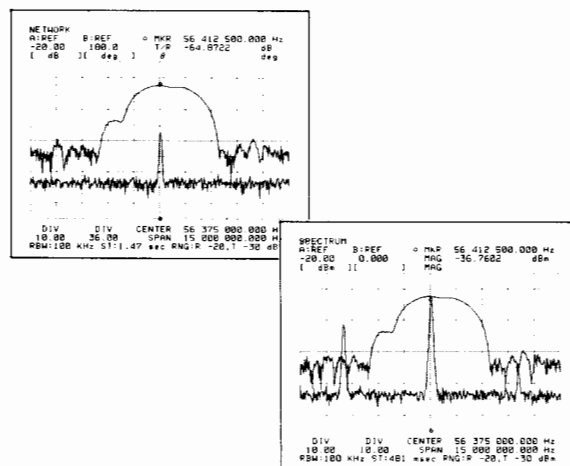

High Accuracy and Resolution Measurement

The HP 4195A measures amplitude ratio and phase with an accuracy of $\pm 0.05\text{dB}/\pm 0.3\text{ deg}$ and a resolution of $0.001\text{dB}/0.01\text{ deg}$. The amplitude and phase distortion of transmission devices, such as filters, amplifiers, delay lines and cables, affect the quality of information and create bit errors in PSK or QAM systems. The HP 4195A can evaluate distortion with high accuracy and resolution. For accuracy enhancement, 1 Port Full Cal, 1 Port Partial Cal, Normalization and Port Extension capabilities are available. For spectrum analysis, high level accuracy of $\pm 0.1\text{dB}$ and fully synthesized pure local OSC, typically -100 dBc/Hz (100 Hz offset), allow you to obtain stable and reliable C/N, harmonic distortion or intermodulation distortion measurements. In addition the high shaped digital IF filter technique makes discrimination of closely spaced signals easy, so 50/60 Hz power-line sidebands can be measured using the 10Hz RBW.

User Functions for Easy Customized Operation

The HP 4195A has three user functions for customizing operations for your applications without using an external computer. The User Program gives you a one key solution for performing your application. You can program a sequence from measurement and marker control, computing, through printing a hard copying. This function is very useful and improves efficiency for C/N (Carrier Noise ratio), THD (Total Harmonic Distortion) measurements or automatic device parameter extraction, such as an amplifier's gain, group delay, gain compression or harmonic distortion. The User Math function helps you put the result in the form you need by using the built-in math operators and arithmetic functions. For example, you can display level in volt peak-to-peak instead of volts rms or perform differentiation of gain or max hold. The User Defined Function gives you the power to define functions which can be called with softkeys as you like, such as input of step size, signal tracking, transmission/reflection alternate sweep or gain/level spectrum alternate sweep. In addition, the HP 4195A has the Program Sweep function which can arbitrarily sweep the points programmed in the table. This increases measurement efficiency by reducing excessive points in the Lin or Log sweep. Also, the resolution bandwidth can be independently set for each programmed point. The above user functions and program sweep table can be saved into the built-in 3.5 inch disc, so you can start your application at any time.

```

SPECTRUM          C/N-MEASUREMENT
PROGRAM EDITOR
FILE NAME: CNI

1  C/N-MEASUREMENT
10 MCF2
20 DELT1
30 MKACT1
40 MKM
50 DMKP=1 MHZ:P1=0
60 FOR R0=1 TO 10
70 SWRQ
80 R1=DMKRA+R1

90 R2=R1 R0
100 DISP "C/N:DB",P2
110 NEXT R0
120 CRT "C/N-MEASUREMENT"
130 END
  
```

User Program for C/N Measurement

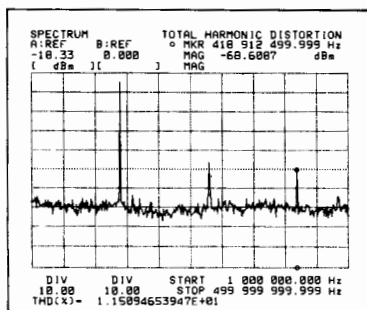

THD Measurement by Using User Define Function

Advanced Marker Action on Color Graphics

The application oriented marker functions are very useful for both network and spectrum measurements. You can quickly obtain the desired results from the easy to see color graphics CRT. The Next Peak is convenient for searching harmonic or spurious signals. The marker target is used for extraction of SAW filter's 3dB bandwidth or an amplifier's -1 dB gain compression point. The delta marker is used for C/N measurement, and the noise marker is used for noise measurements. A maximum of four traces can be simultaneously displayed on the CRT, so it is easy to compare the data. The smith/polar chart is convenient for impedance matching in circuit design. In addition, the results can be directly copied to a compatible plotter or printer without an external computer.

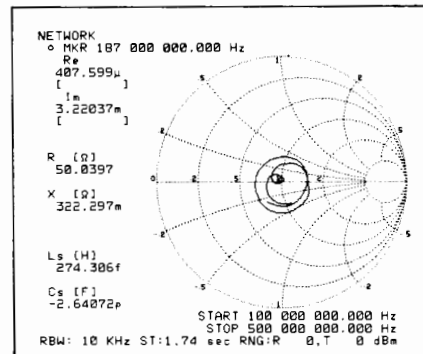

Specifications

Network Measurement

Source

Frequency: 10Hz to 500MHz, 1mHz resolution
Power: -50 dBm to $+15\text{ dBm}$, 0.1dB resolution
Sweep Parameters: Frequency, power and dc bias level
Sweep Types: Linear, log, cw, program and partial
Output: 2 outputs
DC bias level: $\pm 40\text{V}$, 10mV resolution

Receiver

Frequency: 10Hz to 500MHz
Input: 4 inputs, $50\ \Omega$ nominal
Resolution Bandwidth: 3Hz to 300kHz, 1 or 3 step
Input Crosstalk: $\leq -100\text{dB}$

Magnitude Ratio

Dynamic Range: $> 100\text{dB}$
Resolution: 0.001dB
Dynamic Accuracy ($23 \pm 5^\circ\text{C}$, -30dBm R input): $\pm 0.05\text{dB}$ @ -70dBm to -30dBm T input.

Phase

Range: $\pm 180^\circ$
Resolution: 0.01°
Dynamic Accuracy ($23 \pm 5^\circ\text{C}$, -30dBm input): $\pm 0.3^\circ$ @ -70 to -30dBm T input.

Delay

Range: 10ps to 500s
Resolution: 10ps @ 3.6 MHz aperture
Accuracy: depends on phase accuracy

Error Compensation

Mode: Normalization, 1 port partial cal, 1 port full cal and port extension.

Spectrum Measurement

Frequency

Measurement Range: 10Hz to 500MHz
Resolution:
RBW: 3Hz to 300kHz, 1 or 3 step
Selectivity ($60/3\text{dB}$): 4.5 for 3Hz to 30Hz, 9 for 100 Hz to 10 kHz,
8.5 for 30 kHz to 300 kHz.
Noise Sideband: $< -100\text{ dBc/Hz}$ @ 1 kHz offset
 $< -90\text{ dBc/Hz}$ @ 100 Hz offset

NETWORK ANALYZERS

Combined Network/Spectrum Analysis, 10Hz to 500MHz (cont'd)

Model 4195A

Amplitude

Measurement Range: -135 dBm to +20 dBm

Accuracy: ± 1.0 dB 50MHz

Linearity (23 $\pm 5^\circ$ C): ± 0.1 dB @ -40 to 0dB; ± 0.2 dB @ -60 to -40dB

Frequency Response: ± 1.5 dB

Dynamic Range (23 $\pm 5^\circ$ C)

Second Harmonic Distortion: ≤ -70 dBc @ ≥ 2 MHz

T.O.I Distortion: ≤ -80 dBc @ ≥ 2 MHz

Residual Response: -110dB @ ≥ 100 kHz.

Average Noise Level: typically -140dBm @ 10Hz RBW, ≥ 2 MHz

Sweep

Sweep Type: Linear, log, cw, program and partial

Sweep Mode: Continuous, single and manual

Sweep Time: approximately 3.5 sec 500 MHz span, 300 kHz RBW

Input

Number of inputs: 4 inputs

Impedance: 50 Ω nominal

Damage level: +30 dBm

Attenuator: 0 to 50dB, 10dB step

Display and Analysis

Display: 7.5 inch color CRT

Display Format: Rectangulars, Table, Smith and Polar

Traces: 4 traces max

Scale Type: Linear, log

Autoscale

Phase Display Expansion: Display phase continuously more than ± 180 deg.

Video Filter: Digital video filtering reduces random noise

Comment Entry: Display a comment used alphabet, numeral and special characters (, , %, etc).

Marker: MKR \rightarrow Max (Min, Ref, Center, Start and Stop), Next Peak, Width and Delta reading mode.

User Functions

User Math:

Puts the result in the form needed for your application by using built-in math operators, arithmetic functions and editing capability.

User Defined Function:

Provides one-key solution for a specific application without an external computer. 6 user functions can be created and soft-keys can be labeled as you like.

User Program (Auto Sequence Program):

Allows to program the control or measurement, analysis, copy and other sequence without an external computer.

Hardcopy

Hardcopy of traces, measurement data, results of analysis and annotations are produced by the 4195A and HP plotters or printers with LISTEN only capability.

Color Dump Mode: Copy the traces, graticules and annotations to a color graphics printer. Colors are fixed.

Dump Mode: Copy the CRT display to a graphics printer

Plot Mode: Copy the traces, graticule and annotations to an HP-GL compatible digital plotter

Print Mode: Copy measurement data in tabular form to a printer

Storage

Instrument state, trace data, table of Program Sweep and User Program can be independently saved or recalled from the built-in 3.5 inch floppy disk memory via SAVE/GET function.

Instrument state includes active control setting of measurement, active calibration data, active display format, active scale setting, User Math and User Define Function.

Remote programming

HP-IB interface operates according to IEEE 488-1987 and IEC 625 standards and IEEE 628-1982 recommended practices

Interface Function: SH1, AH1, T5, TE0, L4, LE0, SR1, RL1, PP0, DC1, DT1, C0, E1

Transfer Formats: ASCII
32/64 bit IEEE 754 floating point format

General Characteristics:

Operating Conditions:

Temperature: 0°C to +45°C

Humidity: 95% RH at 40°C

Non-Operating Conditions:

Temperature: -40°C to +70

Safety: Based on IEC-348, UL-1244

Power: 100, 120, 220V $\pm 10\%$, 240V -10% +5%, 48Hz to 60Hz, 500VA (max)

Dimensions: 425 (W) x 375 (H) x 620 (D) mm

Weight: Approximately 41kg

41951A Impedance Test Kit

The HP 4195A and HP 41951A Impedance Test Kit, which is designed to use with the 4195A, can be used to perform impedance analysis from 100kHz to 500MHz. The direct reading of impedance parameters, error compensation, variable test signal/dc bias level, and dedicated analysis functions are all convenient for evaluation of components, such as crystal/SAW resonators, coils, and varicap diodes. The equivalent circuit function is very useful for modeling and evaluating components under actual operating conditions to improve the quality and reliability of circuit design.

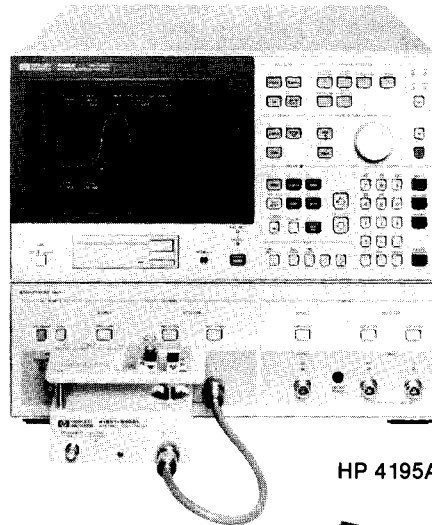

HP 4195A with HP 41951A

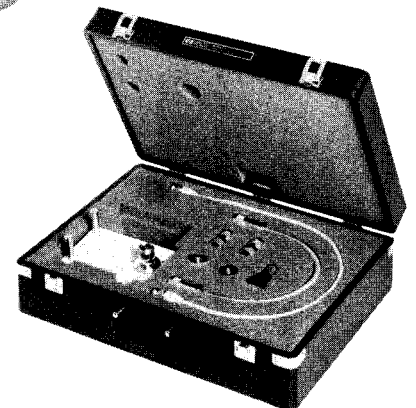

HP 41951A

HP 41951A Impedance Test Kit

The HP 41951A can be used for impedance measurements from 100kHz to 500MHz when used with the HP 4195A.

Measured Parameters: $|Z|$, $|Y|$, θ , L, C, R, X, G, B, D, and Q

Error Compensation: 1 port cal, open/short offset and port extension

Equivalent Circuit Analysis: Circuit constants approximation and simulation of frequency characteristics

Available Accessories: Refer to page 283.

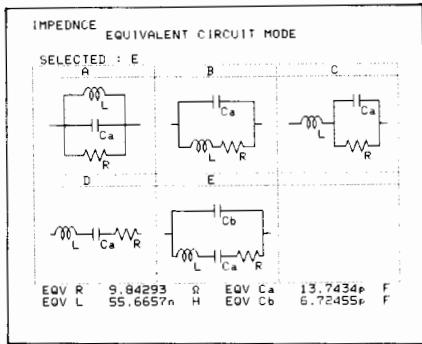

41952A/B Transmission/Reflection Test Sets

The HP 41952A/B Transmission/Reflection Test Sets provide a neat solution to the HP 4195A Network/Spectrum Analyzer to measure both transmission and reflection characteristics. The HP 41952A/B are directly connected to the HP 4195A and include a power splitter and a directional coupler in each compact box. Furthermore, two test sets of the HP 41952A or 41952B (opt. 009) allow the HP 4195A to perform full S parameters measurement without having to remove and reverse the device. The HP 41952A is used for 50 ohm application, and the HP 41952B is used for 75 ohm application.

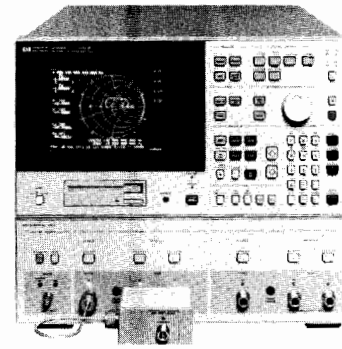

HP 4195A With HP 41952A

41800A Active Probe

The HP 41800A Active Probe is a high input impedance probe which covers the frequency from 5Hz to 500MHz, and makes it easy to perform signal analysis of circuits in audio, video, HF and VHF band. For both spectrum and network analysis, the HP 41800A presents a great value by its low distortion and low noise characteristics. The HP 41800A is directly compatible with HP analyzers, such as the HP 4195A, HP 3577A, HP 3585A or HP 8568B, which supply probe power from the front panel.

Specifications

Bandwidth: 5Hz to 500MHz

Input R, C (nominal): 100k ohm, 3pF (probe alone)

Average Noise Level (typical): 10nV/√Hz 300kHz to 500MHz

2nd Harmonic Distortion: < -50dBc -20dBc input

Output Connector: 50 ohm type N male

Accessories Furnished: 10:1 divider, hook tip, ground leads, spare tips, BNC male adaptor and so on

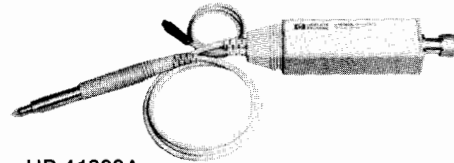

HP 41800A

SPECIFICATIONS

	HP 41952A	HP 41952B
Impedance:	50 ohm	75 ohm
Frequency Range:	100kHz - 500MHz	100kHz - 500MHz
Directivity:	40dB @300kHz-200MHz	35dB @300kHz-200MHz
Frequency Response: *1		
Transmission Magnitude, Phase (@ ≥300kHz) :	±1dB, ±5deg	±1dB, ±5deg
Reflection Magnitude, Phase (@ ≥1MHz) :	±1dB, ±5deg	±1dB, ±5deg
Effective Source Match:		
Test Port:	>20dB @ ≥ 300kHz	>20dB @ ≥ 300kHz
Connector:		
Test Port:	50 ohm type N-(f)	75 ohm type N-(f)
Accessories Furnished:	50 ohm N cable Operating Note Carrying Case	50 ohm N cable HP 11852B M. L. Pad Operating Note Carrying Case

Note: HP 41952B opt. 009 deletes 50 ohm N cable and HP 11852B.

*1 : Typical

Accessories Available

HP 85044A/B Transmission/Reflection Test Set

Refer to page 232.

HP 85024A High Frequency Probe

Refer to page 230.

Ordering Information

	Price
4195A Network/Spectrum Analyzer	\$25,000
Opt W30: 3-year hardware support	\$575
Opt 001: High Stability Frequency Reference Improve the stability of frequency for evaluation high Q devices such as crystal filter, oscillator or resonator.	\$850
Frequency Accuracy: ±1 ppm (23°C ±5°C)	
Frequency Stability: ±1 x 10 ⁻⁸ (23°C ±5°C)	
Opt 907: Front Handle Kit	\$133
Opt 908: Rack Flange Kit	\$74
Opt 909: Rack and Handle Kit	\$189
Opt 910: Extra OP manual	\$50
41951A Impedance Test Kit	\$1500
41952A 50Ω Transmission/Reflection Test Set	\$2200
41952B 75Ω Transmission/Reflection Test Set	\$2700
Opt 009: Delete 50Ω N Cable and 11852B	-\$500
41800A Active Probe	\$1700

NETWORK ANALYZERS

Vector Voltmeter and Input Modules

Models 8508A, 85081A, 85082A

- Economical RF Voltage and Phase Measurements
- 100kHz to 1GHz High Impedance Probe Inputs
- 300kHz to 2GHz 50 ohm Inputs

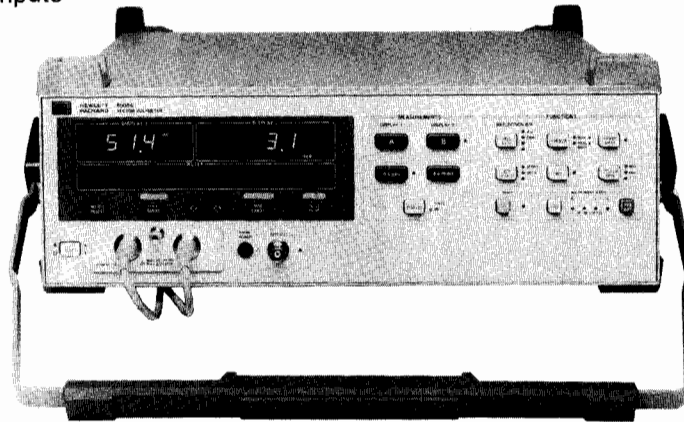

HP 8508A Option 001



The HP 8508A Vector Voltmeter is a fully automatic tuned receiver that makes RF voltage and phase measurements easy. Its narrow-band measuring technique gives it a dynamic range of over 90dB and a sensitivity of 10uV to trace even the smallest signal. The HP 8508A also measures the phase difference between its two input channels with at least 0.1 degree resolution over a full +180 to -180 degree range, so it can be used for another complete set of measurements - like electrical length, phase distortion or impedance. The standard HP 8508A is supplied with the HP 85081A Input Module, and has two high impedance probe inputs that operate from 100kHz to 1GHz. Its ability to store a reference and use it in later measurements means individual circuit sections can be characterized and adjusted independently. Any CW source can be used as a stimulus - even a source that is part of the device being tested, so measurements can be made under normal operating conditions. To adapt the probe inputs for measurements in a 50 ohm environment, the HP 11570A Accessory Kit provides two HP 11536A Probe Tees, an HP 11549A Power Splitter and two HP 908A 50 ohm Terminations. The HP 8508A Option 050 is supplied with the HP 85082A Input Module. Its 50 ohm inputs operate from 300kHz to 2GHz, and provide the accuracy and dynamic range to make measurements on active and passive components. Coaxial transmission and reflection measurements can be made using the HP 85044A (50 ohm) or HP 85044B (75 ohm) Transmission/Reflection Test Sets, and transmission comparison measurements can be made using the HP 11667A power splitter. The HP 11852B 50 to 75 ohm minimum-loss pad can be used to adapt the HP 85082A inputs to a 75 ohm environment.

Specifications Summary

HP 8508A with HP 85081A High Impedance Input Module

(* specifications apply to HP 85082A 50 Ohm Input Module only)

Frequency Range	100 kHz-1 GHz (300 kHz-2 GHz*)
Maximum Input	2V peak ac (+16 dBm*), ±50V dc
A (ref) Channel minimum	10mV (-47 dBm*), 100 kHz-300 kHz
	1 mV (-47 dBm*), 300kHz-3MHz
	300uV, 3MHz-1GHz
	(-57dBm, 3MHz-2GHz*)
B Channel noise level	10uV (-87 dBm*)
Input Crosstalk	>100 dB, 1 MHz-500 MHz
	>80 dB, 500 MHz-1 GHz
	(>70 dB, 1 GHz-2 GHz*)
Magnitude Accuracy	
Absolute Accuracy	+1/-1.5 dB, 100 kHz-300 kHz
(A, B 100 mV, 15-30 deg C)	±.5 dB, 300 kHz-1 MHz
	±.3 dB, 1 MHz-100 MHz
	±.6 dB, 100 MHz-300 MHz
	±1 dB, 300 MHz-1 GHz
	(±1 dB, 300 MHz-1.5 GHz*)
	(+1/-2 dB, 1.5 GHz-2 GHz*)

Ratio Accuracy
(A, B 100mV, 15-30 deg C)

±1 dB, 100 kHz-300 kHz
±.4 dB, 300 kHz-1 MHz
±.2 dB, 1 MHz-100 MHz
±.4 dB, 100 MHz-300 MHz
±.6 dB, 300 MHz-1 GHz
(±.6 dB, 300 MHz-1.5 GHz*)
(±1 dB, 1.5 GHz-2 GHz*)
±4 deg, 300 kHz-1 MHz
±1 deg, 1 MHz-100 MHz
±4 deg, 100 MHz-300 MHz
±6 deg, 300 MHz-1 GHz
(±6 deg, 300 MHz-1 GHz*)
(±12 deg, 1.5 GHz-2 GHz*)

Phase Accuracy
(A, B 100mV, 15-30 deg C)

Search and Lock Time: Lockup (within one range): 40mS, frequencies up to 3 MHz, 20 mS, frequencies greater than 3MHz.
Power: 100, 120, 220 or 240V +5/-10%, 48 to 440Hz, 40VA.
Size: 133mm H x 425.5mm W x 473.3mm D (5.25" x 16.75" x 18.65") Opt 001 158.8mm H x 524.5 W x 524.5mm D (6.25" x 19.75" x 20.65").

Weight: 8.1Kg net, 11Kg shipping; Opt 001 9.4Kg net, 12.5Kg shipping.

HP 11570A Accessory Kit

50 ohm Tee: For monitoring signals on 50 ohm transmission line. Kit contains two each with type N female connectors.

50 ohm Power Splitter: All connectors type N female.

HP 908A 50 ohm Termination: For terminating 50 ohm coaxial systems in their characteristic impedance. Kit contains two each with type N male connectors.

HP 11512A Short: Type N male.

HP 70138A Vector Voltmeter Module (Modular Measurement System)

The HP 70138A is a fully automatic tuned receiver that measures CW RF voltage and phase. It has all the capability of the HP 8508A Vector Voltmeter in a 1/8th rack-width module. Inputs for the HP 70138A are either two high impedance probes, with a frequency range of 100 kHz to 1 GHz, or two 50 ohm type-N connectors covering the 300 kHz to 2 GHz frequency range.

Ordering Information

HP 8508A Vector Voltmeter (includes HP 85081A Input Module).	\$5,500
Opt 001: Add bail handle and front protective cover.	250
Opt 050: Replace HP 85081A Input Module with HP 85082A Input Module.	-0-
Opt 100: Delete Input Module.	-1,500
Opt 801: Adds 2 each HP 11576A 10:1 Divider and HP 10216A Isolators	630
HP 70138A Vector Voltmeter	5,800
HP 85081A Input Module (100 kHz to 1 GHz, high impedance probe inputs).	1,500
HP 85082A Input Module (300 kHz to 2 GHz, 50 ohm Type N inputs)	1,500
HP 11570A Accessory Kit (measurement in 50 ohm systems with standard HP 8508A).	955
☛ Fast-ship product — see page 734.	

NETWORK ANALYZERS

RF Network Analyzer, 300 kHz to 3 GHz

HP 8752A

229

- 300 kHz to 1.3 or 3 GHz
- Integrated 1 Hz resolution synthesized source
- Integrated transmission/reflection test set
- Crisp color display
- Direct save/recall to an external disk drive

- Execute complex test procedures with the test sequence function
- 100 dB of dynamic range
- Group delay and deviation from linear phase
- Superb uncorrected performance

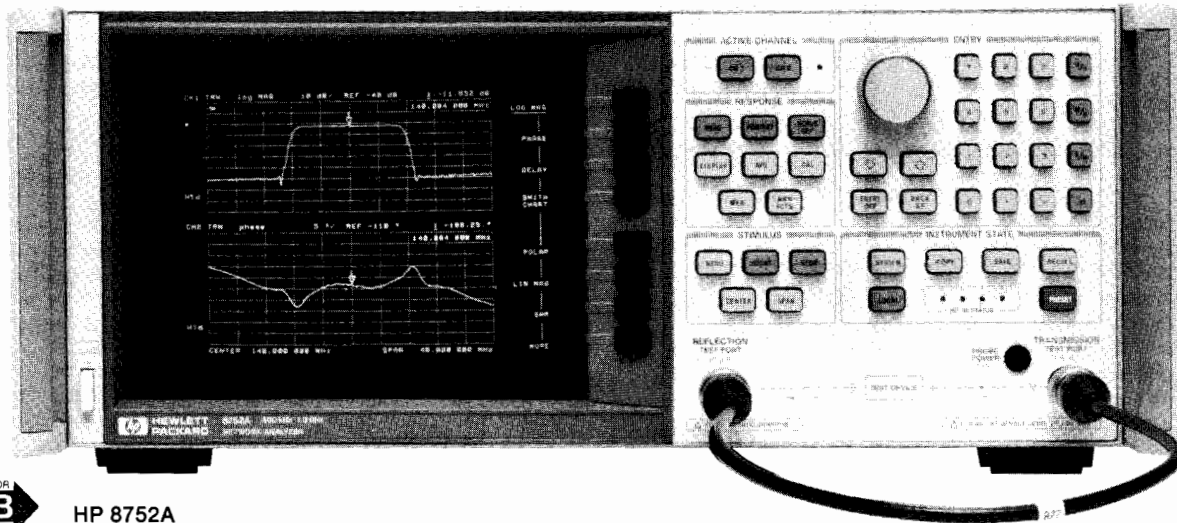

HP 8752A

HP 8752A RF Network Analyzer

The HP 8752A provides simple and complete vector network measurements in a compact and fully integrated RF network analyzer. Characterize your RF components and networks accurately and economically with the HP 8752A RF network analyzer in the 300 kHz to 1.3 or 3 GHz frequency range. Integration of the swept synthesized source, test set, and receiver, results in a network analyzer that is easy to set up and use which is ideal for service, incoming inspection, production and final test measurements.

The integrated synthesized source provides measurement port power level of +5 to -20 dBm with linear, log, list, power, and CW sweep types. The sensitive, tuned receivers provide 100 dB of dynamic range.

With two independent display channels available, you can simultaneously measure the reflection and transmission characteristics of the device under test on the crisp color display. Data can be displayed in log magnitude, linear magnitude, SWR, phase, group delay, polar, real, or Smith chart formats. The easy-to-use softkey measurement functions allow you to quickly measure the desired characteristic of your device under test.

Designed for Manufacturing

The productivity features of the HP 8752A increase your throughput in production. The test sequence function provides rapid and consistent execution of complex, repetitive tests with a single key-stroke. In sequencing mode, you make the measurement once from the front panel and the instrument automatically saves the keystrokes without an external computer.

The HP 8752A offers excellent uncorrected performance, allowing simple and accurate measurements of your device under test without the need for measurement calibration. Other productivity enhancements include a plot/print buffer, limit testing, arbitrary frequency testing, and marker tracking functions. Up to four on-screen markers are available per channel for hardcopy outputs or for tuning at specific frequencies.

Time Domain Analysis

The HP 8752A with option 010 has the capability of displaying the time domain response of a network, obtained by computing the inverse Fourier transform of the frequency domain response. Two time

domain modes are offered with the HP 8752A. The low pass mode provides traditional time domain reflector (TDR) measurement capability and gives the response of a mathematically simulated step or impulse response. The band pass mode, which has only the impulse stimulus, provides the time domain response of frequency-selective devices such as SAW filters and antennas.

Specifications

Source

Frequency characteristics

Range: 300 kHz to 1.3 GHz
(Option 003: 300 kHz to 3 GHz)

Resolution: 1 Hz

Accuracy: ± 10 ppm

Output characteristics

Power range: -20 to +5 dBm

Resolution: 0.1 dB

Flatness: < 2 dB p-p

Level accuracy (50 MHz, -5 dBm): ± 0.5 dB

Level linearity (relative to -5 dBm):

-20 to -15 dBm: ± 0.5 dB

-15 to 0 dBm: ± 0.2 dB

0 to +5 dBm: ± 0.5 dB

Impedance: 50 Ω

Receiver

Frequency range: 300 kHz to 1.3 GHz

(Option 003: 300 kHz to 3 GHz)

Noise level: reflection -85 dBm (typical)

Transmission -100 dBm

Maximum input level: 0 dBm

Impedance: 50 Ω

Crosstalk: (300 kHz to 1.3 GHz) 100 dB

(1.3 to 3 GHz) 90 dB

Dynamic accuracy: ± 0.05 dB, ±0.3 deg over a 50 dB input range

Delay characteristics:

Range: 1/(2*minimum aperture)

Aperture (selectable): frequency span/(points - 1) to 20% of the frequency span

Accuracy: (phase accuracy)/(360 * aperture)

NETWORK ANALYZERS

RF Network Analyzer, 300 kHz to 3 GHz

HP 8752A (cont'd.)

Physical Characteristics

Size: 178H x 425W x 482mmD (7.0" x 16.75" x 20.0")

Weight: net, 22kg (48lb); shipping 25kg (55lb)

Accessories

HP 11878A adapter kit

The HP 11878A Adapter Kit provides the RF components generally required when a SMA or 3.5 mm device needs to be measured with the HP 8752A standard type N configuration. The kit includes four type N to 3.5 mm adapters to accommodate both male and female connectors.

Test port return cable (HP 8120-4781)

Hewlett Packard supplies a 610 mm (24 in) 50 Ω type N RF cable with every HP 8752A. Additional or replacement cables can be ordered separately.

HP 11852B 50 Ω /75 Ω minimum loss pad

The HP 11852B is a low SWR minimum loss pad required when measurements are made on 75 Ω devices with the HP 8752A network analyzer. Measurements on two port devices require two HP 11852Bs and one 50 Ω type N barrel.

Frequency range: dc to 2.0 GHz

Insertion loss: 5.7 dB

Return loss: 75 Ω typically >30 dB, 50 Ω typically >26 dB

Connectors: 50 Ω type N female and 75 Ω type N male

HP 85024A High Frequency Probe

The HP 85024A High Frequency Probe makes it easy to perform in-circuit measurements. An input capacitance of only 0.7 pF shunted by 1 Megohm of resistance permits high frequency probing without adversely loading the circuit under test. Excellent frequency response and unity gain guarantees high accuracy in swept measurements with this probe. High probe sensitivity and low distortion levels allows measurements to be made while taking advantage of the full dynamic range of HP RF analyzers. Spectrum analyzers which supply probe power from the front panel include the HP 8568B, 8590B, 8591A, 8560A, 8561B, 8562A/B, and 71100A. RF network analyzers like the HP 8753C, 8752A, 3577A, and 4195A are also directly compatible. You can use the HP 85024A with other instruments by using the HP 1122A Probe Power Supply or any dual \pm 15V, 130 mA supply.

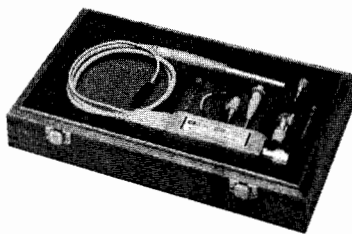

HP 85024A

Specifications

Input Capacitance (@ 500 MHz): <0.7 pF (nominal)

Input Resistance: 1 Megohm (nominal)

Bandwidth: 300 kHz to 3 GHz

Gain (@ 500 MHz): 0 dB \pm 1 dB

Average Noise Level (10 Hz to 10 MHz): <1 mV

Frequency Response: \pm 1.25 dB (300 kHz to 1 GHz)

+ 2, -3 dB (1 GHz to 3 GHz)

Input Voltage for 1 dB Compression: 0.3 V

Maximum Safe RF Voltage: 1.5V peak (with 10:1 divider 15V peak)

Noise Figure: <50 dB (<100 MHz)

<24 dB (100 MHz to 3 GHz)

Distortion (@ 0.3 V): <-30 dBc

Includes

Type N Male Adapter, 10:1 Divider, Spare probe tips, 2.5-inch Ground Lead, Hook Tip, Spanner Tip, and Probe Tip Nut Driver.

Calibration kits

Accuracy enhancement procedures characterize the systematic errors of the measurement system by measuring known devices (standards) on the system over the frequency range of interest. The calibration kits in the HP 8752A family contain precision standards with which to characterize the systematic errors of an HP 8752A measurement system.

HP 85032B Option 001 50 Ω type N calibration kit

Contains precision 50 Ω type N standards used to calibrate the HP 8752A for measurements of devices with 50 Ω type N connectors. This kit can also be used to perform system verification. Option 001 removes the precision phase-matched 7mm-to-type N adapters. Standards include fixed terminations, open circuits, and short circuits.

HP 85033C option 001 3.5 mm calibration kit

Contains precision 3.5 mm standards used to calibrate the HP 8752A network analyzer for measurements of devices with 3.5 mm or SMA connectors. Option 001 removes the precision phase-matched 7mm-to-3.5mm adapters. Standards include fixed terminations, open circuits, and short circuits.

Ordering Information

	Price
HP 8752A Network Analyzer	\$22,000
Opt 003 3 GHz Frequency Extension	+\$4,000
Opt 010 Time Domain Capability	+\$4,800
Opt 802 add Dual Disk Drive and Cable	+\$1,495
Opt 908 Rack Mount Kit (without handles)	+\$35
Opt 910 Extra Manual	+\$150
Opt 913 Rack Mount Kit	+\$40
HP 85032B Opt 001 50 Ω Type N Calibration Kit	\$1,100
HP 85033C Opt 001 3.5 mm Calibration Kit	\$2,000
HP 11878A 3.5 mm Adapter Kit	\$550
HP 11853A 50 Ω Type N Accessory Kit	\$350
HP 11854A 50 Ω BNC Accessory Kit	\$350
HP 8120-4781 Type N Replacement Test Port Cable	\$350
HP 85024A High Frequency Probe	\$1,900

☎ Fast Ship product



NETWORK ANALYZERS

RF Network Analyzer, 300 kHz to 6 GHz

Model 8753C

231

- 300 kHz to 6 GHz
- Integrated 1 Hz resolution synthesized source
- Direct save/recall to an external disc drive
- Time domain analysis
- Execute complex test procedures with the test sequence function
- Crisp color display
- 100 dB of dynamic range
- Group delay and deviation from linear phase
- 0.001 dB, 0.01 deg, 0.01 nanosec marker resolution
- Built-in accuracy enhancement
- Swept harmonic measurements

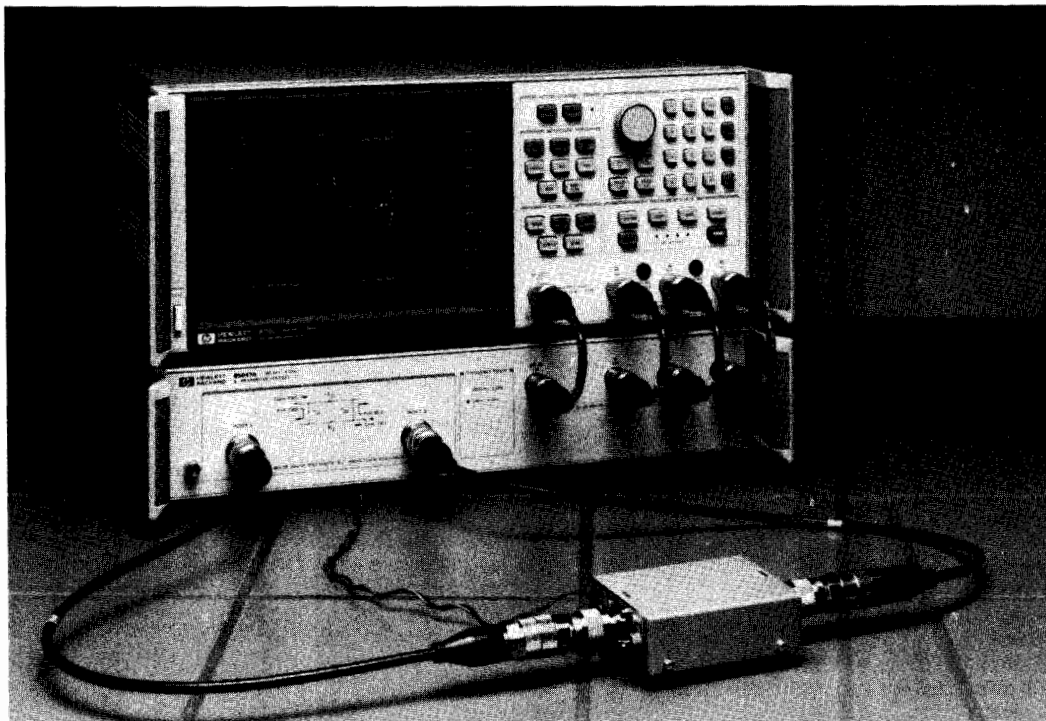

HP 8753C with HP 85047A



Description

The HP 8753C provides excellent RF network measurements for the lab and production test areas. When combined with a test set, it provides a complete solution for characterizing the linear behavior of either active or passive networks, devices, or components from 300 kHz to 6 GHz. With two independent display channels available, you can simultaneously measure and view the reflection and transmission characteristics of the device under test in overlay or split screen format on the crisp color display. The easy-to-use softkey selection of measurement functions allows you to measure the magnitude, phase, or group delay characteristics of your device under test.

The test sequence function allows rapid and consistent execution of complex repetitive tests with a single keystroke. In sequencing mode, you make the measurement once from the front panel and the instrument "learns" the keystrokes so no additional programming expertise is required. You can even set other HP-IB instruments via a test sequence. Other productivity enhancements include a plot/print buffer, limit testing, arbitrary frequency testing, and marker tracking functions. Finally, segmented calibration and interpolative error correction allow you to apply vector accuracy enhancement over a subset of the frequency range that you initially calibrated the HP 8753C.

The HP 8753C's integrated synthesized source provides > 100 mW of output power, 1 Hz frequency resolution, and linear, log, list, power, and CW sweep types. Three tuned, 300 kHz to 3 GHz (Option 006 - extends to 6 GHz) receivers allow versatile independent power measurements or simultaneous ratio measurements over a 100 dB dynamic range. By employing the HP 85047A Test Set with the HP 8753C, the reflection and transmission characteristics of the device under test can be investigated from 300 kHz to 3 GHz or from 3 MHz to 6 GHz with the test set's frequency doubler enabled.

Non-linear Device Testing

Non-linear device characterization is possible with the HP 8753C. Swept 2nd and 3rd harmonic levels of an amplifier can be displayed directly or relative to the fundamental carrier (dBc) when employing the optional harmonic measurement capability (Option 002). Amplifier harmonics up to 40 dBc can be measured quickly and conveniently on a swept-frequency basis for fundamental signals as low as 16 MHz, using the same test configuration used to measure gain. Power meter calibration provides a leveled absolute power to devices that are sensitive to absolute input or output levels. The HP 8753C automatically controls an HP 436A, 437B, or 438A Power Meter to set the power anywhere in the test configuration with power meter accuracy.

The HP 8753C has the capability to perform mixer tracking and conversion loss measurements. These are possible because the HP 8753C's tuned receiver can be offset from its synthesized source by the LO frequency of the mixer.

Time Domain Analysis

Time domain responses can be displayed by the HP 8753C with Option 010. The instrument computes the Inverse Fourier Transform of the frequency domain data to display the reflection or transmission coefficient versus time. The HP 8753C offers two time domain modes. The Low Pass mode provides the traditional Time Domain Reflectometer (TDR) measurement capability and gives the response of the network to a mathematically simulated step or impulse response. This mode gives information of the type of impedance (R, L, C) at the discontinuity. The Band Pass time domain mode, which has only the impulse stimulus, has no frequency restrictions and provides the time domain response of frequency selective devices such as SAW filters or antennas. Gating may be used to selectively isolate a single response to view the frequency domain response of individual portions of a component without disturbing the circuit itself.

NETWORK ANALYZERS

RF Network Analyzer, 300 kHz to 6 GHz (cont'd)

Model 8753C

HP 8753C Specifications Summary

Source

Frequency Characteristics

Frequency Range: 300 kHz to 3 GHz

Frequency Resolution: 1 Hz

Frequency Accuracy (25 C): ± 10 ppm

Output Characteristics

Power Range: -5 to +20 dBm

Power Accuracy (50 MHz, +10 dBm): ± 0.5 dB

Power Linearity (relative to +10 dBm, 25 .5 C):

.5 to 0 dBm: ± 0.5 dB

0 to +15 dBm: ± 0.2 dB

+15 to +20 dBm: ± 0.5 dB

Impedance: 50 ohms

Harmonics: ≤ -25 dBc (20 dBm output level)

typically ≤ -50 dBc (0 dBm output level)

Nonharmonics:

Mixer Related: ≤ -32 dBc (20 dBm output level)

typically ≤ -55 dBc (0 dBm output level)

Other Spurious:

$f < 135$ MHz: -60 dBc

$f \geq 135$ MHz: -60 dBc + $20 \cdot \log(f/135)$ MHz)

Phase Noise

 (10 kHz offset in 1 Hz BW):

$f < 135$ MHz: -90 dBc

$f \geq 135$ MHz: -90 dBc + $20 \cdot \log(f/135)$ MHz)

Receiver

Frequency Range: 300 kHz to 6 GHz

Inputs: A, B 100 dB dynamic range < 3 GHz

95 dB dynamic range 3 to 6 GHz

Sensitivity (noise level):

3 kHz BW: -90 dBm < 3 GHz, -85 dBm 3 to 6 GHz

10 Hz BW: -100 dBm < 3 GHz, -95 dBm 3 to 6 GHz

Maximum Input Level: 0 dBm

Impedance: 50 ohms

Input Crosstalk:

300 kHz to 1 GHz: -100 dB

1 GHz to 3 GHz: -90 dB

3 GHz to 4.5 GHz: -85 dB

4.5 GHz to 6 GHz: -75 dB

Dynamic Accuracy: ± 0.05 dB, ± 0.3 deg over a 50 dB input range

Delay Characteristics:

Range: $1/2 \cdot (1/\text{minimum aperture})$

Aperture: selectable (frequency span)/(# points - 1) to 20% of the frequency span

Resolution: $27.8/(\text{aperture in Hz})$

typically 0.01 nanoseconds

Accuracy: (phase accuracy)/(360 * aperture in Hz)

Dimensions:

178mm H x 425mm W x 498mm D

(7.0 x 16.75 x 20.0 in)

Weight:

Net 22 kg (48 lb); Shipping 25 kg (55 lb)

HP 8753C Accessories

HP 85044A 50 Ohm Transmission/Reflection Test Set

HP 85044B 75 Ohm Transmission/Reflection Test Set

The HP 85044 A/B Transmission/Reflection test sets provide the capability to simultaneously measure the reflection and transmission characteristics of 50 and 75 ohm devices. Two-port devices must be physically turned around to measure their reverse direction characteristics. Test port connectors are precision 7 mm and 75 ohm type N (f), respectively.

Specifications	HP 85044A	HP 85044B
Impedance:	50 ohms	75 ohms
Frequency Range:	300 kHz to 3 GHz	300 kHz to 2 GHz
Directivity³:	35 dB to 1.3 GHz 30 dB to 3.0 GHz	35 dB to 1.3 GHz 30 dB to 2.0 GHz

Typical Tracking:	HP 85044A	HP 85044B
Transmission Magnitude, Phase^{1,3}:		
.3 MHz to 2.0 MHz	± 1.5 dB, $\pm 10^\circ$	± 1.5 dB, $\pm 10^\circ$
2.0 MHz to F_{max}^2	± 1.5 dB, $\pm 10^\circ$	± 1.5 dB, $\pm 10^\circ$
Reflection Magnitude, Phase^{1,3}:		
.3 MHz to 2.0 MHz	± 1.5 dB, $\pm 25^\circ$	± 1.5 dB, $\pm 25^\circ$
2.0 MHz to F_{max}	± 1.5 dB, $\pm 10^\circ$	± 1.5 dB, $\pm 10^\circ$
Effective Source Match³:		
(Test Ports):		
.3 MHz to 2.0 MHz	14 dB	14 dB
2.0 MHz to 1.3 GHz	20 dB	17 dB
1.3 GHz to F_{max}	16 dB	16 dB
RF Connectors:		
Test Port:	precision 7 mm	75 ohm type N (f)
All others:	50 ohm type N (f)	50 ohm type N (f)
Includes:	HP 85044A—one precision 7 mm to 50 ohm type N (f) adapter; HP 85044B—one HP 11852B minimum loss pad.	
Recommended Accessories:	HP 11851B RF cable kit	
Dimensions:	615H x 101 W x 204 mm D (2.44 x 7.5 x 8.0 in)	
Weight:	net 1.7 kg (3.8 lb)	

S-Parameter Test Sets

The S-parameter test sets provide the capability to measure reflection and transmission characteristics (including s-parameters) of 2 port devices in either direction with a single connection. The test sets are controlled from the HP 8753C and include a programmable step attenuator.

HP 85046A/B S-Parameter Test Set

Test port connectors are precision 7 mm and 75 ohm type N (f) respectively. Both connectors can be adapted to other interfaces with the appropriate precision adapters.

Specifications	HP 85046A	HP 85046B
Impedance:	50 ohms	75 ohms
Frequency Range:	300 kHz to 3 GHz	300 kHz to 2 GHz
Directivity:	35 dB to 1.3 GHz 30 dB to 3.0 GHz	35 dB to 1.3 GHz 30 dB to 2.0 GHz

Typical Tracking:	HP 85046A	HP 85046B
Transmission Magnitude, Phase^{1,3}:		
.3 MHz to 2.0 MHz	± 1.5 dB, $\pm 20^\circ$	± 1.5 dB, $\pm 20^\circ$
2.0 MHz to F_{max}^2	± 1.5 dB, $\pm 10^\circ$	± 1.5 dB, $\pm 10^\circ$
Reflection Magnitude, Phase^{1,3}:		
.3 MHz to 2.0 MHz	± 1.5 dB, $\pm 25^\circ$	± 1.5 dB, $\pm 25^\circ$
2.0 MHz to F_{max}	± 1.5 dB, $\pm 10^\circ$	± 1.5 dB, $\pm 10^\circ$
Effective Source Match³:		
(Test Ports):		
.3 MHz to 2.0 MHz	14 dB	14 dB
2.0 MHz to 1.3 GHz	20 dB	17 dB
1.3 GHz to F_{max}	16 dB	16 dB

RF Connectors:

Port 1, 2: precision 7 mm 75 ohm type N (f)

All others: 50 ohm type N (f) 50 ohm type N (f)

Includes: Four 190 mm (7.5") cables with type N (m) connectors for connection to the HP 8753C. One HP 8753C test set interconnect cable.

Recommended Accessories: HP 11857D cables HP 11857B cables

Dimensions: 90 H x 426 W x 553 mm D
(3.5 x 16.75 x 21.5 in.)

Weight: 9.1 kg (20 lb)

¹Degrees, specified as deviation from linear phase.

² F_{max} is the upper frequency limit of the associated test set.

³Can be improved through Accuracy Enhancement.

HP 85047A S-parameter Test Set

This test set includes a frequency doubler that can be switched in to measure 3 MHz to 6 GHz in a single sweep or switched out to measure 300 kHz to 3 GHz in a single sweep. The HP 8753C controls the frequency doubler. HP 8753C Option 006 (6 GHz receiver) is required to activate the HP 85047A. There are two rear panel BNC outputs. One provides a TTL signal which indicates the result of a limit test. The second TTL output is controlled from the HP 8753C Test Sequence function.

Specifications

Impedance: 50 ohms

Frequency ranges: 300 kHz to 3 GHz
3 MHz to 6 GHz

Directivity: 300 kHz to 1.3 GHz 35 dB
1.3 GHz to 3 GHz 30 dB
3 GHz to 6 GHz 25 dB

Typical tracking:

Transmission magnitude, phase:

300 kHz to 3 GHz ± 1.5 dB, ± 10 deg.

3 GHz to 6 GHz $+0.5$, -2.5 dB, ± 20 deg.

Reflection magnitude, phase:

300 kHz to 3 GHz ± 1.5 dB, ± 10 deg.

3 GHz to 6 GHz ± 1.5 dB, ± 20 deg.

Effective source match: 300 kHz to 1.3 GHz 20 dB
1.3 GHz to 3 GHz 16 dB
3 GHz to 6 GHz 14 dB

RF connectors:

Port 1, 2: 7 mm precision

All others: 50 ohm type N(f)

Includes: Four 190 mm (7.5") cables with Type N(m) connectors for connection to the HP 8753C. One HP 8753C test set interconnect cable.

Recommended accessories: HP 11857D cables

Dimensions: 90 H x 426 W x 533 mm D

Weight: 10 kg (22 lb.)

HP 11850C/D Three-Way Power Splitters

Specifications

	HP 11850C	HP 11850D
Impedance:	50 ohms	75 ohms
Frequency Range:	DC to 3 GHz	DC to 2 GHz
Tracking:	± 25 dB, $+3^\circ$	± 2 dB, $\pm 2.5^\circ$
Equivalent Source Match (ratio or leveling)	30 dB @ 1.3 GHz 20 dB @ 3 GHz	30 dB @ 1.3 GHz 20 dB @ 3 GHz
Nominal Insertion Loss:	9.5 dB +1 dB/GHz	7.8 dB

Input Port Match:

DC to 1.3 GHz 20 dB
1.3 GHz to F_{max}^1 10 dB

RF Connectors:

RF Input: 50 ohm type N (f) 50 ohm type N (f)
All Others: 50 ohm type N (f) 75 ohm type N (f)
Includes: 3 ea HP 11852B
50 to 75 ohm min. loss pads

Recommended

HP 11851B RF Cable Kit

Accessories:

¹ F_{max} is the upper frequency limit of the associated power splitter.

HP 11851B RF Cable Kit

General: three 610 mm (24 in.) 50 Ω cables phase matched to 4° at 1.3 GHz and one cable 860 mm (34 in.). Connectors are Type N Male. Recommended for use with HP 85044A/B Transmission/Reflection Test Set and HP 11850C/D Power Splitter.

Weight: net, 0.91 kg (2 lb); shipping, 1.36 kg (3 lb).

HP 11852B 50 Ω /75 Ω Minimum Loss Pad

General: the HP 11852B is a low SWR minimum loss pad required for transmission measurements on 75 Ω devices with HP 8753C receiver (50 Ω).

Frequency range: dc to 2.0 GHz.

Insertion loss: 5.7 dB.

Return loss: 75 Ω typically ≥ 30 dB. 50 Ω typically ≥ 26 dB.

Maximum input power: 250 mW (+24 dBm).

Connectors: 50 Ω Type N female and 75 Ω Type N male.

Type N Accessory Kits

Kit contains a Type N Female short, a Type N Male short, two Type N Male barrels, two Type N Female barrels and storage case.

HP 11853A 50 Ω Type N Accessory Kit

General: the HP 11853A furnishes the RF components required for measurement of devices with 50 Ω Type N Connectors using the HP 11850C, 85044A, 85046A or 85047A.

HP 11855A 75 Ω Type N Accessory Kit

General: the HP 11855A provides the RF connecting hardware generally required for measurement of devices with 75 Ω Type N connectors using the HP 85044B, 85046B or 11850D. This kit also contains a 75 Ω Type N Male termination.

BNC Accessory Kits

Kit contains two Type N Male to BNC Female adapters, two Type N Male to BNC Male adapters, two Type N Female to BNC Female adapters, two Type N Female to BNC Male adapters, a BNC Male short and storage case.

HP 11854A 50 Ω BNC Accessory Kit

General: the HP 11854A furnishes the RF components required for measurement of devices with 50 Ω BNC Connectors using the HP 11850C, 85044A, 85046A or 85047A.

HP 11856A 75 Ω BNC Accessory Kit

General: the HP 11856A provides the RF connecting hardware generally required for measurement of devices with 75 Ω BNC connectors using the HP 85044B, 11850D, or 85046B. This kit also contains a 75 Ω BNC Male termination, and storage case.

HP 11857D 50 Ω APC-7 Test Port Extension Cables

General: two precision 61 cm (24 in.) cables, phase matched to 2° at 1.3 GHz for use with HP 85046 A S-parameter test set. Connectors are 50 Ω APC-7.

HP 11857B 75 Ω Type N Test Port Extension Cables

General: two precision 61 cm (24 in.) cables, phase matched to 2° at 1.3 GHz for use with HP 85046B S-parameter test set. One cable has 75 Ω Type N Male connectors on both ends; the other has one Type N Male and one Type N Female connector.

HP 11600B/11602B Transistor Fixtures

Function: mounts on front of HP 85046 and 85047 S-Parameter Test Sets, holds devices for s-parameter measurements in a 50 ohm, coax circuit.

Transistor Base Patterns

Model 11600B: accepts TO-18/TO-72 packages.

Model 11602B: accepts TO-5/TO-12 packages.

Calibration references: short circuit termination on a 50 ohm through-section.

Frequency range: dc to 2 GHz.

Impedance: 50 ohms nominal.

Reflection coefficient: < 0.05 , 100 MHz to 1.0 GHz: < 0.09 , 1.0 to 2 GHz.

Connectors: hybrid APC-7; Option 001, type N female.

HP 11858A Transistor Fixture Adapter

General: the HP 11858A adapts the HP 11600B and 11602B transistor fixtures (vertical test port configuration) to the HP 85046A or 85047A S-parameter test set. Connectors are APC-7.

HP 85043B Systems Cabinet

The HP 85043B systems cabinet has been ergonomically designed specifically for the HP 8753C and the HP 85046A/B or 85047A S-parameter test sets. The 122 cm (48-inch) system cabinet includes a bookcase, a drawer, and a convenient work surface.

Calibration Kits

Accuracy enhancement procedures characterize the systematic errors of the measurement system by measuring known devices (standards) on the system over the frequency range of interest. The calibration kits in the HP 8753C family contain precision standards with which to characterize the systematic errors of a HP 8753C measurement system.

HP 85031B 7 mm Calibration Kit

The HP 85031B 7 mm calibration kit contains a set of precision 7 mm fixed terminations, an open circuit, and a short circuit used to calibrate the HP 8753C and its 50 ohm test sets for measurement of devices with precision 7 mm connectors.

NETWORK ANALYZERS

Accessories (cont'd)

8753C Series

HP 85032B 50 Ω Type N Calibration Kit

The HP 85032B Calibration Kit contains precision 50 Ω type N standards used to calibrate the HP 8753C and its 50 Ω test sets for measurement of devices with 50 Ω type N connectors. Precision phase-matched 7 mm to 50 Ω type N adapters are included for accurate measurements of non-insertable devices. Standards include fixed terminations, open circuits, and short circuits.

HP 85033C 3.5 mm Calibration Kit

The HP 85033C Calibration Kit contains precision 3.5 mm standards used to calibrate the HP 8753C and its 50 Ω test sets for measurement of devices with 3.5 mm and SMA connectors. Standards include fixed terminations, open circuits, and short circuits. Precision 7 mm to 3.5 mm adapters are included for accurate measurements of non-insertable devices.

HP 85036B 75 Ω type N Calibration Kit

The HP 85036B Calibration Kit contains precision 75 Ω type N standards used to calibrate the HP 8753C and its 75 Ω test sets for measurement of devices with 75 Ω type N connectors. Standards include fixed terminations, open circuits, and short circuits. Precision phase-matched adapters are included for accurate measurements of non-insertable devices.

Verification Kits

Measuring known devices, other than the calibration standards, is a convenient way of verifying that the HP 8753C measurement system is operating properly.

HP 85029B 7 mm Verification Kit

The HP 85029B Verification Kit contains a set of precision 7 mm devices, with data traceable to NBS, used to verify the calibrated performance of an HP 8753C measurement system. The devices have precision 7 mm connectors and include a 20 dB pad, a 50 dB pad and a mismatch attenuator. Verification process requires only an HP 85031B calibration kit, an HP 85029B verification kits and an external 3.5" disc drive connected to the HP 8753C.

Software

Software operates with a BASIC operating system using an HP Series 300 computer (2 megabytes of memory required).

HP 85160A Measurement Automation Software

Measurement Automation Software simplifies device measurements by providing guided measurements, limit testing, sequencing to test all four S-parameters, data formatting flexibility (data files can be formatted to be compatible with Touchstone® linear circuit simulation programs) and complete save/recall capability to a floppy disc. Once configured, simply recall a test file and calibration data, connect the device-under-test, and output the results.

HP 85165A Resonator Measurement Software

Resonator Measurement Software performs complete characterization of crystals, SAWs, and other resonant devices using the HP 8753C. The software guides the user through the measurement process and calculates key parameters of the device under test according to the EIA-512 resonator measurement standard.

Service and Support Products

Service and support products are available for HP 8753C measurement systems. On-site support products require a specific 50 ohm two-port measurement configuration.¹ Contact your local HP sales office for availability and price.

Ordering Information

	Price
HP 8753C Network Analyzer	\$25,500
Option 002 Harmonic Measurement Capability	3,000
Option 006 6 GHz Receiver Option	3,000
Option 010 Time Domain Capability	4,800
Option 802 add Dual Disc Drive and HP 10883A cable	1,495
Option 908 Rack Mount Kit (without handles)	35
Option 910 Extra Operating and Service Manual	150
Option 913 Rack Mount Kit	40
HP 85047A 6 GHz S-Parameter Test Set	9,800
Option 913 Rack Mount Kit	40
HP 85046A 50 Ohm S-Parameter Test Set	8,000
Option 913 Rack Mount Kit	40
HP 85046B 75 Ohm S-Parameter Test Set	8,000
Option 913 Rack Mount Kit	40
HP 85044A 50 Ohm Transmission/Reflection Test Set	3,200
HP 85044B 75 Ohm Transmission/Reflection Test Set	3,700
HP 85029B Precision 7 mm Verification Kit	1,600
HP 85031B Precision 7 mm Calibration Kit	1,200
HP 85032B 50 Ohm type N Calibration Kit	1,600
HP 85033C Precision 3.5 mm Calibration Kit	2,500
HP 85036B 75 Ohm type Calibration Kit	2,000
HP 85043B Systems Rack	2,900
HP 85033A SMA Kit	1,000
HP 85160A Measurement Automation Software	1,500
HP 85165A Resonator Measurement Software	5,000
HP 11850C 50 Ohm Power Splitter	900
HP 11850D 75 Ohm Power Splitter	1,400
HP 11851B type N RF Cable Kit	800
HP 11852B 50 to 75 Ohm Minimum Loss Pad	350
HP 11853A 50 Ohm type N Accessory Kit	350
HP 11854A 50 Ohm BNC Accessory Kit	350
HP 11855A 75 Ohm type N Accessory Kit	450
HP 11856A 75 Ohm BNC Accessory Kit	450
HP 11857B 75 Ohm type N Test Port Extension Cables	1,455
HP 11857D 50 Ohm APC-7 Test Port Extension Cables	1,050
HP 11600B/11602B Transistor Fixtures	1,800
HP 11858A Transistor Fixture Adapter	980

¹The specific 50 ohm two-port measurement system includes the HP 8753C, the HP 85046A S-parameter test set, the HP 85031B 7 mm calibration kit, and the HP 11857D 7 mm test port extension cable set. This is a minimum configuration required for on-site verification.

NETWORK ANALYZERS

Microwave Network Analyzers, 130 MHz to 13.5 or 20 GHz

HP 8719A, 8720B, 85162A

- 130 MHz to 13.5 or 20 GHz frequency range
- Fast-sweeping synthesized source built in
- Integrated switching s-parameter test set
- Direct save/recall to an external disk drive
- Up to 95 dB dynamic range
- Built-in accuracy enhancement

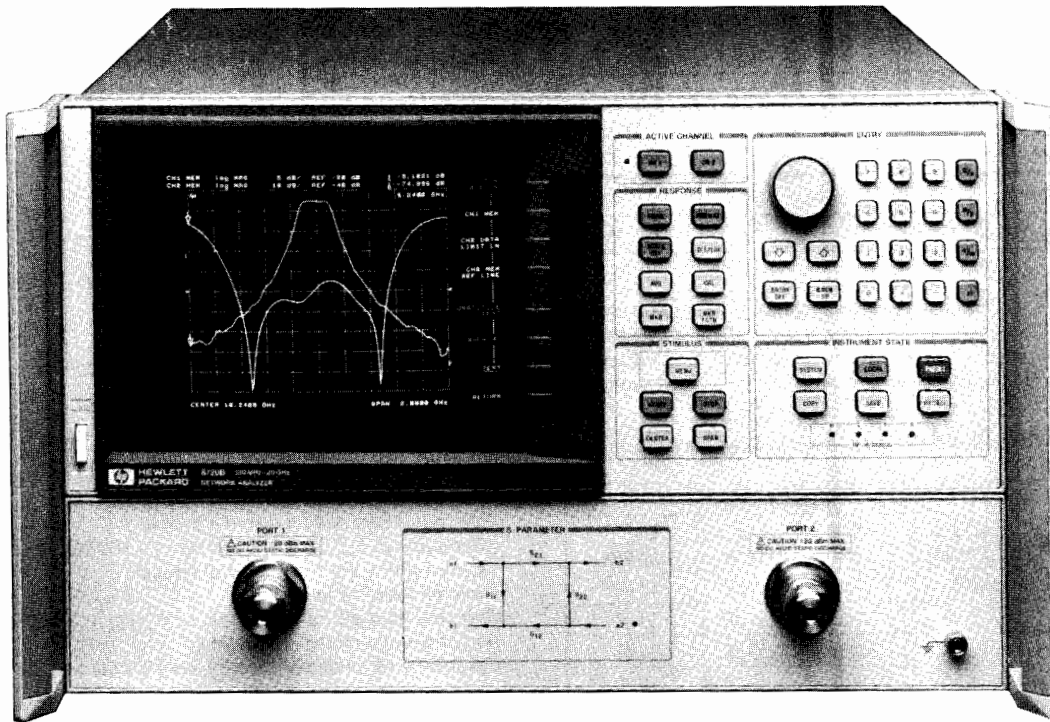

HP 8720B

HP 8719A, 8720B Microwave Network Analyzers

The HP 8719A or 8720B microwave network analyzers characterize microwave components and networks to 13.5 or 20 GHz. These vector network analyzers include a fast-sweeping synthesized source, switching s-parameter test set, and large, full color display in a single integrated package. These compact instruments are economical and easy to use. They are ideal choices for manufacturing, incoming inspection, and final test.

Affordable Analyzers with Excellent Performance

The integral source is fully synthesized, even while sweeping, and it provides stability and accuracy within 10 ppm (typical). Yet, the source sweeps extremely fast: measurement update times are typically about 1 ms per point. Frequency resolution is 100 kHz standard; option 001 provides 1 Hz resolution for narrow-band or long devices.

With tuned receivers and variable-bandwidth IF filters, the HP 8719A and 8720B microwave network analyzers provide over 85 dB of dynamic range. Option 003 boosts the forward dynamic range to 95 dB; solutions to 100 dB are available. The built-in test set measures all four s-parameters (both forward and reverse) with a single connection.

A step attenuator controls incident power level from -10 to -65 dBm in 5 dB steps, and two internal tees provide bias to active devices through the test ports.

Two independent channels can display reflection and transmission characteristics at the same time. The receiver detects both magnitude and phase, and presents results in a variety of useful formats, including group delay, deviation from linear phase, complex impedance, or SWR, on rectangular, polar, or Smith charts.

Built-in vector accuracy enhancement supports calibration kits in 3.5 mm, 7 mm, and type-N connectors; a user kit supports waveguide. Choose from a simple response normalization to full 2-port error correction. And the frequency subset feature lets you zoom in on a response without recalibrating.

Time domain capability (option 010) computes and displays the DUT's response versus time or distance (instead of frequency). Use time domain to locate and quantify individual discontinuities in a network. Or apply the gating feature to remove the effects of unwanted reflections (separated in time), then view the DUT's true response versus frequency.

Time-Saving Productivity Features

Limit test capability makes pass/fail decisions quantitative and decisive. Define up to 22 test limits per channel, based on the specifications of your components. Tuning is faster, and testing is more consistent.

To document results without a computer, the copy feature sends the entire display to a compatible plotter or printer.

Annotate specific trace features with markers — up to four per channel, all displayed at once. Advanced marker functions track a maximum or minimum point (while tuning), or compute the delta between two markers. For bandpass filters, markers automatically determine center frequency, bandwidth, and Q.

With save/recall capability, an experienced user can define and save test configurations for each DUT. Other users can recall identical conditions later, and align/test each DUT consistently. Use five internal memory registers, or save/recall directly to an external CS80 disk drive.

Software

Automate the HP 8719A or 8720B microwave network analyzers with HP-IB for added capability. The HP 85162A Measurement Automation Software guides you through measurements and simplifies test configuration. You can measure transistors quickly and completely with the HP 85014C Active Device Measurements Application Pac. The software includes models to de-embed the HP 85014A transistor fixture, and also controls the bias supply. Or, you can use the HP 85165A Resonator Measurement Software to characterize SAW devices and crystal.

NETWORK ANALYZERS

Microwave Network Analyzer, 130 MHz to 13.5 or 20 GHz

Models 8719A, 8720B, 85162A (cont'd)

HP 8719A/8720B System Performance

All specifications apply to the HP 8719A up to 13.5 GHz.

Dynamic Range¹

	Frequency range (GHz)			
	0.13 to 0.5	0.5 to 2	2 to 8	8 to 20*
Transmission (S_{21} or S_{12})(standard)	70 dB	80 dB	85 dB	85 dB
Forward Transmission (S_{21})(Option 003)	99 dB	98 dB	97 dB	95 dB
Reverse Transmission (S_{12})(Option 003)	30 dB	55 dB	65 dB	65 dB

Measurement Port Characteristics²

The following specifications show the residual system uncertainties (including switch repeatability) after accuracy enhancement using a full 2-port measurement calibration (including isolation) with an IF bandwidth of 10 Hz, and the specified calibration kit. Environmental temperature is $23 \pm 3^\circ\text{C}$.

Calibration Kit: HP 85052B (3.5 mm, male and female lowband and sliding loads)

	Frequency Range			
	0.13 to 0.5 GHz	0.5 to 2 GHz	2 to 8 GHz	8 to 20 GHz
Directivity	40 dB	40 dB	40 dB	40 dB
Source Match	30 dB	30 dB	30 dB	30 dB
Load Match	35 dB	35 dB	30 dB	30 dB
Reflection Tracking	± 0.10 dB	± 0.10 dB	± 0.10 dB	± 0.20 dB
Transmission Tracking	± 0.10 dB ⁶	± 0.10 dB ⁶	± 0.12 dB	± 0.15 dB

Calibration Kit: HP 85052D (3.5 mm, male and female broadband precision fixed load)

	Frequency Range			
	0.13 to 0.5 GHz	0.5 to 2 GHz	2 to 8 GHz	8 to 20 GHz
Directivity	40 dB	40 dB	38 dB	36 dB
Source Match	30 dB	30 dB	30 dB	29 dB
Load Match	35 dB	35 dB	30 dB	30 dB
Reflection Tracking	± 0.10 dB	± 0.10 dB	± 0.10 dB	± 0.20 dB
Transmission Tracking	± 0.10 dB ⁶	± 0.10 dB ⁶	± 0.12 dB	± 0.15 dB

System Accessories

	3.5 mm	7 mm ³	Type N ³
Test port cables			
Standard	HP 85131C/D	HP 85132C/D	HP 85132C/D ⁴
Flexible ⁵	HP 85131E/F	HP 85132E/F	HP 85132E/F ⁴
Adapter sets	HP 85130D	HP 85130B	HP 85130C
Calibration kits			
Standard (sliding loads)	HP 85052B	HP 85050B	HP 85054B
Economy (fixed loads)	HP 85052D	HP 85050D	HP 85054D
Verification kits	HP 85053B	HP 85051B	HP 85055A

¹Limited by maximum output power and system noise floor. Specified for an IF bandwidth of 10 Hz, using a full 2-port measurement calibration (including an isolation calibration performed with an averaging factor of 16).

²Crosstalk, after an isolation calibration, is below the system noise floor and can be ignored.

³HP 85130B/C Special Adapter Sets required if devices with 7 mm or Type N connectors are to be connected directly to the HP 8719A/HP 8720B's test ports.

⁴Use the cables recommended for 7 mm devices. Precision 7 mm to Type N adapters are included in the HP 85054B/D Type N calibration kits.

⁵Standard cables are warranted for 90 days. Flexible cables carry a standard one-year warranty.

⁶With Option 003, reverse transmission tracking and maximum Port 2 power level are reduced.

General Characteristics

Source Frequency Characteristics

Range: HP 8719A, 130 MHz to 13.5 GHz

HP 8720B, 130 MHz to 20.0 GHz

Resolution: 100 kHz (1 Hz with Option 001)

Stability: typically ± 7.5 ppm @ 0° to 55°C
typically ± 3 ppm/year

Accuracy: 10 ppm @ $25^\circ \pm 3^\circ\text{C}$

Output characteristics (at test ports, $25^\circ \pm 3^\circ\text{C}$)

Power range: -10 to -65 dBm in 5 dB steps⁶

Power level: -10 dBm ± 3 dB⁶

Harmonics: < -15 dBc @ -10 dBm (typical)

Test ports

Connector type: 3.5 mm (male)

Impedance: 50 ohms nominal

Switch type: Mechanical

Switch lifetime: > 3 million cycles (typical)

Maximum input level: $+20$ dBm

DC bias: 500 mA, 40 VDC maximum

Rear Panel Connectors

External reference frequency input:

Frequency: 1, 2, 5, and 10 MHz; $\leq \pm 200$ Hz at 10 MHz

Level: -10 dBm to $+20$ dBm, typical

Impedance: 50 ohms

External trigger: Triggers start of sweep on a negative TTL transition or contact closure to ground.

External AM auxiliary input: 0 to 10 volts (-1 dB/volt) into a 10 kohm resistor, 5 kHz max.

Auxiliary voltage input: -10 to $+10$ V

IO interconnect:

Type: DB-25

Output: Standard LS TTL output (active high logic) on pin 17 indicative of PASS/FAIL status during limit testing. Output voltage remains at $+5$ Vdc (nominal) until a FAIL condition occurs. Remains at 0 Vdc until a PASS condition occurs.

HP 85162A Measurement Automation Software

The HP 85162A Measurement Automation software is designed specifically to operate on an HP 9000 series 200 or 300 computer with BASIC 3.0 or higher. The software complements the HP 8720A microwave network analyzer, providing calibration, measurement, and data output capabilities with a minimum of operator interaction.

Ordering Information

	Price
HP 8719A Network Analyzer (130 MHz to 13.5 GHz)	\$44,000
Option W30 Extended Repair Service. See page 725.	1,100
Option W31 On-site Repair Service. See page 725.	1,980
Option W32 Calibration Service. See page 725.	665
HP 8720B Network Analyzer (130 MHz to 20.0 GHz)	\$55,000
Option W30 Extended Repair Service. See page 725.	1,375
Option W31 On-site Repair Service. See page 725.	2,500
Option W32 Calibration Service. See page 725.	665

Following options available for both HP 8719A and 8720B:

Option 001 1 Hz frequency resolution 9,500

Option 003 High forward dynamic range N/C

Option 010 Time Domain Capability 9,000

Option 802 add HP 9122C Dual Disc Drive, HP 10833A cable 1,495

Option 830 add HP 85052D Cal Kit, HP 85131E cable 5,100

Option 913 Rack Mount Kit 40

HP 85162A Measurement Automation Software Requires BASIC 3.0 or above and 2 Mbytes of RAM 1,500

Must select media option (no charge):

Option 630 for 3.5 in. disc media N/C

Option 655 for 5.25 in. disc media N/C

NETWORK ANALYZERS

Microwave Network Analyzers, 45 MHz to 110 GHz

8510 Series

237

- 45 MHz to 110 GHz frequency range
- "Real Time" error-corrected measurements
- 60 dB effective directivity and source match

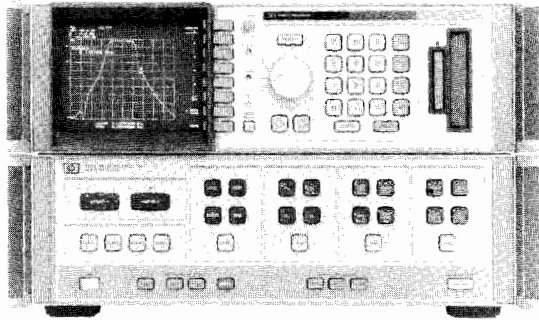

HP 8510B

Description

The HP 8510 series microwave vector network analyzers provide a complete solution for characterizing the linear behavior of either active or passive networks over the 45 MHz to 40 GHz frequency range. A complete system comprises the HP 8510B network analyzer, an S-parameter test set, and a compatible RF source. For millimeter-wave measurement needs, complete systems operating to 110 GHz can be configured.

Measurement results can be displayed on one of two independent, yet identical, channels. The channels may be displayed individually, or simultaneously, with results presented in either log/linear magnitude, phase, or group delay format on rectangular or polar coordinates. Direct measurement of impedance is possible with the Smith chart format. The value and frequency of the data can be read with one of five independent markers. The entire measurement trace can be copied directly to a plotter, such as the HP 7440A, 7475A, or 7550A without the need of an external computer. Also, a list of the trace values can be sent to a printer such as the HP 2225A.

Powerful measurement enhancement functions are also available. Data averaging can be employed to narrow the effective receiver IF bandwidth, extending dynamic range and increasing signal-to-noise ratio. Trace smoothing aids in the interpretation of measurement results and is used to control the aperture of group delay measurements. The equivalent of an electronic line stretcher is available with the electrical delay function.

Built-in storage provides the capability to save and recall up to eight different front panel states, eight separate calibrations, and eight separate measurements in nonvolatile memory. Extension of the internal storage capacity is possible via the built-in tape cassette unit or an external disc drive.

High Performance

Along with the capability to completely characterize a microwave network with a single connection over the extremely broad 45 MHz to 40 GHz frequency range, the HP 8510 system offers wide dynamic range. Depending on the test set used, 80 dB to 100 dB of dynamic range is available. The precision IF processing and detection system contributes as little as ± 0.05 dB and ± 0.5 degree measurement uncertainty at a level of 50 dB below the reference. Meaningful resolutions of 0.001 dB, 0.01 degree, and 0.01 nanosecond are easily available.

- 80 dB to 100 dB dynamic range
- 0.001 dB, 0.01 degree, 0.01 nanosecond measurement resolution
- Time domain analysis

"Real Time" Error Correction

The HP 8510's built-in, high speed computer provides the capability to characterize and effectively remove the impact of systematic errors through accuracy enhancement techniques. Effective directivity and source match can be improved to as much as 60 dB. The data processing speed of the system is such that a fully error-corrected, 401 point trace of data is updated in under one second. This virtual "real time" display of error-corrected data means that you can easily adjust your test device while it's being measured, with the assurance that you are viewing the data at the highest possible accuracy.

Time Domain Analysis

The HP 8510 (with option 010) has the capability of displaying the time domain response of a network, obtained by computing the Inverse Fourier Transform of the frequency domain response. The time domain response displays the reflection coefficient of the network versus time, which displays the magnitude and location of each individual discontinuity, or else the transmission coefficient versus time, which displays each individual transmission path.

RF Sources

The recommended system source for the HP 8510B is the HP 8360 synthesized sweeper. It provides 1 Hz frequency resolution, phase-locked narrowband sweeps, and fully synthesized start frequencies for broadband ramp sweeps. All HP 8360-series synthesized sweepers are compatible with the HP 8510B. However, the HP 83621A (20 GHz) and 83631A (26 GHz) models are optimized for HP 8510B system operation. Both the HP 8340-series synthesized sweeper and HP 8350B-series sweep oscillators are also compatible with the HP 8510B.

System Rack

HP 85043A System Rack Kit

The HP 85043A system rack stands 123.7 cm (48.7") high, 60 cm (23.6") wide, and 80 cm (31.5") deep. Complete with support rails and AC power distribution (suitable for 50 to 60 Hz, and 110-240 Vac), it includes rack mounting hardware for all instruments. Therman design is such that no rack fan is needed.

System Software

HP 85161A Measurement Automation Software

The HP 85161A Measurement Automation Software provides a more simplified and flexible user interface to the HP 8510B system. The program leads the operator through the measurement sequence one step at a time, from system setup and calibration, to device measurement and hardcopy output. Complete measurement configurations can be saved to disc for later recall. Also, data printout formats can be customized by the operator.

The HP 85161A software is designed for use with HP 9000 Series 200 or 300 computers and the BASIC operating system (3.0 or higher).

Ordering Information

Ordering Information	Price
HP 8510B Network Analyzer	\$34,100
Option 010 Time Domain Capability	9,800
Option W30 2 Years Additional Hardware Service	add \$670
HP 85043A System Rack Kit	2,900
HP 85161A Measurement Automation Software	1,500
Option 630 3 1/2" disc media	N/C
Option 655 5 1/4" disc media	N/C

NETWORK ANALYZERS

Test Sets

8510 Series

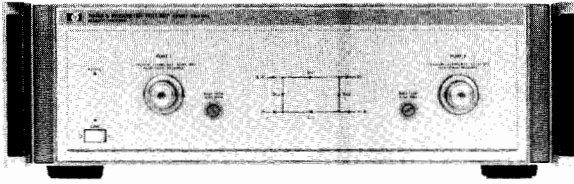

HP 8515A

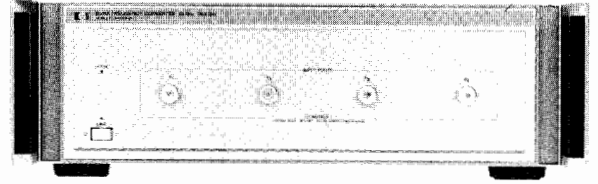

HP 8511A

S-Parameter Test Sets

Several S-parameter test sets are available for the HP 8510B network analyzer for broadband coaxial measurements from 45 MHz to 40 GHz. The HP 8514B, 8515A, and 8516A test sets have a dual port architecture which develops a separate reference channel for each incident port. RF switching is done with a single built-in electronic switch. For active device measurements, the test sets include the ability to apply DC bias (external) to the test port center conductors. Also available are two 90 dB step attenuators (60 dB in the HP 8516A) which allow control of the port 1 and port 2 signal levels.

High Dynamic Range Configurations

The HP 8514B and 8516A test sets are coupler-based. Two alternate coupler configurations are available. The standard configuration is symmetrical and has identical dynamic range performance in both forward (S21) and reverse (S12) transmission measurements. The port 1 step attenuator allows reduction of the port 1 output power for forward measurements, and the port 2 attenuator allows reduction of the port 2 output power for reverse measurements.

With the Option 003 configuration, the port 2 coupler is reversed. For forward measurements, the port 2 signal is sampled directly through the main arm of the port 2 coupler. Since coupling loss is removed, dynamic range is increased in the forward direction. Since the port 2 step attenuator is in-line with the port 2 sampler, the power incident on port 2 may be reduced. With Option 003, up to 1 Watt may be input into port 2.

Test Set General Information

	HP 8514B	HP 8515A	HP 8516A
Frequency range (GHz)	0.045 to 20	0.045 to 26.5	0.045 to 40
Test ports (port 1 or 2): Nominal operating power level (dBm)	0 to -5	-5 to -25	-10 to -20
Test Port Connector type	3.5 mm (M)		2.4 mm (M)
Impedance DC bias	50 ohm nominal 500 mA, 40 Vdc maximum		
Attenuation range (incident signal)	0 to 90 dB, in 10 dB steps (0 to 60 dB for HP 8516A)		

HP 8511A Frequency Converter

With the HP 8511A Frequency Converter, the HP 8510 becomes a general purpose four-channel magnitude/phase receiver. Add your own power splitters for transmission measurements, and bridges or directional couplers for reflection measurements. Since one input is used for system phase-lock, the other three inputs are available for measurements of multi-port devices, subsystems, and antennas. All four inputs have precision 3.5 mm (f) connectors.

Multiple Test Set Operation

A single HP 8510B system may be configured with two test sets. In this configuration, the test sets have different addresses, and the user may select between them from the front panel of the HP 8510 without reconnections. This capability is useful, for example, when combining a microwave coaxial test set with a millimeter-wave test set in the same HP 8510 system.

IF switching (option 001). In the multiple test set configuration, the 20 MHz IF signal is daisy-chained from the test sets to the HP 8510. This capability requires test set option 001 in one of the two test sets.

RF switching. The RF signal must be routed to the desired test set using an HP 33311C coaxial RF switch and an HP 11713A switch driver. The switch driver is controlled automatically by the HP 8510B over the HP 8510 system interface.

Ordering Information

	Price
HP 8511A Frequency Converter	\$19,200
Option 001: Add IF switching	add \$2,500
Option W30: 2 years additional hardware service	add \$350
HP 8514B S-Parameter Test Set	\$27,300
Option 001: Add IF switching	add \$2,500
Option 002: Delete step attenuators and bias tees	less \$6,500
Option 003: High forward dynamic range	n/c
Option W30: 2 years additional hardware service	add \$540
HP 8515A S-Parameter Test Set	\$38,300
Option 001: Add IF switching	add \$2,500
Option 002: Delete step attenuators and bias tees	less \$7,000
Option W30: 2 years additional hardware service	add \$750
HP 8516A S-Parameter Test Set	\$40,000
Option 001: Add IF switching	add \$2,500
Option 002: Delete step attenuators and bias tees	less \$7,000
Option 003: High forward dynamic range	n/c
Option W30: 2 years additional hardware service	add \$740

NETWORK ANALYZERS

Millimeter-wave Measurement System

8510 Series

239

The HP 8510B system can be easily configured for making measurements at the millimeter-wave frequencies. Hewlett-Packard offers hardware for configuring systems in the 26.5 to 40 GHz, 33 to 50 GHz, 40 to 60 GHz, 50 to 75 GHz, and 75 to 110 GHz waveguide bands. These S-parameter configurations allow both forward and reverse measurements to be made with a single connection to the device under test. The greatest convenience and highest accuracy is assured through the TRL (Thru-Reflect-Line) calibration technique, which is now possible with a millimeter-wave S-parameter configuration.

HP 85106B Millimeter-wave Network Analyzer Subsystem

The HP 85106B millimeter-wave network analyzer subsystem includes an HP 8510B network analyzer, an HP 85105A millimeter-wave controller, an HP 83621A synthesized source, an HP 8350B/83540A source (LO), and an HP 9122C dual disk drive, all mounted in a single bay rack with extendable worksurface. The HP 9122C disk drive and system set-up disk that are part of the HP 85106B system make the retrieval of system states fast and easy. System installation at your facility and one year on-site service are included with the HP 85106B at no additional cost. Two HP 85104A series test set modules are required to complete the system. Precision calibration kits and verification kits are also available for these waveguide bands.

The HP 85106B can be configured as a combination microwave/millimeter-wave S-parameter system with Option 001. This option adds an HP 8516A microwave test set, HP 85133D test port return cable set, HP 85056A calibration kit and appropriate cabling for convenient switching between mm-wave operation and microwave operation with no re-connections required.

The HP 8510B's external phase-locked control allows the use of the economical HP 8350B sweep oscillator as the local oscillator (LO) source. However, a synthesizer can also be used as the LO source when faster measurement speeds are desired. Option 002 substitutes an HP 83621A synthesized source for the HP 8350B/83540A source as the local oscillator.

Option 010 adds time domain capability to the HP 8510B for transferring frequency domain data to the time domain for observing the effects of impedance discontinuities as a function of distance or time.

HP 85104A Series Test Set Modules

An HP R/Q/U/V/W 85104A test set module contains all of the necessary waveguide hardware (frequency multiplier, isolators, directional couplers and harmonic mixers) compactly integrated into one box. Any pair of the test set modules can be connected to the HP 85105A millimeter-wave controller for S-parameter millimeter-wave measurement capability. These modules are easy to maneuver and make the system extremely simple to set-up.

HP 11644A Series Calibration Kits

Each HP R/Q/U/V/W 11644A precision calibration kit contains two straight waveguide test port sections with precision flanges, a flush short circuit, a precision quarter-wavelength shim, and a sliding or fixed load termination. In addition to providing the "offset" for the offset short and offset load, the shim is also used as the "line" standard for a TRL calibration. The standards in the kit allow you to take full advantage of the built-in accuracy enhancement and data processing features of the HP 8510B.

HP 11645A Series Verification Kits

Each HP R/Q/U/V/W 11645A verification kit contains a standard section, mismatch section, and a 20 dB and 50 dB attenuator. The devices in the kit are shipped with nominal data and uncertainties traceable to the US National Institute of Standards and Technology (NIST).

Ordering Information

	Price
HP 85106B mm-Wave Network Analyzer Subsystem	TBA
Opt 001 Add Microwave Test Set (HP 8516A) and 2.4 mm Accessories	\$50,600
Opt 002 Synthesized LO (HP 83621A) for the fastest measurement speed	\$18,900
Opt 010 add Time Domain Capability to the HP 8510B	\$9,800

Test Set Modules (order 2 each)

HP R85104A WR-28 (26.5 to 40 GHz) Test Set Module	TBA
HP Q85104A WR-22 (33 to 50 GHz) Test Set Module	TBA
HP U85104A WR-19 (40 to 60 GHz) Test Set Module	TBA
HP V85104A WR-15 (50 to 75 GHz) Test Set Module	TBA
HP W85104A WR-10 (75 to 110 GHz) Test Set Module	TBA

Calibration Kits

HP R11644A WR-28 (26.5 to 40 GHz) Calibration Kit	\$3,600
HP Q11644A WR-22 (33 to 50 GHz) Calibration Kit	\$3,850
HP U11644A WR-19 (40 to 60 GHz) Calibration Kit	\$4,200
HP V11644A WR-15 (50 to 75 GHz) Calibration Kit	\$4,200
HP W11644A WR-10 (75 to 110 GHz) Calibration Kit	\$4,400

Verification Kits

HP R11645A WR-28 (26.5 to 40 GHz) Verification Kit	TBA
HP Q11645A WR-22 (33 to 50 GHz) Verification Kit	TBA
HP U11645A WR-19 (40 to 60 GHz) Verification Kit	TBA
HP V11645A WR-15 (50 to 75 GHz) Verification Kit	TBA
HP W11645A WR-10 (75 to 110 GHz) Verification Kit	TBA

NETWORK ANALYZERS

Microwave Network Analyzer Accessories
8510, 8719/8720 Series

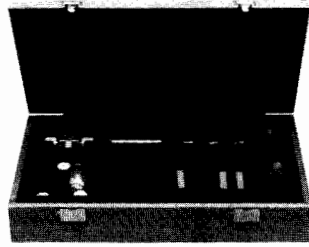

HP 85041A

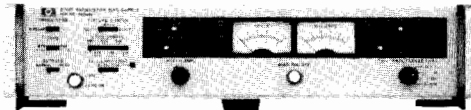

HP 8717B

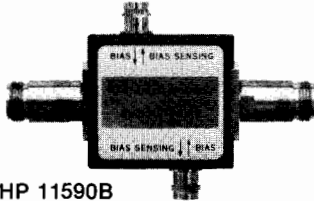

HP 11590B



HP 11612A

Active Device Test

Hewlett-Packard offers an extensive array of accessories designed for the needs of active device test and measurement, including fixtures, bias supplies, bias networks, and application software.

HP 85041A Transistor Test Fixture Kit

The HP 85041A transistor test fixture (TTF) kit is a comprehensive measurement system for testing and characterizing stripline packaged microwave transistors. Only useful when used with the HP 85014B active device measurement software.

Frequency Range: dc to 18 GHz

Transistor Package Inserts: 70 mil and 100 mil

Verification Devices: Short and through circuits

Connectors: precision 7 mm

Accessories Supplied: fixture stand, torque tool, tweezers, and lid opening tool

HP 8717B Transistor Bias Supply

The HP 8717B transistor bias supply provides manual or automatic biasing for transistor testing. This supply 8717B has two meters for independently monitoring current and voltage. Bias connections are conveniently selected for all transistor configurations with a front panel switch.

Voltage Ranges: 1,3,10,30,100 V

Current Ranges: 0.1,0.3,1,3,10,30,100,300,1000 mA

Accuracy: 4% of full scale for both current and voltage

Option 001: programmable D/A converter

Option 011: programming cable for HP Series 200/300 computers

HP 11608A Transistor Fixture

Function: provides the capability of completely characterizing stripline transistors. A through-line microstrip and bolt-in grounding structure machineable by customer is included.

Frequency range: db to 12.4 GHz.

Reflection coefficient: <0.05, dc to 4 GHz; <0.07, 4.0 to 8.0 GHz; >0.15, 8 to 12.4 GHz.

Package Styles

Opt 003: 0.205 inch diameter packages.

Calibration references: option 003 only, short circuit termination and a 50-ohm through-section.

Connectors: APC-7 hybrid.

Weight: net, 0.9 kg (2 lb); shipping, 1.4 kg (3 lb.).

Size: 25 H x 143 W x 89 mm D (1" x 5.63" x 3.5").

Bias Networks

Bias networks are available for applying DC bias to the center conductor of a coaxial line which can be connected to a device under test. The bias network also provides a DC block to the RF input port.

Bias Network	11590B	11590B Opt 001	11612A	11612B
Frequency Range (GHz)	.1-12.4	.1-18	.045-26.5	.045-50
Connectors				
RF Input	Type N (f)	7 mm	3.5 mm (f)	2.4 mm (f)
RF Output	Type N (f)	7 mm	3.5 mm (m)	2.4 mm (f)
DC Bias	BNC (f)	BNC (f)	SMB snap-on (m)*	SMB snap-on (m)*
Insertion Loss (max)	0.8 dB	0.8 dB, .1-12.4 GHz 1.2 dB, 12.4-18 GHz	0.8 dB, .045-12.4 GHz 1.3 dB, 12.4-26.5 GHz	0.8 dB, .045-12.4 GHz 1.3 dB, 12.4-26.5 GHz 26.5-50 GHz
Return Loss (min)	19 dB	19 dB, .1-12.4 GHz 14 dB, 12.4-18 GHz	20 dB, .045-8 GHz 18 dB, 8-18 GHz 14 dB, 18-26.5 GHz	20 dB, .045-8 GHz 18 dB, 8-18 GHz 14 dB, 18-26.5 GHz 10 dB, 26.5-50 GHz
Bias current (max)	500 mA	500 mA	500 mA**	500 mA
Bias voltage (max)	100V	100V	40V	40V

*Cable included, SMB(f) to BNC(m).

**Option 001 provides for 2 Amps maximum bias current over the 400 MHz to 26.5 GHz frequency range. Higher bias currents may be applied with pulsed operation.

HP 11635A Bias Decoupling Network

The HP 11635A bias decoupling network is a recommended accessory for prevention of bias oscillations when biasing microwave bipolar transistors with any HP bias network or s-parameter test set. Installing the HP 11635A between the bias supply and the base bias network prevents low frequency oscillations.

Application Software

Hewlett-Packard offers application software packages that complement the HP 8510 system providing automated calibration and measurement capability. Software is available for HP Series 200/300 desktop computers using BASIC 2.0, 3.0, 4.0 or 5.0 operating systems on both 3 1/2" and 5 1/4" disc media.

HP 85014B/C Active Device Measurement Application Pac

The HP 85014B/C software pac provides the capability for measurement of RF and microwave transistors (HP 85014B for the HP 8510B and HP 85014C for HP 8719A/8720B). Features include automated device biasing with the HP 6626A precision power supply or HP 8717B bias supply, system calibration, and de-embedding of s-parameters when using the HP 85041A transistor test fixture. It is also usable with other HP transistor fixtures as well as user-designed fixtures. Plotted and listed output of device S, H, Y, and Z parameters, as well as the device amplifier summary and termination summary are provided. Also available is the capability to store and retrieve s-parameter data in formats suitable for computer-aided-design applications.

Ordering Information

	Price
HP 85041A Transistor Test Fixture	\$5,500
HP 8717B Transistor Bias Supply	5,500
Option 001 Programmable Operation (GP-IO)	add 670
Option 011 Programming Cable	add 250
Option W30 2 Years Additional Hardware Service	add 100
HP 11590B Bias Network	675
HP 11612A Bias Network	700
Option 001 2 Amps maximum bias current	add 175
HP 11612B Bias Network	990
HP 11635A Bias Decoupling Network	275
HP 85014B/C Active Device Measurement Software	3,000
HP 11608A Transistor Fixture Customer Machineable	1,700
Option 003 0.205 inch diameter Package Style	add 450

NETWORK ANALYZERS

Microwave Network Analyzer Accessories

8510, 8719/8720 Series

241

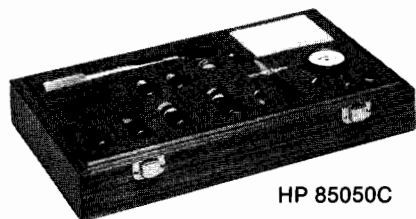

HP 85050C

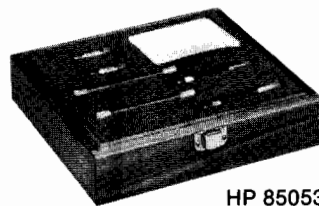

HP 85053B

Microwave Network Analyzer Accessories

A wide range of accessories is available for both the HP 8719A/8720B and the HP 8510B series network analyzers, including calibration kits, verification kits, cables, and adapters for 7 mm, 3.5 mm, Type N and 2.4 mm connector interfaces. The standards used in the 3.5 mm, Type N and 2.4 mm connectors use the precision slotless connector (PSC-3.5, PSC-N and PSC-2.4).

Calibration Kits

Error-correction procedures require that the systematic errors in the measurement system be characterized by measuring known devices (standards) on the system over the frequency range of interest. All network analyzer calibration kits contain precision standard devices to characterize the systematic errors of the HP 8719A/8720B or 8510B network analyzer system.

The calibration kits also contain adapters to change the sex of the test port, connector gages for verifying and maintaining the connector interface, and a torque wrench for proper connection. Each kit contains standards definitions contained on tape for the HP 8510B. (These definitions are already included in the HP 8719A/8720B.)

Verification Kits

Measuring known devices, other than the calibration standards, is a straightforward way of verifying that the network analyzer system is operating properly. Hewlett-Packard offers verification kits that include precision airlines, mismatch airlines and precision fixed attenuators. Traceable measurement data for all devices is shipped with each kit on disc (for HP 8719A/8720B) and on tape (for HP 8510B).

Verification kits may be recertified by Hewlett-Packard. This recertification includes a new measurement of all standards, as well as new data and uncertainties. Certification in compliance with MIL-STD 45662 is also available.

Verification Kit Summary

Verification Kit	Connector Type	Frequency Range (GHz)	Price
85051B	7 mm	.045-18	\$3,000
85053B	3.5 mm	.045-26.5	\$3,000
85055A	Type N	.045-18	\$3,000
85057A	2.4 mm	.045-40	\$4,500

Calibration Kit Summary

Calibration Kit	Connector Type	Frequency Range (GHz)	Performance Summary		Description	Price
			Directivity/Source Match at Fmax w/8719A/8720B	w/8510B		
85050B	7 mm	.045-18	45/30	52/41	Contains open and short circuits and fixed and sliding terminations.	\$4,500
85050C	7 mm	.045-18	n/a	60/60	Contains standards for TRL calibration on HP 8510B, including precision airline. Also contains open and short circuit and fixed termination.	\$5,400
85050D	7 mm	.045-18	36/30	40/35	Economy kit. Contains open and short circuits and precision-fixed termination. No gages included.	\$2,000
85052B	3.5 mm	.045-26.5	40/30	44/31	Contains open and short circuits (m and f) and fixed and sliding terminations (m and f), and in-series adapters.	\$7,500
85052D	3.5 mm	.045-26.5	36/29	36/30	Economy kit. Contains open and short circuits (m and f) and precision fixed termination (m and f), and in-series adapters. No gages included.	\$4,000
85054B	Type N	.045-18	40/30	42/32	Contains open and short circuits (m and f) and fixed and sliding terminations (m and f), in-series adapters, and 7mm to type N (m and f) adapters.	\$8,000
85054D	Type N	.045-18	34/28	34/28	Contains open and short circuits (M and F) and broadband fixed terminations, in series adapters, and 7mm-to-type N (M and F) adapters.	\$4,900
85056A ¹	2.4 mm	.045-40	n/a	38/33	Contains open and short circuits (m and f) and fixed and sliding terminations (m and f), in-series adapters, and 7mm to type N (m and f) adapters.	\$9,000
R11644A	WR-28	26.5-40	n/a	50/45	Contain flush short circuit, a precision shim used to make the offset short, and a sliding (R,Q,U) or fixed (V,W) termination. Also contain two straight sections with precision flanges.	\$3,600
Q11644A	WR-22	33-50	n/a	50/45		\$3,850
U11644A	WR-19	40-60	n/a	50/40		\$4,200
V11644A	WR-12	50-75	n/a	50/37		\$4,200
W11644A	WR-10	75-100	n/a	46/36		\$4,400

¹For measurements in the K-connector, order the HP 85056A 2.4mm calibration kit and the HP 11904S adapter kit.

NETWORK ANALYZERS

Microwave Network Analyzer Accessories (cont'd) 8510, 8719/8720 Series

Test Port Return Cables and Adapters

Test port cables and adapter sets are available for various connector types. The cable/adapter configurations are described below. All cables are designed with one end that connects directly to the special ruggedized ports of the network analyzer test set, and one end that connects to the device under test.

Special test port adapter sets are also available to convert the ruggedized ports of the network analyzer test set to the desired connector interface. Each kit contains two adapters, one male and one female.

Both the cables and the special adapters have one special female connector which is designed to connect directly to the 3.5 mm test port (2.4 mm for HP 8516A). This side of the cable or adapter can only be connected to the test set port, and cannot be mated to a standard 3.5 mm (or 2.4 mm) male connector. The male test set ports, however, can be mated to a standard 3.5 mm (or 2.4 mm) female connector.

Choose one of the configurations shown.

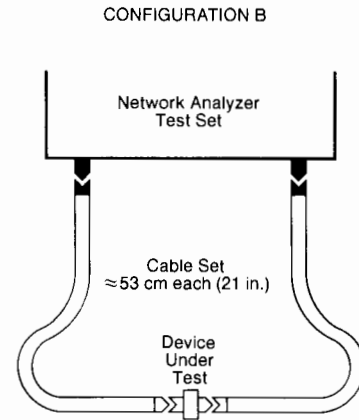
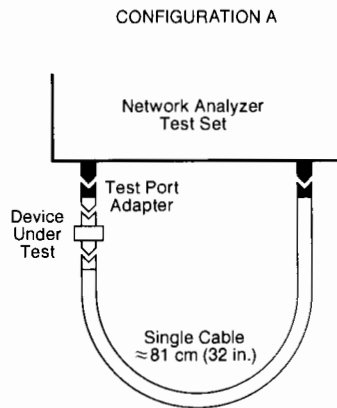

Configuration A For HP 8719A/8720B Network Analyzer or HP 8514B/8515A Test Sets (3.5 mm test port)

	Cables/Adapters	Connector Type (on device side of cable/adapter)	Price
For 3.5 mm devices	85131C Semi-rigid Cable or 85131E Flexible Cable	3.5 mm (f)	\$700
	85130D Adapter Set ^a	3.5 mm (m or f)	\$990
	85132C Semi-rigid Cable or 85132E Flexible Cable	7 mm	\$600
For 7 mm devices	85130B Adapter Set	7 mm	\$1,600
	85130C Adapter Set	Type N (m or f)	\$700
For Type N devices	Use 7 mm cables and the 7 mm to N adapters included in the HP 85054B 10 calibration kit.		—

a. Recommended but not required.

Configuration A For HP 8516A Test Set (2.4 mm test port)

	Cables/Adapters	Connector Type (on device side of cable/adapter)	Price
For 2.4 mm devices	85133C Semi-rigid Cable	2.4 mm (f)	\$900
	85130G Adapter Set ^a	2.4 mm (m or f)	\$990
For 3.5 mm devices	85134C Semi-rigid Cable or 85134E Flexible Cable	3.5 mm (f)	\$700
	85130F Adapter Set	3.5 mm (m or f)	\$1,800
	85135C Semi-rigid Cable or 85135E Flexible Cable	7 mm	\$990
For 7 mm devices	85130E Adapter Set	7 mm	\$600
	85130E Adapter Set	7 mm	\$1,600

a. Recommended but not required.

Configuration A. This cable arrangement is for applications where the device under test is connected directly to the test set port. This setup offers the best mechanical rigidity for device connection. To adapt the test set port (port 1) to the device under test, choose the appropriate special adapter set. Besides converting the test port to the desired interface, these adapters also function as "test port savers" which protect the test set from damage and wear due to heavy use.

Configuration B. This cable arrangement is for applications where the device under test is connected between cable ends. This setup offers more flexibility when connecting to the device under test. Choose semi-rigid or flexible cables.

The cables for 3.5 mm and 7 mm devices are available as semi-rigid cables, offering excellent performance and suitable for applications where the connectors of the device under test are in-line, or as super-flexible cables which are more rugged and have a tighter bending radius, ideal for manufacturing environments. The semi-rigid cables carry a 90-day warranty, whereas the flexible cables are warranted for one full year.

Configuration B For HP 8719A/8720B Network Analyzer or HP 8514B/8515A Test Sets (3.5 mm test port)

	Cable Set	Connector Type (on device side of cables)	Price
For 3.5 mm devices	85131D Semi-rigid Cable Set or 85131F Flexible Cable Set	3.5 mm (one male, one female)	\$1,200
		3.5 mm (one male, one female)	\$2,800
For 7 mm devices	85132D Semi-rigid Cable Set or 85132F Flexible Cable Set	7 mm	\$1,000
		7 mm	\$2,600
For Type N devices	Use 7 mm cables and the 7 mm to N adapters in the 85054B 10 calibration kit.		—

Configuration B For HP 8516A Test Set (2.4 mm test port)

	Cable Set	Connector Type (on device side of cables)	Price
For 2.4 mm devices	85133D Semi-rigid Cable Set	2.4 mm (one male, one female)	\$1,600
For 3.5 mm devices	85134D Semi-rigid Cable Set or 85134F Flexible Cable Set	3.5 mm (one male, one female)	\$1,200
		3.5 mm (one male, one female)	\$2,800
For 7 mm devices	85135D Semi-rigid Cable Set or 85135F Flexible Cable Set	7 mm	\$1,000
		7 mm	\$2,600

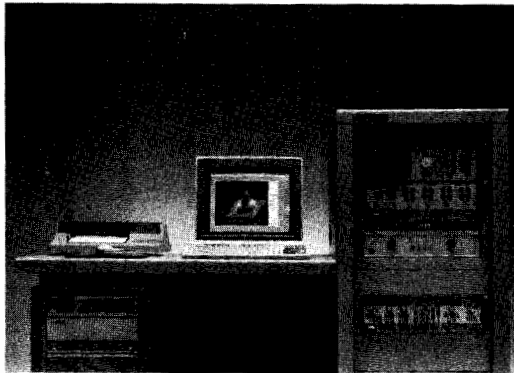

HP 85301A

HP 85301A Antenna Measurement System

The HP 85301A Antenna Measurement System is an integrated system, which includes all of the RF measurement instrumentation, workstation controller, and system software necessary to perform far field antenna pattern measurements. The system includes installation, training, and one year on-site support.

The exact system configuration depends on performance requirements and antenna range. Two frequency converter options are available; the HP 85310A Distributed Frequency Converter and the HP 8511A Frequency Converter are summarized below. For detailed information, refer to the HP 85301A Antenna Measurement System technical data sheet and configuration guide.

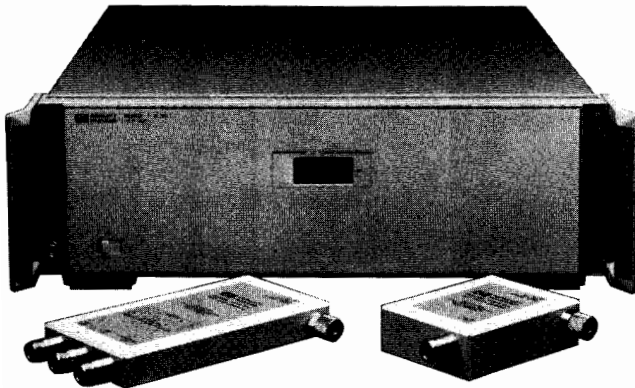

HP 85310

HP 85310A Distributed Frequency Converter

The HP 85310A Distributed Frequency Converter provides a high-sensitivity frequency converter which can be remoted from the HP 8510B network analyzer. The HP 85310A Distributed Frequency Converter consists of an HP 85309A LO/IF distribution unit, one HP 85320A test mixer module, and one HP 85320B reference mixer module. The standard converter provides one phase-lock reference channel and one test channel; an optional second test channel is also available. Standard frequency coverage is 1GHz to 26GHz, extendable to 110GHz.

HP 8511A Frequency Converter

When used with the HP 8511A Frequency Converter, the HP 8510B network analyzer provides high-performance measurements from 45 MHz to 26.5 GHz. The HP 8511A contains four separate RF-to-IF converters, all of which can operate over the entire dynamic range of the system.

HP 8511A Options H40 and H41 both extend the frequency coverage to 40GHz. HP 8511A Option H40 is best suited for indoor far field antenna measurements. HP 8511A Option H41 also includes an internal, switched doubler to provide a 0.045 to 40 GHz test signal using a 20 GHz synthesized source. The HP 8511A Option H41 frequency converter must be located close to the synthesizer and is therefore best utilized in RCS measurement configurations.

HP 85360A Antenna Measurement Software

The HP 85360A Antenna Measurement Software automates the HP 8510B for acquisition, presentation, and storage of far field antenna radiation patterns. One day of on-site customer training is provided with the software.

Feature Summary

Acquisition modes	Data presentation	Data analysis
Single axis	Real time plot	Peak gain
Dual axis	Rectangular	Half power
CW frequency	Log magnitude	Beam width
Multiple CW frequency	Phase	Target
Swept frequency	Polar	Beamwidth
Dual parameter	Log magnitude	Trace math
Batch mode	3-Dimensional	Interactive markers
Gain horn calibration	Contour	
	Waterfall	Delta markers

HP 85320A Test Mixer Module

HP 85320B Reference Mixer Module

The HP 85320A/B mixer modules are part of the HP 85310A distributed frequency converter, and they provide high-performance, weatherproof downconverters for use in antenna and RCS measurement systems. The HP 85320A is configured as a mixer module for the antenna under test with a built-in LO/IF diplexer to facilitate the use of a single channel rotary joint and to simplify cabling requirements. The HP 85320B is configured as a mixer module for a reference antenna, and it uses an integral leveling detector for LO source power leveling. Both modules are EMI shielded for additional isolation.

HP 85380A Weatherproof Enclosure

The HP 85380A weatherproof enclosure is designed to protect the HP 85309A LO/IF distribution unit from inclement weather. The enclosure can accommodate up to two LO/IF distribution units. Included with the enclosure are interconnect cables for one LO/IF distribution unit, mounting base plate, and one twist-lock ac power cord connector.

HP 85381A/B/C Microwave Cable

The HP 85381-series microwave cables should be used for the connections between the HP 8510B, LO source, HP 85310A, and HP 85320A/B mixer modules. Refer to the HP 85300A-series configuration guide for detailed information.

Ordering Information

	Price
HP 85301A Antenna Measurement System	Contact HP
HP 85310A Distributed Frequency Converter	\$28,750
Opt H01 Additional test channel. Consists of an HP 85309A Option H01 LO/IF distribution unit and one additional HP 85320A test mixer module.	Contact HP
Opt 908 Adds rack mount kit	+\$32
Opt 913 Adds rack mount kit with handles	+\$35
HP 85360A Antenna Measurement Software	\$19,500
Opt 001 Adds Series 300 Model 332 Controller, HP 98785A 16-inch color monitor, HP 46060A HP-HIL mouse, HP 9153C 20 Mbyte hard disk. Factory software installation included.	\$12,445
Opt 002 Adds Series 300 Model 360 Controller, HP 98752A 19-inch color monitor, HP 46060A HP-HIL mouse, HP 7957B 81 Mbyte fixed disk drive. Factory software installation included.	\$23,580

For ordering information on accessory products, refer to the HP 85301A system configuration guide.

LOGIC ANALYZERS

General Information

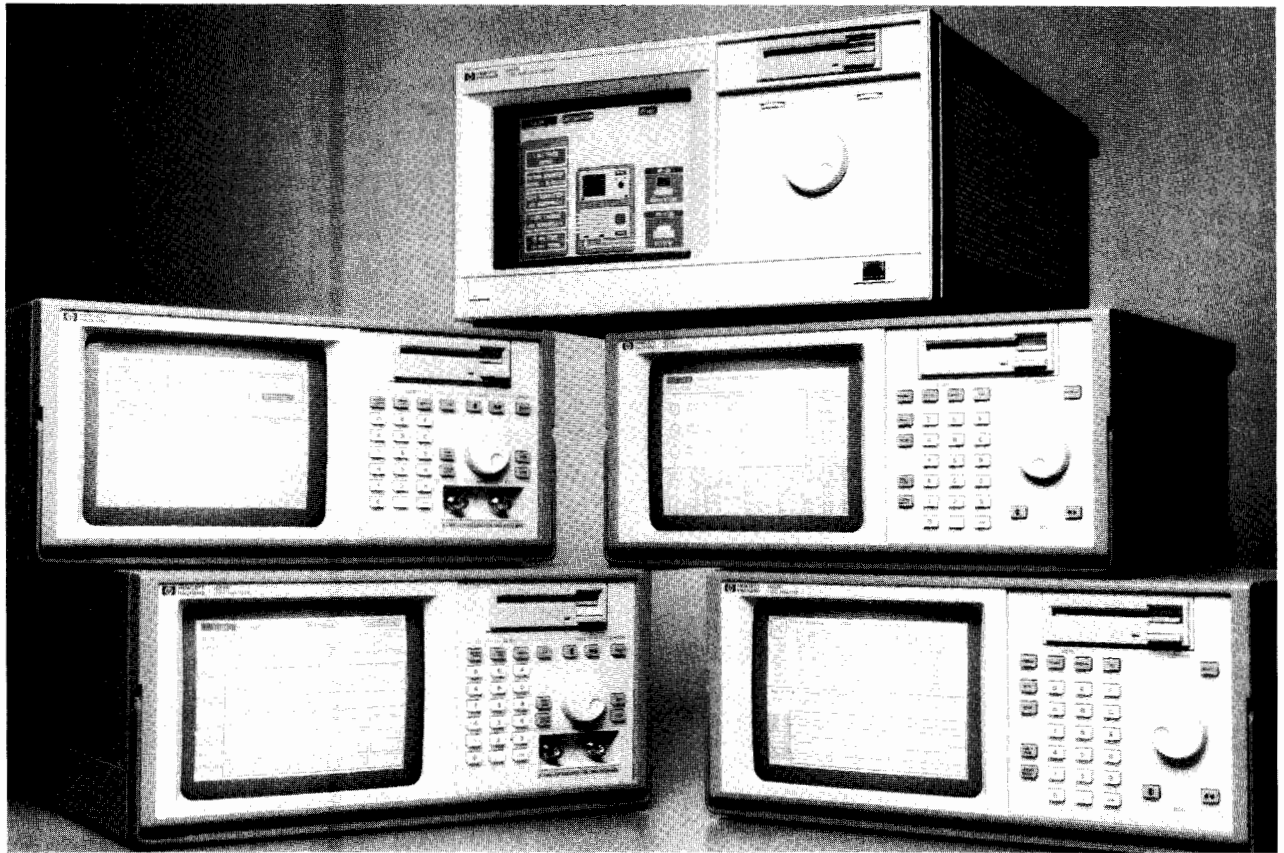

HP Family of Logic Analyzers



The HP Family of Logic Analyzers

HP offers you a wide selection of logic analyzers tailored to meet your measurement needs. HP logic analyzers support such diverse applications as software and hardware debugging, software performance analysis, hardware characterization, prototype verification, system integration, low-volume manufacturing test, and failure analysis. HP is committed to providing you with the tools you need to design, to characterize, and to debug digital systems.

Value

HP logic analyzers offer value. In addition to the price and performance offered by HP logic analyzers, you can rely on Hewlett-Packard's traditional reliability and quality for low cost-of-ownership.

Option W30 adds to product warranty to provide 3 years of customer return repair service from the time of hardware delivery. When you purchase option W30, Hewlett-Packard provides you with all labor, parts, and materials necessary to maintain your product in good operating condition. In addition, Hewlett-Packard performs preventative maintenance and installs factory-recommended improvements and modifications,

when appropriate, at the time of product repair. You can get assistance when and where you need it with the HP worldwide sales and support organization.

Ease-of-Use

Set up measurements quickly using the HP 16500A touch screen. Make analysis of results easier by creating your own label names and channel assignments. To change a parameter, simply point to the field you need to change, then enter the value with a pop-up keypad or knob. Automatically configure the instrument to a predetermined state upon turning on the instrument.

Use Different Measurement Modules to find the Problem

When the symptom can be captured, but the problem is not identified, use the intermodule bus to trigger other measurement modules to help find the problem. For example, you might find a glitch with the timing analyzer, but cannot tell what is causing the problem. Is it noise or ringing? By triggering the oscilloscope with the timing analyzer, you can get a picture of the event and can more quickly identify its cause.

See Analog Phenomena with a Built-in Scope

You rely on a scope for the toughest parametric measurement tasks. So why not get a scope in a logic analyzer? Only Hewlett-Packard offers a scope with every type of logic analyzer, from the 32-channel HP 1653B logic analyzer to the HP 16500A logic analysis mainframe. Get a full 100 MHz analog bandwidth (400 MSa/s) oscilloscope with the digitizing advantages of waveform storage and recall, automatic measurements and markers, and powerful logic triggering. In addition, you get up to 80 channels of full-feature state or timing for much less than the instruments would cost separately.

Make Measurements Quickly with a Wide Range of HP Microprocessor and Bus Support

Hewlett-Packard offers broad support for busses, interfaces, and microprocessors. Support includes inverse assembler software and quick connection probes for most popular processors. If your design includes a proprietary processor, you can create your own inverse assembler, or have Hewlett-Packard design a custom solution. See pages 248 and 249 for microprocessor support details.

Unmatched Compatibility

Compatibility protects your investment because you can use any of HP's analyzers to make your measurement. Most preprocessors are compatible with every HP analyzer, as are configuration files and data files.

All HP logic analyzers use the same user interface concepts. If you are familiar with one instrument, you will find the same functions in the same place on other models.

Programmability is the same for all models. You do not need to learn new commands or constructs when changing models. Programs written for the HP 1650B run on the HP 16510B.

Many analyzers can be upgraded to include more powerful measurement features. For example, the HP 1651B 32-channel 25 MHz state/100 MHz timing analyzer can be upgraded to the HP 1653B state/timing analyzer with a 100 MHz bandwidth Oscilloscope, while the HP 16510A can be upgraded from 25 MHz to 35 MHz state analysis. See page 273 for upgrade kits information.

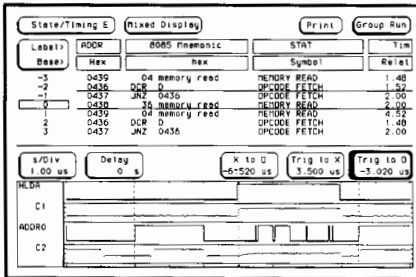

State, Timing and Oscilloscope Time correlated on the same display.

State and timing data is compatible across all logic analyzer models. You can transfer important information with ease. When you capture data with a portable HP logic analyzer, you can display and analyze it with the HP 16500A logic analysis system. You can also use captured data in the digital pattern to reduce functional test development time.

ALL state and timing analyzer data can also be translated and transferred to many popular simulators and testers... automatically. The data you capture with your HP logic analyzer can be automatically transferred to popular workstations and analyzed, or it can be transferred to ASIC verification, board, and IC testers.

A Computer in Each Analyzer

Compact, portable analyzers mean that you have measurement power where you need it. At the heart of each HP analyzer is a

powerful 16-bit processor dedicated to quickly making and displaying measurements. You do not need to tie up a personal computer in order to make measurements, and portability is increased.

If you need to put measurement data into your personal computer memory, Hewlett-Packard provides the documentation to make it easy. Ask your HP sales representative for "HP's Logic Analyzer and Personal Computer Programming Series" (HP Pub No. 5952-4241).

Powerful State Triggering

HP logic analyzers have complex state triggering to filter unnecessary data and provide you with only the data you need for your measurement. Up to five clocks or qualifiers can be used to determine exactly when to sample. Eight full-featured sequence levels, each with storage qualification, branching, and complex pattern triggering, allow you to store only the data you need. Eight pattern recognizers and a range term offer the flexibility to extract data from complex code. Tag time or events to keep track of how and when your code is executed.

Quickly Store or Recall Setups and Data

Store measurements and configurations to the built-in disk drive(s). Use auto-load to recall a specific configuration when turning on the instrument. Use the disk to store information captured from a remote location, then examine the error in more detail on another HP logic analyzer in the lab.

HP-IB and RS-232: Standard on Every Analyzer

Both HP-IB and RS-232 ports are standard on each instrument. You can program any analyzer from either interface, while using the other interface to control a printer. Upload measurement data to your computer quickly for additional analysis.

Complete Package

The price of each HP logic analyzer includes all you need to start making measurements, including general-purpose probing,

grabbers, and software. Your preprocessor also includes everything you need to make measurements on your processor, including probing and inverse assembly software.

Instant Documentation

With the push of a button, you can document results professionally with the standard hardcopy feature. Documentation helps you trace your steps and communicate findings to others. Either the HP-IB or RS-232 port can be assigned to control a printer. The HP 16500A supports HP DeskJet, LaserJet, PaintJet, ThinkJet, QuietJet, and Epson printers (such as the RX-80, RX-100, MX-80 and the MX-100).

Links to Simulation, Manufacturing Test

Transfer and translate simulation vectors to the HP 16500A pattern generator and state analyzer to perform functional prototype analysis. Or, capture data from known good boards and transfer that information to board testers, or transfer the information back to the simulator.

Lightweight, Flexible Probes

Lightweight, flexible passive probes make connection to the target system easier than ever. There are no heavy active pods to dislodge the probing scheme at the wrong time. Cooling is not a problem because the passive probes do not generate heat.

Loading at the point of contact with your circuit is 100 K Ω shunted by 8 pF capacitance. Passive probing provides excellent impedance over a wide frequency range. And the low capacitance loading means that critical edges are not affected by probing. Hewlett-Packard's complete general-purpose probing solution comes standard with each analyzer. See page 264 for information on connectors that make it easy to interface to your design.

Identify Performance Bottlenecks

The HP 10390A system performance analysis software adds three measurements to HP state analyzers. The state histogram and state overview measurements display the intensity of activity in specific areas of memory or identify modules that are prime targets for optimization. The time interval measures execution time of a module, time between calls to a module, or time between two different modules.

LOGIC ANALYZERS

Selection Guide

The following selection guide is an overview of the HP logic analyzers. It has two sections. The first section lists the portable

logic analyzers, and the second section lists logic analysis systems.

For more information on features and benefits, refer to the individual product sections on the following pages.

Portable Logic Analyzers

	HP 1650B	HP 1651B	HP 1652B	HP 1653B
Timing analysis rate	100 MHz	100 MHz	100 MHz	100 MHz
State analysis maximum input clock	35 MHz	25 MHz	35 MHz	25 MHz
Number of channels	80	32	80	32
Number of clocks/qualifiers	5	2	5	2
Trigger width	80 channels	32 channels	80 channels	32 channels
Minimum detectable glitch width	5 ns	5 ns	5 ns	5 ns
Sequence levels – STATE	8	8	8	8
Storage-data/configuration	3.5 Inch disk	3.5 Inch disk	3.5 Inch disk	3.5 Inch disk
Printer control/screen copy/programmable	RS232/HP-IB	RS232/HP-IB	RS232/HP-IB	RS232/HP-IB
100 MHz oscilloscope	Upgradable-HP 10449A	Upgradable-HP 10449A	2 channels	2 channels

Logic Analysis Systems

HP 16500A

5-slot mainframe
9-inch color display
Touch screen or mouse control
2 - 3.5 Inch disk drives
Inter-card triggering via intermodule bus
Screen hardcopy via RS232 + HP-IB
Programmability via RS232 + HP IB
Simultaneous display of state timing, and oscilloscope traces
Links to CAE and manufacturing testers

HP 16510B

80 channels/card
Up to 5 cards/16500A
100 MHz sampling for timing analysis
35MHz maximum input clock in state analysis
Detects glitches as small as 5 nsec
Simultaneous state/timing analysis
HP 16511B
Combines 2 HP 16510B Systems
Triggers up to 160 channels wide

HP 16515/516A

1 GHz timing analysis
16 channels/card
Up to 80 channels with full capability/16500
1 ns resolution
8 Kbit/channel memory
HP 16520/521A
50 Mbits/sec pattern generator
Up to 204 channels/16500A
ECL and TTL output
Can be combined with 16510B or 16515/516A for stimulus/response testing

HP 16530/531A

Oscilloscope timebase and acquisition
Up to 8 input channels per 16500A
Can be triggered by state or timing analysis
400 Msamples/sec for 100 MHz bandwidth for single-shot and repetitive signal analysis
Automatic measurements and statistics

This page shows some examples to indicate the breadth of measurement applications served by HP logic analyzers. Each menu depicts different applications made using an HP logic analyzer.

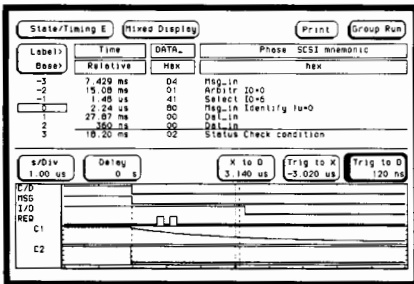

Using the HP 16500A, you can display state listing, timing diagrams and oscilloscope waveforms from the same menu. In this case, data captured from a SCSI device is displayed.

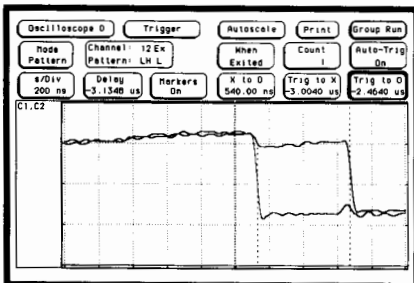

The HP 1652B/1653B and the HP 16530A/16531A are full-featured oscilloscopes embedded in logic analyzers. In addition to time-correlated measurements with the timing and state analyzers, you can use the oscilloscopes for precision time interval and voltage measurements.

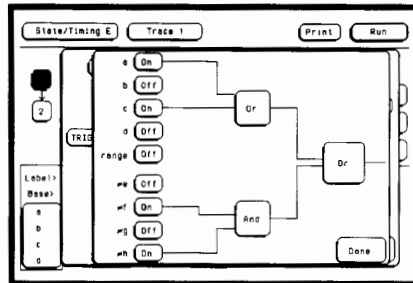

Powerful state triggering lets you locate the problem quickly. Here, resource terms are combined to create a complex trigger words. Pop-up menus make it easy to move around the analyzer.

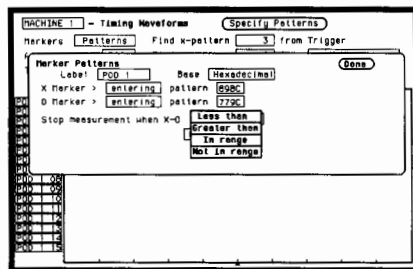

Postprocessing lets you set up measurements to detect timing violations. In this case, when the time between patterns violates a user-specified time, the analyzer stops acquiring data and displays the results.

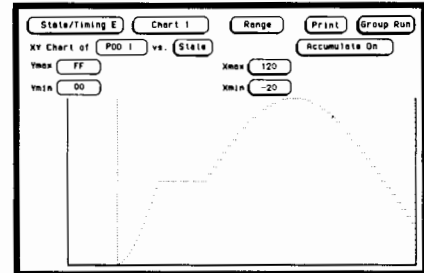

Chart mode lets you display digital data on an X-Y chart. Here, digital data captured from an analog-to-digital converter is displayed, allowing you to quickly find a discontinuity.

State/Timing E

Listing 1

Print Run

Markers Pattern Find o-pattern 1 from Trigger

Pattern

Label	addr	data	Type of Transfer	op
13	0000100H	207C001CH	Block Write	0
			System Reserved Address Modifier Code	
14	0000100H	0000100CH	Data NOT Transferred	0
			Block Write	
			System Reserved Address Modifier Code	
15	0000100H	000051CFH	Block Write	0
			System Reserved Address Modifier Code	
16	0000100H	FFF3323CH	Block Write	0
			System Reserved Address Modifier Code	

Hewlett-Packard offers broad microprocessor support. Here, an HP 16500A logic analysis system with an HP 16510B module is decoding VME bus instructions. See page 250 for bus and preprocessor information.

LOGIC ANALYZERS

Microprocessor and Bus Support

Simplified Data Interpretation and Interconnections

Hewlett-Packard offers broad support for microprocessors, microcontrollers, interfaces, busses, and digital signal processors. Support includes inverse assemblers, which display target system activity in easy-to-understand mnemonics, and single-probe connection schemes for most processors.

If your design includes a custom processor, or ASIC, you can use the user-definable inverse assembler and microprocessor interface kit to develop your own support package.

Additional software tools enable you to identify software bottlenecks in your system. The system performance analysis package (SPA) can help you find out where your system is spending its time.

HP Support for Your Custom Processors

The U.S. Project Center (USPC) in Fullerton, California, offers consulting services

for a variety of needs. The USPC can customize hardware and software for application-specific requirements, enabling you to connect HP logic analyzers to your target system. For more information on HP Project Centers, see page 732 or contact your HP sales representative.

HP Support for the Newest Processors

Hewlett-Packard has the resources and commitment to support the newest microprocessors. Hewlett-Packard works with semiconductor vendors to ensure that, as processors become available for development, you can use your HP logic analyzer to integrate them into your new system. If your processor is not listed in the table below, contact your HP sales representative to determine its support status.

Additional Microprocessor Support through Third Parties

Hewlett-Packard works with a variety of third parties to provide the most complete

support. Hewlett-Packard recognizes that other vendors offer products to enhance your measurement solutions. Emulation Technology, Inc, of Santa Clara, California, provides a complete line of probing accessories for popular microprocessors. Tasco Electronics Services, of Anaheim, California, provides complete support for selected microprocessors.

How to Calculate your System's Bus Rate

The logic analyzer state speed required to capture data from a microprocessor system depends on its bus rate. Bus rate is a function of microprocessor clock speed, which varies for different microprocessors. Complex instruction set computers (CISC) typically require two to four clock cycles per bus cycle. Many reduced instruction set computers (RISC) require one clock cycle per bus cycle. Data showing the minimum clock cycles per bus cycle is shown for each HP-supported processor listed in the tables below.

Microprocessor (Package Type)*	Logic Analyzers Supported	Number of Pods Used	Fastest Clock Rate Supported	Minimum Clock Cycles/Bus Cycle	10269C Required	Ordering Number*	Price
Advanced Micro Devices (AMD)							
Am29000 (PGA)	HP 1650A/B, HP 16510A/B	5, 8 or 9	50 MHz CLKIN	2	No	[3]	\$1800
GTE							
65816 [5]	HP 1650A/B, HP 16500A/B	3	All	N/A	No	[5] [6]	Factory supplied-contact your HP representative
Hitachi							
64180 (DIP)	HP 1650A/B, HP 16510A/B	3	All	N/A	No	10336G	\$590
64180 (PLCC)	(HP 1651A/B Limited)	3	All	N/A	No	10336H	\$1160
6301/6303 (DIP)	HP 1651A/B, HP 1650A/B, HP 16510A/B	2	All	N/A	No	10335G	\$590
Intel							
MCS-51 (DIP) [1]	HP 1650A/B, HP 1651A/B, HP 16510A/B	2	16 MHz CLKIN	12	Yes	[3]	\$1900
MCS-96 (PLCC/PGA) [2]	HP 1650A/B, HP 16510A/B	3	12 MHz	2	Yes	[3]	\$2450 (PLCC) \$1950 (PGA)
8080	HP 1651A/B, HP 1650A/B, HP 16510A/B	2	All	N/A	No	[5] [6]	Factory supplied-contact your HP representative
8085 (DIP)	HP 1651A/B, HP 1650A/B, HP 16510A/B	2	12 MHz CLKIN	3	Yes	10304B	\$880
8086/8088 (DIP)	HP 1650A/B, HP 16510A/B	3	10 MHz CLKIN	4	Yes	10305B	\$1235
80186/80188 (LCC)	HP 1650A/B, HP 16510A/B	3	16 MHz CLKIN	4	Yes	10306B	\$2000
80186 (PGA)	HP 1650A/B, HP 16510A/B	3	25 MHz CLKIN	4	No	10306G	\$700
80286 (LCC/PGA)	HP 1650A/B, HP 16510A/B	3	20 MHz CLKIN	4	Yes	10312D	\$2040
80386 (PGA)	HP 1650A/B, HP 16510A/B	5	66 MHz CLKIN	4	Yes	10314D	\$2200
80386SX (PQFP) and 80376 (PGA)	HP 1650A/B HP 16510A/B	5	All	4	No	[5]	Factory supplied-contact your HP representative
80486	HP 1650A/B HP 16510A/B	5	33 MHz	1	No	E2403A	Contact your HP representative
i860	HP 16511B	8	25 MHz	2	No	E2405A	Contact your HP representative

*See page 250 for footnotes

Quick, Reliable, Complete Connections with Target Systems and HP's Logic Analyzers

HP microprocessor support offers you a quick, reliable connection to your target system. HP preprocessors are the mechanical and electrical connection between your target system and HP logic analyzers. They provide reliable, correct, fast and convenient connections to your system. HP preprocessors are engineered to provide low capacitance probing, so your target system will not be disturbed. HP provides all clocking and demultiplexing circuits to correctly capture

your system operation. Additional status lines are provided to further decode the operation of your processor.

Microprocessor Support: the Window to System Behavior

Analyze the code in your microprocessor-based system while operating at full clock speed. HP microprocessor support allows you to follow the path of your software without intrusion, from power-up through interrupts to fatal system crashes.

Inverse assembly software translates logic levels captured by the logic analyzer into

microprocessor mnemonics that you are already familiar with. The resulting display can easily be compared to original assembly language listings to track down software defects.

Most preprocessors include an inverse assembler disk. When loaded into the logic analyzer from the internal disk drive, this software configures the instrument for use with your microprocessor and transforms acquired address, data, and status of each state into microprocessor mnemonics.

Microprocessor (Package Type)*	Logic Analyzers Supported	Number of Pods Used	Fastest Clock Rate Supported	Minimum Clock Cycles/Bus Cycle	10269C Required	Ordering Number*	Price
MIPS							
R3000 (PGA)	HP 16510A/B	7	17.5 MHz	1	No	E2401A	Contact your HP representative
Motorola							
146805E2 [5]	HP 1651A/B, HP 1650A/B, HP 16510A/B	2 (3 for Port A/Port B signals)	All	N/A	No	[5] [6]	Factory supplied-contact your HP representative
56000 [5]	HP 1650A/B, HP 16510A/B	3	All	N/A	No	[5]	Factory Supplied-contact your HP representative
6800/6802 (DIP)	HP 1651A/B, HP 1650A/B, HP 16510A/B	2	2 MHz CLK	2	Yes	10307B	\$1110
6803 [5]	HP 1651A/B, HP 1650A/B, HP 16510A/B	2	All	N/A	No	[5] [6]	Factory supplied-contact your HP representative
6809/6809E (DIP)	HP 1650A/B, HP 16510A/B, HP 1651A/B	2	2 MHz CLK	2	Yes	10308B	\$1110
68008 (DIP)	HP 1650A/B, HP 16510A/B	3	10 MHz CLK	4	Yes	10310B	\$1110
68000/68010 (DIP)	HP 1650A/B, HP 16510A/B	3	12.5 MHz CLK	4	Yes	10311B	\$1320
68000/68010 (PGA)	HP 1650A/B, HP 16510A/B	3	12.5 MHz CLK	4	No	10311G	\$600
68020 (PGA)	HP 1650A/B, HP 16510A/B	5	25 MHz CLK	3	No	10313G	\$850
68030 (PGA)	HP 1651A/B, HP 1650A/B, HP 16510A/B	5	25 MHz CLK	2	No	10316G	\$875
68HC11 (DIP)	HP 1651A/B, HP 1650A/B, HP 16510A/B	2	8.4 MHz CLK	2	No	10315G	\$750
68HC11 (PLCC)	HP 1651A/B, HP 1650A/B, HP 16510A/B	2	8.4 MHz CLK	2	No	10315H	\$1500
88000	HP 1650A/B, HP 16510A/B	5	35 MHz CLK	1	No	E2400A	\$1200
National Semiconductor							
NSC800	HP 1651A/B, HP 1650A/B, HP 16510A/B	2	All	N/A	Yes	10303B	\$1010
NS32532, 32GX532	HP 1650A/B, HP 16510A/B	5	60 MHz	2	Yes	[3]	\$2950
NS 32016 [5]	HP 1650A/B, HP 16510A/B	3	All	N/A	No	[5]	Factory Supplied-contact your HP representative
NEC							
7810/11	HP 1650A/B, HP 16510A/B	3	All		N/A	[5]	Factory Supplied-contact your HP representative
Rockwell International							
6502 [5]	HP 1651A/B, HP 1650A/B, HP 16510A/B	2	All	N/A	No	[5] [6]	Factory Supplied-contact your HP representative

LOGIC ANALYZERS

Microprocessor and Bus Support (continued)

Backplane and Bus Interfaces

Backplane and interface standards are becoming more common. They minimize hardware design efforts while increasing the complexity of systems that designers can assemble. This has created a need for better system integration tools. Hewlett-Packard has led the way in providing tools for bus and interface analysis with support for standards such as MIL-STD-1553A/B, SCSI, VME, and RS-232C.

Interactions Between Modules and the CPU

Your new peripheral board won't work with the computer. Is it a hardware or software problem? Use HP bus preprocessors to examine code flow and find the symptoms of the problem. Then use timing analysis to determine whether your system meets timing specifications.

Examine and Correlate Analog Behavior with a Built-in Scope Capture single shot analog events with the 400 MS/s digitizing oscilloscope. The bus analyzer can be used to trigger the oscilloscope so that you can capture pre- or post-trigger data.

Monitor Bus Hardware and Information Flow

The HP 10342B bus preprocessor provides analysis capabilities for three popular interface busses: HP-IB (Hewlett-Packard's implementation of IEEE-488-1978), RS-

232C/CCITT v.24, or RS-449. This package gives you software that sets up the analyzer for the measurement at hand, a complete view of asserted control lines, and conversion of the captured data into easy-to-understand mnemonics.

Mil-Standard 1553A/B Bus Analysis

The HP 10341B bus monitor provides complete mechanical and electrical connection between your MIL-STD-1553A/B bus system and your HP logic analyzer. The preprocessor acts as a monitor and does not take up an address slot on the bus. You can trigger on specific types of bus error, such as parity or Manchester error, then use the logic analyzer's built-in scope to view pre-trigger bus activity.

Small Computer Systems Interface (SCSI) Analysis

Capture and analyze command sets and data activity for most 8-bit SCSI devices as specified in the SCSI Standard X3t9.2/86-109 Revision 2. The preprocessor allows you to use the logic timing analyzer to check for timing violations. You can also use the built-in oscilloscope to examine control or data lines in detail. To use an HP logic analyzer monitor both the CPU and the SCSI bus at the same time to correlate data transfer accuracy. One state analyzer monitors the SCSI bus while the other captures micropro-

cessor data flow. All data can be displayed in time-correlated interleaved state listings.

Minicomputer Interfaces for Popular Busses

When you need to monitor the flow of information from card to card in a minicomputer, turn to HP minicomputer interfaces. These modules plug into the minicomputer backplane to give the logic analyzer access to the important address, data, and control lines that transfer information between slots in the card cage. Each card buffers the signals from the backplane and generates the proper clocking signals for the logic analyzer. In addition, switches on each card filter unwanted bus cycles, so that only the information of interest is sent to the logic analyzer.

VME Bus Analysis

Capture activity on your A or B size VME backplane with the HP 10344A/B preprocessor. The preprocessor acts as an extender card in your system and lets you monitor bus activity between modules without interruptions. All VME bus operations are displayed. Data rates of greater than 50 MB/s can be monitored.

Microprocessor (Package Type)	Logic Analyzers Supported	Number of Pods Used	Fastest Clock Rate Supported	Minimum Clock Cycles/Bus Cycle	10269C Required	Ordering Number	Price
Texas Instruments							
TMS 32020/320C25	HP 1650A/B, HP 16510A/B	3	40 MHz CLKX/R [25] 20 MHz CLKX/R [20]	4	Yes	[3]	\$2500
TMS 370C050	HP 1651A/B, HP 1650A/B, HP 16510A/B		20 MHz	10	No	[3]	\$1000
Zilog							
Z80	HP 1651A/B, HP 1650A/B, HP 16510A/B	2	All	N/A	Yes	10300B	\$880
Z8001 [5]	HP 1650A/B, HP 16510A/B	3	All	N/A	No	[5] [6]	Factory Supplied— contact your HP representative
Z8002 [5]	HP 1650A/B, HP 16510A/B	3	All	N/A	No	[5] [6]	Factory Supplied— contact your HP representative
Bus and Interface Preprocessors							
HP-IB, RS-232 and RS-449 [8]	HP 1651A/B, HP 1650A/B, HP 16510A/B	2	19.2 kbits/s RS232/RS449 All—HP-IB	N/A	Yes	10342B [7]	\$1220
HP-IB	HP 1651A/B, HP 1650A/B, HP 16510A/B	2	All	N/A	No	10342G	\$350
SCSI	HP 1651A/B, HP 1650A/B, HP 16510A/B	2	10 MHz	N/A	Yes	10343B	\$1500
MIL-STD 1553A/B	HP 1651A/B, HP 1650A/B, HP 16510A/B	2	1 MHz CLKIN	N/A	Yes	10341B	\$3910
VMEBus (A-size) VMEBus (B-size)	HP 1650A/B, HP 16510A/B	5	16.67 MHz	N/A	No	10344A 10344B	\$600 \$600
PDP-11 Unibus	HP 1650A/B, HP 16510A/B	3	N/A	N/A	Yes	10275A [4]	\$470
LSI-11 Q-Bus	HP 1650A/B, HP 16510A/B	3	N/A	N/A	Yes	10276A [4]	\$520
Intel Multibus	HP 1650A/B, HP 16510A/B	3	N/A	N/A	Yes	52126A [4]	\$370

Environmental specifications for all preprocessors:

Temperature: operating, 0 to 55 C (32 to 131 F). Non-operating, -40 to 75 C (-40 to 167 F) for all modules.

Altitude: operating, up to 4500 m (15,000 ft). Non-operating, up to 15300 m (50,000 ft).

Humidity: 90% non-condensing. Avoid sudden, extreme temperature change that could cause condensation within the instrument.

[1] Includes 8031/8032/8051/8052, 8751 and CMOS versions

[2] Includes 8096/7-90, -AH, -BH, 80C196KA, -KB

[3] These products are available from the US Project Center in Fullerton, CA. Contact your HP Field Engineer to order.

[4] Requires 10320C also.

[5] Available as Inverse Assembler with Operating Note only. No interfacing hardware provided.

[6] 10320C and 10322C recommended but not required.

[7] Supplied with:

(1) RS232C/V.24 ribbon cable 0.75 m (2.5 ft)

(1) RS449 ribbon cable 0.75 m (2.5 ft)

(1) HP-IB ribbon cable 0.75 m (2.5 ft)

Supports both balanced and unbalanced (RS422A and RS423A) implementations of RS449.

*UNI-BUS, Q-BUS, and LSI-11 are registered trademarks of Digital Equipment Corporation. MULTIBUS is a registered trademark of Intel Corporation.



An HP Vectra PC or IBM PC-compatible is all you need to develop your own, custom inverse assembler.

Designing Your Own Preprocessor . . . the HP 10320C

The HP 10320C user-definable interface allows you to build a custom preprocessor. Use the HP 10320C when you need any of the following:

- an interface for analyzing custom or proprietary devices with your logic analyzer
- a semi-custom test fixture for using your logic analyzer in a manufacturing test environment
- a link for ribbon cables or connections to your logic analyzer

The HP 10320C provides a breadboard that fits inside the HP 10269C general purpose probe interface. In addition, the kit includes mechanical hardware to mount the breadboard in place and connectors for sending your signals to the HP 10269C. The accompanying manual discusses the interface design process, including what to look for in your target system, how to design so that set up and hold requirements are met, and tips on power supply distribution.

Building and Connecting the Interface . . .

Companion accessories enhance the utility of the HP 10320C. The HP 10321A microprocessor interface kit provides many of the parts needed when designing an interface that uses ICs and other active devices. It includes sockets, bypass capacitors and a fuse for power distribution, and wire-wrap headers to simplify the wiring of your interface. With the HP 10321A, you only need to provide the specific components and active parts used in the interface design.

The HP 10322A, HP 10323A, and HP 10324A cables provide a reliable mechanical and electrical connection between a socket on your target system and the HP 10320C user-definable interface. Each cable has a special socket assembly for easy connection without damaging the pins of your device. Remove your IC from your system, plug the cable in its place, then plug your chip into the zero-insertion-force

socket on the cable. This technique minimizes the capacitive loading to your system and gives you a low-profile, reliable hook-up.

For 40-pin DIP packages, order the HP 10322A; 48-pin devices require the HP 10323A. 64-pin DIP ICs are supported by the HP 10324A.

Display Mnemonics Match Your Custom Interface

Just as the HP 10320C user-definable interface allows you to design customer hardware, the HP 10391A inverse assembler development package allows you to design a custom inverse assembler for your logic analyzers. This software package allows you to write an inverse assembler that will display your system operation in familiar mnemonics.

The HP 10391A is a macro assembler that runs on the HP Vectra PC or IBM-PC compatibles. The HP 10391A includes Pascal-like instructions such as CASE and IF-THEN statements, strong bit-manipulation capabilities for extraction of single bits, or conditional branching on a few bits within a word, and assembly-language constructs including AND, ROTATE, and INCREMENT/DECREMENT instructions.

Required Equipment

The HP 10391A requires the following equipment:

- 1) HP Vectra PC, IBM-PC* or PC compatible with a minimum of 256K of memory and MS-DOS**2.1 or above.
- 2) 1 floppy disk drive with an internal hard disk (recommended configuration) for the PC, or two floppy disk drives.
- 3) RS-232C port and cable. Recommended card: HP 24540A Serial/Parallel Card or HP 24541A Dual Serial card. For 25-pin ports, use cable HP 13242G or equivalent. For 9-pin ports, use cable HP 24542G.
- 4) HP 1650A/B, 1651A/B, 1652B, 1653B Logic Analyzer, or HP 16500A Logic Analysis System with an HP 16510B/16511B State/Timing card installed.

*IBM-PC is a trademark of International Business Machines

**MS-DOS is a U.S. registered trademark of MicroSoft Corporation

LOGIC ANALYZERS

Portable Logic Analyzers

HP 1650B, 1651B

- HP 1650B: 80 channels of 35 MHz state/100 MHz timing
- HP 1651B: 32 channels of 25 MHz state/100 MHz timing
- Broad support for microprocessors, busses and interfaces
- Simultaneous state/state or state/timing measurements

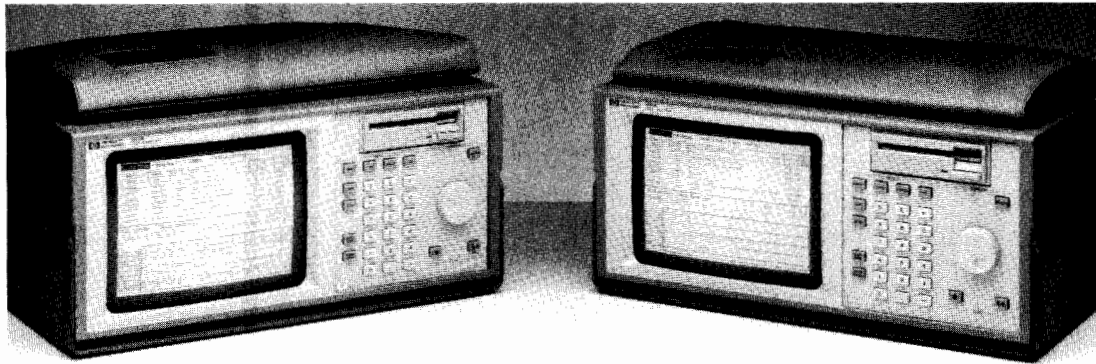

HP 1650B

HP 1651B



HP 1650B, HP 1651B: Best Value in General-Purpose Logic Analyzers

For microprocessor analysis or general purpose state and timing-debug, the HP 1650B and HP 1651B logic analyzers offer the best value. Each analyzer can be configured as a one- or two-state analyzer, a state analyzer/timing analyzer, or a timing analyzer. Data captured by either analyzer can be displayed with full time correlation. Lightweight, flexible, passive probing is included.

Support for Most Microprocessors, Busses and Interfaces

The HP 1650B 1651B supports a broad range of microprocessors, busses, and interfaces. Each support package turns your analyzer into a powerful debugging tool dedicated to the task at hand. Most support packages include a 3 1/2" disk that configures the analyzer and translates captured data into mnemonics. See pages 248-250 for details on support for your system.

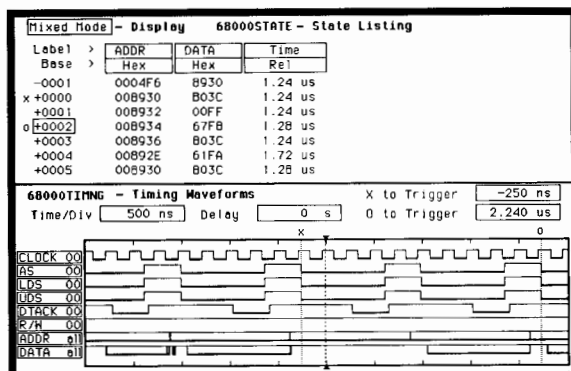

Time Correlated State and Timing Displayed on the Same Screen

Powerful State Analysis Helps You Focus on Needed Information

The HP 1650B/1651B powerful state triggering filters out unnecessary data and provides a listing of the crucial data:

- 5 clock inputs and 4 clock qualifiers allow your system to determine when the analyzer takes a sample.
- Storage qualification allows you to specify which states are stored in memory.
- 8 sequence levels determine the sequence of states required for trigger and help you to focus on a specific area of code execution.
- 8 pattern recognizers, 1 range recognizer, or logical combinations of these are used to identify stored states.
- Tagging keeps track of the amount of time or the number of states between stored states.
- Enable/disable can be used to restrict storage to the activity of a specific routine.

Transitional Timing on ALL Channels Extends the Measurement Range

Each analyzer provides 10 ns timing resolution on every channel. The analyzer stores data only when there is a transition, thus avoiding redundant data storage. 100 MHz transitional timing on all channels effectively extends the memory by lengthening the time covered by the acquisition. Because timing analyzer samples at full speed, events that are seconds or minutes apart are captured with 10 ns resolution. You can use pattern, edge, or duration triggering across all 80 channels when you need to see what is happening around a hardware interrupt or handshake.

Glitch Capture on ALL Channels

You no longer need to move probes around your system to detect intermittent problems with glitch capture on all channels. You can trigger on and capture 5 ns glitches on all channels of your HP 1650B and 1651B analyzers. Glitches are displayed as vertical dashed lines so you can easily distinguish legitimate system activity from glitches.

Capture the Data You Want to See

You can trigger on a pattern across the full number of channels, or qualify a pattern by specifying a duration, glitch, or edge. Or, you can specify a pattern duration to capture error conditions indicated by a pattern that exceeds a specified limit. When you need to see what is happening around a troublesome glitch or hardware interrupt signal, use glitch or edge triggering. Use postprocessing to determine statistical variance of edge placement, or detect propagation delays that fall outside of specified values.

Flexible Data Display Modes Decrease Debugging Time

- Display state acquisitions in one of five forms:
- State listing, which displays your acquisition as a binary, hexadecimal, octal, decimal, or ASCII listing.
- Symbolic/inverse assembler, which displays your data in easy-to-interpret mnemonics.
- State waveform mode, which displays the data in waveform diagram format.
- X-Y chart mode, which displays the value of a data label versus acquisitions or other labels.
- State compare mode, which enables you to compare an acquisition to previously acquired state data.

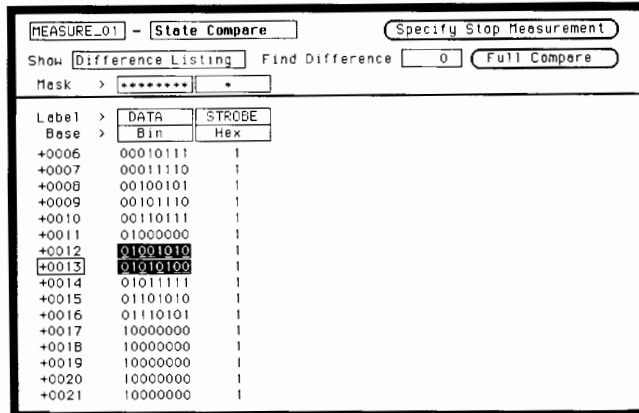

Compare state acquisitions to previously acquired state data. Select channel and range masks to zoom in on important data. Repetitively capture data until compare is equal or not equal.

Lightweight, Flexible Probing

Like all HP logic analyzers, the HP 1650B and 1651B feature lightweight, flexible, passive probing. Passive probing means lower cost and increased reliability, because no active circuitry is needed at the probe tip. Measurement quality is not sacrificed; each probe only loads your digital system with 100 KΩ and 8 pF.

Compact and Portable

With its small footprint, the HP 1650B and 1651B fit easily on your workbench, within the same field of vision as what you are working on. At only 22 pounds, these analyzers can be carried easily with the built-in handle or soft carrying case. The case allows you to keep all of the probes and cables conveniently stored on top of the instrument.

Measurement Compatibility

Save setup time by transferring state and timing configurations or measurements made with one instrument to another. Make measurements in the field with confidence that the setups and data can be reproduced later in the office. Use a 3 1/2 inch disk to transfer information from one analyzer to another. You can use the HP 10392A state-to-pattern generator link to transfer activity captured in the field to the HP 16500A digital pattern generator to duplicate failure modes in the lab.

Programmability over HP-IB or RS-232 . . . Standard!

You get both HP-IB and RS-232 interface ports as standard equipment on both the HP 1650B and HP 1651B. You can program most front panel functions from either interface, or send hardcopy output to HP-IB or RS-232 printers.

Built-in Upgrade Path

The HP 1650B/1651B feature a built-in upgrade path to the HP 1652B/1653B logic analyzers with built-in oscilloscopes. You can get a 32- or 80-channel analyzer now and upgrade with a 400 MSA/s oscilloscope when the occasion arises.

The HP 1651B . . . When 32 Channels is All You Need

The HP 1651B offers most of the features of the HP 1650B, except state speed and channel count. For debugging most 8 bit processors, or to monitor timing activity across up to 32 channels, the HP 1651B is the ideal tool.

	HP 1650B	HP 1651B
Timing	100 MHz ALL 80 channels	100 MHz ALL 32 channels
State	35 MHz ALL 80 channels	25 MHz ALL 32 channels
Memory	1 Kbit/channel	1 Kbit/channels
Microprocessor Support	Most 8-, 16- and 32-bit microprocessors	Most 8-bit microprocessors

Ordering Information

- HP 1650B 80-Channel Logic Analyzer
- HP 1651B 82-Channel Logic Analyzer

Price

- \$7,800
- \$3,900

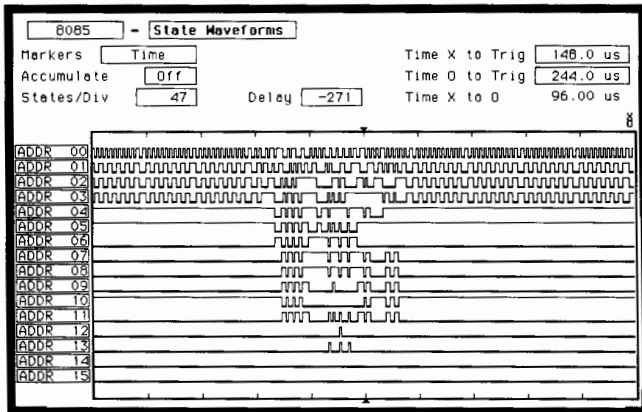

View an entire state acquisition at a glance to examine bus activity or processor control, fully correlated with state listing, X-Y chart and compare modes.

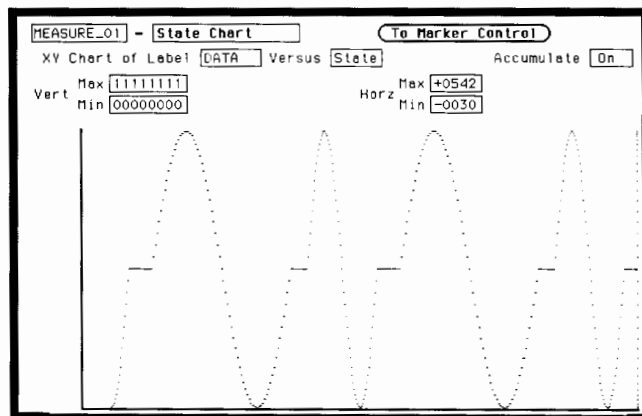

Plot label versus states to check A/D converters or memory coverage. Plot label versus label to obtain a 'signature' of a circuit or routine. Correlate chart display to inverse assembled listing.

LOGIC ANALYZERS

Portable Logic Analyzers

HP 1652B, 1653B

- 80 channels of state/timing
- 2 channels of 400 MS/s digitizing oscilloscope
- More measurement power at a lower cost than separate instruments

- See analog events with a general purpose 100 MHz BW digitizing scope
- Automatic pulse parameter measurements

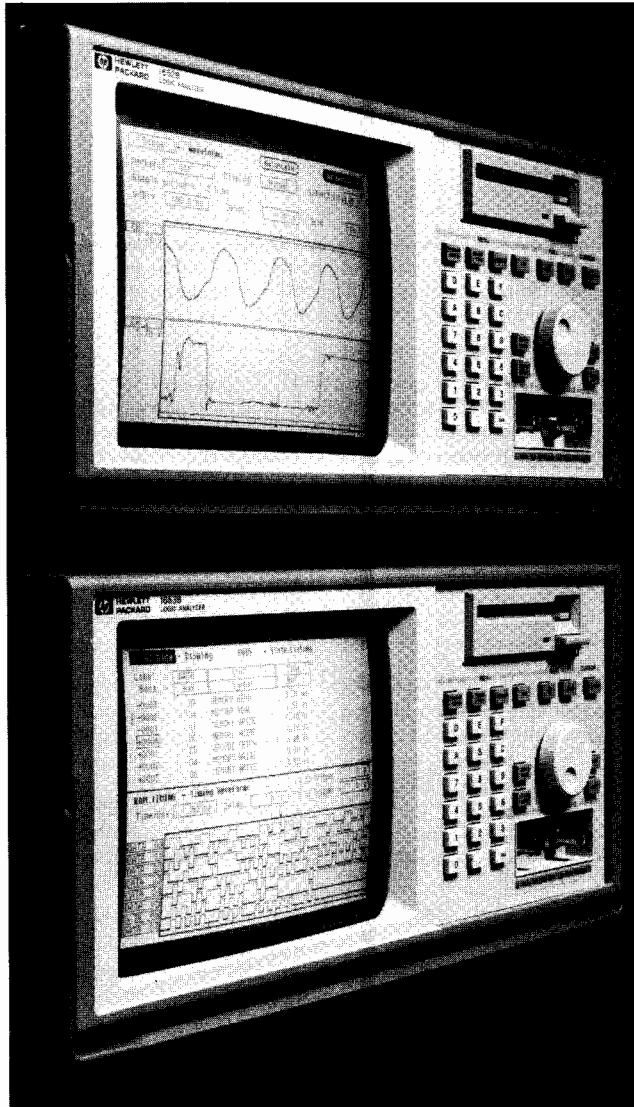

Logic Analyzers with a Digitizing Oscilloscope

The HP 1652B and HP 1653B logic analyzers have all of the features of the HP 1650B and HP 1651B plus two 400 MSa/s digitizing oscilloscope channels, automatic pulse parameter measurements, and time-correlated state, timing and oscilloscope displays. You can still completely analyze your 8-, 16-, or 32-bit microprocessor while getting better definition on system signals with the 2-channel oscilloscope.

You can characterize critical timing parameters with time interval measurements to better than 1 ns accuracy or examine glitches in your system with the built-in scope to determine if noise or loading is the problem. Or, you can use the scope to enhance your troubleshooting capabilities.

Two Simultaneous 400 MSa/s Analog Channels

Each scope channel is a full-featured, 400 MSa/s, 100 MHz bandwidth oscilloscope. Both channels simultaneously capture non-repeating events with a full 2,048 samples per channel. The built-in scope is based on the same technology used in the popular HP 54502A 100 MHz BW oscilloscope. The scope features include precision voltage and time interval measurements, powerful triggering, and auto-calibration.

Time-Correlated State, Timing and Oscilloscope Measurements

System debugging becomes easier when you display time-correlated state, timing, and analog displays on the same screen. You can see how hardware and software interact, while getting an accurate view of how your system sees the signal.

Cross-Trigger Measurement Modules

You can use the state analyzer's powerful triggering capabilities to determine when the oscilloscope should start looking for a signal. Once the scope is armed, you can use traditional edge triggering to focus on the area of interest.

Glitch triggering on all channels makes the timing analyzer another great tool for arming or triggering the scope. Simply set up the timing analyzer to trigger on a glitch, then trigger the oscilloscope to capture the activity around the glitch. By getting an analog display of the signal, you can determine if the glitch is really a problem.

HP 1652B and HP 1653B



Portable Analyzers

The HP 1652B/1653B portable analyzers are ideal for service applications. Their small size and light weight (just 24 lbs) make them easy to carry to test sites. With the built-in scope, you have two complete instruments in one small package.

See Pre-trigger Events

The 2K memory depth and powerful triggering allow you to look at the events that led up to a system failure. Each channel can be set to capture the data up to 40 screen diameters before the trigger event occurred.

Automatic Pulse Parameter Measurements

Quickly analyze a signal's analog properties without having to count gratitudes. Choose automatic measurements or time markers to measure voltage and timing relationships. The HP 1652B/1653B automatically measures the following pulse parameters:

- + pulse width
- frequency
- rissetime
- peak-peak voltage
- preshoot
- pulse width
- period
- falltime
- overshoot

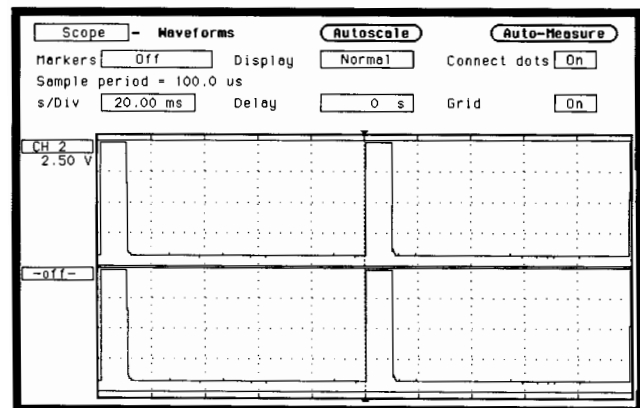

The HP 1652B/1653B offers full-featured digitizing oscilloscope performance.

Automatic Marker Search

Using the automatic marker search, you can examine waveforms for specific patterns that could be the cause of a system crash. Or, use the automatic marker search statistics to reveal setup and hold time violations as you make repeated measurements on the system. After each run, the markers are placed on specified patterns, and statistics are compiled on the mean, minimum, and maximum marker placement times, so you can see how often a specific event occurs.

Hardcopy Output

After using the built-in oscilloscope to find an elusive problem, use either an HP-IB or RS-232 printer to obtain a permanent record. The HP 1652B and 1653B support over 10 printers.

All Other Features of the HP 1650B/1651B

All of the other features of the HP 1650B/1651B logic analyzers are included in the HP 1652B/1653B. These features include 80 channels of state and timing analysis, full-featured triggering, built-in disk drives, and support for most popular processors and bus interfaces. Plus, the data and configuration files of the HP 1652B/1653B are compatible with the HP 1650B/1651B and with the HP 16510B. You can transfer information from one analyzer to another.

	HP 1652B	HP 1653B
Timing	100 MHz all 80 channels	100 MHz all 32 channels
State	35 MHz all 80 channels	25 MHz all 32 channels
Analog	2 - 400 MSa /s 100 Mhz BW Simultaneous acquisition channels	2 - 400 MSa/s 100 MHz BW Simultaneous acquisition channels
Memory	1 Kbit/channel	1 Kbit/channel
Microprocessor support	Most 8-, 16- and 32-bit microprocessors	Most 8-bit microprocessors, busses

Ordering Information

- HP 1652B Logic Analyzer with Oscilloscope
- HP 1653B Logic Analyzer with Oscilloscope

Price

- \$7,400
- \$11,300

LOGIC ANALYZERS

Logic Analysis Systems

HP 16500A and Measurement Modules

- Modular, configurable logic analysis system
- Powerful cross-module triggering
- Support for most microprocessors
- Oscilloscope, 1 GHz timing and pattern generation modules

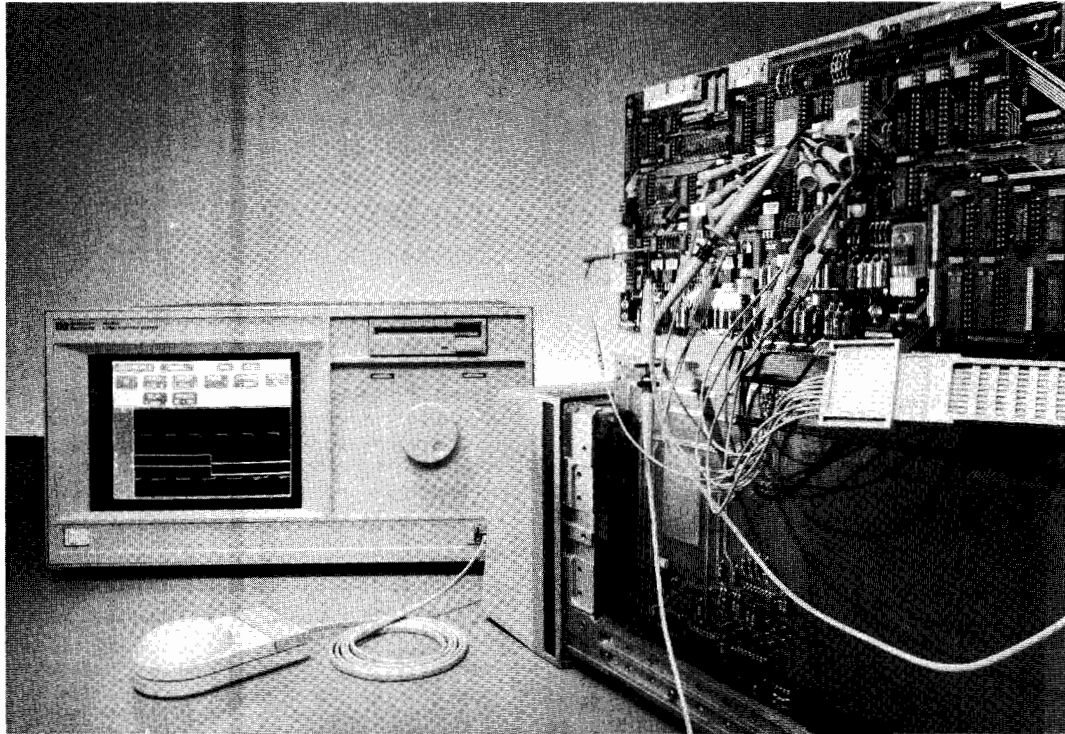

HP 16500A



Modular Logic Analysis System

The HP 16500A Logic Analysis System can be configured for a wide range of measurement tasks, including microprocessor debug, hardware design verification and debug, software performance analysis, characterization, and functional pass/fail testing. Start with a focused system, then expand as your needs evolve.

The HP 16500A logic analysis 5 card slots accept 4 measurement modules. With the HP 16500A, you can do the following:

- Customize your own system by adding cards to the five card slots.
- Make time-correlated measurements between cards using the intermodule bus.
- Compare hardware measurement data with design simulation data.
- Program the HP 16500A with easily understood commands through HP-IB or RS-232C built-in interfaces.
- Store setups and measurement results in either of two built-in disk drives for fast recall or permanent record.
- Generate report-quality documentation with pushbutton ease.

Color Touchscreen: Easy to Learn and Easy to Use

Save time and reduce errors with the HP 16500A color touch screen. Simply point to the field you want to change; the touchscreen eliminates the need to search a front panel for the right button. Pop-up menus offer all choices at a glance, and the software does not allow you to make an incorrect choice.

Color discriminates between overlapped traces and emphasizes important points. In addition, you can customize for personal preference and environmental considerations. Even infrequent users spend less time making measurements and more time analyzing the results.

Data display areas are not touch-sensitive, so there is no need to worry about losing your latest acquisition. You can use the optional HP mouse or trackball if you are in an environment that prevents using the touchscreen.

Use Cross-Domain Triggering for Complex Measurements

Use state to arm timing, or use timing to arm state when the symptom of a problem is best isolated with one analyzer and the cause is best isolated with the other. For example, track a microprocessor program flow around a hardware interrupt. Find the edge of the interrupt signal with the timing analyzer. After the signal is found, the timing analyzer can arm the state analyzer to start acquiring data.

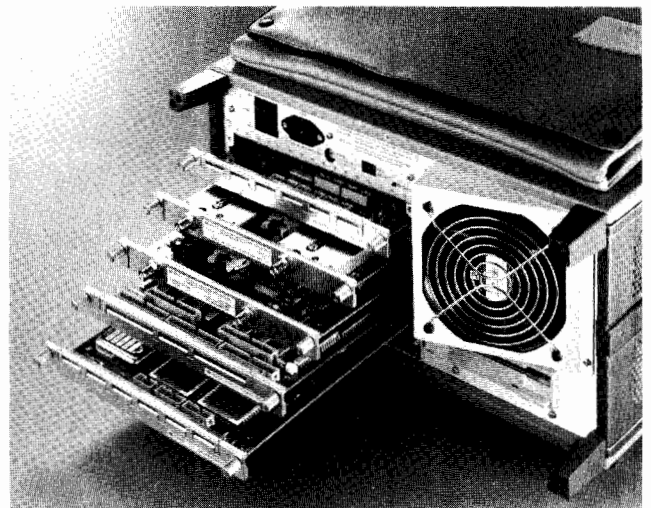

The HP 16500A holds up to 5 measurement modules.

Perform Time-Correlated State Analysis

In multiple microprocessor environments, systems are driven by multiple clocks. The HP 16500A/16510B provides simultaneous capture of separately clocked systems while time-tagging all states. You can capture the states from several microprocessors, then analyze their flow with interleaved, time-correlated state displays. Monitor up to 10 independently-clocked microprocessors systems with 5 HP 16510B modules while monitoring the activity with state-to-state time-correlated listings.

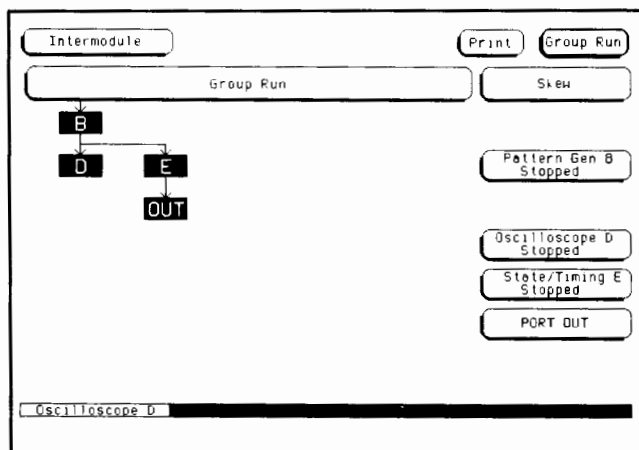

With the HP 16500A intermodule bus you can arm or trigger one measurement module for another.

Configure Your System

The HP 16500A logic analysis system can be configured for your debug, characterization, systems integration, or pass/fail testing applications. Start with a focused system, then expand it as your needs evolve. For example, start with an 80-channel logic analyzer and a 2-channel oscilloscope, then add more capability as needed.

High Performance System

Verify or analyze the performance of circuits through combined analog, state, and timing measurements. The five card slots hold state/timing cards, timing cards, pattern generator cards, and digitizing oscilloscope cards. Use these cards in combination to make measurements that could not be made with separate instruments. For example, state can arm both oscilloscope and timing waveform capture, allowing you to display a mixture of timing and scope waveforms on screen to measure time relationships between events.

Store Setups and Data Quickly

It is easy to store and retrieve measurement results and setups with the two built-in 3 1/2 inch disk drives. Use the back disk drive for the operating system, leaving the front disk free for measurement files.

Correlate 1 GHz Timing with Oscilloscope Waveforms

Connect several 1 GHz timing lines while probing simultaneously with oscilloscope channels. For example, configure 32 channels of 1 GHz timing with 4 oscilloscope channels to provide time correlation from a single trace point. This procedure allows you to capture the number of channels you need while simultaneously capturing parametric information.

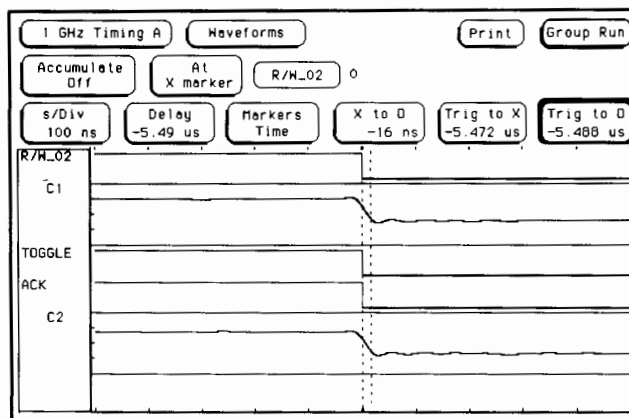

1 GHz Timing waveforms time-correlated with 400 MSa/s digitizing oscilloscope waveforms.

Application Driven Trigger Selection

Select the trigger mode that best suits your application. Use glitch, state, analog, or timing triggers to capture state, analog, and/or timing data. To analyze interrupt handling in a microprocessor system, use the oscilloscope to arm timing, state, and analog on the asynchronous interrupt. Then capture microprocessor program flow with state, capture control lines with timing, and capture the interrupt line with the scope. The HP 16500A logic analysis system connects state, timing, analog, and pattern generation trigger qualification serially in any order to meet your needs.

Generate Patterns Interactively

Generate patterns triggered by the intermodule bus or by the pattern generator's external qualification. The intermodule bus provides state, analog, timing, and/or pattern generator program flow qualification. Test your circuit's response to patterns derived from simulation, for rigorous functional analysis of prototypes. You can quickly generate simple patterns for applications where you need to toggle just a few lines, using the HP 10392A state-to-pattern generator link.

LOGIC ANALYZERS

State and Timing Analysis Modules

HP 16510B, 16511B



The HP 16510B and HP 16511B: Full-Featured State Analysis

The HP 16510B offers 80 channels of full-featured state and timing analysis. You can configure up to 400 channels of state and timing in the HP 16500A frame, or examine up to 10 processors at the same time. Each HP 16510B can operate as a separate state/timing analyzer, while time correlation is available over the HP 16500A intermodule bus (IMB).

Trigger Across 160 Channels

Simplify data tracking through pipelined architectures with the use of the HP 16511B 160-channel 35 MHz state/100 MHz timing module. You can trigger across all 160 channels, making the flow through the pipeline easier to follow.

Trigger on complex handshaking routines across several synchronous processors and display all of the data on the same screen to debug multiprocessor systems. RISC, wide bus, and ASIC integration tasks become easier when you can look at all of the data with one state or timing analyzer. Data correlation across all 160 channels is built-in; you do not have to create arming sequences.

View Activity of two parts of a System

The HP 16510B and 16511B can be configured into two independent state analyzers or a single state and one timing analyzer. Measurements that would normally require two instruments can now be made with a single instrument.

For example, by using the state analyzer to focus on a specific I/O routine, you can watch both the program execution and the activity on the I/O lines with a time-correlated display. Or, when you need to examine the interaction of two microprocessors, the HP 1650A/1651A/16510A can display time-correlated state listings.

Use the State Analyzer as a Window to the System

When a trigger sequence is too complex for the scope, use the state analyzer's powerful 8-level, 8 resource term trigger to locate the problem; then use another measurement module to get a detailed picture of the fault. The state and timing analyzer can be used together to define when a problem occurs and then either arm or trigger the HP 16530A, 16531A oscilloscope or HP 16515A, 165156A 1 GHz timing analyzer to capture data. This approach saves time and helps avoid the extra work of finding a problem with a scope alone.

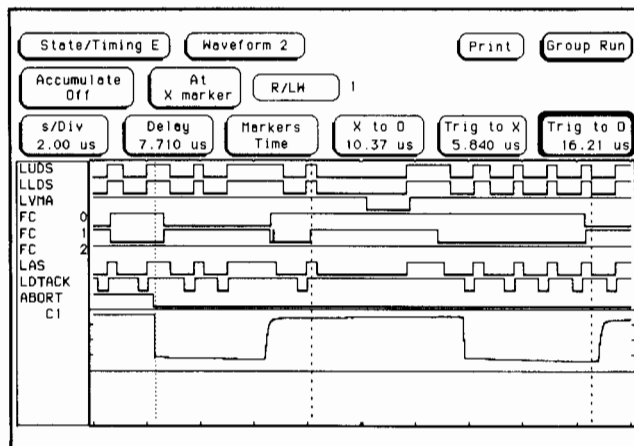

Transitional timing on every channel gives a wide view of system activity. (Shown here with a time-correlated oscilloscope channel.)

Measure the Time Between States

With time tagging turned on, you can measure the time it takes your system to make the transition between one state or another. The time information is displayed along with the state data, so you can get a clear picture of an event's duration. Combine state tagging with storage qualification to confirm the length of an information transfer without actually storing all of the data.

Transitional Timing on ALL Channels

The HP 16510B and 16511B logic analyzers store timing data only when there is a transition, thus avoiding redundant data. This effectively extends the memory by lengthening the time covered by an acquisition. Because the timing analyzer samples at full speed, events that are seconds or even minutes apart are captured with 10 ns resolution. Use transitional timing for analysis of asynchronous data buses, where activity often occurs in bursts, followed by long periods of dead time.

Label>	HMDATA	Time
Base>	Binary	Relative
29	11101111	400 ns
30	11101111	1.00 us
31	11101111	400 ns
32	11101111	400 ns
33	11101111	1.00 us
34	11101111	400 ns
35	11101111	400 ns
36	11101111	1.00 us
37	11101111	400 ns
38	11101111	400 ns
39	11101111	1.00 us
40	11101111	400 ns
41	11101111	400 ns
42	11101111	1.00 us
43	11101111	400 ns
44	11101111	400 ns

Time tagging measures the time between states. You can get an accurate picture of the time it takes your system to make the transition from one state to another.

Use Postprocessing to Snare Elusive Timing Faults

Use the timing analyzer's postprocessing to find setup and hold violations. Use the specify-stop-measure feature to acquire data until the time interval between two patterns violates a specified condition. Transitional timing can supply a long pre-trigger record length, so you can look back in time to discover the cause of the problem.

System Performance Analysis

The HP 10390A system performance analysis software (SPA) provides an overview of system activity. It can be used with another state machine in the same analyzer to find the activity of interest in order to make time interval measurements. Or, it can be used in state overview mode to help identify execution segments as prime targets for optimization.

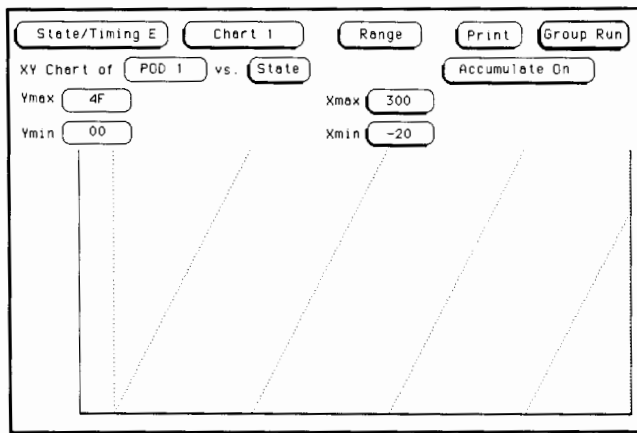

Chart mode shows characteristic signature of a memory read cycle.

Debug Microprocessors

HP preprocessors tailor the HP 16510B and 16511B to microprocessors from Intel, Motorola, Zilog, National, Hitachi, GTE, Rockwell, and NEC. These preprocessors simply plug directly into the CPU socket. Companion software converts the acquired state data to microprocessor mnemonics, making it easy to monitor program execution. See pages 248 through 250 for microprocessor and bus interface support details.

For designs that use custom or proprietary CPUs, use the HP 10320C user-definable interface to connect the HP 1650A/1651A/16510A to your system. The HP 10391A inverse assembler development package can be used to develop custom software that converts the acquired state data to CPU mnemonics.

```

State/Timing E  Listing 1  Invasm  Print  Run
Markers Pattern  Find o-pattern  1  from Trigger
Pattern> 00001000
Label> ADDR 68020 Mnemonic
Base> Hex decimal (* = hex)
2 0000FE0 MOVEC CACR,D0
3 0000FE4 BCHK *00,D0
4 0000FEB MOVEC D0,CACR
5 0000FEC MOVE.L *$00090000,$00090000
6 0000FF0 *$00000009 supr prgm read
7 0000FF4 MOVE.L *$00000202,$00090004
8 00090000 *$00090000 supr data write
9 0000FFB *$00000202 supr prgm read
10 0000FFC *$00090004 supr prgm read
11 00001000 MOVE.W *$7FFF,D7
12 00090004 *$00000202 supr data write
13 00001004 MOVEA.L *$001C0000,A0
14 0000100B MOVE.B *$00,(A0)
15 0000100C DBF D7,$0000100A
16 00001010 MOVE.W *$----,D7
17 001C0000 *$00xxxxxx supr data write
    
```

A Motorola 68020 inverse assembly listing.

Model	HP 16510B	HP 16511B
Timing	100 MHz all 80 channels	100 MHz all 160 channels
State	35 MHz all 80 channels	35 MHz all 160 channels
Memory	1 Kbit/channel	1 Kbit/channel
Triggering	8 Levels, each with branching, store qualification, complex pattern recognition	

```

State/Timing E  Compare 1  Print  Run
Difference listing  Find Error 0  Compare Full  Specify Stop Measurement
Mask> *****
Label> ADDR DATA STAT
Stop measurement when Compare is Equal
21 001C0000 00000000000000000000000000000000 155
22 0000100B 00000000000000000000000001000010111100 063
23 0000100C 00000000000000000000000001000011001111 063
24 00001010 11111111111110100011111000111100 063
25 001C0000 00000000000000000000000000000000 155
26 0000100B 00000000000000000000000001000010111100 063
27 0000100C 000000000000000000000101000111001111 063
    
```

Use the state analyzers' compare mode to identify faulty states.

LOGIC ANALYZERS

Digitizing Oscilloscope Modules

HP 16530A, 16531A

Built-in Full-Featured Scope

The HP 16530A/31A offers the advantages of a full-featured digitizing oscilloscope, integrated into your logic analyzer. You get a full 100 MHz analog-equivalent bandwidth scope with digitizing advantages such as autoscale, automatic measurements, and powerful triggering, and negative time viewing.

Arm or trigger the oscilloscope from any other module in the HP 16500A logic analysis mainframe. You can capture and display the analog events that affect the digital system. Correlate the oscilloscope to state listings and timing waveforms to identify cause and effect relationships.

Correlate Single-shot Events with Precision Time Interval Measurements

Make time interval measurements with markers at better than 1 ns accuracy single-shot (after deskewing). Accuracy at the probe tip is ensured by a calibration routine that reduces channel-to-channel skew. You can also calibrate for delays caused by uneven probe lengths, to ensure that the measurement is correct.

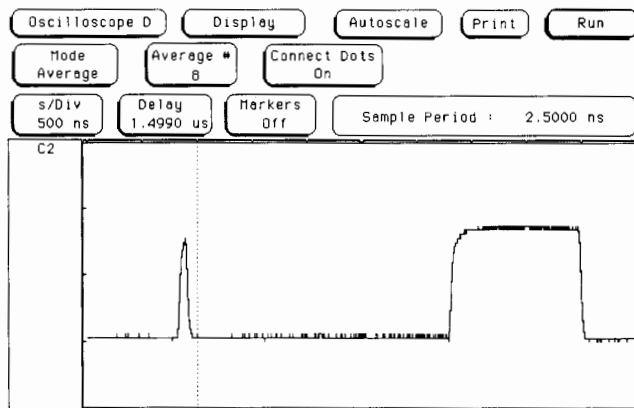

The HP 16530A/16531A Digitizing Oscilloscope finds a glitch

Single-shot Analysis

The HP 16531A 2 channel, 400 Megasamples/s digitizing oscilloscope captures 100 MHz bandwidth signals single-shot. You can capture up to 8 channels simultaneously to determine relationships between infrequent events. A high-resolution color display and post-capture scroll and zoom allow detailed examination of waveforms.

Capture Many Waveforms Simultaneously

Run up to four HP 16531A oscilloscope cards with a single HP 16530A timebase card for simultaneous acquisition. The HP 16530A/16531A oscilloscope module can be configured to acquire from two to eight signals simultaneously. Save time when debugging and characterizing systems by observing multiple test points during each test.

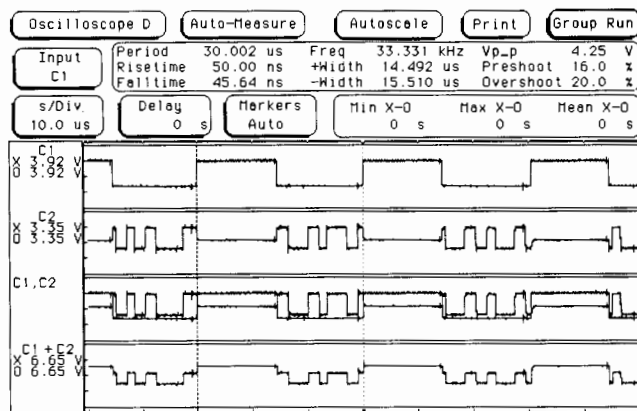

Waveform math functions are available

Measure Slow and Fast Events Simultaneously

Use the 4K sample depth to measure periods and time intervals. Then zoom in for rise time measurements. Add a second oscilloscope module to create a dual time base digitizing oscilloscope, and to display events with different time bases on the same screen.

Find the Causes of Errors

Each channel has 4K memory depth for capturing events before or after the trigger event. View events up to 10 μ s before the trigger event with greater than 1 ns accuracy.

View Analog and Digital Waveforms . . . and More

Capture random signal variations with the accumulate mode. Filter out noise with average mode. Show true single-shot events with Single mode. Scan many periods of the waveform easily with the Connect-the-dots feature. View analog-like waveforms with 6 bit vertical resolution. Analyze differential waveforms with the A-B mode. The HP 16530A/16531A gives you all of the features of a digitizing oscilloscope plus the power of a logic analyzer in one frame.

Automatic Measurements

Automatic pulse parameters allow fast analysis without having to count gratitudes. Parameters such as frequency, period, pulse width, peak-to-peak voltage, maximum voltage, minimum voltage, risetime, falltime, preshoot, and overshoot require just one keystroke. Measure voltage and timing relationships by placing the markers and reading the results on the display. Display the time between markers, acquire until capturing specified time between markers, perform statistical analysis on the time between markers. Setup is easy with automatic waveform scaling, TTL & ECL presets and automatic marker placement on specified edges.

Model	HP 16530A, HP 16531A
Channels	2, 4, 6, 8
Bandwidth (-3dB)	dc - 100 MHz
Maximum sample rate	400 MSa/s
Waveform record length	4,096 points
Triggering	edge, pattern, other modules, external, event

HP 16515A/16516A Timing Analyzers: Affordable 1 GHz Timing

Measure precise time relationships to 1 ns resolution with the HP 16515A/16516A 1 GHz timing analyzer. Make time interval measurements or view the order of events in your high-speed system with 1 ns single-shot resolution on every channel. There is no need to compromise channel count for sample speed. Every channel runs to the full 1 GHz sample rate.

Debug quickly with up to 80 channels of 1 GHz timing in one HP 16500A logic analysis mainframe. More channels means that you can avoid having to move probes in order to find the problem. 16 channels of 1 GHz timing complements the HP 16510B 100 MHz timing to help you get a clearer picture of critical timing behavior.

Find the Cause of Problems with 8 Kbit/Channel Memory Depth

Find and analyze events that occur before or after the trigger event. Each channel stores 8 ksamples to allow 8 μ s of negative time capture with 1 ns resolution for pre-trigger applications. Deep memory stores data over many clock cycles while retaining precise edge placement information. Deep memory also helps you find elusive problems more quickly when you're not sure exactly where to trigger.

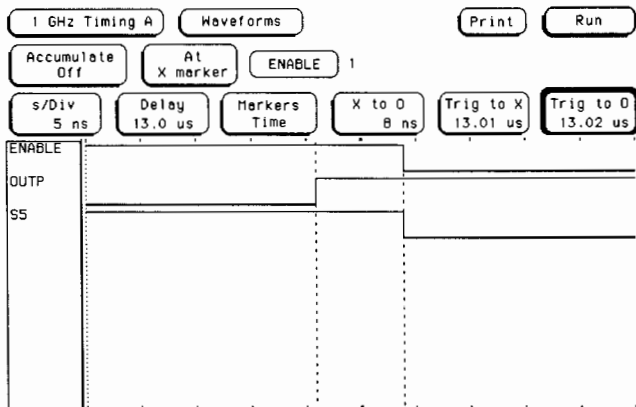

Make time interval measurements with 1 ns resolution.

Hook Up Easily to Your Circuit with HP's New Lightweight Probes

Lightweight 10k Ω , 2 pF passive probes are easy to connect. These probes can be connected with probe tips or plugged directly into any .1 in grid with .026 in to .033 in diameter round pins or .025 in square pins. Individual grounds are provided for each channel to shorten ground loops.

Correlate 1 GHz Timing with Other Modules

Use the state analyzer to find the problem, then examine events around it with 1 ns resolution. Display state, timing and analog activity on the same screen. Use the automatic pattern search and specify-stop-measurement to determine if timing violations occurred

	HP 16515A	HP 16516A
Channel Count	16	16
Memory Depth	8,092	8,092
Maximum Sample Rate	1 GSa/s	1 GSa/s
Triggering	Pattern, pattern duration, edge, other modules	



LOGIC ANALYZERS

Pattern Generator Modules

HP 16520A, 16521A

Functionally Test Your System

The HP16520A/16521A digital pattern generator modules are the perfect tools for functional test of a digital design. Standard 3M¹ connectors eliminate the need to design custom test points onto your PC board. With the HP 16520A/16521A providing the stimulus, you can use any of the HP 16500A acquisition modules to determine whether the system is responding correctly.

Pattern Generator Benefits

During the prototype debug phase of design, digital pattern generators offer several benefits. Pattern generators can simulate signals from not-yet-completed parts of the system, such as backplane buses, other PC boards, or peripherals. Pattern generators allow you to check the functional characteristics of your system and also allow you to see how your system responds to unanticipated signals. You can perform margin testing, to determine exactly when your system fails.

Easy Pattern Development

Eliminate the painful process of developing test patterns by hand. Use the HP 10392A state-to-pattern generator link to obtain patterns from a known good system or from the interface you want to simulate. The HP 10392A translates these patterns to the pattern generator. You can specify which control lines you want assigned to the pattern generator's return-to-zero (RZ) lines, and simulate complex data sequences by using the state analyzer's time tagging information.

Label	Instr	Symbol	Symbol	Symbol	Symbol	Hex
	HOLD					
	3STATE					
	N_WR					
	N_RAM					
	ADDR					
	Symbol					
	Symbol					
	Symbol					
	Symbol					
	Hex					

Symbols can be used to display data in your system's mnemonics, making debug and documentation easier.

Get the Patterns You Need from Simulation

If the patterns you need were developed as a result of a simulation, you can now transfer this information to the HP 16500A pattern generator and state analyzer. To speed your design confirmation efforts, the HP 16520/16521A digital pattern generator can accept data from most popular commercial simulators.

Digital Stimulus and Response

Configure the HP 16500A to provide both stimulus and response in one instrument. The pattern generator runs the device-under-test through an initialization sequence, then tells the state analyzer to begin making measurements. During the measurements, use state compare determine if the device is functioning properly.

Up to 108 channels of stimulus and 160 channels of response can be installed in one frame.

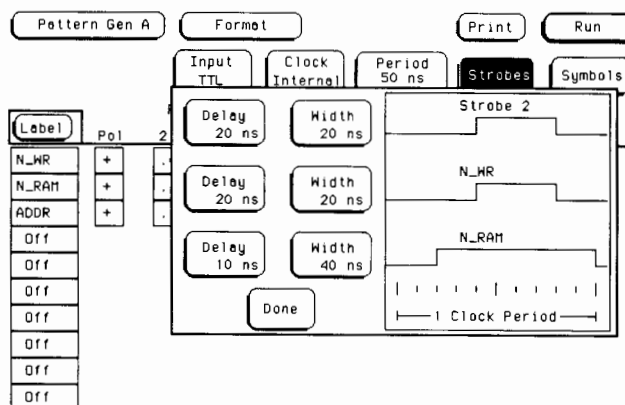

Three return-to-zero channels can be adjusted via pop-up windows.

Low Volume Manufacturing Test

Use the HP 16500A with digital pattern generation and state response as a low-volume manufacturing test system. The standard 3M¹ connectors make hook-up easy. The user interface, learn string capability, and standard HP-IB/RS-232 interfaces support fast test development.

Failure Analysis

Use the HP 16520A/16521A digital pattern generator to track down and repeat failures, then use state or timing analysis to transfer the information back to a computer for more analysis. The data can be transferred to many popular testers in order to enhance test program development.

Easy Operation

Only two menus are needed for complete data entry; a format and a listing menu. The format menu allows you to group data channels together for easy data entry. Enter data in hex, octal, binary, decimal, or symbols. Editing is enhanced with delete, insert, and copy functions. You can merge stored programs to create more complex data files quickly. Macros allow you to repeat portions of code quickly. Symbols can be generated to replace complex data patterns.

To allow pattern generation when complex trigger conditions occur, derive run control for the pattern generator from the screen, external sources, or intermodule bus.

Quick Circuit Connection

Easily attach to boards through probe tips or 2 x 10, .1 in center connectors on your circuit board. Standard connectors eliminate the need to purchase special connectors or to build custom fixtures to hook into your DUT. The lightweight and passive probing system provides ECL or TTL patterns through 50 ohm connections. Series termination eliminates the need for external 50 ohm terminations. Generate ECL differential, TTL or CMOS Tristate patterns with the 10345A ECL Differential Driver, the HP 10346A TTL Tristate Pod, or the 10348A CMOS Tristate Pod.

	HP 16520A	HP 16521A
Channel Count	12 NRZ, 3 RZ	48 NRZ
Memory Depth	4095	4095
Maximum Data Rate	50 Mbits/s	50 Mbits/s
Output Levels	ECL, TTL CMOS ²	ECL, TTL, CMOS ²

¹ 3M is a registered trademark of Minnesota Mining and Manufacturing.

² CMOS voltage levels require an HP 10348A.

Simulation Vectors for Hardware Verification

Perform functional verification of your simulated design by transferring and translating simulation vectors to the HP 16500A logic analysis system. You can compare actual circuit behavior with simulation results to detect and isolate design faults. By using simulation vectors as the basis for your prototype verification, you can develop just the tests you need to verify that your design works.

CAE Link Benefits

Links between simulation and prototype test save you time. For functional prototype verification you can quickly and easily transfer and translate just the test vectors you need. CAE Links eliminate manual reentry of test vectors and make the development of test suites easy. As a result, products get to market sooner.

An added benefit of CAE Links is the ability to transfer prototype test vectors to manufacturing test. You can develop a core set of test vectors, make sure that they fully test your product's functionality in the lab, then hand the completed design and test vectors to manufacturing.

Acquire Test Vectors from Known Good Boards

Reduce the time spent on tedious entry of zeros and ones while creating manufacturing tests. Use the HP 16500A state and timing modules to gather the data for you from a known good board. With the HP 16515A/16516A 1 ns resolution, you can develop tests for the most demanding designs and most complex testers.

Connect the HP 16500A acquisition modules to the known good board and make successive data acquisitions. You can then modify this data and transfer it to your board or IC testers as a complete test program!

Begin Your ASIC Design Cycle with Real-World Test Vectors

Before beginning your next ASIC design, capture test vectors from the systems that it will be designed to replace. Use the HP 16500A to acquire a representative sample of data from key nodes in the system. Then transfer the test vectors back to the simulation environment for use as behavioral test data. This process lets you verify that your ASIC design behaves properly in your system before you send it to the foundry.

Analyze and Correlate Production Tester Behavior with Simulation

You can correlate the behavior of your device under test with simulated behavior by using the HP 16500A state and timing modules. These permit you to monitor behavior of the device while it is in the test fixture. In turn, the captured data can be compared to simulated data to determine if the test, tester, or design is at fault.

Protect Your Test Development Investment

Protect your test development investment by using the HP 16500A to transfer tests developed on one tester to another. The HP 16500

can capture your test program with 1 ns resolution. This information can be used to reconstruct test programs for another tester.

HP and TSSI: Working Towards YOUR Productivity

The HP 16500A is supported by Test Systems Strategies, Inc. (TSSI) of Beaverton, Oregon (USA). TSSI markets software that links design and test. TSSI supports most simulators in addition to supporting many popular ASIC Verification, IC and board testers. For more information on TSSI, contact your HP sales representative.

TSSI software supports the HP 16500A pattern generator modules and all HP state and timing analyzers. You can capture system behavior with any of these analyzers, and then transfer that information to TSSI's proprietary waveform database where it can then be transferred to testers or simulators.

TSSI also supports the compare mode found in all HP state analyzers. This means that you can compare simulation results with acquisitions to detect system faults.

TSSI software runs on DEC VAX, Apollo 3000 and 4000 Series, HP 9000 Series 300, and SUN 3/Series computer systems.

CAE Simulators Supported by TSSI

Most popular commercial simulators and many proprietary simulators are supported by TSSI. The list of supported commercial simulators includes: Calma TEGAS/TEXOUT/TEXSIM; Daisy Logician DLS; Gateway Verilog; HP EDS; HHB Systems CADAT; LSI Logic, Lattice Logic Expert; Logic Modeling Systems; Mentor Graphics QuickSim; QuickTurn; Silicon Compiler Systems LSim; Silvar-Lisco Logix/Helix; SimuCad SILOS; Teradyne LASAR; Valid Logic ValidSIM; Vantage; Viewlogic ViewSim; and Zycad ZILOS.

Popular Testers Supported by TSSI

Many ASIC verification, board, and IC testers are supported, including the HP 82000 ASIC Evaluation System, HP 3065/3070 series board testers, and the HP 9480 Analog LSI Test System. For more information on tester support, contact your HP sales representative.

Links HP Electronic Design System

The HP 74240A/B CAE Link and Data File Comparator allow you to bring real-world measurements into the simulation environment. The HP 74240A transfers simulation data from the HP Electronic Design System to the HP 16520A/16521A pattern generator via HP-IB or disk, and translates HP 16510B or HP 16515A/16516A timing data into simulation files.

The HP 74240B compares simulation with measurements to detect functional and timing errors. The comparator can help you detect critical timing problems, such as setup or hold violations, and isolate their cause through re-simulation.

LOGIC ANALYZERS

Accessories

Accessories for Your HP Logic Analyzer

Logic analyzer accessories make your measurement tasks easier. Probing accessories, such as HP termination adaptors allow you to connect to your target system with industry standard 3M* connectors. With the wide range of HP oscilloscope probes you can choose the impedance that best matches your measurement.

Easy and Quick Connection to Your Circuit

HP offers a wide range of probing solutions. You can use the general-purpose probes, which consist of flying lead sets and grabbers, to make measurements while you are debugging a circuit. A complete set of general-purpose probes comes with each analyzer.

For a more permanent connection to your target system, you can use the 01650-63201 termination adaptor. The termination adaptor connects the logic analyzer's probe cable to your target system via a flexible 3M connector. The connection to your device under test consists of a 2 x 10, 0.1 in center female header. Any 3M-type connector can be used as the interface to your system. The termination adaptor contains the passive network needed to properly terminate the logic analyzer's probes. It provides a 100 K Ω , 8 pF termination to your system.

If you want to have the termination closer to the active components on your board, you can use the 1810-1278 termination dip package to provide the logic analyzer's termination. The 18-pin dip package consists of 9 termination networks. Each IC is designed to provide a signal path for 8 data channels and a clock line.

Oscilloscope Probes

Selecting the right probe for your particular measurement involves many choices. While the oscilloscope modules in each analyzer come with probes that meet most measurement needs, you may require a probe with other characteristics.

The HP 1652B/1653B are shipped with HP 10430A probes. The HP 16530A/16531A oscilloscopes are shipped with the HP 10433A mini-probes.

If you require more information on HP oscilloscope accessories, refer to "Oscilloscope Probes and Accessories" guide (HP part number 5954-2678). This guide includes information on probe selection, and lists other oscilloscope accessories.

Capture Patterns with Your State Analyzer

The HP 10392A translates state analyzer data into pattern generator data. You can use the state-to-pattern generator link to help develop test vectors for simulation of missing boards or modules,

functional verification, or regeneration of patterns captured at a remote site.

Functional test with the pattern generator and state analyzer is easier when you can obtain test vectors from a known good source. You can obtain test vectors from a number of sources, then merge them into the pattern generator to create just the test you need.

The HP 10392A state-to-pattern generator link software runs on the HP 16500A logic analysis system without the use of an external controller. This software lets you translate state analyzer data files from your HP 1650B/1651B/1652B/1653B or HP 16510B state analyzer to the HP 16520A/16521A pattern generator.

You can choose automatic or manual label generation and channel assignments, to best meet your test setup needs. Automatic translation of symbols from the state analyzer to the pattern generator makes data interpretation easier. When the state analyzer's time tagging feature is turned on, the pattern generator's clock rate is automatically set, and repeat statements are used to duplicate as closely as possible the data rates of your system.

HP Testmobiles and Carrying Cases

Make your logic analysis system a portable one with the HP testmobile. Each testmobile is designed to withstand rugged use. Drawers for storing your accessories are included. The HP 1008A testmobile with option 006 is designed for the HP 16500A logic analysis system. The HP 1180A is designed for the HP 165X-series logic analyzers.

The 1540-1066 soft carrying case for the HP 165X-series logic analyzers allows you to easily carry your logic analyzer and its accessories to remote sites.

Pattern Generator Output Drivers

The HP 10345A 8-channel ECL differential output driver pod translates the HP 16500A ECL signals into ECL differential output levels. The HP 10346A 8-channel TTL tristate buffer pod allows you to tristate groups of pattern generator channels. The HP 10346A is useful when you are driving bidirectional busses, such as backplane busses. The HP 10348A CMOS tristate buffer pod provides CMOS voltage levels and will allow you to tristate channels in the same manner as the HP 10346A.

* 3M is a registered trade mark of Minnesota Mining and Manufacturing Co.

Optimize Your System

See an overall picture of your system to find the routines that are slowing performance. The HP 10390A system performance analysis software (SPA) converts your HP logic state analyzer into a powerful tool for finding bottlenecks in your system. SPA can help you find the routines that are called most often, identify inefficient use of disks and peripherals, and find processes that use too much CPU time.

The state analyzer repetitively samples your target system as it operates. The analyzer takes a sample of your system, sorts the captured data into ranges, then delays a random amount of time before starting again. The random delay ensures that the measurement won't sync on only a small portion of your system's code. After each acquisition, the captured information is translated into histograms and bar charts to present the big picture of your system's operation.

SPA performs three kinds of measurements; state overview, state histogram, and time interval measurements.

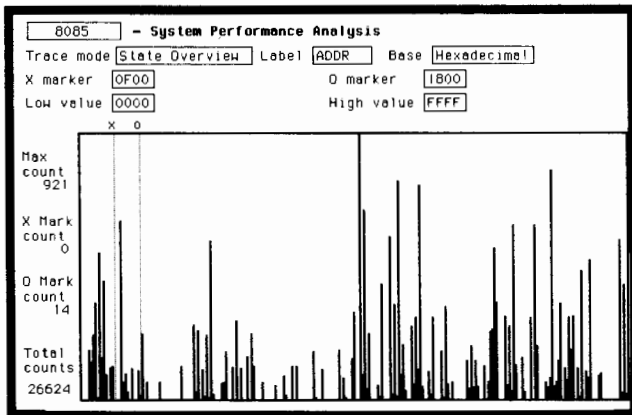

State overview mode on the address lines of microprocessor.

State Overview: a Macro View

The state overview measurement shows an overview of system activity. Set the state overview to look at address lines; the display shows how many times the process accesses each address. This measurement quickly tells you which addresses have activity and which addresses are never used. Use this as a coverage test for diagnostic software or to verify that there are no accesses to protected segments of memory.

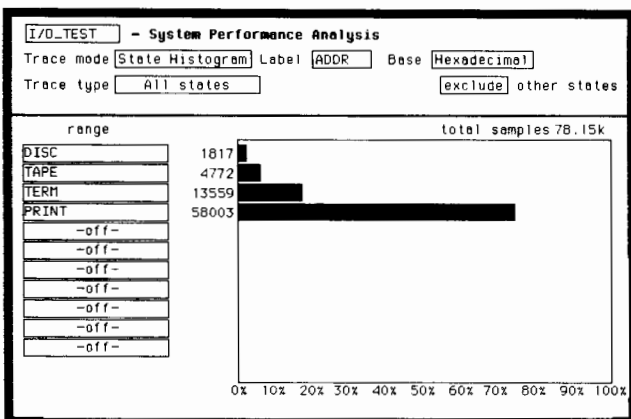

State histogram of system activity.

State Histogram: Software Usage

State histograms allow you to break your measurement into small ranges that correspond to the natural boundaries in your system. A trace shows you the percentage of all operations that occur in a specific range. How often does your system access a disk drive or a printer? Use the state histogram mode to characterize the peripheral usage to optimize your system.

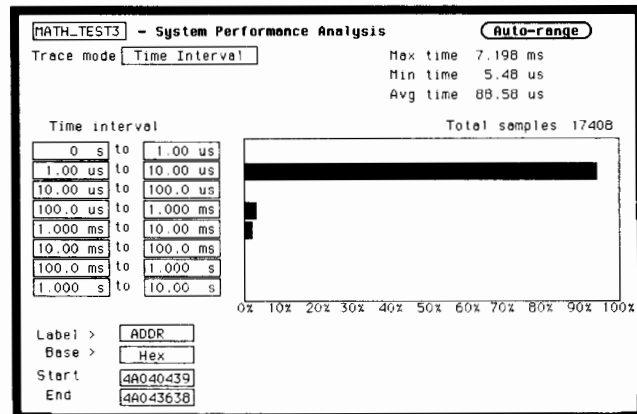

Time interval mode measures the time spent between two events in your system.

Time Interval: Real-Time Performance

When characterizing the speed of your software, use the time interval measurement. Time interval mode measures the time between two events in your system. Now you can find I/O routines that reduce system performance by spending too much time in wait loops, or you can identify error recovery procedures that sometimes take too long.

The time interval mode produces a histogram of time intervals, divided into as many as eight user-definable time ranges. In addition, the average, minimum, and maximum times captured between system events, plus the total number of time interval samples taken, can be read directly off the display.

Operating Characteristics

State overview: bar chart of all possible values of a label versus number of occurrences of each value, available on any label setup in the state format specification. X-axis is all possible values for a label. (Example: for a label with 16 bits, the x-axis can go from 0 to FFFFH.)

State histogram: Histogram of states that occur within specified values of a label. Available on any label setup in the state format specification. User may specify up to 11 ranges of values. Time interval: histogram of the time intervals between user-specified start and stop events. 40 ns time resolution, 60 ns minimum sample period.

Time interval size: 10 ns to 999,000 seconds. Calculated statistics: maximum time, minimum time, average time, total number of time intervals sampled. Start and stop can be qualified from another machine in the logic analyzer.

System performance analysis IS NOT programmable.

LOGIC ANALYZERS

Specifications and Characteristics

HP 1650B, 1651B, 1652B, 1653B, 16510B, 16511B

Logic Analyzers: Key State and Timing Specifications and Characteristics

Model	HP 1650B	HP 1651B	HP 1652B	HP 1653B	HP 16510B	HP 16511B
Channel count	80	32	80	32	80	160
Maximum state input Clock rate *	35 MHz	25 MHz	35 MHz	25 MHz	35 MHz	35 MHz
Setup time *	10 ns	10 ns	10 ns	10 ns	10 ns	10 ns
Hold time *	0 ns	0 ns	0 ns	0 ns	0 ns	0 ns
Minimum state clock Pulse width *	10 ns	10 ns	10 ns	10 ns	10 ns	10 ns
Number of state clocks/qualifiers	5	2	5	2	5	5
Memory depth per channel	1024	1024	1024	1024	1024	1024
Sequence levels	8	8	8	8	8	8
Trigger width	80 ch	32 ch	80 ch	32 ch	80 channels	160 channels
Minimum detectable glitch width * (at threshold)	5 ns	5 ns	5 ns	5 ns	5 ns	5 ns
Input R	100 K Ω $\pm 2\%$	100 K Ω $\pm 2\%$	100 K Ω $\pm 2\%$	100 K Ω $\pm 2\%$	100 K Ω $\pm 2\%$	100 K Ω $\pm 2\%$
Input C	~ 8 pF	~ 8 pF	~ 8 pF	~ 8 pF	~ 8 pF	~ 8 pF
Lead sets included	YES	YES	YES	YES	YES	YES

* = Specifications

Additional Specifications

Probes

Minimum input voltage swing: 600 mV peak-to-peak.

Input threshold accuracy: ± 150 mV accuracy over the range -2.0 to 2.0 volts. ± 300 mV accuracy over the ranges -9.9 to -2.1 volts and 2.1 to 9.9 volts.

Input dynamic range: ± 10 volts about the threshold.

State clocking

Maximum clock rate with time/event tagging on: 16.67 MHz (60 ns).

Master-slave clocking (mixed/demultiplexed clocking): master-clock must follow slave clock by at least 10 ns and precede the next slave clock by at least 50 ns.

Supplemental Characteristics

Probes

Minimum input overdrive: 250 mV or 30% of the input amplitude, whichever is greater.

Maximum input voltage: ± 40 volts peak.

Threshold setting: threshold levels can be defined for pods 1, 2 and 3 on an individual basis. One threshold can be defined for pods 4 and 5. When using the HP 16511B, each card has independent threshold levels as defined above.

Threshold range: -9.9 to $+9.9$ volts in 0.1 volt increments.

Channel assignment: each group of 16 channels (a pod) can be assigned to analyzer 1, analyzer 2 or remain unassigned.

State analysis

Clocks: five clocks are available (two clocks on the HP 1651B and 1653B) and can be used by either one or two state analyzers at any time. Clock edges can be ORed together and operate in single

phase, two phase demultiplexing, or two phase mixed mode. Clock edge is selectable as positive, negative, or both edges for each clock. **Clock qualifier:** the high or low level of four clocks can be ANDed with the clock specification. Setup time: 20 ns; hold time: 5 ns.

Pattern recognizers: each recognizer is the AND combination of bit (0, 1, or X) patterns in each label. 8 pattern recognizers are available when one state analyzer is on. 4 are available to each analyzer when two state analyzers are on.

Clock probing: while using the HP 16511B, and when more than 80 channels are assigned to Analyzer 1, each clock probed by pods on the first card must be probed by pods on the second card also. **Range recognizer:** recognizes data which is numerically between or on two specified patterns (ANDed combination of zeros and/or ones). The maximum size is 32 bits.

Qualifier: a user-specified term that can be anystate, nostate, a single pattern recognizer, range recognizer, or logical combination of pattern and range recognizers.

Branching: each sequence level has a branching qualifier. When satisfied, the analyzer will restart the sequence or branch to another sequence level. Branching not allowed across sequence that contains the trigger.

Occurrence counter: sequence qualifier can be specified to occur up to 65535 times before advancing to the next level.

Storage qualification: each sequence level has a storage qualifier that specifies the states that are to be stored.

Triggering: user can specify a trigger word that can occur across any combination of channels, up to 80 (HP 16510B) or 160 (HP 16511B).

Tagging

State Tagging: Counts the number of qualified states between each stored state. Measurement can be shown relative to the previous state or relative to trigger. Maximum count is 4.4×10^{12} .

Time Tagging: Measures the time between stored states, relative to either the previous state or to the trigger. Maximum time between states is 48 hrs. With tagging on, the acquisition memory depth is halved. Minimum time between states is 60 ns.

Symbols

Pattern symbols: User can define a mnemonic for the specific bit pattern of a label. When data display is SYMBOL, mnemonic is displayed where the bit pattern occurs.

Range symbols: User can define a mnemonic covering a range of values. When data display is SYMBOL, values within the specified range are displayed as mnemonic + offset from base of range.

Number of pattern and range symbols: 100 per analyzer. Symbols can be downloaded over RS-232 or HP-IB.

Timing analysis

Transitional timing mode: sample is stored in acquisition memory only when the data changes. A time tag stored with each sample allows reconstruction of waveform display. Time covered by a full memory acquisition varies with the number of pattern changes in the data. Sample period: Every 10 ns.

Maximum time covered by data: 5000 seconds

Minimum time covered by data: 10.24 μ s

Glitch capture mode: data sample and glitch information is stored every sample period

Sample period in glitch mode: 20 ns to 50 ms in a 1-2-5 sequence, dependent on sec/div and delay settings, sample period displayed when markers are off

Time covered by data in glitch mode: sample period \times 512

Timing waveform display

Sec/div: 10 ns to 100s; 0.01% resolution

Hardware delay: 20 ns to 10 ms

Accumulate: waveform display is not erased between successive acquisitions

Overlay mode: Multiple channels can be displayed on one waveform display line. Primary use is to view summary of bus activity.

Maximum number of displayed waveforms: 24 lines

Time interval accuracy

Sample period accuracy: 0.01% of sample period

Channel-to-channel skew: 4 ns typical

Time interval accuracy: \pm (sample period + channel-to-channel skew + 0.01% of time interval reading)

Trigger specification

Asynchronous pattern: Trigger on an asynchronous pattern less than or greater than specified duration. Pattern is the logical AND of specified low, high, or don't care for each assigned channel. If pattern is valid but duration is invalid, there is a 20 ns reset time before looking for patterns again.

Greater than duration: Maximum duration is 40 ns to 10 ms with 10 ns or 0.01% resolution, whichever is greater. Pattern must be valid for at least 20 ns. Accuracy is +20 ns to -0 ns. Trigger occurs at the end of the pattern.

Glitch/Edge Triggering: Trigger on glitch or edge following valid duration of asynchronous pattern and while the pattern is still present. Edge can be specified as rising, falling, or either. Less than duration forces glitch and edge triggering off.

Measurement and display functions

Arming: Each analyzer can be armed by the run key, the other analyzer, the intermodule bus (HP 16500A), or the built-in oscilloscope (HP 1652B/1653B).

Trace mode: Single mode acquires data once per trace specification; repetitive mode repeats single mode acquisitions until stop is pressed or until pattern time interval or compare stop criteria are complete.

Labels: Channels can be grouped together and given a 6-character name. Up to 20 labels in each analyzer can be assigned with up to 32 channels per label.

Activity indicators: provided in the configuration, state format, and timing format menus for monitoring device-under-test activity while setting up the analyzer.

Markers: two markers (X and O) are shown as dashed lines in the display.

Trigger: displayed as a vertical dashed line in the timing waveform, state waveform and X-Y chart displays and as line 0 in the state listing and state compare displays.

Measurement functions

Run: starts acquisition of data in specified trace mode.

Stop: In single trace mode or the first run of a repetitive acquisition, the Stop function halts acquisition and displays the current acquisition data. For subsequent runs in repetitive mode, Stop halts acquisition of data and does not change current display.

Time interval: The X and O markers measure the time interval between events occurring on one or more waveforms or states (only available when time tagging is on).

Delta states: The X and O markers measure the number of tagged states between any two states.

Patterns: The X or O marker can be used to locate the nth occurrence of a specified pattern before or after trigger, or after the beginning of data. The O marker can also find the nth occurrence of a pattern before or after the X marker.

Statistics: X to O marker statistics are calculated for repetitive acquisitions. Patterns must be specified for both markers, and statistics are kept only when both patterns can be found in an acquisition. Statistics are minimum X to O time, maximum X to O time, average X to O time, and ratio of valid runs to total runs.

Compare mode functions: Performs post-processing bit-by-bit comparison of the acquired state data and compare image data.

Compare image: Created by copying a state acquisition into the compare image buffer. Allows editing of any bit in the compare image to a 1, 0 or X. Compare image can be edited via HP-IB or RS-232.

Compare image boundaries: Each channel (column) in the compare image can be enabled or disabled with bit masks in the compare image. Upper and lower ranges of states (rows) in the compare image can be specified. Any data bits that do not fall within the enabled channels and the specified range are not compared.

Stop measurement: Repetitive acquisitions can be halted when the comparison between the current state acquisition and the current compare image is equal or not equal.

Displays: Compare listing shows the compare image and bit masks; difference listing highlights differences between the current state acquisition and the compare image.

Data entry/display

Display modes: State listing, state waveforms, state chart, state compare listing, compare difference listing, timing waveforms, interleaved time-correlated listing of two state analyzers (time tagging on), time-correlated state listing and timing waveform on the same display; oscilloscope displays (HP 1652B/1653B only): oscilloscope waveform, time-correlated timing with oscilloscope, time-correlated state listing and timing waveform with oscilloscope waveform.

State X-Y chart display: Plots value of a specified label (on y-axis) versus states or another label (on x-axis). Both axes can be scaled.

Markers: Correlated to state listing, state compare, and state waveform displays. Available as pattern, time, or statistics (with time counting) and states (with state counting on).

Accumulate: Chart display is not erased between successive acquisitions.

State waveform display: displays state acquisitions in waveform format.

States/division: 1 to 104 states

Delay: - 1023 to + 1024 states

Accumulate: waveform display is not erased between successive acquisitions.

Overlay mode: Multiple channels can be displayed on one waveform display line. Primary use is to view summary of bus activity.

Maximum number of displayed waveforms: 24.

Markers: Correlated to the state listing, state compare, and X-Y chart displays.

Timing waveform: Pattern readout of timing waveforms at X or O marker.

Bases: Binary, octal, decimal, hexadecimal, ASCII (display only), user-defined symbols

LOGIC ANALYZERS

Specifications and Characteristics (Cont'd)

HP 1652B, 1653B

Logic Analyzers: Key Oscilloscope Specifications and Characteristics

Model(s)	HP 1652B, HP 1653B
Type	2 channel simultaneous acquisition
Bandwidth (-3dB) *	dc to 100 MHz (single shot)
Maximum sample rate	400 MSA/s
Transition time (10% - 90%)	≤ 3.5 ns
A/D	6 bit real-time
A/D resolution	±1.6% of full scale
Waveform record length	2048 points
Time interval measurement accuracy *	±(2% x s/div + .01% x delta t + 500 ps)
dc gain accuracy *	± 3% of full scale
dc offset accuracy *	± (2 mV + 2% of channel offset + 2.5% of full scale)
Voltage measurement accuracy *	Gain accuracy + offset accuracy + ADC resolution
Trigger	Either/both input channels, rising or falling edge(s)
Armed by	run, external BNC low input, or analyzer 1 or 2
Trigger sensitivity *	10% of full screen
Input coupling	dc
Input R	1 MΩ ± 1% or 50 Ω ± 1%
Input C	Approximately 7 pF
Probes included	2 - HP 10430A 10:1, 1 MΩ, 6.5 pF, 1m mini-probes

* = Specifications (valid within ± 10° C of software calibration temperature).

Supplemental Characteristics

Vertical (at BNC)

Vertical sensitivity range: 15 mV/div to 10 V/div (1:1 probe)

Vertical sensitivity resolution: Adjustable 2 digit resolution

dc offset range: ± 2.0 V for ≤ 50 mV/div (1:1 probe)
 ± 10 V for 100 mV/div and 200 mV/div
 ± 50 V for 500 mV/div and 1 V/div
 ± 250 V for ≥ 2 V/div
 ± 5 V max if input impedance at 50 ohm.

dc offset resolution: 200 μV for ≤ 50 mV/div (1:1 probe)
 1 mV for 100 mV/div and 200 mV/div
 5 mV for 500 mV/div and 1 V/div
 25 mV for ≥ 2 V/div
 or 4 digits of resolution, which ever is greater

Probe factors: Any integer ratio from 1:1 to 1000:1.

Maximum safe input voltage: 1 MΩ: ± 250 V [dc + peak ac (<10kHz)]; 50 Ω: 5 V rms.

Channel isolation: 40 dB: dc to 50 MHz; 30 dB: 50 MHz to 100 MHz (with channels at equal sensitivity).

Horizontal

Timebase range: 5 ns/div to 5 s/div

Timebase resolution: for t < 10 ns/div, 100 ps resolution; for t ≥ 10 ns/div, adjustable with 3-digit resolution

Delay pre-trigger range: 40 x (s/div) for all time/div settings

Delay post-trigger range:

Time/division Setting	Available Delay
50 ms - 5 s/div	40 x (s/div)
100 us - 20 ms/div	1 s
5 ns - 50 us/div	10,000 x (s/div)

Triggering

Trigger level range: dc offset ± 6 divisions

Trigger level resolution: 400 μV for ≤ 50 mV/div (1:1 probe)
 2 mV for 100 mV/div and 200 mV/div
 10 mV for 500 mV/div and 1 V/div
 50 mV for ≥ 2 V/div

Trigger mode descriptions

Immediate: Triggers immediately after arming condition is met.

Edge: Triggers on rising or falling edge from channel 1 or 2.

Auto Trigger: Self triggers if no trigger condition is found within approximately 1 second after arming.

Trigger Out: Arms Analyzer 1 or 2 or triggers the rear panel BNC.

Waveform display

Display formats: 1 to 8 scope waveforms displayed

Display resolution: 500 points horizontal, 240 points vertical

Display modes

Single: new acquisition replaces old

Accumulate: new acquisition displayed in addition to previous acquisitions until screen is erased

Average: New acquisitions are averaged with old acquisitions and displayed. Maximum number of averages 256.

Overlay: Channel 1 and Channel 2 can be overlaid in the same area.

Connect-the-dots: Sampled data values connected by straight lines.

Waveform reconstruction: A reconstruction filter fills in missing data points for timebase ≤ 100 ns/div.

Waveform math: Display capability of A-B and A+B functions is provided.

Mixed mode: Scope plus logic analyzer displays on same screen.

Measurement aids

Time markers: Two vertical markers labeled X and O. Voltage levels displayed for each marker. Time interval measurements can be made between any two events.

Automatic search: Searches for a specified absolute or percentage voltage level at a positive or negative edge, count adjustable from 1 to 1024.

Auto Search Statistics: Mean, maximum, and minimum values for elapsed time from X to O markers for multiple runs. Number of valid runs and total number of runs displayed.

Trigger level marker: Horizontal trigger level marker displayed in Trace/Trigger menu only.

Automatic measurements: Automatic measurement of: + pulse width, - pulse width, frequency, period, risetime, falltime, V p-p, preshoot, overshoot.

Grid: Can be selected.

Setup aids

Autoscale: Auto scales the vertical and horizontal ranges, offset, and trigger levels to best display input signals. Requires an amplitude above 10 mV peak, and a frequency between 50 Hz and 100 MHz.

Preset: Scales the vertical range, offset, and trigger level to best display TTL and ECL waveforms.

Calibration: vertical, trigger, channel 1 to channel 2 deskewing, delay, and all defaults.

Probe compensation source: External BNC supplies square wave approx. -400 mV to -900 mV at approximately 1.25 KHz.

Interactive measurements

Acquisition: Analog, timing, and state can occur simultaneously or in series.

Mixed displays: Timing channels and analog channels can be displayed on the same screen. State listings with time tags, timing channels and analog channels can be displayed on the same screen.

Time correlation: All modules are time correlated with the exception of the scope being armed by the logic analyzer and the scope not in trigger immediate mode.

Time interval accuracy

Between modules: Equals the sum of channel to channel time interval accuracies of each machine used for a measurement.

LOGIC ANALYZERS

Specifications and Characteristics

Models 16515A, 16516A

269

1 GHz Timing Analyzers:

Key Characteristics

Model	HP 16515A, HP16516A
Sample rate	1 ns to 1.6 ms
Number of channels	16 per HP 16515A or 16516A
Memory depth per channel	8192
Input R	10 K Ω \pm 2%
Input C	Approximately 3 pF
Leads sets included	YES

Specifications

Minimum input voltage swing: 500 mV peak-to-peak

Input threshold accuracy: \pm 150 mV \pm 3.0% from 0 to +5 volts; \pm 150 mV \pm 2.0% from -3.5 volts to 0 volts

Input dynamic range: \pm 7.0 volts

Supplemental Characteristics

Probes

Minimum input overdrive: 250 mV or 30% of the input amplitude, whichever is greater, above the pod threshold

Maximum input voltage: \pm 40 volts

Threshold range: -3.5 to +5.0 volts in 0.1 volt increments

Time interval accuracy*

Timebase accuracy: \pm .01% of the time interval reading added to: \pm 500 ps at 250 MHz to 1 GHz sample rate. \pm 2 ns at \leq 125 MHz sample rate.

Time interval accuracy: \pm sample period \pm timebase accuracy \pm (2 ns within a pod; 2.5 ns between pods)

Trigger*

Asynchronous pattern: Trigger on asynchronous pattern less than or greater than specified duration, or trigger on not-equal to pattern greater than the specified duration. If pattern is valid but duration is invalid, there is a 2.6 ns reset time before the instrument is ready to look for the pattern again.

Greater than duration: Trigger occurs at pattern valid followed by duration expired.

Greater than duration range: 2 ns to 507 sample periods for patterns specified within a pod. 7 ns to 507 sample periods for patterns specified across pods on the same board. 10 ns to 507 sample periods for patterns specified across boards within a module (1 each 16515A/16516A).

Greater than duration resolution: 4 sample periods

Greater than duration accuracy: \pm 2 ns for 2 ns setting. For all other settings: \pm 1 sample period \pm 2 ns for patterns specified within a pod; 6 ns for patterns specified across pods on the same board; 8 ns for patterns specified across boards.

Less than duration: Trigger occurs at the end of the pattern. Patterns specified within a pod must be valid for at least 1.5 ns. Patterns specified across pods on the same board must be valid for at least 11 ns. Patterns may not be specified across boards.

Less Than duration range: 16 ns to 507 sample periods for patterns specified within a pod. 20 ns to 507 sample periods for patterns specified across pods on the same board.

Less than duration resolution: 4 sample periods

Less than duration accuracy: \pm 1 sample period \pm 3 ns for patterns specified within a pod; 7 ns for patterns specified across pods

Edge trigger: Trigger on edge following valid duration of asynchronous pattern. Less than duration forces edge triggering off. Minimum pulse width 1.5 ns.

Delay from trigger to port-out BNC: Less than 50 ns from the probe tip.

Arming: By the run key, or from any other module or the external port-in via the intermodule bus.

Display functions

Data display/entry labels: Channels may be grouped together and given a 6 character name. Up to 20 labels may be assigned with up to 32 channels per label.

Bases: Binary, octal, decimal, hexadecimal, ASCII (display only), user-defined symbols.

Timing waveform: interleaved, time-correlated listing of timing waveforms and waveforms from other measurement modules (i.e. another timing analyzer or oscilloscope).

Waveform display: sec/div adjustable from 1 ns to 1 s, with 3-digit resolution

Delay: -12.5 s to 53.5 ks

Accumulate: Waveform display is not erased between successive acquisitions.

Overlay mode: Multiple channels can be displayed on one waveform display line. Primary use is to view summary of bus activity.

Maximum number of displayed waveforms: 24

Symbols: 100 maximum

Marker functions

Time interval: The X and O markers measure the time interval between events occurring on one or more waveforms.

Patterns: The X or O markers can be used to locate the 0 to 8192 occurrence of a specified pattern.

* These characteristics are true for input signal, VH = -0.90 V, VL = -1.70 V, threshold = -1.3V, slew rate = 1 V/ns.

LOGIC ANALYZERS

Specifications and Characteristics

Models 16520A, 16521A

50 MBit/s Digital Pattern Generators: Key Characteristics

Model	HP 16520A Master	HP 16521A Expansion
Number of channels	12	48
Bits per channel	4095	4095
Maximum bit rate	50 MBit/s NRZ	50 MBit/s NRZ
Number of return-to-zero channels	3	0
Output voltages	TTL, ECL	TTL, ECL
Lead sets included	YES	NO

Specifications

Internal clock period accuracy: $\pm 2\%$ of period ± 1 ns

External clock duty cycle: 10 ns minimum high time, 10 ns minimum low time

Supplemental Characteristics

Clock sources (16520A only)

Internal clock period: 20 ns to 200 μ s in a 1-2-5 sequence

External clock period: 1 Hz to 50 MHz. Internal frequency divide (/1, /5, or /10) provided.

Return-to-zero (RZ) channels (16520A only)

Number of RZ channels: 3

Bits/channel: 4095

Maximum bit rate: 20 MBit/s (50 ns Period)

Edge placement: > 100 ns period: tenths of period; 50 ns to 100 ns Period: fifths of period; where delay + width \leq period.

Minimum delay: 0

Minimum width: 1/10 data period for > 50 ns period; 1/5 of data period for 50 ns data period

Data rate with external clock: User can divide data rate by 1/5 or 1/10 the external clock rate.

Output Characteristics

Eight-channel pods can be assigned as either standard ECL or TTL levels. All characteristics are valid at the the probe tip.

Output Levels

	ECL	TTL
Voh (steady state)	-0.98 V	2.7 V
Vol (steady state)	-1.55 V (into 10 K Ω , 10 pF)	0.6 V (into 10 K Ω , 10 pF)
Risetime/ falltime (typ)	2.3 ns (-0.98 V to -1.55 V)	2.5 ns (0.6 V to 2.7 V)
Skew* (same card)	≤ 5 ns	≤ 5 ns
Skew* (card-to-card)	< 10 ns	< 10 ns
Number of standard loads	3 (10 KH ECL, leaving Vnh=150 mV)	3 (LS. @ Vnl=250 mV)
Look-back impedance	50 Ω	50 Ω

(output measurements made into a load consisting of 10 K Ω in series shunted with 10 pF to ground.)

(*) Skew measured at (+1.6 V) TTL and (-1.3 V) ECL levels.

Additional Output Options

TTL and CMOS tristate: via buffer pods. User must supply 5 V power and tristate signal.

Differential ECL: via ECL differential pods. User must supply -5 V power.

Clock/input probe

Maximum input voltage: ± 40 V

Input impedance: 100 K Ω , 8 pF

External clock-in to clock-out delay: Approximately 50 ns

	ECL	TTL
Vih (min)	-1.00 V	2.08 V
Vil (max)	-1.52 V	1.12 V

Editing functions

Program listing: delete, merge, copy, insert

Data display formats: binary, octal, decimal, hex, and symbol

Symbols: 100 maximum

Step mode: single-step program execution in 1 to 999 program line steps, from a break

Data instruction set

Break: Stops program execution, last data vector is held at output

Repeat: Repeats vector up to 256 times

Wait IMB: Wait for inter-modular trigger

Wait External: Wait for user-defined 3-bit pattern on external input pod to become true. Pattern must be valid during time period -30 ns to 0 ns before next Clock edge. Latency between valid pattern and next state can occur.

Signal IMB: arms other measurement modules

Macro: Four Macros can be defined and inserted. Macros can be named using a 6-character label. Macros can contain any data instruction.

LOGIC ANALYZERS

Specifications and Characteristics

Models 16530A, 16531A

271



Logic Analyzers: Key Specifications and Characteristics

Model	HP 16530A, HP 16531A
Type	HP 16530A: time base card; supports up to 8 channels of simultaneous acquisition HP 16531A: 2 channel acquisition card
Bandwidth (-3dB) *	dc to 100 MHz (single shot)
Maximum sample rate	400 MSa/s
Transition time (10% - 90%)	≤ 3.5 ns
A/D	6 bit real-time
A/D resolution	± 1.6% of full scale
Waveform record depth	4096 points
Time interval measurement accuracy *	± .75 ns ± .2% of time base range ± .02% of reading (@ 2.5 ns sample period) or ± .2% of time base range ± .02% of reading (all other sample periods)
dc gain accuracy *	± 3% of full scale
dc Offset Accuracy *	± (1 of offset + 3% of full scale)
Voltage measurement accuracy *	Gain accuracy + offset accuracy + ADC resolution
Trigger	16530A: external trigger input 16531A: either/both input channels rising or falling edge(s), pattern trigger
Armed by	run, IMB, external trigger input
Trigger sensitivity * (dc - 100 MHz)	16530A: ≤ 20 mV 16531A: ≤ 12% of full scale
Input coupling	dc
Input R	1 MΩ ± 2% 50 Ω ± 3%
Input C	Approx. 13 pF
Probes Included	2- HP 10433A 10:1, 10 MΩ, 10 pF, 2m mini-probe

* = Specifications (valid within ± 10 °C of auto-calibration temperature).

Supplemental Characteristics

Vertical (at BNC)

Vertical sensitivity range: 5 mV/div to 2 V/div (1:1 probe)

Vertical sensitivity resolution: Adjustable with 2-digit resolution

DC offset range: ±800 mV for < 800 mV/div
± 16 V for ≥ 800 mV/div

dc offset resolution: 1 mV for < 800 mV/div
20 mV for ≥ 800 mV/div

Probe factors: any integer ratio from 1:1 to 1:1000

Maximum safe input Voltage: 1 MΩ input, ± 40 V (dc + peak ac)
50 Ω input, ± 5 V (dc + peak ac)

Horizontal

Time base range: 5 ns/div to 10 s/div

Time base resolution: Adjustable with 3-digit resolution

Delay pre-trigger range: 4096 x sample period

Delay post-trigger range: 500 screen diameters

Triggering

Internal trigger level range: within display window (full scale and offset)

Internal trigger level resolution: 1% of full scale

External trigger level range: ± 2 V

External trigger level resolution: 2 mV

Maximum safe input voltage: 1 MΩ input: ± 40 V (dc + peak ac);
50 Ω input: ± 5 V (dc + peak ac).

Trigger mode descriptions

Immediate: Triggers immediately after arming condition is met.

Edge: Triggers on rising or falling edge of any internal channel or external trigger, count adjustable from 1 to 32,000.

Pattern: Triggers on entering or exiting a specified pattern of all internal channels and external trigger, count adjustable from 1 to 32,000.

Auto-trigger: Self triggers if no trigger condition is found within approximately 25 ms after arming.

Events delay: The trigger can be set to occur on the nth edge or pattern, as specified by the user. The number of events (n) can be set from 1 to 32,000 events.

Trigger out: Arms another measurement module or triggers the rear-panel BNC.

Waveform display

Display formats: 1 to 8 waveforms can be displayed

Display resolution: 500 points horizontal, 240 points vertical

Display modes

Single: new acquisition replaces old

Accumulate: New acquisitions are displayed in addition to previous acquisitions until screen is erased.

Average: New acquisitions are averaged with old acquisitions and displayed.

Overlay: Up to 8 acquired waveforms can be overlaid in the same display area.

Connect-the-dots: Provides a display of the sample points connected by straight lines.

Waveform Reconstruction: A reconstruction filter fills in the missing data points when sampling at 400 MSa/s.

Waveform math: Display capability of A-B and A+B functions is provided.

Measurement aids

Time markers: Two vertical markers labeled X and O. Voltage levels are displayed for each marker. Time interval measurements can be made between any two events.

Automatic search: Searches for specified absolute or percentage voltage level at positive or negative edge, count adjustable from 1 to 1024.

Automatic search statistics: Mean, maximum, minimum value for elapsed time from X to O markers for multiple runs. Number of valid runs and total number of runs displayed.

Automatic measurements: Automatic measurement of: + pulse width, - pulse width, frequency, period, risetime, falltime, V p-p, V top-base, preshoot, overshoot.

Grid: Graticules may be displaced in background of waveform area.

Setup aids

Autoscale: Auto scales the vertical and horizontal ranges, offset, and trigger level to best display the input signals. Requires an amplitude above 10 mV peak, and a frequency between 50 Hz and 100 MHz.

Pre-set: Scales the vertical range, offset, and trigger level to best display ECL or TTL waveforms.

Calibration: vertical, trigger, channel 1 to channel 2 deskewing, delay and all defaults. Cal factors stored to disk.

Probe compensation source: External BNC (on HP 16530A) supplies a square wave; approximately -400 mV to -900 mV at approximately 1 kHz.

LOGIC ANALYZERS

General Characteristics

Models 1650B, 1651B, 1652B, 1653B, 16500A

Logic Analyzers: Characteristics

Built-in Disk Drive(s)

File types: system software, configuration (contains instrument configuration, data, pointer to inverse assembler file), inverse assembler, auto-configuration.

Autoload designation: a pre-defined configuration file can be loaded at powerup.

Disk operations: store, load, copy, duplicate disk, pack disk, rename, purge, format Disk.

Programmability

Instrument settings and operating modes can be remotely programmed for ALL logic analyzer models with either RS-232C or HP-IB (IEEE-488). Both ports are standard on all analyzers. Either port can be used for hardcopy output.

Hardcopy Output

Printers supported: HP ThinkJet, HP QuietJet, HP LaserJet, HP PaintJet, HP DeskJet, Epson and Epson-compatible (e.g., Epson RX-80, RX-100, MX-80, MX-100) printers via RS-232C or HP-IB.

HP-IB interface functions: SH1, AH1, T5, TE0, L3, LE0, SR1, RL1, PP1, DC1, DT1, C0 and E2.

RS-232C configurations

Protocols: XON/XOFF, ENQ/ACK, none, data

Bits: 8

Stop Bits: 1, 1½, 2

Parity: none, odd, even

Baud Rates: 110, 300, 600, 1200, 4800, 9600, 19200.

Input/output rear-panel BNCs

Input BNC: Labeled port-in (HP 16500A) or external trigger input (HP 1650B/1651B/1652B/1653B). Input signal must drive two LS TTL loads.

Output BNC: Labeled Port-out (HP 16500A) or External Trigger Output (HP 1650B/1651B/1652B/1653B). Output signal is active high, TTL output level, high > 2 V into 50 ohms, < 0.4 V into 50 ohms.

Auxiliary power available through cables: The HP 1650B/1651B/1652B/1653B/16510B provide power through the state/timing cables. Each cable is capable of providing 2/3 amp @ 5 V, to a maximum of 2 amp @ 5 V per analyzer or card. The HP 16500A logic analysis mainframe can provide 16.3 amp - current draw of installed cards @ 5 V. The primary use of the auxiliary power is as a source for preprocessors.

Current draw per card: 3.0 amp per HP 16510B, 1.3 amp per HP 16515A, 1.4 amp per HP 16516A, .7 amp per HP 16520A, .8 amp per HP 16521A, .4 amp per HP 16530A, 1.1 amp per HP 16531A.

HP 16500A InterModule Bus (IMB)

Run control: Analog, timing, state, and pattern generation can be armed by group run. Modules can run concurrently or be armed in series. Each module can arm one or more modules.

Mixed display modes: Any timing or oscilloscope waveform displays can be mixed. State listings can be included with waveforms in the state/timing Mixed Mode display.

Acquiring data for mixed displays: To obtain a mixed display, multiple modules must be armed through the IMB. To include a state listing(s) in mixed mode display, state time tagging must be on.

Time interval accuracy between modules: Equals the sum of the channel-to-channel time interval accuracies of each module used in the measurement, for a deskewed measurement.

Operating Environment

Temperature: Instrument, 0° to 50°C (+32° to 122°F). Disk media, 10° to 40°C (+50° to 104°F). Probes and cables, 0° to 65°C (+32° to 149°F).

Humidity: Instrument, up to 95% relative humidity at +40°C (+104°F). Disk media, 8% to 80% relative humidity.

Altitude: to 4600 m (15 000 ft)

Vibration-operating: random vibration 5-500 Hz, 10 minutes per axis, ~ 0.3 g (rms)

Vibration-non-operating: random vibration 5-500 Hz, 10 minutes per axis, ~ 2.41 g (rms); and swept sine resonant search, 5-500 Hz, 0.75 g (0-peak), 5 minute resonant dwell @ 4 resonances per axis.

Weight

HP 1650B/1651B: net, 10.0kg (22lb); shipping 18.2kg (40lb).

HP 1652B/1653B: net, 11.0kg (24lb); shipping 19.0kg (42lb) shipping

HP 16500A (max): net, 18.1kg (40lb) + (.7kg (1.6lb) * number of cards); shipping 25.9kg (57lb) + (3.6kg (8lb) * number of cards)

Power

HP 1650B/1651B/1652B/1653B: 115V/230 V, 48-66 Hz, 200 W max

HP 16500A: 115V/230 V, 48-66 Hz, 475 W max

Size

HP 1650B/1651B/1652B/1653B: 194.3H x 425.4W x 355.6mmD (7.65" x 16.62" x 14.0") including rear feet, excluding bottom feet

HP 16500A: 222.2H x 425.7W x 548.6mmD (8.75" x 16.76" x 21.6"), including rear feet, excluding bottom feet

Logic Analyzer Upgrade Kits

Upgrade kits for logic analyzers include software, hardware, or both, to enhance the performance of your logic analyzer. The text below summarizes the upgrade options available for the HP logic analyzers listed. See page 274 for prices.

HP 1650A and 1651A Upgrades

You can upgrade the software capabilities of your HP 1650A or HP 1651A logic analyzer with the HP 10449A software upgrade kit. This kit includes RAM, ROM, software, and manual inserts to add the following features to the HP 1650A or HP 1651A:

- state compare mode
- state waveforms
- state chart mode

The HP 10449A upgrade kit does NOT include the HP-IB interface or 35 MHz state analysis features present on the HP 1650B. HP Service Center installation is highly recommended and is not included in the price.

HP 16510A Upgrade

The 16510-68703 adds the following software features to your HP 16510A logic analyzer:

- state compare mode
- state waveforms
- state chart mode

This upgrade kit contains software only, and you can install it yourself. The software in this kit is compatible with all HP 16500A modules.

HP 16510A-to-HP 16510B Upgrade

The HP 10448A 35 MHz state hardware upgrade kit for the HP 16510A logic analyzer provides an upgrade to 35 MHz state analysis as well as state compare, state waveforms, and state chart mode. This kit includes the following:

- 80-channel 35 MHz state/100 MHz timing card with no probe assemblies (requires transfer of probe assemblies from the HP 16510A to the new HP 16510B 35 MHz state card)
- software for the new card
- manual inserts

You can install this upgrade kit yourself. It is compatible with all HP 16500A modules. The new card also includes connectors to allow installation of the HP 16511B 160-channel 35 MHz state/100 MHz timing conversion kit. See page 258 for a description of the HP 16511B logic analyzer.

HP 1650B to HP 1651B and HP 1651B to HP 1653P Upgrades

The HP 10349B oscilloscope upgrade kit converts the HP 1650B or HP 1651B logic analyzer to a HP 1652B or HP 1653B, respectively. The upgrade kit includes the following:

- 2-channel 400 MSa/s digitizing oscilloscope board
- software
- manual inserts

HP Service Center installation is highly recommended, and is not included in the price.

LOGIC ANALYZERS

Ordering Information

Ordering Information

Portable Logic Analyzers

	Price
HP 1650B 80 Channel Logic Analyzer	\$7,800
Opt 908 Rackmount Tray	+\$300
Opt 910 Extra Operating and Programming Manual	+\$100
Opt W30 Extended Repair Service. See page 725.	+\$195
HP 1651B 32 Channel Logic Analyzer	\$3,900 ☎
Opt 908 Rackmount Tray	+\$300
Opt 910 Extra Operating and Programming Manual	+\$100
Opt W30 Extended Repair Service. See page 725.	+\$100
HP 1652B 80 Channel Logic Analyzer with Oscilloscope	\$11,300
Opt 908 Rackmount Tray	+\$300
Opt 910 Extra Operating and Programming Manual	+\$100
Opt W30 Extended Repair Service. See page 725.	+\$270
HP 1653B 32 Channel Logic Analyzer with Oscilloscope	\$7,400
Opt 908 Rackmount Tray	+\$300
Opt 910 Extra Operating and Programming Manual	+\$100
Opt W30 Extended Repair Service. See page 725.	+\$175

Modular Logic Analyzers

HP 16500A Logic Analysis System Mainframe	\$7,400
Opt 908 Rackmount Kit (8 $\frac{3}{4}$ " EIA rackmount)	+\$40
Opt 910 Extra Operating and Programming Manual	+\$100
Opt W03 Convert 1 yr return-to-HP to 90 days on-site	\$0
Opt W30 Extended Repair Service. See page 725.	+\$180
HP 16510B 80 Channel 35 MHz State/100 MHz Timing	\$5,200
Opt 910 Extra Operating and Programming Manual	+\$100
Opt W03 Convert 1 yr return-to-HP to 90 days on-site	\$0
Opt W30 Extended Repair Service. See page 725.	+\$130
HP 16511B 160 Channel Logic Analyzer 35 MHz State/100 MHz Timing Conversion Kit (2 HP 16510Bs needed)	\$500
HP 16515A 16 Channel 1 GHz Timing Master Card	\$8,000
Opt 910 Extra Operating and Programming Manual	+\$100
Opt W03 Convert 1 yr return-to-HP to 90 days on site	\$0
Opt W30 Extended Repair Service. See page 725.	+\$195
HP 16516A 16 Channel 1 GHz Timing Expansion Card	\$6,700
Opt W03 Convert 1 yr return-to-HP to 90 days on-site	\$0
Opt W30 Extended Repair Service. See page 725.	+\$165
HP 16520A 12 Channel 50 Mbit/s Pattern Generation Card	\$3,800
Opt 910 Extra Operating and Programming Manual	+\$100
Opt W03 Convert 1 yr return-to-HP to 90 days on site	\$0
Opt W30 Extended Repair Service. See page 725.	+\$95
HP 16521A Pattern Generator Expansion Card	\$4,100
Opt W03 Convert 1 yr return-to-HP to 90 days on-site	\$0
Opt W30 Extended Repair Service. See page 725.	+\$100
HP 16530A 400 MSa/s Oscilloscope Timebase Card	\$1,550
Opt 910 Extra Operating and Programming Manual	+\$100
Opt W03 Convert 1 yr return-to-HP to 90 days on-site	\$0
Opt W30 Extended Repair Service. See page 725.	+\$50
HP 16531A 2 Channel 400 MSa/s Scope Acquisition Card	\$4100
Opt W03 Convert 1 yr return-to-HP to 90 days on-site	\$0
Opt W30 Extended Repair Service. See page 725.	+\$100

Upgrade Kits

HP 10449A Software Upgrade Kit for HP 1650A/51A ¹	\$500
HP 16510-68703 Software Upgrade Kit for HP 16510A	\$95
HP 10448A 35 MHz State Upgrade Kit for HP 16510A	\$3,200
HP 10349B Scope Upgrade Kit for HP 1650B or HP 1651B ¹	\$4,000
CAE Link Software	
HP 74240A HP EDS-to-HP 16500A Bi-Directional CAE Link	\$2000
HP 74240B HP EDS Data File Comparator	\$2000
Accessory Software	
HP 10390A System Performance Analysis Software	\$500
HP 10391A Inverse Assembler Development Package	\$1000
HP 10392A State-to-Pattern Generator Link	\$500

Probe Interface

HP 10269C General Purpose Probe Interface (Required with many microprocessor support packages. See page 248.	\$470 ☎
--	---------

¹ Price for upgrade kit does not include installation.

Microprocessor Preprocessors

HP 10335G Hitachi 6301/6303 (DIP)	\$590
HP 10336G Hitachi 64180 (DIP)	\$590
HP 10336H Hitachi 64180 (PLCC)	\$1160
HP 10304B Intel 8085 (DIP)	\$880
HP 10305B Intel 8086/88 (DIP)	\$1235
HP 10306B Intel 80186/88 (LCC/PGA)	\$2000
HP 10312D Intel 80286 (LCC/PGA)	\$2040
HP 10314B Intel 80386 (PGA)	\$2200
HP 10307B Motorola 6800/02 (DIP)	\$1110
HP 10308B Motorola 6809/09E (DIP)	\$1110
HP 10310B Motorola 68008 (DIP)	\$1110
HP 10311B Motorola 68000/10 (DIP)	\$1320
HP 10311G Motorola 68000/10 (PGA)	\$600
HP 10313G Motorola 68020 (PGA)	\$850
HP 10315G Motorola 68HC11 (DIP)	\$750
HP 10315H Motorola 68HC11 (PLCC)	\$1500
HP 10316G Motorola 68030 (PGA)	\$875
HP 10303B National NSC800 (DIP)	\$1010
HP 10300B Zilog Z80 (DIP)	\$880

Bus and Interface Preprocessors

HP 10342B HP-IB, RS-232C and RS-449 Busses	\$1220
HP 10342G HP-IB Bus	\$350
HP 10341B MIL-STD 1553A/B Bus	\$3910
HP 10343B SCSI Bus	\$1500
HP 10344A A Size VME Bus	\$600
HP 10344B B Size VME Bus	\$600

Minicomputer Interfaces (Need HP 10269C & HP 10320C)

HP 10275A PDP-11 Unibus ²	\$470
HP 10276A LSI-11 Q-Bus ²	\$520
HP 52126A Intel Multibus ³	\$370

User-Definable Interface Products

HP 10320C User Definable Interface	\$270
HP 10321A Microprocessor Interface Parts Kit	\$235
HP 10322A 40-pin DIP Interface Cable	\$410
HP 10323A 48-pin DIP Interface Cable	\$470
HP 10324A 64-pin DIP Interface Cable	\$570
HP 10391A Inverse Assembler Development Package	\$1,000

Printers and Accessories

HP 3630A PaintJet Color Graphics Printer	\$1395
Opt 001 with RS-232C/V.24 Interface	\$0
Opt 002 with HP-IB Interface	\$0
HP 2225A ThinkJet Printer with HP-IB Interface	\$495
HP 2225D ThinkJet Printer with RS-232C/V.24 Interface	\$495
HP 92261A ThinkJet Print Cartridges	\$10.95
HP 92261N Paper (2500 Sheets, for ThinkJet, DeskJet)	\$50.95
HP 92261S Mini-printer Stand	\$49
HP 2276A DeskJet Printer, Centronics/Rs-232C/v.24 Itfc	\$795
HP 10833A HP-IB Cable, 1m	\$80 ☞
13242-60010 RS-232C Cable, 3m	\$69
Oscilloscope Accessories	
HP 10503A BNC-to-BNC cable, 1.2m	\$35 ☞
HP 10240B BNC-to-BNC Blocking Capacitor	\$45
HP 10211A IC Probe Clip	\$81
HP 10024A 16-pin IC test clip	\$20
Oscilloscope Probes	
HP 10020A 1:1-100, 50-5000 Ohm, < 1pF resistive divider probe set, 1.2m	\$495
HP 10430A 10:1, 1 MΩ, 6.5 Pf mini-probe, 1m	\$115
HP 10433A 10:1, 10 MΩ, 10 pF mini-probe, 2m	\$105 ☞
HP 10435A 10:1, 1 MΩ, 7.5pF mini-probe, 1m	\$115 ☞
HP 10437A 1:1, 50 Ω, mini-probe, 2m	\$80 ☞
HP 10438A 1:1, 1 MΩ, 40 pF mini-probe, 1m	\$85 ☞
HP 10439A 1:1, 1 MΩ, 64 pF mini-probe, 2m	\$90 ☞
HP 10440A 100:1, 10 MΩ, 2.5 pF mini-probe, 2m	\$115 ☞
State and Timing Analyzer Replacement Probes and Lead Sets	
HP 01650-61670 16 Channel woven Probe Cable for HP 1650B, 1651B, 1652B and 1653B	\$130
HP 16510-61601 16 Channel woven Probe Cable for HP 16510B pods 1, 3 or 5	\$160
HP 16510-61602 16 Channel woven Probe Cable for HP 16510B pods 2 or 4	\$140
HP 5959-9333 5 Probe Leads for HP 1650 B Series	\$25
HP 5959-9334 5 Short Ground Leads for HP 1650B, 1651B, 1652B, 1653B and 16510B	\$20
HP 5959-9335 5 Long Ground Leads for HP 1650B, 1651B, 1652B, 1653B, 16510B	\$75
HP 01650-61608 16-Channel Probe Lead Set for HP 1650B, 1651B, 1652B, 1653B, 16510B	\$145
HP 01650-63201 Termination Adaptor for HP 1650B, 1651B, 1652B, 1653B, 16510B	\$100
HP 1251-8106 2 x 10, .1" center header (similar to 3-M p/n 3592-6002) ⁴	\$7.50

HP 5959-0288 Grabbers (package of 20)	\$20
HP 16515-61604 1-Channel Coax Probe Cable for HP 16515A, 16516A	\$72.50
HP 16515-69502 8 1-Channel Lead Set for HP 16515A, 16516A	\$115
HP 16515-68703 Grounding Kit for HP 16515A, 16516A	\$150
HP 16515-68705 Probe Pins for HP 16515A, 16516A	\$120
Pattern Generator Accessories; Replacement Probes and Lead Sets	
HP 10392A State to Pattern Generator Link	\$500
HP 16520-61601 Input Qualifier Probe Cable	\$110
HP 16520-69501 Input Qualifier Probe Kit	\$145
HP 16520-61602 8-Channel Data Probe Cable	\$160
HP 16520-61603 Clock/Strobe Probe Cable	\$185
HP 10347A Pattern Generator Probe Lead Set	\$200
HP 10345A 8-Channel ECL Differential Driver Pod	\$120
HP 10346A 8-Channel TTL Tristate Buffer Pod	\$120
HP 10348A 8-Channel CMOS Tristate Buffer Pod	\$120
HP 5959-0288 Grabbers (package of 20)	\$20
Other Accessories for the HP 1650B, 1651B, 1652B, 1653B	
HP 1180A Testmobile for HP 1650B, 1651B, 1652B, 1653B	\$290
HP 92199B Power Strip	\$36
HP 1540-1066 Soft Carrying Case for HP 1650B, 1651B, 1652B, 1653B	\$135
HP 92192A Blank Double-sided 3.5 in Disks (box of 10)	\$29
HP 5061-6175 Rackmount Kit for HP 1650B, 1651B, 1652B, 1653B	\$300
HP 1494-0015 Rackmount Slide Tray for HP 1650B, 1651B, 1652B, 1653B	\$120
HP 9211-2645 Transit Case HP 1650B, 1652B, 1652B, 1653B	\$430
HP 5061-6183 Front Cover for HP 1650B, 1651B, 1652B, 1653B	\$35
Other Accessories for the HP 16500A	
HP 92192A 10 Double-sided 3.5 in Disks (box of 10)	\$29
HP 1008A Testmobile for the HP 16500A	\$970
Opt 006 Power Strip and Cabinet	+\$270
HP 46060A HP Mouse	\$155
HP M1309A Trackball	\$302
HP 5061-9679 Rackmount Kit for HP 16500A	\$40
HP 9211-2658 Transit case for HP 16500A	\$520

☞ Fast-ship product — see page 734.

² PDP-11, LSI-11, Unibus, and Q-Bus are trademarks of Digital Equipment Corporation.³ Multibus is a trademark of Intel Corporation.⁴ 3-M is a registered trademark of Minnesota Mining and Manufacturing Corporation.

DIGITAL CIRCUIT TESTERS

Signature Multimeter, Combines Counter and Multimeter Functions with Signature Analysis

Model 5005B

- Digital and analog measurement capability optimized for digital troubleshooting
- Easy to use single probe measurement of logic signals, voltage, and frequency

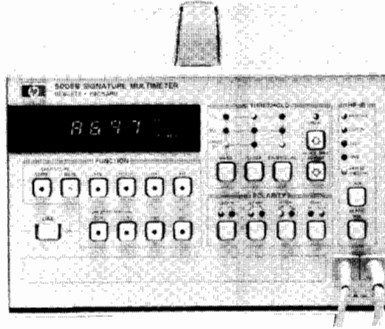

HP 5005B Programmable Signature Multimeter



HP 5005B

Total checkout of a digital system often requires characterizing both digital data activity and analog signal parameters. A typical troubleshooting procedure may specify a digital multimeter for checking power supplies and circuit board integrity (shorts and opens), a universal counter to measure clock frequencies and time intervals between signals, and a means to verify the analog integrity of active digital signals. The HP 5005B Signature Multimeter offers, in a single instrument, a measurement set optimized for these types of digital troubleshooting applications.

- Field proven Signature Analysis (for multiple logic families).
- Digital multimeter (DC volts, resistance and differential voltage).
- Frequency counter (frequency, totalize, time interval).
- Voltage threshold (upper voltage peak, lower voltage peak).
- Multifunction probe.

Signature Analysis

HP's patented Signature Analysis technique enables the HP 5005B to generate a compressed, four digit "fingerprint" or signature of the digital data stream at a logic node. Any fault associated with a device connected through the node will force a change in the data stream and, consequently, produce an erroneous signature.

Specific features of the HP 5005B Signature Analyzer include:

- Multiple logic family compatibility—preset threshold levels for TTL, CMOS, and ECL or adjustable thresholds (+12.5 V to -12.5 V) assure coverage of a wide variety of logic device types.
- 25 MHz clock frequency—extends Signature Analysis to high speed circuits such as CRT controllers.
- Qualified signature mode—speeds fault isolation in complex products by windowing signature collection to specific modules or devices without requiring major test setup changes. This simplifies the engineering involvement in hardware and software testability and accelerates test procedure preparation.

Digital Multimeter

Certain digital problems result from analog circuit failures: a low power supply voltage, an open or shorted circuit path, a faulty A/D or D/A converter. Each may contribute to a system failure. The HP 5005B contains a 4½ digit dc voltmeter, ohmmeter, and differential voltmeter, each with performance geared toward analog measurements necessary in digital troubleshooting.

The implementation of each multimeter function emphasizes simplicity and convenience. Automatic internal self calibration and auto-ranging maximize troubleshooting efficiency by eliminating unnecessary interaction with the instrument. Improvements in display interpretation also aid troubleshooting. The ohmmeter, for example, when measuring an open circuit, produces an "OPEN" indication on the display rather than the typical overload display.

- 25 MHz, multiple logic family signature analysis with qualified clocking mode
- Complete HB-IB programmability of every function

Frequency Counter

The counter within the HP 5005B provides totalize and frequency measurements to 50 MHz, and time interval measurements to 100 nanosecond resolution. Intended to extend the digital troubleshooting capabilities of the Signature Analysis (synchronous measurements), the counter functions provide the ability to characterize one-shots and timers through time interval measurement; test interrupt lines, reset lines, and asynchronous communication interfaces (RS-232) through totalize; and verify clock and clock driver circuitry through frequency measurement.

Voltage Threshold

Logic level degradation is a common and troublesome malfunction in digital products. Isolating this failure typically requires displaying and interpreting the waveform. The HP 5005B's peak voltage measurement mode provides a simple, direct method of measuring logic high and logic low voltage of active digital signals.

The peak voltage measurement mode allows the HP 5005B to characterize and display either the greatest (positive peak) or lowest (negative peak) voltage measured at the probe. Selection of either positive peak or negative peak mode displays the appropriate measured threshold for comparison against the specifications of the logic family.

Multifunction Probe

Several measurement functions incorporated into a single instrument can provide optimal troubleshooting efficiency only when each function is easy to use. The operator, when troubleshooting, must be able to measure the analog signal parameters and digital functional characteristics of a node without requiring time consuming and error-prone probe or instrument setup changes. The HP 5005B multifunction probe solves this problem by providing automatic access to the Signature Analyzer, multimeter, and counter functions through a single probe. All signal multiplexing to the appropriate measurement function is accomplished inside the HP 5005B.

This efficient probing scheme becomes particularly important in automatic applications. The HP 5005B takes advantage of the several functions available in the multifunction probe. A switch, located on the side of the probe, allows the operator to trigger automatic measurement. The instrument controller can then characterize both the analog parameters and functional digital operation of a circuit node while the operator probes the same point. This greater automatic measurement efficiency translates into increased troubleshooting productivity.

HP-IB Programmability

Complete programmability makes the HP 5005B an ideal choice for automatic digital testing and troubleshooting. Every HP 5005B measurement and control function can be programmed through the HP-IB interface. This flexibility allows the automatic test system designer full access to the many measurement functions in the instrument.

Simplified programming enhances the automatic testing and troubleshooting productivity improvements inherent in the HP 5005B. Straightforward commands and data output formats aid in accelerating test program development. A measurement trigger switch located in the probe allows direct operator communication to the controller. Audible feedback, supplied by the beeper in the HP 5005B, can then indicate the completion of the measurement cycle. This closed-loop communication (controller-to-operator) aids in improving trouble-shooting efficiency.

HP 5005B Specifications

Signature

Display: 4 digits. Characters 0-9, ACFHPU.

Fault detection accuracy: 100% probability of detecting single-bit errors; 99.998% probability of detecting multiple-bit errors.

Minimum gate length: 1 clock cycle (1 data bit) between START and STOP.

Maximum gate length: no limit.

Minimum timing between gates: 1 clock cycle between STOP and START.

Data Probe Timing

Setup time: 10 ns (data to be valid at least 10 ns before selected clock edge.)

Hold time: 0 ns (data to be held until occurrence of selected clock edge.)

START, STOP, QUAL Timing

Setup time: 20 ns (signals to be valid at least 20 ns before selected clock edge.)

Hold time: 0 ns (signals to be held until occurrence of selected clock edge.)

CLOCK Timing

Maximum clock frequency: 25 MHz.

Minimum pulse width: 15 ns in high or low state.

Qualify mode: allows data clock qualification by an external signal.

DATA probe input impedance ≈ 50 k Ω to the average value of "0" and "1" threshold settings (± 6 V max); 15 pF.

START, STOP, CLOCK, QUAL input impedance ≈ 100 k Ω ; 15 pF.

Front panel indicators: flashing GATE light indicates detection of valid START, STOP, CLOCK conditions. Flashing UNSTABLE light indicates a difference between 2 successive signatures, and possible intermittent faults.

Frequency

Display: 5 digits.

Ranges: 100 kHz, 1 MHz, 10 MHz, 50 MHz, autoranged.

Resolution: 1 LSD (1 Hz on 100 kHz range).

Accuracy: $\pm 0.01\%$ of reading ± 1 count.

Minimum pulse width ≈ 10 ns in high or low state.

Gate time ≈ 1 s, fixed.

Input impedance ≈ 50 k Ω to the average value of "0" and "1" threshold settings (± 6 V max); 15 pF.

Totalizing

Display: 5 digits.

Range: 0-99,999 counts.

Resolution: 1 count.

Maximum input frequency ≈ 50 MHz, with a minimum pulse width of 10 ns, and minimum pulse separation of 10 ns.

Minimum START/STOP pulse width ≈ 20 ns.

DATA input impedance ≈ 50 k Ω to the average value of "0" and "1" threshold settings (± 6 V max); 15 pF.

START, STOP input impedance ≈ 100 k Ω ; 15 pF.

Time Interval

Display: 5 digits.

Ranges: 10 ms, 100 ms, 1 s, 10 s, 100 s, autoranged.

Resolution: 1 count (100 ns on 10 ms range).

Accuracy: $\pm 0.01\%$ of reading ± 2 counts.

Minimum START/STOP pulse width ≈ 20 ns.

START, STOP input impedance ≈ 100 k Ω ; 15 pF.

Resistance

Display: 4 or 5 digits, depending on range.

Ranges: 30 k Ω , 300 k Ω , 1 M Ω , 3 M Ω , 10 M Ω , autoranged.

Accuracy: (at 15°C–30°C).

RANGE	FULL SCALE	ACCURACY	DISPLAY RESOLUTION
30 k Ω	29.999 k Ω	$\pm 1\%$ of reading ± 2 Ω	1 Ω
300 k Ω	299.99 k Ω	$\pm 1\%$ of reading	10 Ω
1 M Ω	999.9 k Ω	$\pm 1\%$ of reading	100 Ω
3 M Ω	2999. k Ω	$\pm 10\%$ or reading	1 k Ω
10 M Ω	10000. k Ω	$\pm 10\%$ of reading	10 k Ω
Input impedance ≈ 20 k Ω to ± 2 V			

DC Voltage

Display: 4½ digits.

Ranges: ± 25 V, ± 250 V, autoranged; referenced to earth ground.

Accuracy: (at 15°C–30°C).

RANGE	ACCURACY	RESOLUTION
25 V	$\pm 0.1\%$ of reading ± 2 mV	1 mV
250 V (<100 V)	$\pm 0.25\%$ of reading ± 20 mV	10 mV
250 V (≥ 100 V)	$\pm 0.25\%$ of reading ± 20 mV	100 mV

Input impedance ≈ 10 M Ω .

Differential Voltage

Reading: reads input voltage present at the probe and displays difference between it and voltage at the time ΔV key was depressed.

Specifications: same as for DCV, above. Voltage range is determined by larger of 2 compared voltages.

Peak Voltage

Display: 3½ digits.

Range: 0– ± 12 Vp.

Resolution: 50 mV.

Accuracy: $\pm 2\%$ of reading $\pm 5\%$ of p-p signal ± 100 mV.

Minimum peak duration ≈ 10 ns.

Maximum time between peaks ≈ 50 ms.

Input impedance ≈ 100 k Ω ; 15 pF.

Signature Analyzer Logic Thresholds

Preset thresholds: TTL, ECL, CMOS.

Adjustable thresholds: each preset threshold can be adjusted.

Range: ± 12.5 V, in 50 mV steps.

Accuracy: $\pm 2\%$ of setting, ± 2 V

Logic threshold circuitry is operative during NORM, QUAL, kHz, TOTLZ and ms measurements.

General

Data probe tip: acts as high-speed logic probe in the NORM, QUAL, kHz and TOTLZ modes. Lamp indicates high, low, bad-level and pulsing states.

Minimum detected pulse width is 10 ns.

Data Probe Protection

Continuous Overload

DCV, ΔV , k Ω modes only: ± 250 V ac/dc.

All other modes: ± 150 V ac/dc, 20 V rms at input frequencies > 2 MHz.

Intermittent overload: ± 250 V ac/dc, up to 1 min, for all modes.

Timing Pod Protection

Continuous overload: ± 100 V ac/dc, 20 V rms at input frequencies > 2 MHz.

Intermittent overload: ± 140 V ac/dc, up to 1 min.

Auxiliary power supply: three rear-panel connectors supply 5 V at 0.7A total for accessories (HP 5005A only)

Operating temperature: 0°C to +55°C.

Power: selectable 100 V, 120 V, 220 V or 240 V ac line (+5%–10%), 48–66 Hz, 35 VA maximum.

Weight: Net: 5.5 kg (12.0 lb.) Shipping: 8.7 kg (19 lb.)

Size: 133 mm H x 212 mm W x 432 mm D (5¼" x 8⅜" x 17"), excluding handle.

Ordering Information

HP 5005B Signature Multimeter

Opt 910: Additional Manual

Price

\$6,200

+ \$70

DIGITAL CIRCUIT TESTERS

Signature Analyzer, A Digital Troubleshooting Tool

Model 5006A

- Reduce warranty and service support costs
- Full at-speed testing of digital products

- Reduce comparisons to documentation with composite signature
- Compare signatures in groups with signature memory

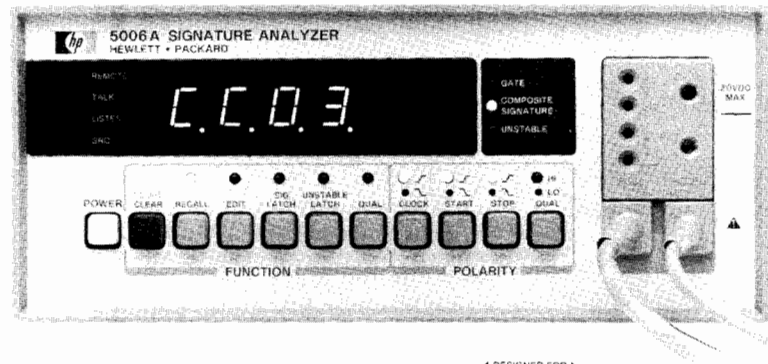

HP 5006A



HP 5006A Signature Analyzer

The Technique

Signature Analysis is a fast and accurate troubleshooting method for digital circuits. Fault finding is reduced to tracing signal flow and comparing measured signatures to those recorded on paper or in a computer. Troubleshoot with Signature Analysis by probing the circuit, reading the display and comparing to the known good signature. A signature is a cyclic redundancy code (CRC) used as an error detection check on blocks of data. Test patterns may be generated within a circuit or stimulated externally.

Programmability Means Efficiency

The HP 5006A is completely programmable using the optional HP-IB interface. Upgrade production test and troubleshooting systems to include digital troubleshooting by adding the HP-IB option.

Signatures compress the necessary troubleshooting information of a bit stream into 16 bits. Instead of entire bit streams, only signatures need be compared to detect bit errors in the unit under test.

Time Savers

Composite signature and signature memory save time for the troubleshooter who does not have a computer-aided system. Composite signature is the binary sum of individual signatures. The HP 5006A computes it for any grouping of digital signals (i.e., bus or IC). Only one "composite" signature need be compared to documentation if all signals for that group are good.

Signatures are stored in the HP 5006A memory after the probe switch is pushed. The memory stores the last 32 signatures probed. Individual signatures can now be compared in groups instead of after each probe by reviewing the memory in the RECALL mode.

HP 5006A Specifications

General

Display: 4 digits. Characters 0-9, ACFHPU.

Fault detection accuracy: 100% probability of detecting single-bit errors; 99.998% probability of detecting multiple-bit errors.

Composite signature: maximum number of signatures: No limit.

Sums all signatures, triggered by probe switch, following depression of CLEAR key, or power-up.

Signature memory: signatures recallable by probe switch: The last 32 signatures triggered by probe switch.

Timing

Clock: maximum frequency: 25 MHz. Minimum clock time: 15 ns in high or low state.

Probe: setup time: 10 ns with 0.2 V overdrive. (Data to be valid at least 10 ns before selected clock edge.) Hold time: 0 ns. (Data to be held after occurrence of selected clock edge.)

Start, stop, qualifier: setup time: 20 ns with 0.2 V overdrive. (Data to be valid at least 20 ns before selected clock edge.) Hold time: 0 ns. (Data to be held until occurrence of selected clock edge.)

Minimum gate length: 1 clock cycle (1 data bit) between START and STOP.

Maximum gate length: no limit.

Minimum timing between gates: 1 clock cycle between STOP and START.

Input Impedance

Probe: 50 k Ω to ground nominal.

Pod: 100 k Ω to ground nominal.

Overload Protection

Probe: ± 150 V continuous.

± 250 V intermittent.

250 Vac for 1 minute.

Pod: ± 20 V continuous.

± 140 V intermittent.

± 140 Vac for 1 minute.

CMOS sense: 20 Vdc maximum.

TTL Thresholds

Probe: Logic one: 2 V + .2–.3. Logic zero: 0.8 V + .3–.2

Pod: 1.4 V \pm .6

CMOS Thresholds

Logic one: 70% of sensed voltage.

Logic zero: 30% of sensed voltage.

Display and Indicators

Signature: four seven-segment digits with decimal point.

Lamps: Key Status: Recall, edit, signature latch, unstable latch, qualify mode, timing polarities. Programmable: Remote, talk, listen, SRQ. (Option 040). Status: Composite signature, gate, unstable.

Probe: logic levels indicated: High, low, open and pulsing. Minimum pulse width: 10 ns.

Other

Selectable power: 115 V +10%–25% ac line, 48–440 Hz.

230 V +10–15% ac line, 48–66 Hz. 25 VA maximum.

Operating environment: temperature: 0–55°C. Humidity: 95% RH at +40°C. Altitude: 4600 m (15,000 ft).

Size: 89 mm H x 216 mm W 279 mm D (3-1/2 in. x 8-1/2 in. x 11 in.).

Net weight: 2.4 kg (5.3 lb). Shipping weight: 4.1 kg (9 lb).

Ordering Information

HP 5006A Signature Analyzer

Opt 40 HP-IB Interface

Opt 910 Additional Manual

HP 5060-0173 Half Rack Mount Kit

Price

\$2100

+\$300

+\$16.50

\$68

HP 545A TTL/CMOS Logic Probe

The HP 545A Logic Probe contains all the features built into other HP probes, plus switch-selectable, multi-family operation and built-in pulse memory. Employing straightforward one-lamp display the HP 545A operates from 3 to 18 volts in CMOS applications or from 4.5 to 15 Vdc supplies in the TTL mode while maintaining standard TTL thresholds.

The probe's independent, built-in pulse memory and LED display help you capture hard to see, intermittent pulses. Just connect the probe tip to a circuit point, reset the memory, and wait for the probe to catch those hard to find glitches.

The hand-held HP 545A is light, rugged, overload protected, and very fast: 80 MHz in TTL, 40 MHz in CMOS. It also employs handy power supply connectors that enable you to easily hook up to supply voltage almost anywhere in the unit under test.

HP 545A Probe Specifications

Input current: $\leq 15 \mu\text{A}$ (source or sink).

Input capacitance: $\leq 15 \text{ pF}$.

Logic thresholds

***TTL:** Logic one $2.0 + 0.4$, -0.2 V . Logic zero $0.8 + 0.2$, -0.4 V .

CMOS: 3–10 Vdc supply

Logic one: $0.7 \times V_{\text{supply}} \pm 0.5 \text{ Vdc}$.

Logic zero: $0.3 \times V_{\text{supply}} \pm 0.5 \text{ Vdc}$.

CMOS: ≥ 10 –18 Vdc supply.

Logic one: $0.7 \times V_{\text{supply}} \pm 1.0 \text{ Vdc}$.

Logic zero: $0.3 \times V_{\text{supply}} \pm 1.0 \text{ Vdc}$.

Input minimum pulse width: 10 ns using ground lead (typically 20 ns without ground lead).

Input maximum pulse repetition frequency:

TTL, 80 MHz. CMOS, 40 MHz.

Input overload protection: $\pm 120 \text{ V}$ continuous (dc to 1 kHz); ± 250 for 15 seconds (dc to 1 kHz).

Pulse memory: indicates first entry into valid logic level; also indicates return to initial valid level from bad level for pulse $\geq 1 \mu\text{s}$ wide.

Power Requirements

TTL: 4.5 to 15 Vdc*.

CMOS: 3 to 18 Vdc.

Maximum current: 70 mA.

Overload protection: $\pm 25 \text{ Vdc}$ for one minute.

Accessory included: ground clip.

* $\pm 5 \pm 10\%$ Vdc power supply; usable to $+15 \text{ Vdc}$ with slightly increased logic low threshold.

HP 546A Logic Pulser

The Logic Pulser solves the problem of how to pulse IC's in digital circuits. Merely touch the Pulser to the circuit under test, press the pulse button and all circuits connected to the node (outputs as well as inputs) are briefly driven to their opposite state. No unsoldering of IC outputs is required. Pulse injection is automatic, high nodes are pulsed low and low nodes, high, each time the button is pressed.

Automatic polarity pulse output, pulse width, and amplitude make for easy multi-family operation when you use the HP 546A Logic Pulser. But, the real surprise comes when you code in one of its six ROM-programmable output patterns (single pulses; pulse streams of either 1, 10, or 100 Hz; or bursts of 10 or 100 Hz; or bursts of 10 or 100 pulses). This feature allows you to continually pulse a circuit when necessary, or it also provides an easy means to put an exact number of pulses into counters and shift registers. Used with our multi-family IC Troubleshooters, the HP 546A acts as both a voltage and current source in digital troubleshooting applications.

HP 546A Pulser Specifications

Output

Family	Output Current	Pulse Width	Typical Output Voltage	
			HIGH	LOW
TTL/DTL	$\leq 650 \text{ mA}$	$\geq 0.5 \mu\text{s}$	$\geq 3 \text{ Vdc}$	$\leq 0.8 \text{ Vdc}$
CMOS	$\leq 100 \text{ mA}$	$\geq 5.0 \mu\text{s}$	$\geq (V_{\text{supply}} - 1 \text{ Vdc})$	$\leq 0.5 \text{ Vdc}$

Power supply requirements: TTL; 4.5 to 5.5 Vdc at 35 mA, CMOS; 3 to 18 Vdc at 35 mA, protected to $\pm 25 \text{ Vdc}$ for 1 min.

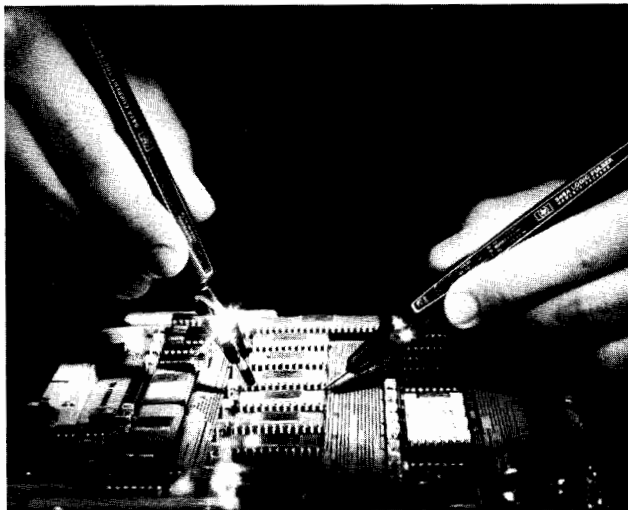

HP 547A/546A

HP 547A Digital Current Tracer

The HP 547A Current Tracer precisely locates low-impedance faults in digital circuits by locating current sources or sinks. For example, on a bad node the Tracer can verify that the driver is functioning and also show where the problem is by tracing current flow to the source or sink causing the node to be stuck. The Tracer is designed to troubleshoot circuits carrying fast rise-time current pulses. The Tracer senses the magnetic field generated by these signals in the circuit and displays transitions, single pulses, and pulse trains using a simple one-light indicator. Because it is not voltage sensitive, the Tracer operates on all logic families having current pulses exceeding 1 mA, including CMOS, where even lightly loaded outputs can have up to 2 to 3 mA of instantaneous charging current.

To use the Tracer, align the dot on its tip at a reference point, usually the output of a node driver. Set the sensitivity control to indicate the presence of ac current activity. As you probe from point to point or follow traces, the lamp will change intensity; when you find the fault the Tracer will indicate the same brightness found at the reference point.

HP 547A Current Tracer Specifications

Input

Sensitivity: 1 mA to 1 A.

Frequency response: light indicates single-step current transitions; single pulses $\geq 50 \text{ ns}$ in width; pulse trains to 10 MHz (typically 20 MHz for current pulses $\geq 10 \text{ mA}$).

Risetime: light indicates current transitions with risetime $\leq 200 \text{ ns}$ at 1 mA.

Power Supply Requirements

Voltage: 4.5 to 18 Vdc.

Input current: $\leq 75 \text{ mA}$.

Maximum ripple: $\pm 500 \text{ mV}$ above 5 Vdc.

Overvoltage protection: $\pm 25 \text{ Vdc}$ for one minute.

Accessories Available

Accessory	Price
HP 00545-60104: Tip Kit for HP 546A Pulser, 545A Probe	\$65 ☞
HP 10526-60002: Multi-Pin Stimulus Kit	\$75 ☞
HP 1250-1948 Adapter, Coax Str.	\$25

Ordering Information

HP 545A Logic Probe	\$260 ☞
HP 546A Logic Pulser	\$350 ☞
HP 547A Digital Current Tracer	\$630 ☞

☞ Fast-ship product—see page 734.

DIGITAL CIRCUIT TESTERS

Logic Clip, Logic Comparator

Models 548A & 10529A



HP 548A

HP 548A Logic Clip

The Logic Clip is an extremely handy service and design tool which clips onto dual-in-line package (DIP) ICs, instantly displaying the states of up to 16 pins. Each of the clip's 16 LEDs independently follows level changes at its associated pin. Lit diodes are logic High, extinguished diodes are Low.

The Logic Clips's real value is in its ease of use. It has no controls to set, needs no power connections, and requires practically no explanation as to how it is used. The clip has its own gating logic for locating ground and V_{CC} pins and its buffered inputs reduce circuit loading.

The Logic Clip is much easier to use than either an oscilloscope or a voltmeter when you are interested in whether a circuit is in the high or low state, rather than its actual voltage. The Clip, in effect, is 16 binary voltmeters, and the user does not have to shift his eyes away from his circuit to make the readings.

The intuitive relationship of the input to the output—lighted diode corresponding a high logic state—greatly simplifies the troubleshooting procedure. The user is free to concentrate his attention on his circuits, rather than on measurement techniques. Also, timing relationships become especially apparent when clock rates can be slowed to about 1 pulse per second.

When used in conjunction with the Logic Pulser, the Logic Clip offers unparalleled analysis capability for troubleshooting sequential Logic Devices used to inject pulses between gates allowing it to supply signals to the IC under test absolutely independent of gates connected to the IC. All outputs may then be observed simultaneously on the Logic Clip. Deviations from expected results are immediately apparent as the Pulser steps the IC through its truth table.

HP 548A Multi-Family Logic Clip

Fully automatic and protected to 30 Vdc, and employing bright individual LEDs in its display, the HP 548A brings multi-family operation to the HP line of IC Troubleshooters. The Clip can be externally powered, if desired, using a simple power connector.

HP 548A Specifications

Input threshold: $(\geq 0.4 \pm 0.06 \times \text{Supply Voltage}) = \text{Logic High}$.

Input impedance: 1 CMOS load per input.

Input protection: 30 Vdc for 1 minute.

Supply voltage: 4-18 Vdc across any two pins.

Auxiliary supply input: 4.5 to 20 Vdc applied via connector. Supply must be ≥ 1.5 Vdc more positive than any pin of IC under test.

Supply current: <55 mA.

HP 548A Logic Clip

☎ Fast-ship product—see page 734.

\$320 ☎

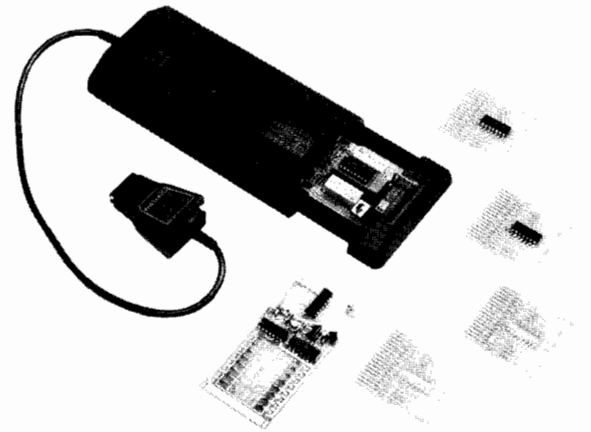

HP 10529A

HP 10529A Logic Comparator

The HP 10529A Logic Comparator clips onto powered TTL or DTL ICs and detects functional failures by comparing the in-circuit test IC with a known good reference IC inserted in the Comparator. Outputs of the particular IC to be tested are selected via 16 miniature switches which tell the Comparator which pins of the reference IC are inputs and which are outputs. Any logic state difference between the test IC and reference IC is identified to the specific pin(s) on 14- or 16-pin dual in-line packages on the Comparator's display. A lighted LED corresponds to a logic difference. Intermittent errors as short as 300 nanoseconds (using the socket board) are detected, and the error indication on the Comparator's display is stretched for a visual indication. A failure on an input pin, such as an internal short, will appear as a failure on the IC driving the failed IC; thus a failure indication actually pinpoints a malfunctioning node. A test board is supplied to exercise all of the circuitry, test leads, and display elements to verify proper operation.

HP 10541A: twenty additional blank reference boards; identical to the 10 boards provided with the Logic Comparator.

HP 10541B: twenty preprogrammed reference boards. The 10541B includes the following ICs: 7400, 7402, 7404, 7408, 7410, 7420, 7430, 7440, 7451, 7454, 7473, 7474, 7475, 7476, 7483, 7486, 7490, 7493, 74121, 9601.

HP 10529A Specifications

Input threshold: 1.4 V nominal (1.8 V nominal with socket board), TTL or DTL compatible.

Test IC loading: outputs driving Test IC inputs are loaded by 5 low-power TTL loads plus input of Reference IC. Test IC outputs are loaded by 2 low-power TTL loads.

Input protection: voltages < -1 V or > 7 V must be current limited to 10 mA.

Supply voltage: 5 V $\pm 5\%$, at 300 mA.

Supply protection: supply voltage must be limited to 7 V.

Maximum current consumption: 300 mA.

Sensitivity

Error sensitivity: 200 ns with reference board or 300 ns with socket board. Errors greater than this are detected and stretched to at least 0.1 second.

Delayed variation immunity: 50 ns. Errors shorter than this value are considered spurious and ignored.

Frequency range: maximum operational frequency varies with duty cycle. An error existing for a full clock cycle will be detected if the cycle rate is less than 3 MHz.

Accessories included: 1 test board; 10 blank reference boards; 1 programmable socket board; 1 carrying case.

Accessories Available

HP 10541A: Twenty Blank Reference Boards

Price

\$140 ☎

HP 10541B: Twenty Pre-programmed Boards

\$440 ☎

HP 10529A Logic Comparator

☎ Fast-ship product—see page 734.

\$1100 ☎

DIGITAL CIRCUIT TESTERS

Logic Troubleshooting Kits

Models 5011T, 5021A, 5022A, 5023A & 5024A

281

- Complete multi-family kits
- Stimulus-response capability
- In-circuit fault finding

- In-circuit analysis
- Dynamic and static testing
- Multi-pin testing

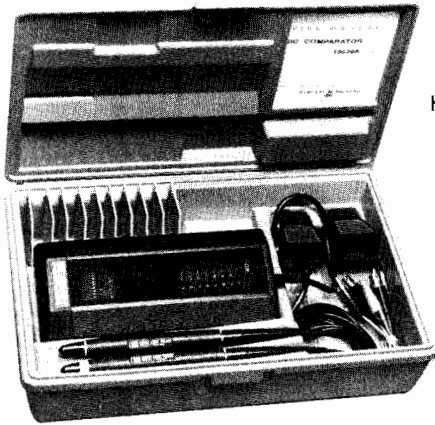

HP 5011T

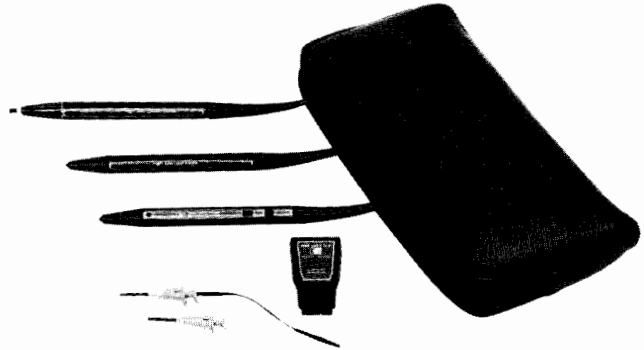

HP 5022A

FAULT	STIMULUS	RESPONSE	TEST METHOD
Shorted Node ¹	Pulser ²	Current Tracer	<ul style="list-style-type: none"> • Pulse shorted node • Follow current pulses to short
Stuck Data Bus	Pulser ²	Current Tracer	<ul style="list-style-type: none"> • Pulse bus line(s) • Trace current to device holding the bus in a stuck condition
Signal Line Short to Vcc or Ground	Pulser	Probe, Current Tracer	<ul style="list-style-type: none"> • Pulse and probe test point simultaneously • Short to Vcc or Ground cannot be overridden by pulsing • Pulse test point, and follow current pulses to the short
Supply to Ground Short	Pulser	Current Tracer	<ul style="list-style-type: none"> • Remove power from circuit under test • Disconnect electrolytic bypass capacitors • Pulse across Vcc and ground using accessory connectors provided • Trace current to fault
Internally Open IC	Pulser ²	Probe	<ul style="list-style-type: none"> • Pulse device input(s) • Probe output for response
Solder Bridge	Pulser ²	Current Tracer	<ul style="list-style-type: none"> • Pulse suspect line(s) • Trace current pulses to the fault • Light goes out when solder bridge passed
Sequential Logic Fault in Counter or Shift Register	Pulser	Clip	<ul style="list-style-type: none"> • Circuit clock de-activated • Use Pulser to enter desired number of pulses • Place Clip on counter or shift register and verify device truth table

1. A node is an interconnection between two or more IC's.
2. Use the Pulser to provide stimulus or use normal circuit signals, whichever is most convenient.

Used individually, each of HP's IC Troubleshooters provide their own unique and important troubleshooting function. Together they become invaluable stimulus-response testing partners that help pinpoint faults and ensure fast non-destructive repair of digital circuits.

To help you take advantage of the usefulness of the IC Troubleshooters, HP has packaged them into kits which offer both ordering convenience, and cost savings. Also, applications information is available, such as AN 163-2, "New Techniques of Digital Troubleshooting", to help users derive maximum benefit from these instruments.

The table shows a series of typical node and gate faults and the combination of tools used to troubleshoot the circuit. As with all sophisticated measuring instruments, operator skill and circuit knowledge are key factors once the various clues or "bits" of information are obtained using the IC Troubleshooters.

To accomplish troubleshooting at the node and gate level, both stimulus (Pulser) and response (Probe, Tracer, Clip and Comparator) instruments are needed. Moreover, instruments with both voltage and current troubleshooting capability help isolate electrical faults where the precise physical location is hard to identify.

The HP 547A Current Tracer, the latest and most sophisticated of these troubleshooters, lets you "see" current flow on nodes and buses that otherwise appear stuck at one voltage level. Used with the HP 546A Pulser, stimulus-response testing is now also possible in the current domain.

IC Troubleshooter Kits Ordering Information

Kit	H mm (in)	W mm (in)	D mm (in)	Net Wt kg (lbs, oz)	Ship Wt kg (lbs, oz)
HP 5011T	82.6 (3.25)	203 (8)	311 (12.25)	1.49 (3.5)	2.11 (4.11)
HP 5021A	64 (2.5)	146 (5.75)	298 (11.75)	0.51 (1.2)	0.62 (1.6)
HP 5022A	64 (2.5)	146 (5.75)	298 (11.75)	0.65 (1.7)	0.76 (1.11)
HP 5023A	225 (8.88)	200 (7.88)	337 (13.25)	1.63 (3.10)	2.19 (4.14)
HP 5024A	64 (2.5)	146 (5.75)	298 (11.75)	0.60 (1.5)	0.71 (1.9)

IC Troubleshooter Kits Selection Guide

HP MODEL	545A TTL/CMOS Probe	546A TTL/CMOS Pulser	547A TTL/CMOS Current Tracer	548A TTL/CMOS Clip	10529A TTL Comparator	PRICE \$
5011T Kit	X	X		X	X	2000 ☎
5021A Kit	X	X		X		910 ☎
5022A Kit	X	X	X	X		1530 ☎
5023A Kit	X	X	X	X	X	2600 ☎
5024A Kit	X	X	X			1220 ☎

☎ Fast-ship product—see page 734.

Accessories Available

HP 00545-60104: Tip Kit for HP 545A Probe, and 546A Pulser \$65 ☎

HP 10526-60002: Multi-pin Stimulus Kit for Logic Pulser \$75

HP 10529-60006: External Reference Kit for HP 10529A Comparator \$440

HP 10541A: Twenty blank reference boards for HP 10529A Comparator \$140 ☎

HP 10541B: Twenty pre-programmed reference boards for HP 10529A Comparator \$440 ☎

☎ Fast-ship product—see page 734.

COMPONENT MEASUREMENT

General Information Impedance Measurement

Application Area	Component/Material Manufacturer			Component User	
	R&D and QA	Production	Incoming Inspection	R&D	
Major Requirements	Verify that device has sufficient performance	Perform GO/NO-GO testing based on MIL, IEC, etc.		Evaluate devices/circuits under actual working conditions	
Required Measurement Functions	Multi-function/General Purpose Wide freq. range Auto freq. sweep Variable signal level & DC Bias Multi-parameter High accuracy and resolution	High Speed/Single Function High Speed Fixed frequency level & DC Bias Single parameter		Multi-function/General Purpose High frequency resolution Auto freq. sweep Variable signal level & DC Bias Multi-parameter High accuracy and resolution	
HP 4195A					
HP 4194A					
HP 4192A					
HP 4191A					
HP 4193A					
HP 4284A					
HP 4274A/ 4275A					
HP 4278A					
HP 4276A/ 4277A					
HP 4279A					
HP 4261A/ 4262A					
HP 4342A					
HP 4328A					
HP 4329A					

Table 1 Component measurement applications and HP products

Note: Refer to page 224 for complete information of the HP 4195A.

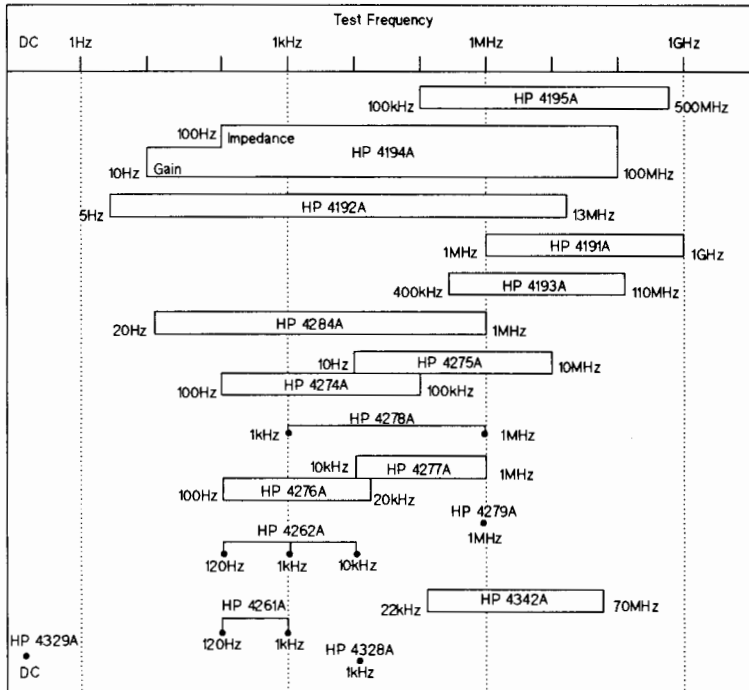

Table 2 HP component measurement products vs. test frequency

Note: Refer to page 224 for complete information of the HP 4195A.

Component Measurement

An impedance-measuring instrument measures impedance characteristics of electronic components, materials and circuits. HP impedance instruments provide:

1. A broad product line, to fit each application;
2. Full evaluation of impedance characteristics under conditions of varying frequency, test-signal level and DC bias.
3. High-precision, high-resolution impedance measurement, with error correction for test-lead or test-fixture effects.

Impedance-measuring instruments can be divided into two general categories: LCR meters and impedance analyzers. The LCR meter primarily measures the inductance, capacitance and resistance of a test device. The impedance analyzer, in addition to all of the functions of the LCR meter, measures the impedance and phase of the test device, and makes detailed analysis of the impedance measurement.

The major applications of impedance-measurement instruments are in electronic-component materials manufacture and electronic equipment manufacture (electronic component users). Table 1 shows the type of evaluation and the functions required according to instrument application.

Impedance measurements can be divided into two general categories:

1. Tests of whether the test device functions properly under application conditions and
2. Tests under conditions stipulated by MIL or IEC standards.

When type 1 measurements are conducted in an R&D department, the purpose is to shorten development time through careful evaluation. Therefore, a multi-function, general-purpose instrument for the measurement of many characteristics is required, such as an impedance analyzer or high-resolution LCR meter.

Type 2 measurements are conducted for go/no-go tests in manufacturing or incoming inspection. The measurement data are fed back to vendors or manufacturing processes for correction and improvement. Because of volume, test costs must be minimized. Therefore, a high-speed, single-function instrument may be used. Sorting and interpreting test results may be required, so an LCR meter with a comparator option can be used.

Table 2 shows HP's line of instruments arranged according to measurement frequency and performance. Test frequencies of these instruments range from 5 Hz to 1 GHz, and some have fixed MIL/IEC standard frequencies between 1 kHz and 1 MHz.

Since the time that HP introduced the first digital LCR meter, the company has continued to create high-performance impedance-measurement instruments. Because of this effort, it is now possible for virtually anyone to make the most difficult impedance measurements with ease and great accuracy.

Variety of available test fixtures and cables

A variety of test fixtures and cables are available for the HP LCR meters for many applications. Table 3 and Figure 1 are compatibility charts for the test fixtures and cables and HP's LCR meters. Refer to the individual LCR meter data sheet for details.

- 1: information given with cable length; connector type; recommended frequency for use; max. applicable dc voltage.
- 2: information given with recommended frequency for use; max. applicable dc voltage.
- 3: information given with cable length; recommended frequency for use; max. applicable dc voltage; (shape of UNKNOWN terminals).
- 4: a cable with 7 mm connectors required.

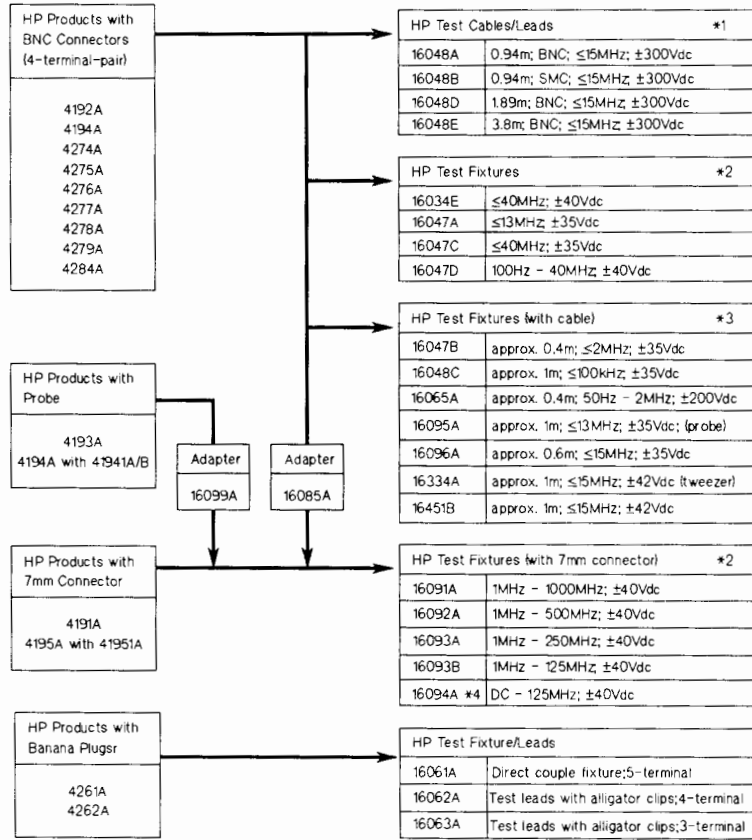
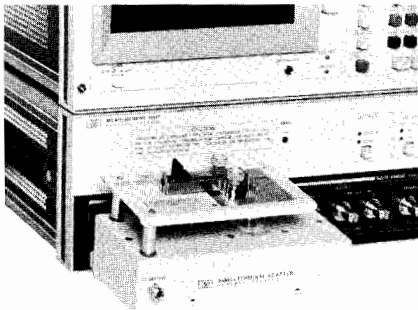
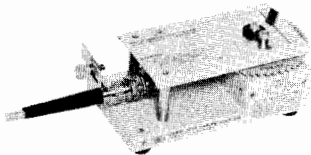

Figure 1. HP instruments vs. accessories



HP 16092A with HP 16085A



HP 16093A with HP 16099A

Note: Refer to the sections of the HP 41941A/B and 41951A for more information.

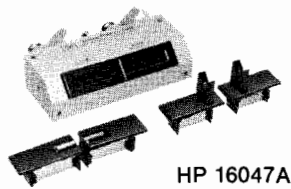

HP 16047A

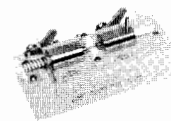

HP 16034E



HP 16047C

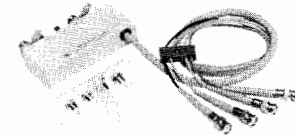

HP 16048A

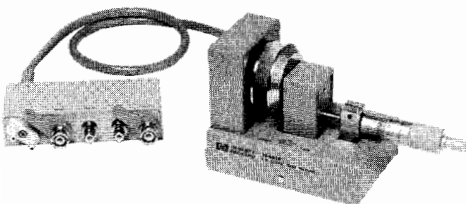

HP 16451B

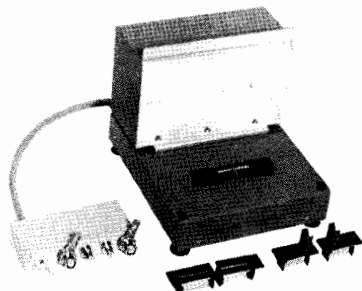

HP 16065A

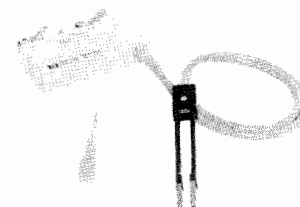

HP 16334A

COMPONENT MEASUREMENT

Impedance/Gain-Phase Analyzer

Model 4194A

- High Accuracy and Wide Range
Impedance Measurement:
100Hz to 40MHz, 0.1m Ω to 1.6M Ω , 0.17%
10 kHz to 100 MHz, 0.1 Ω To 1M Ω , 1.5% when
used with the HP 41941A/B
- Gain-Phase Measurement:
10Hz to 100MHz, -107dBm to +15dBm, 0.1dB
resolution
- Flexible Measurement, Computation and Analysis Capabilities on a Color Graphic Display
- Fully Programmable

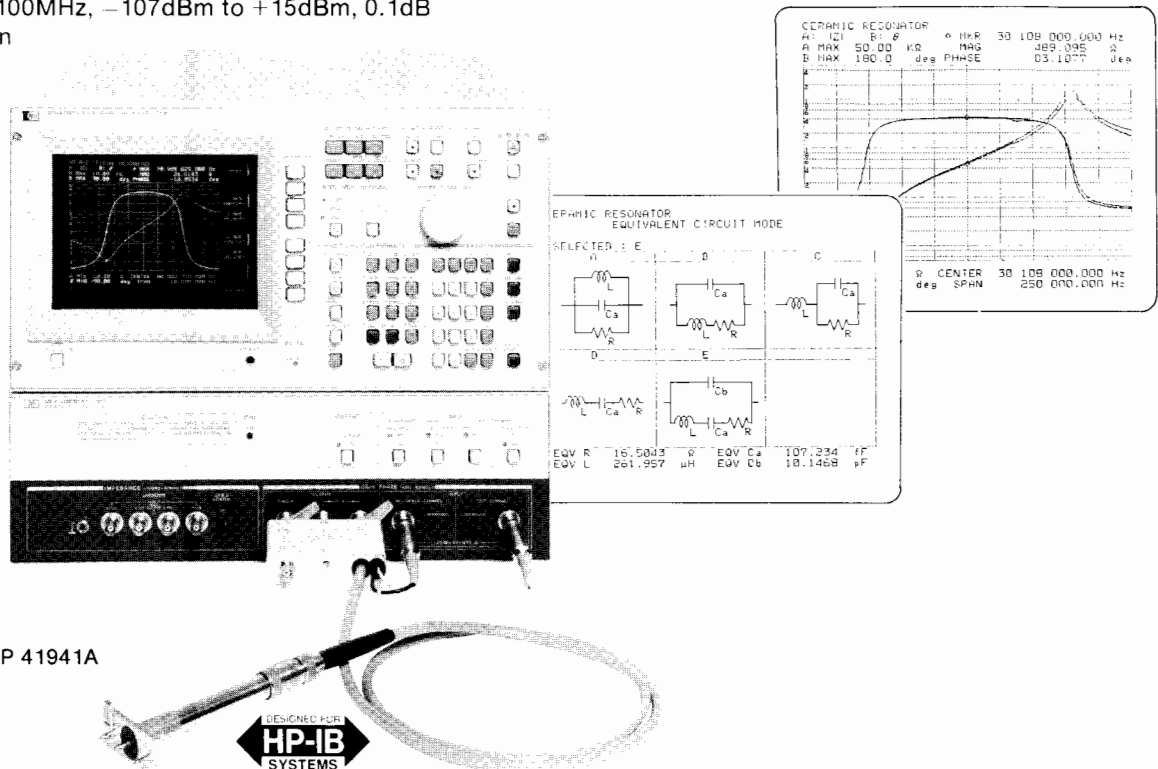

HP 4194A with HP 41941A

Description

The HP 4194A Impedance/Gain-Phase Analyzer is an integrated solution for efficient measurement and analysis or go/no-go testing of components and circuits. Detailed impedance and transmission characteristics including secondary parameter derivations can be simply and quickly evaluated or tested. The HP 4194A can contribute to improving engineering productivity and reducing test cost. The analyzer is flexible and has wide measurement capabilities in both impedance and transmission measurements, plus it is fully programmable using Auto Sequence Programming (ASP). Desired measurements and computations, including graphics analysis, can be programmed simply by storing front panel keystroke operations, allowing you to customize measurement, computation and analysis functions. The HP 4194A also features high accuracy and error elimination functions to ensure reliable measurements.

Wide Range Accurate Measurement

Featuring a wide test frequency range — 100Hz to 40MHz for impedance measurements (10kHz to 100MHz when using the HP 41941A/B Impedance Probe Kit) and 10Hz to 100MHz for gain-phase measurements — the HP 4194A satisfies a wide spectrum of needs. Realistic device characteristics can be analyzed under actual operating conditions by varying the test frequency, test signal level, and dc bias. The HP 4194's high degree of measurement accuracy — 0.17% for impedance measurements (1.5% when using the HP 41941A/B) with an amplitude ratio of 0.1 dB — ensures that you'll improve the quality of your test devices.

Quick Analysis

The HP 4194A makes high speed measurements, (approximately 3.7ms per point), displays results on a color CRT, and performs parameter analysis of components and circuits quickly and efficiently;

substantially reducing development and evaluation time. The analysis function not only provides you with impedance and transmission characteristics, but also allows you to determine secondary parameters. Using the marker and line cursor functions, you can obtain the resonating frequency of resonators and the pass band width of band pass filters quickly.

Equivalent Circuit Analysis Function

Using the HP 4194A's Equivalent Circuit Analysis Function, you can easily and quickly obtain those equivalent circuit constants that, until now, required a number of time-consuming, complicated calculations. By using measured values, this unique function can approximate the circuit constant values of five circuit models. For example, a resonator's equivalent circuit elements or a coil's self inductance, lead resistance, and stray capacitance can be easily obtained.

The equivalent Circuit Analysis function also simulates the frequency characteristics of components by using derived circuit values or values you specify. By using approximation and simulation, you can compare design values to measurement values, and thereby, improve component design efficiency.

Auto Sequence Program (ASP)

The HP 4194A's ASP function, an internal programming feature, allows you to control all HP 4194A operations (measurement, display, and analysis) without the need for an external computer. By using ASP and actual measurement values, you can readily calculate many secondary parameters that you may need to evaluate. You can



then use the HP 4194A's powerful analysis functions to analyze these calculated parameters.

You can also use ASP to enhance such HP 4194A functions as alternate sweep, sweep timing control, and marker tracking. Because ASP eliminates the need for external controller, thereby eliminating data transfer time, the HP 4194A can quickly and efficiently perform production line go/no-go testing of components such as resonators and filters. All these features combine to increase your engineering and manufacturing productivity.

Increased Capabilities With The HP 41941A/B Impedance Probe Kit

When using the HP 4194A with the HP 41941A/B Impedance Probe Kit, you can perform reliable impedance evaluations up to 100MHz. Measurement errors due to residual impedance and stray admittance are eliminated by using the calibration standards furnished with the HP 41941A/B and the HP 4194A's automatic calibration function. This makes it possible to make highly accurate measurements (basic measurement accuracy 1.5 to 3%) over a wide measurement range of 100mΩ to 1MΩ. Calibration accuracy is guaranteed to the tips of the HP 41941A (1.5m) and HP 41941B (3m) impedance probes.

The HP 41941A/B can be used as a grounded probe to evaluate the impedance of in-circuit components such as printed circuit patterns, and the input/output impedance of circuits. In addition, you can connect an external dc bias source directly to the HP 41941A/B to perform dc biased measurements up to ±150V/0.5A, to measure the dc characteristics of inductors, capacitors, materials, and semiconductors. To perform swept dc bias measurements, use the HP 4194A's ±40V internal dc bias source.

Specifications

Impedance Measurements

Measurement Parameters: |Z|, |Y|, θ, R, X, G, B, L, C, D, Q. 20 parameter combinations are available.

Test Frequency: 100 Hz - 40 MHz (CABLE LENGTH: 0m), 100Hz - 15 MHz (CABLE LENGTH: 1m), 1mHz resolution.

OSC Level: 10mV - 1Vrms (≤10MHz), 10mV - 0.5Vrms (>10MHz) (UNKNOWN terminal open), 3 digit resolution

DC Bias: 0 - ±40V, 10mV resolution

Measurement terminal: 4 - terminal pair configuration

Measurement Range and Maximum Resolution:

Measurement Parameter	Range	Max Resolution
Z ,R,X	10mΩ to 100MΩ	100μΩ
Y ,G,B	10nS to 100S	1nS
θ	± 180°	0.01°
L	1nH to 100kH	10pH
C	10fF to 0.1F	0.1fF
D	0.001 to 10	0.0001
Q	0.1 to 1000	0.1

Basic Measurement Accuracy: 0.17%

Level Monitor:

Gain-Phase Measurements

Measurement Parameters: Tch/Rch (dB, Linear Ratio), Tch, Rch (V, dBm, dBV), θ(degree, rad), τ

Tch= Test Channel, Rch= Reference Channel, τ = Group Delay

Measurement Frequency: 10Hz - 100MHz, 1mHz resolution

Aperture Frequency Range (Group Delay Measurements): 0.5% - 100% of frequency span

OSC Level: -65dBm - +15dBm, 0.1dB resolution

Measurement Range:

Tch/Rch: 0 - ±120dB, 0.001dB resolution

Tch, Rch: -107dBm - -5dBm (0dB Attenuator)
-87dBm - +15dBm (20 dB Attenuator)
0.001dB resolution

θ: ±180° (can display phase continuously with the phase scale expansion function), 0.01° resolution

τ: 0.1ns - 1s, 0.1ns resolution

Basic Measurement Accuracy:

Tch/Rch: 0.1dB, 0.5°

Tch, Rch: 0.35dBm

θ: 0.5°

Level Monitor

Impedance Measurements using the HP 41941A/B

The specifications listed below are for the HP 4194A when used with the HP 41941A/B.

Frequency Range: 10 kHz - 100 MHz, 1 mHz resolution

OSC Level: Opt. 350: 10 mV - 1.28 Vrms

Opt. 375: 10 mV - 1.54 Vrms

DC Bias: Internal: ± 40V, ± 20 mA

External: ± 150V, ± 500 mA, max 25 W

Measurement Range: 100 mΩ - 1 MΩ

Basic Measurement Accuracy:

± 1.5% to 3% (≥ 100 kHz), ±3% to 6% (< 100 kHz)

Cable Length: HP 41941A: 1.5 m, HP 41941B: 3 m

Common Specifications

Trigger Mode: Internal, External and Manual

Sweep Capability:

Sweep Parameter: Frequency, OSC Level, DC Bias (impedance measurements only)

Entry: START/STOP or CENTER/SPAN

Sweep Type: LIN, LOG, ZERO SPAN (DC Bias: LIN or ZERO SPAN only)

Number of Measurement Points: 2 to 401 points

Sweep Functions: Partial Sweep, Expand Markers Sweep, Program Points Measurement

Display

CRT: 7.5 inch color CRT

Display Mode: Rectangular (X- A & B), Rectangular (A - B), Table

Display Control: Autoscale, Superimpose and Storage

Analysis

Maker: Single, Delta, Double Makers

Line-Cursor: Line-Cursor, Delta-Line Cursor

Equivalent Circuit Function: Approximation, Simulation

Arithmetic Operation

Data Register Manipulation: Use arithmetic operations and functions to manipulate data registers.

GO/No-Go Limits

Programming

Auto Sequence Program (ASP): Control the HP 4194A's operation with an internal program language. ASP Programs can be entered using the front panel keys or downloaded from HP-IB.

Program Memory Size: 20kBytes of non-volatile memory

Copy: Dump, Plot, Print Mode

General Specifications

Operating Temperature and Humidity: 0°C - 40°C (HP 41941A/B: -20 - +65°C), ≤95%RH at 40°C

Storage Temperature: -30°C - +60°C (HP 41941A/B: -40 - +65°C)

Safety: Based on IEC - 348, UL - 1244

Power: 100, 120, 220V ±10%, 240V - 10% + 5%, 48 - 66Hz, 400VA (max)

Dimensions: 425 (W) x 375 (H) x 620(D) mm

Weight: Approximately 37kg (net)

Reference Data

Typical Measurement Speed:

Impedance: Approximately 3.7ms/point

Gain-Phase: Approximately 3.5ms/point

Impedance when used with the HP 41941A/B: Approximately 6 ms/point

Accessories Furnished

HP 16047D: Direct Coupled Test Fixture

HP 8120-1838: 30cm BNC Cable (2ea) (OPT.350)

HP 04194-61640: 30cm BNC Cable (2ea) (OPT.375)

HP 8120-1839: 60cm NNC Cable (OPT.350)

HP 04194-61641: 60cm NNC Cable (OPT.375)

HP 1250-0080: BNC Adapter

Accessories Available

Refer to page 283

Ordering Information

4194A Impedance/Gain-Phase Analyzer

Price

Opt 350*: 50 Ohm System

\$22,500

Opt 375*: 75 Ohm System

\$0

Opt W30: 3-year hardware support

\$565

Opt 001: High Stability Frequency Reference

\$865

HP 41941A* Impedance Probe Kit (1.5m)

\$1760

HP 41941B* Impedance Probe Kit (3 m)

\$1760

*Must select either OPT.350 or 375

COMPONENT MEASUREMENT

LF Impedance Analyzer (5 Hz to 13 MHz)

Model 4192A

- 5 Hz to 13 MHz variable measuring frequency
- Gain-phase measurement: amplitude, phase, group delay
- Floating or grounded devices
- Impedance measurement: $|Z|$ • $|Y|$ • θ • R • X • G • B • L • C • D • Q • Δ • $\Delta\%$
- Standard HP-IB

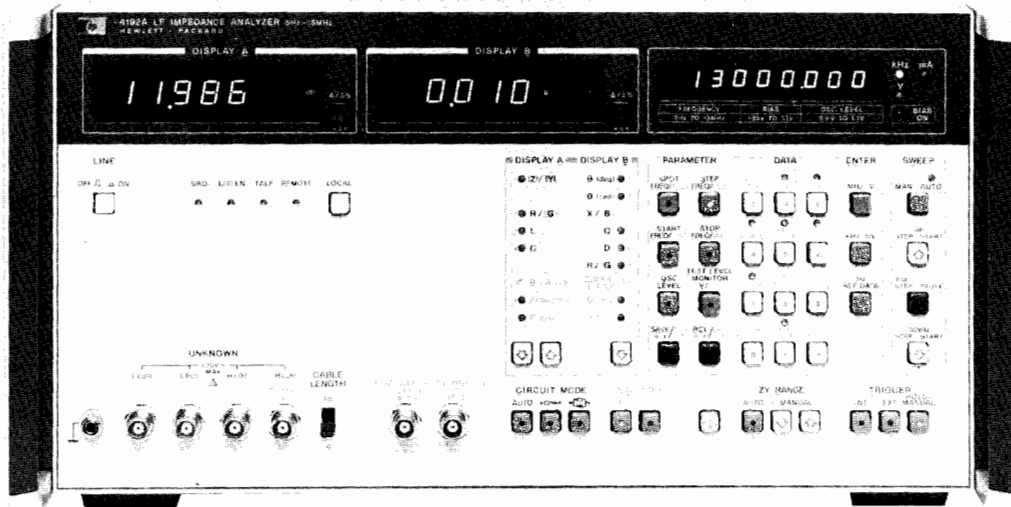

HP 4192A (shown with Opt. 907 handles)



Description

The HP 4192A LF Impedance Analyzer performs both network analysis and impedance analysis on devices such as telecommunication filters, audio/video electronic circuits, and basic electronic components. Both floating and grounded devices can be tested.

Automatic Swept Frequency Measurement of All Impedance Parameters

The HP 4192A can measure 11 impedance parameters ($|Z|$, $|Y|$, θ , R, X, G, B, L, C, D, Q) over a wide range $|Z|$: 0.1 m Ω to 1 M Ω ; $|Y|$: 1 nS to 10 S).

The built-in frequency synthesizer can be set from 5 Hz to 13 MHz with a maximum resolution of 1 mHz. This feature allows accurate characterization of high Q devices such as crystals. Test signal level is variable from 5 mV to 1.1 V with 1 mV resolution. Also, an internal dc bias voltage source provides ± 35 V at 10 mV increments. Thus, the HP 4192A can evaluate components and entire circuits near actual operating conditions.

Specifications (complete specifications on data sheet)

Measuring signal (23 \pm 5 $^{\circ}$ C)

Frequency range: 5 Hz to 13 MHz

Frequency step: 0.001 Hz (5 Hz to 10 kHz), 0.01 Hz (10 kHz to 100 kHz), 0.1 Hz (100 kHz to 1 MHz), 1 Hz (1 MHz to 13 MHz).

Frequency accuracy: ± 50 ppm

OSC level: 5 mV to 1.1 Vrms variable into 50 Ω (amplitude-phase measurement) or open circuit (impedance measurement).

OSC level step: 1 mV (5 mV to 100 mV), 5 mV (100 mV to 1.1 V).

OSC level accuracy: 5 Hz to 1 MHz: $\pm((5 + 10/f)\%$ of setting + 2 mV) where f is in Hz. 1 MHz to 13 MHz: $\pm((4 + 1.5 \times F)\%$ of setting + 2 mV) where F is in MHz.

Level monitor (impedance measurement): current through or voltage across sample can be monitored

Control: spot and sweep via front panel or HP-IB

Measuring Mode

Spot measurement: at specific frequency (or dc bias)

Swept measurement: manual or automatic sweep from START to STOP frequency (or dc bias) at selected STEP frequency (or dc bias) rate

Sweep mode: linear or logarithmic (frequency only)

Recorder outputs: output dc voltage proportional to each measured value, and frequency or dc bias.

Maximum output voltage: ± 1 V

Output voltage accuracy: $\pm(0.5\%$ of voltage + 20 mV)

Key status memory: 5 sets of measuring conditions can be stored and recalled at any time.

HP-IB data output and remote control: standard

Self-test: automatic introspective testing

Trigger: internal, external, manual or HP-IB

Amplitude—Phase Measurement

Parameter measured: relative amplitude B-A (dB) and phase θ (degrees or radians), B-A and group delay, absolute amplitude A (dBm or dBV) or B (dBm or dBV), and deviation (Δ , $\Delta\%$) of all parameters

Reference amplitude: 0 dBV = 1 Vrms, 0 dBm = 1 mW (with 50 Ω termination)

OSC output resistance: 50 Ω

Channels A and B: input impedance: 1 M Ω $\pm 2\%$, shunt capacitance: 25 pF ± 5 pF

Display Range and Resolution

B-A: 0 to ± 100 dB, 0.001 dB (0 to ± 20 dB), 0.01 dB (± 20 to ± 100 dB)

θ : 0 to $\pm 180^{\circ}$, 0.01 $^{\circ}$

Group delay: 0.1 ns to 19 s, max. resolution 4 $\frac{1}{2}$ digits

A or B: +0.8 to -100 dBV, 0.001 dB (> -20 dB), 0.01 dB (≤ -20 dB), +13.8 to -87 dBm, 0.001 dB (> -20 dBm), 0.01 dB (≤ -20 dBm)

Measuring accuracy (23 \pm 5 $^{\circ}$ C): specified at BNC unknown terminals after 30 minute warmup (test speed: normal or average)

B-A (relative amplitude) and θ (phase) Measurement

Determined by sum of channel A and B accuracies given below (accuracy of each channel changes according to absolute input level)

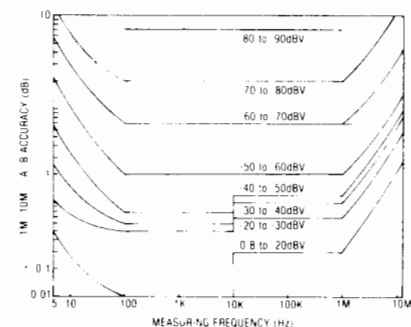

FIGURE 1. GAIN MEASUREMENT ACCURACY

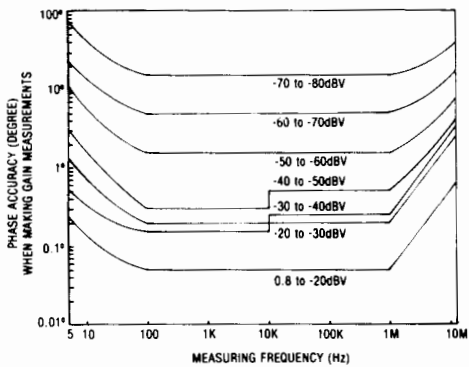

FIGURE 2: PHASE ACCURACY WHEN MAKING GAIN MEASUREMENTS

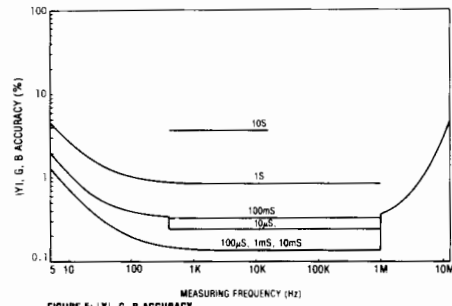

FIGURE 5: |Y|, G, B ACCURACY

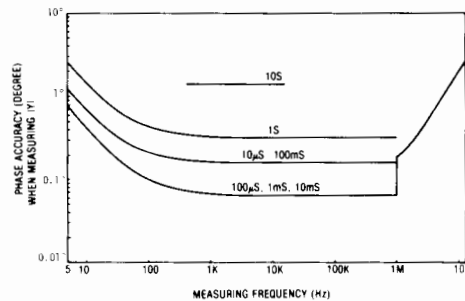

FIGURE 8: PHASE ACCURACY WHEN MEASURING |Y|

Impedance Measurement

Parameter measured: $|Z| - \theta, |Y| - \theta, R - X, G - B, L - D \cdot Q \cdot R \cdot G, C - D \cdot Q \cdot R \cdot G$ and deviation ($\Delta, \Delta\%$) of all parameters

Display: 4½ digits, max. display 12999 counts, 19999 for L & C.

Circuit mode: series equivalent circuit (—□—) and parallel equivalent circuit (—□—). Automatic selection available.

Auto ZERO adjustment: automatic normalization of the readout offset due to residuals of the test fixture by pushbutton operation (at spot frequency)

Measuring range and accuracy (23 ± 5°C): specified at BNC unknown terminals after 30 minute warmup when OSC level is more than 0.1 V and when auto ZERO adjust is performed (test speed: normal or average). Accuracy given below is only valid when the measured value is equal to full scale of each range.

|Z| - θ, R - X measurement: range: |Z|, R, X: 0.1 mΩ to 1.2999 MΩ; θ: -180.00° to +180.00°. Accuracy: R accuracy (D ≥ 10); X accuracy (D < 1)

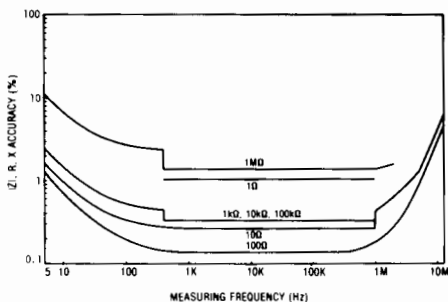

FIGURE 3: |Z|, R, X ACCURACY

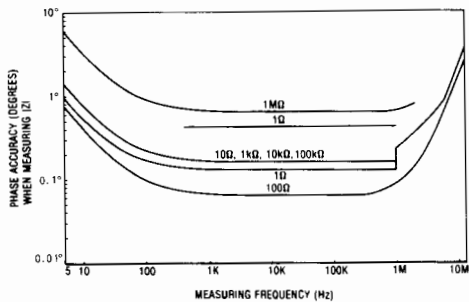

FIGURE 4: PHASE ACCURACY WHEN MEASURING |Z|

|Y| - θ, G - B measurement: range: |Y|, G, B: 1 nS to 12.999 S; θ: -180.00° to +180.00°. Accuracy: G accuracy (D > 1); B accuracy (D ≤ 0.1).

L - D · Q, C - D · Q measurement: (automatically calculated from measured Z/Y values)

Parameter	Measuring Range*	Basic Accuracy
L	0.01 nH to 1000 H	0.27%
C	0.1fF to 199** mF	0.15%
D(L/Q)	0.0001 to 19.999	0.001 (C-measurement) 0.003 (L-measurement)

*Varies with measuring frequency except for D(L/Q)

**Accuracy of C ranges over 100 mF is not specified.

Internal dc bias: standard (impedance measurement only)

Voltage range: -35 V to +35 V, 10 mV step

Setting accuracy (23 ± 5°C): 0.5% of setting +5 mV

Bias control: spot and swept, using front panel controls or HP-IB

General

Measuring Time (high speed mode)

B-A and θ, A or B: 88 to 127 ms (≥ 400 Hz)

Impedance parameters: 58 to 91 ms (≥ 1 kHz)

Test Level Monitor Range (impedance measurement)

Voltage: 5 mV to 1.1 V

Current: 1 µA to 11 mA

Operating temperature: 0 to 55°C, ≤ 95% RH at 40°C

Power: 100, 120, 220 V ±10%, 240 V + 5% to -10%, 48 to 66 Hz, 150 VA max.

Size: 425.5 mm W x 235 mm H x 615 mm D (16.75" x 9" x 22.6").

Weight: approx. 19 kg (41.9 lb)

Furnished accessories and parts: HP 16047A test fixture, HP 11048C 50 Ω feed thru terminations (2 ea.), power splitter, HP 11170A BNC cables (2 ea.), BNC adapter

Accessories available

- HP 16095A Probe Fixture
- HP 16096A 2-port Component Test Fixture
- HP 16097A Accessory Kit
- HP 16047C Test Fixture
- HP 16048A Test Leads (BNC connector)
- HP 16048C Test Leads with alligator clip

Price

- \$865
- \$1,425
- \$2,240
- \$310
- \$330
- \$430

Refer To Page 283

HP 4192A LF Impedance Analyzer

\$15,300

☎ Fast-Ship product — see page 734.

COMPONENT MEASUREMENT

RF Impedance Analyzer

Model 4191A

- 1-1000 MHz variable test frequency with sweep capability
- Direct reading of $|Z| - \theta$, $|Y| - \theta$, $|\Gamma| - \theta$;
 $L \bullet C - R \bullet G \bullet D \bullet Q$
 $R - X, G - B, \Gamma_x - \Gamma_y$

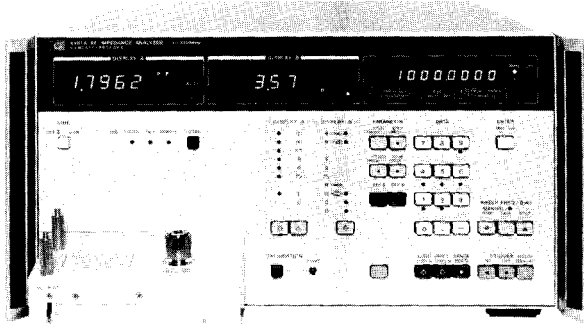

HP 4191A (Shown with Opt 907 Handles)



Description

The HP 4191A RF Impedance Analyzer measures 14 parameters with a maximum resolution of 4½ digits. The internal synthesizer provides variable frequencies from 1 MHz through 1000 MHz covering the UHF, VHF and video bands with automatic sweep capability. An internal dc bias supply with auto sweep function covers the voltage range of ± 40 V in 10 mV steps.

The HP 4191A permits reliable measurements over a wide measuring range. Its outstanding repeatability, frequency response and accuracy are made possible by unique error correction capability and specially designed test fixtures. These features allow the HP 4191A to be used in evaluation of electronic materials, components and circuitry.

The internal synthesizer provides a maximum resolution of 100 Hz (Opt 002) with an accuracy of 3 ppm, allowing small changes in the resonant frequency of the device under test to be easily detected. The swept frequency capability aids in the analysis of frequency characteristics of the device.

Two complete front panel settings (parameter selection and the sweep control) can be stored in a non-volatile memory and recalled at any time with a single key operation. This, together with the standard HP-IB interface, makes the HP 4191A extremely efficient either as a stand-alone or systems instrument.

These unique features permit very wide applications in: (1) semiconductor testing such as surface state evaluation at high frequencies (C-V/G-V and conductance (G/ ω - ω) characteristics), and the input/output impedance evaluation of diodes and transistors, (2) resonator, filter, and magnetic and dielectric materials testing, (3) evaluation of LCR components such as high frequency chip and leaded components, and (4) testing of communications related components such as cables, connectors, etc.

Specifications (Refer to data sheet for complete specifications)

Parameter measured: $|Z| - \theta$, $|Y| - \theta$, $|\Gamma| - \theta$, R-X, G-B, $\Gamma_x - \Gamma_y$
 $L - R \bullet G \bullet D \bullet Q, C - R \bullet G \bullet D \bullet Q$

Display: 4½ digit, max display 19999 counts

Deviation Measurement (deviation from stored reference)

Δ : -19999 to +19999 counts $\Delta\%$: -1999.9 to +19999.9%

Measuring Signal ($23 \pm 5^\circ\text{C}$)

Frequency range: 1 MHz to 1000 MHz

Frequency step:

Standard: 100 kHz, 1-500 MHz 200 kHz, 500-1000 MHz
 Opt 002: 100 Hz, 1-500 MHz 200 Hz, 500-1000 MHz

Frequency accuracy: ± 3 ppm

Signal level (into 50 Ω): -20 ± 3 dBm

Frequency control: spot and swept

- High resolution—4½ digit max
- Wide measuring range—1 m – 100 k ($|Z|$)
- Versatile, easy-to-use test fixtures

Measuring Mode

Spot measurement: at specific frequency (or dc bias)

Swept measurement: manual or automatic sweep from start to stop frequency (or dc bias) at step frequency (or dc bias) rate in linear or logarithmic form.

Auto Calibration

Automatic error compensation referenced to connected terminations (0 Ω , 50 Ω , 0 S), 51 frequencies including start and stop frequencies.

Electrical length compensation: automatic compensation for electrical length of test fixtures. (Range: 0 to 99.99 cm).

Internal dc Bias: Voltage range: -40 to $+40$ V, 10 mV step

Setting accuracy: 0.1% of setting $+10$ mV

Bias control: spot and swept

External dc Bias: Voltage range: -40 to $+40$ V

Max allowable current: 100 mA

Key status memory: 2 sets of measuring conditions can be stored and recalled at any time. These conditions are kept in storage even when LINE is turned off.

Ranging: Auto/Range hold **Trigger:** Internal, External or Manual

Self-test: automatic internal program test

HP-IB data output and remote control: standard

$|\Gamma| - \theta / \Gamma_x - \Gamma_y$ Measurement

Measuring Range: $|\Gamma|, \Gamma_x, \Gamma_y$: 0.0001 to 1.0000

θ : 0° to $\pm 180.00^\circ$ (0 to $\pm \pi$ rad.)

$|\Gamma|, \Gamma_x, \Gamma_y$ resolution: 0.0001

Reference Data (Not Specified)

Temperature coefficient for $|\Gamma|$: 0.0001/ $^\circ\text{C}$ ($23 \pm 5^\circ\text{C}$)

Measuring time: < 800 ms or < 250 ms (high speed mode)

Frequency switching time: ≤ 200 ms

$|\Gamma|, \Gamma_x, \Gamma_y$, ACCURACY

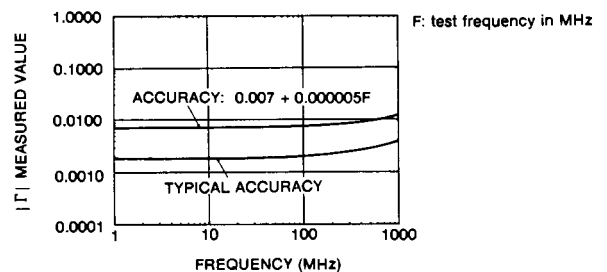

General

Temperature: 0 - 55 $^\circ\text{C}$, $< 95\%$ RH

Power: 100, 120, 220 V $\pm 10\%$, 240 V $\pm 5\%$ - 10%, 48 - 66 Hz, 150 VA max.

Size: 425.5 mm W x 230 H x 574 mm D (16.75" x 9" x 22.6").

Weight: approx. 24 kg (52.8 lb)

Accessories furnished: accessory case (with reference terminations included).

Accessories Available

Accessories Available	Prices
HP 16091A Coaxial Test Fixture	\$570
HP 16092A Spring Clip Test Fixture	\$550
HP 16093A Binding Post Test Fixture	\$224
HP 16093B Binding Post Test Fixture	\$238
HP 16094A Probe Fixture	\$208

Refer to page 283.

Ordering Information

HP 4191A RF Impedance Analyser	\$18,550
Opt W30 3-year hardware support	\$465
002: 100 Hz/200 Hz resolution synthesizer	\$2,140
004: Recorder Outputs	\$560

COMPONENT MEASUREMENT

Vector Impedance Meter (400 kHz to 110 MHz)

289

Model 4193A

- 400 kHz to 110 MHz spot or swept frequency
- Measure impedance magnitude (10 m Ω to 120 k Ω) and phase (-180.0° to $+180.0^\circ$)
- Test components in-circuit and out-of-circuit

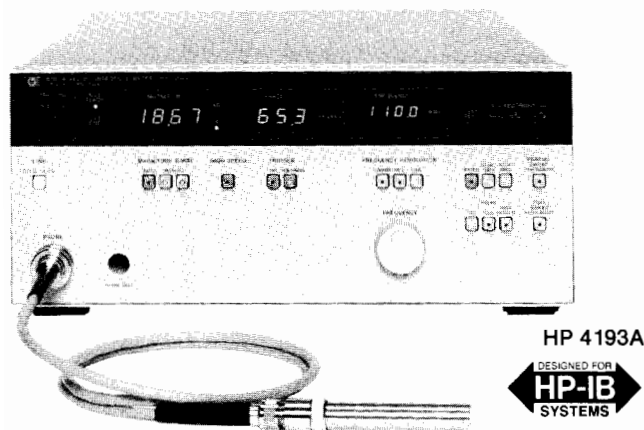

Description

The HP 4193A Vector Impedance Meter measures impedance magnitude and phase. An internal oscillator provides test signals from 400 kHz to 110.0 MHz. The test signal is constant current between 10 μ A and 100 μ A, depending on $|Z|$ range.

Reliable and Accurate Impedance Measurement

The HP 4193A can measure and display impedance magnitudes from 10 m Ω to 120 k Ω . Impedance phase is displayed from $+180.0^\circ$ to -180.0° . Accuracy is as good as 3.0% of reading (magnitude) and 3.2° (phase).

Also, the HP 4193A's $3\frac{1}{2}$ digit resolution makes it easy to see small changes in measurement results during adjustment procedures, for example.

Frequency Sweep for Complex Component Testing

When testing complex components like ceramic resonators, it is useful (1) to sweep frequency to get the big picture and (2) identify critical impedance points such as the series resonant point. This requires both swept measurement and measurements at individual "spot" frequencies. The HP 4193A can do both.

The HP 4193A can be tuned to any individual frequency from 400 kHz to 110.0 MHz with maximum resolution of 1 kHz. If greater frequency resolution is required, it can be provided by connecting an external synthesized source such as the HP 3335A or HP 8656B to the HP 4193A EXT OSC input.

Flexible internal frequency sweep is an exciting HP 4193A feature. Frequency can be swept linearly over any portion of the HP 4193A frequency range—or swept logarithmically over the entire 400 kHz to 110.0 MHz range.

Test In-Circuit and Out-of-Circuit Components

Several test fixtures help adapt the HP 4193A to your device under test. For example, the handy L-ground probe is useful for in-circuit testing. The HP 16099A Test Fixture Adapter and three associated fixtures help connect to out-of-circuit devices of various sizes and shapes.

Specifications (Refer to data sheet for complete specifications)

Test Signal Output Specifications

Test signal is output from the furnished low-ground probe.

Frequency range: 400 kHz to 110.0 MHz

Frequency Resolution

400 kHz to 9.999 MHz: 1 kHz resolution

10.00 MHz to 99.99 MHz: 10 kHz resolution

100.0 MHz to 110.0 MHz: 100 kHz resolution

Frequency accuracy: $\pm 0.01\%$ of setting after calibration.

Frequency stability: ± 100 ppm per month (0 to 55 $^\circ$ C)

Frequency Control

Spot: spot frequency is set using coarse, medium and fine controls

Full sweep: logarithmic sweep at 43 points over full range of 400 kHz to 110 MHz

- Fixtures include low-grounded probe, spring clip fixture and binding post fixture
- Standard HP-IB and analog outputs

Partial sweep: linear sweep from selected START to STOP frequency. Number of steps is selected as 100, 1000 or "HIGH RESOLN". When "HIGH RESOLN" steps are selected, the operator must also select "coarse", "medium" or "fine" resolution.

EXT OSC: increase frequency resolution by connecting an external frequency synthesizer.

Impedance Measurement Specifications

Input configuration: low-grounded probe (furnished)

Digital display of impedance: $3\frac{1}{2}$ digits

$|Z|$: 0 to 1999 counts (0 to 120 counts on 100 k Ω range)

θ : -1800 to $+1800$ counts (-180 to $+180$ counts on 100 k Ω range)

Measurement trigger: internal, external, and manual

Measurement range control: auto, hold, and manual

Measurement Range

$|Z|$: Five decade ranges: 10 Ω , 100 Ω , 1 k Ω , 10 k Ω , 100 k Ω

minimum $|Z|$ (sensitivity): 10 m Ω

maximum $|Z|$: 120 k Ω

θ : One range: -180.0° to $+180.0^\circ$

Reference Data

Test Signal Output

Frequency settling time: 5 ms to 400 ms. Best case is when $(\Delta f/f)\%$ is less than 10% (below 10 MHz) and less than 1% (above 10 MHz).

Signal Purity

Spurious: -60 dBc (dBc is dB below carrier)

Harmonics: -30 dBc

Residual FM: measured in a 100 Hz band centered on the carrier

1 MHz to 110 MHz: 100 Hz p-pFM

Test level: constant current source

Impedance Measurement

Residual Impedance of Probe (at probe tip)

Resistance: $\leq 0.55 \Omega$

Inductance: $\leq (4.9 + 10/f)$ nH where f is measuring frequency in MHz

Parallel Capacitance: ≤ 0.11 pF

Measuring speed: assumes range is fixed; recorder output is OFF

HI SPEED: approximately 150 ms per measurement

NORMAL: approximately 1 s per measurement

Ranging time: approximately 1.2s

Temperature coefficient at 23 $^\circ$ C $\pm 5^\circ$ C

$|Z|$: 2 m $\Omega/^\circ$ C, θ : 0.02 $^\circ/^\circ$ C

General

Operating temperature/humidity: 0 to 55 $^\circ$ C, $\leq 95\%$ RH @ 40 $^\circ$ C. Note that measurement error in 0 $^\circ$ C to 55 $^\circ$ C temperature range is typically double the error in the 23 $^\circ$ C $\pm 5^\circ$ C range.

Power: 100/120/220 V $\pm 10\%$, 240 V -10% to $+5\%$, 48 to 66 Hz, 150 VA max

Size: 426 mm W x 178 mm H x 498 mm D, (16.75" x 7" x 19.6")

Weight: 18 kg (40 lb)

Accessories furnished: low-ground probe kit includes probe, spare pins, spare clips, BNC adapter, component mounting adapter, probe socket and accessory case.

Accessories Available

HP 16099A Test Fixture Adapter (used with HP \$500 ☎

16092A and HP 16093A/B)

HP 16092A Spring Clip Fixture (used with HP \$550 ☎

16099A)

HP 16093A Binding Post Fixture (used with HP \$224 ☎

16099A)

HP 16093B Binding Post Fixture (used with HP \$238 ☎

16099A)

Refer to page 283.

HP 4193A Vector Impedance Meter

\$10,500

☎Fast-Ship Products. See page 734.

COMPONENT MEASUREMENT

Precision LCR Meter (20 Hz to 1 MHz)

Model HP 4284A

- 20 Hz to 1 MHz, with over 8600 test frequencies
- 0.05% basic accuracy
- 0.01m Ω to 100M Ω impedance range
- Test signal level (OPT 001): 5 mV to 20 Vrms, 50 μ A to 200 mArms
- High resolution 6-digits: D= 0.000001
- High speed measurements (1 MHz): 30 ms/meas
- Measures |Z|, |Y|, θ , R, X, G, B, L, C, Q, D, and ESR
- 10-bin component sorting - comparator

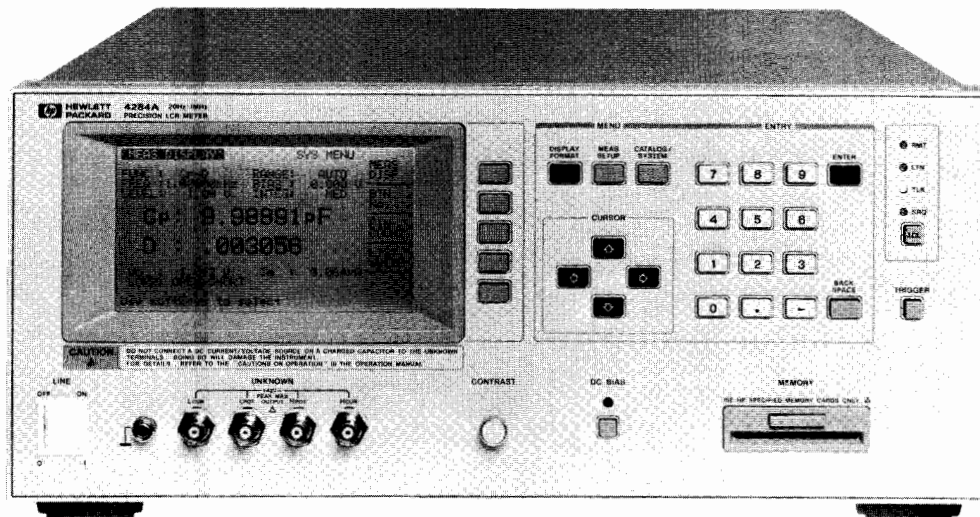

HP 4284A



Description

The HP 4284A Precision LCR Meter is a cost effective solution for component and material measurement, which can be used to improve component quality by providing an accurate, high throughput test solution. The wide 20 Hz to 1 MHz test frequency range and superior test signal performance allows the HP 4284A to test components to the most commonly used test standards, such as IEC/MIL standards, and under conditions which simulate the intended application. Whether in R/D, production, quality assurance, or incoming inspection the HP 4284A will meet all of your LCR meter test and measurement requirements.

A Wide Range of Test Signal and DC Bias

The test signal (voltage/current) is variable from 5 mVrms to 2 Vrms, and from 50 μ Arms to 20 mArms. The constant test signal level feature guarantees that the applied test signal level will remain constant for demanding tests. Option 001 will allow you to vary the test signal level from 5 mVrms to 20 Vrms and from 50 μ Arms to 200 mArms, offering a convenient method of testing components over a wide range of working conditions. The dc bias is selectable from \pm 1 mV to \pm 40 V with an accuracy of 0.1% for applications which require accurate bias control, such as measuring the C-V characteristics of semiconductors.

High Accuracy, Resolution, and Test Throughput

The HP 4284A's wide impedance measurement range covers from 1 Ω to 100M Ω full scale with 0.01m Ω minimum resolution and with an unmatched basic accuracy of 0.05% to 1MHz. Six full digits of resolution for all measurement parameters allow you to determine even

the smallest differences in materials or component performance. A dissipation factor measurement resolution of 0.000001 is very useful when developing low loss capacitors and inductors used in high performance electronic equipment. The measurement time needed to obtain the optimum accuracy is only 190 ms/meas (1 kHz). A selectable integration time permits a high throughput testing with a measurement time of only 40 ms/meas (1 kHz) for a slight trade off in accuracy.

High Current Biasing for Power Inductor Evaluation

Combining the HP 4284A Precision LCR Meter, HP 42841A Current Source, and HP 42842A/B Current Fixture gives you a high performance power inductor and transformer test system, which enables the testing of inductors up to 1 MHz and at high dc current levels, up to 20 A (40 A with two HP 42841As and the HP 42842B) demanded for components used in advanced switching power supplies.

Flexibility and Ease of System Integration

The HP 4284A's built-in comparator, advanced compensation, and optional handler and scanner interfaces permit easy integration with automatic component handling equipment. The 10-bin comparator allows for error free Go/No-Go testing by comparing a component's measured value with user selected test limits. The scanner interface provides control and compensation for up to 128 multiplexed measurement channels. The list sweep feature permits up to ten frequencies, test signal levels, or bias level points to be automatically measured. The high speed HP-IB interface and HP-SL programming language are excellent for data logging and system applications.

Simple Operation for Error Free Measurement Setup

The large easy-to-read LCD screen displays the instrument settings and the measurement results. The new softkey and cursor operation provides user-friendly front panel operation. The memory card allows storing and retrieving up to ten entire instrument setups, including bin limit information. It improves operator efficiency and minimizes setup errors.

Specifications (Refer to datasheet for complete specifications)

Parameters measured: |Z|- θ , |Y|- θ , R-X, G-B

C-D, Q, ESR, G, Rp

L-D, Q, ESR, G, Rp

Deviation and % deviation

Measurement Circuit Modes: Series and Parallel

Ranging: Auto and Manual

Trigger: Internal, External and Manual

Delay time: 0 to 60.000 sec in 1 ms steps

Measurement terminals: Four-Terminal Pair

Test cable length: Standard: 0 and 1 meters

With Option 006: 0, 1, 2 and 4 meters

Integration time: Short, Medium and Long

Averaging: 1 to 256, programmable

Test Signal

Test frequency: 20 Hz to 1 MHz, 8610 selectable frequencies

Test signal modes: **Normal:** Programs selected voltage or current at the measurement terminals open or shorted, respectively, and not at the device under test.

Constant: Maintains selected voltage or current at the device under test independent of changes in the device's impedance.

Test signal level:

Standard

		Range	Accuracy
Normal	V	5 mVrms to 2 Vrms	$\pm(10\% + 1 \text{ mVrms})$
	I	50 μ Arms to 200 mArms	$\pm(10\% + 10 \text{ } \mu\text{Arms})$
Constant	V	10 mVrms to 1 Vrms	$\pm(6\% + 1 \text{ mVrms})$
	I	100 μ Arms to 10 mArms	$\pm(6\% + 10 \text{ } \mu\text{Arms})$

With Option 001:

		Range	Accuracy
Normal	V	5 mVrms to 20 Vrms	$\pm(10\% + 1 \text{ mVrms})$
	I	50 μ Arms to 200 mArms	$\pm(10\% + 10 \text{ } \mu\text{Arms})$
Constant	V	10 mVrms to 10 Vrms	$\pm(10\% + 1 \text{ mVrms})$
	I	100 μ Arms to 100 mArms	$\pm(10\% + 10 \text{ } \mu\text{Arms})$

DC Bias:

Standard: 0 V, 1.5 V and 2 V

With Option 001: 0 V to ± 40 V.

Range	Resolution	Accuracy
$\pm(0.000$ to $4.000)$ V	1 mV	$\pm(0.1\% + 1 \text{ mV})$
$\pm(4.002$ to $8.000)$ V	2 mV	$\pm(0.1\% + 2 \text{ mV})$
$\pm(8.005$ to $20.000)$ V	5 mV	$\pm(0.1\% + 5 \text{ mV})$
$\pm(20.01$ to $40.00)$ V	10 mV	$\pm(0.1\% + 10 \text{ mV})$

Measurement Range

Parameter	Range
Z , R, X	0.01 m Ω to 99.9999 M Ω
Y , G, B	0.01 nS to 99.9999 S
C	0.01 fF to 9.99999 F
L	0.01 nH to 99.9999 kH
D	0.000001 to 9.99999
Q	0.01 to 99999.9
θ	-180.000 $^\circ$ to 180.000 $^\circ$
$\Delta\%$	-999.999 % to 999.999 %

Display

LCD Dot-matrix display: displays measured values, control settings, comparator limits and decisions, list sweep tables, self test messages and annunciations.

Correction Function

Zero OPEN/SHORT: Eliminates measurement errors due to the test fixture's stray parasitic impedance.

Load: Improves measurement accuracy by using a calibrated device as a reference.

List Sweep Function

A maximum of ten frequencies or test signal levels can be programmed. Single or sequential testing can be performed. When Option 001 is installed, DC voltage bias testing can also be performed.

LIST SWEEP DISPLAY (example)

```

<LIST SWEEP DISPLAY>   SYS MENU
MODE = SEQ
FREQ[Hz]  Cp[F ]  DC  ]  CMP
1.00000k  3.26040n  .000905
2.00000k  3.25844n  .000897
5.00000k  3.25803n  .000630
10.0000k  3.26243n  .000305
20.0000k  3.25947n  .000767
50.0000k  3.25849n  .000340
100.000k  3.26038n  .000098
200.000k  3.25946n  .000318
500.000k  3.25901n  .000169
1.00000M  3.26019n  .000296
    
```

COMPONENT MEASUREMENT

Precision LCR Meter (20 Hz to 1 MHz) (cont'd)

Model HP 4284A

Comparator

Ten bin sorting for the primary measurement parameter, IN/OUT for the secondary measurement parameter.

Bin count: 0 to 999999

List sweep comparator: HIGH/IN/LOW decision output for each measurement point in the list sweep table.

BIN COUNT DISPLAY (example)

<BIN COUNT DISPLAY>				SYS MENU
FUNC = Cp-D				NOM = 3.26000nF
BIN	LOW [%]	HIGH [%]	>COUNT	
1	- 1.000	+ 1.000	565	
2	- 2.000	+ 2.000	45	
3	- 3.000	+ 3.000	18	
4	- 4.000	+ 4.000	29	
5	- 5.000	+ 5.000	11	
6	- 6.000	+ 6.000	6	
7	- 7.000	+ 7.000	4	
8	- 8.000	+ 8.000	4	
9	- 9.000	+ 9.000	3	
2nd []				
REJ CNT AUX: OFF				OUT: 9

Basic Measurement Accuracy

The following measurement accuracy is specified when all of the following conditions are satisfied.

1. Warm up time: ≥ 30 minutes
2. Ambient temperature: $23 \pm 5^\circ\text{C}$
3. Test signal voltage: 0.3 Vrms to 1 Vrms
4. Test cable length: 0 m
5. OPEN and SHORT corrections have been performed
6. $D \leq 0.1$ for C, L, X and B measurements
 $Q \leq 0.1$ for R and G measurements

Accuracies are relative to calibrated standards. Absolute accuracies are given as: (HP 4284A's relative accuracy + calibration uncertainty of standards).

Basic relative accuracy of $|Z|$, R, X, C, L and D is shown in Figure 1. The accuracies are represented as:

$|Z|$, R, X, C and L: \pm (A % of reading)

D: \pm A/100 (D value)

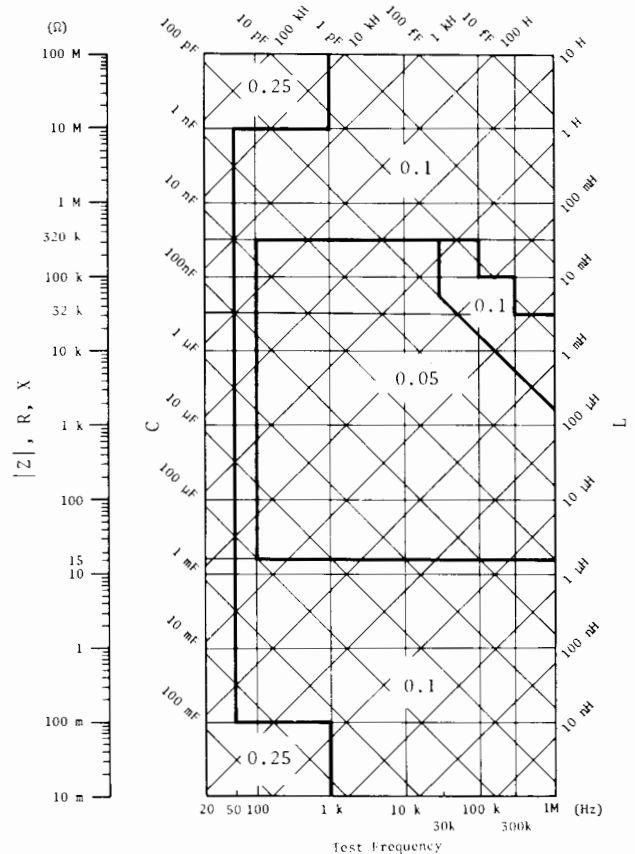

Figure 1

Other Functions

STORE/LOAD: Ten instrument setups can be stored/loaded from the internal non-volatile memory. Ten additional setups can also be stored/loaded from a memory card.

HP-IB: All instrument control settings, measured values, comparator limits, list sweep tables, and self test results.

The memory buffer can store a maximum of 128 measurement results and output the data over HP-IB. ASCII and 64-bit binary data formats.

General

Power requirements: 100/120/220 V $\pm 10\%$, 240 V $+5\%$ / -10% , 47 to 66 Hz

Power consumption: 150 VA max

Operating temperature and humidity: 0°C to 55°C , $\leq 95\%$ RH at 40°C

Size: 426 (W) x 177 (H) x 498 (D) mm

Weight: Approximately 15 kg

Supplemental Characteristics

Measurement time: Typical measurement time from the trigger command to the EOM (End of Measurement) output at the handler interface connector.

	20 Hz	100 Hz	1 kHz	10 kHz to 1 MHz
SHORT	1,100 ms	270 ms	40 ms	30 ms
MEDIUM	1,320 ms	400 ms	190 ms	180 ms
LONG	1,320 ms	1,040 ms	830 ms	820 ms

Option 001

DC Bias current output: 100 mA max

Options

- Opt 001:** Increases the AC test signal to 20 Vrms/200 mArms. Variable ± 40 Vdc bias.
- Opt 002:** Allows the HP 4284A Precision LCR Meter to control the HP 42841A Bias Current Source.
- Opt 006:** Increases test cable length capability. Adds 2 and 4 meter operation
- Opt 109:** Delete HP-IB Interface
- Opt 201:** Handler Interface
- Opt 202:** Handler Interface
- Opt 301:** Scanner Interface. Provides control interface for operation with a scanner. OPEN/SHORT/LOAD correction data for up to 128 measurement channels at three frequencies is stored in non-volatile memory.

Accessories

HP 42841A Bias Current Source

Bias Current Output: (23°C $\pm 5^\circ$ C)

Range	Resolution	Accuracy
0.00A to 1.00A	0.01A	$\pm(1\%$ of setting + 5mA)
1.1 A to 5.0 A	0.1A	$\pm(2\%$ of setting)
5.1A to 20.0A	0.1A	$\pm(3\%$ of setting)

Output Voltage:

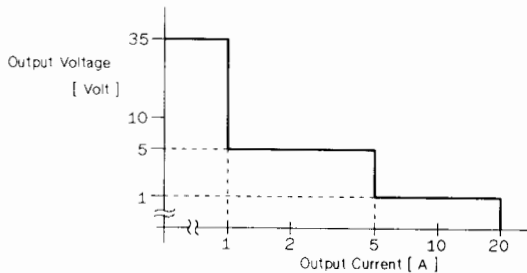

Basic Impedance Accuracy: 1% when used with the HP 4284A
Interface: Custom, directly controllable by the HP 4284A with Option 002.

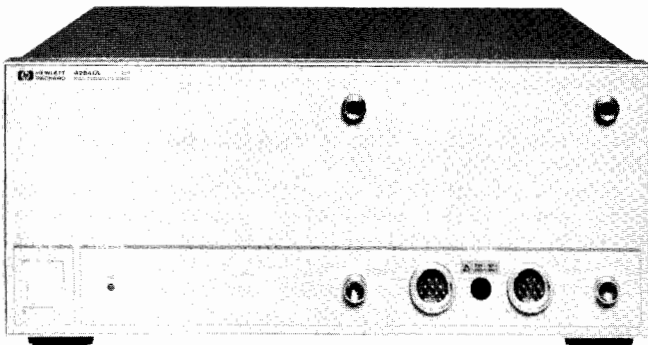

HP 42841A

HP 42842A/B Bias Current Test Fixture

Used with the HP 4284A and HP 42841A for high DC bias current measurements.

HP 42842A: 20A max

HP 42842B: 40A max

HP 42843A Bias Current Cable

Used with the HP 4284A, HP 42841A (2 units) and HP 42842B for 40A maximum applications.

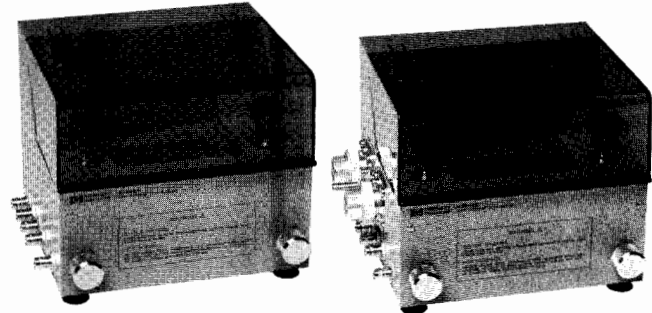

HP 42842A

HP 42842B

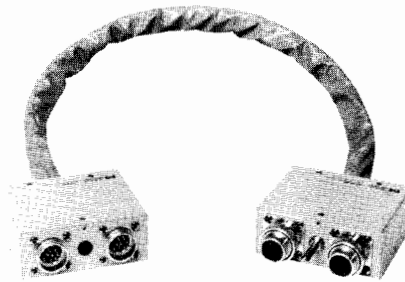

HP 42843A

Ordering Information

- HP 4284A Precision LCR Meter** \$9,400
- Opt W30:** 3-year hardware support \$235
- Opt 001:** Power Amplifier/DC Bias \$1,200
- Opt 002:** Bias Current Interface \$280
- Opt 006:** 2m/4m Cable Length Operation \$180
- Opt 008:** Add Japanese Operation Manual \$80
- Opt 009:** Delete Operation Manual -\$80
- Opt 109:** Delete HP-IB Interface -\$240
- Opt 201:** Handler Interface \$280
- Opt 202:** Handler Interface \$310
- Opt 301:** Scanner Interface \$600
- Opt 907:** Front Handle Kit \$71
- Opt 908:** Rack Mount Kit \$41
- Opt 909:** Rack Flange and Handle Kit \$102
- Opt 910:** Extra Operation Manual \$80
- HP 42841A Bias Current Source** \$6,800
- HP 42842A Bias Current Test Fixture (20A max)** \$1,600
- HP 42842B Bias Current Test Fixture (40A max)** \$2,000
- HP 42843A Bias Current Cable** \$1,000

Refer to page 283 for accessories.

COMPONENT MEASUREMENT

Multi-Frequency LCR Meters

Models 4274A & 4275A

- Test frequencies – HP 4274A: 100 Hz to 100 kHz
HP 4275A: 10 kHz to 10 MHz
- Test signal level – HP 4274A: 1 mV to 5 Vrms
HP 4275A: 1 mV to 1 Vrms
- 0.1% basic accuracy
- High resolution – 5½ digit; D=0.00001
- Measure L/C – D/Q/ESR/G; |Z| – θ ,
R-X/B/L/C; Δ LCRZ, Δ %

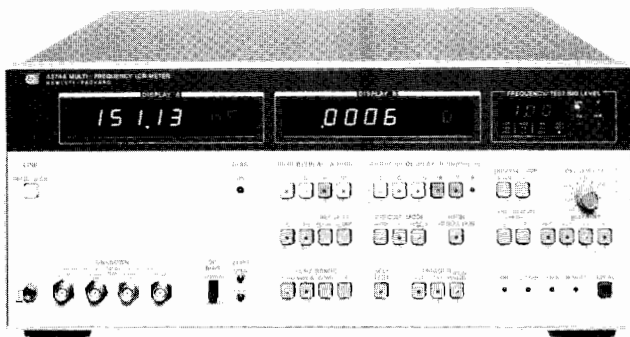

HP 4274A

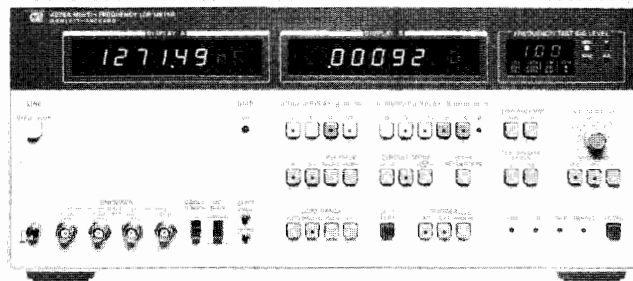

HP 4275A



Description

The HP 4274A and HP 4275A Multi-frequency LCR Meters, microprocessor-based impedance measuring instrumentation. Both instruments offer LCR components, complex components, electronic circuits "tested under actual working conditions", and semiconductor materials. A measurement under conditions similar to the intended use contributes to the improvements in quality and reliability of electronic components, devices and circuits.

Reliable Measurements with 5½ Digit Resolution

The HP 4274A and HP 4275A measure only the value of the component and/or device under test, with 5½ resolution and 0.1% basic accuracy by reducing the possibility of errors due to self or mutual inductance, stray capacitance and/or residual inductance in the test leads or test fixture used. This measurement is obtained by a state-of-the-art four terminal pair configuration and a built-in automatic ZERO-offset capability to compensate for these errors.

The fast measurement speed, high resolution, and high accuracy can make major contributions for the component manufacturer and user who is concerned about reducing his costs, improving quality, and throughput efficiency. In these areas, the HP 4274A and the HP 4275A are ideal for D-measurements of film capacitors or insulation material (with the high resolution of 0.00001), the C-G measurements of semiconductors (with maximum resolutions of 0.01 fF, 0.01nS, respectively), and for the low impedance measurement of aluminum electrolytic capacitors (with a maximum resolution of 0.001 m Ω).

Multi-Frequency Capability

To insure the high reliability in circuits and devices, it is most important that they be tested and evaluated at test signals similar to those of actual operating conditions.

The HP 4274A covers the wide frequency range of 100 Hz to 100 kHz in 11 spot frequencies and the HP 4275A has 10 spot frequencies from 10 kHz to 10 MHz, in 1-2-4 step sequence with 1-3-5 as an option. This feature produces the frequency characteristics of components or devices. In addition, two optional special frequencies (for example, 455 kHz and 10.7 MHz) are available within the frequency

range of each instrument. This wide frequency range selection offers evaluation of circuit design with a continuously variable test signal over the range of 1 mV to 5 Vrms (to 1 Vrms for the HP 4275A), and with internal dc bias optionally available with 1 mV maximum resolution. The test voltage or current values can be monitored on the 3-digit display for accurately setting the actual conditions under which the device-under-test will operate.

Multi-Parameter Measurements

The HP 4274A and HP 4275A measure equivalent series resistance (ESR), impedance (|Z|), phase angle (θ), reactance (X), susceptance (B), and conductance (G), in addition to the conventional L,C,R,D and Q parameters in certain combinations with a dual 5½ digit display, and an HP-IB standard for systems integration.

This wide selection of 11 parameters provides for more accurate evaluation of electronic materials or components with high measurement speed for most needed combined parameters; for example, the C-G measurement of semiconductors, an R-X measurement in circuit design, or the C-ESR or |Z| - θ measurement of tantalum capacitors.

In addition, a deviation measurement capability (Δ , Δ %) for the L,C,R, and |Z| functions displays the difference between the actual value and a stored reference, either as a difference value or in percent. Deviation applications include, for example, a temperature dependence measurement of devices in environmental tests.

Automatic Semiconductor and Component Measurements with HP-IB

Integrating the HP 4274A and the HP 4275A into an HP-IB controlled system is an excellent method for improving efficiency and cost savings both in the laboratory and on the production line. These automatic measurement systems are assembled by connecting the HP-IB cables between the instruments to be utilized for a specific task.

For example, the evaluation of semiconductors based on the frequency dependence of its C-V characteristics that requires a wide range and fast measurement speeds is easily accomplished with these instruments.

Specifications

Refer to the HP 4274A & HP 4275A data sheet for details.

Parameters Measured

L: inductance	Q: =1/D	θ : phase angle
C: capacitance	ESR: equivalent series resistance	Δ : deviation for L, C, R, Z,
R: resistance	G: conductance	$\Delta\%$: % of deviation
Z: impedance	X: reactance	
D: dissipation factor	B: susceptance	

Measurement Range

MODEL	HP 4274A	HP 4275A
L	100.00 nH – 1000.0 H	100.00 nH – 10.00 H
C	1.0000 pF – 1.00 F	1.0000 pF – 100.00 μ F
R, Z , ESR, & X	100.00 m Ω – 10.000 M Ω	1.0000 Ω – 10.000 M Ω
D	0.00001 – 9.9999	0.00001 – 9.9999
Q (1/D)	0.01 – 9900	0.01 – 9900
G & B	1.0000 μ S – 100.00 S	1.0000 μ S – 10.00 S
θ	0 – $\pm 180^\circ$	0 – $\pm 180^\circ$

Measurement Accuracy

FREQUENCY RANGE	C-D/Q	L-D/Q
	D-range: 0.00001-9.9999 Q-range: 0.01-9900 (=1/D) (C & D accuracies apply only when C: full scale and D: ≤ 0.1)	D-range: 0.00001-9.9999 Q-range: 0.01-9900 (=1/D) (L & D accuracies apply only when L: full scale and D: ≤ 0.1)

HP 4274A

100 Hz	C: 1000 pF-1000 mF, 0.1% + 3 D: 0.33% + 0.0008 + 1	L: 100 μ H-10 kH, 0.1% + 3 D: 0.33% + 0.0013 + 1
200 Hz	C: 1000 pF-1000 mF, 0.1% + 2 D: 0.32% + 0.0007 + 1	L: 100 μ H-10 kH, 0.1% + 3 D: 0.32% + 0.0012 + 1
400 Hz	C: 100 pF-100 mF, 0.14% + 1 D: 0.34% + 0.0013 + 1	L: 100 μ H-10 kH, 0.1% + 3 D: 0.31% + 0.0011 + 1
1 kHz	C: 100 pF-100 mF, 0.1% + 3 D: 0.33% + 0.0008 + 1	L: 10 μ H-1000 H, 0.1% + 3 D: 0.33% + 0.0013 + 1
2 kHz	C: 100 pF-100 mF, 0.1% + 2 D: 0.32% + 0.0007 + 1	L: 10 μ H-1000 H, 0.1% + 3 D: 0.32% + 0.0012 + 1
4 kHz	C: 10 pF-10 mF, 0.14% + 1 D: 0.34% + 0.0013 + 1	L: 10 μ H-1000 H, 0.1% + 3 D: 0.31% + 0.0011 + 1
10 kHz	C: 10 pF-10 mF, 0.1% + 3 D: 0.33% + 0.0008 + 1	L: 1 μ H-100 H, 0.1% + 3 D: 0.33% + 0.0013 + 1
20 kHz	C: 10 pF-10 mF, 0.1% + 2 D: 0.32% + 0.0007 + 1	L: 1 μ H-100 H, 0.1% + 3 D: 0.32% + 0.0012 + 1
40 kHz	C: 1 pF-1000 μ F, 0.14% + 1 D: 0.34% + 0.0013 + 1	L: 1 μ H-100 H, 0.1% + 3 D: 0.31% + 0.0011 + 1
100 kHz	C: 1 pF-1000 μ F, 0.1% + 3 D: 0.33% + 0.0008 + 1	L: 100 nH-10 H, 0.1% + 3 D: 0.33% + 0.0013 + 1

HP 4275A

10 kHz	C: 10 pF-100 μ F, 0.1% + 3 D: 0.33% + 0.0008 + 1	L: 10 μ H-100H, 0.1% + 3 D: 0.33% + 0.0013 + 1
20 kHz	C: 10 pF-100 μ F, 0.1% + 2 D: 0.32% + 0.0007 + 1	L: 10 μ H-100 H, 0.1% + 3 D: 0.32% + 0.0012 + 1
40 kHz	C: 1 pF-10 μ F, 0.14% + 1 D: 0.34% + 0.0009 + 1	L: 10 μ H – 100 H, 0.1% + 3 D: 0.31% + 0.0011 + 1
100 kHz	C: 1 pF-10 μ F, 0.1% + 3 D: 0.33% + 0.0008 + 1	L: 1 μ H – 10 H, 0.1% + 3 D: 0.33% + 0.0013 + 1
200 kHz	C: 10 pF-10 μ F, 0.1% + 2 D: 0.32% + 0.0007 + 1	L: 1 μ H – 1000 mH, 0.2% + 3 D: 0.53% + 0.0023 + 1
400 kHz	C: 1 pF-1000 nF, 0.14% + 1 D: 0.34% + 0.0009 + 1	L: 1 μ H – 1000 mH, 0.2% + 3 D: 0.51% + 0.0021 + 1
1 MHz	C: 1 pF-1000 nF, 0.1% + 3 D: 0.33% + 0.0008 + 1	L: 100 nH – 100 mH, 0.2% + 3 D: 0.55% + 0.0025 + 1
2 MHz	C: 10 pF-100 nF, 0.3% + 3 D: 0.55% + 0.0025 + 1	L: 1 μ H – 10 mH, 0.5% + 5 D: 1.0% + 0.0033 + 1
4 MHz	C: 1 pF-10 nF, 1% + 20 + 0.002 pF D: 3.3% + 0.01 + 1	L: 1 μ H – 10 mH, 1% + 5 D: 2.0% + 0.0063 + 1
10 MHz	C: 1 pF-10 nF, 2% + 20 + 0.002 pF D: 4% + 0.011 + 1	L: 100 nH – 1 mH, 2% + 7 D: 3.1% + 0.002 + 1

Range: full scale range, accuracy: % of reading + counts (D accuracy: % of reading + absolute D value + count).

(Conditions: Warm-up time ≥ 30 minutes, environment temperature: 23°C \pm 5°C). Refer to technical data sheet for accuracy details.

Measurement Frequencies

HP 4274A: 100 Hz–100 kHz, 11 spots (100 Hz, 120 Hz, 200 Hz, 400 Hz, 1 kHz, 2 kHz, 4 kHz, 10 kHz, 20 kHz, 40 kHz, 100 kHz; $\pm 0.01\%$)

HP 4275A: 10 kHz–10 MHz, 10 spots (10 kHz, 20 kHz, 40 kHz, 100 kHz, 200 kHz, 400 kHz, 1 MHz, 2 MHz, 4 MHz, 10 MHz; $\pm 0.01\%$)

Test Signal Level:

HP 4274A: 4-ranges (1 mVrms–5 Vrms) continuously variable

HP 4275A: 3-ranges (1 mVrms–1 Vrms) continuously variable

Test Signal Level Monitor: standard.

Displays: dual 5/2-digit and single 3-digit; maximum display 199999 (full scale and overrange in high resolution mode), and 4 1/2-digit: maximum display 19999 in normal mode. (Number of digits depends on measurement frequency, test level, and range).

Circuit modes: $\text{---} \square \text{---}$ series equivalent circuit and $\text{---} \square \text{---}$ parallel equivalent circuit. Automatic selection available in AUTO mode.

Deviation measurement: difference between recallable stored reference and displayed is deviation value (count or percent).

Ranging: AUTO or MANUAL (UP/DOWN).

Trigger: internal, external or manual.

Measurement terminals: four-terminal pair with guard.

Auto zero adjustment: automatic normalization of the readout off-set due to residuals of the test fixture by pushbutton operation.

Normalization range: C < 20 pF, L < 2000 nH, R < 0.5 Ω , G < 5 μ S.

Self test: automatic operational verification check indicates pass or fail condition.

Reference Data

Measurement time: (typical) 140–180 ms (> 1 kHz); 140–210 ms ≤ 1 kHz (measurement time depends on range, sample value and off-set adjustment value).

Z – θ measurement time: 170–210 ms > 1 kHz; 170–240 ms ≤ 1 kHz.

High resolution mode: approximately 8 times the normal measurement time.

Auto ranging time: 100 ms - 300 ms per range change.

General Information

Operating Temperature and Humidity: 0°C – 55°C, $\leq 95\%$ RH at 40°C

Power: 100, 120, 220V $\pm 10\%$, 240V + 5% – 10%, 48 – 66Hz, 135VA max. (HP 4274A); 165VA max. (HP 4275A)

Size: 177H x 425W x 574Dmm (7" x 16.75" x 22.6")

Weight: 18kg (39.6lbs)

Accessory Furnished

HP 16047A: Direct coupled test fixture.

Accessory Available

HP 16023B: dc Bias Controller, for control of dc bias \$350
Opt 001 or 002 Internal Bias Supply.

Special Options

One or two arbitrary test frequencies for each instrument are available. For more details, please contact nearest HP sales office.

Selectable Frequency Range

HP 4274A: 100 Hz to 100 kHz to $\pm 0.1\%$. If two frequencies are added, at least one frequency must satisfy the following equation: $f = 1200/N$ kHz where N is an integer from 12 to 12000.

HP 4275A: 10 kHz to 10.7 MHz $\pm 0.1\%$.

Ordering Information

HP 4274A Multi-Frequency LCR Meter

Opt W30: 3-year hardware support

HP 4275A Multi-Frequency LCR Meter

Opt W30: 3-year hardware support

Opt 001: 0 to ± 35 internal dc bias, max resolution; 1 mV steps

Opt 002: 0 to ± 99.9 V internal dc bias, resolution: 100 mV steps.

Opt 004: Frequency steps in 1-3-5 sequence

☎ Fast-Ship product—see page 734.

Price

\$10,700

\$270

\$12,850

\$320

\$965

\$915

N/C

COMPONENT MEASUREMENT

1 kHz / 1 MHz Capacitance Meter

Model 4278A

- Measurement Speed: 6.5ms/10ms/21ms
- Measurement Parameters: C-D•Q•ESR•G
- C-D Measurement Accuracy:
 - 0.07%, 0.0005(1kHz, 21ms)
 - 0.05%, 0.0002(1MHz, 21ms)
- High Resolution: 6 digit, D:0.0001
- Intelligent Built-in Comparator: 10-bin Sorting

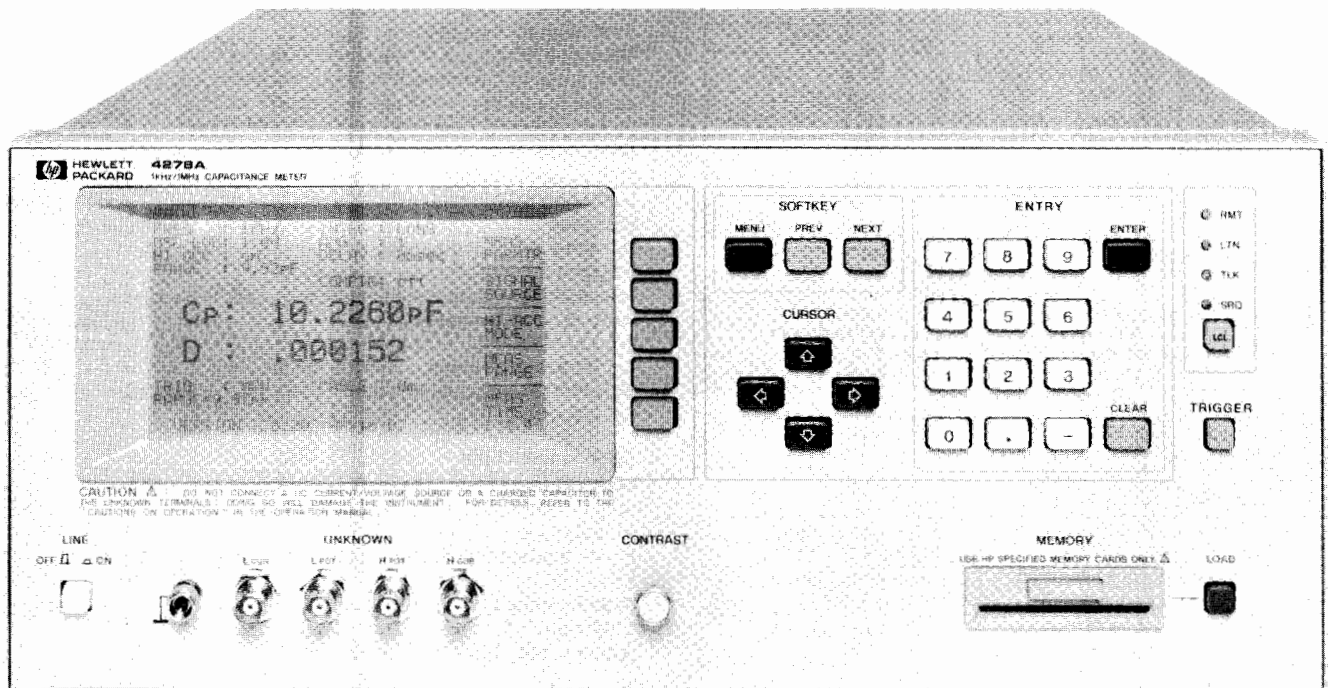

HP 4278A

Description

The HP 4278A 1kHz/1MHz Capacitance Meter is a high speed, highly reliable, precision test instrument aimed at incoming/outgoing capacitor inspection applications on the production line and in quality control. The HP 4278A will improve test efficiency by performing comparative measurements of low to medium value capacitors (up to 200 μF —a range that covers most ceramic and film capacitors) several times faster than previously available capacitance meters.

The HP 4278A's standard measurement frequencies and oscillator output levels are 1kHz/1MHz and from 0.1V to 1V in 0.1V steps, respectively. The HP 4278A's ability to make precision capacitance measurements and to measure low dissipation values will give you an edge in improving the quality of your devices.

The built-in comparator function of the HP 4278A gives you the ability to sort parts into ten bins. A high speed HP-IB interface and an optional handler interface are available for combining the HP 4278A with an automatic handler and an external computer to build a total solution for automatic testing and data acquisition and analysis.

High Speed Measurements

One of the HP 4278A's main features is its selection of high measurement speeds: 6.5ms (153 measurements/sec), 10ms (100 measurements/sec), or 21ms (47 measurements/sec), with a fast settling time. Additionally, the HP 4278A's built-in comparator and high speed HP-IB interface make it possible to construct a measurement system using an automatic handler and an external computer to minimize production test time, and, therefore, cost.

High Accuracy and Resolution

Dissipation factor (D), the parameter measured to determine the quality of capacitors, can be measured with an accuracy of 0.0002 (1MHz) and 0.0005 (1kHz) with a resolution of 0.00001 without degrading measurement speed. The HP 4278A has high capacitance measurement accuracy, 0.05% (1MHz) and 0.07% (1kHz) with 6 full digits of resolution in all measurement ranges, 1pF to 2048 pF (1MHz), and 100pF to 100 μF (1kHz).

The pushbutton zero adjustment function is used to compensate for stray impedance and admittance of the handler and test fixture. The auto calibration function, when used with a capacitance standard, can be used to calibrate the system up to the point of device connection.

Intelligent Built-in Comparator

The intelligent built-in comparator gives the HP 4278A the capability to use nine sets of high and low capacitance values and one set of dissipation limits to sort capacitors into nine bins, according to their capacitance values and whether or not they meet the dissipation limits. Capacitors which are not within the capacitance limits or do not meet the dissipation limits go into the tenth or no-go bin.

All comparator settings can be controlled and monitored using an external computer, and the results of the comparisons can be transferred to a handler interface (optional). All control settings and comparator parameters can be saved on the removable EEPROM memory module (memory card) to facilitate instrument setup and to minimize the chance of an instrument setup error.

Specifications

(refer to data sheet for complete specifications)

Measurement Parameters: C-D•Q•ESR•G

Display: Dot-matrix LCD. Displays measurement values with 4, 5, or 6 digit resolution, control settings, comparator limits, the comparator's decision, self test messages and annunciations.

Measurement Circuit Modes: Parallel and Series

Test Signals:

Frequency: 1kHz and 1 MHz, $\pm 0.02\%$

Signal Level: 0.1 to 1 Vrms, $\pm 10\%$ ($C \leq 20\mu\text{F}$), in 0.1 Vrms steps

Measurement Time Modes: SHORT, MEDIUM, and LONG

Measurement Times:

Mode	SHORT	MEDIUM	LONG
Time*	6.5ms	10ms	21ms

* Measurement time includes Settling, Integration (analog measurements), Calculation, and Comparison times.

No additional measurement time is required for measurements performed in an overload (shorted capacitor) condition.

Measurement Range

Measurement Parameter	1 KHz	1 MHz Normal Mode
		1 MHz High Accuracy
C	0.001 pF to 200.000 μF	0.00001 pF to 1280.00 pF 0.00001 pF to 2663.00 pF
DF	0.00001 to 9.99999	0.00001 to 9.99999 .000001 to .999999
Q	0.1 to 99999.9	0.1 to 99999.9 20 to 99999.9
G	0.00001 μS to 9.99999S	0.00001 μS to 9.99999 mS 0.00001 μS to 9.99999 mS
ESR	0.00001 Ω to 9.99999 M Ω	0.001 Ω to 999.999 K Ω 0.001 Ω to 999.999 K Ω

- 1 kHz Normal Mode: 7 decade ranges 100pF to 100 μF full scale. 100% overranging on all ranges, (max. 200000 counts) when $D \leq 0.5$.
- 1 MHz Normal Mode: 11 binary ranges, 1pF to 1024pF full scale. 25% overranging on all ranges, when $D \leq 1$.
- 1 MHz High Accuracy Mode: Measurement range is $\pm 30\%$ of the user defined nominal value, maximum 2048pF. When $D \leq 0.05$.

Measurement Accuracy

It is specified at the UNKNOWN terminals and at the end of standard 1 or 2 meter test leads under the following conditions.

Refer to data sheet for details.

1. Warm Up Time: ≥ 10 minutes.
2. Ambient Temperature is $23 \pm 5^\circ\text{C}$ and variance is less than $0.2^\circ\text{C}/\text{minute}$.
3. Test signal level is set to 1 Vrms.
4. Test cable length is 0, 1, or 2 meters (HP 16048A/B/D).
5. Zero OPEN/SHORT compensation has been performed.
6. $D \leq 0.05$ for 1 MHz High Accuracy Mode.
 $D \leq 0.1$ for 1 kHz and 1 MHz Normal Modes.
7. Accuracies are only valid when the measured value is equal to full scale of each range.
8. Accuracy stated in the tables is given for MEDIUM (upper) and LONG (lower) integration times.
9. Accuracy equations are read as follows:
C: \pm (% of reading + % of full scale)
D: \pm (% of reading + absolute D value)
(C: \pm (% of reading + absolute C value) for Table 3)

Table 1 1kHz Measurement Accuracy

C range	C	D
100 μF	0.13% + 0.3% 0.07% + 0.025%	0.13% + 0.003 0.065% + 0.0025
100pF - 10 μF	0.1% + 0.05% 0.05% + 0.025%	0.1% + 0.001 0.05% + 0.0005

Table 2 1MHz Normal Mode Measurement Accuracy

C range	C	D
256 - 1024pF	0.2% + 0.02% 0.1% + 0.02%	0.2% + 0.002 0.1% + 0.0005
4 - 128pF	0.2% + 0.02% 0.05% + 0.02%	
2pF	0.2% + 0.03% 0.05% + 0.03%	0.2% + 0.004 0.1% + 0.001
1pF	0.2% + 0.06% 0.05% + 0.06%	

Table 3 1MHz High Accuracy Mode Measurement Accuracy

Nominal C + Open Circuit C	C	D
1024 - 2048pF	0.11% 0.11%	0.0007 0.0004
256 - 1024pF	0.11% 0.07%	0.0007 0.0003
4 - 256pF	0.11% 0.05%	0.0007 0.0002
2 - 4pF	0.1% + 0.0004pF 0.06% + 0.0004pF	0.0008 0.0003
0 - 2pF	0.1% + 0.0004pF 0.08% + 0.0004pF	0.0016 0.0006

Trigger Modes: Internal, External, or Manual

Measurement Terminals: Four-terminal pair, guarded

Cable Length Compensation: 0, 1, or 2m

Compensation Function

Zero OPEN/SHORT: Compensation range: $R \leq 20\Omega$, $G \leq 20\mu\text{S}$, and unlimited C and L.

Standard: Improves measurement accuracy by using a standard capacitor as a reference.

Offset: Arithmetic correction of measurement data.

Comparator: Ten-bin sorting for capacitance, and go/no-go testing for D, Q, ESR, and G.

Sorting Modes: Sequential sorting into un-nested bands with absolute limits, and tolerance sorting into nested bands with absolute or percent limits.

Self Test: Checks the HP 4278A's basic operation.

Memory Card: External memory for storing and recalling control settings and comparator limits.

General Specifications

Operating Temperature and Humidity: $0-55^\circ\text{C}$, 95% RH @ 40°C
Power: 100, 120, 220VAC $\pm 10\%$, 240VAC $+5 -10\%$, 48-66Hz, 200VA max.

Dimensions (in mm): Approximately 426(W) by 177(H) by 498(D)

Weight: Approximately 10kg (22lb., standard)

Reference Data

Stability: LONG integration and constant operating temperature.

C $\leq 0.01\%/ \text{day}$

D $\leq 0.0001/ \text{day}$

Temperature Coefficient: LONG integration and $23 \pm 5^\circ\text{C}$.

C $\leq 0.01\%/^\circ\text{C}$; 1kHz and 1MHz.

D $\leq 0.0001/^\circ\text{C}$; 1kHz and 1MHz Normal Mode.

D $\leq 0.00004/^\circ\text{C}$; 1MHz High Accuracy Mode.

HP-IB Data Output Speed: Maximum 100 bytes/ms, typically 3ms for handshake, depending on the system controller.

Accessories Available

HP 16270A: Memory Card Set \$280

HP 16334A: Tweezer-type Test Fixture for Chip Components \$440

HP 16047A: Direct-coupled Test Fixture \$270

HP 16047C: Test Fixture \$310

HP 16048A: Test Leads, BNC (1m) \$330

HP 16048B: Test Leads, SMC (1m) \$330

HP 16048D: Test Leads, BNC (2m) \$430

HP 16380A: Standard Capacitor Set \$3010

HP 16380C: Standard Capacitor Set \$4585

Refer to page 283.

Ordering Information

HP 4278A 1kHz/1MHz Capacitance Meter \$7840

Opt W30: 3-year hardware support \$180

Opt 001: 1kHz test frequency only -\$830

Opt 002: 1MHz test frequency only -\$360

Opt 003: 1% frequency shift; prevents possible test signal interference when component test contacts are located close to those of other test units \$0

Opt 009: Delete Manual -\$30

Opt 101: HP-IB compatibility \$240

Opt 201: Handler Interface \$280

Opt 202: Handler Interface \$310

Opt 301: Scanner Interface \$600

☎ Fast-ship product, see page 734.

COMPONENT MEASUREMENT

LCZ Meters

Models 4276A & 4277A

- 3-digit frequency setting:
100 Hz to 20 kHz (801 spots)
10 kHz to 1 MHz (701 spots)
- High speed measurements
- Measure L/C-D/Q/ESR/G, $|Z| - \theta$, high speed L/C
- 10-bin component sorting-comparator (OPT. 002)
- 0.1% basic accuracy over impedance range of 100 m Ω to 10 M Ω (HP 4276A), 10 Ω to 1 M Ω (HP 4277A)

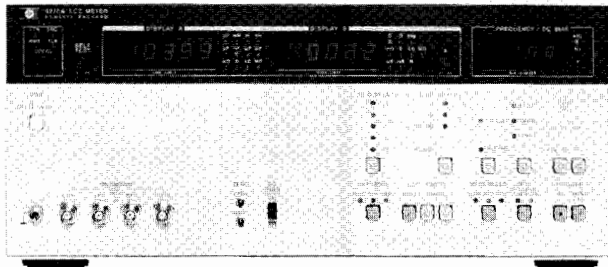

HP 4276A

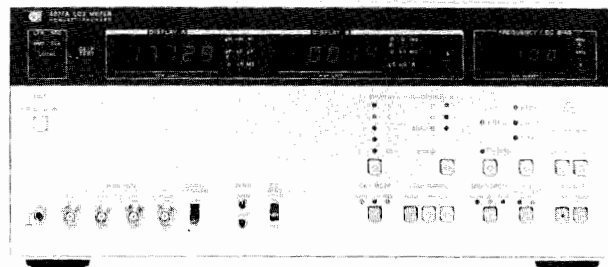

HP 4277A

Description

HP's 4276A and 4277A LCZ Meters are general purpose impedance measuring instruments designed to measure circuit components such as capacitors and inductors using frequency and dc bias conditions identical to those of the intended application. Both HP 4276A and HP 4277A feature variable test frequency (100 Hz – 20 kHz and 10 kHz – 1 MHz respectively), optional dc bias variable from 0 to ± 40 V, multiple parameters (L • C • $|Z|$ • D • Q • ESR • G • θ) with fully automatic high speed measurements, and $4\frac{1}{2}$ digit resolution. The HP 4276A has an impedance range of 100 m Ω to 10 M Ω and the HP 4277A 10 Ω to 1 M Ω .

Both instruments are ideal for production line, quality control, and circuit design applications, and are versatile enough for stand-alone use or systems use under HP-IB control (standard). An optional comparator for 10-bin sorting with measurement time of less than 100 ms make the HP 4276A/4277A a good choice for production line testing of discrete components.

Specifications (Refer to data sheet for complete specifications)
Common to HP 4276A and HP 4277A

Parameters measured: C • D • Q • ESR • G • L • D • Q • ESR • G
high speed L, high speed C
 $|z| - \theta$ and Δ (deviation for any parameter)

Display: $4\frac{1}{2}$ digits (max), maximum display 19999

Measurement circuit modes: Auto, Parallel, and Series

Frequency control modes: SPOT, COARSE (10 freq./decade), and FINE (max. freq. resolution).

Test Signal Level (unknown terminal open)

	HIGH	LOW
HP 4276A	1 Vrms $\pm 10\%$ @ 1kHz	50 mV $\pm 20\%$ (CP only) @ 1kHz
HP 4277A	1 Vrms $\pm 10\%$	20 mV $\pm 15\%$

Test frequencies:

HP 4276A - 100 Hz to 20 kHz $\pm 0.01\%$ (801 points)

HP 4277A - 10 kHz to 1 MHz $\pm 0.01\%$ (701 points)

Measurement accuracy and range: specified at the front panel unknown connectors when all of the following conditions are satisfied:

- (1) warmup time ≥ 30 min.
- (2) test signal level is set to HIGH (1 Vrms)
- (3) measurement speed mode: MED or SLOW
- (4) ambient temperature is 23°C ± 5 °C
- (5) cable length switch is set to 0 m (HP 4277A)
- (6) OPEN and SHORT adjustments have been made
- (7) $D \leq 0.1$

C Measurement Basic Accuracy:

HP 4276A: 0.1% + 17 counts to 3% + 2 counts

HP 4277A: 0.1% + 17 counts to 3% + 4 counts

DC Bias

Internal dc bias (opt.): 0 to ± 40 V

Reference Data

Measurement Speed (Typical): (Circuit mode: AUTO, test signal level: HIGH, display digit: 3 digits, FAST mode)

Measurements	HP 4276A @ 1kHz	HP 4277A @ 1MHz
C-D • ESR • G	65 ms	75 ms
L-D • ESR • G	75 ms	65 ms
Z- θ	80 ms	75 ms
High Speed C	35 ms	40 ms

General Specifications

Operating temperature and humidity: 0° to 55°C, $\leq 95\%$ RH at 40°C.

Power requirements: 100/120/220 Vac $\pm 10\%$, 240 V + 5% – 10%; 48 to 66 Hz.

Power consumption: 65 VA max (HP 4276A); 75 VA max (HP 4277A).

Size: 188 mm H x 426 mm W x 422 mm D ($7\frac{1}{2}$ " x $16\frac{3}{4}$ " x $16\frac{2}{3}$ ").

Weight: approx. 8.5 kg (18.7 lb).

Special Options

HP 4276A Opt H05: 1 kHz C-D measurement only (1V/100mV)

HP 4276A Opt H06: 1 kHz C-D measurement only (1V/300mV)

HP 4276A Opt H07: 1 kHz C-D measurement only (1V/500mV)

HP 4277A Opt H03: Programmable DC bias for high speed C-V measurement (1V/20mV, 1 MHz only)

HP 4277A Opt H04: Programmable DC bias for high speed C-V measurement (500mV/20mV, 1 MHz only)

HP 4277A Opt H07: High accuracy DC bias

Contact your nearest HP sales office for more information.

Accessories

Furnished accessories: HP 16047A Direct Coupled Test Fixture

Accessories Available

HP 16064A: Retrofit Kit for Comparator (HP 4276A/HP 4277A, Opt 002)

Ordering Information

HP 4276A LCZ Meter

HP 4277A LCZ Meter

Opt 001: Internal dc bias, 0 to ± 40 V, max resolution 10 mV/100 mV.

Opt 002: 10-bin sorting for L/C/ $|Z|$ and go/no-go testing for D/Q, interfaceable with component handler.

Opt W30: 3-year hardware support (HP 4276A)

Opt W30: 3-year hardware support (HP 4277A)

Prices

\$5,300

\$7,440

\$234

\$815

\$135

\$185

COMPONENT MEASUREMENT

1MHz C-V Meter
Model 4279A

299

- Built-in programmable dc bias sweep source with a voltage accuracy of 0.1%
- High speed C-V measurements: 10ms, 20ms, and 30ms/meas point

- 0.1% basic accuracy and 6 digit resolution for C measurement
- Automatic dc bias polarity control
- High reliability for production testing

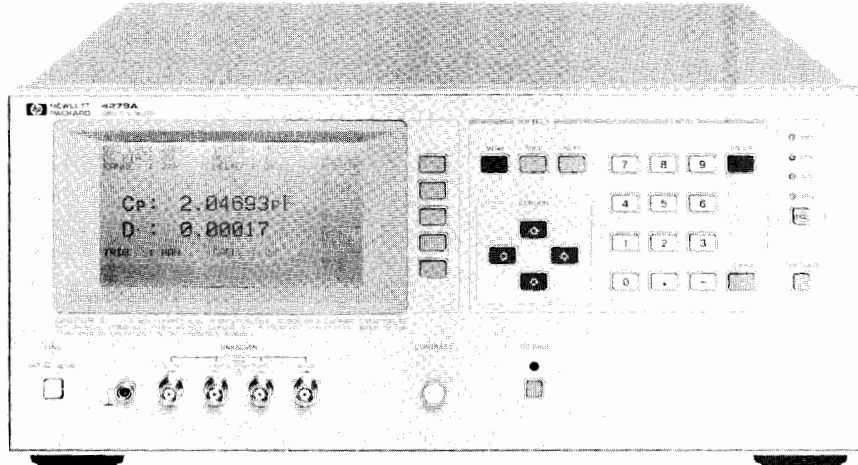

HP 4279A



The HP 4279A 1MHz C-V Meter offers the optimum solution for increasing quality and throughput when measuring the capacitance vs bias voltage characteristics of semiconductors. The HP 4279A measures capacitance over a range of 0.00001pF to 1280.00pF with a basic accuracy of 0.1% and a 6 digit display resolution, while sweeping the dc bias voltage. An internal, programmable dc bias sweep source with a 0.1% voltage accuracy throughout the $\pm 38V$ range assures very low measurement error due to bias voltage uncertainty. It makes the HP 4279A ideal for the precise characterization and testing of varactor diodes, MOS diodes, etc.. Measurement time can be selected from three modes of 10ms, 20ms and 30ms/meas to maximize productivity. The HP 4279A's very fast ranging and high speed HP-IB data transfer capabilities reduce test time. The automatic bias polarity control feature allows quick selection of the correct polarity bias voltage for the device under test. This new function eases manual testing of samples in incoming/outgoing inspection and provides a simple method of polarity control for automatic test systems.

Specifications

Parameters measured: C-D•Q•ESR•G

Display: 4, 5, 6 digits, selectable, maximum display 999999

Measurement circuit modes: Series and parallel.

Ranging modes: Auto, Manual and Program

Measurement frequency: 1MHz $\pm 0.02\%$

Test signal level (unknown terminal open): 20mV, 50mV, 100mV, 200mV, 500mV and 1Vrms, selectable

Measurement terminals: 4-terminal pair

Test cable length compensation: 0m, 1m and 2m

Error-correction: OPEN and SHORT adjustments and STD and temperature compensation functions

Measurement time:	Mode	SHORT	MEDIUM	LONG
	Time	10ms	20ms	30ms

Ranging time: Less than 3ms in program mode (unspecified)

Trigger: Internal, External and Manual

Delay time: 0 to 1000ms, programmable in 1ms steps

Measuring range and accuracy

C-D measurement range: 0.00001pF to 1280.00pF;
0.00001 to 9.99999D

C measurement accuracy: Specified at the front panel unknown terminals and the ends of standard 1m or 2m test leads (HP 16048A/B/D) when all of the following conditions are satisfied:

- (1) Ambient temperature is $23^{\circ}C \pm 5^{\circ}C$ and temperature variance $\leq 0.2^{\circ}C/min$
- (2) Warmup time $\geq 10min$.

- (3) OPEN, SHORT and temperature compensations have been made
- (4) $D \leq 0.1$

Accuracies for C measurements in MEDIUM mode are given in Table 1 and are read as $\pm(\%$ of reading + $\%$ of full scale value). (Refer to the HP 4279A data sheet for complete accuracy specifications, including D/Q/ESR/G accuracies.)

C range	Test signal level			
	20mV	50mV	100mV	200mV-1V
1024pF 512pF 128pF	0.07%+0.03%	0.07%+0.03%	0.07%+0.03%	0.07%+0.03%
32pF			0.06%+0.04%	0.06%+0.04%
8pF	0.06%+0.08%	0.06%+0.04%		
2pF	0%+0.3%	0%+0.15%	0%+0.1%	0.06%+0.04%

DC bias

Internal dc bias: 0V to $\pm 38V$

Bias voltage	Voltage step	Accuracy (at $23^{\circ}C \pm 5^{\circ}C$)
$\pm(0.000-4.000)V$	1mV	$\pm(0.1\%$ of setting +1mV)
$\pm(4.002-8.000)V$	2mV	$\pm(0.1\%$ of setting +2mV)
$\pm(8.005-20.000)V$	5mV	$\pm(0.1\%$ of setting +3mV)
$\pm(20.01-38.00)V$	10mV	$\pm(0.1\%$ of setting +10mV)

Bias voltage sweep: Max. 51 sweep points can be programmed via HP-IB

Auto bias polarity control: Completed within 4ms after triggered (unspecified)

External dc bias: 0V to $\pm 100V$ via rear panel connector

HP-IB: Standard. Remote control and ASCII or binary data output (packed data output when swept bias measurements are made.)

General

Operating temperature and humidity: $0^{\circ}C$ to $55^{\circ}C$, $\leq 95\%RH$ at $40^{\circ}C$

Power: 100/120/220V $\pm 10\%$, 240V +5% -10%: 48 to 66Hz; 200VA maximum

Size: 177mmH x 426mmW x 498mmD (7" x 16.8" x 19.6")

Weight: Approximately 15kg

Accessories Available

Refer to page 283.

Ordering information

HP 4279A 1MHz C-V Meter

Opt. W30: 3-year hardware support

Opt. 003: 1% frequency shift

Opt. 009: Delete manual

Opt. 910: Extra manual

Price

HP 4279A 1MHz C-V Meter

\$9700

Opt. W30: \$245

Opt. 003: \$0

Opt. 009: -\$36

Opt. 910: \$36

COMPONENT MEASUREMENT

Digital LCR Meters

Models 4261A and 4262A

- Automatic balancing, ranging & circuit mode selection
- Test frequencies: HP 4261A, 120 (100) Hz and 1 kHz
HP 4262A, 120 (100) Hz, 1 kHz and 10 kHz
- Versatile accessories and options
- High reliability

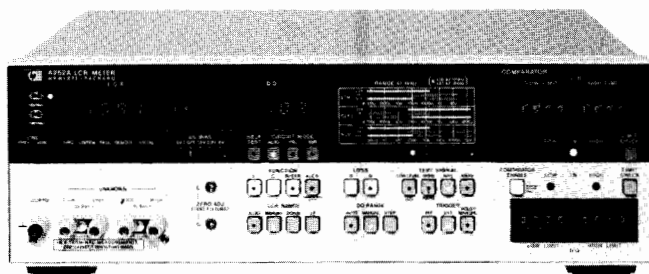

HP 4262A with Opt 004



HP 4261A

Description

The HP 4261A and HP 4262A are 3½ digit LCR meters that meet today's requirements for component measurements. Both instruments feature fully automatic operation over wide measuring ranges. Simply select the measuring functions and one of the test frequencies, then insert the device to be measured. The instrument does the rest—automatically selecting the proper measuring range and equivalent circuit mode.

In addition to automatic measurements, the HP 4261A and HP 4262A provide high accuracy (0.2% reading), internal dc bias, and series and parallel equivalent circuit modes.

These relatively low cost and easy-to-use LCR meters are capable of a wide range of applications — measuring electrolytic/ceramic capacitors, filter coils, pulse transformers, internal resistance of dry cells and semiconductor junction capacitance, as well as ordinary LCR components. Extended features of these reliable instruments include optionally available HP-IB (HP 4262A) and BCD (HP 4261A) data output capabilities and a comparator option which is convenient for production line applications.

Specifications (refer to data sheet for complete specifications) Measurement ranges and accuracies: see table on this page. Accuracy applies over a temperature range of 23°C ±5°C (at 0° to 55°C, error doubles). 10 kHz and Q specifications are given only for the HP 4262A.

	HP 4261A	HP 4262A
Parameters measured	L-D, C-D R	L-D • Q, C-D • Q R (ESR), ΔLCR
Display	3-1/2 digits max. display 1900	3-1/2 digits max. display 1999
Basic Accuracy	0.2%	
Test frequency	120(100) Hz, 1 kHz ±3%	120(100) Hz, 1 kHz 10 kHz ±3%
Test signal level (typical)	1 V, 50 mV (Cp mode only)	
DC bias	Int	1.5 V, 2.2 V, 6 V ±5%, selectable
	Ext	0 to +30 V 0 to +40 V
Equivalent circuit modes	auto, parallel, series	
Ranging modes	LCR	auto, manual
	DQ	D only - fixed auto, manual
Trigger	internal, external, manual	
Measuring terminal	5-terminal configuration	

Deviation measurement (HP 4262A): displays the difference between a stored value (that is, measured value when LCR switch is depressed) and subsequent measured data.

Offset adjustments (HP 4262A): front panel adjustments to compensate for stray capacitance (C: 0 to 10 pF) and residual inductance (L: 0 to 1 μH) of the test fixture.

Self-test (HP 4262A): automatically checks basic functions.

General

Measuring time (typical): for a 1000 count measurement on a low loss component on a fixed range:

1 kHz, 10 kHz: C/L 220-260 ms, R 120-160 ms

120 (100) Hz: C/L 900 ms, R 700 ms

Ranging Time

1 kHz, 10 kHz: 180 ms/range step

120 (100) Hz: 670 ms/range step

Reading rate: INT (internal trigger) approximately 30 ms between end of measurement cycle and start of the next cycle. EXT (external trigger) measuring cycle is initiated by a remote trigger input.

Accessories available: HP 16061A: test fixture, direct couple, 5-terminal; HP 16062A: test leads with alligator clips, 4-terminal (for low impedance measurements); HP 16063A: test leads with alligator clips, 3-terminal (for high impedance measurements).

Ordering Information (HP 4261A *1)

HP 4261A Digital LCR Meter \$3,260

Opt 001: BCD Output (L/C/R and D simultaneously) \$244

Opt 002: BCD Output (L/D, C/D, R alternately) \$214

Opt 003: BCD Remote Control \$112

Opt 010: 100 Hz Test Frequency \$0

HP 16061A Test Fixture, Radial/Axial Lead devices \$228

HP 16062A Test Leads, 4-wire \$122

HP 16063A Test Leads, 3-wire \$132

*1: Options 001 and 002 are mutually exclusive.

Ordering Information (HP 4262A *2)

HP 4262A Digital LCR Meter \$4,380

Opt 001: BCD Output \$430

Opt 004: Digital Comparator \$1,070

Opt 010: 100 Hz Test Frequency \$0

Opt 101: HP-IB Interface \$715

HP 16061A Test Fixture for Radial/Axial Lead Devices \$228

HP 16062A Test Leads, 4-wire \$122

HP 16063A Test Leads, 3-wire \$132

*2: Option combinations 101/001 and 101/004 cannot be ordered.

COMPONENT MEASUREMENT

**Q Meter
Model 4342A**

301

- Frequency range: 22 kHz to 70 MHz
- Q range: 5 to 1000

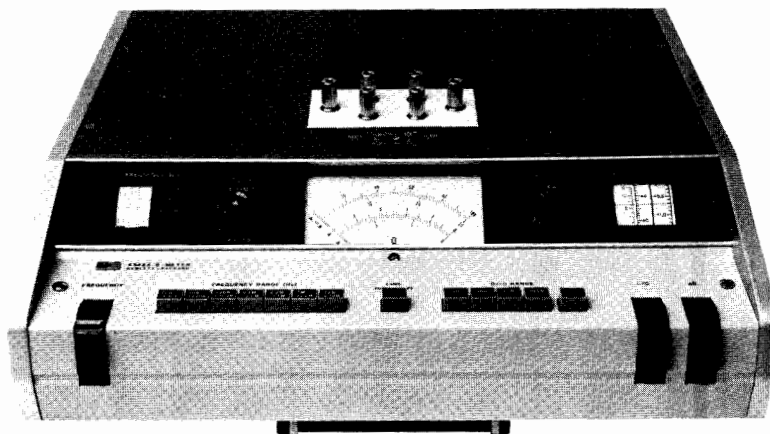

HP 4342A

Description

The direct-reading expanded scale of the HP 4342A permits measurement of Q from 5 to 1000 and readings of very small changes in Q resulting from variation in test parameters. The HP 4342A is solid state with the elimination of specially matched, fragile thermocouple components.

The HP 4342A will measure dissipation factor and dielectric constant of insulating materials. The Q meter can measure coefficient of coupling, mutual inductance, and frequency response of transformers. RF resistance, reactance, and Q of resistors and capacitors can also be determined.

Pushbutton operation of frequency range and Q/ Δ Q range selection provides straightforward measurement. Automatic indication of meter scales, frequency dials and frequency multipliers are featured, adding to simplicity and reading speed.

Specifications

RF Characteristics

RF range: 22 kHz to 70 MHz in 7 bands: 22 to 70 kHz, 70 to 220 kHz, 220 to 700 kHz, 700 to 2200 kHz, 2.2 to 7 MHz, 7 to 22 MHz, 22 to 70 MHz.

HP 4342A Opt 001: 10 kHz to 32 MHz in 7 bands: 10 to 32 kHz, 32 to 100 kHz, 100 to 320 kHz, 320 to 1000 kHz, 1 to 3.2 MHz, 3.2 to 10 MHz, 10 to 32 MHz.

RF accuracy: $\pm 1.5\%$ from 22 kHz to 22 MHz; $\pm 2\%$ from 22 MHz to 70 MHz; $\pm 1\%$ at "L" point on frequency dial.

HP 4342A Opt 001: $\pm 1.5\%$ from 10 kHz to 10 MHz; $\pm 2\%$ from 10 MHz to 32 MHz; $\pm 1\%$ at "L" point on frequency dial.

RF increments: approximately 1% resolution.

Q Measurement Characteristics

Q range: 5 to 1000 in 4 ranges: 5 to 30, 20 to 100, 50 to 300, 200 to 1000.

Q accuracy: % of indicated value: (at 25°C)

	HP 4342A & HP 4342A Opt. 001	HP 4342A
Q Freq.	22 kHz-30MHz	30 MHz-70 MHz
5-300	± 7	± 10
300-600	± 10	± 15
600-1000	± 15	± 20

Q increments: upper scale, 1 from 20 to 100; lower scale, 0.5 from 5 to 30.

Δ Q range: 0 to 100 in 4 ranges: 0 to 3, 0 to 10, 0 to 30, 0 to 100.

Δ Q accuracy: $\pm 10\%$ of full scale.

Δ Q increments: upper scale, 0.1 from 0 to 10; lower scale, 0.05 from 0 to 3.

Inductance Measurement Characteristics

L range: 0.09 μ H to 1.2 H, direct reading at 7 specific frequencies.

L accuracy: $\pm 3\%$ after substitution of residuals (approx. 10 nH).

Resonating Capacitor Characteristics

Capacitor range: main dial, 25 to 470 pF, vernier dial, -5 to $+5$ pF.

Capacitor accuracy: main dial, $\pm 1\%$ or 1 pF, whichever is greater; vernier dial, ± 0.1 pF.

Capacitor increments: main dial, 1 pF from 25 to 30 pF, 2 pF from 30 to 200 pF, 5 pF from 200 to 470 pF; vernier dial, 0.1 pF.

General

Rear Panel Outputs

Frequency monitor: 170 mV rms min. into 50 Ω .

Q analog output: 0 to 1 V ± 50 mV dc after 15 minutes warmup, proportional to meter deflection. Output impedance approximately 1 k Ω .

Over limit signal output: contact closure at the rear panel. Relay contact capacity 0.5 A/15 VA.

Over limit display time: selectable, 1 s or continuously on, after limit exceeded.

Temperature range: 0°C to 50°C.

Power: 115 or 230 V $\pm 10\%$, 50-400 Hz, approximately 40 VA.

Size: 138 mm H x 425 mm W x 414 mm D (5 $\frac{1}{16}$ " x 16 $\frac{3}{4}$ " x 16 $\frac{5}{16}$ ").

Weight: net, 14 kg (31 lb); shipping, 18.45 kg (41 lb).

Accessories Available

HP 16014A series loss test adaptor: designed for measuring low-value inductors and resistors and high-value capacitors.

HP 16451A Dielectric Test Adapter: designed for measuring the dielectric constant, capacitance and dissipation factor of insulating materials.

HP 16462A Auxiliary Capacitor: designed to extend the Q and L measurement capability of the HP 4342A Q Meter. It is especially useful for measuring small inductors at low frequencies.

HP 16470A Reference Inductors: A range of 20 inductors (any of which can be supplied separately) which can be used with the HP 4342A Q Meter when measuring the RF characteristics of capacitors, resistors, or insulating materials.

HP 16470B Stable Inductors: A set of 4 inductors (any of which are separately available) which can be used to compensate indicated Q values and/or instrumental variation in the maintenance of the HP 4342A Q Meter. They are usable over a range of 800 kHz to 50 MHz with excellent long-term temperature stability.

Options and Accessories

Opt 001: Frequency Range (10 kHz - 32 MHz)

Opt 910: Extra Manual

HP 16014A Series Loss Test Adaptor

HP 16451A Dielectric Test Adapter

HP 16462A Auxiliary Capacitor

HP 16470A Reference Inductors, set of 20

HP 16470B Stable Inductors, set of 4

HP 16470C Complete set of 24 Inductors (HP 16470A

+ HP 16470B)

HP 4342A Q Meter

Price

\$335

\$21

\$173

\$715

\$660

\$3155

\$1730

\$4890

\$7,200

COMPONENT MEASUREMENT

Milliohmmeter/High Resistance Meter

Model 4328A/4329A

- 20 $\mu\Omega$ resolution on 1 m Ω range
- Four terminal measurement
- Low test voltage

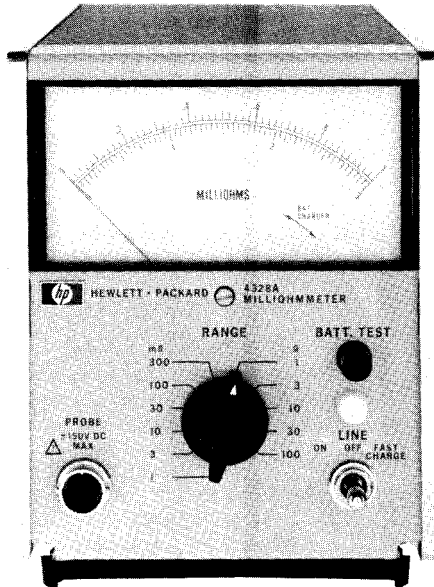

HP 4328A

Description

HP's 4328A Milliohmmeter is a high sensitivity portable instrument for measurement of low resistances. The 1 m Ω to 100 Ω measuring range and 20 $\mu\Omega$ resolution make the HP 4328A ideal for measuring the contact resistance of switches, relays, and connectors and the resistivity of conductors and semiconductors. Series reactances of up to twice the full scale resistance will not affect the accuracy. The maximum voltage across a sample, with the instrument at the proper range, is less than 200 μ V peak. Even at incorrect range settings, the voltage across the sample will not exceed 20 mV peak.

The special probes that allow four-terminal measurement in two probes are furnished with the HP 4328A.

The basic HP 4328A is line operated but Opt 001 permits operation from rechargeable batteries for 15 continuous hours.

Specifications

Range: 0.001 to 100 ohms full scale in a 1, 3 sequence.

Accuracy: $\pm 2\%$ of full scale. No additional error is caused by series reactance of samples up to two times full scale.

Measuring frequency: 1000 Hz ± 100 Hz.

Voltage across sample: 200 μ V peak at full scale.

Maximum voltage across sample: 20 mV peak.

Superimposed dc: 150 V dc maximum (external source).

Recorder output: 0.1 V dc output at full scale, output resistance approx. 1 k Ω .

Applied current (mA): constant by range, 150/(full scale value in milliohms).

General

Power requirements: 115/230 V $\pm 10\%$, 50 to 60 Hz, 1.5 VA.

Weight: 3.2 kg (7 lb).

Size: 155 mm H x 130 mm W x 280 mm D (6 $\frac{1}{32}$ " x 5 $\frac{1}{8}$ " x 11").

Accessories furnished: HP 16005A Probe, HP 16006A Probe, HP 16007A/B Test Leads and HP 16143A Probe Cable.

Ordering Information

HP 4328A Milliohmmeter

Opt 001: Rechargeable battery operation

Opt 910: extra manual

Price

\$2,400

\$132

\$15

- Wide range: 500 k Ω to $2 \times 10^{16} \Omega$
- Selectable test voltages: 10 V to 1000 V

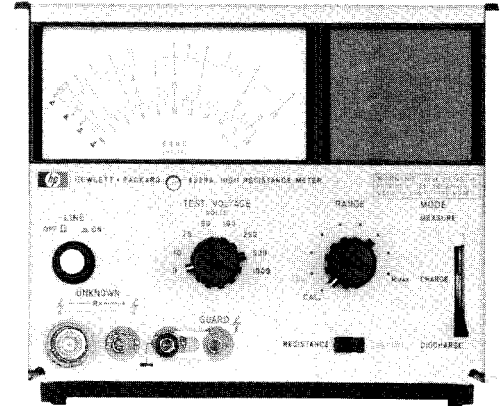

HP 4329A

Description

The HP 4329A is a solid-state insulation resistance meter designed for easy, accurate and direct readings of the very high resistance values typically found in synthetic resins, porcelain, insulating oils and similar materials. It is also useful for measurements in electrical components such as capacitors, transformers, switches and cables. Seven fully regulated dc test voltages (between 10 and 1000 Vdc) are provided as test sources.

The HP 4329A is instantly convertible from ungrounded-to-grounded-sample operation via a simple relocation of the front panel ground strap from "guard" to "+" position.

The HP 4329A also has a current measurement capability. Minute currents as low as 0.05 pA can be readily measured.

The HP 16008A Resistivity Cell, designed for use with the HP 4329A, can safely, rapidly and conveniently measure the volume and surface resistivity of sheet insulation materials (maximum sample size: 125 mm W x 125 mm D x 7 mm H).

Specifications

Resistance Measurement

Range: 500 k Ω to $2 \times 10^{16} \Omega$. (Depends on the test voltage).

Accuracy: total accuracy is determined by test voltage and range used. At low resistance end of each scale, accuracy is $\pm 3\%$, near center scale $\pm 5\%$, and near the specified upper limit on the meter scale (a quarter of full scale), accuracy is $\pm 10\%$. Accuracy is not specified above these limits. On all voltage ranges, if multiplier is set to Rmax., an additional $\pm 3\%$ is included.

Test voltages: 10 V, 25 V, 50 V, 100 V, 250 V, 500 V and 1000 V $\pm 3\%$.

Current Measurement

Range: 5×10^{-14} to 2×10^{-5} A in 8 ranges.

Accuracy: $\pm 5\%$ of full scale deflection (there can be an additional $\pm 3\%$ error at the top decade).

General

Recorder output: 0 to 100 mV dc, proportional to meter deflection; 1 k Ω output resistance.

Power: 115/230 V $\pm 10\%$, 50-60 Hz, approximately 3 VA.

Size: 155 mm H x 198 mm W x 204 mm D (6 $\frac{1}{2}$ " x 7 $\frac{25}{32}$ " x 8 $\frac{25}{32}$ ").

Weight: 3.5 kg (7.7 lb).

Accessory furnished: HP 16117A Low Noise Test Leads.

Accessory available: HP 16008A Resistivity Cell.

Ordering Information

HP 16008A Resistivity cell

HP 4329A High resistance meter

Opt 910: extra manual

Price

\$1,120

\$2,950

\$15

COMPONENT MEASUREMENT

Standard Capacitor Set and Decade Capacitor

Models 16380A, 16380C, 4440B

303

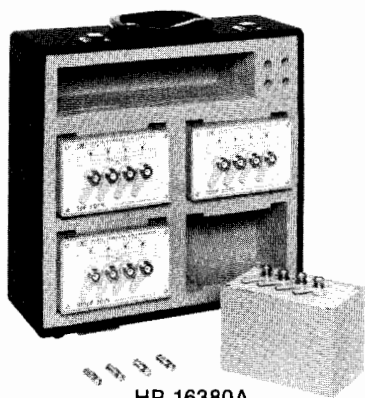

HP 16380A

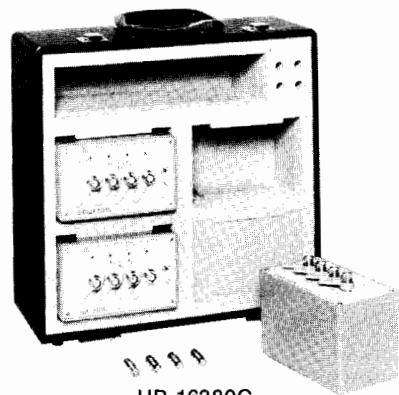

HP 16380C

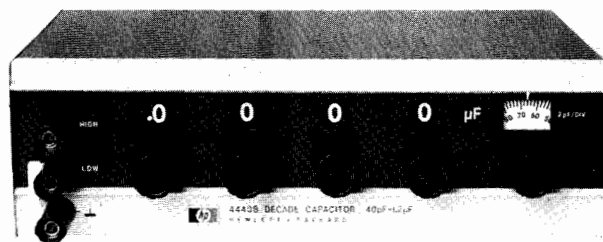

HP 4440B

HP 16380A, HP 16380C Description

The HP 16380A and HP 16380C are precision standard capacitor sets that cover the range of 1 pF to 1 μ F in decade steps. The HP 16380A consists of four discrete air-dielectric capacitors with nominal values of 1 pF, 10 pF, 100 pF, and 1000 pF. Similarly, the HP 16380C consists of four discrete capacitors, but with solid dielectrics and with nominal values of 0.01 μ F, 0.1 μ F, and 1 μ F.

Both the HP 16380A and HP 16380C are furnished with test certification of 0.01% calibration accuracy. Capacitance stability with respect to time varies from capacitor to capacitor but is specified in the range of ± 50 or ± 300 ppm/year.

The HP 16380A and HP 16380C both have the four-terminal pair configuration to allow direct connection to any of Hewlett-Packard's many four-terminal pair impedance measuring instruments. The HP 16380A/C can be easily adapted to two-, three-, and five-terminal configurations.

HP 16380A, 16380C Specifications (valid at 1 kHz, 23 \pm 5 $^{\circ}$ C)

HP 16380A

Capacitance	1 pF	10 pF	100 pF	1000 pF
Nominal Accuracy			$\pm 0.1\%$	
Calibration Accuracy			$\pm 0.01\%$	
Stability			<300 ppm/yr	
Dissipation Factor			<0.0001	
Dimensions	112 mm (H) x 142 mm (W) x 88 mm (D)			
Weight	8.0 kg (includes case)			

HP 16380C

Capacitance	0.01 μ F	0.1 μ F	1 μ F
Nominal Accuracy			$\pm 0.1\%$
Calibration Accuracy			$\pm 0.01\%$
Stability			<50 ppm/yr
Dissipation Factor	<0.0004	<0.0005	<0.0007
Dimensions	117 mm (H)x142 mm(W)x88 mm(D)		
Weight	6.3 kg (includes case)		

HP 4440B Description

The Hewlett-Packard 4440B Decade Capacitor is a high accuracy instrument providing usable capacitances from 40 pF to 1.2 μ F. Its 0.25% accuracy makes it an ideal aid for circuit design or as a working standard.

The use of silvered-mica capacitors in all four decades provides higher accuracy, lower dissipation factor and good temperature coefficient. An air capacitor vernier provides 100 pF (from 40 pF to 140 pF) with resolution of 1 pF. Capacitors are housed in a double shield in such a way that increased capacitance from two terminals to three terminals is held to 1 pF.

4440B Specifications

Capacitance: 40 pF to 1.2 μ F in steps of 100 pF with a 40 pF to 140 pF variable air capacitor providing continuous adjustment to better than 2 pF between steps.

Direct reading accuracy: $\pm(0.25\% + 3 \text{ pF})$ at 1 kHz for three-terminal connection.

Resonant frequency: typical values of the resonant frequency are 450 kHz at 1 μ F, 4 MHz at 0.01 μ F and 40 MHz at 100 pF

Dissipation factor: for $C \geq 1040 \text{ pF}$, 0.001 max. at 1 kHz.
for $C < 1040 \text{ pF}$, 0.005 max. at 1 kHz.

Temperature coefficient: $< +70 \text{ ppm}/^{\circ}\text{C}$.

Insulation resistance: 5 G Ω minimum, after 5 minutes at 500 V dc.

Maximum voltage: 42 Vdc or 30 Vrms.

Weight: net, 2.5 kg (5 1/2 lb); shipping, 3.6 kg (8 lb).

Size: 76 mm H x 264 mm W x 152 mm D (3" x 11" x 6").

Ordering Information

	Price
HP 16380A Standard Capacitor Set (1 pF, 10 pF, 100 pF, 1000 pF)	\$3,010
HP 16380C Standard Capacitor Set (0.01 μ F, 0.1 μ F, 1 μ F)	\$4,585
HP 4440B Decade Capacitor	\$1,800

LIGHTWAVE TEST EQUIPMENT

General Information

Probably the most remarkable fact about the evolution of fiber optics has been their rapid market growth. Design work began some twenty years ago, with trial projects carrying live telephone traffic being installed ten years later. Today, optical fibers are mass-produced for many applications worldwide.

Technical Background

In general, all fiber optic systems incorporate the following elements: transmitters, fibers, repeaters, and receivers, all of which are linked by connectors and/or splices.

Today, size, lifetime, reliability and ruggedness are major factors in the choice of sources and receivers for optical communication links.

Sources employ LEDs or LDs (laser diodes) to generate the optical output, while APDs or PIN diodes are used to detect the incident optical power on the receiving side.

Optical Sources

LEDs are primarily used in short distance systems (<10km) with data rates below 100MHz. A limiting factor is their broad spectral width and the low coupling efficiency compared with an LD. Advantages are their simpler drive electronics, a higher reliability, and the lower price.

LDs, on the other hand, feature a small spectral width, an excellent coupling efficiency, and reach data rates up to 2 GHz. Thus LDs enable repeaterless data transmission over great distances (up to 150km).

Optical Fibers

Inside the fiber, light is guided by total reflection at the core/cladding boundary due to corresponding differences in the refractive indices. Single-mode fibers are dominating today.

Optical Receivers

To convert light back into an electrical signal for further processing PIN diodes serve as receiving detectors when high data rates are required. This property is combined with favorable linearity and high stability. When increased sensitivity is of major concern, APDs are preferred. Due to their non-linearity, APDs are used only for purely digital applications, while PIN diodes can be used in both analog and digital systems.

Lightwave Test Equipment

HP's line of lightwave test equipment offers new measurement capabilities for design and production engineers in a wide range of different application areas, from computer networks to high-speed, long-distance telecommunication links.

Basic Test Instrumentation

Designers, manufacturers and end-users of fiber optic components, modules or systems face a large variety of measurement tasks. These tasks range from physical measurements, such as fiber geometry or numerical aperture, to system performance tests in the time or frequency domain.

HP offers two powerful lines of basic lightwave test instruments. The first line consists of the HP 8152A Optical Average Power Meter with two different optical heads for the 450-1700nm range, the HP 8151A Pulse Power Meter, and the HP 81511/81512A Optical Heads. The HP 8154B LED Sources for 850nm, 1300nm and 1550nm (option 001, 002, and 003), the HP 8155A LD Sources for 1300nm and 1550nm (option 002 and 003), the HP 8157A Optical Attenuator for 1200-1650nm, single-mode, the HP 8158B Optical Attenuators for 600-1200nm and 1200-1650nm (option 001 and 002), for multimode and single-mode.

The HP 8152A features excellent accuracy (directly traceable to NBS and PTB) and linearity (typically better than 1%) for absolute and relative power measurements.

The HP 8151A, together with the HP 81511/81512A, provides technicians and engineers with an ideal tool for verifying analog and digital power level parameters in terms of peak and average power.

The 8157A Optical Attenuator offers very high optical return loss and polarization insensitivity for tests on your fastest transmitters and automated bit error rate measurements. The HP 8158B Optical Attenuator is very flexible as it handles all fibers with an NA <0.3. (Single mode and Multimode)

And the HP 8154B LED Sources and HP 8155A LD Sources serve as very stable stimuli for insertion loss measurements.

The second line consists so far of one instrument, the HP 8145A Optical Time Domain Reflectometer. It is a portable, high performance unit for field maintenance and applications in a factory environment. Large dynamic range, superb measurement speed and its ease of use are its main contributions.

High Speed Instrumentation

In addition to the basic tools for making lightwave measurements, HP offers two high speed lightwave instruments designed to measure lightwave modulation.

In most lightwave systems today, information is transmitted via an intensity modulated light carrier. HP's high speed instrumentation consists of a lightwave signal analyzer, which measures the intensity modulation itself, and a lightwave component analyzer, which measures the modulation transfer function of lightwave components.

In addition to supporting the traditional modulation schemes, the high speed instrumentation also has applications in state-of-the-art coherent communication systems.

The Lightwave Signal Analyzer

Until now the only way to measure modulation on optical signals has been to use a custom photodetector as the optical front end of a microwave spectrum analyzer. But these custom systems are difficult to calibrate and often have poor sensitivity. The HP 71400A Lightwave Signal Analyzer combines HP's highest performance microwave spectrum analyzer with a sensitive, wide bandwidth optical receiver module to produce the first off-the-shelf instrument for analyzing the modulation on lightwave communication systems and components. With it you can measure modulated light on single-mode optical fibers simply and accurately for modulation rates from 100 kHz to 22 GHz. Optical signals, noise, and average power are presented on a fully-calibrated display. You can accurately characterize semiconductor lasers, laser transmitters, optical modulators, detectors, or any other RF device involved in modulated light. An RF version, the HP 71401A, is also available.

The Lightwave Component Analyzer

A fiber optic transmission system is made up of lightwave components ranging from lasers, photodiodes, and fiber to electrical amplifiers and transmission lines. As the information bandwidth of lightwave systems increase, it becomes important to characterize the modulation transfer function of each of these lightwave components. For example, the relaxation oscillation frequency of a laser limits the highest frequency it will pass, and the bias of a pin photodiode directly affects its speed.

The HP 8702B/8703A Lightwave Component Analyzers provide the ability to measure all of these lightwave components. Measurements are made at fixed wavelengths (850nm, 1300 nm, 1550 nm), while the modulation frequency is swept from 300 kHz to as high as 20 GHz. In this way, the modulation transfer function of a laser, the modulation bandwidth of fiber, and the demodulation transfer function of a photodiode can be measured.

The lightwave coupler allows the system to make reflection measurements such as optical return loss of a photodiode or connector. The frequency domain information is used to calculate the time domain impulse response, allowing the location of multiple discontinuities as close as 1 cm apart.

LIGHTWAVE TEST EQUIPMENT

Optical Pulse Power Meter
Model 8151A with 81511A/81512A

305

- Peak and average power measurements
- Accuracy $\pm 2.5\%$
- O/E transducer capability

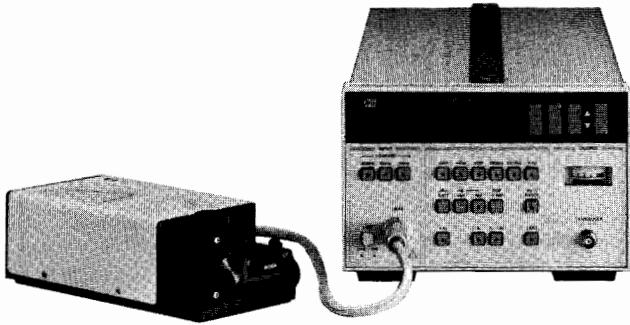

HP 81511A

HP 8151A

The HP 8151A, in combination with the HP 81511A/81512A Optical Heads, is a response measuring instrument for the level characterization of lightwave components, modules and systems. In addition to performing average power measurements, the HP 8151A enables the user to accurately determine upper and lower peak power levels - important in digital applications. This feature is also useful for applications where non-repetitive signals need to be evaluated, or where threshold levels are to be determined. The instrument's versatility is further enhanced by capabilities which allow the user to measure the amplitude, mesial power and extinction ratio of a signal.

The instrument's transducer has a frequency range of 250MHz (150MHz) and outputs an electrical signal which corresponds directly to the optical input waveform. The transducer output can be applied to other instruments for further processing, or displayed on an oscilloscope. By using the transducer, timing related measurements as functions of optical power (e.g. propagation delay versus power) are possible.

The HP 81511A Optical Head is for use at operating wavelengths between 550 and 950nm (calibrated for 850nm), and the HP 81512A for use between 900 and 1725nm (calibrated for 1300nm).

All heads carry interface adapters for fiber connectors and bare fibers.

A calibration grid on top of each optical head indicates typ. correction factors to be entered into the HP 8151A for operating wavelengths other than that for which the head is calibrated. Thus, the HP 8151A can be adapted to operate at any wavelength in the 550 to 1725nm range.

HP 8151A, HP 81511A, HP 81512A Specifications

Wavelength range HP 81511A: 550 to 950nm, cal for 850nm

HP 81512A: 900 to 1725nm, cal for 1300nm

Maximum core diameter: HP 81511A: 200 μ m **HP 81512A:** 100 μ m

Parameters measured: high, low, and mesial power levels, amplitude, extinction ratio, average power

Measurement range: HP 81511A: +10dBm to -60dBm

HP 81512A: 0dBm to -50dBm

Resolution: 3 digits (Watts), 4 digits (dB)

Calibration Accuracy: HP 81511A $\pm 3\%$

HP 81512A $\pm 8\%$

Accuracy: (applies to linear display in Watt, rel. to calibration):

Range [dBm]	\pm (of read + counts)	Hi/Low Peak Power	
		Flatness	Average Power
+10 ¹	0.3 dB + 5	200 Hz - 9.99MHz: ± 0.4 dB of ampl. ²	0.1 dB + 5
0	0.3 dB + 30 ²	10 MHz - 99.9 MHz: ± 0.6 dB of ampl. ²	0.1 dB + 5
-10	0.35 dB + 50		0.1 dB + 5
Bandwidth			
-20	0.2 dB + 10	10kHz	0.1 dB + 5
-30	0.2 dB + 10	6kHz	0.1 dB + 5
-40	0.2 dB + 20 ²	1kHz ²	0.15 dB + 10 ²
-50	0.2 dB + 50 ²	1kHz ²	0.2 dB + 50 ²
-60 ¹	0.3 dB + 80 ¹	4kHz ¹	0.2 dB + 50 ¹

1) not valid for HP 81512A 2) better specifications for HP 81511A

Transducer

Conversion Accuracy⁴ (for 30Hz squarewave):

Range [dBm]	Conversion Factor DC	Accuracy of Conversion	Bandwidth w/o Lowpass	rms Noise [dBm]
+10 ¹	1V/10mW ¹	± 0.3 dB ± 10 mV ¹	DC-250MHz ¹	-20 ¹
0	1V/ 1mW	± 0.3 dB ± 10 mV	DC-250MHz ²	-20 ³
-10	1V/ .1mW	± 0.35 dB ± 20 mV	DC-250MHz ²	-30
-20	1V/10 μ W	± 0.3 dB ± 20 mV	DC-10 kHz	-40 ³
-30	1V/ 1 μ W	± 0.3 dB ± 20 mV	DC-6 kHz	-50 ³
-40	1V/ .1 μ W	± 0.3 dB ± 20 mV	DC-1 kHz ³	-60 ³
-50	1V/10nW	± 0.3 dB ± 50 mV ³	DC-1 kHz ³	-60 ³
-60 ¹	1V/ 1nW ¹	± 0.3 dB ± 20 mV ¹	DC-4 kHz ³	-70 ¹

1) for HP 81511A only 2)150MHz for HP 81512A 3)better specifications for HP 81511A

4) HP 81511A calibrated at 850nm, HP 81512A calibrated at 1300nm

Pulse Response

Transition time: ≤ 2 ns full bandwidth (≤ 3 ns for HP 81512A)

Perturbations: $\leq 10\%$ of amplitude

General

HP-IB capability

Interface function: SH1, AH1, T6, L4, SR1, RL1, PP0, DC1, DT1, C0

Recalibration period: 1 year

Environmental

Storage temperature: -40°C to +70°C

Operating temperature: 0°C to +55°C.

Humidity: 95% R.H. from 0°C to +40°C

Power: 100/120/220/240 Vrms; +5%, -10%, 48 to 66Hz, 100VA max.

Weight: HP 8151A: net 8kg (17.5lbs), shipping 10kg (22lbs)

HP 81511A: net 1.3kg (2.9lbs), shipping 2kg (4.4lbs)

HP 81512A: same as for HP 81511A

Size: HP 8151A: 140mm(H) x 220mm(W) x 530mm(D) (5.7" x 9" x 21.6")

HP 81511A: 60mm(H) x 96mm(W) x 200mm(D) (2.5" x 3.9" x 8.2")

HP 81512A: same as for HP 81511A

Ordering Information

HP 8151A Optical Pulse Power Meter

Price

\$8150

Opt. W30 3 years of customer return repair service

\$205

Opt. 907: Front handle kit

\$65

Opt. 908: Rack mount kit

\$33

Opt. 910: Extra operating and service manual

\$60

HP 81511A Optical Head 550 to 950nm

\$4050

Opt. W30 3 years of customer return repair service

\$100

HP 81512A Optical Head 900 to 1725 nm

\$5950

Opt. W30 3 years of customer return repair service

\$150

Note: The HP 8151A cannot be used without an optical head and connector adapter. For connector adapters, see 'Lightwave Test Accessories' below.

☎ Fast-Ship product—see page 734.

Accessories

Lightwave test accessories for HP 8151A and HP 81511A/81512A

One end of the 2m optical cable is terminated with the standard Diamond HFS1/KV connector. The other end can be selected from the following table.

Customer Connector	Adapter for Optical Head	Price
Diamond HFS1/KV	HP 81510A	\$300
NEC D4	HP 81510B	\$230
Bare Fiber, 50/125 μ m	HP 81510C	\$230
Bare Fiber, 200/250 μ m	HP 81510D	\$230
Amphenol 906 SMA	HP 81510E	\$230
FC	HP 81510G	\$230
Biconic	HP 81510H	\$230
F&G 3702	HP 81510J	\$230
Stratos 430	HP 81510K	\$230
AMP-SMA	HP 81510N	\$230
Optical Base Plate	HP 81510Q	\$150
Parallel Beam Adapter	HP 81510R	\$510
Blank Adapter	HP 81510Z	\$130

LIGHTWAVE TEST EQUIPMENT

Optical Average Power Meter

Model 8152A/81520A/81521B/81522A

- Two optical inputs
- Optical heads individually calibrated from 450 to 1700nm
- Multi- and single-mode
- 1% typical linearity

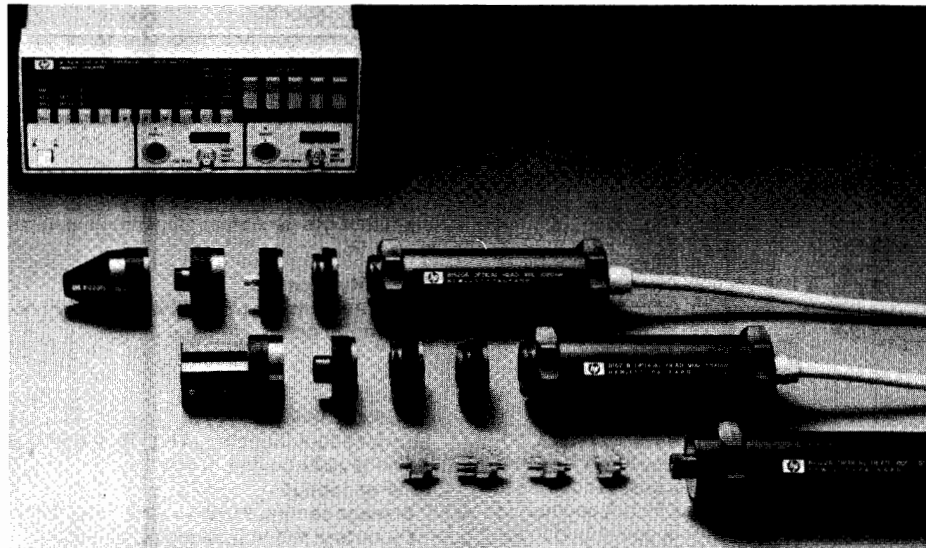

HP 8152A

The HP 8152A Optical Average Power Meter and its optical heads provide the accuracy and versatility for absolute and relative power measurements in a lightwave test environment. Applications range from output power measurement of active optical components, or loss/attenuation measurement of passive optical components, to ratio measurement of power levels at same or different wavelengths.

Individually calibrated optical heads ensure highly precise measurement results over the entire wavelength range from 450 to 1700nm. After entering the operating wavelength, the appropriate sensitivity correction factor will automatically be taken into account to ensure the correct measurement value is displayed.

The combination of 2 independent optical inputs, the capability to perform ratio measurements, plus an HP 81000AS/BS Optical Power Splitter provides a fast, easy solution to determine the insertion loss and attenuation of optical components while eliminating the effect of optical source instabilities.

All functions can be set manually via front panel controls, or programmed via HP-IB for complete remote control. The HP 8152A is therefore an ideal tool for departments such as R&D, production and incoming evaluation.

Due to its excellent traceability accuracy offered over the entire wavelength range, the HP 8152A can also be used as a secondary standard in your metrology lab.

HP 8152A/81520A/81521B/81522A Specifications

	81520A	81521B	81522A
Wavelength Range	450-1020nm	900-1700nm	1000-1650nm
Measurement Range	+10 to -100dBm	+3 to -80dBm	+3dBm to -100dBm
Resolution	0.01dB, 0.1pW	0.01dB, 10pW	0.01dB, 0.1pW
Absolute Accuracy	±4%	±3.5%	±5%
Linearity (typ.)	±0.05dB (1%)	±0.05dB (1%)	±0.05dB (1%)
Sensor Element	cooled Si PIN diode	cooled Ge PIN diode	cooled InGaAs PIN diode
Sensor Diameter	5mm	5mm	500µm
Bandwidth (typ.)	700Hz	700Hz	700Hz

General

HP-IB capability

Interface function: SH1,AH1,T6,L4,SR1,RL1,PP0,DC1,DT1,C0

Recalibration period: 1 year

Warm-up time: 15 minutes

Environmental

Storage temperature: -40°C to +75°C

Operating temperature: 0°C to +55°C

Humidity: <95% R.H. from 0°C to +40°C

Power: 100/120/220/240Vrms, +5%, -10%, 90VA max., 48-400Hz

Weight: HP 8152A: net 4.3kg (9.5lbs), shipping 8.6kg (19lbs)

HP 81520A/21B/22A: net 0.45kg (1lbs), shipping 1kg (2.2lbs)

Size: HP 8152A: 89mm(H) x 212.3mm(W) x 345mm(D)
(3.5" x 8.36" x 13.6")

HP 81520A/21B/22A: 37.7 diameter, 140mm length
(1.5" x 5.5")

Ordering Information

	Price
HP 8152A Optical Average Power Meter	\$3450
Opt. 907: Front handle kit	\$50
Opt. 908: Rack flange kit	\$51
Opt. 916: Additional operating manual	\$40
Opt. H02 Head Rack Mount Kit	\$440
Opt. W30 Extended Repair Service. See page 725.	\$85
HP 81520A Optical Head 450 to 1020nm	\$1550
HP 81521B Optical Head 900 to 1700nm	\$2300
HP 81522A Optical Head 1000 to 1650nm ¹	\$3800

Note: The HP 8152A cannot be used without an optical head, appropriate connector adapter and optical lens. For additional information, see "Lightwave Test Accessories" on page 309.

¹) The exchangeable connector interfaces for Diamond® HMS-10/HP, FC/PC, DIN 47256 and ST connectors are available as additional accessories, see page 309.

☎ Fast-Ship product—see page 734.

LIGHTWAVE TEST EQUIPMENT

LED Source / Laser Diode Source

Models 8154B, 8155A

307

- Stability $\pm 0.003\text{dB}/12\text{h}$
- External modulation up to 1MHz
- Customer-exchangeable connector adapters

- Stability $\pm 0.005\text{dB}/12\text{h}$
- External modulation up to 850MHz
- Customer-exchangeable connector adapters

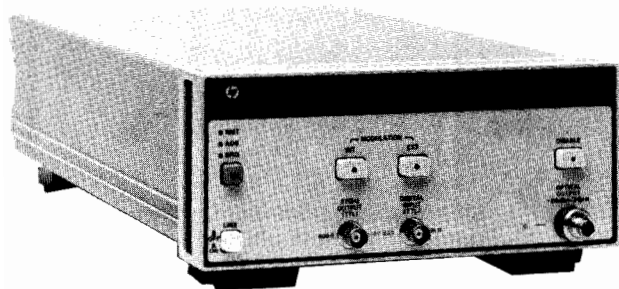

HP 8154B, option 002, option 011



HP 8155A, option 002, options 011 to 014



The HP 8154B is a high performance LED source, optional for 850nm, 1300nm and 1550nm. Whether the insertion loss of connectors, attenuation of cables or the splice loss of optical links needs to be evaluated, the HP 8154B provides the required power level stability of typically 0.003dB at constant ambient temperature over 12h.

The HP 8155A is a narrow linewidth laser diode source, optional for 1300nm and 1550nm with excellent short- and long-term stability. It outputs CW or 270Hz chopped light. External modulation up to 850MHz is also possible, and allows digital signal performance tests on fast telecommunication links.

Both, the HP 8154B and the HP 8155A, offer customer-exchangeable connector interfaces, which also allow easy access for cleaning.

HP 8154B, 8155A Specifications

Optical Characteristics

	LED 8154B			LD 8155A	
	option 001	option 002	option 003	option 002	option 003
Wavelength	850 \pm 30nm	1300 \pm 40nm	1550 \pm 40nm	1310 \pm 30nm	1550 \pm 40nm
Spectral Bandwidth	30–90nm	40–90nm	70–150nm	<2.5nm (RMS)	<4nm (RMS)
Optical Power	$\geq -17\text{dBm}$	$\geq -20\text{dBm}$	$\geq -23\text{dBm}$	$\geq -4\text{dBm}$	$\geq -4\text{dBm}$
Stability/15min./const. temp	—	—	—	$\pm 0.003\text{dB}$	$\pm 0.003\text{dB}$
Stability/12h/const. temp.(typ.)	$\pm 0.005\text{dB}$	$\pm 0.003\text{dB}$	$\pm 0.003\text{dB}$	$\pm 0.005\text{dB}$	$\pm 0.005\text{dB}$
Stability/12h/ $\pm 2\text{C}$	$\pm 0.03\text{dB}$	$\pm 0.02\text{dB}$	$\pm 0.02\text{dB}$	$\pm 0.03\text{dB}$	$\pm 0.03\text{dB}$
Fiber Type	50/125 μm	50/125 μm	50/125 μm	9/125 μm	9/125 μm

Connector: Diamond HMS-10/HP, FC/PC, DIN 47256, ST, Biconic

Supplementary Performance Characteristics

Digital Input

Input levels: TTL (8154B), $\pm 0.2\text{V}$ (8155A)

Max. input voltage: $\pm 10\text{V}$ (8154B), $\pm 2.5\text{V}$ (8155A)

Input impedance: 10 kOhm (8154B), 50 Ohm (8155A)

Input frequency: 0 to 1MHz (HP 8154B), DC, 1kHz to 850 MHz (HP 8155A)

Operating Modes

Output disable: LED, LD switched off

External modulation enable: Activates the digital input

Internal modulation enable: Activates internal 270Hz generator

General

Recalibration period: 1 year

Warm-up time: 45 minutes

Environmental

Storage Temperature: -40°C to $+75^{\circ}\text{C}$

Operating Temperature: 0°C to $+55^{\circ}\text{C}$

Humidity: <95% R.H. from 0°C to $+40^{\circ}\text{C}$

Power: 100/120/220/240Vrms, $\pm 10\%$, 48–400Hz, 35VA max. (8154B), 45VA max. (8155A)

After being switched off the instruments will come up with the output and digital input disabled.

Dimensions: 89mm(H) x 212.3mm(W) x 345mm(D) (3.5" x 8.36" x 13.6")

Weight: net 3.75kg (8.3lbs), shipping 7.8kg (17.2lbs) (HP 8154B)
net 4.5kg (9.9lbs), shipping 8.55kg (18.85lbs) (HP 8155A)

Ordering Information

	Price
HP 8154B LED Source	\$1700
Opt. 001: 850nm	\$1170
Opt. 002: 1300nm	\$3055
Opt. 003: 1550nm	\$4175
Opt. W30: Extended Repair Service, See page 725.	\$50
HP 8155A LD Source	\$2500
Opt. 002: 1300nm	\$8900
Opt. 003: 1550nm	\$10600
Opt. 011¹: Diamond HMS-10/HP connector interface	\$305
Opt. 012¹: FC/PC connector interface	\$305
Opt. 013¹: DIN 47256 connector interface	\$305
Opt. 014¹: ST connector interface	\$305
Opt. 015: Biconic connector interface	\$305
Opt. 907: Front handle kit	\$50
Opt. 908: Rack flange kit	\$51
Opt. 916: Additional operating manual	\$40
Opt. W30: Extended Repair Service. See page 725.	\$365
P/N 5061-9701 Bail handle kit	\$58

¹for both the HP 8154B and the HP 8155A, customer-exchangeable

For adapters, cables and other accessories see "Lightwave Test Accessories" on page 309

Fast-Ship product—see page 734.

LIGHTWAVE TEST EQUIPMENT

Optical Attenuator

Models 8157A, 8158B

- High resolution of 0.01dB
- Short settling time (typ. 80ms)
- Suited for multimode and single-mode fibers (8158B)



HP 8158B option 002 option 011

The HP 8158B Optical Attenuator is a fully programmable and highly flexible test instrument. Due to its state-of-the-art fiberless design, all applications employing fibers with a numerical aperture up to 0.3 are covered with one instrument. Multimode and single-mode (Options 002, 001 and 013 only) measurements can thus be easily performed.

HP 8158B Specifications

All specs. are measured with Diamond HMS-10/HP connectors

Optical Characteristics

Wavelength Range: 600-1200nm (opt. 001),
1200-1650nm (opt. 002)

Applicable Fiber Type: all fiber types with an $NA \leq 0.3$

Attenuation Range (excluding insertion loss): 60.00dB

Insertion loss (incl. both connectors)

	single-mode $9\mu\text{m}^2$	multimode $50\mu\text{m}$
worst case	<4.0dB	<2.0dB
typical	2.0dB	1.0dB

¹option 002 only

Linearity: $\pm 0.4\text{dB}$ for single-mode, $\pm 0.2\text{dB}$ for multimode

Return loss (incl. connectors): 14dB (fresnel)

General

HP-IB Capability

All modes and parameters can be programmed

Listen (time to receive, verify and set up parameter)

Output disable/enable, attenuation, λ : <20 to 550ms (HP 8157A),
<20 to 400ms (HP 8158B)

(depending on actual setting/programmed parameter)

Cal: <5ms

HP-IB Interface Function Code: SH1, AH1, T6, L4, SR1, RL1,
PP0, DC1, DT0, C0

Recalibration period: 1 year

No warm-up time required if previously stored within operating temperature range.

Environmental

Storage Temperature: -40°C to $+75^\circ\text{C}$

Operating Temperature: 0°C to $+55^\circ\text{C}$

Humidity: <95% R.H. from 0°C to $+40^\circ\text{C}$

Power: 100/120/220/240Vrms, $\pm 10\%$, 48-400Hz,
90VA max.

Battery back up (for non-volatile memory): with instrument switched off all current modes and data will be maintained for at least 10 years after instrument delivery

Dimensions: 89mm(H) x 212.3mm(W) x 345mm(D) (3.5" x
8.36" x 13.6")

Weight: net 5.3kg (11.7lbs), shipping 9.6kg (21.2lbs)

- Customer-exchangeable connector interfaces (8157A)
- >36dB typical return loss (8157A)



HP 8157A shown with user exchangeable connector interfaces (in the foreground)

HP 8157 Optical Attenuator

The 8157A is a high performance single-mode attenuator for the 1200-1650nm wavelength range. Its excellent linearity, very high return loss and polarization insensitivity make it the ideal attenuator for bit error rate tests on optical systems, for high data rates.

HP 8157A Specifications

Optical Characteristics

All specifications are measured with Diamond HMS-10/HP connectors. The connectors must have Manufacturing Date Code Week 31-87 or higher.

Wavelength Range: 1200-1650nm

Applicable Fiber Type: single-mode fiber

Attenuation Range (excluding insertion loss): 60.00dB

Insertion loss (incl. two Diamond HMS-10/HP connectors):
 $\leq 4.0\text{dB}$

Linearity: $\pm 0.2\text{dB}$ (typical $\pm 0.05\text{dB}$)

Return loss >33 dB (HMS-10/HP)

Typical Return Loss:

HMS-10/HP	PC	DIN 47256	ST	BICONIC	FC**
>36 dB	>30 dB	>33 dB	>30 dB	>30 dB	<14 dB

HP 8157A/HP 8158B Specifications

Display

Display range: 0.00 to 64.00dB

Display resolution: 0.01dB (min. step size)

Repeatability (of attenuation after a max. of 6 matings with same connector):

single-mode ($9\mu\text{m}$): <0.2dB

multimode ($50\mu\text{m}$): <0.1dB (HP 8158B only)

Ordering Information

	Price
HP 8158B Optical Attenuator	\$2350
Opt. 001: 600-1200nm (multimode only)	\$4700
Opt. 002: 1200-1650nm	\$4700
Opt. 011: Diamond HMS-10/HP connector*	\$710
Opt. 012: FC/PC connector* (multimode only)	\$1020
Opt. 013: DIN 47256 connector*	\$1020
Opt. 014: ST connector* (multimode only)	\$1020
HP 8157A Optical Attenuator 1200-1650nm	\$8600
Opt. 011: Diamond HMS-10/HP connector interfaces	\$610
Opt. 012: FC/PC connector interfaces	\$610
Opt. 013: DIN 47256 connector interfaces	\$610
Opt. 014: ST connector interfaces	\$610
Opt. 015: Biconic interfaces	\$610
Opt. 907: Front handle kit	\$51
Opt. 908: Rack flange kit	\$51
Opt. 916: Additional operating manual	\$31
P/N 5061-9701 Bail handle kit	\$38

*not exchangeable

For interface adapters, cables and accessories see "Lightwave Test Accessories" on page 309.

Fast-Ship product—see page 734.

Lightwave test accessories for HP 8145A, HP 81520A, HP 81521B, HP 8154B, HP 8155A, HP 8157A, HP 8158B

One end of the 2m optical cable is terminated with the standard Diamond HMS-10/HP connector. The other end can be selected from the following table.

Customer Connector	Cable 10/125um		Cable 50/125um		Cable 62.5/125um		Cable 100/140um	
	2.5mm Ferrule	Price	2.5mm Ferrule	Price	2.5mm Ferrule	Price	2.5mm Ferrule	Price
Diamond* HMS-10/HP	HP 81101AC	\$630	HP 81501AC	\$580	HP 81621AC	\$580	HP 81991AC	\$580
Bare Fiber	HP 81101BC	\$380	HP 81501BC	\$345	HP 81621BC	\$345	HP 81991BC	\$345
FC	HP 81101FC	\$630	HP 81501FC	\$580	—	—	—	—
Radial VFO-DF slant	HP 81101EDC	\$630	—	—	—	—	—	—
straight	HP 81101DEC	\$630	—	—	—	—	—	—
NEC D4	HP 81101GC	\$630	HP 81501GC	\$580	—	—	—	—
Amphenol 906 SMA	—	—	HP 81501HC	\$580	HP 81621HC	\$580	HP 81991HC	\$580
AMP-SMA	—	—	HP 81501JC	\$580	—	—	HP 81991JC	\$580
F&G 3702	—	—	HP 81501LC	\$580	—	—	—	—
Stratos 430	—	—	HP 81501NC	\$580	—	—	—	—
PC	HP 81101PC	\$870	—	—	—	—	—	—
DIN 47256	HP 81101SC	\$630	HP 81501SC	\$580	—	—	—	—
ST	HP 81101VC	\$630	HP 81501VC	\$580	HP 81621VC	\$580	—	—
Biconic	HP 81101WC	\$730	HP 81501WC	\$580	—	—	—	—
Diamond* HFS-1	—	—	HP 81501YC	\$630	—	—	—	—

Lenses

If accurate power measurements from a fiber are required, one of the following lenses must be used in front of the optical head.

- HP 81050AL:** Lens for 450-1020nm and NA=0.2 fibers¹ \$160
- HP 81050BL:** Lens for 900-1700nm and NA=0.2 fibers¹ \$160
- HP 81010BL:** Lens for 900-1700nm and NA=0.1 fibers \$160

¹Can be used for NA<0.3 fibers

HP 81220FL Attenuating Lens Adapter \$510

This Adapter, screwed onto an HP 81521B Optical Head, allows to measure the power emerging from an LED or LD chip. The beam's NA may be up to 0.5, the wavelength range is 1200nm to 1650nm.

HP 81001FF Fixed Filter \$160

This 10dB fixed filter is used to attenuate signals from sources which are too high powered for the HP optical heads. The 81520A can measure linearly up to +10dBm, and the 81521B up to +3dBm. The wavelength range for the 81001FF is from 450nm to 1700nm.

Optical Power Splitter

The optical power splitter is mode- and polarization insensitive. The split ratio is appr. 1:10. It has to be used with an optical head such as the HP 81521B. One connector option must be ordered. The HP 81000AS/BS Optical Power Splitters are for multimode and single-mode fibers with NA<0.3. (Opt 012, 014 only for multimode)

- HP 81000AS:** Optical Power Splitter for 600-1200nm \$1450
- HP 81000BS:** Optical Power Splitter for 1200-1600nm \$1450
- Opt. 011:** HMS-10/HP Connector Interfaces \$460
- Opt. 012:** FC/PC Connector Interfaces multimode only \$460
- Opt. 013:** DIN 47256 Connector Interfaces \$460
- Opt. 014:** ST Connector Interfaces multimode only \$460

For single-mode fibers with NA<0.1, a dedicated Power Splitter, the HP 81010BS, is available. The connector interfaces are customer exchangeable. The typical return loss depends on the connectors used.

- HP 81010BS:** Optical Power Splitter for 1200-1600nm \$2400
- Opt. 011:** HMS-10/HP Connector Interfaces typ.36dB \$610
- Opt. 012:** FC/PC Connector Interfaces typ.14/30dB \$610
- Opt. 013:** DIN 47256 Connector Interfaces typ.33dB \$610
- Opt. 014:** ST Connector Interfaces typ.20dB \$610
- Opt. 015:** Biconic Connector Interface \$000

HP 81000AF Filterholder \$80

This filterholder picks up all presently available standard filters with a diameter up to 1".

HP 81000AM Through Adapter Diamond \$360

To connect two HMS-10 connectors.

HP 15475A Cleaning Kit \$102

The kit consists of cleaning brush, tissue and tape etc. to clean the optical surfaces of fibers and lenses. It is supplied in a plastic carrying case.

Fiber Optics Handbook Pub.No. 5952-9654 \$20

An introduction and reference guide to fiber optic technology and measurement techniques.

☎ Fast-Ship Product—see page 734

Connector adapters for HP 81520A, HP 81521B

To interface the optical head to the optical fiber use one of the following connector adapters.

Customer Connector	Adapter for Optical Head	Price
Diamond HMS-10	HP 81000AA	\$150
Bare Fiber, 50/125um	HP 81000BA	\$480
Bare Fiber, 100/140um	HP 81000CA	\$480
Radial VFO-DF	HP 81000DA	\$130
FC	HP 81000FA	\$130
NEC D4	HP 81000GA	\$150
Amphenol 906 SMA	HP 81000JA	\$130
AMP-SMA	HP 81000KA	\$130
F&G 3702	HP 81000LA	\$130
Stratos 430	HP 81000NA	\$130
PC	HP 81000FA	\$130
DIN 47256	HP 81000SA	\$130
ST	HP 81000VA	\$130
Biconic	HP 81000WA	\$130
Diamond* HFS-1	HP 81000YA	\$150
Blank Adapter	HP 81000ZA	\$50

HP 81000RA Non-Reflective Adapter \$510

Low insertion loss (typ. 0.06dB) and high return loss. Together with the HP 81000RA Non-reflective Adapter one of the customer-exchangeable connector interfaces must be used. The connector interfaces listed below can be ordered also separately.

Customer-Exchangeable Connector Interfaces

Available Connector Interfaces	Typ. Return Loss	Price
HP 81000 AI Diamond* HMS-10/HP	38 dB	\$305
HP 81000 FI PC	33 dB	\$305
HP 81000 SI DIN 47256	36 dB	\$305
HP 81000 VI ST	33 dB	\$305
HP 81000 WI Biconic	30 dB	\$305

Optical Power Splitter HP 81010BS

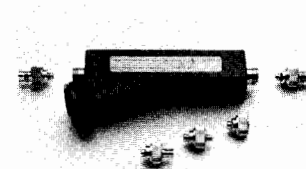

Non-Reflective Adapter HP 81000RA

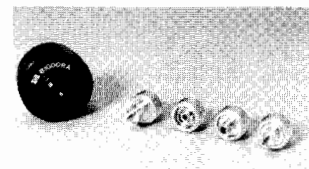

OPTICAL HEAD
FILTER
LENS
CONNECTOR ADAPTER

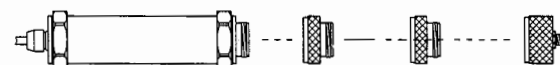

LIGHTWAVE TEST EQUIPMENT

Optical Time Domain Reflectometer

Model 8145A option 002 (1300nm), option 003 (1550nm), option 023 (1300nm/1550nm)

- Dynamic range of 28dB (1300nm)/26dB (1550nm) with single-mode fiber
- Customer-installable laser modules (1300nm or 1550nm)
- Easy-to-learn softkey-guided menu concept
- Non-volatile memory for more than 100 waveforms
- Rugged and light-weight

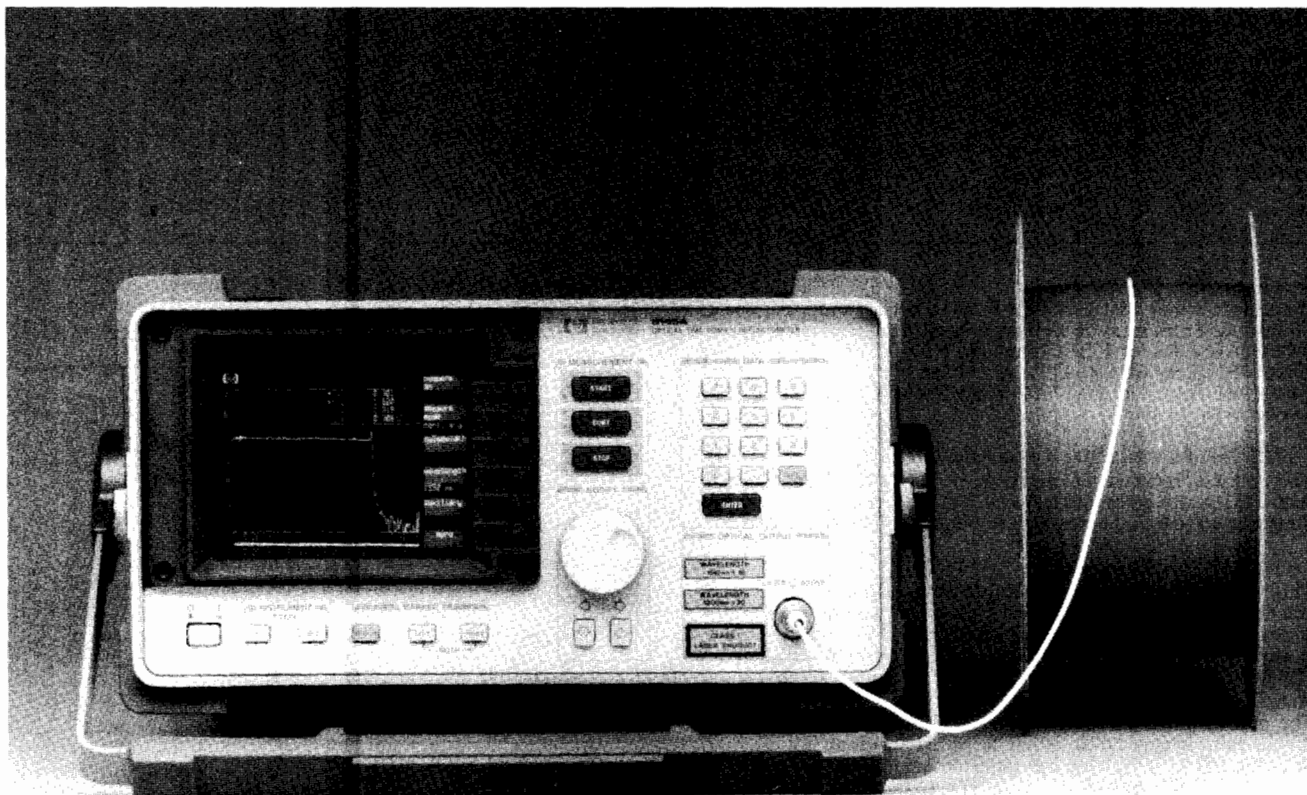

HP 8145A



The HP model 8145A is a high performance optical time domain reflectometer for field maintenance and bench applications. A unique data correlation technique increases the dynamic range to more than 28dB at 1300nm (26dB at 1550nm, regardless, whether the 1300nm module is installed) single-mode and drastically reduces the measurement time.

For field maintenance the HP 8145A features light weight and rugged design. It may be operated on batteries (12 to 30V DC), due to its low power consumption, or mains (90 to 260V AC). Display resolution is 0.01dB and 1m over the entire range of 200km.

Unhandy dataloggers and external disk drives which are sensitive to temperature changes, humidity and dust are not needed any more, as a plug-in non-volatile memory module (HP 81450A) stores more than 100 traces, each with all related measurement information. If immediate documentation is required, any data set can be directly printed or plotted out using a Thinkjet, Quietjet or any HP-IB plotter without a controller.

For bench applications including performance tests on optical fibers and cables in design and production the HP 8145A OTDR offers an excellent set of features.

Any previously taken trace may be recalled as reference and compared against the presently sampled one. This ensures fast and easy detection of inhomogeneities and attenuation changes.

The HP 8145A has an easy-to-learn softkey guided operating concept. The user can blank unwanted keys for even easier operation. The OTDR is also fully HP-IB programmable.

By means of two optional laser modules the HP 8145A operates at either of the wavelengths 1300nm, 1550nm or both. The laser modules are user-installable.

Five exchangeable connector options (Diamond HMS-10, FC/PC, DIN47256, ST and Biconic) are available, which allow easy access to the optical output for cleaning.

HP 8145A Specifications

Optical Characteristics

	option 002	option 003	option 023
Wavelength	1300±30nm	1540±30nm	both wavelength
Dynamic range one way backscatter (SNR=1)	28dB	26dB	28/26dB
Fresnel reflection (4%)	42dB	40dB	42/40dB

Both wavelength options are user-installable. If both are installed in the HP 8145A, they are switch-selectable. Dynamic range figures are independent of number of options installed.

Measurement time: 22dB dynamic range after 10 seconds (16dB after 1 second) at 1300nm on fiber without end reflection (worst case condition for break detection)

Pulsewidth: 125/250/500ns/1/2/4/8μs

Output connector: optional Diamond HMS-10, FC/PC, DIN 47256, ST, Biconic. All options are user-exchangeable.

Horizontal Parameters

Start-km: 0.000 - 199.500km (see "Resolution")

Span: 0.500km - 200.000km (see "Resolution")

Center-km: 0.250km - 199.750km (see "Resolution")

Resolution: 1m in all three cases for parameter setting and distance read-out

Accuracy: ±8m, uncertainty of fiber refractive index not included, for 125 ns pulsewidth

Refractive index: 1.4000 - 1.5999, in steps of 0.0001 settable

Length correction: 1.000 - 4.000, in steps of 0.001 settable. Serves to enter actual ratio of fiber/cable length into the OTDR

Length unit: switch-selectable between km, miles and feet

Vertical Parameters

Vertical scale: 0.20 - 5.00dB/div

Resolution: 0.01dB for parameter setting, 0.001dB for attenuation/loss read-out

Linearity: 0.05dB/dB

Zoom: All combinations of horizontal and vertical parameters can be entered while the instrument is running. Serves to zoom in on any point of the waveform and allowing close examinations without interrupting the averaging process.

Documentation

Waveform memory: 12 waveforms and related instrument settings can be stored in the HP 8145A in non-volatile memory and recalled. More than 100 waveforms and related instrument settings can be stored in each HP 81450A Memory Module and recalled. The modules contain non-volatile memory and plug into the rearpanel of the HP 8145A.

ID Codes: An identification code of up to 38 alpha-numerical characters can be entered for each memory location. All ID codes are displayed when the directory is called up.

Compare mode: Presently displayed waveform can be compared against any previously stored one, if the horizontal parameters are identical. Zooming capability is provided.

Hardcopy: Any displayed or previously stored waveform can be directly dumped to a Thinkjet, Quietjet or any HPGL plotter.

Instrument settings: storage and recall of 9 user selectable instrument settings, recall of 1 standard setting.

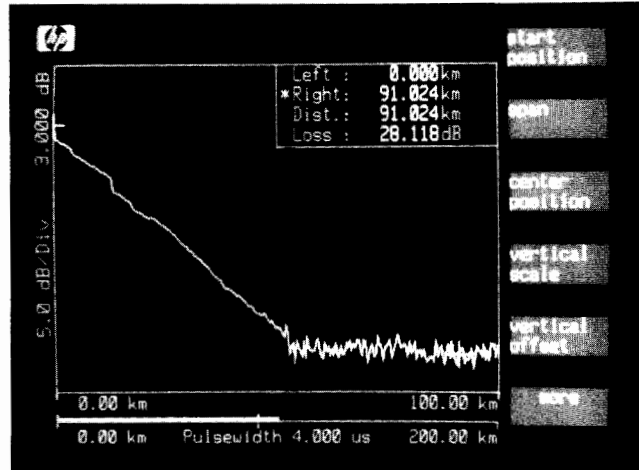

General

CRT: 15cm (6"), green

Laser safety class: Class 1

Recalibration period: 1 year

HP-IB Capability

All modes and parameters can be programmed
HP-IB Interface Function Codes: SH1, AH1, T5, L3, SR1, RL1, PP0, DC1, DT1, C0

Environmental

Storage temperature: -40°C to +75°C

Operating temperature: -20°C to +65°C (-10°C to +55°C to meet specs)

Humidity: 95% R.H. from 0°C to +40°C

Power

DC: 12 - 30V DC, 80Wmax

AC: 100/120/220/240Vrms ±10%, 90VAmx, 48-400Hz

Battery back up (for non-volatile memory): with instrument switched off all current modes and data will be maintained for at least 10 years at 25°C temp.

Dimensions: 190mm H, 340mm W, 465mm D (7.5" x 13.5" x 18.3")

Weight: net 16 kg (35.3 lbs), shipping 22 kg (48.5 lbs)

Ordering Information

8145A Optical Time Domain Reflectometer	\$12900
Opt. 002: 1300nm	\$10800
Opt. 003: 1550nm	\$14800
Opt. 023: 1300nm/1550nm	\$21800
Opt. 011: Diamond HMS-10/HP connector interface	\$305
Opt. 012: FC/PC connector interface	\$305
Opt. 013: DIN 47256 connector interface	\$305
Opt. 014: ST connector interface	\$305
Opt. 015: Biconic connector interface	\$305
Opt. 050: DC power cable	\$770
Opt. W30 3 years of return repair service	\$625
81450A: Memory module	\$1100

The connector-interfaces for Diamond HMS-10/HP FC/PC, DIN47256, ST and Biconic connectors are available as additional accessories.

For adapter cables and other accessories see "Lightwave Test Accessories" on page 309.

LIGHTWAVE TEST EQUIPMENT

Lightwave Component Analyzer

HP 8702B, 8703A

- 300 kHz to 20 GHz Modulation Frequency
- Calibrated measurements of high-speed optical, electro-optical, and electrical components.

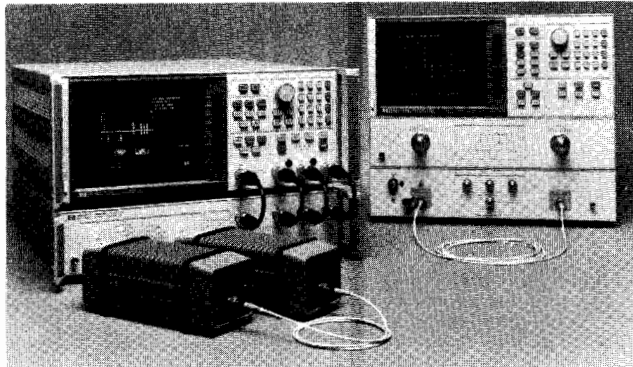

HP 8702B & 8703A

Lightwave Component Analyzer

As the transmission rate or bandwidth of fiber optic systems is pushed upward, high frequency design considerations become key. Both the HP 8702B and 8703A measure each of the elements that transmit these wide bandwidths. They make calibrated measurements of lasers or LED transmitters, photodiode receivers, optical fibers, and the electrical components they work with. The lightwave component analyzers operate with a swept modulation frequency to precisely characterize how these components operate on the high-speed, information-bearing signal. Information on how each component responds independent of the others provides insight into how systems can be predicted and improved.

Both the HP 8702B and 8703A operate at a fixed wavelength and sweep the frequency of the intensity modulation signal over the bandwidth you select. The HP 8702B has transducers (lightwave source and receivers), which allow it to operate at 850, 1300, and 1550 nm. The HP 8703A can operate at 1300 and 1550 nm. These sources and receivers come with calibration data to allow calibrated measurements of the electro-optical components.

Measure Optical Components

Measurements can be made of components such as connectors, splitters, couplers, and lenses, as well as fiber itself. This yields modulation bandwidth, insertion loss, length, and optical return loss. In the distance-time domain, reflections can be located without the dead zone typical of OTDR type measurements. Transmission measurements can be also be displayed in the distance-time domain to view the impulse or step response of the component. Delay and dispersion are easily viewed in this manner.

Measure Electro-Optical Components

Often the limiting elements in a fiber optic system are the electro-optical components (e.g., lasers, APD's, PIN photodiodes, and modulators), which convert the electrical information to optical or vice versa. The conversion efficiency or responsivity of these devices is a function of many variables. The characterized lightwave source and receiver in the lightwave component analyzer allows each of these devices to be uniquely tested. Data can be displayed in the frequency domain as the modulation frequency response or in the time domain as the step response.

Measure Electrical Components

When used to measure linear electrical components such as amplifiers, filters, and transmission lines, the lightwave component analyzers have the full measurement capability of a microwave network analyzer. Typical measurements are bandwidth, insertion loss/gain, phase, impedance, match, and group delay.

- 850, 1300, or 1550 nm Operation
- Reflection measurements with < 1mm resolution
- up to 50 dB dynamic range.

Measure Both Transmission and Reflection Characteristics

Complete characterization on component behavior depends on knowing how the signal is transmitted through it and how it is reflected back. For optical reflections, the lightwave component analyzers use a lightwave directional coupler to make the reflection measurements. Data can be presented in the modulation frequency domain or in the distance-time domain to locate and measure the source of the reflection. Because of the wide measurement bandwidth, reflections can be located with < 1mm of resolution and up to 50 dB dynamic range. For electrical reflection measurements, the analyzer uses a test set to perform the measurement. Results, such as impedance, can then be displayed.

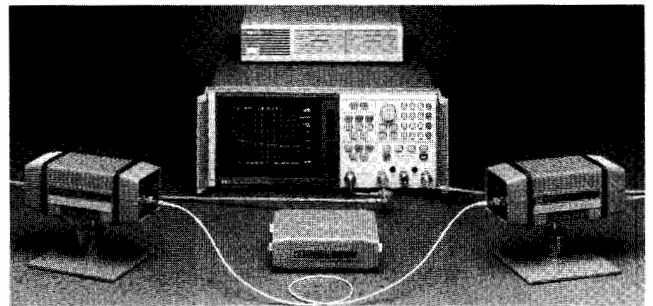

HP 8702B

HP 8702B Lightwave Component Analyzer

Standard configuration requires an HP 8702B, an RF interface kit, a lightwave source, lightwave receiver, and fiber cable. For reflection measurements, a lightwave coupler is required.

HP 8702B Accessories

Lightwave Source Modules

All with directly modulated Fabret-Perot lasers.

- HP 83400A, 300 kHz-3 GHz, 1300 nm, 9/125 um fiber
- HP 83401A, 300 kHz-3 GHz, 1300 nm, 50/125 um fiber
- HP 83402A, 300 kHz-6 GHz, 1300 nm, 9/125 um fiber
- HP 83403A, 300 kHz-3 GHz, 1550 nm, 9/125 um fiber
- HP 83404A, 300 kHz-3 GHz, 850 nm, 50/125 um fiber

Lightwave Receiver Modules

All with PIN photodiodes.

- HP 83410B, 300 kHz-3 GHz, 1300/ 1550 nm, 62.5/125 um fiber
- HP 83411A, 300 kHz-6 GHz, 1300/ 1550 nm, 9/125 um fiber
- HP 83411B, 300 kHz-6 GHz, 1300/ 1550 nm, 9/125 um fiber
- HP 83412A, 300 kHz-3 GHz, 850 nm, 62.5/125 um fiber

Lightwave Directional Couplers

A 3-port, directional coupler for making reflection measurements and monitoring transmission signals. The couplers have a nominal 3 dB coupling factor.

- HP 11890A 9/125 um fiber
- HP 11891A 50/125 um fiber

RF Interface Kit

HP 11889A

This kit contains the RF accessories required to operate the HP 8702 when a test set is not used. Contains a power splitter, a 20 dB pad, SMA accessories and adapters for the analyzer.

High Frequency Probe

HP 85024A

Performs in-circuit measurements. It's high impedance (.7 pF in shunt with 1 megaohm) permits high frequency probing without adversely loading the circuit under test. See Page 230 for more information.

S Parameter Test Set

- HP 85046A 300 kHz-3 GHz
- HP 85047A 300 kHz-6 GHz

These test sets provide the capability to measure impedance and transmission characteristics of two port electrical devices in either forward or reverse direction with a single connection. The HP 85047A is required for 6 GHz operation.

Calibration Kit

- HP 85033C 3.5 mm

Contains precision 3.5 mm standards used to calibrate the HP 8702 for electrical measurements of components with 3.5 mm or SMA connectors.

Fiber Optic Cable

- HP 11871A PC Fiber Cable, 9/125 um, 1 meter
- HP 11871B ST Fiber Cable, 9/125 um, 1 meter
- HP 11871C Biconic Fiber Cable, 9/125 um, 1 meter
- HP 11886A Interconnect Cable Kit, 9/125 um
- HP 11887A Interconnect Cable Kit, 50/125 um

Upgrade Kit

- HP 11876A

For upgrading an HP 8753A network analyzer to an HP 8702A lightwave component analyzer.

Ordering Information

HP 8702B Lightwave Component Analyzer	\$32,800
Opt 006 6 GHz receiver operation	+\$3,000
Opt 011 Delete time domain	-\$4,800
Opt 802 Add Disk Drive & Cable	+\$1,495
HP 83400A Lightwave Source	\$12,700
HP 83401A Lightwave Source	\$12,700
HP 83402A Lightwave Source	\$14,700
HP 83403A Lightwave Source	\$12,700
HP 83404A Lightwave Source	\$12,700
HP 83410B Lightwave Receiver	\$5,000
HP 83411A Lightwave Receiver	\$3,900
HP 83411B Lightwave Receiver	\$12,000
HP 83412A Lightwave Receiver	\$5,000
HP 11890A Lightwave Coupler	\$3,900
HP 11891A Lightwave Coupler	\$3,900
HP 11871A PC fiber cable	\$150
HP 11871B ST fiber cable	\$150
HP 11871C Biconic fiber cable	\$150
HP 11886A Interconnect cable kit	\$1,200
HP 11887A Interconnect cable kit	\$1,200
HP 11889A RF Interface Kit	\$1,500
HP 85024A High Frequency Probe	\$1,900
HP 85046A S parameter test set	\$8,000
HP 85047A S parameter test set	\$9,800
HP 11876A Upgrade Kit	\$3,500

HP 8703A lightwave component analyzer

- 130 MHz to 20 GHz Modulation Frequency
- 1300 and 1550 nm operation

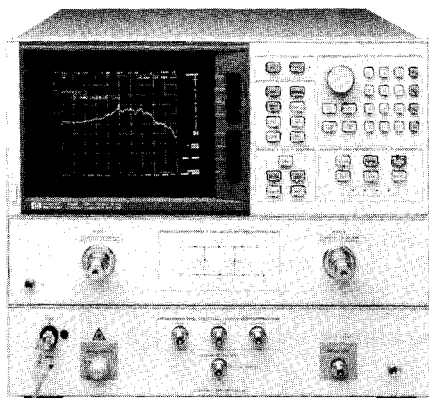

HP 8703A

HP 8703A Lightwave Component Analyzer

Standard configuration includes an internal 1300 nm Fabre-Perot (FP) laser and one 1300/ 1550 nm receiver. The external lightwave source input is used with the HP 83424A or 83425A Lightwave CW Sources for additional 1550 or 1300 nm DFB capability.

**HP 8703A Accessories
20 GHz lightwave test set**



HP 83420A, 83421A, 83422A, 83423A

HP 83420A Lightwave Test Set

Includes a 1300 nm FP laser, modulator, receiver, and directional coupler. Basic lightwave component analyzer tests from 130 MHz-20 GHz can be made when combined with an external controller and an HP 8510 microwave analyzer system.

20 GHz lightwave accessories

- HP 83421A Lightwave Source
- HP 83422A Lightwave Modulator
- HP 83423A Lightwave Receiver

For stand alone applications, these accessories all have modulation bandwidths of 130 MHz-20 GHz.

Ordering Information

	Price
HP 8703A Lightwave Component Analyzer	\$104,000
Opt 01X Select optical connector	\$0
Opt 100 External lightwave source input	+\$2,800
Opt 210 1550 nm DFB laser	+\$15,000
Opt 220 1300 nm DFB laser	+\$10,500
Opt 300 Additional lightwave receiver	+\$10,900
Opt 802 Add Disk Drive & Cable	+\$1,495
Opt 830 Add HP 3.5mm Cal Kit & Cable	+\$5,100
HP 83424A Lightwave CW Source- 1550 nm	\$27,500
Opt 100 External lightwave source input	+\$2,800
HP 83425A Lightwave CW Source	\$24,100
Opt 100 External lightwave source input	+\$2,800
HP 83420A Lightwave Test Set	\$47,500
Opt 01X Connector option	\$0
Opt 100 External lightwave source input	+\$2,800
Opt 210 1550 nm DFB laser	+\$15,000
Opt 220 1300 nm DFB laser	+\$10,500
HP 83421A Lightwave Source	\$29,500
Opt 01X Connector option	\$0
Opt 100 External lightwave source input	+\$2,800
Opt 210 1550 nm DFB laser	+\$15,000
Opt 220 1300 nm DFB laser	+\$10,500
HP 83422A Lightwave Modulator	\$20,000
Opt 01X Connector option	\$0
HP 83423A Lightwave Receiver	\$13,500
Opt 01X Connector option	\$0
Opt 300 Additional lightwave receiver	+\$10,900

LIGHTWAVE TEST EQUIPMENT

Lightwave Signal Analyzer 1200 nm to 1600 nm
Model 71400C and Accessory 11980A

- Calibrated measurement of intensity modulation
- 100 kHz to 22 GHz bandwidth
- Single-mode fiber-optic input
- Reference-receiver capability
- Customer-exchangeable connector adapters
- High-performance electrical spectrum analyzer

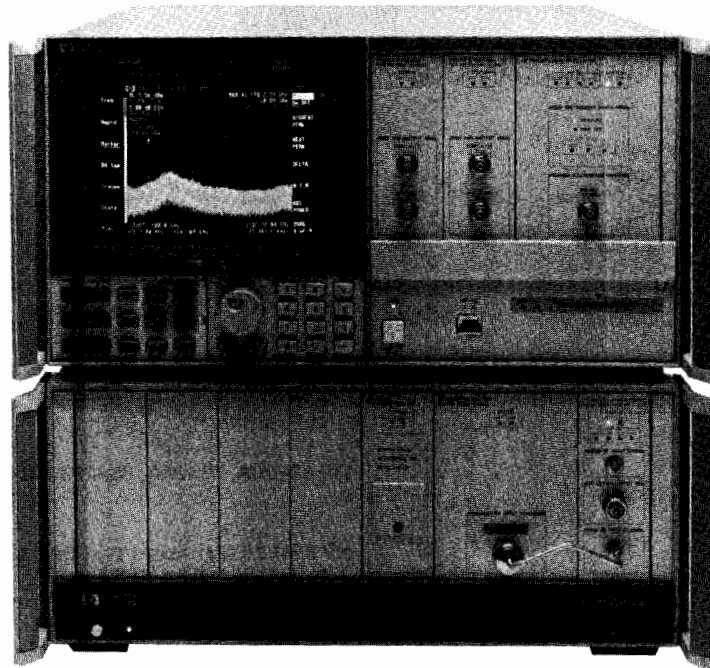

HP 71400C

Calibrated Measurement of Intensity Modulation to 22 GHz

The HP 71400C combines a high-performance microwave spectrum analyzer with a wideband, highly sensitive optical receiver. This system measures modulated light on single-mode optical fibers simply and accurately from 100 kHz to 22 GHz. Optical modulation, noise, and average power are presented on a fully calibrated display. The system characterizes semiconductor lasers, laser transmitters, optical modulators, and detectors. With the addition of the HP 11980A fiber-optic interferometer and a gateable source, the system will measure linewidth and FM characteristics of distributed-feedback (DFB) and other single-mode lasers.

In addition to being a lightwave signal analyzer, this system also functions as a microwave spectrum analyzer with all the capability of the HP 71210C. And because the lightwave signal analyzer is part of the HP 70000 modular measurement system, its measurement capabilities can be expanded easily. One possibility, for example, is the addition of a tracking generator module for modulation response measurements to 18 GHz. (See pages 115 to 121 for more information.)

The HP 71400C system measures intensity modulation up to 22 GHz and operates over the wavelengths from 1200 nm to 1600 nm. It can achieve an optical sensitivity of better than -60 dBm. The analyzer also offers average-power measurement, displayed as both a real-time vertical power bar and as a digital readout. Full calibration of both average power and modulation power makes this system a reference receiver for measuring and characterizing optical detectors and receivers.

Lightwave Measurement with the HP 70810 Module

The HP 70810A lightwave section is a 1/8-width lightwave-receiver module for the HP 70000 modular measurement system. The HP 70810A offers a wavelength range of 1200 nm to 1600 nm, a detected modulation bandwidth of 100 kHz to 22 GHz, and a built-in RF amplifier of 32 dB that provides an optical sensitivity of -60 dBm in a

10-Hz bandwidth. The module also features both optical- and electrical-input capability.

The HP 70810A may be used in stand-alone applications as a lightwave receiver housed in an HP 70000 mainframe. In this configuration, the electrical output is the detected intensity modulation in its amplified and uncorrected state.

If the lightwave module is ordered for an existing HP 70000 system that includes the HP 70908 or 70904 RF (input) section, option 20 offers extended system calibration and adjustment. In this case, the two modules are mated, tested, and calibrated together at the factory for optimum optical and electrical specification and amplitude flatness.

Fiber-optic Interferometer for Laser-chirp Measurements

The HP 11980A is a Mach Zehnder interferometer of fixed delay for measuring and characterizing single-linewidth lasers. Using a new technique developed by Hewlett-Packard, the HP 11980 accessory and the HP 71400C lightwave signal analyzer measure chirp and FM components on DFB lasers, as well as making traditional measurements of laser linewidth. Together the interferometer, lightwave signal analyzer, and gateable RF source permit the true power spectrum of single-frequency lasers (including intensity modulation linewidth and chirp components caused by the intensity modulation) to be displayed.

Input Connectors

An important feature of these lightwave systems and accessories is their versatile input-connector system. A variety of optical screw-on connector-interface adapters are available as well as various patch cords for other connector systems. See ordering information on page 315.



HP 11980A

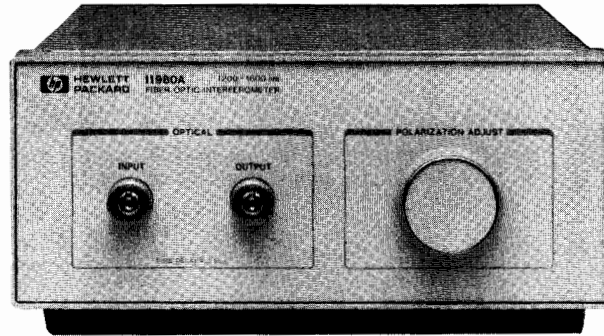

Specifications

HP 71400C

For general analyzer and electrical-mode specifications, refer to data sheets for the HP 71210C.

Optical

Wavelength Range: 1200 nm to 1600 nm

Input Return Loss (characteristic): >27 dB (optical) with input attenuation \geq 5 dB.

Frequency

Frequency Range: 100 kHz to 22 GHz

Span: 1 Hz to 22 GHz plus 0 Hz

Amplitude (at 25° C)

Maximum Input Average Power: +30 dBm (optical);

Modulated Power: +15 dBm (optical)

Average Power Accuracy (at 1300 or 1550 nm): \pm 0.65 dB (optical), \pm 0.5 nW, \pm connector losses

Modulated Power Accuracy (relative to average power) at 100 MHz: \pm 1.0 dB (optical)

Frequency Response (relative to 100 MHz): 100 kHz to 22 GHz, \pm 1.0 dB (optical)

Displayed Average Optical Noise Level, Optical dB (10 Hz Res BW, 0 dB Input Attenuation): -52 dBm, 100 kHz to 1 MHz; -58 dBm, 1 MHz to 10 MHz; -64 dBm, 10 MHz to 16 GHz; -58 dBm, 16 GHz to 22 GHz

Inputs

Optical: Choice of Diamond®, PC/FC, ST, Biconic or DIN single-mode fiber connectors (see Ordering Guide)

Electrical: SMA for optical bypass, 100 Hz to 22 GHz (see HP 71210C data sheet for other system inputs)

HP 70810A Module

Optical

Wavelength Range: 1200 nm to 1600 nm

Responsivity: determined for each instrument to +20%; typical average value at 100 MHz: 1200 V/W

Input Return Loss (characteristic): > 27 dB (optical) with input attenuation \geq 5 dB

Frequency

Frequency Range: 100 kHz to 22 GHz

Amplitude

Maximum Input Average Power: +30 dBm (optical)

Modulated Power: +15 dBm (optical)

Frequency Response, corrected, relative to 100 MHz: 100 kHz to 2.9 GHz, \pm 2.0 dB; 2.9 GHz to 22 GHz, \pm 5.0 dB

Uncorrected: typically < 25 dB roll-off 100 kHz to 22 GHz

Noise Equivalent Power (optical dB): -56 dBm/Hz, 100 KHz to 1 MHz; -62 dBm/Hz, 1 MHz to 10 MHz; -68 dBm/Hz, 10 MHz to 16 GHz; -62 dBm/Hz, 16 GHz to 22 GHz

Inputs

Optical: Choice of Diamond®, PC/FC, ST, Biconic or DIN single-mode fiber connectors (see Ordering Guide)

Electrical: SMA for optical bypass

HP 11980 Specification Summary

This accessory is a Mach Zehnder interferometer for use with the HP 71400C.

Wavelength Range: 1250 nm to 1600 nm

Optical Insertion Loss: 8 dB (optical) at 1300 and 1550 nm

Delay Time: typically 3.5 μ sec

Inputs

Optical: Choice of Diamond®, PC/FC, ST, Biconic or DIN single-mode fiber connectors (see Ordering Guide)

Ordering Information

	Price
HP 71400C Lightwave Signal Analyzer, 100 kHz to 22 GHz	\$98,325

The system includes the HP 71210C modular spectrum analyzer and HP 70810A module. Order must also include one of connector options 011 to 015 below.

Opt 206 Delete HP 70004A mainframe; add HP 70001A mainframe	-1,600
--	--------

Opt W30 Additional two years of HP service	+1,610
---	--------

Opt 908 Rack mount without handles	+36
---	-----

Opt 913 Rack mount with handles	+41
--	-----

HP 70810A Lightwave Section, 100 kHz to 22 GHz	\$18,350
---	----------

Order must also include one of the connector options 011 to 015 below.

Opt 020 System adjustment and calibration (use HP 71400A specifications)	+1,975
---	--------

Opt W30 Additional two years of HP service	+460
---	------

Opt 098 or 099 System LO firmware upgrade	\$0
--	-----

HP 11980 Fiber Optic Interferometer	\$6,320
--	---------

Order must also include one of the connector options 011 to 015 below.

Opt W30 Additional two years of HP service	+160
---	------

Connector Options for the HP 71400C, 70810A, and 11980A

Opt 011 Diamond HMS-10/HP connector interface	\$0
--	-----

Opt 012 FC/PC connector interface	\$0
--	-----

Opt 013 DIN 47256 connector interface	\$0
--	-----

Opt 014 ST connector interface	\$0
---------------------------------------	-----

Opt 015 Biconic connector interface	\$0
--	-----

Additional Interface Connectors

HP 81000 AI Diamond® HMS-10/HP	\$305
---------------------------------------	-------

HP 81000 FI FC/PC	\$305
--------------------------	-------

HP 81000 SI DIN 47256	\$305
------------------------------	-------

HP 81000 WI Biconic	\$305
----------------------------	-------

HP 81090 VI ST	\$305
-----------------------	-------

HP 15475A Cleaning Kit for Optical Surfaces	\$102
--	-------

DATA GENERATORS & DATA ANALYZERS

General Information

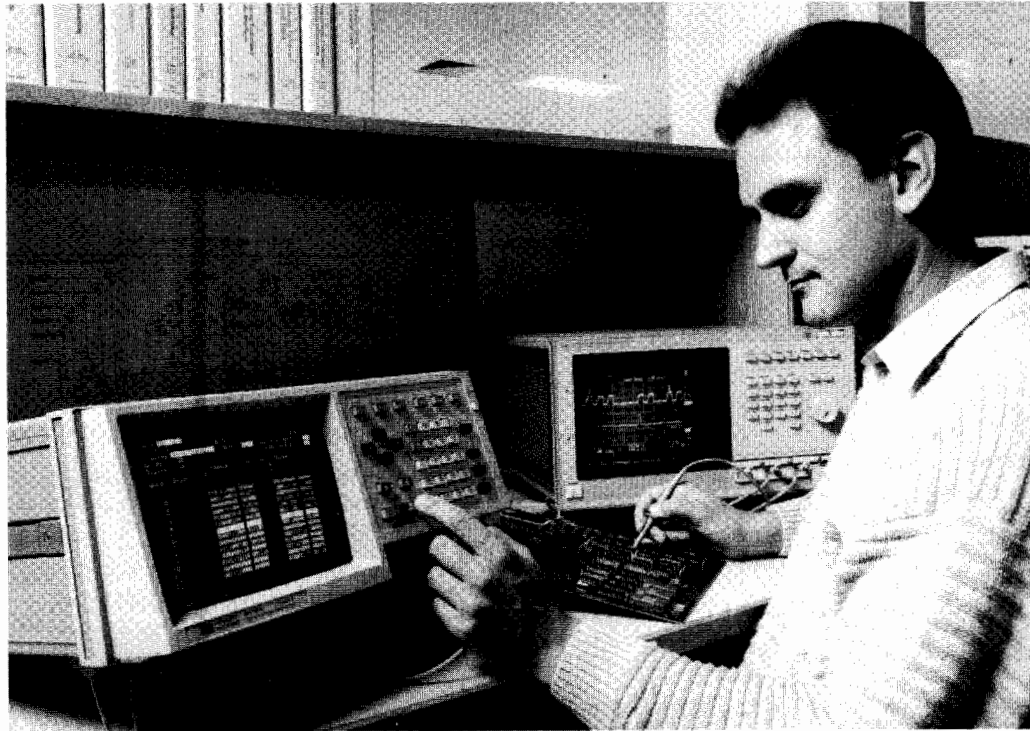

HP 8118A

Data Generator Selection Chart

Model	8180B* (8181B)	8175A	8118A	8080A DO1 DO2, DO3
page	320	318	317	446
Parameter				
Datarate (Mbit/s)	50	50 paral. 100 ser.	100	300
Number of channels	8 paral. (16 opt.) (128 ext.)	24 paral. 2 ser.	2 ser.	1 ser. (2 ser.)
Memory depth (Pattern)	16384	1024 par. 8096 ser.	16384 each ch.	64
var. del, width	0 ... 999ms 0 ... 999ms on 8 ch.	20 ... 40ns delay only on 4 ch.	75ns.950ms 10ns.950ms	special option
resolution	100ps	100ps	100ps	
RZ/NRZ	RZ/NRZ	NRZ	RZ/NRZ	RZ/NRZ
individual pattern duration	no	20ns.9.99s	no	no
resolution		10ns		
output levels	TTL,ECL,VAR -1V ... 17V(HIL) -2V ... 16V(LOL) (high imp.)	TTL,ECL, Tri state var high: 2.4 ... 9.9V (high imp.)	-15.8V ... 16.0V(HIL) -16.0V ... 15.8V(LOL) (high imp.)	DO1: 0.2V ... 2V DO2,DO3: 0.6V ... 1.2V Offs. DO1: ±1.0V DO2,DO3: ±1.2V
resolution	10mV	100mV	10mV	Poti
channel addition	no	no	yes	no
50Ω source impedance	yes	no	yes	yes
HP-IB	yes	yes	yes	no

*For information about pattern generator modules of the HP 82000 IC evaluation system, please refer to page 526

DATA GENERATORS & DATA ANALYZERS

100 Mbit/s Pulse Pattern Generator

Model 8118A

317

- 2 channels / 16 kbit ea / 100 Mbit/s ea
- Strobe channel (bit, word, or frame trigger)
- Variable word and frame length

- Variable width and delay
- Rise/fall time separately programmable
- Var. high and low level; channel addition

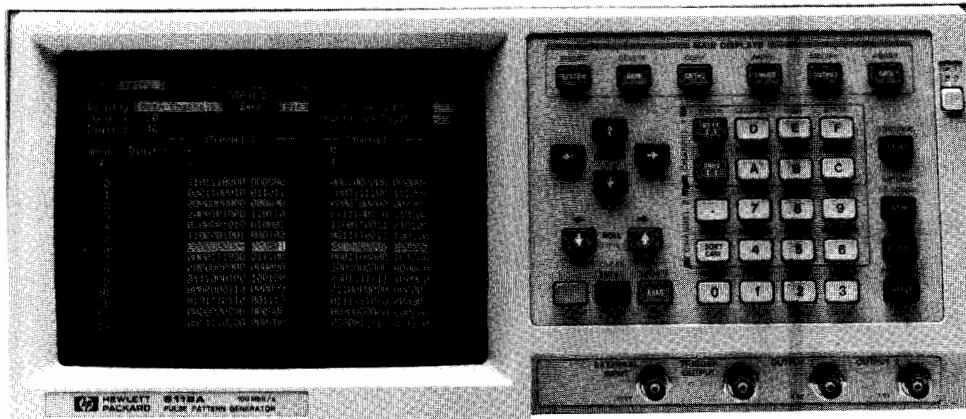

HP 8118A

HP 8118A Pulse Pattern Generator

The HP 8118A is a two channel serial data generator for pattern lengths up to 16 kbit for each channel with programmable word and frame length, and data rates up to 100 Mbit/s. Furthermore, it provides full control over levels, timing, and transition times.

The HP 8118A is an excellent combination of a fully programmable serial data generator and a pulse generator in one product. It offers functional test capabilities for testing ICs, modules, and boards. With the built-in parametric capabilities, it is possible to combine the digital information with the signal degradation that occurs in practice, and so, testing the DUT with the real-life signal is feasible; thus, the worst case conditions can be evaluated.

For data entry, the HP 8118A offers a convenient and comprehensive set of editing capabilities; thus, the required serial data can be achieved to match the test signal demands of a wide variety of applications. The digital patterns can be combined with PRBS (pseudorandom-binary-sequence), either to just create scrambled data or to generate a true PRBS. Setting the instrument in "Word Mode", it is possible to create word and frame oriented data pattern. Wordlengths from 3 bit up to 256 bit and the number of words up to 3640 are allowed. Protocols with preamble-data-postamble structure and a certain word and frame length, as it is used for data transmission in serial data networks, can be rapidly created.

Specifications

Specifications describe the instrument's warranted performance (30 minutes warm-up, 50-ohm load) at 0°C to 55°C [20°C to 30°C] ambient temperature.

Timing Parameters

(measured at 50% of amplitude with fastest edges).

Common Specifications:

- Resolution** 3 digits (best case, 100 ps)
- Repeatability** factor 4 better than accuracy
- RMS-jitter*** 0.05% of programmed value + 30 ps
- Period (PER)** 20(10)**ns to 950 ms
- Accuracy** ±5% of progr. value ±2 ns [±2% ±1 ns]
- Delay** 75 ns to 950 ms (max: PER +55 ns)
- Accuracy** ±5% of progr. value ±4 ns [±2% ±4 ns]
- Double Pulse** 20 ns to 950 ms (max: PER - WID)
- Accuracy** ±5% of progr. value ±2 ns [±2% ±2 ns]
DEL and DOUB are mutually exclusive
- Width (WID)** 10 ns to 950 ms (max: PER - 10 ns)
- Accuracy** ±5% of progr. value ±2 ns [±2% ±2 ns]
- Linear Transitions** (between 10% and 90% of amplitude)
- Range** 6.5 ns to 95 ms
- Accuracy** ±5% of progr. value ±2 ns [±5% ±2 ns]

Output (voltages double when driving into open)

High Level -7.90 V to +8.00 V

*see page 433

**10 ns with NRZ data format

Low Level -8.00 V to +7.90 V

Resolution 3 digits, (10 mV)

Level-Accuracy ±1% of progr. value ±3% of ampl. ±40 mV
[±1% ±1% ±20 mV]

Repeatability factor 4 better than accuracy

Pattern

Data Capacity 16384 bits per channel. (In bit mode: max No of bits)

Data Formats RZ with programmable Delay and Width up to 50 Mbit/s DNRZ with programmable Delay up to 50 Mbit/s NRZ up to 100 Mbit/s

Word length 3 to 256 bits, common for both channels (word mode only)

No of words Number of words * Word length < 16384 bits, common for both channels (word mode only)

Random Pattern up to 16384 bits long, PRBS sequence if blocklength is 2(exp n)-1.

Supplemental Specifications

Trigger Mode Manual, Auto, Trigger, Gate

Addition Adds up channel 2 to channel 1.

Operating Modes Bit Mode, Word Mode, Break, Start/Stop, Continue, Autocycle, Single Cycle

Strobe Output Fixed TTL levels; Delay, Width independently programmable; bit, word, or frame trigger

Control Modes High level, Period, Delay, Width

General

Storage Temperature -40°C to +65°C

Operating Temperature 0°C to 55°C

Power 100-120/220-240 Vrms, ±10%, 450 VA max., 48-66 Hz

Weight 17 kg (38.8 lb)

Dimensions (H*W*D) 190 mm * 426 mm * 584 mm,
[7.5 in * 16.75 in * 23 in]

Recalibration Period 1 year recommended

Ordering Information

HP 8118A 100 Mbit/s Pulse Pattern Generator

Price

\$12,000

Options

908 Rack Flange Kit (P/N 5061-9678)

\$36

910 Set of Operating/Programming and Service Manual

\$138

915 Service Manual (P/N 08118-90001)

\$106

916 Additional Operating and Programming Manual (P/N 08118-90011)

\$32

W30 Two additional years of HP service

\$300

Accessories

P/N 1494-0059 Rack Slide Kit (requires HP 8118A #H01)

\$100

☎ Fast-Ship product—see page 734.

DATA GENERATORS & DATA ANALYZERS

50 MHz Digital/Analog Signal Generator Model 8175A

- 24 channels / 1 kbits ea / 50 Mbits/s ea
2 channels / 8 kbits ea / 100 Mbits/s ea
- Individual pattern duration 20 ns to 9.99 s

- Virtual Memory Expansion
- Interaction with DUT
- Dual Arbitrary Waveform Generator (opt)

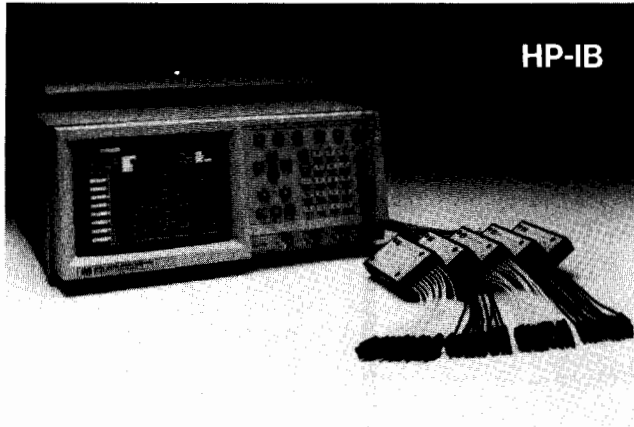

HP 8175A with output pods (15461A/15462A/15464A) and trigger pod (15463A)

HP 8175A Digital/Analog Signal Generator

The HP 8175A delivers high-speed parallel and serial data with programmable patterns, adequate for at-speed testing of most of present and future logic circuits. Individually Programmable Pattern Durations permit complex timing set-ups for simulation of extreme, asynchronous timings without wasting memory. Virtual Memory Expansion allows very long data sequences by branching to up to 255 user-definable memory segments. Interaction with a device under test provides for simulation of a wide range of data paths in digital systems. Output pods provide the appropriate levels for most logic families and flexible interface adapters ensure the specified signal quality at the probe tip, a precondition for reliable results.

A Fine Timing option (opt. 001) enhances the timing resolution provided with Programmable Pattern Durations in order to delay four channels with 100 ps.

Operational convenience is stressed through a large, menu driven CRT, a comprehensive data editor including waveform graphics and the capability to directly access (via HP-IB) a printer for documentation and a flexible disc drive for use as a test data library.

In Engineering Test, this versatile feature set provides early simulation of elements not yet available, speeding design cycles through reduced integration time at circuit, module and system level.

In Production Test and Incoming Inspection, automated at-speed testing at the module and system level results in early failure detection, thus reducing production cost and improving quality.

Combining the HP 8175A Digital Signal Generator with a HP 1630/31 family logic analyzer results in a complete Stimulus-Response measurement system. For more information on the HP 1630/31 family logic analyzers refer to the respective pages in this catalog.

Option 002 (Dual Arbitrary Waveform Generator)

With Option 002, the HP 8175A provides two arbitrary channels in addition to the full capabilities of the standard digital signal generator. Thus, some of the stimulation challenges -whether digital, analog or both together- can be met with a single unit (for further information about the analog capabilities, see page 420).

Data Page (PHPT)

Data (Pattern) Setup

Address	Location Name	Used Format	Allocation	Duration
1022		000	00000000	00
1023		000	00000000	00
0000	STHPT	000	00000011	00
0001		000	00000000	00
0002		000	00000011	00
0003		000	00000011	10
0004		000	00000011	11
0005	DOWN	000	00000011	31
0006		000	00000011	01
0007		000	00000011	00
0008		000	00000000	00
0009		000	00000010	00
0010		000	00000010	10
0011	UP	000	00000010	11
0012		000	00000010	01
0013		000	00000010	01

Data Page: Pattern Set-Up

Data can be entered and displayed in various codings. Channels to be displayed can be selected. Comprehensive data editing support is provided. For instance, segments can be moved or copied to other memory addresses or data segments can be 'block modified'. Easy exchange of data between channels avoids having to rearrange probes at the test fixture. Also, fixed patterns such as up and down counters with selectable start and stop address are loaded with a few keystrokes. All codings from the pattern Set-Up page will be automatically converted into a timing diagram when switched to this page. Or, the data can be set-up from scratch or easily edited in terms of waveforms.

Program Page (PHP)

Module Assignment

Available Segments: 255 (max. 255 Segments)

Step	Segment Name	Label or Address	Label or Address	Repetition Times
000	INIT	[from] STHPT	[to] 100	001
001	CLEAR	from 01	to 100	014
015	TEST1	from 000	to UP	002
017		from 050	to 070	001
		end		
018	TEST2	from 001	to 100	001
019		from 000	to 000	001
		end		

Program Page: Segment Assignment

This page gives an example of how pattern sequencing can be defined. Up to 255 segments of data memory can be defined by first and last addresses or labels in the 0000 to 1023 address range. During data execution the segments are real-time sequenced in the given order thus virtually expanding the memory depth far beyond the physical depth of 1024 data patterns.

Specifications

Specifications apply for operating temperatures from 0°C to 55°C.

Parallel / Serial Data Generator

Number of channels: 24 parallel, 2 serial

Bits per channel: 1024 parallel, 8192 serial

Max. NRZ Bit rate per ch.: 50 Mbit/s parallel, 100 Mbit/s serial

Pattern Duration (with internal clock):

In *Parallel* mode the duration of each individual pattern is programmable. In *Serial* mode the duration of the data bits is programmable with successive bits always having the same duration. The duration is equal for all channels.

Range/Resolution: (10)*, 20 ns - 9.99 μ s / 10 ns
 10 μ s - 999 μ s / 1 μ s
 1 ms - 99.9 ms / 100 μ s
 0.1 s - 9.99 s / 10 ms

*10 ns in serial mode with fixed timing

Accuracy: $\pm 0.05\%$ of progr. duration ± 2.5 ns
 (asynchronous start)
 $\pm 0.5\%$ of progr. duration ± 2.5 ns
 (synchr. start, clock calibration)
 $\pm 3.0\%$ of progr. duration ± 2.5 ns
 (synchr. start, no clock cal.)

Jitter (max.): 0.1% of progr. value ± 150 ps

Pattern Duration (with external clock): Period of ext. clock x m

m (Range)	/ Resolution:
(1)2** to 999	/ 1 period
1 000 to 99 900	/ 100 periods
100 000 to 9 990 000	/ 10 000 periods
10 000 000 to 999 000 000	/ 1 000 000 periods

**Min. Pattern duration in parallel mode 20ns, in serial mode 10ns.

Clock

The clock has a programmable period. It is available on line 7 of the pod for the output flags. In serial mode an additional Clock is available providing a pulse at every bit.

Period (with internal clock):

Range / Resolution: 20ns - 9.99 μ s / 10ns; 2 μ s - 999 μ s / 1 μ s

Accuracy: $\pm 0.05\%$ of progr. value ± 2.5 μ s
 (asynchronous start)
 $\pm 0.5\%$ of progr. value ± 2.5 μ s
 (synchr. start, clock cal.)
 $\pm 3\%$ of progr. value ± 2.5 μ s
 (synchr. start, no clock cal.)

Period (with external clock): Period of external clock x m

Range: m = 2,3,4 ... 999, 1000, 1100, 1200, ... 99 900

Skew (maximum time difference between the leading or trailing data bit edges of the same memory address with Fine Timing off)

across ECL pods: ≤ 6 ns; typical ≤ 3 ns

across TTL/CMOS pods: ≤ 7 ns; typical ≤ 3 ns

Option 001 Fine Timing

(can be retrofitted in HP service office)

Parallel Data Generator

Channels: 0,1,2 and 3 of pod 0

Delay (Range/Resolution): 20 ns to 40 ns / 100 ps

Accuracy: $\pm 5\%$ of progr. value ± 1 ns

Serial Data Generator

Channels: 0 and 2 of pod 0

Delay (Range/Resolution): 0 ns to 20 ns / 100 ps

Accuracy: $\pm 5\%$ of progr. value ± 2 ns

External Input (BNC)

This connector can be used to start / stop datacycling with selectable transitions.

Impedance: 10 k Ω / 50 pF

Threshold (Range/Resolution): -9.9V to +9.9 V/100 mV

Accuracy: $\pm 5\%$ of progr. value ± 250 mV

Min. swing: 600 mV pp

Min. overdrive: 250 mV or 30% of input amplitude

Max. input voltage: ± 20 V

External Clock (BNC)

Clock rate (Range): 8Hz to 100 MHz

All other specifications see External Input (BNC).

External Reference (BNC)

Input characteristics: LS TTL compatible

Ordering Information

HP 8175A Digital/Analog Signal Generator

Note: HP 8175A must be ordered with at least one of the options #002, #003, #004, #005 or individual pods, as required.

Options:

Opt. 001 Fine Timing; 4 channels, 100 ps resolution add \$1350

Opt. 002 Dual Arbitrary Waveform Generator add \$3500

Opt. 003 Set of 4 ECL Pods Model HP 15461A and 1 Trigger Pod Model HP 15463A add \$4520

Opt. 004 Set of 4 TTL Pods Model HP 15464A and 1 Trigger Pod Model HP 15463A add \$3040

Opt. 005 Set of 4 TTL/CMOS Pods Model HP 15462A and 1 Trigger Pod Model HP 15463A add \$6760

Opt. 908 Rack Flange Kit (PN 5061-9678) add \$36

Opt. 910 Set of Operating Programming and Service Manual add \$204

Opt. 915 Service Manual \$168

Opt. 916 Additional Operating/Programming Manual add \$36

Opt. W30 Two additional years of HP Service \$280

Pods:

HP 15461A ECL Pod (fixed ECL levels, includes 1 ea HP 15429A) \$990

HP 15462A TTL/CMOS Pod (programmable High Level, incl. 1 ea HP 15429A) \$1550

HP 15463A Trigger Pod (includes lead set and 10 ea probe tip) \$560

HP 15464A TTL Pod (fixed TTL levels, includes 1 ea HP 15429A) \$620

Adaptors for HP 15461A, HP 15462A and HP 15464A:

HP 15408A plug-on grabbers with ground leads 5 ea \$100

HP 15409A plug-on BNC adaptors, 5 ea \$100

HP 15410A plug-on SMB adaptors, 5 ea \$100

HP 15411A plug-on coax open-end adaptors, 5 ea \$65

HP 15415A plug-on miniprobe, usable with HP 10024A IC clip, 5 ea \$100

HP 15429A solder-in receptacles (standard accessory, 5x2 ea) \$51

Adaptors for HP 15463A:

HP PN 15463-63201 lead set \$65

HP PN 10230-62101 probe tip, 1 ea (10 ea necessary per pod) \$3

Others:

HP 15430A cable for synchronized master-slave operation of two ea HP 8175A \$76

HP 10062A Protective Cover (for front panel) \$75

☛ Fast-Ship product—see page 734

DATA GENERATORS & DATA ANALYZERS

Data Generator/Analyzer System

Models 8180B, 8181B, 8182B

- Digital ac parametric and functional evaluation
- 50MHz, 16kbit vector memory depth
- 100ps timing/10mV level resolution



HP 8180B Data Generator

- Real-time data comparison
- Ease-of-use



HP 8182B Data Analyzer

The Tool for At-Speed Evaluation of Digital IC's, Boards & Modules

The HP 8180B is a modular, high speed Data Generator for the stimulation of digital IC's and boards. For the analysis of a digital circuit's response, the HP 8182B provides capabilities for data capture and comparison, and for level and timing characteristics measurements. The Data Generators and Data Analyzers are matched in performance with regard to vector rates, vector memory depth and measurement accuracy and functionality.

Modular Configurations - From Stand-Alone to Complete Systems

On the bench, the Data Generators and Analyzers are fully operational without an external controller due to a softkey-driven, interactive operating concept.

In remote operation, all set-ups can be programmed with an external controller via the standard HP-IB interface. This enables interactive operation as well as full automation of Stimulus/Response setups.

Specifications:

(For complete specifications, please refer to data sheet P/N 5952-9612)

HP 8180B, 8181B Data Generator/Extender

Memory depth: 16Kbit/channel

Number of channels: up to 192, depending on the configuration.

HP8180B channels types: max. 8 RZ (independent timing), max. 16 NRZ minus the installed RZ channels, 1 strobe, 2 clocks with independent timing.

HP8181B channel types up to 24 DNRZ channels, one programmable group delay.

Pattern edit: clear, set, copy, counter, pseudo random, macro.

Timing

Clock period: 20 ns to 950 ms (1.05 Hz to 50 MHz).

Delay: 0.0 ns to 950 ms, max 90% of period-18ns.

Width: 10.0 ns to 950 ms, max 90% of period-8ns.

Skew: ≤ 2 ns for NRZ ch. and RZ ch. programmed for zero delay.

Resolution: 3 digits (best case 100ps).

Outputs

4 different high/low level pair can be defined and assigned to any number of outputs.

Level range: -2 to 5.5V (into 50 Ohm); -2 to 17V (into open)

Resolution: 10 mV; 20 mV into open.

Transition time: 20 to 80% at ECL levels: 1.5 ns

Applications that Reflect in Features

For at-speed functional verification of prototype circuits, the Generators and Analyzers offer programmable digital patterns at data rates up to 50 MHz. The linear vector memory depth of 16 Kbit/channel allows you to generate and capture the immense number of testvectors required for testing complex devices. Real-time comparison between "expected" data and captured data generates an "Error Map" which gives immediate feedback and increases throughput.

For thorough characterization of a circuits' performance limits, timing edges can be positioned with a best resolution of 100 ps and level pairs can be programmed with a 10 mV resolution. "Window Comparison" simultaneously checks proper upper and lower logic level and timing conditions. This makes the equipment the ideal tool for Critical Path Analysis of prototype circuits and for in-depth analysis of circuits failing a test.

Please refer to the semiconductor test section (page 524) to find information about the HP 82000, a fully integrated IC evaluation system. It features highest performance, like 200 MHz speed and ± 250 ps accuracy on up to 384 true I/O pins.

HP 8182B Data Analyzer

Memory depth: 16Kbit/channel

Number of channels: up to 32. Up to 128 in parallel operation.

Data analysis mode: synchronous sampling with variable sampling point or asynchronous sampling. Comparison with expected data.

Result displays: state list, timing diagram, error map.

Real-time compare mode: comparison of actual data with expected data throughout a variable time window. Real time error output.

Timing

Clock: external 0 to 50 MHz, internal 1 Hz to 50 MHz (1-2-5 steps)

Delay: 0.0 ns to 1 s, max 95% period - 1ns

Compare window width: 10.0 ns to 1 ns, max 95% period - 9ns

Skew: ≤ 2 ns.

Resolution: 3 digits (best case 100 ps)

Inputs

Data: 6 different thresholds or dual threshold pairs can be defined and assigned to any number of inputs.

Threshold range: -10.0 to 10.0 V

Resolution: 3 digits (best case 10 mV)

Control signals: Trigger arm, stop, Trigger + clock qualifier.

Ordering and Literature

For Ordering Information (also on accessories) and detailed Technical Data Sheets and Application Notes on the products covered in this chapter, please contact your HP sales office.

DATA GENERATORS & DATA ANALYZERS

50 Mbit/s Pattern Generator

Model 16500A with 16520A and 16521A Modules

321

- From 12 to 204 data channels
- 50 Mbit/s (NRZ) maximum data rate
- 4095 bits memory per channel

- 3 strobes (RZ)
- ECL or TTL output levels
- Data entry in hex, octal, binary, decimal or symbols



HP 16500A Logic Analysis System

... working interactively to serve the breadth of your system design and test needs.

Modular, User-configurable

The HP 16500A logic analysis system is a modular, user-configurable instrument that can provide up to 204 channels of 50 Mbit/s NRZ pattern generation. Its modularity gives it a capability to provide a complete stimulus-response system when used with other system modules, including 100 MHz timing analysis, 25 MHz state analysis, 1 GHz timing analysis, and 100 MHz digitizing oscilloscope capability.

A Synergistic Solution

Configure the HP 16500A to provide both stimulus and response in one instrument. Use the HP 16520A 50 MBit/s pattern Generator master card to provide the functional stimulus. Use the digitizing oscilloscope, 25 MHz state/100 MHz timing cards or 1 GHz timing cards to capture functional and parametric response.

Software links to CAE simulation systems are also available, which allows the HP 16500A's stimulus-response capabilities to be used for prototype functional testing.

Configuration

The HP 16520A pattern generator master card provides 12 channels of NRZ pattern generation. Channel count can be increased in increments of 48 by adding up to four HP 16521A expansion cards — or you can configure the system in mix-and-match combinations of other measurement modules. An intermodule bus keeps track of which modules are installed and allows cross-module triggering, providing measurement capabilities that would not be possible using individual instruments.

Perform Functional Verification

Avoid designing custom hardware or using other time-consuming methods to provide stimulus to your circuit. The HP 16500A offers you functional tests at a low cost per channel.

Shorten your Design Cycle

Test partial systems, even if they are missing components. The HP 16500A's pattern generator capabilities can be used to substitute for boards, ICs, and busses. Instead of waiting for missing pieces, you can continue to test and verify your design.

Friendly Circuit Connection

The HP 16500A's pattern generator has lightweight, passive probes that let you attach to your board through probe tips or 2 x 10, 0.1" center connectors on your circuit board. Standard connectors eliminate the need to purchase special connectors or to build custom fixtures to hook up to your device under test. The probing system provides ECL or TTL patterns through 50 ohm connections. Series termination eliminates the need for external 50 ohm terminations. HP also offers an ECL differential driver and a TTL tristate pod.

For complete specifications and more information about the HP 16500A logic analysis system and its measurement modules, please refer to page 256 in the logic analyzer section of this catalog.

Ordering Information

HP 16500A logic analysis mainframe	\$7,400
HP 16520A 12-channel, 50 MBit/s master card	\$3,800
HP 16521A 48-channel, 50 MBit/s expansion card	\$4,100

TRANSCEIVER TEST EQUIPMENT

Automated Test Systems

Models 8953A, 8955A, 8957S, 8953A-J45

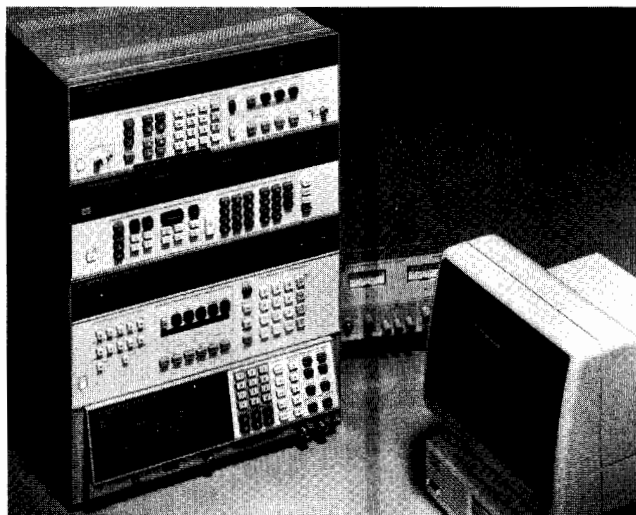

Transceiver Test Systems

Hewlett-Packard's transceiver test product line was designed to offer maximum flexibility, modularity and expandability to the mobile communications market. All systems are based on three "designed for systems" instruments: the HP 8656B Synthesized Signal Generator, the HP 8903B Audio Analyzer, and the HP 8901A/B Modulation Analyzer. These products together perform the majority of in-channel tests on any AM or FM transceiver. Combining these three basic building blocks, together with a programmable interface for system integration, creates a modular solution that is flexible enough to meet your needs today and tomorrow. These systems then can be automated using one of the many software packages available for the Series 300 and Vectra computers.

Based on the three basic measurement instruments and our system interface product line, Hewlett-Packard has created three separate test systems: the HP 8953A Transceiver Test Set, the HP 8955A RF Test System and the HP 8957S Cellular Radio Test System. From these beginnings, you can add or change instruments depending on your requirements.

HP 8953A

The HP 8953A Transceiver Test Set is Hewlett-Packard's lowest-priced system. It combines the measurement power of the three basic measurement instruments with the HP 8954A Transceiver Interface to create a solution capable of performing the majority of in-channel tests and expandable enough to meet all but the most demanding of testing requirements.

Ordering Information

HP 8953A Transceiver Test System (consisting of:)

- HP 8901A** Modulation Analyzer
 - Opt 001 RF output connectors on rear panel only
 - Opt 002 High stability time base
- HP 8656B** Synthesized Signal Generator
 - Opt 002 RF output connectors on rear panel only
- HP 8903B** Audio Analyzer
 - Opt 001 RF output connectors on rear panel only
 - Opt 010 400 Hz high pass filter
 - Opt 051 CCITT weighting filter
- HP 8954A** Transceiver Interface
- HP 8498A** Attenuator
 - Opt 030 25 watt, 30 dB

Cables and connectors

Price

\$31,200

HP 8955A

The HP 8955A RF Test System is a powerful and versatile system developed for designers, manufacturers and users of RF communication equipment. It provides a flexible combination of instruments for testing transmitters, receivers, subassemblies and modules in the frequency range from 150 kHz to 1000 MHz. The basic system consists of the three basic measurement instruments and the HP 436A Power Meter for increased measurement accuracy. The instruments are then integrated using the HP 8956A System Interface. The system also includes a cabinet, side table and comprehensive documentation.

Before a system is shipped, it is assembled and tested at the factory. This includes installing the instruments into the rack and thoroughly testing them as a system, ensuring that the HP 8955A meets its specifications.

Ordering Information

HP 8955A RF Test System (consisting of:)

- HP 8901A** Modulation Analyzer
 - Opt 001 RF connectors on rear panel only
- HP 8656B** Synthesized Signal Generator
 - Opt 001 high stability time base
 - Opt 002 RF connectors on rear panel only
- HP 8903B** Audio Analyzer
 - Opt 001 RF connectors on rear panel only
 - Opt 010 400 Hz high pass filter
 - Opt 051 CCITT weighting filter
- HP 8956A** System Interface
- HP 436A** Power Meter
- HP 8482A** Power Sensor

System Cabinet
Cables and connectors

Price

\$59,950

HP 8957S

The HP 8957S Cellular Radio Test System combines the three basic measurement instrument with the HP 8958A Cellular Radio Interface. This system will perform all signaling necessary to test AMPS and TACS compatible cellular radios. By adding the HP 11799A Signaling Box, the systems capabilities can be increased to include NMT cellular radios.

Ordering Information

HP 8957S Cellular Radio Test System (consisting of:)

- HP 8901B** Modulation Analyzer
 - Opt 001 RF connectors on rear panel only +\$232
 - Opt 002 high stability time base +\$800
- HP 8656B** Synthesized Signal Generator \$6,250
 - Opt 002 RF connectors on rear panel only +\$200
- HP 8903B** Audio Analyzer \$6,250
 - Opt 001 RF connectors on rear panel only +\$100
 - Opt 010 400 Hz high pass filter +\$210
 - Opt 051 CCITT weighting filter (for TACS only) +\$210
 - Opt 053 C-Message weighting filter (for AMPS only) +\$210
- HP 8958A** Cellular Radio Interface \$11,850
- HP 6024A** Power Supply \$1,600
- HP 11804A** Accessory Kit \$2,730

Price

\$0

\$14,400

+\$232

+\$800

\$6,250

+\$200

\$6,250

+\$100

+\$210

+\$210

+\$210

only

\$11,850

\$1,600

\$2,730

HP 8953A-J45

The HP 8953A-J45 Agile Transceiver Test System is a high-performance, automated solution for single-channel and dynamic testing of frequency agile transceivers. The system, which utilizes the HP 8645A as the dynamic signal source, requires the user to supply a radio-specific ECCM interface to accommodate the TRANSEC and COMSEC functions of the agile radio. For more information on the HP 8953A-J45, please contact your local HP Field Representative.

Automated Transceiver Test

Hewlett-Packard's transceiver test solutions are flexible combinations of instrumentation and software for automatically testing radio transmitters and receivers. This approach to transceiver test provides comprehensive, expandable solutions for a wide range of applications, allowing you to choose the right combination of hardware and software to fit your needs today and in the future.

An integral part of Hewlett-Packard's transceiver test product line is the wide variety of software application test packages that are available to meet your testing needs. These packages offer a broad spectrum of solutions ranging from basic in-channel measurements to full radio characterization. With test times typically measured in seconds, these packages quickly and accurately measure transceiver performance.

HP 11805A Transceiver Test Software Exceptional Flexibility and Expandability

The HP 11805A transceiver test software package is a comprehensive solution for automatically testing radio receivers and transmitters. The HP 11805A software package provides quick and easy testing with full softkey operation, concise graphics, and easy-to-read test results.

The software consists of a main executive program and a separate series of measurement test packages. You purchase only the measurement capability you need; you can expand with full compatibility later. This new approach to software development allows the HP 11805A to fit into any testing environment, dependent only on the measurement capability purchased. If you have a specialized application, the software can easily be modified. It is written in BASIC language. The HP 11805A tests multiple channel radios and, for standard FM and AM radios, can encode and decode Continuous Tone Controlled Squelch (CTCSS) and Digital Coded Squelch (DCS) tones automatically. In addition, the test packages allow all tests on all channels, selected prime channels, or selected test/channel combinations.

For cellular radio applications the HP 11805A offers test packages that are fully compatible with the AMPS, TACS and EIA-800 cellular radio test standards. In addition, there are application packages capable of fully testing AM and SSB-SC radios.

Pass/Fail limit testing allows you to quickly verify your radio's performance. Optimized for speed and repeatability, the HP 11805A increases productivity and efficiency. With the optional bar code reader, radio parameters can be entered in seconds and stored on disc for future use. In addition, a Manual Mode allows you to manually control test instrument settings through the computer without leaving

the program. Clear instructions, easy-to-read graphics, and helpful program prompts guide you through every step of the program.

Utility programs are also among the powerful capabilities of the HP 11805A software package. The System Interconnection Verification program is designed to ensure that all instruments are responding to the computer controller. The System Calibration program measures all the path losses from the radio through the interface. These path losses are then accounted for in the measurement test routines, increasing the accuracy and repeatability of the test results.

HP 11798A Cellular Radio Software

NMT Cellular Radio Software

The HP 11798A Cellular Radio Test Software provides the comprehensive RF and signaling tests required for testing cellular mobile radios conforming to the 450 and 900 MHz standards of the Nordic Mobile Telephone (NMT) system. With user-written software, the system is also capable of simulating a mobile station for base station signaling tests.

Tests can be selected and run in any order, giving you complete control of your test routines. These routines include call processing functions such as origination, origination reorder and paging. The results are then displayed in a concise format with Pass/Fail limits, allowing you to quickly verify your radios performance. The HP 11798A is an excellent solution to your NMT cellular radio testing needs.

Additional features of the HP 11798A include a calibration utility capable of measuring and correcting for the insertion and path losses in the system and a special Manual mode which allows you to manually control the test instruments from the computer controller.

Ordering Information

HP 11805A Software Application Pac	Price
Opt 001 Operating System Executive	\$1,620
Opt 100 North American FM Tests	+\$515
Opt 101 Extended North American FM Tests	+\$800
Opt 200 European ϕ M Tests	+\$515
Opt 201 Extended European ϕ M Tests	+\$800
Opt 300 AM Radio Tests	+\$515
Opt 400 SSB-SC Radio Tests	+\$800
Opt 500 AMPS Cellular Radio Tests	+\$800
Opt 510 TACS Cellular Radio Tests	+\$800
Opt 520 EIA-800 Cellular Radio Tests	+\$800
Opt 530 TACS with AMPS Bus Cellular Radio Tests	+\$800
Opt 540 E-TACS Cellular Radio Tests	\$775
HP 11798A Software Application Pac	\$1,130

HP Model No	HP 11805A											HP 11798A	
	Opt 100	Opt 101	Opt 200	Opt 201	Opt 300	Opt 400	Opt 500	Opt 510	Opt 520	Opt 530	Opt 540		
Type of radios Tested	FM	Extended FM	PM	Extended PM	AM	SSB-SC	AMPS	TACS	EIA-800	TACS w/ AMPS Bus	E-TACS	NMT	
Controllers Supported ¹	200 300 Vectra	200 300 Vectra	200 300 Vectra	200 300 Vectra	200 300 Vectra	200 300 Vectra	200 300 Vectra	200 300 Vectra	200 300 Vectra	200 300 Vectra	200 300 Vectra	200 300	
Language Supported	BASIC 5.0	BASIC 5.0	BASIC 5.0	BASIC 5.0	BASIC 5.0	BASIC 5.0	BASIC 5.0	BASIC 5.0	BASIC 5.0	BASIC 5.0	BASIC 5.0	BASIC 5.0	
Systems Supported	8953A 8955A 8957S	8953A ² 8955A	8953A 8955A 8957S	8953A ² 8955A	8953A 8955A	8953A 8955A		8957S	8957S	8957S	8957S	8957S	8957S ³
Measure Squelch	CTCSS DCS	CTCSS DCS	CTCSS DCS	CTCSS DCS									
Generate Squelch	CTCSS DCS	CTCSS DCS	CTCSS DCS	CTCSS DCS									
Number of tests Performed	20	9	17	8	17	16	35	20	19	29	21	21	

¹ Only selected configurations are supported

² HP 8953A system must include Option 100

³ HP 11798A is also required

TRANSCEIVER TEST EQUIPMENT

RF Interfaces

Models 8954A, 8956A, 8958A, 11799A

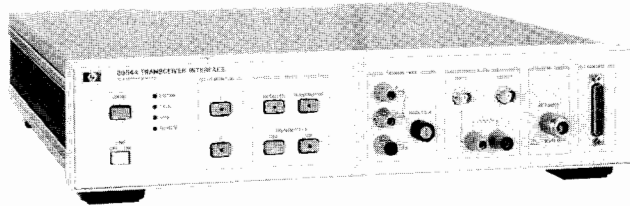

HP 8954A



HP 8958A

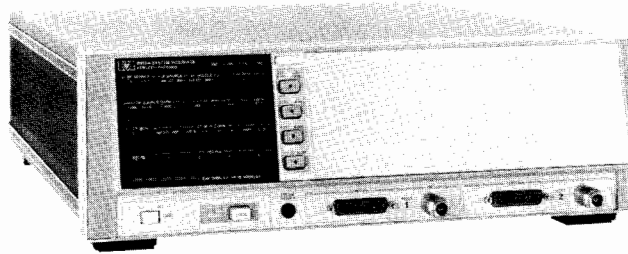

HP 8956A

HP 8954A Transceiver Interface

The HP 8954A is Hewlett-Packard's lowest priced transceiver test interface. It is fully programmable and uses microwave switches and hardware in all RF paths. Designed for dc to 18 GHz measurements, the HP 8954A Transceiver Interface provides the flexibility needed for most AM, FM and SSB receiver and transmitter testing.

HP 8954A-H03 Transceiver Interface

The HP 8954A Option H03 Transceiver Interface is a full-duplex version of the standard HP 8954A. The standard RF switching hardware is replaced with a power divider network that is designed for 10 MHz to 1500 MHz use. The HP 8954A Option-H03, when used with the HP 11799A Signaling Unit, is part of the recommended configuration for testing NMT (Nordic Mobile Telephone) cellular radios.

HP 8956A System Interface

The HP 8956A System Interface, with its multiple paths and connections, provides added flexibility in the designing of systems in the frequency range from dc to 1000 MHz. It has two RF test ports for duplex testing, stimulus/response testing and reduced connect/disconnect times. A built-in, switchable 120 watt 30 dB attenuator can be inserted for transmitter testing and removed for receiver testing, increasing receiver measurement range.

Additional functions of the HP 8956A include current drain and timing measurements.

HP 8958A Cellular Radio Interface

The HP 8958A Cellular Radio Interface gives your system the capability to fully test a cellular radio. With the flexible Channel Simulator, you can simulate cell-site operation, verify signaling protocol, or perform highly complex and sophisticated tests using an external controller to generate and analyze data content.

HP 11799A Signaling Unit

For testing cellular radios compatible with the 450 and 900 MHz protocols of the Nordic Mobile Telephone (NMT) system, Hewlett-Packard supplies the HP 11799A Signaling Unit.

When used with the three basic transceiver test instruments and a duplex interface, the HP 11799A simulates a base station and mobile exchange for over-the-air RF and signaling tests of cellular mobile radios.

Ordering Information

HP 8954A Transceiver Interface
 HP 8954A-H03 Transceiver Interface
 HP 8956A System Interface
 HP 8958A Cellular Radio Interface
 HP 11799A Signaling Unit

Price

\$4,325
 \$6,715
 \$14,400
 \$11,850
 \$14,400

System Interface Comparison

	HP 8954A	HP 8954A-H03	HP 8956A	HP 8958A
Frequency Range	DC to 18 GHz	10 to 1500 MHz	DC to 1000 MHz	10 to 1500 MHz
Number of RF Ports	4	4	6	6
Number of Audio Ports	2	2	4	2
Number of UUT Ports	1	1	2	1
Duplex Capabilities	NO	YES	YES	YES
Typical Applications	AM, FM, \emptyset M, SSB	AM, FM, \emptyset M, SSB, NMT ¹	AM, FM, \emptyset M, SSB	AMPS, TACS, NMT ¹

¹Requires the HP 11799A Signaling Unit

TRANSCEIVER TEST EQUIPMENT

0.3 GMSK Modulation Measurement Software

HP 11836A

325

- Global measurement of GSM digital cellular radio transmitters
- rms phase error accuracy - greater of 0.1° rms or 5% of reading
- Peak phase error accuracy - < 1.0° peak

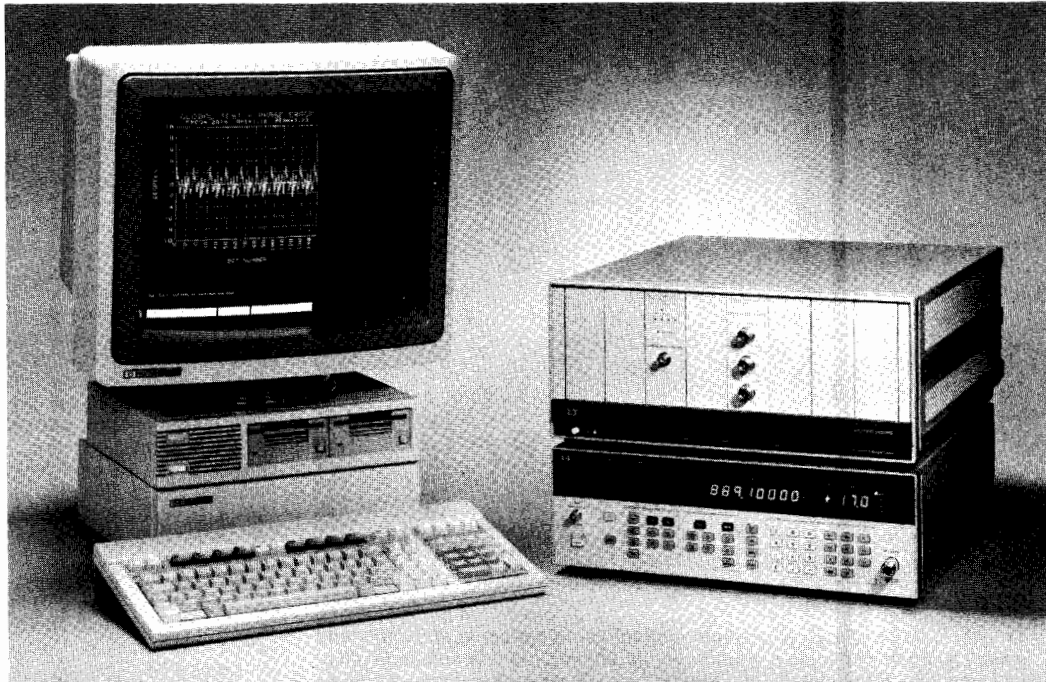

HP 11836A

HP 11836A 0.3 GMSK Modulation Measurement Software

The HP 11836A software package is an easy-to-use, accurate solution for testing transmitters designed for the Groupe Special Mobile (GSM) Pan-European Digital Cellular Radio System. By digitizing the signal and performing mathematical calculations, it measures transmitter carrier frequency accuracy, modulation phase error (peak and rms), and amplitude envelope, and it recovers the data along with a measuring the spectrum of the signal over a single time slot. This technique is often referred to as the global method.

The software digitally reconstructs the actual transmitted data, and from it, computes the phase trajectory from a theoretically perfect 0.3 Gaussian Minimum Shift Keying modulator. It also uses the recovered data to very precisely regenerate the data clock, to use to synchronize the data stream. By subtracting the actual phase trajectory from the calculated ideal trajectory, the phase error is obtained and frequency error, rms phase error and peak phase error can be determined.

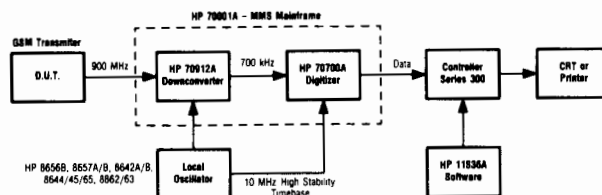

0.3 GMSK Modulation Measurement System Block Diagram (Global Method)

Ordering Information

HP 11836A 0.3 GMSK Modulation Measurement Software

Price
\$10,000

Associated equipment

Required:

HP 70001A System Mainframe \$5,610
 HP 70700A Digitizer Module \$7,800
 HP 70912A Downconverter Module \$3,500

Local Oscillator (one of the following):

HP 8642A/B, HP 8644A, HP 8645A, HP 8656B, HP 8657A/B, HP 8662A, HP 8663A, or HP 8665A contact HP

Controller: The software requires BASIC 5.13 on an HP 9000 Series 200/300 or the BASIC Language Processor (HP 82300B) for the HP Vectra Personal Computers. Due to the extensive computations done by the software, the HP 9000 Model 340 or HP 9000 Model 332 (with Opt. 882) is recommended.

Memory: At least 2 Mbyte RAM

Optional equipment:

Printers: HP-IB Printers such as the HP ThinkJet \$495

Modular Measurement System Graphics

Displays:
 HP 70205A Graphics Display \$5,100
 HP 70206A System Graphics Display \$7,140

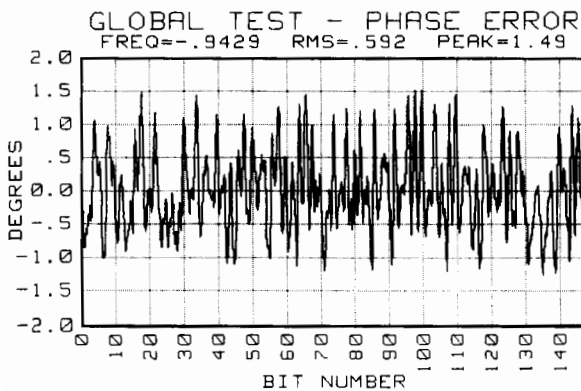

Sample software output

NOISE FIGURE METER

Noise Measurements

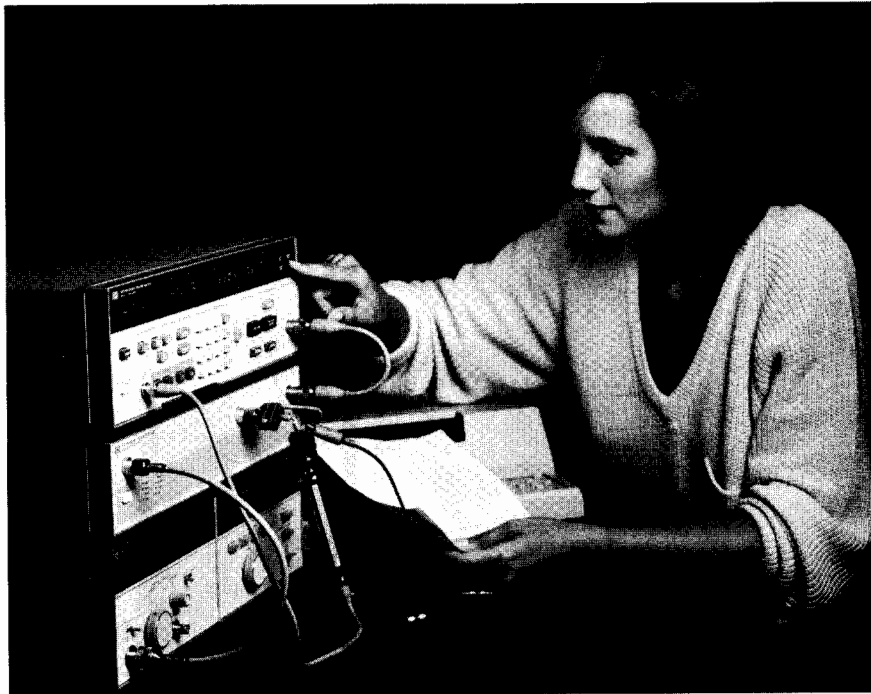

What is Noise Figure?

Modern receiving systems must often process very weak signals. Noise added by the receiving system components often determines whether or not an input signal can be processed properly. Unlike other ways to measure receiver noise (minimum discernable sensitivity, tangential sensitivity, etc.) noise figure is an objective measure, it does not depend on the judgement of the person measuring. In addition, noise figure is universal; it may be determined for transistors, amplifiers, and mixers as well as entire systems.

Noise figure can be expressed as the ratio of total output noise power (at a source temperature of 290K) compared to the output noise power if there were no noise added by the device under test (DUT).

Noise figure is typically measured by applying two known noise powers to the test device input and measuring the corresponding output powers. Assuming the device is linear, it can then be characterized with respect to total output noise power for all values of input noise power. Noise figure is calculated (ratio of total output noise power versus output noise power assuming no device noise) assuming an input noise power generated from a 290K thermal noise source.

To learn more about noise figure basics and measurement, read HP Application Note 57-1 (see Literature on this page).

Single- and Double-sideband Noise Figure Measurements

There are both advantages and disadvantages to single- and double-sideband measurements.

Double sideband microwave measurements are easy. The most basic set-up requires only a mixer and local oscillator. However, the resulting noise figure is the average of the test device performance at the two down-converted frequencies. If the device characteristics vary rapidly with fre-

quency, such as transistors or amplifiers with narrow passbands, double-sideband measurement can introduce significant error. In addition, spurious and harmonically-related signals can also render double-sideband measurement data invalid.

Single-sideband measurements eliminate double-sideband problems. Double-sideband problems like image, spurious, and harmonic signals are removed by pre-selecting the desired noise sideband before mixing. Single-sideband measurements, however, require accurately designed filtering systems (like temperature-compensated YIG filters) which are difficult to design and maintain. In spite of its difficulties, single-sideband is the only way to make a standard, down-converted noise figure measurement - its measured value does not depend on the device characteristics.

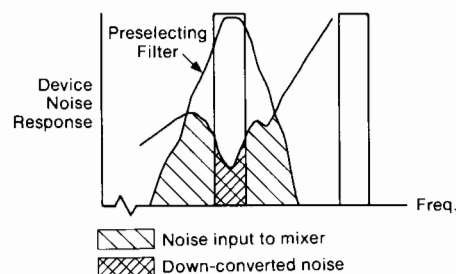
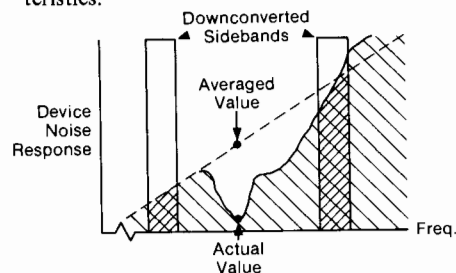

Noise Figure Measurement Applications

Hewlett-Packard's noise figure measurement equipment is exceptional in applications like these:

Amplifiers: 1) Simultaneous noise figure and gain measurement, 2) Results automatically corrected for ENR variations, ambient temperature, and mixer, LO, and IF noise contributions, 3) Real-time, swept, corrected output to oscilloscope for easy tuning (display is digitally stored), 4) Single-test-port calibration and measurement from 10 MHz to 26.5 GHz (with the 8970S/T/U systems).

Transistors: All the benefits of measuring amplifiers plus: 1) Easy real-time tuning for best noise figure and gain, 2) real-time tuning to actual transistor F_{min} without second stage effects, 3) Broadband (10 MHz to 26.5 GHz) single-sideband measurement (with the HP 8970S/T/U system), 4) Low mismatch effects (the HP 346A features virtually identical impedance for T_h and T_c), 5) Easy to program for automatic systems.

Receivers and mixers: 1) Simultaneous measurement of gain (conversion loss) and noise figure, 2) Tunable and swept IF from 10 to 1600 MHz (with the HP 8970B) and 10 MHz to 26.5 GHz (with the HP 8970S/T/U), 3) No external IF gain needed, 4) Automatic ENR correction, even for broadband sweeps, 5) Effects of LO power, IF power, and IF frequency changes on noise figure are easily observed, 6) Easy to program.

Literature

Product Note 8970B/S-2, Applications and Operation of the HP 8970B Noise Figure Meter, describes the HP 8970B and many of its applications in more detail. It is both an introduction to the HP 8970B and a summary reference manual.

Product Note 8970B/S-3, Noise Parameter Measurement using the HP 8970B Noise Figure Meter and the ATN NP4 Noise Parameter Test Set, describes noise parameter measurement on transistors.

Application Note 57-1, Fundamentals of RF and Microwave Noise Figure Measurements, explains the theory behind noise figure and its measurement. This note includes an extensive glossary of noise related terms.

Application Note 57-2, Noise Figure Measurement Accuracy, discusses considerations for making accurate noise figure measurements and for determining the accuracy of noise figure measurements.

Product Note 8970B/S-4, Displaying HP 8970B Noise Figure Meter Measurements on the HP 8757 Scalar Network Analyzer, shows how to use a single display for noise and scalar parameters in production test situations.

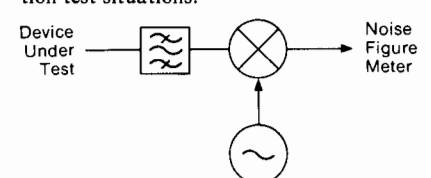

Single sideband noise measurement system.

NOISE FIGURE METER

Automatic Noise Figure Meter

Model 8970B

327

- 10 MHz to 1600 MHz.
- Accurate and simple, swept or CW measurements.
- Second stage correction.

- Displays both noise figure and gain.
- Calibrated display on oscilloscope, recorder, or plotter.
- Powerful special function enhancements.



HP 8970B



HP 8970B Noise Figure Meter

With the HP 8970B Noise Figure Meter, noise figure measurements are easy, accurate, and repeatable. Automatic second stage correction makes accurate noise figure readings possible even for low gain devices. The HP 8970B's dynamic range allows gain measurements of at least 40 dB (higher in some cases) or loss measurements to -20 dB, with no external attenuation or amplification. The HP 8970B can store up to 4 ENR (Excess Noise Ratio) noise source calibration tables. It also properly interpolates ENR values at each measurement frequency.

Microprocessor and Controller Functions

The HP 8970B takes the mystery out of noise figure measurements. It uses a microprocessor to make the calculations and corrections necessary for truly accurate, convenient, and flexible noise figure measurements. The meter also controls external local oscillators (such as the HP 8670 series synthesizers, HP 8340 series synthesized sweepers, or the HP 8350 sweep oscillator) and the HP 8971B Noise Figure Test Set. This makes accurate, broad-band microwave measurements of amplifiers, mixers, and transistors as simple as RF measurements.

Virtually all of the HP 8970B's front panel keys and functions are accessible over HP-IB, Hewlett Packard's enhanced version of IEEE-488. The meter has an independent System Interface Bus (SIB) to control the HP 8971B and local oscillator. This additional bus frees you from having to write computer code to control an instrument on the SIB (like the local oscillator) when used in an automated set-up. Pass-through capability allows other instrument controllers to send messages through the meter to any other instrument on the SIB.

Simple Calibration and Second Stage Correction

Noise figure measurement accuracy is enhanced because the meter measures its own noise figure (and that of the rest of the measurement system) at up to 181 points. It stores this information, interpolates where necessary, and corrects for it when displaying the device-under-test noise figure. The HP 8970B also measures the test device gain.

Display

The HP 8970B's front panel LEDs display frequency, gain, and noise figure. Rear panel BNC connectors allow swept display of noise figure and gain versus frequency on an oscilloscope or x-y recorder. You can also get the noise figure and gain vs. frequency display sent to a digital plotter over the HP 8970B's System Interface Bus. All display modes are easily and accurately scaled to the desired resolution from the meter's front panel. The swept oscilloscope display allows you to optimize your test device in real time for both noise figure

and gain. You can easily change the noise figure display from noise figure to effective noise temperature (T_e) or Y factor.

Front Panel and Special Functions

The HP 8970B front panel keys control the number entry, calibration, and measurement functions. STORE, RECALL, and SEQ keys allow up to 9 front panel settings to be stored and sequenced automatically or manually to save set-up time. Smoothing INCREASE and DECREASE keys are used to average up to 512 readings before display. This increases accuracy and eliminates display flicker.

For those who need greater measurement power than that provided by the HP 8970B's simple front panel, there are more than 200 special functions selected by pressing a numerical code and the special function key. Two examples are hot-cold measurements and automatic compensation for losses at the input of the test device. One of the special functions is a catalog that quickly shows you the current special functions being used. Three pull-out cards serve as a mini-reference manual for the instrument. They include most of the special functions, the HP-IB formats and codes, error messages, and typical measurement set-ups.

HP 8970B Partial Specifications

(See technical data sheet for complete specifications)

Noise figure (gain) measurement range: 0 to 30 dB (-20 to at least 40 dB).

Noise figure (gain) instrumentation uncertainty: ± 0.1 dB for 0 to 55°C (± 15 dB).

Noise figure resolution: .01 dB (.001 dB over HP-IB).

Gain resolution: .01 dB (.001 dB over HP-IB).

Frequency range: tunable from 10 to 1600 MHz.

Tuning accuracy (from 10 to 40°C): $\pm (1\text{MHz} + 1\%$ of frequency), 6MHz maximum.

Frequency resolution: 1 MHz.

Noise figure (for input power levels below -60 dBm): < 7 dB + .003 dB/MHz.

Maximum operating input power: -10 dBm.

Maximum net external gain: > 65 dB between noise source and HP 8970B RF input.

Noise source drive: $28.0 \pm .1$ volt.

Operating temperature: 0°C to 55°C .

Storage temperature: -55° to 75°C .

Power: 100, 120, 220, or 240 V ($+5\%$, -10%); 48–66 Hz; 150 VA maximum.

Dimensions: 143 H x 425 W x 476 mm D (5.68" x 16.75" x 18.38").

Weight: Net, 15.5 kg (34 lb). Shipping, 18.5 kg (40 lb).

NOISE FIGURE METER

Noise Figure Measurement System

Models 8970S/T/U, 8971C

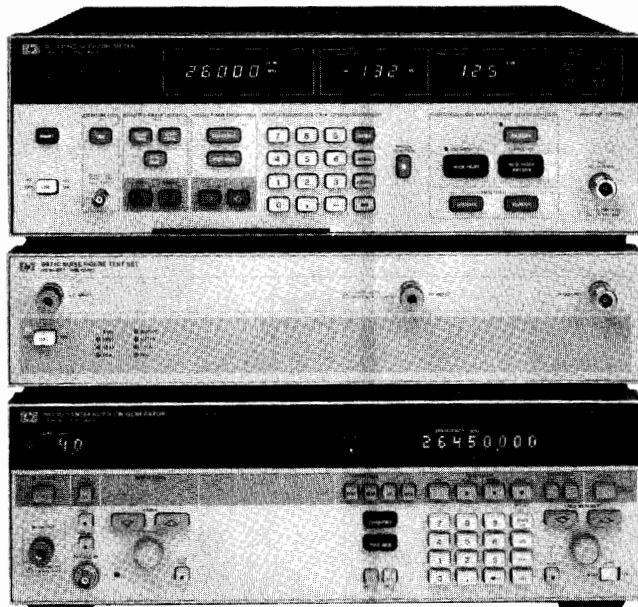

HP 8970S/T/U



HP 8970S/T/U Microwave Noise Figure Measurement Systems

Until now, there was no standardized way to make a microwave noise figure measurement, users had to design and support their own microwave system, and measurements crossing from RF to microwave were difficult because they required multiple system configurations.

Hewlett Packard's answer to these problems is the HP 8970S, HP 8970T and 8970U noise figure measurement systems. Each system consists of the HP 8970B Noise Figure Meter, the new HP 8971C Noise Figure Test Set, and a synthesized local oscillator. (The recommended LOs for the 8970S are listed in the 8970S Partial Specifications; the HP 8970T uses the HP 8671B Synthesized CW Generator as its local oscillator; the HP 8970U uses the HP8673G Synthesized CW Generator as its local oscillator.)

The HP 8970S/T/U system eliminates the tedious job of designing the measurement system and selecting components. The HP 8970B acts as the controller to the system so all system operation is transparent to you, the user. To insure specified performance, the HP 8970S/T/U systems are given specifications just like an RF noise figure meter (i.e HP 8970B).

HP 8970S/T/U Partial Specifications

(See 8970S technical data sheet for complete specifications)

Frequency range: 10 MHz to 26.5 GHz.

Noise figure measurement range: 0 to 30 dB.

Noise figure instrumentation uncertainty: $< \pm .25$ dB (for a 14 to 16 dB ENR noise source in a 0 to 55°C environment).

Gain instrumentation uncertainty: $< \pm .45$ dB.

Noise figure (max): 10 to 25 MHz: 13 dB

0.025 to 12 GHz: 8 dB

12 to 18 GHz: 10 dB

18 to 26.5 GHz: 14 dB

Input SWR: 10 MHz to 24 GHz: 2.0

24 to 26.5 GHz: 2.5

Gain/noise figure repeatability: .2 dB.

Recommended local oscillators: HP 8671B, 8672A, 8673B/C/E/G, 8340B, and 8341B.

- 10 MHz to 26.5 GHz
- Fully specified system
- Removes double-sideband inaccuracies
- As easy to operate as the 8970A or B

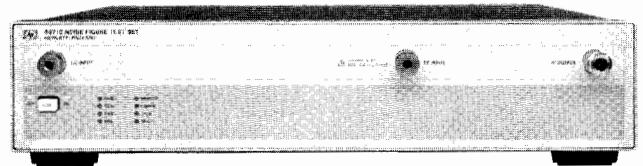

HP 8971C



HP 8971C Noise Figure Test Set

The HP 8971C Noise Figure Test Set brings the simplicity of double sideband measurements and the accuracy of single sideband measurements together in one package. Careful design and high performance components, including a stable YIG filter, allow broadband single-sideband measurements from 10 MHz to 26.5 GHz with a single calibration and sweep. A low noise preamplifier built into the Noise Figure Test Set lowers the second stage noise figure thereby reducing a major source of measurement uncertainty.

Measurement modes in the HP 8970B allow for double down conversion using the HP8971C as the second down-converter. These modes can be used for millimeter-wave measurements of amplifiers and transistors and measurements of receivers and mixers with IFs above 1.6 GHz.

HP 8971C Partial Specifications

(See 8970S technical data sheet for complete specifications)

Frequency range: 10 MHz to 26.5 GHz.

Gain/noise figure repeatability: $\pm .2$ dB.

Input SWR: 10 MHz to 24 GHz: 2.0

24 to 26.5 GHz: 2.5

Image and odd-harmonic rejection: 20 dB.

Accessories supplied:

1 LO-to-HP 8971B cable - SMA(f), 300 mm

1 HP 8971B-to-HP 8970B cable - N(m), 190 mm

1 N(m)-to-SMA(m) adapter

2 HP-IB cables - .5 m



NOISE FIGURE METER

Noise Sources

Models HP 346 A/B/C, R/Q347B

329

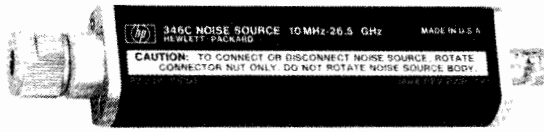

HP 346C

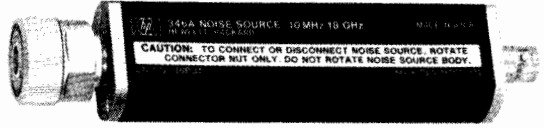

HP 346A (option 002)

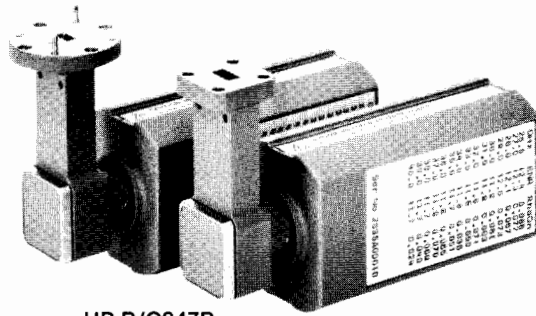

HP R/Q347B

HP 346A/B/C Broadband Noise Sources

The ideal companion to the HP's noise figure meter and systems is the HP 346 family of noise sources. Since they are broadband (10MHz to either 18 or 26.5 GHz), they eliminate the necessity for several sources at different frequency bands. Each source has individually calibrated ENR values at specific frequencies. The calibration is printed on its label (see illustration) for easy loading into the HP 8970B. The low SWR of each noise source reduces a major source of measurement uncertainty - re-reflections of test signals. In addition, the variety of connectors available reduces the need for degrading accuracy with connector adapters.

The HP 346 family of noise sources are designed for a broad range of measurement applications. The HP 346C covers the broadest frequency range, 10 MHz to 26.5 GHz. The HP 346B's high ENR, low SWR, and variety of connectors make it a general purpose noise source. The HP 346A is designed especially for accurate characterization of input-impedance-sensitive devices (like GaAsFETs and many UHF amplifiers). Its very small change in reflection coefficient (<0.01) from ON to OFF minimizes errors when measuring noise figure and gain as a function of input impedance.

FREQ GHz	ENR dB
0.01	15.18
0.10	15.49
1.0	15.26
2.0	15.17
3.0	14.93
4.0	14.86
5.0	14.91
6.0	14.83
7.0	14.90
8.0	15.05
9.0	15.26
10.0	15.39
11.0	15.43
12.0	15.50
13.0	15.41
14.0	14.93
15.0	15.51
16.0	15.55
17.0	15.62
18.0	15.66

SERIAL NO.
2027A00428

Example label of HP 346B Noise Source

HP 346 A/B/C Partial Specifications

(See technical data sheet for complete specifications.)

Frequency range: 10 MHz to 18 GHz for HP 346A/B; 10 MHz to 26.5 GHz for HP 346C.

Excess noise ratio (ENR) limits: HP 346A: 5 to 7 dB; HP 346B: 14 to 16 dB; HP 346C: 12 to 16 dB (10 MHz to 12 GHz) and 14 to 17 dB (12.0 to 26.5 GHz).

Maximum SWR (reflection coefficient) on and off:

HP 346A/B: 10 to 30 MHz — 1.3 (0.13); 30 to 5000 MHz — 1.15 (0.07); 5 to 18 GHz — 1.25 (0.11).

HP 346C: 10 MHz to 18 GHz — 1.25 (0.11); 18 to 26.5 GHz — 1.35 (0.15).

Power required: 28 ± 1 Vdc.

Dimensions: 140 H x 21 W x 30 mm D (5.5" x 0.8 x 1.2").

Weight: net, 0.108 kg (3.5 oz). Shipping, 0.5 kg (1 lb).

Standard connector: APC - 3.5(m)

HP R & Q347B Solid-state Noise Sources

The performance and reliability you have come to expect from Hewlett-Packard RF and microwave solid-state noise sources, is now extended to millimeter-wave frequencies with the HP R347B (26.5 to 40 GHz) and HP Q347B (33 to 50 GHz) noise sources. A new GaAs avalanche diode specifically designed for high noise output and long term reliability was developed for the HP R/Q347B Noise Sources. This results in excellent ENR stability over time. In turn, this insures long recalibration cycles and very accurate noise figure measurements.

HP 346C Option K01 Broadband Noise Source

This new coaxial noise source features coverage from 1 to 50 GHz with the 2.4mm coaxial connector. ENR is nominally 20 dB at 1 GHz and 7dB at 50 GHz. Contact HP for technical specifications.

HP R & Q347B Noise Sources

(See technical data sheet for complete specifications)

Frequency Range: R347B - 26.5 to 40 GHz

Q347B - 33 to 50 GHz

Excess Noise Ratio (ENR) Range:

HP R347B: 10 to 13 dB

HP Q347B: 10 to 13 dB (33 to 42 GHz)

6 to 12.5 dB (42 to 50 GHz)

Max. SWR (reflection coefficient):

HP R347B: <1.42 (.17)

HP Q347B: <1.57 (.22)

Supplemental Characteristics

ENR Variation with temperature: <.009 dB/C

ENR Variation with time:

R 347B: .15 dB typ. (over 2000 hrs.)

Q 347B: .15 dB typ. (over 2000 hrs.)

Ordering Information

HP 8970B Noise Figure Meter \$11,300

Option H18: Increases upper frequency from 1600 to 1800 MHz + \$350

Option 907: Front panel handle kit + \$55.00

Option 908: Rack mounting flange kit + \$32.50

Option 909: Both options 907 and 908 + \$80.00

Option 700: External mate translator \$7,055.00

HP 8971C Noise Figure Test Set \$19,500

Option 001: Add L.O. Power amplifier +\$4,500

Option 002: Delete RF preamplifier -\$3,500

HP 8970T Noise Figure Measurement System (10 MHz to 18 GHz) \$54,400

HP 8970S Noise Figure Measurement System See HP8970S

Ordering Guide

HP 8970U Noise Figure Measurement System (10 MHz to 26.5 GHz) \$63,900

HP 346A Noise Source \$1,650

HP 346B Noise Source \$1,550

HP 346C Noise Source \$2,100

HP 346 Opt. K01 Noise Source \$3,600

Option 001 (HP 346A/B only): Type N (m) connector N/C

Option 002 (HP 346A/B only): APC-7 connector + \$25

Option 004 (HP 346A/B only): Type N (f) connector N/C

HP R347B Noise Source \$2,350

HP Q347B Noise Source \$2,950

MICROWAVE TEST ACCESSORIES

Microwave Measurements and Accessories

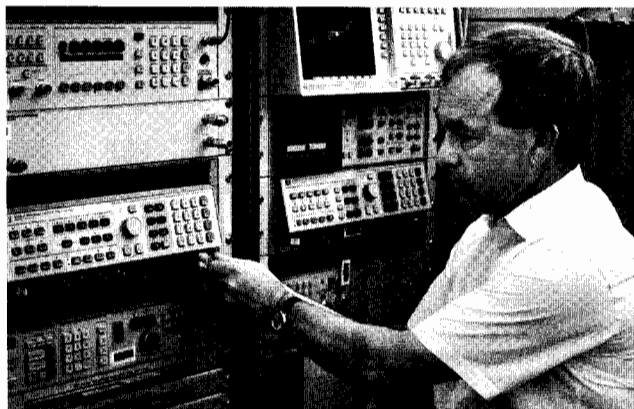

The Key to Better Measurements

Your test area is a tough environment. Large test volumes put great stress on the measurement components. A worn and non-repeatable adapter significantly degrades system directivity. A lossy cable decreases the dynamic range of a measurement. A non-repeatable switch or step attenuator introduces random insertion errors. For these reasons, HP components and accessories are designed to help ensure long life and repeatability under very demanding conditions.

When you use these products, you take advantage of Hewlett-Packard's experience. Microwave testing is our business, and HP components must meet standards to ensure that our own instruments meet our stringent specifications and reliability goals.



Technology For Better Measurements

Hewlett-Packard believes that technology creates the performance, quality, and cost that is necessary for a competitive edge now and in the future. This means using precision machining and processes that meet exceptionally tight tolerances in order to allow for the design and manufacture of a 50 GHz 2.4mm coaxial connector that mates with a 65 GHz 1.85mm connector. Also, this means using HP plating and chemical milling facilities to produce connector mating surfaces that have exceptional electrical performance at mm-wave frequencies and that are environmentally rugged for extended life.

HP's solid state technology permits us to build the components and accessories such as Planar Doped Barrier (PDB) diodes and Monolithic Microwave Integrated Circuits (MMICs). PDB diodes are the key to a new family of detectors that provide excellent flatness and sensitivity to 50 GHz in coax, and to higher frequencies in waveguide. MMICs are the heart of new amplifier and probe products that increasingly find their way into the component building blocks you will need to design even more sophisticated test systems.

Confidence in Component Performance

You can depend on our specifications because our components are not merely sampled; every component is 100% tested, usually on automatic test systems. We use the latest test equipment and techniques,

and test data is stored and tracked with statistical quality control techniques to ensure that we continually improve the products we deliver to you. On many products, you can order actual test data to further reduce measurement uncertainties.



Hewlett-Packard as Your Partner

Hewlett-Packard will help integrate your measurement systems. For instance, we will integrate an entire series of coaxial switches to create custom automatic test system (ATS or ATE) switch matrixes for your specific requirements. And we will also characterize and document the performance of the switch matrix. For a higher level of system integration, we will help integrate the entire measurement system — switch matrixes, instruments, and controlling computers.

Hewlett-Packard wants to work with you to optimize your test systems. We encourage you to call us with your special requirements when existing products might not meet your exact needs.



RF, Microwave, & mm-Wave Measurement Accessories Catalog

Configuring a microwave measurement system for the device you are testing requires many precision accessories. We know that low reflection adapters, high directivity couplers and bridges, repeatable switches, and rugged cables all have as great an impact on measurement accuracy as the measuring instruments themselves.

The HP RF, Microwave, and mm-Wave Measurement Accessories catalog is designed to help you find these precision accessories. It offers a broad selection of accessories in coax to 50 GHz, waveguide to 110 GHz, and high impedance probes to 3 GHz. The catalog is HP literature number 5953-2346.

MICROWAVE TEST ACCESSORIES

Transmission Reflection Test Sets, Power Splitters, Power Dividers

Models 8721A, 85044A/B, 11850C/D, 11667A/B/C, 11636A/B

331

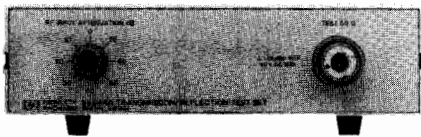

HP 85044A

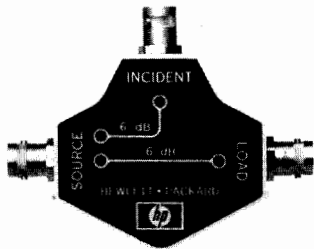

HP 8721A

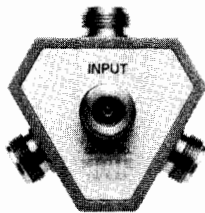

HP 11850C



HP 11667A



HP 11636A

Description

Accurate broadband measurements of transmission and reflection parameters are highly dependent on the device used to separate signals for the measurement. Some devices separate the reflected and transmitted signals and some split power for ratio and comparison measurements.

HP 8721A Directional Bridge

HP 8721A Option 008 75 Ohm Version

Frequency range: 0.1 - 110 MHz.

Directivity: >40 dB, 1 - 110 MHz, typically >30 dB, 0.1 - 1 MHz.

Load port match: >30 dB (VSWR <1.07).

Transmission arm: Nominal loss, 6 dB. Frequency response, <0.2 dB.

Coupling arm: Nominal coupling, 6 dB. Frequency response, <0.6 dB.

Maximum input power: +20 dBm.

Weight: net, 0.55 kg (0.25 lb); shipping, 1.1 kg (0.5 lb).

Size: 59 H x 39 W x 123 mm D (1.5 x 1 x 3.13 in.).

HP 85044A 50 Ohm Transmission Reflection Test Set

HP 85044B 75 Ohm Transmission Reflection Test Set

The HP 85044 contains a power splitter and directional bridge that permits simultaneous transmission and reflection measurements with over 30 dB directivity from 300 kHz to 3.0 GHz. Detailed specifications on the HP 85044A and HP 85044B appear on page 232.

HP 11850C 50 Ohm Power Splitter

HP 11850D 75 Ohm Power Splitter

These three-way power splitters are designed for ratio measurements from dc to 3.0 GHz (11850C) or 2 GHz (11850D). One output port provides the reference and the other two output ports can be used for independent transmission measurements. They provide 0.25 dB tracking and >20 dB output match. Detailed specifications are on page 233.

HP 11667A Power Splitter (Type N)

HP 11667B Power Splitter (3.5 mm)

HP 11667C Power Splitter (2.4 mm)

These two-way, two-resistor splitters provide good input and output source match in ratio measurement and source leveling applications. The HP 11667A operates from dc to 18 GHz with output match >17 dB and tracking <0.25 dB. The HP 11667B operates from dc to 26.5 GHz and has output source match >18 dB and tracking <0.4 dB. The HP 11667C operates from dc to 50 GHz and has an output source match >12 dB and tracking <0.4 dB. Detailed specifications are on page 217.

HP 11636A/B Power Dividers/Combiners

The HP 11636A/B are two-way, three-resistor power dividers for use in non-ratio measurements. They can also be used as power combiners for combining two independent signals. They are ideal for fault location measurements made with the HP 8757S and the HP 85016A software.

Frequency Range

HP 11636A: DC to 18 GHz.

HP 11636B: DC to 26.5 GHz.

Impedance: 50 ohms nominal.

Insertion loss: 6 dB nominal.

	DC-10 GHz	DC-18 GHz	DC-26.5 GHz
Input SWR			
HP 11636A	<1.25	<1.35	
HP 11636B	<1.22	<1.29	<1.29
Output SWR			
(non-ratio measurements)			
HP 11636A	<1.25	<1.35	
HP 11636B	<1.22	<1.29	<1.29
Output Tracking			
(between output arms)			
HP 11636A	<0.4 dB	<0.5 dB	
HP 11636B	<0.25 dB	<0.25 dB	<0.5 dB
Typical Phase Tracking			
(between output arms)			
HP 11636A	2°	2°	
HP 11636B	2°	2.5°	3°
Maximum Input Power			
HP 11636A +30 dBm			
HP 11636B +27 dBm			
Connectors			
HP 11636A: Type N male input port, female output ports.			
HP 11636B: APC-3.5 female on all ports.			
Dimensions			
HP 11636A: 42 H x 45 W x 18 mm D (1.64 x 1.75 x 0.69 in.)			
HP 11636B: 40 H x 47 W x 10 mm D (1.6 x 1.9 x 0.4 in.)			
Weight			
HP 11636A: net, 0.14 kg (0.31 lb); shipping, 0.45 kg (1 lb)			
HP 11636B: net, 0.06 kg (0.13 lb); shipping, 0.14 kg (0.3 lb)			

Ordering Information

	Price
HP 8721 Directional Bridge	\$325
Option 008: 75 Ohm Version	add \$50
HP 85044A 50 Ohm Transmission Reflection Test Set	\$3,200
HP 85044B 75 Ohm Transmission Reflection Test Set	\$3,700
HP 11850C 50 Ohm Power Splitter	\$930
HP 11850D 75 Ohm Power Splitter	\$1,400
HP 11667A Power Splitter (DC - 18GHz)	\$930
Option 001: Type N Male Input, Type N Female Outputs	N/C
Option 002: Type N Female Input, APC-7 On Outputs	add \$75
HP 11667B Power Splitter (DC - 26.5 GHz)	\$995
HP 11636A Power Divider (DC - 18 GHz)	\$500
HP 11636B Power Divider (DC - 26.5 GHz)	\$995

MICROWAVE TEST ACCESSORIES

Coaxial Fixed Attenuators

Models 8490D, 8491A/B, 8492A, 8493A/B/C, 8498A, 11581/2/3A/3C, 33340A/B/C/D

- Flat frequency response
- Low SWR
- Specifications traceable to NBS



HP 11581A

HP 8490D, 8491A/B, 8492A, 8493A/B/C Fixed Attenuators

Hewlett-Packard coaxial fixed attenuators provide precision attenuation, flat frequency response, low SWR over broad frequency ranges (dc-50.0 GHz) at low prices. Attenuators are available in nominal attenuations of 3-dB and 6-dB, also 10-dB increments from 10 dB to 60 dB. These attenuators are swept-frequency tested to ensure meeting specifications at all frequencies. Calibration points are provided on a nameplate chart attached to each unit.

HP 11581A, 11582A, 11583A/C Attenuator Sets

A set of four Hewlett-Packard attenuators—3, 6, 10 and 20 dB—are furnished in a handsome walnut accessory case. The HP 11581A set consists of HP 8491A Attenuators; the HP 11582A set, HP 8491B Attenuators; the HP 11583A set, HP 8492A Attenuators; and the HP 11583C set, HP 8493C Attenuators. The set includes calibration reports certified traceable to the National Institute of Standards and Technology, containing both the attenuation and the reflection coefficients for each attenuator at the frequencies indicated under "Option 890" calibration data on the next page. Thus it is not required to specify Option 890.

These sets are ideal for calibration labs or where precise knowledge of attenuation and SWR is desired.

HP 8498A High Power Attenuator

The HP 8498A Option 030 is designed to meet the needs of high power attenuation applications in the RF and microwave frequency range. It is specified from dc to 18 GHz at 25 watts average, 500 watts peak, from dc to 5.8 GHz and 125 watts peak from 5.8 to 18 GHz. Available only in a 30 dB model (option 030), the unit offers low SWR (<1.30 at 18 GHz) and good accuracy (± 1 dB at 18 GHz). The unit also features 'human engineered' cooling fins that prevent operator burns even under continuous maximum input power conditions.



HP 33340C

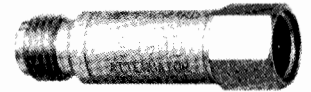

HP 8490D

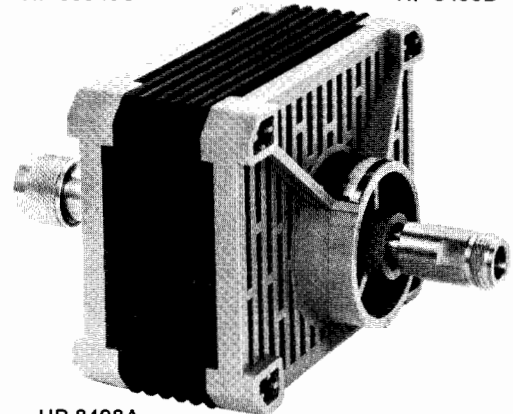

HP 8498A
Option 030

Option 890 Calibration Data

Extensive calibration data is available on HP attenuators at low cost. When option 890 is specified for the fixed attenuators or microwave step attenuators, standardized calibration data in frequency steps no larger than 500 MHz is provided over the frequency range of the units. This data is generated from measurements made on an HP 8510 Automatic Network Analyzer and features excellent accuracy (traceable to NIST) and low cost. Data is given for attenuation and the SWR (reflection coefficient for the HP 8493C) of each port and is provided in a protective plastic envelope.

Calibration data has important uses in applications such as RF substitution measurements and test system verification. Using the actual calibration data rather than data sheet specifications allows the attenuation uncertainty to be reduced 60% or more. Also, the calculated mismatch uncertainty for a test system is lower if the actual SWR data for the attenuators is used. Similar calibration data is used in HP production areas to verify the performance of manual and automated test systems. For automated system checkout, the calibrated unit is tested and the results are compared to the previously stored calibration data. If the differences are within the measurement uncertainty, proper operation is ensured. For step attenuators, the calibration data can be used in automated test systems to more accurately characterize a device's characteristics. By storing the calibration data for the individual steps, the measurement results can be adjusted by the actual amount of attenuation (for example, when a nominal 10 dB step is actually 9.6 dB).

The calibration data frequencies, prices, and ordering information for fixed attenuators are on the next page.

HP 33340A/B/C/D Fixed Attenuators

The HP 33340A, 33340B, 33340C, and 33340D are Coaxial Fixed Attenuators intended for OEM and systems use. Frequency range specifications are dc—12.4 GHz, dc—18 GHz, dc—26.5 GHz and dc—50 GHz respectively. These OEM attenuators are similar to the HP 8493 and HP 8490 Series Attenuators.

For more information regarding the HP 33340 series refer to the data sheet (5952-8279).

Ordering Information

	Price*
HP 33340A Coaxial Fixed Attenuator (SMA)	\$90
Option 890	+ \$20
HP 33340B Coaxial Fixed Attenuator (SMA)	\$120
Option 890	+ \$25
HP 33340C Coaxial Fixed Attenuator (APC-3.5)	\$250
Option 890	+ \$40
HP 33340D Coaxial Fixed Attenuator (2.4 mm)	\$375

*Note: Prices are for quantities of 1-9. OEM discounts are available.



HP 8491A/B series



HP 8492 series



HP 8493A/B/C series

Ordering Example

Include appropriate frequency range/connector and attenuation designations from the ordering example below with every attenuator order.

Calibration Data

Include "Option 890" or "Option 894" in addition to attenuation option when ordering calibration data.

8491B Option 010 Option 890 or 894

Connectors and Frequency Range

0D: 2.4mm (m,f), dc-50.0 GHz

1A: Type N (m,f), dc-12.4 GHz

1B: Type N (m,f), dc-18 GHz

2A: APC-7, dc-18 GHz

3A: SMA (m,f), dc-12.4 GHz

3B: SMA (m,f), dc-18 GHz

3C: APC 3.5 (m,f), dc-26.5 GHz

8A: Type N (m,f), dc-18 GHz

8498 is available in a 30 dB model only

* Not available for HP 8493A/B

** Not available for HP 8493C and HP 8490D

Attenuation

003: 3 dB

006: 6 dB

010: 10 dB

020: 20 dB

030: 30 dB

040: 40 dB*

050: 50 dB**

060: 60 dB**

Option 890 Example

HEWLETT PACKARD CALIBRATION REPORT				
MODEL: 8493B DPT 006/890	SER NO: 02521			
DATE: 11-08-85	TECHNICIAN: 33806			
HERE SYSTEM: 8542E SYSTEM A				
PORT IDENTIFICATION: With the label facing the user, PORT 1 is on the left and PORT 2 is on the right.				
FREQUENCY (MHZ)	ATTENUATION (DB)	SWR PORT 1	SWR PORT 2	
100.00	5.84	1.004	1.009	
300.00	5.85	1.005	1.009	
500.00	5.86	1.005	1.009	
700.00	5.85	1.005	1.010	
900.00	5.87	1.006		
1000.00	5.86	1.006		
1250.00	5.89			
1500.00	5.91			
1750.00				
2000.00				

Ordering Information

- HP 11581A** 3, 6, 10, 20 dB HP 8491A set
- HP 11582A** 3, 6, 10, 20 dB HP 8491B set
- HP 11583A** 3, 6, 10, 20 dB HP 8492A set
- HP 11583C** 3, 6, 10, 20 dB HP 8493C set

Price

- \$450
- \$550
- \$1,050
- \$950

HP 8490D, 8491A/B, 8492A, 8493A/B/C, 8498A, Option 890 Specifications

HP Model	Frequency Range GHz	SWR Maximum	Maximum Input Power	Attenuation Accuracy								Connector	Price (Specify option)
				3 dB (Option 003)	6 dB (Option 006)	10 dB (Option 010)	20 dB (Option 020)	30 dB (Option 030)	40 dB (Option 040)	50 dB (Option 050)	60 dB (Option 060)		
8490D	dc-50.0	dc-8 GHz: 1.1 8-12.4 GHz: 1.15 12.4-26.5 GHz: 1.25 (1.27 Opt.006)	2 W Avg. 100 W Peak	±0.5 dB dc-18 GHz	±0.6 dB	±0.3 dB	±0.5 dB	±0.7 dB	±1.0 dB	-	-	APC 2.4 (m.f)	\$375
8491A 3-30 dB	dc-12.4	dc-8 GHz: 1.2 8-12.4 GHz: 1.3	2 W Avg. 100 W Peak	±0.3 dB	±0.4 dB	±0.6 dB	±0.6 dB	±1 dB	-	-	-	N(m,f)	\$125
40-60 dB				-	-	-	-	-	±1.5 dB	±1.5 dB	±2 dB		\$175
8491B 3-30 dB	dc-18	dc-8 GHz: 1.2 8-12.4 GHz: 1.3 12.4-18 GHz: 1.5	2 W Avg. 100 W Peak	±0.3 dB dc-12.4 GHz ±0.4 dB 12.4-18 GHz	±0.4 dB dc-12.4 GHz ±0.5 dB 12.4-18 GHz	±0.6 dB	±0.6 dB dc-12.4 GHz ±1.0 dB 12.4-18 GHz	±1 dB	-	-	-	N(m,f)	\$150
40-60 dB				-	-	-	-	-	±1.5 dB	±1.5 dB	±2 dB		\$210
8492A 3-30 dB	dc-18	dc-8 GHz: 1.15 dc-12.4 GHz: 1.25 12.4-18 GHz: 1.35	2 W Avg. 100 W Peak	±0.3 dB dc-12.4 GHz ±0.4 dB 12.4-18 GHz	±0.4 dB dc-12.4 GHz ±0.5 dB 12.4-18 GHz	±0.6 dB	±0.6 dB dc-12.4 GHz ±1.0 dB 12.4-18 GHz	±1 dB	-	-	-	APC-7	\$275
40-60 dB				-	-	-	-	-	±1.5 dB	±1.5 dB	±2 dB		\$340
8493A 3-20 dB	dc-12.4	dc-8 GHz: 1.2 8-12.4 GHz: 1.3	2 W Avg. 100 W Peak	±0.3 dB	±0.4 dB	±0.6 dB	±0.6 dB	-	-	-	-	SMA (m,f)	\$120
30 dB				-	-	-	-	±1 dB	-	-	-		
8493B 3-20 dB	dc-18	dc-8 GHz: 1.2 8-12.4 GHz: 1.3 12.4-18 GHz: 1.5	2 W Avg. 100 W Peak	±0.3 dB dc-12.4 GHz ±0.4 dB 12.4-18 GHz	±0.4 dB dc-12.4 GHz ±0.5 dB 12.4-18 GHz	±0.6 dB	±0.6 dB dc-12.4 GHz ±1.0 dB 12.4-18 GHz	-	-	-	-	SMA(m,f)	\$145
30 dB				-	-	-	-	±1 dB	-	-	-		
8493C	dc-26.5	dc-8 GHz: 1.1 8-12.4 GHz: 1.15 12.4-26.5 GHz: 1.25 (1.27 Opt. 006)	2 W Avg. 100 W Peak	±0.5 dB dc-18 GHz	±0.6 dB	±0.3 dB	±0.5 dB	±0.7 dB	±1.0 dB	-	-	APC 3.5 (m.f)	\$250
				±1.0 dB 18-26.5 GHz	±0.6 dB	±0.5 dB	±0.6 dB	±1.0 dB	±1.3 dB	-	-		
8498A Option 030	dc-18	dc-2 GHz: 1.1 2-12.4 GHz: 1.2 12.4-18 GHz: 1.35	25 W Avg. 500 W Peak (dc-5.8 GHz) 125 W Peak (5.8-18 GHz) 500 watt-µs max. per pulse	-	-	-	-	±1 dB	-	-	-	N(m,f)	\$975
Option 890 Calibration Data		HP Models		Calibration Frequencies (MHz)								Option 890 Price	
		8491A, 8493A		.2 GHz to 12.4 GHz in 200 MHz steps								add \$20	
		8491B, 8492A, 8493B, 8498A		.2 GHz to 18.0 GHz in 200 MHz steps								add \$25	
		8493C		1.5 GHz to 26.5 GHz in 250 MHz steps								add \$40	

☎ Fast-Ship product — see page 734.

MICROWAVE TEST ACCESSORIES

Coaxial Step Attenuators

HP 355 Series, 8494/5/6/7 Series, 11716 Series, 33320 Series

- Excellent repeatability
- Manual and programmable

- Calibration data available
- Five million cycles per section reliability

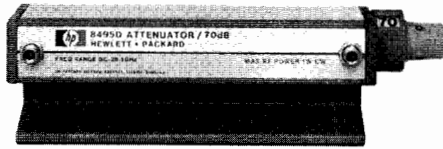

HP 8495D

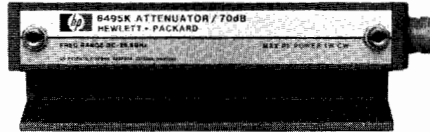

HP 8495K

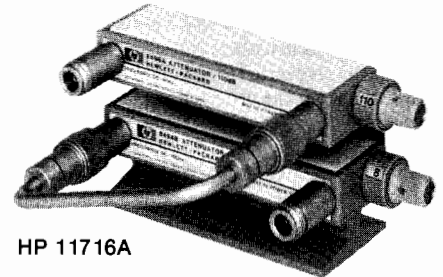

HP 11716A



HP 355C/D/E/F Manual and Programmable Step Attenuators, dc to 1000 MHz

Precision attenuation from dc to 1000 MHz is available with the Hewlett-Packard 355 series attenuators. HP 355C/E models provide 0 to 12 dB in 1-dB steps, and models HP 355D/F provide 0 to 120 dB in 10-dB steps. For the HP 355E and 355F models, attenuation programming is done through a 7-pin connector. All standard models are equipped with BNC connectors.

HP 8494A/B/G/H, 8495A/B/D/G/H/K, 8496A/B/G/H, 8497K Manual and Programmable Step Attenuators, dc to 26.5 GHz

Four attenuation ranges are available: 0 to 11 dB in 1-dB steps (HP 8494), 0 to 70 dB in 10-dB steps (HP 8495), 0 to 110 dB in 10-dB steps (HP 8496), and 0 to 90 dB in 10-dB steps (HP 8497). There is a choice of three connectors: Type N (f), SMA (f), and APC-7 (3.5mm on HP 8495D/K and HP 8497K only).

Manual and programmable versions are available, as well as coverage of three frequency ranges: dc-4 GHz, dc-18 GHz and dc-26.5 GHz.

Calibration data (SWR and attenuation) is available on the HP 8494/5/6/7 models as option 890. The data is generated by an automatic network analyzer test system and is given for each step of the attenuator at 14 frequencies (dc-4 GHz models), 47 frequencies (dc-18 GHz models) or 72 frequencies (dc-26.5 GHz models). This data can be used to improve the measurement accuracy in manual and automated test systems.

Each attenuator consists of three or four attenuation sections connected in cascade. Attenuator sections are inserted and removed by cam-actuated edge line contacts. These contacts are gold-plated leaf springs designed for long life (over one million cycles) and high repeatability (typically 0.01 dB).

The G, H, and K programmable models offer the same high performance as the manual models with the addition of fast-switching solenoids. Attenuation programming is done through a 12-pin connector. For ease of connection to the driving circuit, each attenuator is provided with a five-foot cable assembly that includes a mating connector. With the addition of an HP 11713A Attenuator Driver, the attenuators are easily integrated into a Hewlett-Packard Interface Bus (HP-IB) automated system.

Custom Combinations of Attenuators & Switches

Custom step attenuator/switch combinations are possible. Examples can be as simple as adding a SPDT switch to a standard 70 dB attenuator (figure 1) or creating a dual transfer switch (figure 2). See the RF Microwave and mm-Wave Measurement Accessories catalog for more information.

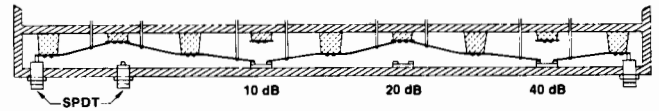

Figure 1. 70 dB plus SPDT.

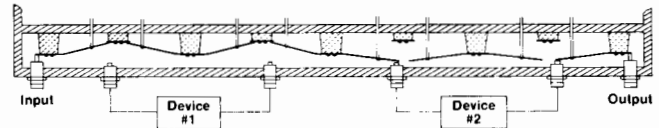

Figure 2. Dual transfer switch showing device #2 inserted in signal path.

HP 11716A/B/C/D Interconnection Kits

Convenient interconnection of 1-dB step and 10-dB step attenuators is provided with HP 11716A/B interconnection kits. These kits consist of a rigid RF cable, a mounting bracket, and the screws required to connect any pair of HP 8494/5/6 attenuators in series (see photo above). Attenuators must be ordered separately. The HP 11716C/D kit connects any pair of HP 84904/6/7 attenuators in series. See the following pages for further details.

Ordering Information

	Price
HP 11716A Interconnection Kit	\$200
HP 11716B Interconnection Kit	\$290
HP 11716C Interconnection Kit	\$135
HP 11716D Interconnection Kit	\$135

HP 33320 Series OEM Step Attenuators

HP 33320 series step attenuators are compact versions of the HP 8494/5/6/7 bench attenuators (same specifications) and are configured for incorporation into microwave systems and instruments. Manual or electronically actuated versions are available. The manual models occupy less than 1.5 square inches of panel space. OEM quantity discounts are available for the HP 33300 and 33320 series. HP 33320 series have a five-million-step reliability guarantee.

Programmable models are supplied with a five-foot cable, fitted with a round 12-pin connector (Viking) that mates with the HP 11713A Attenuator/Switch Driver. A flat ribbon cable with a DIP-type connector, compatible with a standard 14-pin DIP IC socket, is available. For further details, request the RF and Microwave Designer's Guide from your nearest HP sales representative.

How to Order the HP 8494/5/6/7 Series Attenuators

Each order must include basic model number, suffix letter, and connector option.

Optional calibration data.

HP 8494 A Option 001 Option 890

- 4 (1 dB step, 11 dB max)
- 5 (10 dB step, 70 dB max)
- 6 (10 dB step, 110 dB max)
- 7 (10 dB step, 90 dB max)

- A (Manual, dc—4 GHz)
- B (Manual, dc—18 GHz)
- D (Manual, dc—26.5 GHz)*
- G (Programmable, dc—4 GHz)
- H (Programmable, dc—18 GHz)
- K (Programmable, dc—26.5 GHz)*

- 001 (N-Female)
- 002 (SMA Female)
- 003 (APC-7)
- 004 (APC-3.5 Female)*

* Option 004 is only available on 'D' and 'K' models.

HP 355 Series, 8494/5/6/7 Series Specifications

HP Model and (Switching Mode)	Frequency Range (GHz)	Incremental Attenuation (dB)	SWR Maximum (50 Ω Nominal)	Insertion Loss (0 dB setting)	Attenuation Accuracy	Power Rating, Minimum Life	Solenoid Voltage Speed Power	Size, Shipping Weight	Connector Options Available	Price
355C (Manual)	dc—1	0—12 1 dB steps	dc—0.25 GHz: 1.2 dc—0.5 GHz: 1.3 dc—1.0 GHz: 1.5	0.11 dB + 1.39 dB/GHz	±0.1 dB @ 1000 Hz ±0.25 dB: dc—0.5 GHz ±0.35 dB: dc—1.0 GHz	0.5 W avg 350 W peak 0.3 million cycles per section	— 15—18 V <65 ms 3.0 W	67 H × 70 W × 152 mm D (2.6" × 2.75" × 6") 1.4 kg (3 lb)	BNC (f) See Note 1	\$595 \$925
355E (Programmable)										
355D (Manual)	dc—1	0—120 10 dB steps	dc—0.25 GHz: 1.2 dc—0.5 GHz: 1.3 dc—1.0 GHz: 1.5	0.11 dB + 1.39 dB/GHz	±0.3 dB @ 1000 Hz ±1.5 dB to 90 dB, and ±3 dB to 120 dB @ 1 GHz	0.5 W avg 350 W peak 0.3 million cycles per section	— 15—18 V <65 ms 3.0 W	67 H × 70 W × 152 mm D (2.6" × 2.75" × 6") 1.4 kg (3 lb)	BNC (f) See Note 1	\$595 \$925
355F (Programmable)										
8494A (Manual)	dc—4	0—11 1 dB Steps	1.5	0.6 dB + 0.09 dB/GHz	±0.2 dB: 1—2 dB ±0.3 dB: 3—6 dB ±0.4 dB: 7—10 dB ±0.5 dB: 11 dB	1 W avg 100 W peak 10 μs max. 5 million cycles per section	— 20—30 V <20 ms 2.7 W	43 H × 73 W × 159 mm D (1.7" × 2.9" × 6.2") 0.9 kg (2 lb) 43 H × 73 W × 142 mm D (1.7" × 2.9" × 5.6")	001 002 003 See Note 2	\$620 \$845
8494G (Programmable)										
8494B (Manual)	dc—18	0—11 1 dB steps	dc—8 GHz: 1.5 dc—12.4 GHz: 1.6 dc—18 GHz: 1.9	0.6 dB + 0.09 dB/GHz	dc—12.4 GHz ±0.3 dB: 1—2 dB ±0.4 dB: 3—4 dB ±0.5 dB: 5—6 dB ±0.6 dB: 7—10 dB ±0.7 dB: 11 dB dc—18 GHz ±0.7 dB: 1—5 dB ±0.8 dB: 6—9 dB ±0.9 dB: 10—11 dB	1 W avg 100 W peak 10 μs max. 5 million cycles per section	— 20—30 V <20 ms 2.7 W	43 H × 73 W × 159 mm D (1.7" × 2.9" × 6.2") 0.9 kg (2 lb) 43 H × 73 W × 142 mm D (1.7" × 2.9" × 5.6")	001 002 003 See Note 2	\$915 \$1,220
8494H (Programmable)										
8495A (Manual)	dc—4	0—70 10 dB steps	1.35	0.4 db + 0.07 dB/GHz	±1.7% of setting or ±0.4 dB, whichever is greater	1 W avg 100 W peak 10 μs max. 5 million cycles per section	— 20—30 V <20 ms 2.7 W	43 H × 73 W × 130 mm D (1.7" × 2.9" × 5.1") 0.9 kg (2 lb) 43 H × 73 W × 114 mm D (1.7" × 2.9" × 4.5")	001 002 003 See Note 2	\$515 \$720
8495G (Programmable)										
8495B (Manual)	dc—18	0—70 10 dB steps	dc—8 GHz: 1.35 dc—12.4 GHz: 1.5 dc—18 GHz: 1.7	0.4 dB + 0.07 db/GHz	±3%: dc—12.4 GHz ±4%: dc—18 GHz % in dB from Atten. Setting	1 W avg 100 W peak 10 μs max. 5 million cycles per section	— 20—30 V <20 ms 2.7 W	43 H × 73 W × 130 mm D (1.7" × 2.9" × 5.1") 0.9 kg (2 lb) 43 H × 73 W × 114 mm D (1.7" × 2.9" × 4.5")	001 002 003 See Note 2	\$670 \$920
8495H (Programmable)										
8495D (Manual)	dc—26.5	0—70 10 dB steps	dc—6 GHz: 1.25 6—12.4 GHz: 1.45 12.4—18.0 GHz: 1.6 18.0—26.5 GHz: 1.8	0.6 dB + 0.09 dB/GHz	±0.3 dB at 6 GHz 10 dB attenuation to ±2.8 dB at 26.5 GHz 90 dB atten- uation. See Data Sheet 5952-8278 for details.	1 W avg 100 W peak 10 μs max. 5 million cycles per section	— 20-30 V <20 ms 2.7 W	43 H × 52 W × 159 mm D (1.7" × 2.1" × 6.2") 0.9 kg (2 lb) 43 H × 52 W × 168 mm D (1.7" × 2.1" × 6.6")	004 APC-3.5 See Note 2	\$875 \$1,170
8495K (Programmable)										
8496A (Manual)	dc—4	0—110 10 dB steps	1.5	0.6 dB + 0.09 dB/GHz	±1.7% of setting or ±0.4 dB, whichever is greater	1 W avg 100 W peak 10 μs max. 5 million cycles per section	— 20—30 V <20 ms 2.7 W	43 H × 73 W × 159 mm D (1.7" × 2.9" × 6.2") 0.9 kg (2 lb) 43 H × 73 W × 142 mm D (1.7" × 2.9" × 5.6")	001 002 003 See Note 2	\$620 \$845
8496G (Programmable)										
8496B (Manual)	dc—18	0—110 10 dB steps	dc—8 GHz: 1.5 dc—12.4 GHz: 1.6 dc—18 GHz: 1.9	0.6 dB + 0.09 dB/GHz	±3%: dc—12.4 GHz ±4%: dc—18 GHz % in dB from Atten. Setting	1 W avg 100 W peak 10 μs max. 5 million cycles per section	— 20—30 V <20 ms 2.7 W	43 H × 73 W × 159 mm D (1.7" × 2.9" × 6.2") 0.9 kg (2 lb) 43 H × 73 W × 142 mm D (1.7" × 2.9" × 5.6")	001 002 003 See Note 2	\$915 \$1,220
8496H (Programmable)										
8497K (Programmable)	dc—26.5	0—90 10 dB steps	dc—6 GHz: 1.25 6—12.4 GHz: 1.45 12.4—18.0 GHz: 1.6 18.0—26.5 GHz: 1.8	0.6 dB+ 0.09 dB/GHz	±0.3 dB at 6 GHz 10 dB attenuation to ±2.8 dB at 26.5 GHz 90 dB atten- uation. See Data Sheet 5952-8278 for details.	1 W avg 100 W peak 10 μs max. 5 million cycles per section	5 V or 24V	43 H × 52 W × 143 mm D (1.7" × 2.1" × 5.6") 0.9 kg (2 lb)	004 APC-3.5 See Note 2	\$1,320
Option 890 Calibration Data		Option 890 Frequency List (MHz)				Models				Option 890 Price
DC to 4 GHz Models: 100, 300, 500, 700, 900, 1000, 1250, 1500, 1750, 2000, 2500, 3000, 3500, 4000		DC to 26.5 GHz Models every 500 MHz 2 to 16 GHz every 250 MHz 16 to 26.5 GHz				8494A/G, 8496A/G, 33320A/G, 33322A/G 8495A/G, 33321A/G				add \$25 add \$25
DC to 18 GHz Models: Same as above to 4000 MHz, every 500 MHz to 16000 (plus 12400 MHz), every 250 MHz from 16000 to 18000.						8494B/H, 8496B/H, 33320B/H, 33322B/H 8495B/H, 33321B/H 8495D/K, 8497K				add \$35 add \$35 add \$50
Note 1: 355C/D/E/F connector options (BNC (f) standard) Option 001 N(f) Option 005 TNC(f) Option 007 Transistor protection (355E/F only)		Price add \$25 add \$10 add \$55		Note 2: 8494/5/6/7 orders must specify connector option. See ordering example above. Option 001 N(f) Option 002 SMA(f) Option 003 APC-7 Option 004 APC-3.5 (HP 8495D/K, 8497K only)				N/C N/C add \$50 N/C		

Fast-ship product—see page 734.

MICROWAVE TEST ACCESSORIES

40 GHz Programmable Step Attenuators

HP 84904/6/7L



HP 84904/6/7L

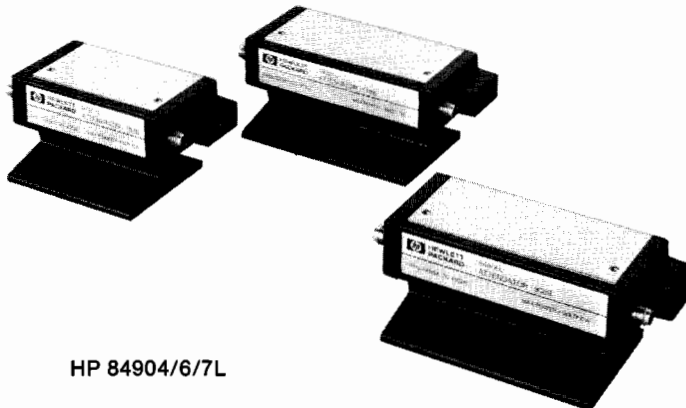

Coaxial Programmable Attenuators

This new HP 84904/6/7L family of programmable step attenuators extends coaxial frequency measurements to 40 GHz in a compact, rugged design. The three initial models in this family are the HP 84906L, which offers outstanding performance across an attenuation range of 0 to 90 dB in 10 dB steps, the HP 84904L, providing 0 to 11 dB of attenuation in 1 dB steps, and the HP 84907L, with 0 to 70 dB of attenuation in 10 dB steps. Two connector types are available. The 2.4mm connector is recommended for rugged and repeatable connections, and the 2.92mm connector is compatible with both SMA and 3.5mm connectors, but is less sturdy than the 2.4mm connector.

These attenuators feature the same solenoids and switching circuits as the HP 8494/5/6/7 step attenuator family. Switching time is a maximum of 20 milliseconds, including contact settling time. Once switched, the units are latched with permanent magnets. In the latched state, they are capable of withstanding mechanical shock in excess of 10 g's without performance degradation. The solenoids automatically disconnect after switching, which minimizes the attenuators' dc power consumption and simplifies the driver circuit design.

The units come equipped with 10-pin DIP plugs (m). Available accessories include 8-inch or 16-inch ribbon cables (HP 11764C, HP 11764D) equipped with 10-pin DIP-type sockets (f) and 14-pin DIP plugs (m) for mating the attenuators to standard 14-pin DIP IC sockets. Alternatively, a five-foot drive cable (HP 11764A) can be used to connect the attenuator to an HP 11713A Attenuator/Switch Driver. The use of the attenuator with the HP 11713A Attenuator/Switch Driver permits easy integration of the attenuator into HP-IB controlled automatic test systems. For custom applications, there is an optional five-foot cable with a 10-pin DIP socket (f) on one end and bare leads on the other.

These attenuators feature extended operating lives (greater than five million switching cycles) and superior repeatability (better than 0.03 dB). Performance data sheets for individual attenuators, which include SWR and attenuation test data, are an available option. This data, measured with an HP Automatic Network Analyzer, can be ordered as option 890.

Equivalent versions of these attenuators for OEM applications are available as model numbers HP 33324L, 33326L and 33327L. For details, request the HP RF and Microwave Designer's Guide from your nearest HP sales representative.

Ordering Information

Attenuators	Price
HP 84904L Attenuator 0-11 dB, 1 dB steps	\$2400
HP 84906L Attenuator 0-90 dB, 10 dB steps	\$2400
HP 84907L Attenuator 0-70 dB, 10 dB steps	\$2200
Opt 006 2.92mm (f) connectors instead of 2.4mm (f)	+\$75
Opt 890 Test Data	\$100

Attenuator Accessories

HP 11764A Interconnect Cable 10-pin socket (f) to "Viking" connector for HP 11713A Attenuator/Switch Driver	+\$10
HP 11764B Interconnect Cable with 10-pin DIP socket (f) and bare leads	+\$10
HP 11764C Interconnect Cable - 203mm (8") ribbon cable, 10-pin DIP socket (f), 14-pin DIP plug (m)	+\$5
HP 11764D Interconnect Cable - 406mm (16") ribbon cable, 10-pin DIP socket (f), 14-pin DIP plug (m)	+\$5
HP 11716C Attenuator Interconnection Kit (2.92mm)	\$135
HP 11716D Attenuator Interconnection Kit (2.4mm)	\$135

HP 84904/6/7L Specifications

HP Model	Frequency Range	Incremental Attenuation	SWR Maximum (50 Nominal) STD and (Opt 006)	Insertion Loss (0 dB Setting)	Attenuation Accuracy de-40 GHz	Sensitivity Power dB/dB/Watt (Temperature dB/dB/°C)	Power Rating, Minimum Life	Solenoid Voltage Speed Power	Shipping Weight	Connector Options Available
84904L	dc to 40 GHz*	0 to 11 dB 1 dB Steps	dc-12.4 GHz: 1.3 (1.5) 12.4-34 GHz: 1.7 (1.9) 34-40 GHz: 1.8 (2.0)	0.8 dB + 0.04 dB/GHz	± 0.6 dB : 1 dB ± 0.6 dB : 2 dB ± 0.7 dB : 3 dB ± 0.7 dB : 4 dB ± 0.7 dB : 5 dB ± 0.8 dB : 6 dB ± 0.9 dB : 7 dB ± 0.9 dB : 8 dB ± 1.0 dB : 9 dB ± 1.1 dB : 10 dB ± 1.2 dB : 11 dB	0.001 (0.0001)	1W Avg 50W Peak 10 µs Max. Pulse Width 5 Million Cycles per Section	20-30V <20 ms 2.7W	291 g. (10.3 oz.)	2.4mm Standard Option 006: SMA Compatible 2.92mm
84906L		0 to 90 dB 10 dB Steps	dc-12.4 GHz: 1.3 (1.5) 12.4-34 GHz: 1.7 (1.9) 34-40 GHz: 1.8 (2.0)	0.8 dB +0.04 dB/GHz	± 0.5 dB : 10 dB ± 0.6 dB : 20 dB ± 0.7 dB : 30 dB ± 1.0 dB : 40 dB ± 1.2 dB : 50 dB				291 g. (10.3 oz.)	
84907L		0 to 70 dB 10 dB Steps	dc-12.4 GHz: 1.25 (1.4) 12.4-34 GHz: 1.5 (1.7) 34-40 GHz: 1.7 (1.9)	0.6 dB + 0.03 dB/GHz	± 1.6 dB : 60 dB ± 1.9 dB : 70 dB ± 2.3 dB : 80 dB ± 2.7 dB : 90 dB				229 g. (8.1 oz.)	

Opt 890 Calibration Data 1.5 GHz to 26.5 GHz every 0.25 GHz; 26.5 GHz to 40 GHz every 0.27 GHz.

* Higher frequency specials available.

MICROWAVE TEST ACCESSORIES

Coaxial Switches

337

HP 8761A/B, 8762B/C, 8763B/C, 8764B/C, 8765A/B/C, 8766/7/8/9 Series

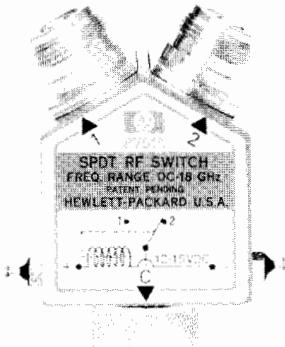

HP 8761A

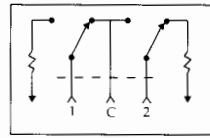

HP 8762 FIG. 1

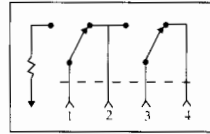

HP 8763 FIG. 2

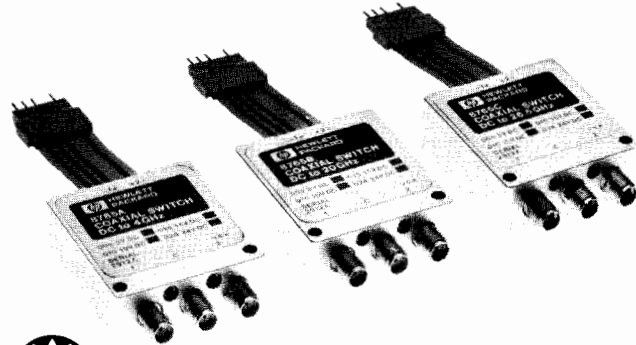

HP 8765A, HP 8765B, HP 8765C

Coaxial Switches

HP coaxial switches feature low SWR, low insertion loss, and excellent isolation. All HP switches use latching solenoids and break-before-make switching circuits.

The HP 8761A/B is an SPDT switch for dc to 18 GHz use. Each port has six connector options plus a 50-ohm termination, making it useful for switching between components with different connector types or for making switch "trees".

The HP 8762B and HP 8762C switches (dc - 18 GHz and dc - 26.5 GHz) are also SPDT type. They feature exceptional isolation of 90 dB to 18 GHz and internally switched 50-ohm loads so that all ports maintain a 50-ohm match. The internal loads are rated for 1 watt average or 100 watts peak (10 μ S pulse width).

The HP 8762/3/4 switches all use latching solenoids and have dc circuit interrupts to cut off the solenoid current when switching is complete.

The HP 8763B and HP 8763C switches (dc - 18 GHz and dc - 26.5 GHz) are used for transfer switching. They can insert or remove a component from a signal path. They can also be used as the intersecting switching elements in a larger microwave matrix. They include one internal 50-ohm switched load.

The HP 8764B and HP 8764C switches (dc - 18 GHz and dc - 26.5 GHz) are five-port switches with essentially the same internal structure as the HP 8762 switches. Elimination of the internal load makes it possible to utilize the extra ports for a variety of purposes, such as adding external high power loads to extend the power handling capability or reversing signal path.

The HP 8765 series switches are single throw double throw switches which offer outstanding performance with a life of 5 million cycles (HP 8765A, dc - 4 GHz; HP 8765B, dc - 20 GHz; and HP 8765C, dc - 26.5 GHz). These new switches are designed for long life and high reliability in mind. They do not have internal switched loads or dc current interrupts, as do the HP 8762B/Cs. Voltage options cover the complete range of 4.5 Vdc to 30 Vdc. The standard HP 8765 comes with a ribbon cable and .025 square inch pins in a single inline connector for convenient connection to the HP 11761A adapter cable or to any other Berg single inline connector package. Solder terminals are also available. Other features include magnetically latching solenoids and configurable solenoid control.

HP-IB Compatible

All of the HP 8760 series of switches can be remotely controlled by the HP-IB interface bus with the HP 11713A Attenuator/Switch Driver, the HP 3235A, or the HP 3488A.

HP 8766/7/8/9 Series Single-pole, Multi-throw Switches

The HP 8766/7/8/9 series switches are modified versions of the coaxial edgeline design (dc to 26.5 GHz) for applications requiring a single-pole, 3-throw, 4-throw, 5-throw, or 6-throw coaxial switch.

These compact switches offer the same reliability, repeatability (typically 0.01 dB), and long life (5 million switching cycles per section) as the HP 8494/5/6/7 series step attenuators from which they are derived.

The switches are fully programmable with HP-IB, using the HP 11713A attenuator/switch driver. The switches are also available with flat ribbon cables and DIP-type connectors compatible with standard 14-pin DIP IC sockets.

Isolation and Insertion Loss

Isolation and insertion loss vary with frequency and depend on the port selected, as shown in the figure and tables below. The input connector 'C' is always defined as the connector at the opposite end from the dc drive cable. The output ports are numbered sequentially from the input connector. For example, if port 3 (the third connector from the input) is selected, the isolation to port 1 and 2 will follow curve A. Isolation to port 4 follows curve B, and isolation to ports 5 and 6 follows curves C and E, respectively. Reading from the isolation chart, the worst case isolation for ports 1 and 2 at 8 GHz is 30 dB; to port 4, 50 dB; to port 5, 70 dB; and to port 6, 100 dB. The important thing to note is that for certain applications, port assignments can be important to optimize performance at higher frequencies.

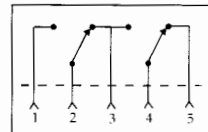

HP 8764 FIG. 3

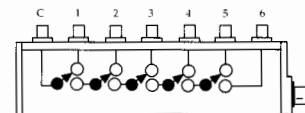
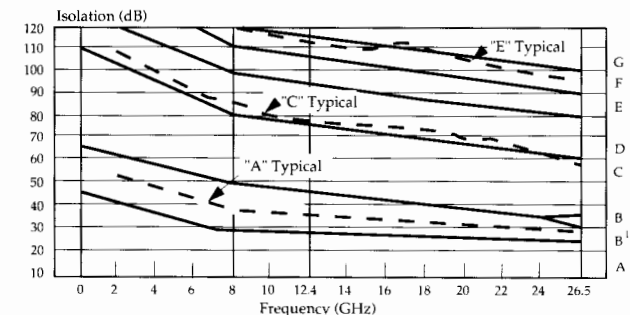

FIG. 4



Isolation Curves

Port Selected	Isolation to Other Ports (See curves A, B, C, D, E, F, G, above)					
	1	2	3	4	5	6
1	—	B	D	E	F	G
2	A	—	B'	D	E	F
3	A	A	—	B	C	E
4	A	A	A	—	A	C
5	A	A	A	A	—	B
6	A	A	A	A	A	—

MICROWAVE TEST ACCESSORIES

Coaxial Switches Product Specifications

HP 8761A/B, 8762B/C, 8763B/C, 8764B/C, 8765A/B/C, 8766/7/8/9K Specifications

HP Model (OEM Model)	Frequency Range (GHz)	SWR 50-ohm Nominal	Insertion Loss	Isolation	Switching speed	RF Connector	Dimensions HxWxD (mm)	Shipping Weight (grams)	Price
HP 8761A SPDT	dc-18	1.2 to 12.4 GHz 1.25 to 18 GHz	0.8 dB @ 18 GHz	>50 dB to 12.4 GHz >45 dB to 18 GHz	35 - 50 msec	See table on page 339	41x38x38	300	\$325
HP 8761B SPDT	dc-18	1.2 to 12.4 GHz 1.25 to 18 GHz	0.8 dB @ 18 GHz	>50 dB to 12.4 GHz >45 dB to 18 GHz	35-50 msec		41x38x38	300	\$325
HP 8762B (33311B) SPDT	dc-18	1.25 to 12.4 GHz 1.5 to 18 GHz	<0.5 dB @ 18 GHz	>90 dB to 18 GHz	30 msec	SMA(f)	54x53x14	220	\$505 ☎
HP 8762C (33311C) SPDT	dc-26.5	1.25 to 12.4 GHz 1.5 to 16 GHz 2.3 to 26.5 GHz	<1.4 dB @ 26.5 GHz	>90 dB to 18 GHz >50 dB to 26.5 GHz	30 msec	3.5mm(f)	54x53x14	220	\$580 ☎
HP 8763B (33312B) 4-Port	dc-18	1.25 to 12.4 GHz 1.5 to 18 GHz	<0.5 dB @ 18 GHz	>90 dB to 18 GHz	30 msec	SMA(f)	54x53x14	220	\$555 ☎
HP 8763C (33312C) 4-Port	dc-26.5	1.25 to 12.4 GHz 1.5 to 16 GHz 2.3 to 26.5 GHz	<1.4 dB @ 26.5 GHz	>90 dB to 18 GHz >50 dB to 26.5 GHz	30 msec	3.5mm(f)	54x53x14	220	\$630 ☎
HP 8764B (33313B) 5-Port	dc-18	1.25 to 12.4 GHz 1.5 to 18 GHz	<0.5 dB @ 18 GHz	>90 dB to 18 GHz	30 msec	SMA(f)	54x53x14	220	\$555 ☎
HP 8764C (33313C) 5-Port	dc-26.5	1.25 to 12.4 GHz 1.5 to 16 GHz 2.3 to 26.5 GHz	<1.4 dB @ 26.5 GHz	>90 dB to 18 GHz >50 dB to 26.5 GHz	30 msec	3.5mm(f)	54x53x14	220	\$630 ☎
HP 8765A (33314A) SPDT	dc-4	1.15 to 2 GHz 1.2 to 4 GHz	<0.18 dB @ 4 GHz	>111 dB to 4 GHz	15 msec	SMA(f)	14x33x45	220	\$190 ☎
HP 8765B (33314B) SPDT	dc-20	1.15 to 2 GHz 1.2 to 4 GHz 1.25 to 12.4 GHz 1.4 to 20 GHz	<0.46 dB @ 20 GHz	>111 dB to 4 GHz >75 dB to 20 GHz	15 msec	SMA(f)	14x33x45	220	\$220 ☎
HP 8765C (33314C) SPDT	dc-26.5	1.15 to 2 GHz 1.2 to 4 GHz 1.25 to 12.4 GHz 1.4 to 18 GHz 1.9 to 26.5 GHz	<0.63 dB @ 26.5 GHz	>111 dB to 4 GHz >75 dB to 20 GHz >60 dB to 26.5 GHz	15 msec	3.5mm(f)	14x33x45	220	\$270 ☎
HP 8766K (33363K) SP3T	dc-26.5; or dc-18 for opt. 002	1.3 to 8 GHz 1.5 to 12.4 GHz 1.6 to 18 GHz 1.8 to 26.5 GHz	Port 1: 0.2 dB + 0.05 dB/GHz Port 2: 0.2 dB + 0.06 dB/GHz		20 msec Max	3.5mm(f)	44.5x81.5x22.9	178	\$625 ☎
HP 8767K (33364K) SP4T	"	"	Port 3: 0.2 dB + 0.08 dB/GHz Port 4:		20 msec Max	3.5mm(f)	44.5x104.9x22.9	235	\$685 ☎
HP 8768K (33365K) SP5T	"	"	0.25 dB + 0.095 dB/GHz Port 5:		20 msec Max	3.5mm(f)	44.5x132.3x22.9	292	\$745 ☎
HP 8769K (33366K) SP6T	"	1.3 to 8 GHz 1.55 to 12.4 GHz 1.8 to 18 GHz 2.05 to 26.5 GHz	0.25 dB + 0.108 dB/GHz Port 6: 0.25 dB + 0.12 dB/GHz		20 msec Max	3.5mm(f)	44.5x160x22.9	349	\$895 ☎

☎ Fast-ship product-see page 734.

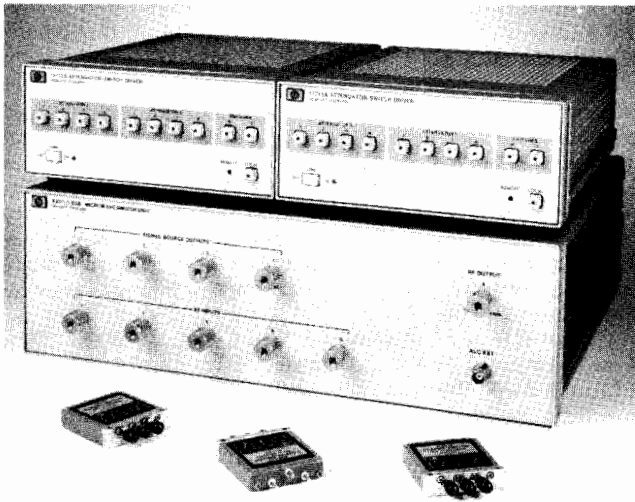

Custom matrix switch.

Ordering Information

HP 8761A/B Coaxial Switch

Specify voltage and connectors (including built-in 50 ohm terminations) by alphabetic suffix on the switch model number and the appropriate three-digit option number. Specify all connectors.

HP 8761A 12 - 15 Volt Solenoids	\$325
HP 8761B 24 - 30 Volt Solenoids	\$325

Connector options: 0 0 1
(see table below) Port 1 Port 2 Port 3

Option Code	Connector Type	Option Code	Connector Type
0	N (f)	4	APC-7 for UT-250 Coax
1	N (m)	5	SMA (f)
2	APC-7	6	SMA (m)
	W/threaded sleeve		
3	APC-7	7	50 ohm termination
	W/coupling nut		

HP 8762B/C, HP 8763B/C, HP 8764B/C Coaxial Switches

Specify frequency and voltage by the alphabetic suffix and option number. The standard model has 24V solenoids.

	Price
HP 8762B SPDT, dc - 18 GHz	\$505
HP 8762C SPDT, dc - 26.5 GHz	\$580
HP 8763B Transfer, dc - 18 GHz	\$555
HP 8763C Transfer, dc - 26.5 GHz	\$630
HP 8764B 5-Port, dc - 18	\$555
HP 8764C 5-Port, dc - 26.5 GHz	\$630
Opt 011 5 Vdc Solenoids	\$0
Opt 015 15 Vdc Solenoids	\$0

HP 8765A/B/C Coaxial Switches

A voltage option must be ordered with the mainframe. Specify frequency, voltage, dc connectors, and ribbon cable extension options by alphabetic suffix and option number.

	Price
HP 8765A SPDT, dc - 4 GHz	\$190
HP 8765B SPDT, dc - 18 GHz	\$220
HP 8765C SPDT, dc - 26.5 GHz	\$270
Opt 005 5 Vdc Solenoids	\$0
Opt 010 10 Vdc Solenoids	\$0
Opt 015 15 Vdc Solenoids	\$0
Opt 024 24 Vdc Solenoids	\$0
Opt 100 Solder Terminals	\$0
Opt 108 8-inch ribbon cable extension	+\$10
Opt 116 16-inch ribbon cable extension	+\$10
Opt 890 Calibration data	
for HP 8765A	\$25
for HP 8765B	\$35
for HP 8765C	\$50

HP 8766K, 8767K, 8768K, 8769K Coaxial Switches

Specify RF connectors (and frequency), solenoid voltages, dc connectors by option number. Standard unit is 24 Vdc, 3.5 mm RF connectors (dc - 26.5 GHz) and viking-type dc connector.

	Price
HP 8766K SP3T multi-port switch	\$625
HP 8767K SP4T multi-port	\$685
HP 8768K SP5T multi-port switch	\$745
HP 8769K SP6T multi-port switch	\$895
Opt 002 Replaces 3.5 mm (m) with SMA (m) connectors	-\$25
Opt 008 8-inch ribbon cable and DIP connector	-\$50
Opt 011 5 Vdc Solenoids	\$0
Opt 015 15 Vdc Solenoids	\$0
Opt 016 16-inch ribbon cable and DIP connector	-\$50
Opt 890 Calibration Data	\$35

Switch Driving Options

The 8760 series of switches are designed to be driven by a variety of switch and attenuator drivers. For more information on those listed, refer to other sections of this catalog.

	Price
HP 11713A Attenuator/Switch Driver	\$1750
HP 11717A Attenuator/Switch Rack Mount Support Kit	\$55
HP 11761A HP 8765 / HP 11713A Adapter Cable	\$35
HP 11764A HP 84904/6/7 to HP 11713A Drive Cable	\$35
HP 11764B HP 84904/6/7 to 5-foot ribbon cable with 14-pin DIP connector	\$10
HP 11764C HP 84904/6/7 to 8-inch ribbon cable with 14-pin DIP connector	\$5
HP 11764D HP 84904/6/7 to 16-inch ribbon cable with 14-pin DIP connector	\$5
HP 44476B Microwave Switch nodule for HP 3488A Holds up to 3 HP 8762/3/4 Opt 005 switches	\$440
HP 34530T Microwave Switch Terminal Block for HP 3235A. Holds up to 4 HP 8762/3/4 switches. Can be used with HP 34350A/B or customer-modified HP 8762/3/4 switches.	\$295

Custom Switch Matrixes

Hewlett-Packard produces custom microwave switch matrixes for ATE systems and communication systems for routing signals to test equipment for testing the integrity of system components.

Matrix switches provide multiple path routing of signals under computer control, and often can include calibration paths for checking system instruments and switching. Hewlett-Packard can also include other components required to build a high-performance solution, including step attenuators, mixers, couplers, power splitters, detectors, power sensors, and noise sources. Each HP matrix is fully documented with a general description, RF and dc schematics, interior parts identifier photos, parts list, drive logic, and operation data.

All HP switching matrixes are custom-configured to meet the specific application. Customers specify requirements for unused ports, connector types, and connector locations. They select the type of matrix: full-access, switch-tree, or common highway. They specify the location of input and output switches and the type of drivers for the switches, whether it is an HP solution such as the HP 11713A, HP 3488A, HP 3235A, or a customer-designed driver.

More information on how to specify and order a custom matrix from Hewlett-Packard is available in Product Note 8760-1 (HP literature number 5959-7860).

HP 11713A Attenuator/Switch Driver

The HP 11713A Attenuator/Switch Driver provides HP-IB control of up to two programmable attenuators of the HP 8494/5/6 or HP 33320/1/2 series and concurrently up to two electromechanical switches (e.g., HP 8761 or HP 8762 series). The HP 11713A can also supply +24V common and ten pairs of current sinking contacts (total current less than 1.25A) to control up to ten relays. No external power supply is needed. The HP 11713A includes an integral power supply (with short circuit protection) that can provide 125 milliamps at 24 volts to all contacts for control of the attenuators and switches. Each HP 11713A is provided with two plug-in drive cables for the programmable attenuators.

The HP 11713A also features convenient front-panel control for manual activation of individual attenuation sections and switches in local mode. Switching time for the drivers is less than 10 milliseconds.

MICROWAVE TEST ACCESSORIES

Coaxial and Waveguide Detectors

HP 423B, 8470 Series, 422 Series

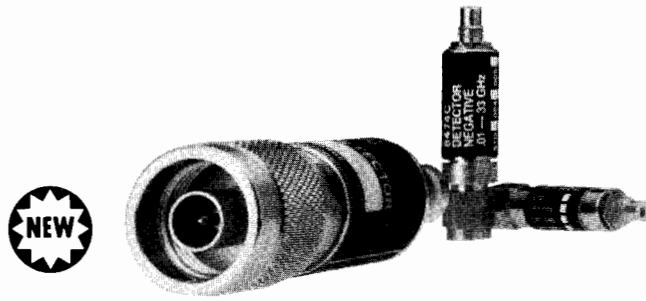

HP 8474A/B/C/D/E

Low Barrier Schottky Diode Detectors

HP 423B, HP 8472B, HP 8473B/C

These LBSD detectors have been widely used for many years in a variety of applications including leveling and power sensing. They offer good performance and ruggedness. Matched pairs (option 001) offer very good detector tracking. A video load option (option 002) extends the square-law region to at least 0.1 mW (-10 dBm).

HP 8471D

The HP 8471D provides coverage from 100 KHz to 2 GHz. It is a LBSD detector with excellent performance at a reasonable price. It is offered with options for positive output (option 103) and optimal square-law load (option 102). For applications requiring a 75 ohm input impedance, option 175 is available.

Planar Doped Barrier Detectors

HP 8473D/E Planar Doped Barrier Detectors

The HP 8473D and 8473E detectors were the first gallium arsenide, planar doped barrier diodes introduced. They feature broadband performance and excellent flatness vs frequency, along with superior temperature stability. The HP 8473D is available with a 3.5mm (m) RF connector and a BNC output connector. The HP 8473E features a 2.4mm (m) RF connector with a BNC output connector.

Specifications and Ordering Information

Low-Barrier Schottky Diode Detectors

HP Model (OEM Equivalent No.)	Frequency Range (GHz)	Frequency Response (dB)	SWR Maximum (50Ω Nom.)	Low Level Sensitivity	Maximum Input (Peak or Average)	Short-Term Maximum Input (<1 Min.)	Option 001 Matched Response	Option 002 Optimum Square-Law Load	Option 003 Positive Polarity Output	Input Connector	Price
HP 423B	.01-12.4 GHz	±0.2/octave to 8 GHz ±0.3 overall	<1.15 to 4 GHz <1.3 to 12.4 GHz	>0.5 mV/uW	200 mW	1W (Typical)	±0.2 dB to 12.4 GHz	Yes	Yes	N(m)	\$245 ☎
HP 8471D (33331D)	.0001-2 GHz	±0.2 to 1 GHz ±0.4 to 2 GHz	<1.23 to 1 GHz <1.46 to 2 GHz	>0.5 mV/uW	200 mW	1W (Typical)	±0.2 dB to 12.4 GHz ±0.3 dB to 18 GHz		Yes	BNC(m)	\$110 ☎
HP 8470B	0.01-18 GHz	±0.2/octave to 8 GHz ±0.3 to 12.4 GHz ±0.6 to 18 GHz	<1.15 to 4 GHz <1.3 to 15 GHz <1.4 to 18 GHz	>0.5 mV/uW	200 mW	1W (Typical)	±0.2 dB to 12.4 GHz ±0.3 dB to 18 GHz	Yes	Yes	APC-7	\$310 ☎
8470B Opt 012										N(m)	-\$10
HP 8472B	0.01-18 GHz	±0.3 to 12.4 GHz ±0.5 to 15 GHz ±0.6 to 18 GHz	<1.2 to 4 GHz <1.35 to 7 GHz <1.5 to 12.4 GHz <1.7 to 18 GHz	>0.5 mV/uW	200 mW	1W (Typical)	±0.2 dB to 12.4 GHz ±0.3 dB to 18 GHz	Yes	Yes	SMA(m)	\$310 ☎
HP 8473B (33330B)	0.01-18 GHz	±0.2/octave to 8 GHz ±0.3 to 12.4 GHz ±0.6 to 18 GHz	<1.2 to 4 GHz <1.5 to 18 GHz	>0.5 mV/uW	200 mW	1W (Typical)	±0.2 dB to 12.4 GHz ±0.3 dB to 18 GHz	No	Yes	3.5mm(m) (Mates w/SMA)	\$320 ☎
HP 8473C (33330C)	0.01-26.5 GHz	Same as 8473B to 8 GHz ±1.5 dB from a -3.3 dB slope from 18 to 26.5 GHz	<1.2 to 4 GHz <1.5 to 18 GHz <2.2 to 26.5 GHz	>0.5 mV/uW	200 mW	1W (Typical)	±0.2 dB to 12.4 GHz ±0.3 dB to 18 GHz ±0.5 dB to 26.5 GHz	No	Yes	3.5mm(m) (Mates w/SMA)	\$360 ☎

☎ Fast-ship product — see page 734.

HP 8474A/B/C/D/E High Performance Planar Doped Barrier Detectors

These detectors are the newest addition to the HP family of high-performance detectors. Utilizing a gallium arsenide, planar doped barrier diode as the detecting element, these detectors offer superior performance when compared to earlier detector designs. They feature extremely flat frequency response over their entire band of operation (typically better than ±1 dB to 50 GHz) and very good frequency response stability versus temperature. For applications where broadband frequency coverage is not required, octave band options are available in specific bands, usually with improved frequency response specifications.

The HP 8474 detectors are available with APC-7 (0.01-18 GHz), Type-N (0.01-18 GHz), 3.5mm (mates with SMA, 0.01-33 GHz), 2.92mm (0.01-40 GHz), or 2.4mm (0.01-50 GHz) connectors. These detectors are offered with options for optimal square-law loads (option 102) and for positive polarity output (option 103). Because the unit-to-unit frequency response tracking of these devices is typically better than ±0.3 dB, no matched response option is offered.

Waveguide Detectors

In addition to coaxial detectors, Hewlett-Packard offers a line of waveguide detectors that cover a portion of the millimeter frequency band. The HP Q422A and HP U422A are silicon, low barrier Schottky diode detectors operating in Q band (33-50 GHz) and U band (40-60 GHz) respectively. They offer good frequency response (±1.5 dB) and SWR (3.0). Each of the standard units comes with negative polarity output, but is available with positive polarity output (option 003).

The HP K422C and HP R422C are GaAs, planar doped barrier diode detectors that offer the same superior performance found in the 8474 family of coaxial detectors. The HP K422C covers the 18-26.5 GHz band, and the HP R422C covers 26.5-40 GHz. They both feature extremely good frequency response (±0.6 dB or better) and excellent SWR (<1.8). Due to their exceptionally flat frequency response, any two standard HP K422Cs or R422Cs can be considered a matched pair. As a result, the matched pair option, option 001, is not offered for these models.

MICROWAVE TEST ACCESSORIES

Coaxial and Waveguide Detectors, Mixers

Models 8470 Series, 422 Series, 11970 Series, 10514/34A

341

Planar Doped Barrier Diode Detectors (OEM Equivalent Model No.)

HP Model	Frequency Range (GHz)	Frequency Response (dB)	SWR Maximum (50Ω Nom.)	Low Level Sensitivity	Maximum Input (Peak or Average)	Short-Term Maximum Input (<1 Min.)	Option 001 Matched Response	Option 002/102 Optimum Square-Law Load	Option 003/103 Positive Polarity Output	Input Connector	Price (\$)
8473D (33330D)	0.01-33 GHz	±0.25 to 12.4 GHz ±0.4 to 26.5 GHz ±1.25 to 33 GHz	<1.2 to 14 GHz <1.36 to 26.5 GHz <2.96 to 33 GHz	>0.45 mV/uW	200 mW	1W (Typical)	Note 1	Note 2	Note 3	3.5mm(m) (Mates w/SMA)	430
8473E (33330E)	0.01-50 GHz	±0.25 to 12.4 GHz ±0.4 to 26.5 GHz ±0.6 to 40 GHz ±1.0 to 50 GHz		>0.45 mV/uW	200 mW	1W (Typical)	Note 1	Note 2	Note 3	2.4mm(m) (Mates w/1.85mm)	575
8474A (33334A)	0.01-18 GHz	±0.35	<1.15 to 4 GHz <1.3 to 15 GHz <1.4 to 18 GHz	>0.45 mV/uW	200 mW	0.75W	Note 1	Note 2	Note 3	APC-7	275
8474B (33334B)	0.01-18 GHz	±0.35	<1.3	>0.45 mV/uW	200 mW	0.75W	Note 1	Note 2	Note 3	N(m)	285
8474C (33334C)	0.01-33 GHz	±0.45 to 26.5 GHz ±0.7 to 33 GHz	<1.4 to 26.5 GHz <2.2 to 33 GHz	>0.45 mV/uW	200 mW	0.75W	Note 1	Note 2	Note 3	3.5mm(m) (Mates w/SMA)	265
8474D (33334D)	0.01-40 GHz	±0.4 to 26.5 GHz ±0.6 to 40 GHz	<1.3 to 26.5 GHz <1.8 to 40 GHz	>0.45 mV/uW	200 mW	0.75W	Note 1	Note 2	Note 3	2.92mm(m) (Mates w/SMA)	375
8474E (33334E)	0.01-50 GHz	±0.4 to 26.5 GHz ±0.6 to 40 GHz ±1.0 to 50 GHz	<1.2 to 26.5 GHz <1.6 to 40 GHz <2.8 to 50 GHz	>0.45 mV/uW	200 mW	0.75W	Note 1	Note 2	Note 3	2.4mm(m) (Mates w/1.85mm)	360

Waveguide Detectors

HP Model	Frequency Range (GHz)	Frequency Response (dB)	SWR Maximum (50Ω Nom.)	Low Level Sensitivity	Maximum Input (Peak or Average)	Short-Term Maximum Input (<1 Min.)	Option 001 Matched Response	Option 002 Optimum Square-Law Load	Option 003 Positive Polarity Output	Input Flange (Equivalent Waveguide)	Price (\$)
K422C	18-26.5 GHz	±0.6	<1.78	>0.42 mV/uW	100 mW	1W (Typical)	Note 1	Note 2	Note 3	UG-595/U MIL-W-85/1-102 (EIA WR-42) (MIL-F-3922/54C-001)	800
R422C	26.5-40 GHz	±0.6	<1.78	>0.42 mV/uW	100 mW	1W (Typical)	Note 1	Note 2	Note 3	UG-599/U MIL-W-85/3-008 (EIA WR-28) (MIL-F-3922/54-003)	800
Q422A	33-50 GHz	±1.5	<2.0	>0.25 mV/uW	100 mW	0.5W	Note 1	Note 2	Yes	UG-383/U MIL-W-85/3-010 (EIA WR-22) (MIL-F-3922/67B-006)	1200
U422A	40-60 GHz	±1.5	<2.0	>0.20 mV/uW	100 mW	0.5W	Note 1	Note 2	Yes	UG-383/U (mod.) MIL-W-85/3-014 (EIA WR-19) (MIL-F-3922/67B-007)	1500

Note 1: Not applicable for HP K422C and R422C. Available as a special option for Q/U422A. Consult an HP representative.

Note 2: Available as a special option on request. Consult your HP representative.

Note 3: Available as a special option on request. Consult your HP representative.

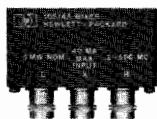

HP 10514A

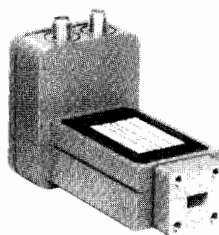

HP 11970 Series

HP 10514A, 10534A Double Balanced Mixers

These mixers are excellent in a variety of mixing applications as well as AM, pulse, and square-wave modulation applications. The careful balancing of the hot carrier diodes in the HP 10514A and 10534A provides excellent output suppression of the local oscillator and input frequencies. Frequency ranges are 0.2-500 MHz for the HP 10514A and 0.05-150 MHz for the HP 10534A. Connectors are BNC.

HP 11970 Series Harmonic Mixers

Although designed for operation with HP spectrum analyzers, these broadband mixers also serve a wide variety of general-purpose uses for the frequency bands from 18 to 110 GHz. Such uses include down-conversion for noise figure and network analysis measurements.

As down-conversion mixers for test receivers, the HP 11970s offer flat response, low SWR, and low conversion loss without requiring bias. These mixers can also serve as harmonic generators with input signals from 2 to 6.1 GHz. Outputs are at the band specified, and each mixer is individually calibrated for conversion loss over its complete band. See page 129 for more technical performance information.

Ordering Information

HP 10514A Double Balanced Mixer (0.2-500 MHz)	\$214.20
HP 10534A Double Balanced Mixer (0.05-150 MHz)	\$153.30

HP 11970 Series Specifications

HP Models	Frequency Range (GHz)	Freq. Response (dB)	Waveguide and Equivalent Flange	Price
11970K	18 - 26.5	±1.9 ±2.1	WR-42 UG-595/U	\$1750
11970A	26.5 - 40	±1.9 ±2.1	WR-28 UG-599/U	\$1800
11970Q	33 - 50	±1.9 ±2/3	WR-22 UG-383/U	\$1950
11970U	40 - 60	±1.9 ±2.3	WR-19 UG-383/U (mod)	\$2200
11970V	50 - 75	±2.1 ±2.5	WR-15 UG-385/U	\$2650
11970W	75 - 110	±3.0	WR-10 UG-385/U (mod)	\$3000

MICROWAVE TEST ACCESSORIES

Coaxial Connector Gage Kits, Blocking Capacitor, Air Line Extensions, Terminations
Models 11752C/D/E, 11742A, 11566/7/A, 908A, 909 Series, 85138A/B

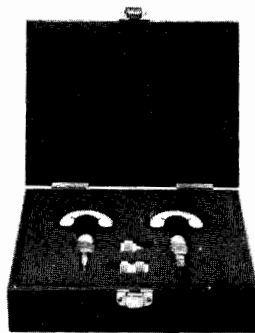

HP 11752



HP 11742A



HP 11566A



HP 909C

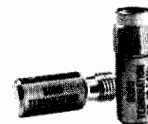

HP 909D

HP 11752C/D/E Coaxial Connector Gage Kits

When using SMA connectors, or the newer 2.4, 2.92, or 3.5mm connectors, pin depth and dielectric control is critical to ensure repeatable measurements and to prevent connector damage. The new HP 11752C SMA Connector Gage Kit joins the other two members of the HP connector gage family. The SMA gage is designed to measure not only pin depth or setback, but also dielectric protrusion. Each gage kit is supplied to make both measurements, on either male (option 001) or female (option 002) connectors. All gages feature rugged mechanical indicators graduated in 0.0001-inch increments for accurate adjustment of center conductor pin depth and dielectric protrusion. Each kit is supplied with a handsome walnut case and a comprehensive user's manual.

The HP 11752D is used for measuring center conductor pin depth on 3.5mm connectors and the HP 11752E measures 2.92 and 2.4mm connectors. Each of these kits contain a male and female gage plus their respective gage set masters.

HP 11742A/E Blocking Capacitor

The HP 11742A is a high performance outside blocking capacitor. It features broadband performance, low SWR (1.2 from .01 to 26.5 GHz) and low insertion loss (.6dB from .01 to 26.5 GHz). The HP 11742A comes with APC-3.5 connectors. It is ideal for use with high frequency oscilloscopes and in bias circuits for the attenuation of low frequencies and D.C. voltages from signal paths where D.C. voltages do not exceed 50V.

HP 11566A, 11567A Air Line Extension

Impedance: 50 ohms.

Frequency: dc-18 GHz.

Reflection coefficient: 0.018 + (0.001 x frequency in GHz).

Connector: APC-7.

Length: 11566A, 10.21 cm (4 in.); 11567A, 20.21 cm (8 in.)

Shipping weight: 0.45 kg (1 lb).

Ordering Information

HP 11752C SMA Connector Gage Kit

Opt 001 Male Pin Depth & Dielectric

Opt 002 Female Pin Depth & Dielectric

HP 11752D 3.5mm Connector Gage Kit

HP 11752E 2.92 & 2.4 mm Connector Gage Kit

HP 11742A Blocking Capacitor

HP 11566A Air Line Extension

HP 11567A Air Line Extension

Price

\$1,200

\$1,200

\$1,300

\$1,400

\$170

\$325

\$375

HP 908A, 909A/C/D/E/F, 85138A/B Coaxial Fixed Terminations (50 and 75 Ω)

The HP 908A, 909A and 909D Terminations are low reflection loads for terminating 50 Ω coaxial systems in their characteristic impedance. The HP 909C (50 Ω) and HP 909E (75 Ω) are precision ultra low reflection terminations intended for use as calibration standards.

HP 908A, 909A/C/D Specifications

HP Model	Frequency Range (GHz)	Impedance (ohms)	SWR	Power Rating	Connector	Price
HP 908A	dc-4	50	1.05	½ W avg. 1 kW pk	N (m)	\$115
HP 909A	dc-18	50	1.05: 0-4 GHz 1.1: 4-12.4 GHz 1.25: 12.4-18 GHz	2 W avg. 300 W pk	APC-7	\$180
HP 909A Opt 012 Opt 013			1.06: 0-4 GHz 1.11: 4-12.4 GHz 1.3: 12.4-18 GHz		Opt. 012 N (m) Opt. 013 N (f)	-\$15
HP 909C	dc-2	50	1.005	½ W avg. 100 W pk	APC-7	\$310
HP 909C Opt 012 Opt 013			1.01		Opt. 012 N (m) Opt. 013 N (f)	-\$25
HP 909C Opt 200	dc-0.2	50	52 dB to 200 MHz	½ W avg. 100 W pk.	Must be ordered with Opt. 012 N (m) or Opt. 013 N(f)	\$0
HP909C Opt 201			1.01		Must be ordered with Opt. 012 N(m)	-\$20
HP 909D	dc-26.5	50	1.02: dc-3 GHz 1.036: 3-6 GHz 1.12: 6-26.5 GHz	2 W avg. 100 W pk	APC-3.5 (m)	\$230
HP 909D Opt 011					Opt. 011 APC-3.5 (f)	\$0
HP 909D Opt 040			1.02:dc-4 GHz 1.036:4-6 GHz 1.12:6-26.5 GHz		APC-3.5 (m)	+ \$15
HP 909E Opt 201	dc-0.2	75	1.01	½ W avg. 100 W pk.	N(m)	\$265
HP 909F	dc-6	50	1.005:dc-5 GHz 1.01:5-6 GHz	½ W 100 W pk.	APC-7	\$325
HP 909F Opt 012	dc-6	50	1.007:dc-2 GHz 1.01:2-3 GHz 1.016:3-6 GHz	½ W 100 W pk.	N(m)	-\$25
HP 909F Opt 013					N(f)	
HP 85138A	dc-50	50	1.22	½ W	2.4 mm (m)	\$475
HP 85138B	dc-50	50	1.22	½ W	2.4 mm (f)	\$525

MICROWAVE TEST ACCESSORIES

Coaxial and Waveguide Terminations

Models HP 905, 910, 911, 914, 920, 921

343

- Precision loads and shorts for measurements to 60 GHz



HP U921A



HP Q914C



HP X910B

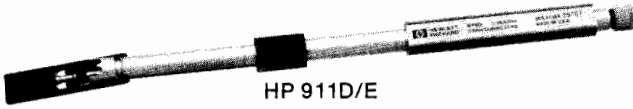

HP 911D/E

HP 911D/E Sliding Loads and 911F/G Sliding Mismatches

The HP 911D/E/F/G family of sliding loads and mismatches represent an advance in calibration and verification of network analyzers. The new loads and mismatches utilize integral male (HP 911D/G) and female (HP 911E/F) connectors to form a near perfect airline without the discontinuities, which cause reflections, associated with changeable connectors. The sliding load element is highly stable, with a reflection coefficient variation of less than .00032 as the location of the element is varied, providing a very accurate and consistent reflection which greatly increases the integrity of a calibration. The sliding mismatches exhibit the same load stability, but provide a higher reflection, as is desired for calibration of scalar network analyzers.

A new center-conductor locking mechanism is used to locate and lock the center conductor reference plane to within .00005" of the outer conductor reference plane. The HP 911D/Gs have a unique nut which was designed to reduce the translation of torque from the nut to the body, reducing the possibility of connector damage.

HP 911D/E/F/G Specifications

HP Model	Freq. Range (GHz)	Moveable Load SWR	Load Stability + Connect & Airline	Power Rating	Length (mm) in.	Shipping Weight	Price
911D (m) Load	3-26	1.066	1.008	1W Avg. 5kW Pk.	(256) 10.1	(.95kg) 2.1 lbs	\$1700
911E (f) Load	3-26	1.066	1.008	1W Avg. 5kW Pk.	(256) 10.1	(.95kg) 2.1 lbs	\$1700
911F (f) Mismatch	3-20 20-26.5	1.1 Norm. 1.083 1.134	1.005 1.008	1W Avg. 5kW Pk.	(256) 10.1	(.95kg) 2.1 lbs	\$1700
911G (m) Mismatch	3-20 20-26.5	1.1 Norm. 1.083 1.134	1.005 1.008	1W Avg. 5kW Pk.	(256) 10.1	(.95kg) 2.1 lbs	\$1700

HP 905A, 911C Coaxial Sliding Loads

The HP 905A is a movable, low reflection 50 Ω loads for precision measurements. It is supplied with three interchangeable connectors, N-male, N-female and APC-7.

The HP 911C is a sliding load designed for 3.5 mm coaxial transmission lines and uses the APC-3.5 connector. This permits mode-free operation to 26.5 GHz. The HP 911C is furnished with interchangeable male and female connectors in a carrying case.

HP 905A, 911A, 911C Specifications

HP Model	Frequency Range (GHz)	Load SWR	Power Rating	Length (mm) in.	Shipping Weight	Price
905A	1.8-18	1.05	1 W avg. 5 kW pk	(440) 17.25	(1.4 kg) 3 lb	\$1000
911C	2-26.5	1.2, 2-10 GHz; 1.07, 10-26.5 GHz	1 W avg. 5 kW pk	(266) 10.5	(1.7 kg) 3.8 lb	\$1550

HP 920C, 921A Waveguide Shorts

The HP R920C, Q920C and U920C are low-loss movable shorts for waveguide systems operating from 26.5 to 60.0 GHz.

The HP R921A, Q921A and U921A are fixed shorts for waveguide systems.

HP 920C, 921A Specifications

HP Model	Frequency Range (GHz)	Type	Waveguide Size EIA	Price
R920C	26.5-40.0	movable	WR28	\$800
Q920C	33.0-50.0	movable	WR22	\$800
U920C	40.0-60.0	movable	WR19	\$810
R921A	26.5-40.0	fixed	WR28	\$ 85
Q921A	33.0-50.0	fixed	WR22	\$ 75
U921A	40.0-60.0	fixed	WR19	\$ 75

HP 910A/B/C, 914B/C Waveguide

Fixed and Movable Terminations

The HP 910A/B/C are fixed terminations for waveguide systems. The HP 914A/B are similar to the HP 910A/B/C, except that their absorptive elements are movable and locking plungers control the position of the elements. HP 914C models use micrometer adjustment.

HP 910A/B/C, 914A/B/C Specifications

HP Model	Frequency Range (GHz)	SWR	Power Rating	Type	Waveguide Size (EIA)	Price
X910B	8.2-12.4	1.015	1 watt	fixed	WR90	\$325
P910A	12.4-18.0	1.02	1 watt	fixed	WR62	\$285
R910A	26.5-40.0	1.03	1 watt	fixed	WR42	\$260
Q910A	33.0-50.0	1.03	1 watt	fixed	WR22	\$275
U910A	40.0-60.0	1.04	1 watt	fixed	WR19	\$275
V910C	50.0-75.0	1.025	0.3 watt	fixed	WR15	\$650
W910C	75.0-110.0	1.03	0.2 watt	fixed	WR10	\$650
X914B	8.2-12.4	1.01	1 watt	sliding	WR90	\$665
P914A	12.4-18.0	1.01	½ watt	sliding	WR62	\$810
K914B	18.0-26.5	1.01	½ watt	sliding	WR42	\$800
R914C	26.5-40.0	1.01	½ watt	sliding	WR28	\$775
Q914C	33.0-50.0	1.01	½ watt	sliding	WR22	\$825
U914C	40.0-60.0	1.01	½ watt	sliding	WR19	\$875

HP 11511A, 11512A, 11565A Coaxial Shorts & Opens

These shorts and opens are used for establishing measurement planes for known reflection phase and magnitude in 50 Ω and 75 Ω coaxial systems for various connectors.

Ordering Information

Model	Price
HP 11511A N-(f) short (50 ohm)	\$60
HP 1250-1531 N-(f) short (75 ohm)	\$44
HP 11512A N-(m) short (50 ohm)	\$60
HP 1250-1530 N-(m) short (75 ohm)	\$55
HP 11565A APC-7 short (50 ohm)	\$110
HP 0960-0054 SMA-(f) short (50 ohm)	\$22.50
HP 0960-0055 SMA-(m) short (50 ohm)	\$11
HP 11652-60001 BNC (m) 50 ohm Termination	\$120
HP 85138A 2.4mm (m) 50 ohm Termination	\$475
HP 85138B 2.4mm (f) 50 ohm Termination	\$525
HP 85140A 2.4mm (m) short	\$250
HP 85140B 2.4mm (f) short	\$275
HP 85141A 2.4mm (m) open	\$275
HP 85141B 2.4mm (f) open	\$300

☎ Fast-Ship product—see page 734.

MICROWAVE TEST ACCESSORIES

Coaxial Single and Dual-Directional Couplers

HP 770 Series, 11691D, 11692D

- Broadband coverage
- High directivity
- Close tracking

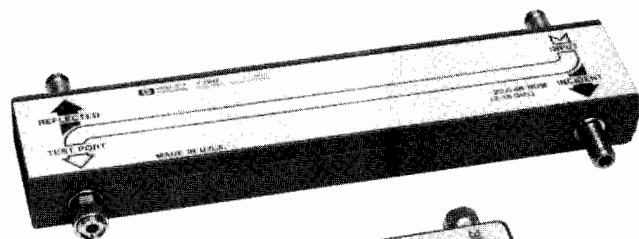

HP 772D

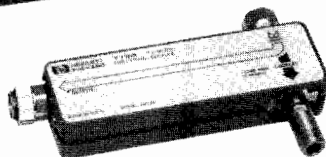

HP 773D

HP 773D Directional Coupler

The HP 773D is a high-directivity coupler for broadband swept measurements in the 2 to 18 GHz frequency range. It is designed to replace several couplers without performance degradation, adding convenience and economy to coaxial microwave measurements by reducing setup and calibration time. Though primarily designed to meet Hewlett-Packard's need for a high-performance coupler for vector network analyzers, the HP 773D is ideal for leveling broadband sources when used with an HP 8474B detector.

HP 779D Directional Coupler

The HP 779D directional coupler spans more than two octaves from 1.7 to 12.4 GHz with excellent directivity. With increased coupling factors (typically 24 dB), the HP 779 is useful down to 500 MHz. Upper frequency usefulness extends to 18 GHz with directivity reduced to about 15 dB. Various connector options are available.

HP 11691D Directional Coupler

The HP 11691D is an ultra-wide-band single directional coupler covering 2 to 18 GHz with high directivity. It is useful as a power monitoring or leveling coupler, or for making reflection measurements. Couplers are preferred over broadband bridges in reflectometer applications in situations where the power level of the source is limited, or where simultaneous measurement of return loss and insertion loss is desired.

HP 773D, 779D, 11691D Specifications

HP Model	Frequency Range (GHz)	Mean Output Coupling (dB)	Output Coupling Variation (dB)	Minimum Directivity (dB)	Equivalent ¹ Source Match	Price
HP 773D	2.0-18	20	±0.9	2-12.4: 30 12.4-18: 27	1.2	\$1,250
HP 779D	1.7-12.4	20 ± 0.5	±0.75	1.7-4 GHz: 30 4-12.4 GHz: 26	1.2	\$1,300
HP 11691D	2-18	22 Nominal	±1.0	2-8 GHz: 30 dB 8-18 GHz: 26 dB	1.2	\$1,895

HP 779D Standard connectors
Primary Line N(m) input, N(f) output; auxiliary arm N(f)

Opt 010 Primary Line N(f) input, N(m) output; auxiliary output N(f)
Other options: APC-7 on any or all ports \$0
Contact HP

HP 11691D and 773D Standard connectors
Primary line: APC-7, APC-7; Auxiliary Arm: N(f)

Opt 001 All N(f) - \$30
Opt 005 (11691D only) All APC-7 + \$25

¹Apparent SWR at the output port of a coupler when used in a closed-loop leveling system.

HP 772D Dual Directional Coupler

The HP 772D is a high-performance dual directional coupler designed for broadband swept reflectometer applications in the 2 to 18 GHz frequency range. When used with HP power sensors and power meters (such as the HP 438A Dual Power Meter), the HP 772D is ideal for forward and reverse power measurements on transmitters, components, or other broadband systems. The broadband design reduces the inconvenience of multiple setups and calibrations necessary with octave band or narrower band couplers.

HP 774D-777D Dual-Directional Couplers (octave bands)

The economical HP 774D-777D couplers cover frequency spreads of more than two-to-one, each centered on one of the important VHF/UHF bands. With their high directivity and a mean coupling accuracy of ±0.5 dB, these couplers are ideal for reflectometer applications. Furthermore, the close tracking of the auxiliary arms makes these couplers particularly useful for reflectometers driven by sweep oscillators such as the HP 8350B with its appropriate plug-in. Power ratings are 50 W average, 500 W peak.

HP 778D, 11692D Dual-Directional Couplers (multi-octave bands)

These couplers are ideal for swept-frequency reflectometer testing of broadband coaxial components. The HP 778D covers 100 MHz to 2 GHz and the HP 11692D covers 2 to 18 GHz. High directivity and close tracking of the auxiliary arms are featured. Various connector options are available. Both couplers handle 50 W average power. Peak power: HP 778D, 500 W; HP 11692D, 250 W.

HP 772D, 774D, 775D, 776D, 777D, 778D, 11692D Specifications

HP Model	Frequency Range (GHz)	Nominal Coupling (dB)	Maximum Coupling Variation (dB)	Minimum Directivity (dB)	SWR Primary Line Maximum (50Ω Nom.)	Price
HP 772D	20-18	20	±0.9	2-12.4: 30 12.4-18: 27	2-12.4: 1.3 12.4-18: 1.4	\$2,350
HP 774D	0.215-0.450	20	±1	40	1.15	\$1,100
HP 775D ¹	0.450-0.940	20	±1	40	1.15	\$1,100
HP 776D ¹	0.940-1.90	20	±1	40	1.15	\$1,100
HP 777D	1.90-4.0	20	±0.4	30	1.2	\$1,190
HP 778D	0.10-2.0	20	±1.5	0.1-1 GHz: 36 ² 1-2 GHz: 32	1.1	\$1,190
HP 11692D	2.0-18.0	22	±1 incident to test port	2-8 GHz: 30 8-18 GHz: 26 ³	2-12.4 GHz: 1.3 12.4-18 GHz: 1.4	\$3,225

HP 774D-777D Standard connectors
Primary Line: N(m), N(f)
Auxiliary Arm: N(f), N(f)

HP 778D Standard connectors
Primary Line: N(m), N(f); Auxiliary Arms: N(f), N(f)

Opt 011 Primary Line, APC-7, N(f) + \$25
Opt 012 Primary Line, N(m), N(f) \$0

HP 772D Standard Connectors
Primary Line: APC-7, APC-7; Auxiliary Arms: N(f)

Opt 001 Primary Line, N(f), N(f) - \$15

HP 11692D Standard connectors
Primary line: N(f), APC-7; Auxiliary Arms: N(f), N(f)

Opt 001 Primary Line, N(f), N(f) - \$15
Opt 002 Primary Line, N(f), N(m) - \$15

¹Maximum auxiliary arm tracking: 0.3 dB for HP 776D; 0.5 dB for HP 777D
²30 dB, 0.1 to 2 GHz, input port.
³24 dB with Type N connector on the test port.

MICROWAVE TEST ACCESSORIES

Frequency Meters, Isolators and Waveguide Directional Couplers

Models 365 Series, 532 Series, 537A, 752 Series

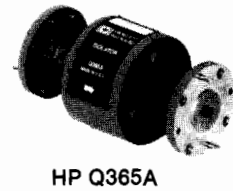
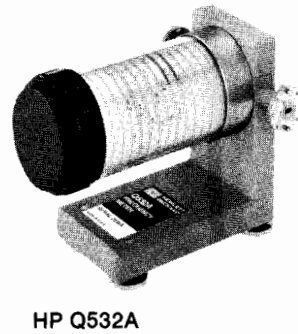
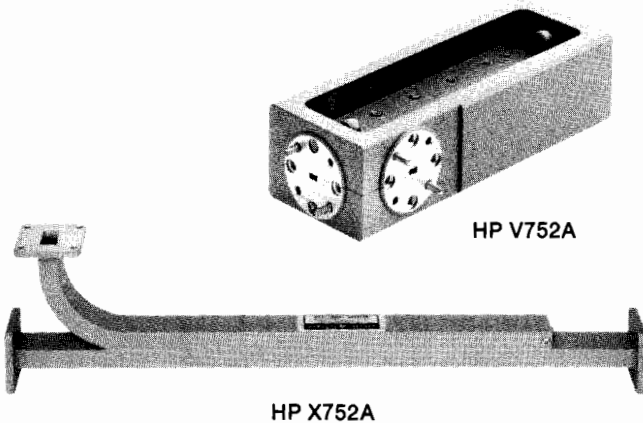

HP 752 Series Waveguide Directional Couplers

The HP 752 series Couplers are specified to meet a wide variety of microwave applications. Every coupler has a minimum directivity of 30 dB over its entire frequency range. Each coupler is swept-frequency tested to ensure that the main guide SWR and directivity specifications are accurate. Performance characteristics are unaffected by humidity, temperature, and time, making these units especially useful in microwave "standards" measurements.

The HP 752 Couplers are an essential part of many waveguide measurement systems. Attenuation measurements, reflectometer setups, power measurements, source leveling and network analysis are just a few areas in which these couplers are used.

HP 752 Series Specifications

HP Model	Frequency Range (GHz)	Nominal Coupling (dB)	Mean Coupling Accuracy (dB)	Maximum Coupling Variation (dB)	Minimum Directivity (dB)	Waveguide & Flange	Price
X752A	8.2-12.4	3	±0.4	±0.6	40	WR90 UG-135/U	\$800
X752C		10					\$835
X752D		20					\$900
P752A	12.4-18.0	3	±0.4	±0.5	40	WR62 UG-419/U	\$825
P752C		10					\$825
P752D		20					\$800
K752A	18.0-26.5	3	±0.7	±0.5	40	WR42 UG-595/U	\$1200
K752C		10					
K752D		20					
R752A	26.5-40.0	3	±0.7	±0.6	40	WR28 UG-599/U	\$1400
R752C		10					
R752D		20					
R752AS	26.5-40.0	3	±0.7	±0.6	40	WR28 UG-599/U	\$915
R752CS		10					
R752DS		20					
Q752A	33.0-50.0	3	±0.7	±0.7	36	WR-22 UG-383/U	\$935
Q752C		10					
Q752D		20					
U752A	40.0-60.0	3	±0.7	±0.7	36	WR-19 UG-383/U (Mod.)	\$955
U752C		10					
U752D		20					
V752C	50.0-75.0	10	±1.0	±1.0	33	WR 15 UG-381/U	\$975
V752D		20					
W752C	75.0-110.0	10	±1.0	±1.0	30	WR 18 UG-387/U (Mod)	\$995
W752D		20					

HP 365A Millimetre-Wave Waveguide Isolators

The HP Q and U365A Isolators use a Faraday-rotation-type design consisting of a section of waveguide containing low-loss ferrite material and impedance matching elements. A permanent magnet supplies the external magnetic bias field to the ferrite core. This results in excellent broadband isolation ratios of at least 25 dB along with low SWR and insertion loss.

HP 365A Waveguide Isolator Specifications

HP Model	Frequency Range (GHz)	SWR (Max.)	Maximum Insertion Loss (dB)	Minimum Isolation (dB)	Maximum Input Power (Avg)	Waveguide & Equivalent Flange	Price
R365A	26.5-40.0	1.4	1.5	25	1.5W	WR-28 UG-599/U	\$900
Q365A	33-50	1.4	1.5			WR-22 UG-383/U	\$1090
U365A	40-60	1.4	1.8			WR-19 UG-383/U(Mod)	\$1275
V365A	50-75	2.0	3.0			WR-15 UG-381/U	\$1575
W365A	75-110	2.0	3.0			WR-10 UG-387/U(Mod)	\$2000

HP 532 Series, 537A Frequency Meters

These direct-reading frequency meters measure frequencies from 33.0 to 60.0 GHz in waveguide and from 3.7 to 12.4 GHz in coax quickly and accurately. Their long scales and numerous calibration marks provide high resolution which is particularly useful when measuring frequency differences or small frequency changes. Frequency is read directly in GHz so neither interpolation nor charts are required.

The instruments comprise a special transmission section with a high-Q resonant cavity which is tuned by a choke plunger. A 1 dB or greater dip in output indicates resonance; virtually full power is transmitted off resonance. Overall accuracy of each frequency meter includes allowance for 0 to 100 percent relative humidity and temperature variation from 13 to 33°C.

HP 532 Series, 537A Specifications

HP Model	Frequency Range (GHz)	Overall Accuracy (%)	Calibration Increment (MHz)	W/G-Coax Equivalent Flange (Connector)	Price
537A	3.7-12.4	0.170	10	Coax Type N(f)	\$1950
Q532A	33.0-50.0	0.12	20	WR-22 UG-383/U	\$2525
U532A	40.0-60.0	0.15		WR-19 UG-383/U (Mod.)	\$2658

MICROWAVE TEST ACCESSORIES

Waveguide Variable, Fixed Attenuators, Stands, Filters

Models 382 Series, 362 Series, 370 Series, 11540 Series

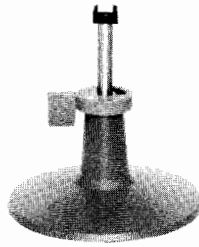

HP Q382A

HP 11540A
HP 11548A

HP X362A

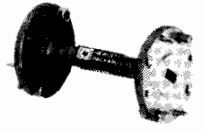

HP Q370A

HP 382 Series Waveguide Attenuators

Operation of these HP 382 series rotary-vane, continuously-variable attenuators depends on a mathematical law rather than on the resistivity of the attenuator card. They are direct-reading and provide accurate attenuation from 0 to 50 dB regardless of temperature and humidity.

HP 382 Series Specifications

HP Model	Frequency Range (GHz)	Accuracy	Attenuation Range (dB)	Waveguide & Equivalent Flange	Price
X382A	8.2-12.4	±2% of reading or 0.1 dB whichever greater	0-50	WR 90 UG-135/U	\$2660
P382A	12.4-18.0	±2% of reading or 0.1 dB whichever greater	0-50	WR 62 UG-419/U	\$2695
K382A	18.0-26.5	±2% of reading or 0.1 dB whichever greater	0-50	WR 42 UG-597/U	\$3700
R382A	26.5-40.0	±2% of reading or 0.1 dB whichever greater	0-50	WR 28 UG-599/U	\$3400
Q382A	33.0-50.0	±2% of reading or 0.1 dB (whichever greater)	0-50	WR-22 UG-383/U	\$2100
U382A	40.0-60.0			WR-19 UG-383/U (Mod.)	\$2150

HP 11540 Series Waveguide Stand, Waveguide Holders

The HP 11540A Waveguide Stand locks HP waveguide holders at any height from 70 to 133 mm (2.75 in. to 5.25 in.). The waveguide holders are offered in five sizes to hold waveguide covering frequencies from 22 to 40 GHz.

Ordering Information

HP 11540A Waveguide stand	Price \$80
HP 11545A X-Band, 11548A R-Band Waveguide holders	each \$50
HP 11546A P-Band, 11547A K-Band, Waveguide holders	each \$50

HP 362 Series Waveguide Low Pass Filters

These Hewlett-Packard low-pass filters facilitate microwave measurements by eliminating undesirable signals (such as harmonics) from the measurement system. Suppression of such signals is particularly important in applications such as broadband reflection and transmission measurements or slotted line measurements where harmonics generated by the signal source could otherwise impair measurement accuracy.

HP 362 Waveguide Low Pass Filter Specifications

HP Model	Passband (GHz)	Stopband (GHz)	Passband Insertion Loss	Stopband Rejection	SWR Maximum	Waveguide Size	Equivalent Flange	Length mm (in)	Shipping Weight kg (lb)	Price
X362A	8.2-12.4	16-37.5	<1 dB	At least 40dB	1.5	WR 90	UG-39/U	136 (5.4)	0.9 (2)	\$1400
P362A	12.4-18.0	23-54			1.5	WR 62	UG-419/U	94 (3.7)	0.37 (13 oz)	\$1250
K362A ¹	18.0-26.5	31-80			1.5	WR 42	UG-595/U	64 (2.5)	0.15 (5.3 oz)	\$1275
R362A ¹	26.5-40.0	47-120	<1 dB	>35 dB	1.7	WR 28	UG-599/U	42 (1.7)	0.11 (4 oz)	\$1500
										\$250

¹Circular Flange Adapters: For K-Band, specify HP 11515A (UG-425/U). For R-Band, specify HP 11516A (UG-381/U).

HP 370A/B/C Millimetre-Wave Fixed Attenuators

The HP Q and U 370 Fixed Attenuators offer precise attenuation, flat frequency response, and low SWR. Their ruggedness, reliability, and small size make them ideal for bench systems applications. They are also useful for general purpose applications, such as reduction of power levels to sensitive components and systems.

HP 370A/B/C Fixed Attenuator Specifications

HP Model	Frequency Range (GHz)	SWR (Max)	Max. Input Power	Attenuation	Attenuation Accuracy	Waveguide & Equivalent Flange	Price
Q370A	33-50	1.2	.5W Avg. 100W Peak	3dB	±0.3dB	WR-22	\$550
Q370B				6dB	±0.6dB		
Q370C				10dB	±0.3dB		
U370A	40-60	1.2	.5W Avg. 100W Peak	3dB	±0.3dB	WR-19	\$575
U370B				6dB	±0.6dB		
U370C				10dB	±0.6dB		

HP 373D/G Millimetre-Wave Fixed Attenuators

The HP R, Q, U, V, and W 373 Precision Fixed Attenuators offer very precise attenuation, flat frequency response, very low SWR, and low attenuation drift with age. The split block design offers this excellent performance in a rugged, reliable package. Intended for use on the bench in applications requiring very precise signal reduction, or where a precise attenuation standard is needed. Available in 20 and 50 dB values.

HP 373D/G Fixed Attenuator Specifications

HP Model	Frequency Range (GHz)	SWR (Max)	Max. Input Power	Attenuation	Attenuation Accuracy	Attenuation Variation	Waveguide & Equivalent Flange	Price
R373D	26.5-40	1.05	.5W Avg. 100W Peak	20dB	±.7dB	±.7dB	WR28	\$700
R373G				50dB			UG-599/U	
Q373D	33-50	1.05	.5W Avg. 100W Peak	20dB	±.7dB	±.7dB	WR22	\$700
Q373G				50dB			UG-383/U	
U373D	40-60	1.05	.5W Avg. 100W Peak	20dB	±.7dB	±.7dB	WR19	\$750
U373G				50dB			UG-383/U(mod)	
V373D	50-75	1.08	.3W Avg. 60W Peak	20dB	±1.0dB	±.7dB	WR15	\$750
V373G				50dB			UG-385/U	
W373D	75-110	1.08	.2W Avg. 40W Avg.	20dB	±1.0dB	±.7dB	WR18	\$750
W373G				50dB			UG-387/U(mod)	

MICROWAVE TEST ACCESSORIES

Adapters, Bends, Twists, Straights, Mismatches

347



HP UV292A



HP Q898A



HP Q899A

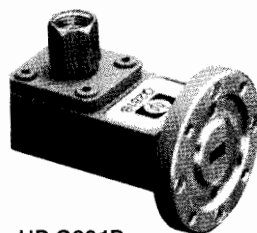

HP Q281B



HP Q897A

HP 281A/B/C, 292A/B, 11515A/6A Coax and Waveguide Adapters

HP 281A Adapters transform waveguide transmission line into 50-ohm coaxial line. The HP 281C family has improved SWR. HP R/Q281 Adapters use the new 2.4 mm coaxial connector capable of non-modifying performance all the way to 50 GHz.

HP 292A/B Waveguide-to-Waveguide Adapters connect two different waveguide sizes with overlapping frequency ranges. HP 11515A/16A adapt circular to rectangular flanges in K-band and R-band.

HP 281A/B/C Specifications

HP Model	SWR	Frequency Range (GHz)	Waveguide Size EIA	Coaxial Connector	W/G Flange UG-() U	Price
S281A	1.25	2.60-3.95	WR284	N (f)	584	\$345
G281A	1.25	3.95-5.85	WR187	N (f)	407	\$295
J281A	1.25	5.30-8.20	WR137	N (f)	441	\$240
H281A	1.25	7.05-10.0	WR112	N (f)	138	\$225
X281A	1.25	8.20-12.4	WR90	N (f)	135	\$215
X281C	1.05	8.20-12.4	WR90	APC-7	135	\$425
Option 012				N (m)		-\$15
Option 013				N (f)		-\$15
P281B	1.25	12.4-18.0	WR62	APC-7	419	\$250
Option 013				N (f)		-\$15
P281C	1.06	12.4-18.0	WR62	APC-7	419	\$435
Option 012				N (m)		-\$15
Option 013				N (f)		-\$15
K281C	1.07	18.0-26.5	WR42	APC-3.5 (f)	597	\$450
Option 012				APC-3.5 (m)		N/C
R281A	1.1	26.5 - 40.0	WR-28	2.4 mm (f)	381	\$850
R281B				2.4 mm (m)		\$800
Q281A	1.1	33.0 - 50.0	WR-22	2.4 mm (f)	383	\$850
Q281B				2.4 mm (m)		\$800

HP 292A/B, 11515A, 11516A Specifications

HP Model	Frequency Range (GHz)	SWR	W/G Size Flange	to	W/G Size Flange	Price
HX292B	8.2-10.0	1.05	WR 112 UG-51/U		WR 90 UG-39/U	\$275
MX292B	10.0-12.4	1.05	WR 75 Cover		WR 90 UG-39/U	\$345
MP292B	12.4-15.0	1.05	WR 75 Cover		WR 62 UG-419/U	\$275
NP292A	15.0-18.0	1.05	WR 51 Cover		WR 62 UG-419/U	\$275
NK292A	18.0-22.0	1.05	WR 51 Cover		WR 42 UG-595/U	\$275
RQ292A	33.0-40.0	1.15	WR-28 UG-381/U		WR-22 UG-383/U	\$470
QU292A	40.0-50.0	1.15	WR-22 UG-383/U		WR-19 UG-383/U(Mod.)	\$500
UV292A	50.0-60.0	1.15	WR-19 UG-383/U(Mod.)		WR-15 UG-385/U	\$490
11515A	18.0-26.5	—	WR 42 UG-425/U		WR 42 UG-595/U	\$250
11516A	26.5-40.0	—	WR 28 UG-381/U		WR 28 UG-599/U	\$250



HP 894, 896, 897, 898, 899 Millimetre-Wave Waveguide Accessories

Waveguide accessories, such as E- & H-Plane bends, twists, and straight sections, are necessary and useful for assembling waveguide measurement systems.

HP offers HP R/Q/U/V/W 897A/B E-Plane and H-Plane bends of 90 degrees. HP R/Q/U/V/W 898A/B twists can be specified for either right rotation (A-Model) or left rotation (B-Model) of 90 degrees. And, finally, several HP R/Q/U/V/W 899A/B straight sections are available in 2.5 and 5.0 cm lengths to fill out the proper dimensions of complicated test set-ups.

Network analysis calibration is verified by measuring a precise and traceable reference impedance. HP's R/Q/U/V/W 896 standard sections and R/Q/U/V/W 894 standard mismatches are this kind of references.

They have very low SWR, less than 1.016. Their impedance is traceable to the National Bureau of Standards, using laser interferometry to accurately measure waveguide dimensions.

The HP Q/U896 have a unique precision flange design. When mating with a standard MIL-spec flange, this design improves repeatability by about a factor of two (when mating two HP precision flanges, repeatability is improved by a factor of five).

HP 897A/B, 898A/B, 899A/B Waveguide Accessories Specifications

Frequency Range (GHz)	Description and HP Model	SWR	W/G	Equiv. Flange	Price
33 - 50 40 - 60	Bends H-Plane Q897A E-Plane Q897B U897A U897B	1.1	WR-22	UG-383/U	180
		1.1	WR-19	UG-383/U(mod)	195
33 - 50 40 - 60 50 - 75 75 - 110	Twists 90° R.H. Q898A 90° L.H. Q898B U898A U898B V898A W898A	1.1	WR-22	UG-383/U	200
		1.1	WR-19	UG-383/U(mod)	185
		1.1	WR-15	UG-385/U	175
		1.15	WR-10	UG-387/U(mod)	175
26.5 - 40 33 - 50 40 - 60 50 - 75 75 - 110	Straights 2.5cm 5cm 10cm R896B R896D Q899A Q899B Q896B Q896D U899A U899B U896B U896D V896B W896B	1.016	WR-28	UG-599/U	\$485
		1.016	WR-28	UG-599/U	\$550
		1.1	WR-22	UG-383/U	\$175
		1.016	WR-22	UG-383/U	\$526
		1.016	WR-22	UG-383/U	\$510
		1.1	WR-19	UG-383/U(mod)	\$185
		1.016	WR-19	UG-383/U(mod)	\$530
		1.02	WR-15	UG-385/U	\$610
		1.03	WR-10	UG-387/U(mod)	\$640
		26.5 - 40 33 - 50 40 - 60 50 - 75 75 - 110	Mismatches 5cm 10cm Mismatch Reflection (each port) R894D Q894D U894D V894B W894B	.25	WR-28
.25	WR-22			UG-383/U	\$510
.25	WR-19			UG-383/U(Mod)	\$530
.25	WR-15			UG-385/U	\$610
.25	WR-10			UG-385/U(Mod)	\$640
.25					

DIMENSIONAL MEASUREMENTS

Laser Interferometry Measurement Systems

HP 5527A, 5528A, VMEbus, 5501A

- High accuracy and resolution
- High stability and repeatability
- Fast axis velocity



HP 5527A system with the new HP 10780C receiver and the new 10780F receiver.

Precision Positioning Products

Hewlett-Packard precision positioning systems combine Michelson interferometry with a highly stabilized, two-frequency HeNe laser to measure linear distance, pitch, roll and yaw, flatness, straightness, squareness and parallelism. These systems also have the capability to compensate for changes in the refractive index of air. The resolution is 10 nm to 2.5 nm (0.4 to 0.1 microinches). Hewlett-Packard's patented two-frequency design makes measurements over distances up to 80 meters (260 feet).

These systems offer a wide selection of measurement optics and electronics that include the new HP 10780F Remote Receiver. The high sensitivity receivers permit measurements in six degrees of freedom. Applications range from OEM precision positioning stages such as IC wafer stepper systems, IC inspection and repair systems, and flat panel systems, to optical and magnetic servo track writers, as well as precision cutting and measuring machines, to general-purpose metrology.

Each system is made up of optics, electronics and laser heads. The optics are common to all systems. The electronics of the HP 5527A, VMEbus, and HP 5501A are designed to be built into precision positioning systems.

The HP 5528A Laser Measurement System is a single axis, easy-to-use, transportable measurement system with a wide range of applications. Examples of its use are fabrication (calibration of machine tools and coordinate measuring machines), manufacturing (precision alignment and positioning), R&D (non-contact measurements), and metrology (calibration of scales, gauges and surface plates).

System Components

HP laser transducer systems use common optics. Only the laser heads and the electronics, differ between systems. Outputs available are position, position error, A quad B, up/down pulse, and motor-drive. The technical data sheet for each system provides detailed information.

The optics and laser head for the HP 5528A are unique to that system but are compatible with the transducer system for special applications.

Laser Heads

Three laser heads are recommended for HP transducer systems; these are the HP 5517A, HP 5517B (250 mm/sec axis velocity), and HP 5501B.

The total accuracy of a transducer system is the sum of the errors from the laser head, the choice of optics, and the effects of the environment. All HP laser heads have a vacuum wavelength accuracy of ± 0.1 ppm (± 0.02 ppm with factory calibration to MIL-STD 45662A) and a demonstrated MTBF greater than 100K hours.

- Multiple optics
- Automatic compensation
- Remote sensing with fiber optics

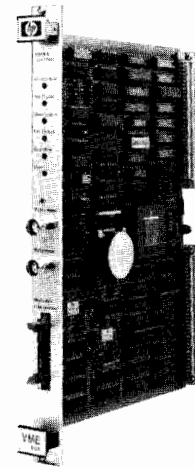

The new HP 10895A VME laser axis board for VME-based systems.

Optics

A variety of optics are available to optimize optical layout for a system. The HP 10702A Linear Interferometer is the basic measurement optic, and it is used with the HP 10703A Retroreflector. The smaller HP 10705A Single Beam Interferometer and the HP 10704A Retroreflector are used where space is limited and low mass is required.

Plane mirror interferometers are normally required for X-Y stages and offer twice the resolution, at half the axis velocity of linear and single beam interferometers. The HP 10706B High Stability Plane Mirror Interferometer is insensitive to thermal effects and thus offers excellent stability. The HP 10715A Differential Interferometer offers the highest thermal stability.

The new HP 10716A High Resolution Plane Mirror interferometer offers twice the resolution (2.5nm) with half the axis velocity of the other plane mirror interferometers.

Electronics

The electronics are the most significant differentiator of the transducer systems. Four basic outputs are available. Both open-loop measurement data and position error data for custom closed-loop positioning are available from all three transducer systems. A-quad-B with up/down pulse outputs, are available with the HP 5501A Transducer System's electronics. Closed-loop in the form of ± 10 V, PWM, and 16-bit binary, are available to drive motor amplifiers. These outputs are found on the HP 10936A Servo-Axis Board which is part of the HP 5527A Transducer System's electronics. Real-time 32-bit position output is available from the HP 10932A Axis Board - also part of the HP 5527A electronics. The new HP 10780C Receiver and the new HP 10780F Remote Receiver each work with all three systems.

Improving Accuracy and Repeatability

Maximum accuracy and repeatability requires compensation for certain parameters. HP laser interferometer systems depend on the high accuracy of the laser's wavelength. However, the wavelength of light in air depends upon the air's refractive index, which is a function of air temperature, pressure, and composition. In addition to the wavelength of light effects, errors can result from thermal expansion of the workpiece. To take full advantage of Hewlett-Packard's high wavelength stability, the HP 10717A Wavelength Tracker compensates for changes in the air's refractive index, and the new HP 10780F Remote Receiver eliminates thermal effects due to the receiver electronics. Product Note 5527A-2, describes in detail how to achieve maximum accuracy and repeatability. Further details on the transducer systems are provided on the following pages.

DIMENSIONAL MEASUREMENTS

Laser Interferometry Measurement Systems

HP 5527A, VMEbus

349

- High axis velocity
- Electronic system test
- Multiple axes measurements

- Servo-loop positioning
- Multiple outputs
- Atmospheric compensation

HP 5527A Laser Position Transducer System

The HP 5527A offers improved system performance with finer resolution, faster axis velocities, remote sensing receivers, and complete servo-control capability. It can be configured for closed or open-loop control, multi-axis capabilities, automatic compensation, and special prototyping abilities for custom electronics.

Electronics

The HP 5527A system electronics combine superior performance with greater ease of use and full EMC compliance. The system is controlled with HP-IB, and three outputs are available, depending on the boards used. The HP 5507A with the HP 10932A Axis Board provides open-loop measurements and position data for custom closed-loop positioning. These outputs are available in 32-bit digital format and via HP-IB. The HP 5507A with the HP 10936A Servo-Axis Board provides open-loop measurements (same as the HP 10932A Axis Board) and closed-loop outputs for various types of motor amplifiers. These closed-loop outputs are $\pm 10V$ analog, 16-Bit digital, and pulse width modulated. The HP 10941A Prototyping Board provides the capabilities for custom electronic designs. The HP 10946B Automatic Compensation Board works with the HP 10717A Wavelength

Tracker or the HP 10751A Air Sensor and the HP 10757A Material Temperature Sensor to automatically compensate for the wavelength of light and temperature effects. The HP 10780C Receiver enables the system to have up to six measurement axes.

Servo Electronics

The HP 10936A Servo-Axis Board provides closed-loop outputs for precision positioning. It is a software-programmable digital servo with built-in motion control algorithms, and it allows the down-loading of custom algorithms. A built-in trace function speeds and simplifies servo loop characterization and position control unique to each system.

VME Electronics

The new HP 10895A Laser Axis Board, compatible with VME Rev. C.1, provides capability similar to the HP 10932A Axis Board. Outputs are position data, in 32-bit format, for closed-loop positioning systems. This VME solution permits easy, cost-effective integration of laser electronics into VMEbus systems.

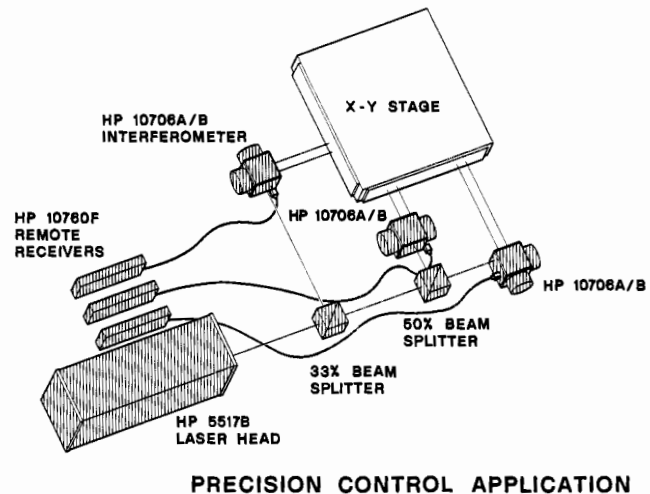
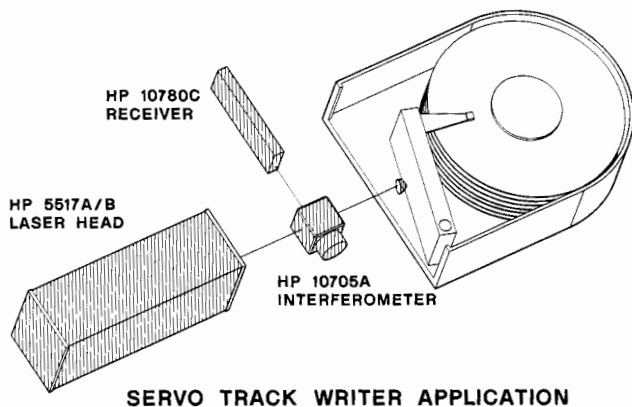

System Specifications

	HP 5527A	VMEbus	HP 5501A
Accuracy			
Vacuum	0.1 ppm	0.1 ppm	0.1 ppm
With MIL STD 45662A	0.02 ppm	0.02 ppm	0.02 ppm
Maximum Resolution			
Linear optics	10 nm	10 nm	10 nm
Plane mirror optics	5 nm	5 nm	5 nm
High resol. optics	2.5 nm	2.5 nm	2.5 nm
Maximum Axis Velocity			
Linear optics	500 mm/sec	500 mm/sec	500 mm/sec
Plane mirror optics	250 mm/sec	250 mm/sec	250 mm/sec
High resol. optics	125 mm/sec	125 mm/sec	125 mm/sec
Maximum Range	40 m	40 m	40 m
Maximum Data Output Rates			
Position/position error	3.3 MHz	3.3 MHz	300 KHz
A quad B	N/A	N/A	1.6 MHz
Up/down pulse	N/A	N/A	22.5 MHz
Motor-drive	8 KHz	N/A	N/A

DIMENSIONAL MEASUREMENTS

Laser Interferometry Measurement Systems (cont'd.)

Ordering Information	5527A	VMEbus	Price			
System Component						
Laser Heads						
HP 5517A Laser Head	X	X	\$6630	HP 10723A High Stability Plane Mirror Converter	X	X \$700
HP 5517B Laser Head	X	X	\$6630	HP 10724A Plane Mirror Reflector	X	X \$575
HP 5501B Laser Head (HP 5501A System)			\$9000	Compensation		
Electronics				HP 10751A Air Sensor - 5m cable, 1 per system	X	\$4400
HP 5507A Transducer Electronics	X		\$4400	HP 10751B Air Sensor - 15m cable	X	\$4500
Opt 032 Axis Board, 1 per axis	X		\$2040	HP 10757A Material Temp. Sensor, 5m cable, 2 per system	X	\$970
Opt 036 Servo-Axis Board, 1 per axis	X		\$4000	HP 10757B Material Temp. Sensor, 10m cable	X	\$1020
Opt 046 Automatic Compensation Board	X		\$1840	HP 10757C Material Temp. Sensor, 20m cable	X	\$1070
HP 10932A Axis Board, 1 per axis	X		\$2450	HP 10717A Wavelength Tracker (requires HP 10780C receiver)	X	\$6730
HP 10936A Servo-Axis Board, 1 per axis	X		\$4200	HP 10946B Automatic Compensation Board	X	\$2240
HP 10941A Prototyping Kit Board	X		\$500	Cabling		
HP 10895A Laser Axis Board for VMEbus		X	\$2750	HP 10790A Receiver Cable 3m cable, 1 per rcvr	X	X \$130
Receivers				HP 10790B Receiver Cable 10m cable	X	X \$160
HP 10780C High Sensitivity Receiver	X	X	\$660	HP 10790C Receiver Cable 20m cable	X	X \$210
HP 10780F Remote Receiver - 2m fiber optic cable*	X	X	\$770	HP 10791A Laser Head Cable 3m cable		X \$380
Optics				HP 10791B Laser Head Cable 7m cable		X \$420
HP 10700A 33% Beam Splitter	X	X	\$610	HP 10791C Laser Head Cable 20m cable		X \$510
HP 10701A 50% Beam Splitter	X	X	\$550	HP 10793A Laser Head Cable 3m cable, 1 per sys	X	X \$230
HP 10702A Linear Interferometer	X	X	\$2040	HP 10793B Laser Head Cable 10m cable	X	X \$255
HP 10702A				HP 10793C Laser Head Cable 20m cable	X	X \$360
Opt 001 Linear Interferometer /windows	X	X	\$2530	Support Literature		
HP 10703A Reflector	X	X	\$610	HP 5527A Designer's Guide Manual		\$100
HP 10704A Reflector	X	X	\$610	HP 5501A Technical Data Sheet		\$0
HP 10705A Single Beam Interferometer	X	X	\$2450	HP 5527A Technical Data Sheet		\$0
HP 10706A Plane Mirror Interferometer	X	X	\$3060	AN 325-10 Sub-Micron Positioning with the HP 5527A Laser Positioning System		\$0
HP 10706B High Stability Plane Mirror Interferometer	X	X	\$3060	AN 325-11 Disk Drive Servo Track Writing with Laser Interferometers		\$0
HP 10707A Beam Bender	X	X	\$450	PN 5527A-1 Rapid Data Collection with the HP 5527A System		\$0
HP 10710A Adjustable Mount	X	X	\$180	PN 5527A-2 Achieving Maximum Accuracy and Repeatability with the HP 5527A System		\$0
HP 10711A Adjustable Mount	X	X	\$200			
HP 10715A Differential Interferometer	X	X	\$4590			
HP 10715A						
Opt 001 Differential Interferometer turned configuration	X	X	\$4590			
HP 10716A High Resolution Interferometer	X	X	\$4500			
HP 10716A						
Opt 001 High Resolution Interferometer turned configuration	X	X	\$4500			
HP 10722A Plane Mirror Converter	X	X	\$560			

NOTE: For complete detailed system configurations use the appropriate technical data sheet for each system. For complete information on HP 5501A system, ask for technical data sheet P/N 5952-7930.

* Additional length cables are available.

DIMENSIONAL MEASUREMENTS

Laser Interferometer Measurement Systems

HP 5528A

351

- Transportable
- Stand Alone
- Easy-to-use
- PC-compatible software

- Optimized for machine tool calibration
- Acceptance testing of new machines
- Multiple measurements
- Long distance measurements

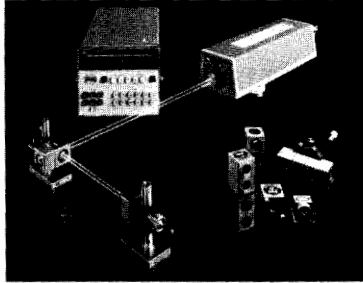

HP 5528A



Machine tool calibration with the HP 5528A

HP 5528A Laser Measurement System

The HP 5528A Laser Measurement System quickly detects and easily measures critical errors in positioning and geometry of precision machines. These measurements include distance and velocity, pitch and yaw, flatness, straightness, squareness and parallelism. The system can be used for machine tools, and it is also used to calibrate coordinate measuring machines, printed-circuit board fabrication equipment, and other precision equipment. Because it does not degrade from wear or aging, the HP 5528A system makes an ideal reference length standard for metrology labs and various R&D applications (non-contact measurements).

Using the HP 5528A Laser Measurement System to completely characterize machines provides the following benefits:

- ensures new machines meet their specifications
- reduces scrap, rework, and inspection cost by increasing the ability to produce repeatable accurate parts.
- reduces preventative maintenance cycles.

Measurement Versatility Through Modular Design

Although the basic HP 5528A measures distance and velocity, additional measurement optics are available for measurement of pitch, yaw, flatness, straightness, squareness, and parallelism. The basic system consists of the HP 5508A Measurement Display, HP 5518A Laser Head, HP 10793A Laser Head Cable, and applicable measurement optics. The following measurement optic kits are available:

- HP 55280A Linear Measurement Kit (distance and velocity)
- HP 55281A Angular Optics Kit (pitch and yaw)
- HP 55282A Flatness Accessory Kit (surface plate flatness)
- HP 55283A Straightness Measurement Kit (straightness and parallelism)
- HP 10777A Optical Square (squareness)

This modular design allows the HP 5528A system to be configured to meet present needs while offering economical expansion in the future.

Measurement and Analysis

The addition of a personal computer and metrology software greatly enhances the capabilities of the HP 5528A system. HP 10754A Dimensional Metrology Analysis Software provides complete data collection, storage, analysis, and print out for system measurements. This software operates on the HP Vectra PC family of computers and others that are compatible with the IBM PC-XT and AT.

The HP 10754A metrology software greatly increases the efficiency of machine tool calibration and other measurements with the Laser Measurement System. The time saved over manual data collection and calculation reduces machine downtime and increases productivity.

Improved Accuracy and Repeatability

With automatic and manual compensation, the HP 5528A system provides increased measurement accuracy and repeatability. The manual compensation consists of measuring air temperature, pressure, and relative humidity, finding the compensation factor that corresponds to these measurements in a look-up table, and then entering this number into the HP 5508A measurement display. Automatic

compensation is provided by the HP 10751A Air Sensor. This device measures air temperature and pressure, calculates the compensation factor and automatically updates the HP 5508A measurement display. Automatic compensation assures maximum measurement accuracy and repeatability in changing environments.

Material temperature compensation is also available to correct for errors induced by thermal expansion of the measured object. Material temperature can be manually entered into the HP 5508A measurement display, or automatically monitored and updated by one to three HP 10757A Material Temperature Sensors.

Specifications

General

- Laser:** two frequency HeNe. 1.0 mW maximum power output.
- Power:** 100, 120, 220, 240 Vac (+5%, -10%), 48-66 Hz, 175 VA maximum.
- Display update rate:** 40 Hz nominal

Distance

- Accuracy:** ± 0.1 parts per million (ppm) in vacuum ± 0.02 ppm in vacuum with factory calibration to MIL-STD 45662 ± 1.7 ppm with HP 10751A Air Sensor (15-25 C)
- Resolution:** $0.01 \mu\text{m}$ (1.0 $\mu\text{in.}$)
- Measurement range:** 40m (130 ft), 80m (260 ft) with C01-5518A Long Range Special
- Measurement velocity:** 27.4 m/min (1080 in./min)

Pitch and Yaw

- Resolution:** 0.1 arc-sec.
- Measurement range:** $\pm 3600^\circ$ arc-sec. ($\pm 1^\circ$ degrees)

Straightness

- Resolution:** $0.01 \mu\text{m}$ (1.0 $\mu\text{in.}$) using short range optics $0.1 \mu\text{m}$ (10.0 $\mu\text{in.}$) using long range optics
- Measurement range:** $\pm 1.5\text{mm}$ (0.060 in.)
- Axial range:** 0.1-3.0 m (0.3-10 ft) using short range optics 1.0-30 m (3.0-100 ft) using long range optics

Ordering Information

	Price
HP 5508A Measurement Display	\$7040
HP 5518A Laser Head	\$7040
HP C01-5518A Long Range Special	\$1500
HP 10751A Air Sensor	\$4400
HP 10753A Tripod	\$1430
HP 10754A Dimensional Metrology Analysis Software	\$1,200
HP 10757A Material Temperature Sensor	\$970
HP 10777A Optical Square	\$4500
HP 10793A Laser Head Cable	\$230
HP 55280A Linear Measurement Kit	\$4400
HP 55281A Angular Optics Kit	\$970
HP 55282A Flatness Accessory Kit	\$2900
HP 55283A Straightness Measurement Kit	\$7400

For detailed information, ask for the following literature:

- HP 5528A Data Sheet
- HP 10754A Data Sheet
- Application Note 325-2 Machine Tool Calibration with the Laser Measurement System

PRESSURE & TEMPERATURE

Quartz Pressure Probe, Quartz Pressure Set, & Pressure Signal Processor Models 2813E/D, 2816A

- 0.001 psi resolution (6,9 Pa)
- High performance

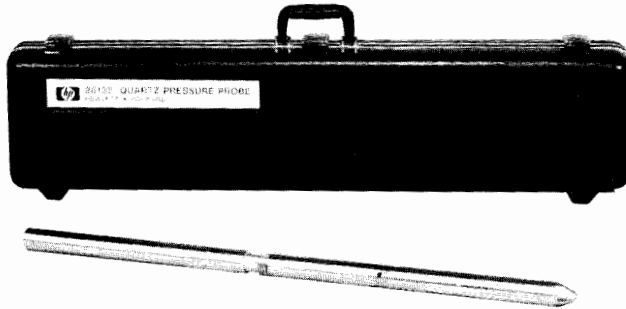

HP 2813E Quartz Pressure Probe

HP 2813E/D Quartz Pressure Probe and Pressure Set

The quartz technology that Hewlett-Packard first introduced to the oil- and gas-well industry in 1970 is still the standard for pressure measurement applications requiring extremely high accuracy, resolution and repeatability. These features, combined with its rugged construction, make the 2813E probe ideally suited for petroleum applications, oceanographic research and subterranean hydrodynamic studies.

High Precision, Resolution and Repeatability

Capable of sensing wellbore pressure changes as small as 0.001 psi, the probe's measurements can be instantly observed and recorded on the surface. With an accuracy better than ± 1.0 psi plus $\pm 0.01\%$ of the pressure reading, the HP 2813E/D gives you confidence in the precision of your measurements. Also, with a repeatability of 0.4 psi over the full calibrated pressure range (200 - 11,000 psia) at constant temperature, you can be confident that changes in successive measurements are due to changes in the well, not probe measurement error.

Advanced Calibration Procedures

Advanced calibration procedures also contribute to the probe's high performance, with each probe being checked at 105 discrete calibration points over its full operating pressure and temperature range. The calibration data is processed by computer to yield coefficients of an equation that describe the relationship between frequency output, applied pressure and temperature.

Faster Thermal Restabilization

Based on the earlier Model HP 2813B/C, the HP 2813E thermally restabilizes four to ten times faster than the HP 2813B/C. This performance, due to a redesigned mechanical package, shortens costly test time.

Higher Temperature Range

Improvements in the sensor crystal's processing have increased the probe's temperature range from 302°F to 350°F.

Rugged and Reliable

Though a precision instrument, the HP 2813E is rugged and reliable in an oil field environment. Housed in a 1 $\frac{1}{16}$ inch OD case made of Nitronic 50 stainless steel, the probe can withstand pressures of up to 12,000 psia and temperatures of up to 350°F.

Easy to Use and Service

The simplicity of the HP 2813E's mechanical design makes it easy to use and service in the field.

Quick Factory Service

Your probe receives immediate attention when we receive it. An exchange set of the reference crystal, sensor crystal and electronics pc board is available, reducing repair time to one week. Standard recalibrations and repairs take four weeks or less.

- Rugged and reliable
- Simple operation



HP 2813D Quartz Pressure Set

Adapt to Your Own Instrumentation System

The reference crystal, sensor crystal and electronics pc board are available as matched components in the HP 2813D Quartz Pressure Set. This enables designing the essential pressure-measuring components of the HP 2813E into your own downhole instrumentation package.

How It Works

The essential pressure-measuring components of the HP 2813E Quartz Pressure Probe are its sensor crystal, reference crystal and electronics pc board. The sensor crystal, which is in direct fluid communication with the well, changes the frequency of its oscillations in response to pressure. The reference crystal, which is protected from applied pressure, subtracts the effects of temperature changes from the sensor crystal's frequency.

The resulting frequency is then transmitted by the electronics pc board through a center conductor, armored-electric line to an HP 2816A Signal Processor on the surface. This processor conditions the pressure-related signal to drive a frequency counter. The counter's signal can then be converted to a pressure reading when processed with the calibration data in a desktop computer.

The sensor crystal's high resolution is essentially constant and independent of operating pressure and temperature. Its stability minimizes hysteresis and zero drift, thus eliminating the need for frequent recalibration.

HP 2816A Signal Processor

Specifically designed to process the pressure-related signal from the HP 2813E/D, this processor conditions the signal to drive a frequency counter. The processed output frequency changes about 105 Hz/psi, allowing a resolution of 0.001 psi. It also supplies dc operating power to the probe through a center conductor, armored-electric line.

HP 2813E/D Specifications

Operating Environment

Calibrated pressure range: 200-11,000 psi (1,38-75,8 MPa).

Calibrated temperature range: 95-350°F (35-177°C).

Static Measurement (pressure and temperature are constant)

Accuracy: ± 1.0 psi (6,9 kPa) (due to curve fit error) + 0.01% of actual pressure (due to calibration system error).

Repeatability: ± 1.0 psi (6,9 kPa) over the entire calibrated pressure and temperature range; or, ± 0.4 psi (2,76 kPa) over the entire calibrated pressure range with temperature held to a single value.

Aging: Error due to aging of sensor and reference crystal pair is typically less than ± 0.5 psi (3,45 kPa) per year.

Temperature uncertainty error: $(\Delta T) * (0.28 \text{ psi} + 0.02\% \text{ of actual pressure in psi})$ for temperature in degrees F.

Resolution: 0.001 psi (6,9 Pa) when sampling for 1 second.

Sensitivity: 105 Hz/psi (15,2 Hz/kPa) nominal at output of HP 2816A Signal Processor. The HP 2816A multiplies the incoming signal from the HP 2813E/D by 72 as part of the signal processing.

Non-Operating Characteristics (HP 2813E)

Outside diameter: 1 $\frac{1}{16}$ in. (37 mm.).

Length: 39.3 in. (998 mm.).

Weight: 11 lb (5 kg).

Static Tensile Pull Strength: > 20,000 lb (9070 kg)

Steel Case Material: Nitronic 50 high strength.

HP 2813E Quartz Pressure Probe	\$25,000
HP 2813D Quartz Pressure Set	\$19,500
HP 2816A Signal Processor	\$3,600

PRESSURE & TEMPERATURE

Quartz Thermometer

Model 2804A

353



HP 2804A

- $\pm 0.04^{\circ}\text{C}$ absolute accuracy
- 0.0001°C or 0.001°F resolution
- -80° to $+250^{\circ}\text{C}$ range
- Display of absolute or differential temperature
- Flexible HP-IB system interface
- Variable resolution analog output
- Easy ice-point or triple-point adjustment



HP 2804A Quartz Thermometer

The HP 2804A Quartz Thermometer allows you to easily measure temperature with exceptionally high accuracy and resolution. Absolute accuracy is ± 40 millidegrees Celsius over the range of -50°C to 150°C , NBS traceable to IPTS-68. The useable resolution of 0.0001°C allows you to measure temperature changes that could not be detected by other digital thermometers.

The HP 2804A can be used with one or two temperature sensing probes. The temperature of either probe, or their difference, can be measured and displayed under pushbutton control. Display resolution is selectable from 0.01 to 0.0001°C (0.1 to 0.001°F) by pushbuttons. An internal switch allows you to easily select measurement in the Celsius or Fahrenheit temperature scale.

Temperature is measured and displayed automatically with the microprocessor and electronics provided in the HP 2804A package. There is no need to balance a bridge, perform calculations using resistance- or voltage-temperature tables or curves, or to use calibration correction tables. The only adjustment necessary to remove effects of thermal history on the sensor is a simple ice point or triple point calibration adjustment using the front panel thumbwheel switches.

How It Works

The HP 2804A temperature sensor is a quartz crystal whose precise angle of cut gives a stable and repeatable relationship between resonant frequency and temperature. Each quartz sensor is individually calibrated at the factory over the full temperature range. The calibration data for each sensor is processed and stored in a calibration module which is supplied with the probe.

In operation, a microprocessor in the thermometer performs the complex control and calculation operations to accurately measure temperature from the quartz sensor frequency and probe calibration information in the calibration module. The microprocessor also performs self-checks to detect fault conditions. If a problem occurs that would give an improper measurement, an error message is displayed to indicate the source of the problem.

System Oriented Design

The HP-IB (standard) offers you a simple, yet flexible, way to connect the Quartz Thermometer to either an HP computing controller or printer. Temperature data can easily be sent to a computer for processing and recording. All front-panel controls can be operated automatically by commands sent on the bus.

The analog output (standard) converts any three consecutive digits to a voltage between 0 and $+10$ volts to drive a chart recorder. Front-panel controls allow easy adjustment of pen zero and full scale as well as normal or offset (center-zero) operation. Any three digits can be selected for conversion, allowing you to change the full scale value on the recorder.

HP 2804A Specifications

Performance

Range: -80 to 250°C .

Absolute accuracy: HP 2804A with HP 18110A, or HP 18111A Quartz Probe —

$\pm 0.040^{\circ}\text{C}$ from -50 to 150°C

$\pm 0.075^{\circ}\text{C}$ from -80 to 250°C

NBS traceable to IPTS-68

Resolution: three levels can be selected:

Level of selection	Resolution		Nominal time between readings in seconds	
	$^{\circ}\text{C}$	$^{\circ}\text{F}$	T1 or T2	T1 - T2
Low	0.01	0.1	0.1	0.2
Medium	0.001	0.01	1	2
High	0.0001	0.001	10	20

General

Display: 7-digit LED with polarity, decimal, and degree C or F annunciator.

Probes: laboratory probes are available for use with the HP 2804A. Refer to the data sheet for specifications and sheath configurations.

Power Required

100, 120, 220, or 240 Vac, $+5\%$ – 10% , 48 to 66 Hz, <30 VA.

Accessories and Probes

	Price
HP 18107A External Oscillator	\$750
HP 18110A Laboratory Probe and cal module, 25 mm (1 in.), Opt 001 Extra Prom	\$2500
HP 18111A Laboratory Probe and cal module, 230 mm (9.1 in.), Opt 001 Extra Prom	\$150
Opt 002 Threaded Probe Connector	\$2500
	\$150
	\$100

HP 2804A Quartz Thermometer

\$7200

SIGNAL GENERATORS

Signal Generators to 110 GHz

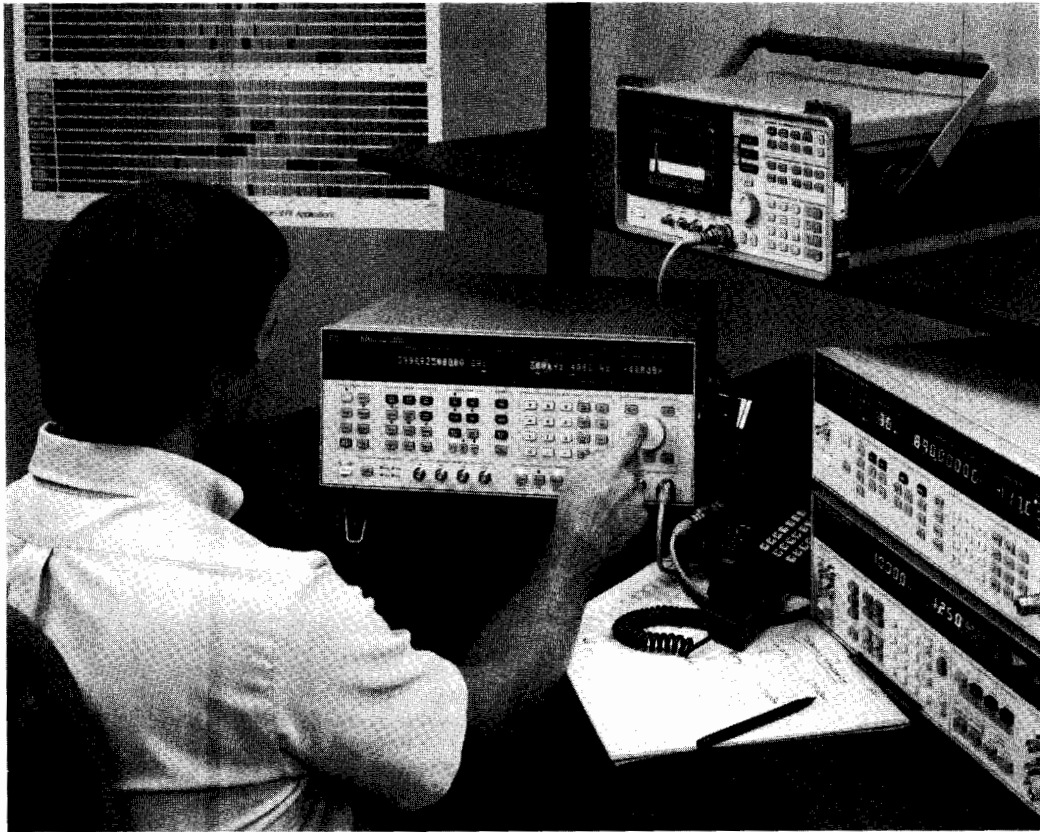

Hewlett-Packard offers the widest selection of high-performance signal sources from dc to 110 GHz. They cover every application range from low-frequency navigation signals through cellular mobile radio, to millimeter-wave satellite systems. Each offers calibrated frequency and level, and a wide range of modulation capabilities.

Signal generators can be mechanically tuned, synthesized, or digitally synthesized. Mechanically-tuned generators combine fundamental cavity-tuned oscillators with solid-state circuitry to yield spectrally pure signals with very good spurious performance and low residual FM. Collectively covering a frequency range from 10 kHz to 26.5 GHz

(and to 110 GHz with multipliers), synthesized signal generators offer programmability, high frequency stability, and accuracy. Modulation capabilities range from AM, FM, ϕ M, and pulse to complex formats such as QPSK, 16- and 64-QAM up to 150 Mbaud.

Signal Generator Summary

Economy RF

Frequency	Model	Characteristics	Page
0.1 to 990 MHz	HP 8656B	Economically priced signal generator. ± 1.0 dB absolute level accuracy from +13 to -127 dBm in 0.1 dB steps. Calibrated AM and FM. Frequency resolution of 10 Hz. Time base aging rate of ± 2 PPM/year.	356
0.1 to 1040 MHz	HP 8657A	Spectral purity and electronic attenuator at an economical price. < -130 dBc/Hz @ 500 MHz SSB phase noise. < -60 dBc spurious. Electronic attenuator. ± 1 dB level accuracy. AM and FM.	358
0.1 to 2060 MHz	HP 8657B	Spectral purity and pulse to 2 GHz at an economical price. < -130 dBc/Hz @ 500 MHz SSB phase noise. < -60 dBc spurious. ± 1 dB level accuracy. AM, FM and pulse with > 90 dB on/off at 1030 MHz.	360

High-Performance RF

0.252 to 1030 MHz 0.252 to 2060 MHz	HP 8644A	Performance signal generator for RF design. < -128 dBc/Hz @ 1 GHz SSB phase noise (< -137 dBc optional). < -100 dBc spurious. AM, FM, pulse modulation. Advanced modulation source. Lowest specified leakage. Avionics option available (Opt. 009).	362
0.1 to 1057.5 MHz 0.1 to 2115 MHz	HP 8642A, 8642B	Broadband spectral purity and FM for phase noise testing. High spectral purity. 1 Hz frequency resolution. ± 1 dB absolute output level accuracy. AM, FM, ϕ M and pulse. Sweep. 2-hour on-site repair.	368
0.01 to 110 MHz 1 to 1300 MHz 1 to 2600 MHz	HP 8660D	Plug-in modules for high-rate/wide-deviation modulation. 1 Hz frequency resolution, 3×10^{-9} /day stability. Calibrated and leveled output from +13 to -146 dBm. HP-IB and BCD programmable. AM, FM, ϕ M, pulse modulation. Plug-ins determine frequency range and modulation capability.	373
0.01 to 1280 MHz	HP 8662A	Low close-in noise. 0.1 Hz frequency resolution, 5×10^{-10} /day stability. Calibrated and leveled output from +13 to -140 dBm. Digital sweep. Completely HP-IB programmable. AM/FM modulation. Fast switching.	370
0.1 to 2560 MHz	HP 8663A	Low close-in noise with complex modulation. 0.1 Hz frequency resolution, 5×10^{-10} /day stability. Calibrated and leveled output from +16 to -130 dBm. Digital sweep. Completely HP-IB programmable. AM, FM, ϕ M, pulse modulation. Fast switching.	370
0.1 to 4.2 GHz	HP 8665A	Performance signal generator for 4.2 GHz testing. Spectral purity to 4.2 GHz. AM and FM. Advanced modulation source.	366

Economy Microwave

Frequency	Model	Characteristics	Page
2 to 12.4 GHz 5.4 to 18 GHz	HP 8673H	High-performance, multiband synthesizers for cost-sensitive applications. 1 to 3 kHz frequency resolution, 5×10^{-10} /day stability. +8 to -100 dBm output, AM, FM and pulse modulation, digital sweep, millimeter capability. Completely HP-IB programmable.	384

CW Microwave

2 to 18 GHz	HP 8671B	Precision CW signals, pure and simple. 1 to 3 kHz frequency resolution, 5×10^{-10} /day stability. +8 to -120 dBm output. Completely HP-IB programmable.	386
2 to 26 GHz	HP 8673G	Digital sweep and mm wave capability add powerful flexibility in CW applications. 1 to 4 kHz frequency resolution, 5×10^{-10} /day stability, 0 to -100 dBm output (+8 dBm with Opt. 008), digital sweep, millimeter capability. Completely HP-IB programmable.	387

High-Performance Microwave

2 to 18 GHz	HP 8672A	Field proven performance and reliability. 1 to 3 kHz frequency resolution, 5×10^{-10} /day stability. Calibrated and leveled output from +3 to -120 dBm. Completely HP-IB programmable. Metered external AM and FM.	392
0.01 to 18 GHz	HP 8672S	Field proven performance and reliability extended down in frequency. 1 to 3 kHz frequency resolution, 5×10^{-10} /day stability. Internal pulse modulator. Calibrated and leveled output from +2 to -120 dBm. Metered external AM and FM. Completely HP-IB programmable.	392
2 to 18 GHz	HP 8673E	Exceptional value in a full feature synthesizer. 1 to 3 kHz frequency resolution, 1.5×10^{-9} /day stability. +8 to -120 dBm output. Pulse, amplitude and frequency modulation. Digital sweep. Completely HP-IB programmable.	391
0.05 to 18.0 GHz 0.05 to 26.0 GHz	HP 8673C, 8673D	State of the art spectral purity for demanding applications in wideband receiver test. Harmonics and sub-harmonics < -60 dBc. 1 to 3 kHz resolution, C-model; 1 to 4 kHz, D-model; +2 to -100 dBm output, C-model; +5 to -100 dBm, D-model. Pulse, amplitude and frequency modulation. Digital sweep. Completely HP-IB programmable.	388
2 to 26.0 GHz	HP 8673B	Optimum choice for high performance microwave receiver and subsystem test. 1 to 4 kHz frequency resolution, 5×10^{-10} /day stability. +8 to -100 dBm output. Pulse, amplitude and frequency modulation. Digital sweep. Completely HP-IB programmable.	388
0.01 to 40.0 GHz	HP 8360 Series	Programmable, general-purpose sweeper with full network analyzer compatibility. 1 Hz frequency resolution, 1×10^{-10} /day stability. +20 to -110 dBm output. Pulse, frequency and amplitude modulation. Continuous analog sweep with spans from 100 Hz to 26.49 GHz. Completely HP-IB programmable. Complete analog, list, and step sweep capability.	390

Frequency Agile/Complex Signal Simulation

0.252 to 1030 MHz 0.252 to 2060 MHz	HP 8645A	Performance signal generator for testing frequency agile radios and surveillance receivers. 15 μ sec switching speed. Spectral purity. AM, FM, pulse modulation. FM deviation to 20 MHz. Flexible control of frequency.	364
dc to 50 MHz	HP 8770A/S	High performance arbitrary waveform source for baseband simulation and advanced modulation. Simulates highly complex baseband and modulated carriers for radar/EW, communications, disc drive, and other applications. 12-bit resolution, excellent spectral purity. 125 MHz clock rate. HP 11776A Waveform Generation Software runs on HP Technical Desktop Computer.	378
0.01 to 3 GHz	HP 8780A	Precision wideband analog and digital modulation source for digital microwave communications and radar. Synthesized signal generator for wideband and complex modulation formats. Digital formats from BPSK to 64 QAM. Vector (quadrature) bandwidths dc to 350 MHz. +10 to -100 dBm.	382
1 to 250 MHz	HP 8782A	Economy digital modulation source. Synthesized signal generator for digital modulations BPSK through 256 QAM. DC to 100 MHz symbol rates. +7 to -100 dBm.	383
0.01 to 3 GHz	HP 8791A	Reconfigurable agile signal simulator for radar, EW and spread-spectrum simulation. Advanced frequency-agile signal simulation for EW, radar and communication receiver test. 250 ns frequency hopping over 3 GHz. Arbitrary control over AM, FM, ϕ M, pulse modulation and agile carrier. 40 MHz modulation bandwidth. Easy-to-use application-specific instrument-on-a-disk software.	380

Portable Cavity-Tuned Sources

0.5 to 1024 MHz	HP 8640B	High-performance RF for bench. Calibrated and leveled output from +19 to -145 dBm. AM, FM and external pulse modulation. Built-in counter and phase lock capability.	376
2.3 to 6.5 GHz 5.4 to 12.5 GHz	HP 8683B, 8684B	Rugged, portable sources with high performance modulation. High spectral purity, stability. ± 2.5 dB absolute level accuracy from +10 to -110 dBm. AM, FM standard. High performance internal pulse modulator and pulse generator. Portable, rugged (19.1 kg).	385
2.3 to 13 GHz 5.4 to 18 GHz	HP 8683D, 8684D	Rugged, portable sources with high performance modulation and wideband frequency coverage. Same as B model except with wideband frequency coverage. DC coupled FM with ± 10 MHz deviations available. -3 dBm standard output power in doubled frequency band. +10 dBm available with Option 001.	385

Millimeter Sources

26.5 to 40 GHz 33 to 50 GHz 40 to 60 GHz 50 to 75 GHz 75 to 110 GHz	HP 83554A, 83555A, 83556A, 83557A, 83558A	Efficient frequency multipliers. Effectively extends the performance of an 11 to 20 GHz microwave source HP 8673B/C/D, 8340, 8341, 8350B, 8360 to the millimeter-wave frequency ranges.	405
---	---	--	-----

SIGNAL GENERATORS

Synthesized Signal Generator Model 8656B

- 100 kHz to 990 MHz
- ± 1.0 dB absolute level accuracy
- Amplitude offset and phase adjustment capability
- 150 millisecond frequency switching speed
- Versatile simultaneous modulation including dc FM
- Fully HP-IB programmable

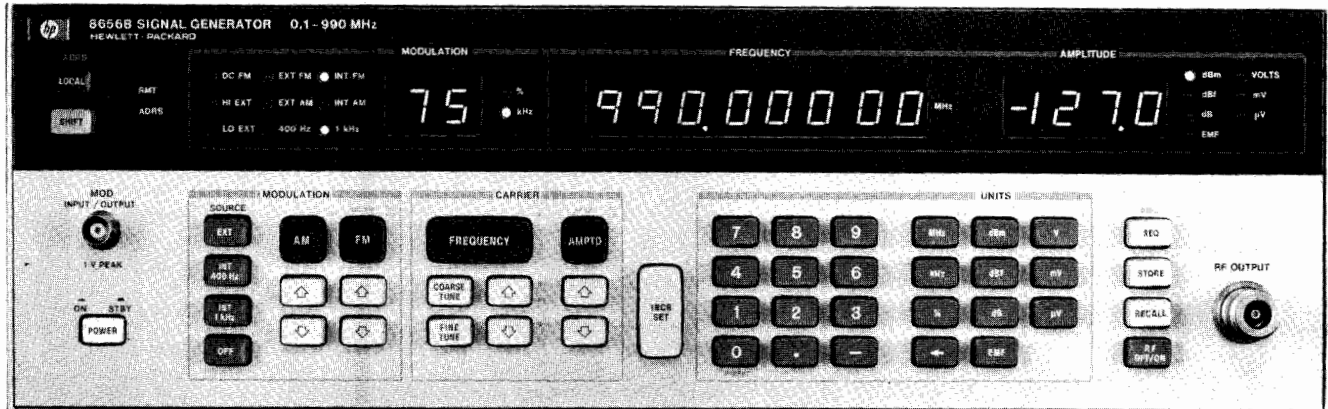

HP 8656B



HP 8656B Synthesized Signal Generator

The HP 8656B is a programmable synthesized signal generator that offers exceptional value through a powerful combination of performance, quality and economy.

Communication Band Frequency Coverage

The HP 8656B provides frequency coverage from 0.1 to 990 MHz (with under-range to 10 kHz). This wide range covers the IF and LO frequencies as well as the RF frequencies of most receivers. It also allows testing in a variety of communication systems including the 800 MHz FM mobile band. Frequency resolution of 10 Hz allows convenient setting of increments including narrow channel spacings, while characterization of phase sensitive devices is made easier with the help of the phase increment/decrement feature. The standard internal reference has an aging rate of 2 ppm/year. Improved stability and accuracy can be achieved by adding the optional 1.5×10^{-7} /day high stability time base (Option 001) or using an external reference of 1, 5 or 10 MHz.

Precise Output Control

The 8656B also features ± 1.0 dB absolute level accuracy and 0.1 dB resolution for accurate receiver sensitivity tests, circuit characterization and R&D applications. The output levels are calibrated from +13 dBm (over-range to +17 dBm) to -127 dBm and may be set and displayed in any one of 14 convenient units including dBm, volts, dB μ V or Vemf. The output level can also be offset to compensate for cable and/or other losses external to the generator, or turned on or off with a dedicated key. Shielding keeps leakage at $< 1.0 \mu$ V for testing RFI susceptible devices, and standard resettable reverse power protection for up to 25 watts guards against accidental damage from transmitters.

Versatile Modulation

The HP 8656B's modulation capabilities include simultaneous and mixed modulation modes (AM/AM, FM/FM and AM/FM) from internal (1 kHz and 400 Hz) and external sources. AM is ac coupled while FM can be either ac or dc coupled. The patented dc coupling technique used in the HP 8656B provides exceptional long term stability (< 10 Hz/hour) and center frequency accuracy (± 500 Hz) eliminating the need for retuning in the dc FM mode. For calibrated external modulation, a 1V peak signal is required, and HI/LO annunciators on the HP 8656B indicate when the external signal is within 5% of the correct amplitude. (For information on pulse modulation, refer to the HP 8657B Opt. H60.)

Ease of Operation For Improved Productivity

The HP 8656B is designed for efficient operation in a bench environment. Features such as being able to change Frequency, Modulation and Level without having to access "hidden" displays or menus will streamline your testing. Additionally, the Frequency, Modulation and Level functions each have their own UP/DOWN arrow keys for rapid front-panel setup and tuning.

Up to ten complete front-panel setups can be stored in the HP 8656B's memory for recall during testing. These setups can be accessed sequentially by pushing one front-panel key or by using the rear-panel SEQ port. (The SEQ port can be connected to a foot switch or other operator-controlled device.)

Programmability for High Volume Testing

Full HP-IB programmability is standard with the HP 8656B. Each programming command has an easy-to-remember, two-character, alpha-numeric HP-IB code. All functions are quickly and easily programmed using the same function/data/units format used on the front panel.

Additionally, the HP 8656B program codes are 100% upwards compatible with the new HP 8657A Synthesized Signal Generator. This provides you with even more flexibility in system configuration without having to modify any program code.

HP 8656B Specifications

Frequency

Range: 100 kHz to 990 MHz (8 digit LED display).

Frequency underrange: 10 kHz with uncalibrated output.

Resolution: 10 Hz.

Accuracy and stability: same as internal time base.

Typical Time Base Characteristics

Typical Characteristics	Standard Time Base	Option 001 Time Base
Aging Rate	±2 ppm/year	1.0x10 ⁻⁷ /day after 45 days
Frequency	50 MHz	10 MHz
External Reference Input (rear panel)	Accepts any 1, 5, or 10 MHz (±0.002%) frequency standard at a level >0.15 Vrms into 50 ohms.	

Frequency switching speed (to be within 100 Hz of final frequency): <150 ms.

Phase Offset: adjustable via HP-IB or from the front panel in nominal 1 degree increments.

Spectral Purity

Spurious Signals (≤ +7 dBm output levels)

Harmonics: < -30 dBc.

Non-harmonic spurious (greater than 5 kHz from carrier in CW mode): < -60 dBc.

Sub-harmonics: none.

Residual FM

Post Detection Noise Bandwidth	Frequency Range (MHz)			
	0.1 to 123.5	123.5 to 247	247 to 494	494 to 990
0.3 to 3 kHz	<7 Hz rms	<2 Hz rms	<4 Hz rms	<7 Hz rms
0.05 to 15 kHz	<15 Hz rms	<4 Hz rms	<8 Hz rms	<15 Hz rms

Residual AM (0.05 to 15 kHz post detection noise bandwidth): 0.025%.

SSB Phase Noise (CW only)

Offset from Carrier	0.1 to 123.5 MHz (dBc/Hz)	123.5 to 247 MHz (dBc/Hz)	247 to 494 MHz (dBc/Hz)	494 to 990 MHz (dBc/Hz)
20 kHz	<-114	<-126	<-120	<-114

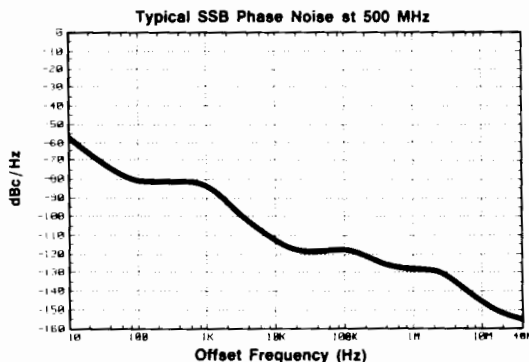

Output

Level range (into 50 ohms): +13 dBm to -127 dBm (3½ digit LED display; uncalibrated output to +17 dBm).

Resolution: 0.1 dB.

Absolute level accuracy: <±1.0 dB; 123.5 to 990 MHz <±1.5 dB; f_c < 123.5 MHz, levels > +7 dBm and < -124 dBm.

Level flatness (100 kHz to 990 MHz): ±0.5 dB at an output level setting of 0.0 dBm.

Reverse power protection: protects signal generator from application of up to 25 watts (from a 50Ω source) of RF power to 990 MHz into generator output; dc voltage cannot exceed 25V.

Amplitude Modulation (2 digit LED display)

AM depth¹: 0 to 99% to +7 dBm and 0 to 30% to +10 dBm.

Resolution: 1%.

AM rate: internal 400 Hz and 1 kHz, ±3%; external (1 dB bandwidth), 20 Hz to 40 kHz.

AM distortion (at internal rates): <1.5%, 0-30% AM; <3%, 31-70% AM; <4%, 71-90% AM.

Indicator accuracy (for depths <90% internal rates and levels < +7 dBm)¹: ≤±(2% + 4% of reading).

Incidental phase modulation (at 30% AM depth and internal rates): <0.3 radian peak.

Frequency Modulation (2 digit LED display)

FM Peak Deviation

Center Frequency	Maximum Peak Deviation	
	AC Mode	DC Mode
0.1 to 123.5 MHz	The lesser of 99 kHz or 4000 x rate (Hz)	99 kHz
123.5 to 247 MHz	50 kHz or 1000 x rate (Hz)	50 kHz
247 to 494 MHz	99 kHz or 2000 x rate (Hz)	99 kHz
494 to 990 MHz	99 kHz or 4000 x rate (Hz)	99 kHz
FM not specified for $f_c - (\Delta f_{pk}) < 100$ kHz		

Resolution: 100 Hz for deviations less than 10 kHz; 1 kHz for deviations greater than 10 kHz.

FM rate: internal 400 Hz and 1 kHz, ±3%; external (1 dB BW), dc coupled, dc to 50 kHz; ac coupled, 20 Hz to 50 kHz.

Center frequency accuracy in dc FM mode: <±500 Hz.

Center frequency stability in dc FM mode: <10 Hz/hour.

FM distortion (internal rates and ≥3 kHz peak deviations): <0.5%.

Indicator accuracy¹: ±5% of reading at internal rates.

Incidental AM (for center frequency ≥500 kHz, peak deviation <20 kHz and internal rates): <0.1%.

Remote Programming

Interface: HP-IB (Hewlett-Packard's implementation of IEEE - 488).

HP-IB interface functions: SH0, AH1, T0, L2, SR0, RL1, PP0, DC1, DT0, C0 and E1. (For more on these codes, refer to the HP-IB section of this catalog.)

General

Operating temperature range: 0° to +55° C.

Leakage: conducted and radiated interference is within the requirements of methods RE02 of MIL STD 461B, FTZ 1115. Furthermore, RF leakage of less than 1.0 μV is induced in a two-turn loop, 2.5 cm in diameter, held 2.5 cm away from the front surface.

Power requirements: 100, 120, 220, or 240 Vac; +5%, -10%; 48 to 440 Hz, 125 VA maximum.

Weight: net, 18.2 kg (40 lb); shipping, 23.6 kg (52 lb).

Size: 133 H x 425 W x 520 mm D (5.25" x 16.75" x 20.5"). HP System II module size: 5¼ H x 1 MW x 17 D. For cabinet accessories, see page 716.

Rack slides and transit case: HP part numbers are: slide kit, 1494-0018; tilt slide kit, 1494-0025; full module transit case, 9211-2661.

Ordering Information

HP 8656B Signal Generator²

Opt 001 High stability time base

Opt 002 RF connectors on rear panel only

Opt 907 Front handle kit (5061-9689)

Opt 908 Rack flange kit (5061-9677)

Opt 909 Rack flange kit with front handles (5061-9683)

Opt 910 Provides an additional operation and calibration manual (08656-90204) and two service manuals (08656-90205)

Opt 915 Add service manual (08656-90205)

Opt W30 Extended repair service. See page 725.

Opt W32 Calibration service. See page 725.

Price

\$6,250

+ \$900

+ \$200

+ \$57

+ \$33

+ \$82

+ \$360

+ \$154

+ \$155

+ \$655

¹AM depth and FM deviation are further limited by Indicator Accuracy specifications.

²HP-IB cables not included. For description and price, see page 569.

SIGNAL GENERATORS

Synthesized Signal Generator Model 8657A

- 100 kHz - 1040 MHz frequency coverage
- -130 dBc/Hz SSB phase noise at 20 kHz offsets
- Fully HP-IB programmable
- Solid-state output attenuator
- ± 1 dB absolute level accuracy (typically ± 0.5 dB)
- Versatile, simultaneous AM/FM modulation

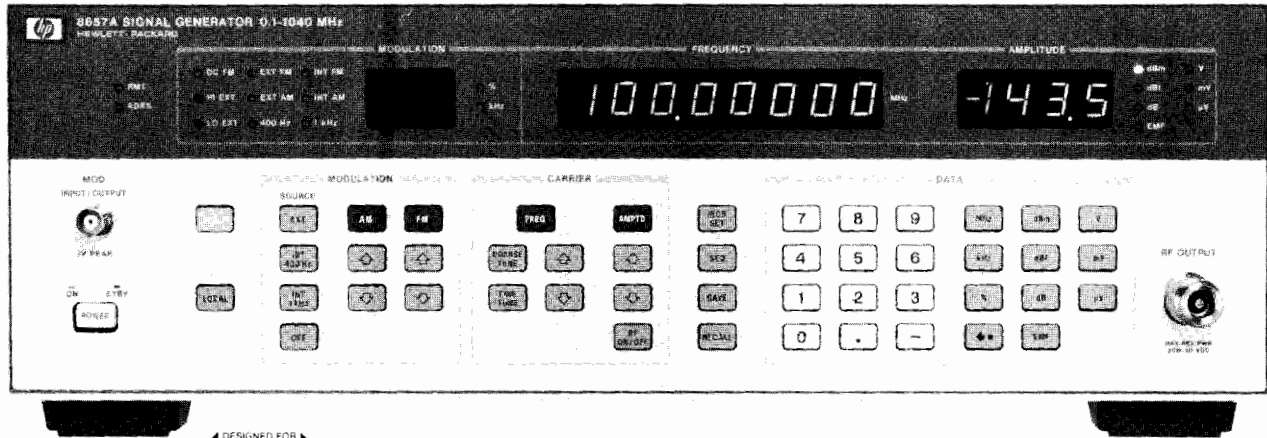

HP 8657A



HP 8657A Synthesized Signal Generator

The HP 8657A is a 100 kHz to 1040 MHz synthesized signal generator that offers truly outstanding performance at an economical price. The HP 8657A gives enhanced performance above the HP 8656B signal generator to form a complementary set of low cost/high performance RF signal generators from Hewlett-Packard.

Spectral Purity for Demanding Applications

The HP 8657A provides excellent phase noise performance across its full 100 kHz to 1040 MHz range. When characterizing an RF receiver, the SSB phase noise of the HP 8657A (-130 dBc/Hz at 500 MHz), provides the performance for almost all measurements requiring test signals at adjacent or out-of-channel offsets.

Additionally, due to a new oscillator design, the HP 8657A has a residual FM specification of <4 Hz rms (typically <2 Hz rms) when measured in a 300 Hz to 3 kHz detection bandwidth. Lower residual FM means lower measurement uncertainty in key measurements such as: distortion, signal-to-noise, and hum and noise.

RF Output with Electronic Attenuator

The HP 8657A has a patented, solid-state attenuator that provides accurate output levels to ± 1.0 dB (typically ± 0.5 dB). The electronic attenuator has an estimated 3 million hour MTBF (Mean Time Between Failures). The HP 8657A instrument is backed with a 5-year warranty against attenuator failure, providing you with the highest level of insurance for trouble free performance.

The HP 8657A provides high RF output power (+13 dBm with over-range to +17 dBm) for driving mixers and overcoming cable losses without the use of an external amplifier. The unique RF leveling-loop design also lowers intermodulation distortion to typically better than -50 dBc. Reverse power protection is provided standard for protection up to 50 watts and 50 Vdc.

Versatile Modulation

The HP 8657A can combine modulation modes for AM+AM, FM+FM, and AM+FM from both internal and external modulation sources. Like the HP 8656B, the HP 8657A has ac coupled AM and ac/dc coupling for FM.

The patented dc coupling technique provides excellent long term stability (<10 Hz/hour drift) as well as center frequency accuracy (± 500 Hz worst case). When dc FM is enabled, SSB phase noise and residual FM performance are not degraded as with other generators. DC FM can allow the HP 8657A to be used as an ideal VCO in a design application or to be used to faithfully reproduce digital squelch tones when modulating the carrier signal.

Pulse modulation is available and can be ordered under HP 8657B Option H60.

Designed for Ease of Operation

The HP 8657A contains many features that streamline operation in both the manual/bench or ATE environments. The easy-to-use front panel, for example, has up/down arrow keys to control frequency, amplitude, and modulation independently. Up to 100 of your front panel settings can be stored in non-volatile storage registers with recall capability through the numeric keypad or sequentially with the SEQ key. Sequencing through the storage registers can also be done by attaching a momentary contact switch to the rear panel SEQ port of the HP 8657A for remote sequence control by, for example, a foot switch.

The HP 8657A is designed for ATE applications with its <135 ms switching speed for high throughput in a production environment. Like the HP 8656B, the HP 8657A's programming codes are easy to remember (silk-screened on the front panel) and to implement.

The HP-IB program codes for the HP 8656B are 100% upwards compatible with the HP 8657A. This provides you with maximum flexibility when considering upgrading your system from the HP 8656B to the enhanced performance of the HP 8657A.

HP 8657A Specifications

Frequency

Range (8 digit display): 100 kHz to 1040 MHz. Underrange to 10 kHz with uncalibrated level and modulation.

Resolution: 10 Hz.

Display resolution: 10 Hz (100 Hz, $f_c > 1000$ MHz).

Switching speed (to be within 100 Hz of final frequency): <135 ms.

Accuracy and stability: Same as time base used.

Typical Timebase Characteristics

	Standard	Option 001
Aging rate	± 2 ppm/year	1.0×10^{-9} /day after 45 days
Temperature (0-55° C)	± 10 ppm	7×10^{-9}
Line Voltage	—	2×10^{-9} (+5%, -10%)
Frequency	50 MHz	10 MHz
Timebase Reference Signal (Rear Panel)	Available at a level of $>0.15 V_{rms}$ into 50 Ω . (Output of 10, 5 or 1 MHz is selectable via internal jumper). If external reference is used, output will be the same frequency.	
External Reference Input (Rear Panel)	Accepts any 10, 5 or 1 MHz ($\pm 0.002\%$) frequency standard at a level $>0.15 V_{rms}$ into 50 Ω .	

Spectral Purity

Spurious Signals ($\leq +7$ dBm Output Levels)

Harmonics: < -30 dBc.

Sub-harmonics: none.

Non-harmonics (CW mode, 5 kHz - 2 MHz offsets):

-60 dBc, f_c : 0.1 - 130 MHz and 520 - 1040 MHz;

-66 dBc, f_c : 260 - 520 MHz;

-72 dBc, f_c : 130 - 260 MHz.

Residual FM (in CW mode):

Frequency Range	Post Detection BW (rms detector)	
	300 Hz to 3 kHz	50 Hz to 15 kHz
0.1- 130 MHz	4 Hz	6 Hz
130- 260 MHz	1 Hz	1.5 Hz
260- 520 MHz	2 Hz	3 Hz
520-1040 MHz	4 Hz	6 Hz

Residual AM (50 Hz to 15 kHz BW in CW mode): $< 0.04\%$ AM.

SSB phase noise (in CW mode):

Carrier Frequency	SSB β -Noise 20 kHz Offset
0.1 to 130 MHz	< -124 dBc/Hz
130 to 260 MHz	< -136 dBc/Hz
260 to 520 MHz	< -130 dBc/Hz
520 to 1040 MHz	< -124 dBc/Hz

Typical HP 8657A SSB Phase-Noise at 500 MHz

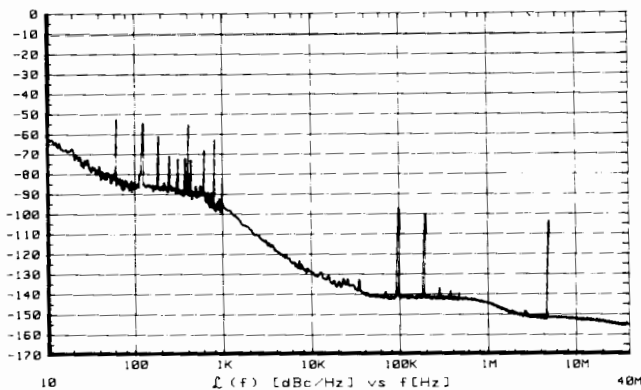

Output

Level range (3 1/2-digits): $+13$ dBm to -143.5 dBm into 50Ω , $+10$ dBm to -143.5 dBm for frequencies from 100 kHz to 1 MHz.

Resolution: 0.1 dB.

Absolute level accuracy¹: ± 1.0 dB, $+7$ to -127 dBm; ± 1.5 dB, $> +7$ dBm.

Typical absolute level accuracy: ± 1.5 dB, output levels < -127 dBm; ± 0.5 dB, $25^\circ\text{C} \pm 10^\circ\text{C}$, $+7$ to -127 dBm.

Level flatness (0.1 - 1040 MHz): ± 0.5 dB, at 0 dBm.

SWR ($f_c \geq 400$ kHz): < 1.5 , level < -3.5 dBm; < 2.0 , level $\leq +13$ dBm.

Reverse power protection: protection up to 50W from a 50Ω source. DC voltage cannot exceed 50V.

Amplitude Modulation

AM depth (2-digit display): 0 to 99%, level $\leq +7$ dBm, $f_c \geq 400$ kHz. 0 to 30%, level $\leq +10$ dBm, $f_c \geq 400$ kHz².

Resolution: 1%.

AM rate, internal: 400 Hz and 1 kHz, $\pm 2\%$. External: 20 Hz to 40 kHz (1 dB bandwidth, AC coupled).

AM distortion (at internal rates): $< 1.5\%$, 0 to 30% AM; $< 3.0\%$, 30 to 70% AM, $< 4.0\%$, 70 to 90% AM.

Indicator accuracy (for depths $< 90\%$ and internal rates and levels $< +7$ dBm): $\pm (2\% + 6\%$ of setting).

Incidental θ M (at 30% AM, internal rates): < 0.3 radians peak.

¹ Absolute level accuracy includes allowances for output linearity, temperature, flatness, attenuator accuracy and measurement error.

² 0 - 30% for $f_c < 400$ kHz, levels $\leq +7$ dBm.

Frequency Modulation

Maximum FM peak deviation (2-digit LED display):

Center Frequency	Maximum Peak Deviation	
	AC Mode (the lesser of)	DC Mode
0.1- 130 MHz	99 kHz or 4000 \times rate (Hz)	99 kHz
130- 260 MHz	50 kHz or 1000 \times rate (Hz)	50 kHz
260- 520 MHz	99 kHz or 2000 \times rate (Hz)	99 kHz
520-1040 MHz	99 kHz or 4000 \times rate (Hz)	99 kHz

FM not specified for $f_c - (\Delta f_{pk}) < 100$ kHz.

Resolution: 100 Hz, dev. < 10 kHz; 1 kHz, dev. ≥ 10 kHz.

FM rate: Internal: 400 Hz and 1 kHz, $\pm 2\%$. External: dc/5 Hz - 100 kHz, 3 dB BW; dc/20 Hz - 50 kHz, 1 dB BW.

Center frequency accuracy in DC mode: ± 500 Hz.

Center frequency stability in DC mode: < 10 Hz per hour.

FM distortion (at internal rates, pk. dev. ≥ 3 kHz)³: $< 0.5\%$.

Indicator accuracy (internal rates): $\pm 5\%$ of setting.

Incidental AM (dev. < 20 kHz, 400 and 1 kHz, $f_c \geq 500$ kHz): $< 0.1\%$.

Remote Programming

Interface: HP-IB (Hewlett-Packard's implementation of IEEE Standard 488).

HP-IB functions: SH0, AH1, T0, L2, SR0, RL1, PP0, DC1, DT0, C0, E1.

General

Operating temperature: 0 to $+55^\circ\text{C}$.

Storage temperature: -55 to $+75^\circ\text{C}$.

Leakage: Conducted and radiated interference is within the requirements of RE02 of MIL STD 461B, and FTZ 1046. Furthermore, RF leakage of $< 1 \mu\text{V}$ is induced in a two-turn loop, 2.5 cm in diameter, held 2.5 cm away from the front surface (typically $< 0.05 \mu\text{V}$, $f_c \leq 500$ MHz).

Save/recall/sequence storage registers: 100 non-volatile registers are available that save front panel settings.

Power requirements: 100, 120, 220, or 240V ($+5\%$, -10%) from 48 to 440 Hz, 175 VA maximum.

Weight: net 18.2 kg (40 lb); shipping 23.6 kg (52 lb).

Size: 133H \times 425W \times 520 mmD (5.25" \times 16.75" \times 20.5").

HP System II module size: 5/4 H \times 1 MW \times 17D.

Accessories Available

HP 11721A Frequency Doubler extends HP 8657A range to 2080 MHz.

HP 11687A 50-75 Ω adapter is recommended for 75 Ω systems.

Transit case, HP 9211-2655 provides protection in transportation.

Rack slide kit, HP 1494-0060 allows easy access in a system.

HP 8347A 100 kHz - 3 GHz, $+2$ to $+20$ dBm RF amplifier.

Ordering Information

	Price
HP8657A Synthesized Signal Generator ³	\$8,300
Opt 001 High stability timebase	+\$900
Opt 002 RF connections on rear panel only	+\$200
Opt 907 Front handle kit (5061-9689)	+\$57
Opt 908 Rack flange kit (5061-9677)	+\$34
Opt 909 Rack flange kit with front handles (5061-9683)	+\$82
Opt 910 Provides an additional operation and calibration manual (08657-90003) and two service manuals (08657-90004)	+\$360
Opt 915 Add service manual (08657-90004)	+\$154
Opt W30 Extended repair service. See page 725.	+\$200
Opt W32 Calibration service. See page 725.	+\$510

³ Power cable and operating manual supplied. HP-IB cables are not provided. For description and price, see page 569.

SIGNAL GENERATORS

Synthesized Signal Generator

HP 8657B

- 100 kHz - 2060 MHz frequency coverage
- 1 Hz carrier frequency resolution
- Optional 35 nsec rise/fall time pulse modulation

- Low SSB phase noise
- ± 1 dB absolute level accuracy (typically ± 0.5 dB)
- Carrier phase adjust in 1 degree increments



HP 8657B



HP 8657B Synthesized Signal Generator

The HP 8657B is an L-Band synthesized signal generator offering excellent performance at an economical price. The HP 8657B is ideal for radio receiver and radar system and subsystem design and testing.

Spectral Purity for Radar and Satellite

The low residual FM and low SSB phase noise provides excellent value as a local oscillator, low noise VCO or test source with AM/FM and pulse modulation. In addition to great noise performance, features such as carrier phase adjust allow you to characterize phase sensitive devices such as phase detectors or phase interferometers using precise 1 degree phase offsets with respect to another signal source. Display blanking and nonvolatile memory clear are also available for operation in secure environments.

Advanced Performance

The HP 8657B offers wide dynamic output range from +13 to -143.5 dBm output level with unparalleled accuracy of ± 1 dB. Additionally, the HP 8657B has extremely low radiated emissions for making sensitivity measurements on your receiver or for design work on extremely sensitive circuitry. High stability dcFM keeps center frequency drift below 10 Hz/hour which allows accurate VCO simulation or low rate FM modulation.

High Performance Pulse Modulation

The HP 8657B has a GaAs FET pulse modulator (Option 003) for fast risetime, high isolation pulse. The HP 8657B has 35 to 50 nsec risetimes (typically 10 to 18 nsec) and 70 to 90 dB on/off ratios. For pulse modulation coverage to 1040 MHz only, refer to the HP 8657B Option H60.

Specifications

Frequency

Range: 100 kHz to 2060 MHz. Underrange to 10 kHz

Resolution: 1 Hz

Switching speed (within 100 Hz of final frequency): <135 msec¹

Accuracy and stability: Same as time base used

Supplemental characteristics

Phase offset: Signal phase is adjustable in 1° increments.

Timebase characteristics:

	Standard	Option 001
Aging Rate	± 2 ppm/yr	1.0 x 10 ⁻⁹ /day after 45 days
Timebase Reference Signal (Rear Panel)	Available at a level of >0.15 Vrms into 50 Ω . (Output of 10, 5 or 1 MHz is internally selectable). If external reference is used, output will the same frequency.	
External Reference Input (Rear Panel)	Accepts any 10, 5, or 1 MHz ($\pm 0.002\%$) frequency standard at a level >0.15 Vrms into 50 Ω .	

¹Output level settles to within ± 1 dB of level in 160 msec when switching from frequencies ≥ 130 MHz to frequencies <130 MHz

Spectral Purity

Spurious signals ($\leq +7$ dBm output levels)²:

Type of Spurious	Frequency (MHz)	
	0.1-1030	1030-2060
Harmonic	<-30 dBc	<-25 dBc
Sub-harmonic	None	<-40 dBc

Nonharmonic spurious:

Carrier Frequency	Carrier Offset	
	>5 kHz	>2 MHz
0.1 to 130 MHz	<-63 dBc	<-60 dBc
130 to 260 MHz	<-75 dBc	<-60 dBc
260 to 520 MHz	<-66 dBc	<-60 dBc
520 to 1030 MHz	<-63 dBc	<-60 dBc
1030 to 2060 MHz	<-57 dBc	<-54 dBc

Residual FM in Hz_{rms} (in CW mode)

Post Detection Bandwidth	Frequency Range (MHz)				
	0.1-130	130-260	260-520	520-1030	1030-2060
0.3-3 kHz	<4 Hz	<1 Hz	<2 Hz	<3 Hz	<6 Hz
0.05-15 kHz	<6 Hz	<1.5 Hz	<3 Hz	<4 Hz	<8 Hz

Residual AM (50 Hz to 15 kHz BW in CW mode): <0.04% AM. SSB phase noise (in CW Mode)

Carrier Frequency	SSB Noise 20 kHz Offset	(Typical) 20 kHz Offset
0.1 to 130 MHz	<-124 dBc/Hz	<-130 dBc/Hz
130 to 260 MHz	<-136 dBc/Hz	<-140 dBc/Hz
260 to 520 MHz	<-130 dBc/Hz	<-136 dBc/Hz
520 to 1030 MHz	<-124 dBc/Hz	<-130 dBc/Hz
1030 to 2060 MHz	<-118 dBc/Hz	<-123 dBc/Hz

²When $f_c < 1030$ MHz and pulse modulation is installed, spurious specifications apply for output levels $\geq +4$ dBm

Output**Level range:** +13 dBm to -143.5 dBm into 50 Ω ¹**Resolution:** 0.1 dB**Absolute level accuracy**²: $\pm 1.0\text{ dB}$ (+3.5 to -127 dBm), $\pm 1.5\text{ dB}$ (level >+3.5 dBm)**Level flatness (100 kHz to 2060 MHz):** $\pm 0.5\text{ dB}$, output level level setting of 0 dBm**SWR:** <math>< 1.5</math> for levels $\leq -6.5\text{ dBm}$; <math>< 2.0</math> for levels $\leq +13\text{ dBm}$ **Reverse-power protection:** 50W, 2.5 Vdc (from a 50 Ω source)**Supplemental characteristics****Attenuator repeatability:** 0.01 dB**Output level overrange:** to +17 dBm**Amplitude Modulation****AM depth ($f_c > 400\text{ kHz}$):** 0 to 100%, level $\leq +7\text{ dBm}$; 0 to 30%, level $\leq +10\text{ dBm}$ **Resolution:** 1%**AM rate internal:** 400 Hz and 1 kHz, $\pm 2\%$.**External:** 20 Hz - 40 kHz (1 dB), 20 Hz - 100 kHz (3 dB typical).**AM distortion (at 400 Hz and 1 kHz rates, levels $\leq +10\text{ dBm}$)³**

AM Depth	$f_c < 1030\text{ MHz}$	$f_c > 1030\text{ MHz}$
0 to 30% AM	<math>< 1.5\% \text{ THD plus noise.}</math>	<math>< 4.0\% \text{ THD plus noise}</math>
31 to 70% AM	<math>< 3.0\% \text{ THD plus noise.}</math>	<math>< 4.0\% \text{ THD plus noise}</math>
71 to 90% AM	<math>< 4.0\% \text{ THD plus noise.}</math>	<math>< 7.0\% \text{ THD plus noise}</math>

Indicator accuracy (for depths <math>< 90\%</math>, 400 Hz and 1 kHz rates and levels $\leq +7\text{ dBm}$): $\pm (6\% \text{ of setting} + 2\%)$ **Incidental phase modulation** (at 30% AM depth, internal rates): <math>< 0.3\text{ radians peak}</math>**Frequency Modulation****Maximum FM peak deviation (3-digit LED display)**

Center Frequency	Maximum Peak Deviation	
	ac Mode (the lesser of)	dc Mode
0.1 to 130 MHz	200 kHz or 4000 X rate (Hz)	200 kHz
130 to 260 MHz	50 kHz or 1000 X rate (Hz)	50 kHz
260 to 520 MHz	100 kHz or 2000 X rate (Hz)	100 kHz
520 to 1030 MHz	200 kHz or 4000 X rate (Hz)	200 kHz
1030 to 2060 MHz	400 kHz or 8000 X rate (Hz)	400 kHz

Minimum FM dev: FM not specified if ($f_c - \text{FM dev.}$) <math>< 100\text{ kHz}</math>

FM setting resolution:

FM Deviation	Carrier Frequency	
	$f_c < 1030\text{ MHz}$	$f_c > 1030\text{ MHz}$
<math>< 100\text{ kHz}</math>	100 Hz	200 Hz
>math>100\text{ kHz}</math>	1 kHz	2 kHz

FM rate internal: 400 Hz and 1 kHz, $\pm 2\%$ **External:** (dc) 5 Hz to 100 kHz, 3 dB bandwidth
(dc) 20 Hz to 50 kHz, 1 dB bandwidth**Center frequency accuracy in dc mode**

Center Frequency	Accuracy
0.1 to 130 MHz	$\pm 500\text{ Hz}$
130 to 260 MHz	$\pm 125\text{ Hz}$
260 to 520 MHz	$\pm 250\text{ Hz}$
520 to 1030 MHz	$\pm 500\text{ Hz}$
1030 to 2060 MHz	$\pm 1000\text{ Hz}$

Center frequency stability in dc mode: <math>< 10\text{ Hz per hour drift.}</math>**FM distortion** (at 400 Hz and 1 kHz rates, $\geq 6\text{ kHz}$ peak deviations)⁴: <math>< 0.5\% \text{ THD plus noise}</math>**Indicator accuracy** (400 Hz and 1 kHz): $\pm 5\%$ of setting¹When $f_c < 1030\text{ MHz}$ and pulse modulation is installed, maximum output level is +10 dBm.²Absolute level accuracy includes allowances for detector linearity, temperature, flatness, attenuator accuracy and measurement uncertainty.³When $f_c < 1030\text{ MHz}$ and pulse modulation is installed, maximum specified output level in AM is reduced by 3 dB.⁴FM distortion specification applies when: (FM dev) = $\frac{1}{2}$ (maximum specified FM dev) for carrier frequencies below 520 MHz.**Incidental AM** (peak dev. <math>< 20\text{ kHz}</math>, 400 Hz and 1 kHz rates):<math>< 0.1\% \text{ AM}</math>; $f_c > 500\text{ kHz}$ <math>< 0.5\% \text{ AM}</math>; $f_c > 1030\text{ MHz}$ **Supplemental characteristics****FM distortion:** worst case distortion at all specified deviations, rates, and carrier frequencies is 1.5%**External sensitivity:** 1 Vpk for indicated accuracy (1V dc when in dc-FM mode)**External modulation input:** Front panel BNC, 600 Ω dc-coupled; front panel annunciators indicate 1 Vpk signal $\pm 5\%$ **Simultaneous modulation:**Internal/external: AM/FM, FM/AM, AM/AM, FM/FM, AM/FM/Pulse⁵

Internal/internal, external/external: AM/FM

Pulse Modulation (Option 003)**ON/OFF ratio:** >70 dB, $f_c \geq 130\text{ MHz}$; >95 dB, $f_c > 1030\text{ MHz}$ **Rise/fall time:** 35 nsec, $f_c \geq 130\text{ MHz}$; 50 nsec, $f_c > 1030\text{ MHz}$ **Supplemental characteristics****Typical rise/fall time:** 10 nsec, $f_c > 130\text{ MHz}$; 18 nsec, $f_c > 1030\text{ MHz}$ **Maximum repetition rate:** dc - 30 MHz**Remote Programming**

Interface functions implemented: SH0, AH1, T0, L2, SR0, RL1, PP0, DC1, DT0, C0, E1

General**Operating temperature range:** 0 $^\circ$ to +55 $^\circ$ C**Storage temperature range:** -55 $^\circ$ to +75 $^\circ$ C**Leakage:** conducted and radiated interference is within the requirements of CE03 (except broadband conducted below 70 kHz), and of RE02 of MIL STD 461B, and FTZ.1115. RF leakage of less than 1.0 μ V is induced in a two-turn loop, 2.5 cm in diameter, held 2.5 cm away from the front surface. (Typical leakage <math>< 0.05\ \mu\text{V}</math>, level <math>< -40\text{ dBm}</math>)**Save/recall/sequence storage registers:** 100 non-volatile registers are available to save front panel settings**Rear panel SEQ input level:** TTL low to recall next storage register contents**Power requirements:** 100, 120, 220, or 240V ($\pm 10\%$) from 48 to 440 Hz; 125 VA maximum**Weight:** net, 19.5kg (43lb); shipping, 25.0kg (55lb)**Size:** 133H x 425W x 574mmD (5.25" x 16.75" x 22.6")**HP System II cabinet module size:** 5.25"H x 1M W x 17"D**Ordering Information**

	Price
HP 8657B Signal Generator ⁶	\$12,500
Opt 001 High stability timebase	+ \$900
Opt 002 Rear panel input and output (All connectors on rear panel only)	+ \$200
Opt 003 Pulse modulator (Pulse modulator is factory installable only)	+ \$795
Opt 907 Front handle kit (5061-9689)	+ \$57
Opt 908 Rack flange kit (5061-9677)	+ \$34
Opt 909 Rack flange kit with front handles (5061-9683)	+ \$82
Opt 910 Provides an additional operation/calibration manual (08657-90006) and 2 service manuals (08657-90007)	+ \$350
Opt 915 Add service manual (08657-90007)	+ \$150
Opt W30 Extended Repair Service. See page 725.	+ \$240
08656-82001 Rack Slide Kit for HP rack enclosures	\$100
1494-0061 Slide Adapter Bracket Kit for non-HP rack enclosures (order with Rack Slide Kit).	\$46
9211-2661 Transit case	\$550

⁵Pulse modulation specifications apply for levels $\leq +7\text{ dBm}$. (Frequency switching speed typically increases by 30 msec with pulse modulation on.) Additionally, when $f_c > 1030\text{ MHz}$, AM is unspecified with pulse modulation turned on.⁶HP-IB cables not included. For description and prices, see page 569.

SIGNAL GENERATORS

Synthesized Signal Generator

HP 8644A

- 252 kHz to 2060 MHz frequency range
- -136 dBc/Hz phase noise at 20 kHz offset, 1 GHz carrier
- -100 dBc/Hz nonharmonic spurious

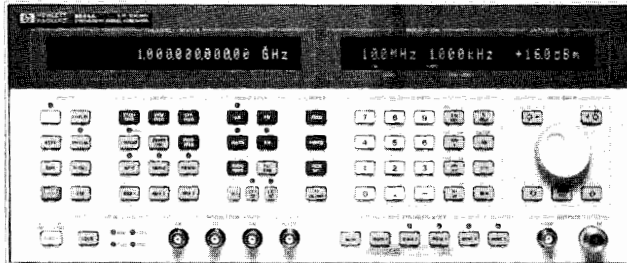

HP 8644A



HP 8644A Synthesized Signal Generator

The HP 8644A Synthesized Signal Generator is a high performance, 252 kHz to 2060 MHz generator that provides excellent spectral purity for confidence in RF measurements. For R&D or stringent testing of communications equipment, the low phase noise and low spurious provide the measurement margin necessary for repeatability and accuracy.

The HP 8644A uses a modular platform that allows you to configure the instrument for your application.

High Performance Modulation

For receiver measurements the HP 8644A offers AM, FM, and pulse modulation. FM deviations up to 20 MHz combined with specified rates to 100 kHz can test most communication receivers. AM performance includes 0-100% depth and rates to 100 kHz.

Advanced Internal Modulation Source

An optional internal modulation synthesizer provides four sources each with a frequency coverage of 0.1 Hz to 400 kHz and sine, square, sawtooth, and white gaussian noise waveforms. Two of these sources can be summed together to provide two-tone capability, and one of these sources can be modulated by up to three of the sources with AM/FM/PM, and pulse. This source can also generate signals for testing VOR and ILS receivers.

Lowest Specified Leakage of Any Signal Generator

The standard HP 8644A has typical leakage of $<1 \mu\text{V}$ induced in a two-turn loop, which is sufficient for most R&D or production testing. For sensitive measurements, Option 010, a low leakage configuration, provides more RF shielding and has typical leakage of $0.1 \mu\text{V}$.

On-Site Repair and Calibration

The HP 8644A contains its own firmware and hardware for calibration, troubleshooting, and monitoring instrument performance. Built-in sensors continually monitor internal voltages to notify the user of temperature drift, hardware failures, or the need for recalibration.

HP 8644A Specifications

Frequency

Range: 251.46485 kHz to 1030 MHz; 251.46485 kHz to 2060 MHz with Opt 002. See Optional Internal Modulation Source for coverage below 252 kHz.

Frequency bands: The approximate endpoints of each frequency band can be determined by dividing the 1030 to 2060 MHz band by two for each band decrease.

Stability, Opt 001: $<5 \times 10^{-10}$ /day aging after 10 day warm-up.

- AM, FM, and pulse modulation
- Internal modulation source for complex waveforms
- Options to configure for specific applications
- On-site repair and calibration

Typical SSB phase noise and spurs at 1 GHz.

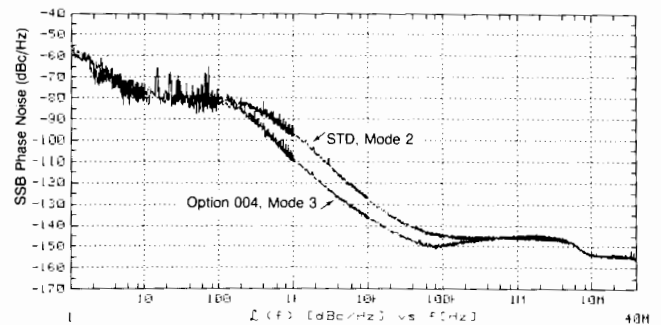

Residual AM: $<0.01\%$ AM rms, 0.3 to 3 kHz post detection bandwidth.

Spectral Purity

Phase noise (CW, AM, or FM¹ operation)

Standard/Option 004

Carrier Frequency (MHz)	Offset Frequency		
	1 kHz (dBc/Hz)	20 kHz (dBc/Hz)	100 kHz (dBc/Hz)
1030 - 2060	-84/-94	-121/-130	-131/-136
515 - 1030	-90/-100	-128/-136	-138/-142
257 - 515	-96/-106	-134/-142	-141/-145
128 - 257	-101/-111	-138/-145	-142/-145
64 - 128	-106/-116	-140/-145	-144/-145
32 - 64	-111/-121	-142/-145	-145/-145
16 - 32	-117/-127	-144/-145	-145/-145
8 - 16	-120/-130	-145/-145	-145/-145
4 - 8	-125/-135	-145/-145	-145/-145
2 - 4	-129/-135	-145/-145	-145/-145
1 - 2	-133/-135	-145/-145	-145/-145
0.5 - 1	-137/-135	-145/-145	-145/-145
0.25 - 0.5	-140/-135	-145/-145	-145/-145

Spurious Signals

Harmonics: -30 dBc, output $<+8$ dBm; -25 dBc, 1030 to 2060 MHz, output $<+8$ dBm.

Subharmonics: none, 0.25 to 515 MHz; <-60 dBc, 515 to 1030 MHz; <-40 dBc, 1030 to 2060 MHz.

Nonharmonics: <-100 dBc, >15 kHz offset, 0.25 to 1030 MHz; <-94 dBc, >15 kHz offset, 1030 to 2060 MHz.

Residual FM² (CW, AM, FM³ operation)

Standard/Option 004

Carrier Frequency (MHz)	Post Detection Bandwidth	
	0.3 to 3 kHz (Hz rms)	0.05 to 15 kHz (Hz rms)
0.25- 257	$<1 / <.5$	$<1.2 / <.5$
257- 515	$<1.2 / <.5$	$<2 / <1$
515- 1030	$<2 / <1$	$<4 / <2$
1030- 2060	$<4 / <2$	$<8 / <4$

¹ FM at 1% maximum specified deviation for offsets >1 kHz, FM at minimum deviation for offsets <1 kHz.

² Specified for 48 to 63 Hz power line. Typical for 400 Hz power line.

³ Deviation $\leq 0.1\%$ of maximum available.

Output

Maximum level: +16 dBm, 0.25 to 1030 MHz; +13 dBm with Opt 005; Opt 002: +14 dBm, 0.25 to 1030 MHz; +13 dBm, 1030 to 2060 MHz.

Minimum level: -137 dBm

Resolution: 0.1 dB.

Absolute accuracy: ± 1 dB, output ≥ -127 dBm.

Reverse power protection: 50W from a 50 Ω source, 25 Vdc.

Typical third order intermodulation: < -50 dBc, outputs < 8 dBm.

Typical output level overrange: 2 dB more than maximum level.

Typical SWR: $< 1.7:1$, output < -2 dBm.

Modulation

External modulation inputs: AC or DC, 600 Ω . Pulse, DC only.

Amplitude Modulation

AM depth: 0 to 100%, for output $< +7$ dBm. 0.1% resolution.

AM Indicator accuracy: $\pm(6\%$ of setting $+1\%)$, up to 90% depth, 1 kHz rate.

AM distortion, at 400 Hz and 1 kHz rates:

Depth	0.25 - 1030 MHz	1030 - 2060 MHz
0 - 30%	2%	4%
0 - 70%	3%	4%
70 - 90%	5%	6% AM

3 dB bandwidth: > 5 kHz, 0.25 to 8 MHz. > 50 kHz, 8 to 128 MHz; > 100 kHz, 128 to 2060 MHz.

Frequency Modulation

FM deviation range: 20 MHz for carriers from 1030 to 2060 MHz. Maximum deviation divides in half for each carrier band lower.

FM maximum rate: 100 kHz, 8-2060 MHz 19.5 kHz, 1-2 MHz
78 kHz, 4-8 MHz 9.7 kHz, .5-1 MHz
39 kHz, 2-4 MHz 4.8 kHz, .25-.5 MHz

FM indicator accuracy:¹

Accuracy	Mode 3	% of Deviation	Rates
5%	6%	$\leq 10\%$	0-30 kHz
10%	15%	$\leq 10\%$	0-100 kHz
12%	NA	100%	0-30 kHz
20%	NA	100%	0-100 kHz

¹ Accuracy for rates that do not exceed maximum rate.

FM distortion, rates 20 Hz to 100 kHz: 1%, 0.1% of max. FM; 3%, 1-5% of max. FM; 5%, 5-100% of max. FM.

Carrier frequency accuracy in FM: $\pm 0.5\%$ of FM deviation setting.

Pulse Modulation

On/off ratio: > 35 dB; > 80 dB for 1030 to 2060 MHz.

Rise fall time: < 100 nsec, between 10% and 90% response points.

Maximum pulse repetition frequency: 1 MHz.

Minimum pulse width: 0.5 μ sec.

Internal Modulation Source

Rates: .3, .4, 1, 3 kHz. Accuracy $\pm 5\%$.

Optional Internal Modulation Source

Frequency range: 0.1 Hz to 400 kHz; 0.1 Hz resolution.

Maximum output level: 0 to 2 V_{pk} into 600 Ω ; 2 mV resolution.

Phase Continuous Sweep

Sweep type: linear, phase continuous.

Sweep time: 20 msec to 10 sec.

Maximum sweep span: twice maximum FM deviation.

Digitally Stepped Sweep

Sweep type: linear or log, frequency stepped.

Sweep time: 500 msec. to 1000 sec.

Remote Programming

Interface/language: HP-IB/HP-SL (Hewlett-Packard Systems Language)

General

Power requirements: $\pm 10\%$ of 100, 120, 220, or 240V; 48 to 440 Hz 400 VA maximum.

Operating temperature range: 0 to 55°C.

Storage temperature range: -55 to +75°C.

Leakage: Typical leakage is < 1 μ V induced in a two-turn loop 1 inch from any surface with output level < 0 dBm; < 0.1 μ V with Opt 010.

Calibration interval: 3 years (MTBC).

Storage registers: 10 full function and 40 frequency/amplitude.

Weight: net, 28 kg (61 lb); shipping, 35 kg (77 lb).

Size: 178 x 425 x 648mmD (7" x 16.75" x 23.5"). Opt 010 adds 35mm (1.4") to the depth.

Avionics Specifications

Option 009 provides specified VOR/ILS performance for the HP 8644A with Option 007. These specifications apply when using the HP 8644A with Option 007 to generate standard VOR and ILS signals. Do not order with Option 002 or Option 005.

VOR bearing accuracy: 0.1 degrees.

VOR, LOC, G/S AM accuracy: $\pm 5\%$ of setting.

VOR, LOC, G/S AM distortion: 2%.

VOR FM accuracy (480 Hz deviation): ± 1.5 Hz.

Localizer DDM resolution: 0.0002 DDM.

Localizer DDM accuracy: $\pm 0.0004 \pm 5\%$ of DDM.

Glide slope DDM resolution: 0.0004 DDM.

Glide slope DDM accuracy: $\pm 0.0008 \pm 5\%$ of DDM.

Marker beacon AM accuracy (95% AM): $\pm 5\%$ of setting $+1\%$.

Marker beacon AM distortion (95% AM): 5%.

Ordering Information

	Price
HP 8644A Synthesized Signal Generator ¹	\$17,000
Opt 001 High stability time base	+\$1,500
Opt 002 2 GHz doubled output	+\$7,000
Opt 003 RF connectors on rear panel only	+\$400
Opt 004 Enhanced spectral purity	+\$4,000
Opt 005 Electronic attenuator (5-year warranty on attenuator, cannot be used with Opt 002)	+\$500
Opt 007 Synthesized audio oscillator	+\$1,000
Opt 009 Specified VOR/ILS performance (Do not order with Opt 002 or Opt 005)	+\$1,500
Opt 010 Reduced leakage configuration	+\$1,500
Opt 907 Front handle kit (5061-9690)	+\$65
Opt 908 Rack flange kit (5061-9678)	+\$35
Opt 909 Rack flange kit with front handles (5061-9684)	+\$90
Opt 910 Provides an additional operation and calibration manual (08644-90009) and two service manuals (08645-90024)	+\$190
Opt 915 Add service manual (08645-90024)	+\$65
Opt W30 Extended repair service. See page 725.	
08645-61116 Service kit	+\$500

¹ HP-IB cables not included. For description and price, see page 569.

SIGNAL GENERATORS

Synthesized Signal Generator

Model 8645A

- 252 kHz to 2060 MHz frequency range
- 15 μ sec frequency switching
- Stand alone control of frequency agility

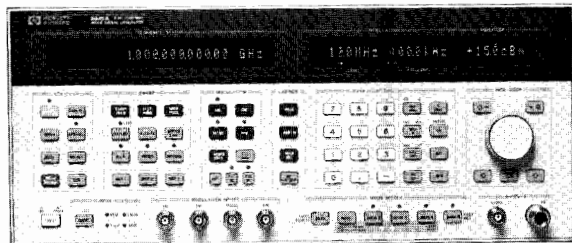

HP 8645A



HP 8645A Agile Signal Generator

The HP 8645A Agile Signal Generator combines high performance with frequency agility for new fast-switching test requirements. These capabilities are important for performance testing of such devices as frequency agile radios and surveillance receivers. Besides extending traditional receiver testing to agile applications, the HP 8645A can be used to create complex signal simulations involving several modulation types and frequency agility. These complex RF signals can quantitatively exercise a receiver's vulnerability to a jamming transmission. The HP 8645A can also be a fast-switching stimulus needed to decrease production test times. The high performance and frequency agility of the HP 8645A provide capability for both static and agile test requirements with just one calibrated signal generator.

Specified Agile Performance

The HP 8645A provides specified signal performance in both static and agile operation. Fully-synthesized outputs with high timebase accuracy are standard when not frequency hopping. The Fast Hop mode activates a frequency-lock loop to allow frequency switching as fast as 15 μ sec from 128 to 2060 MHz. Over the frequency range of 8 to 2060 MHz, the fastest switching time is 85 μ sec and outputs below 8 MHz require 500 μ sec. Frequency accuracy of each output is better than ± 2 ppm while in Fast Hop mode. At each frequency, a specific amplitude can be assigned within a 20 dB range for performance tests versus amplitude while frequency hopping. For a full test of a receiver, up to 2400 frequencies can be entered and sequences of up to 4000 frequency settings can be specified. Performance parameters such as phase noise, spurious, amplitude accuracy, and modulation remain high quality and are completely specified while fast hopping to insure confident test results.

Flexible, High Performance Modulation

For receiver measurements the HP 8645A offers independent or simultaneous FM and AM for both static and hopped frequency tests. The modulating signal can be the internal 0.1 Hz to 400 kHz synthesizer or an external input that allows FM deviations up to 20 MHz at rates up to 10 MHz. In Fast Hop operation, maximum deviation is 3.5 MHz with 10 MHz rates. AM is available with up to 100 kHz rates and 99% depth. Pulse modulation allows a 35 dB on/off ratio with 100 nsec rise/fall times.

Complete Control of Frequency Hopping

The HP 8645A offers flexible and comprehensive control of the frequency hopping output. Parameters can be entered from the front panel, through the HP-IB port or using TTL inputs on the rear panel. Extensive hopped frequency simulations including hop frequencies, dwell times, hop rate, modulation, etc. can be entered into non-volatile memory from the front panel. Activating a hop sequence requires only a press of the Hop key. Agile control is available by a computer with the added advantage of using the new Hewlett-Packard Systems Language (HP-SL). For real-time control, rear panel inputs accept TTL signals for triggering, dwell time and frequency selection to allow direct connection with the hardware under test. With this wide

- Specified performance while fast hopping
- FM rates to 10 MHz, deviations to 20 MHz
- Low spurious and phase noise

choice of control, use of the HP 8645A can be readily customized to a wide variety of test situations from benchtop use to ATE systems.

HP 8645A Specifications

Frequency

Range: 251.46485 kHz to 1030 MHz; 251.46485 kHz to 2060 MHz with Option 002 or with HP 11845A 2 GHz Retrofit Kit installed.

Frequency bands: The exact endpoints of each frequency band can be determined by dividing the 1030 to 2060 MHz band by two for each band decrease. The specifications use approximate endpoints.

Phase offset: adjustable in 1 degree increments.

Reference oscillator stability, Option 001: $< 5 \times 10^{-10}$ /day aging.

Fast Hop Operation

Frequency switching time: 128 to 2060 MHz: $< 15 \mu$ sec, 8 to 2060 MHz: $< 85 \mu$ sec, 0.25 to 2060 MHz: $< 500 \mu$ sec. Opt. 002: add 5 μ sec.

Frequency hop range: 0.25 to 2060 MHz. With FM on, limited to any three consecutive frequency bands.

Frequency accuracy¹: ± 2 ppm of carrier frequency.

Channel and sequence tables: In Fast Hop, each specific frequency and amplitude to be output is entered into a Channel Table. The order of channels to be output is entered into a Sequence Table.

Maximum number of channels: 2400.

Maximum number of channels in Sequence Table: 4000.

Hop rate range: fixed rates from 8 Hz to 50 kHz using internal timer. An external input allows more range and variable rates.

Dwell time range: fixed times of 6.4 μ sec to 99 msec using the internal timer. External input allows longer and variable dwell.

Learn cycle time: typically, 10 sec. to 3.5 min., depending on sequence size.

Fast Hop bus: allows real-time selection of any channel for output. Typically, frequency switching time increases by 5 μ sec.

Modulation: internal or external AM, FM, or simultaneous AM/FM.

Output level: Allowed amplitude variation of all channels entered is 0 to 20 dB. Output level is reduced by > 60 dB while switching between channels. External dc AM can be used to shape the output.

Spectral Purity

SSB phase noise (CW, AM, or FM² operation):

Carrier Frequency (MHz)	Standard Operation		Fast Hop 20 kHz (dBc/Hz)
	20 kHz (dBc/Hz)	100 kHz (dBc/Hz)	
1030 to 2060	-120	-127	-116
515 to 1030	-127	-134	-123
257 to 515	-132	-137	-128
128 to 257	-136	-140	-133
64 to 128	-139	-141	-137
32 to 64	-141	-141	-139
16 to 32	-142	-142	-141
8 to 16	-143	-143	-142
4 to 8	-144	-144	-143
Less than 4 MHz	-144	-144	-144

Harmonics: < -30 dBc, output ≤ 10 dBm. Opt. 002, output > 8 dBm: < -30 dBc, 0.25 to 1030 MHz; < -25 dBc, 1030 to 2060 MHz.

Subharmonics: none, < 515 MHz. < -60 dBc, 515 to 1030 MHz. < -40 dBc, > 1030 to 2060 MHz.

Nonharmonics: > 20 kHz offset³: < -100 dBc, < 2060 MHz. < -94 dBc, > 1030 to 2060 MHz.

¹Typically, $+2$ ppm of carrier frequency multiplied by the temperature change in $^{\circ}$ C must be added if ambient temperature changes occur between the learn operation and the conclusion of frequency hopping. FM at minimum deviation.

²FM at minimum deviation.

³Typically, nonharmonic spurs at all offsets are < 30 dB above the instrument's phase noise level as measured in a 1 Hz bandwidth.

Residual FM¹ (CW, AM, FM² operation):

Carrier frequency (MHz)	Post detection bandwidth	
	0.3 to 3 kHz (Hz rms)	0.05 to 15 kHz (Hz rms)
0.25 to 257	<1	<1.2
257 to 515	<1.2	<2
515 to 1030	<2	<4
1030 to 2060	<4	<8

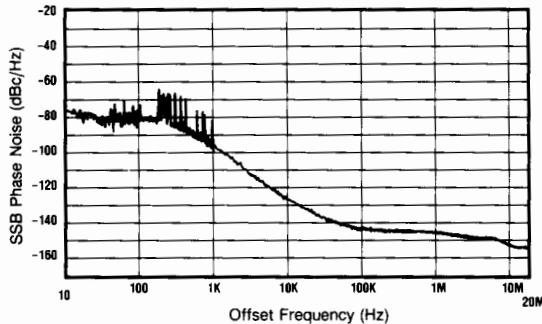
Typical SSB phase noise and spurs at 1 GHz:

Residual AM: <0.01% AM rms, 0.3 to 3 kHz post detection BW.
Typical SSB AM noise floor, offsets > 100 kHz: <-157 dBc/Hz at +16 dBm output, 0.25 to 1030 MHz. <-150 dBc/Hz at +13 dBm output, 1030 to 2060 MHz.

Output

Maximum level: +16 dBm, 0.25 to 1030 MHz; Opt. 002: +14 dBm, 0.25 to 1030 MHz; +13 dBm, above 1030 MHz.
Minimum level: -137 dBm.
Absolute accuracy: ± 1 dB, output ≥ -127 dBm.
Reverse power protection: 50 watts from a 50 Ω source, 25 Vdc.
Typical third order intermodulation: <-50 dBc, outputs <8 dBm.
Typical output level overrange: 2 dB more than maximum level.
Typical SWR and output impedance: <1.7:1, 50 Ω .

Modulation

External modulation input: Coupling is ac or dc for AM, FM and phase modulation. Pulse modulation input is dc coupled. Displayed deviation or depth corresponds to ± 1 V external input.
Simultaneous modulation: AM/FM, AM/Phase, AM/Pulse, FM/Pulse, Phase/Pulse, AM/FM/Pulse, AM/Phase/Pulse.
Simultaneous internal/external modulation: FM and Phase.

Amplitude Modulation

Depth: 0 to 99.9%, for output $\leq \pm 7$ dBm.
Indicator accuracy: $\pm(6\%$ of setting + 1% AM), up to 90% and <1 kHz.
Distortion, at 400 Hz and 1 kHz rates:

Depth	Carrier frequency	
	0.25 to 1030 MHz	1030 to 2060 MHz
0 to 30%	<2%	<4%
30 to 70%	<3%	<4%
70 to 90%	<5%	<6%

3 dB bandwidth³: >5 kHz, 0.25 to 8 MHz. >50 kHz, 8 to 128 MHz. >100 kHz, 128 to 2060 MHz.

Incidental phase modulation: <0.2 rad peak, at 30% depth and 1 kHz.

Typical external input impedance: 600 Ω .

Frequency Modulation

FM deviation and rate: In the highest frequency band of 1030 to 2060 MHz, the maximum FM peak deviation is 20 MHz for standard operation and 3.52 MHz for Fast Hop. Maximum FM rate (3 dB bandwidth) in the 515 to 1030 MHz band and above is 10 MHz. Divide rate and deviation by two for each frequency band decrease.

FM indicator accuracy⁶: $\pm 10\%$, <50 kHz rate and <10% of maximum deviation (<50% of maximum deviation in Fast Hop.)

FM distortion: Rates 20 Hz to 100 kHz: <2.7%, deviation <2% of maximum available (Fast Hop: <10% of maximum deviation.)

Carrier frequency accuracy in FM: $\pm 0.4\%$ of deviation setting, ac or dc coupled. Typically add 1% of deviation in Fast Hop.

Incidental AM: <0.5%, deviation limited to <6% of max. or 20 kHz.

Typical external FM group delay: 30 μ sec for rates 20 Hz to 20 kHz, decreases to <1 μ sec at rates >200 kHz. Fast Hop: <1 μ sec.

Typical external FM input impedance: 50 or 600 Ω .

Pulse Modulation

On/off ratio: >35 dB.

Rise/fall time: <100 nsec, between 10% and 90% response points.

Maximum pulse repetition frequency: 1 MHz.

Minimum pulse width: 0.5 μ sec.

Typical output level accuracy: ± 2 dB.

Typical external input levels and impedance: on: >3.0V peak; off: <0.8V peak. Damage level: $\geq \pm 10$ V peak. 600 Ω .

Internal Modulation Source

Waveforms: sine, square, sawtooth and white Gaussian noise.

Frequency range: sine, white Gaussian noise: 0.1 Hz to 400 kHz. Square, sawtooth: 0.1 Hz to 50 kHz.

Frequency accuracy: same as internal reference oscillator.

Output level: Typically, 1 V_{pk} max. into 600 Ω . Accuracy: ± 20 mV.

Output level resolution: 2 mV. Typical impedance: 600 Ω .

Distortion: <0.1%, output at 1V peak and ≤ 15 kHz.

Frequency Sweep

Phase continuous sweep: linear sweep with times from 10 msec to 10 sec, not dependent on span. Maximum span is 40 MHz from 1030 to 2060 MHz frequency band, divided by two for each band decrease.

Fast Hop sweep: linear or log stepped with times from 10 msec to 100 sec. Number of steps varies with time selected. Typical time per step is 30 μ sec for outputs within 128 to 2060 MHz, 170 μ sec for 8 to 2060 MHz, and 650 μ sec for 0.25 to 2060 MHz.

Sweep control and markers: X-axis: 0 to +10V. Z-axis: +5V retrace, +1V trace, 0V markers. Three markers available.

General

Remote control: HP-IB (IEEE-488.2-1987). The control language used is the Hewlett-Packard Systems Language (HP-SL). All front panel functions except power switch and knob. A unique Fast Hop bus interface accepts TTL levels for frequency agile control.

Operating temperature range: 0 to +55° F.

Leakage: meets Mil Std 461B RE02 and FTZ 1046.

Storage registers: 10 full function and 40 freq./ampl. locations.

Memory erasure: all memory contents according to Mil Std 380-380.

Weight: net, 31 kg (69 lbs); shipping, 42 kg (95 lbs).

Size: 177H x 426W x 624mmD (7" x 16.8" x 24.6").

Ordering Information

	Price
HP 8645A Agile Signal Generator ⁴	\$32,000
Opt 001 High stability time base	+\$1,500
Opt 002 2 GHz output	+\$6,000
Opt 003 RF connectors on rear panel only	+\$300
Opt 907 Front handle kit (5061-9690)	+\$65
Opt 908 Rack flange kit (5061-9678)	+\$35
Opt 909 Rack flange kit with front handles (5061-9684)	+\$90
Opt 910 Provides an additional operation/calibration manual (08645-90023) and 2 service manuals (08645-90025)	+\$190
Opt 915 Add service manual (08645-90025)	+\$65
Opt W30 Extended repair service. See page 725	+\$775
HP 11845A 2 GHz Retrofit Kit	\$6,180
08645-61116 Service kit	\$500
9211-2662 Transit case	\$550
1490-0913 Transit case wheels	\$210
1494-0059 Non-tilting rack slide kit	\$100
1494-0063 Tilting rack slide kit	\$190

⁴HP-1B cables not included. For description and price, see page 569.

¹Specified for 48 to 63 Hz power line. Typical for 400 Hz power line and Fast Hop operation.

²Deviation <0.1% of maximum available.

³Lower 3 dB bandwidth limit is 0 Hz for dc coupling and typically 20 Hz for ac coupling.

SIGNAL GENERATORS

Synthesized Signal Generator

Model 8665A

- 100 kHz to 4.2 GHz
- < -134 dBc/Hz SSB phase noise at 20 kHz offset

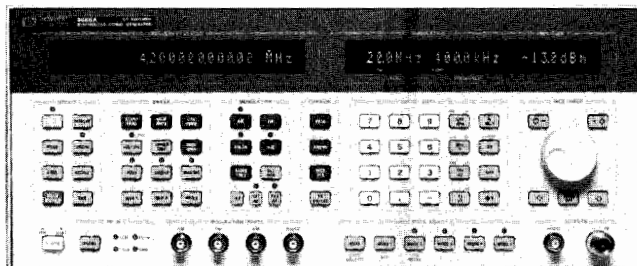

HP 8665A



HP 8665A Synthesized Signal Generator

The HP 8665A Synthesized Signal Generator is a high performance, programmable signal generator intended for out-of-channel RF receiver measurements, particularly receiver measurements such as spurious rejection, which often require frequency coverage to 4.2 GHz. A frequency range from 100 kHz to 4.2 GHz allows the HP 8665A to be used in all out-of-channel receiver measurements.

Excellent Spectral Purity

The HP 8665A exhibits excellent spectral purity by having both low SSB phase noise and low spurious. Low SSB phase noise of < -134 dBc/Hz at 20 kHz offset and 1 GHz carrier is for high performance characterization of receiver selectivity, while low spurious of < -100 dBc is for characterization of receiver spurious rejection. This spectral purity, coupled with the HP 8665A's frequency coverage to 4.2 GHz, provides a solution to measurements that often could be done only by two separate signal generators.

AM, FM and Optional Pulse Modulation

The HP 8665A offers AM, FM and optional pulse modulation across its full frequency range. FM rates of up to 2 MHz and deviations to 20 MHz peak (at 4.2 GHz and 800 kHz rate) allow the HP 8665A to be used in many applications, such as telemetry, requiring higher FM performance. An optional pulse modulator with ON/OFF ratio > 80 dB and rise and fall times < 5 ns is offered on the HP 8665A. Pulse width and delay can be internally adjusted between 50 ns and 999 msec, eliminating the need for an external pulse generator.

Internal Modulation Synthesizer

The HP 8665A provides an internal modulation synthesizer with a frequency range from 0.1 Hz to 400 kHz. Sine, square, sawtooth and white gaussian noise waveforms are available. A second internal source, identical to the source described above, may also be selected and summed with the first source. This provides variable two-tone capability. Plus, the first source can be internally modulated with AM, FM, phase modulation, pulse modulation and double sideband modulation to further enhance this internal modulation synthesizer.

HP 8665A Specifications

Frequency

Range: 100 kHz to 4200 MHz. See internal modulation source for coverage below 100 kHz.

Resolution: 0.01 Hz.

Accuracy and stability: in CW, same as reference oscillator.

Relative Phase Adjust

Preset: adjustable in 1° increments.

Analog: 200 radians/volt in 515 to 1030 MHz band from an internal or external input through phase modulation input.

Analog bandwidth: STD mode: 150 Hz; low noise mode, Option 004: 20 Hz.

External input impedance: Typically, 50 Ω .

Internal Reference Oscillator

Typical stability: standard: aging rate; ± 2 ppm/year; Option 001: $< 10^{-9}$ /day aging rate after 10 days warmup.

- < -100 dBc non-harmonic spurious
- FM rates to 2 MHz
- Optional pulse modulation

Spectral Purity

SSB phase noise (CW, AM, or FM¹ operation) measured in a 1 Hz BW in dBc/Hz

Carrier Frequency Range (MHz)	Offset Frequency					
	1 kHz		20 kHz		100 kHz	
	STD	Opt 004	STD	Opt 004	STD	Opt 004
4120 to 4200	-63	-83	-105	-116	-122	-121
3000 to 4120	-63	-89	-105	-122	-122	-127
2060 to 3000	-67	-89	-111	-122	-128	-127
1500 to 2060	-67	-94	-111	-128	-128	-133
1030 to 1500	-73	-94	-117	-128	-134	-133
750 to 1030	-73	-100	-117	-134	-134	-139
515 to 750	-79	-100	-122	-134	-138	-139
375 to 515	-79	-106	-122	-139	-138	-144
257.5 to 375	-85	-106	-128	-139	-143	-144
187.5 to 257.5	-85	-112	-128	-144	-143	-146
30 to 187.5	-73	-94	-117	-128	-132	-133
.1 to 30	-73	-100	-117	-131	-132	-134

Typical SSB phase noise at 1 GHz comparing STD with Low Noise Opt 004

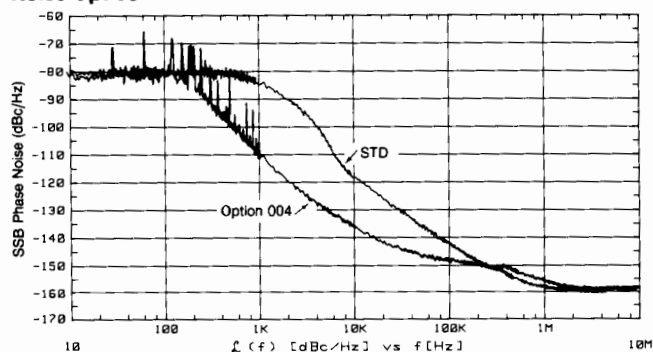

SSB broadband noise floor: in 1 Hz BW at > 1 MHz offset from carrier with > 5.1 dBm output level.

- < -145 dBc for carrier frequencies > 187.5 MHz, < 4200 MHz;
- < -140 dBc for carrier frequencies > 10 MHz, < 187.5 MHz

Spurious Signals

Harmonics: < -30 dBc, output level $< +10$ dBm; < -25 dBc, output level $< +13$ dBm.

Sub-harmonics: < -75 dBc, 100 kHz to < 1500 MHz; < -40 dBc, 1500 to < 3000 MHz; < -50 dBc, 3000 to 4200 MHz.

Non-harmonics: < -100 dBc, > 10 kHz offset, 187.5 to 2060 MHz, STD mode and low noise mode, Opt 004; < -90 dBc, > 10 kHz offset, 0.1 to 187.5 MHz, STD mode and low noise mode, Opt 004; < -90 dBc, > 10 kHz offset, 2060 to 4200 MHz, STD mode and low noise mode, Opt 004.

Residual FM²: (CW, AM, FM Operation) < 15 Hz STD mode, < 2.5 Hz low noise mode Opt 004, 750 to 1500 MHz, .3 to 3 kHz BW.

Residual AM: $< 0.02\%$ AM rms, 0.3 to 3 kHz post detection bandwidth.

SSB AM noise floor, offsets > 100 kHz with AM off: < -140 dBc/Hz at $+13$ dBm output, 0.1 to 187.5 MHz; < -150 dBc/Hz at $+13$ dBm output, 187.5 to 4200 MHz.

Output

Maximum level: $+13$ dBm, 0.1 to 4200 MHz; $+9$ dBm with pulse modulation, Opt 008.

¹ FM at minimum deviation.

² Specified for 48 to 63 Hz power line. Typical for 400 Hz power line.

SIGNAL GENERATORS

Synthesized Signal Generator (cont'd)

Model 8665A

367

Minimum level: -139.9 dBm.

Display resolution: 0.1 dB.

Absolute accuracy: ± 1 dB, output > -119.9 dBm, 0.1 to 3000 MHz; ± 1.5 dB, output > -119.9 dBm, 3000 to 4200 MHz.

Reverse power protection: 25W into 50 Ω , .1 to 2060 MHz. 1W into 50 Ω , 2060 to 4200 MHz.

Third order intermodulation: typically, < -50 dBc with two signals at +8 dBm and 25 kHz apart, passing through a resistive combiner.

Output level overrange: typically, 2 dB more than maximum level.
SWR: $< 1.5:1$, output < 0 dBm; $< 1.75:1$, output > 0 dBm; 0.1 to 3000 MHz; $< 1.75:1$, output < 0 dBm, $< 2.0:1$, output > 0 dBm, 3000 to 4200 MHz.

Output impedance: nominally 50 Ω .

Modulation

External modulation input: Coupling is ac or dc for AM and FM modulation. Pulse modulation input is dc coupled. 1V peak input is required for calibrated operation in AM and FM.

Amplitude Modulation

AM depth: 0 to 99.9%, for output $< +7$ dBm, ≤ 3 dBm (Opt. 008).

AM resolution: 0.1%.

AM indicator accuracy: $\pm(6\%$ of setting + 1% AM), up to 90% depth at 1 kHz rate.

AM distortion, at 400 Hz and 1 kHz rates: $< 4\%$ for depths 30 to 70%.

AM 3 dB bandwidth: > 5 kHz, 1 to 10 MHz; > 10 kHz, for > 10 MHz carrier frequencies.

Incidental phase modulation: at 30% depth and 1 kHz rate. < 0.2 radians peak, 0.1 to 2000 MHz f_c ; < 0.4 radians peak, 2000 to 4200 MHz f_c .

External AM input impedance: 600 Ω .

Frequency Modulation

FM Deviation and Rate:

Carrier Frequency (MHz)	Maximum Peak Deviation		
	STD Mode (kHz)	Low Noise Mode Option 004 (kHz)	Maximum Rate ¹ (3 dB BW) (kHz)
3000 to 4200	20000	400	800
1500 to 3000	10000	200	800
750 to 1500	5000	100	800
375 to 750	2500	50	800
187.5 to 375	1250	25	800
10 to 187.5	5000	100	800
< 10	5000	100	800

FM resolution: 2.5% of setting.

FM indicator accuracy²: DC to 20 kHz rates. $\pm 9\%$ of FM deviation setting STD mode; $\pm 11\%$ of FM deviation setting, low noise mode, Opt 004.

FM distortion: $< 1\%$ for rates 20 Hz to 20 kHz.

Carrier frequency accuracy in FM: $\pm 0.5\%$ of deviation setting, ac or dc coupled.

Incidental AM: $< 0.1\%$, at < 20 kHz deviation, 1 kHz rate.

External FM group delay: < 30 μ sec for rates < 20 kHz, decreases to < 1 μ sec at rates above 200 kHz.

External FM input impedance: 600 Ω .

Pulse Modulation (Option 008)

On/Off ratio: > 80 dB.

Rise/Fall time: < 5 nsec, between 10% and 90% response points.

Pulse repetition frequency: internal, 0.1 Hz to 400 kHz; external, DC to 10 MHz.

Pulse width: internally variable between 50 ns and 999 ms.

Pulse delay: internally variable between 50 ns and 999 ms.

Output level accuracy: same as with no pulse modulation.

External input level: TTL.

External input impedance: 50 Ω or Schottky TTL.

Internal Modulation Source

Number of sources: Source 1, source 2, simultaneously available through summation, independently adjustable in frequency, phase, amplitude and waveform. Source 1 may also be internally modulated

¹ Typically the 3 dB BW is > 2 MHz for deviations $< \text{maximum peak deviation}/10$.

² Typical accuracy up to 20 kHz rates and maximum deviations is better than $\pm 7\%$.

independently with AM, FM, phase modulation, pulse modulation and double sideband modulation.

Waveforms: sine, square, sawtooth and white gaussian noise.

Frequency range: 0.1 Hz to 400 kHz, sine and white gaussian noise. 0.1 Hz to 50 kHz, square and sawtooth.

Frequency resolution: 0.1 Hz.

Frequency accuracy: same as internal reference oscillator.

Maximum output level: 1 V_{pk} into 600 Ω .

Output level resolution: < 2 mV. Typically, < 1 mV.

Output impedance: Typically, 600 Ω .

Total harmonic distortion: $< 0.1\%$, output at 1 V_{pk} and < 20 kHz. Typically, $< .1\%$ to 100 kHz.

Frequency Sweep

Phase Continuous Sweep

Sweep time: 10 msec to 10 sec.

Maximum sweep span: up to 40 MHz in the 3000 to 4200 MHz band.

Digitally Stepped Sweep

Sweep type: linear or log, frequency stepped.

Sweep time range: 500 msec to 100 sec. Typical time per step is 90 msec.

X-Axis output: nominal 0 to +10V.

Z-Axis output: nominal +5V during retrace.

Markers available: 3.

Remote Programming

Interface: HP-IB (Hewlett-Packard's implementation of IEEE-488.2-1987). HP-IB select code range: 00 to 30. Interface function is listener and talker.

Control language: Hewlett-Packard Systems Language (HP-SL).

Functions controlled: all front panel functions except power switch and knob.

HP-IB functions: SH1, AH1, T6, TE0, L4, LE0, SR1, RL1, PP0, DC1, DT0, C0, E2.

General

Power requirements: $\pm 10\%$ of 100, 120, 220, or 240V; 48 to 440 Hz; 500 VA maximum.

Operating temperature range: 0 to $+55^\circ\text{C}$.

Leakage: Conducted and radiated interference meets MIL STD 461B RE02 and FTZ 1046. RF leakage is typically 1 μV below 1 GHz f_c , induced in a two-turn loop antenna 2.5 cm in diameter held 2.5 cm away from the front panel for output levels < 0 dBm. Option 010 reduces RF leakage to typically < 0.5 μV .

Calibration interval: 3 years (MTBC).

Storage registers: 10 full function and 40 frequency/amplitude registers.

Memory erasure: All memory contents, except generic calibration data, can be erased according to Mil Std 380-380.

Weight: net, approx. 29 to 31 kg (63 to 69 lb); shipping, 40 to 42 kg (88 to 94 lb) depending on the options ordered.

Size: approx. 178H x 425W x 648 mmD (7" x 16.75" x 25.5"). Opt 010 adds 35 mm (1.4") to the depth.

Ordering Information

	Price
HP 8665A Synthesized Signal Generator ³	\$35,000
Opt 001 High stability time base (includes EFC)	+\$1,500
Opt 003 RF inputs on rear panel only	+\$400
Opt 004 Low noise mode	+\$4,000
Opt 008 Pulse modulation	+\$3,500
Opt 010 Reduced leakage configuration	+\$1,500
Opt 907 Front handle kit (5061-9690)	+\$65
Opt 908 Rack flange kit (5061-9678)	+\$35
Opt 909 Rack flange kit (5061-9684) with front handles	+\$90
Opt 910 Provides an additional operation and calibration manual (08665-90026) and two service manuals (08645-90024)	+\$190
Opt 915 Add service manual (08645-90024)	+\$65
Opt W30 Extended repair service. See page 725.	+\$875
08665-61116 Service kit	\$500
9211-2662 Transit case	\$550
1490-0913 Transit case wheels	\$210
1494-0059 Non-tilting rack slide kit	\$100
1494-0063 Tilting rack slide kit	\$190

³ HP-IB cables not supplied. For description and price, see page 569.

SIGNAL GENERATORS

Synthesized Signal Generators

Models 8642A and 8642B

- 100 kHz to 2.115 GHz
- < -134 dBc/Hz SSB phase noise at 20 kHz offset
- -100 dBc nonharmonic spurious

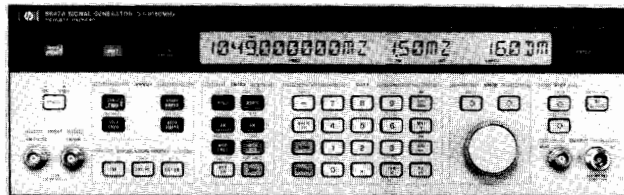

HP 8642A



HP 8642A/B Synthesized Signal Generators

The HP 8642A and HP 8642B synthesized signal generators are high performance programmable signal generators intended for the most demanding out-of-channel RF receiver measurements and other stringent RF applications. The HP 8642A covers the frequency range from 100 kHz to 1057.5 MHz and the HP 8642B to 2115 MHz.

Low SSB Phase Noise

The HP 8642A/B provide state-of-the-art in SSB phase noise at 20 kHz offsets of -134 dBc/Hz at 1 GHz.

-100 dBc Spurious

Nonharmonic spurious are held to below -100 dBc on the HP 8642A/B up to 1 GHz and to below -94 dBc above 1 GHz. These two generators allow receiver spurious rejection tests to be fully automated with the utmost confidence in test results.

Repeatability and Level Accuracy

In addition to a high-reliability attenuator, absolute output level accuracy is ± 1 dB down to -127 dBm ($0.1 \mu\text{V}$). In R&D or on the production line, the HP 8642A/B will accurately measure receiver sensitivities.

Up to $+20$ dBm Output Level

Up to $+20$ dBm is available from the HP 8642A/B to perform a variety of high level measurements, often eliminating the need for external amplifiers.

This extra power can be used to overcome cabling losses. With the relative amplitude feature, the display can be offset to show correct output level at the end of the cable.

AM, FM, Φ M and Pulse Modulation

The HP 8642A/B offer AM, FM, Φ M and pulse modulation across their full frequency ranges.

A low distortion internal modulation oscillator can be used to modulate the HP 8642A/B up to 100 kHz rates. The internal audio oscillator can also be used as a stand-alone audio source with variable rates and levels.

HP 8642A/B Specifications

Frequency

Range: 100 kHz to 1057.5 MHz, HP 8642A; 100 kHz to 2115 MHz, HP 8642B.

Bands: Both generators cover their ranges in one continuous span. However, many other specifications are dependent on carrier frequency. To simplify such specifications, the HP 8642A and 8642B carrier frequency ranges are divided into bands shown in the table below.

- $+20$ dBm maximum output level
- AM, FM, Φ M and pulse modulation
- On-site repair and calibration

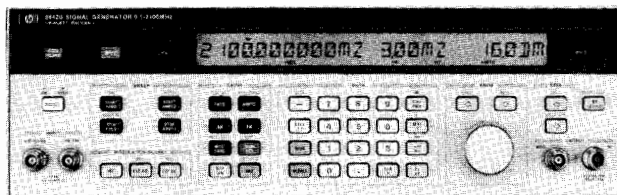

HP 8642B



Band	Carrier Frequency (MHz)	Band	Carrier Frequency (MHz)
10	1057.500001-2115 (HP 8642B)	4	16.523438- 33.046875
9	528.750001-1057.5	3	8.261719- 16.523437
8	264.375001- 528.75	2	4.130860- 8.261718
7	132.187501- 264.375	1	0.1 - 4.130859
6	66.093751- 132.1875	HET	0.1 -132.1875
5	33.046876- 66.09375		

Resolution: 1 Hz, 0.1 Hz with special function.

Stability: same as reference oscillator.

Internal Reference Oscillator

Standard: aging rate: ± 2 ppm/year; **Option 001:** $< 10^{-9}$ /day aging rate after 8 days warm-up.

Spectral Purity

Residual FM (in CW, AM or Angle Modulation $< 1/3$ Max. Dev.):

500 MHz: < 1.2 Hz (0.3 - 3 kHz BW), < 2 Hz (0.05 - 15 kHz BW);

1000 MHz: < 2 Hz (0.3 - 3 kHz BW), < 5 Hz (0.05 - 15 kHz BW);

2000 MHz: < 5 Hz (0.3 - 3 kHz BW), < 9 Hz (0.05 - 15 kHz BW).

SSB Phase Noise at 20 kHz offset (CW, AM or FM/ Φ M $< 1/60$ Maximum Deviation):

125 MHz: -144 dBc/Hz;

250 MHz: -141 dBc/Hz;

500 MHz: -137 dBc/Hz;

1000 MHz: -134 dBc/Hz;

2000 MHz: -125 dBc/Hz.

Residual AM: $< 0.01\%$ AM rms, 0.3 - 3 kHz BW.

Spurious

Harmonics: -30 dBc, level $\leq +10$ dBm, -25 dBc $f_c > 1057.5$ MHz.

Subharmonics: none, $f_c \leq 1057.5$ MHz; -45 dBc, $f_c > 1057.5$ MHz.

Nonharmonics (> 10 kHz offsets): -100 dBc, (-94 dBc $f_c > 1057.5$ MHz).

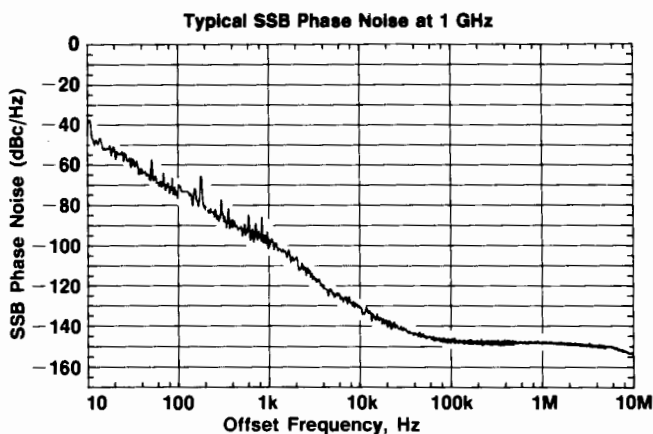

SIGNAL GENERATORS

Synthesized Signal Generators (cont'd)

Models 8642A and 8642B

369

Output

Level range: from maximum available to -140 dBm (0.023 μ V).

Maximum Level Available:

	HP 8642A	HP 8642B
+20 dBm (2.24V)	bands 1 thru 7	bands 1 thru 7
+19 dBm (2.00V)	n/a	band 8
+18 dBm (1.78V)	bands 8 & HET	HET
+17 dBm (1.58V)	n/a	band 9
+16 dBm (1.41V)	band 9	band 10

Resolution: 0.1 dB.

Absolute accuracy: ± 1 dB, output level ≥ -127 dBm.

Flatness: $\leq \pm 0.75$ dB, +10 dBm output level.

Impedance: 50 Ω nominal.

SWR: <1.5:1, level <0 dBm; <2.0:1, level ≥ 0 dBm.

Reverse power protection: 50W, from a 50 Ω source 25 Vdc (HP 8642A), 25W, 50 Vdc (HP 8642B).

Third order intermodulation: <-50 dBc at +10 dBm, two generators 25 kHz apart into a resistive combiner. Typically decreases 10 dB for every 5 dB of combined level decrease.

Amplitude Modulation

AM depth: 0 to 99.9%, output level $\leq +10$ dBm.

AM resolution: 0.1%.

AM indicator accuracy at 1 kHz rate and up to 90% AM:

$\pm(3.5\%$ of setting +1% AM), $f_c \leq 528.75$ MHz (8642A), $f_c \leq 1057.5$ MHz (8642B);

$\pm(5\%$ of setting +1% AM), $f_c > 528.75$ MHz (8642A), $f_c > 1057.5$ MHz (8642B).

AM distortion at 1 kHz rate:

Depth	Distortion	
	8642A; $f_c \leq 528.75$ MHz 8642B; $f_c \leq 1057.5$ MHz	8642A; $f_c > 528.75$ MHz 8642B; $f_c > 1057.5$ MHz
0 to 30% AM	<1%	<2%
30 to 70% AM	<2%	<4%
70 to 90% AM	<4%	<6%

AM 3 dB bandwidth, depth $\leq 90\%$:

External dc/ac coupling: dc/20 Hz to 100 kHz, f_c : 01-4.13 MHz, 33.04-2115 MHz, HET; dc/20 Hz to 20 kHz, f_c : 4.13-33.04 MHz.

Internal: same as external ac.

Incidental θ M at 1 kHz rate and 30% AM: <0.2 radians peak.

Frequency Modulation

Maximum FM deviation:

Carrier Frequency Band	Maximum Deviation DC Coupled	Maximum Deviation AC Coupled or Internal
10	3 MHz	(the smaller of) 3 MHz or $f_{mod} \times 2160$
9	1.5 MHz	1.5 MHz or $f_{mod} \times 1080$
8	750 kHz	750 kHz or $f_{mod} \times 540$
7	375 kHz	375 kHz or $f_{mod} \times 270$
6	187 kHz	187 kHz or $f_{mod} \times 135$
5	93.8 kHz	93.8 kHz or $f_{mod} \times 67.5$
4	46.9 kHz	46.9 kHz or $f_{mod} \times 33.75$
3	23.4 kHz	23.4 kHz or $f_{mod} \times 16.88$
2	11.7 kHz	11.7 kHz or $f_{mod} \times 8.44$
1	93.8 kHz	93.8 kHz or $f_{mod} \times 67.5$
HET	1.5 MHz	1.5 MHz or $f_{mod} \times 1080$

FM resolution: 0.7% of setting or 0.0004% of maximum deviation, whichever is larger.

FM indicator accuracy, rates ≤ 100 kHz: $\pm(5\%$ of setting +10 Hz).

FM distortion, rates 20 Hz to 100 kHz: 4% for max. dev., 2% for $1/2$ max. dev., 0.4% for $1/10$ maximum dc coupled deviation.

FM 3 dB bandwidth: (dc/ac coupling): dc/20 Hz to 200 kHz.

Incidental AM: 0.3%, 20 kHz peak dev., 1 kHz rate, $f_c > 400$ kHz.

Phase Modulation

Maximum phase deviation:

Carrier Frequency Band	Maximum Deviation (Radians)
10	200
9	100
8	50
7	25
6	12.5
5	6.25
4	3.13
3	1.56
2	0.78
1	6.25
HET	100

θ M accuracy: $\pm(5\%$ of setting +0.09 radians), 1 kHz rate.

θ M resolution: Greater of 0.7% of setting or 0.0004% of max. dev.

θ M distortion: <0.4%, 1 kHz rate.

θ M 3 dB bandwidth: dc/20 Hz to 15 kHz.

Pulse Modulation (for output levels $\leq +15$ dBm)

Pulse on/off ratio: >40 dB; >80 dB, $f_c > 1057.5$ MHz.

Rise/fall time: <400 ns, 10% to 90%.

Maximum repetition frequency: 100 kHz.

Minimum pulse width: 2 μ s.

Internal Modulation Oscillator

Rates: 20 Hz to 100 kHz.

Frequency resolution: 1% of setting.

Frequency accuracy: 2% of setting.

Output level range: 0 to 3V peak into 600 Ω .

Output level resolution: 4 mV.

Distortion: <0.02%, 0.02 kHz to 15.8 kHz; <0.15%, >15.8 kHz.

Output level accuracy: $\pm(4\%$ +15 mV) within 1 second.

Output impedance: 600 Ω $\pm 10\%$.

Frequency Sweep

Modes: Start-Stop, Span, and Phase continuous.

X axis output: 0 to 10 Vdc, $\pm 10\%$.

Z axis output: TTL positive true for crt display blanking during retrace.

Remote Programming

Interface: HP-IB (IEEE-488-1978).

HP-IB functions: listener, talker, and controller. SH1, AH1, T5, TE0, L3, LE0, SR1, RL1, PP1, DC1, DT1, C1, C3, C28, E2.

General

Operating temperature range: 0 $^\circ$ to 55 $^\circ$ C.

Storage temperature: -55 $^\circ$ C to +75 $^\circ$ C.

Leakage: conducted and radiated interference is within the requirements of MIL STD 461B method RE02. Interference is also within the standards set by FTZ 1046. Also, RF leakage of <0.5 μ V is induced in a two turn loop 2.5 cm in diameter, held 2.5 cm away from any surface for output levels ≤ 0 dBm.

Power requirements: 100, 120, 220, or 240V; +5%, -10%; 48 to 440 Hz; 300 VA max.

Size: 133H X 425W X 617D mm (5.25" X 16.75" X 24.3").

HP System II module size: 5/4H X 1MW X 23D.

Weight: Net, 32.7 kg (71.5 lb); shipping, 43 kg (95 lb).

Ordering Information

HP 8642A Synthesized Signal Generator¹ \$27,000

HP 8642B Synthesized Signal Generator¹ \$37,000

Opt 001 High stability time base +\$2,300

Opt 002 Input/output connectors on rear panel only +\$165

Opt 710 On-site repair manual +\$74

Opt 907 Front handle kit (5061-9689) +\$57

Opt 908 Rack flange kit (5061-9677) +\$33

Opt 909 Rack flange kit (5061-9683) with front handles +\$82

Opt 910 Provides an additional operation and calibration manual (08642-90224) and two service manuals (08642-90226) +\$565

Opt 915 Add service manual (08642-90026) +\$255

HP 8642A Opt W30 Extended repair service. See page 725. +\$615

HP 8642B Opt W30 Extended repair service. See page 725. +\$845

HP 11801A On-site repair kit for HP 8642A \$21,100

HP 11801B On-site repair kit for HP 8642B \$27,800

HP 11801C On-site repair kit for HP 8642A/B \$29,350

¹HP-IB cables not supplied. For description and price, see page 569.



SIGNAL GENERATORS

Synthesized Signal Generators

Models 8662A, 8663A

- 10 kHz to 1280 MHz frequency range
- < -147 dBc/Hz SSB phase noise at 10 kHz offset
- 0.1 Hz frequency resolution

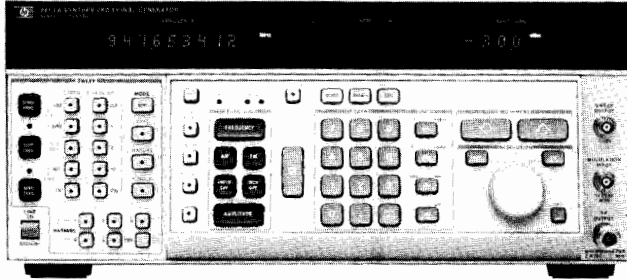

HP 8662A



HP 8662A Synthesized Signal Generator

The HP 8662A derives exceptional RF performance from an indirect frequency synthesis technique that results in frequency resolution of 0.1 Hz from 10 kHz to 640 MHz and 0.2 Hz from 640 MHz to 1280 MHz.

Output level accuracy is held to ± 1 dB using microprocessor correction. This makes the HP 8662A an ideal generator for performing precise receiver sensitivity tests either manually or in automated systems.

The HP 8662A offers versatile phase-locked AM/FM using either internal 400 Hz and 1 kHz rates or externally applied modulating signals, which can be either dc or ac coupled. Several different modes of simultaneous modulation (such as AM + FM or FM + FM) are possible.

Exceptional Spectral Purity

The key contribution of the HP 8662A is spectral purity. Fast-tuning, switched-inductance, voltage-controlled oscillators combined with a low noise reference multiplication chain result in very low SSB phase noise, especially at small offsets from the carrier. The phase noise at 20 kHz to 50 kHz offsets is comparable to that of the best cavity-tuned fundamental oscillators. Such excellent noise performance makes possible complete automation of receiver out-of-channel measurements.

With its excellent long and short-term frequency stability, high output power, fine frequency resolution, and broad frequency range the HP 8662A also meets the requirements of the most critical low noise local oscillator applications. In addition, its fast frequency switching and sweep capabilities also permit its use in many frequency agile and swept local oscillator applications.

An advanced microprocessor-based controller allows convenient keyboard control of all HP 8662A functions. For example, all functions can be incremented and decremented in any user-defined step size within the resolution of the synthesizer using the increment keys and the knob. Up to nine full front panel setups can be stored in the HP 8662A's memory and recalled for later use in any user-defined sequence at the touch of a pushbutton. This permits time-saving semi-automation of generator operation in production setups where the generator must perform many different tests.

Precision Digital Sweep

Fast frequency switching combined with microprocessor control gives the HP 8662A a powerful sweep capability. Automatic, single, and manual modes are available for both linear and logarithmic sweeps with user-selectable step size and number of steps. Five different sweep speeds can be chosen and up to five amplitude or Z-axis markers can be set. All sweep parameters can be controlled with full synthesizer resolution.

- 100 kHz to 2560 MHz frequency range
- AM/FM/ØM/pulse in one generator
- Internal variable modulation oscillator

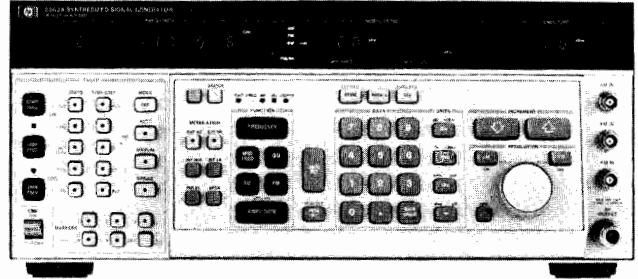

HP 8663A



HP 8663A Synthesized Signal Generator

The HP 8663A provides all the features and the exceptional spectral purity of the HP 8662A with increased frequency range and modulation capability.

The HP 8663A also has U.S. Air Force MATE (Modular Automatic Test Equipment) system compatibility, Option 700. Option 700 is an external translator that provides the HP 8663A with the capability to be controlled by the MATE language CIIL (Control Interface Intermediate Language).

Broad Frequency Range

The HP 8663A utilizes the complete frequency synthesis portion of the HP 8662A with the addition of an internal frequency doubler to achieve a broad frequency range of 100 kHz to 2560 MHz in a single instrument. In the HP 8663A, the exceptional spectral purity of the HP 8662A is maintained up to 1280 MHz. Above this, phase noise is typically increased 6 dB to a level of -124 dBc/Hz at 10 kHz offset from a 2.5 GHz carrier. High output power of +16 dBm (with over-range to 19.9 dBm) is available for efficiently driving frequency translators when low noise microwave signals are needed. Combined with a microwave synthesizer such as the HP 8673A, full frequency coverage from 100 kHz to 26 GHz is possible.

Flexible Modulation

Complete modulation capability across a wide carrier frequency range is the key contribution of the HP 8663A. AM and FM characteristics are similar to those offered in the HP 8662A. The HP 8663A adds high performance pulse and biphasic modulation with wide bandwidth linear phase modulation available with Option 002. For complete flexibility the HP 8663A Option 002 has the capability to simultaneously provide AM+FM+pulse+phase modulation across its entire frequency range. AM, FM, and linear phase are either AC or DC coupled while biphasic and pulse are DC coupled. This modulation flexibility assures exact signal simulation when testing complex systems such as those involving pulsed doppler radar and electronic warfare. An internal 100 kHz sinusoidal modulation synthesizer phase locked to the 10 MHz time base is standard. Microprocessor flexibility allows the sweep functions to be applicable to the internal audio synthesizer, as well as the RF synthesizer, making applications involving swept modulation possible with a single instrument.

Similarity to the HP 8662A

Because the HP 8663A has been designed to be upward compatible with the HP 8662A, the two generators have identical control and performance characteristics for those functions that are common. Either generator can be combined with the HP 11729A Microwave Converter and the HP 3048A Phase Noise Measurement System to perform microwave phase noise measurements simply and quickly.

HP 8662A Specifications

Frequency

Range: 10 kHz to 1280 MHz (1279.9999998 MHz).

Resolution: 0.1 Hz (0.2 Hz above 640 MHz).

Accuracy and stability: same as reference oscillator.

Internal reference oscillator: 10 MHz quartz oscillator. Aging rate < 5×10^{-10} /day after 10 day warm-up (typically 24 hrs in normal operating environment).

Spectral Purity

Residual SSB Phase Noise in 1 Hz BW ($320 \leq f_c < 640$ MHz)

Offset from Carrier				
10 Hz	100 Hz	1 kHz	10 kHz	100 kHz
-100 dBc	-112 dBc	-121 dBc	-131 dBc	-132 dBc

SSB broadband noise floor in 1 Hz BW at 3 MHz offset from carrier:

< -146 dBc for f_c between 120 and 640 MHz at output levels above +10 dBm.

Spurious Signals

	Frequency Range (MHz)				
	0.01 to 120	120 to 160	160 to 320	320 to 640	640 to 1280
Spurious non-harmonically related ^{1,2}	-90 dBc	-100 dBc	-96 dBc	-90 dBc	-84 dBc
Sub-harmonically related ($\frac{1}{2}$, $\frac{3f}{2}$, etc.)	none	none	none	none	-75 ³ dBc
Power line (60Hz) related or microphonically generated (within 300 Hz) ⁴ .	-90 dBc	-85 dBc	-80 dBc	-75 dBc	-70 dBc
Harmonics	<-30 dBc				

Output

Level range: +13 to -139.9 dBm (1V to 0.023 μ V_{rms} into 50 Ω).

Resolution: 0.1 dB.

Absolute level accuracy (+15° to +45°C): ± 1 dB between +13 and -120 dBm, ± 3 dB between -120 and -130 dBm.

SWR: typically from 1.5 to 1.8 depending on output level and frequency.

Reverse power protection: typically up to 30W or ± 8 Vdc.

Amplitude Modulation

Depth: 0 to 95% at output levels of +8 dBm and below (+10 dBm in uncorrected mode). AM available above these output levels but not specified.

Resolution: 1%, 10 to 95% AM; 0.1%, 0 to 9.9% AM.

Incidental PM (at 30% AM): 0.15-640 MHz, < 0.12 radian peak; 640-1280 MHz, < 0.09 radian peak.

Incidental FM (at 30% AM): 0.15-640 MHz, < 0.12 $\times f_{mod}$; 640-1280 MHz, < 0.09 $\times f_{mod}$.

Indicated accuracy: $\pm 5\%$ of reading $\pm 1\%$ AM. Applies for rates given in table below, internal or external mode, for depths $\leq 90\%$.

Rates and Distortion with Internal or External Modulating Signal

Frequency range	AM rate	AM Distortion		
		0-30% AM	30-70% AM	70-90% AM
0.15-1 MHz	dc-1.5 kHz	2%	4%	5.75%
1-10 MHz	dc-5 kHz	2%	4%	5.75%
10-1280 MHz	dc-10 kHz	2%	4%	5.75%

Frequency Modulation

FM rates (1 dB bandwidth): external ac, 20 Hz to 100 kHz; external dc, dc to 100 kHz.

FM deviation: from 25 to 200 kHz depending on carrier frequency.

Indicated FM accuracy: $\pm 8\%$ of reading plus 10 Hz (50 Hz to 20 kHz).

FM resolution: 100 Hz for deviations < 10 kHz, 1 kHz for deviations ≥ 10 kHz.

Incidental AM (AM sidebands at 1 kHz rate and 20 kHz deviation): < -72 dBc, $f_c < 640$ MHz; < -65 dBc, $f_c \geq 640$ MHz.

FM distortion: < 1.7% for rates < 20 kHz, < 1% for rates < 1 kHz. **Center frequency accuracy and long term stability in AC mode:** same as CW mode.

Supplemental Characteristics

Typical Absolute and Residual SSB Phase Noise, 639 MHz Carrier.

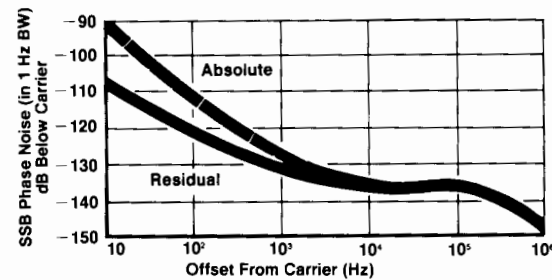

Frequency switching speed:⁵ From 420 μ sec to 12.5 msec, depending on the programming mode.

HP 8663A Specifications

The HP 8663A signal generator is related to the HP 8662A in both concept and structure. The HP 8662A concept of an extremely low phase noise signal source incorporating signal generator modulation capabilities and output characteristics is carried even further by the HP 8663A. While maintaining high spectral purity, the HP 8663A offers increased frequency range to 2560 MHz, increased output level to +16 dBm, and the addition of phase and pulse modulation. The result is a highly flexible and powerful signal generator that utilizes and extends the proven circuitry of the HP 8662A. Thus, the HP 8662A and HP 8663A share many of the same specifications as shown below:

Frequency

Range: 100 kHz to 2560 MHz (2559.9999996 MHz)

Resolution: 0.1 Hz ($f_c < 640$ MHz)

0.2 Hz ($640 \text{ MHz} \leq f_c < 1280 \text{ MHz}$)

0.4 Hz ($f_c \geq 1280 \text{ MHz}$)

Accuracy, stability, and internal reference oscillator: identical to HP 8662A.

¹In the remote mode it is possible to have microprocessor clock related spurious signals spaced 3 MHz apart at an absolute level of typically less than -145 dBm.

²Spurious signals can be up to 3 dB higher in the dc FM mode.

³f/2 spurs not specified for carrier frequencies above 850 MHz.

⁴At a 50 Hz line frequency, power line or microphonically related spurious signals may be up to 3 dB higher and appear at offsets as high as 1 kHz from the carrier.

⁵Due to automatic leveling loop bandwidth changes, brief (30 msec) level inaccuracies may occur when switching through 150 kHz and 1 MHz RF output frequencies.

Spectral Purity

Residual SSB phase noise in 1 Hz BW ($320 \leq f_c < 640$ MHz): identical to HP 8662A.

Typical SSB phase noise: identical to the HP 8662A for f_c between 100 kHz and 1280 MHz (see graph). For f_c between 1280 and 2560 MHz, the noise will be approximately 12 dB higher than the 639 MHz curve on the "typical SSB phase noise" graph.

Absolute SSB phase noise in a 1 Hz BW: identical to the HP 8662A for f_c between 100 kHz and 1280 MHz. For f_c between 1280 and 2560 MHz, the specified noise is 6 dB higher than the 640 to 1280 MHz specification in the table.

Spurious signals: identical to HP 8662A except for f_c between 1280 and 2560 MHz the spurious non-harmonics are -78 dBc, the subharmonically related ($f/2$, $3f/2$, etc.) between 640 and 1280 MHz are -70 dBc and between 1280 and 2560 MHz are -40 dBc, and the power line (60 Hz) or microphonically generated spurious are -65 dBc.

Harmonics: < -30 dBc, $\leq +13$ dBm output, < -25 dBc, $+13$ dBm to $+16$ dBm output, $f_c < 1280$ MHz; < -25 dBc, $f_c \geq 1280$ MHz

Output

Level range: $+16$ dBm to -129.9 dBm

Resolution: 0.1 dB

Absolute level accuracy ($+15^\circ$ to $+45^\circ\text{C}$): ± 1 dB, $+16$ dBm to -119.9 dBm; ± 3 dB for -120 dBm and below.

SWR: < 1.5

Amplitude Modulation

Depth: 0 to 95% at levels of $+10$ dBm and below

Resolution: 0.1%

Incidental FM (at 30% AM): identical to HP 8662A except: $< 0.3 \times f_{\text{mod}}$ for $1280 \leq f_c < 2560$ MHz.

Indicated accuracy: $\pm 6\%$ of reading $\pm 1\%$ AM (400 Hz and 1 kHz, depth 90%)

AM Bandwidth (1dB):

DC to > 1.5 kHz, 0.15 MHz $\leq f_c < 1$ MHz; DC to > 5 kHz, 1 MHz $\leq f_c \leq 10$ MHz; DC to > 10 kHz, $f_c > 10$ MHz. External dc coupling. External ac coupling or internal; low frequency coupling is 20 Hz.

Distortion (400 Hz and 1 kHz): $< 2\%$ (0–30% AM); $< 4\%$ (30–70% AM); $< 6\%$ (70–90% AM).

Frequency Modulation

FM rates (1 dB bandwidth): external ac, 20 Hz to 100 kHz, external dc, dc to 100 kHz.

Maximum allowable peak deviation: identical to HP 8662A for f_c between 100 kHz and 1280 MHz. Up to 400 kHz for f_c between 1280 and 2560 MHz.

Indicated FM accuracy (50 Hz to 20 kHz): $\pm 9\%$ of setting $+10$ Hz. **FM resolution:** 100 Hz to 1 kHz depending on f_c and deviation setting.

Incidental AM (AM sidebands at 1 kHz rate and 20 kHz deviation): < -72 dBc ($10 \leq f_c < 640$ MHz); < -65 dBc ($640 \leq f_c < 2560$ MHz).

FM distortion: $< 1.25\%$ (400 Hz and 1 kHz rates); $< 1.75\%$ (rates less than 20 kHz).

Phase Modulation (Option 002)

Maximum peak phase deviation: from $\pm 25^\circ$ for f_c between 120 and 160 MHz up to $\pm 400^\circ$ for f_c between 1280 and 2560 MHz.

Maximum rate: from 10 kHz for f_c between 0.15 and 10 MHz up to 10 MHz for f_c between 250 and 2560 MHz.

Phase deviation resolution: 1° ($0.1 \leq f_c < 640$ MHz); 2° ($640 \leq f_c < 1280$ MHz); 4° ($1280 \leq f_c < 2560$ MHz).

Phase modulation distortion: 10% at maximum rate.

Biphase Modulation

Biphase modulation is available on the standard HP 8663A for f_c less than 640 MHz and available for all f_c with Option 002.

Deviation: $\pm 90^\circ$.

Carrier null when modulated with 1 MHz, 50% duty cycle square wave: > 25 dBc.

Modulation input required: TTL positive true. The internal modulation oscillator can be used for 50% duty cycle modulation. External input is on rear panel.

Pulse Modulation¹

Pulse on/off ratio: > 80 dB (50–2560 MHz).

Pulse rise/fall time: < 250 ns (50–120 MHz); < 800 ns (120–640 MHz); < 100 ns ($f_c \geq 640$ MHz).

Pulse Repetition Frequency (50% duty cycle):

Internal: 10 Hz to 99.9 kHz.

External: 10 Hz to 2 MHz, 50 MHz $< f_c < 640$ MHz; 10 Hz to 5 MHz, $f_c > 640$ MHz.

Internal Modulation Oscillator

Rates: 10 Hz to 99.9 kHz.

Frequency resolution: 3 digits.

Frequency accuracy: same as reference oscillator.

Output level (available on rear panel): 1 volt peak into 600 Ω .

Output impedance: 600 Ω .

Flatness (referenced to 1 kHz): $< \pm 1\%$.

Distortion: $< 1\%$.

Other HP 8662A and HP 8663A Information

Remote programming: the HP-IB interface is standard on the HP 8662A and HP 8663A signal generators. All functions controlled from the front panel with the exception of the line switch are programmable with the same accuracy and resolution as in manual mode.

Operating temperature range: 0° to $+55^\circ\text{C}$.

Leakage: meets radiated and conducted limits of MIL STD 461A methods RE02 and CE03 as well as VDE 0871.

Power requirements: 115 (90-126) V or 230 (198-252) V; 48 to 66 Hz; 450 VA max.

Weight: HP 8662A: net, 30 kg (65.5 lb.); shipping, 36 kg (80 lb.).

HP 8663A: net, 33.8 (74 lb.); shipping, 40 kg (88 lb.).

Size: HP 8662A: 178H x 425W x 572 mmD (7" x 16.75" x 22.5").

HP 8663A: 178H x 425W x 642 mmD (7" x 16.75" x 25.3"). Note: depth includes front panel depth of 45 mm (1.75").

Ordering Information

	Price
HP 8662A 1280 MHz Signal Generator ²	\$37,100
Opt 001 RF connectors on rear panel only	+ \$385
Opt 003 Specified SSB phase noise for 640 MHz output	+ \$540
Opt 907 Front handle kit (5061-9690)	+ \$67
Opt 908 Rack flange kit (5061-9678)	+ \$36
Opt 909 Rack flange kit with front handles (5061-9684)	+ \$93
Opt 910 A total of two sets of operating and service manuals (08662-90069)	+ \$139
HP 11721A External frequency doubler for operation to 2.56 GHz (HP 8662A only)	\$700
HP 8663A 2560 MHz Signal Generator ²	\$51,200
Opt 001 RF connectors on rear panel only	+ \$385
Opt 002 Wideband linear phase modulation	+ \$5,670
Opt 003 Specified SSB phase noise for 640 MHz output.	+ \$540
Opt 700 External MATE translator	+ \$7,050
Opt 907 Front handle kit (5061-9690)	+ \$67
Opt 908 Rack flange kit (5061-9678)	+ \$36
Opt 909 Rack flange kit with front handles (5061-9684)	+ \$93
Opt 910 Provides an additional operation and calibration manual (08663-90069) and service manuals (08663-90071)	+ \$360
Opt 915 Add service manual (08663-90071)	+ \$155
HP 11714A Service Support Kit (required for servicing HP 8662A/8663A)	\$1,555

¹Pulse modulation is available for $f_c < 50$ MHz but is unspecified.

²HP-IB cables not supplied. For description and price, see page 569.

SIGNAL GENERATORS

Synthesized Signal Generators

Model 8660D

373

- 10 kHz to 2600 MHz
- Synthesizer stability and accuracy
- 1 Hz resolution (2 Hz above 1300 MHz)

- Ten digit display
- Calibrated output over > 140 dB range
- AM, FM, Φ M, or pulse modulation



HP 8660D (with HP 86633A and HP 86603A plug-ins)

HP 8660D Synthesized Signal Generator

System Concept

The HP 8660 is a modular, solid-state, plug-in system. Each system includes: 1) a programmable, synthesized signal generator mainframe, 2) an RF section plug-in, and 3) a modulation section. Synthesized accuracy and stability, along with complete programmability, make the HP 8660 ideal for automated receiver, subsystem and component testing.

Mainframes

The HP 8660D offers front panel and HP-IB or BCD control of center frequency and frequency sweep. An external reference may be used to replace the internal, high stability reference oscillator.

Plug-In RF Sections

The HP 86601A (0.01 – 110 MHz), HP 86602B (1 – 1300 MHz), and HP 86603A (1 – 2600 MHz) are the three RF section choices. The HP 11661B Frequency Extension Module (mainframe Option 100) must be used with the HP 86602B and HP 86603A and is installed internally to an HP 8660 mainframe. (When using the HP 8660A mainframe, the HP 86603A plug-in must be ordered with Option 003.)

Plug-In Modulation

There are five modulation sections from which to choose. The HP 86631B Auxiliary Section provides external AM and pulse modulation. The HP 86632B offers AM and FM and utilizes a free-running VCO to provide high FM deviations and rates while the HP 86633B provides AM and phase locked FM. The HP 86634A offers high performance phase modulation with rates to 10 MHz while the HP 86635A provides both FM and phase modulation. (The HP 86634A and HP 86635A must be used with Option 002 RF Section.)

HP 8660D Mainframe Specifications

Frequency accuracy and stability: CW frequency accuracy and long term stability are determined by internal reference oscillator, or by external reference.

Reference Oscillator

Internal: 10 MHz quartz oscillator. Aging rate less than ± 3 parts in 10^9 per 24 hours.

External: rear panel switch allows operation from 5 MHz or 10 MHz frequency standard at a level between 0.5 and 2.5 Vrms into 170 ohms.

Reference output: rear panel BNC connector provides output of reference signal selected at level of at least 0.75 Vrms into 170 ohms.

Digital sweep: auto, single, or manual. Selectable speeds 0.1, 1, or 50 seconds.

Remote Programming

Functions

HP 8660D: CW frequency, frequency stepping (STEP \uparrow , STEP \downarrow), output level, and most modulation functions are programmable.

Programming Input

Connector type: 36-pin Cinch type 57 (mating connector supplied). 24-pin Cinch type 57 for HP-IB control. BCD and HP-IB control internal jumper selectable.

Logic: TTL compatible (negative true).

Switching time: less than 10 ms to be within 100 Hz of any new frequency selected. (Less than 175 ms to be within 10 Hz.)

General

Operating temperature range: 0° to +55°C.

Power: 100, 120 (+5%, -10%), 48-400 Hz; 220, 240V (+5%, -10%), 48-66 Hz; approximately 350 watts.

Weight (mainframe only): net, 23.8 kg (53 lb). Shipping, 29.6 kg (65 lb).

Supplemental Characteristics

Typical Single Sideband Phase Noise

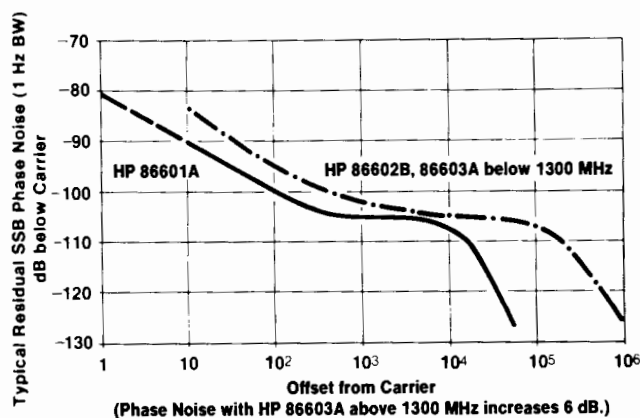

SIGNAL GENERATORS

Synthesized Signal Generators

Models 86601A-86603A

10 kHz to 110 MHz

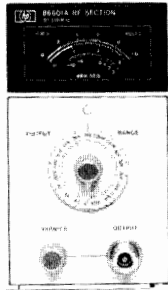

HP 86601A

1 MHz to 1300 MHz

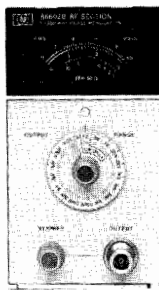

HP 86602B (HP 11661B required)

1 MHz to 2600 MHz

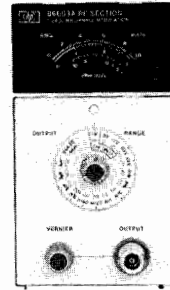

HP 86603A (HP 11661B required)

RF Section Specifications (installed in HP 8660D mainframe)

		HP 86601A	HP 86602B (requires HP 11661B)	HP 86603A (requires HP 11661B)		
FREQUENCY CHARACTERISTICS	Frequency Range	0.01–110 MHz (109.999999 MHz)	1–1300 MHz (1299.999999 MHz)	1–2600 MHz (2599.999998 MHz)		
	Frequency Resolution	1 Hz	1 Hz	CF <1300 MHz	CF ≥1300 MHz	
	Harmonics	≤−40 dBc	≤−30 dBc (<−25 dBc above +3 dBm)	≤−20 dBc ¹		
	Spurious Non Harmonically Related (greater than 10 kHz offsets)	≤−76 dBc	≤−80 dBc below 700 MHz ≤−80 dBc above 700 MHz within 45 MHz of carrier ≤−70 dBc above 700 MHz >45 MHz from carrier	≤−74 dBc within 45 MHz of carrier ¹ ≤−64 dBc >45 MHz from carrier		
	Power Line Related (CW, AM, φM only) ²	≤−60 dBc	≤−50 dBc on +10 dBm range ≤−60 dBc	≤−60 dBc		
Signal To Phase Noise Ratio (CW, AM, φM only, offsets >300 Hz)	>50 dB	>45 dB	>39 dB			
OUTPUT CHARACTERISTICS	Output Level (into 50Ω)	+13 dBm to −146 dBm	+10 to −146 dBm	+10 to −136 dBm	+7 to −136 dBm ³	
	Output Accuracy (local and remote)	±1 dB, +13 to −66 dBm ±2 dB, −66 to −146 dBm	±1.5 to −76 dBm ±2.0 to −146 dBm	±2.5 dB to −76 dBm ³ ±3.5 dB to −136 dBm		
	Flatness (output level variation with frequency)	<±0.75 dB	<±1.0 dB	<±2.0 dB		
	Impedance	50Ω				
MODULATION CHARACTERISTICS	AM	AM Modulation Depth	0 to 95%	0 to 90% ⁴	0 to 50% ⁴	
		3 dB Bandwidth:	0–30%	200 Hz, CF<0.4 MHz 10 kHz, 0.4≤CF<4 MHz 100 kHz, CF≥4 MHz	10 kHz, CF<10 MHz 100 kHz, CF≥10 MHz	5 kHz
			0–70%	125 Hz, CF<0.4 MHz 6 kHz, 0.4≤CF<4 MHz 60 kHz, CF≥4 MHz	6 kHz, CF<10 MHz 60 kHz, CF≥10 MHz	N/A
			0–90%	100 Hz, CF<0.4 MHz 5 kHz, 0.4≤CF<4 MHz 50 kHz, CF≥4 MHz	5 kHz, CF<10 MHz 50 kHz, CF≥10 MHz	N/A
	Distortion, ⁵ THD at 30% AM at 70% AM at 90% AM	<1%, 0.4–110 MHz <3%, 0.4–110 MHz <5%, 0.4–110 MHz	<1% <3% <5%	<5% N/A N/A		
	FM	FM Rate	dc to 1 MHz with HP 86632B and HP 86635A 20 Hz to 100 kHz with HP 86633B	dc to 200 kHz with HP 86632B and HP 86635A 20 Hz to 100 kHz with HP 86633B		
		Maximum Deviation (peak)	1 MHz with HP 86632B and HP 86635A 100 kHz with HP 86633B	200 kHz with HP 86632B and HP 86635A 100 kHz with HP 86633B	400 kHz w/HP 86632B, 86635A 200 kHz w/HP 86633B	
		Distortion, THD (at rates up to 20 kHz)	<1% up to 200 kHz dev. <3% up to 1 MHz dev.	<1% up to 200 kHz dev. <1% up to 400 kHz dev.		
	PULSE	Pulse Rise/Fall Time	200 ns	50 ns		
		ON/OFF Ratio (with pulse level control at max.)	>50 dB	>40 dB		
φM ⁶	φM Rate	N/A	dc to 1 MHz with HP 86635A dc to 1 MHz for CF <100 MHz dc to 10 MHz for CF ≥100 MHz with HP 86634A			
	Maximum Peak Deviation	N/A	0 to 100 degrees		0 to 200 degrees	
	Distortion, THD	N/A	<5% up to 1 MHz rates <7% up to 5 MHz rates <15% up to 10 MHz rates			
GENERAL	Weight	Net 5 kg (11 lb) Shipping 6.8 kg (15 lb)	Net 4.1 kg (9 lb) Shipping 5.5 kg (12 lb)	Net 5 kg (11 lb) Shipping 6.4 kg (14 lb)		
		HP 11661B: Net 2.3 kg (5 lb); shipping 2.7 kg (6 lb)				

¹For output levels +3 dBm and below; slightly higher +3 to +7 dBm.

²Measured in a 30 kHz band centered on the carrier excluding a 1 Hz band centered on the carrier.

³For +3 to +7 dBm output levels, output accuracy and flatness will be slightly degraded (above 1300 MHz only)

⁴For RF output level meter readings from +3 dB to −6 dB and only at +3 dBm and below.

⁵Applies only at 400 Hz and 1 kHz rates with output meter set between 0 and +3 dB. At −6 dB

meter setting the distortion approximately doubles.

⁶Phase modulation is only possible with Option 002 RF Sections.

SIGNAL GENERATORS

Synthesized Signal Generators (Cont'd)

Models 86631B-86633B, 86634A-86635A

375

Pulse/AM

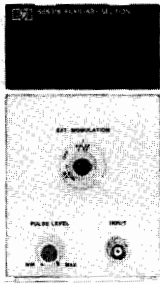

HP 86631B

AM/High Deviation FM

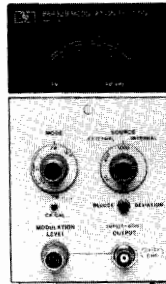

HP 86632B

AM/ ϕ Locked FM

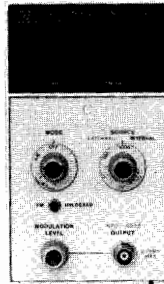

HP 86633B

High rate ϕ M

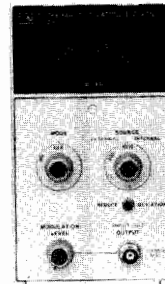

HP 86634A

ϕ M/FM

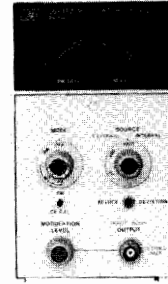

HP 86635A

Modulation Section Specifications

		HP 86631B	HP 86632B	HP 86633B	HP 86634A	HP 86635A
	Functions	Ext. Only	Int. and Ext.	Int. and Ext.	—	—
AM	Indicated Accuracy (at 400 and 1000 Hz rates)	—	±5% of full scale With HP 86601A RF Section: ±7%, center frequency ≥100 MHz. With HP 86603A RF Section: ±10%, center frequency ≥1300 MHz.		—	—
FM	Functions	—	Int. and Ext., FM CF CAL	Int. and Ext.	—	Int. and Ext., FM CF CAL
	Center Frequency Long Term Stability	—	Typically less than 200 Hz/hr	Same as in CW Mode (3×10^{-9} /day)	—	Typically less than 200 Hz/hr
	Indicated Accuracy (up to 20 kHz rates)	—	±5% of full scale		—	±5% of full scale
Pulse	Functions	Ext. Only	—	—	—	—
ϕ M	Functions	—	—	—	Int. and Ext.	Int. and Ext.
	Indicated Accuracy (15°C to 35°C)	—	—	—	±5% of full scale up to 100 kHz rates ±8% of full scale up to 2 MHz rates ±15% of full scale up to 10 MHz rates	
Meter		—	0–100% AM 0–10, 100, 1000 kHz FM Pk. Dev. (0–20, 200, 2000 kHz FM for CF ≥1300 MHz)	0–100% AM 0–10, 100 kHz FM Pk. dev. (0–20, 200 kHz FM for CF ≥1300 MHz)	0–100° Peak ϕ M (0–200° for CF ≥ 1300 MHz)	0–10, 100, 1000 kHz FM, 0–100° Pk. ϕ M (0–20, 200, 2000 kHz FM, 0–200° Pk. ϕ M for CF ≥1300 MHz)
Internal Modulation Source Output		None	400 Hz and 1 kHz ±5% 200 mV minimum into 10 k Ω . Available at front panel BNC connector			
Input Impedance		50 Ω Pulse 600 Ω AM	600 Ω	600 Ω	50 Ω	600 Ω
Weight		Net, 1.4 kg (3 lb) Shipping, 2.3 kg (5 lb)	Net, 2.7 kg (6 lb) Shipping, 4.1 kg (9 lb)	Net, 2.7 kg (6 lb) Shipping, 4.1 kg (9 lb)	Net, 1.8 kg (4 lb) Shipping, 3.2 kg (7 lb)	Net, 2.7 kg (6 lb) Shipping, 4.1 kg (9 lb)

Ordering Information

HP 8660D Synthesized Signal Generator mainframe¹

Opt 001 ±3 × 10⁻⁹/day internal reference oscillator

Opt 002 No internal reference oscillator

Opt 003 Operation from 48 to 440 Hz line

Opt 005 Factory configured for HP-IB programming operation.

Opt 100 HP 11661B factory installed inside main frame

Opt 908 Rack flange kit (08660-60347)

Opt 910 Provides an additional operation and calibration manual (08660-90103) and two service manuals (08660-90104)

Opt 915 Add service manual (08660-90104)

Opt W30 Extended repair service. See page 725.

HP 86601A 0.01–110 MHz RF Section

¹HP-IB cables not supplied. For description and price, see page 569.

Price

\$15,700

+ \$0

– \$300

\$0

\$0

\$0

+ \$6,280

+ \$113

+ \$255

+ \$103

+ \$365

\$8,240

HP 86602B 1–1300 MHz RF Section²

HP 86603A 1–2600 MHz RF Section²

Opt 002 adds phase modulation capability (HP 86602B, 86603A only)

Opt 003 allows operation of HP 86603A with HP 8660A mainframe

HP 86607A field retrofit for HP 8660A/C to HP 8660D

HP 86631B AM/Pulse Auxiliary Section

HP 86632B AM/FM Modulation Section

HP 86633B AM/FM Modulation Section

HP 86634A ϕ M Modulation Section

HP 86635A ϕ M/FM Modulation Section

Note: Opt 910, 2 sets of operation and service manuals, is available for each modulation section. Contact your HP sales representative for part numbers and prices.

HP 11661B Frequency Extension Module

HP 11672A Service Accessory Kit

HP 11707A Test Plug-in

²HP 86602B and HP 86603A RF sections require an HP 11661B for operation.

\$9,275

\$11,500

+ \$2,500

+ \$255

\$4,800

\$800

\$3,850

\$3,850

\$3,050

\$4,200

\$6,650

\$1,450

\$2,850

SIGNAL GENERATORS

Mechanically Tuned VHF Signal Generators

HP 8640B

- 0.5 to 512 MHz frequency range with optional coverage to 1024 MHz
- +19 to -145 dBm output power range
- Low SSB phase noise
- Calibrated, metered AM, FM and pulse modulation
- Internal phase lock/synchronizer, digital frequency readout, external count capability to 550 MHz

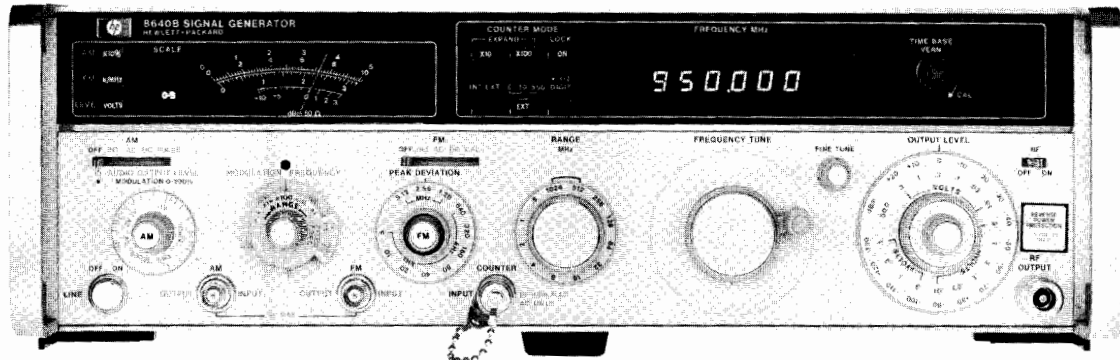

HP 8640B (with Options 001, 002, 003)

HP 8640B Signal Generator

The HP 8640B Signal Generator covers the frequency range 500 kHz to 512 MHz and can be extended to 1024 MHz with an internal doubler (Option 002). Using the HP 11710B Down Converter, the HP 8640B frequency range can be extended down to 10 kHz. An optional internal audio oscillator (Option 001) has a frequency range of 20 Hz to 600 kHz.

The HP 8640B has an output level range of +19 to -145 dBm (2V to 0.013 μ V) which is calibrated, metered, and leveled to within ± 0.5 dB across the full frequency range of the instrument. The output is protected against up to 50W of reverse power (with Option 003).

The HP 8640B also has AM, FM, and pulse modulation for a wide range of receiver test applications.

Spectrally Pure Output Signals

Noise of the HP 8640B is extremely low beyond 10 kHz offsets. At a 20 kHz offset from the carrier, SSB phase noise is < -130 dBc at 450 MHz and < -122 dBc at 550 MHz. Broadband noise floor is better than -140 dBc/Hz.

Phase Locked Stability

The HP 8640B can phase lock to the RF output frequency of the crystal timebase used in the counter (resulting in drift that is better than 5×10^{-8} /hr) while still maintaining its spectral purity. The HP 8640B can also be locked to an external 5 MHz standard.

In the phase locked mode, FM capability and spectral purity are maintained while providing FM rates from 50 Hz to 250 kHz.

HP 8640B Specifications

Frequency

Range: 500 kHz to 512 MHz in 10 octaves, (1024 MHz with Option 002 internal frequency doubler).

Fine Tuning

Unlocked: > 1000 ppm total range.

Locked mode: $> \pm 20$ ppm by varying internal time base vernier.

Internal Counter Resolution (unlocked)

Frequency Ranges (MHz)	Normal Mode	Expand X10	Expand X100
0.5-1	10 Hz	1 Hz	0.1 Hz
1-16	100 Hz	10 Hz	1 Hz
16-128	1 kHz	100 Hz	10 Hz
128-1024	10 kHz	1 kHz	100 Hz

Optimum Counter Resolution When Phase-Locked

Frequency Ranges (MHz)	With 6 Digits	$\pm 1/2$ Digit
0.5-0.9999995	1 Hz	0.5 Hz
1.0-9.999995	10 Hz	5 Hz
10.0-99.99995	100 Hz	50 Hz
100.0-999.9995	1 kHz	500 Hz
1000-1024	10 kHz	5 kHz

Accuracy: $6\frac{1}{2}$ digit LED display with X10 and X100 expand; accuracy depends on internal or external reference used.

Stability (after 2 hr warmup):

Normal: < 10 ppm/10 min. Locked: < 0.05 ppm/hr.

Restabilization time after frequency change:

Normal: < 15 min. Locked: < 1 min. to be within 0.1 ppm.

Output

Range: 10 dB steps and 18 dB vernier provide the following output power settings into 50 Ω .

Frequency Range (MHz)	HP 8640B	With Option(s)		
		002	003	002/003
0.5-612	+19 to -145 dBm	+18.5 to -145 dBm	+18.5 to -145 dBm	+18 to -145 dBm
512-1024 (Opt 002)		+13 to -145 dBm		+12 to -145 dBm

Level Flatness (referred to output at 50 MHz and applies to 1V range and for top 10 dB of vernier range)

Frequency Range (MHz)	HP 8640B	With Option(s)		
		002	003	002/003
0.5-64	± 0.5 dB	± 0.75 dB	+0.75 dB	+1.0 dB
64-512		± 1.0 dB	-1.25 dB	-2.0 dB
512-1024 (Opt 002)		± 1.5 dB		± 2.0 dB

Level accuracy: (worst case as indicated on level meter) ± 1.5 dB to ± 4.5 dB depending on level, frequency, and options installed.

Spectral Purity

Harmonics (at 1V, +10 dBm output range and below):

- <-30 dBc, 0.5 to 512 MHz;
- <-12 dBc, 512 to 1024 MHz (Option 002).

Spurious (greater than 15 kHz offsets):

Nonharmonically related: <-100 dBc;

Subharmonically related: <-100 dBc, <-20 dBc; $f_c > 512$ MHz

Residual AM (averaged rms in a 0.3 - 3 kHz BW): <-85 dBc.

Residual FM (averaged rms in a 0.3 - 3 kHz BW): <5 Hz, (<10 Hz; $f_c > 512$ MHz).

Measured SSB phase noise (typical): triangles are specified limits.

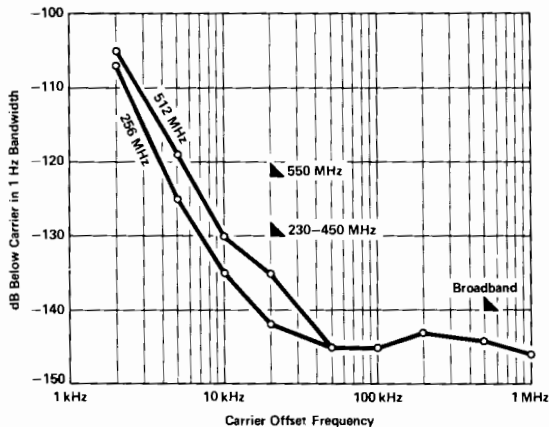

Modulation

General: internal AM, FM, external AM, FM and Pulse.

Simultaneous AM and FM or Pulse and FM.

Frequency: fixed 400 Hz and 1 kHz $\pm 3\%$; also, 20 Hz to 600 KHz, $\pm 15\%$ with Opt. 001.

Output level: Standard: 10 mV to 1 V_{RMS} into 600 Ω .
Opt. 001: 1 mV to 3 V_{RMS} into 600 Ω .

Amplitude Modulation

Depth: 0 to 100%, amplitude <+13 dBm; 0 to 100%, amplitude <+7 dBm (excluding top 6 dB of vernier) at $f_c > 512$ MHz.

AM Bandwidth

Standard: 3 dB bandwidth (lower ac limit is 20 Hz)

Frequency Ranges	0 to 50% AM	50 to 90% AM
0.5 to 2 MHz	dc - 20 kHz	dc - 12.5 kHz
2 to 8 MHz	dc - 40 kHz	dc - 25 kHz
8 to 512 MHz	dc - 60 kHz	dc - 50 kHz
512 to 1024 MHz	dc - 60 kHz	dc - 50 kHz

AM distortion (400 Hz and 1 kHz rates):

- <1%, 0 - 50% AM; <3%, 50 - 90% AM;
- <10%, 0 - 30% AM ($f_c > 512$ MHz);
- <20%, 30 - 90% AM ($f_c > 512$ MHz).

External input impedance: 600 Ω .

AM sensitivity (400 Hz and 1 kHz rates into 600 Ω):

0.1% AM/mV peak; (0.1 \pm 0.005)% AM/mV pk when $f_c < 512$ MHz.

AM accuracy: (400 and 1 kHz rates)

\pm (5.5% of reading + 1.5% of full scale), $f_c < 512$ MHz.

Incidental θ M (at 30% AM): <0.15 rad, $f_c < 128$ MHz; <0.3 rad, $f_c < 512$ MHz; 0.6 rad, $f_c > 512$ MHz.

Pulse Modulation¹

	Frequency Ranges (MHz)					
	0.5-1	1-2	2-8	8-32	32-512	512-1024
Rise and Fall Times	<9 μ s	<4 μ s	<2 μ s	<1 μ s		<1 μ s (typical)
Pulse Repetition Rate	50 Hz to 50 kHz		50 Hz to 100 kHz	50 Hz to 250 kHz	50 Hz to 500 kHz	
Minimum Pulse Width ²	10 μ s	5 μ s	2 μ s			
Pulse ON/OFF ratio at max. vernier	>40 dB					>60 dB
Peak Input Required	Nominally +0.5V (5V max). Sinewave or pulse return to zero into 50 Ω					

Frequency Modulation

Deviation: 640 kHz, f_c : 64 to 128 MHz. (Deviation doubles at each octave above 128 MHz and halves at each octave below 64 MHz.)

FM 3 dB bandwidth: internal and external ac, 20 Hz to 250 kHz; external dc, dc to 250 kHz. (Locked mode: FM above 50 Hz only).

FM distortion (at 500 Hz and 1 kHz rates):

- <1% for deviations up to $\frac{1}{8}$ maximum allowable.
- <3% up to maximum allowable deviation.

External FM sensitivity: 1V peak into 600 Ω yields maximum deviation indicated on PEAK DEVIATION switch with FM vernier at full clockwise position.

Indicated FM accuracy (400 Hz and 1 kHz rates from 15 $^\circ$ to 35 $^\circ$ C, using internal meter): +(7% of reading + 1.5% of full scale).

Incidental AM (at 400 Hz and 1 kHz rates)

0.5-512 MHz: <0.5% AM for FM up to $\frac{1}{8}$ maximum allowable deviation; <1% AM for FM at maximum allowable deviation.

512-1024 MHz (Opt. 002): <1% AM for FM up to $\frac{1}{8}$ maximum allowable deviation; <7% AM for FM deviations up to maximum allowable.

Counter

Frequency range: 1 Hz to 550 MHz.

Sensitivity: >200 mV_{RMS} from a 50 Ω source impedance, ac only.

Resolution (6 digit LED display with X10 and X100 expand mode): 100 Hz for f_c : 0 - 10 MHz; 10 kHz for f_c : 10 - 550 MHz.

General

External reference input: 5 MHz, nominally >0.5 V_{pp} into 1 k Ω .

Internal reference (after 2 hr. warmup at 25 $^\circ$ C):

Aging rate: <0.05 ppm/hr; <2 ppm/90 days.

Drift: <2 ppm; 15 to 35 $^\circ$ C, <10 ppm; 0 to 50 $^\circ$ C.

Typical accuracy: ± 2 ppm; 15 to 35 $^\circ$ C.

Operating temperature: 0 to 55 $^\circ$ C.

Power requirements: 100, 120V (+5%, -10%); 48 to 440 Hz, 220, 240V (+5%, -10%); 48 to 66 Hz. 175 VA max (Opt. 002: 190 VA max).

Weight: net, 20.8 kg (46 lb); shipping, 24.1 kg (53 lb).

Size: 140H x 425W x 467 mmD (5.5" x 16.75" x 18.75").

Ordering Information

	Price
8640B Signal Generator	\$14,100
Opt 001 20 Hz - 600 kHz internal audio oscillator	+\$540
Opt 002 Internal doubler 512 - 1024 MHz	+\$1,200
Opt 003 Reverse power protection	+\$400
Opt 908 Rack mount kit (5060-8740)	+\$39
Opt 910 Provides an additional operation and calibration manual (08640-90208) and two service manuals (08640-90215).	+\$350
Opt 915 Add service manual (08640-90215)	+\$155
Opt W30 Extended repair service. See page 725.	+\$450

¹Pulse performance degrades below 500 Hz repetition rates.

²For level accuracy within 1 dB of CW (>0.1% duty cycle).

SIGNAL GENERATORS

Signal Simulator System, dc - 50 MHz

Models 8770S, 8770A, 11776A

- A new source of "real-life" signals to 50MHz
- A software reconfigurable modulation source
- Simulate very complex baseband and IF signals
- Excellent spectral purity

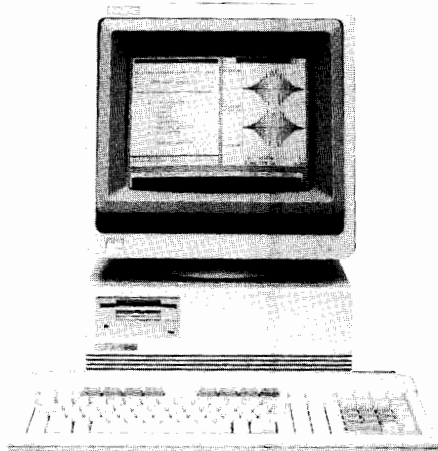

Simulate Signals for Radar, EW, Communications, Magnetic Disk and Other Applications

Today's sophisticated electronic systems require "real-life" functional testing to ensure that they will perform properly under their intended operating conditions. The HP8770S helps you answer critical questions: "... Will this radar accurately detect and decode multiple targets? Will my EW receiver correctly identify advanced threats? Will this digital communication receiver properly reconstruct transmitted signals in the presence of fading or jamming? Will this magnetic disk read circuits respond properly to a missing bit?"

Description

The HP 8770S Signal Simulator System consists of the:

- HP 8770A Arbitrary Waveform Synthesizer
- HP 9000 Series 300 Technical Computer
- HP 11776A Waveform Generation Software.

Design waveforms with the software, then generate the waveforms with the HP 8770A. Use this advanced simulation system to generate complex baseband and IF signals from dc to 50 MHz. Add precise amounts of distortion and noise to test the operating margins of your system early in the development cycle. All signal parameters are under complete software control, allowing quick changes to meet new test demands. The HP 8770A has a complete HP-IB command set for full automatic control and easy downloading of waveform data previously defined by the HP 11776A or by other means. Regardless of your application, the use of precise complex test signals improves the evaluation of your circuits and systems.

The HP 8770A Arbitrary Waveform Synthesizer (AWS) forms the heart of the HP 8770S. Advanced digital synthesis techniques ensure precise waveform generation.

Features

- 8 ns Sample Update Rate
- 12-bit Words
- 125 MHz Internal Clock (phase-locks to crystal osc.)
- Special "Deglitching" Circuits
- 110 dB RF Attenuator
- 512K Memory

Benefits

- Rapid Signal Parameter Changes
- High Amplitude Resolution
- Time Base with Synthesizer Accuracy
- Low Harmonic and Spurious Distortion Levels
- 12-bit Resolution Even at Low Signal Levels
- Highly Complex Waveforms, Longer Waveform Sequences

- Outstanding reliability (> 100,000 hrs MTBF)
- 125MHz sample rate
- 12-bit resolution, 512K word memory



The HP 11776A Waveform Generation Software operates on the HP 9000 Series 300 technical computers. It consists of the Waveform Generation Language (WGL), an HP BASIC 5.13 operating system, and application disks for powerful waveform development. Use over 100 easy commands and math functions to create and manipulate waveforms as desired. Add noise or spurs to generate real-life test signals. Add waveforms together to create harmonically distorted waves, or multiply waves to create complex modulated signals. Create waves in either the frequency or time domain and quickly convert from one to the other. Capture data from other instruments such as spectrum analyzers and oscilloscopes. Once waveforms have been developed, you can download them into the HP 8770A for immediate generation or store them on a disk for later use in multiple stations. Thus, WGL makes "what if" testing to determine a device's performance easy and affordable.

Build Waveform Libraries for Complete Tests

Any HP-IB computer can control the HP 8770A and download previously defined waveform data. Generate a library of test waveforms with the HP 11776A software or your own BASIC program. Then download them to the HP 8770A from the computer in your ATE system for use in your applications.

Stretch Memory with Sequencing

Certain parts of waveforms often repeat themselves and quickly fill up even the largest memory. This leaves less memory to define the rest of the desired test signal. The HP 8770A avoids this problem by allowing sections of memory (packets) to be repeated any number of times and in any order. This sequencing capability and the large 512K word memory free large amounts of memory for greater flexibility when defining complex waves. Many test signals can also be stored simultaneously in the memory and accessed at any time with the sequencer. In a production ATE environment, this substantially decreases download time, reducing costs.

Applications Overview

Radar

The HP 8770S simulates multiple targets for more effective radar testing. Simulate complex radar video and IF signals. Add noise, pulse jitter, and clutter. Shape radar chirps to exact specifications. Stagger multiple radar pulses. Vary the PRF as a function of time. Control radar pulse parameters with extremely precise resolution. Finally, manipulate doppler shift and range or superimpose multiple targets together, resulting in complex, demanding test signals.

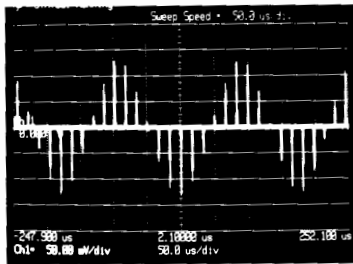

Doppler shifted return of moving target

Electronic Warfare

Simulate MOP, exotic threats, and other complex modulated signals to test next-generation EW receivers and signal processors. Vary pulse amplitudes, rise and fall times, pulse width, PRI, and stagger, of individual radars.

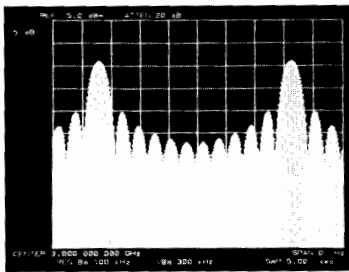

Antenna scan pattern

Communications

The HP 8770S is an excellent signal simulator for conventional analog communication systems, digital microwave radios, and satellite communications systems. Design and generate amplitude-, frequency-, and phase-modulated communications signals with digital precision. Exploit memory sequencing to hop from one frequency to the next with fast frequency switching speed and phase continuity. Simulate Nyquist filter responses in software to eliminate time-consuming and costly hardware filters.

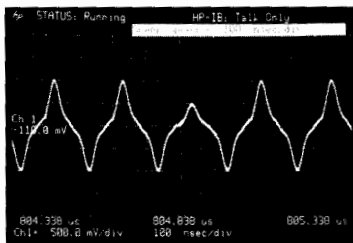

Missing bit

Magnetic Disk

The signal simulation system continues to be extremely successful in magnetic disk applications. Replace the head disk assembly to test read/servo channel boards for design integrity, calibrate disk media certifiers, or verify board operation in production test. Test bit shift susceptibility to less than 50ps shift resolution. The Programmer's Starter Kit (P/N 08770-60064) interactively creates seven common disk-test waveforms.

Other Applications

- Video and Imaging
- Component Test

HP 8770A Performance Characteristics

Frequency

Range: dc to 50 MHz

Frequency Switching Speed: 8 ns, phase continuous

RF output

Power range: +10 dBm to -110 dBm

Attenuator: 110 dB in 10 dB steps

Max Output Voltage: 2 V p-p into 50 or 75 ohms

Number of DAC bits: 12 true bits, monotonic

Amplitude Resolution: .024% of full scale

Amplitude Flatness: $\pm 0.65\text{ dB}$ (<math>< 0.1\text{ dB w/pre distortion}</math>)

Phase Linearity (dc - 50MHz): $\pm 5^\circ$ (<math>< \pm 1^\circ\text{ w/pre distortion}</math>)

Output Impedance: 50 Ω (75 Ω for option 002)

Output SWR: <math>< 1.2:1</math>

Connector: Type N (female)

Spectral Purity

Harmonic Distortion (output level = +10dBm):

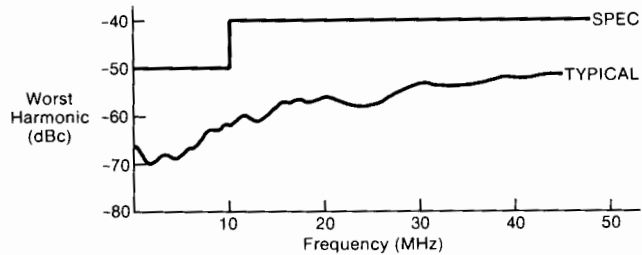

Inband Spurious and Nonharmonic Distortion:

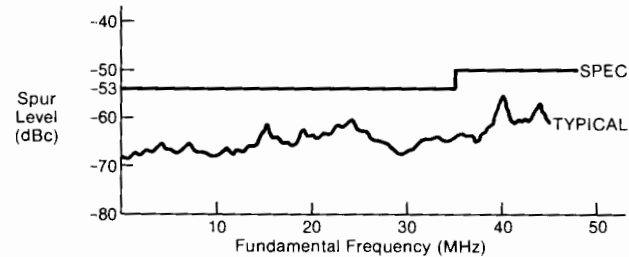

Two-Tone Intermodulation Distortion: <math>< -65\text{ dBc}</math> for a 10.000 MHz and 10.124 MHz signal at +4 dBm each.

SSB Phase Noise @10MHz: <math>< -120\text{ dBc/Hz}</math> @ 10kHz offset.

Modulation Capabilities

AM, FM, Φ M, Chirp, Pulse, Digital (BPSK, QPSK, BPSK, QAM), Antenna Scan, I/Q.

External System Triggering:

Repetitive, Single-Shot, Gated;
Outputs: Scan Start, Packet Start, Sequence Start, Equal Address, Packet Advance Ready.

Inputs: Packet Advance Trigger, System Start Trigger, System Stop Trigger.

Clock

Sampling Clock Rate: 125 MHz (externally variable)

Reference Oscillator: 10 MHz quartz crystal. Aging rate <math>< 5 \times 10^{-10}/\text{day}</math> after a 24 hour warmup and an oscillator time-off of less than 24 hours.

Remote Operation

HP-IB, 16-bit GPIO parallel port

General

Operating Temperature: 15-40 C

Power: 445 VA

Weight: Net, 23.6 kg (52 lb), Shipping, 29.5 kg (65 lb)

Size: 235 H x 425.5 W x 622 mm D (9.25" x 16.75" x 24.5")

Ordering Information

HP 8770S Signal Simulator System

Price

\$0

To ensure coordination of shipments and compatibility of instruments, computers and software, use the system model number when ordering individual components. Obtain the HP 8770A and HP 11776A Data Sheet and an HP 8770S Ordering Guide from your local sales office.

HP 8770A Arbitrary Waveform Synthesizer

\$25,000

Option 002: 75 ohm Output Impedance

N/C

HP 11776A Waveform Generation Software (5.25" Diskettes Standard)

\$6,500

Option 630: 3.5" Diskettes Only

N/C

HP P/N 08770-60064 Programmer Starter Kit

\$75

SIGNAL GENERATORS

Frequency Agile Signal Simulator, 10 - 3000 MHz

HP 8791 Models 10, 100, 200, 2000

- Advanced signal simulation
- 250 ns frequency agility
- 40 MHz instantaneous modulation bandwidth
- Arbitrary control over AM, FM, Φ M, pulse, and frequency hop



HP 8791 Model 10

Model 10 Frequency Agile Signal Simulator

Model 100 Precision Signal Generator

(Instrument-on-a-Disk software)

Model 200 Radar Simulator (Instrument-on-a-Disk software)

Model 2000 Advanced Agile Threat Simulator (System)

Exotic Test Signals for EW, Radar, and Communications

The new HP 8791 Model 10 Frequency Agile Signal Simulator (FASS) system generates exotic, agile test signals for advanced EW threat simulation, radar-target simulation and secure communications test. Covering 10 to 3000 MHz with 250 ns agility and a 40-MHz instantaneous modulation bandwidth, the system is capable of generating advanced spread-spectrum formats like chirps, Barker-coded pulses, maximal-length sequences, QAM and FSK. Comprehensive application software on a 20 Mbyte removable disk harnesses the power of FASS, giving the system an easy-to-use, mouse-driven front panel.

The application-specific Instrument-on-a-Disk (ID) software includes the HP 8791 Model 200 Radar Simulator, which features various intrapulse modulations and antenna scans, and the HP 8791 Model 100 Precision Signal Generator, which gives easy access to FASS's agile carrier, AM, FM, Φ M, and pulse modulation functions. An upconversion option extends FASS coverage to 18 GHz.

Description

The Frequency Agile Signal Simulator uses high-speed memory, signal processing, digital-to-analog conversion, and direct digital and analog synthesis for precise signal simulation with unprecedented flexibility.

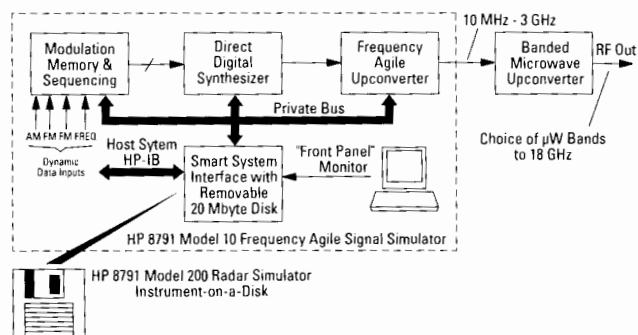

- Easy-to-use application-specific software
- Precise synthesized signal control
- Stand-alone or subsystem operation
- 18-GHz operation available with optional upconverters

The modulation data source's digital memory and sequencers store signal characteristics, namely carrier frequency hop patterns, amplitude, frequency, phase, and pulse modulation data. This data is supplied to the agile carrier synthesizer, where it is processed and converted to an analog signal made up of a carrier and its modulation. This 13.5- to 58-MHz signal is then translated to anywhere between 10 and 3000 MHz by the agile upconverter. The smart interface manages data flow and signal generation functions within FASS, as specified by inputs from its front panel or over HP-IB.

System Contributions

The Frequency Agile Signal Simulator is characterized by the following:

- High performance modulation and agility
- Instrument-grade, repeatable, accurate
- Easy-to-use, software reconfigurable user interface
- Low cost of ownership
- Off-the-shelf instrumentation

Application Overview

Electronic Warfare

FASS is ideal for simulating single advanced threats with intrapulse modulation, PRI stagger, frequency agility, and antenna scan modulation. Being fully synthesized, FASS is especially well suited for pulse Doppler radar simulation.

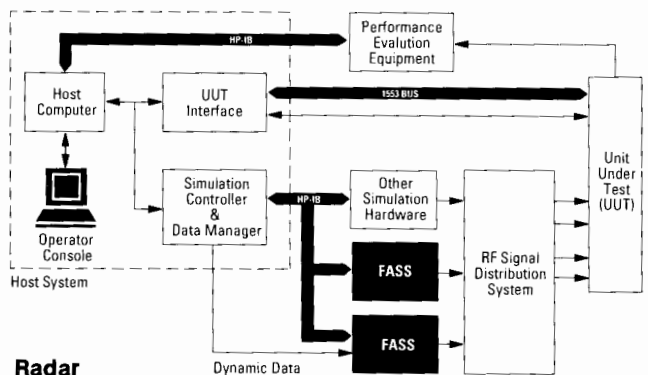

Radar

FASS can simulate target returns for testing and calibrating radar receivers. FASS can also be used as a major subsystem for instrumentation radars, serving as a complex waveform exciter or a frequency agile STALO for coherent systems.

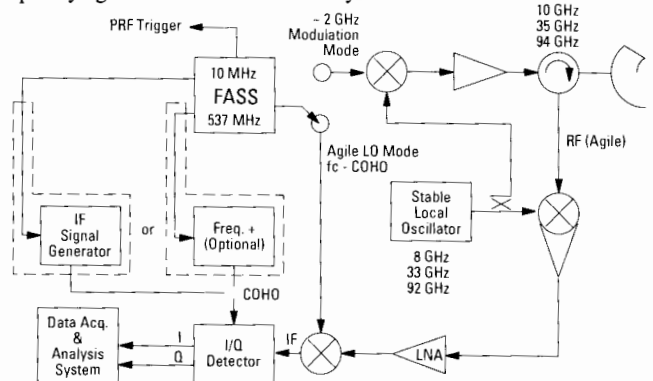

Communications

FASS can produce a variety of sophisticated agile signals useful for testing secure communication systems. Margin and tolerance testing can be accomplished by precisely adding distortion to ideal signals. In addition, common signals for testing sensitivity, bandwidth, frequency accuracy, selectivity, intermodulation, and distortion are readily available.

Modes of Operation

Instruments on a Disk (IDs)

Instruments-on-a-Disk (IDs) make this otherwise complex system easy to use and give FASS the front panel personality of specific applications. By clicking clearly labeled softkeys with the mouse, users can select sophisticated signal characteristics like PRI stagger and antenna scan patterns.

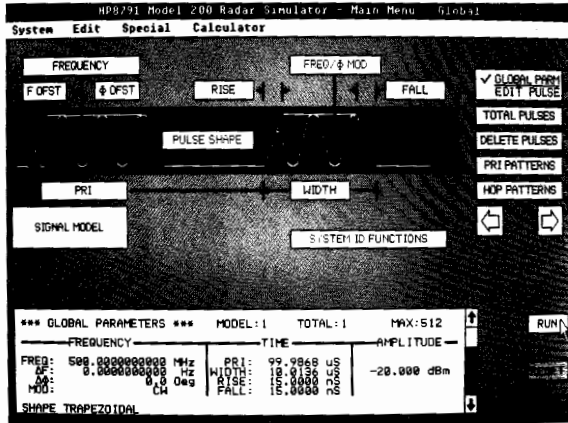

HP 8791 screen

Remote HP-IB

Remote HP-IB commands in FASS come in two varieties. There are the commands that simply mimic front-panel key strokes of an Instrument-on-a-Disk and the general-purpose commands that give access to all the functions of FASS. Whichever set of standard HP-IB commands are used, integrating FASS's high-integrity, advanced signal simulation capability into an existing simulation system is very convenient.

Waveform Generation Language (WGL)

For advanced applications where existing Instrument-on-a-Disk software is insufficient, users can program FASS with the Waveform Generation Language (WGL) software. WGL could be used to generate a non-standard signal such as a non-linear chirp or a pulse with droop.

Dynamic Data

Dynamic data mode allows selective, external control of instantaneous frequency, FM, Φ M and AM, as well as pulse modulation and level. In dynamic data mode, data maps are downloaded to the modulation data source's frequency and modulation memories. Dynamic data supplied at rates of up to 33 MHz addresses desired locations in memory. The output of FASS is determined by the values mapped at that location.

Performance Characteristics

HP 8791 Frequency Agile Signal Simulators

Frequency

Range: 0.01 to 3 GHz (to 18.5 GHz with upconversion)

Resolution: 0.125 Hz

Switching speed: < 250 ns over full 3 GHz BW

Amplitude

Fast level control switching speed: < 250 ns in 6.02 dB steps

Output power: +10 to -107 dBm

Modulation capabilities

Instantaneous bandwidth: 40 MHz

Formats: Arbitrary FM, Φ M, AM, Pulse, Frequency Hopping

Spectral purity

Spurious response: -55 dBc, typical

Phase noise: < -125 dBc/Hz @ 10 kHz offset, 2 GHz, typical

Remote Operation

HP-IB compatible

Dynamic data: AM, FM, Φ M, carrier frequency, pulse

Dynamic data rates: Up to 33 megawords/sec/channel

General

Dimensions: rack 1237H x 600W x 803mmD (48.7" x 23.6" x 31.6")
consol 1064H x 754W x 756mmD (41.9" x 29.7" x 29.8")

Weight: shipping, rack 295kg (650lb); consol 75kg (165lb)

HP 8791 Model 100 Precision Signal Generator

The HP 8791 Model 100 Precision Signal Generator Instrument-on-a-Disk (PSID) software configures HP 8791 Model 10 FASS to

be a precise signal generator with the modulation capabilities of an advanced waveform generator.

Carrier: amplitude, phase, frequency

AM

Modulation index: 0 to infinite (DSB-SC)

Modulation frequency: 0.1 Hz to 20 MHz

Two-tone: 0.2 Hz to 40 MHz spacing over 0.01 to 3 GHz

FM

Frequency deviation: 0.125 Hz to 20 MHz

Modulation frequency: 0.1 Hz to 10 MHz - $\Delta F/2$ (upper limit dictated by 40 MHz system bandwidth)

Φ M

Peak phase deviation: +180°

Modulation frequency: 0.1 Hz to 10 MHz / ($\Delta\Phi$) (upper limit dictated by 40 MHz system bandwidth)

Pulse

Pulse width: 50 ns to CW

PRF: 0.1 Hz to 1 MHz

Modulation Waveforms

Sine, rectangle, sawtooth, noise, user-defined

HP 8791 Model 200 Radar Simulator

The Model 200 Radar Simulator Instrument-on-a-Disk (RSID) software configures HP 8791 Model 10 FASS to simulate advanced pulsed radar emitters.

Frequency hopping: constant, linear, scheduled, user-defined

Intrapulse modulation: coherent, non-coherent, chirp, Barker, user-defined

Pulse width: 29.8 ns to 100 ms

Rise and fall: 29.8 ns to 230 us

Pulse shapes: trapezoidal, Gaussian, exponential, user-defined

Pulse repetition frequency: 1 Hz to 625 kHz

PRF patterns: constant, burst, stagger, jitter, wobble, user-defined

Antenna scan rate: 4 to 100,000 RPM

Main beam width: 0.1 to 360°

Antenna scan patterns: circular, conical, raster, sector, user-defined

Antenna radiation patterns: rectangular, Hamming, Hanning, Blackman, 3-term, cosn, programmable

Vector Arbitrary Waveform Synthesizer

Simulation of Complex Wideband Signals with I/Q Modulation

The Vector Arbitrary Waveform Synthesizer (VAWS) is a customer-configured system that simulates extremely complex signals. It allows functional testing of non-agile communications, radar and EW systems and subsystems. Two HP 8770A arbitrary waveform generators provide the complex modulating signals for the I and Q modulation inputs of an HP 8780A Vector Signal Generator. Because I/Q or vector modulation is used, the signal can be completely defined in terms of phase, magnitude, and frequency. The modulation can be arbitrarily defined, and the effects of actual hardware and environment on a signal can be simulated. For many simulator applications, the Frequency Agile Signal Simulator is the instrument of choice. However, for applications requiring modulation bandwidth greater than 40 MHz (up to 100 MHz), independent I and Q channels, or a coherent reference, the VAWS system is a better fit.

For full details on configuring and calibrating VAWS, refer to Application Note AN 343-5 (HP Literature number 5952-6471).

VAWS Key Contributions

10 - 3000 MHz Frequency Range
100 MHz Arbitrary Waveform Bandwidth
Independent I & Q channels
Deep 512K memory for each channel
Coherent reference

Popular Applications

BPSK to 256-QAM
Filter simulation
Fully synthesized 100-MHz chirp pulses
Static and dynamic multipath fading

Ordering Information

	Price
HP 8791 Frequency Agile Signal Simulator	
Model 10 Frequency Agile Signal Simulator (E2500A)	\$185,000
Model 100 Precision Signal Generator (E2502A)	\$6,000
Model 200 Radar Simulator (E2501A)	\$11,000
HP 11776A Waveform Generation Language	\$0
Opt K10 FASS Version	\$6,500

SIGNAL GENERATORS

Vector Signal Generator

HP 8780A

- Highest performance and most versatile HP modulation source.
- Now with phase modulation for telemetry signals
- BPSK, QPSK, 8PSK, 16QAM, 64QAM, digital modulation and pulse

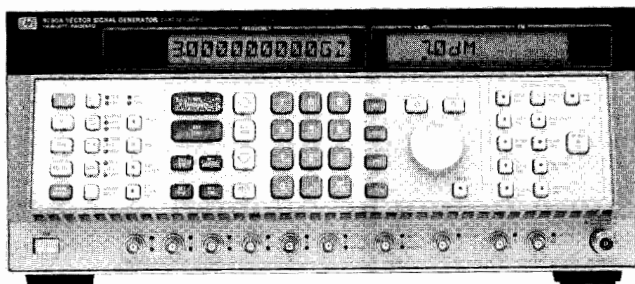

HP 8780A



HP 8780A Vector Signal Generator

The HP 8780A Vector Signal Generator is a synthesized IF source with exceptional modulation for modern receiver and component testing. It is capable of modulation bandwidths almost 100 times wider than previous synthesizers, and has built-in DACs (digital-to-analog-converters) to simplify generation of common digital modulations. Its extra-wide modulation bandwidth comes from a vector modulator that effectively doubles baseband modulation bandwidths for 700 MHz of output modulation. The vector signal generator's wideband modulation is complemented with an unmodulated coherent carrier output for demodulation of test signals.

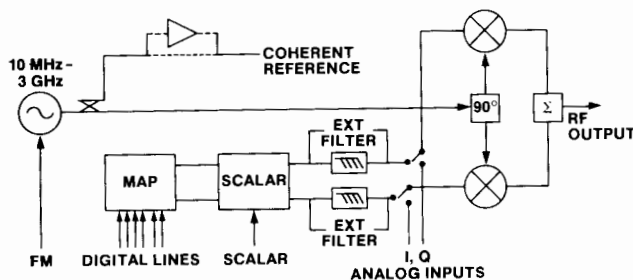

HP 8780A Block Diagram

The Vector Signal Generator offers a wide variety of modulation using both digital and analog inputs. It generates many standard digital modulations like QPSK and 16QAM and traditional modulations like FM, AM and pulse. By combining the different modulation types, signals as diverse as Barker-coded radar pulses and doppler-shifted satellite signals can be simulated.

Applications

The HP 8780A Vector Signal Generator is well suited for receiver measurements where wideband or complex modulations are required. It can be used as a calibrated transmitter to test modern radar EW receivers or communication receivers using vector I/Q modulation techniques. It provides a stable coherent carrier for phase measurement. It can also be upconverted if receivers operate at frequencies higher than 3GHz.

Analog Phase Modulation For Telemetry

HP 8780A option H02 offers analog modulation capability, which can be used in tracking and data relay satellite system (TDRSS). The

- Wideband FM: over 200MHz p-p deviations
- 700MHz modulation bandwidth using I/Q or vector
- 10MHz or 3GHz IF testing
- Pulse modulation with 1ns rise times
- Coherent carrier output

ground station needs linear phase modulation to communicate with satellite and establish command and control. The HP 8780A with option H02 can generate the signals used during both on-ground and in-orbit testing.

HP 8780A Specifications

Frequency

Range: 10 MHz to 3 GHz.

Resolution: 1 Hz.

Output

Level range: +10 to -100 dBm <2.5 GHz,
+4 to -100 dBm \geq 2.5 GHz.
(+12 dBm \leq 3 GHz with Opt 064)

Coherent Carrier Output

Unmodulated (except for FM) and unlevelled version of front panel RF output available at rear panel.

AC Coupled Frequency Modulation

Rates (3 dB frequencies): 20 Hz to 12 MHz.

Deviation ranges: 50 kHz to 50 MHz peak-to-peak (up to >200 MHz p-p possible with slightly higher distortion by overdriving FM input).

DC Coupled Frequency Modulation

Maximum rate (3 dB frequency): 10 kHz.

Deviation ranges: 150 Hz to 150 kHz peak-to-peak.

Digital Modulation

Modulation types: BPSK, QPSK, 8PSK, 16QAM (64QAM with Opt. 064), Arbitrary 2-State, Burst (except 64 QAM).

Parallel data rates: 0 to 150 MHz clocked (except 64 QAM),
0 to 100 MHz clocked 64QAM w/Opt. 064,
0 to 50 MHz asynchronous.

Serial data rates (only with Opt. 064): 0 to 150 MHz clock and data line for 0 to 25 MHz
64QAM symbol rate.

Analog phase modulation (only with opt H02)

Modulation frequency range: dc to 10MHz

Modulation level: 0 to 1.5V peak into 50 ohms

Modulation sensitivity: 1 radian/volt

Modulation index: variable by changing drive level over the range from 0.2 - 1.5 radians.

Scalar Modulation/AM

Traditional AM modulation requires a dc offset of 0.5 V to be added to the scalar input.

Sensitivity: 0 to +1 volt for 0 to full scale envelope modulation

General

Operating temperature range: 0 degrees C to +55 degrees C

Power: 100, 120, 220, 240 V, +5%, -10%, 48-440 Hz; 500 VA max

Weight: net, 31.5kg (70lb); shipping, 35.5kg (78lb)

Size: 177H x 425W x 637mmD (7.0" x 16.7" x 25.1")

Ordering Information

HP 8780A Vector Signal Generator	Price
Opt 001: Rear panel output and modulation inputs	\$60,000 +\$450
Opt 002: +10 dBm Coherent Carrier output	+\$1,900
Opt 064: 64 QAM modulation	\$0
Opt H02: Analog Phase Modulation	+\$4,000

SIGNAL GENERATORS

Vector Signal Generator

HP 8782A

383

- 1MHz to 250MHz covers 70 and 140MHz IFs
- BPSK QPSK 8PSK 16QAM 256QAM digital modulation and burst

- Internal Pseudo Random Binary Sequence generator
- AM/SCALAR modulation to simulate flat fading
- Coherent carrier output

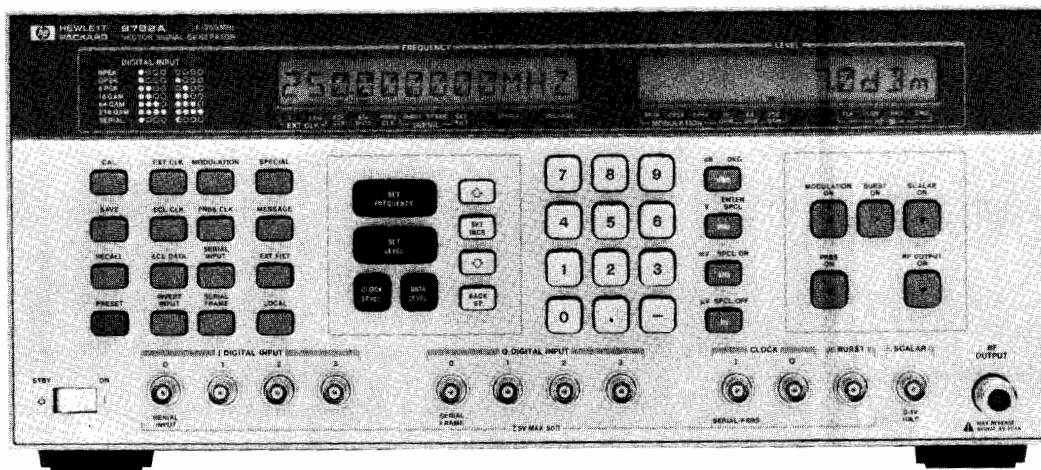

DESIGNED FOR
HP-IB
SYSTEMS
HP 8782A

Description

The HP 8782A vector signal generator is a second-generation synthesized generator. It supports a wide range of built-in digital modulation from BPSK to 256QAM for microwave terrestrial communications and satellite communications applications. It has a 1MHz to 250MHz frequency range, which covers most of the IF frequencies in commercial receivers. An internal pseudo-random bit sequence (PRBS) generator makes all digital modulation possible without using external digital data sources. It also provides an unmodulated coherent carrier output for testing receivers and subsystems before carrier recovery circuits are working. The cost is substantially lower than the HP 8780A Vector Signal Generator, providing IF signal generation for R&D and manufacturing.

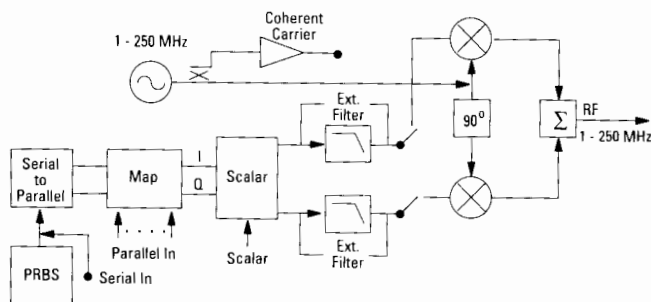

HP 8782A Block Diagram

The HP 8782A offers a wide variety of digital modulation using either the internal PRBS generator or user data source. It generates calibrated test signals as well as specified modulation impairments such as quadrature errors, I/Q imbalance, carrier leakage, and flat fading.

Applications

Using the HP 8782A to align digital radios in manufacturing can improve radio quality. Instead of relying on a golden standard modulator from R&D, the HP 8782A can provide calibrated constellations with extremely low quadrature error and amplitude imbalance. Customers can also simulate transmitter impairments by using the HP 8782A to test receiver performance margins.

HP 8782A Specifications

Frequency

Range: 1MHz to 250MHz

Resolution: 1HZ

RF output level: +7 to -100 dBm for all formats.

Coherent Carrier Output

Typically +10dBm up to 140 MHz

Typically +8.5dBm at >150MHz

Digital Modulation

Modulation types: BPSK, QPSK, 8PSK, 16 QAM, 64QAM, 256QAM, 9PRS, 25PRS, 49PRS, 81PRS

Parallel data rates: 0 to 100MHz clocked 0 to 50 MHz asynchronous.

Serial data rates: 0 to 200MHz clock and data lines for drive signal rise times <1.0 us.

Data input threshold: ECL: -1.3V fixed threshold level.
TTL: -2.5V to +2.5V adjustable.

Burst Modulation

Burst rates: 0 to 50MHz

Burst dc on/off ratio: > 50 dB at 70MHz carrier typical > 50 dB from 1 to 250MHz

Burst rise/fall time: <2.2ns

PRBS: internal Pseudo Random Binary sequence generator with $2^{23}-1$ sequence length

AM/SCALAR Modulation

Sensitivity: 0 to +1V for 0 to full scale output power.

Frequency response: dc to 50KHz at 70MHz carrier frequency
C/N Degradation from theoretical: for 256QAM @ BER = 10E-6, 40MHz BW, 70MHz IF, 0.5 excess BW Nyquist Filter, the Total HP8782A Degradation is typically ≤ 1.25 dB.

General

Operating temperature range: 0C to +55C

Power: 100, 120, 220, or 240 Vac, 48 to 66Hz; 100 or 120 Vac 360 to 440 Hz; 360 VA typical.

Ordering Information

HP 8782A Vector Signal Generator

Price

\$30,000

SIGNAL GENERATORS

Synthesized Signal Generator

HP 8673H

- 2 to 12.4 GHz or 5.4 to 18 GHz
- +8 to -100 dBm calibrated output
- 0.1 dB resolution, digitally displayed

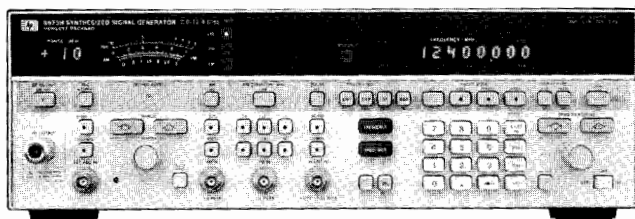

8673H



HP 8673H Multiband Synthesized Signal Generator

Low Price, High-Performance

When full 2.0 to 26.0 GHz frequency coverage is not needed, you can choose the HP 8673H Synthesized Signal Generator with the same reliability and performance at nearly half the cost of a 2 to 26 GHz synthesizer. Choose between option 212 (2 to 12.4 GHz) and option 618 (5.4 to 18.0 GHz) for the frequency coverage you need. What does high performance mean? Standard on either option of the HP 8673H is AM, FM, and pulse modulation, digital sweep, millimeter-drive capability and +8 dBm output power.

Multiband Frequency Coverage for Multiple Applications

Whether your application is receiver test, component test, or frequency translation, the HP 8673H has the performance you need. For pulsed sensitivity testing of radar receivers, you can be confident that pulse shape fidelity will be maintained under all specified output power levels and pulse widths. Leveled output power to -100 dBm provides great dynamic range for sensitivity testing. Digital sweep and high output power make swept frequency component tests simple and easy. The HP 8673H allows measurement flexibility with variable sweep dwell and span. Low phase noise and wide FM deviations to 10 MHz allow for accurate signal substitution in communication systems. With the addition of the HP 83550 millimeter source modules, the HP 8673H gives you the capability to reach 110 GHz.

Drop-in Confidence

The HP 8673H is ideal for automated test systems. Minimum output power of +8 dBm (see typical output power graph on page 388) means sufficient power at the device under test even after losses through switches and cables. For systems that have proven software for an HP 8673 synthesizer, the HP 8673H is a drop-in replacement.

Reliability You Can Count On

Acquisition cost is an important factor in any purchase decision. But what about cost-of-ownership? As a member of the field-proven HP 8673 family, the HP 8673H comes to you with an estimated 20,000 hours mean time between failure (based on component warranty failure rates). To guarantee that the first three years of your HP 8673H are worry-free, option W30 provides three years of return-to-HP service.

HP 8673H Specifications

Frequency Characteristics

Range: 2.0-12.4 GHz (Option 212)
5.4-18.0 GHz (Option 618)

Resolution: 2.0-6.6 GHz: 1 kHz
6.6-12.3 GHz: 2 kHz
12.3-18.0 GHz: 3 kHz

- AM/FM/Pulse Modulation
- Low spurious and phase noise
- Digital sweep

Spectral Purity

Single-sideband phase noise (1 Hz BW, 1 kHz offset, CW mode):

F _c	Offset from F _c				
	10 Hz	100 Hz	1 kHz	10 kHz	100 kHz
Band 1	-58 dBc	-70 dBc	-78 dBc	-86 dBc	-110 dBc
Band 2	-52 dBc	-64 dBc	-72 dBc	-80 dBc	-104 dBc
Band 3	-48 dBc	-60 dBc	-68 dBc	-76 dBc	-100 dBc

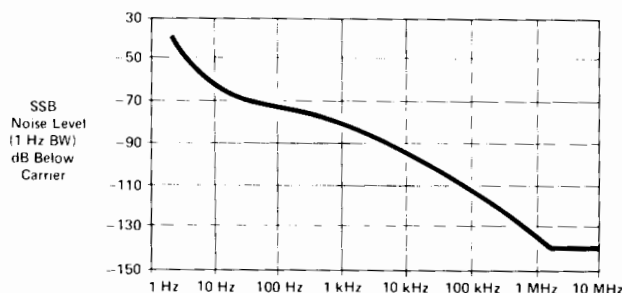

Figure 2. Typical HP 8673H single-sideband phase noise performance using the internal standard, Band 1.

Harmonics (< 0 dBm; +15 to +35 C): < -40 dBc
Subharmonics and multiples thereof: ≤25 dBc

Output Characteristics

Output level (+15 to +35C): +8 to -100 dBm
Resolution: 0.1 dB

Pulse Modulation

ON/OFF ratio: >80 dB
Rise/fall times: <50 ns, typical.
Pulse repetition frequency: 50 Hz to 1 MHz
Minimum duty cycle: <0.0001 for leveled performance.

Amplitude Modulation

Depth: 0 to 75%, at 0 dBm maximum carrier level, +15 to +35C.
Rate (30% depth): 10 Hz to 100 kHz, ±3 dB.
Sensitivity: 30%/Volt and 100%/Volt ranges.

Frequency Modulation

Deviation Range	Rate (±3 dB BW, typical)	Maximum Peak Deviation
30, 100 kHz/V	100 Hz - 10 MHz	The smaller of 3 MHz or: f _{mod} x 5, Band 1
.3, 1, 3 MHz/V	1 kHz - 10 MHz	f _{mod} x 10, Band 2
10 MHz/V		f _{mod} x 15, Band 3

General

Digital Sweep Characteristics: Identical to HP 8673B
Remote Programming: All functions HP-IB programmable except line switch.
Operating temperature range: 0 to +55C
Power: 100, 120, 220, 240V, +5%, -10%: 48-66 Hz; 400 VA max
Weight: net, 29kg (64lb); shipping, 34.5kg (76 lb)
Size: 146 H x 425 W x 620 mm D (5.7" x 16" x 24.4")

Ordering Information

HP 8673H Synthesized Signal Generator	Price
Opt 212 or Option 618	\$23,000
Opt 004 Rear panel RF output	+\$75
Opt 006 Chassis slide kit	+\$75
Opt 907 Front panel handle kit	+\$55
Opt 908 Rack mounting flange kit	+\$33
Opt 909 Front panel & rack mounting kits	+\$80
Opt 915 Service manual	+\$65
Opt 916 Extra operating manual	+\$20
Opt W30 Extended Repair Service. See page 725.	+\$575

SIGNAL GENERATORS

Solid-State Microwave Signal Generators

Models 8683/8684B,D

385

- Portable signal generators with high performance modulation
- Internal pulse modulation source
- Wide FM deviation for satellite video ± 10 MHz peak
- dc coupled FM with rates to 10 MHz

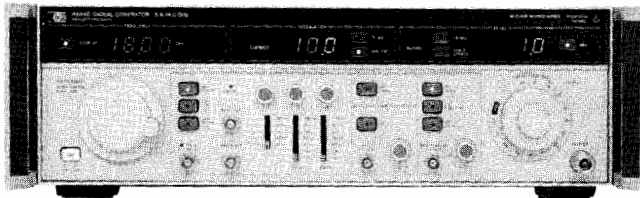

HP 8684D

HP 8683/8684 Microwave Signal Generators

The HP 8683 and 8684 are rugged portable signal generators designed for demanding benchtop and field maintenance environments.

With high performance AM, FM and pulse modulation, including a built in pulse generator, the HP 8683/84 provides the capability to test modern communications, radar and EW systems.

Distinguishing features of the B, & D models		
	8683/84B	8683/84D
Output Power	+10 dBm	+10 dBm, -3 dBm ¹
Opt 001 Power	N/A	+10 dBm ¹
Internal Pulse Generator/Modulator	Yes	Yes
FM Deviation (DC To 10 MHz Rate)	5 MHz	10 MHz ¹

¹ These specifications for the doubled mode

HP 8683B/D, HP 8684B/D Specifications

Frequency Specifications

Range

HP 8683B: 2.3–6.5 GHz.

HP 8683D: 2.3–13.0 GHz.

HP 8684B: 5.4–12.5 GHz.

HP 8684D: 5.4–18.0 GHz.

Resolution: HP 8683, 5 MHz using a 4 digit LED display; HP 8684, 10 MHz using a 3 1/2 digit LED display.

Calibration accuracy: HP 8683B/D, $\pm 1.25\%$ <4.0 GHz, $\pm 0.75\%$ 4.0 to 6.5 GHz; HP 8683D x2 band, $\pm 1.25\%$ 6.5 to 8.0 GHz, $\pm 0.75\%$ >8 GHz; HP 8684B/D, $\pm 1.25\%$ 5.4 to 9.0 GHz, $\pm 0.75\%$ 9.0 to 12.5 GHz; HP 8684D x2 band, $\pm 1.25\%$ 12.5 to 18.0 GHz.

Stability (typical)

vs. time (20 min. after turn-on): <30 kHz/min.

vs. time (60 min. after turn-on): <100 kHz/hr.

vs. temperature (0 to 55°C): HP 8683, <15 MHz; HP 8684, <30 MHz.

vs. line voltage (transients of +5%/–10%): <20 ppm.

Spectral Purity

Harmonics (<18GHz, at specified max output): <–25 dBc.

HP 8683/84D harmonics are unspecified in x2 frequency band.

Fundamental feedthrough (at specified max. output): HP 8683D, <–25 dBc 6.5–9.5 GHz; HP 8684D, <–25 dBc 12.5–18.0 GHz. Not specified for D models with Option 001.

Spurious (non-harmonically related): <–80 dBc; typ, <–90 dBc.

Residual FM (50 Hz to 15 kHz post detection BW): <5 kHz peak. HP 8683/84D in doubled band: <10 kHz peak.

Single-sideband phase noise (avg. rms, 1 Hz BW, 10 kHz offset from carrier, typical): HP 8683B, <–72 dBc; HP 8683D, <–66 dBc; HP 8684B, <–65 dBc; HP 8684D, <–59 dBc.

Residual AM (avg. rms, 300 Hz to 15 kHz post detection BW): <0.15%.

Output Specifications

Range (leveled into 50Ω): HP 8683/84B, +10 to –130 dBm; HP 8683/84D, +10 to –130 dBm (main band), –3 to –130 dBm (x2 band), +10 dBm in x2 bands available with Option 001.

Resolution: 0.1 dB using a 3 1/2 digit LED display.

Accuracy: ± 2.5 dB from maximum specified output power to –110 dBm (to –100 dBm in x2 bands); ± 3.5 dB to –120 dB and 0 to +10 dBm for Opt 001. Typ. $< \pm 0.9$ dB at –100 dBm. Option 002 affects level accuracy $< \pm 0.5$ dB.

Flatness (power level >–10 dBm): ± 1.0 dB. (Not for Opt. 001)

Auxiliary output: rear panel, typically >–15 dBm into 50Ω, prior to AM, pulse, or frequency doubling; source impedance approx. 50Ω.

Amplitude Modulation

Depth (1 kHz rate): 0–70%.

Rates (3 dB BW at 40% depth): dc to 10 kHz (dc coupled); 50 Hz to 10 kHz (ac coupled).

Distortion (THD): <10% at 40% depth and 1 kHz rate.

Incidental FM (30% AM depth): <15 kHz peak to peak. (<30 kHz p-p in doubled band, HP 8683/84D.)

Internal AM: fixed 1 kHz nom. square wave with 50 $\pm 5\%$ duty cycle.

Frequency Modulation

Peak deviation: HP 8683/84 B, ± 5 MHz; HP 8683/84D, ± 5 MHz (main); ± 10 MHz (x2 band).

Rates (3 dB BW): dc to 10 MHz, 100 Hz to 10 MHz (ac coupled).

Distortion: <5% at 100 kHz rate and <1 MHz peak deviation.

Incidental AM (rate <100 kHz, peak deviation <1 MHz): <6%.

Internal FM: FM sawtooth with a fixed sweep rate of 1 kHz nom. and variable deviation up to ± 5 MHz (± 10 MHz for D models, x2 bands).

Phase lock input: typical sensitivity of –5 MHz/V.

Pulse Modulation

HP 8683/84 B/D Internal Pulse Generator

Rate: 10 Hz to 1 MHz continuously adjustable in 5 ranges.

Width: 50 ns to 100 ms continuously adjustable in 7 ranges.

Delay (time between sync out and video out): <50 ns to 100 ms in 7 ranges with continuous adjustment within ranges.

HP 8683/84 B/D External Pulse Input Requirements

Rate: 0 to 1 MHz.

Width: >100 ns.

Level: on >+1.0 V peak; off <+0.4 V peak.

HP 8683/84 B/D RF Pulse Specifications

Rise/fall time: <10 ns.

On/off ratio: >80 dB.

Minimum pulse width: <100 ns.

Maximum pulse repetition frequency: >1 MHz.

Peak pulse power: ± 0.5 dB of level set in CW mode.

General

Operating temperature range: 0° to 55°C.

EMI: MIL-STD-461, VDE0871, CISPR Pub. 11.

Safety: meets the requirements of IEC 348.

Power: 100, 120, 220 or 240V, +5%, –10%; 48 to 66 Hz; <200 VA max.

Dimensions: 145 H x 457 W x 472 mm D (5.7" x 18" x 18.6").

Weight: HP 8683, 17.9kg (39 lb) net, 23.4 kg (51 lb) shipping; HP 8684, 16.5 kg (36 lb) net, 22.0 kg (48 lb) shipping.

Ordering Information

HP 8683/84B Microwave Signal Generator \$16,400

HP 8683/84B

Option W30: Two years additional return-to-HP warranty +\$410

HP 8683/84D Microwave Signal Generator \$23,000

Option 001 +10 dBm in x2 band, HP 8683D +\$3000

Option 001: +10 dBm in x2 band, HP 8684D +\$5000

Option W30: Two years additional return-to-HP warranty +\$530

Option 002: Reverse power protection (except D models) +\$725

Option 910: Extra operating and service manual +\$50

Option 913: Rack mounting flange kit +\$35

SIGNAL GENERATORS

Synthesized CW Generator

Model 8671B

- 2 to 18 GHz frequency range
- +8 dBm calibrated output power
- Low spurious signals
- Low phase noise
- 128 dB dynamic range
- 1 to 3 kHz frequency resolution



HP 8671B

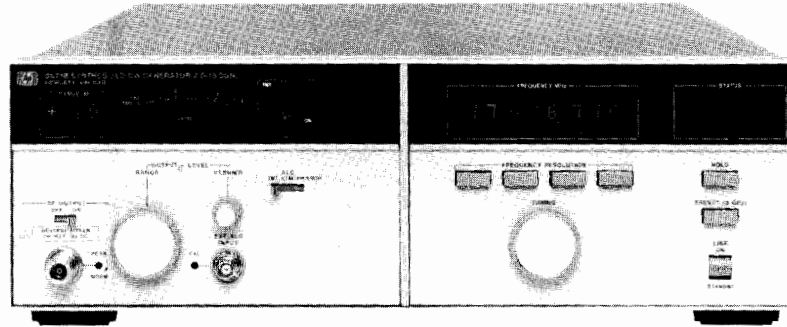

HP 8671B Synthesized CW Generator

The HP 8671B is an economy 2.0 to 18.0 GHz synthesized CW generator. It meets all the requirements for a clean CW source. It features synthesized output with 1, 2 or 3 kHz resolution, 128 dB dynamic range, +8dBm calibrated output power, full programmability, low phase noise and low spurious signals.

General Purpose Measurements

For applications requiring a microwave local oscillator, the HP 8671B is the ideal solution. A simple, uncluttered, easy to use generator, the HP 8671B provides accurate, clean signals to upconvert and downconvert signals into the desired measurement frequency range.

The +8dBm output capability (with plenty of reserve) is just what you need to drive mixers. You can now take full advantage of the entire 2.0 to 18.0 GHz frequency range from a single instrument. The HP 8671B provides broadband synthesizer capability for the price of a non-synthesized source.

As a microwave source for downconversion, important measurements like noise figure and modulation analysis become more affordable. The HP 8671B with an external mixer allows you to make these measurements at an IF with the HP 8970A and 8970B Noise Figure Meters and the HP 8901A/B and HP 8902A Modulation Analyzers. Other downconverted measurements may include network, spectrum, and waveform analysis.

ATE Systems

The +8dBm output capability of the HP 8671B provides the extra margin you need for automated systems. Higher power at the source means sufficient power at the unit under test, even after losses through cables and switches. For automated systems, the requirements for low phase noise, low spurious signals, and precise frequency settability are easily accommodated by the HP 8671B.

HP 8671B Specifications

Frequency Characteristics

Frequency range: 2.0–18.0 GHz (18.6 GHz overrange).

Frequency bands and resolution:

band 1:	2.0 to 6.2 GHz	1 kHz
band 2:	6.2 to 12.4 GHz	2 kHz
band 3:	12.4 to 18.0 GHz	3 kHz

Time base: internal 10 MHz ($<5 \times 10^{-10}$ /day aging rate) or external 5 or 10 MHz.

Frequency switching time: <15 ms to be within specified resolution, all bands.

Spectral Purity

Single-sideband phase noise (1 Hz BW, CW mode):

F_c	Offset from F_c				
	10 Hz	100 Hz	1 kHz	10 kHz	100 kHz
Band 1	-58 dBc	-70 dBc	-78 dBc	-86 dBc	-110 dBc
Band 2	-52 dBc	-64 dBc	-72 dBc	-80 dBc	-104 dBc
Band 3	-48 dBc	-60 dBc	-68 dBc	-76 dBc	-100 dBc

Harmonics (up to maximum frequency, output level meter readings <0 dB on 0 dBm range and below): <-25 dBc.

Sub-harmonics and multiples thereof: <-25 dBc.

Spurious

Non-harmonically related: <-70 dBc, Band 1; <-64 dBc, Band 2; <-60 dBc, Band 3.

Power line related and fan rotation related within 5 Hz below line frequency and multiples thereof:

F_c	Offset from F_c		
	<300 Hz	300 Hz to 1 kHz	>1 kHz
Band 1	-50 dBc	-60 dBc	-65 dBc
Band 2	-44 dBc	-54 dBc	-59 dBc
Band 3	-40 dBc	-50 dBc	-55 dBc

Output Characteristics

Output level (+15°C to +35°C): +8 to -120 dBm

Flatness (0 dBm range, +15°C to +35°C): ± 0.75 dB, Band 1, ± 1.00 dB, Band 2, ± 1.25 dB, Band 3.

Output level switching time: <20 ms, internally leveled
 <10 ms, typical within one output level range

Source impedance: 50 ohms nominal.

Remote Operation

Frequency: Programmable over full range with same resolution as manual mode

Output Level: Programmable in 1 dB steps

RF: Choice of either ON or OFF

ALC: Choice of either internal leveling, diode leveling, or power meter leveling

Interface functions:

SH1, AH1, T6, TE0, L4, LE0, SR1, RL0, PP2, DC1, DT0, C0, E1.

General

Operating temperature range: 0°C to +55°C.

Power: 100, 120, 220, 240 V, +5%, -10%, 48-66 Hz; 300 VA max.

Weight: net, 27 kg (60 lb). Shipping, 32.5 kg (72 lb).

Size: 133 mm H x 425 mm W x 603 mm D (5.25" x 16.75" x 23.75").

Ordering Information

HP 8671B Synthesized CW Generator

Option 907: Front panel handle kit

Option 908: Rack mounting flange kit

Option 909: Front panel handle kit plus rack mounting flange kit

Option 910: Extra operating and service manual

Option W30: Two additional years of return to HP warranty

Price

\$24,000

+\$55

+\$33

+\$80

+\$60

+\$600

SIGNAL GENERATORS

Synthesized Signal Generator

HP 8673G

387

- 2 - 26 GHz frequency range
- +8 dBm calibrated output power
- Digital sweep

- Frequency extension capability to 110 GHz
- Low phase noise
- Low spurious signals

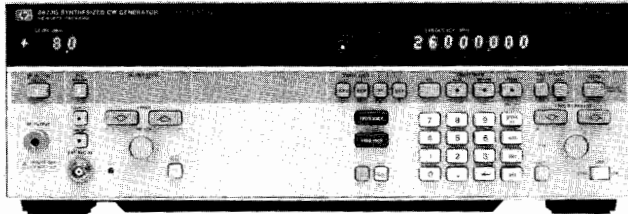

8673G

HP 8673G Synthesized CW Generator

Exceptional Value in a CW Generator

The HP 8673G is the world's lowest priced 2.0 - 26.0 GHz synthesized CW generator. Satisfying all the requirements for a clean CW source, it features the same excellent spectral purity, output range, mm-drive capability, digital sweep, and HP-IB programmability featured in all of the HP 8673 family. The HP 8673G is the ideal CW generator for local oscillator, up/down conversion, and exciter applications to 26 GHz. Because the HP 8673G has full HP-IB compatibility, you can use your existing software proven for other HP 8673 series synthesizers.

Economy and Measurement Flexibility

Not only is the HP 8673G the most economical CW synthesizer to 26 GHz, it provides outstanding measurement flexibility. For up or down conversion applications, harmonics less than -40 dBc and low phase noise provide you with plenty of dynamic range. To ensure sufficient power in ATE systems, the HP 8673G with Option 008 gives you +8 dBm of leveled output power (for typical output power see graph on page 388) all the way to 26 GHz. When making component measurements, the synthesized sweep capability of the HP 8673G and the power of HP-IB programmability allows you to make quick swept measurements of your device under test with synthesizer accuracy.

HP 8673G Specifications

Frequency Extension to 110 GHz

The HP 8673G is one of the lowest-cost methods to achieve millimeter-wave frequencies. It can be used with the HP 83550-series millimeter wave source modules and the HP 8349B Microwave Amplifier to provide leveled output signals at the output of the source module up to 110 GHz. With System mode, the resultant output frequency can be displayed on the HP 8673G front panel by entering the multiplication factor of the source module.

Frequency Characteristics

Range: 2.0 - 26.0 GHz

Resolution: 2.0 - 6.6 GHz: 1 kHz
6.6 - 12.3 GHz: 2 kHz
12.3 - 18.6 GHz: 3 kHz
18.6 - 26.0 GHz: 4 kHz

Spectral Purity

Single-sideband phase noise (1 Hz BW, 1 kHz offset, CW mode):

F _c	Offset from F _c				
	10 Hz	100 Hz	1 kHz	10 kHz	100 kHz
Band 1	-58 dBc	-70 dBc	-78 dBc	-86 dBc	-110 dBc
Band 2	-52 dBc	-64 dBc	-72 dBc	-80 dBc	-104 dBc
Band 3	-48 dBc	-60 dBc	-68 dBc	-76 dBc	-100 dBc
Band 4	-46 dBc	-58 dBc	-66 dBc	-74 dBc	-98 dBc

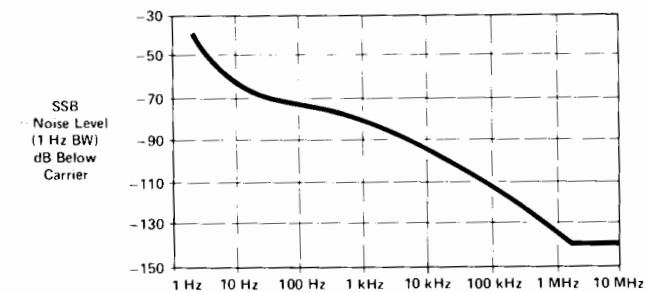

Typical HP 8673G single-sideband phase noise performance using the internal standard, Band 1.

Harmonics (<0 dBm; +15 to +35° C): <-40 dBc

Subharmonics and multiples thereof: 2.0 - 18.6 GHz: <-25 dBc, 18.6 - 26 GHz: <-20 dBc

Spurious (non-harmonically related): 2.0 - 18.6 GHz: <-60 dBc, 18.6 - 26.0 GHz: <-58 dBc

Spurious (power line and fan rotation related): 2.0 - 18.6 GHz: <-40 dBc, 18.6 - 26.0 GHz: <-38 dBc

Output Characteristics

Output Level: 2.0 - 18.0 GHz: +8 dBm, 18.0 - 22.0 GHz: +4 dBm, 22.0 - 26.0 GHz: +1 dBm

With Opt 008: 2.0 - 26.0 GHz: +8 dBm

Resolution: 0.1 dB

General

Digital Sweep Characteristics: Identical to HP 8673B

Remote Programming: All functions HP-IB programmable except line switch

Operating temperature range: 0 to +55°C

Power: 100, 120, 220, 240V, +5%, -10%; 48-66 Hz; 400 VA max

Weight: net, 29kg (64lb); shipping, 34.5kg (76lb)

Size: 146H x 425W x 620mmD (5.7" x 16.8" x 24.4")

Ordering Information

HP 8673G Synthesized CW Generator

Price

HP 8673G Synthesized CW Generator	\$29,000
Opt 004 Rear panel RF output	+\$75
Opt 006 Chassis slide kit	+\$75
Opt 008 +8 dBm output power	+\$5,000
Opt 907 Front panel handle kit	+\$55
Opt 908 Rack mounting flange kit	+\$33
Opt 909 Front panel & rack mounting kits	+\$80
Opt 910 Service manual and extra operating manual	+\$80
Opt 915 Service manual	+\$65
Opt W30 Extended Repair Service. See page 725.	+\$725

SIGNAL GENERATORS

Synthesized Signal Generators (cont'd)

Models 8673B, 8673C, 8673D

- 10 MHz to 26.5 GHz frequency range
- < -60 dBc harmonics/subharmonics
- Low spurious and phase noise

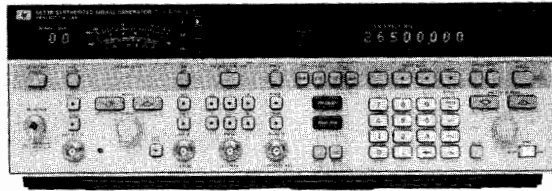

HP 8673B



- +8 to -100 dBm calibrated output
- Internally leveled AM/FM/pulse modulation
- Frequency extension capability to 60 GHz

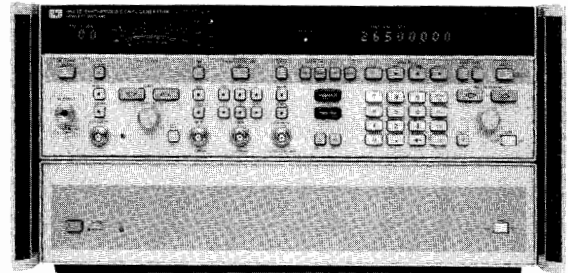

HP 8673D



HP 8673B, 8673C and 8673D Synthesized Signal Generators

The HP 8673B/C/D Synthesized Signal Generators are full performance synthesizers designed to generate precise microwave signals over the 50 MHz to 26.5 GHz frequency range. These generators offer calibrated and leveled power, AM, FM, pulse modulation, digital sweep, programmability, and frequency extension capability to 110 GHz. The HP 8673B covers the 2.0 to 26.5 GHz range, while the HP 8673C/D pair cover from 50 MHz to 18.6 GHz and 26.5 GHz respectively.

Excellent Spectral Purity

A variety of applications ranging from microwave radar to communications systems require the frequency stability available from the HP 8673B/C/D. The broadband frequency coverage is derived from multiplying a fundamental 2.0 to 6.6 GHz YIG-tuned oscillator. This technique provides the wide frequency coverage in a single instrument. Indirect synthesis phase-locks the YIG-tuned oscillator to a 10 MHz quartz crystal reference to provide excellent long term and short term stability (frequency drift $< 5 \times 10^{-10}$ per day). Phase locked loops are optimized for lowest possible single-sideband phase noise. The HP 8673C and HP 8673D include an internal tracking YIG-filter to further reduce unwanted harmonic, subharmonic, and nonharmonic spurious signals above 1.2 GHz to < -60 dBc.

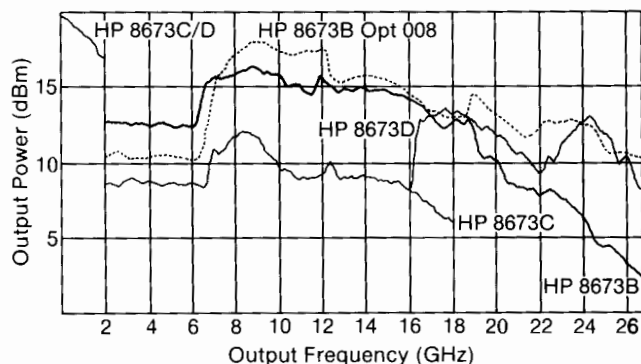

Figure 1. Maximum power typically available from HP 8673D, 8673C, 8673B/G/H, and 8673B/G Option 008 at 25°C.

Wide Dynamic Output Range

For broadband component and receiver testing applications, the HP 8673B/C/D deliver exceptionally flat power output across the full frequency ranges. For receiver sensitivity measurements, power is internally (or externally) leveled to -100 dBm. Maximum available power varies with frequency as shown in Figure 1.

Internally Leveled Pulse Modulation

The HP 8673B/C/D features an internal pulse modulator that provides high-quality pulse modulation over the entire 50 MHz - 26.5 GHz range. Since the modulation is done before the frequency multiplication, the peak pulsed power can be leveled and calibrated to within typically $+1.5/-1.0$ dBm of the set level referenced to CW. External TTL level pulse rates up to 1 MHz and pulse widths as narrow as 100 ns can be easily accommodated by the HP 8673B/C/D to provide ON/OFF ratios in excess of 80 dB.

Calibrated AM/FM Modulation

AM and FM capability is included in the HP 8673B/C/D to expand the versatility in receiver testing applications. AM depth at rates up to 100 kHz can be accurately set using the front panel meter. Six ranges of metered FM are available at rates and peak deviations up to 10 MHz. Both AM depth and FM deviation are linearly controlled by varying the externally supplied modulating input voltage up to 1V peak. Simultaneous modulation of AM, FM, and pulse is possible to simulate complex environments.

Frequency Extension to 110 GHz

The HP 8673B/C/D can be used as microwave drivers for the HP 83550-series millimeter-wave source modules. This combination (with the addition of the HP 8349B Microwave Amplifier) can provide leveled output signals up to 110 GHz with the "System Leveling" mode. The resultant output frequency can be displayed on the HP 8673B/C/D front panel by entering the multiplication factor of the source module.

Full Programmability and Digital Sweep

The HP 8673B/C/D provides full programmability of all front panel functions for automatic test applications. Output level can be controlled in steps as fine as 0.1 dB. An internal microprocessor is used to simplify HP-IB program code generation and follow front-panel keystroke sequences. This design allows the implementation of digital sweep. Sweep spans can be set over the entire frequency range with variable rates, step sizes, and selectable markers available.

HP 8673B/C/D Specifications

Frequency Characteristics

Frequency Range: HP 8673B: 2.0–26.0 GHz (1.95 to 26.5 GHz in overrange).

HP 8673C: 0.05–18.6 GHz (0.01–18.6 GHz in overrange).

HP 8673D: 0.05–26.0 GHz (0.01–26.5 GHz in overrange).

Frequency Bands: Band 0: 0.05–2.0 GHz

Band 1: 2.0–6.6 GHz

Band 2: 6.6–12.3 GHz

Band 3: 12.3–18.6 GHz

Band 4: 18.6–26.0 GHz

Frequency Resolution: 1 kHz Band 0 and 1 3 kHz Band 3

2 kHz Band 2 4 kHz Band 4

Time base: internal 10 MHz ($<5 \times 10^{-10}$ /day aging rate) or external 5 or 10 MHz.

Frequency switching time: <25 ms (HP 8673B) and <50 ms (HP 8673C/D) to be within specified resolution, all bands.

Spectral Purity

Single-sideband phase noise (1 Hz BW, CW mode):

F _c	Offset from F _c				
	10 Hz	100 Hz	1 kHz	10 kHz	100 kHz
Band 0	-64 dBc	-70 dBc	-78 dBc	-86 dBc	-105 dBc
Band 1	-58 dBc	-70 dBc	-78 dBc	-86 dBc	-110 dBc
Band 2	-52 dBc	-64 dBc	-72 dBc	-80 dBc	-104 dBc
Band 3	-48 dBc	-60 dBc	-68 dBc	-76 dBc	-100 dBc
Band 4	-46 dBc	-58 dBc	-66 dBc	-74 dBc	-98 dBc

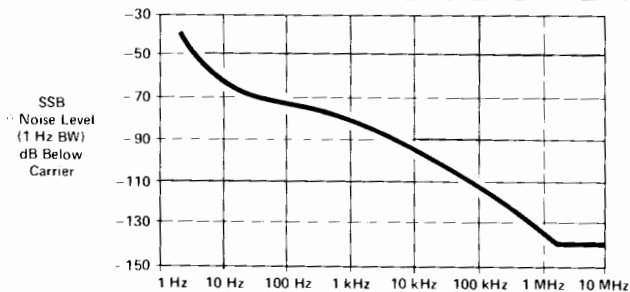

Figure 2. Typical HP 8673B/C/D single-sideband phase noise performance using the internal standard, Band 1.

Harmonics (up to maximum frequency, output level meter readings <0 dB on 0 dBm range and below): <-40 dBc (HP 8673B).

<-40 dBc, 50MHz–1.2GHz, <-60 dBc, 1.2–26.0 GHz (HP 8673C/D).

Sub-harmonics and multiples thereof: <-60 dBc (HP 8673C/D)

<-25 dBc, Bands 1–3; <-20 dBc, Band 4 (HP 8673B).

Spurious (CW and AM modes)

Non-harmonically related: <-60 dBc, Band 0; <-70 dBc, Band 1; <-64 dBc, Band 2; <-60 dBc, Band 3; <-58 dBc, Band 4.

Power line related and fan rotation related within 5 Hz below line frequency and multiples thereof:

F _c	Offset from F _c		
	<300 Hz	300 Hz to 1 kHz	>1 kHz
Band 0	-50 dBc	-60 dBc	-65 dBc
Band 1	-50 dBc	-60 dBc	-65 dBc
Band 2	-44 dBc	-54 dBc	-59 dBc
Band 3	-40 dBc	-50 dBc	-55 dBc
Band 4	-38 dBc	-48 dBc	-53 dBc

Output Characteristics

Output level (+15°C to +35°C):

8673B		8673C		8673D	
Level (dBm)	Freq. (GHz)	Level (dBm)	Freq. (GHz)	Level (dBm)	Freq.(GHz)
+8 to -100	2-18	+11 to -100	.05-2.0	+11 to -100	.05-2.0
+4 to -100	18-22	+5 to -100	2-16	+5 to -100	2-22
0 to -100	22-26	+2 to -100	16-18.6	+6 to -100	22-26

Flatness (0 dBm range, +15°C to +35°C): ± 0.5 dB through Band 0, ± 0.75 dB through Band 1, ± 1.0 dB through Band 2, ± 1.25 dB through Band 3, ± 1.75 dB through Band 4.

Remote programming output level resolution: 0.1 dB.

Source impedance: 50 ohms nominal.

Pulse Modulation

ON/OFF ratio: >80 dB.

Rise/fall times: <30 ns, Band 0; <40 ns, Bands 1–4.

Minimum leveled pulse width: <100 ns.

Pulse repetition frequency: 50 Hz - 1 MHz.

Maximum peak power: same as in CW mode.

Peak level accuracy (relative to CW, +15°C to +35°C): ± 1.5 dB, Band 0; $\pm 1.5/-1.0$ dB, Band 1–4.

Pulse modulation input requirements: normal mode, positive-true TTL levels; complement mode, negative-true TTL levels.

Video feedthrough: typically <-50 dBc.

Amplitude Modulation

Rates (3 dB BW, 30% depth): 20 Hz-100 kHz.

Sensitivity: 30%/V, 100%/V ranges. Max. input 1 V peak into 600 Ω .

Frequency Modulation

Sensitivity	Rate (3 dB BW, typical)	Maximum Peak Deviation
30 kHz/V	50 Hz to 10 MHz	the smaller of 10 MHz or: fmod x 5, Band 0 fmod x 5, Band 1 fmod x 10, Band 2 fmod x 15, Band 3 fmod x 20, Band 4
100 kHz/V	50 Hz to 10 MHz	
300 kHz/V	1 kHz to 10 MHz	
1 MHz/V	1 kHz to 10 MHz	
3 MHz/V	1 kHz to 10 MHz	
10 MHz/V	1 kHz to 10 MHz	

Digital Sweep Characteristics

Sweep function: start/stop or ΔF (span) sweep.

Sweep modes: manual, auto, or single sweep.

Step size: maximum of 9999 frequency points per sweep; minimum step size equals frequency resolution.

Dwell time: set from 1 to 255 ms per frequency.

Markers: 5 independent, settable frequency markers.

Sweep outputs: 0 to +10 V ramp start to stop; 0.5 V/GHz ramp; Z-axis blanking/markers; tone marker; penlift.

Remote Programming

All functions HP-IB programmable except line switch. The HP 8673B/C/D can output over the interface frequency and output level settings, error/malfunction codes, and operational status codes.

Interface functions:

SH1, AH1, T5, TE0, L3, LE0, SR1, RL1, PP1, DC1, DT1, C0, E1.

General

Operating temperature range: 0°C to +55°C.

Power: 100, 120, 220, 240 V, +5%, -10%, 48-66 Hz; 400 VA max. (HP 8673B), 500 VA max. (HP 8673C/D)

Weight: HP 8673B: net 29 kg (64 lb); shipping 34.5 kg (76 lb).

HP 8673C/D: net 42.4 kg (94 lb.); shipping 46.5 kg (103 lb).

Size: HP 8673B: 133 mm x 425 mm x 603 mm (5.25" x 16.75" x 23.75") HxWxD. HP 8673C/D: 234 mm x 425 mm x 620 mm (9.2" x 16.8" x 24.4") HxWxD.

Ordering Information

	Price
HP 8673B Synthesized Signal Generator	\$42,000
Option 001: Delete RF output attenuator	-\$600
Option 002: Delete reference oscillator	-\$735
Option 003: Operation at 400 Hz line	+\$460
Option 004: Rear panel RF output	+\$75
Option 005: Rear panel RF output without RF attenuator	-\$525
Option 006: Chassis slide kit	+\$75
Option 008: +7 dBm output level	+\$7,000
Option 907: Front panel handle kit	+\$55
Option 908: Rack mounting flange kit	+\$33
Option 909: Combination of Opt. 907 plus 908	+\$80
Option W30: Two additional years of return-to-HP warranty	+\$1050
Option 910: Extra operating and service manual	+\$65
HP 8673C Synthesized Signal Generator	\$51,000
Options 001, 002, 003, 004, 005, and 006: same as HP 8673B	
Option 908: Rack mounting flange kit	+\$55
Option 913: Rack flanges for standard front handles	+\$45
Option 910: Service and extra operating manual	+\$85
Option 915: Service manual	+\$20
Option 916: Extra operating manual	+\$65
Option W30: Two additional years of return to HP warranty	+\$1170
HP 8673D Synthesized Signal Generator	\$57,000
Options 001, 002, 003, 004, 005, 006, 908, 913, 910, 915, and 916: Same as HP 8673C	
Option W30: Two additional years of return to HP warranty	+\$1250
HP 11726A Support Kit (for HP 8673B)	\$1,800

SIGNAL GENERATORS

Synthesized Sweepers 10 MHz - 40 GHz (or 110 GHz)

HP 8360 Series

- 1 Hz frequency resolution (option 008)
- Low spurious and phase noise
- 1 μ s leveled pulse width capability
- +20 dBm to -110 dBm calibrated output
- Complete analog sweeper
- dc to 250 kHz amplitude modulation
- <-50 dBc harmonics

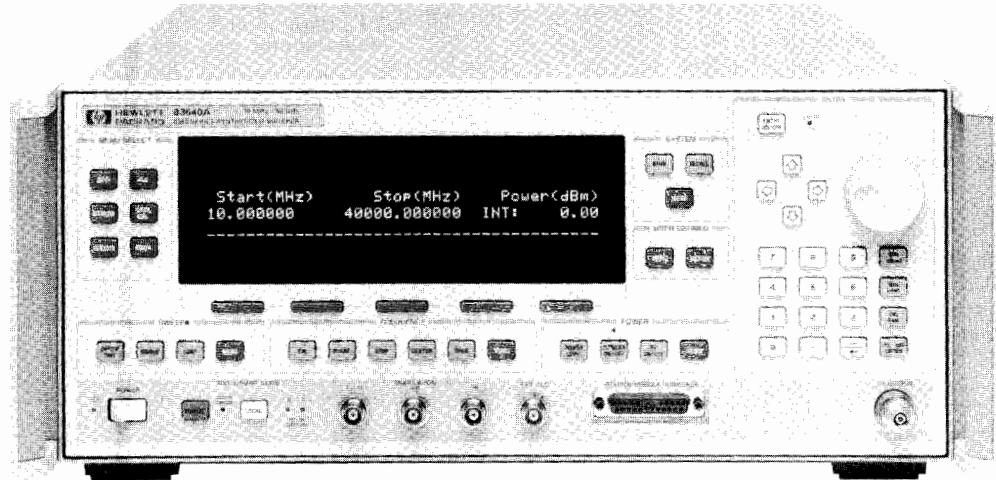

HP 8360 Series Synthesized Sweepers

The HP 8360 series synthesized sweepers are the standard of excellence for applications requiring the high performance and accuracy of a synthesized source and the speed and versatility of a sweep oscillator. The HP 8360 series synthesized sweepers offer the same commitment to quality and reliability that is inherent in the previous industry standard HP 8340/8341.

Frequency Precision and Spectral Purity

The synthesized broadband frequency coverage and the precise 1 Hz frequency resolution (option 008) are generated by indirect synthesis, enabling the HP 8360 to achieve the same low single-sideband phase noise performance as the HP 8340/8341, HP 8671B, HP 8672A, and HP 8673 series synthesized signal generators.

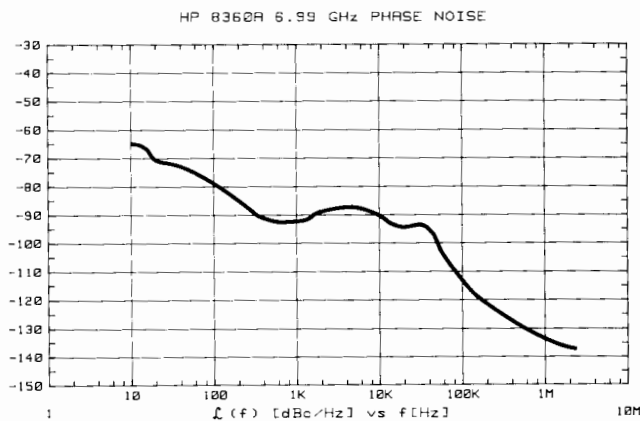

HP 8360A Phase Noise performance from 2.3 to 8.0 GHz

Stepped CW Switching Times

The HP 8360 features list and stepped frequency switching times as fast as 5 ms. Additionally, the HP 8360 provides arbitrary CW switching times less than 50 ms.

Output Power

The HP 8360 provides high output power ranging between +20 and -110 dBm with 0.02 dB resolution and feature power sweep capability with >20 dB dynamic range for complete characterization of level-sensitive devices.

Pulse, Amplitude and Frequency Modulation

The HP 8360 has high-performance pulse modulators with >80 dB on/off ratio, and rise/fall times <10 ns (option 006).

The HP 8360 also features dc-coupled amplitude modulation capability with a 3 dB bandwidth of 250 kHz, and a 90% modulation depth. Pulse and amplitude modulation capabilities can be used simultaneously.

The HP 8360 also offers dc-coupled frequency modulation capability with rates up to 8 MHz.

<-50 dBc Harmonics

The HP 8360 delivers excellent harmonic performance with harmonics at least 50 dB below the carrier from 1.8 to 40 GHz.

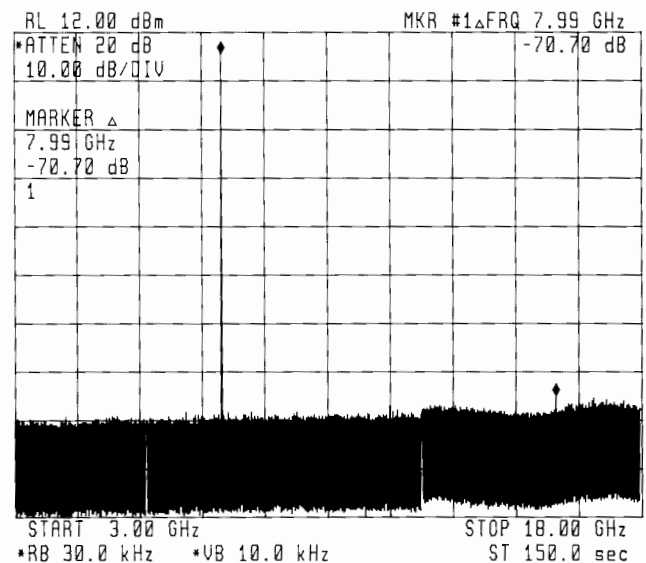

Harmonic Performance of the HP 83620A

For additional performance and ordering information about the HP 8360 series synthesized sweepers, refer to page 396.

SIGNAL GENERATORS

Synthesized Signal Generators

Model 8673E

391

- 2 to 18 GHz
- +8 to -120 dBm calibrated output
- 0.1 dB resolution, digitally displayed

- AM/FM/Pulse Modulation
- Low spurious and phase noise
- 1 to 3 kHz frequency resolution



HP 8673E



HP 8673E Synthesized Signal Generator

The HP 8673E is a synthesized signal generator that delivers value-oriented performance in precise microwave signal simulation. It is optimized for applications requiring high performance signal generation in the 2.0 to 18.0 GHz frequency range while also providing 128 dB dynamic output range. The HP 8673E includes the necessary modulation features required in a full performance microwave synthesizer.

Exceptional Output Performance

The HP 8673E provides frequency coverage from 2.0 to 18.0 GHz with resolution of 1, 2, or 3 kHz depending upon the frequency band. Optimized for output level flexibility, power is internally (or externally) leveled and calibrated from -120 dBm to +8 dBm. Adding to your measurement convenience, the output level is displayed on the front panel with 0.1 dB resolution with a digital display.

Flexible Modulation

As a full performance synthesized signal generator, the HP 8673E includes amplitude, frequency, and pulse modulation capability. AM depth up to 75% at rates up to 10 kHz is ideal for most applications. The HP 8673E features two types of FM: locked and unlocked operation. In the locked mode, operation is like other synthesizers providing up to 3 MHz deviation that is dependent upon modulation index. The unlocked mode allows up to 10 MHz deviation at rates as low as 50 Hz. Internally leveled pulse modulation over the entire 2 to 18 GHz range with ON/OFF ratios >70 dB is available with any externally supplied TTL-level input signals. Output pulses will have rise/fall times typically less than 50 ns.

Many More Features

The HP 8673E includes many more features including excellent spectral purity and a YIG-tuned oscillator phase-locked to a 10 MHz quartz crystal reference. Full HP-IB and digital sweep capability identical to the HP 8673B/C/D is also included.

HP 8673E Specifications

Frequency Characteristics

Range: 2.0 - 18.0 GHz (1.95 - 18.6 GHz overrange)
Resolution: 1 kHz, 2.0 - 6.6 GHz
 2 kHz, 6.6 - 12.3 GHz
 3 kHz, 12.3-18.0 GHz

Spectral Purity

Single-sideband phase noise (1Hz BW, 1kHz offset, CW mode): ≤ -60dBc
Harmonics: ≤ -40dBc at +3dBm
Subharmonics and multiples thereof: -35dBc at +3dBm

Output Characteristics

Output level (+15°C to +35°C): +8 to -120 dBm
Resolution: 0.1dB, digital display

Pulse Modulation

ON/OFF ratio: ≥70 dB
Rise/fall times: <50 ns, typical
Pulse repetition frequency: 50 Hz to 1MHz
Minimum duty cycle: <0.0001 for leveled performance

Amplitude Modulation

Depth: 0 to 75%, at 0dBm maximum carrier level, 15°C to 35°C
Rate (30% depth): 10 Hz - 50kHz, ±3dB
Sensitivity: 30%/V and 100%/V ranges

Frequency Modulation

Deviation Range	Rate (±3 dB BW)	Maximum Peak Deviation
30 kHz/V	100 Hz - 2 MHz	the smaller of 3 MHz or: $f_{mod} \times 5$, 2.0 - 6.6 GHz $f_{mod} \times 10$, 6.6 - 12.3 GHz $f_{mod} \times 15$, 12.3 - 18.0 GHz
100 kHz/V	100 Hz - 2 MHz	
300 kHz/V	3 kHz - 2 MHz	
1 MHz/V	3 kHz - 2 MHz	
3 MHz/V	3 kHz - 2 MHz	
10 MHz/V (unlocked)	50 Hz - 2 MHz, (typical)	10 MHz

Digital Sweep Characteristics

Identical to HP 8673B/C/D

Remote Programming

All functions HP-IB programmable except line switch.

Interface functions: SH1, AH1, T5, TE0, L3, LE0, SR1, RL1, PP1, DC1, DT1, C0, E1

General

Operating temperature range: 0°C to +55°C
Power: 100, 120, 220, 240V, +5%, -10%; 48-66Hz; 400 VA max
Weight: 29kg (64 lb.) net
Size: 620mm D x 425mm W x 146mm H (24.4" x 16.8" x 5.7")

Ordering Information

	Price
HP 8673E Synthesized Signal Generator	\$37,500
Option 907: Front panel handle kit	+\$55
Option 908: Rack mounting flange kit	+\$33
Option 909: Front panel handle with rack mounting flange kit	+\$80
Option 910: Extra operating and service manual	+\$70
Option W30: Two additional years of return to HP warranty	+\$915

SIGNAL GENERATORS

Synthesized Signal Generators, Pulse Modulator

Models 8672A, 8672S and 11720A

- Frequency coverage to 18 GHz
- AM, FM pulse* modulation
- Low spurious and phase noise (*HP 8672S only)

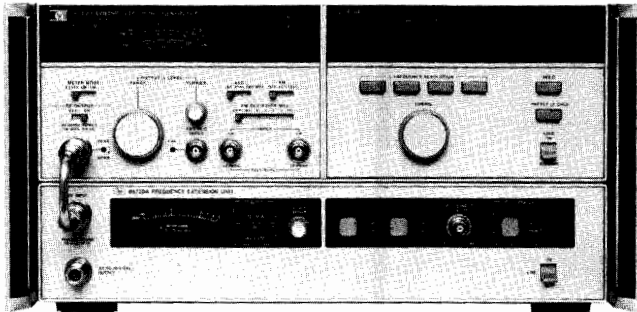

HP 8672S



HP8672A and 8672S Synthesized Signal Generators

The HP 8672A Synthesized Signal Generator delivers precise microwave signals over the 2.0 to 18.0 GHz frequency range. It features calibrated and leveled output power, AM/FM modulation capability, and full HP-IB programmability.

The HP 8672S consists of an HP 8672A and an HP 86720A frequency extension unit. Specifications for the HP 8672S are identical to those of a standard HP 8672A for the 2 to 18 GHz frequency range with the exception of 1 dB less maximum output power and no AM modulation below 2 GHz. It also adds pulse modulation capability over the entire 10 MHz to 18.0 GHz frequency range.

Existing HP 8672A Signal Generators can be retrofitted to the HP 8672S configuration by ordering the HP 86720A Frequency Extension Unit and an HP 11731A or 11732A Frequency Extension Retrofit Kit.

HP 8672A and 8672S Specifications

Frequency Characteristics

Frequency range: HP 8672A: 2.0–18.0 GHz (18.6 GHz overrange)
HP 8672S: 0.01–18.0 GHz (18.6 GHz overrange)

Frequency bands and resolution:

Band 0:	0.01 - 2.0 GHz	1 kHz
Band 1:	2.0 - 6.2 GHz	1 kHz
Band 2:	6.2 - 12.4 GHz	2 kHz
Band 3:	12.4 - 18.0 GHz	3 kHz

Time base: internal 10 MHz ($<5 \times 10^{-10}$ /day aging rate) or external 5 or 10 MHz.

Frequency switching time: <20 ms to be within specified resolution, all bands.

Spectral Purity

Single-sideband phase noise: same as HP 8673B/C/D

Harmonics (up to maximum frequency, output level meter readings <0 dB on 0 dBm range and below): <-25 dBc.

Sub-harmonics and multiples thereof: <-25 dBc, Bands 1-3.

Spurious (CW and AM modes): Same as HP 8673B/C/D

Output Characteristics

Output level (+15°C to +35°C): HP 8672A: +8 to -120 dBm
HP 8672S: +13 dBm to -120 dBm, 0.01–2.0 GHz; +2 dBm to -120 dBm, 2.0–18.0 GHz

Flatness (0 dBm range, +15°C to +35°C):

HP 8672A: same as HP 8673B/C/D

HP 8672S: same as HP 8672A degraded by ± 0.25 dB

Remote programming output level resolution: 1.0 dB.

Source impedance: 50 ohms nominal.

Modulation Characteristics

Amplitude Modulation: same as HP 8673B/C/D (2-18 GHz)

Frequency Modulation: same as HP 8673B/C/D (2-18 GHz)

Pulse Modulation: HP 8672S only

>80 dB ON/OFF ratio; <15 ns rise/fall times; peak pulsed power within 1.0 dB of level selected in CW mode for 0.01–2 GHz, uncalibrated for 2.0–18.0 GHz.

2 to 18 GHz Pulse Modulator

- <10 ns rise and fall times
- >80 dB ON/OFF ratio

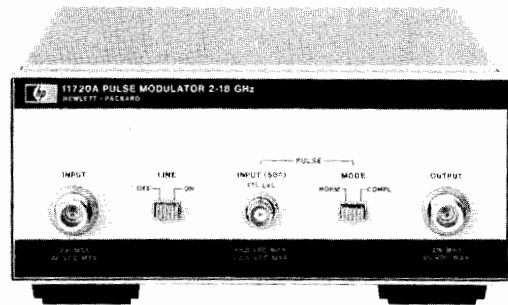

HP 11720A

General

Programming: all functions HP-IB programmable except line switches and meter mode.

Operating temperature range: 0 to +55°C.

Power: 100, 120, 220, 240V, +5%, -10%, 48–66 Hz; 400 VA max.

Weight: HP 8672A: net 27 kg (60 lb); shipping 32.5 kg (72 lb).

HP 8672S: net 39.5 kg (87 lb); shipping 43.6 kg (96 lb).

Size: HP 8672A: 133 mm × 425 mm × 603 mm (5.25" × 16.75" × 23.75") H × W × D

HP 8672S: 222 mm × 425 mm × 620 mm (8.8" × 16.8" × 24.4") H × W × D

HP 11720A Pulse Modulator

The HP 11720A Pulse Modulator is a high performance microwave pulse modulator covering the range of 2 to 18 GHz.

In addition to wide frequency coverage, the HP 11720A features extremely short rise and fall times (<10 ns) and a high on/off ratio (>80 dB), making it suitable for almost any pulsed RF application.

HP 11720A Specifications

Frequency range: 2 to 18 GHz.

ON/OFF ratio: >80 dB.

Rise and fall times: <10 ns.

Insertion loss: <6 dB, 2 to 12.4 GHz; <10 dB, 2 to 18 GHz.

Maximum RF input power: +20 dBm.

Maximum repetition rate: >5 MHz.

Minimum RF pulse width: <50 ns.

Video feedthrough: <60 mV peak-to-peak.

Ordering Information

	Price
HP 8672A Synthesized Signal Generator	\$41,000
Option 006: Chassis slide kit	+\$45
Option 907: Front panel handle kit	+\$55
Option 908: Rack mounting flange kit	+\$33
Option 909: Combination of Opt. 907 plus 908	+\$80
Option W30: Two additional years of return to HP warranty	+\$1,000
Option 910: Extra operating and service manual	+\$60
HP 8672S Synthesized Signal Generator	\$58,500
Option 006: Chassis slide kit	+\$80
Option 009: Delete internal pulse modulator	-\$1,100
Option 010: Delete pulse modulator and step attenuator	-\$1,700
Option 908: Rack flange kit	+\$55
Option 913: Rack flanges for standard front panel handles	+\$45
Option 910: Extra operating and service manuals	+\$80
HP 86720A Frequency Extension Unit	\$20,000
HP 11731A Frequency Extension Retrofit Kit	\$1,000
HP 11732A Frequency Extension Retrofit Kit	No Charge
HP 11712A Support Kit	\$1,200
HP 11720A Pulse Modulator	\$4000
Option 910: Extra manual	+\$5.00
Option W30: Two additional years of return to HP warranty	+\$100

SIGNAL GENERATORS

Accessories, Frequency Doublers

Models 11509A, 11687A, 11690A, 11710B, 11721A

393

- Additional capabilities for signal generators



HP 11687A



HP 11509A

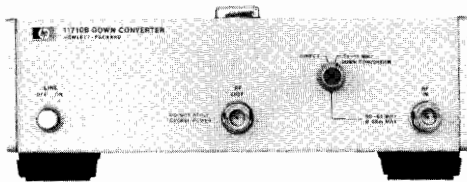

HP 11710B



HP 11690A



HP 11721A

HP 11509A Fuseholder

Accidental burnout of attenuators in HP 8640 and HP 8654 signal generators can be prevented by using this fuse element between the signal generator and a transceiver. The fuseholder has a frequency range of dc to 480 MHz, insertion loss of ≤ 1 dB, SWR of ≤ 1.35 (50 Ω load), and Type N connectors. Ten extra fuses are furnished.

HP 11687A 50-75 Ω Adapter

This 50-75 Ω adapter with Type N connectors is recommended for use with HP 8640, 8642, 8654, 8660, 8656, and 8662 signal generators for measurements in 75 Ω systems. The voltage calibration on the output level meter is unaffected by use of the adapter, but 1.76 dB must be subtracted from the dB scale on the meter to determine the output in dBm into 75 Ω . Frequency range is dc to 1300 MHz.

HP 11690A Frequency Doubler

The HP 11690A extends the frequency range of all HP 8640 series signal generators by doubling the 256-512 MHz frequency band up to 1024 MHz (to 110 MHz with band overrange). All HP 8640s indicate the correct doubled output frequency on a dial or counter when the 512-1024 MHz range is selected. The HP 11690A will also perform well with any source meeting the input requirements of 200-550 MHz at +10 to +19 dBm. Conversion loss is < 13 dB, output flatness has < 4 dB total variation, and the first and third input harmonics are suppressed > 20 dB. Connectors are BNC.

HP 11710B Down Converter

The HP 11710B Down Converter is an accessory for the HP 8640 and HP 8654 series signal generators. Frequency inputs from 50.01 to 61 MHz are down converted to the 10 kHz to 11 MHz range respectively. The output level and modulation functions of the HP 8640 and HP 8654 remain calibrated. A straight-through selection switch allows the input to pass through unchanged, and thus minimizes the necessity to move cables when testing. Option 001 provides rails and semi-rigid coax for combining the HP 11710B with an HP 8654A/B Signal Generator.

HP 11710B Specifications

Input

Down-conversion mode: 50.01 to 61.00 MHz at ≤ 0 dBm.

Straight-through mode: 0.01 to 1100 MHz (dc coupled).

Down-Converted Output

Frequency range: 10 kHz to 11 MHz.

Level range: 0 to -107 dBm

Level flatness: RF source flatness ± 0.5 dB (referred to 4.0 MHz).

Total level accuracy: ± 1 dB plus input level accuracy).

Harmonics: > 35 dB below the carrier (dBc).

Intermixing spurious: > 60 dBc.

Local oscillator feed-through (50 MHz): < -100 dBm.

Internal Reference Characteristics

Time base output: 1 MHz or 5 MHz selectable, nominally $> 0.5V$ p-p into 500 Ω . This will drive an HP 8640B external time base input.

Typical overall accuracy: (within 3 months of calibration and from 15 $^{\circ}C$ to 35 $^{\circ}C$): ± 2 ppm.

General

Operating temperature range: 0 $^{\circ}$ to 55 $^{\circ}C$.

Power requirements: 100, 120, 220, 240V (+5%, -10%), 48 to 440 Hz; 25 VA maximum.

Weight: net, 3.2 kg (7 lb); shipping, 4.5 kg (9 lb).

Size: 102 H \times 266 W \times 295 mm D (4" \times 10.5" \times 11.6"). 1/2 MW \times 4 H \times 11 D System 1 Module.

HP 11721A Frequency Doubler

The HP 11721A Doubler is an ideal accessory for extending the usable frequency range of signal generators, frequency synthesizers, or other signal sources. Operating on input frequencies of 50 MHz to 1300 MHz, it provides a doubled output in the range of 100 MHz to 2600 MHz. The HP 11721A will work well with any RF source with an output in the range 50 to 1300 MHz.

The 50 Ω passive circuit of the HP 11721A offers low conversion loss, low spurious, and excellent flatness over its entire frequency range when operated above +10 dBm.

HP 11721A Specifications

Input frequency range: 50 to 1300 MHz.

Output frequency range: 100 to 2600 MHz.

Conversion loss (+13 dBm input, 50 to 1280 MHz): < 15 dB.

Spurious referenced to desired output frequency f (+13 dBm input with harmonics < -50 dBc, 50 to 1280 MHz): $f/2$, -15 dB; $3f/2$, -15 dB.

Input SWR: 1.5 typical.

Input/output impedance: 50 Ω nominal.

Operating temperature range: 0 $^{\circ}$ to +50 $^{\circ}C$.

Connectors: input, type N male; output, type N female.

Size: 161 L \times 30 W \times 20.5 mm H (6 3/8" \times 1 3/16" \times 13/16").

Weight: net, .02 kg (0.5 lb); shipping, 0.4 kg (1 lb).

Ordering Information

HP 11509A Fuseholder

HP 11687A 50 Ω -75 Ω Adapter

HP 11690A Frequency Doubler

HP 11710B Down Converter

Opt 001 Combining Kit

Opt 910 2 sets of operation/service manuals (11710-90005)

HP 11721A Frequency Doubler

☛ Fast ship product — see pg. 734

Price

\$285

\$215

\$325

\$3,295

\$165

\$6

\$720

SWEEP OSCILLATORS

General Information

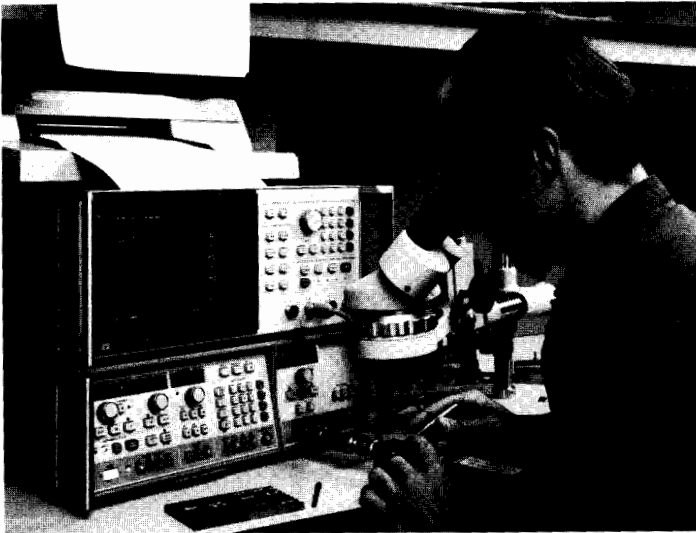

Sweep Oscillators

Sweep oscillators are important in a number of applications where the characteristics of a device or system must be determined over a continuous range of frequencies. By replacing laborious point-by-point techniques, swept measurements increase the speed and convenience of broadband testing. The continuous frequency characterization of the unknown device or system also eliminates the chance of missing important information between frequency points.

Hewlett-Packard sweepers cover the entire frequency spectrum from dc to 110 GHz. The HP 8620 and HP 8350 family of solid state oscillators provide a versatile choice of configurations—single band, straddle band, or very wide band plug-ins. The HP 8360 series, the HP 8340B and the HP 8341B are broadband synthesizers that combine the excellent stability, frequency accuracy, and phase noise of a synthesizer with the versatile characteristics of a sweep oscillator. And for coverage in the millimeter-wave frequency range, the HP 83550-series frequency multipliers effectively extend the excellent performance of Hewlett-Packard's sweep oscillator family to 110 GHz.

A chart of the complete frequency coverage of Hewlett-Packard's line of sweep oscillators is shown on page 00.00.

Sweep Flexibility

Every HP sweeper has several different sweep modes available for setting the frequency limits of the instrument. A full band or independently adjustable start/stop frequency sweep can be selected. Alternately, a marker sweep or a symmetrical ΔF sweep about the desired center frequency can be chosen. Sweep times from 0.01 to more than 100 seconds are possible.

Marker capability, both Z-axis intensity dots and RF pips, are available on HP sweepers to note important measurement frequencies. Two or more independent markers are offered on all sweepers with up to five markers on the HP 8360 series, HP 8340B/41B and HP 8350 mainframe. Crystal markers are also offered on the HP 86222B, 83522A, and 83525A/B RF plug-ins.

Another powerful feature available on the HP 8360 series, HP 8340B/8341B and 8350 sweeper mainframe is Save/Recall Mode where up to nine, (eight on the 8360 series) complete front panel states can be stored in memory and later recalled when the measurement is repeated.

The HP 8360 series, 8340/8341, 8350 sweep oscillator mainframe and 83500 series RF plug-ins offer total HP-IB control of all front panel functions.

Power Output and Leveling

Power output is continuously adjustable at the front panel with built-in attenuators available on most plug-ins for greater power control. Internal or external leveling capability ensures high accuracy when making swept measurements.

For applications that require high power, the HP 83550A with the HP 8350 sweep oscillator mainframe offers at least +20 dBm of leveled output power from 2 to 18.6 GHz and +18 dBm to 20 GHz.

When higher output is required from an existing source, the HP 8349B microwave amplifier (2 to 20 GHz) can be driven by the RF output of the sweeper to provide a full +20 dBm of output power from 2 to 18.6 GHz. The amplifier can be easily leveled via its built-in directional detector and the automatic level control (ALC) circuitry of the sweeper.

Power as well as frequency can be swept with the HP 8360 series, the HP 8340B/8341B or the HP 8350 and 83500 series plug-ins using the Power Sweep function. This means that both the frequency response and power response of level sensitive devices like transistors and amplifiers can be measured using the same test set-up. Using the power sweep function the 1 dB gain compression can easily be measured at a CW frequency. Also, the ability to alternate between two successive sweeps allows a swept measurement of the 1 dB gain compression point.

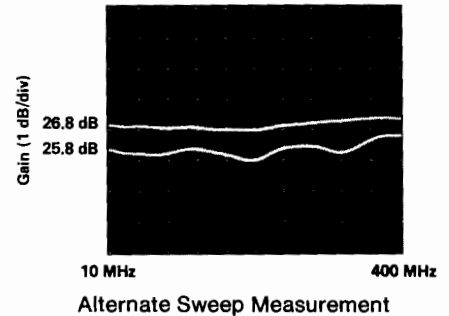

Modulation

Modulation capabilities further extend the sweeper's usefulness both as a sweeper and a signal generator for signal simulations. The sweep oscillators described here offer versatile pulse, FM and AM modulation capabilities.

The HP 8360 series synthesized sweeper, as well as all HP 83500 and most 86200 series plug-ins (when used with the HP 8350 sweep oscillator mainframe) are capable of directly producing the 27.8 kHz square wave modulation required by the HP 8757 family of scalar network analyzers, eliminating the need for an external modulator. The HP 8340B/8341B may be externally modulated with the 27.8 kHz square wave, via the scalar analyzer's modulator drive.

Low Harmonics

For those measurements requiring low harmonics from a swept source there are a number of choices available. The HP 83592C RF plug-in for the HP 8350 sweep oscillator mainframe offers -55 dBc harmonic suppression from 2.4 to 20 GHz. The HP 83595C and HP 83596A/83597A RF plug-ins provide -50 dBc harmonic suppression from 1.5 to 20 GHz. The HP 83596A/83597A also provide -40 dBc from 20 to 40 GHz. The HP 8341B Option 003 specifies -50 dBc harmonics from 1.4 to 20 GHz. From the 8360 series of synthesized sweepers, the HP 83620A and HP 83640A provide -50 dBc for the 1.8 to 20 GHz range. The HP 83640A also specifies -40 dBc from 20 to 40 GHz.

Covering Millimeter-wave Frequencies

The new HP 83550-series millimeter-wave source modules answer the growing need for high-performance sweep oscillators in the millimeter-wave frequency ranges. The source modules are frequency multipliers that effectively extend the excellent performance of HP sweep oscillators covering the 11 to 20 GHz range to the 26.5 to 40 GHz (HP 83554A), the 33 to 50 GHz (HP 83555A), the 40 to 60 GHz (HP 83556A), the 50 to 75 GHz (HP 83557A), and the 75 to 110 GHz (HP 83558A) millimeter-wave frequency ranges.

Sweeper Applications

Sweepers are an integral part of many kinds of test applications. Their versatility and extensive feature set make them the perfect choice for scalar/vector network analysis, noise figure measurements, frequency translation measurements, signal simulation and many other applications. The sweepers described here are designed to be compatible with all relevant measurement solutions from HP.

Sweepers are used extensively with swept scalar network analyzers to characterize the amplitude responses of broadband devices or with vector network analyzers when the amplitude and phase characteristics of the device (i.e. s-parameters) are needed. Examples of such analyzers are the HP 8757C/E scalar network analyzers and the HP 8510 vector network analyzer. The HP 8360 series, HP 8340B/8341B and HP 8350B sweepers can be controlled by these analyzers via a private "system interface bus." This makes use of the sweepers full programmability and creates synergistic performance.

For scalar measurements requiring more dynamic range, the HP 8349B microwave amplifier can be used to extend the dynamic range from 76 dB to typically > 90 dB.

For measurements that require an entirely spurious-free environment and phase information, sweepers may be used with vector network analyzers such as the HP 8510. Extremely high performance vector measure-

ments can be made with the HP 8360 series or the HP 8340B/8341B and the HP 8510.

Noise figure measurements above 1600 MHz can be made using the HP 8970 noise figure meter with either the HP 8360 series, the HP 8340B/8341B or the HP 8350 serving as the local oscillator. With this equipment noise figure and gain measurements can be made on microwave components

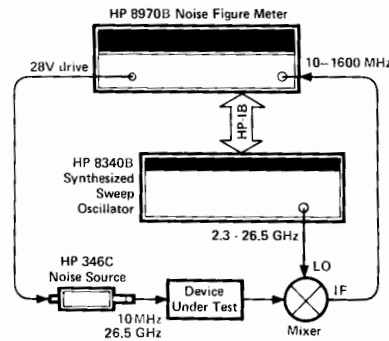

such as amplifiers, transistors or mixers. The HP 8360 series and HP 8340B/41B can also be used as a microwave LO in an HP 8902S and 8952S measurement systems that makes several important measurements on microwave sources.

Two-tone sweep testing of devices such as mixers and receiver front ends requires two signals offset from each other by the IF. This

is accomplished by phase-locking the difference frequency of two sweep oscillators to a very stable source. The sweepers may then be swept across the band of interest.

In communications applications where up-converter simulation is required in conjunction with the HP Microwave Link Analyzer, several of the HP 86200 series plug-ins are compatible (as an option) with such a system to permit very accurate RF to RF, RF to IF and RF to BB distortion measurements.

The modulation and built-in attenuator features of Hewlett-Packard sweep oscillators make them useful in many traditional CW signal generator applications. The excellent stability, phase noise, frequency range and modulation capability of the HP 8360 series, and the HP 8340B and 8341B make them well suited for most of these applications. In addition, the accuracy, linearity, and flatness of the HP 83500/86200 series broadband plug-ins make them more than adequate in many applications requiring a general purpose CW generator. For wide-band applications these RF plug-ins feature performance that rivals octave band oscillators in the areas of frequency purity and accuracy, harmonics, flatness, and power.

A Product Line Summary of Swept Microwave Sources (HP Part No. 5956-4350), as well as specific data sheets, application notes and product notes are available from your local Hewlett-Packard sales office.

Swept Oscillator—Summary Chart

Frequency Range*	Model Number																
	8350 Series	8620 Series**	Other Sweepers	10 MHz	100 MHz	1 GHz	2 GHz	4 GHz	8 GHz	12 GHz	18 GHz	26 GHz	40 GHz	50 GHz	60 GHz	75 GHz	110 GHz
10 MHz-2.4 GHz	83522A	86222A/B		←→													
10 MHz-8.4 GHz	83525A/B			←→													
10 MHz-20 GHz	83592A/B/C		8341B	←→													
10 MHz-26.5 GHz	83595A/C		8340B	←→													
10 MHz-40 GHz	83597A			←→													
1.7-4.3 GHz		86235A				←→											
2-8.4 GHz	83540A/B	86240A/B				←→											
3.6-8.6 GHz		86240C				←→											
2-18.6 GHz		86290B/C				←→											
2-20 GHz	83590A					←→											
2-22 GHz		86290B Opt H08				←→											
2-26.5 GHz	83594A					←→											
2.4-40 GHz	83596A					←→											
3.2-6.5 GHz		86241A				←→											
5.9-9.0 GHz		86242D					←→										
5.9-12.4 GHz	83545A	86245A					←→										
7-11 GHz		86250D Opt H08					←→										
7.5-18.6 GHz		86251A					←→										
8-12.4 GHz	83550A	86250D					←→										
8-20 GHz							←→										
10-15.5 GHz		86260B						←→									
12.4-18 GHz		86260A						←→									
17-22 GHz		86260C						←→									
18-26.5 GHz	83570A							←→									
26.5-40 GHz	83572C							←→									
26.5-40 GHz***			83554A										←→				
33-50 GHz***			83555A										←→				
40-60 GHz***			83556A										←→				
50-75 GHz***			83557A											←→			
75-110 GHz***			83558A												←→		

*Other Special Frequency Ranges Can Be Provided Upon Request.

**HP 86200 Series RF Plug-ins are usable with the HP 8350B Mainframe via the HP 11869A Adapter.

***The HP 83550-series millimeter-wave source modules are frequency multipliers that require a +17 dBm microwave input. See page 394.

SWEEP OSCILLATORS

Synthesized Sweepers 10 MHz - 40 GHz (or 110 GHz)

HP 8360 Series

- 1 Hz frequency resolution (option 008)
- Low spurious and phase noise
- +20 dBm to -110 dBm calibrated output
- Pulse, amplitude, and frequency modulation
- Complete analog sweeper
- <-50 dBc harmonics 1.8 to 20 GHz

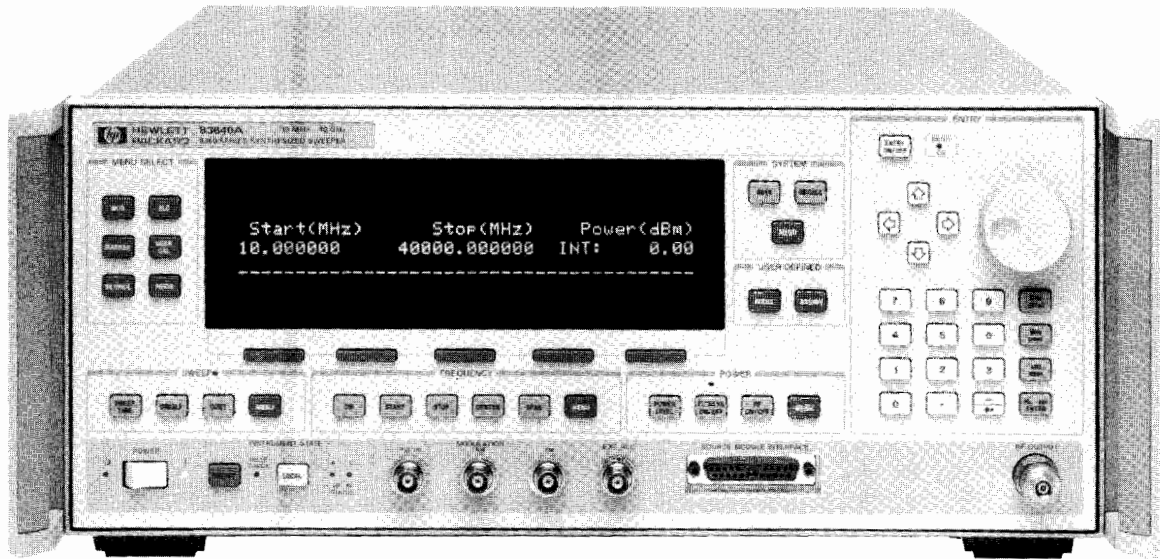

HP 83640A



HP 8360 Series Synthesized Sweepers

The HP 8360 series synthesized sweepers are the standard of excellence for applications requiring the high performance and accuracy of a synthesized source, and the speed and versatility of a sweep oscillator. The HP 8360 series synthesized sweepers offer the same commitment to quality and reliability that is inherent in the previous industry standard HP 8340/8341.

Frequency Precision and Spectral Purity

The synthesized broadband frequency coverage and precise 1 Hz frequency resolution (Option 008) are generated by indirect synthesis, enabling the HP 8360 to achieve the same low single-sideband phase noise performance as the HP 8340/8341, HP 8671B, HP 8672A, and HP 8673 series synthesized signal generators.

The HP 8360 provides list and stepped frequency switching times as fast as 5 ms. In addition, the HP 8360 provides arbitrary CW switching times less than 50 ms.

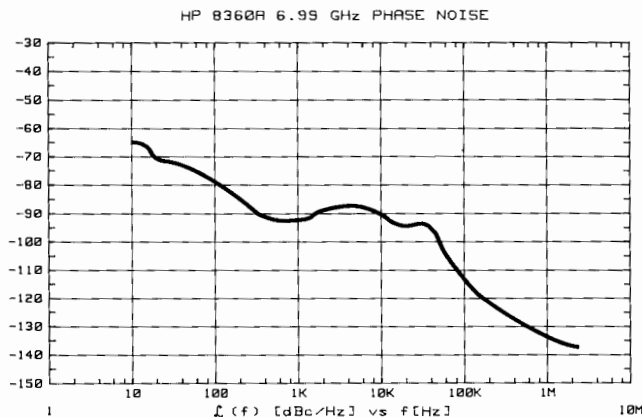

HP 8360 Phase Noise performance from 2.3 to 8.0 GHz

Output Power

The HP 8360 provides output power ranging between +20 and -110 dBm (Option 001) with 0.02 dB resolution and feature power sweep capability with > 20 dB dynamic range for complete characterization of level-sensitive devices.

<-50 dBc Harmonics

The HP 8360 delivers excellent harmonic performance with harmonics at least 50 dB below the carrier from 1.8 to 20 GHz, and at least 40 dB below the carrier above 20 GHz.

Pulse, Scan, Amplitude and Frequency Modulation

High-performance pulse modulators with > 80 dB on/off ratio, and rise/fall times < 10 ns (option 006), make the HP 8360 suitable for the most demanding pulse modulation applications.

In addition to its linear AM mode (100%/V), the HP 8360 offers a new scan modulation mode (10 dB/V). Both of these modes provide dc-coupled amplitude modulation capability with a 3 dB bandwidth of 250 kHz, and 99% (40 dB), of modulation depth. Pulse and amplitude modulation capabilities can be used independently and simultaneously.

The HP 8360 also offers dc-coupled frequency modulation capability with rates up to 8 MHz.

System Compatibility

The versatility of the HP 8360 is evident in its many system applications. The HP 8360 a high performance microwave signal generator with excellent signal purity and modulation capability, and it also serves as a source for stimulus response device characterization, such as network analysis and noise figure measurements.

Network Analysis

The HP 8360 series includes two dedicated HP 8510 models that are preconfigured as the recommended system sources for the HP 8510 vector network analyzer (Rev. 4.0+). They have no front panel, rear panel output, 1 Hz resolution. The ability of these sources to produce both narrow and broadband, analog, list, and step sweeps makes them the optimum sources for fast and comprehensive device characterization.

The HP 8360 is also compatible with the HP 8757C/E scalar network analyzers, and produces an internal 27.8 kHz square wave signal for use with the HP 8757 AC detection mode.

In addition, five flexible markers, along with useful marker functions such as marker sweep, marker to center frequency and marker delta simplify swept device testing.

HP 8970 Noise Figure Systems

High output power and low broadband noise make the HP 8360 the optimum source for HP 8970 noise figure systems.

mm-Wave Source Systems

When driven by an HP 8360 the HP 8355X series millimeter-wave source modules provide millimeter-wave test signals from 26.5 -110 GHz.

HP 85301 Antenna Systems

The broadband frequency coverage and 5 ms/point switching speed of the HP 8360 make it the ideal source for the HP 85301A Antenna Measurement System.

Specifications

See technical data sheet for complete specifications.

Frequency

Range (By Model):

HP 83620A	10 MHz to 20 GHz	
HP 83622A	2 to 20 GHz	
HP 83623A	10 MHz to 20 GHz (High Power)	
HP 83624A	2 to 20 GHz (High Power)	
HP 83640A	10 MHz to 40 GHz	
HP 83642A	2 to 40 GHz	

Resolution (CW Mode): 1 kHz standard, 1 Hz optional

Time Base: Internal 10 MHz time base. Aging rate: less than 5 X 10⁻¹⁰/day and 1 X 10⁻⁷/year after 30 day warm-up.

RF Output

Range: +20 to -110 dBm

Resolution: 0.02 dB

Maximum Leveled Power (by model):

HP 83620A	10 MHz to 20 GHz	+10 dBm
HP 83622A	2 to 20 GHz	+10 dBm
HP 83623A	10 MHz to 20 GHz	+17 dBm
HP 83624A	2 to 20 GHz	+20 dBm
HP 83640A	10 MHz to 40 GHz	+2 dBm
HP 83642A	2 to 40 GHz	+2 dBm

RF Output Connector:

3.5 mm on 20 GHz Models, 2.4 mm on 40 GHz Models; nominal 50 ohm output impedance.

Spectral purity

Harmonics and subharmonics:

<-50 dBc at output frequencies <20 GHz
<-40 dBc at output frequencies >20 GHz

Non-harmonically related spurious:

<-60 dBc at output frequencies <20 GHz
<-54 dBc at output frequencies >20 GHz

Single-sideband phase noise (dBc/1 Hz BW, CW Mode):

Frequency Range (GHz)	Offset from Carrier			
	100 Hz	1 kHz	10 kHz	100 kHz
.01 - 2.3	-70	-78	-86	-107
2.3 - 7.0	-70	-78	-86	-107
7.0 - 12.5	-64	-72	-80	-101
12.5 - 20.0	-60	-68	-76	-97
20.0 - 25.5	-58	-66	-74	-95
25.5 - 40.0	-54	-62	-70	-91

Modulation

Pulse modulation

On/off ratio: >80 dB

Rise and fall times: <50 ns (<10 ns optional)

Minimum internally leveled RF pulse width: <1 us

Minimum unleveled RF pulse width: <100 ns

Scan modulation

Rates (3 dB BW): dc to 250 kHz

Depth: 0 to 40 dB

Sensitivity: 10 dB/V

Amplitude modulation

Rates (3 dB BW): dc to 250 kHz

Depth: 0 to 90% (20 dB), and 0 to 99% (40 dB) above 10 Hz

Sensitivity: 100%/V and 10 dB/V

Frequency modulation

Locked mode

Modulation rate (3 dB BW): 100 kHz to 8 MHz

Peak deviations: 8 MHz

Unlocked mode

Modulation rate (3 dB BW): dc to 8 MHz

Peak deviations: 8 MHz

Sensitivity: 1 MHz/V or 10 MHz/V, user selectable

Ordering Information

HP 8360 models

HP 83620A	Synthesized Sweeper	\$35,900
HP 83622A	Synthesized Sweeper	\$32,900
HP 83623A	Synthesized Sweeper	\$42,900
HP 83624A	Synthesized Sweeper	\$39,900
HP 83640A	Synthesized Sweeper	\$49,900
HP 83642A	Synthesized Sweeper	\$46,900
Opt 001	Add Step Attenuator	\$2,000/\$3,800
Opt 003	Delete Front Panel Keyboard/Display	-\$1,500
Opt 004	Rear Panel RF Output	\$200
Opt 006	Fast Pulse Modulation	\$4,000
Opt 008	1 Hz Frequency Resolution	\$2,500
Opt 700	Mate System Compatibility	\$4,000
Opt W30	Extended Repair Service. See page 725.	
Opt W32	Calibration Service. See page 725.	

Dedicated HP 8510 Synthesized Sweepers

HP 83621A	Synthesized Source	\$33,900
HP 83631A	Synthesized Source	\$42,900
Opt W30	Extended Repair Service. See page 725.	
Opt W32	Calibration Service. See page 725.	

SWEEP OSCILLATORS

Model 8350 Series: 10 MHz to 40 GHz

Model 8350 Series

- Versatile microprocessor-controlled mainframe
- Single-band, straddle-band and broad band plug-ins
- 10 MHz to 40 GHz from a single plug-in
- 10 mW output power to 26.5 GHz
- Total HP-IB programmability

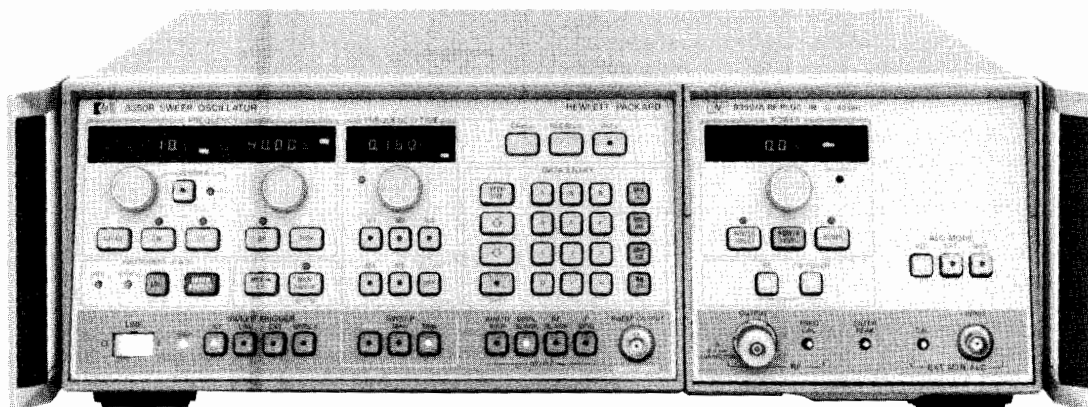

HP 8350B



HP 8350 System

The HP 8350 is a powerful general-purpose source for swept microwave measurements, wideband CW signal generation and automatic testing. It incorporates the efficiency of microprocessor control with state-of-the-art YIG-tuned oscillators and GaAs FET amplifiers to produce a high performance sweep oscillator system ideally suited for either manual or automatic measurements.

You can easily configure a source to meet your application's frequency coverage and power requirements. Just combine the versatile HP 8350 mainframe with any of the 34 standard RF plug-ins (see table at right) and you are ready to make measurements. Both the advanced HP 83500 series plug-ins and the existing HP 86200 series plug-ins (via the HP 11869A adapter) are accepted by the HP 8350 mainframe.

HP 8350 Mainframe

The HP 8350 has been designed to include many features that not only speed up and simplify measurements but also improve accuracy. In addition, it is compatible with HP network analyzers, counters, noise figure meters, power meters, and microwave link analyzers to provide complete solutions.

All function values (sweep limit frequencies, marker frequencies, etc.) are indicated on high resolution digital displays. Function values are easily modified using the appropriate knob, step keys, or data entry keyboard.

Five independent, continuously variable markers are available to note your measurement frequencies. The active marker frequency or the frequency difference between any two markers is read easily from a high resolution digital display. You can also use marker sweep to zoom in on a particular frequency span while retaining your original sweep limits.

Another particularly useful feature in making repetitive measurements is the HP 8350's Save/Recall Mode. Once the sweeper has been set for a particular measurement, all front panel settings (HP 8350 and HP 83500 series plug-in) can be *Saved* and later *Recalled* to repeat the measurement by accessing one of nine internal storage registers.

In the past, HP-IB programming of sweepers was limited to a series of CW frequencies. With the HP 8350 all front panel functions, e.g. sweeps, markers, sweep time, even output power (HP 83500 series plug-ins) can be programmed. This means there are no limitations in designing your own customized test systems. Utilizing the Learn Mode function, the HP 8350 becomes a "talker" as well as "listener" on the bus, transferring all manually entered front panel controls to the computer.

The HP 8350 provides full compatibility with the HP 8510 Network Analyzer and the HP 8757 Scalar Network Analyzers for convenient vector and scalar measurements. The HP 5343A Counter can be combined with the HP 8350 to measure Start, Stop, or marker frequencies with up to 100 kHz accuracy while sweeping. Microwave noise figure measurements may be made using the HP 8350 with the HP 8970 Noise Figure Meter. In addition, the HP 8350B, with an appropriate plug-in driving the HP 8349B microwave amplifier, provides up to +20 dBm of output power across a 2 to 18.6 GHz range.

HP 83500 Series Plug-Ins

Broadband frequency coverage from 10 MHz to 40 GHz with high output power is provided in the HP 83500 series RF plug-ins. One plug-in, the HP 83597A covers the entire 10 MHz to 40 GHz frequency range with -50 dBc harmonics from 1.5 to 20 GHz and -40 dBc from 20 to 40 GHz. The HP 83595A/C, operate from 10 MHz to 26.5 GHz without sacrificing frequency accuracy (± 12 MHz at 26.5 GHz). The HP 83595C also provides -50 dBc harmonics and subharmonics from 1.5 to 26.5 GHz. The HP 83592C, 10 MHz to 20 GHz RF plug-in has -55 dBc harmonics and subharmonics from 2 to 20 GHz. The HP 83550A provides +20 dBm of output power from 8.0 to 18.6 GHz, +18 dBm from 18.6 to 20.0 GHz and also has a built-in source module interface to drive the HP 83550-series millimeter-wave source modules. The 18 GHz to 26.5 GHz band is filled by the HP 83570A RF plug-in and boasts a 10 mW power level (comparable to most BWOs). The millimeter-wave bands are covered by the HP 83550-series millimeter-wave source modules, frequency multipliers that provide coverage in the 26.5 to 40 GHz (HP 83554A), 33 to 50 GHz (HP 83555A), 40 to 60 GHz (HP 83556A), 50 to 75 GHz (HP 83557A), and 75 to 110 GHz (HP 83558A) bands by effectively extending the characteristics of an 11 to 20 GHz microwave source to the millimeter frequency range.

The HP 83500 series plug-ins offer output power level control previously unavailable on a swept source. Power level control is calibrated with 0.1 dB resolution and up to 80 dB range (with Opt 002 attenuator). Calibrated power sweeps are available for characterizing device performance as a function of power. Slope and internal leveling controls are standard on all units. The HP 83500 series plug-ins (except the HP 83572C) are also capable of power meter leveling with the HP 432A/B/C, 436A, and 438A power meters.

All HP 83500 series front panel functions are HP-IB programmable including power level. This means your automatic test systems can now characterize a device both as a function of frequency and input power level.

HP 86200 Series Plug-Ins

Simply combining the HP 86200 series plug-in (including the one you may already own) with an HP 11869A Adapter makes all the convenient digital controls, markers, and HP-IB capability of the HP 8350 immediately available to you. The HP 86200 series are a particularly attractive plug-in choice when economical single-band operation is desired with the HP 8350 mainframe. For measurements with HP Microwave Link Analyzers, specially characterized HP 86200 series plug-ins can be used with the HP 8350 to create an upconverter for communications distortion measurements.

The HP 86290B/C plug-ins cover the 2-18 GHz frequency range with 10 mW and 20 mW of output power respectively. Frequency accuracy at 18 GHz is 30 MHz, exceeding that available on most single-band plug-ins. Both HP 83500 series and HP 86200 series plug-ins compatible with the HP 8350 mainframe are summarized in the table. Note that the HP 11869A Adapter is required with all HP 86200 series plug-ins.

- Accurate, high resolution, digital displays
- Five markers with marker Δ and marker sweep
- Save/recall 9 complete front panel states

- Accepts all HP 83500 series plug-ins
- Total HP-IB programmability
- Compatible with HP Network Analyzers

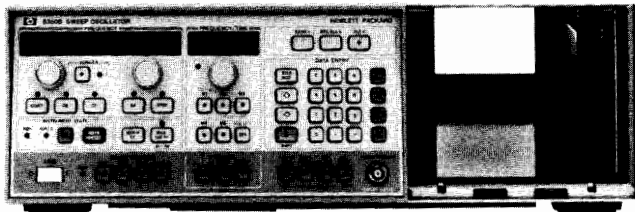

HP 8350B



HP 8350B

Sweep Oscillator applications are greatly enhanced by the features of the HP 8350B. Along with the traditional swept and CW frequency functions, the HP 8350B adds extensive marker capabilities, versatile data entry and complete HP-IB programmability. Besides the popular HP 83500-series RF plug-ins, the HP 8350B also accepts the HP 86200-series plug-ins via the HP 11869A adapter. And the HP 8350B is directly compatible with such measurement systems as the HP 8510 vector network analyzer and the HP 8757 scalar network analyzers. Frequency accuracy is easily enhanced by using the HP 5343A counter to count the START, STOP, or ACTIVE MARKER frequencies.

The HP 8350B has three methods of changing function values: control knobs, keyboard entry, or step key entry.

Five markers are available with the HP 8350B. These markers, combined with the high resolution digital readout, make the accurate location of important frequency responses easy. A key marker feature, marker Δ , computes the difference between any two markers. The markers can also modify the center frequency (marker \rightarrow CF) or the START/STOP frequency (Marker Sweep).

A necessity in making repetitive measurements or automatic tests is the Save/Recall feature. This feature supplies nine memory locations, each storing a complete front panel set-up. Nonvolatile memory is included so that all memories are retained even when line power is removed.

The HP 8350B makes "simultaneous" comparison of two separate frequency ranges or power levels easy via the alternate sweep mode. When the alternate sweep mode is activated, the HP 8350B alternates between the current front panel setting and any stored memory setting on successive sweeps. The output from this function may be processed through a network analyzer such as the HP 8757 and viewed on a two channel display.

All front panel controls (except the ac line switch) may be programmed or controlled via the HP-IB. The HP 8350B may interact as a listener or as a talker on the HP-IB.

A self test is performed at turn on or whenever the instrument preset function is activated. This function verifies that the HP 8350B is functioning properly. If there is a problem, error codes are displayed on the front panel to help locate the problem quickly to the board and component level.

HP 8350B Specifications

Frequency Control Functions

Refer to RF plug-in for frequency range, linearity and accuracy specifications.

START/STOP sweep: sweeps up from the START frequency to the STOP frequency.

CF/ Δ Sweep: sweeps symmetrically upward, centered on CF.

Δ F: frequency width of sweep continuously adjustable from zero to 100% of frequency range.

CF Resolution: 0.00038% (262,144 points across band).

Δ F Resolution: 0.1% of full band (1024 points across band), 0.012% of band for $\frac{1}{8}$ of band or less, 0.0015% of band for $\frac{1}{64}$ of band or less.

Display resolution: 5 digits.

CW operation: single frequency RF output.

CW resolution: same as CF.

Vernier: adjusts CW frequency or swept center frequency up to 0.05% of RF plug-in band being swept.

Vernier resolution: 4 ppm (64 points between each CW point; 262,144 points across band).

Offset: allows the CW frequency or center frequency to be offset by any amount up to the full range of the plug-in.

Frequency markers: five frequency markers are independently adjustable and fully calibrated over the entire sweep range. Amplitude or intensity markers available.

Resolution: 0.4% of selected sweep width (256 points/sweep).

Sweep and Trigger Modes

Internal: sweep recurs automatically.

Line: sweep triggered by ac power line frequency.

External trigger: sweep is actuated by external trigger signal.

Single: selects mode and triggers a single sweep.

Sweep time: continuously adjustable from 10 ms to 100 seconds.

Manual sweep: continuous manual adjustment of frequency between end frequencies.

External sweep: sweep is controlled by external signal applied to SWP OUTPUT/SWP INPUT connector.

Sweep output: direct-coupled sawtooth, zero to approximately +10 volts, concurrent with swept RF output.

Instrument State Storage

Save n/recall n: 9 different front panel settings can be stored.

Alt n: causes the RF output to alternate on successive sweeps between the current front panel setting and a setting stored in memory.

Modulation

External AM: refer to RF plug-in specifications.

Internal AM: Selectable to 27.8 kHz or 1 kHz. On/off ratio, refer to RF plug-in specifications.

External FM: refer to RF plug-in specifications.

Remote Programming (HP-IB)

The HP 8350B has both input and output capability. All front panel controls except the ac line power switch are programmable.

Frequency resolution: same as CF/ Δ F plus vernier.

Power resolution: see HP 83500 Series Plug-ins.

HP-IB interface functions: SH1, AH1, T6, L4, SR1, RL1, PPO, DC1, DT1, CO, E1.

General Specifications

Nonvolatile memory: continuous memory that retains the contents of all instrument state storage registers, the HP-IB address, and current instrument state when ac line power is off.

Operating temperature range: 0°C to +55°C.

Power: 100, 120, 220 or 240 volts \pm 10%, 50 to 60 Hz (Option 400, 60 to 400 Hz). Approximately 375 volt-amperes including RF plug-in.

Weight (not including RF unit): Net 16.5 kg (36.4 lb). Shipping 22.7 kg (50 lb).

Dimensions: 425 mm wide, 133.3 mm high, 422 mm deep (16.75" x 5.25" x 16.6").

Ordering Information

HP 8350B Sweep Oscillator Mainframe

Options

803: HP 5343A Interface Cables

910: Extra Manual

W30: Extended Repair Service. See page 725.

W32: Calibration Service. See page 725.

Price

\$4,900

add \$60

add \$80

add \$125

add \$360

SWEEP OSCILLATORS

Model 8350 Series: RF Plug-Ins

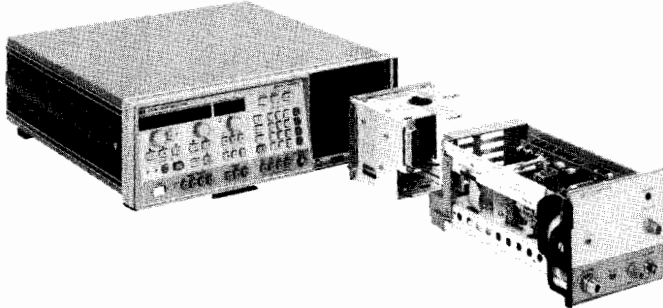

Plug-ins Compatible With The HP 11869A Adapter

The HP 11869A adapter attaches to the back of the HP 86200 series plug-in and is equipped with a switch for setting the specific interface code for the plug-in being used.

The following plug-ins will operate in the HP 8350 by using the HP 11869A.

HP 86220A ^{1,2}	HP 86240A/B/C	HP 86250A ¹ /B ¹ /C/D ²
HP 86222A/B	HP 86241A ¹	HP 86251A ³
HP 86230B ^{1,2}	HP 86242A ¹ /C/D ²	HP 86260A ¹ /B ^{1,3} /C ^{1,3}
HP 86235A	HP 86245A	HP 86290A ² /B/C

HP 11869A Adapter

The HP 11869A adapter provides the electrical and mechanical interface between the HP 8350 and 86200 series plug-ins. All of the HP 8350's standard operating features, including HP-IB remote programming, are available. However, specific plug-in functions (output power level, RF on/off, etc.) cannot be controlled or remotely programmed by the HP 8350 mainframe.

See page 407 for HP 86200 series plug-in specifications.

Ordering Information

HP 11869A Adapter Price \$750

Options

004: Extension Cables for Plug-ins with Rear Panel RF Output add \$200

006: Type N Aux Out Interface Connector for HP 86251A and 86290A²/B/C add \$200

W30: Two Additional Years Return to HP Support add \$50

¹ Not compatible with 27.8 kHz square wave modulation.

² Models HP 86220A, 86230B, 86290A, 86250A/B/C, and 86242A/C are obsolete. However, existing models can interface to HP 8350B mainframe via the HP 11869A adapter.

³ Requires a special PROM for the HP 11869A, which is shipped with every HP 86251A, 86260B/C.

RF Plug-in Summary

	HP Model number	Frequency range (GHz)	Leveled power output	CW Frequency accuracy (MHz)	Complete specifications on page
Broad-band Plug-ins	83597A	0.01-40	1 mW	±20	403
	83596A	2.4-40	1 mW	±20	403
	83595A	0.01-26.5	2.5 mW	±12	401
	83595C	0.01-26.5	10 mW/20mW ¹	±12	401
	83594A	2-26.5	2.5 mW	±12	401
	83592A/B	0.01-20	10 mW/20 mW ¹	±10	401
	83592C	0.01-20	2.5 mW/4 mW ²	±10	401
	83590A	2-20	10 mW	±10	401
	83525A/B	0.01-8.4	20 mW/10 mW	±15/12	404
	83522A	0.01-2.4	20 mW	±5	404
	86222A/B	0.01-2.4	20 mW	±10	407
	86290B	2-18.6	10 mW	±30	407
86290C	2-18.6	20 mW	±30	407	
Straddle-band Plug-ins	83540A/B	2-8.4	40 mW/20 mW	±12	404
	86240A	2-8.4	40 mW	±25	407
	86240B	2-8.4	20 mW	±25	407
	86240C	3.6-8.6	40 mW	±25	407
	86251A	7.5-18.6	10 mW	±20 ³	407
	83550A	8.0-20.0	100 mW/63 mW ⁴	±20	404
Single-band Plug-ins	86235A	1.7-4.3	40 mW	±20	407
	86241A	3.2-6.5	5 mW	±30	407
	86242D	5.9-9	10 mW	±35	407
	83545A	5.9-12.4	50 mW	±20	404
	86245A	5.9-12.4	50 mW	±20	407
	86250D	8.0-12.4	10 mW	±40	407
	86260B	10-15.5	10 mW	±50	407
	86260A	12.4-18	10 mW	±50	407
	86260C	17-22	10 mW	±50	407
	83570A	18-26.5	10 mW	±30	404
	83572A	26.5-40	1.6 mW (Opt 001)	±100	404
	83572B	26.5-40	4 mW (Opt 001)	±100	404

NOTE: The HP 11869A Adapter is required to interface HP 86200 series plug-ins with the HP 8350B mainframe.

¹ 20 mW to 18 GHz (HP 83592B) and 20mW to 20 GHz (HP 83595C).

² HP 83592C: 4 mW to 18.6 GHz.

³ When installed in HP 8350 with HP 11869A Adapter.

⁴ HP 83550A: 100 mW to 18.6 GHz.

SWEEP OSCILLATORS

Model 8350 Series: Broadband RF Plug-Ins

Models 83595A/C, 83592A/B/C, 83594A, 83590A

401

- Calibrated output power with 0.1 dB resolution
- +13 dBm from 0.01 to 20.0 GHz
- 12 MHz frequency accuracy at 26.5 GHz

- -55 dBc harmonics and subharmonics from 3.5 to 20 GHz
- Internal leveling and slope standard
- HP-IB

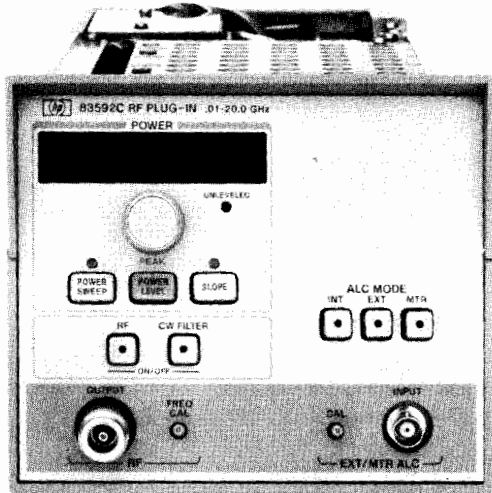

HP 83592C



The HP 83590 series plug-ins feature wideband frequency coverage, while maintaining narrowband precision, with excellent frequency accuracy and stability. At 26.5 GHz the HP 83595A/C maintain an accuracy of ± 12 MHz. The HP 83595C does not sacrifice excellent performance for broadband high frequency coverage; the output power is internally leveled for a minimum of +13 dBm to 20 GHz and +10 dBm to 26.5 GHz, with < -50 dBc harmonics and subharmonics from 1.5 to 26.5 GHz. The 83592B offers +13 dBm internally leveled output power to 18.6 GHz, while maintaining ± 0.9 dB flatness. The HP 83592C provides a clean test signal with -55 dBc harmonic and subharmonic levels (3.5-20 GHz) to maximize dynamic range. Power output capabilities have been expanded to provide power sweep and slope control. In addition, the HP 83590 series plug-ins are completely HP-IB programmable.

The most outstanding feature of the HP 83590 series plug-ins is their broad frequency range. Innovative technology is used to create this precision frequency range. The principle behind this technology is the Switched YIG Tuned Multiplier circuit (SYTM). The YTM circuit uses the output of a fundamental oscillator to drive a high-efficiency multiplier that has been integrated with a tracking YIG filter in order to create and select high order harmonics to be used as output frequencies.

A figure of merit for the HP 83590 series is their flat output power over the entire frequency range. The output power is internally leveled within 0.9 dB with a displayed resolution of 0.1 dB. The power level may be controlled to a minimum settable power level of -5 dBm (-2 dBm for the HP 83592B and HP 83595C). This level may be extended to -75 dBm on the HP 83592A and HP 83590A or to -72 dBm on the HP 83592B with Option 002 (70 dB Step Attenuator), or to -60 dBm on the HP 83592C, the HP 83595A and HP 83594A with Option 002 (55 dB Step Attenuator), or to -62 dBm on the HP 83595C with Option 002 (60 dB Step Attenuator).

Since power parameters are critical to high frequency measurements, the HP 83590 Series (along with all HP 83500 series plug-ins) offer many modes of power output. In addition to a single power output, the HP 83590 Series offer a Power Sweep function. The Power Sweep function sweeps a power range for characterizing level sensitive devices like amplifiers and transistors. The Slope mode is supplied to provide compensation for cable or test set losses. In all these modes the power output is internally monitored and leveled. If preferred, the power may be externally leveled. The HP 83590 Series plug-ins are capable of power meter leveling with the HP 432A/B/C, 436A, and 438A power meters.

HP-IB programmability is an essential feature when one of the HP 83590 series is used in automatic test systems. For example, the automated tests of amplifiers for gain compression are possible. These plug-ins are completely programmable, which means the power mode may be selected and the power level may be set with .01 dB resolution.

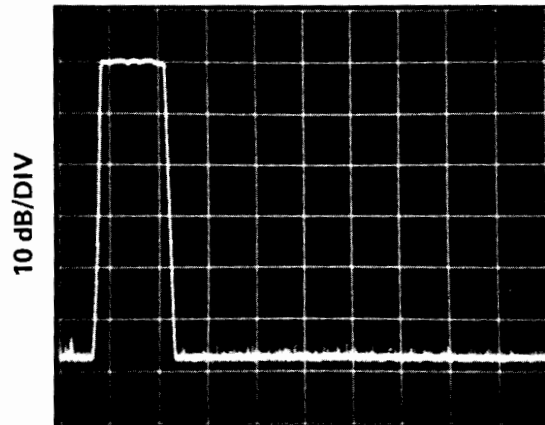

2.0 GHz

1.8 GHz/DIV

20.0 GHz

Output Characteristics

Output Power Resolution

Displayed: 0.1 dB

Programmable/Settable: 0.01 dB

Power Sweep

(with Option 002 Power Sweep cannot cross an attenuator step)

Calibrated Range: > 9 dB

Accuracy (including linearity), typical: 1.5 dB

Power Slope (with Option 002 Power Slope cannot cross an attenuator step)

Calibrated Range: Up to 5 dB/GHz; > 9 dB for full sweep

Linearity, typical: 0.2 dB

Residual AM in 100 kHz Bandwidth, typical: -50 dBc

Source Output VSWR (50 ohm nominal) typical: < 1.9

Modulation Characteristics

External AM

Frequency Response, typical: 100 kHz

Range of Amplitude Control, typical: 15 dB

Sensitivity, typical: 1 dB/V

Internal Square Wave Modulation

1 kHz or 27.8 kHz square wave modulation selectable by internal jumper in HP 8350B. The 27.8 kHz modulation ensures operation with all Hewlett-Packard scalar network analyzers.

On/Off Ratio: > 30 dB

Symmetry: 40/60

External Pulse Modulation

(HP 83592A/B/C, 83595A specifications only)

Pulse Input: TTL compatible

Rise/Fall Time, typical: 15 nsec (0.01-2.5 GHz)

10 nsec (2.5-20 GHz or 26.5 GHz)

Minimum RF Pulse Width:

Internally Leveled, typical: 1 μ sec

Unleveled, typical: 200 nsec (0.01-2.5 GHz)

100 nsec (2.5-20 GHz or 26.5 GHz)

External FM

Maximum Deviations for Modulation Frequencies:

DC to 100 Hz: ± 75 MHz

100 Hz to 1 MHz: ± 7 MHz

1 MHz to 2 MHz: ± 5 MHz

2 MHz to 10 MHz: ± 1 MHz

Sensitivity (switch selectable), typical

FM Mode: -20 MHz/V

Phase-lock Mode: 6 MHz/V

SWEEP OSCILLATORS

Model 8350 Series: Broadband RF Plug-Ins (cont'd)

Models 83595A/C, 83592A/B/C, 83594A, 83590A

General Specifications

Minimum Sweep Time

- 10 msec for single band
- HP 83590A, 83592A/B/C: 25 msec for full sweep
- HP 83594A, 83595A/C: 30 msec for full sweep
- HP 83592C: 35 msec for full sweep

Auxiliary Output

(rear panel fundamental oscillator output, nominally 0 dBm):

- HP 83590A, 83594A: 2.0-7.0 GHz
- HP 83592A/B/C, 83595A: 2.3-7.0 GHz

Frequency Reference Output

(rear panel BNC output, switch selectable):

- 1 V/GHz (<18 GHz) or 0.5 V/GHz (<20 GHz or <26.5 GHz) ± 25 mV

RF Output Connector

- HP 83590A, 83592A/B/C: Type N female
- HP 83594A, 83595A: Type APC 3.5 male

Weight:

- Net 6.0 kg (13.2 lb), Shipping 9.2 kg (20 lb)

Ordering Information

HP 83590A 2.0 to 20 GHz RF Plug-in	\$15,700
HP 83592A 0.01 to 20 GHz RF Plug-in	\$18,200
HP 83592B 0.01 to 20 GHz (high power) RF Plug-in	\$20,200
HP 83592C 0.01 to 20 GHz (low harmonics) RF Plug-in	\$20,200
HP 83594A 2.0 to 26.5 GHz RF Plug-in	\$22,200
HP 83595A 0.01 to 26.5 GHz RF Plug-in	\$24,000
HP 83595C 0.01 to 26.5 GHz RF Plug-in (high power, low harmonics)	\$27,000
Option 002: 70 dB Step Attenuator (HP 83590A, 83592A/B)	Add \$1,500
55 dB Step Attenuator (HP 83592C, 83594A, 83595A)	
60 dB Step Attenuator (HP 83595C)	Add \$1,800
Option 004 Rear Panel RF Output	Add \$200
Option W30 Two Additional Years Return-to-HP Support	See HP 8350B Data Sheet
Option W32 Two Additional Years Return-to-HP Calibration	

	Band 0	Band 1	Band 2	Band 3	Band 4	Full Band
Frequency Characteristics						
Range						
HP 83590A	-	2-7	7-13.5	13.5-20	-	2-20
HP 83592A/B/C	.01-2.4	2.4-7	7-13.5	13.5-20	-	.01-20
HP 83594A	-	2-7	7-13.5	13.5-20	20-26.5	2-26.5
HP 83595A/C	.01-2.4	2.4-7	7-13.5	13.5-20	20-26.5	.01-26.5
Accuracy (MHz, 25°C)						
CW Mode	±5	±5	±10	±10	±12	
All Sweep Modes (sweep time >100 ms)	±15	±20	±25	±30	±35	±50
Linearity (MHz), typical						
	±2	±2	±4	±6	±10	±10 (±15 ¹)
Stability, typical						
With Temperature (MHz/°C)	±0.2	±0.2	±0.4	±0.6	±0.8	
With 10 dB Power Change (kHz)	±200	±200	±400	±600	±800	
With 3:1 Load SWR (kHz)	±100	±100	±200	±300	±400	
With Time ² (kHz)	±100	±100	±200	±300	±400	
Residual FM (kHz peak, 10 Hz-10 kHz bandwidth)						
	<5	<5	<7	<9	<12	
Output Characteristics						
Maximum Leveled Power (mW, 25°C)	10 (20 ³)	10 (20 ³ , 4 ⁴)	10 (20 ³ , 4 ⁴)	10 (2.5 ⁴ , 20 ⁹)	2.5 (8 ⁹)	10 (2.5 ⁴ , 8 ⁹)
With Option 002	10 (16 ⁶)	7 (14 ² , 2.8 ¹⁰)	6.3 (13 ² , 2.5 ¹⁰)	5 (1.4 ¹⁰)	1.25 (5 ⁵)	5 (1.25 ⁵ , 1.4 ⁴)
Power Level Accuracy (dB)						
Internally Leveled	±1.5	±1.3	±1.3	±1.4	±1.7	±1.5 (±1.8 ⁹)
Power Variation (dB, max specified power)						
Internally Leveled	±0.9	±0.7	±0.7	±0.8	±0.9	±0.9 (±1.0 ⁹)
Externally Leveled ⁵	±0.2 (0.3 ⁹)	±0.2 (0.25 ⁹ , 0.3 ⁹)	±0.2 (0.25 ⁹ , 0.3 ⁹)	±0.2 (0.25 ⁹ , 0.3 ⁹)	±0.2 (0.25 ⁹ , 0.3 ⁹)	
Minimum Settable Power (dBm)						
With Option 002	-5 (-2 ⁹)	-5 (-2 ⁹)	-5 (-2 ⁹)	-5 (-2 ⁹)	-5 (-2 ⁹)	
	-60	-60	-60	-60	-60	
	(-72 ¹ , -75 ⁶)	(-72 ¹ , -75 ⁶)	(-72 ¹ , -75 ⁶)	(-72 ¹ , -75 ⁶)	(-62 ⁹)	
Spurious Signals (dBc, max specified power)						
Harmonically Related						
	<-25	<-25	<-25	<-25	<-20	
	(<-20 ¹ , <-45 ⁷)	(<-50 ⁹ , <-55 ⁷)	(<-50 ⁹ , <-55 ⁷)	(<-50 ⁹ , <-55 ⁷)	(<-50 ⁹)	
Non-harmonics						
	<-25	<-50 (<-55 ⁷)	<-50 (<-55 ⁷)	<-50 (<-55 ⁷)	<-50	

¹ HP 83594A, 83595A specifications only.

² 10 minute period after one hour warm-up at same frequency.

³ HP 83592B specifications only.

⁴ HP 83592C specifications only.

⁵ Negative crystal detector (sweep time >100 msec) or HP 432A/B/C, 436A or 438A Power Meter (sweep time ≥ 100 sec), excludes coupler/detector variation.

⁶ HP 83590A, HP 83592A specifications only.

⁷ HP 83592C only: <-25 dBc (.01-1.4 GHz)

<-45 dBc (1.4-2.4 GHz)

<-50 dBc (2.4-3.5 GHz)

<-55 dBc (3.5-20 GHz)

⁸ HP 83594A specifications only.

⁹ HP 83595C specifications only.

SWEEP OSCILLATORS

Model 8350 Series: Broadband RF Plug-ins

Models 83597A, 83596A

403

- 10 MHz to 40 GHz frequency coverage with the 2.4 mm coaxial connector
- -50 dBc harmonics and subharmonics from 1.5 to 20 GHz, -40 dBc from 20 to 40 GHz

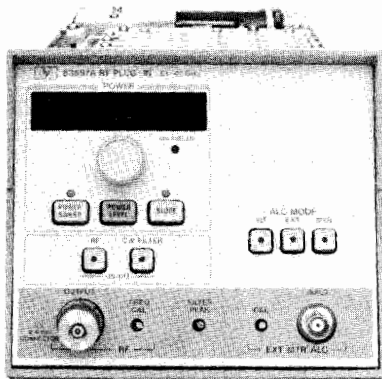

HP 83597A

The HP 83597A and 83596A RF plug-ins provide the highest performance and reliability available up to 40 GHz from a swept source. They feature high output power, as well as excellent harmonic performance. They also incorporate the 2.4 mm connector which makes high performance broadband coaxial measurements possible. The superiority of the 2.4 mm connector lies in its ruggedness, repeatable performance and excellent match over the entire frequency range.

A 40 GHz broadband swept scalar measurement system is easy to configure using this sweep oscillator with the HP 8757A/C/E Scalar Network Analyzers, and the appropriate 2.4 mm scalar network analyzer accessories. With -50 dBc of harmonic and subharmonic suppression from 1.5 to 20 GHz, and -40 dBc from 20 to 40 GHz, these plug-ins are the ideal choice for scalar network analysis.

The broadband frequency coverage and high output power of the HP 83597A and 83596A plug-ins make them ideal as local oscillators for down-converting high frequency signals to a lower intermediate frequency. These plug-ins provide the broadest frequency coverage for mixer measurement systems or coaxial noise figure measurements with the HP 8970B Noise Figure Meter.

The outstanding performance of the HP 83597A and 83596A plug-ins make them especially attractive as stand-alone sources for various signal generation and simulation applications. Frequency accuracies of better than ± 5 to ± 20 MHz are specified depending on the frequency of operation. These plug-ins additionally have very flexible amplitude, frequency and pulse modulation capabilities.

Output Characteristics

Output Power Resolution

Displayed: 0.1 dB
Programmable/Settable: ± 0.01 dB

Minimum Settable Power: -15 dBm

Power Variation:

Externally Leveled (excluding coupler/detector variation)
Negative Crystal detector² or HP 432A/B/C, 436A or 438A
Power Meter³: ± 0.2 dB, typical

Power Sweep

Calibrated Range: > 19 dB (< 18.6 GHz), > 15 dB (> 18.6 GHz)
Accuracy (including linearity): ± 1.5 dB, typical
Resolution (displayed): 0.1 dB, typical

Power Slope

Calibrated Range: up to 5 dB/GHz, up to 15 dB for full sweep
Linearity: 0.2 dB, typical
Resolution (displayed): 0.01 dB/GHz, typical

Residual AM in 100 kHz Bandwidth: -50 dBc, typical

Source Output VSWR

(50 Ohm, nominal impedance): $< 2.0:1$, typical

Modulation Characteristics

External AM

Frequency Response: 100 kHz, typical
Maximum Input: 15V
Range of Amplitude Control: 15 dB, typical
Sensitivity: 1 dB/V, typical
Input Impedance: approximately 25 k Ω

Internal Square Wave Modulation

1 kHz or 27.778 kHz square wave modulation selectable by internal jumper in HP 8350B. The 27.778 kHz modulation ensures operation with all Hewlett-Packard scalar network analyzers.

On/Off Ratio: > 30 dB

External Pulse Modulation:

Rise/Fall Time (neglecting overshoot): < 50 nsec, typical

Minimum RF Pulse Width:

Internally Leveled: < 1.5 μ sec, typical

Unleveled: < 1 μ sec, typical

On/Off Ratio: > 60 dB, typical

External FM

Maximum Deviations for Modulation Frequencies:

DC to 100 Hz: ± 75 MHz (cross-over coupled),
 ± 12 MHz (direct coupled)

100 Hz to 1 MHz: ± 7 MHz

1 MHz to 2 MHz: ± 5 MHz

2 MHz to 10 MHz: ± 1 MHz

Sensitivity (switch selectable):

FM Mode: -20 MHz/V, typical

Phase-lock Mode: -6 MHz/V, typical

General Specifications

Minimum Sweep Time: 30 ms for a single band, 75 ms for < 20 GHz sweep width, 150 ms for > 20 GHz sweep width.

Auxiliary Output: Rear panel 2.3-7.0 GHz fundamental oscillator output, nominally 0 dBm.

Frequency Reference Output: Switch selectable 0.5 V/GHz (0.01-38 GHz) or 0.25V/GHz (0.01-40 GHz), ± 25 mV (< 2.4 GHz) or ± 100 mV (> 2.4 GHz).

RF Output Connector: Type 2.4 mm male.

Weight: Net 6.5 kg (14.4 lb), Shipping 9.5 kg (21 lb).

Ordering Information

HP 83597A 10 MHz to 40 GHz RF Plug-In \$33,500

HP 83596A 2.4 GHz to 40 GHz RF Plug-In \$30,000

Opt. 004 Rear Panel RF Output add \$200

Opt. H20 55 dB Step Attenuator add \$2,700

Opt. W30 Two Additional Years Return-to-HP See HP 8350B

Data Sheet

	Band 0	Band 1	Band 2	Band 3	Band 4	Full Band
Frequency Characteristics						
Range						
HP 83597A	0.01-2.4 GHz	2.4-7.0 GHz	7.0-13.5 GHz	13.5-20.0 GHz	20.0-40.0 GHz	0.01-40.0 GHz
HP 83596A		2.4-7.0 GHz	7.0-13.5 GHz	13.5-20.0 GHz	20.0-40.0 GHz	2.4-40.0 GHz
Accuracy¹						
CW Mode:	± 5 MHz	± 5 MHz	± 10 MHz	± 10 MHz	± 20 MHz	
All Sweep Modes: ²	± 15 MHz	± 20 MHz	± 25 MHz	± 30 MHz	± 50 MHz	± 75 MHz
Residual FM (peak): ³	< 5 kHz	< 5 kHz	< 7 kHz	< 9 kHz	< 18 kHz	
Output Characteristics						
Maximum Leveled Power^{4,5}	2.5 mW	2.5 mW	2.5 mW	2.5 mW (< 18.6 GHz) 1 mW (> 18.6 GHz)	1 mW	
Power Level Accuracy^{1,5,6}	± 1.5 dB	± 1.3 dB	± 1.3 dB	± 1.4 dB	± 2.0 dB	± 2.0 dB
Power Variation^{1,5,6}	± 0.9 dB	± 0.7 dB	± 0.7 dB	± 0.8 dB	± 1.2 dB	± 1.3 dB
Spurious Signals⁷						
Harmonics and Subharmonics	< -25 dBc (< 1.5 GHz) < -50 dBc (> 1.5 GHz)	< -50 dBc	< -50 dBc	< -50 dBc	< -40 dBc ⁸	
Non-harmonics:	< -25 dBc	< -50 dBc	< -50 dBc	< -50 dBc	< -50 dBc	

1. 25°C $\pm 5^\circ$ C.

2. For sweep times ≥ 100 ms.

3. 10 Hz to 10 kHz bandwidth, CW mode with CW filter on.

4. Typically degrades 0.1 dB/ $^\circ$ C above 25°C.

5. Includes power level variations.

6. Degrades typically ± 0.05 dB/ $^\circ$ C outside the 20°C-30°C range.

7. At specified maximum leveled power.

8. Typically < -40 dBc above 40 GHz.

9. For sweep times ≥ 10 sec and ≥ 2.5 sec/GHz.

SWEEP OSCILLATORS

Model 8350 Series RF Plug-Ins

	Broadband			Straddle-Band			Single-Band		
	HP 83522A ¹	HP 83525A ¹	HP 83525B ¹	HP 83540A	HP 83540B	HP 83550A	HP 83545A	HP 83570A ²	HP 83572C ³
HP 83500 Series Plug-Ins: Specifications Summary									
Frequency Characteristics									
Range (GHz)	0.01-2.4	0.01-8.4	0.01-8.4	2-8.4	2-8.4	8-20	5.9-12.4	18-26.5	26.5-40
Accuracy (MHz, 25°C)									
CW Mode	±5	±15 ⁴	±12 ⁴	±12	±12	±20	±20	±30	±100
All Sweep Modes (sweep time >100 ms)	±15	±20 ⁴	±20 ⁴	±20	±20	±50	±35	±55	±150
Residual FM (kHz peak, 10 Hz-10 kHz bandwidth)	<5	<9 ⁴	<7 ⁴	<7	<7	<25 ¹³	<15	<30	<60
Output Characteristics									
Maximum Levelled Power (mW, 25°C)	>20	>20	>10	>40	>20	>100 ⁵	>50	>10	>5 ⁶
Power Level Accuracy (dB)									
Internally Levelled	±1	±1.5	±1.5	±1.5	±1.5	±1.5	±1	±1.8	±1.5 ⁷
Power Variation (dB, at max specified power)									
Internally Levelled	±0.25	±1	±1	±1	±1	±1.25	±0.6	±1.4	±3 ⁸
Externally Levelled, typical (excluding coupler/detector variations)	±0.1	±0.1	±0.1	±0.1	±0.1	±0.1	±0.1	±0.1	±0.2
Spurious Signals (dBc, at max specified power)									
Harmonically Related	<-25	<-20	<-45 ⁹	<-20	<-45	<-20 ⁹	<-30 ¹⁰	<-25	<-20
Non-harmonics	<-25	<-60 ⁸	<-60 ⁸	<-60	<-60	<-50	<-60	<-50	<-50
Source SWR, typical (50 ohms nominal, internally levelled)	<1.5	<1.6 ⁸	<1.6 ⁸	<1.6	<1.6	<2.5	<1.6	<2.5	<1.5 ⁷
Modulation Characteristics									
External Pulse, typical									
Rise/Fall Time (ns)	n/a	20 ⁴	20 ⁴	20	20	25	15	20	300/50 ¹¹
Minimum RF Pulse Width									
Levelled (µs)	n/a	1 ⁴	5 ⁴	1	5	1	1	1	n/a
Unlevelled (ns)	n/a	100 ⁴	100 ⁴	100	100	100	100	100	500 ¹¹
External FM									
Maximum Deviation (MHz)									
DC to 100 Hz Rates	±75	±75	±75	±75	±75	±75	±75	±75	±150
100 Hz to 200 kHz Rates	±7	±7	±7	±7	±7	±12	±7	±7	±3.5
200 kHz to 1 MHz Rates	±7	±7	±7	±7	±7	±12	±7	±7	n/a
1 MHz to 2 MHz Rates	±5	±5	±5	±5	±5	±12	±5	±5	n/a
2 MHz to 6 MHz Rates	±1	±1	±1	±1	±1	±12	±1	±1	n/a
6 MHz to 10 MHz Rates	±1	±1	±1	±1	±1	±12	±1	±1	n/a
Sensitivity (MHz/volt), typical	-20/-6	-20/-6	-20/-6	-20/-6	-20/-6	-20/-6	-20/-6	-20/-6	-20/-6
External AM									
Frequency response (kHz), typical	100	100	100	100	100	100	100	100	10
Range (dB), typical	>15	>15	>15	>15	>15	>20	>15	>11	>11 ⁷
Sensitivity (dB/volts)	+1	+1	+1	+1	+1	+1	+1	+1	+1 ⁷
Internal AM (1 kHz/27.8 kHz square wave)									
On/Off Ratio (dB)	>30	>30	>30	>30	>30	>30	>40	>25	>20 ¹¹
Prices									
Plug-in	\$8,200	\$12,800	\$14,000	\$9,900	\$10,500	\$16,000	\$9,900	\$12,500	\$19,200
With Opt 001 (Calibrated External Leveling)	n/a	n/a	n/a	n/a	n/a	n/a	n/a	n/a	+ \$1,600
With Opt 002 (70 dB Attenuator)	+ \$1,005	+ \$1,105	+ \$1,105	+ \$1,105	+ \$1,105	+ \$1,305 ¹²	+ \$1,105	n/a	n/a
With Opt 004 (Rear Panel RF Output)	+ \$200	+ \$200	+ \$200	+ \$200	+ \$200	+ \$200	+ \$200	n/a	n/a
With Opt 006 Int. Sq. Wave Mod. & Ext. Pulse Mod.	n/a	n/a	n/a	n/a	n/a	n/a	n/a	n/a	+ \$1,800
With Opt W30 (Two Years Extended Service)	+ \$205	+ \$250	+ \$350	+ \$250	+ \$265	+ \$400	+ \$250	+ \$320	+ \$350

¹ Enhanced frequency accuracy is provided by internal crystal markers of 10 MHz and 50 MHz (over full range for HP 83522A, and below 2 GHz for HP 83525A/B). 1 MHz harmonic markers are available below 1 GHz.

² WR42 waveguide RF output connector type.

³ WR28 waveguide RF output connector type.

⁴ Specifications apply from 2-8.4 GHz only. 0.01-2 GHz specifications are the same as the HP 83522A plug-in.

⁵ 63 mW from 18.6-20 GHz.

⁶ Unlevelled output power.

⁷ Externally levelled (requires option 001 which consists of a calibrated crystal detector, external coupler, and BNC cable).

⁸ Specifications apply only from 2-8.4 GHz.

⁹ -15 dBc from 8-11 GHz.

¹⁰ -17 dBc from 5.9-7 GHz.

¹¹ Requires option 006 which provides internal square wave modulation and external pulse and square wave modulation capabilities.

¹² 50 dB step attenuator.

¹³ 20 Hz - 15 kHz bandwidth.

SWEEP OSCILLATORS

HP 83550 Series Millimeter-Wave Source Modules

Models 83554A, 83555A, 83556A, 83557A and 83558A

- 26.5 to 110 GHz frequency range
- Leveled high output power
- Can be driven by many HP microwave sources

- Source module remotable up to a meter length
- Low entry cost

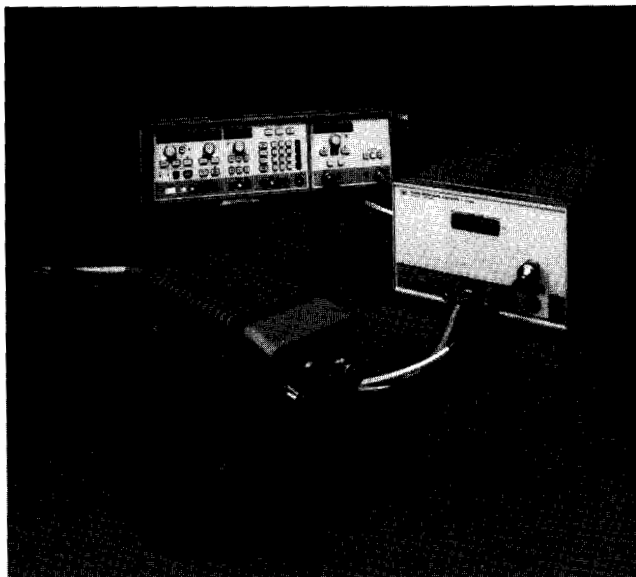

The three HP 83550 series millimeter-wave source modules provide a simple approach to extend the frequency range of 11 to 20 GHz sources to cover 26.5 to 40 GHz (HP 83554A), 33 to 50 GHz (HP 83555A) 40 to 60 GHz (HP 83556A) 50-75 GHz (HP 83557A), and 75-110 GHz (HP 83558A) bands. The HP 83550 series source modules offer leveled high output power, full waveguide band frequency coverage, and the high frequency accuracy and resolution of the driving microwave source.

As shown in Figure 1, there are 3 basic ways of configuring a millimeter-wave source to best suit your specific needs. Your choice can range from a sweep oscillator (HP 8350B/83550A) to a sophisticated synthesized sweeper (HP 8341B/8349B).

High Output Power

Leveled output power from the source modules is rated at +8 dBm for the HP 83554A, +3 dBm for the HP 83555A, +3 dBm for the HP 83556A, +2 dBm for the HP 83557A, and -1 dBm for the HP 83558A. This high output power can permit the source module to serve as a mixer LO in some applications, and also expands the available dynamic range in frequency response measurements.

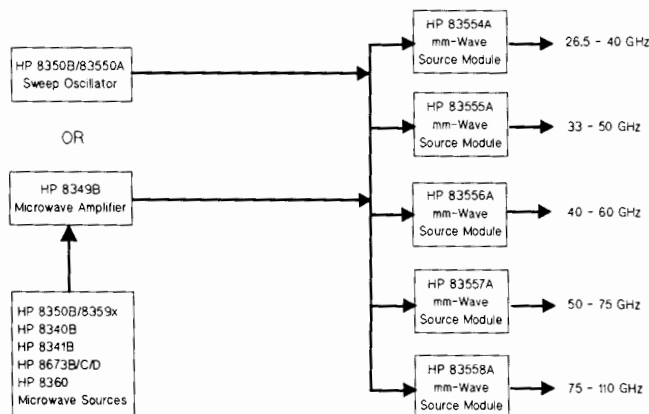

Pulse, AM and FM Modulation

The high performance pulse modulators of the HP synthesized sources offer >80 dB ON/OFF ratio and <50 ns rise and fall times. Pulse amplitudes are leveled for pulse widths as narrow as 1 μs.

The HP 8340B/8341B also feature dc-coupled AM with a 3 dB bandwidth of 100 kHz. Pulse and amplitude modulation can be used to simultaneously simulate antenna scan patterns.

FM rates between 100 Hz and 10 MHz may be applied to the HP 8673B/C/D synthesizer input to achieve deviations up to 20 MHz (HP 83554A) and 30 MHz (HP 83555A, 83556A), 40 MHz (HP 83557A) and 60 MHz (HP 83558A) at millimeter-wave frequencies.

All at a Lower Cost

The HP 83550-series source modules combines performance and quality with a low cost of entry. This is possible because the source modules are backward-compatible with existing HP millimeter-wave sources. Thus, you can generate a full waveguide band of millimeter-wave frequencies for just the cost of the HP 8349B and a source module. Also, the cost of ownership to you is reduced even further by the two-year warranty on the microcircuits of the HP 83550-series source modules and the HP 8349B microwave amplifier.

HP 83554A Output Characteristics ¹	HP 8350B/83550A	HP 8350B/83590 Series/8349B	HP 8340B/8349B, HP 8341B/8349B	HP 8673B/C/D/8349B
Maximum Leveled Power (25°C±5°C)	+8 dBm, 26.5-37.2 GHz +7 dBm, 37.2-40.0 GHz	+8 dBm, 26.5-37.2 GHz +7 dBm, 37.2-40.0 GHz	+8 dBm, 26.5-37.2 GHz +7 dBm, 37.2-40.0 GHz	+8 dBm, 26.5-37.2 GHz +7 dBm, 37.2-40.0 GHz
Minimum Settable Power:	-5 dBm	-5 dBm	-5 dBm	-5 dBm
Power Level Accuracy ² (25°C±5°C)	±2.00 dB	±2.00 dB	±2.00 dB	±2.00 dB
Power Flatness (at max leveled power)	±1.50 dB	±1.50 dB ³	±1.50 dB ³	±1.50 dB ³
Source Output SWR	<2.0	<2.0	<2.0	<2.0
Spurious Signals				
Harmonically related spurious:				
26.5 to 26.7 GHz	<-25 dBc	<-25 dBc	<-25 dBc	<-25 dBc
26.7 to 40.0 GHz	<-50 dBc	<-20 dBc ⁴	<-20 dBc ⁵	<-20 dBc ⁶

SIGNAL GENERATORS

HP 83550 Series Millimeter-Wave Source Modules (cont'd)

Models 83555A, 83556A, 83557A, and 83558A

HP 83555A Output Characteristics ¹	HP 8350B/83550A	HP 8350B/ 83590 Series/8349B	HP 8340B/8349B, HP 8341B/8349B	HP 8673B/C/D/8349B
Maximum Leveled Power (25°C±5°C) Minimum Settable Power:	+3 dBm -5 dBm	+3 dBm -5 dBm	+3 dBm -5 dBm	+3 dBm -5 dBm
Power Level Accuracy ² (25°C±5°C) Power Flatness (at max leveled power)	±2.00 dB ±1.50 dB	±2.00 dB ±1.50 dB ³	±2.00 dB ±1.50 dB ³	±2.00 dB ±1.50 dB ³
Source Output SWR	<2.0	<2.0	<2.0	<2.0
Spurious Signals Harmonically related spurious: 33.0 to 37.5 GHz 37.5 to 49.5 GHz 49.5 to 50.0 GHz	<-20 dBc <-50 dBc <-20 dBc	<-20 dBc <-20 dBc ⁴ <-20 dBc	<-20 dBc <-20 dBc ⁵ <-20 dBc	<-20 dBc <-20 dBc ⁶ <-20 dBc

HP 83556A Output Characteristics ¹	HP 8350B/83550A	HP 8350B/ 83590 Series/8349B	HP 8340B/8349B, HP 8341B/8349B	HP 8673B/C/D/8349B
Maximum Leveled Power (25°C±5°C) Minimum Settable Power:	+3 dBm -5 dBm	+3 dBm -5 dBm	+3 dBm -5 dBm	+3 dBm -5 dBm
Power Level Accuracy ² (25°C±5°C) Power Flatness (at max leveled power)	±2.25 dB ±1.75 dB	±2.25 dB ±1.75 dB ³	±2.25 dB ±1.75 dB ³	±2.25 dB ±1.75 dB ³
Source Output SWR	<2.0	<2.0	<2.0	<2.0
Spurious Signals ⁷ Harmonically related spurious: 40.0 to 45.0 GHz 45.0 to 60.0 GHz	<-20 dBc <-50 dBc	<-20 dBc <-20 dBc ⁴	<-20 dBc <-20 dBc ⁵	<-20 dBc <-20 dBc ⁶

HP 83557A Output Characteristics	HP 83623A or 83624A	HP 8341 opt 003/8349B	HP 8673 C/D/8349B	HP 8350B/83550A or HP 8350B/83592C/95C/ 8349B
Maximum Leveled Power (25°C±5°C) Minimum Settable Power:	+2 dBm -5 dBm	+2 dBm -5 dBm	+2 dBm -5 dBm	+2 dBm -5 dBm
Power Level Accuracy (25°C±5°C) Power Flatness (at max leveled power)	±2.0 dB ±1.5 dB	±2.5 dB ±2.0 dB	±2.5 dB ±2.0 dB	±2.5 dB ±2.0 dB
Source Output SNR Leveled: Unleveled:	<2.0 <3.0	<2.0 <3.0	<2.0 <3.0	<2.0 <3.0
Spurious Signals ⁷ Harmonically related spurious:	<-20 dBc	<-20 dBc	<-20 dBc	<-20 dBc

HP 83558A Output Characteristics	HP 83623A or 83624A	HP 8341 opt 003/8349B	HP 8673 C/D/8349B	HP 8350B/83550A or HP 8350B/83592C/95C/ 8349B
Maximum Leveled Power (25°C±5°C) Minimum Settable Power	-1 dBm -5 dBm	-1 dBm -5 dBm	-1 dBm -5 dBm	-1 dBm -5 dBm
Power level accuracy (25°C±5°C) Power flatness (at max leveled power)	±2.0 dB ±1.5 dB	±2.5 dB ±2.0 dB	±2.5 dB ±2.0 dB	±2.5 dB ±2.0 dB
Source Output SNR Leveled: Unleveled:	<2.0 <3.0	<2.0 <3.0	<2.0 <3.0	<2.0 <3.0
Spurious Signals ⁷ Harmonically related spurious:	<-20 dBc	<-20 dBc	<-20 dBc	<-20 dBc

¹All specifications apply to internally leveled operation only.

²Specified with respect to HP 83550A or HP 8349B power display. Includes power level flatness.

³Must have 0.5 V/GHz modification on microwave source.

⁴Except for the HP 83592C which is -45 dBc.

⁵Except for the HP 8341B Option 003 which is -40 dBc.

⁶Except for the HP 8673C/D which are -50 dBc.

⁷Expressed in dB relative to the carrier level (dBc).

General Specifications

Waveguide Output Connector

HP 83554A: EIA size WR 28 waveguide; JAN UG-599 flange.

HP 83555A: EIA size WR 22 waveguide; JAN UG-383 flange.

HP 83556A: EIA size WR 19 waveguide; JAN UG-383 (mod.) flange.

HP 83557A: EIA Size WR 15 waveguide; JAN UG-385 flange.

HP 83558A: EIA Size WR 10 waveguide; JAN UG-387 flange.

Weight: Net, 1.7 kg (4 lb).

Dimensions: Module, 80 mm Wx 80 mm Hx 210 mm D (3.15" × 3.15" × 8.27")

Furnished with Each Source Module: Operating and Service Manual, Modification Procedures for 0.5 V/GHz output, Type-N RF Cable, Module Base Assembly, Synthesizer Interface Cable.

Ordering Information

HP 83554A 26.5-40.0 GHz mm-Wave Source Module	\$9,000
HP 83555A 33.0-50.0 GHz mm-Wave Source Module	\$9,000
HP 83556A 40.0-60.0 GHz mm-Wave Source Module	\$9,000
HP 83557A 50.0-75.0 GHz mm-Wave Source Module	\$15,000
HP 83558A 75.0-110.0 GHz mm-Wave Source Module	\$15,000

Opt 910: Extra Manual

Opt W30: Two Years Extended Service

add \$40

add \$225

SWEEP OSCILLATORS

Model 8350 Series: RF Plug-Ins

Model 86200 Series

407

HP 86200 Series Plug-Ins: Specifications Summary	Broadband			Straddle-Band				Single-Band						
	HP 86222B ¹	HP 86290B ²	HP 86240A	HP 86240B	HP 86240C	HP 86251A	HP 86235A	HP 86241A	HP 86242D	HP 86245A	HP 86250D	HP 86260B	HP 86260A	HP 86260C
Frequency Characteristics														
Range (GHz)	0.01-2.4	2.0-18.6	2.0-8.4	2.0-8.4	3.6-8.6	7.5-18.6	1.7-4.3	3.2-6.5	5.9-9.0	5.9-12.4	8.0-12.4	10.0-15.5	12.4-18.0	17.0-22.0
Accuracy (MHz, 25°C)														
CW Mode	±10	±20	±25	±25	±25	±60	±20	±30	±35	±40	±40	±50	±50	±50
Remote Programming, typical	±6	±2.5	±3.5	±3.5	±3.5	±20	±3.5	±10.5	±5.0	±20	±20	±25	±25	±25
All Sweep Modes (sweep time >100 ms)	±15	±80	±40	±50	±35	±60	±30	±33	±40	±50	±50	±70	±70	±70
Residual FM (kHz peak, 10 Hz-10 kHz bandwidth)	<5	<30	<9	<9	<9	<30	<7	<7	<15	<15	<15	<25	<25	<25
Output Characteristics														
Maximum Leveled Power (mW, 25°C)	>20	>10	>40	>20	>40	>10	>40	>5	>10	>50	>10	>10	>10	>10
Power Variation (dB, at max specified power)														
Internally Leveled	±0.33	±0.9	±1	±0.5	±0.8	±0.8	±0.8	±0.8	±0.5	±0.6	±0.5	±0.7	±0.7	±0.7
Externally Leveled (excluding coupler and detector variations)	±0.1	±0.15	±0.1	±0.1	±0.1	±0.15	±0.1	±0.1	±0.1	±0.1	±0.1	±0.1	±0.1	±0.1
Spurious Signals (dBc, at max specified power)														
Harmonically Related	<-25	<-25	<-16	<-45	<-16	<-30	<-20	<-16	<-40	<-17	<-40	<-25	<-25	<-25
Non-harmonics	<-25	<-50	<-60	<-60	<-60	<-50	<-60	<-60	<-60	<-60	<-60	<-60	<-50	<-50
Source SWR (50 ohms nominal, internally leveled)	<1.5	<1.9	<1.6	<1.6	<1.6	<1.9	<1.6	<1.6	<1.6	<1.6	<1.6	<1.6	<2.0	<1.6
Modulation Characteristics														
External Pulse														
Rise/Fall Time, typical (ns)	n/a	n/a	20	20	20	n/a	20	n/a	n/a	n/a	n/a	n/a	n/a	n/a
On/Off Ratio (dB)			40	40	40		40							
For Input (volts)			+6	+6	+6		+6							
External FM³														
Maximum Deviation (MHz)														
DC to 100 Hz Rates	±75	±75	±75	±75		±75	±75	±25	±150	±150	±150			
100 Hz to 1 MHz Rates	±5	±5	±5	±5	MLA ³	±5	±5	±2	±7	±7	±7			
1 MHz to 2MHz Rates	±2	±5	±2	±2		±5	±2		±1.5	±1.5	±1.5			
DC to 200 Hz Rates														
200 Hz to 200 kHz Rates												±75	±75	±75
Sensitivity, nominal (MHz/volt)	-20/-6	-20/-6	-20/-6	-20/-6	-20/-6	-20/-6	-20/-6	-6	-20/-6	-20/-6	-20/-6	-20/-6	-20/-6	-20/-6
External AM														
Linear Mode														
Frequency Response, Typical (kHz)	150	300	125	125	125	100	125	30	30	30	30	500	500	500
Attenuation (dB), typical, For Input (volts)	>30 +5	>30 +5	>30 +5	>30 +5	>30 +5	>30 +5	>30 +5	>25 -10	>20 +6	>20 +6	>20 +6	>25 -10	>25 -10	>25 -10
Square Wave Mode														
On/Off Ratio (dB), For Input (volts)	n/a	>30 +5	n/a	n/a	n/a	>30 +6	n/a	n/a	>40 +6	>40 +6	>40 +6	n/a	n/a	n/a
Compatible with HP 8757/8756 Mod Drive signal	Yes	Yes	Yes	Yes	Yes	Yes	Yes	No	Yes	Yes	Yes	No	No	No
Internal AM														
1 kHz Square Wave On/Off Ratio (dB)	>30	>25	>40	>40	>40	>25	>40	>25	>40	>40	>40	>25	>25	>25
Prices														
Plug-in	\$7,100 (86222A \$6,100)	\$15,600 (86290C: \$20,000)	\$6,700	\$7,900	\$7,700	\$12,500	\$6,200	\$5,500	\$6,500	\$8,100	\$6,400	\$7,700	\$7,500	\$9,950
With Opt 002 (70 dB Attenuator)	+ \$750	n/a	+ \$905	+ \$905	+ \$905	n/a	+ \$850	n/a	n/a	n/a	n/a	n/a	n/a	n/a
With Opt 004 (Rear Panel RF Output)	+ \$200	+ \$200	+ \$200	+ \$200	+ \$200	+ \$200	+ \$200	+ \$200	- \$200	+ \$200	+ \$200	+ \$200	+ \$200	+ \$200

¹HP 86222A specifications identical to HP 86222B, except that the HP 86222B has 1, 10, and 50 MHz crystal markers which allow enhancement of frequency accuracy to better than ±200 kHz.

²HP 86290C specifications identical to HP 86290B, except that the HP 86290C has maximum leveled power >20 mW. HP 86290B specifications listed apply to frequencies 6 to 12.4 GHz.

³Many HP 86200 series plug-ins have optional Microwave Link Analyzer (MLA) compatibility capabilities.

AMPLIFIERS

RF Amplifier

Model 8347A

- Broadband 100 kHz to 3 GHz coverage
- +20 dBm output power
- Low harmonics
- 25 dB gain
- Internally leveled

HP 8347A

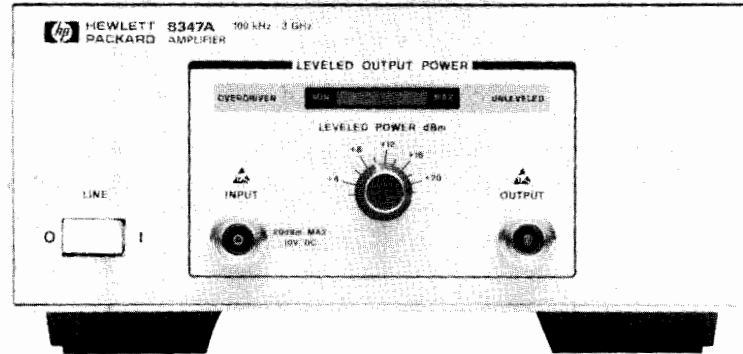

The HP 8347A is a general-purpose broadband instrumentation amplifier capable of providing gain and power to overcome systematic RF losses, drive high-power devices, or improve measurement system performance.

Switching and signal routing in ATE systems, frequency conversion, and long transmission paths to remote devices like antennas on towers are examples of systematic power losses. With more than 25 dB of gain, the HP 8347A can overcome such losses, and its internal leveling loop can reduce mismatch and reflection effects in a system.

Many devices, like mixers, power amplifiers, and optical modulators, require high-power drive signals. These devices are often very level-sensitive as well. The flat, leveled, +20 dBm output power of the HP 8347A allows proper device operation or complete characterization.

EMI, surveillance, and other demanding small-signal measurements sometimes stretch the capabilities of even the best test equipment. The HP 8347A can be used as a preamplifier to increase sensitivity in spectrum analysis and frequency counting applications, and can also extend dynamic range and increase low-level sweep speed in network analysis.

Improve HP 8753 Dynamic Range or Sweep Time

Using the illustrated configuration, the HP 8753 RF network analyzer dynamic range can be improved from 100 to 120 dB, or alternatively, sweep time increased by almost 100 times.

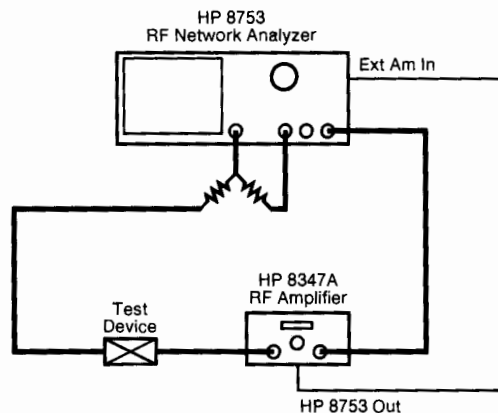

Extended Dynamic Range Configuration

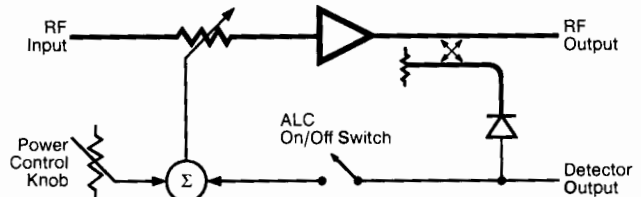

Simplified Block Diagram

Specifications

Frequency Range: 100 kHz to 3 GHz

Maximum Leveled Output Power: $\geq +20$ dBm

Output Power Leveling Range (≥ 300 kHz): +2 to +20 dBm

Power Flatness (internally-leveled, ± 300 kHz): ± 1.5 dB

Gain: ≥ 25 dB

Harmonics (at +20 dBm output)

Internal Leveling Off (ALC Off): ≤ -25 dBc

Internal Leveling On (ALC On): ≤ -20 dBc

Supplemental Characteristics

Maximum Input for Minimum Internally-Leveled

Output: -14 dBm

1 dB Compression Point: +22 dBm

Third-Order Intercept: +30 dBm

RF Input and Output Impedances: 50 ohms

VSWR

Input: 2.0:1

Output

Internally-Leveled: 1.5:1

Unleveled

Below 2 GHz: 2.0:1

2 to 3 GHz: 3.0:1

Reverse Isolation: 60 dB

Noise Figure

10 MHz to 3 GHz: 15 dB

Below 10 MHz: 20 dB

General

RF Input and Output Connectors: Type N female.

Dimensions: 102 H X 213 W X 298 mm D (4.0" X 8.4" X 11.8").

Weight: Net 4 kg (8 lb). Shipping 5 kg (11 lb).

Ordering Information

HP 8347A RF Amplifier

Price

\$3,950

- 2 to 22 GHz
- 28 dB gain
- 10 dB noise figure

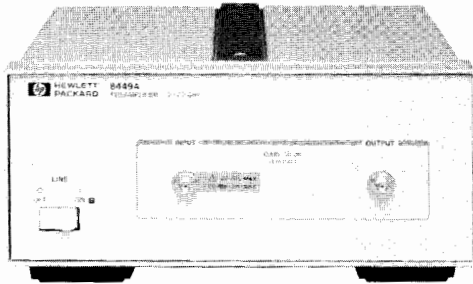

HP 8449A

- 2 to 8 GHz wideband frequency coverage
- 40 milliwatt (+16 dBm) output power
- Adjustable, calibrated power level

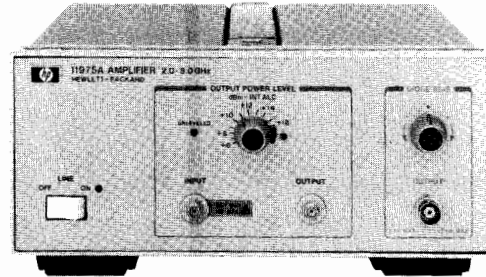

HP 11975A

Improve Sensitivity and Reduce Measurement Time

HP 8449A Preamplifier

This 2 to 22 GHz high gain, low noise preamplifier increases the sensitivity of any microwave spectrum analyzer. By improving sensitivity, you can detect and analyze very low level signals in dramatically reduced measurement time. Ordinarily, detecting low level signals requires the use of narrow bandwidths. As bandwidths are narrowed, however, sweep time becomes longer and measurement speed is reduced. The improved sensitivity added by the HP 8449A lets you widen bandwidths and measure low level signals using much shorter sweep times.

Frequency Specifications

Range: 2.0 to 22.0 GHz

Flatness: ± 3.4 dB, 2 to 22 GHz; typically 2.4 dB (0-55°C)

Input and Output Specifications

Minimum Small Signal Gain: 23 dB; 28 dB (25°C)

Noise Figure: <10 dB

Typical System Performance With Addition of HP 8449A (25° C):

Frequency	Displayed Average Noise Level (dBm)	
	8566B (10 Hz Res BW)	8562A (100 Hz Res BW)
4 GHz	-155	-145
8 GHz	-152	-139
16 GHz	-148	-135
22 GHz	-144	-130

Output Power: At 1 dB gain compression; +5 dBm (typical)

Input: SMA, 50 Ω characteristic

Output: SMA, 50 Ω characteristic

Maximum Safe Power Input: +20 dBm (100 mW)

Maximum DC Input: 20V

VSWR: (Typical) 2:1, 2 to 18 GHz, input & output

2.5:1, 18 to 22 GHz, input

2.2:1, 18 to 22 GHz, output

Reverse Isolation: >70 dB (typical)

Spectral Purity: TOI = +15 dBm at output (typical)

General Specifications

Power Requirements: 100,120,220, or 240 Volts (+10%), 47-440 Hz

Temperature Range: 0° to +55°C operation; -40° to +75°C storage

Environmental: MIL-T-28800C, Type III, Class 5, Style E

EMI: MIL-STD-461B CE03 and RE02 of; CISPR Publication 11 (1975); FTZ 1046

Weight: 2.9 kg (6.4 lbs.)

Size: 102Hx213Wx297mmD (4.0"x8.4"x11.7")

Ordering Information

HP 8449A Preamplifier	Price
Option 907 Front Handle Kit	\$7,650.00
Option 908 Rack Mount Kit	+\$51.00
Option 910 Extra Manual	+\$50.00
Option W30 2 Years Additional Hardware Service	+26.00
	+150.00

HP 11975A Microwave Amplifier

This general purpose, leveled microwave amplifier has a frequency range of 2 to 8 GHz and an adjustable output of +6 to +16 dBm. In addition, the amplifier has an adjustable bias current output port that supplies a maximum of ± 11 milliamps at ± 3 volts. This bias current is needed by some external harmonic mixers. The amplifier has automatic leveling control (ALC) that can be switched on and off. An "unleveled" light indicates that ALC is off.

Use the HP 11975A as an LO driver for the HP 11970/71/74 series harmonic mixers to achieve maximum performance.

Frequency Specifications

Range: 2 to 8 GHz

Flatness: ± 1.0 dB, ± 0.5 dB typical

Input and Output Specifications

Minimum small-signal gain:	Frequency	Gain
	2.0 to 4.5 GHz	15 dB
	4.5 to 6.1 GHz	11 dB
	6.1 to 8.0 GHz	9 dB

Noise Figure: 13 dB typical

Output power: +6 to +16 dBm adjustable

Input: SMA connector (female)

Output: SMA connector (female)

Maximum Input: +30 dBm; ± 35 Vdc

VSWR: 1.7:1 (ALC on)

Reverse isolation: >40 dB

Spectral purity: TOI = + 25 dBm typical

General specifications

Power Requirements: 100, 120, 220, or 240 Vac, 48 to 440 Hz, 36 VA

Environmental: MIL-T-28800C, Type III, Class 5, Style E

EMI: CE03 and RE02 of MIL STD 461A and CISPR Pub 11 (1975)

Weight: 3.904 kg (8.6 lb). Shipping 5.45kg (12.2 lb)

Size: 102Hx213Wx297mmD (4.0"x8.4"x11.7")

Ordering Information

HP 11975A Amplifier	Price
Option 001 Type N Connectors	\$4,700.00
Option W30 2 Years Additional Hardware Service	+102.00
	+115.00
HP P/N 5061-0072 Rack Mount Kit	+53.00

AMPLIFIERS

Microwave Amplifier

Model 8349B

- Continuous 2 to 20 GHz coverage
- 15 dB gain to 18.6 GHz



HP 8349B

The HP 8349B Microwave Amplifier delivers increased microwave power performance across a 2 to 20 GHz frequency range. This general-purpose broadband power amplifier is designed for maximum reliability and configured for the greatest convenience in interfacing with Hewlett-Packard's microwave sources, the HP 8350B Sweep Oscillator, HP 8340B/8341B/8360 Series Synthesized Sweepers, and HP 8671B, 8672A, or 8673 series Synthesized Signal Generators.

Providing 100 mW (+20 dBm) of unlevelled output power from 2 to 18.6 GHz, 63 mW (+18 dBm) from 18.6 to 20 GHz, the HP 8349B offers one of the broadest operating bandwidths available from a solid-state power amplifier. This performance is achieved using a multiple stage GaAs FET design, resulting in >15 dB of gain from 2 to 18.6 GHz, and >12 dB of gain from 18.6 to 20 GHz.

The HP 8349B can also provide externally-leveled output power without using an external coupler and detector, since these components are built-in and are compatible with Hewlett-Packard microwave sources. The HP 8349B is also equipped with an output power display, minimizing the need for an external power meter and enhancing the amplifier's utility. For example, the HP 8349B can be placed at the end of a long RF cable where the microwave output needs to be amplified, leveled and monitored.

Naturally, the versatile power control features of the microwave source (e.g., calibrated power, power sweep, power slope and remote power control via the Hewlett-Packard Interface Bus) can be accurately transmitted through the HP 8349B during external leveling operations.

The HP 8349B also has a built-in source module interface, enabling it to properly bias and control the HP 83550 series millimeter-wave source modules. Using the HP 8349B and a millimeter source module extends the capabilities of any 11 to 20 GHz HP microwave source to millimeter-wave frequencies.

Applications

The broadband high power of the HP 8349B is ideal, whether in a versatile bench-top arrangement or a dedicated rack-mount system. In antenna testing, the HP 8349B can be placed at the end of long RF cables, delivering high power right to the device under test. In EW/ECM systems, the HP 8349B can be combined with the HP 8340B/8341B/8360 Series, or the HP 8673 series Synthesized Signal Generators to provide high power pulses with little degradation in pulse performance. The HP 8349B is also an excellent choice as a microwave driver for TWTs, high power amplifiers, or mixers. And with a typical noise figure <13 dB, the HP 8349B is often used as a pre-amplifier for spectrum analyzers and frequency counters.

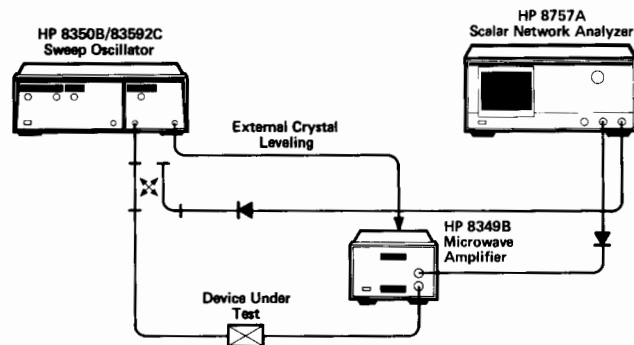

Extended Dynamic Range Configuration

- 100 milliwatts across 2 to 18.6 GHz
- <13 dB typical noise figure

The dynamic range of a scalar network analyzer measurement system is limited by the maximum output power of the microwave source and the sensitivity of the detectors. Using the illustrated configuration, up to 100 dB of dynamic range can be achieved by combining the calibrated dynamic range of the reference detector (R) with that of the transmission detector (B) in a ratio measurement (B/R). The HP 8349B makes this possible by extending the external crystal leveling power control of the microwave source. Hewlett-Packard Application Note 327-1 discusses this application in detail.

RFI susceptibility tests can also greatly benefit from the high quality amplifying characteristics of the HP 8349B.

Frequency Specifications

Range: 2-20 GHz

Output and Input Specifications (25°C ±5°C)

Minimum Output Power (at +5dBm input):

Frequency Range (GHz)	Output	
	Leveled	Unleveled
2.0 to 18.6	19 dBm (80mW)	20 dBm (100mW)
18.6 to 20.0	17 dBm (50mW)	18 dBm (63mW)

1 dB Compression Point: +21 dBm, nominal

Power Flatness (Leveled): ±1.25 dB

Minimum Small Signal Gain (at -5 dBm input):

2.0 to 18.6 GHz: 15dB

18.6 to 20.0 GHz: 13dB

Noise Figure: <13 dB, typical

Impedance (Input and Output): 50 ohms, nominal

VSWR:

Frequency Range (GHz)	Input	Output	
		Leveled	Unleveled (typical)
2.0 to 5.0	≤2.8	≤2.5	≤4.8
5.0 to 11.0	≤2.8	≤2.5	≤3.8
11.0 to 18.0	≤2.8	≤2.5	≤3.2
18.0 to 20.0*	≤2.8	≤2.5	≤3.2

*VSWR from 18.0 to 20.0 GHz is typical

Maximum Continuous Input, to the input or output ports:

+27 dBm (RF), ±10V (DC)

Spectral Purity

Harmonics (at +20 dBm output):

2.0 to 11.0 GHz: <-20 dBc

11.0 to 20.0 GHz: <-30 dBc typical

Non-Harmonic Spurious: ≤-55 dBc.

Third Order Intercept: +33 dBm, nominal.

Pulse Transmission Capability

Rise/Fall Time: <10 ns typical

General

Reverse Isolation: >50 dB, typical

RF Input/Output Connectors: Type N Female

Size: 133 H x 214 W x 366 mm D (5.2" x 8.36" x 13.6").

Weight: Net, 7 kg (15 lb); shipping, 14 kg (31 lb).

Ordering Information

HP 8349B 2 to 20 GHz Microwave Amplifier

Opt 001 Rear Panel RF Input/Output

Opt 002 Rear Panel RF Input with Front Panel RF Output

Opt W30 Two Years Extended Service

Price

\$8,000

add \$100

add \$100

add \$140

SWEEP OSCILLATORS

RF Amplifiers
Models 8447A/D/E/F

411

- Wide band (multi-decade)
- Low noise
- Flat response

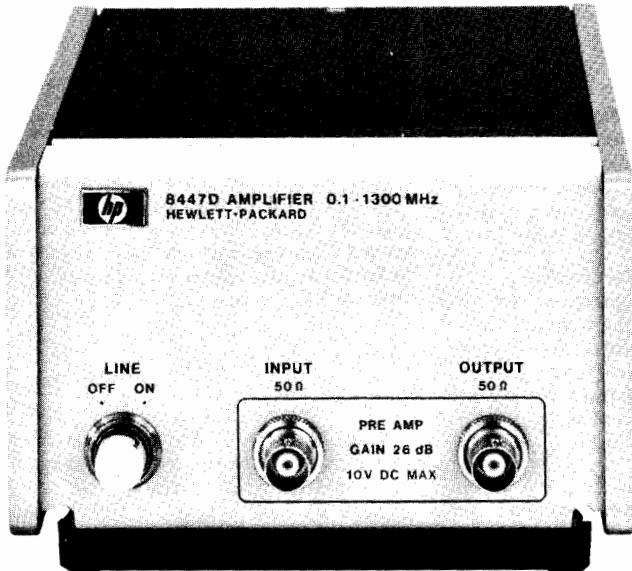

RF voltmeters, EMI meters, power meters, and other devices; or to increase the maximum power available from a signal generator or sweeper.

Broadband Frequency Coverage

The HP 8447 series offers an amplifier for nearly every application in the 100 kHz to 1.3 GHz frequency range. The amplifiers' wide bandwidths are compatible with other wideband instruments used for making measurements involving broadband spectra.

Options

Standard connectors are BNC (f) on all amplifiers.
 Option 010 N (f) connectors on single channel amplifier
 Option 001 Dual channel amplifier, BNC (f) connectors
 Option 011 Dual channel amplifier, N (f) connectors
Note: dual-channel amplifiers are ideal for dual-channel systems such as oscilloscopes or network analyzers. Channels may also be cascaded for increased small-signal gain.

General

Weight: net, 1.56 kg (3.4 lb). Shipping, 2.30 kg (5.1 lb)
Size: 85.8 H x 130 W x 216 mm D (3.4" x 5.1" x 8.5")
Power requirements: 110 or 230 V ac \pm 10%, 48-440 Hz, 15 watts

Ordering Information

Price

HP 8447A Preamp	\$1,400
Opt 910: Extra Operating and Service Manual (HP 8447A)	\$2
HP 8447D Preamp	\$1,500
HP 8447E Power Amp	\$1,700
HP 8447F Preamp-Power Amp	\$2,550
Opt H64: 9 KHz - 1300 MHz Preamp	\$0
Opt 910: Extra Operating and Service Manual (HP 8447D/E/F)	\$4

HP 8447D

The HP 8447 series of general-purpose amplifiers offers high reliability and the convenience of a small, lightweight package.

High Performance

These low noise, high gain amplifiers provide the flat frequency response and low distortion required for a wide range of uses. They can be used to improve the sensitivity of counters, spectrum analyzers,

Specifications

	HP 8447A Preamp	HP 8447D Preamp	HP 8447E Power Amp	HP 8447F Preamp-Power Amp
Frequency Range	0.1-400 MHz	100 kHz-1.3 GHz	100 kHz-1.3 GHz	100 kHz-1.3 GHz
Typical 3 dB Bandwidth	50 kHz-700 MHz	75 kHz-1.7 GHz	75 kHz-1.4 GHz	50 kHz-1.4 GHz
Gain (Mean, per channel)	20 dB \pm 1.0 dB at 10 MHz (20°C-30°C) 20 dB \pm 1.7 dB at 10 MHz (0°C-55°C)	>25 dB (20°C-30°C)	22 dB \pm 1.5 dB (20°C-30°C)	→ HP 8447D AND 8447E COMBINED IN A SINGLE PACKAGE →
Gain Flatness Across Full Frequency Range	\pm 1.8 dB \pm 0.7 dB (0°-55°C) (20°-30°C) Characteristic	\pm 1.5 dB	\pm 1.5 dB	
Noise Figure	<7 dB	<8.5 dB	<11 dB typical	
Output Power for 1 dB Gain Compression	>+6 dBm	>+7 dBm typical	>+12.5 dBm 100 MHz - 1 GHz	
Harmonic Distortion	-32 dB for 0 dBm output	-30 dB for 0 dBm output (typical)	-30 dB for +8 dBm output	
Output for <-60 dB Harmonic Distortion	-25 dBm (Characteristic)	-30 dBm	-20 dBm	
VSWR	<1.7	<2.0 input <2.2 output 1-1300 MHz	<2.2 input <2.5 output 1-1300 MHz	
Impedance	50 Ω	50 Ω	50 Ω	
Reverse Isolation	>30 dB	>40 dB	>40 dB	
Maximum DC Voltage Input	\pm 10 V	\pm 10 V	\pm 10 V	
Options Available	001	001, 010, 011	010	010
Option Prices	add \$610	add \$665, \$102, \$1,100	add \$102	add \$395

FREQUENCY, FUNCTION & WAVEFORM SYNTHESIZERS

General Information

Introduction

Hewlett-Packard offers a wide variety of signal sources for almost any application, including function generators, and frequency or waveform synthesizers. Output frequencies range from 1 μ Hz to 80 MHz.

For higher frequency applications, refer to the "Signal Generators" and "Sweep Oscillators" sections of this catalog.

Standard

Standard function generators typically offer a variety of waveforms, such as sine-wave, square, triangle and ramp.

The HP 8111A offers, in addition, pulse capabilities and the HP 3312A has modulation and sweeping capabilities. Both generators can be used in manual operation only.

Multi-Functional

Functionality describes function generators which are capable of more than generating a variety of waveforms. For example up to 150 vectors can be defined with the HP 3314A for the generation of arbitrary signals.

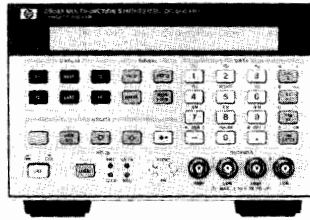

Analog/Digital Arbitrary Waveforms

The HP 8175A Digital Signal Generator is a data generator, which provides, with the option 002, arbitrary signals on two analog channels. Digital pattern and analog signals can also be generated simultaneously.

Synthesized Arbitrary Waveforms

The HP 8770A in conjunction with an HP 9000 series 300 Desktop Computer and the HP 11776A Waveform Generation Software is a complete system for the generation of most complex arbitrary waveforms with synthesizer accuracy. Waveforms can be created in both the time and frequency domain.

Multifunction Synthesized Waveforms

The HP 8904A Multifunction Synthesizer digitally creates a multitude of complex signals from six simple waveforms. It begins with a Synthesizer/Function generator offer-

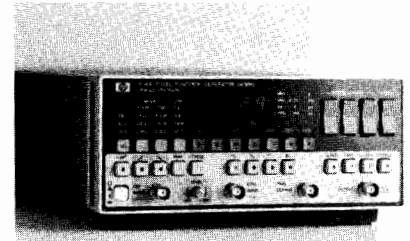

ing standard waveforms, DC and noise. Option 001 adds three channels which can modulate the first synthesizer, option 002 adds a second independent synthesizer output. Modulation capabilities include AM, FM, PM, DSB and pulse.

Fast

These instruments offer all of the standard waveforms over the full frequency range up to 50 MHz. The HP 8116A and HP 8165A combine these features with different modes, modulation and sweep capabilities. Both instruments can be used as pulse generators. The HP 8165A with its frequency stability of 1 ppm/day has synthesizer quality.

HP Function Generators Summary I

HP Models	Standard		Multi-Functional					Fast	
	8111A	3312A	3245A	3314A	8904A	8175A	8770A	8116A	8165A
Sine Wave Min. Frequency Max. Frequency	1Hz 20MHz	0.1Hz 13MHz	0Hz 1MHz	1mHz 20MHz	0Hz 600kHz	DC 25MHz	DC 50MHz	1mHz 50MHz	1mHz 50MHz
Waveforms Square Triangle Ramp Pulse Arbitrary	1Hz-20MHz 1Hz-20MHz 1Hz-20MHz 1Hz-20MHz	0.1Hz-13MHz 0.1Hz-13MHz 0.1Hz-13MHz	0Hz-1MHz 0Hz-1MHz 2048 points	1mHz-20MHz 1mHz-20MHz 150 vectors	0.1Hz-50kHz 0.1Hz-50kHz 0.1Hz-50kHz	Full Arbitrary Waveform	Full Arbitrary Waveform	1mHz-50MHz 1mHz-50MHz 1mHz-50MHz 1mHz-50MHz	1mHz-50MHz 1mHz-50MHz 1mHz-50MHz 1mHz-20MHz
Modes Trigger Gate Counted Burst	ext ext 1 to 1999	int/ext int/ext	int/ext int/ext int subroutine	int/ext int/ext 1 to 1999	Creates signals from six basic Waveforms	Full Arbitrary Waveform	Full Arbitrary Waveform	ext ext 1-1999	ext ext 1-1999
Modulation AM FM PM PWM		int/ext int/ext	int subroutine Arbitrary	ext ext	int int int	Full Arbitrary Waveform	Full Arbitrary ext HP 11776A	ext ext ext	ext ext
Sweep Lin. Log. VCO		int/ext int/ext	int int int sub routine	int int ext	int none int	Full Arbitrary Waveform	Full int/ext Waveform	ext int/ext ext	ext
Output (into 50 Ohms) Amplitude (p-p) DC Offset Output Impedance- Ω	16V $\pm 8V$ 50	10V $\pm 4.5V$ 50	10V $\pm 5V$ 0150	10V $\pm 5V$ 50	10V $\pm 5V$ 50	16V $\pm 8V$ 50	2V 50	16V $\pm 8V$ 50	20V $\pm 10V$ 50/1000
Programmability			HP-IB	HP-IB	HP-IB	HP-IB	HP-IB	HP-IB	HP-IB
Notes			2 independent channels, also AC current and 6-digit precision DC voltage or current.	also 1/2 cycle bursts, phase lock	4 internal channels. One is modulated or sequenced	2 analog outputs dig./analog signals simultaneously	HP Series 300 Controller, plus HP 11776A Software recommended		
Catalog page	426	427	430	428	414	421	378	424	423

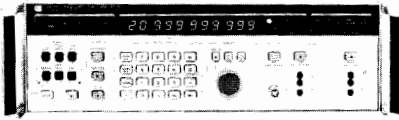

Synthesizers

Synthesizers provide sinewaves with the focus on a very high frequency stability and excellent level accuracy. You can choose among different output impedances. The HP 3335A generates sinewaves up to 81 MHz and the HP 3336A/B/C has modulation capabilities.

Synthesized Function Generators

Synthesized function generators combine the frequency stability of a synthesizer with the feature set of the function generator. The HP 3324A has good synthesizer performance and versatile sweep modes which are phase continuous over the full frequency range. In addition, the HP 3325B provides various modulation capabilities and excellent synthesizer performance. The HP 3326A plays a special part because of its two channels, which can be combined in various ways to produce two-tone signals or calibrated two-phase signals.

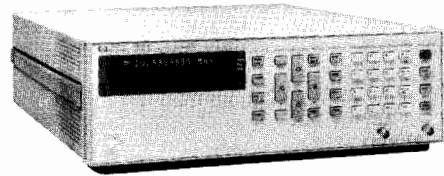

Which function generator do you need?

HP's function generators and synthesizers are the best solution for most applications. The tables shown on these two pages will help you to determine the right one for your application. The instruments are split into categories, depending on their main specifications. For an explanation of the instrument's full range of capabilities, see the following information.

Broad application range

If your applications involve a large variety of measurements then one of HP's standard function generators is the right solution.

Simulating real life signals

HP's Arbitrary Function Generators are dedicated for the simulation of real-life signals. Ranging from disc drive or video test signals to mechanical vibration simulation. Applications such as VOR, FM stereo and communications signalling are covered by the Multifunction Synthesizer HP 8904A.

Versatility and speed

Many applications require standard waveforms over the full frequency range up to 50 MHz and with versatile operating modes. These requirements can be fulfilled with the HP 8116A and HP 8165A. Especially for those applications requiring 50 MHz in conjunction with good frequency stability the HP 8165A can be recommended.

Highly accurate reference sources

Applications such as PLL-testing, calibration of measurement instruments and testing of Frequency Division Multiplex equipment are ideally suited for HP's synthesizers. The very stable frequency source and the excellent level accuracy make these synthesizers the right choice if a reference source is required.

Accuracy and versatility

Synthesized function generators are for those applications which require a combination of an accurate frequency source and a versatile function generator. Sweeping over the entire frequency range without any phase discontinuity makes these generators ideal for applications such as simulation of rotation signals and filter testing. Even the calibration of phase measuring instruments is possible by programming a certain phase offset between two generators or using the HP 3326A's two outputs.

HP Function Generators Summary II

HP Models	SYNTHESIZERS		SYNTHESIZED FUNCTION GENERATORS		
	3335A	3336A/B/C	3324A	3325B	3326A
Sinewave Min. Frequency Max. Frequency	200Hz 81MHz	10Hz 21MHz	1mHz 21MHz	1μHz 21MHz	DC 13MHz
Frequ. Stability	10 ⁻⁹ /day	1.5x10 ⁻⁹ /day	10 ⁻⁷ /month	10 ⁻⁷ /month	10 ⁻⁷ /month
Frequ. Resolution	1mHz	1μHz	1mHz	1μHz	1μHz
Waveforms Square Triangle Ramp Pulse			1mHz-11MHz 1mHz-11kHz 1mHz-11kHz	1MHz-11MHz 1mHz-11kHz 1mHz-11kHz	DC - 13MHz DC - 13MHz
Modulation AM FM PM PWM		ext		int/ext int/ext	int/ext int/ext ext
Sweep Lin. Log. Discrete VCO	int	int int	int int int	int int int	int int
Level Range - 50 Ω	-87 to +13dBm	-71 to + 8dBm	10V(p-p)	10V(p-p)	10V(p-p)
Level Resolution	0.01 dB	0.001 dB	4 digits	4 digits	4 digits
Level Accuracy	±0.1 dB	±0.08 dB	±0.9 dB	±0.9 dB	±1.0 dB
DC Offset-50Ω			±5V	±5V	±5V
Output impedance-Ω	50/75/124/ 135	50/75/124/ 135/150/600	50	50	50
Spurious	-75 dBc	-70 dBc	-55 dBc	-70 dBc	-70 dBc
Phase noise	-58 to -70 dBc	-64 dBc	-50 dBc	-60 dBc	-66 dBc
Notes			60MHz TTL clock, multi-interval and multi-marker sweep	Modulation source can be used separately	2 channels, two-tone and two phase signals
Catalog page	420	420	416	418	429

FREQUENCY, FUNCTION & WAVEFORM SYNTHESIZERS

Multifunction Synthesizer

Model 8904A

- Sinewaves dc to 600 kHz
- Square, ramp, triangle dc to 50 kHz
- Direct digital synthesis
- Tone, DTMF, digital sequence modes
- One or two outputs
- One to four internal channels
- AM, FM, θ M, DSBSC and pulse modulation
- External timing control for fast hop

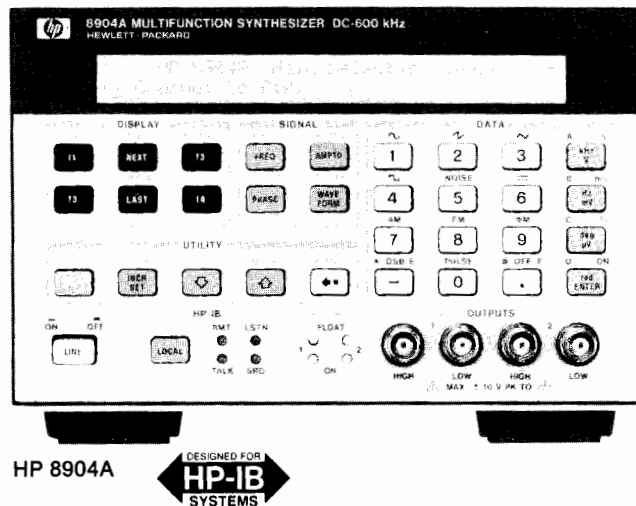

HP 8904A Multifunction Synthesizer

The HP 8904A Multifunction Synthesizer uses the latest VSLIC technology to create complex signals from six fundamental waveforms. The standard HP 8904A digitally synthesizes precise sine, square, triangle, ramp, white noise, and dc waveforms and routes these signals to a single output. Option 001 adds three more identical internal synthesizers (channels) which either can modulate the first synthesizer or be summed to the output. Frequency, amplitude, waveform, phase, and destination can be set independently for each synthesizer. Available modulation types for channel A include AM, FM, θ M, DSBSC, and pulse modulation. Option 002 adds a second output, providing a second, separate signal for two-channel applications. Option 003 adds fast hop and digital modulation capability to the HP 8904A. All this unique capability makes the HP 8904A a powerful new tool for demanding applications like VOR, ILS, FM Stereo, and communications signaling.

Function Synthesizer

The HP 8904A Multifunction Synthesizer delivers synthesizer accuracy, along with six waveforms in a compact, economical package. Broad sinewave frequency coverage from 0 Hz to 600 kHz with 0.1 Hz resolution make the HP 8904A ideal for a number of low-frequency applications. In addition to sinewave generation, the HP 8904A has five other standard functions: square, triangle, ramp, dc, and Gaussian white noise. Of these five, square, ramp, and triangle functions are available from 0 Hz to 50 kHz. All waveform values in the HP 8904A are DIGITALLY calculated in real time by Hewlett-Packard's Digital Waveform Synthesis IC. The use of this chip results in signals with very well-defined accuracy and exact repeatability.

Two Outputs

Option 002 adds a second, identical synthesizer and floating output section to make the HP 8904A TWO synthesizers in one half-rack width instrument. Frequency, amplitude, waveform, and phase can be independently set for each of the two synthesizers.

Although both synthesizers are independent, the relative phase between the two outputs can be controlled precisely. Either synthesizer can be varied in phase from 0 degrees to 359.9 degrees with a resolution of 0.1 degree. Testing phase detectors, servo systems, shaft encoders, sonar, and other phase sensitive two-port devices is easy and accurate with the HP 8904A Option 002.

Complex Signal Generation

By adding three more (total of four) internal synthesizers which can modulate or be summed with synthesizer A (channel A), Option

001 is the key to complex signal generation for the HP 8904A Multifunction Synthesizer. All four internal synthesizers can be set to generate different waveforms, frequencies, amplitudes, and phase offsets at the same time. These signals then can be DIGITALLY summed before routing to the output. In addition to summing, Option 001 allows channels B, C, and D to be used as modulation sources for channel A. The allowable modulation types for channel A are: AM, FM, θ M, DSBSC (Double Sideband Suppressed Carrier) and pulse modulation. Using summation and modulation, the HP 8904A Option 001 can generate precise VOR composite, ILS composite, and FM Stereo Multiplex composite signals. Only your imagination limits the possibilities for signal generating with the HP 8904A Multifunction Synthesizer.

Communication Signaling

In addition to the extra channels, Option 001 also adds three sequence modes to the HP 8904A: tone sequence mode, DTMF sequence mode, and digital sequence mode. These modes make the HP 8904A a powerful tool for generating sequences used in communications signaling. Tone sequence mode allows entry of sixteen unique sine wave tones, each with an "on-time" and "off-time". From these sixteen tones, sequences can be built up to a length of 250 tones. The minimum on and off time duration is 800 μ s with 10 μ s resolution while the maximum value is 655.35 ms. Digital sequence mode can generate digital bit streams up to 1000 bits in length. Minimum period in the digital mode is 100 μ s with 10 μ s resolution. On and off "levels" in the digital mode can be set to any value for simulating different logic families and asserted "high" or asserted "low" logic conventions. For ease of entry, data may be entered in binary, octal, or hexadecimal formats. All three modes contain extensive sequence-editing features and three control modes: single sequence, continuously repeat sequence, and manual step-through the sequence.

Fast Hop

Option 003 adds the ability to hop the HP 8904A in frequency, phase, and/or amplitude. Up to 16 frequency/phase/amplitude states can be entered into the "HOP RAM" memory. To hop, an external device must address the four-bit TTL-level address bus provided on the digital port connector on the rear panel. As the address supplied to the bus is varied, the HP 8904A will hop to the frequency/phase/amplitude state that corresponds to that address of the HOP RAM memory. Fast hop can be performed only on channel A. Phase continuous frequency switching can be done in as little as 8 μ s.

HP 8904A Specifications

Frequency

Range:

Sinewave: 0 Hz to 600 kHz.

Square, triangle, ramp: 0 Hz to 50 kHz.

Resolution: 0.1 Hz.

Accuracy:

Internal 10 MHz timebase: ± 50 ppm.

AC Amplitude

Range: 0 to 10V p-p into a 50 Ω load.

Resolution: 3 1/2 digits.

Accuracy (>40 mV p-p into 50 Ω):

Sine: 1%, 0.1 Hz to 100 kHz; 3%, 100 kHz to 600 kHz.

Flatness (>630 mV p-p into 50 Ω): $\pm 0.1\%$ (± 0.009 dB), 0.1 Hz to 100 kHz. $\pm 1.0\%$ (± 0.09 dB), 100 kHz to 600 kHz.

DC Amplitude

Range: 0 to ± 10 V open circuit.

Resolution: 3 1/2 digits.

Accuracy: ± 6 mV or $\pm 0.6\%$, whichever is greater.

Spectral Purity (sine wave)

THD+N (including spurs, amplitude >50 mV rms):

-63 dBc rms (0.07%), 20 Hz to 7.5 kHz, 30 kHz BW.

-63 dBc rms (0.07%), 7.5 kHz to 20 kHz, 80 kHz BW.

-55 dBc rms (0.18%), 20 kHz to 100 kHz, 750 kHz BW.

Typical THD+Noise in 80 kHz measurement BW at 5V_{p-p} into a 50 Ω Load.

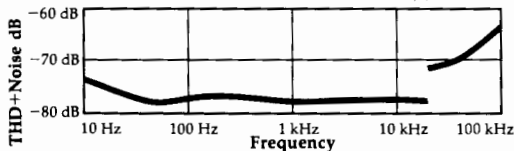

Phase (sine wave)

Range: 0° to 359.9°.

Resolution: 0.1°.

Increment accuracy (relative to 0° for a fixed frequency):

$\pm 0.05^\circ$, 0.1 Hz to 100 kHz.

Gaussian Noise

Spectral characteristic: Equal energy per unit bandwidth ("white").

Flatness (>100 mV p-p into 50 Ω): typically

± 0.5 dB, 0.1 Hz to 100 kHz.

± 1.0 dB, 100 kHz to 600 kHz.

Option 001 Specifications

Modulation for channel A ONLY, and specified for sinewave carrier and modulation. Internal channels B, C, and D can be used to modulate channel A either collectively with one modulation type, or to provide simultaneous modulation of channel A with any of the available modulation types. External modulation is NOT possible.

Amplitude Modulation (with Option 001)

Rate: 0 Hz to 600 kHz.

Depth range: 0% to 100% of carrier amplitude.

Resolution: 0.1% of carrier amplitude.

Frequency Modulation (with Option 001)

Range: 0 Hz to 600 kHz.

Deviation range: 0 Hz to 600 kHz.

Resolution: 0.1 Hz or 3 1/2 digits, whichever is less.

Phase Modulation (with Option 001)

Rate: 0 Hz to 600 kHz.

Range: 0° to 179.9°/channel, except:

$[(\text{mod. freq.} \times \text{deviation}/57.3) + \text{carrier freq.}] \leq 600$ kHz.

Resolution: 0.1° or 0.001 radians.

Pulse or DSBSC Modulation (with Option 001)

Rate: 0 Hz to 50 kHz (up 600 kHz for DSBSC).

Summation (with Option 001)

Two, three or four channels may be summed into a single output. Two or three channels may be summed for modulation of channel A. All combinations of channels are acceptable, EXCEPT FOR: [A+C and B+D at the same time] or [A+D and B+C at the same time].

FM stereo multiplex separation (L-R): typically >65 dB, audio frequency 20 Hz to 15 kHz.

Channel to channel phase accuracy (equal amplitude sinewaves summed to one output): $\pm 0.1^\circ$ or 30 ns, 0.1 Hz to 100 kHz, whichever is greater.

Tone Sequence (with Option 001)

Number of different frequencies: 16 user-definable tones each with an individual on time and off time.

On/off time duration: 0 ms, 0.80 ms to 655.35 ms.

Sequence length: 250 tones, user-definable from front panel or HP-IB programmable.

DTMF Sequence (with Option 001)

Number of tone pairs: 16 standard DTMF tone pairs (0-9, A-D, #, *).

On/Off time duration: 0 ms, 1.0 ms to 655.35 ms.

Sequence length: 250 DTMF tones, user-definable from front panel or HP-IB programmable.

Digital Sequence (with Option 001)

User definable: On level, Off level, and period.

Sequence entry: Binary, Octal, or Hexidecimal.

Sequence length: up to 1000 bits.

Period duration: 0.10 ms to 655.35 ms.

General

Output impedance: 50 $\Omega \pm 3\%$ typically, 0.1 Hz to 600 kHz.

Output type: floating or grounded, HP-IB programmable.

Maximum float voltage (signal+float): 10V peak maximum from high or low side to chassis ground.

Operating temperature range: 0° C to 50° C.

Storage temperature range: -20° C to 70° C.

Humidity range: 95% RH, 0° C to 40° C.

Remote operation: HP-IB. All functions except the line switch are remotely controllable.

HP-IB functions: SH1, AH1, T6, TE0, L4, LE0, SR1, RL1, PP1, DC1, DT0, C0.

Power requirements: 100V, 120V; $\pm 10\%$; 48 to 440 Hz.

220V, 240V; $\pm 10\%$; 48 to 66 Hz. 80 VA max.

Weight: Net, 5.9 kg (12.8 lb); shipping, 13 kg (28.6 lb).

Size: 133H X 213W X 513 mmD (5.25" X 8.36" X 20.2").

Ordering Information

HP 8904A Multifunction Synthesizer (one output standard)¹ **Price** \$2,750

Opt 001 Add three (two when ordered with option 002) internal channels, Channel A modulation, summation, and sequence capability +\$1,575

Opt 002 Add second internal synthesizer and output capability +\$1,250

Opt 003 Add fast hop and digital modulation capability +\$525

Opt 004 Connectors on rear panel only +\$50

Opt 910 Provides an additional operation and calibration manual (08904-90007) and two service manuals (08904-90008) +\$123

Opt 915 Add service manual (08904-90008) +\$36

Opt W30 Extended repair service. See page 725. +\$65

08955-60014 560 Ω feedthrough barrel for 600 Ω output impedance \$170

5061-9657 Rack Mount Adapter Kit (for rack mounting a single HP 8904A) \$60

5061-9697 Support Shelf Kit (for rack mounting two HP 8904s side by side) \$195

HP 8904A Retrofit Kits (customer retrofittable):

HP 11816A Retrofit Kit for Option 001 \$1,905

HP 11817A Retrofit Kit for Option 002 \$1,520

HP 11818A Retrofit Kit for Option 003 \$620

¹HP-IB cables not included. For description and price, see page 569.

FREQUENCY, FUNCTION & WAVEFORM SYNTHESIZERS

1 MHz to 21 MHz Synthesized Function/Sweep Generator

Model 3324A

- Reference Source
- Function Generator
- Programmable
- Multi-Interval Sweeper
- Two-Phase Signals
- 60 MHz TTL clock

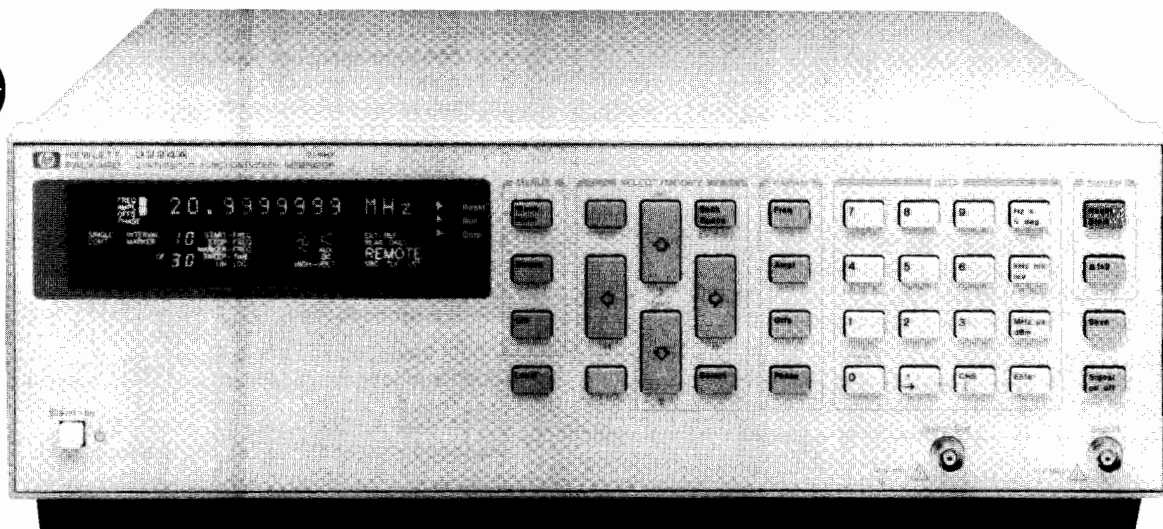

HP 3324A

The HP 3324A Synthesized Function/Sweep Generator

The HP 3324A complements HP's family of synthesized function generators. It combines good synthesizer quality with extended sweep capabilities, at a low price.

The Reference Source

Many applications, like PLL testing and calibration of measurement instruments, require a frequency reference which can be accurately tuned and which is stable over a long period of time. The accuracy and stability of the HP 3324A fulfills this requirement.

For those applications which require a better stability than 5 ppm/year, a high stability frequency reference oven provides a stability of 0.05 ppm/week (optional).

Good Spectral Purity

In addition to the highly stable frequency the HP 3324A provides good sinewave spectral purity with -50 dBc phase noise and -55 dBc spurious signals.

The Clock Generator (1 MHz to 60 MHz)

Complex test set-ups can be built only if a reliable clock generator minimizes jitter or timing uncertainties. The HP 3324A provides clock frequencies from 1 MHz up to 60 MHz - synthesized over the full frequency range.

The Variety of Waveforms

Sine, square, triangle and ramp are the waveforms which make the HP 3324A a function generator, therefore it can compete with other versatile function generators but with the advantage that all waveforms are generated with the accuracy of a synthesizer. The linearity of triangle and ramp waveforms (up to 11 kHz) is 0.05% of full p-p output, thus making it, for example, the ideal generator for the fast evaluation of linearities of Analog to Digital Converters.

Multi-Interval Sweeping

At this time linear and logarithmic sweeps are standard for a generator, like the HP 3324A, but interval sweep capabilities are new.

This means that up to 50 different sweep intervals can be programmed. Intervals can be swept linearly or logarithmically. Each interval

has its individual start and stop frequency, sweep time and if it is a "linear" interval it can contain a marker frequency. A user definable sequence which can contain up to 100 intervals allows the repetition of certain intervals and the mixture of "logarithmic" and "linear" intervals.

Sweeping in intervals is useful for applications such as Frequency Shift Keying or simulation of rotating signals. It also makes the operation with the HP 3324A more convenient than with standard sweep generators.

The HP 3324A operates in all sweep modes phase-continuous over the full frequency range (1 MHz to 21 MHz).

Two-Phase-Signals

For devices which require phase dependent input signals the HP 3324A is the right stimulus.

For synchronisation two HP 3324A can be connected with BNC cables. With the Automatic Phase Calibration option the phase offset between both instruments is automatically calibrated to 0 degree. After calibration the phase offset can be adjusted at one or both instruments to between $\pm 719.9^\circ$.

High Output Voltage

If more than 10 V (p-p) amplitude is required then the High Voltage Option enhances the amplitude range up to 40 V (p-p) (limited for frequencies up to 1 MHz).

Structured Front Panel

The HP 3324A's front panel is clearly structured and is supported by an alphanumeric fluorescence display. The status of the instrument can be seen immediately, as all of the selected parameters and functions are displayed.

Specifications

For complete specifications refer to the HP 3324A data sheet (Pub. No. 5952-9678).

Waveforms

Sine, Square, Triangle, negative and positive Ramps, DC, TTL clock

Frequency Range

Sine:	1 mHz - 21,000,000,0 MHz
Square:	1 mHz - 11,000,000,0 MHz
Triangle/Ramps:	1 mHz - 11,000,000,0 kHz
Auxiliary TTL clock:	1 mHz - 60,000,000,0 MHz

Resolution

1 mHz for up to 999,999,999 kHz, 100 mHz for 1 MHz up to 21,000,000,0 MHz

Accuracy: ± 5 ppm of selected value, 20° to 30° C

Stability

± 5 ppm/year, 20° to 30° C, standard (see also option 001)

Main Signal Output

Impedance: 50 Ω

Amplitude (all waveforms except Auxiliary TTL clock)

Range: 1 mV to 10 V (p-p) in 8 amplitude ranges, 1-3-10 sequence.

Resolution: 4 digits (0.03% of full range)

Accuracy (without DC offset)

Sine

1mHz-100kHz: ≥ 3 V (p-p) ± 0.2 dB

>100kHz-21MHz: ≥ 3 V (p-p) ± 0.4 dB

Squarewave

1mHz-100kHz: ≥ 3 V (p-p) $\pm 1.5\%$

100kHz-10MHz: ≥ 3 V (p-p) $\pm 5\%$

Triangle

1mHz-2kHz: ≥ 3 V (p-p) $\pm 1.5\%$

2kHz-10kHz: ≥ 3 V (p-p) $\pm 5\%$

Sinewave Spectral Purity

Phase Noise

- 50 dBc for a 30 kHz band centered on a 20 MHz carrier (excluding ± 1 Hz about the carrier).

Spurious

All non-harmonically related output signals will be more than 55 dB below the carrier.

Sinewave harmonic distortion

Harmonically related signals will be less than the following levels relative to the fundamental:

Frequency Range	Harmonic Level
.1 Hz - 199 kHz	- 60 dBc
200 kHz - 1.99 MHz	- 40 dBc
2 MHz - 14.9 MHz	- 30 dBc
15 MHz - 20 MHz	- 25 dBc

Waveform Characteristics

Squarewave characteristics

Rise/Fall time: (10% to 90% at full output) = < 20 ns

Overshoot: 5% of peak to peak amplitude at full output

Triangle/Ramp characteristics

Linearity (10%-90%, 10 kHz): $\pm 0.05\%$ of full p-p output voltage

DC Offset

Range: DC only (no AC signal): 0 to ± 5 V/50 Ohm

Resolution: 4 digits

Phase Offset

Range

$\pm 719.9^\circ$ with respect to arbitrary starting phase or assigned zero phase. See also option 003 and 004.

Resolution: 0.1°

Frequency Sweep

Sweep sequence modes: single, continuous

Sweep function modes:

Multi-Interval: Up to 50 different intervals can be sequenced and repeated in a sequence which can contain up to 100 intervals.

Multi-Marker: One marker frequency can be set in each interval or up to 9 marker frequencies can be set if only one interval is used.

Sweep time (settable for each interval): Linear, 10 ms to 10⁵s. Log. 100 ms to 10⁵s.

Maximum sweep width (settable for each interval): full frequency range of the main signal output for the waveform in use, except minimum log start frequency is 1 Hz.

Phase continuity: sweep is phase continuous over the full frequency range of the main output.

Auxiliary Outputs

SYNC output

Phasesynchronous squarewave with same frequency as main signal output, output impedance: 50 Ohm

Auxiliary freq. output: Square, freq. range: 21 MHz to 60 MHz

X-Axis drive output: Linear ramp proportional to sweep time

Z-Axis blank output: Output signal depending on sweep state.

Sweep marker output: Pulses (TTL and CMOS compatible) at selected marker frequencies

1 MHz reference output

1 MHz squarewave for phase locking additional instruments to the HP 3324A, output impedance: 50 Ohm, output amplitude: 0 dBm.

Auxiliary Input

Reference input: For phase locking the HP 3324A to an external frequency reference. Signal from 0 dBm to 20 dBm into 50 Ohm.

HP-IB Interface Functions

Interface functions: SH1,AH1,T6,L3,SR1,RL1,PP0, DC1,DT0,C0,E2

Option 001, High Stability Frequency Reference

Aging rate

$\pm 5 \times 10^{-8}$ /week after 72 hours continuous operation.

$\pm 1 \times 10^{-7}$ /month after 15 days continuous operation.

10 MHz oven output

10 MHz squarewave for phaselocking additional instruments to the HP 3324A, output impedance: 50 Ohm, output level: > 4.5 dBm

Option 002, High Voltage Output

Frequency range: 1 mHz to 1 MHz

Amplitude

4 mV to 40 V (p-p) in 8 ranges, 4-12-40 sequence into 500 Ohm, < 500 pF load.

Accuracy: $\pm 2\%$ of full output for each range at 2 kHz.

Flatness: $\pm 10\%$ relative to programmed amplitude.

Waveform characteristics

Sinewave harmonic distortion

Harmonically related signals will be the same as the standard instrument up to 1 MHz.

Squarewave characteristics (500 Ohm, 500 pF load)

Rise/Fall Time: (10% to 90% of p-p output voltage) ≤ 125 ns

Overshoot: $\leq 10\%$ of p-p output voltage

Output impedance: < 3 Ohm at DC, < 10 Ohm at 1 MHz

DC Offset: 4 times the specified range of the standard instrument

Options 003 and 004, Automatic Phase Calibration

These options provide automatic phase calibration if two HP 3324As are connected to generate phase related signals. Option 003 has to be installed into one of the instruments and option 004 into the other.

Phase shifted signals can be achieved by selection of a certain phase offset.

General

Power: 100/120/220/240 V, 48 to 66 Hz, max. 100 VA

Weight: 11 kg net

Dimensions: 132.6 mm high x 425.5 mm wide x 497.8 mm deep

Ordering Information

HP 3324A Synthesized Function/Sweep Generator	Price
Opt 001 High Stability Frequency Reference	\$765
Opt 002 High Voltage Output	\$255
Opt 003 Automatic Phase Calibration, slave	\$450
Opt 004 Automatic Phase Calibration, master	\$270
Opt 907 Front Handle Kit	\$55
Opt 908 Rack Flange Kit	\$33.50
Opt 909 Rack Flange and Handle Combination Kit	\$82.50
W30 2 years additional hardware service	\$90

Fast-Ship product - see page 734

FREQUENCY, FUNCTION & WAVEFORM SYNTHESIZERS

Synthesizer/Function Generator 1 μ Hz to 21 MHz

HP 3325B

- Fully synthesized microhertz resolution
- Functions—sine, square, triangle, ramps, arbs, dc offset
- Internal programmable modulation source
- Log, lin, discrete sweep
- Excellent signal purity
- dc to 60 MHz SYNC output

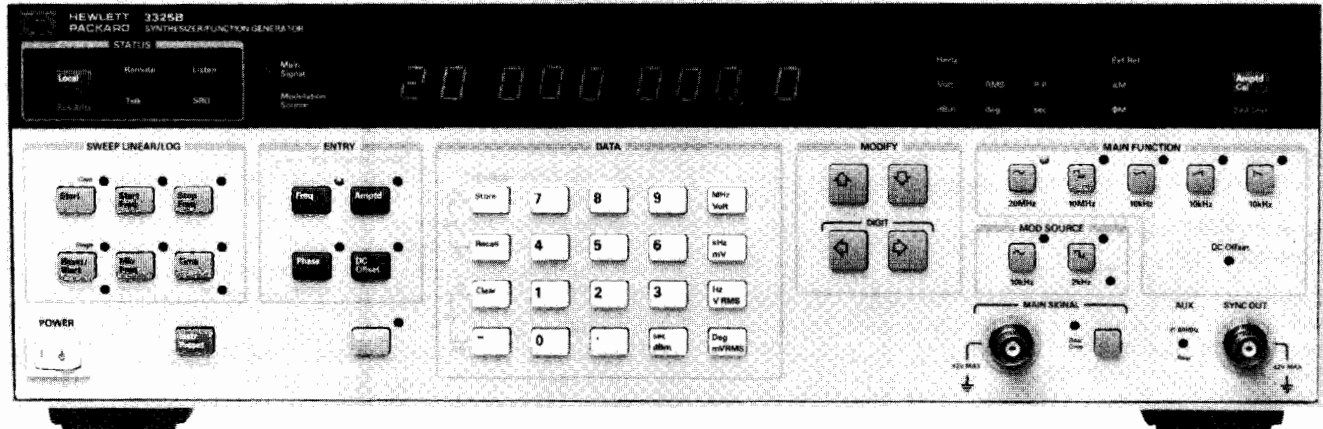

HP 3325B

DESIGNED FOR
MATE
SYSTEMS

HP 3325B Synthesizer/Function Generator

The HP 3325B is a 1 μ Hz to 21 MHz synthesizer/function generator with high performance, exceptional versatility and value. Testing is made fast and efficient in general purpose applications whether on the bench or in ATE systems.

Synthesizer Precision

HP 3325B frequency accuracy is determined by a precision frequency reference and can be set with a resolution of 1 μ Hz. It has up to -65 dBc harmonic and -70 dBc spurious levels for precision measurements. The phase of the output signal can be precisely controlled ± 719.9 deg with 0.1 deg resolution, and multiple HP 3325Bs can be locked together for multi-phase applications.

Function Generator Versatility

Precision squarewaves to 10,999,999 MHz have 20 ns risetimes with synthesizer accuracy and precision. Triangle and ramp waveshapes are also available with .05% linearity up to 10,999,999 kHz. DC and phase offset can be added to these waveshapes. The modulation source can be used as an arbitrary function generator via HP-IB, providing user-defined waveshapes. These features make the HP 3325B one of the most versatile sources for bench or ATE system applications. Save-recall memory includes 10 non-volatile memory locations, for simple and rapid access to frequently used test setups.

Discrete Sweep

The enhanced feature set of the HP 3325B includes 100-segment discrete sweep capability which allows arbitrarily defined multi-segment linear or stepped sweeps and tone sequences. This complements its linear and log, phase continuous sweep capability.

Internal Modulation Source

A built-in programmable modulation source provides sine, square and arbitrary waveshapes for internal amplitude or phase modulation, or for use as a second source. In addition, a rear panel sync output provides a TTL compatible dc to 60 MHz signal with 1 μ Hz resolution for use as a precision, high resolution clock signal, and extended frequency coverage.

ATE Systems Compatibility

All functions, including frequency, amplitude, phase, modulation, sweep and waveshapes are programmable via HP-IB or RS 232 interface. The HP 3325B is fully compatible in form, fit and function, with the HP 3325A. All HP-IB programs written for the HP 3325A are fully compatible with the HP 3325B. An isolated interface, combined with floating outputs and inputs assures trouble free operation in a systems environment. The main output can be switched to the rear panel by a simple front panel keystroke, or under program control for optimum systems configuration.

Easy to Maintain

General or specific self-tests can be initiated from the front panel or by remote control. Pass/fail indications and specific self-test status reports are provided on the display and through the remote interfaces. Elapsed time and instrument identification information is available from the HP 3325B's memory to determine when calibration is required.

Specifications

Waveforms

Sine, Square, Triangle, negative and positive Ramps.

Frequency

Range

Sine: 1 μ Hz to 20,999 999 999 MHz
Square: 1 μ Hz to 10,999 999 999 MHz
Triangle/ramps: 1 μ Hz to 10,999 999 999 kHz

Resolution: 1 μ Hz, < 100 kHz
 1 mHz \geq 100 kHz

Accuracy: $\pm 5 \times 10^{-6}$, 20° to 30°C at time of calibration

Warm-up time: 20 minutes to within specified accuracy

Main signal output (all waveforms)

Impedance: 50 Ω

Connector: BNC; switchable to front or rear panel, nonswitchable with option 002, except by internal cable change.

Amplitude

Range: 1 mV to 10 Vp-p in 8 amplitude ranges, 1-3-10 sequence (10 dB steps), into 50 Ω load.

Function	Sine		Square		Triangle/Ramps	
	min	max	min	max	min	max
peak-peak	1.000 mV	10.00 V	1.000 mV	10.00 V	1.000 mV	10.00 V
rms	0.354 mV	3.536 V	0.500 mV	5.000 V	0.289 mV	2.887 V
dBm (50 Ω)	-56.02	+23.98	-53.01	+26.99	-57.78	+22.22

Resolution: 0.03% of full range or 0.01 dB (4 digits).

Amplitude accuracy (without dc offset, relative to programmed amplitude and accuracy)

Sinewave amplitude accuracy

1 mHz to 100 kHz: ± 0.1 dB, ≥ 3 Vpp; ± 0.2 dB, < 3 Vpp
100 kHz to 20 MHz: ± 0.4 dB, ≥ 3 Vpp; ± 0.6 dB, 0.1 to 3 Vpp

Squarewave amplitude accuracy

1 mHz to 100 kHz: 1%, ≥ 3 Vpp; 2.2%, < 3 Vpp
100 kHz to 10 MHz: 11.1%, ≥ 3 Vpp; 13.6%, < 3 Vpp

Triangle amplitude accuracy

1 mHz to 2 kHz: 1.5%, ≥ 3 Vpp; 2.7%, < 3 Vpp
2 kHz to 10 kHz: 5%, ≥ 3 Vpp; 6.2%, < 3 Vpp

Sinewave spectral purity

Phase noise: -60 dB for a 30 kHz band centered on a 20 MHz carrier (excluding ± 1 Hz about the carrier) with high-stability option 001 installed.

Spurious: all non-harmonically related output signals will be more than 70 dB below the carrier (60 dB with dc offset), or less than -90 dBm, whichever is greater.

Sinewave harmonic distortion: harmonically related signals will be less than the following levels (relative to the fundamental) at full output for each range:

Frequency Range	Harmonic Level
0.1 Hz to 50 kHz	-65 dB
50 kHz to 200 kHz	-60 dB
200 kHz to 2 MHz	-40 dB
2 MHz to 15 MHz	-30 dB
15 MHz to 20 MHz	-25 dB

Squarewave characteristics

Rise/fall time: ≤ 20 ns, 10% to 90% at full output

Overshoot: $\leq 5\%$ of peak to peak amplitude, at full output

Settling time: < 1 μ s to settle to within .05% of final value.

Phase Offset

Range: $\pm 719.9^\circ$ with respect to arbitrary starting phase or assigned zero phase

Resolution: 0.1°

Accuracy: $\pm 0.2^\circ$

DC offset

Range: dc only (no ac signal): 0 to ± 5.0 V/50 Ω .

dc + ac: Maximum dc offset ± 4.5 V on highest range, decreasing to ± 4.5 mV on lowest range.

Resolution: 4 digits

Sinewave amplitude modulation

Modulation depth at full output for each range: 0-100%

Modulation frequency range: dc to 400 kHz (0-21 MHz carrier frequency)

Sensitivity: ± 5 V peak for 100% modulation

Sinewave phase modulation

Range: $\pm 850^\circ$, ± 5 V input

Modulation frequency range: dc -5 kHz

Frequency sweep

Sweep time

Linear: 0.01 s to 1000s.

Logarithmic: 1 s to 1000s single, 0.1 s to 1000s continuous.

Discrete sweep

Number of segments: 100 maximum.

Time/Segment: 0.01 s to 1000s, 0.01 s resolution.

Maximum sweep width: full frequency range of the main signal output for the waveform in use, except minimum log start frequency is 1 Hz.

Phase continuity: sweep is phase continuous over the full frequency range of the main output.

Modulation source

Frequency range: sine 0.1 Hz to 10 kHz, square 0.1 Hz to 2 kHz.

Frequency accuracy: 0.1%, typical.

Impedance: drives 10 k Ω or greater load.

Sinewave purity: -34 dBc or better, typical.

Waveforms: sine, square, arbitrary.

Auxiliary inputs and outputs

Reference input: for phase-locking HP 3325B to an external frequency reference signal from 0 dBm to $+20$ dBm into 50 Ω . Reference signal must be a subharmonic of 10 MHz from 1 MHz to 10 MHz.

Auxiliary frequency output: 21 MHz to 60.999 999 999 MHz, under range coverage to 19.000 000 001 MHz, frequency selection from front panel; 0 dBm; output impedance 50 Ω .

Sync output: square wave with V (high) ≥ 1.2 V, V (low) ≥ 0.2 V into 50 Ohm. Frequency range is the same as main signal for front panel sync and dc to 60 MHz for rear panel sync.

X-Axis drive: 0 to $> +10$ V dc linear ramp proportional to sweep frequency, linearity, 10-90%, $\pm 0.1\%$ of final value.

1 MHz reference output: 0 dBm output for phase-locking additional instruments to the HP 3325B.

10 MHz oven output: 0 dBm internal high stability frequency reference output for phase-locking HP 3325B. (Opt. 001 only)

HP-IB interface functions

SH1, AH1, T6, L3, SR1, RL1, PP0, DC1, DT1, C0, E1.

MATE/CIIL Compatibility

For MATE system applications, option 700 provides internal CIIL compatibility.

Option 001 high stability frequency reference

Aging rate: $\pm 5 \times 10^{-8}$ /week (72-h warm up); $\pm 1 \times 10^{-7}$ /month (after 15 days continuous operation).

Ambient stability: $\pm 5 \times 10^{-8}$ (0° to $+55^\circ\text{C}$).

Warm-up time: reference will be within $\pm 1 \times 10^{-7}$ of final value 15 minutes after turn-on for an off time of less than 24 hours.

Option 002 high voltage output

Frequency range: 1 μ Hz to 1 MHz

Amplitude

Range: 4.00 mVpp to 40.00 Vpp (≥ 500 μ , ≤ 500 pF load).

Accuracy: $\pm 2\%$ of full output for each range at 2 kHz.

Flatness: $\pm 10\%$ relative to programmed amplitude

Sinewave distortion: harmonically related signals will be the same as the standard instrument to 1 MHz

Maximum output current: 20 mA pk.

Output impedance: < 2 Ω at dc, < 10 Ω at 1 MHz

dc offset range: 4 times the specified range of the standard instrument.

General

Operating environment

Temperature: 0°C to 55°C .

Relative humidity: 95%, 0°C to 40°C .

Altitude: $\leq 15,000$ ft.

Power: 100/120/220/240 V, $+5\%$, -10% , 48 to 66 Hz; 90 VA, 120 VA with all options; 10 VA standby.

Weight: 9 kg (20 lb) net; 14.5 kg (32 lb) shipping.

Size: 132.6 H x 425.5 W x 497.8 mm D (5.25" x 16.75" x 19.63").

Ordering Information*

HP 3325B Frequency Synthesizer	Price
Opt 001: High Stability Frequency Reference	\$4,590
Opt 002: High Voltage Output	$+\$765$
Opt 700: Internal MATE Programming	$+\$255$
Opt W30: Extended Repair Service. See page 725.	(call)
	$+\$170$

*HP-IB cable not supplied.

FREQUENCY, FUNCTION & WAVEFORM SYNTHESIZERS

Synthesizer/Function Generator

HP 3335A, 3336C

- 200 Hz to 81 MHz
- High spectral purity
- Precision amplitude control
- 1 MHz resolution

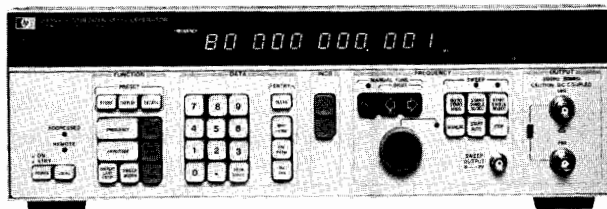

HP 3335A

HP 3335A Synthesizer/Level Generator

The HP 3335A Synthesizer/Level Generator has performance characteristics that make it ideally suited for the telecommunications industry as well as for traditional synthesizer applications, including testing of Frequency Division Multiplex (FDM) equipment and R&D and production testing of communications systems.

Precision Amplitude, Frequency

The HP 3335A incorporates a state-of-the-art attenuator with accuracies of up to ± 0.025 dB over the 81 MHz frequency range. Frequency stability up to $\pm 1 \times 10^{-8}$ /day is provided by an internal temperature-controlled oscillator.

Frequency Sweep, Tracking Generator

The HP 3335A combines the frequency, accuracy and stability of a synthesizer with the time-saving convenience of a digital sweeper. In addition, the HP 3335A operates as a tracking generator with the HP 3746A/B Selective Level Measuring Set (SLMS) or the HP 3586A/B/C Selective Level Meter for automatic or semi-automatic testing of FDM systems.

Specifications

Contact your local HP Sales Office for more information including a data sheet with complete specifications.

Frequency

Standard Range: 200 Hz–81 MHz;

Option 002/004 Range: 75 Ω , 200 Hz–81 MHz; 124 Ω , 10 kHz–10 MHz; 135/150 Ω , 10 kHz–2 MHz.

Option 003 Range: 75 Ω , 200 Hz–81 MHz; 150 Ω , 10 kHz–2 MHz.

Resolution: .001 Hz.

Stability, long term: $\pm 1 \times 10^{-10}$ /day; $\pm 1 \times 10^{-7}$ /month.

Option 001 (high stability frequency reference)

Aging rate: $\pm 5 \times 10^{-8}$ /day; $\pm 2 \times 10^{-8}$ /month.

Spectral purity

Harmonic distortion: 200 Hz–10 MHz: < -45 dBc; 10 MHz–80 MHz: < -40 dBc.

Phase noise: (30 kHz band, excluding ± 1 Hz, centered on the carrier): 9.9 MHz: < -63 dBc; 20 MHz; < -70 dBc; 40 MHz; < -64 dBc; 80 MHz: < -58 dBc.

Spurious: nonharmonically related signals: the greater of -75 dBc or -125 dBm (50/75 Ω), -97 dBm (124 Ω), -68 dBm (135/150 Ω).

Amplitude range

-88.74 dBm to $+13.01$ dBm depending on option

Resolution: 0.01 dB.

Absolute level accuracy (max. output at 100 kHz, 10°C to 35°C): 50/75 Ω ± 0.05 dB; 124/135/150 Ω : ± 0.1 dB.

Flatness (relative to 100 kHz, full amplitude): 50/75 Ω : 1 kHz–25 MHz: ± 0.07 dB, 200 Hz–80 MHz: ± 0.15 dB; 124 Ω : 50 kHz–10 MHz: ± 0.15 dB, 10 kHz–10 MHz ± 0.4 dB; 135/150 Ω : 10 kHz–2 MHz: ± 0.18 dB.

Ordering Information

HP 3335A Synthesizer/Level Generator	Price
Opt 001 High-stability reference $\pm 5 \times 10^{-10}$ /day	\$11,900
Opt 002 Connector (75/124/135 Ω)	+\$1,270
Opt 003 Connector (75/150 Ω)	+\$575
Opt 004 Connector (75 Ω , miniature WECO on 124/135 Ω)	+\$365
	+\$575

- 10 Hz to 20.999 MHz
- 11 digit resolution
- Excellent amplitude accuracy
- 1 MHz resolution

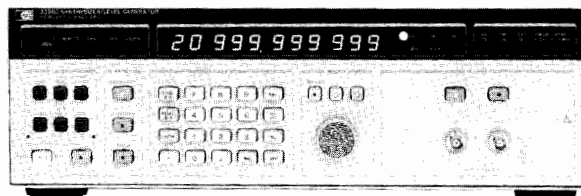

HP 3336C

HP 3336C Synthesizer/Function Generator

The HP 3336C is designed for traditional synthesizer applications as well as R&D and production testing of systems or components. It features precision level control, high spectral purity, optional frequency stability of $\pm 5 \times 10^{-8}$ /week, internal frequency sweep and numerous other user conveniences.

Precision Frequency Measurements, Amplitude Accuracy

A single loop fractional-N synthesis technique allows synthesizer accuracy with 11 digits of resolution, with completely phase continuous frequency sweep over any of the instruments' frequency ranges. HP attenuator technology coupled with custom designs in leveling loops and thermal converters produce amplitude accuracies of up to ± 0.5 dB. The fast leveling loop makes extremely flat sweeps possible at high sweep speeds.

Models HP 3336 A & B are also available for the telecommunications industry (see page 504).

Specifications

Contact your local HP Sales Office for more information including a data sheet with complete specifications.

Frequency

Range: 10 Hz to 20.999 999 999 MHz.

Resolution: 1 μ Hz for frequencies < 100 kHz, 1 MHz for frequencies ≥ 100 kHz.

Aging rate: $\pm 5 \times 10^{-6}$ /year (20° to 30°C).

Amplitude

Range: 50 Ω : -71.23 to $+8.76$ dBm; 75 Ω : -72.99 to 7.00 dBm.

Absolute accuracy: ± 0.05 dB, 20° to 30°C (for the top 9.99 dB of amplitude range at 10 kHz), ± 0.08 dB, 0° to 55°C.

Flatness: 50/75 Ω , ± 0.1 dB (± 0.07 dB with option 005) referenced to 10 kHz.

Amplitude Modulation

Modulation depth: 0 to 100%.

Modulation frequency range: 50 Hz to 50 kHz.

Phase Modulation

Range: 0° to $\pm 850^\circ$.

Linearity: $\pm 0.5\%$ from best fit straight line.

Modulation frequency range: DC to 5 kHz.

Frequency sweep

Sweep time: Linear; 0.01 s to 99.99 s. Single Log: 2 s to 99.99 s.

Continuous Log: 0.1 s to 99.99 s.

Dimensions

Size: 132.6H x 425.5W x 497.8mmD, (5.2" x 16.8" x 19.6").

Weight: net, 10 kg. (22 lb); shipping, 15.5 kg. (34 lb).

Ordering Information

HP 3336C Synthesizer/Level Generator (General Purpose)	Price
Opt 004 High Stability Frequency Reference	\$5,250
Opt 005 High Accuracy Attenuator	+\$685
Opt 907 Front Handle Kit	+\$685
Opt 908 Rack Flange Kit	+\$58
Opt 909 Rack Flange and Handle Kit	+\$34
Opt W30 Extended Repair Service. See page 725.	+\$84
	+\$130

FREQUENCY, FUNCTION & WAVEFORM SYNTHESIZERS

Dual Arbitrary Waveform Generator

Model 8175A Option 002

421

- 2 analog channels / 1 kpoints ea / 50 MHz ea
- individual datapoint durations 20 ns to 9.99 s
- 10 bit amplitude resolution
- digital and analog signals simultaneously

- 4 waveform entry modes; calculator, graphical editing, abs. and rel. levels, various codings
- up to 32 Vp-p output voltage (into open), separately programmable offset (max ± 16 V)

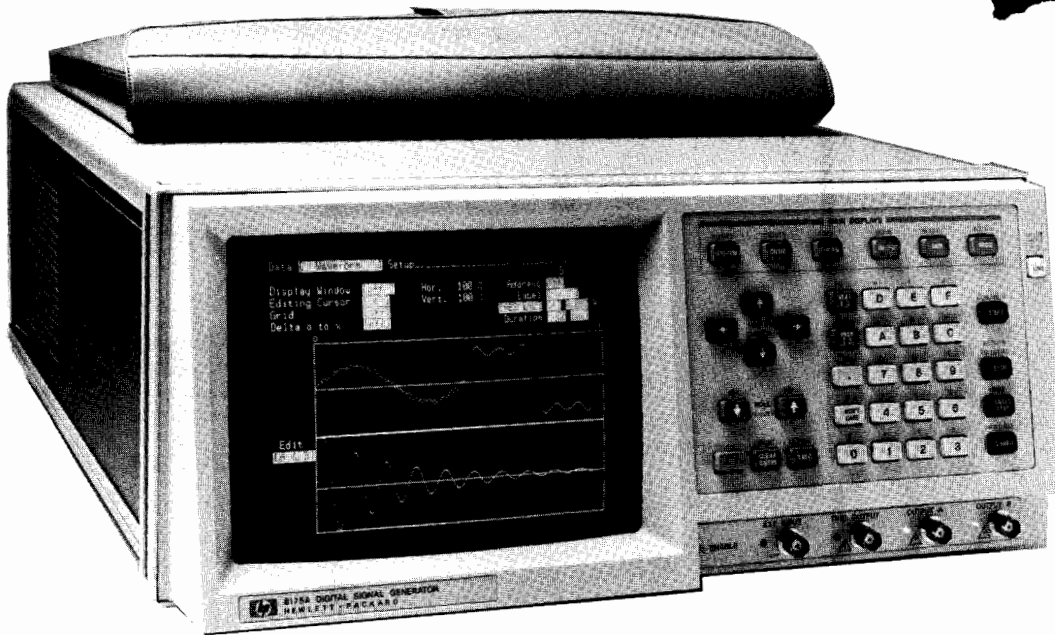

HP 8175A, Option 002; Data Page: Waveform Setup

Application Examples

With the Option 002, the Dual Arbitrary Waveform Generator, the HP 8175A offers the new Arbitrary Waveform mode in addition to the existing Parallel and Serial modes. In the Arbitrary Waveform mode, you have: Dual arbitrary waveform channels, and simultaneous equivalent digital signals. This means you have the ideal source for difficult applications, for example:

- simulation of two dependent variables, like force and distance, at the same time.
- digital and analog stimulation of devices like programmable filters.
- stimulus and compare signals at the same time for DACs or ADCs.

The arbitrary outputs are 50 Mpoints/s, synchronous, but independent in shape and amplitude (max 16 V p-p into 50 Ohm and max 32 V p-p into open), and the waveforms can be set up by means of: a) algorithms (a fundamental set of mathematical functions are available, including noise), b) interpolations (linear and spline), c) graphic or tabular entry of instantaneous level (or amplitude and offset), d) tabular entry of equivalent digital pattern. Additionally, any existing waveform can be modified. One way is simply by tabular or graphical editing. A more powerful alternative is the "Combine" feature. This allows you to combine an algorithm arithmetically with any desired part of the current waveform.

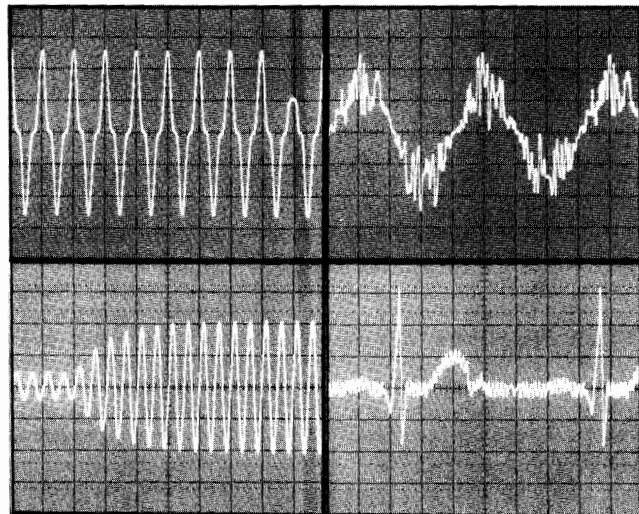

The comprehensive feature set, together with the outstanding memory management and interaction capability, mean that "real-life" simulation for the most exacting circuits is within your grasp.

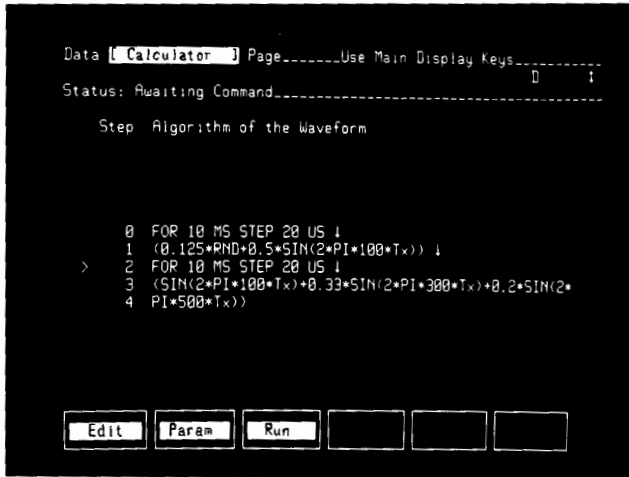

Data Page: Calculator

The built in Calculator provides a comfortable method of setting up very complex, mathematically-definable waveforms by simply entering the formula. Softkeys support most of the fundamental mathematical functions. The Combine capability allows any previously generated function to be combined with the current calculated function. By this means, noise can be introduced into any desired parts of the waveform.

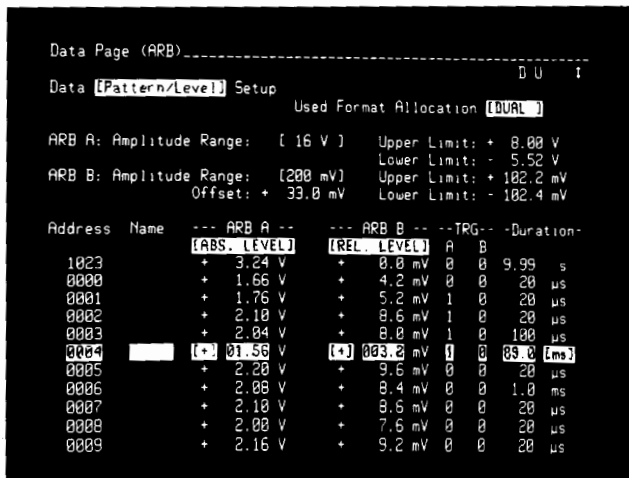

Data Page: Pattern/Level Set-Up

Data Points of a waveform can be entered and displayed in absolute or relative levels or in various codes. Comprehensive waveform editing support is provided. For instance, segments of data points can be moved or copied to other memory locations or waveform segments can easily be exchanged between the two analog channels. In this way it is easy to produce phase shifted signals. Graphical editing of the waveform, including interpolation between data points, is possible on this menu.

Specifications

apply for operating temperatures from 0° to 55°C.

Option 002 Dual Arbitrary Waveform Generator (can be retrofitted in HP service office)

Number of Analog Outputs: 2

Number of Bits: 10

Number of Data Points:

Horizontal: 1024 points

Vertical: 1000 points with additional 24 points override

800 points for 16 V p-p Output Voltage Range

640 points for 32 V p-p Output Voltage Range

Differential Non-Linearity: ≤1 LSB (monotonic)

Output Impedance: 50 Ohm ±5%

Output Levels

Load Impedance: 50 Ohm:

7 Output Voltage Ranges: 0.2 V to 16 V, Res. 0.2 mV to 20 mV

2 Offset Ranges: ±0.8 V and ±8 V (Output Volt. Range >1 V)

Load Impedance: ≥50 kOhm

7 Output Voltage Ranges: 0.5 V to 32 V, Res. 0.5 mV to 50 mV

2 Offset Ranges: ±1.6 V and ±16 V (Output Volt. R. >2V)

Accuracy (Output A and Output B)

Amplitude Accuracy: ±4% ±4 LSB

Offset Accuracy: ±1% of programmed value

±2% of (progr. High Level of p-p Output Volt. +

progr. Low Level of p-p Output Volt.) (if High and

Low Level are identical in magnitude, but opposite in sign, this error

will be zero).

plus:

into 50 Ohm: ±10 mV for 0.2 V, 0.5 V and 1 V ranges

or: ±25 mV for 2 V and 5 V range

or: ±50 mV for 10 V and 16 V range

into ≥50 kOhm: ±20 mV for 0.5 V, 1 V and 2 V ranges

or: ±50 mV for 5 V and 10 V range

or: ±100 mV for 20 V and 32 V range

Timing (for Output A and B)

The maximum sample update rate is 50 MHz.

The Data Point Duration is 20 ns to 9.99 s.

Trigger Output Characteristics:

Number of Trigger Output Channels: 2

Trigger Output Impedance: 50 Ohm ±5%

Trigger Output Levels: ECL into 50 Ohm

TTL into 50 Ohm and ≥50 kOhm

Trigger Pulse Width: The trigger can be set for each individual data point to High Level or Low Level. The trigger width depends on the programmed Data Point Duration.

Ordering Information

Price

HP 8175A Digital/Analog Signal Generator

\$11500

Note: HP 8175A must be ordered with at least option #002 or one of the digital options (refer to page 319).

Opt. 002 Dual Arbitrary Waveform Generator

\$3500

Opt. 908 Rack Flange Kit (P/N 5061-9678)

\$36

Opt. 910 Additional Operating/

\$290

Programming/Service Manual

W30 Two Additional years of HP service

\$280

Opt. 916 Additional Programming Manual

\$72

☎ Fast-Ship product—see page 734.

FREQUENCY, FUNCTION & WAVEFORM SYNTHESIZERS

50 MHz Programmable Signal Source

Model 8165A

423

- Pulse/function capability
- Sine, triangle, square to 50 MHz
- Pulses and ramps to 20 MHz

- Trigger, gate and counted burst
- Synthesizer stability, precision amplitude
- Storage of operating parameters

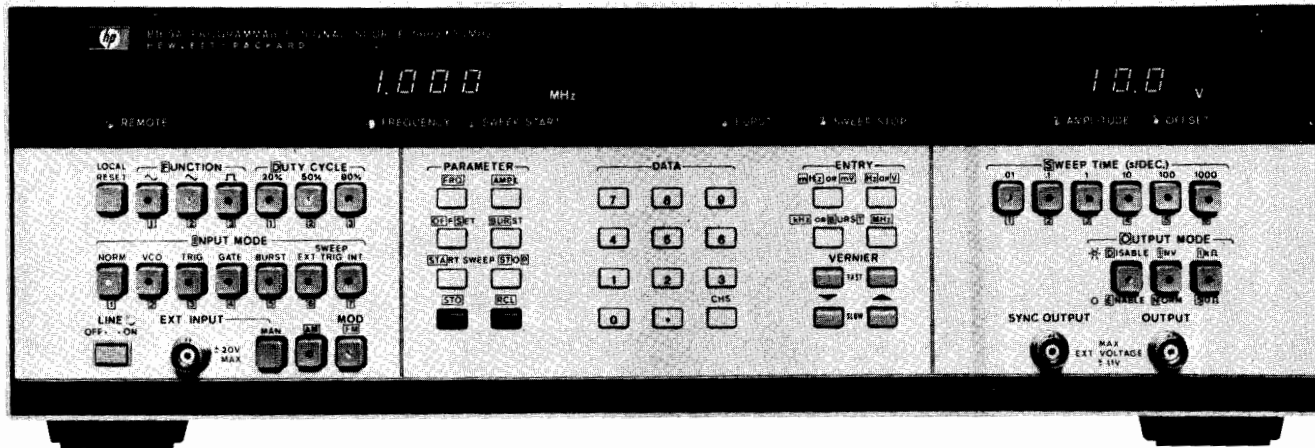

Picture shows 8165A with option 002, AM and Logarithmic Sweep.

Versatility and Simplicity for Systems and Bench

The HP 8165A Programmable Signal Source is a versatile function generator with good accuracy and many trigger features. Microprocessor control assures rapid, accurate setup whether programming locally or via HP-IB.

Operating Set Storage

Ten complete sets of operating information can be stored and recalled. In the event of power failure, battery back up retains all data plus the active settings.

Stability and Resolution

Stable frequency is ensured with an internal crystal. The four-digit frequency display provides a 1 μ Hz resolution in the 1 to 9.999 MHz range. In Normal mode, the accuracy is 0.001% with a stability of $\pm 1 \times 10^{-6}$.

Specifications

Waveforms and Frequency Range

Sine, square, triangle (50% duty cycle): 1.000 mHz to 50.00 MHz.

Pulse/ramp (20, 80% symmetry): 1.000 mHz to 19.99 MHz.

Haversine/havertriangle: please inquire for special option.

Output Characteristics

Range: amplitude and offset independently variable within ± 10 V window.

Source impedance: selectable 50 $\Omega \pm 1\%$ or 1 k $\Omega \pm 10\%$

Amplitude: 10.0 mV_{pp} to 10.0 V_{pp} (50 Ω into 50 Ω)
2.00 V_{pp} to 20.0 V_{pp} (1 k Ω into 50 Ω)

Accuracy	Sine V _{RMS}	Square	Triangle (50%)	Ramp (20%-80%)	Pulse (20%-80%)
<1kHz	$\pm 3\%$	$\pm 2\%$	$\pm 3\%$	$\pm 3\%$	$\pm 2\%$
1kHz-4.99MHz	$\pm 3\%$	$\pm 2\%$	$\pm 3\%$	$\pm 5\%$	$\pm 2\%$
5 MHz-19.9MHz	$\pm 8\%$	$\pm 5\%$	$\pm 10\%$	$\pm 10\%$	$\pm 5\%$
20MHz-50MHz	$\pm 8\%$	$\pm 5\%$	+5% to -20%	-	-

Offset: 0 ± 10 mV to ± 5.00 V (50 Ω into 50 Ω)
0 ± 20 mV to ± 10.0 V (1 k Ω into 50 Ω)

Accuracy: $\pm 1\%$ programmed value $\pm 1\%$ signal V_{pp} ± 20 mV.

Sine Characteristics

Distortion: total harmonic distortion (THD) for fundamental up to 1 MHz: 38 dBc.

Harmonic signals: (fundamental above 1 MHz): ≤ -30 dB.

Square/Pulse Characteristics

Transition times: (10% to 90%): ≤ 5 ns (50 Ω into 50 Ω), ≤ 7 ns (1 k Ω into 50 Ω)

Preshoot/Overshoot/Ringing: $\leq \pm 5\%$ (50 Ω into 50 Ω), $\pm 10\%$ (1 k Ω into 50 Ω).

Triangle/Ramp Characteristics

Linearity: (10% to 90%): $\leq \pm 1\%$ ($\leq \pm 5\%$ above 5 MHz).

Operating Modes

Norm (continuous phase locked), **VCO** (external sweep voltage),

Trig (ext or man. one-shot), **Gate**, **Burst** (1-9999 counted cycles),

Frequency Modulation

HP-IB: control and learn capability for all modes and parameters.

Interface functions*: SH1, AH1, T6, L4, SR1, RL1, PP0, DC0, DT1, C0, E1.

General

Memory: non volatile. 10 addressable locations plus one for active operating state. Each location can store a complete set of operating parameters and modes.

Power: 100/120/220/240 Vrms; $\pm 5\%$, -10%; 48 to 66 Hz, 200 VA max.

Operating temperature: 0° to 50°C

Weight: net 12 kg (26.5 lbs). Shipping 16 kg (35.3 lbs).

Size: 133 H x 426 W x 422 mm D (5.2" x 16.8" x 16.6").

Ordering Information

HP 8165A Programmable Signal Source**

Opt. 002: AM and logarithmic sweep

Opt. 003: Rear Panel Connectors

Opt. 907: Front Handle Kit (Part No HP 5061-9689)

Opt. 908: Rack Mount Flange Kit (Part No HP 5061-9677)

Opt. 909: Opt 907, 908 combined (Part No HP 5061-9683)

Opt. 910: Additional Operating and Service Manual

Opt. W30: 2 years additional hardware service

*For more on these codes refer to the HP-IB section of this catalog.

**HP-IB cables not supplied, see page 569.

☎ Fast-Ship product—see page 734

Price

\$8550

add \$1100

N/C

add \$56

add \$33.50

add \$82.50

add \$71

\$200

FREQUENCY, FUNCTION & WAVEFORM SYNTHESIZERS

1 mHz–50 MHz Pulse/Function Generator

Model 8116A

- Sine, triangle, square, haversine functions and dc
- 1 mHz–50 MHz, 32 Vpp for all waveforms
- Variable (10 ns min) pulse width, 6 ns transitions
- Wide range of operating capability
- Self-prompting operating concept
- Error recognition and self test



Picture shows 8116A with Option 001, Burst and Logarithmic Sweep.

The fully programmable HP 8116A features pulse as well as function generator capabilities in one small unit. A broad 1 mHz–50 MHz band for all waveforms and a wide choice of operating and modulating modes assure high flexibility. These factors, plus good repeatability, make the HP 8116A a sound, long-term investment.

Unique Operating Concept Saves Engineering Time

HP's custom IC's have made it feasible to put the many HP 8116A capabilities into such a small volume. Handling is simplified by a unique, microprocessor-controlled, operating concept which ensures a clear overview of the compact front panel at all times. When the mode and waveform have been selected, illuminated labels show which parameters must be set. There's no clutter, no confusion.

Auto vernier. In normal mode, the HP 8116A's auto-vernier increments any desired parameter continuously until a stop signal is applied. This means that thresholds can be measured automatically, without a controller.

Level or amplitude programming. The HP 8116A's output can be programmed in terms of high and low levels or in terms of amplitude and offset. Consequently a direct, automatic, conversion is always feasible so that the HP 8116A can be programmed in the same terms as the device is specified.

Safe limit. Devices can be protected by the limit feature. This prevents the output from exceeding a given magnitude.

Rectangular Waveforms

For applications such as laser diodes or dc motors, square waves can be programmed for constant duty cycles from 10% to 90%. For digital test, or for simulating very low duty-cycle events, pulse width can be programmed down to 10 ns. Square wave and Pulse modes provide clean 6 ns edges that are ideal for many technologies. Pulse width modulation and pulse recovery capability are available in Pulse mode.

Sine and Triangle Functions

10% to 90% duty cycle, programmable in 1% steps, provides ramps and asymmetrical sine waves for testing VCO's, servos, amplifier linearity and industrial process control systems. Haversine functions,

available in External Trigger, Gate and Burst modes, extend the applications to areas such as telephone line and vibration testing.

Modulation

All waveforms can be amplitude or frequency modulated. VCO operation allows frequency variation over two decades with an external voltage; consequently transducer output can be conditioned for mag tape recording, or frequency-shift keying or linear sweep can be carried out.

Option 001

10 1/2-decade log sweep. Sweep mode covers the wide 1 mHz – 50 MHz band in a single up sweep. Test setups require no more than an X-Y recorder or scope because all necessary control signals are available. The HP 8116A sweeps can be internally triggered, if desired.

Accurate, counted bursts. A preprogrammed number of cycles of any waveform can be generated in Burst mode. With sine, triangle and square functions, bursts can be triggered internally as well as externally.

Hold capability. For material stress testing, low frequency functions can be held at instantaneous levels. Hold is controlled by an external signal.

Low-Cost Automation for Bench and Systems

Powerful capability, small size and wide specified temperature range make the HP 8116A a good choice for automatic test systems. Also, the low cost means that it's now realistic to automate those routine bench jobs and leave more time for design. Comfortable software features such as easy syntax and flexible format contribute to rapid system design.

Operating Confidence

There's reliance in the HP 8116A's output because proper operation is always ensured by the instrument's error detector. This helps the user to recover from an incorrect front panel or programming operation by indicating the offending parameter. Also, the built-in test and diagnosis feature verifies correct function each time the instrument is switched on.

Specifications

Specifications apply with 50-ohm load and temperatures in the range 0°C to 55°C.

Functions

Sine, triangle, ramp, square, pulse, haversine, havertriangle, dc.

Timing

Frequency

Range: 1 mHz to 50 MHz (3-digit resolution).

Accuracy¹ (pulse mode, 50% d/c): $\pm 3\% \pm 0.3$ mHz below 100 kHz, $\pm 5\%$ above 100 kHz.

Jitter (pulse mode, 50% d/c): $< 0.1\% + 100$ ps.

Stability: $\pm 2\%$ (1 hour), $\pm 5\%$ (24 hours).

Duty cycle: (sine, triangle, square, haversine, havertriangle).

Range: 10% to 90% (20% to 80% above 1 MHz), 2-digit resolution.

Accuracy¹: ± 0.5 digits (± 3 digits above 1 MHz).

Pulse Width

Range: 10.0 ns to 999 ms (3-digit resolution).

Accuracy¹: $\pm 5\% \pm 2$ ns.

Jitter: $< 0.1\%$ ($0.2\% + 200$ ps for width ≤ 10 μ s).

Output Characteristics

(voltages double into high impedance).

Amplitude

Range: 10.0 mV_{pp} to 16.0 V_{pp} (3-digit resolution).

Accuracy¹: $\pm 5\%$ (at 1 kHz for sine and triangle).

Flatness (sine): $\pm 3\%$ ($\pm 5\%$ above 1 MHz, $+5$ – 15% above 10 MHz).

Flatness (triangle): $\pm 3\%$ ($\pm 5\%$ above 1 MHz, $+5$ – 25% above 10 MHz).

Offset and dc Mode

Range: 0.00 to ± 7.95 V (0 to ± 795 mV for amplitude < 100 mV_{pp}).

Resolution: 3 digits.

Accuracy¹: 0.5% of setting $\pm 1\%$ of ampl ± 40 mV ($+2$ mV if ampl < 100 mV_{pp}, ± 20 mV in dc mode).

Distortion (sine, normal mode, 50% duty cycle).

Total harmonic distortion (10 Hz–50 kHz): $< 1\%$ (-40 dB)*.

Harmonic related signals (50 kHz–1 MHz): < -34 dB,
(1 MHz–50 MHz): < -23 dB*.

*May increase by 3 dB below 10°C and above 45°C.

Non-linearity (triangle, ramp, 100 mHz–1 MHz): $< \pm 3\%$.

Pulse and Square Wave Characteristics

Transitions: < 7 ns.

Pulse perturbations: $< \pm 5\% \pm 2$ mV.

Output impedance: 50 ohm $\pm 5\%$.

Operating Modes

Normal, trigger*, gate*, external width.

Additional Modes in HP 8116A Option 001

Logarithmic Up Sweep (for all waveforms).

Range: Start and stop frequencies selectable up to full range (1 mHz–50 MHz).

Sweep time: selectable in 1–2–5 sequence from 10 ms to 500 seconds per decade.

Sweep repetition: continuous sweeps (internal sweep) or externally triggered.

Counted Burst* (for all waveforms).

Burst length: 1 to 1999 cycles.

Burst repetition: internally triggered at selectable intervals from 100 ns to 999 ms (except in Pulse mode), or externally triggered, up to 40 MHz.

*Selectable (-90°) start-phase for haversine, havertriangle.

Control Modes

Frequency modulation: $\pm 5\%$ max deviation.

Sensitivity: 1 V for 1% deviation.

Modulating frequency: dc to 20 kHz.

Amplitude Modulation

Sensitivity: ± 2.5 V for 100% mod. ($+2.5$ V to -7.5 V for DSBSC).

Modulating frequency: dc to 1 MHz.

Pulse Width Modulation

Range: 10 ns to 1 s in 8 non-overlapping decade ranges.
Max. width ratio: 10:1.

Sensitivity: ± 9 V for 1:10 ratio.

Voltage-Controlled Oscillator

Range: 2 decades in range 1 MHz–50 MHz.

Sensitivity: 0.1 V to 10 V for 2 decades.

Modulating frequency: dc to 1 kHz.

Auxiliary Modes

Manual: simulates external input.

1 cycle (option 001): triggers single output cycle in Trigger, Gate and Ext Burst modes.

Auto vernier: continuous vernier which can be remotely or manually stopped.

Limit: programmable maximum output levels to protect DUT.

Complement: selectable normal/complement output.

Disable: relay disconnects output.

Auxiliary Inputs and Outputs

External Input

Threshold: ± 10 V adjustable.

Max input voltage: ± 20 V.

Sensitivity: 500 mV_{pp}.

Min pulse width: 10 ns.

Input impedance: 10 k Ω typ.

Trigger slope: positive, negative and off.

Control Input

Max input voltage: ± 20 V.

Input impedance: 10 k Ω typ.

Trigger Output

Output levels: 0/2.4 V typ.

Output impedance: 50 ohm typ.

X-Output (Option 001) for sweep X-Y recording (rear panel).

Output levels: 0 V (= start frequency) to 10 V max.

Slope: 1.5 V per sweep decade.

Marker Output (Option 001) for sweep (rear panel).

Output levels: TTL

Leading edge: positive at selected marker frequency.

Hold Input (Option 001), rear panel.

Input levels: TTL

Leading edge: positive transition causes HP 8116A output (f < 10 Hz) to hold at instantaneous level. Output droop 0.01% per second.

Max input voltage: ± 20 V

HP-IB Capability

All manual key operations are programmable. Talk mode provides learn, status byte and error report capabilities.

Memory

Battery-backup RAM retains current operating state.

General

Repeatability: factor 4 better than accuracy.

Environmental

Storage temperature: -40°C to $+70^\circ\text{C}$.

Operating temperature: 0°C to 55°C .

Humidity: 95% RH, 0°C to 40°C .

Power: 100/120/220/240 V rms; $+5\%$, -10% ; 48 to 440 Hz; 120 VA max.

Weight: net, 5.9 kg (13 lb). Shipping, 8.0 kg (18 lb).

Size: 89 H x 212.3 W x 422 mm D (3.5" x 8.36" x 16.6").

Ordering Information

HP 8116A Programmable Pulse/Function Generator*

Opt. 001: Burst and Logarithmic Sweep

Opt. 910: Extra Operating & Service Manual

HP 5061-9701: Bail Handle Kit

HP 5061-9672: Rack Mount Kit (single HP 8116A)

HP 5061-9674: Rack Mount Kit (two instruments)

HP 5061-9694: Lock Link Kit (for use with

HP 5061-9674)

Prices

\$3775

add \$510

add \$41

\$38 

\$51 

\$31 

\$25 

*HP-IB cables not supplied, see page 569.

 Fast-Ship product — see page 734

¹Applies from 15°C to 35°C, %-error increases 0.05 per °C outside this range.

FREQUENCY, FUNCTION & WAVEFORM SYNTHESIZERS

1 Hz–20 MHz Pulse/Function Generator

Model 8111A

- Sine, triangle, square, haversine functions
- 20 MHz, 32 Vpp for all waveforms
- Variable duty cycle or pulse width
- Trigger, gate, VCO and optional burst
- Digital display for all parameters
- Error recognition

Picture shows 8111A with Option 001, Counted Burst.



The HP 8111A combines pulse generator and function generator capabilities in a single, compact unit. Triggered operation for all waveforms, and the ability to define rectangular waveforms in terms of pulse width or duty cycle, are examples of the HP 8111A's versatility.

Saves Space and Equipment

Small size and manifold capability make the HP 8111A an ideal source for service and bench. Digital display, error detector and good repeatability assure high operating confidence. This reduces the need for output monitoring and consequently saves equipment.

Flexible

Operating modes include VCO which permits frequency-shift keying and dc-to-frequency conversion as well as sweep and FM applications. Option 001's Burst mode simplifies tone burst generation and digital preconditioning by generating a precise number of waveform cycles. An "extra cycle" feature activated after a burst allows critical events to be examined.

Pulse mode's variable width down to 25 ns and clean 10 ns transitions provide useful digital test capability. High analog flexibility is assured because all waveforms can be generated in trigger, gate and burst modes. Adjustable duty cycle up to 999 kHz means that CRT sawtooth waveforms and rectangular signals for dc motor control can be simulated.

Specifications (50-ohm load resistance)

Waveforms

sine, triangle, ramp, square, pulse, haversine functions.

Timing

Frequency

Range: 1.00 Hz to 20.0 MHz (3-digit resolution).
Accuracy (50% duty cycle): 5% ($\pm 10\%$ below 10 Hz).
Jitter: $< 0.1\% + 50$ ps.
Stability: $\pm 0.2\%$ (1 hour), $\pm 0.5\%$ (24 hours).

Duty Cycle (sine, triangle, square, haversine functions):

	Calibrated	Variable (below 1 MHz)
Range:	50% nominal	10% to 90%.
Resolution:	2 digits	2 digits.
Accuracy:	± 1 digit	± 6 digits (± 3 in range 20 to 80%).

Pulse Width

Range: 25.0 ns to 100 ms (3-digit resolution).
Accuracy: $\pm 5\% \pm 2$ ns.

Output Characteristics

(voltages double into high impedance)

Amplitude

Range: 1.60 mVpp to 16.00 Vpp ($3\frac{1}{2}$ digit resolution).
Accuracy: $\pm 5\%$ (at 1 kHz for sine and triangle).
Flatness (sine, triangle): $\pm 3\%$ ($+10\%$, -15% above 1 MHz).

Offset

Range: 0.00 mV to ± 8.00 V (3-digit resolution).
Accuracy: $\pm 5\%$ setting $\pm 2\%$ amplitude ± 20 mV
(ampl ≥ 160 mVpp),
 $\pm 5\%$ setting $\pm 2\%$ amplitude ± 1 mV
(ampl < 160 mVpp).

Distortion: THD (1 Hz–1 MHz) $< 3\%$ (-30 dB); harmonics (1 MHz–20 MHz) < -26 dB. Distortion may increase by 3 dB below 10°C and above 45°C .

Linearity (triangle): $< \pm 3\%$ ($< \pm 1\%$ below 1 MHz)

Pulse and Squarewave Performance

Transitions: < 10 ns.
Perturbations: $< \pm 5\%$ ($< \pm 10\%$ below 0.16 Vpp).

Output impedance: ± 50 ohm $\pm 5\%$.

Modes

normal, trigger*, gate*, VCO and (Option 001) burst*.
*Adjustable start-phase for haversine, haversine triangle

VCO range: 2 decades, ext. signal 0.1 V to 10 V (dc to 1 kHz).

Burst length: 1 to 1999 periods for all waveforms.

General

Repeatability: factor 2.5 better than accuracy.

Environmental

Storage temperature: -40°C to $+75^\circ\text{C}$.

Operating temperature: 0°C to 55°C .

Humidity: 95% RH, 0°C to 40°C .

Power: 100/120/220/240 V rms; $+5\% - 10\%$; 48 to 440 Hz; 70 VA max.

Weight: net, 4.6 kg (10 lb). Shipping, 6.6 kg (15 lb).

Size: 89 H x 212.3 W x 345 mm D (3.5" x 8.36" x 13.6").

Ordering Information

HP 8111A Pulse/Function Generator

Opt. 001: Burst

Opt. 910: Extra Operating and Service Manual

HP 5061-9701: Bail Handle Kit

HP 5061-9672 Rack Mount Kit (single HP 8111A)

HP 5061-9674 Rack Mount Kit (two instruments)

HP 5061-9694 Lock Link Kit (for use with HP 5061-9674)

☎ Fast-Ship product—see page 734

Price

\$2500 ☎

add \$480

add \$39

\$38 ☎

\$51 ☎

\$31 ☎

\$25 ☎

FREQUENCY, FUNCTION & WAVEFORM SYNTHESIZERS

Function Generator

HP 3314A, 3312A

427

- Lin/Log sweeps, gate, counted burst, AM/FM/VCO
- Arbitrary waveform generator
- Phase lock xN and $\div N$ modes, 1/2-cycle mode



HP3314A



HP 3314A Multi-Waveform Generator

The HP 3314A Function/Waveform Generator has the precision and versatility to produce numerous waveforms. Its feature set includes accurate sine, square, and triangle waves, with ramps and pulses available using variable symmetry. Additional features include counted bursts, gate, lin/log sweeps, AM, FM/VCO, dc offset, and phase lock. For increased versatility, the arbitrary waveform mode allows a countless number of user-defined waveforms. Because complete programmability is provided, all of these capabilities are available for ATE systems, as well as bench applications.

Precise Functions

The HP 3314A provides sine, square, and triangle waveforms from 0.001 Hz to 19.99 MHz with an amplitude range of 0.01 mV to 10 Vp-p into 50 ohms, with optional 30 Vp-p into > 500 ohms.

Continuous waveforms are provided with high accuracy and low distortion, with frequency accuracy on the upper range of 0.01% and sine distortion < -55 dBc to 50 kHz.

Pulses and ramps are provided to 2 MHz using the variable symmetry control over the full 5% to 95% symmetry range. This provides narrow pulses with 9 ns rise/fall times for digital circuit testing, and positive or negative ramps for amplifier testing and process control.

Independent dc offset to ± 5 V (into 50 ohms) can be added to any ac signal. A post-attenuator summing technique is used to provide large ac signals with small offsets and vice versa.

Burst and Gate

The N cycle burst mode generates an integer number of complete cycles at each trigger. Bursts of 1 to 1999 cycles are possible for use in applications ranging from sonar testing to digital circuits. Variable symmetry and start/stop phase can be used to produce single ramps and haversines.

Like burst mode, gate mode can be triggered internally or externally. In gate, the HP 3314A output consists of complete cycles, pulses or arbitrary waveforms which start when the trigger is true, and stop after the trigger goes false. In gate and burst modes, the full frequency range applies for sine, square, triangle, pulse, and ramp waveforms.

New 1/2 Cycle and Integer Phase Lock Modes

The new 1/2 cycle burst mode allows simulation of specialized signals found in electronics. At each trigger, alternating 1/2 cycles of sines or triangles are produced. With the addition of variable start/stop phase and symmetry, pulses with variable rise/fall time and overshoot can be produced. Repetition rate, 1/2 cycle frequency, symmetry, and phase can be set independently to produce a variety of waveforms.

The Fin X N and Fin $\div N$ modes provide powerful phase locking capability. With integer phase lock, fractions or multiples of the reference signal can be provided, and ± 200 deg of phase offset is available. The HP 3314A phase locks to the plus or minus edge of the

trigger signal; it can lock to a variety of signals such as sines, squares, pulses, ramps, and others, with complete control of output function, symmetry, N, phase, amplitude and offset.

Modulation and Sweep

Complete AM, FM/VCO modulation give the HP 3314A versatile signal modifying capabilities. With 100 kHz bandwidths, AM and FM/VCO can be used separately or simultaneously to produce a many of waveforms.

Multi-frequency measurements can be made with HP 3314A sweep capabilities. Linear, logarithmic, and manual sweep make measurements of filters, amplifiers, and other networks convenient and accurate. X drive, marker, and trigger output signals are also provided.

Arbitrary Waveforms

For specialized low frequency applications, you can use the HP 3314A arbitrary (ARB) waveform mode to create custom waveforms as a series of voltage ramps or vectors. Values are easy to enter from the front panel, using the modify knob as a pencil and an oscilloscope as a pad. For remote programming, use a desktop or mainframe computer to calculate the values, then program them using the HP-IB. Arbitrary waveforms are automatically stored in non-volatile memory for quick recall.

Two Sources in One

A square wave trigger source is included for generation of complex waveforms with a single HP 3314A. The 0.5 MHz to 500 kHz internal trigger is useful in gated, burst, and phase locked waveforms. This signal is provided as an output for synchronizing the HP 3314A to other devices.

Specifications

Frequency

Range: 0.001 Hz to 19.99 MHz-sine, square and triangle waveforms, 0.001 Hz through 2 MHz range when symmetry \neq 50%.

Resolution: 3 1/2 digits.

Accuracy

Autorange	Range Hold	Accuracy
0.001 Hz-19.99 Hz	0.001 Hz-19.99 Hz	$\pm(0.4\%$ setting $+0.2\%$ range)
15 Hz-199.9 kHz	0.1 Hz-199.9 kHz	$\pm(0.2\%$ setting $+0.1\%$ range)
150 kHz-19.99 MHz	1 kHz-19.99 MHz	$\pm(0.01\%$ setting $+50$ ppm/yr)

Amplitude

Range: 0.01 mVp-p to 10 Vp-p into 50 Ω .

Resolution: 3-1/2 digits.

Absolute Amplitude Accuracy 10 kHz, 1.00-10.00 Vp-p.

Autorange ON
 $\pm(1\%$ of display + 0.035 Vp-p), sine and square wave.

$\pm(1\%$ of display + 0.06 Vp-p), triangle.

Flatness-sinewave: relative to 10 kHz, 1.00V to 10.0V (range 4).

20 Hz	50 kHz	1 MHz	19.99 MHz
	.07 dB	.33 dB	1.5 dB

Frequency Sweep

Linear: 0 to 2 decades, 7.2 ms to 1999 s/sweep

Log: 1 to 7 decades (integer only), 40 ms to 1999 s/decade

Manual sweep: modify knob tunes between start and stop frequencies. X drive follows sweep.

Modulation Inputs:

Bandwidth	Sensitivity	Range	Z
AM: dc to 100 kHz	2 Vp-p for 100% -1 Vdc for suppressed carrier	>100%	10 k Ω
FM: 100 Hz to 100 kHz	± 1 Vp for 1% of range deviation	$\pm 1\%$ of freq. range	10 k Ω
VCO: dc to 100 kHz	10%/volt	+1 to -10V	10 k Ω

FREQUENCY, FUNCTION & WAVEFORM SYNTHESIZERS

Function Generator

HP 3314A, 3312A

Waveform Characteristics

Sine harmonic distortion: individual harmonics will be below these levels, relative to the fundamental.



Square wave rise/fall time:

< 9 ns, 10% to 90% at 10 V_{p-p} output.

N integer:

N = 1 to 1999, Preset to 1
For Phase-lock Fin ÷ N, Fin X N
or N CYCLE (counted burst).

Function invert: inverts ac portion of signal outputs.

Phase

Phase offset-phase lock modes

Resolution: 0.1°

Range: ±199.9°

Start/stop phase-burst modes

Resolution: 0.1°

Range: ±90.0° for frequencies to 19.99 MHz.

Trigger

Internal trigger

Range: .002 ms (500 kHz) to 1999 s (0.5 mHz) square wave.

Period accuracy: ± (0.01% (+ 50 ppm/year) of displayed interval (excluding sweep intervals).

Trigger output: Low <0.5 V, high >2.5 V; output resistance 1 kΩ.

External trigger

For Gate, N Cycle, 1/2 Cycle, Fin X N, Fin ÷ N, and external sweep triggers.

Frequency range: 50 Hz to 20 MHz.

Trigger slope: selectable, positive or negative.

Symmetry

Symmetry range: 5% to 95% of period, 2 Hz–2 MHz ranges

Arbitrary waveforms

Output consists of a series of voltage ramps called vectors. Arbitrary waveforms can be composed of 2 to 150 vectors. A maximum of 160 vectors can be stored in six available storage registers with a minimum of 2 vectors per waveform. Feature includes MARKER and SYNC outputs and a GATE mode. Practical frequencies are 0.002 Hz to 2.5 kHz.

Option 001 - Voltage Multiplier

Simultaneous X3 amplitude output on rear panel (into > 500 Ω.
30 V_{p-p} max, dc to 1 MHz.

General

Power: 100/120/220/240 V + 5% –10%, 48 to 66 Hz 95 VA maximum.

Weight: net, 7.3kg (16lb); shipping, 10.5kg (23lb).

Size: 132.6H x 212.3W x 419.0mmD (5.22" x 8.36" x 16.50")

HP-IB

IEEE Standard 488–1978 abbreviated definition.

SH1 AH1 T6 TE0 L3 LE0 SR1 RL1 PP0 DC1 DT1 C0 E2.

Ordering Information

HP 3314A Function Generator

Opt 001 Simultaneous X3 Output

Opt W30 Extended Repair Service. See page 725.

Price

\$4,715

+\$265

+\$115

- Two function generators in one instrument
- AM-FM, sweep, trigger, gate and burst (int & ext)

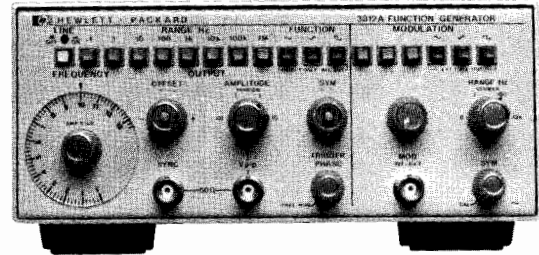

HP 3312A

HP 3312A Function Generator

Hewlett-Packard's 3312A Function Generator combines two separate, independent function generators with a modulator section in one compact instrument. The main generator can—via pushbutton control—be triggered by the modulation generator to provide sweep functions, AM, FM or tone burst, and includes dc offset up to 10 volts p-p into 50 Ω.

Specification Summary

Output waveforms: Sine, square, triangle, ±ramp, pulse, AM, FM, sweep, triggered and gated.

Frequency characteristics

Range: 0.1 Hz to 13 MHz in 8 decades ranges.

Dial accuracy: ±5% of full scale. Unspecified in Uncal Mode.

Square wave rise or fall time (10% to 90%): <20 ns.

Variable symmetry: 80:20:80 to 1 MHz.

Sine wave distortion: <0.5% (–46dB) THD from 10 Hz to 50 kHz. (10 kHz range maximum). (>30 dB below fundamental from 50 kHz to 13 MHz, at full-rated output.

Output characteristics

Impedance: 50 Ω ± 10%.

Level: 20 V_{p-p} into open circuit, >10 V_{p-p} into 50Ω at 1 kHz.

Level flatness (sine wave): <±3% from 10 Hz to 100 kHz at full rated output (1 kHz reference). <± from 100 kHz to 10 MHz.

Sync output: Impedance: 50 Ω ±10% > 1 V_{p-p} square wave into open circuit. Duty cycle varies with symmetry control.

dc offset: Variable up to ±10 volts. Instantaneous ac voltage + V_{dc} offset cannot exceed ±10 V (open circuit) or ± 5 V (50 Ω).

Modulation characteristics

Types: Internal and external AM, FM, sweep, trigger, gate or burst.

Waveforms: Sine, square, triangle, ramp or variable symmetry pulse.

Frequency range: 0.01 Hz to 10 kHz.

Amplitude and frequency modulation

Depth: 0 to 100% (AM), 0 to 5% (internal FM)

Modulation frequency: 0.01 Hz to 10 kHz (internal). DC to >1 MHz (AM external), DC to >50 kHz (FM external)

Sweep characteristics

Sweep width: >100:1 on any range.

Sweep rate: 0.01 Hz to 10 kHz, 90:10 ramp.

Gate characteristics

Start/stop phase range: +90° to –80°.

Frequency range: 0.1 Hz to 1 MHz (useful to 10 MHz).

External frequency control and FM

Range: 1000:1 on any range.

Linearity: 0.5% of F_{max} for F_{max} ≤ 1 MHz, freq. span ≤ 100:1.

General

Power: 100 V, 120 V, 220 V, 240 V, +5%, –10%, switchable; 48 Hz to 440 Hz; ≤30 V A.

Size: 102 H x 213 W x 377 D (4" x 8.4" x 14.8").

Weight: net, 3.8 kg (8.4 lb); shipping, 5.9 kg (13 lb).

Ordering Information

HP 3312A Function Generator

Option W30: Extended Repair Service. See page 725.

☎ Fast-Ship product – see page 734.

Price

\$1585

\$50

FREQUENCY, FUNCTION & WAVEFORM SYNTHESIZERS

Two Channel Synthesizer, DC to 13 MHz

HP 3326A

429

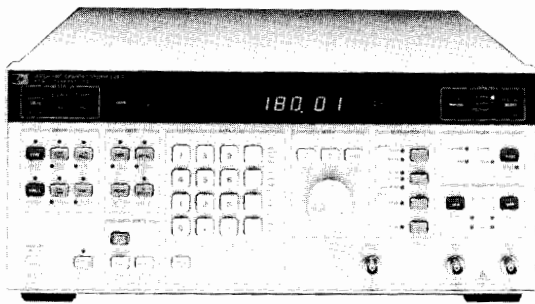

HP 3326A



HP 3326A Two-Channel Synthesizer

The HP 3326A Two-Channel Synthesizer combines two independent synthesizers, flexible modulation and control circuitry into a single, powerful package. This single instrument provides precise phase offset, two-tone sweep, fast frequency switching, internal modulation, and pulse signals for bench or systems use.

With multiple channels and modes, the HP 3326A does the job of several sources. Phase continuous sweeps are available in linear and multielement discrete modes. DC offset is available in all modes, and all outputs are floating. Frequency resolution is 11 digits, with flexible triggering for frequency, amplitude and phase changes and sweeps.

Complete Two-Phase, Two-Tone

The HP 3326A can provide two signals with phase is adjustable to 0.01° and calibrated to 0.2°. This is possible anywhere in the 13 MHz frequency range without an external phasemeter.

The HP 3326A is also the single-source answer for producing a wide variety of broadband two-tone signals. The two channels can be offset up to ±100 kHz in the CW mode or while sweeping, from separate outputs or the built-in signal combiner.

High Performance Modulation and Pulses

Amplitude and phase modulation are easy with the two-channel HP 3326A. One channel can modulate the other or each channel can be used with simultaneous AM and PM.

In the pulse mode, both pulse and pulse-complement outputs are provided. Symmetry range is 1 to 99% in 0.1% steps. In addition, both pulse amplitudes and their offsets can be set independently.

Specifications Summary

For complete specifications, refer to the HP 3326A data sheet.

Operating modes

Two channel: channels A and B are independent.

Two-phase: channels A and B are the same frequency, with calibrated phase offset between the two signals.

Two-tone: channel B frequency offset 0 to 100 kHz from channel A frequency.

Pulse: channel B is the complement of channel A.

Frequency (waveforms are sine, square, pulse, and dc)

Range: 0 Hz to 13 MHz.

Resolution: 1 μHz below 100 kHz, 1 mHz at and above 100 kHz. Stability: ± 5x10⁻⁶/year, 20° to 30°C. See also option 001, High Stability Frequency Reference.

Accuracy: ± 5x10⁻⁶/year, 20° to 30°C, at time of calibration with standard frequency reference. Integrated phase noise: -63 dBc (Option 001 only, for a 30 kHz band centered on a 10 MHz carrier excluding ±1 MHz about the carrier).

Sinewave spectral purity

Harmonics: harmonically related signals will be less than the following levels relative to the fundamental, or -90 dBm, whichever is greater:

	10 Hz	50 Hz	100 kHz	1 MHz	13 MHz
+23.98 dBm					
+13.98 dBm	-80 dBc	-70 dBc	-55 dBc	-30 dBc	
-36.02 dBm	-80 dBc	-80 dBc	-65 dBc	-50 dBc	
-56.02 dBm					

Output amplitude (sine mode)

Range: 1 mVpp to 10 Vpp in 8 ranges without DC offset. See also option 002 High Voltage Output.

Units: volts peak-to-peak, Volts rms, dBm 50Ω, dBV.

Accuracy: relative to programmed value after self-calibration

	0.001 Hz	100 kHz	1 MHz	13 MHz
+23.98 dBm	±0.1 dB	±0.3 dB	±0.6 dB	
+3.98 dBm	±0.2 dB	±0.5 dB	±0.8 dB	
-36.02 dBm	±0.2 dB	±0.5 dB	±1.0 dB	
-56.02 dBm				

Squarewave and pulse characteristics

Rise/fall time: ≤15 ns, 10% to 90% at full output.

Overshoot: ≤5% of peak-to-peak amplitude at full output.

Pulse width range: 1% to 99% of period or 20 ns, whichever is greater.

DC Offset

Range: (See also option 002, high voltage output).

dc only: 0 to ± 5 V.

dc+ac: dc+ac peak ± 5V; Max. dc offset is affected by ac range, maximum is ± 4.5 V decreasing to ±4.5 mV on lowest range.

Phase offset

(channel A vs B in two-phase mode)

Range: ± 720 degrees.

Resolution: 0.01 degree.

Accuracy: after self-calibration, for equal-level sinewaves 1 V to 10 V peak-to-peak.

0.1 Hz to 10 Hz ±0.5 degrees

10 Hz to 100 kHz ±0.2 degrees

100 kHz to 1 MHz ±0.3 degrees

1 MHz to 13 MHz ±2.0 degrees

Amplitude, phase modulation

Both channels can be modulated externally or channel B can be used to modulate channel A.

Waveforms: sine, square, or (external only) pulse, dc, etc.

Frequency range:

Carrier: dc to 13 MHz

Modulation: dc-100 kHz (AM), dc-5 kHz (PM)

Frequency sweep

Sweep types: linear, discrete (2-63 discrete elements)

Sweep time: 5 ms to 1000 s, Linear or per element.

Frequency reference (10 MHz)

+3 dBm output to lock other instruments to the HP 3326A

+3 dBm oven-stabilized reference output (Opt 001 only)

1, 2, 5, 10 MHz reference input; 0 to +20 dBm

Output combiner

Channel A and B are combined on the channel A output.

HP-IB remote control

Compatible with IEEE standard 488-1978.

Option 001 High Stability Frequency Reference

Stability: ±5x10⁻⁸/week after 72 hours continuous operation.

±1x10⁻⁷/month after 15 days continuous operation. Option 002

High Voltage Output

Frequency range: dc to 1 MHz

Amplitude range: 4 mV to 40 Vpp into > 1k Ω, < 200 p Fload.

dc offset: ±20 V, independent of amplitude range. dc + ac peak must not exceed 20V.

General

Power: 100/120/220/240 V, +5%, -10%, 48 to 66 Hz; 290 VA max.

Weight: net, 2kg (60lb); shipping, 37kg (81lb)

Size: 177H x 425.5W x 497.8mmD (7" x 16 3/4" x 19 1/8")

Ordering Information

HP 3326A Two-Channel Synthesizer

Opt 001 High Stability Frequency Reference

Opt 002 High Voltage Output

Opt 003 Rear Terminal Outputs (Rear only)

Opt W30 Extended Repair Service. See page 725.

Price

\$10,250

+\$665

+\$305

\$0

+\$250

FREQUENCY, FUNCTION & WAVEFORM SYNTHESIZERS

Universal Source

HP 3245A

- Precision DC Outputs with 6½ Digits of Resolution
- Synthesized AC With 0.4% Amplitude Accuracy
- Sine, Square, Triangle, and ARB to 1 MHz
- Ramp and Pulse to 100 KHz
- Floating Outputs
- Non volatile storage of up to 14 setups
- Second Channel Output Available
- Phase Continuous Frequency Changes
- Optional Software for Waveform Modification
- Downloadable Subroutines

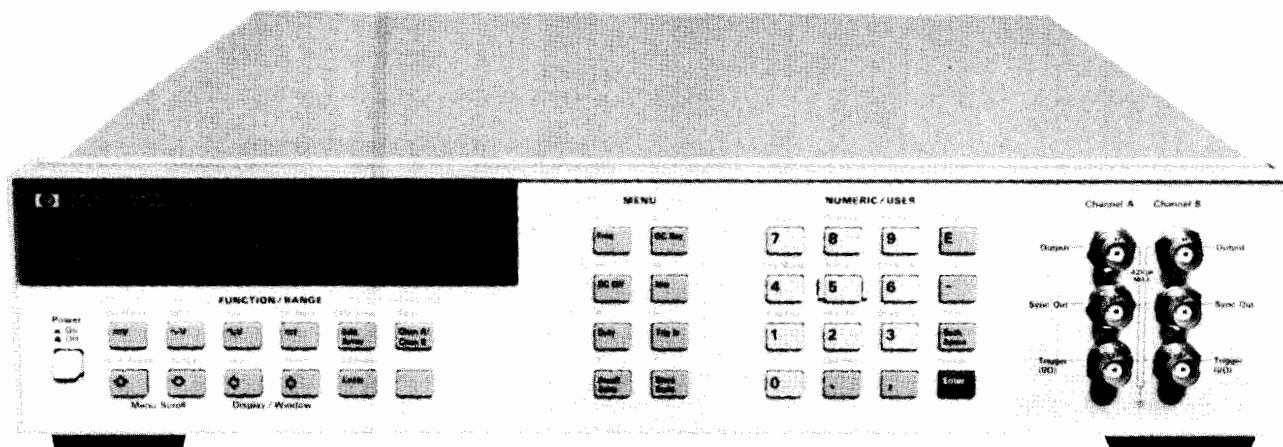

Model 3245A



Description

The HP 3245A Universal Source offers a unique mix of precision DC capabilities with versatile AC performance, including arbitrary waveform generation. This versatility can be put to advantage on the bench, where the HP 3245A may well be all the source you will ever need. The HP 3245A can also fit into your Computer Aided Test System, providing the capabilities of AC, DC, and second channel options in a single 3.5" tall instrument.

Precision DC

The HP 3245A provides precision DC outputs of both voltage and current. In the high-resolution mode, you get 24-bit resolution with 60 ppm, 90-day accuracy. The low-resolution mode provides 12-bit resolution with 100 usec settling times. This type of precision means you can use the HP 3245A to test A/D converters, Voltage to Frequency converters, VCO's, transducers, and anywhere that a highly accurate DC voltage or current is required. There are two output ranges in the high resolution mode; ± 1 volt and ± 10 volts. In the low resolution mode, there are 7 ranges. In current, there are four ranges of output, from 0.1 mA to 100 mA. Output impedance is selectable as either zero ohms or 50 ohms.

Accurate AC

The HP 3245A can generate AC voltage outputs, including sine, triangle, and square waves, at frequencies of up to 1 MHz. Variable duty-cycle pulse and ramp outputs can be generated at up to 100 kHz. In the AC mode, the HP 3245A can make phase continuous frequency changes "on-the-fly". All AC waveforms are synthesized, and have 0.001 Hz resolution and 50 ppm frequency accuracy. 90-day amplitude accuracy for Sine, Ramp, and ARB is 0.35% of output + 0.41% of range.

Second Channel Option

The addition of a second channel allows for the generation of two waveforms, either independent, or phase related to one another. The second channel output can be phase synchronized to the first channel, or to an external input. Such capabilities are especially useful if you are doing modem testing, tone sequence generation, DTMF generation, or FSK generation, or anywhere where two outputs are required.

Arbitrary Waveform

The HP 3245A offers arbitrary waveform operation at a full 1 MHz bandwidth. This is accomplished by a sampling technique whereby the values loaded into RAM are sampled at approximately 4.3 MHz and then run through a 1.25 MHz 5-pole low-pass filter. This allows full 1 MHz rep rate while maintaining 0.001 Hz resolution at any frequency. The HP 3245A can also store multiple arrays that can be accessed for arbitrary waveform generation. Array depth is 2048 bytes.

Waveform Generation Software

A powerful software package, useful for creating specialized waveforms, is available as an option to the HP 3245A. This menu driven software facilitates the capture of a waveform using a separate hardware digitizer, such as the HP 3458A. The waveform can then be modified, if desired. The waveform can then be played back via the HP 3245A. The use of a graphics tablet makes the modifying of waveforms especially easy. The software also contains a library of standard waveforms which can be used as is, or mixed with other waveforms to generate complex outputs.

System Operation

The HP 3245A includes features that make it especially powerful in system applications. Because it contains many BASIC-like constructs, such as IF . . . THEN and FOR . . . NEXT, it is possible to have the HP 3245A do much of the work that normally would require intervention from the host computer. Now, subroutines can be downloaded to the HP 3245A, which can then run stand-alone, minimizing host computer interaction. Built in math capabilities add to the power of the HP 3245A. Electronic calibration is both easy and accurate, and does not require that the instrument be removed from a rack or opened up to perform a calibration.

All the above features combine to make the HP 3245A a truly universal source, combining precision DC outputs, accurate AC waveforms, and arbitrary waveform capabilities, all in a single instrument.

DC Volts Output High Resolution Mode

Range	0 Ω Mode Resolution	50 Ω Mode Resolution
1V	1 μ V	.5 μ V
10V	10 μ V	5 μ V

Low Resolution Mode

Range	0 Ω Mode Resolution	50 Ω Mode Resolution
.078125V	—	40 μ V
.15625V	79 μ V	79 μ V
.3125V	157 μ V	157 μ V
.625V	313 μ V	313 μ V
1.25V	625 μ V	625 μ V
2.5V	1250 μ V	1250 μ V
5V	2.5 mV	2.5 mV
10V	5.0 mV	—

Current Compliance: 100 mA on all ranges

Settling Time (Delay 0):

High Resolution Mode:

.1% of step: 20 mSEC
.001% of step: 40 mSEC
(1 SEC if function changed)

Low Resolution Mode:

.1% of step (0 Ω Mode): 100 μ SEC
(50 Ω Mode): 25 μ SEC
.5% of step (50 Ω Mode): 5 μ SEC

Overshoot:

High Resolution Mode: <5% of step + .15% of range
Low Resolution Mode: <30% of step + 2% of range

DC Volts Accuracy (<10 Hz noise): \pm (% of programmed output + volts), impedance mode, >1Mohm load. Tcal is the temperature of calibration from 18°C to 28°C. One hour warm-up.

24 Hour: Tcal \pm 1C

Range	High Resolution Mode	Low Resolution Mode
10 V	0.0007% + 85 μ V	0.09% of Output + 0.02% of range
1 V	0.0008% + 15 μ V	(for all ranges)

90 DAY: Tcal \pm 5°C

High Resolution Mode		Low Resolution Mode	
Range	Accuracy	Range	Accuracy
10V	.0038% + 180 μ V	10V	.17% + 37mV
1V	.0042% + 31 μ V	5V	.17% + 19mV
		2.5V	.17% + 9.2mV
		1.25V	.17% + 4.6mV
		.625V	.17% + 2.5mV
		.3125V	.17% + 1.3mV
		.15625V	.17% + .73mV

DC Current Output Resolution

Range	High Resolution	Low Resolution
0.1mA	0.1nA	50nA
1mA	1nA	500nA
10mA	10nA	5 μ A
100mA	100nA	50 μ A

90 DAY: Tcal \pm 5C. After one hour warm-up.

High Resolution Mode		Low Resolution Mode	
Range	Accuracy	Range	Accuracy
100mA	.0202% + 3.3 μ A	100mA	.32% + 400 μ A
10mA	.0074% + 220 nA	10mA	.30% + 52 μ A
1mA	.0052% + 20 nA	1mA	.25% + 3.8 μ A
0.1mA	.0052% + 3.3 nA	0.1mA	.25% + .38 μ A

AC Volts Output Characteristics (sine, square, ramp, arbitrary)

Frequency Range:

0 to 1 MHz for sine, arbitrary and square (at 50% duty cycle)
0 to 100 kHz for ramp
0 to 100 kHz for square w/Duty cycle not equal to 50%

Amplitude and/or Offset Resolution:

Range (Peak-Peak)	50 Ω Mode Resolution	0 Ω Mode Resolution
.15625V	79 μ V	—
.3125V	157 μ V	157 μ V
.625V	313 μ V	313 μ V
1.25V	625 μ V	625 μ V
2.5V	1250 μ V	1250 μ V
5V	2.5 mV	2.5 mV
10V	5.0 mV	5.0 mV
20V	—	10.0 mV

Amplitude can be set from 10% to 100% of range.

AC Amplitude Accuracy (Sine, Ramp, Arbitrary)

24 Hour: Tcal \pm 1C 0.16% of output + .25% of range
90 Day: Tcal \pm 5C 0.29% of output + .36% of range

Sinewave Characteristics (50 Ω Mode):

Frequency	Harmonic and Spurious Levels (amp1 \geq 50% of range)*	THD (amp1 \geq 50% of range)	Flatness in reference to 1 kHz
<3kHz	< -62 dB	< -56 dB	.07 dB
to 10 kHz	< -62 dB	< -50 dB	.07 dB
to 30 kHz	< -55 dB	< -48 dB	.07 dB
to 100 kHz	< -46 dB	< -46 dB	.20 dB
to 300 kHz	< -40 dB	—	.60 dB
to 1 MHz	< -40 dB	—	2.00 dB

*additional fixed spurious response >4MHz: 500 μ Vrms

Squarewave Characteristics (50 Ω Mode):

risetime: <250 nSEC, 10% to 90%
settling time: <1 μ SEC to 1% of amplitude
overshoot: < 5% of peak-to-peak amplitude
duty cycle range: 5% to 95%, 0 to 100 kHz

50% above 100 kHz

duty cycle accuracy: \pm (0.8% of period + 120nSEC)

Frequency Resolution: .001 Hz

Frequency Accuracy: \pm 50 ppm, 18 to 28 C

Frequency Temperature Coefficient: \pm 1 ppm/C

Phase Offset:

Range: -360 to +360 degrees

Resolution: < .001 degrees

Ramp Linearity to 1 kHz (50 Ω Mode):

.3% of p-p value measured @ 50% duty cycle from 10% to 90% point

Ramp Duty Cycle Range: 5% to 95% with < .1% resolution)

Ordering Information

HP 3245A Universal Source	\$4200
Option 001 Second Channel Output	\$2500
Option 005 Waveform Generation Software	\$400
Option 907 Front Handle Kit	\$51
Option 908 Rack Flange Kit	\$31
Option 909 Rack flange and Handle Combination Kit	\$73
Option W30 Extended Warranty	\$126

Price

PULSE GENERATORS

General Information

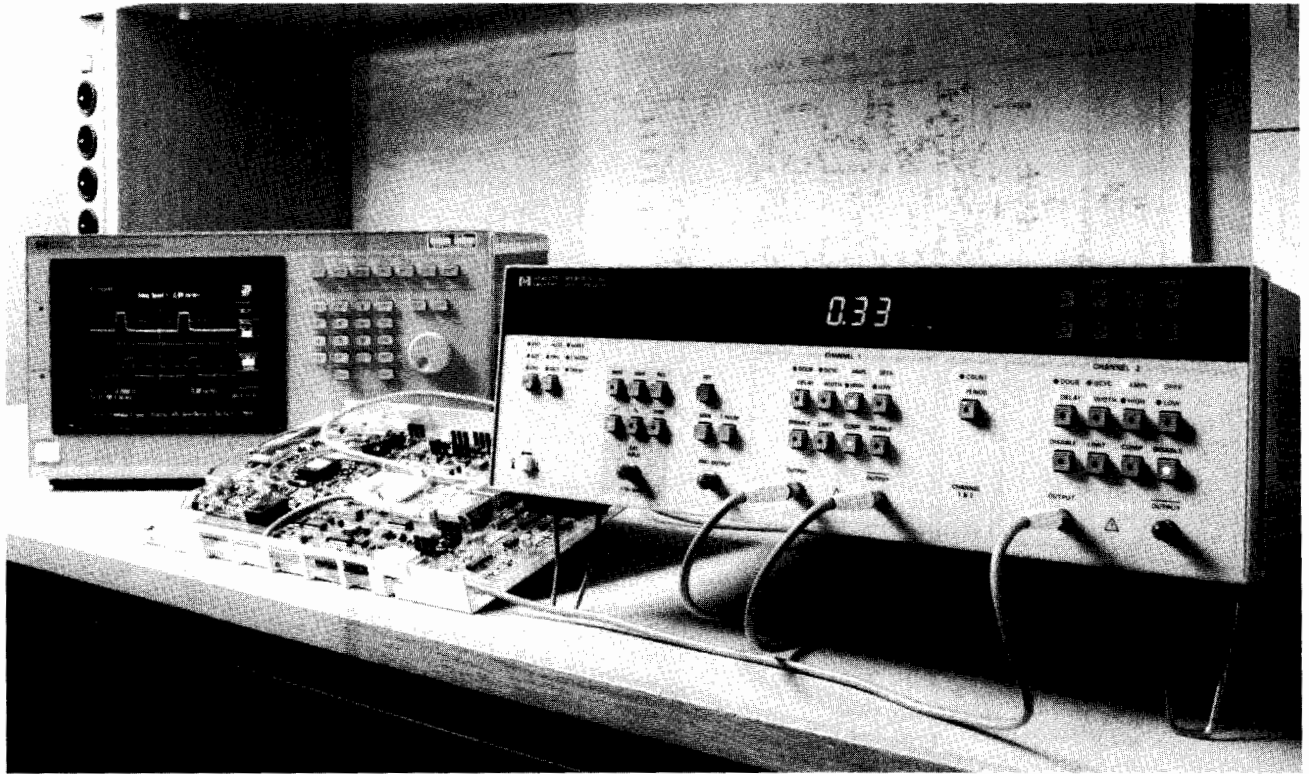

Analog and Digital Test

HP's *pulse generators* range from simple, inexpensive units to high performance, microprocessor-based instruments offering precision pulse generation. Depending on model, variable clock speeds to 1 GHz and variable amplitudes up to 100 V are available.

Pulse parameters are independently variable for thorough characterization and worst-case testing. Variable pulse transitions permit parametric analysis like trigger circuit hysteresis, and the fastest settings are ideal for at-speed logic test and amplifier transient investigations.

Pulse/function generators combine pulse capability with all features expected of a function generator. The benefits are high flexibility for analog requirements plus an entry into logic test.

Operating Comfort

Clear front panel layout, guided parameter selection, and error detection and recovery features, mean quick familiarization and rapid, error-free use. In addition, great emphasis is placed on ruggedness, reliability and serviceability. The generators are developed and produced using high quality standard components and custom-designed ICs. Resultant technical benefits are, for exam-

ple, broad operating temperature range and clean 50-Ohm output impedance.

Selectable polarity, complement and offset help make hook-up simpler and, for further flexibility, *inverters, adders and splitters* are available (page 446*).

Complex waveform capability allows glitches, ringing and multi-level signals to be simulated. Constant numbers of pulses, unaffected by other parameters are available in HP's counted burst mode.

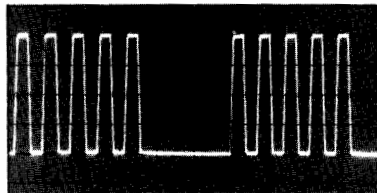

Bench and Automatic Test

A new generation of very versatile models offer good repeatability and high operating comfort for fast, accurate testing. These instruments also offer HP-IB which makes bench automation a reality for time-consuming tests. Setup time is a minimum because the syntax is simple and uses the same command sequence as the front panel.

Straight-forward syntax helps develop ATS software quickly; good repeatability and error reporting eliminate the need for software measurement loops. Specified performance over the entire 0°C to 55°C operating temperature range guarantees reliability in system racks.

Time Synthesis (page 447*)

Time Synthesizers are mainly used in radar and laser ranging, component and circuit testing, and precise triggering and calibrating applications. They give a precisely timed output pulse with an accurate, adjustable delay which may be incremented in steps as small as 50 pico-seconds. A fixed, virtually jitter-free insertion delay allows phase locking to equipment under test.

Technologies Covered

CMOS: HP 8011A, 8111A, 8112A, 8115A, 8116A, 8160A, 8165A

HCMOS: HP 8131A, 8161A

TTL: HP 8012B, 8013B, 8111A, 8112A, 8115A, 8116A, 8160A, 8165A

LS-TTL: HP 8082A, 8131A, 8161A

ECL: HP 8080A, 8082A, 8131A, 8161A

GaAs: HP 8131A

Pulse Generator Selection Chart

HP Model Page	Pulse Generators										Pulse/Function Generators				
	214B 443	8011A 444	8012B 444	8013B 444	8082A 445	8080A 446	8112A 434	8115A 435	8160A 440	8161A 440	8131A 438	8130A 436	8111A 444	8116A 424	8165A 423
Timing															
Max frequency (MHz)	10	20	50	50	250	300/1000	50	50	50	100	500	300	20	50	50
Transition time (ns)	15	10	5 var	3.5	1 var	0.8/0.3	5 var	6.5 var	6 var	1.3 var	0.2	1 var	10	6	5
Var width (ns) min	25	25	10	10	2	Sp Opt	10	10	10	4	0.5	1.5	25	10	10
Square/duty cycle (%)	1-10	Sq	Sq	Sq	Sq	Sq	1-99	1-99			1-90	1-90	10-90	10-90	20/50/80
Variable delay	•	•	•	•	•	•	•	•	•	•	•	•			
Output (max values are quoted: see specifications for conditions).															
Amplitude (V)	100	16	10	10	5	4/2.4	32	32	20	5	5	5	32	32	20
Offset/Window (V)			±2.5/±7.5	±2.5/±7.5	±2/±5	±2/±4	±16/±16	±16/±16	±20/±20	±5/±5	±4.9/±5	±4.9/±5	±16/±16	±16/±16	±10/±10
Format	+/-	•	•	•	•	•	•	•	•	•	•	•	•	•	•
• = positive, negative, symmetrical, normal and complement formats.															
Outputs	1	1	1	+ and -	1	Configurable	1	2	2-chan option	2-chan option	2-chan option	2-chan option	1	1	1
Channel addition									•	•	•				
Additional outputs					Compl					Compl	Compl	Compl			
Operating Modes															
Trigger	•	•	•	•	•	•	•	•	•	•	•	•	•	•	•
Ext width			•	•	•	•	•	•	•	•	•	•		•	•
Gate	•		•	•	•	•	•	•	•	•	•	•		•	•
Ext burst	Option	Option											Option	Option	•
Int burst													Option		
Double pulse	•	•	•	•	•	•	•	•	•	•	•	•			
Control (Modulation) Modes													•	•	

Pulse Generator Definitions

Time Reference Point: Median (50 % amplitude point on pulse edge).

Pulse Period: The time interval between the leading edge medians of consecutive trigger output pulses.

Trigger Delay: Interval between trigger point of input signal and the trigger output pulse's leading edge median. Applies in trigger, external width, gate and burst modes.

Pulse Delay: Interval between leading edge medians of trigger output pulse and output pulse.

Double Pulse: Interval between leading edge medians of the double pulse.

Interchannel Delay/Skew: Interval between corresponding leading edge medians.

Pulse Width: Interval between leading- and trailing-edge medians.

Additional Information for Pulse Generators with Variable Transition Times

Pulse Width: The specified and displayed value is that obtained with fastest edges; essentially equal to the interval from the start of the leading edge to the start of the trailing edge.

By designing so that the pulse edges turn about their start points, the interval from leading edge start to trailing edge start stays unchanged* when transition times are varied. This is more convenient for programming and the width display is easy to interpret.

*In practice, start points may shift with change in transition time.

Delay: The specified and displayed value is that obtained with the fastest leading edge. For a slower edge, the actual delay exceeds the displayed delay by the combined shift of start-point and median.

Transition Time: Interval between the 10 % and 90 %-amplitude points on the leading/trailing edge.

Linearity: Peak deviation of an edge from a straight line through the 10 %- and 90 %-amplitude points, expressed as percentage of pulse amplitude.

Jitter: Short-term timing instability of period, delay and width:

Jitter: has been traditionally defined as the p-p window. Newer Instruments quote "rms jitter" as this offers better measurement repeatability (the value is established over 1000 measurements, and is identical to the statistical evaluation of standard deviation).

Stability: Long-term average instability, expressed as percentage of main parameter over a specific time duration, e.g. hour, year. Excludes jitter.

Pulse Level: High level and low level. Any limitation is expressed by an amplitude specification.

Pulse Amplitude (alternative to level definition): Pulse amplitude and offset* are specified. Any limitation is expressed by a window (max high level, min low level).

*Pulse generators use baseline offset. Function generator outputs are symmetrical and consequently use median offset.

Preshoot, Overshoot, Ringing: Preshoot and overshoot are peak distortions preceding/following an edge. Ringing is the positive peak and negative peak distortion, excluding overshoot, on pulse top or base. A combined preshoot/overshoot, ringing specification of e.g. = 5 % implies:

- Overshoot/undershoot < 5 %,
- Largest pulse-top oscillation < = 5 %, of pulse amplitude.

Settling Time: Time taken for pulse levels to settle within level specification, measured from 90 % point on leading edge.

Duty Cycle: Percentage ratio of pulse width to period. In pulse/function generators, this term is also used to define sine and triangle symmetry.

Output Impedance/Resistance: Effective pulse source impedance/dc resistance.

Reflection Coefficient: Reflection at pulse generator output expressed in percent of incident pulse amplitude. (Test pulse edges correspond to generator's fastest transitions).

Repeatability: When an instrument operates under the same environmental conditions, and with the same settings, the value of a parameter will lie within a band inside the accuracy window. Repeatability defines the width of this band.

HP-IB Programming Times

Listen Time: The time an instrument occupies the bus to receive and verify a message. The NRFD signal is active during this period.

Settling Time: The time taken by the instrument to execute an HP-IB message, and for the output to settle within the accuracy specification. NRFD inactive.

Execution Time: The sum of Listen Time and Settling Time.

Talk Time: The time an instrument occupies the bus to output a specified string. Output data is typically instrument error status, or current or stored parameters.

PULSE GENERATORS

Programmable Low Cost Pulse Generator Model 8112A

- Full pulse capability
- Modulation
- Ramps and haversines
- Width/duty cycle
- Device protection
- Error recognition and self test

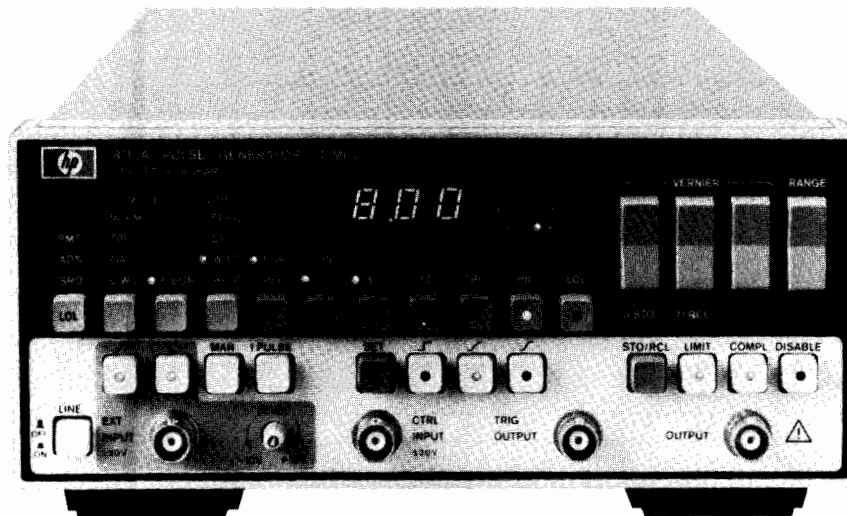

HP 8112A



The HP 8112A is a fully programmable 50 MHz pulse generator with 5 ns transitions and 32 V_{pp} (into open circuit) max output amplitude. All pulse parameters are variable including delay and double pulse spacing.

Besides the comprehensive trigger modes, external modulation capabilities extend applicability. 3-level signals and upper level, width, period and delay-modulated signals are available. These can be combined with the trigger modes so that complex real-life signals like modulated bursts are simulated easily.

Step response and trigger hysteresis measurements require fast transitions or sawtooth signals as obtained in the HP 8112A's linear transition mode—either fixed 5 ns or variable from 6.5 ns. The new cosine transitions, also variable from 6.5 ns, mean that band-filtered signals are now just as simple to obtain.

Sensitive devices are protected by programming output limits and the upper level can be controlled by the device supply. Also, constant energy or constant width can be programmed.

Dual channel operation is feasible by operating HP 8112A's in a master/slave combination.

For really easy operation a green button gives error-free settings. A new softkey operating concept plus detailed error recognition make the HP 8112A's powerful versatility easy to handle.

Specifications

Specifications apply with 50-ohm load, and temperatures in the range 0°C to 55°C.

Timing (specifications apply for min transition times)

Period: 20.0 ns to 950 ms.

Delay: 75.0 ns to 950 ms.

Double pulse: 20.0 ns to 950 ms.

Width: 10.0 ns to 950 ms.

Accuracy: ± 5% of progr value ± 2 ns (delay: ± 4 ns).

Duty cycle: 1% to 99% (Min: 10 ns. Max: period - 10 ns).

Accuracy: ± 10% of progr value.

Pulse Characteristics (voltages double when driving into open circuit)

Levels

High level: -7.90 V to 8.00 V.

Low level: -8.00 V to 7.90 V.

Accuracy: ± 1% of progr value ± 3% amplitude ± 40 mV.

Settling time: 100 ns + transition time.

Transition times

Fixed: 5 ns typical

Linear and Cosine: 6.5 ns to 95.0 ms (max edge ratio 1:20 within a 1.5-decade range. Ranges overlap by 0.5 decade).

Accuracy: ± 5% of programmed value ± 2 ns.

Preshoot, overshoot, ringing: ± 5% ± 10 mV (variable transitions), ± 10% ± 10 mV (fixed transitions).

Output resistance: 50 ohm ± 5%.

Operating modes: Normal, Trigger, Gate, Ext Width (pulse restoration), Ext Burst (1 to 1999 pulses).

Control (Modulation) Modes

Period, delay, width covered in 8 non-overlapping decades (max input frequency 8 kHz.).

High level: -8 V to +8 V, independent of progr low level (min input transition 200 μs).

General

HP-IB: all keys programmable. Learn, status and error reporting capability. Interface functions: SH1, AH1, T6, L4, SR1, RL1, PP0, DC1, DT1.

Memory: retains current operating state. 9 store/recall locations, 1 fixed set of parameters.

Repeatability: factor 4 better than accuracy.

Environmental

Storage temperature: -40°C to +65°C.

Operating temperature: 0°C to 55°C.

Humidity: 95% RH, 0°C to 40°C.

Power: 100/120/220/240 V rms; +5%; -10%; 48 to 440 Hz; 120 VA max

Weight: net, 5.9 kg (13 lb). Shipping, 8.0 kg (18 lb).

Size: 89 H x 212.3 W x 450 mm D (3.5" x 8.36" x 17.7").

Ordering Information

HP 8112A Programmable Pulse Generator* \$6000

Opt. 910 Extra Operating and Service Manual +\$49

Opt. W30 Extended Repair Service. See page 725 \$150

HP 5061-9701 Bail Handle Kit \$38

HP 5061-9672 Rack Mount Kit (single HP 8112A) \$51

HP 5061-9674 Rack Mount Kit (two instruments) \$31

HP 5061-9694 Lock Link Kit (for use with HP 5061-9674) \$25

* HP-IB cables not supplied, see page 569

☎ Fast-Ship product—see page 734

Prices

PULSE GENERATORS

50 MHz Dual Channel Pulse Generator

Model 8115A

435

- Two 50 MHz output channels
- Variable transitions, width, delay
- Variable high and low level

- Channel addition mode
- Control capabilities
- CRT for convenient operation

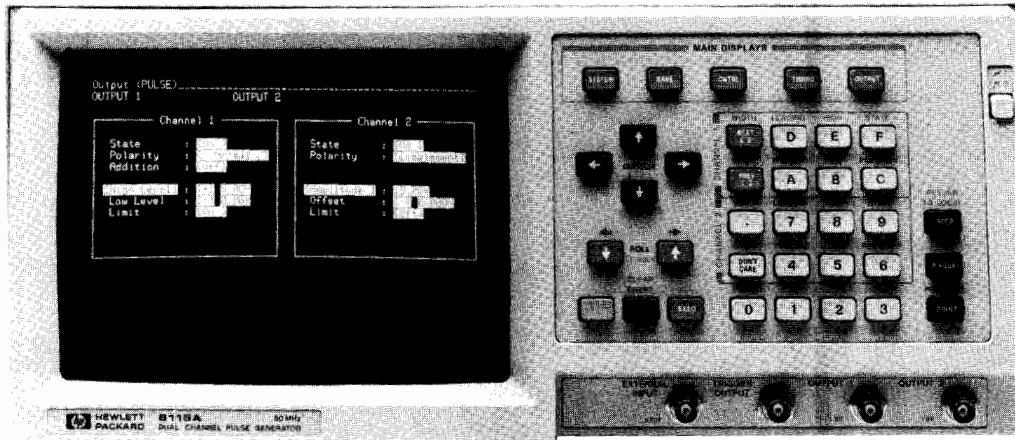

HP 8115A



Bench and ATE-System suitable

The HP 8115A is a fully programmable 50 MHz dual channel pulse generator, which delivers pulse trains with up to 32 Vp-p into high impedance and variable transitions from 6.5 ns up to 95 ms.

The HP 8115A is suitable to operate as a stand-alone instrument or in an ATE-System. The specifications are for a wide temperature range, 0°C to 55°C, useful for ATE-Systems. Much higher accuracy is achieved in the limited temperature range 20°C to 30°C; this is useful for bench-top applications which require higher accuracy. The high and low level for each channel is independently programmable. The output voltages can also be programmed as amplitude and offset.

Two Channels / Channel Addition

Two channels are available; they are designed as parameter-independent but synchronous outputs. With the delay capability, phase-shifted signals can be achieved. The two channels can be added, thus 3-level, 4-level signals or spikes can be created.

Specifications

Specifications describe the instrument's warranted performance (30 minutes warm-up, 50-ohm load) at 0°C to 55°C [20°C to 30°C] ambient temperature.

Timing Parameters

(measured at 50% of amplitude with fastest edges).

Common Specifications:

Resolution	3 digits (best case 100 ps)
Repeatability	factor 4 better than accuracy
RMS-jitter*	0.05% of programmed value +30 ps
Period (PER)	20 ns to 950 ms
Accuracy	±5% of progr. value ±2 ns [±2% ±1 ns]
Delay (DEL)	75 ns to 950 ms (max: PER + 55 ns)
Accuracy	±5% of progr. value ±4 ns [±2% ±4 ns]

*see page 433

Double Pulse (DOUB)	20 ns to 950 ms (max: PER - WID)
Accuracy	±5% of progr. value ±2 ns [±2% ±2 ns]
Width (WID)	10 ns to 950 ms (max: PER - 10 ns)
Accuracy	±5% of progr. value ±2 ns [±2% ±2 ns]
Linear Transitions (between 10% and 90% of ampl)	
Range	6.5 ns to 95 ms
Accuracy	±5% of progr. value ±2 ns [±5% ±2 ns]
Output (voltages double when driving into open)	
High Level	-7.90 V to +8.00 V
Low Level	-8.00 V to +7.90 V
Resolution	3 digits (best case 10 mV)
Level-Accuracy	±1% of progr. value ±3% of ampl. ±40 mV [±1% ±1% ±20 mV]
Repeatability	factor 4 better than accuracy

Supplemental Specifications

Trigger Modes	Manual, Auto, Trigger, Gate
Addition	Adds up channel 2 to channel 1.
Control Modes	High level, Period, Delay, Width

General	
Storage Temperature	-40°C to +65°C
Operating Temperature	0°C to 55°C
Power	100-120/220-240 Vrms, ±10%, 450 VA max., 48-66 Hz
Weight	16 kg (35.5 lb)
Dimensions (H*W*D)	190 mm * 426 mm * 584 mm, [7.5 in * 16.75 in * 23 in]
Recalibration Period	1 year recommended

Ordering Information

HP 8115A 50 MHz Dual Channel Pulse Generator **Price**
\$9,800

Options

908 Rack Flange Kit (P/N 5061-9678)	\$36 ☎
910 Set of Operating/Programming and Service Manuals	\$138
915 Service Manual (P/N 08115-90001)	\$106
916 Additional Operating and Programming Manual (P/N 08115-90011)	\$32
W30 Two additional years of HP service	\$245
Accessories	
P/N 1494-0059 Rack Slide Kit (requires #H01)	\$100 ☎

☎ Fast-Ship product—see page 734.

PULSE GENERATORS

300 MHz Pulse Generator, Variable Transitions

HP 8130A

- 1 ns variable transitions
- 300 MHz repetition rate
- 5V p-p amplitude

- Minimum resolution: 10 ps; 10 mV
- 1 channel (2 optional)
- fully HP-IB programmable

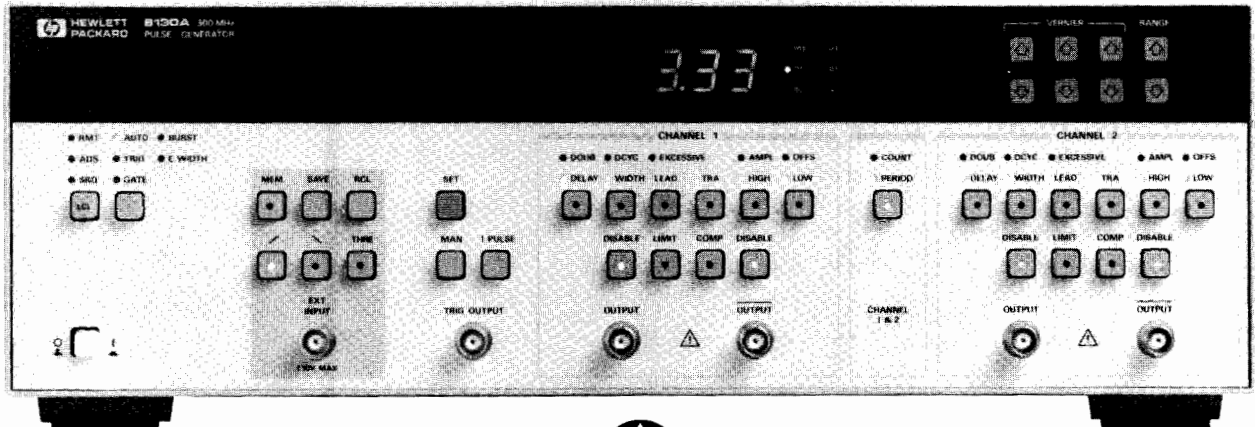

HP 8130A with Option 020, second channel



300 MHz Pulse Generator

The 300 MHz repetition rate of the HP 8130A Pulse Generator establishes a new class of high-speed programmable pulse generator with variable transition times. In many cases, the HP 8130A will perform parametric and function tests up to 300 MHz, because delay and width have a degree of adjustment at this speed. This increases your confidence in the device, because measurements can be performed at a higher speed and even at-speed measurements are feasible.

Variable Transition Times

Clean edges down to 1 ns mean repeatable, reliable measurements on fast digital ICs like BiCMOS, ECL and ECLips*. Variable transition times mean you can optimize switching speed and thus reduce the effects of ringing and reflection when driving reactive or unmatched loads. In addition, the variable transitions open a wide range of analog and digital applications, such as measuring operational amplifiers slew rate, or comparator threshold uncertainty, because trapezoidal and triangular waveforms can be generated.

5V p-p Amplitude and 10 mV Resolution

With 5 V p-p pulse amplitude into 50 ohms, you can cover the level requirements of all high-speed semiconductor technologies like BiCMOS, ECL, and ECLips. Minimum signal sensitivity down to 100 mV can be tested using a direct connection to the HP 8130A. Attenuators can be inserted for smaller signal amplitudes; e.g., with a 20 dB attenuator, the minimum amplitude is 10 mV with 1 mV resolution.

10 ps Timing Resolution

A timing resolution of an order of magnitude higher than typical gate-delays eliminates time-window uncertainties, making more accurate and reliable measurements possible.

Data and Clock Simulation

Two signals—data and clock—are needed in order to characterize flip-flops. The HP 8130A with Option 020, second channel, is a convenient way of generating two different but synchronized signals. Double-pulse can be selected in one channel to simulate a clock, the other channel then appears to produce a series of binary ones and

zeros in NRZ (non-return-to-zero) format. Data rates up to 280 Mbit/s can be simulated.

Rapid ATE Integration

The HP 8130A is the first fully programmable product to offer full pulse performance flexibility up to 300 MHz. Even the input trigger level can be programmed to automate your measurements. This makes it an extremely useful instrument not only for R&D and production engineering environments, but also in incoming component inspection, and for high-speed functional test applications in production test. A new standardized programming language (HP-SL) enables you to program, upload, and down-load new parameters or complete settings for future requirements; i.e., you can rapidly acquire set-ups you have previously set manually.

Fast and Convenient Manual Operation

The proven design of Hewlett-Packard's pulse generators has been adapted to the requirements of the HP 8130A. This reduces your training, and lets you concentrate on your measurement task.

Specifications

Specifications describe the warranted performance. Non-warranted values are described as "typical". All specifications apply after a 30 minute warm-up phase with 50 ohms load resistance at all outputs, and are valid at 0°C to 55°C ambient temperature.

Timing Parameters

Common Specifications

Measurement conditions: normal mode, measured at 50% of amplitude and fastest transitions.

Resolution: 3 digits, best case: 10 ps

Repeatability: factor 4 better than accuracy.

RMS-jitter: 0.025% of programmed value + 15 ps (0.05 % of programmed value + 15ps for range 10 ns to 100 ns)

Period

Range: 3.33 ns to 99.9 ms

Accuracy: ±5% of programmed value ±100 ps

Width

Range: 1.5 ns to 99.9 ms

Accuracy: ±5% of programmed value ±250 ps

*registered trade mark of Motorola Inc.

Delay

(measured between trigger out and main out)

Fixed delay (trigger to main out): 18 ns

Variable range: from 0 ns to 99.9 ns

Accuracy: $\pm 5\%$ of programmed value ± 250 ps

Transition Times (measured at 10% to 90% of amplitude)

Range: 1 ns to 100 μ s

Accuracy: $\pm 10\%$ of programmed values ± 300 ps

Linearity:

transitions 1.00 ns to 1.99 ns: $\leq \pm 20\%$ of amplitude

transitions 2.00 ns to 49.9 ns: $\leq \pm 10\%$ of amplitude

transitions > 50 ns: $\leq \pm 3\%$ of amplitude

Under-Programmability

Period, width and transitions are under-programmable to ensure that the specified minimum values can always be obtained.

Output Levels

Output levels double when driving into open circuits. Instrument disables outputs if levels exceed ± 6.5 V, or amplitude exceeds 6.5 V p-p.

High level: -4.90 V to $+5.00$ V

Low level: -5.00 V to $+4.90$ V

Resolution: 3 digits, best case: 10 mV

Level accuracy: $\pm 1\%$ of programmed value $\pm 3\%$ of amplitude ± 40 mV

Repeatability: factor 4 better than accuracy

Settling time: 20 ns (at fastest transition time)

Operating Characteristics

Operating Characteristics describe typical, non-warranted performance.

Duty cycle

(Width and duty cycle are mutually exclusive)

Range: 1% to 90%

Resolution: 1%

Subject to width and period specifications

Input and output

BNC connectors on the front panel. Rear panel connectors are optional.

Main outputs (differential outputs)

Amplitude: 100 mV p-p to 5 V p-p into 50 Ω

Offset: -4.95 V to 4.95 V into 50 Ω

Source impedance: 50 $\Omega \pm 1 \Omega$

Maximum external voltage: ± 5 V

Short circuit current: 200 mA

External input

Trigger, Gate, Burst, and External width mode

Trigger slopes can be selected positive or negative.

Input impedance: 50 $\Omega \pm 2.5 \Omega$

Threshold: -5 V to $+5$ V

Resolution: 100 mV

Maximum input voltage: ± 10 V

Input transition: < 50 ns

Input frequency: dc to 300 MHz

Minimum pulse width: 1.5 ns

Input sensitivity: ≥ 300 mV p-p

Trigger output

Levels: high at 2.4 V, low at 0.3 V into 50 Ω

Trigger pulse width:

Period (PER)	Pulse width (WID)
3.33 ns to 99.9 ns	50% of PER
100 ns to 999 ns	95% of PER
1.00 μ s to 9.99 μ s	99.5% of PER
10.0 μ s to 99.9 ms	99.95% of PER

Transition times: < 1 ns

Source impedance: 50 $\Omega \pm 2.5 \Omega$

Delay from external input or trigger output:

In Trigger and External Width mode: 16 ns

In Gate and Burst mode: 18.5 ns

Max/Min external voltage: $+7/-2$ V

Operating Modes

Manual: simulates an external input signal.

1 Pulse: in Trigger, Gate and Burst mode, one pulse to double pulse is generated.

Auto: continuous pulse stream

Trigger: each active input transition generates a single output pulse or double pulse.

Gate: external signal enables period generator. First output pulse synchronous with active edge. Last pulse always completed. Width and period of first pulse may deviate 10% from subsequent pulses.

External burst: each active input transition generates a preprogrammed number of pulses (1 to 9999), minimum burst period is 5 ns. Width and period of first pulse may deviate 10% from subsequent pulses.

External width: pulse recovery (external edges toggle output). Output levels and transition times are selectable.

Limit: maximum high and low levels into 50 Ω can be limited to protect the device under test. Pushing the limit key declares present levels as limits which then cannot be exceeded as long as the mode is active.

Complement: normal/complement is selectable per output

Disable: relays connect/disconnect outputs.

Set: sets parameters to fixed ratio relative to period (delay = 0 ns, width = 50% of period, transitions = 10% of period, limited to min 1 ns; period, high level and low level = current values).

HP-IB capabilities

All modes and parameters are programmable, downloadable and uploadable. ASCII and binary formats are supported.

Non-volatile Memory

Current settings are saved on power-down. Additionally, 19 complete set-ups can be stored.

General

Storage temperature: -40°C to $+65^\circ\text{C}$

Operating temperature: 0°C to 55°C

Power: 100/120/220/240 Vrms, $\pm 10\%$, 250 VA max, 50-60 Hz

Weight: 20 kg (44.4 lb)

Size: 145H x 426W x 525mmD
(5.7" x 16.75" x 20.65")

Recalibration period: 1 year recommended

Ordering Information

	Price
HP 8130A 300 MHz Pulse Generator	\$12,100
Opt 001 Rear Panel Connectors	\$0
Opt 020 Second Channel	\$6,300
Opt 908 Rack Mount Flange Kit (P/N 5062-3977)	\$33.50 ☎
Opt 916 Additional Operating/Programming Manual (P/N 08130-90011)	\$32
Opt W30 Extended Repair Service. See page 725.	contact HP office
Opt W32 Calibration Service. See page 725.	contact HP office
Opt H01 Preparation for rack slides (rack slide kit required)	contact HP office
Accessories	
HP 1494-0059 Rack Slide Kit	\$100 ☎
HP 8493A#020 20dB Attenuator	\$120 ☎
HP 1250-1200 BNC-SMA Adaptor	\$40 ☎
☎ Fast ship product—see page 734.	

PULSE GENERATORS

500 MHz High-speed Pulse Generator

Model 8131A

- 1/2 (optional) channels / 500 MHz repetition rate
- <200 ps fixed transitions
- minimum resolutions: 10 ps; 10 mV
- suitable for BICMOS, ECL, and GaAs technology
- 1 GHz Transducer Mode
- fully HP-IB programmable

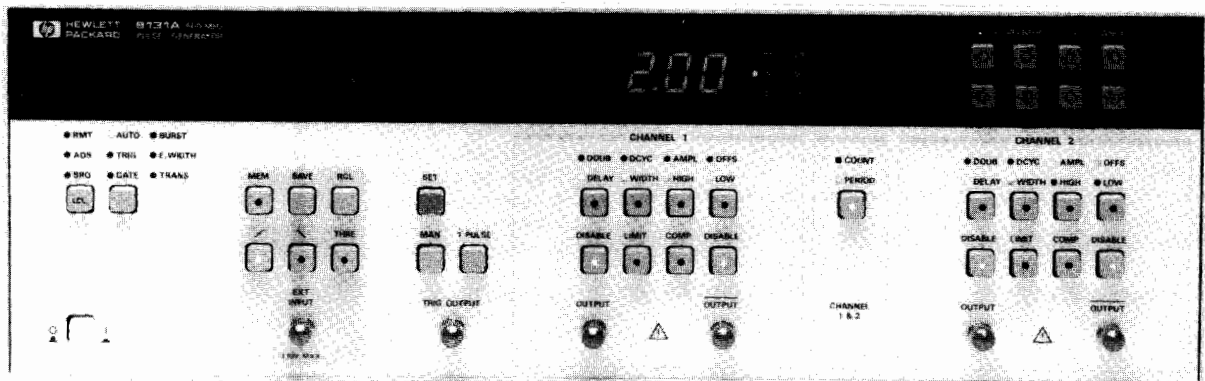

HP 8131A



200 ps Transition Times

The HP 8131A delivers excellent performance to help you solve high-speed measurement problems. Transition times of less than 200 ps from the 10% to 90% amplitude (20% to 80% of amplitude: typical 150 ps) enable repeatable and reliable timing measurements on high speed digital circuits. Since compromises in edge speed directly affect your measurement accuracy, the clean and sharp edges offered by the HP 8131A minimize errors due to threshold uncertainties. Matching the requirements of the most advanced ECL and GaAs devices, you now can characterize components and circuits with repetition rates up to 500 MHz (in Transducer Mode up to 1 GHz). The HP 8131A is the first product that offers 200 ps edge speed in a fully programmable product which makes it extremely useful not only in R&D environments but also in high speed production test applications.

10 ps Timing Resolution

The high timing resolution allows precisely measure timing parameters like setup and hold times. Especially in the two channel version, the ability to precisely position sharp pulses anywhere within a period with independent delay and width makes the HP 8131A a very useful tool in evaluating fast digital circuits. With a timing resolution that is about one order of magnitude higher than the typical gate delay of ECL devices, it is easy to detect trends when varying a critical pulse parameter without losing a required timing relation. Spikes can be simulated with 500 ps small pulses, and in combination with the 10 ps width resolution, timing and energy related failures can be examined.

5V Amplitude and 10 mV Resolution

The 5V amplitude makes it possible to stimulate high speed circuits such as ECL, GaAs, or BICMOS devices. In addition, you now can test the excess-voltage immunity of your high speed components and evaluate crosstalk caused by 5 V, 200 ps transitions. The 10 mV resolution helps to slowly approach the threshold levels of digital circuits. The minimum amplitude of 100 mV is enough to check for minimum signal swing up to a 500 MHz (1 GHz in Transducer Mode) repetition rate. In combination with the full programmability, you now can do detailed analysis of critical level conditions in an automated test routine.

500 MHz Repetition Rate

The 500 MHz repetition rate of the HP 8131A establishes a new class of high speed programmable pulse generator, which allows testing at the maximum toggle rate of your ECL, CMOS and complex GaAs devices. Now it is possible to perform functional and parametric tests of fast digital circuits under program control. In R&D, this means more reliable tests under repeatable conditions and easy documentation of test results. In production, the programmability opens new possibilities to functionally test high speed digital components with significantly higher throughput under well defined conditions. For the first time, the HP 8131A can test digital components at rated speed, thus increasing your confidence in the performance of your device and ensuring high quality of your product.

1 GHz Transducer Mode

If you need to functionally test your component at frequencies beyond 500 MHz, the 1 GHz transducer mode allows to shape an externally provided sinewave into a squarewave with transition times of 200 ps. Especially if you need a very fast, programmable clock source, the combination of the HP 8131A and a microwave signal generator is ideal. This way, you can test maximum toggle frequency with a true digital 1 GHz signal.

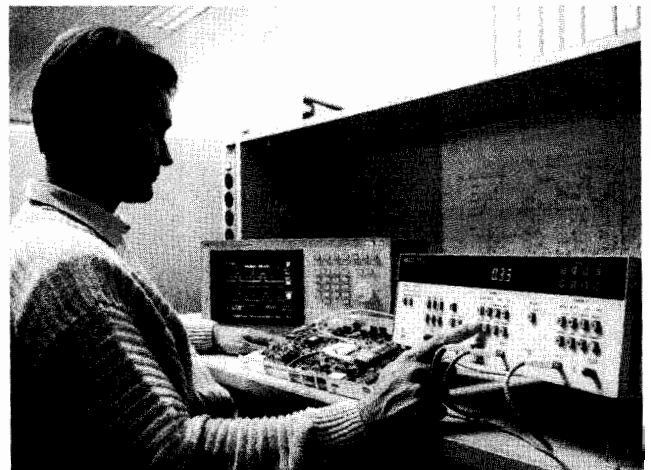

Transition Time Converters (HP 15432/3/4A)

HP 8131A's fast edges are ideal for testing some of today's fastest digital ICs. But what happens when a practical circuit - through unavoidably long ground connections, for example - is reactive?

It doesn't take much inductance to cause violent ringing when shot at with edges faster than 200 ps. It's unlikely that a reduction in repetition rate will improve circuit performance unless it is accompanied by an increase in switching time, but the transition time converter satisfy the need for slower edges.

Flexibility

You can test not only today's fastest digital ICs, but also those that need slower transition times and less overshoot and ringing.

At high frequencies, the quality of cables, connectors, and terminations can influence the transition times significantly. Always think of the route from the HP 8131A to the device as a transmission line, and the transition time converter as simply a filter that removes some of the highest frequencies, slowing the edges, damping reflections, and reducing overshoot and ringing.

Typical Performance Characteristics:

	15432A	15433A	15434A
Output Transition Times	300 ps	500 ps	1000 ps
Intrinsic Transition Times	260 ps	480 ps	990 ps
3 dB Corner Frequency	1120 MHz	660 MHz	330 MHz
Input Voltage	< 10.0 V peak-to-peak		
Insertion Loss	< 0.2 dB		
Overshoot and Ringing	< 5%		
VSWR	< 2.0		

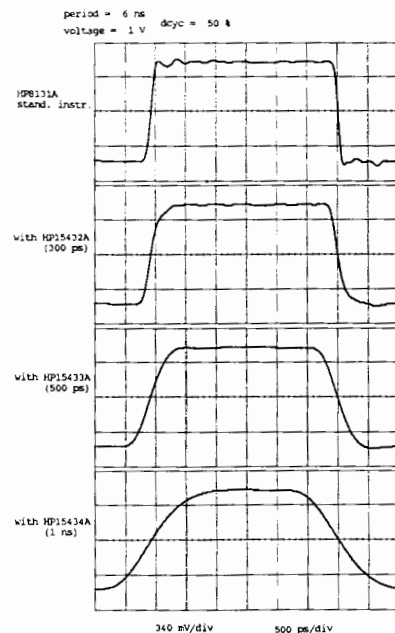

Waveforms are plotted from the HP 54121T Digitizing Oscilloscope

Specifications

Specifications describe the instrument's warranted performance (30 minutes warm-up, 50-Ohm load) at 0°C to 55°C ambient temperature.

Timing Parameters (measured at 50% of amplitude)

Common Specification

Resolution: 3 digits (best case: 10 ps)

Period: 2 ns to 99.9 ms

Delay: 20 ns to 99.9 ms

Fixed: 20 ns

Variable Range: from 0 ns to 99.9 ms measured between trigger out and main out.

Double Pulse: 2 ns to 99.9 ms

Double Pulse and Delay are mutually exclusive.

Width: 500 ps to 99.9 ms

Transition Times: (for leading and trailing edges)

10%-90% of amplitude: <200 ps, 300mV to 3V range

20%-80% of amplitude: <200 ps, 100mV to 5V range

Differential outputs

Output Levels: (into 50 Ω, output levels double when driving into open circuits, instrument disables outputs if levels exceed ±6.5V, or ampl. exceeds 6.5V)

High Level: -4.90V to +5.00V

Low Level: -5.00V to +4.90V

Resolution: 3 digits (best case: 10 mV)

Settling Time: 10 ns

Operating Characteristics

(values describe typical, non-warranted performance)

Inputs and Outputs

External Input: (Trigger, Gate, Burst, Ext. Width)

Trigger slopes can be selected pos/neg.

Input impedance: 50 Ohm ±2.5 Ohm

Threshold: -5 V to +5 V

Input Frequency: dc to 500 MHz

Min. pulse width: 1 ns

Input sensitivity: ≥ 300 mV (p-p)

Transducer Input:

Input Impedance: 50 Ohm ±2.5 Ohm

Input transition: <50 ns.

Input Frequency: 10 MHz to 1 GHz

Input sensitivity: ≥ 600 mV (p-p)

Trigger Output:

Levels: high 0V, Low-0.6 V

Delay from external input to trigger output: 16 ns

source impedance: 50 Ohm ±5 Ohm

HP-IB Capabilities

All modes and parameters are fully HP-IB programmable.

Operating Modes

Manual: Simulates an external input signal

1 Pulse: in Trigger, Gate and Burst mode one pulse or double pulse is generated.

Auto: Continuous pulse stream

Trigger: Each active input transition generates a single output pulse or double pulse.

Gate: External signal enables period generation. First output pulse synchronous with active edge. Last pulse always completed.

E. Width: Restoration of external signal with selectable output levels

Burst: Each active input transition generates a preprogrammed number of pulses (1 to 9999), min burst period is 5 ns

Transducer: External sinewave (up to 1 GHz) toggles output. Output levels are selectable

Limit: Max. high and low levels into 50 Ohm can be limited to protect the device under test. Pushing the limit key declares present levels as limits which then can not be exceeded as long as the mode is active.

Complement: Normal/complement selectable

Disable: Relays connect/disconnect outputs

Set: Sets parameters to fixed ratio relative to period.

Store: Stores complete setting in displayed location

Recall: Recalls complete setting from displayed location.

General

Storage Temperature: -40°C to +65°C

Operating Temperature: 0°C to 55°C

Power: 100-120/220-240 Vrms, ±10%, 400 VA max., 48-66 Hz

Weight: 20 kg (44.4 lb)

Dimensions (H*W*D) 145 mm * 426 mm * 525 mm,
[5.7 in * 16.75 in * 20.65 in]

Recalibration Period: 1 year recommended

Ordering Information

HP 8131A 500 MHz Pulse Generator

Price
\$14,300

Options

Opt. 001 Rear Panel Connectors

N/C

Opt. 020 Second channel

\$7,400

Opt. 908 Rack Mount Flange Kit (P/N 5061-9677)

\$33.50

Opt. 910 Set of Operating/Programming and Service Manual

\$138

Opt. 915 Service Manual (P/N 08131-90001)

\$106

Opt. 916 Additional Operating and Programming Manual (P/N 08131-90011)

\$32

Opt. W30 Two additional years of Return-to-HP service

\$360

Accessories

HP 15432A 300 ps Transition Time Converter

\$240

HP 15433A 500 ps Transition Time Converter

\$240

HP 15434A 1 ns Transition Time Converter

\$240

HP 8493A Option 010; 10 dB Attenuator

\$120

HP 8493A Option 020; 20dB Attenuator

\$120

P/N 8120-4948 Cable, Coax (SMA)

\$180

☛ Fast-ship product - see page 734

PULSE GENERATORS

Programmable Precision Pulse Generators

Models 8160A, 8161A

- 50 MHz repetition rate
- 6.0 ns variable transition time
- 20 V output amplitude

- 1-3% pulse parameter accuracy
- Full dual channel capability (option 020)
- 1 year recalibration period

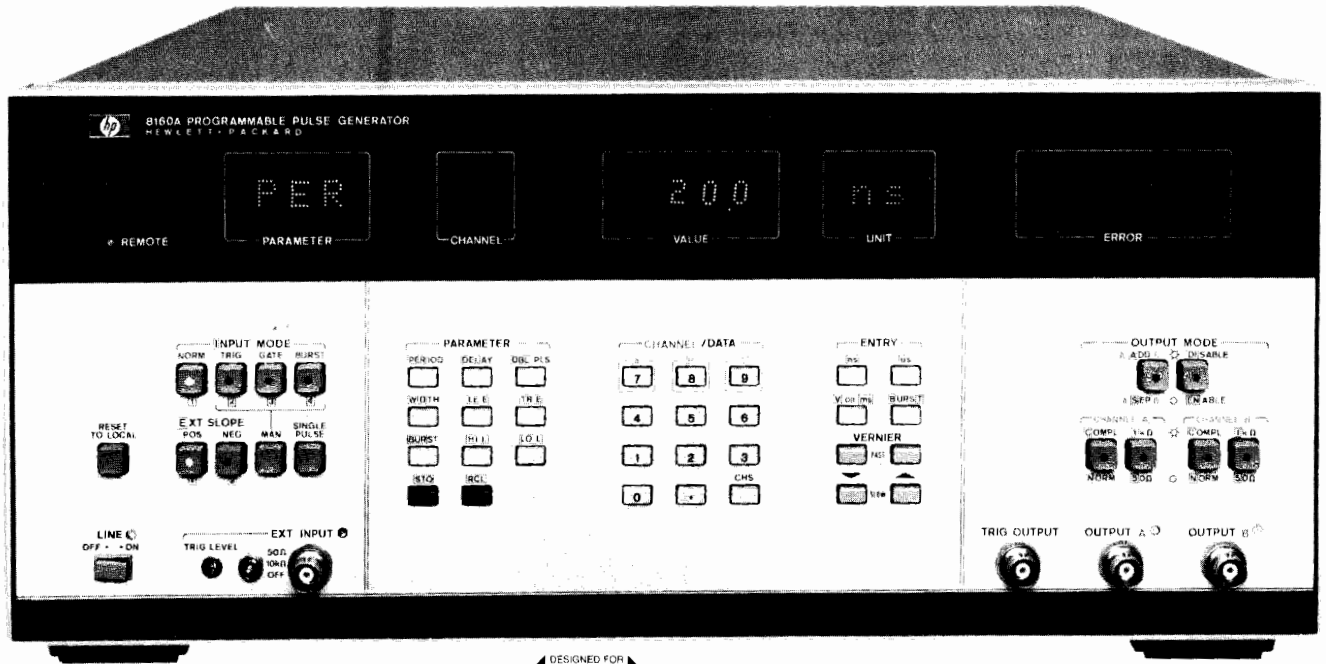

Designed For
MATE
Systems



Picture shows 8160A
with Option 020, Dual Channel
with Option 700, MATE/CIIIL compatibility

- 100 MHz repetition rate
- 1.3 ns variable transition time
- 5 V amplitude

- 1-3% basic timing accuracy
- Full dual channel capability (option 020)
- 1 year recalibration period

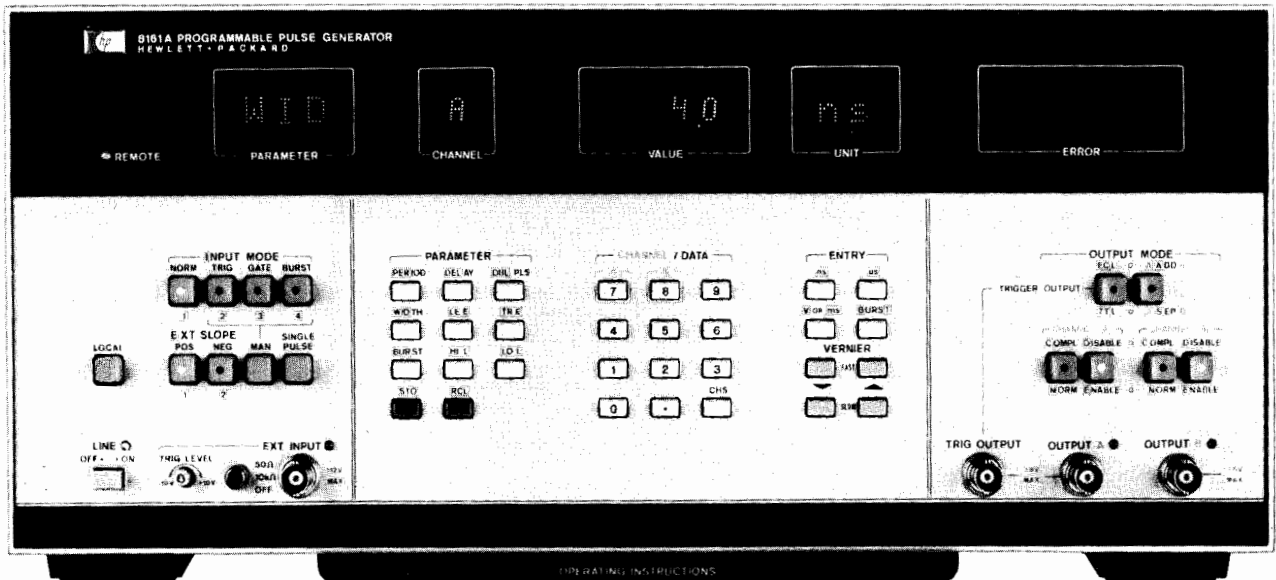

Designed For
MATE
Systems



Picture shows 8161A
with Option 020, Dual Channel
with Option 700, MATE/CIIIL compatibility



The HP 8160A and 8161A are fully programmable pulse generators designed for high performance applications on the bench and in automatic test systems. Operation is made easy because the pulse parameters are controlled independently and do not inter-react. Dual channel options permit synchronous or complex waveforms to be generated. With its 50 MHz repetition rate, 20 V output, and 6 ns variable transition times, the HP 8160A is a general purpose pulse generator. The HP 8161A covers the high end of technology with its 100 MHz, 5 V and 1.3 ns variable transition times. Measured between the 20% to 80% amplitude points, these transitions are faster than 1 ns and meet ECL requirements.

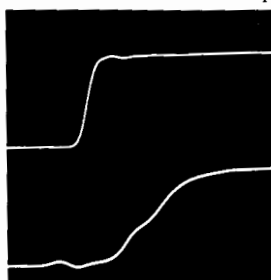

HP 8161A input pulse (upper) and ECL memory output pulse (lower).

Combining high programming accuracy with microprocessor-based control capabilities, pulses can be set up without a measuring instrument. Pulse parameters are entered and displayed numerically, and generated with a basic timing accuracy of 1-3%, depending upon parameter.

An easy-to-use HP-IB interface brings high-accuracy pulses to automatic test. All parameters and operating modes are remotely programmable using straight-forward command sequences. Faster, easier program generation and reduced software costs are direct benefits.

Precision Pulse Generation

Both models provide precision control over all parameters of their output pulses. The HP 8160A's leading and trailing edge transition times may be independently programmed down to 6 ns. The HP 8161A's transitions have a common control from 1.3 ns to 5 ns, and are independent above 5 ns. Variable transition times are indispensable when digital IC's need to be characterized: either the IC's data sheeted input transition time is required, or the IC's functioning range with various transitions needs to be evaluated.

Direct entry of the high and low levels of the output pulse enables easy adjustment to the logic levels concerned. Pulse width is variable from 4 ns (HP 8161A) or 10 ns (HP 8160A) to 1 s, giving a wide range of duty cycle programmability. Delay shifts the output pulse in relation to the trigger output or, in double pulse mode, defines the pulse spacing.

In the dual-channel versions, double pulse can be selected in either or both channels. This means, for example, that simultaneous clock and data signals can be generated.

Complex Signals

Independent pulse parameters plus individual programmability of the Option 020's dual outputs are augmented by the A ADD B mode. Summation allows complex signals to be precisely and easily set up. Here are some examples:

Applications such as radar coincidence circuits and special codes in communications require 3- and 4-level signals. These are conveniently generated by combining channel A and channel B pulses.

A
SEP
B

A ADD B

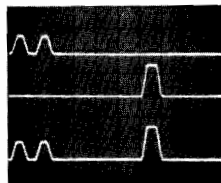
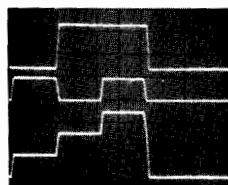

A
SEP
B

A ADD B

Transponder circuits need accurate delays, often with respect to a double-pulse interrogation signal. In the HP 8160A, this is arranged by operating one channel in double pulse mode and setting up the transponder delay in the other.

A critical test for digital circuits and IC's is its glitch and noise sensitivity, which can be easily performed with the A ADD B mode.

A
SEP
B

A ADD B

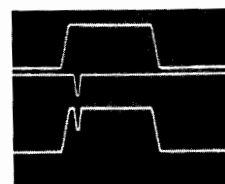

Counted Burst

Using Burst Mode, a predetermined number of pulses is generated independent of frequency. Bursts from 0 to 9999 pulses in length may be produced, and can be triggered via an external signal manually or with an HP-IB command.

Wide Temperature Range for System Reliability

The HP 8160A's and 8161A's 0-50°C operating range ensures calculable performance. Indeed, temperatures will generally be between 20-40°C where there is no derating factor.

User Features

Fast, Reliable Setup

Microprocessor control promotes highly accurate pulses. Parameters are directly entered via the instrument's keyboard, and are then displayed on numeric LED's with 3-digit resolution.

In bench applications, the vernier controls give a fine adjust capability to "tweak-in" any pulse parameter. You can increment or decrement the selected parameter either in single steps or at speed.

Error detection by the microprocessor further simplifies pulse setup by solving the old problem of incompatible settings. Should pulse width exceed pulse period, for example, the microprocessor indicates a TIMING error. All possible mis-settings are detected and the type of error is indicated to aid rapid correction.

HP-IB Programming

Microprocessor control over all interface functions makes remote programming as easy and straight-forward as manual control. The instruments employ keystroke programming so that data entry via the HP-IB is an exact simulation of manual entry. Bus commands for each front panel key simply replace manual keystrokes.

Parameter Storage

Complete parameter and mode information for 9 independent instrument set-ups can be stored. Waveforms may be stored and recalled either manually or via the HP-IB.

By utilizing a single command to recall an entire instrument set-up, controller time is saved. In simple repetitive testing applications, storage of test waveforms gives a high degree of user convenience without an external controller.

Specifications overleaf

PULSE GENERATORS

Programmable Precision Pulse Generators (cont'd)

Models 8160A, 8161A

Learn Mode

When interrogated by the system controller, the instruments output a character string to the interface bus. This string completely describes the pulser's current set-up or any one of its stored parameter sets. Using Learn Mode, you can enter and try out waveforms manually and then automatically transfer them via the HP-IB to the controller for storage in a program.

Verification Software for the 8160A

Test system accuracy is guaranteed by accessory software which verifies the HP 8160A's performance standards. The software is fully documented and comes recorded on a cassette suitable for HP Model 9825A Desktop Computer.

In the event of a failure, downtime is minimized because the software also delivers diagnostic information to accelerate repair and calibration.

Specifications

(50-ohm source into 50-ohm load). Standard instruments are single channel. Option 020 provides independent dual channels with common pulse period.

Timing (with minimum transitions)	HP Model 8160A	HP Model 8161A
Period Range: Accuracy: Max Jitter:	20 ns to 999 ms. ±3% of progr value ±0.3 ns (period < 100 ns); ±2% of progr value (period ≥ 100 ns). 0.1% of progr value + 50 ps.	10 ns to 980 ms. ±3% of progr value ±0.5 ns (period < 100 ns); ±2% of progr value (period ≥ 100 ns). 0.1% of progr value + 50 ps.
Delay, Double Pulse, Width Delay Range: Double Pulse Range: Width Range: Accuracy: Max Jitter:	0.0 ns to 999 ms. 20.0 ns to 999 ms. 10.0 ns to 999 ms. ±1% of progr value ±1 ns. 0.1% + 50 ps (≤999 ns); 0.05% (999 ns < ≤9.99 μs); 0.005% (>9.99 μs).	0.0 ns to 990 ms. 8.0 ns to 990 ms. 4.0 ns to 990 ms. ±1% of progr value ±1 ns. 0.1% + 50 ps (≤999 ns); 0.05% (999 ns < ≤9.99 μs); 0.005% (>9.99 μs).
Output Characteristics Output levels High Level Range: Low Level Range: Amplitude: Level Accuracy: Settling Time:	50 Ω into 50 Ω -9.89 V to 9.99 V. -9.99 V to 9.89 V. 0.10 V min, 9.99 V max. ±1% of progr value ±1% of ampl ±50 mV. 40 ns.	50 Ω into open or 1 kΩ into 50 Ω -19.7 V to 19.9 V -19.9 V to 19.7 V 0.2 V min, 19.9 V max -4.95 V to 5.00 V. -5.00 V to 4.95 V. 0.06 V min, 5.00 V max. ±1% of progr value ±3% of ampl ±25 mV. 20 ns plus transition time.
Transition Times (10 – 90% amplitude) Leading Edge: Trailing Edge: Accuracy: Linearity:	6.0 ns to 9.99 ms. 6.0 ns to 9.99 ms. ±3% of progr value ±1 ns. ±3% for transitions > 30 ns.	1.3 ns to 900 μs. 1.3 ns to 900 μs. ±10% of progr value ±1 ns. ±5% for transitions > 30 ns.
Preshoot, Overshoot, Ringing:	±5% of ampl ±10 mV.	±5% of ampl ±10 mV (may increase to ±10% of ampl ±10 mV for transitions < 2.5 ns).
A ADD B:	Adds channel A and B outputs (Opt 020 only).	Adds channel A and B outputs (Opt 020 only).
Output Format:	Normal/Complement Selectable. (Independently selectable in each channel in Option 020.)	Simultaneous Normal and Complement Outputs. (Independently selectable in each channel in Option 020.)
Source Impedance:	50 ohm/1 kohm selectable.	50 ohm.

Operating modes: Normal, Trigger, Gate, Ext Burst (0–9999 pulses).

HP-IB capability: all modes and parameters can be programmed. Talk mode for status, error messages, stored parameters.

Memory: 9 programmable locations*,
1 location for active operating state*,
1 location with fixed parameter set.

Capacity: 1 complete operating state per location.
*Battery back-up for power-off storage

General

Recalibration period: 1 year.

Repeatability: factor 2 better than specified accuracy.

Operating temperature: 0°C to 50°C (Specifications apply from 20°C to 40°C. Accuracy derating factors for 0°C to 20°C and 40°C to 50°C).

Power: 115/230 V ac + 10%, –22%, 48–66 Hz; 675 VA max.

Weight: net 20.8 kg (46 lbs). Shipping 25 kg (55 lbs).

Size: 178 H x 426 x 530 mm D (7" x 16.8" x 20.9").

Ordering Information

Price

	HP 8160A	HP 8161A
HP 8160A/8161A Programmable Pulse Generator*	\$15,100	\$17,500
Opt. 001: Rear panel inputs and outputs	N/C	N/C
Opt. 020: Second channel (Rate common)	\$7,040	\$7,550
Opt. 700: Built-in MATE/CIIL compatibility	\$3,060	\$3,060
Opt. 907: Front handle kit (P/N HP 5061-9690)	\$66	\$66
Opt. 908: Rack flange kit (P/N HP 5061-9678)	\$36	\$36
Opt. 909: Opt 907, 908, combined (P/N HP 5061-9684)	\$92	\$92
Opt. 910: Set of Operating/Progr. and Service manuals	\$122	\$153
Opt. W30: Two additional years of HP service	\$380	\$440

* HP-IB cables not supplied, see page 569

☎ Fast-Ship product—see page 734

PULSE GENERATORS

Fast, High Power Pulse Generator

Model 214B

443

- High power 100 V, 2 A output
- 10 MHz repetition rate

- Constant duty cycle
- Counted pulse burst option

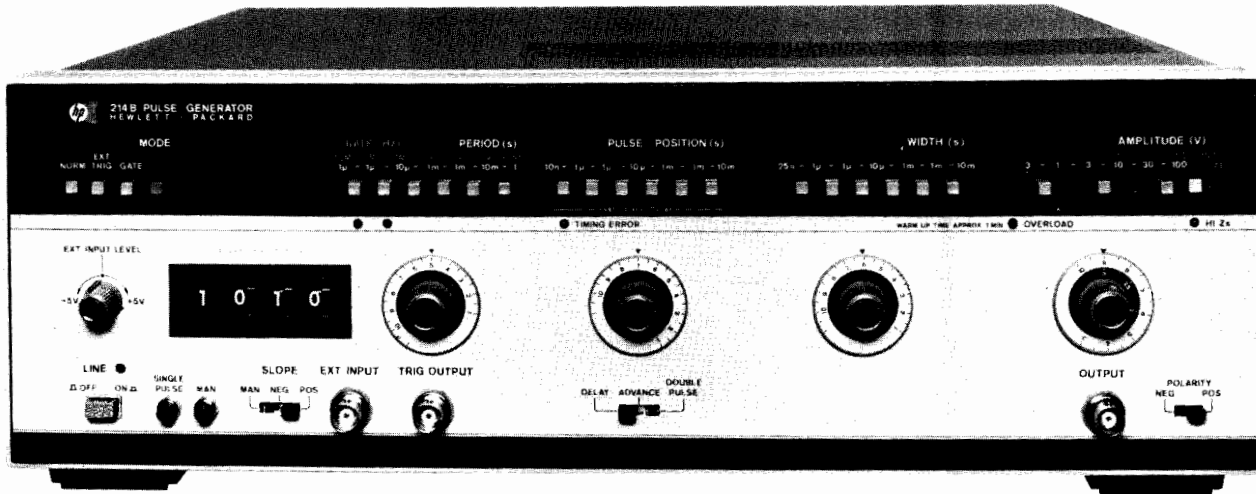

Picture shows 214B with Option 001, Counted Burst.

The HP 214B pulse generator employs semiconductor technology for high power pulse generation at up to 10 MHz repetition rate. Delivering 100 V pulses with 15 ns risetimes, the HP 214B meets the speed demands of today's applications.

State-of-the-art VMOS FETS used as current sources for the output amplifier tubes enable pulse width to be specified down to 25 ns. The HP 214B is thus well-equipped for low duty cycle applications such as laser diode pulsing or transient simulation.

Where changing duty cycle threatens destruction to the device under test, the HP 214B Constant Duty Cycle (CDC) mode provides device protection. In CDC operation the duty cycle, hence power, remains constant as frequency is varied. The HP 214B is itself protected against excessive duty cycles via an overload protect circuit.

Easy operation is assured by the timing error indication. Calibrated dials enable fast accurate adjustments. Operating into unmatched loads, clean pulse shape is guaranteed by the low reactance 50 Ω source impedance. Pulse distortions such as preshoot and overshoot are specified as 5% at all amplitudes.

Specifications

Timing

Repetition rate: 10 Hz to 10 MHz in 6 ranges. In 30 V - 100 V amplitude range, maximum rep. rate is 4 MHz. Calibrated vernier provides continuous adjustment within ranges. **Vernier accuracy:** $\pm(10\%$ of setting + 1% full scale). **Period Jitter:** $\leq 0.1\% + 300$ ps.

Pulse delay/advance: pulse can be delayed/advanced with respect to the trigger output from 10 ns to 10 ms (\pm fixed delay of 45 ns) in 5 ranges. Calibrated vernier provides continuous adjustment within ranges. **Vernier accuracy:** $\pm(10\%$ of setting + 1% full scale) + fixed delay. **Position Jitter:** $\leq 0.1\% + 500$ ps

Maximum pulse position duty cycle: $\geq 50\%$

Double pulse: 5 MHz maximum in all ranges except 30 V - 100 V range which is max. 2 MHz. Minimum separation is 100 ns.

Pulse width: 25 ns to 10 ms in 6 decade ranges. Calibrated vernier provides continuous adjustment within ranges. **Accuracy:** $\pm(10\%$ of setting + 1% full scale) + 5 ns. **Width Jitter:** $\leq 0.1\% + 500$ ps.

Max. duty cycle: $\geq 10\%$ for 30 - 100 V range. $\geq 50\%$ all other ranges.

Constant duty cycle mode (disabled in ext. trigger mode): duty cycle of output pulse remains constant as the period is varied. The duty cycle limits in this mode are typically 8% fixed for the 10 M - 1 MHz range (max. 4 MHz); 2.5% to 10% for 1 MHz - .1 MHz range; .25% to 10% for .1 MHz - 10 kHz range; 0.1% for all other ranges. Calibrated vernier provides continuous adjustment within ranges.

Accuracy: $\pm(15\%$ of setting + 1% of full scale).

Trigger Output

Amplitude: $\geq +5$ V (50 ohm into open circuit).

Pulse width: 10 ns typical.

External Operating Modes

External Input (impedance 10 k ohm, dc coupled)

Repetition rate: dc to 10 MHz. **Sensitivity:** 500 mVpp, dc coupled.

Slope: pos. or neg. **Trigger level:** +5 V to -5 V adjustable.

Maximum input level: ± 100 V. **Trigger pulse width:** ≥ 10 ns.

EXT TRIG mode: an output pulse is generated for each input pulse.

GATE mode: gate signal turns on rep. rate generator synchronously. Last pulse always completed.

BURST mode (optional): preselected number of pulses generated on receipt of trigger signal. **Number of pulses:** 1 to 9999. Minimum spacing between bursts: 200 ns.

Manual: pushbutton can be used for triggering single pulses (EXT TRIG mode), generating gate signals (GATE mode) or triggering pulse bursts (BURST mode).

Output

Amplitude: 0.3 V to 100 V in 5 ranges. Calibrated vernier provides adjustment within ranges. **Vernier accuracy:** $\pm 10\%$ of setting.

Source impedance: fixed 50 Ω nominal on ranges up to 10 V. Selectable 50 Ω nominal or HI-Z on 10 - 30 - 100 V ranges (with 50 Ω / 50 Ω impedance, amplitude decreases to 5 - 15 - 50 V).

Polarity: pos. or neg. selectable.

Transition times: ≤ 15 ns for leading and trailing edges.

Pulse top perturbations: $\leq \pm 5\%$ of amplitude.

General

Operating temperature: 0°C to 55°C.

Power: 100/120/220/240 Vrms; +5%, -10%, 48 to 66 Hz, 360 VA max.

Size: 133 mm H x 426 mm W x 422 mm D (5.2" x 16.8" x 16.6").

Weight: net 13.6 kg (30 lb). Shipping 15.6 kg (34.3 lb).

Ordering Information

HP 214B Pulse Generator

Opt. 001: Counted Burst

Opt. 003: 48-440 Hz Line

Opt. 907: Front Handle Kit (part number HP 5061-9689),

Prices

\$4950

add \$770

add \$120

add \$56

add \$33

add \$82

add \$34

\$120

Opt. 908: Rack Mount Kit (part number HP 5061-9677).

Opt. 909: Opt 907, 908 Combined (part number HP 5061-9683).

Opt. 910: Set of Operating/Progr. and Service Manuals

Opt. W30: Two additional years of Return-to-HP service

☎ Fast-Ship product—see page 734.

PULSE GENERATORS

20/50 MHz Pulse Sources

Models 8011A/8012B & 8013B

- Repetition rates up to 50 MHz
- Fixed transitions down to 3.5 ns
- Variable transitions from 5 ns to 0.5 s
- Output voltage up to 16V
- Up to 2 ch., select. output formats
- Selectable source impedance



HP 8011A



HP 8012B



HP 8013B

Specifications

Model Parameter	HP 8011A	HP 8012B	HP 8013B
Period	50ns to 10s	20ns to 1s	20ns to 1s
Pulse width	25ns to 100ms	10ns to 1s	10ns to 1s
Duty Cycle in pulse compl.	>50% 100%	40% to 75% 100%	40% to 75% 100%
Pulse delay	—	35ns to 1s	35ns to 1s
Transition Times (int. Load IN)	<10ns fixed —	6ns to 0.5s 5ns to 0.5s	5ns fixed 3.5ns fixed
jitter	0.1% of prog. value + 50ps	0.1% of prog. value + 50ps	0.1% of prog. value + 50ps
max. out. voltage 50 Ohm source to 50 Ohm load into open	8V 16V	5V 10V	5V 10V
offset	—	±2.5V	±2.5V
overshoot, ringing may increase to:	<±5% <±10% if ccw of vernier	<±5% <±10% for int. load OUT	<±5% <±10% for int. load OUT
switchable Source impedance 50 Ohm / high imp	yes	yes	yes
Square wave, max frequency	10MHz	25MHz	25MHz

The HP 8011A 20 MHz, HP 8012B and HP 8013B 50 MHz Pulse Sources are versatile and reliable low-cost pulse generators. They provide the suitable solution to almost all digital logic testing problems. The simple and logical operation, which is achieved by a clearly designed front panel, guarantees rapid familiarization; the risk of setting up incompatible parameters is minimized. The instruments feature normal and complement output modes and a switchable internal 50 Ohm source. These features and performance emphasize the cost effectiveness of these models for many applications.

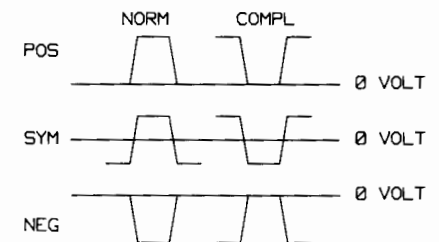

Supplemental Specifications

(values describe typical, non-warranted performance)

Operating Modes

HP 8011A

Manual: front panel pushbutton for generating single pulse
Ext. Repetition Rate: 0 Hz to 20 MHz. In square wave mode, output frequency is half the input frequency.
Trigger source: manual or ext. signal. Min. ext. signal width > 10 ns.
Pulse burst mode (option 001): preselected number (up to 9999) of pulses generated on receipt of trigger.

Burst trigger source: man. or ext. signal. Min. signal width is 25 ns.

HP 8012B & HP 8013B

Manual: front panel pushbutton for generating single pulse
Ext. Repetition Rate: 0 Hz to 50 MHz. In square wave mode, output frequency is half the input frequency.
Trigger source: manual or ext. signal. Min. ext. signal width > 7 ns.
Gate mode: Last pulse is completed even if the gate signal ends during pulse.

General

Operating temperature: 0°C to 55°C

Humidity: 95% RH from 0°C to 40°C

Power: 100/120/220/240 Vrms, +5%, -10%, 48 to 440 Hz, 70 VA max.

Weight: 4 kg (9 lbs)

Dimensions (HxWxD): 142 mm x 200 mm x 330 mm
5.6 in x 7.9 in x 13 in

Ordering Information

	Price
HP 8011A 20 MHz Pulse Generator	\$1300
HP 8012B 50 MHz Pulse Generator	\$2000
HP 8013B 50 MHz Pulse Generator	\$1950

Options

001 Counted Burst for HP 8011A	\$380
910 Additional Operating and Service Manual for HP 8011A or HP 8012B	\$20
for HP 8013B	\$13
W30 Two additional years of Return-to-HP service	
HP8012B	\$65
HP8013B	\$50

Accessories

HP 15179 Rack Mounting Kit	
Adaptor for rack-mounting one or two pulse generators HP 8011A, HP 8012B or HP 8013B	\$235

☎ Fast-Ship Product — see page 734.

PULSE GENERATORS

250 MHz Fast Pulse Source

Model 8082A

445

- <1 ns variable transition times
- Ultra-clean 50 ohm source

- Switch-selectable ECL levels
- Dual ± 5 V outputs

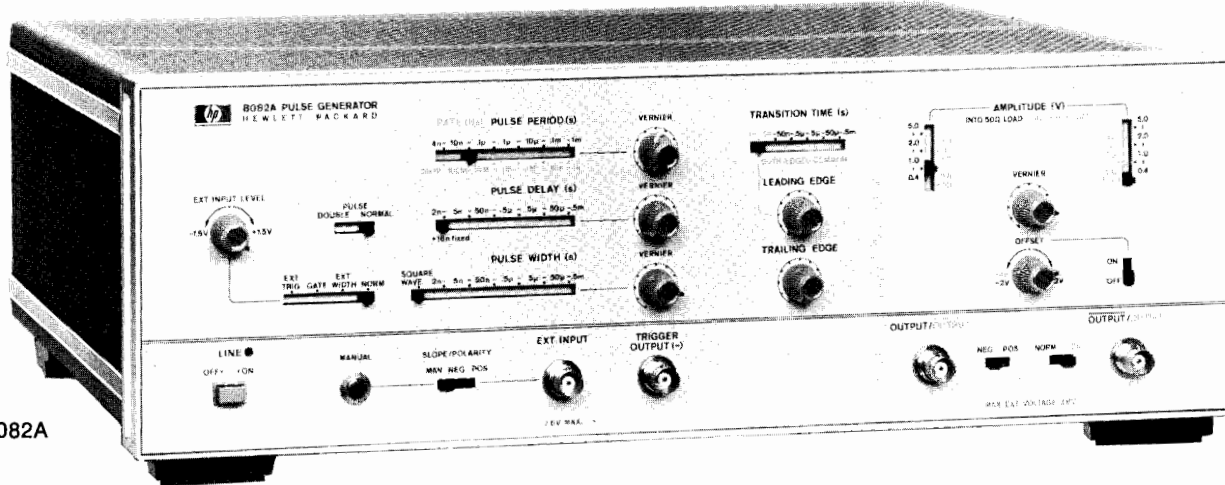

HP 8082A

The HP 8082A is a fast pulse generator with all pulse parameters variable. With repetition rates to 250 MHz, transition times down to 1 ns and amplitudes to 5 V, the HP 8082A is ideally suited for state-of-the-art TTL and ECL logic designs. Using the HP 8082A, you can rapidly test logic circuits under all operating conditions by simply varying pulse parameters. Although a highly sophisticated instrument, the HP 8082A is still easy to operate because of its logical front panel layout and switch selectable ECL output levels. Another feature that contributes to ease of operation is the square wave mode. You can, for example, carry out toggle rate tests in this mode up to 250 MHz without having to worry about pulse duty cycle.

Hybrid IC's, manufactured by Hewlett-Packard, are used extensively in the design of the HP 8082A. These ICs eliminate the need for fans, reduce power consumption and enable a low reactance 50 ohm source impedance to be used. This source impedance absorbs 98% of reflections from signals up to 4 V amplitude.

Specifications

Pulse Characteristics (50 Ω source and load impedance)

Transition times: (10% to 90%): 1 ns to 0.5 ms in 6 ranges at amplitudes >1.8 V and >4.5 V respectively in the two upper output ranges. Minimum value may increase to 1.2 ns at other amplitudes. Leading/trailing times are common on fastest range, and independently variable over 1:10 ratio on other ranges.

Overshoot and ringing: $\leq \pm 10\%$ of pulse amplitude may increase to $\pm 10\%$ with amplitude vernier CCW.

Preshoot: $\leq \pm 5\%$ of pulse amplitude.

Linearity: linearity aberration for both slopes $\leq 5\%$ for transition times >5 ns.

Output: maximum amplitude is 5 V from 50 Ω into 50 Ω . Maximum output voltage is ± 5 V (amplitude + offset).

Offset: ± 2 V, into 50 Ω .

DC-source impedance: 50 Ω +5% -10%.

Reflection coefficient: 5% in ECL setting, increasing to 15% in 5 V range.

Output protection: cannot be damaged by open or short circuits or application of ext. $\leq \pm 6$ V or ± 200 mA independent of control settings.

Attenuator: two separate three step-attenuators reduce the outputs to 1 V. Vernier is common for both outputs and reduces the output to 0.4 V minimum. A further position provides ECL-compatible outputs (-0.9 V to -1.7 V typ. open circuit).

Timing

Repetition rate: 250 MHz to 1 kHz in 6 ranges.

Period jitter: <0.1% of setting +50 ps.

Delay: 2 ns -0.5 ms in 6 ranges plus typ. 17 ns fxd. with respect to trigger output. Duty cycle >50%.

Delay jitter: <0.1% of setting +50 ps.

Double pulse: up to 125 MHz max. (simulates 250 MHz).

Pulse width: 2.4 ns to 0.5 ms in 6 ranges.

Width jitter: <0.1% of setting +50 ps.

Width duty cycle: >50%.

Square wave: delay and double pulse are disabled, max. Rep. Rate 250 MHz. Duty cycle is 50% $\pm 10\%$ up to 100 MHz, 50% $\pm 15\%$ for >100 MHz.

Trigger output: negative going Square Wave (50% duty cycle typ.) >500 mV from 50 Ω into 50 Ω . Internal 50 Ω can be switched off by slide-switch on PC-board. Amplitude up to 1 V into 50 Ω up to 200 MHz.

Trigger output protection: cannot be damaged by short circuit or application of external ± 200 mA.

External Operating Modes

External Input

Input impedance: 50 Ω $\pm 10\%$. dc coupled.

Maximum input: ± 6 V.

Trigger level: adjustable -1.5 V to $+1.5$ V.

Slope control: positive, negative or manual selectable. In the manual position all ext. functions can be controlled by push button. Button pushed in simulates an "on-signal."

Sensitivity: sine-wave >200 mV p-p pulses >200 mV.

Repetition rate: 0 to 250 MHz.

External-Controlled Modes

External trigger: there is approximately 7 ns delay between the external input and the trigger output. Rep. rate is externally controlled (is triggered by external signal). Trigger output provides the pulse-shaped input signal.

Synchronous gating: gating signal turns rep. rate generator on. Last pulse normal width even if gate ends during pulse.

External width: output pulse width determined by width of drive input. Rep. rate and delay are disabled. Trigger output provides shaped input signal.

General

Operating temperature: 0°C to 55°C.

Power: 100/120/220/240 Vrms; +5%, -10%; 48-440 Hz. 85 VA max.

Weight: net, 7.9 kg (17.44 lb). Shipping 8.9 kg (19.63 lb).

Size: 133 mm H x 426 W x 345 mm D (5.2" x 16.75" x 13.6").

Ordering Information

HP 8082A Pulse Generator

Opt. 907: Front Handle Kit (part number HP 5061-9689).

Opt. 908: Rack Flange Kit (part number HP 5061-9677).

Opt. 909: Opt 907, 908 Combined (part number HP 5061-9683).

Opt. 910: Additional Operating and Service Manual

Opt. W30: Two additional years of Return-to-HP service

☎ Fast-Ship product—see page 734

Price

\$5950

add \$55 ☎

add \$33 ☎

add \$82 ☎

add \$28

\$195

PULSE GENERATORS

Configurable Pulse/Data Stimuli

HP 8080A Series

Example: HP 8080A SO4

- 1 GHz, 300 ps transitions
- Interchannel delay

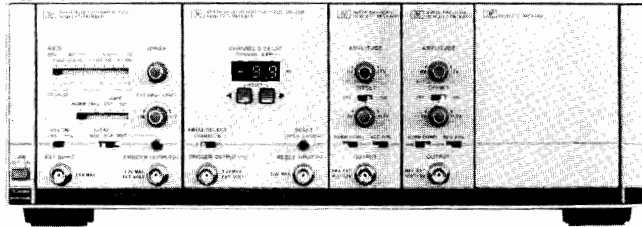

HP 8091A Rate Generator HP 8092A Delay Generator CHA CHB HP 8093A Output Amplifiers HP 15400A Blank Panel

Example: HP 8080A DO1

- 300 MHz, 800 ps transitions
- Manually programmable data

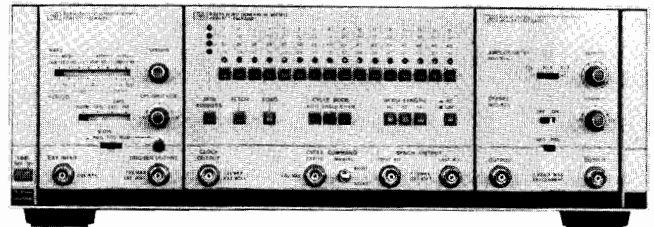

HP 8081A Rate Generator HP 8084A Word Generator HP 8083A Output Amplifier

Research and development in advanced technologies such as subnanosecond ICs, fiber optics and nucleonics, require fast pulses for thorough characterization. HP 8080A configurations can generate simultaneous 1 GHz clock and simulated NRZ data for testing today's fastest memories. (see 8080A#S04, above). Another example (8080A#D03) is simultaneous normal and complement data with up to 64 bits and fast 300 ps edges.

A series of Multi-channel Data and Pulse Generator configurations are available, and further variations can be factory-systemized on request.

Full details on all the modules and some of the factory-systemized configurations are contained in the HP8080A data sheet. Users who wish to do their own systemizing should request the Systemizing Guide (publication number 5952-9546).

Leading Characteristics (50-ohm load)

HP 8080A SO4

Timing

Repetition rate: 100 Hz – 1 GHz.

Interchannel delay: ± 9.9 ns in 0.1 ns steps.

Channel B divider: 0.5 f selectable for simulating NRZ data.

Width: Square wave.

Modes: Int, Ext Width, Gate, Manual.

Independent 50-ohm Outputs

Amplitude: 0.6 V to 1.2 Vpp.

Offset: ± 1.2 V.

Transitions times (10% to 90%): <300 ps.

Polarity: selectable

Format: Normal/Complement selectable

HP 8080A DO1

Timing

Repetition rate: 10 Hz–300 MHz.

Width: square wave (RZ) or NRZ.

Modes: Int, Ext/Manual Width.

Data cycle modes: Ext/Man Single and Gated Cycle, Auto Cycle.

Data: Serial, 16/32/64 bit selectable.

Simultaneous Normal and Complement 50-ohm Outputs

Amplitude: 0.2 V to 2 V.

Offset: ± 1 V.

Transition times (10% to 90%): <800 ps.

Polarity: selectable.

General

Operating temperatures: 0°C to 55°C.

Power: 115/230 V rms; +10%, -22%; 48 to 66 Hz, 200 VA max.

Weight: (typical, HP 8080A Mainframe plus full complement of modules) 9.4 kg (16.6 lbs) net; 19.7 kg (43.3 lbs) shipping.

Size: (HP 8080A Mainframe): 133 H x 426 W x 422 mm D (5.24" x 16.77" x 16.61").

Ordering Information

HP 8080A Mainframe	\$3,750
Opt. 907: Front handle kit (P/N HP5061-9689)	add \$55
Opt. 908: Rack flange kit (P/N HP5061-9677)	add \$33
Opt. 909: Opt 907, 908 combined (P/N HP5061-9683)	add \$82
Opt. Series S: Single- and Multi-Channel Pulse Generator systems	ask for information and prices
Opt. Series D: Single- and Multi-Channel Data Generator systems	ask for information and prices
Opt. W30 Two additional years of Return-to-HP service	ask for info and prices
HP 8081A 300 MHz Rate Generator module	\$1,850
HP 8083A 300 MHz Output Amplified module	\$1,850
HP 8084A 300 MHz Word Generator module	\$5,250
HP 8091A 1 GHz Rate Generator module	\$5,500
HP 8092A 1 GHz Delay Generator module	\$4,400
HP 8093A 1 GHz Output Amplifier module	\$3,000
HP 8093A Opt H01: Variable-width operation (requires HP 8092A)	add \$480
Additional manuals: Opt 910, per module	add \$28
Accessories Available	
HP 15400A Blank Panel, 1/4 mainframe width	\$140
HP 15401A Blank Panel, 1/2 mainframe width	\$110
HP 15402A BNC Feedthru panel, 1/2 width	\$300
Pulse Generator Accessories	



HP 15104A/15115A	HP 15116A
HP 15104A Pulse Adder/Splitter dc to 2 GHz	\$120
HP 15116A Pulse Inverter 3 MHz to 2 GHz	\$230
HP 15115A Pulse Splitter/Inverter 3 MHz to 2 GHz	\$230
☎ Fast-Ship product — see page 734.	

PULSE GENERATORS

High Resolution Time Synthesizer

Model 5359A

447

- Precise digital delays 0-160 ms
- 50 ps increments
- Jitter < 100 ps

- Programmable
- Fully synchronous to external trigger
- Automatic calibration

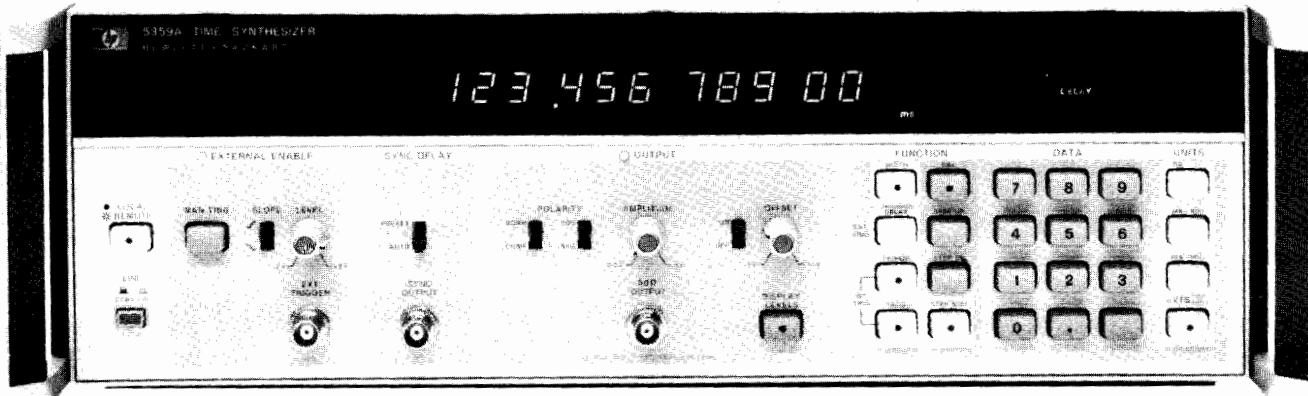

HP 5359A



HP 5359A Time Synthesizer

The HP 5359A Time Synthesizer produces two extremely precise, low jitter time delays. These delays, T_d and T_w , are individually selectable by means of the keyboard, in 50 ps or greater steps to generate delays of up to 160 ms.

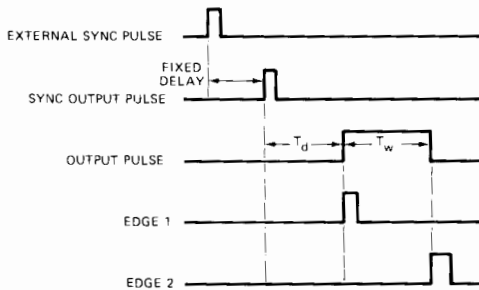

The HP 5359A has many applications and may be used for the calibration of Radar, Loran, DME and Tacan Systems, or for precision generation of delayed sweeps in oscilloscopes, and for extremely accurate "time positioning" control of external gates on frequency counters. In component and circuit test, the instrument may be used for extremely accurate delay line simulation.

Condensed Specifications

Modes

External trigger mode: the delays from the sync out to the beginning of the output pulse, and the width of the output pulse, are selected.

Internal trigger mode: the "period" or "frequency", and the width of the output pulse, are selected.

Range

Delay T_d : 0 ns to 160 ms.

Width T_w : 5 ns to 160 ms (width & delay \leq 160 ms).

Period: 100 ns min or width + 85 ns; 160 ms max.

Frequency: same as corresponding "period".

Repetition rate: 10 MHz max.

Accuracy: ± 1 ns \pm time base error (± 100 ps \pm time base error after external calibration).

Insertion delay: fixed at < 150 ns; selectable as < 50 ns for delays > 100 ns.

Jitter: typical 100 ps rms; maximum 200 ps rms (delays to 10 ms).

External trigger input: -2 V to +2 V slope selectable.

Sync output: 1 V - 50 Ω ; 5 V - 1 M Ω . Width 35 ns nominal.

Output Pulse

Amplitude: 0.5 V to 5 V into 50 Ω .

Polarity: positive or negative.

Offset: -1 V to 1 V, or OFF.

Transition time: < 5 ns.

External voltage must not be applied. Offset and Amplitude voltage into 50 Ω may be displayed.

EDGE 1 OUTPUT (rear panel): occurs in Sync with leading edge of output pulse (same spec. as Sync out).

EDGE 2 OUTPUT (rear panel): occurs in Sync with falling edge of output pulse (same spec. as Sync out).

Events mode: substitutes external input (to 100 MHz) for the internally counted clock (delay and width must both be specified in terms of events instead of time).

Triggered frequency mode: the same as internal frequency mode except the output is a burst beginning in synchronism with an external trigger signal, and continues for the duration of this signal.

Calibrate mode: performs an internal calibration to remove the effects of internal delay differences.

External probes: provides outputs to control the HP 5363B probes and accepts inputs from the probes to include external devices in the calibration loop.

HP-IB: All controls except trigger levels are programmable as standard.

Time Base

High Stability Oven Oscillator

Frequency: 10 MHz.

Aging: $< 5 \times 10^{-10}$ /day.

Temperature: $< 2.5 \times 10^{-9}$, 0°C to 50°C.

Line voltage: $< 1 \times 10^{-10}$, $\pm 10\%$ from nominal.

Size: 133 H x 426 W x 521 mm D (5.25 in. x 16.75 in. x 20.50 in.).

Weight: 13.6 kg (30 lb).

Power requirements: 100, 120, 220, or 240 Vac +5% -10%, 48 to 66 Hz, less than 250 VA.

Front handles: supplied with instrument.

Ordering Information

HP 5359A Time Synthesizer

Opt 908 Rack Flange Kit for use without handles

Opt 913 Rack Flange Kit for use with supplied handles

HP 10870A Service Kit

Price

\$13,200

+ \$32.50

+ \$35

\$930

DC ELECTRONIC LOADS

300 Watt Single Input Electronic Load

Model 6060A

- 300 Watt load: 0-60 A, 3-60 V
- HP-IB control of current, voltage, and resistance
- HP-IB readback of current, voltage, and power
- External analog programming of current in Constant Current mode
- Built-in programmable pulse waveform generation.
- Protection from overpower, overtemperature, overcurrent, overvoltage and reverse polarity
- Standard 3-year warranty

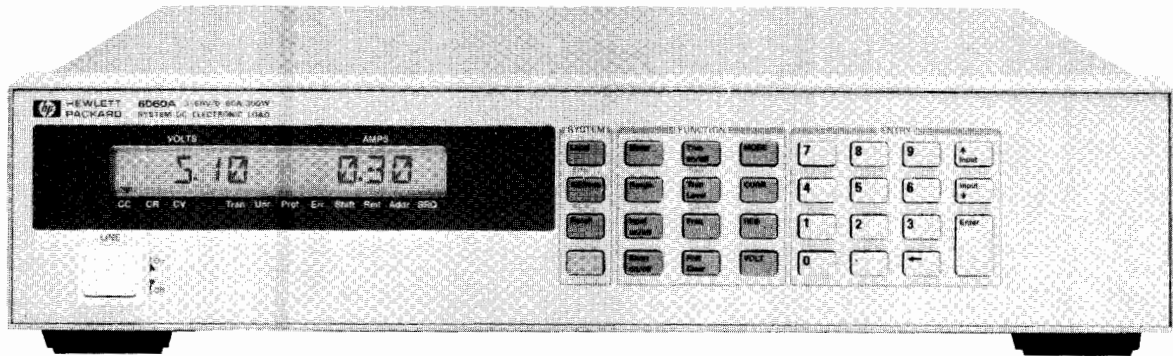

HP 6060A 300 Watt Single Input Electronic Load

Key Features

- Parallelable in constant current mode
- Software calibration
- Non-volatile user-defined power-up state
- Front panel voltmeter, ammeter, and full feature keypad
- IEEE 488.2 and HP-SL compatible instruction set
- Trigger for external synchronization
- Analog voltage & current monitors
- Remote voltage sensing
- Control signal for external disconnect or shorting relay
- Rack mountable (3.5")
- Fan speed control for low acoustic noise

The new HP 6060A 300 Watt Single Input Electronic Load is designed for test, evaluation, and burn-in of DC power supplies, batteries, and power components. It is suitable for applications in areas such as R&D, production test, and field repair. The Electronic Load Family offers advantages in performance, quality, reliability, and price/performance. The built-in HP-IB interface further simplifies system integration and allows control and readback of all load functions.

The features and instruction set of the HP 6060A Single Input Load are compatible with the HP 6050A and HP 6051A mainframe load products. For example, test programs developed for an HP 6060A 300 Watt Single Electronic Load can be used later for an HP 60502A 300 Watt Module Load in another application.

The HP 6060A 300 watt load is suitable for bench use too. The front panel keypad allows easy, repeatable and reliable control of the load when it is used manually. Front panel settings are remembered after AC power is removed. The front panel LCD meters indicate voltage, current, and power readings. Connection to the load is made at the rear panel; front panel binding posts are available as an option.

Specifications

Modes: Constant current (CC), constant voltage (CV), and constant resistance (CR)

DC Input Ratings: 0-60 A, 3-60 V, (current derated from 0-3 volts) power limited to 300 W at 40 C (225 watts at 55 C)

Programmable ranges CC mode: 0-6 A, 0-60 A

CR mode: 0.033-1.0 ohm, 1-1000 ohms, 10-10,000 ohms

Programming Accuracy: $\pm 0.1\%$ $\pm 65\text{ma}$ (in 60A CC range)

Programming Resolution: 16mA (in 60A CC range)

Readback Resolution: 16mA, 16mV

Readback Accuracy: 0.05% $\pm 65\text{ ma}$, 0.05% $\pm 45\text{ mv}$

Built-in pulse waveform generation:

Frequency (0.25 Hz - 10 kHz);

Duty cycle (6-94%);

Slew rate (1.0 A/mS to 5 A/ μS) in 60 A range

Analog programming bandwidth in CC mode: 10 kHz

Programmable electronic short: 33 milliohms (20 mohms typical)

Programmable electronic open: 20 k ohms (typical)

Ordering Information

HP 6060A 300 Watt Single Input Load	Price
HP 6060A 300 Watt Single Input Load	\$1995
Opt 100 87-106 Vac, 48-63 Hz, (for Japan only)	\$0
Opt 220 191-233 Vac, 48-63 Hz	\$0
Opt 240 209-250 Vac, 48-63 Hz	\$0
Opt 020 Front Panel Binding Posts	+\$80
Opt 908 Rack Mount Kit for one unit with no handles	+\$31
Opt 909 Rack Mount Kit for one unit with handles	+\$74
Opt 910 Extra Manuals	+\$31

DC ELECTRONIC LOADS

1800 Watt Multiple Input Electronic Load Mainframe

HP 6050A

449

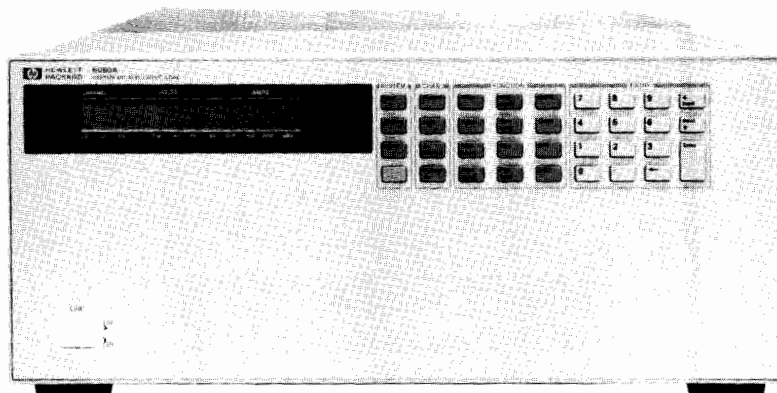

DESIGNED FOR
HP-IB
SYSTEMS
HP 6050A

HP 6050A 1800 Watt Multiple Input Electronic Load Mainframe

Key Features

- Programmable amplitude, frequency, duty cycle and slew rate
- Protection from overpower, overtemperature, overcurrent, overvoltage and reverse polarity
- Load modules are parallelable in constant current mode
- Software calibration
- Non-volatile state storage, including user-defined power-up state
- Front panel voltmeter, ammeter, and full feature keypad
- IEEE 488.2 and HP-SL compatible instruction set
- Hardware and software triggering for synchronization
- Analog voltage and current monitors
- Remote voltage sense
- Digital I/O port for external disconnect relay and/or short relay
- Fan speed control for low acoustic noise

The HP 6050A 1800 Watt Electronic Load Mainframe and the single input load modules are designed for test, evaluation, and burn-in of dc power supplies, batteries, and power components. They are suitable for R&D, production test, and field repair.

The electronic load family offers advantages in performance, quality, reliability, and price/performance. The HP 6050A mainframe's built-in HP-IB interface simplifies system integration and allows control and readback of each module's functions using a single HP-IB address. The load modules are user-installable for easy initial installation, reconfiguration, or service. The mainframe has six slots. The HP 60503A, HP 60502A, and HP 60501A occupy one slot each. The HP 60504A occupies two slots.

The features and instruction set of the HP load modules are compatible with the HP 6060A Single Input Load. For example, test programs developed for an HP 6060A 300 Watt single electronic load or an HP 60502A 300 Watt load module are interchangeable. Programming meets all currently defined HP-SL standards and therefore assures programming compatibility with future products.

The HP 6050A 1800 Watt Load Mainframe is also suitable for bench use. The front panel keypad allows easy, repeatable, and reliable control of the load when it is used manually. Front panel settings are remembered after ac power is removed. The front panel LCD meters indicate voltage, current, and power readings of the selected channel.

Specifications:

HP 60504A 600 Watt Single Input Load Module

DC input ratings: 0-120A, 3-60V, (current derated from 0-3V) power limited to 600W

Modes: constant current (CC), constant voltage (CV), and constant resistance (CR)

Programmable ranges: CC mode: 0-12A, 0-120A

CR mode: 0.017-0.5 ohm, 0.5-500 ohm, 5-5000 ohm

Programming accuracy: $\pm 0.12\% \pm 130$ mA (in 120A CC range)

Programming resolution: 32 mA (in 120 A CC range)

Programmable electronic short: 0.017 ohm (0.012 ohm typical)

Readback resolution: 32 mA, 16 mV

Readback accuracy: $0.1\% \pm 110$ mA, $0.1\% \pm 45$ mV

Built-in pulse waveform generation:

Frequency 0.25 Hz-10 kHz

Duty cycle 6-94%

Slew rate 2 A/ms-10 A/ μ s in 120A CC range

Analog programming: 0-10V

Analog programming bandwidth: 10 kHz in CC mode

HP 60502A 300 Watt Single Load Input Module

DC input ratings: 0-60A, 3-60V, (current derated from 0-3V) power limited to 300W

Modes: constant current (CC), constant voltage (CV), and Constant Resistance (CR)

Programmable ranges: CC mode: 0-6A, 0-60A

CR mode: 0.033-1.0 ohm, 1-1000 ohm, 10-10000 ohm

Programming accuracy: $\pm 0.1\% \pm 65$ mA (in 60A CC range)

Programming resolution: 16 mA (in 60 A CC range)

Programmable electronic short: 0.033 ohm (0.020 ohm typical)

Readback resolution: 16 mA, 16 mV

Readback accuracy: $0.05\% \pm 65$ mA, $0.05\% \pm 45$ mV

Built-in pulse waveform generation:

Frequency 0.25 Hz-10 kHz

Duty cycle 6-94%

Slew rate 1.0 A/ms-5 A/ μ s in 60A CC range

Analog programming: 0-10V

Analog programming bandwidth: 10 kHz in CC mode

HP 60501A 150 Watt Single Input Load Module

DC input ratings: 0-30A, 3-60V, (current derated from 0-3V) power limited to 150W

Modes: constant current (CC), constant voltage (CV), and constant resistance (CR)

Programmable ranges: CC mode: 0-3A, 0-30A

CR mode: .067-2.0 ohm, 2-2000 ohm, 20-10000 ohm

Programming accuracy: $\pm 0.1\% \pm 40$ mA (in 30A CC range)

Programming resolution: 8 mA (in 30A CC range)

Programmable electronic short: 0.067 ohm (0.040 ohm typical)

Readback resolution: 8 mA, 16 mV

Readback accuracy: $0.06\% \pm 40$ mA, $0.05\% \pm 45$ mV

Built-in pulse waveform generation:

Frequency 0.25 Hz-10 kHz

Duty cycle 6-94%

Slew rate 0.5 A/ms-2.5 A/ μ s in 30A CC range

Analog programming: 0-10V

Analog programming bandwidth: 10 kHz in CC mode

Ordering Information

HP 6050A 1800 Watt Load Mainframe

Price

\$1800

NOTE: Line voltage option (100, 220, 240) must be specified

Opt 100 87-106 V ac, 48-63 Hz (for Japan only)

\$0

Opt 220 191-233 V ac, 48-63 Hz

\$0

Opt 240 209-250 V ac, 48-63 Hz

\$0

Opt 908 Rack Mounting Kit for one mainframe without handles

+\$38

Opt 909 Rack Mounting Kit for one mainframe with handles

+\$89

Opt 910: extra Operating and Service Manual

\$31

HP 60504A 600 Watt Single Input Load Module

\$2150

Opt 910 extra Operating and Service Manual

+\$31

HP 60502A 300 Watt Single Input Load Module

\$1550

Opt 910 extra Operating and Service Manual

+\$31

HP 60501A 150 Watt Single Input Load Module

\$1250

Opt 910 extra Operating and Service Manual

+\$31

DC ELECTRONIC LOADS

600 Watt Electronic Load Mainframe

HP 6051A

- Compatible with HP 60501A, HP 60502A, HP 60503A, and HP 60504A load modules
- Up to 600 watts in a seven-inch high, half-rack width package
- HP-IB control of current, voltage, and resistance
- HP-IB readback of current, voltage, and power
- External analog programming
- Built-in pulse/continuous waveform generation
- Standard 3-year warranty



HP 6051A



600 Watt Electronic Load Mainframe

Hewlett-Packard dc electronic loads are designed for applications where load emulation is needed, such as in the test and evaluation of dc power supplies, batteries, and power components. They are well suited for R&D, production, and incoming inspection applications. The HP electronic load family offers advantages in performance, reliability, and price/performance.

The newest Hewlett-Packard multiple input load product is the HP 6051A 600 Watt Electronic Load Mainframe. This two-slot load mainframe provides a front panel and HP-SL instruction set identical to those of the HP 6050A 1800 watt, six-slot load mainframe, and it accommodates all of the currently available load modules, the HP 60501A, HP 60502A, HP 60503A, and HP 60504A. The HP 6051A can be user-configured in any of the following input combinations:

- Two HP 60501A modules for a total of 300 watts
- One HP 60501A and one HP 60502A for a total of 450 watts
- Two HP 60502A modules for a total of 600 watts
- Two HP 60503A modules for a total of 500 watts
- One HP 60504A module for a total of 600 watts

The addition of the HP 6051A to the HP electronic load family provides increased flexibility in electronic load input configurations where only one or two low-to-medium power inputs are needed, and for applications where instrument size and rack space are critical. The seven-inch high, half-rack wide packaging of the HP 6051A is well suited for test systems including other half-rack wide instrumentation such as the HP 6033A or HP 6038A 200 Watt Autoranging System Power Supply. Many electronic load applications such as over-voltage protection testing for power supplies, zero volt load simulation for testing batteries, and power pulse generation for testing power components require power supplies in the test system configuration. By using the half-rack packaging of the HP 6051A combined with a Hewlett-Packard half-rack power supply, these testing configurations can be provided efficiently in seven inches of rack space.

The HP 6051A, similar to the HP 6060A Single Input Load, is equally suitable for manual use on the bench. The front panel LCD meters can indicate voltage, current, and power readings. The front panel keypad allows easy, repeatable, and reliable control of the modules configured in the HP 6051A. Using various combinations of the existing load modules, the HP 6051A can be configured as a dual-

input or single-input load with dimensions that facilitate the economical use of bench space.

As a new member of the HP electronic load family, the HP 6051A offers all of the superior features and benefits provided by the current HP electronic load products. When configured with the HP 60501A, HP 60502A, HP 60503A, or HP 60504A load modules, the HP 6051A can make test system integration easier by providing internal voltage and current monitors, built-in transient generation with programmable amplitude, frequency, duty cycle, pulse-width, and slew rate, and built-in HP-IB control and readback of each module's functions. Six volatile user-definable states allow you to save settings for later recall via the HP-IB on front panel keypad. An additional non-volatile, user-definable power-up state allows you to define settings that are remembered when the unit is switched off and recalled when it is switched on again. The HP 6051A comes with a standard 3-year warranty and can be rack-mounted with a standard System II rack tray.

Ordering Information

HP 6051A 600 Watt Load Mainframe

Price

\$1700

NOTE: Line voltage option (100, 220, 240) must be specified.

Opt 100 87-106 V ac, 48-63 Hz, (for Japan only)	\$0
Opt 220 191-233 V ac, 48-63 Hz	\$0
Opt 240 209-250 V ac, 48-63 Hz	\$0
Opt 800 Rack Mounting Kit for two units mounted side-by-side	+\$67
Opt 908 Rack Mounting Kit	+\$67

NOTE: Rack mounting the HP 6051A with other instruments requires rack side rails to support the weight. Rack rails are normally an accessory for the particular rack being used.

Opt 910 extra manual set, including one each of the following Operating Manual, Programming Reference Manual, and Service Manual. The Programming Manual is not available with the individual modules.

\$50

HP 60501A 150 Watt Load Module	\$1250
HP 60502A 300 Watt Load Module	\$1550
HP 60504A 600 Watt Load Module	\$2150

DC ELECTRONIC LOADS

250W, 240V Single Input Load, 250W, 240V Load Module

HP 6063A, 60503A

451

- 0-10 A, 3-240 V (power limited to 250W)
- High performance
- HP-IB control and readback of voltage, current, and power

- Built-in pulse/continuous waveform generation
- Standard 3-year warranty

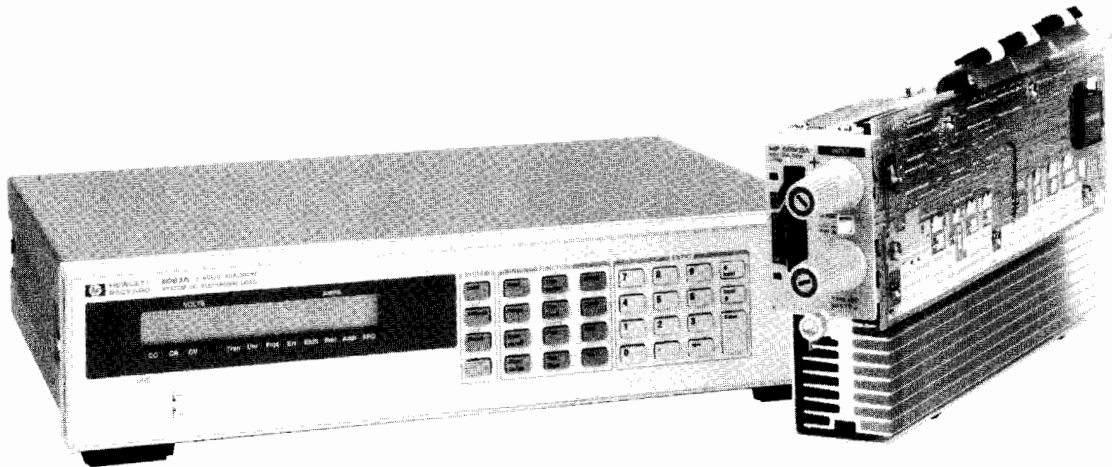

HP 6063A, HP 60503A



240 Volt Single Input Load and Load Module

Key Features

- Parallel for higher current applications in constant current mode
- Software calibration
- Protection from overpower, overvoltage, overcurrent, overtemperature, and reverse polarity
- Non-volatile state storage, including user-defined power-up state
- Trigger for external synchronization
- IEEE 488.2 and HP-SL compatible instruction set
- Analog voltage and current monitors
- Remote voltage sense
- Digital I/O port for external disconnect relay and/or short
- Fan speed control for low acoustic noise

The HP 6063A 240 Volt Single Input Load and the HP 60503A 240 Volt Load Module are the newest additions to the HP electronic load family. Similar to the existing electronic loads offered by Hewlett-Packard, they are suitable for the test, evaluation, and burn-in of high voltage DC power supplies, batteries, and power components in production, R & D, and service environments.

The addition of the HP 6063A and HP 60503A to the HP load family offers increased flexibility for applications requiring load input voltages up to 240 volts. These new models offer improved regulation and lower HP-IB programming accuracy offsets in constant current mode, in addition to improved analog programming accuracy. The feature set and programming instruction set are identical to the existing HP load products, which provides a truly compatible solution for an automated test environment.

Specifications

HP 6063A 240V Single Input Load

Modes: constant current (CC), constant voltage (CV), and constant resistance (CR)

DC input ratings: 0-10A, 3-240V (current derated from 0-3V), power limited to 250W

Programmable ranges: CC mode: 0-1A, 0-10A

CR mode: 0.2-24 ohms, 24-10000 ohm, 240-50000 ohm

Programming accuracy: $\pm 0.15 \pm 10$ mA (both ranges in CC mode)

Programming resolution: 2.6 mA (0-10A range in CC mode)

Readback resolution: 2.6 mA, 64 mV

Readback accuracy: $\pm 0.12 \pm 10$ mA, $\pm 0.1 \pm 150$ mV

Built-in pulse waveform generation:

Frequency 0.25 Hz-10 kHz

Duty cycle 6-94%

Slew rate 0.17 A/ms-0.83 A/us in 10 A range

Analog programming bandwidth in CC mode: 10 kHz

Analog programming voltage: 0-10V

Programmable electronic short: 0.20 ohm

Programmable electronic open: 80000 ohm (typical)

HP 60503A Electrical Specifications:

Modes: constant current (CC), constant voltage (CV), and constant resistance (CR)

DC input ratings: 0-10A, 3-240V (current derated from 0-3V), power limited to 250W

Programmable ranges: CC mode: 0-1A, 0-10A

CR mode: 0.2-24 ohms, 24-10000 ohm, 240-50000 ohm

Programming accuracy: $\pm 0.15 \pm 10$ mA (both ranges in CC mode)

Programming resolution: 2.6 mA (0-10A range in CC mode)

Readback resolution: 2.6 mA, 64 mV

Readback accuracy: $\pm 0.12 \pm 10$ mA, $\pm 0.1 \pm 150$ mV

Built-in pulse waveform generation:

Frequency 0.25 Hz-10 kHz

Duty cycle 6-94%

Slew rate 0.17 A/ms-0.83 A/us in 10A range

Analog programming bandwidth in CC mode: 10 kHz

Analog programming voltage: 0-10V

Programmable electronic short: 0.20 ohm

Programmable electronic open: 80000 ohm (typical)

POWER SUPPLIES

General Information

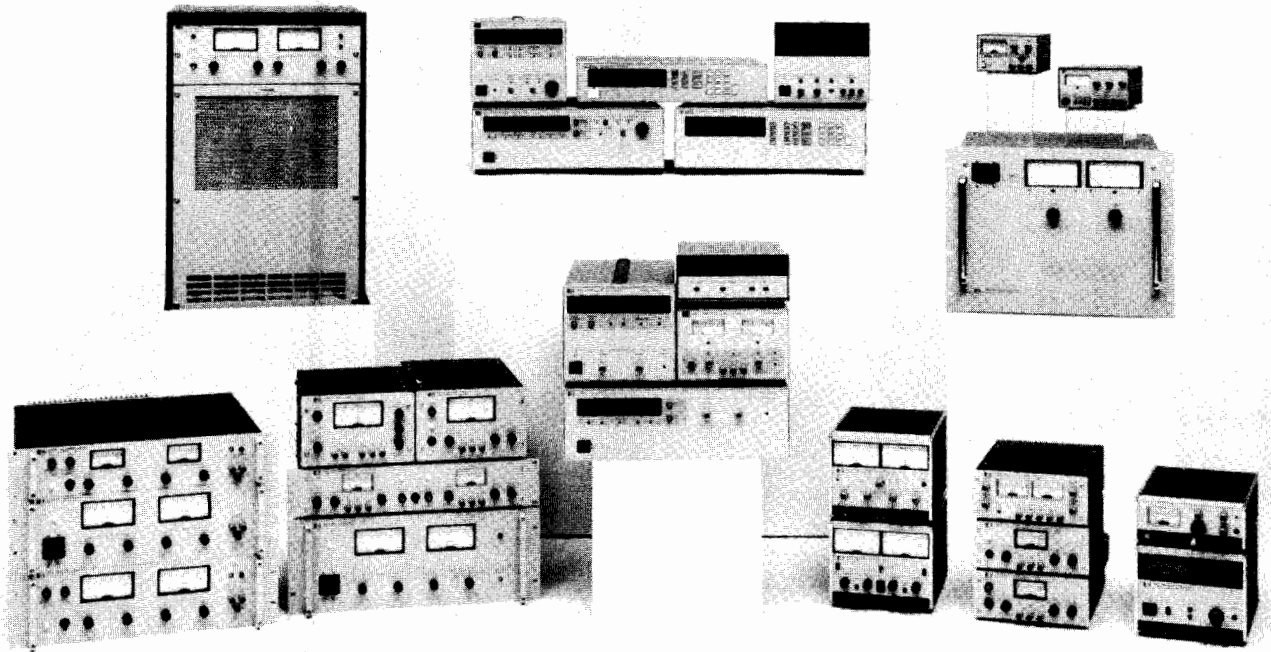

Introduction

Hewlett-Packard's extensive variety of power supplies serve a wide range of applications, in research and development, industrial applications, and computer automated test systems. All power supplies are designed for high reliability and ease of use. Hewlett-Packard provides advanced capabilities through innovative technology.

Power Supply Selection Tables - Page 456

There are three selection tables

- HP-IB Programmable Power Supplies
- Analog Programmable Power Supplies
- Special Purpose and Laboratory Bench Power Supplies

Choose the table that most closely fits your requirements. Each table is structured in ascending order of maximum output voltage. Upon selection of a model which fits your needs reference the appropriate page number for further information. If you are unsure of a selection or require additional information contact the nearest Hewlett-Packard sales office. A complete listing of Hewlett-Packard sales offices can be found toward the rear of this catalog.

The "One-Box Solution"

Hewlett-Packard has power supplies which can be remotely programmed via resistance, voltage, or directly through the HP-IB. The new "One-Box Solution" system power supplies (HP models 6030A-6038A, 6621A-6627A, 6632A-6634A) have built-in HP-IB programmers for voltage and current. Also included is a built-in DVM and precision current shunt for measured read-back of voltage and current via the HP-IB.

New 1989/90 Power Supply Catalog

For more details concerning Hewlett-Packard power supplies, ask your HP sales representative for a DC Power Supply Catalog, or fill in the card at the rear of this catalog.

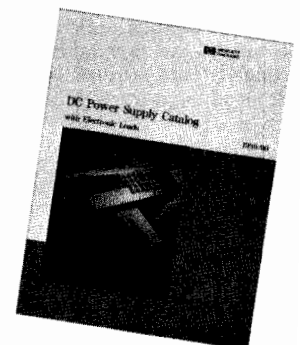



HP-IB Programmable Power Supplies Pages 460 to 473

- 100 Watt Single Output
- Multiple Output
- Precision Multiple Output
- 200 and 1000 Watt Autoranging
- CIIL Programming
- HP-IB Programmer for Analog Programmable Power Supplies

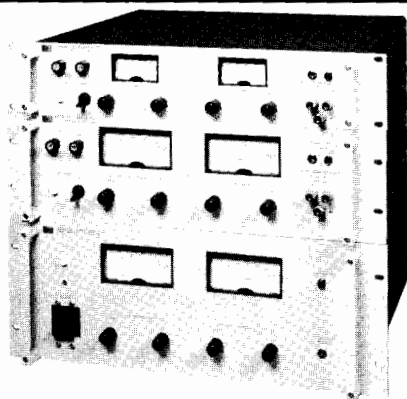

Analog Programmable Power Supplies Pages 474 to 481

- General Purpose 25-200 Watt
- 200 and 1000 Watt Autoranging
- General Purpose 120-2000 Watt
- General Purpose 300-11,000 Watt

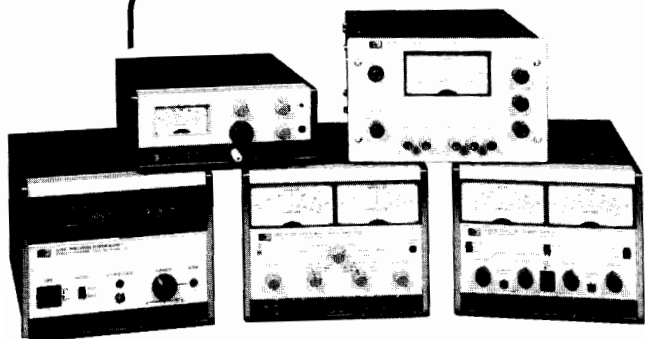

Special Purpose Power Supplies Pages 482 to 487

- Bipolar/Amplifiers
- Precision Voltage and Current Sources
- Precision Bipolar System Supplies

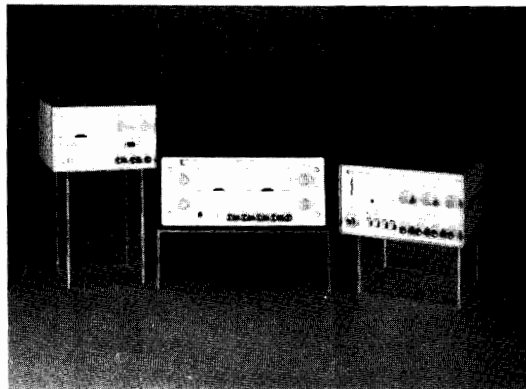

Laboratory Bench Power Supplies Page 483 to 485

- Single Output Bench
- Dual Output Bench
- Triple Output Bench

POWER SUPPLIES

Power Products Modification Service

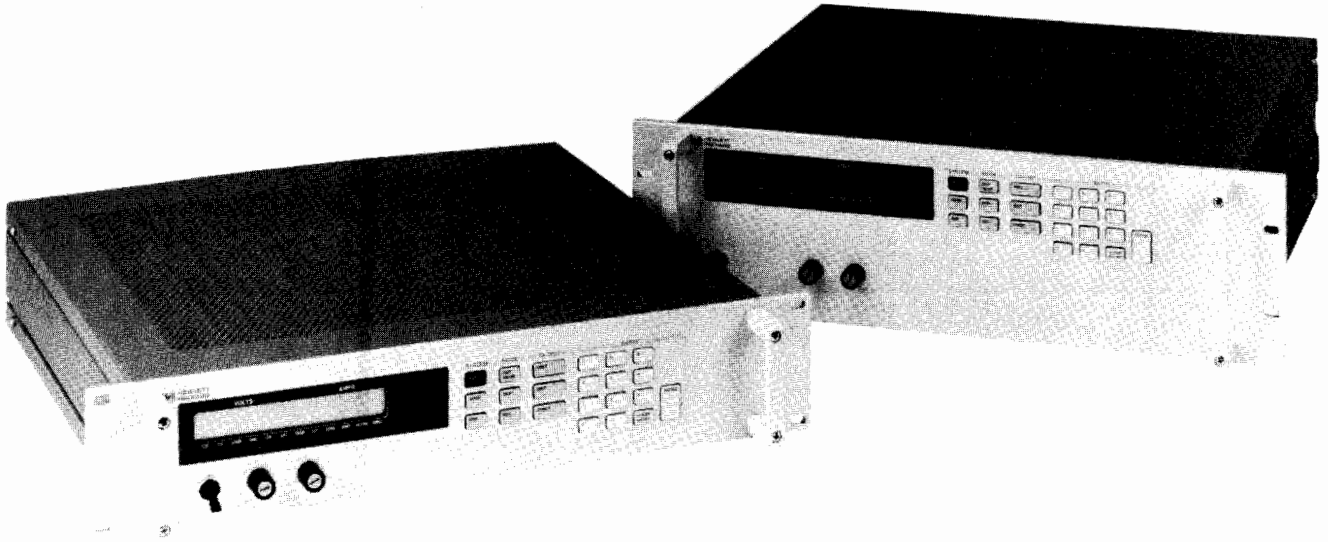

Selected 625XA, 626XA, and 627XA Series power supplies with Special Option Z-10. This option not only provides greatly enhanced front panel control, but also full-functioned HP-IB programmability.

Modification Service

Although HP power supplies are intended to satisfy a wide range of applications, the standard products might not match all needs. To solve specific power supply problems, Hewlett-Packard offers a special modification service. This service entails the design and manufacture of modified versions of standard catalog models of dc power supplies and electronic loads.

Modified products are designed, manufactured, tested, and supported to the same high quality and reliability standards as other HP products. Any changes in the manufacturing processes are well documented in the factory. Any necessary updates are also provided for the operating and service literature.

By taking advantage of Hewlett-Packard's engineering expertise to address your special power supply needs, you can allow your engineering staff to focus on your main business. The associated engineering costs can be amortized over a number of units, contingent on volume commitment and other project specifics.

OEM customers find the modification services particularly valuable when integrating power supplies into their final products. Although the scope of this service is usually limited to the modification of standard products, HP engineers welcome discussion to determine the feasibility of meeting particular requirements.

The Modification Process

The basic steps of the modification process are as follows:

- You contact your local Hewlett-Packard sales office and discuss your power supply and/or electronic load needs with a sales representative.
- The sales representative submits your request for quote to the power products engineering staff.
- Communication begins between you and an HP power products application engineer. This direct line of communication continues throughout the project, to make sure that the design meets your needs.
- Your sales representative quotes a price based on proposed engineering design changes, production cost, and estimated quantity.
- You submit an order, letter of intent, or other contractual agreement appropriate for the project, as agreed with Hewlett-Packard.
- The modified product is designed, then prototypes are built and evaluated.
- HP provides a prototype for your evaluation, based on previous agreement and complexity of modification.
- Hewlett-Packard writes manufacturing and service documentation, and any user literature necessary.
- The modified product is produced, and future production quantities are scheduled based on your requirements.

Examples of Typical Modifications

Typical modifications to the Hewlett-Packard power products that have been provided through this service include:

Mechanical and Cosmetic Changes

- Customization of front panel paint, panel markings, or silk screening of logos or other special characters.
- Military or other special connectors on the front or rear panel.

Output Ratings

- Modification of maximum output voltage or current.
- Auxiliary outputs.

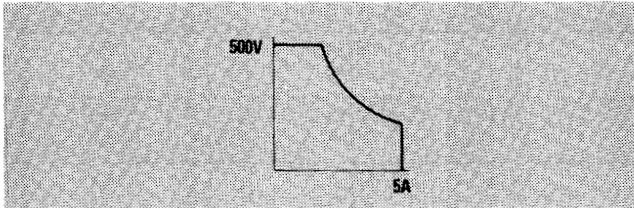

HP 6010A, 6030A-V05: These 1000 watt autoranging power supplies have a modified volt-amp rating as shown by this output curve.

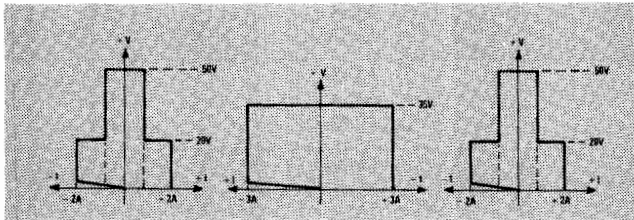

HP 6623A-J03: This power supply originally had two 20 V outputs and one 50 V output. The J03 modification gives it two 50 V outputs and one 35 V output.

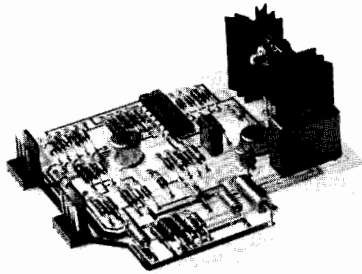

HP 6031A-J07: This modification provides an auxiliary 5 V output.

Performance Specifications

- Alteration of a control loop's compensation for use as a power amplifier or in a closed loop application on some parameter other than output V or I.
- Addition of a customized control loop.
- Improvement of a specific performance specification such as PARD, accuracy, resolution, programming speed, etc.
- Alteration of a control loop's compensation in order to accommodate a highly reactive load.

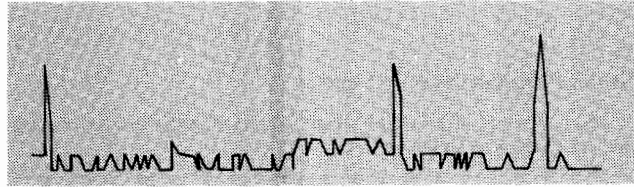

HP 6448B-J25: This modification reduces the PARD specification of the HP 6448B from 600 mV to 20 mV rms.

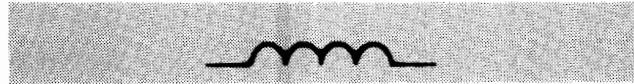

HP 601XA, 603XA-J02: This modification increases the inductive load that can be stably operated into from 100 mH to 10 H.

Features

- Variable fan speed control.
- Custom interface circuits.
- Alteration of a programming or readback coefficient

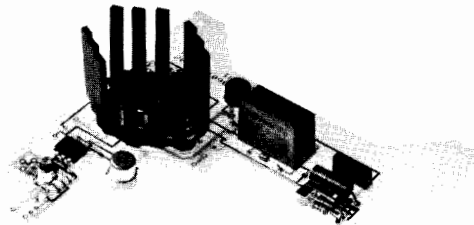

HP 601XA, 602XA, 603XA-J10: This modification allows the power supply fan to operate at slower, quieter speeds under conditions when less cooling is needed.



HP 626XA, 627XA-Z10: This modification adds an internal HP-IB interface with the same programming features as the HP 663XA series. These are listed on the table beginning on page 460.

For more information about the Power Products Modification Service, or any of the modified products described above, contact your local HP Sales Office.

POWER SUPPLIES

Voltage Rating Index



HP-IB Programmable Supplies

The power supplies listed in this table are directly programmable via the HP-IB. Their system oriented features include remote programming and readback in a single unit.

Max Volts (dc)	Max Amps (dc)	Type	HP Model Number	Page
6.7	30	HP-IB Autoranging	6033A	468
7	5	Multiple Output Linear	6623A 6624A	464 464
7	0.5	Precision Multiple Linear	6625A 6626A	466 466
7	10	Multiple Output Linear	6621A 6623A	464 464
7	120	HP-IB Autoranging	6031A	468
±10	0.01	DAC Programmer	59501B	473
16	2	Precision Multiple Linear	6625A 6626A 6628A 6629A	466 466 466 466
20	2	Multiple Output Linear	6623A 6624A 6627A	464 464 464
20	4	Multiple Output Linear	6621A 6622A 6623A	464 464 464
20	5	Single Output Linear	6632A	462
20	10	High Performance Autoranging*	6002A	471
20	10	HP-IB Autoranging	6033A	468
20	10	HP-IB Autoranging	6038A	468
20	50	HP-IB Autoranging	6031A	468
20	50	HP-IB Autoranging	6032A	468
50	0.8	Multiple Output Linear	6623A 6624A 6627A	464 464 464
50	1	Precision Multiple Linear	6625A 6626A 6628A 6629A	466 466 466 466
50	2	Multiple Output Linear	6622A	464
50	2	Single Output Linear	6633A	462
50	4	High Performance Autoranging	6002A	471
60	3.3	HP-IB Autoranging	6038A	468
60	17	HP-IB Autoranging	6030A	468
60	17.5	HP-IB Autoranging	6032A	468
100	1	Single Output Linear	6634A	462
200**	17	HP-IB Autoranging	6030A	468

* Does not include remote programming and readback in a single unit. Option 001 must be ordered to operate the HP 6002A on the HP-IB.

** HP Model 6030A with Special Option V05 can provide up to 500V. See page 454 for more details.

Analog Programmable Supplies

The power supplies listed in this table are programmable with either an analog voltage or resistance signal. They may be incorporated into a system application or a laboratory or bench environment.

Max Volts (DC)	Max Amps (DC)	Type	HP Model Number	Page
6.7	30	Autoranging	6023A	476
7	120	Autoranging	6011A	476
7.5	5	CV/CC	6281A	474
8	1000	CV/CC	6464C	480
10	10	CV/CC	6282A	474
10	50	CV/CC	6259B	478
10	100	CV/CC	6260B	478
15	200	CV/CC	6453A	480
16	600	CV/CC	6466C	480
18	500	CV/CC	6466C	480
20	0.6	Dual Output (20 V, 20 V)	6205C	483
20	1.5	CV/CC	6200B	483
±20	±2	Bipolar PSA	6825A	482
20	3	CV/CC	6284A	474
20	3	Dual Output (20 V, 20 V)	6253A	474
20	10	Autoranging	6023A	476
20	10	Autoranging	6024A	476
20	10	CV/CC	6263B	478
20	10	CV/CC	6286A	474
20	20	CV/CC	6264B	478
20	50	Autoranging	6011A	476
20	50	Autoranging	6012B	476
20	50	CV/CC	6261B	478
25	2	Dual Output (25 V, 25 V)	6227B	474
30	1	CV/CC	6206B	483
36	100	CV/CC	6456B	480
36	300	CV/CC	6469C	480
40	0.3	Dual Output (40 V, 40 V)	6205C	483
40	0.75	CV/CC	6200B	483
40	1.5	CV/CC	6289A	474
40	1.5	Dual Output (40 V, 40 V)	6255A	474
40	5	CV/CC	6266B	478
40	5	CV/CC	6291A	474

Max Volts (DC)	Max Amps (DC)	Type	HP Model Number	Page
40	5.7	Autoranging	6024A	476
40	10	CV/CC	6267B	478
40	25	CV/CC	6434B	480
40	30	Autoranging	6012B	476
40	30	CV/CC	6268B	478
40	50	CV/CC	6269B	478
50	0.5	Precision Current	6177C	487
50	1	Dual Output (50 V, 50 V)	6228B	474
±50	±1	Bipolar PSA	6826A	482
60	0.5	CV/CC	6206B	483
60	1	CV/CC	6294A	474
60	3	CV/CC	6296A	474
60	3.3	Autoranging	6024A	476
60	15	CV/CC	6274B	478
60	17	Autoranging	6010A	476
60	17.5	Autoranging	6012B	476
64	50	CV/CC	6459A	480
64	150	CV/CC	6472C	480
100	0.25	Precision Current	6181C	487
±100	±0.5	Bipolar PSA	6827A	482
100	0.75	CV/CC	6299A	474
110	100	CV/CC	6475C	480
120	2.5	CV/CC	6443B	480
200*	5	Autoranging	6010A	476
220	50	CV/CC	6477C	480
300	0.1	Precision Current	6186C	487
300	35	CV/CC	6479C	480
320	0.1	CV/CC	6209B	483
440	25	CV/CC	6483C	480
500	20	CV/CC	6483C	480
600	1.5	CV/CC	6448B	480
600	15	CV/CC	6483C	480

*HP Model 6010A with Special Option V05 can provide up to 500 V. See page 454 for more details.

POWER SUPPLIES

Voltage Rating Index (cont'd)

Special Purpose and Laboratory Bench Power Supplies

The power supplies listed in this table include special purpose (current sources, bipolar, four-quadrant power supplies and precision power supplies) and laboratory bench power supplies. Although some of the special purpose supplies may be programmed with an analog signal, most of the power supplies listed here are controlled manually.

Max Volts (DC)	Max Amps (DC)	Type	HP Model Number	Page
6	1	Triple Output (6, ± 18 V)	6235A	473
6	2.5	Triple Output (6, ± 20 V)	6236B	473
10	1	CV/CC	6214C	473
18	1	Triple Output (18, ± 20 V)	6237B	473
± 18	0.2	Triple Output (6, ± 18 V)	6235A	473
± 20	0.5	Triple Output (6, ± 20 V)	6236B	473
± 20	0.5	Triple Output (18, ± 20 V)	6237B	473
± 20	± 2	Bipolar Amplifier	6825A	482
20	2	Precision Voltage	6114A	486
25	0.2	Dual Output (25, 25 V)	6234A	473
25	0.4	CV/CC	6216C	473
40	1	Precision Voltage	6114A	486
50	0.2	CV/CC	6218C	473
50	0.5	Precision Current	6177C	487
50	0.8	Precision Voltage	6115A	486
± 50	± 1	Precision Bipolar Voltage	6130C	472
± 50	± 1	Bipolar Amplifier	6824A	482
± 50	± 1	Bipolar Amplifier	6826A	482
± 50	± 5	Precision Bipolar Voltage	6129C	472
100	0.1	CV/CC	6212C	483
± 100	± 0.16	Precision Bipolar Current	6140A	472
100	0.25	Precision Current	6181C	487
100	0.4	Precision Voltage	6115A	486
± 100	± 0.5	Bipolar Amplifier	6827A	482
± 100	± 0.5	Precision Bipolar Voltage	6131C	472
300	0.1	Precision Current	6186C	487

Power Supply Terms

Ambient temperature: the temperature of the air immediately surrounding the power supply.

Auto-parallel operation: a master-slave connection of the outputs of two or more supplies used for obtaining a current output greater than can be obtained from one supply.

Autoranging power supply: a power supply that can provide maximum rated power over a wide range of voltage and current without external intervention to change range.

Auto-series operation: a master-slave connection of the outputs of two or more supplies used for obtaining a voltage greater than can be obtained from one supply.

Auto-tracking operation: a master-slave connection of two or more supplies each of which has one of its output terminals in common with one of the output terminals of all of the other supplies.

Complementary tracking: a master-slave interconnection of two supplies in which the voltage of the slave is equal to or proportional to that of the master and of opposite polarity with respect to a common point.

Compliance voltage: the output voltage of a power supply operating in the constant-current mode.

Constant-current (CC) power supply: a power supply that stabilizes output current with respect to changes in influence quantities. Thus, for a change in load resistance, the output current remains constant while the output voltage changes by whatever amount necessary to accomplish this.

Constant-voltage (CV) power supply: a power supply that stabilizes output voltage with respect to changes in influence quantities. Thus, for a change in load resistance, the output voltage remains constant while the output current changes by whatever amount necessary to accomplish this.

Constant-voltage/constant-current (CV/CC) power supply: a power supply that operates as a constant voltage power supply or a constant-current power supply depending on load conditions. It acts as a constant-voltage source for comparatively large values of load resistance and as a constant-current source for comparatively small values of load resistance.

Constant-voltage/current-limiting (CV/CL) power supply: a power supply similar to a constant-voltage/constant-current supply except that at comparatively small values of load resistance, its output current is limited instead of being stabilized.

Crowbar: see overvoltage protection.

Current limiting: the action of limiting the output current of a constant-voltage supply to some predetermined maximum value (fixed or adjustable) and automatically restoring the output voltage to its normal value when the overload or short circuit is removed. There are three types of current limiting: 1) by constant-voltage/constant-current crossover, 2) by decreasing the output voltage as the current increases, 3) by decreasing both voltage and current as the load resistance decreases (referred to as foldback or cutback current limiting).

Drift: the maximum change of an output voltage or current during an 8-hour period following a 30-minute warmup, with all influence and control quantities maintained constant during the warm-up time and the period of drift measurement. Drift includes both periodic and random deviations over the bandwidth from zero frequency (dc) to a specified upper frequency limit (usually 20 Hz).

Load effect: formerly known as load regulation, load effect is the change in the steady-state value of the stabilized output voltage or current resulting from a full-load change in the load current of a constant-voltage supply or the load voltage of a constant-current supply, with all other influence quantities maintained constant.

Load effect transient recovery time: the time interval between a specified step change in the load current of a constant-voltage supply (usually a full-load or 5-ampere change, whichever is smaller) or in the load voltage of a constant-current supply and the instant when the stabilized output quantity returns to and stays within the specified transient recovery band.

Master-slave operation: a method of interconnecting two or more supplies such that one of them (the master) serves to control the others (the slaves). The outputs of the slave supplies always remain equal to or proportional to the output of the master. The outputs of

the master supply and of one or more slaves may be connected in series, in parallel, or with just their negative or positive output terminals in common. (See also complementary tracking.)

Nominal value: the value that exists "in name only," not the actual value. For example, in the case of a power supply with a calibrated output control, the nominal value is the value indicated by the control setting. For a supply with a fixed output, the nominal output is the output indicated on the nameplate. The nominal value of a 120-volt \pm 10% line voltage is 120 volts.

Output impedance: the complex ratio of a sinusoidal voltage and sinusoidal current at the output terminals, the one being caused by the other and being of external origin.

Overcurrent protection: protection of the power supply and/or connected equipment against excessive output current.

Overtemperature protection: protection of the power supply or parts of it against temperatures exceeding specified values.

Overvoltage protection: protection of the power supply and/or connected equipment against excessive output voltage. Overvoltage protection is usually by means of a crowbar protection circuit, which rapidly places a low resistance shunt across the supply's output terminals to reduce output voltage to a low value if a predetermined voltage is exceeded. A supply equipped with an overvoltage crowbar must also be protected by a means of limiting or interrupting output current.

PARD (acronym for periodic and random deviation): the term PARD replaces the former term ripple and noise. PARD is the periodic and random deviation of a dc output voltage or current from its average value, over a specified bandwidth (20 Hz to 20 MHz) and with all influence and control quantities maintained constant.

Programming speed: the maximum time required for the programmed output voltage or current to change from a specified initial value (usually zero or maximum output) to a value within a specified tolerance band of a specified newly programmed value (for most models 99.9% or 0.1% of maximum output, respectively; 99% and 1% for the HP 6114A, 6115A, 6177C-6186C, and HP 6434B-6483C) following the onset of a step change in an analog programming signal, or the gating of a digital signal.

Remote control: also referred to as remote programming, remote control is the setting of the power supply voltage, current, or other function by means of an external control quantity such as a variable resistance, voltage, or current, or a digital signal.

Remote sensing: remote sensing, or remote error sensing, is a means by which a power supply monitors the stabilized voltage directly at the load using extra sensing leads. The resulting circuit action compensates for voltage drops in the load leads (up to a specified limit).

Resolution: for a bench supply, the smallest change in output voltage or current that can be obtained using the front panel controls. For a system supply, the smallest change that can be obtained using either the front panel controls or a computer.

Reverse voltage protection: protection of the power supply against reverse voltage applied at the output terminals.

Slave operation: see master-slave operation.

Source effect: formerly known as line regulation, source effect is the change in the steady-state value of the stabilized output voltage on current resulting from any change in the source voltage within its specified range, with all other influence quantities maintained constant. Source effect may be measured at any output voltage and current within rating.

Temperature effect coefficient: the maximum steady-state change in a power supply's output voltage or current per degree Celsius following a change in the ambient temperature within specified limits, with all other influence quantities maintained constant.

Voltage limiting: the action of limiting the output voltage of a constant-current supply to some predetermined maximum value (fixed or adjustable) and automatically restoring the output current to its normal value when the load conditions are restored to normal. There are two types of voltage limiting: 1) by constant-voltage/constant-current crossover, 2) by decreasing the output current as the voltage increases.

Warm-up time: the time interval after switching on a power supply until it complies with all performance specifications.

POWER SUPPLIES

System Power Supply Programming Features

HP-IB system power supplies are extremely easy to program. The following tables list the programming commands and queries for these power supplies. Notice the large selection of features. There are

also many commands for service only, which have not been included in these lists.

Standard Control Features Comparison

Command	Header	Description	HP 6030A to HP 6038A	HP 6621A to HP 6624A and HP 6627A	HP 6632A to HP 6634A	HP 6625A, HP 6626A, HP 6628A and HP 6629A
Set voltage	VSET	Programs output voltage setting	X	X	X	X
Set current	ISET	Sets output current limit	X	X	X	X
Set overvoltage	OVSET	Sets overvoltage trip level		X	X	X
OC protection on/off	OCP	Enable or disable over current protection		X	X	X
Output on/off	OUT	Enable or disable output	X	X	X	X
Unmask	UNMASK	Defines conditions which generate a fault which is latched into the fault register	X	X	X	X
Reprogram delay (in seconds)	DLY	Delays the onset of certain fault conditions and prevents the power supply from registering a fault when these conditions are true	X	X	X	X
Reset overvoltage	OVRST	Resets OVP once it's been triggered	1	X	1	X
Reset overcurrent	OCRST	Resets OCP once it's been triggered	1	X	1	X
Service request	SRQ	Enable or disable service request capability	X	X	X	X
Power-on SRQ on/off	PON	Enable or disable service request capability at power-on		X	X	X
Display on/off	DSP	Turns on/off the front panel display		X	X	X
Display char.	DSP	Displays messages of up to 12 characters on the front panel display		X		X
Store settings	STO	Stores voltage and current settings	X	X		X
Recall settings	RCL	Recalls stored settings	X	X		X
Clear supply	CLR	Clears all settings and returns power supply to initial power-on values	X	X	X	X
Trigger	TRG	Implements values stored using hold command	X			
Hold	HOLD	Stores values which are implemented by the trigger command	X			
Voltage maximum	VMAX	Sets maximum voltage value power supply will accept	X			
Current maximum	IMAX	Sets maximum current value power supply will accept	X			
Foldback	FOLD	Enable or disable foldback	X			
Reset	RST	Resets OVP, OCP or foldback when triggered	X		X	
Calibration mode	CMODE	Turns calibration mode on or off		X	X	X
Set power on	DCPON	Sets the state of all outputs at power on		X		X
Set voltage range	VRSET	Sets full scale output voltage range				X
Set current range	IRSET	Sets full scale output current range				X
Meter	METER	Selects which output will be metered				X
Voltage Step	VSTEP	Increases or decreases an output in voltage steps				X
Current Step	ISTEP	Increases or decreases an output in current steps				X

1 The reset command accomplishes this function.

Standard Monitoring Features Comparison

Query	Header	Action Taken by Power Supply	HP 6030A to HP 6038A	HP 6621 to HP 6624A and HP 6627A	HP 6632A to HP 6634A	HP 6625A, HP 6626A, HP 6628A, and HP 6629A
Voltage setting	VSET?	Returns programmed voltage value	X	X		X
Current setting	ISET?	Returns programmed current value	X	X		X
Voltage output	VOUT?	Voltage output value measured	X	X	X	X
Current output	IOUT?	Returns measured current value	X	X	X	X
OVP setting	OVSET?	Returns condition of OVP	X	X		X
OC protection on/off	OCP?	Returns condition of OCP (enabled/disabled)	†	X		X
Output on/off	OUT?	Returns condition of the output (on/off)		X		X
Unmask setting	UNMASK?	Returns a number corresponding to the unmasked settings in the fault register	X	X		X
Delay setting	DLY?	Returns delay setting	X	X		X
Status	STS?	Returns a number corresponding to the present status	X	X	X	X
Accumulated status	ASTS?	Returns contents of accumulated status register	X	X	X	X
Fault	FAULT?	Returns contents of fault register	X	X	X	X
Error	ERR?	Returns error code	X	X	X	X
Service request setting	SRQ?	Returns condition of SRQ (enabled/disabled)	X		X	X
Power-on SRQ on/off	PON?	Returns condition of the SRQ at power-on (enabled/disabled)		X		X
Display on/off	DSP?	Returns condition of front panel display (enabled/disabled)		X		X
Model number	ID?	Returns model number	X	X	X	X
Selftest	TEST?	Initiates selftest	X	X	X	X
Calibration mode	CMODE?	Turns on calibration ratio mode		X		X
Foldback setting	FOLD?	Reports foldback setting	X	†	†	†
Hold setting	HOLD?	Reports hold setting	X			
Voltage maximum	VMAX?	Reports voltage soft limit	X			
Current maximum	IMAX?	Reports current soft limit	X			
Power on state	DCPON?	Returns the power on state of all outputs		X		X
Voltage range setting	VRSET?	Returns the full scale output voltage range				X
Current range setting	IRSET?	Returns the full scale output current range				X
Meter setting	METER?	Returns which output will be metered				X

†Foldback (HP Models 6030A-6038A) is a protective feature similar to overcurrent protection (HP 6621A-6627A and HP 6632A-6634A).

POWER SUPPLIES

Single Output Linear System Power Supplies

Models 6632A, 6633A and 6634A

- 100 Watt Linear Output
- Current Sinking Capability
- Built-in HP-IB Interface
- Overvoltage & Overcurrent Protection
- Readback Measured Voltage and Current Output Via HP-IB

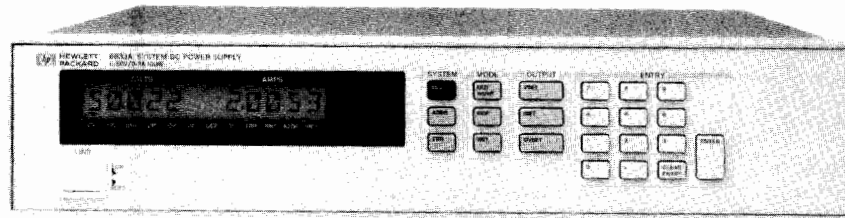

HP 6633A



Description

HP Models 6632A-6634A

HP Models 6632A-6634A are 100 Watt, single output, series pass regulated power supplies optimized for systems applications. They provide a high performance output with a full set of programmable features.

The following voltage and current combinations are available:

HP 6632A: 0-20 V	0±5 A
HP 6633A: 0-50 V	0±2 A
HP 6634A: 0-100 V	0±1 A

Most importantly, these models are one-box solutions for system power supply requirements. Both the voltage and current output can be programmed for either CV or CC operation. A built-in DVM and precision current shunt measure (readback) the actual power supply output. The internal HP-IB interface allows for complete programmability, including status reporting and interrupt generation with user designated fault conditions. In addition, programming commands (such as VSET for voltage programming) are easy-to-use and self-documenting.

Current Sinking

HP Models 6632A-6634A sink as well as source current. This provides very fast down programming times and speeds throughput in production test applications. The negative current setting tracks the user-programmed positive current (CC) setting.

Remote Sensing

Remote sense terminals allow for precise voltage regulation at the load. This feature will compensate for load lead IR drops of up to 2 volts per lead.

Protection Features

HP Models 6632A-6634A have Overvoltage and Overcurrent protection. Both features are programmable via the front panel keypad and HP-IB. The Overvoltage protection includes an SCR crowbar.

Selftest

HP Models 6632A-6634A have a built-in selftest capability. This feature verifies the function of all HP-IB circuitry, D/A's, and A/D's at power on and upon HP-IB command.

Software Calibration

Software calibration eliminates shock sensitive potentiometers normally used for calibration of power supplies and programmers. This

feature enables calibration of these models via the HP-IB while mounted in the rack. An internal jumper is provided which, when removed, prevents recalibration of the power supply.

Fast/Normal Mode Operation

A rear-panel switch designates one of two operating modes. In Fast Mode, the output capacitors are disconnected to speed up the output response time. Normal Mode is optimized for minimal output PARD. See specifications for more information.

Front Panel Binding Posts (Option 020)

Option 020 adds a front panel output in parallel with the rear panel output terminal strip. These front panel binding posts provide flexibility in accessing the power supply output, and are very useful in bench applications and system development.

Isolation, Polarity Reversal Relay and DFI/RI (Option 760)

Optional built-in relays provide output connect/disconnect and polarity reversal. Discrete Fault Indicator and Remote Inhibit lines are included along with a quick disconnect DC output terminal connector. See page 470 for more detail.

HP-IB Functions

The following functions can be programmed via the HP-IB:

Programmable Functions	Readback Functions
— Voltage Output	— Actual Measured Voltage Output
— Current Output	— Actual Measured Current Output
— Overvoltage Protection	— Present Status
— Overcurrent Protection	— Accumulated Status
— Output Enable/Disable	— Programming Error Codes
— Fault Interrupt	— Fault Codes
— Software Calibration	— Service Request
— Selftest	

Specifications (Data Subject to Change)

HP-IB Interface Functions: The following HP-IB functions are implemented:

SH1, AH1 T6, L4, SR1, RL1, PP1, DC1, DT0 and E1.

Safety Agency Compliance: HP Models 6632A-6634A power supplies are designed to comply with the following regulatory standards:

IEC 348, VDE 0411, UL 1244 and CSA Electrical Bulletin 556B.

Weight kg (lb) (all models): Net 10.5 (23), Shipping 12.3 (27)

Input Current: 100 VAC 120 VAC 220 VAC 240 VAC

(Max. rms all models) 3.3 A 2.9 A 1.7 A 1.6 A

Input requirements: 350 VA max.
250 watts max.

Specifications (Data Subject to Change)

Note: Specifications are worst case unless otherwise noted.

	Volts	0-20 V	0-50 V	0-100 V	
	Amps	0.5 A	0.2 A	0.1 A	
	Watts	100 W	100 W	100 W	
Hewlett-Packard Model Specified over an operating temperature range of 0-55°C.		6632A	6633A	6634A	
Load Effect (Load Regulation): For a load change from zero to maximum rated voltage or current of the supply.**	Voltage	2 mV	4 mV	5 mV	
	Current	1 mA	1 mA	1 mA	
Source Effect (Line Regulation): Given for any change within the rated line voltage for any output within the rated output voltage, current, and power of the supply.	Voltage	0.5 mV	1 mV	1 mV	
	Current	0.5 mA	0.25 mA	0.25 mA	
Ripple and Noise (PARD): rms/peak-peak (20 Hz - 20 MHz).	Voltage(Normal)	0.3 mV/3 mV	0.5 mV/3 mV	0.5 mV/3 mV	
	Voltage(Fast)	1 mV/10 mV	1 mV/15 mV	2 mV/25 mV	
	Current(rms)	2 mA	2 mA	2 mA	
Drift (Stability): Change in output over 8-hour interval under constant line, load, and ambient temperature following 30-minute warm-up.	Voltage	0.01%+0.5 mV	0.01%+1 mV	0.01%+1 mV	
	Current	0.01%+1 mA	0.01%+0.5 mA	0.01%+0.3 mA	
Load Effect Transient Recovery: Maximum time required for output voltage to recover within a band of 0.1% of rated voltage around the nominal voltage following a 50% change in load current.	Normal	100 μ s	100 μ s	100 μ s	
	Fast	50 μ s	50 μ s	50 μ s	
Programming: (25 \pm 5°C) Given for control of the output over the HP-IB or with front panel controls.	Voltage	Resolution	5 mV	12.5 mV	25 mV
		Accuracy	0.05%+10 mV	0.06%+20 mV	0.05%+50 mV
	+Current	Resolution	1.25 mA	0.5 mA	0.25 mA
		Accuracy	0.15%+7 mA	0.15%+2 mA	0.15%+1 mA
Minimum CC programming current.		20 mA	8 mA	4 mA	
Temperature Coefficient: Output change per degree Celsius change in ambient following 30-minute warm-up.	Voltage	70ppm+0.25 mV	70ppm+0.5 mV	70ppm+1 mV	
	+Current	150ppm+500 μ A	150ppm+150 μ A	150ppm+75 μ A	
Output Response: Maximum time for output voltage to change within \pm 0.025% of final value (LSB), and from 10% to 90%, or 90% to 10% of voltage excursion (Tr/Tf).	Normal	Tr/Tf	15 ms	15 ms	15 ms
		LSB	60 ms	60 ms	60 ms
	Fast	Tr/Tf	400 μ s	400 μ s	400 μ s
		LSB	2 ms	2 ms	2 ms
HP-IB Programming Command Processing Time: (Display disabled)	Typical	10 ms	10 ms	10 ms	
Voltmeter: (25 \pm 5°C) Refers to data read back to the controller from the HP-IB and as viewed via the front panel display.	Resolution	5 mV	12.5 mV	25 mV	
	Accuracy	0.07%+15 mV	0.07%+30 mV	0.06%+70 mV	
Ammeter: (25 \pm 5°C) Refers to data read back to the controller from the HP-IB and as viewed via the front panel display.	Resolution	1.25 mA	0.5 mA	0.25 mA	
	Accuracy	0.18%+9 mA	0.17%+3 mA	0.15%+2 mA	
DC Output Isolation: Maximum voltage either output terminal (\pm) may be from chassis ground.		\pm 240 VDC	\pm 240 VDC	\pm 240 VDC	
Remote Sensing: Maximum allowable voltage drop per load lead.		2 VDC	2 VDC	2 VDC	

**Specification under Local Sensing.

Ordering Information

6632A: 20 volts, 5 amperes

6633A: 50 volts, 2 amperes

6634A: 100 volts, 1 amperes

(NOTE: Line voltage Option (100, 120, 220 or 240) must be specified)

100: 87-106 Vac, 48-63 Hz, (for Japan only)

120: 104-127 Vac, 48-63 Hz.

220: 191-233 Vac, 48-63 Hz.

240: 209-250 Vac, 48-63 Hz.

020: Front Output Binding Posts

760: Isolation and Polarity Reversal Relay

908: Rack Mount Kit for one unit.

(HP P/N 5061-9674)

909: Rack Mount Kit with Handles

(HP P/N 5061-9675)

Accessory: Rack Slide Kit (HP P/N 1494-0059)

910: One each extra operating and service manuals.

(Operating manual only is shipped with standard unit.)

☎ Fast-Ship product — see page 734.

Price

\$1700 ☎

\$1700 ☎

\$1700 ☎

Dimensions

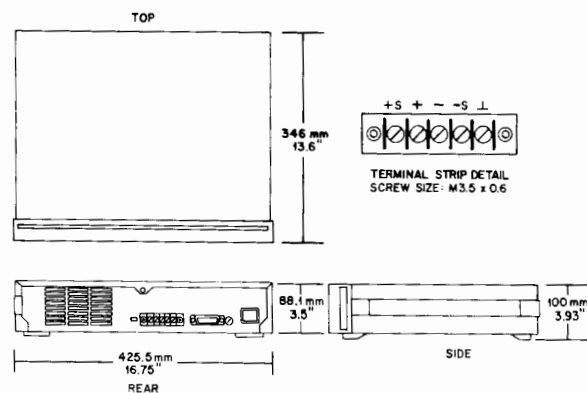

POWER SUPPLIES

Multiple Output Linear System Power Supplies

Models 6621A, 6622A, 6623A, 6624A and 6627A

- 2, 3 or 4 Independent Isolated Outputs per Model
- 160 Watts Total Output Power per Model
- HP-IB Programming of Voltage and Current

- HP-IB Measurement of Voltage and Current
- Full Local Control or Local Lockout
- Programmable Overvoltage and Overcurrent Protection

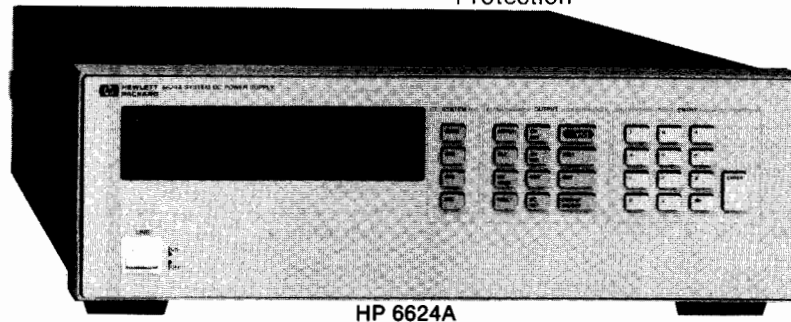

HP 6624A

Description

These HP-IB multiple output series regulated system power supplies feature a combination of intelligence, performance and low price which makes them the choice for power systems applications.

Five models, each offering a total of 160 watts output power, offer a variety of output combinations of 40 and 80 watts with voltages up to 50 volts and currents to 10 amps. Each output can produce power in two ranges (see fig. 1). For example, model 6622A has two 80 watt outputs. Each of these can produce 80 watts at either 20 volts or 50 volts. When operating below 20 volts, each output can source or sink up to 4 amps. When operating between 20 volts and 50 volts, it can source or sink up to 2 amps. Output combinations include:

- 6621A - 2 outputs at 80 watts, either 0-7 or 0-20 volts
- 6622A - 2 outputs at 80 watts, either 0-20 or 0-50 volts
- 6623A - 1 output at 80 watts, 0-7 or 0-20 volts; 1 at 40 watts, 0-20 or 0-50 volts; 1 at 40 watts, 0-7 or 0-20 volts
- 6624A - 4 outputs at 40 watts: two at 0-7 or 0-20 volts and two at 0-20 or 0-50 volts
- 6627A - 4 outputs at 40 watts, either 0-20 or 0-50 volts

The built-in interface is tailored to the power supply, resulting in simpler programming. Specifications supplied with these power supplies already take both the power supply and programming interface into account as a system. Self-contained measurement and readback capabilities eliminate the need for scanning the output or using a separate DVM.

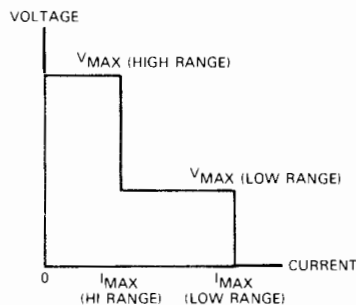

Fig 1. Output Characteristic Curve for HP 662X Series Power Supplies

Programming Capabilities

These power supplies share the programming command set of HP Models 6632A-6634A and 6030A-6038A programmable power supplies. (see page 460) The following functions are implemented:

- Output Voltage and Current Programming
- Output Voltage and Current Measurement and Readback
- Present and Accumulated Status Readback
- Programmable Service Request Mask
- Programmable Overcurrent Protection
- Programmable Overvoltage Protection
- Storage and Recall of Programmed Value Sets (all outputs)
- Echo Queries of Programmable Functions/Settings
- Output Channel Enable/Disable
- Programming Syntax Error Detection
- Reprogramming Delay Time for Service Request Mask

Operating voltage and current range is selected programmatically, with the last parameter programmed (voltage or current) determining the range. No separate command is required to switch output range.

Programmed command processing time is typically 7 milliseconds. Response time to within settling band is additional.

Protection Features

Local lockout capability enables the programmer to disable all front panel controls over the HP-IB except the channel select (to allow display of the output voltage and current of any channel.)

Protection against overcurrent conditions is provided by either the current limit or overcurrent protection. Current limit will prevent the output current from exceeding a programmed value, while overcurrent protection will disable the supply if that value of current is reached. Current limit is always active, while overcurrent protection can be enabled or disabled.

As an example of its use, consider testing PC board subassemblies with a programmable power supply. A shorted component would cause current to be drawn from the power supply at the current limit value, possibly burning the board. Enabling overcurrent protection would cause the power supply to disable itself when the current limit value is reached, thus minimizing damage.

Protection against output overvoltage conditions is also provided. Normally, the power supply voltage will not exceed the programmed voltage setting. Programmable overvoltage protection guards your load against hardware faults by disabling and down-programming the power supply output if the programmed overvoltage setting is exceeded. A crowbar circuit is activated and shorts the output under these conditions.

This series also provides protection from unregulated output in the event of line voltage dropout and also guards against overtemperature conditions. The output is disabled when either of these conditions exists.

A service request can be generated to inform the controller in the event of any user-defined combination of overvoltage, overcurrent, overtemperature or mode change.

Fault trips which disable the output can be reset over the HP-IB.

Output Ratings And Combinations

OUTPUT	CHANNEL	NUMBER OF OUTPUTS PER MODEL				
		6627A (4 output)	6624A (4 output)	6623A (3 output)	6622A (2 output)	6621A (2 output)
0-20/ 0-2	0-7/ 0-5	-	2	1	-	-
0-50/ 0-0.8	0-20/ 0-2	4	2	1	-	-
0-20/ 0-4	0-7/ 0-10	-	-	1	-	2
0-50/ 0-2	0-20/ 0-4	-	-	-	2	-



Software Calibration And Selftest

With this series of power supplies, calibration is performed without removing the instrument's cover. All that is required is a shunt, a dvm, a controller and a few lines of code. Simple commands instruct the power supply to go to preset adjustment points, where voltages or currents are read with the dvm and shunt. Then the readings are sent to the power supply, which adjusts its calibration. Calibration is maintained through line voltage cycling.

Calibration integrity can be assured by using a jumper inside the box which, when removed, will prevent the supply from accepting calibration commands.

These supplies also have considerable selftest capability, which is exercised at power on and upon receipt of the selftest command over the HP-IB. Running selftests over the HP-IB will not cause the output to change.

System Configuration

This series of power supplies offers a number of significant benefits in the area of simplicity and flexibility of system configuration.

A convenient rear panel line voltage module allows switching of input line voltage without removing the covers. (The line voltage option determines line cord plug configuration.)

For applications which require different combinations of voltage and current for different loads, the dual range full power feature will be useful (see fig. 1). If this is not enough, two outputs can be combined in parallel or series combinations for more power at a given voltage or current level.

Where a precisely regulated voltage is required at the load, remote sensing at the load can be used. This capability will compensate for load lead IR drops of up to 1 volt per load lead. Add 1mV to the load effect specification for each 200 mV drop in the negative load lead when remote sensing.

All outputs of these power supplies are isolated for up to 240 volts dc from chassis ground and each other.

For applications which require a hardware trip signal separate from the HP-IB remote disable, terminals are provided on the rear panel barrier block of each output which provide bidirectional overvoltage protection trip capability. These terminals can be used to monitor for an OVP trip signal, strapped together to disable all outputs when one OVP is tripped or used as a remote disable separate from the HP-IB.

These models can sink as well as source current. This means that downprogramming without a load takes the same time as upprogramming. Quick discharging of reactive loads is another benefit resulting from this capability.

Front Panel Control

To aid in system program development, the following capabilities of these power supplies are controllable from the front panel:

- Output Channel Select (Controls and Display)
- OVP Setting
- Overcurrent Protection Enable
- Storage and Recall of Programmed Settings
- Voltage Setting
- Current Setting
- SRQ Mask Delay Time
- Output Enable/Disable
- OVP, OCP Reset
- Local

The alphanumeric LCD display will normally display output voltage and current for the channel selected. When programming from the front panel, the function being programmed and the present value

will be displayed. Fault conditions will be spelled out in alpha characters. Output channel is indicated by an annunciator.

Changing the HP-IB address is done from the front panel, using the address key and the numeric keypad.

CIIL Programming (Option 700)

Enables programming in CIIL, Control Intermediate Interface Language. Includes Option 750.

Relay Controls, Fault Indicator, and Remote Inhibit Option 750

The new Option 750 for the HP 662XA series includes protection features and relay controls. The protection features include the discrete fault indicator line (FLT) and the remote inhibit line (INH). The fault line is a two pin TTL output port which goes true whenever a user-specified error condition exists. The remote inhibit line is a two pin TTL input port which can be used to disable the power supply output. These lines provide protection independent of the HP-IB. The relay controls (RLY), together with external user-supplied relay such as the HP 59510A or HP 59511A, physically disconnect the power supply outputs from the load (or system). Each of the four open collector RLY controls can sink 120 mA. They can be programmed over HP-IB with the RELAY and OUT commands or operated with the front panel OUTPUT ON/OFF function key. See page 470 for further information.

General Specifications

HP-IB interface functions: SH1, AH1, T6, L4, SR1, RL1, PP1, DC1, DT0.

Safety agency compliance: This series of power supplies is designed to comply with the following regulatory standards: IEC 348, VDE 0411, UL 1244, ANSI C39.5, and CSA Electrical Bulletin 556B.

Dimensions (all models): 132.6 mm H x 425.5 mm W x 497.8 mm D. (5.22 in. H x 16.75 in. W x 19.6 in. D)

Input current: 100 VAC 120 VAC 220 VAC 240 VAC
(max.rms, all models) 6.3 A 5.4 A 3.0 A 3.0 A

Weights kg(lb) (all models): Net 17.4(38) Shipping 22.7(50)

Warranty Period: Three years.

Prices And Option Descriptions

- 6621A:** Dual output system power supply. \$3,605
- 6622A:** Dual output system power supply. \$3,605
- 6623A:** Triple output system power supply. \$4,120
- 6624A:** Quad output system power supply. \$4,735
- 6627A:** Quad output system power supply. \$4,735
- 100:** 87- 106 Vac, 47-66 Hz. (for Japan only) \$0
- 220:** 191-233 Vac, 47-66 Hz. \$0
- 240:** 209-250 Vac, 47-66 Hz. \$0
- 700:** CIIL programming for MATE in place of HP-IB + \$525
- 750:** Protection Feature and Relay Controls + \$265
- 908:** Rack Mount Kit for one unit (no handles) + \$35
- 909:** Rack kit with handles + \$85
- 910:** One each extra operating and service manuals. (Operating manual only is shipped with standard unit.) + \$32

Output Channel Specifications (READ ACROSS FROM PREVIOUS PAGE) (at 0° to 55° C unless otherwise specified)

HP-IB OUTPUT SETTINGS				HP-IB MEASUREMENT READBACK ACCURACY **		PAR D (p-p/rms)		REGULATION				PROGRAMMING SPEED		
RESOLUTION		ACCURACY**						LOAD EFFECT		SOURCE EFFECT		TIME CONSTANT	RESPONSE TIME	SETTLING BAND
VOLTAGE	CURRENT	VOLTAGE	CURRENT	VOLTAGE	CURRENT	VOLTAGE	CURRENT	VOLTAGE	CURRENT	VOLTAGE	CURRENT			
6 mV	25 mA	19 mV + 0.06%*	50 mA + 0.16%*	20 mV + 0.05%*	10 mA + 0.1%*	3 mV/500 uV	1 mA rms	2 mV	1 mA	1 mV + 0.01%*	1 mA + 0.06%*	250 μs	2 ms	20 mV
15 mV	10 mA	50 mV + 0.06%*	20 mA + 0.16%*	50 mV + 0.05%*	4 mA + 0.1%*	3 mV/500 uV	1 mA rms	2 mV	0.5 mA	1 mV + 0.01%*	1 mA + 0.06%*	750 μs	6 ms	50 mV
6 mV	50 mA	19 mV + 0.06%*	100 mA + 0.16%*	20 mV + 0.05%*	20 mA + 0.1%*	3 mV/500 uV	1 mA rms	2 mV	2 mA	1 mV + 0.01%*	2 mA + 0.06%*	250 μs	2 ms	20 mV
15 mV	20 mA	50 mV + 0.06%*	40 mA + 0.16%*	50 mV + 0.05%*	8 mA + 0.1%*	3 mV/500 uV	1 mA rms	2 mV	1 mA	1 mV + 0.01%*	2 mA + 0.06%*	750 μs	6 ms	50 mV

*% of setting. ** For a ±5°C range about the calibration temperature

POWER SUPPLIES

Precision Multiple Output System Power Supplies

Models HP 6625A, 6626A, 6628A and 6629A

- 2 or 4 Independent Isolated Outputs per Model
- 14 bit Programming of Voltage and Current
- Two ranges cover: 0.5 mv to 50 volts; 1 μ a to 2 amps

- HP-IB Control and Measurement of Voltage and Current
- Current Sinking Capability for Fast Response
- Extensive Protection for DUT and Power Supply

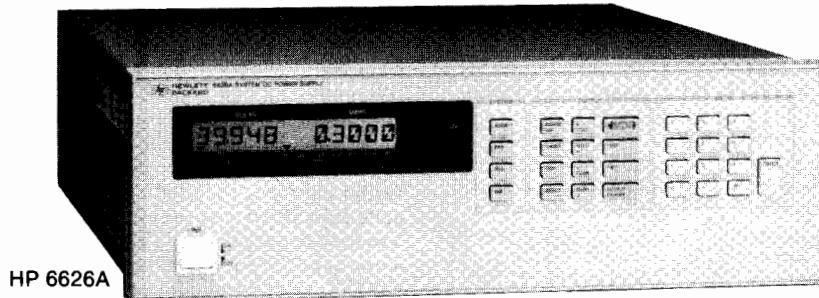

HP 6626A

Description

These HP-IB precision multiple output series regulated system power supplies provide a combination of features and performance that make them an excellent choice for automated component testing and other system applications requiring precision control.

Most importantly, these models are one-box solutions for those applications that require both sourcing and measurement of the load voltage and current. The built in DVM and precision current shunt allow readback of actual power supply output variables over the HP-IB.

The models provide different combinations of two output types: the 25 watt output offers 50 volts at 0.5 amps with a rectangular output characteristic; the 50 watt output offers 50 volts or 2 amps, with an L-shaped output characteristic (see fig. 1.). The HP 6625A is a dual output supply offering one of each output type for a total of 75 watts. The HP 6626A is a quad output supply offering two of each output type for a total of 150 watts. The HP 6628A is a dual output supply and the HP 6629A is a quad output supply, both of which offer all 50 watt outputs.

Each output offers a high and low range of operation for both voltage and current. These ranges may be selected independently, and the resulting output combinations are shown in the table on the facing page.

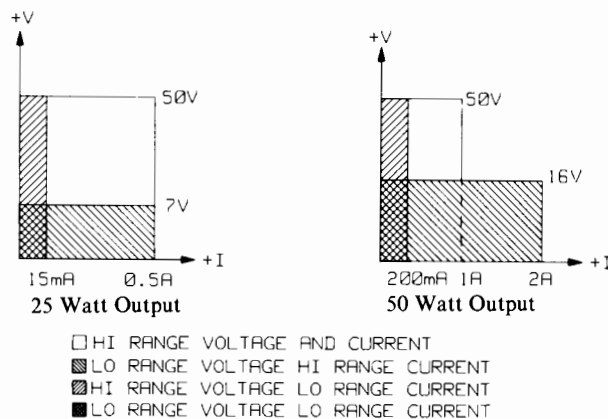

Figure 1: Output characteristics for HP 6625A, 6626A, 6628A, and 6629A.

Current Sinking

Each output has the capability to sink well as source current, so that voltage down-programming can be accomplished as quickly as up-programming, even without a load.

Remote Sensing

Remote sense terminals allow for precise voltage regulation at the load. These power supplies can accommodate up to 10 volts of sense lead drop (within a maximum of 50 volts at the output terminals of the power supply).

Output Configuration Flexibility

Outputs of the same type can be operated in series or parallel combinations for increased output voltage or current capability. All outputs of these supplies are isolated for up to 240 volts dc from chassis ground and from each other.

Bi-polar operation can be achieved by connecting two outputs of the same type in a series opposing mode.

Programming Capabilities

The internal HP-IB interface allows complete programmability, including status reporting and interrupt generation with user designated fault conditions. Programming commands (such as VSET for voltage programming) are easy to use and self documenting. These power supplies share the programming command set of HP Models 6621A-6624A, 6632A-6634A, and 6030A-6038A programmable supplies as described on page 460. The following functions are implemented:

- Output Voltage and Current Programming
- Voltage and Current Range Programming
- Output Voltage and Current Measurement and Readback
- Present and Accumulated Status Readback
- Programmable Service Request Mask
- Programmable Overvoltage and Overcurrent Protection
- Storage and Recall of Programmed Voltage and Current Values for all outputs
- Echo Queries of Programmable Functions and Settings
- Output Enable or Disable
- Programming Syntax Error Detection
- Programmable Delay Time for Service Request and Over Current Protection Mask
- Software Calibration of Voltage, Current, and Overvoltage
- HP-IB Interface Selftest
- Message Display Capability on the Front Panel
- Programmed command processing time is typically 7 milliseconds.
- Response time to within settling band is additional (see Output Response specification on the facing page).

Front Panel Control

To aid in system program development, a wide range of control capabilities are provided from the front panel.

- * Output Channel Select
- * Output Range Setting (Controls and Display)
- * OVP Setting
- * Overcurrent Protection Enable
- * Storage and Recall of Programmed Settings
- * Setting the HP-IB Address
- * Voltage and Current Setting
- * Output Range Setting
- * Output Enable/Disable
- * OVP, OCP Reset
- * Local / HP-IB Operation

The alphanumeric LCD display will normally display output voltage and current for the channel selected. When programming from the front panel, the function being programmed will be displayed. Fault conditions will be spelled out in alpha characters. Output channel is indicated by annunciators.

Protection Features

Local lockout capability enables the programmer to disable all front panel controls over the HP-IB except the channel select (for monitoring purposes).

All outputs have both Overvoltage and Overcurrent protection. The Overcurrent protection will disable the supply if the programmed current limit is reached. Programmable Overvoltage protection guards your load against hardware faults by disabling and down-programming the power supply if the programmed overvoltage setting is exceeded. A crowbar circuit is activated and shorts the output under these conditions.

This series also provides protection from unregulated output in the event of line voltage dropout, and guards against overtemperature. The output is disabled when either of these conditions exists.

A service request can be generated to inform the controller in the event of any user-defined combination of overvoltage, overcurrent, overtemperature or mode change. Fault trips which disable the output can be reset over the HP-IB.

For applications which require a hardware trip signal separate from the HP-IB remote disable, terminals are provided on the rear panel barrier block of each output which have bi-directional trip capability. These terminals can be used to monitor for an OVP trip signal, can be strapped together to disable all outputs when one OVP is tripped, or can be used as a remote disable, separate from the HP-IB.

Relay Controls, Discrete Fault Indicator, and Remote Inhibit

Option 750 includes additional protection features and relay controls. Included is a discrete fault indicator line (FLT) and the remote inhibit line (INH). The fault line is a two pin TTL output port which goes true whenever a user-specified error condition exists. The remote inhibit line is a two pin TTL input port which can be used to disable the power supply output. These lines provide protection independent of the HP-IB. The relay controls (RLY), together with external user supplied relays or accessory relays such as the HP 59510A or HP 59511A, physically disconnect the power supply outputs from the load (or system). Each of the four open collector RLY controls can sink 120 ma. They can be programmed over HP-IB with the RELAY and OUT commands or operated with the front panel OUTPUT ON/OFF function key. See page 470 for a complete description of the Models 59510A and 59511A Relay Boxes.

Software Calibration and Selftest

Just as on the HP 662XA and 663XA series, calibration can be performed without removing the instrument's cover. All that is required is a shunt, a DVM, a controller and a few lines of code. Simple commands instruct the power supply to go to preset adjustment points, where voltages or currents are read with the DVM and shunt. Then the readings are sent to the power supply which adjusts its calibration.

Calibration is maintained through input line voltage cycling. An internal jumper can be removed to prevent the supply from accepting unintentional calibration commands.

The selftest is exercised at power on and upon receipt of the selftest command over the HP-IB. Running selftests over the HP-IB will not cause the output to change.

General Specifications

Output Ratings and Combinations

Output Channel	Number of Outputs per HP Model			
	6625A	6626A	6628A	6629A
25 watt	1	2	0	0
50 watt	1	2	2	4

For additional output channel specifications, see table below.

Output Response: (all outputs)

Max Output Programming Time: 6 ms

Max Time Constant: 750 μ s

Settling Band: Within 50 mV of programmed value

Command Processing Time: Typically 7 ms (with front panel display disabled)

Load Transient Recovery: (all outputs) Time to recover within 75 mV of nominal value: 75 μ s

Current Sink Capability: (for any voltage above 4 volts)

50 watt outputs: 1 amp (2 amp below 16 volts)

25 watt outputs: 0.5 amps

HP-IB interface functions: SH1, AH1, T6, L4, SR1, RL1, PP1, DC1, DT0, C0, E1. For more information on these codes, refer to the HP-IB section of this catalog.

Safety agency compliance: This series of power supplies is designed to comply with the following regulatory standards: IEC 348, VDE 0411, UL 1244, ANSI C39.5, and CSA Electrical Bulletin 556B.

Size (all models): 132.6 mm H x 422.5 mm W x 497.8 mm D.
(5.22" x 16.75" x 19.6")

Input current: 100 VAC 120 VAC 220 VAC 240 VAC
(max. rms, all models) 6.3 A 5.4 A 3.0 A 3.0 A

Weight kg (lb) (all models): Net 17.4 (38) Shipping 22.7(50)

Warranty Period: Three Years

Prices and Option Descriptions

- 6625A:** Dual output system power supply \$4635
- 6626A:** Quad output system power supply \$7725
- 6628A:** Dual output system power supply \$4635
- 6629A:** Quad output system power supply \$7725
- 100:** 87- 106 VAC, 47-66 Hz. (for Japan only) N/C
- 220:** 191-233 VAC, 47-66 Hz. N/C
- 240:** 209-250 VAC, 47-66 Hz. N/C
- 750:** Relay Control and DFI/RI add \$265
- 908:** Rack Mount Kit for one unit (no handles) add \$35
- 909:** Rack Kit with handles add \$85
- 910:** One each extra operating and service manuals add \$32
(Operating manual only is shipped with standard unit.)

Accessory

HP Model 14852A Bias Cable: can be used with either quad output supply (HP 6626A or 6629A) to simplify the design of a three-terminal device test set-up. It leads the four outputs and sense lines to two bnc-style connectors, as described in Application Note 376-1.

\$300

Output Channel Specifications (at 0°C to 50°C unless otherwise specified)

TYPE	OPERATING RANGE	OUTPUT			REARBACK		PARD rms/p-p	REGULATION	
		SETTING	RESOLUTION	ACCURACY*	RESOLUTION	ACCURACY*		LOAD EFFECT	SOURCE EFFECT
25 watt	Lo Range/Voltage	0-7 volts	0.5 mV	1.5 mV +0.016%	0.5 mV	2 mV +0.016%	0.5 mV/3 mV	0.5 mV	0.5 mV
		0-15 mA	1 μ A	15 μ A +0.04%	1 μ A	15 μ A +0.03%			
	Hi Range/Voltage	0-50 volts	4 mV	10 mV +0.016%	4 mV	10 mV +0.016%	0.5 mV/3 mV	0.5 mV	0.5 mV
		0-0.5 amps	40 μ A	100 μ A +0.04%	50 μ A	130 μ A +0.03%			
50 watt	Lo Range/Voltage	0-16 volts	1 mV	3 mV +0.016%	1 mV	3.5 mV +0.016%	0.5 mV/3 mV	0.5 mV	0.5 mV
		0-0.2 amps	15 μ A	185 μ A +0.04%	15 μ A	250 μ A +0.04%			
	Hi Range/Voltage	0-50 volts	4 mV	10 mV +0.016%	4 mV	10 mV +0.016%	0.5 mV/3 mV	0.5 mV	0.5 mV
		0-2 amps	160 μ A	500 μ A +0.04%	160 μ A	550 μ A +0.04%			

* For a $\pm 5^\circ$ C range about the calibration temperature

POWER SUPPLIES

Autoranging System Power Supplies

Models 6030A, 6031A, 6032A, 6033A, and 6038A

- HP-IB programming of voltage and current
- Readback of voltage, current and status
- Overvoltage and overcurrent protection

- Optional CIIL programming
- Built-in self-test and diagnostics
- Up to 1200 watts output
- Full local control enable/disable

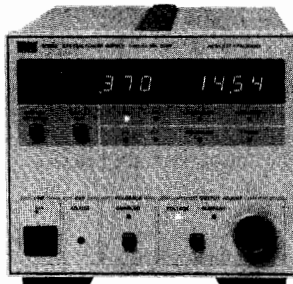

HP 6033A, 6038A

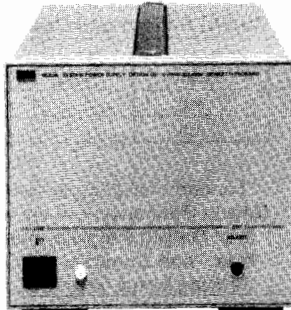

HP 6033A and 6038A
with Opt 001

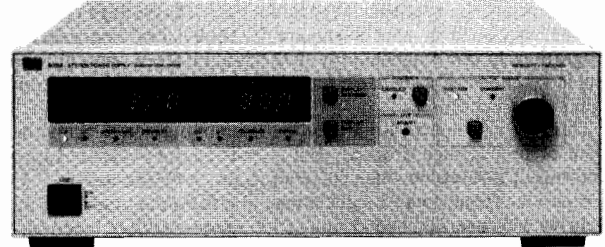

HP 6030A, 6031A and 6032A

Description

These HP-IB CV/CC dc power supplies have many productivity-oriented features which make them easy to program, integrate into systems and use.

A conventional power supply subsystem capable of monitoring and controlling power supply voltage and current requires a variety of hardware in addition to the actual supply. These new power supplies, however, have built-in capabilities which eliminate the need for D/A programmers, DVMS, and associated auxiliary circuitry. Fewer instruments mean less rack space, easier calculation of system specifications, quicker configurations, higher system reliability, more rapid troubleshooting, and simpler software. As autoranging power supplies, these models can provide a wide and continuous range of voltage and current combinations at the maximum rated power. This often allows both present and future requirements to be satisfied with fewer supplies, also reducing the number of instruments in the system. Special modifications are available to extend the output ratings even further. For example, the HP 6030A with Special Option V05 can provide up to 500 volts. See page 454 for more details.

Front Panel Control

Most of the extensive programmable instruction set can be simulated with front panel controls, thus facilitating design and debugging of system hardware and software. During system operation, if local control is not needed, the front panel controls can be disabled with a computer command. If operator interaction is required, a computer command can place limits on the output voltage and current available. Often, control and monitoring via the front panel is very useful during system development, but not needed afterwards. If the system is reproduced without further development, power supplies without front panel controls and meters (Option 001) can then be used. Ordering your power supplies with Option 001 significantly decreases the cost.

Specifications

		Ratings							Regulation				10% Change Transient Recovery	
		Autoranging Output*							Load Effect		Source Effect		Time	Level
Volts	Amperes	V ₁	P ₁	V ₂	P ₂	V ₃	P ₃	HP Model	Voltage	Current	Voltage	Current		
0-20	0-30	20V	200W	14V	242W	6.7V	200W	6033A	0.01% +2mV	0.01% +9mA	0.01% +1mV	0.01% +6mA	1ms	50mV
0-20	0-120	20V	1000W	14V	1064W	7V	840W	6031A	0.01% +3mV	0.01% +15mA	0.01% +2mV	0.01% +25mA	2ms	100mV
0-60	0-10	60V	200W	40V	240W	20V	200W	6038A	0.01% +3mV	0.01% +5mA	0.01% +2mV	0.01% +2mA	1ms	75mV
0-60	0-50	60V	1000W	40V	1200W	20V	1000W	6032A	0.01% +5mV	0.01% +10mA	0.01% +3mV	0.01% +10mA	2ms	100mV
0-200**	0-17	200V	1000W	120V	1200W	60V	1020W	6030A	0.01% +5mV	0.01% +10mA	0.01% +5mV	0.01% +5mA	2ms	150mV

*See the generalized autoranging output characteristic curve.

**HP Model 6030A with Special Option V05 can provide up to 500 volts. See page 454 for more details.

Protection Features

Because of the delicate nature of most loads, these system power supplies provide several different types of protection. Since they are CV/CC supplies, both the output voltage and current will be automatically limited to the programmed values. If reaching a programmed value indicates an undesirable condition, the power supply can be instructed to automatically down-program to zero output. For example, if the programmed current limit is reached while testing a PC board assembly, it may indicate a shorted component. In this case, the FOLDBACK feature, if enabled, would be able to serve as an over-current protection circuit and down-program the power supply automatically. FOLDBACK can be enabled and reset over the HP-IB.

The built-in overvoltage protection circuit is adjustable with a front panel control. The set trip level can be displayed on the front panel meter and also can be read back over the HP-IB, thus making adjusting the level easy. The OVP circuit, once tripped, can be reset over the HP-IB.

Production procedures sometimes require the operator to adjust the output voltage or current of a power supply locally with the front panel controls. If this is done, programmed levels can be set to limit the available adjustment range to a safe margin.

Potentially harmful conditions, such as overtemperature and high or low ac input, will trigger the power supply to automatically down-program to zero output. When these conditions occur, or the FOLDBACK or OVP circuits trip, LEDs on the front panel light to indicate the failure. This status can also be read back to the computer over the HP-IB and can be used to generate interrupts.

Programmable Features

Below are the parameters which can be programmed on the HP 6030A — 6038A and the information which is available for readback over the HP-IB. All of these features are included with the standard user-friendly programming language.

Programmable Functions

- Output Voltage
- Output Current
- Output Disable/Enable
- Soft Voltage Limit
- Soft Current Limit
- Group Trigger
- Foldback Mode
- Device Clear
- Interrupt Mask
- Interrupt Delay
- Pre-set Power Supply States
- Self-Test
- Local Lockout

Readback Functions

- Programmed Voltage
- Programmed Current
- Actual Voltage
- Actual Current
- OVP Trip Level
- Soft Voltage Limit
- Soft Current Limit
- Foldback Mode
- Present Status
- Accumulated Status
- Interrupt Mask
- Programming Error Codes
- Self Test Error Codes
- Output Disable/Enable
- Device ID

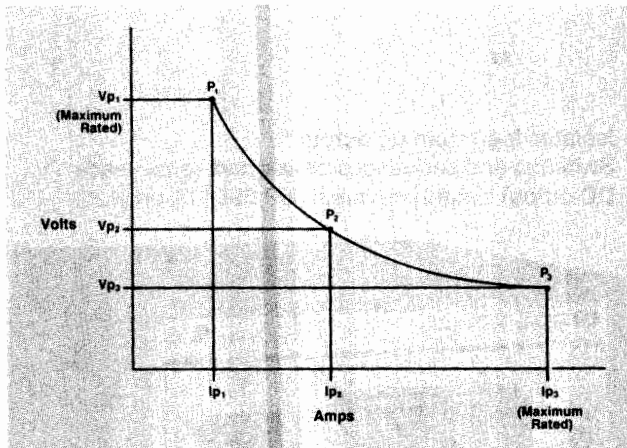

Generalized autoranging output characteristic curve

For added flexibility now a CIIL programming language, Option 700, is available.

System Configuration

If your application requires more power than the output capability of a single unit, you can use an auto-series connection for greater output voltage or an auto-parallel connection for greater output current. Consult your local HP sales office regarding restrictions/limitations for auto-series and auto-parallel operation.

Remote sensing can be used to maintain the CV load effect specification at the load with up to 0.5 volt drop per load lead, and sense wires which are less than 0.2 ohm per lead. Operation is possible with up to 2.0 volts drop per lead; however, the load effect specification may be degraded.

Either terminal may be grounded, or may be floated up to ± 240 (± 550 volts for the HP 6030A) volts from chassis ground.

Analog programming inputs and monitoring terminals are provided on the rear panel in addition to the HP-IB programming capabilities. Zero to full scale voltage or current can be programmed with either 0-5 volt voltage signals, or 0-4000 ohm resistance signals. The monitoring terminals present 0-5 volt buffered signals which are proportional to the output voltage and current.

HP models 6030A, 6031A, 6032A, and 6038A are stable when operating in CC into inductive loads up to 100 mH, and the HP 6033A and 6038A can handle up to 1 H. A special modification is available for HP Models 6030A, 6031A and 6032A to ensure stable operation when operating into inductive loads up to 10 H.

General Specifications

HP-IB interface functions: SH1, T6, AH1, L4, SR1, RL1, PP1, DC1, DT1.

Dimensions: HP 6033A and 6038A: 177.0 mm H x 212.3 mm W x 443.6 mm D (6.97" x 8.36" x 17.872")

HP 6030A, 6031A and 6032A: 132.6 mm H x 425.5 mm W x 503.7 mm D (5.2" x 16.75" x 19.83")

Warranty period: Three years.

Fault Indicator and Remote Inhibit

These HP-IB DC power supplies include a discrete fault indicator line (FLT) and remote inhibit line (INH). FLT is a two pin TTL output port that will go true whenever the power supply goes into

fault mode. INH is a two pin TTL input port that provides a means for disabling the power supply directly. Both the Fault Indicator and Remote Inhibit Lines are separate from, and in addition to, the HP-IB programming control.

Isolation/Polarity Reversal Relay Control

These models can control HP Models 59510A, 59511A relay devices with HP-IB commands. This applies to HP 603XA series products manufactured after May 1, 1988. Consult HP regarding retrofit kit for older HP 603XA series power supplies. See page 470 for more details.

CIIL Programming Language (Option 700)

Option 700 enables programming in CIIL (Control Interface Intermediate Language). CIIL is a test instrument module programming language standard used in military test equipment applications.

Option Descriptions

- 001:** Front panel which has only line switch, line indicator, and OVP adjust. less \$300
- 100:** 87-106 Vac, 48-63 Hz. This option is for use in Japan only. The power supply output power is 75% of the output power available with the other line voltage options. N/C
- 220:** 191-233 Vac, 48-63 Hz. N/C
- 240:** 208-250 Vac, 48-63 Hz. N/C
- 700:** CIIL programming language add \$525
- 800:** Rack mount kit for two units side by side. This applies to HP 6033A and 6038A only. add \$ 79
- 908:** Rack mount kit for a single unit. A blank filler panel is supplied when this option is ordered with HP 6033A and 6038A.
 - HP 6033A and 6038A add \$ 84
 - HP 6030A, 6031A and 6032A add \$ 35
- 909:** Rack mount kit with handles for HP Models 6030A, 6031A, 6032A \$ 85
- 910:** One extra operating and service manual shipped with each power supply. add \$ 32

Specifications cont.

PARD (rms/p-p) 20 Hz-20 MHz		Remote Control				General						
		Resolution		Accuracy		AC Input Current				Weight - kg (lbs)		Price
Voltage	Current	Voltage	Current	Voltage	Current	100 Vac	120 Vac	220 Vac	240 Vac	Net	Shipping	
3mV/30mV	15mA/-	5mV	7.5mA	0.035% +9mV	0.15% +20mA	6.0A	6.5A	3.8A	3.6A	9.6(21)	11.4(25)	\$2675
8mV/50mV	120mA/-	5mV	30mA	0.035% +15mV	0.25% +250mA	24A	24A	15A	14A	17.2(38)	22.7(50)	\$3605
3mV/30mV	5mA/-	15mV	2.5mA	0.035% +40mV	0.085% +10mA	6.0A	6.5A	3.8A	3.6A	9.6(21)	11.4(25)	\$2675
8mV/40mV	25mA/-	15mV	12.5mA	0.035% +40mV	0.2% +85mA	24A	24A	15A	14A	16.3(36)	21.8(48)	\$3605
22mV/50mV	15mA/-	50mV	4.25mA	0.035% +145mV	0.2% +25mA	24A	24A	15A	14A	16.3(36)	21.7(48)	\$3605

POWER SUPPLIES

DC Output Connect/Disconnect and Polarity Reversal Relay Accessories

HP 59510A, 59511A

- Isolates load from dc output
- Switches and sequences power and sense leads
- DC output polarity reversal (HP 59511A only)

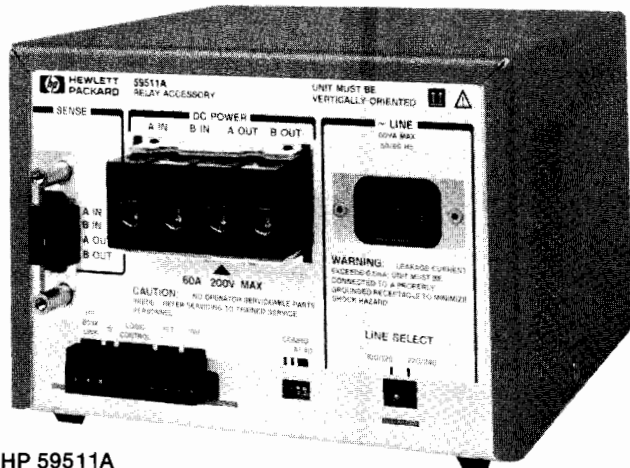

HP 59511A

Relay Devices

The HP 59510A and 59511A are remote controllable relay devices. These power supply accessories can be configured to switch dc power to multiple test fixtures or can be used to provide extra protection when a fault condition requires emergency shut-down. Each unit switches one power supply output. These relays can be used with any dc power supply within the voltage and current limits. The HP 59511A has all of the features of the HP 59510A and also provides relays for polarity reversal.

An internal microprocessor sequences the switching of power and sense leads. This protects the load by minimizing possible voltage overshoots. When used with HP system power supplies that are configured appropriately (see table on this page), the relays can be controlled through the power supply HP-IB port. For other applications, the HP 59510A and 59511A are controlled through a TTL signal port.

Configuring HP Power Supplies for Relay Control

The following table shows the HP power supplies that can be ordered with rear panel connections for direct control of HP 59510A and 59511A.

HP Power Supply	Power Supply Option	Relay Devices Controlled
HP 6621A-6629A	750	4 HP 59510A relays or 2 HP 59511A relays
HP 6632A-6634A	760	This option includes built-in relay devices
HP 6030A-6038A	std*	1 HP 59510A or 59511A

* Models manufactured before May 1, 1988, do not have this capability. Contact your HP sales office for retrofit information.

Mounting

Both relay accessory models can be mounted on any one of three sides to a flat surface with the PEM fasteners provided. The rack mount kit (option 850) eases mounting behind the power supply or toward the front of the equipment rack.

Specifications

Operating ranges: 200V at 20A, or 120V at 30A, or 48V at 60A.

Isolation: input to output: 200 Vdc
input/output to ground: 500 Vdc
TTL control to ground: 240 Vdc

Settling time (TTL control): connect 440 msec, disconnect 160 ms, polarity reversal 600 ms

DC voltage drop (at 60A): 0.5 volts maximum on each relay

AC input: equipped with a line module settable to nominal 100, 120, 220, or 240 Vac (-13% 6%), 48-63 Hz

Weight:

HP 59510A: net, 2.3kg (5lb); shipping, 3.6kg (8lb); shipping with option 850, 4.1kg (9lb)

HP 59511A: net, 3.6kg (8lb); shipping, 5.0kg (11 lb); shipping with option 850, 5.5kg (12lb)

Mounting orientation: within ± 10 deg from vertical.

Size: 130.6H x 185.4W x 198.6mmD (5.14" x 7.26" x 7.81")

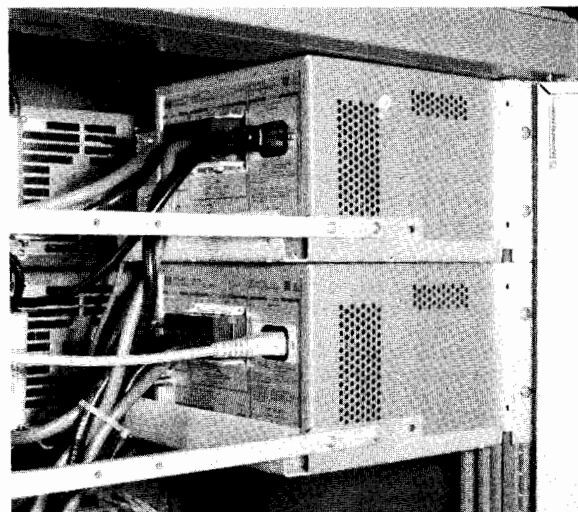

The relay accessories can be mounted behind power supplies using the option 850 rack mounting kit. The device can be oriented in any horizontal position on the tray. The orientation shown above can be used in shallow racks with no space to run cables from the relay accessory to the rear of the rack.

Options

Option 850 is a rack mount kit to facilitate mounting relay accessories. Side-by-side mounting of two devices requires two kits. For side-by-side mounting, adequate clearance is required so that the rear-exiting cables fit inside the rear wall or door of the rack. The clearance needed varies according to the flexibility of the user supplied cables. Approximately four inches from the relay accessory panel is usually adequate.

Option 910 is one extra operating and service manual.

Ordering Information

HP 59510A Output Isolation Relay Accessory	Price
HP 59511A Output Isolation/Polarity Reversal Relay Accessory	\$920
HP 59511A Output Isolation/Polarity Reversal Relay Accessory	\$1230
Opt 850 Rack Mount Kit	+\$77
Opt 910 extra Operating and Service Manual	+\$26

POWER SUPPLIES

200 Watt System Power Supply

Model 6002A

471

- 200 watt autoranging dc output
- Constant-voltage/constant-current operation
- HP-IB programming option

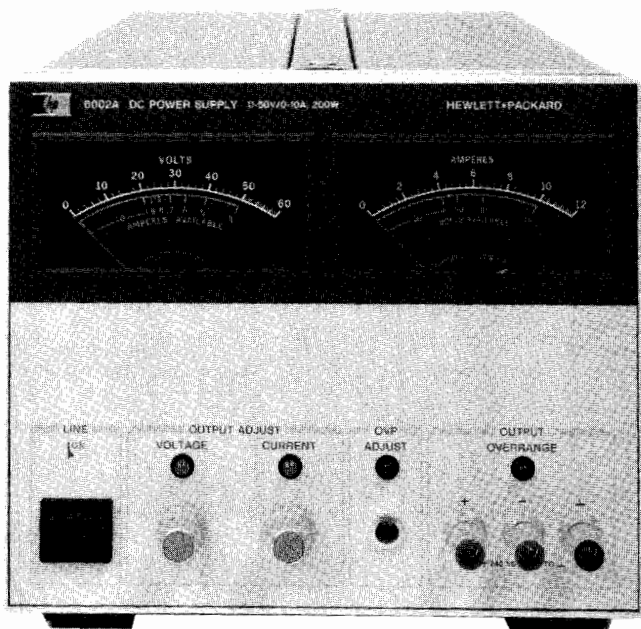

HP 6002A

Description

The HP 6002A dc power supply offers an exceptional combination of performance and flexibility. It employs a unique control concept which provides for an autoranging output with the performance characteristics of linear regulation. The HP 6002A is a 200 watt CV/CC power supply, which may be remotely programmed via the HP-IB when equipped with Option 001.

As an autoranging power supply, the HP 6002A can provide 200 watts over a wide range of voltage and currents without external intervention. This allows it to take the place of multiple conventional power supplies. For example, the HP 6002A can replace both a 50 volt, 4 ampere supply and a 20 volt, 10 ampere supply.

System Features/Remote Control

Analog programming of output voltages and current can be accomplished through the use of remotely controlled resistance or voltage applied to rear panel terminals. Additional control terminals are provided for remote load voltage sensing, auto-series or parallel operation, and for remotely activating the crowbar circuit. A pulse output from the crowbar terminal indicates the overvoltage circuit has been self-activated. A voltage step change appearing on terminal indicates a changeover to or from constant-current operation.

HP-IB Option

Digital programming via Option 001 permits control of output voltage or current by the Hewlett-Packard Interface Bus (HP-IB). Two programmable ranges allow better resolution below 10 volts or 2 amperes. The selection of HP-IB control of either voltage or current is done by rear panel switches. The IEEE 488 interface functions supported by the HP 6002A with Option 001 are basic listener (L2) and acceptor handshake (AH1). Complete explanation of these interface functions is available in the IEEE Std. 488-1978.

Specifications

DC output: voltage and current output can be adjusted over the ranges indicated by front panel controls, analog programming, or an optional HP-IB interface.

Voltage: 0-50 V. **Current:** 0-10 A.
Maximum 200 watts output from 20 V to 50 V.

- Built-in overvoltage protection crowbar
- CV/CC operating status indicators
- Remote analog programming and sensing

Autoranging Output Characteristic

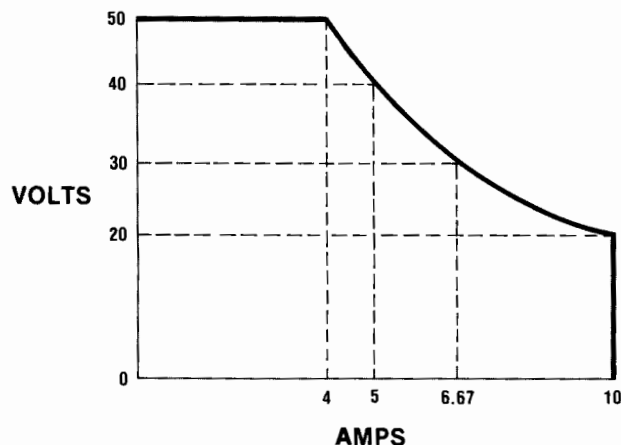

Load effect: constant-voltage, 0.01% +1 mV. Constant-current, 0.01% + 1 mA.

Source effect: CV, 0.01% +1 mV; CC, 0.01% + 1 mA.

Ripple and noise (PAR): rms/p-p, 20 Hz to 20 MHz; CV, 1 mV/10 mV; CC, 5 mA rms.

Temperature coefficient: CV, 0.02% +200 μ V/ $^{\circ}$ C; CC 0.02% +5 mA/ $^{\circ}$ C.

Drift: CV, 0.05% +1 mV/8 h; CC, 0.05% +5 mA/8 h.

Load transient recovery: 100 μ s for output voltage to recover within 15 mV of nominal voltage setting following a load current change of 50% to 100% or 100% to 50% of full load current.

Response time: maximum time for output voltage to change between 0 to 99.9% or 100% to 0.1% of maximum rated output voltage. Up Programming: no load, 100 ms; full load, 100 ms. Down Programming: no load, 400 ms; full load, 200 ms.

Overvoltage protection: trip voltage adjustable from 2.5 V to 60 V. **DC output isolation:** 150 V dc.

Power: 100, 120, 220, or 240 V ac (-13%, +6%), 48-63 Hz.

Temperature rating: 0 $^{\circ}$ C to 55 $^{\circ}$ C operating, -40 $^{\circ}$ C to +75 $^{\circ}$ C storage. Supply is cooled by built-in fan.

Size: 180 H x 212 W x 422 mm D (6.97" x 8.36" x 16.6").

Weight: net, 14.5 kg (32 lb); shipping, 15.9 kg (35 lb).

HP-IB Option

Programmable ranges: high: 0-50 V or 0-10 A,
low: 0-10 V or 0-2 A.

Programming speed: same as response time.

Accuracy: hi range: CV, 0.2% +25 mV; CC, 0.2% +25 mA.
lo range: CV, 0.2% + 10 mV; CC, 0.2% +25 mA.

Resolution: hi range: CV, 50 mV; CC, 10 mA. (12 bit)
lo range: CV, 10 mV; CC, 2 mA. (12 bit)

Isolation: 250 volts dc from bus data lines to power supply.

Options

Options	Price
001: HP-IB interface	add \$585
800: rack flange kit to mount 2 locked HP 6002As	\$79
908: rack mounting adapter kit for one HP 6002A; includes blank filler panel.	\$84
910: one extra operating and service manual	add \$10

HP 6002A Autoranging DC Power Supply **\$2575**

POWER SUPPLIES

Precision Bipolar System Supplies

Models 6129C-6131C & 6140A

- Fast, accurate, high resolution programming
- Bipolar output
- Current sink or source

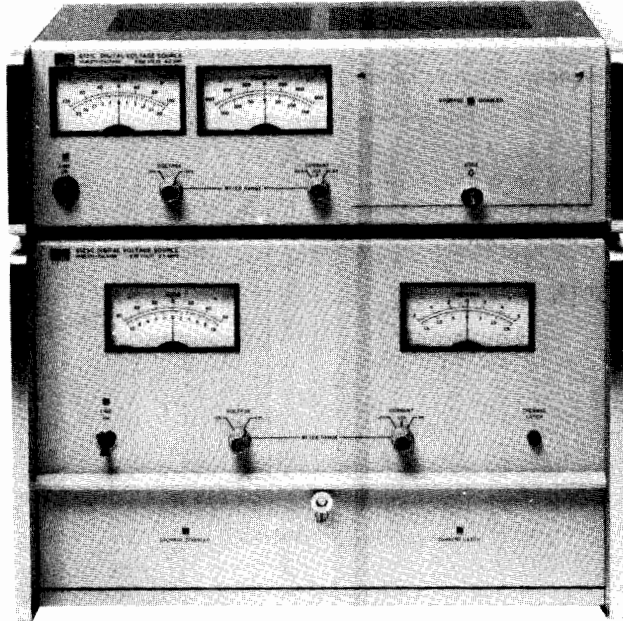

HP 6131C (top) & 6129C

Description

The family of Precision Bipolar System Supplies consists of three voltage sources (HP 6129C, 6130C and 6131C) and one current source (HP 6140A). They provide easy, fast and accurate programming of their dc outputs, with many features oriented specifically towards efficient integration in automatic systems.

Isolation

All digital inputs are completely isolated from the analog outputs.

Programmable Current Limit (Voltage Source)

Valuable loads can be protected by a user programmable current latch. Output power goes to zero when the latch circuit is tripped. The reaction time to the latch can be adjusted, if desired, to avoid tripping when reprogramming with a capacitive load. There is also a fixed current limit at 110% of rated current output.

Current Monitoring Terminals (Voltage Sources)

A voltage is available at the rear barrier strip which is proportional to the output current.

Analog Input

An ac signal may be injected into the output amplifier to simulate various noise and ripple conditions.

Precision Bipolar System Current Source

The HP 6140A Current Source has features which correspond to the voltage sources. It has a programmable voltage limit, voltage monitoring terminal, as well as isolation, and analog input capabilities.

Accessories Furnished

HP 1251-0086 50-contact rear plug.
 HP 5060-7948 Plug-in extender board for voltage source.
 HP 5060-7948/5060-7982. Two plug-in extender boards for current source.

- Programmable current latch (on voltage sources) or voltage limit (on current sources)
- Isolated output

Specifications

	Binary Instruments Option J20 & P05		BCD Instruments Option J99	
	X1 Range	X10 Range	X1 Range	X10 Range
HP 6129C				
Output	±16.384 V, 5 A	±50.00 V, 5 A	±9.999 V, 5 A	±50.00 V, 5 A
Accuracy	1.5 mV	15 mV	1.5 mV	15 mV
Resolution	0.5 mV	5 mV	1 mV	10 mV
HP 6130C				
Output	±16.384 V, 1 A	±50.00 V, 1 A	±9.999 V, 1 A	±50.00 V, 1A
Accuracy	1.5 mV	10 mV	1 mV	10 mV
Resolution	0.5 mV	5 mV	1 mV	10 mV
HP 6131C				
Output	±16.384 V, 0.5 A	±100.00 V, 0.5 A	±9.999 V, 0.5 A	±99.99 V, 0.5 A
Accuracy	1.5 mV	10 mV	1 mV	10 mV
Resolution	0.5 mV	5 mV	1 mV	10 mV
HP 6140A				
Output	±16.384 mA, 100 V	±163.84 mA, 100 V	±9.999 mA, 100 V	±99.99 mA, 100 V
Accuracy	1 µA ±0.01%	10 µA, ±0.01%	10 µA, ±0.01%	10 µA, ±0.01%
Resolution	0.5 µA	5 µA	1 µA	10 µA

Options

AC Power Option

028: transformer tap change for 230 V ac ±10%, single-phase input on HP 6130C and 6131C.
 (HP 6129C and 6140A are 115/230 switch selectable.)
J20: 16 bit binary interface for HP 12661A I/O programmer card for Hewlett-Packard computers.

Price

N/C

N/C

Accessories Available

HP 14533B: Pocket programmer permits manual programming of all input functions by switch closure. \$515
HP 14534A: Pocket programmer extension cable (3 ft). \$255
HP 14535A: HP computer interface kit includes HP 12661A computer I/O card, HP 14539A cable, verification software and RTE Driver. Up to eight PBSS's may be controlled from one HP 14535A. \$2,500
HP 14536A: Chaining cable connects an additional PBSS to the existing chain of PBSS's. \$360

Ordering Information

An interface option must be ordered.
HP 6129C: Digital Voltage Source \$11,350
Opt 908: Rack Flange Kit add \$53
HP 6130C, 6131C: Digital Voltage Source \$6,180
HP 6140A: Digital Current Source \$11,350
Opt 908: Rack Flange Kit add \$39
Opt 910: One extra operating and service manual shipped with each power supply \$15

- HP-IB power supply control
- HP-IB-to-power-supply isolation
- Programmable range

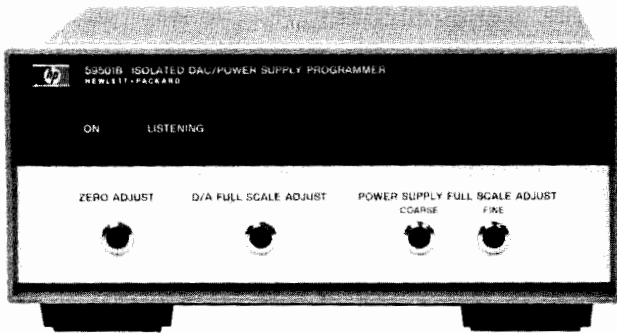

HP 59501B



Description

The HP 59501B is an isolated digital-to-analog converter designed to provide a convenient interface between the Hewlett-Packard Interface Bus and HP power supplies. With the HP 59501B, a wide range of dc voltages and currents becomes automatically controllable via the HP-IB. With proper wiring, the built-in isolation devices protect other instrumentation on the HP-IB from damage that could be caused by power supply outputs. In addition, an internal control circuit holds the output level near zero until programmed data is received. A programmable High/Low range control improves resolution by ten-to-one.

Power supply control is accomplished through the HP 59501B's programmable output voltage and programming network (see below). By making the appropriate connections between the 59501B's rear terminals and the remote programming terminals on the supply, the output voltage (or current) of the supply can be programmed from zero to its full rated output. The HP 59501B front panel controls provide fast and easy calibration of power supply outputs. The Zero Adjust enables the user to correct for small offsets in power supply response to programmed inputs. The Power Supply Full Scale Adjust (part of programming network) enables the user to set the maximum output desired from the power supply when the HP 59501B is programmed to its maximum value. For example, this adjustment would normally be used to calibrate the maximum programmable output of a 320Vdc power supply to 320 volts. However, it could also be used to set the maximum to 200 volts.

The HP 59501B also can be used directly as a low level dc signal source. Unipolar and bipolar output modes are available with output voltages programmable from zero to 9.99 volts, or minus 10.0 to plus 9.98 volts. Output current up to 10 milliamperes is available and is automatically limited to protect the HP 59501B and user equipment. The HP 59501B produces a full scale voltage change in approximately 250 μ s from the time the digital data is received.

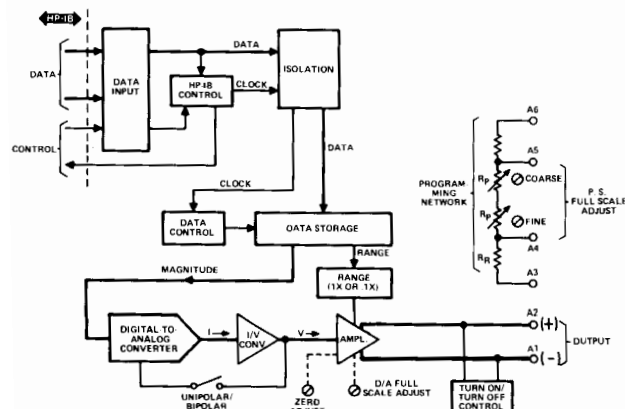

- Programmable 10-volt dc output
- Unipolar/bipolar operation
- Fast digital to analog conversion

Specifications

Digital to Analog Converter

DC output voltage: programmable in high or low ranges within the voltage limits shown below. Output mode is unipolar or bipolar and is selected by a rear panel switch.

Unipolar: 0 to 9.99 V (low range, 0 to 0.999 V).

Bipolar: -10 to +9.98 V (low range, -1 to +0.998 V).

DC output current: 10 mA maximum.

Ripple and noise (PARD): 2 mV rms/10 mV p-p.

Resolution: unipolar, 10 mV (low range, 1 mV). Bipolar, 20 mV (low range, 2 mV).

Accuracy: specified at 23°C \pm 5°C.

Unipolar: 0.1% +5 mV (low range, 0.1% +1 mV).

Bipolar: 0.1% +10 mV (low range, 0.1% +2 mV).

Stability: change in output over 8 hour interval under constant line, load, and ambient following a 30 minute warm-up. Stability is included in accuracy specification measurements over the temperature range indicated.

Unipolar: 0.04% + 0.5 mV (low range, 0.04% +0.1 mV).

Bipolar: 0.04% + 1 mV (low range, 0.04% +0.2 mV).

Temperature coefficient: unipolar, 0.01%/°C +0.5 mV/°C (low range, 0.1%/°C +0.1 mV/°C). Bipolar, 0.01%/°C +0.5 mV/°C (low range, 0.01%/°C +0.1 mV/°C).

Zero adjust: plus or minus 250 millivolts.

D/A full scale adjust: plus or minus 5%.

Programming speed: the time required for output to go from zero to 99% of programmed output change is 250 μ s (measured with resistive load connected to output terminals).

Power Supply Programming

Programming network specifications: in the following specifications, M represents the calibrated full scale value of the supply being programmed and P is the actual programmed output. The full scale value (M) can be any value within the supply's output range and is calibrated with the HP 59501B programmed to its maximum high range output.

Accuracy: specified at 23°C \pm 5°C.

Unipolar: 0.05% M +0.25% P (low range, 0.01% M + 0.25% P).

Bipolar: 0.1% M +0.25% P (low range, 0.02% M +0.25% P).

Isolation: 600 V dc between HP-IB data lines and output terminals.

Temperature coefficient: 0.005% M/°C + 0.015% P/°C (low range, 0.01% M/°C +0.015% P/°C).

Programming resolution: 0.1% M (low range, 0.01% M).

Programming speed: D/A programming speed plus the programming speed of the power supply.

General

Temperature range: operation, 0 to 55°C; storage, -40 to 75°C.

Power: 100, 120, 220, or 240 Vac (+6% -13%) 47-63 Hz, 10 VA (selectable on rear panel).

Size: 101.6 H x 212.9 W x 294.6 mm D (4" x 8.38" x 11.6").

Weight: net, 1.82 kg (4 lb); shipping, 2.27 kg (5 lb).



Several programming notes are available to assist in operating the HP 59501B Power Supply Programmer with the HP desktop computers. For more on free publications, see 760.

Accessories

HP 5060-0173: rack mounting adapter kit for one HP 59501B Price \$80

HP 5060-0174: rack mounting adapter kit to connect two HP 59501B's Price \$87.50

Ordering Information

HP 59501B HP-IB Isolated D/A Power Supply Programmer Price \$900

POWER SUPPLIES

General Purpose: 25–200 W Output

Models 6227B–6299A

- Constant voltage/constant current operation
- Remote sensing and programming
- Auto-series, -parallel, & -tracking operation



HP 6281A, 6284A, 6289A,
6294A, 6299A

- Front and rear output terminals
- Floating output—use as positive or negative source
- Bench or rack mounting

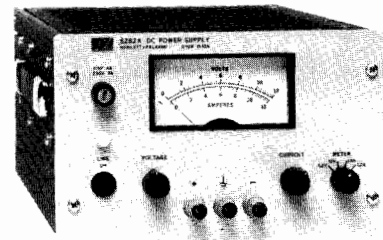

HP 6282A, 6286A,
6291A, 6296A

Description

HP 6281A–6299A Single Output

This series of medium-power constant voltage/constant current power supplies is available in two power ranges: 37–75 watts (packaged in 3½-inch high half-rack cases) and 100–200 watts (packaged in 5¼-inch high half-rack cases). All models except HP 6294A and 6299A have separate coarse and fine voltage and current controls that allow the voltage and current outputs to be varied from zero to the maximum rated values. The latter two models have ten-turn voltage controls. Crossover from constant voltage to constant current operation occurs automatically when the load current exceeds the value established by the current control settings. A four-position meter function switch selects either of two output voltage or output current ranges (X1, X0.1) for display on the panel meter.

The 37–75 watt models are of the series-regulated type. They have excellent regulation and ripple characteristics and include a special output-capacitor discharge circuit for improved programming speed. The 100–200 watt models employ a series-regulator/SCR-preregulator configuration to achieve the high efficiency necessary for a convection-cooled package of this size. They also have excellent regulation, low ripple and noise, and moderate programming speeds.

Specifications

RATINGS			PERFORMANCE							
DC Output		HP Model	Load Effect		Source Effect		Ripple & Noise (PAR) (rms/p-p)		Drift (stability)	
Volts	Amperes		Voltage	Current	Voltage	Current	Voltage	Current	Voltage	Current
0–7.5	0–5	6281A	5 mV	0.01% + 250 μ A	0.01% + 2 mV	0.01% + 250 μ A	200 μ V/1 mV	4 mA rms	0.1% + 2.5 mV	0.1% + 12.5 mA
0–10	0–10	6282A	0.01% + 1 mV	0.05% + 1 mA	0.01% + 1 mV	0.05% + 1 mA	500 μ V/25 mV	5 mA rms	0.1% + 2.5 mV	0.1% + 25 mA
0–20	0–3	6253A*	0.01% + 4 mV	0.01% + 250 μ A	0.02% + 2 mV	0.01% + 250 μ A	200 μ V/1 mV	2 mA rms	0.1% + 2.5 mV	0.1% + 7.5 mA
0–20	0–3	6284A	0.01% + 4 mV	0.01% + 250 μ A	0.01% + 2 mV	0.01% + 250 μ A	200 μ V/1 mV	2 mA rms	0.1% + 2.5 mV	0.1% + 7.5 mA
0–20	0–10	6286A	0.01% + 1 mV	0.05% + 1 mA	0.01% + 1 mV	0.05% + 1 mA	500 μ V/25 mV	5 mA rms	0.1% + 2.5 mV	0.1% + 25 mA
0–25	0–2	6227B*	0.01% + 1 mV	0.01% + 250 μ A	1 mV	100 μ A	250 μ V/4 mV	250 μ A/2 mA	0.2% + 2 mV	0.2% + 3 mA
0–40	0–1.5	6255A*	0.01% + 2 mV	0.01% + 250 μ A	0.01% + 2 mV	0.01% + 250 μ A	200 μ V/1 mV	500 μ A rms	0.1% + 2.5 mV	0.1% + 4 mA
0–40	0–1.5	6289A	0.01% + 2 mV	0.01% + 250 μ A	0.01% + 2 mV	0.01% + 250 μ A	200 μ V/1 mV	500 μ A rms	0.1% + 2.5 mV	0.1% + 4 mA
0–40	0–5	6291A	0.01% + 1 mV	0.05% + 1 mA	0.01% + 1 mV	0.05% + 1 mA	500 μ V/25 mV	3 mA rms	0.1% + 2.5 mV	0.1% + 12.5 mA
0–50	0–1	6228B*	0.01% + 1 mV	0.01% + 250 μ A	1 mV	100 μ A	250 μ V/4 mV	250 μ A/2 mA	0.2% + 2 mV	0.2% + 1.5 mA
0–60	0–1	6294A	0.01% + 2 mV	0.01% + 250 μ A	0.01% + 2 mV	0.01% + 250 μ A	200 μ V/1 mV	500 μ A rms	0.1% + 2.5 mV	0.1% + 2.5 mA
0–60	0–3	6296A	0.01% + 1 mV	0.05% + 1 mA	0.01% + 1 mV	0.05% + 1 mA	500 μ V/25 mV	3 mA rms	0.1% + 2.5 mV	0.1% + 7.5 mA
0–100	0–0.75	6299A	0.01% + 2 mV	0.01% + 250 μ A	0.01% + 2 mV	0.01% + 250 μ A	200 μ V/1 mV	500 μ A rms	0.1% + 2.5 mV	0.1% + 2 mA

*Models 6227B, 6228B, 6253A, and 6255A contain two identical, independently-adjustable power supplies.

HP 6253A and 6255A Dual Output

These versatile dual-output models each contain two identical, independently adjustable 60 watt power supplies in a full-rack width case. The regulator, voltage and current control, and metering circuits of each section of the supply are electrically identical to those of the individual 37–75 watt models described above.

By combining the versatility of a dual power supply with the flexibility of auto-series and auto-parallel operation, twice the maximum rated output voltage or current of each section can be obtained from the one supply. In addition, using the supply's auto-tracking capability, opposite-polarity voltages (± 20 V for HP 6253A or ± 40 V for HP 6255A) are possible.

HP 6227B and 6228B Dual Output

These versatile lab supplies each house two identical 50 W regulated power supplies. A convenient front panel switch selects either independent or tracking operation. In the track mode, the right supply tracks the left within $0.2\% \pm 2$ mV. The tracking mode is especially useful for powering operational amplifiers, push-pull stages, deflection systems, or any application where plus and minus voltages must track with insignificant error. The independent mode permits operation of the two supplies individually, in auto-parallel or in auto-series.

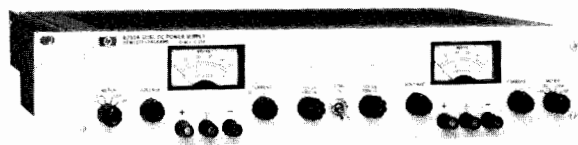

HP 6253A, 6255A

Each side of the dual supply can be operated as a constant voltage or constant current source, and each has its own crowbar for overvoltage protection. In the tracking mode, an overvoltage condition in either supply trips both crowbars. The power supply outputs are isolated up to 300 V from output to chassis or output to output.

Specifications—General

Load effect transient recovery: time, 50 μ s; level, 15 mV.
Meter accuracy: 3% of full scale.
Power: standard input voltage is 115 V ac \pm 10%. Order Option 028 for 230 V ac \pm 10% operation. Input power frequency, maximum input current, maximum power consumption are:
 HP 6227B and 6228B, 48–63 Hz, 2.7 A, 260 W;
 HP 6253A, 48–440 Hz, 2.6 A, 235 W; HP 6255A, 48–440 Hz, 2.6 A, 235 W; HP 6281A, 48–440 Hz, 1.3 A, 118 W; HP 6282A, 57–63 Hz, 3.5 A, 200 W; HP 6284A, 48–440 Hz, 1.5 A, 128 W; HP 6286A, 57–63 Hz, 5.5 A, 320 W; HP 6289A, 48–440 Hz, 1.3 A, 110 W; HP 6291A, 57–63 Hz, 5.5 A, 280 W; HP 6294A, 48–440 Hz, 1.3 A, 114 W; HP 6296A, 57–63 Hz, 4.5 A, 250 W; HP 6299A, 48–440 Hz, 1.5 A, 135 W.
Size: 6227B, 6228B: 155 H x 197 W x 309.55 mm D (6 $\frac{3}{32}$ " x 7 $\frac{25}{32}$ " x 12 $\frac{3}{16}$ ").
 HP 6253A, 6255A: 87 H x 483 W x 403 mm D (3 $\frac{1}{16}$ " x 19" x 15 $\frac{7}{16}$ ").
 HP 6281A, 6284A, 6289A, 6294A, 6299A: 87 H x 209 W x 398 mm D (3 $\frac{1}{16}$ " x 8 $\frac{7}{32}$ " x 15 $\frac{5}{16}$ ").
 HP 6282A, 6286A, 6291A, 6296A: 131 H x 210 W x 435 mm D (5 $\frac{1}{32}$ " x 8 $\frac{1}{4}$ " x 17 $\frac{1}{16}$ ").

Option Descriptions

See list under "Options" in table below for availability.
005: 50 Hz ac input: optimizes power supplies that require adjustment/modification for 50 Hz operation. N/C
010: Chassis slides. Enable convenient access to rack-mounted power supply for maintenance. add \$90



HP 6227B, 6228B

011: Internal overvoltage protection crowbar. Protects sensitive loads against power supply failure or operator error. Monitors the output voltage and places a virtual short circuit (conducting SCR) across load after preset trip voltage is exceeded.

HP 6281A, 6284A, 6289A, 6294A, 6299A add \$132
 HP 6282A, 6286A, 6291A, 6296A add \$215
 HP 6253A, 6255A add \$209
028: 230 Vac \pm 10%, single-phase input. Factory modification reconnects the multi-tap input power transformer for 230 V operation. N/C
040: Interfacing for Multiprogrammer operation. Prepares standard HP power supplies for resistance programming by the HP 6940B, 6942A, 6944A or 6954A. Price per output. Double for dual outputs. add \$80
910: one additional operating and service manual shipped with the power supply
 HP 6227 add \$10
 HP 6253A, 6255A, 6228B add \$7.88
 HP 6281A, 6282A, 6284A, 6286A, 6289A, 6291A, 6294A, 6296A, 6299A add \$5.35

Accessories

HP 14513A: 3.5 in. high rack kit for one HP 6281A, 6284A, 6289A, 6294A, 6299A \$57
 HP 14523A: 3.5 in. high rack kit for two above supplies \$31
 HP 14515A: 5.25 in. high rack kit for one HP 6282A, 6286A, 6291A, 6296A \$62
 HP 14525A: 5.25 in. high rack kit for two above supplies \$36
 HP 5060-8760: blank filler panel for HP 6227B, 6228B \$44
 HP 5060-8762: adapter frame for rack mounting one or two HP 6227B, 6228B \$150

Specifications, continued

REMOTE CONTROL FEATURES								GENERAL					
Resistance Coefficient		Voltage Coefficient		Speed, UP*		Speed, DOWN*		Overvoltage		Weight		Options▲	Price
Voltage	Current	Voltage	Current	NL	FL	NL	FL	Range	Margin	Net	Shipping		
200 Ω /V \pm 1%	200 Ω /A \pm 10%	1 V/V \pm 1%	0.2 V/A \pm 10%	1 ms	2 ms	10 ms	6 ms	2.5–10 V	4% + 2 V	6.4 kg/14 lb	7.2 kg/16 lb	11, 28, 40	\$1030
200 Ω /V \pm 1%	100 Ω /A \pm 10%	1 V/V \pm 1%	100 mV/A \pm 10%	70 ms	200 ms	9 s	40 ms	1–13 V	7% + 1 V	11.3 kg/25 lb	13.6 kg/30 lb	5, 11, 28, 40	\$1285
200 Ω /V \pm 1%	500 Ω /A \pm 10%	1 V/V \pm 1%	0.33 V/A \pm 10%	30 ms	80 ms	400 ms	100 ms	2.5–23 V	4% + 2 V	12.7 kg/28 lb	17.7 kg/39 lb	10, 11, 28, 40	\$1800
200 Ω /V \pm 1%	500 Ω /A \pm 10%	1 V/V \pm 1%	0.33 V/A \pm 10%	30 ms	80 ms	400 ms	100 ms	2.5–23 V	4% + 2 V	6.4 kg/14 lb	7.2 kg/16 lb	11, 28, 40	\$925
200 Ω /V \pm 1%	100 Ω /A \pm 10%	1 V/V \pm 1%	100 mV/A \pm 10%	150 ms	150 ms	9 s	70 ms	2–22 V	7% + 1 V	10.8 kg/26 lb	13.1 kg/29 lb	5, 11, 28	\$1340
200 Ω /V \pm 1%	500 Ω /A \pm 10%	1 V/V \pm 1%	5 V/A \pm 10%	40 ms	200 ms	400 ms	75 ms	5–28 V	7% + 1.5 V	11 ka/24 lb	12.9 kg/28 lb	40	\$2085
200 Ω /V \pm 1%	500 Ω /A \pm 10%	1 V/V \pm 1%	0.66 V/A \pm 10%	15 ms	45 ms	200 ms	40 ms	2.5–44 V	4% + 2 V	12.7 kg/28 lb	17.7 kg/39 lb	10, 11, 28, 40	\$1800
200 Ω /V \pm 1%	500 Ω /A \pm 10%	1 V/V \pm 1%	0.66 V/A \pm 10%	15 ms	45 ms	200 ms	40 ms	2.5–44 V	4% + 2 V	6.4 kg/14 lb	7.2 kg/16 lb	11, 28, 40	\$925
200 Ω /V \pm 1%	200 Ω /A \pm 10%	1 V/V \pm 1%	200 mV/A \pm 10%	275 ms	275 ms	13 s	275 ms	6–43 V	7% + 1 V	11.3 kg/25 lb	12.7 kg/28 lb	5, 11, 28	\$1340
200 Ω /V \pm 1%	1 k Ω /A \pm 10%	1 V/V \pm 1%	1 V/A \pm 10%	50 ms	350 ms	1 s	50 ms	5–55 V	7% + 1.5 V	11 ka/24 lb	12.9 kg/28 lb	40	\$2085
300 Ω /V \pm 1%	1 k Ω /A \pm 10%	1 V/V \pm 1%	1 V/A \pm 10%	25 ms	80 ms	2 s	175 ms	5–65 V	4% + 2 V	5.9 kg/13 lb	6.8 kg/15 lb	11, 28, 40	\$980
300 Ω /V \pm 1%	500 Ω /A \pm 10%	1 V/V \pm 1%	333 mV/A \pm 10%	600 ms	600 ms	5 s	200 ms	9–66 V	7% + 1 V	11.3 kg/25 lb	12.7 kg/28 lb	5, 11, 28	\$1340
300 Ω /V \pm 1%	1 k Ω /A \pm 10%	1 V/V \pm 1%	1.3 V/A \pm 10%	25 ms	200 ms	1.5 s	200 ms	20–106 V	4% + 2 V	5.9 kg/13 lb	6.8 kg/15 lb	11, 28, 40	\$980

*UP = increasing output voltage. NL = No output load current. FL = Full rated output load current.

☞ Fast-Ship product — see page 734.

POWER SUPPLIES

Autoranging Power Supplies

Models 6010A, 6011A, 6012B, 6023A, and 6024A

- Complete front panel control/display
- Constant voltage/constant current operation
- Remote programming and sensing
- Autoranging output
- High efficiency, compact, and light weight
- Ten-turn voltage and current controls

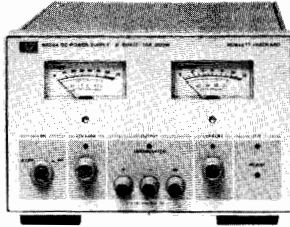

HP 6024A

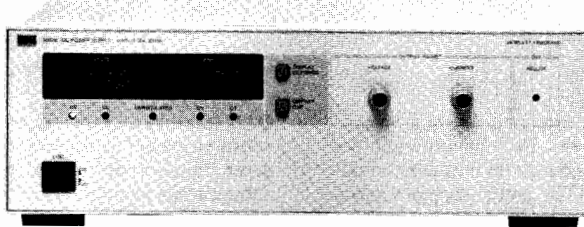

HP 6010A, 6011A, 6012B

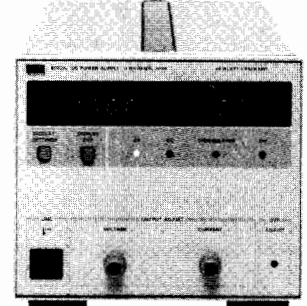

HP 6023A

Description

HP Models 6010A, 6011A, 6012B, and 6023A

This versatile family of dc power supplies provides laboratory grade performance along with many features to meet both laboratory and system needs.

Ten-turn front panel controls provide the means to precisely adjust the output voltage and current. The settings of these controls can be observed on the front panel meters by pressing the Display Settings button. This allows the current limit to be set when operating in the CV mode without shorting the output terminals and the voltage limit to be set when operating in the CC mode without opening the load leads.

Three and one-half digit front panel meters provide a convenient means for monitoring the output voltage and current. The accuracy of these meters allow them to replace external DVMs and monitor resistors in many applications that require monitoring of the power supply output.

The overvoltage protection (OVP) trip level can also be displayed on the front panel meters, allowing the trip level to be accurately adjusted without actually activating the OVP circuitry or disconnecting loads. In addition to the protection provided to the power supply and load by the OVP, these supplies also have protection against operating under excessive ac line or thermal conditions.

As autoranging power supplies, these units can operate at their maximum rated power over a wide and continuous range of voltage and current combinations. This often allows both present and future requirements to be satisfied with fewer supplies.

Special modifications are available to extend the output ratings even further. For example, the HP 6010A with Special Option V05 can provide up to 500 volts. See page 454 for more details.

HP Model 6023A is stable when operating in the CC mode into inductive loads up to one henry. HP Models 6010A, 6011A and 6012B are stable when operating in the CC mode into inductive loads up to 100 mH, and a special modification is available for these three models to assure stability with loads up to ten henries.

System Features

The output voltage and current of these supplies can be remotely controlled with either 0-5 volt or 0-4000 ohm analog programming signals. The actual output levels can be monitored without complicated external circuitry by connecting DVMs to the buffered 0-5 volt monitor outputs. All programming and monitoring signals are referenced to the same common and are accessed through the rear panel barrier strip.

Either terminal may be grounded, or floated up to ± 240 volts from chassis ground for the HP 6011A, 6012B and 6023A, and ± 550 volts for the HP 6010A.

If more output voltage or current is needed than a single unit can provide, auto-series or auto-parallel configurations can be used. Up to four 1000-watt units, or up to two 200-watt units can be connected in auto-parallel, and any combination can be used in auto-series providing up to 240 volts total (550 Vdc for HP 6010A) from chassis ground including output voltage. Remote sensing can be used to maintain the CV load effect specification at the load with up to 0.5 volt drop per load lead and sense wires that are less than 0.2 ohm per lead. Operation is possible with up to 2.0 volts per lead; however, load effect specification may be degraded. For more system control and monitoring capabilities, see Option 002.

Specifications

Ratings*									Regulation				10% Change Transient Recovery
Volts	Amperes	Autoranging Output*						HP Model	Load Effect		Source Effect		Time / Level
		V ₁	P ₁	V ₂	P ₂	V ₃	P ₃		Voltage	Current	Voltage	Current	
0-20	0-30	20V	200W	14V	242W	6.7V	200W	6023A	0.01% +2mV	0.01% +9mA	0.01% +1mV	0.01% +6mA	1ms / 50mV
0-20	0-120	20V	1000W	14V	1064W	7V	840W	6011A	0.01% +3mV	0.01% +15mA	0.01% +2mV	0.01% +25mA	2ms / 100mV
0-60	0-10	60V	200W	40V	240W	20V	200W	6024A	0.01% +3mV	0.01% +3mA	0.01% +5mV	0.01% +5mA	1ms / 75mV
0-60	0-50	60V	1000W	40V	1200W	20V	1000W	6012B	0.01% +5mV	0.01% +10mA	0.01% +3mV	0.01% +10mA	2ms / 100mV
0-200**	0-17	200V	1000W	120V	1200W	60V	1020W	6010A	0.01% +5mV	0.01% +10mA	0.01% +5mV	0.01% +5mA	2ms / 150mV

* See the generalized autoranging output characteristic curve.

** HP Model 6010A with Special Option V05 can provide up to 500 volts. See page 454 for more details.

HP Model 6024A

As an autoranging dc power supply, the HP 6024A can provide 200 watts over a wide and continuous range of voltage and current combinations, with maximums of 60 volts and 10 amperes. This provides greater flexibility than traditional power supplies that have only one maximum power point.

Ten-turn potentiometers provide precise control of the output voltage and current. The output levels can be observed on the separate front panel voltage and current meters. Terminals are available on both the front and rear panel for load connections.

The built-in OVP is adjustable from the front panel. Other protection features include over-temperature and high ac line detection.

The HP 6024A has many system oriented features. It can be remotely programmed with 0-5 volt or 0-2500 ohm analog signals. The output current can be easily monitored without an external shunt with the proportional 0-5 volt buffered monitor output. Remote sensing can be used to eliminate the effects of voltage drops in the load leads, and either terminal may be floated up to ±240 volts from chassis ground. Several units can be combined in auto-series, auto-parallel, and auto-tracking configurations, further increasing the HP 6024A's flexibility.

For more system features, see Option 002.

General Specifications

Dimensions

HP 6010A, 6011A and 6012B: 132.6 mm H x 425.5 mm W x 516.4 mm D (5.2" x 16.75" x 20.33")

HP 6023A: 177.0 mm H x 212.3 mm W x 443.6 mm D (6.97" x 8.36" x 17.872")

HP 6024A: 133.4 mm H x 212.3 mm W x 415.33 D (5.25" x 8.36" x 16.35")

Ordering Information

Option Descriptions

002: provides extra programming and monitoring capabilities for system use. A card inserted into the power supply is accessible through a 37-pin connector on the rear panel. It provides easy access to the control and monitor signals available on standard units, as well as these additional features:

- OVP trip and reset
- power supply inhibit
- status bits indicating CV mode, CC mode, unregulated output, OVP tripped, overtemperature condition, and ac line drop-out
- remote programming via a 0-2 mA current sink
- bias supplies for your circuitry: +5 volts at 100 mA, +15 volts at 75 mA, and -15 volts at 75 mA.
- buffered 0-5 volt outputs representing both the output voltage and output current. (HP 6010A, 6011A, 6012B, and 6023A provide this feature standard, but HP 6024A only provides a scaled 0-5 volt output to represent the output current, not the output voltage.)
- programmable remote/local for use when programming with a current sink.

Price

\$345.00

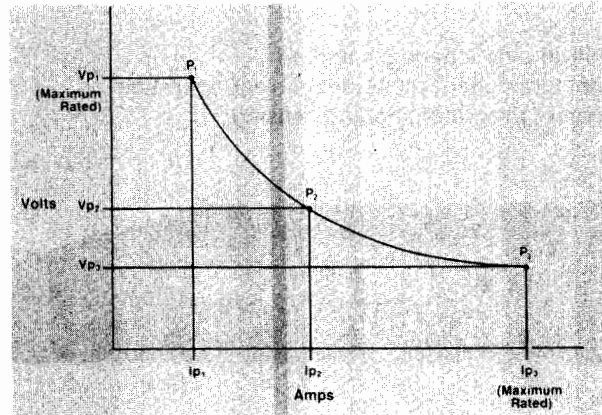

Generalized autoranging output characteristic curve

These features can all be taken advantage of with an HP 6940B or 6942A Multiprogrammer instrument sub-system configured with an HP 69520A or 69709A Power Supply Programming Card. The Multiprogrammer provides a cost-effective solution for controlling a group of power supplies, and also can provide many other digital and analog monitoring and control functions, all on the HP-IB. The voltage and current programming resolution available with either card is 1/1000th of full scale.

The features available with Option 002 can also be interfaced to your own external circuitry rather than an HP Multiprogrammer.

- 100:** 87-106 Vac, 48-63 Hz. HP 6024A Only! This option is for use in Japan only. The power supply output power is 75% of the output power available with the other line voltage options. For HP 6024A only. N/C
- 220:** 191 to 233 Vac, 48-63 Hz. N/C
- 240:** 208 to 250 Vac, 48-63 Hz. N/C
- 800:** Rack-mount kit for two units side by side. This applies to HP 6023A and 6024A only.
 - HP 6023A \$63.00
 - HP 6024A \$69.00
- 908:** Rack-mount kit for a single unit. A blank filler panel is supplied when ordered for half rack width units.
 - HP 6010A, 6011A, 6012B \$36.00
 - HP 6023A \$84.00
 - HP 6024A \$64.00
- 909:** Rack-mount kit with handles for HP Models 6010A, 6011A, and 6012B \$85.00
- 910:** One extra operating and service manual shipped with each power supply.
 - HP 6024A \$10.00
 - HP 6010A, 6011A, 6012B, 6023A \$21.00

PARD (rms/p-p) 20Hz-20MHz		Programming Response Time						General*						Price
		UP			DOWN			4C Input Current†				Weight kg (lbs)		
		Settling Band	Full Load	No Load	Full Load	Light Load		100 Vac	120 Vac	220 Vac	240 Vac	Net	Shipping	
3 mV 30 mV	15 mA —	5 mV	100 ms	100 ms	200 ms	500 ms	50 Ω	—	6.5 A	3.8 A	3.6 A	8.6 (19)	10.5 (23)	\$2010
8 mV 50 mV	120 mA —	30 mV	300 ms	300 ms	500 ms	1.5 sec	50 Ω	—	24 A	15 A	14 A	16.8 (37)	22.2 (49)	\$2935
3 mV 30 mV	5 mA —	60 mV	200 ms	200 ms	300 ms	600 ms	Open	5.3 A	5.3 A	2.9 A	2.7 A	5.4 (12)	7.3 (16)	\$1800
8 mV 40 mV	25 mA —	90 mV	300 ms	300 ms	2.0 sec	3.0 sec	100 Ω	—	24 A	15 A	14 A	15.9 (35)	21.3 (47)	\$2935
22mV 50mV	15mA —	300mV	300ms	300ms	600ms	3.5 sec	Open	—	24 A	15 A	14 A	16.3 (36)	21.7 (48)	\$2935

* An ac input option must be specified when ordering.

POWER SUPPLIES

General Purpose: 200–2000 W Output

Models 6259B–6274B

- Built-in overvoltage protection
- Constant voltage/constant current operation
- Remote programming and sensing

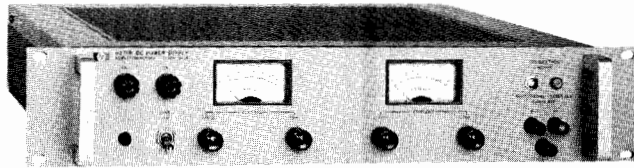

HP 6263B, 6266B

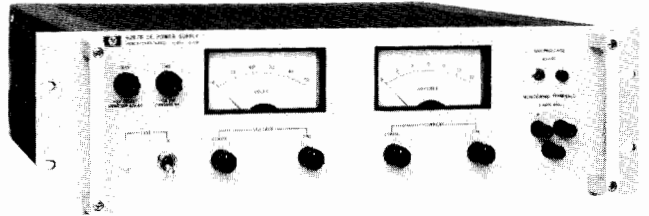

HP 6264B, 6267B

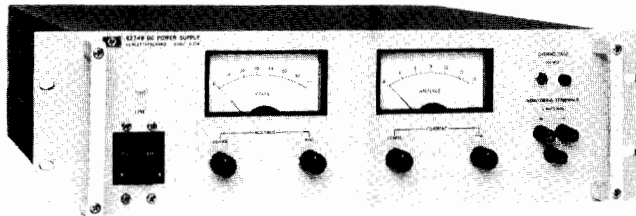

HP 6274B

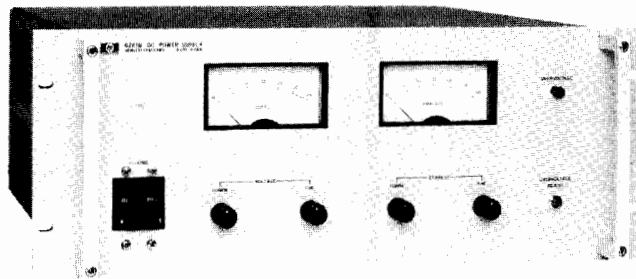

HP 6259B, 6260B, 6261B, 6268B, 6269B

- Remote sensing
- Auto-series, -parallel, and -tracking operation
- $\leq 50 \mu\text{s}$ load transient recovery

Description

Models 6259B–6274B

This series of high-performance constant voltage/constant current supplies includes twelve models with output rating from 10 to 60 V. All models employ a transistor series-regulator/triac-preregulator circuit to achieve high efficiency, excellent regulation, low ripple and noise, and moderate programming speeds in a compact full-rack width package.

Separate coarse and fine voltage and current controls allow the voltage and current outputs to be varied from zero to the maximum rated value, crossover from constant voltage to constant current operation occurs automatically when the load current exceeds the value established by the current control settings.

Additional features include built-in overvoltage crowbar protection; remote error sensing; and auto-series, auto-parallel, and auto-tracking operation. The crowbar trip point adjustment and associated overvoltage indicator are conveniently located on the front panel.

Auto-series, auto-parallel, and auto-tracking connections should ordinarily include no more than three supplies. If a specific application requires the use of more than three supplies in any of the three connections, consult your local HP Field Engineer for additional information.

All dc output, ac input, sensing, control, and programming connections are made to rear-panel terminals. Either the positive or negative output terminal may be grounded or the supplies may be operated floating at up to 300 volts above ground. Models 6263B, 6264B, 6266B and 6267B are convection cooled. All other models in this series employ cooling fans. Models which output more than 200 watts are equipped with terminal blocks for ac input and are not shipped with line cords.

Specifications†

RATINGS			PERFORMANCE							
DC Output		HP Model	Load Effect		Source Effect		PARD (rms/p-p)		Drift (stability)	
Volts	Amperes		Voltage	Current	Voltage	Current	Voltage	Current	Voltage	Current
0–10	0–50	6259B	0.01% + 200 μV	0.02% + 1 mA	0.01% + 200 μV	0.02% + 1 mA	500 $\mu\text{V}/5 \text{ mV}$	25 mA rms	0.03% + 2 mV	0.03% + 10 mA
0–10	0–100	6260B	0.01% + 200 μV	0.02% + 2 mA	0.01% + 200 μV	0.02% + 2 mA	500 $\mu\text{V}/5 \text{ mV}$	50 mA rms	0.03% + 2 mV	0.03% + 20 mA
0–20	0–10	6263B	0.01% + 200 μV	0.02% + 500 μA	0.01% + 200 μV	0.02% + 500 μA	200 $\mu\text{V}/10 \text{ mV}$	3 mA rms	0.03% + 500 μV	0.03% + 6 mA
0–20	0–20	6264B	0.01% + 200 μV	0.02% + 500 μA	0.01% + 200 μV	0.02% + 500 μA	200 $\mu\text{V}/10 \text{ mV}$	5 mA rms	0.03% + 500 μV	0.03% + 6 mA
0–20	0–50	6261B	0.01% + 200 μV	0.02% + 1 mA	0.01% + 200 μV	0.02% + 1 mA	500 $\mu\text{V}/5 \text{ mV}$	25 mA rms	0.03% + 2 mV	0.03% + 10 mA
0–40	0–5	6266B	0.01% + 200 μV	0.02% + 500 μA	0.01% + 200 μV	0.02% + 500 μA	200 $\mu\text{V}/10 \text{ mV}$	3 mA rms	0.03% + 500 μV	0.03% + 3 mA
0–40	0–10	6267B	0.01% + 200 μV	0.02% + 500 μA	0.01% + 200 μV	0.02% + 500 μA	200 $\mu\text{V}/10 \text{ mV}$	3 mA rms	0.03% + 2 mV	0.03% + 3 mA
0–40	0–30	6268B	0.01% + 200 μV	0.02% + 2 mA	0.01% + 200 μV	0.02% + 2 mA	1 mV/5 mV	20 mA rms	0.03% + 2 mV	0.03% + 5 mA
0–40	0–50	6269B	0.01% + 200 μV	0.02% + 2 mA	0.01% + 200 μV	0.02% + 2 mA	1 mV/5 mV	25 mA rms	0.03% + 2 mV	0.03% + 10 mA
0–60	0–15	6274B	0.01% + 200 μV	0.02% + 500 μA	0.01% + 200 μV	0.02% + 500 μA	200 $\mu\text{V}/20 \text{ mV}$	5 mA rms	0.03% + 2 mV	0.03% + 5 mA

†Refer to page 459 for complete specification definitions.

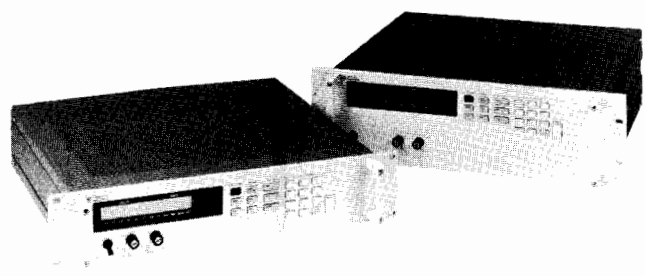

HP Models 6259B - 6274B can be HP-IB controlled when configured with Special Option Z-10. See page 454 for more details.

Option Descriptions	Price
005: 50 Hz ac input: optimizes power supplies that require adjustment/modification for 50 Hz operation.	\$0
010: chassis slides. For access to rack mounted power supplies: HP 6263B, 6264B, 6266B, 6267B	+ \$91.00
HP 6274B, 6259B, 6260B, 6261B, 6268B, 6269B	+ \$168.00
016: Model 6260B only. 115 Vac \pm 10% single phase input. Consists of replacing power transformer and circuit breaker, and reconnecting bias transformer, RFI choke and fans.	+ \$126.00
022: voltage and current programming adjust. Allows the V and I programming coefficients and zero output to be conveniently adjusted to 0.1% accuracy via access holes in the rear panel. Consists of four potentiometers and resistors located inside the rear panel.	+ \$64.00
026: 115 Vac \pm 10%, single phase input. Consists of replacing the input circuit breaker and reconnecting the power transformer, bias transformer, RFI choke, and fans. Models 6259B, 6261B and 6268B only.	\$0
027: 208 Vac, \pm 10%, single phase input. Consists of reconnecting power transformer taps, and other components where necessary.	\$0
028: 230 Vac \pm 10%, single phase input. Consists of reconnecting power transformer taps, and other components where necessary.	\$0
040: Multiprogrammer interface. Prepares standard HP power supplies for resistance programming by the HP 6940B, 6942A, 6944A or 6954A Multiprogrammers. This option includes Option 022, special calibration, and protection check-out procedures (where required).	+ \$80.00
910: one additional operating and service manual shipped with each power supply. HP 6259B-6274B	+ \$7.88

Specification—General

Load effect transient recovery: time, 50 μ s; Level, 10 mV.
Resolution: voltage control, less than 0.02%; current control, less than 0.15%.
Temperature coefficient per °C: 0.01% of output plus 200 μ V.
Temperature ratings: operating, 0 to 55°C; storage, -40 to 75°C.
Remote control programming: these power supplies are capable of being programmed in constant voltage and constant current operation by using an external resistance or dc voltage with coefficients as shown in the table below.

Rear terminal wiring configurations for remote control operation are specified in the operating and service manual supplied with the power supply. For remote control programming procedures and timing considerations, contact your local HP field engineer.

Power: input voltage tolerance is \pm 10%, 57-63 Hz. For other input voltage and frequency options available, see option listing in the specifications table below. Standard input voltage, maximum input current, and maximum power are:

- HP 6259B, 230 V ac, 6 A, 850 W;
- HP 6260B, 230 V ac, 12 A, 1600 W;
- HP 6263B, 115 V ac, 4.5 A, 350 W;
- HP 6266B, 115 V ac, 4 A, 325 W;
- HP 6268B, 230 V ac, 12 A, 1600 W;
- HP 6261B, 230 V ac, 12 A 1500 W;
- HP 6264B, 115 V ac, 8 A, 600 W;
- HP 6267B, 115 V ac, 8 A, 550 W;
- HP 6269B, 230 V ac, 18 A, 2500 W;
- HP 6274B, 115 V ac, 15 A, 1200 W.

AC line connections: three wire, five foot ac power cord included—HP 6263B and 6266B.

Three-terminal barrier strip provided on power supply for ac power connections—HP 6259B, 6260B, 6261B, 6264B, 6267B, 6268B, 6269B and 6274B.

Size

- HP 6263B, 6266B: 83.7 H x 483 W x 479.4 mm D (3.296" x 19" x 18.875").
- HP 6264B, 6267B, 6274B: 127 H x 483 W x 479.4 mm D (5.00" x 19" x 18.875").
- HP 6259B, 6260B, 6261B, 6268B, 6269B: 173 H x 483 W x 479.4 mm D; (6.812" x 19" x 18.875").

Specifications, Continued

REMOTE CONTROL FEATURES								GENERAL					
Resistance Coeff.		Voltage Coeff.		Speed Up*		Speed Down*		Overvoltage		Weight		Options	Price
Voltage	Current	Voltage	Current	NL	FL	NL	FL	Range	Margin	Net	Shipping		
200 Ω /V \pm 1%	4 Ω /A \pm 10%	1 V/V \pm 1%	10 mV/A \pm 10%	70 ms	70 ms	200 ms	100 ms	2-12 V	5% + 2V	31.3 kg/69 lb	35.3 kg/78 lb	5, 10, 22, 26, 27, 40	\$2470
200 Ω /V \pm 1%	2 Ω /A \pm 10%	1 V/V \pm 1%	5 mV/A \pm 10%	70 ms	70 ms	200 ms	75 ms	2-12 V	5% + 2 V	43.9 kg/97 lb	48 kg/106 lb	5, 10, 16, 22, 27, 40	\$2885
200 Ω /V \pm 1%	100 Ω /A \pm 10%	1 V/V \pm 1%	50 mV/A \pm 10%	150 ms	150 ms	7 s	350 ms	2-23 V	5% + 1 V	15.4 kg/34 lb	18.6 kg/41 lb	5, 10, 22, 27, 28, 40	\$1775
200 Ω /V \pm 1%	10 Ω /A \pm 10%	1 V/V \pm 1%	25 mV/A \pm 10%	140 ms	140 ms	10 s	150 ms	2.5-23V	5% + 1 V	21.3 kg/47 lb	24.5 kg/54 lb	5, 10, 22, 27, 28, 40	\$1855
200 Ω /V \pm 1%	4 Ω /A \pm 10%	1 V/V \pm 1%	10 mV/A \pm 10%	150 ms	150 ms	250 ms	250 ms	2-23 V	5% + 2 V	35.3 kg/78 lb	39.4 kg/87 lb	5, 10, 22, 26, 27, 40	\$2675
200 Ω /V \pm 1%	200 Ω /A \pm 10%	1 V/V \pm 1%	100 mV/A \pm 10%	275 ms	275 ms	13 s	1.5 s	2.5-45 V	5% + 1 V	15.4 kg/34 lb	18.6 kg/41 lb	5, 10, 22, 27, 28, 40	\$1775
200 Ω /V \pm 1%	100 Ω /A \pm 10%	1 V/V \pm 1%	50 mV/A \pm 10%	275 ms	275 ms	13 s	750 ms	2.5-45 V	5% + 1 V	17.7 kg/39 lb	20.8 kg/46 lb	5, 10, 22, 27, 28, 40	\$1855
200 Ω /V \pm 1%	6 Ω /A \pm 10%	1 V/V \pm 1%	16.7 mV/A \pm 10%	300 ms	300 ms	1 s	650 ms	4-45 V	5% + 1 V	34.4 kg/76 lb	38.1 kg/84 lb	5, 10, 22, 26, 27, 40	\$2575
200 Ω /V \pm 1%	4 Ω /A \pm 10%	1 V/V \pm 1%	10 mV/A \pm 10%	350 ms	350 ms	1 s	600 ms	4-45 V	5% + 1 V	40.3 kg/89 lb	44 kg/98 lb	5, 10, 22, 27, 40	\$2675
300 Ω /V \pm 1%	67 Ω /A \pm 10%	1 V/V \pm 1%	33.3 mV/A \pm 10%	600 ms	600 ms	40 s	800 ms	6-66 V	5% + 1 V	21.7 kg/48 lb	24.5 kg/54 lb	5, 10, 22, 27, 28, 40	\$2060

*Up = increasing output voltage. NL = No output load current. FL = Full rated output load current

POWER SUPPLIES

General Purpose: 300—11,000 W Output
Models 6434B—6483C

- Outstanding value—low cost/watt
- Up to 75% efficiency at full output
- Constant voltage/constant current operation

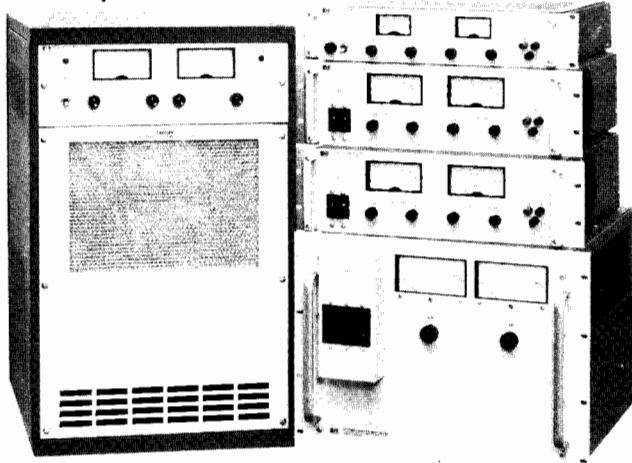

HP 6434B—6483C

Description

This series of SCR-regulated power supplies is designed for medium to high-power applications requiring a fixed or variable dc source with moderate regulation and ripple. For supplies with better regulation, faster response time, and lower ripple, see models HP 6259B—6274B on page 478.

Operating Features

All supplies in this series are of the constant voltage/constant current type. Large easy-to-read panel meters continuously monitor output voltage current.

Input and output power, remote sensing, remote programming, and auto-series, -parallel, and -tracking connections are made to bus bars and terminal blocks on the rear panel.

Specifications†

RATINGS			PERFORMANCE						
DC Output		HP Model	Load Effect		Source Effect		PARD Δ rms/p-p	Temperature Coefficient	Drift
Volts§	Ampere§		Voltage	Current	Voltage	Current			
0-8	0-1000	6464C	0.05% + 5 mV	0.1% + 1 A	0.05% + 5 mV	0.1% + 1 A	80 mV/1 V	0.03% + 100 μ V	0.03% + 1 mV
0-15	0-200	6453A	0.2% + 10 mV††	1% or 2 A††	0.2% + 10 mV††	1% or 2 A††	150 mV rms	0.05% + 2 mV	0.25% + 10 mV
0-16 or 18	0-600 or 500*	6466C	0.05% + 5 mV	0.1% + 0.6 A	0.05% + 5 mV	0.1% + 0.6 A	180 mV/1 V	0.03% + 200 μ V	0.2% + 1 mV
0-36	0-100	6456B	0.2% + 10 mV††	1% or 1 A††	0.2% + 10 mV††	1% or 1 A††	180 mV rms	0.05% + 2 mV	0.25% + 10 mV
0-36	0-300	6469C	0.05% + 5 mV	0.1% + 0.3 A	0.05% + 5 mV	0.1% + 0.3 A	180 mV/1 V	0.03% + 400 μ V	0.15% + 1 mV
0-40	0-25	6434B	40 mV	200 mA	18 mV	200 mA	40 mV/500 mV	0.03% + 5 mV	0.1% + 20 mV
0-64	0-50	6459A	0.2% + 10 mV††	1% or 0.5 A††	0.2% + 10 mV††	1% or 0.5 A††	160 mV rms	0.05% + 2 mV	0.25% + 10 mV
0-64	0-150	6472C	0.05% + 100 mV	0.1% + 0.15 A	0.05% + 100 mV	0.1% + 0.15 A	160 mV/2 V	0.03% + 4 mV	0.15% + 16 mV
0-110	0-100	6475C	0.05% + 100 mV	0.1% + 0.1 A	0.05% + 100 mV	0.1% + 0.1 A	200 mV/2 V	0.03% + 5 mV	0.15% + 20 mV
0-120	0-2.5	6443B	120 mV	25 mA	60 mV	25 mA	240 mV/400 mV	0.03% + 20 mV	0.1% + 60 mV
0-220	0-50	6477C	0.05% + 100 mV	0.1% + 50 mA	0.05% + 100 mV	0.1% + 50 mA	330 mV/2 V	0.03% + 8 mV	0.15% + 35 mV
0-300	0-35	6479C	0.05% + 100 mV	0.1% + 35 mA	0.05% + 100 mV	0.1% + 35 mA	330 mV/3 V	0.03% + 11 mV	0.15% + 45 mV
0-440, 500 or 600	0-25, 20, 15*	6483C	0.05% + 100 mV	0.1% + 35 mA	0.5% + 100 mV	0.1% + 35 mA	600 mV/5 V	0.03% + 20 mV	0.15% + 80 mV
1-600	5 mA-1.5 A	6448B	1 V	40 mA	600 mV	15 mA	600 mV/2 V	0.03% + 100 mV	0.1% + 300 mV

† Refer to page 459 for complete specification definitions.

†† Specified for combined line and load regulation.

Δ For operation with a 50 Hz input (possible only with Option 005), the rms ripple and transient response specifications are increased by 50%.

* The output current rating is given in the same order corresponding with the voltage rating.

Protective Features

In addition to the overload protection inherent in constant voltage/constant current operation, there are many other built-in protective features included in these supplies. The features vary within the three model classifications as follows:

HP 6434B—6448B: (1) Reverse voltage protection. (2) Fused ac input.

HP 6453A, 6456B, 6459A: (1) AC line loss protection circuit monitors 3-phase input and cuts off SCR's and opens output bus if a phase drops out; operation resumes when ac input returns to normal. (2) 3-phase input circuit breaker. (3) Optional internal crowbar (Option 006) protects load from overvoltage condition.

HP 6464C—6483C: (1) High-temperature protection thermostat opens input to power transformer and lights front panel indicator if supply overheats. (2) Prolonged overload protection circuit is activated and lights front panel indicator if output current exceeds approximately 115% of maximum rating. (3) Optional internal crowbar (except on HP 6464C) protects load from overvoltage condition. (4) Turn-on circuit limits peak line current during start-up into low impedance loads. (5) Phase-balance circuit permits operation with line-to-line input voltage imbalance up to 8%. (6) Overcurrent and over-voltage circuits of master slave supplies used in auto-series, -parallel, or -tracking operation can be interlocked.

Auto-Series, -Parallel, -Tracking Operation

Supplies may be connected in auto-series, or auto-tracking (except HP 6448B and 6483C, which cannot be connected in auto-series).

Up to three lower-power models (HP 6434B—6448B) may be connected in any of the above configurations. Higher-power model (HP 6453A/6483C) interconnection should ordinarily include no more than two supplies.

Remote Programming

The voltage and current outputs of the supplies can be programmed by a remote resistance, or for most models, a remote voltage source. Programming speeds and coefficients are detailed in the specifications table.

AC Power Requirements

The ac power requirements vary with the three model classifications (see option listings). When powered from a 50 Hz source (possible with option 005), the rms ripple and transient response specifications increase by 50%. The p-p ripple specification is unchanged by line frequency.

Line Cords

Line cords are not supplied with models 6434B, 6448B and 6453A-6483C.

§ Under light loading conditions, power supply may not meet all published specifications. The graph on the next page defines the permissible operating regions for CV and CC modes of operation.

For operation with a 50 Hz input (possible only with Option 005), output current is linearly derated from 100% at 40°C to 80% at 50°C.

POWER SUPPLY OUTPUT RESTRICTIONS AS A FUNCTION OF LOADING

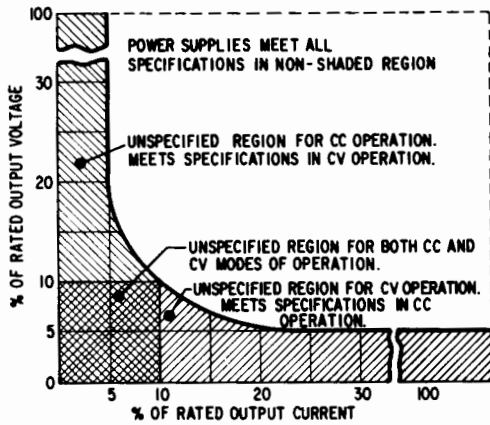

Site Evaluation

Higher power units (HP Models 6464C-6483C) most likely will require installation of a dedicated electrical branch service. It is suggested that a site evaluation be conducted by a qualified electrician or engineer prior to ordering. At that time, the electrician can help determine the correct line voltage option to order.

Size

- Model 6443B:** 89 H x 483 W x 445 mm D (3.5" x 19" x 17.5").
- Models 6434B, & 6448B:** 133 H x 483 W x 432 mm D (5.25" x 19" x 17").
- Models 6453A, 6456B, & 6459A:** 356 H x 483 W x 500 mm D (14" x 19" x 19.7").
- Models 6464C, 6466C, 6469C, 6472C, 6475C, 6477C, 6479C, & 6483C:** 705 H x 483 W x 715 mm D (27.75" x 19" x 28.12").

Option Descriptions

HP 6434B-6448B

- Std:** 115 V ac, ± 10%, single phase, 57-63 Hz
- 005:** realignment for 50 Hz operation
- 010:** chassis slides
- 027:** 208 V ac, ± 10%, single phase, 57-63 Hz
- 028:** 230 V ac, ± 10%, single phase, 57-63 Hz
- 910:** one extra operating and service manual shipped with each power supply

- Price**
- N/C
 - N/C
 - add \$168
 - N/C
 - N/C
 - add \$10

Specifications, continued

HP 6453A, 6456B, 6459A

An ac input option must be specified when ordering.

AC input connections are by means of a 4-conductor connector at rear of unit. Low voltage (208 V, 230 V) models are furnished with an Arrow Hart and Hageman plug (HP 1251-6896). High voltage (380 V, 400 V, 460 V) models are furnished with an Arrow Hart and Hageman plug (HP 1251-6897).

- 001:** 208 V ac, ±10%, 3-phase, 15.5 A/phase, 57-63 Hz N/C
- 002:** 230 V ac, ± 10%, 3-phase, 14 A/phase, 57-63 Hz N/C
- 003:** 460 V ac, ± 10%, 3-phase, 7 A/phase, 57-63 Hz add \$105
- 005:** realignment for 50 Hz operation N/C
- 006:** overvoltage protection crowbar for HP 6453A, 6459A add \$520
- HP 6456B add \$685
- 010:** chassis slides add \$270
- 031:** 380 V ac, ± 10%, 3-phase, 8.5 A/phase, 57-63 Hz add \$158
- 032:** 400 V ac, ± 10%, 3-phase- 8.0 A/phase, 57-63 Hz \$158
- 910:** one extra operating and service manual shipped with each power supply. \$10

HP 6464C-6483C

An ac input option must be specified when ordering.

AC input connections are by means of enclosed 4-wire terminal block

- 001:** 208 V ac, ± 10%, 3-phase, 55 A/phase, 57-63 Hz N/C
- 002:** 230 V ac, ± 10%, 3-phase, 50 A/phase, 57-63 Hz N/C
- 003:** 460 V ac, ± 10%, 3-phase, 25 A/phase, 57-63 Hz add \$270
- 005:** realignment for 50 Hz operation N/C
- 006:** internal overvoltage protection crowbar for HP 6477C, 6479C, 6483C add \$420
- HP 6466C add \$605
- HP 6469C add \$540
- HP 6472C, 6475C add \$490
- 023:** rack mounting attachments for standard 19" rack add \$137
- 031:** 380 V ac, ± 10%, 3-phase, 30 A/phase, 57-63 Hz add \$270
- 032:** 400 V ac, ± 10%, 3-phase, 28.5 A/phase, 57-63 Hz add \$270
- 040:** prepares power supply to be programmed with resistance by an HP 6940B, 6942A, 6944A or 6954A. add \$105
- 910:** one extra operating and service manual shipped with each power supply. add \$15

Accessory

- 14545B:** casters for HP 6464C-6483C—set of four \$103

REMOTE CONTROL												GENERAL		
Resolution		Load Transient Recovery Δ	Resistance Coefficient		Voltage Coefficient†		Up		Down		Net Weight		Options	Price
V	C		Voltage	Current	Voltage	Current	NL	FL	NL	FL	Kg	lb		
8 mV	1 A	100 ms, 500 mV	200 $\Omega/V \pm 2\%$	1 $\Omega/A \pm 2\%$	1 V/V $\pm 1\%$	6.2 mV/A $\pm 7\%$	1.6 s	0.6 s	6 s	0.1 s	235	518	1, 2, 3, 5, 23, 31, 32, 40	\$13900
65 mV	1 A	50 ms, 150 mV	200 $\Omega/V \pm 2\%$	1 Ω/A	0.4 V/V	30 mV/A	1 s	0.5 s	20 s	0.2 s	108	238	1, 2, 3, 5, 6, 10, 31, 32	\$6690
18 mV	0.5 A	100 ms, 500 mV	200 $\Omega/V \pm 2\%$	1.66 $\Omega/A \pm 2\%$	1 V/V $\pm 1\%$	10.3 mV/A $\pm 7\%$	1.6 s	0.6 s	15 s	0.2 s	226	500	1, 2, 3, 5, 6, 23, 31, 32, 40	\$13400
90 mV	0.5 A	50 ms, 300 mV	200 $\Omega/V \pm 2\%$	2 Ω/A	1.66 mV/V	60 mV/A	1 s	0.5 s	60 s	0.5 s	108	238	1, 2, 3, 5, 6, 10, 31, 32	\$6280
36 mV	0.3 A	100 ms, 500 mV	200 $\Omega/V \pm 2\%$	3.33 $\Omega/A \pm 2\%$	1 V/V	20.6 mV/A $\pm 7\%$	1.6 s	3 s	20 s	0.5 s	226	500	1, 2, 3, 5, 6, 23, 31, 32, 40	\$12850
10 mV	12.5 mA	200 ms, 200 mV	200 $\Omega/V \pm 2\%$	12 Ω/A	1 V/V	**	0.3 s	1.2 s	75 s	1.2 s	30.4	67	5, 10, 27, 28	\$2370
100 mV	0.25 A	50 ms, 600 mV	300 $\Omega/V \pm 2\%$	4 Ω/A	94 mV/V	120 mV/A	1 s	0.5 s	45 s	0.7 s	108	238	1, 2, 3, 5, 6, 10, 31, 32	\$6180
64 mV	0.15 mA	100 ms, 750 mV	300 $\Omega/V \pm 2\%$	6.7 $\Omega/A \pm 2\%$	1 V/V $\pm 3\%$	41.2 mV/A $\pm 7\%$	1.4 s	2.5 s	55 s	0.7 s	226	500	1, 2, 3, 5, 6, 23, 31, 32, 40	\$12850
22 mV	0.1 A	100 ms, 1 V	300 $\Omega/V \pm 2\%$	10 $\Omega/A \pm 2\%$	1 V/V $\pm 3\%$	62 mV/A $\pm 7\%$	1.5 s	2 s	80 s	0.7 s	226	500	1, 2, 3, 5, 6, 23, 31, 32	\$12850
30 mV	1.3 mA	200 ms, 600 mV	300 $\Omega/V \pm 2\%$	120 Ω/A	1 V/V	**	0.5 s	2 s	210 s	2 s	14	31	5, 10, 27, 28	\$2060
44 mV	50 mA	100 ms, 2 V	300 $\Omega/V \pm 2\%$	20 $\Omega/V \pm 2\%$	1 V/V $\pm 3\%$	124 mV/A $\pm 7\%$	1.5 s	2 s	95 s	1 s	226	500	1, 2, 3, 5, 6, 23, 31, 32	\$12850
60 mV	35 mA	100 ms, 3 V	300 $\Omega/V \pm 2\%$	28.6 $\Omega/A \pm 2\%$	1 V/V $\pm 3\%$	177 mV/A $\pm 7\%$	1.5 s	2 s	75 s	1.6 s	226	500	1, 2, 3, 5, 6, 23, 31, 32	\$12850
60 mV	25 mA	100 ms, 5 V	300 $\Omega/V \pm 2\%$	40 $\Omega/A \pm 2\%$	1 V/V $\pm 3\%$	0.25 V/A $\pm 7\%$	1.5 s	2 s	120 s	2 s	226	500	1, 2, 3, 5, 6, 23, 31, 32	\$13400
60 mV	0.75 mA	200 ms, 3 V	300 $\Omega/V \pm 2\%$	600 Ω/A	1 V/V	**	0.2 s	1 s	45 s	2 s	27.6	61	5, 10, 27, 28	\$2370

Δ For operation with a 50 Hz input (possible only with Option 005), the rms ripple and transient response specifications are increased by 50%.

**This feature is not available.

*An ac input option must be specified when ordering these 3-phase models.

†Special Option J30 must be ordered with models 6434B-6448B and 6466C-6483C to be programmed with an HP 59501B Power Supply Programmer. Contact your local HP Field Engineer for ordering instructions.

POWER SUPPLIES

Special Purpose: DC Power Supply/Amplifiers

Models 6824A-6827A

- High speed remote programming
- Overload protection
- Wide-band response

- Bipolar voltage
- Current sink or source

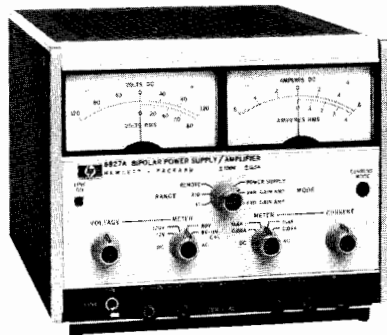

HP 6825A-6827A

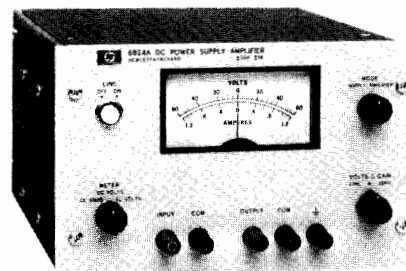

HP 6824A

Description

The Power Supply/Amplifier is a general-purpose instrument useful in any laboratory engaged in research and development of electronic systems, circuitry, or components. The unit can be operated in one of two basic operating modes: power supply or amplifier. Terminals at the rear permit access to various internal control points to further expand the operational capabilities of the instrument. The resulting flexibility lends the Power Supply/Amplifier to an almost unlimited number of applications.

Models 6825A Through 6827A

These models feature dual-range output and constant-voltage/constant-current operation. Output voltage and current as a dc supply, or gain as a power amplifier, are remotely controllable and are compatible with Hewlett-Packard Multiprogrammer Systems.

The unit can furnish a bipolar, constant-voltage or constant-current output. It can be remotely programmed with a resistance, voltage, or current and its high speed programming characteristics adapt it to a wide variety of laboratory and production testing applications. The unit can sink, as well as source, current permitting it to serve as a variable load device.

As a direct-coupled power amplifier, each unit offers a signal-to-noise ratio of approximately 80 dB at full output with low distortion and a frequency response up to 40 kHz in the fixed gain mode.

Model 6824A

Although this model does not provide quite the level of performance and flexibility of Models 6825A through 6827A, it is lower in cost and is suitable for many applications.

As a power supply, this unit offers constant-voltage/current-limiting operation, remote programming, and auto-series, auto-parallel operation.

As a power amplifier, the unit exhibits a high signal-to-noise ratio with a 20 dB gain from dc to 10 kHz. It is useful in servo systems, as a pulse or oscillator amplifier, for motor control, and a variety of other applications.

General Specifications

Temperature: operating, 0 to 55°C; storage, -40 to +75°C.

Power: HP 6824A, standard input voltage is 104-127 V ac, 48-63 Hz. Order Option 028 for 230 V \pm 10% operation. HP 6825A, 6826A, 6827A, switchable, 100, 120, 220, or 240 V ac, -13% +6%, 48-63 Hz, 150 W.

Size: HP 6824A, 131 H x 209 W x 303 mm D (5¹/₂" x 8⁷/₃₂" x 11¹/₁₆"). HP 6825A, 6826A & 6827A, 155 H x 198 W x 316 mm D (6³/₃₂" x 7²⁹/₃₂" x 12⁷/₁₆").

Weight: HP 6824A, 7.7 kg (17 lb); 6825A, 6826A & 6827A, 8.2 kg (18 lb).

Specifications

RATINGS		POWER SUPPLY PERFORMANCE							POWER AMPLIFIER PERFORMANCE						Options	Price
DC Output		HP Model	PARD (rms/p-p)		Transient Recovery		Resolution		Voltage Gain		Frequency Response, +1, -3 dB		Distortion at full output			
Volts	Amperes		Voltage	Current	Time	Level	Voltage	Current	Fixed	Variable	Fixed Gain	Variable Gain	100 Hz	10 kHz		
-5 V to +5 V/ -20 V to +20 V	0-2.0 A Both Ranges	6825A	10/30 mV	5/15 mA	100 μ s	20 mV	40 mV	6 mA	1X 4X	0-2X 0-8X	dc -40 kHz	dc -15 kHz	0.1% THD	0.5%	910	\$2830
-5 V to +5 V/ -50 V to +50 V	0-1.0 A Both Ranges	6826A	6/35 mV	0.8/5 mA	100 μ s	50 mV	100 mV	3 mA	1X 10X	0-2X 0-20X	dc -40 kHz	dc -15 kHz	0.1% THD	0.5%	910	\$2830
-10 V to +10 V/ -100 V to +100 V	0-0.5 A Both Ranges	6827A	10/50 mV	0.4/5 mA	100 μ s	100 mV	200 mV	1.5 mA	2X 20X	0-4X 0-40X	dc -30 kHz	dc -15 kHz	0.1% THD	1%	910	\$2830
-50 V to +50 V	0-1.0 A	6824A	10 mV rms	—	100 μ s	0.02% +5 mV	—	—	—	0-10X	—	dc -10 kHz	0.1% THD	—	910	\$1880

Options Descriptions

028: 230 V ac \pm 10%, single phase input (HP 6824A)

910: one additional manual shipped with each power supply

HP 6824A,
HP 6825A, 6826A, 6827A

Prices

N/C

add \$5.35

add \$15

Accessories

HP 5060-8762: adapter frame for rack mounting one or two HP 6825A-6827A units

\$150

HP 5060-8760: blank filler panel to be used with above units

\$44

HP 14515A: rack mounting kit for one HP 6824A

\$85

HP 14525A: rack mounting kit for two HP 6824As

\$41

POWER SUPPLIES

Laboratory: Single & Multiple Output, 10W to 38W
Models 6200C-6218C and 6234A-6237B

483

- HP 6212C-6218C . . . 10 watts output
- Compact, impact-resistant stackable case
- Short-circuit proof

- HP 6200B-6209B . . . 30 watts output
- Auto series, parallel, and tracking
- Remote sensing

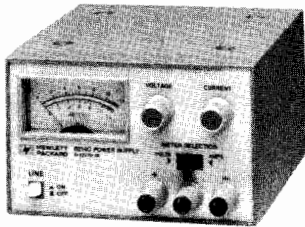

Single Output: HP 6212C-6218C

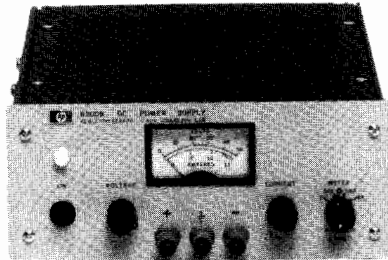

Single Output: HP 6200B-6209B

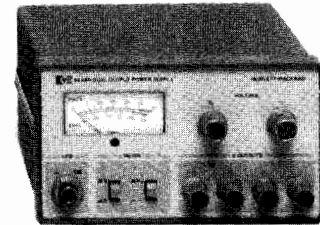

Dual Output: HP 6234A

Description—Single Output Models

Models 6212C-6218C

These popular low-cost CV/CC bench supplies are designed for general laboratory use and are equipped with front-panel mounted voltage and current controls, a combination volt/ammeter, and output binding posts. Output voltage and current are continuously variable, via multiple-turn controls from 0 to 15% above the maximum rated output. A switch selects either output voltage or current for display on the panel meter.

Load connections are made via three binding posts. Either the + or the - post may be grounded through an adjacent GND terminal or the supply may be operated floating at up to 300 volts above ground.

The supplies can also be operated as constant current sources with 500 μ A load regulation. All of these models can be connected in series or parallel.

The molded, impact-resistant case includes an interlocking feature for stacking several units vertically, thus minimizing bench space required for multiple supplies. Alternatively, up to three units can be mounted side by side in a 19" rack using Rack Mounting Kit HP 14521B. These supplies measure 86 H x 133 W x 368 mm D (3.40" x 5.25" x 8") and weigh 2 kg (4.4 lb).

Models 6200B-6209B

This series of low-cost bench supplies includes three models covering an output voltage range from 0–20 V to 0–320 V. All models are equipped with ten-turn voltage and current controls, (except the HP 6206B, which does not have a current control), volt/ampere meter, meter function/range switch, and front and rear output terminals. In addition, on the dual-range models (HP 6200B and 6206B), an output range switch permits the selection of either a high or a low output voltage range.

The constant voltage/current limiting supply, HP 6206B, is short-circuit protected by a fixed current limiting circuit which is activated at approximately 110% of rated load current. The current-limit point can be reduced by changing the value of a single internal resistor. For the constant voltage/constant current supplies, ten-turn current controls allow the current-limit point to be set to any value within the current rating. Using these controls the CV/CC supplies can also be operated as constant-current sources.

Units may be bench operated or rack mounted individually or in pairs using accessory rack mounting hardware.

All models in this group of supplies measure 89 H x 216 W x 317 mm D (3.50" x 8.50" x 12.50") and weigh 4.5 kg (10 lb).

Description—Dual Output Models

Model 6234A

Model 6234A is a low-cost, dual-output bench power supply with two independently adjustable and isolated power sources in one compact unit. Both of the dc power sources are of the constant voltage/current limit type with each output voltage being adjustable continuously over a 0 to 25 V range. The maximum current available per output is 0.2 A and is limited automatically to prevent overload.

The HP 6234A offers considerable flexibility to the user with output voltages that can be arranged to provide identical or different voltages in any polarity combination with respect to 0 or other common positive or negative voltage points. The outputs can also be connected in series to provide up to 50 V at 0.2 A. Both sources are fully isolated to permit either of the output terminals to be grounded.

With pushbutton switches, users can select either voltage or current for each output to be monitored on the unit's meter. Other features include two multiple-turn controls for precise voltage setting, regulation to 0.01%, and ripple and noise of less than 200 microvolts rms.

With dimensions of only 93 mm high, 157 mm wide and 210 mm deep (3.64" x 6.17" x 8.25"), the HP 6234A supply takes up a minimum amount of bench space. Its weight is 2.3 kg (5 lb). The unit can be powered from a 115 V or an optional 230 V, 47-63 Hz ac input, (Option 028).

Model 6205C

This low-cost bench supply is equipped with ten-turn output voltage controls, volt/ampere meter, meter function/ range switch, and front and rear output terminals. In addition, an output range switch permits the selection of either a high or a low output voltage range.

Model 6205C combines the versatility of a dual power supply with the flexibility of auto-parallel and auto-series operation to extend the output ratings of this supply to 20 V/1.2 A, 40 V/0.6 A, and 80 V/0.3 A. In addition, using the supply's auto-tracking capability, opposite

POWER SUPPLIES

Laboratory: Single & Multiple Output, 10W to 38W (cont'd)

Models 6200B-6218C and 6234A-6237B

- Dual output to 24 watts
- Short-circuit proof
- Independent voltage controls

- Triple output to 38 watts
- Short circuit proof
- Tracking ± 20 volt outputs

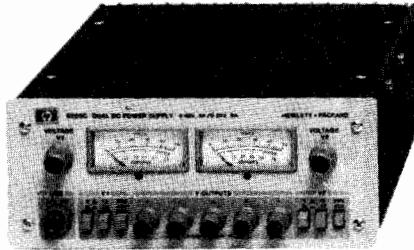

Dual Output: HP 6205C

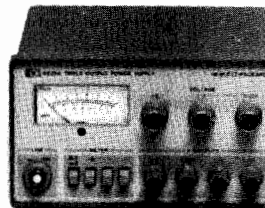

Triple Output: HP 6235A

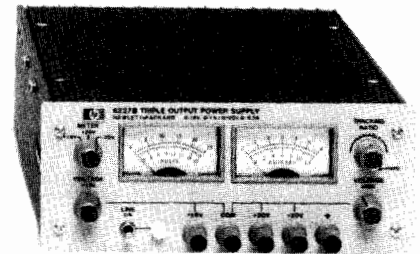

Triple Output: HP 6236B, 6237B

polarity voltages (± 20 V, ± 40 V) can conveniently be obtained from this one supply.

This constant voltage/current limiting supply is short-circuit protected by a fixed current limiting circuit which is activated at approximately 110% of rated load current. The current-limit point can be reduced by changing the value of a single internal resistor. Units may be bench operated or rack mounted individually or in pairs using accessory rack mounting hardware.

Description—Triple Output Models

HP 6235A

This compact, low-cost, three-in-one power supply is a handy addition to the lab bench where single or multiple voltages are needed for designing and testing breadboards and prototypes. The HP 6235A delivers three adjustable dc output voltages: 0 to +6 V at 1 A, 0 to +18 V at 0.2 A, and 0 to -18 V at 0.2 A. A single 0 to 36 volt output at 0.2 A can also be obtained by connecting across the +18 V and -18 V terminals.

The controls, meter, and binding posts are conveniently arranged on the front panel. One voltage control simultaneously adjusts the +18 V and -18 V outputs, which track one another and can be used to power operational amplifiers and other circuits requiring balanced positive and negative voltages. The supply's dual outputs have added versatility with an adjustable tracking ratio control (TRACK) that can set the negative output to a lower voltage than the positive output. Once the tracking ratio control has established a voltage ratio between the positive and negative outputs, the ratio remains constant as the +18 V voltage control is adjusted. A third control sets the 0 to +6 V output voltage.

The supply is a constant voltage/current limit type with each output voltage continuously adjustable over its range, while the maximum current available is automatically limited to prevent overloading. The power supply's outputs share a common terminal and are isolated from chassis ground so that any output terminal can be grounded if desired. Each output voltage or current can be quickly selected and monitored with the push-button meter switches.

Model 6235A measures 89 H x 157 W x 210 mm D (3.5" x 6.17" x 8.25") and weighs 2.3 kg (5 lb).

HP 6236B and 6237B

Microprocessors, digital and linear integrated circuits, and displays used in lab development frequently require triple output power supplies for operating prototypes. The HP 6236B and 6237B are valued additions to the design bench due to their multiple output voltages, small size, ease of operation and application-related performance.

These compact constant voltage/current limiting supplies combine 0 to ± 20 V tracking outputs rated at 0.5 A with a single output rated at 0 to +6 volts at up to 2.5 A in the HP 6236B, and 0 to +18 volts at 1 A in the HP 6237B.

Controls, meters, and binding posts are logically arranged on a neatly laid out front panel. One voltage control simultaneously adjusts the 20 V and -20 V outputs, which track within 1% to power operational amplifiers and circuits requiring balanced voltages. A tracking ratio control can disable the 1:1 tracking feature and set the negative output to a lower voltage than that of the positive output. Once the tracking ratio control has established a voltage ratio between the positive and negative outputs, the ratio remains constant as the ± 20 V voltage control varies both outputs. Another voltage control sets the 0 to +6 V (HP 6236B) or 0 to +18 V (HP 6237B) output.

All outputs are protected against overload and short-circuit damage by fixed current limiting circuits. For any overload condition, the +20 V and -20 V outputs in both models are limited to 0.55 A and the +18 V output in the HP 6237B is limited to 1.1 A. The overload protection circuit for the +6 V output in the HP 6236B has a current foldback characteristic that reduces the maximum available current from about 2.75 A at a 6 V terminal voltage to 1 A at zero volts (or short circuited). This foldback limiting characteristic maximizes the available current in the important 5 to 6-volt range while minimizing dissipation during overloads.

Another protective feature safeguards sensitive load circuitry by preventing an output voltage overshoot when the supply is turned on or off.

Separate dual-range panel meters allow both the voltage and current of any output to be monitored simultaneously. A three-position switch selects the output which the meters will monitor.

Both models measure only 89 H x 216 W x 319 mm D (3.5" x 8.5" x 12.5") and weigh 4.3 kg (9.5 lb).

Specifications

RATINGS		PERFORMANCE							GENERAL	
DC Output		HP Model	Load Effect	Source Effect	PAR D rms/p-p	Control Mode and Resolution	Remote Control Coefficients	Power 115 V ac ± 10%	Options	Price
Volts	Amps									
SINGLE OUTPUT—10 WATTS										
0-10	0-1	6214C	4 mV	4 mV	200 μV/1 mV	CV/CC 5mV/75μA	**	48-440 Hz 0.3 A, 28 W	28	\$380
0-25	0-0.4	6216C	4 mV	4 mV	200 μV/1 mV	CV/CC 5mV/20μA	**	48-440 Hz 0.3 A, 28 W	28	\$380
0-50	0-0.2	6218C	4 mV	4 mV	200 μV/1 mV	CV/CC 10mV/10μA	**	48-440 Hz 0.3 A, 28 W	28	\$380
0-100	0-0.1	6212C	8 mV	4 mV	200 μV/1 mV	CV/CC 20mV/10μA	**	48-440 Hz 0.3 A, 28 W	28	\$450
SINGLE OUTPUT—UP TO 30 WATTS										
Dual range 0-20 or 0-40	0-1.5 0-0.75	6200B	0.01% + 4 mV	0.01% + 4 mV	200 μV/1 mV	CV/CC 10 mV/2 mA	2000/V ± 1% 0.5 kΩ/A ± 10% or 1 kΩ/A ± 10%	48-440 Hz 0.9 A, 70 W	11, 28	\$950
Dual range 0-30 or 0-60	0-1 0-0.5	6206B	0.01% + 4 mV	0.01% + 4 mV	200 μV/1 mV	CV/CL 10 mV/*	3000/V ± 1%	48-440 Hz 1 A, 66 W	11, 28	\$950
0-320	0-0.1	6209B	0.02% + 2 mV	0.02% + 2 mV	1 mV/40 mV	CV/CC 40 mV/200 μA	3000/V ± 1% 150 kΩ/A ± 10%	48-63 Hz 1 A, 60 W	28	\$1055
DUAL OUTPUT—10 WATTS										
Dual output 0-25 and 0-25	0.2 0.2	6234A	0.01% + 1 mV	0.01% + 1 mV	200 μV/1 mV	CV/CL	**	104-127 Vac 47-63 Hz 0.26A, 35 W	28	\$570
DUAL OUTPUT—24 WATTS										
Two dual ranges 0-20/0-40 and 0-20/0-40	0-0.6/0.3 0-0.6/0.3	6205C	0.01% + 4 mV	0.01% + 4 mV	200 μV/1 mV	CV/CL 10 mV/*	2000/V ± 1%	48-440 Hz 0.5 A, 50 W	11, 28 40	\$950
TRIPLE OUTPUT—13 WATTS										
Triple output 0 to 6 and 0 to 18 and 0 to -18	0-1 0-0.2 0-0.2	6235A	8 mV 10 mV 10 mV	8 mV 15 mV 15 mV	1 mV/5 mV 1 mV/5 mV 1 mV/5 mV	CV/CL	** ** **	47-63 Hz 0.26 A, 35 W	28	\$620
TRIPLE OUTPUT—35 WATTS*										
Triple output 0 to +6 and 0 to +20 and 0 to -20	2.5 0.5 0.5	6236B	0.01% + 2 mV	0.01% + 2 mV	350 μV/1.5 mV	CV/CL 70 mV/*	**	104-127 Vac 47-63 Hz 1.2 A, 112 W	100 120 220 240	\$800
TRIPLE OUTPUT—38 WATTS*										
Triple Output 0 to +18 and 0 to +20 and 0 to -20	1 0.5 0.5	6237B	0.01% + 2 mV	0.01% + 2 mV	350 μV/1.5 mV	CV/CL 70 mV/*	**	104-127 Vac 47-63 Hz 1.2 A, 112 W	100 120 220 240	\$800

*fixed current limit
 **remote control not available
 *ac input voltage option must be specified when ordering

Option Descriptions

011: internal overvoltage protection crowbar. Protects delicate loads against power supply failure or operator error. Dual output model has dual crowbar.

HP 6200B, 6206B
 HP 6205C

add \$105
 add \$210
 NC

028: 230 Vac ± 10%, single phase input. Consists of reconnecting power transformer taps, and other components where necessary.

040: Multiprogrammer interface. Prepares HP 6205C power supplies for resistance programming by the HP 6940B or 6942A Multiprogrammer

add \$80

100: 87-106 Vac, 47-63 Hz, single phase input

NC

120: 104-127 Vac, 47-63 Hz, single phase input

NC

220: 191-233 Vac, 47-63 Hz, single phase input

NC

240: 208-250 Vac, 47-63 Hz, single phase input

NC

910: one additional operating and service manual is shipped with each power supply
 HP 6200B-6237B

add \$5.35

Accessories

HP 14513A: rack kit for one HP 6200-6209B, 6236B, or 6237B supply

\$57

HP 14523A: rack kit for two of the above power supplies

\$31

HP 14521C: rack kit for one, two or three HP 6212C-6218C power supplies

\$87

☎ Fast-Ship product — see page 734.

POWER SUPPLIES

Special Purpose; Precision Voltage Sources

Models 6114A and 6115A

- 0.025% output voltage accuracy
- Pushbutton voltage control
- Five minute warm-up



HP 6114A & 6115A

Description

HP Models 6114A and 6115A

These 40-watt precision power supplies are high-accuracy instruments designed for use as low-cost calibrators, working voltage standards, systems reference supplies, or high-performance lab supplies. They are ideal for applications where an accurate, highly stable, and easy-to-use source of dc voltage is required.

Output Ratings

Both models feature automatic dual-range operation. For example, the HP 6114A can supply 0-20V at 0-2A, and 20-40V at 0-1A, without manual range switching. Automatic output current range cross-over occurs when the supply is providing greater than one-half of the maximum rated output voltage.

Output Voltage Controls

Pushbutton voltage controls allow the output voltage to be set rapidly and accurately. The setting is displayed in large, easy-to-read numerals. A four-digit pushbutton switch increases or decreases the output voltage in unit steps, and the switches go directly from "9" to "0" without backing down. A fifth digit, set via a separate front-panel control, provides output voltage resolution of 200 μ V.

The output voltage accuracy is 0.025% (250 ppm) plus 1 mV — for example, at 40 volts output, the output voltage of Model 6114A is accurate within ± 11 mV. This accuracy is attained after only five minutes' warmup, thus making these supplies especially suitable as portable calibrators.

Output Current Controls

A front-panel current control allows the maximum output current of these supplies to be set to any desired value within the maximum rating. Using this control, the supplies can be operated as constant-current sources with 0.01% current regulation. A current mode indicator (a light-emitting diode) immediately lights when the supply is operated in the gross current limit region or when the output current level established by the setting of the front-panel control is reached. When the indicator is lighted, the output voltage is uncalibrated, but the front panel voltmeter continues to indicate the output voltage with an accuracy of 2%. A ten-turn current control with a three-digit graduated dial provides 2 mA current resolution.

Remote Programming

Models 6114A and 6115A are designed to be programmed with either the HP Multiprogrammer or the HP-IB Isolated D/A Power Supply Programmer. Interfacing for Multiprogrammer operation is included as a standard feature in these models; therefore, the addition of Option 040 is not required. See pages 473, 610 and 45.28 for additional information on digital programming interfaces for power supplies. Both supplies can also be remote programmed by means of an external voltage or resistance. However, most specifications will change to those of the programming source.

The output capacitor can be disconnected to reduce current surges, thereby improving the performance of the supply as a constant-current source; this also increases the programming speed by approximately an order of magnitude. Note, however, that some capacitance

- May be used with HP-IB Power Supply Programmer
- Overvoltage and overcurrent indicators
- Built-in overvoltage crowbar

at the load may be required to maintain power supply stability under all loading conditions when the output capacitor is disconnected.

Overvoltage Protection

A built-in overvoltage protection circuit (an SCR crowbar) monitors the output and reduces the output voltage and current to zero whenever a preset voltage limit (adjustable from the front panel) is exceeded. This feature provides a convenient method of limiting the maximum output voltage supplied to voltage-sensitive loads.

Specifications

DC Output: voltage and current output can be adjusted over the range indicated by front-panel controls or analog programming.

HP 6114A: 0-20 volts, 0-2 amperes
20-40 volts, 0-1 amperes

HP 6115A: 0- 50 volts, 0-0.8 amperes
50-100 volts, 0-0.4 amperes

Both models feature automatic dual-range operation, which eliminates manual range switching.

Load effect: constant-voltage deviation, 0.0005% + 100 μ V. constant-current deviation, 0.01% + 500 μ A.

Source effect: over the rated input voltage range: constant-voltage, 0.0005% + 100 μ V; constant-current, 0.005% + 40 μ A.

Ripple and noise (PARD): rms/p-p, 20 Hz to 20 MHz; CV 40 μ V/200 μ V, CC 200 μ A/1 mA.

Temperature coefficient: CV, 0.0001% + 15 μ V/ $^{\circ}$ C; CC, 0.02% + 50 μ A/ $^{\circ}$ C.

Drift: CV, 0.0015% + 15 μ V per 8 hours, 0.0075% + 30 μ V per 90 days.

Output voltage accuracy: output voltage accuracy obtained from front-panel controls at $23 \pm 3^{\circ}$ C at any ac line voltage and load current within rating and following a five-minute warm-up: 0.025% + 1.0 mV.

Resolution: front-panel voltage control, 200 μ V; front-panel current control, 2 mA.

Output impedance: typical value is approximated by 0.05 m Ω in series with 3 mH.

Load transient recovery time: less than 50 μ S is required for output voltage (constant voltage operation) to recover within 50 mV of the nominal output level following a change in output current equal to the current rating of the supply.

Remote programming speed: up programming of voltage at full load: HP 6114A, 1.75s; HP 6115A, 4.5s. Down programming, no load: HP 6114A, 350 ms; HP 6115A, 500 ms.

Overvoltage protection crowbar: adjustable front-panel screwdriver control from 0.5 to 45 volts on the HP 6114A and 0.5 to 110 volts on the HP 6115A.

Power: 104-127 or 208-254 Vac (switchable), 48-440Hz, 150 VA max.

Temperature rating: operating, 0 to 50 $^{\circ}$ C; storage, -40 to +75 $^{\circ}$ C.

Size: 197 mm W x 165 mm H x 337mm D (7.75" x 6.5" x 13.25")

Weight: 7.7 kg (17 lb) net. 9.5 kg (21 lb) shipping.

Accessories

5060-8762: adapter frame for rack mounting one or two 1/2 rack width units. This frame applies to HP 6114A, 6115A

5060-8760: blank filler panel. This 1/2 rack width panel applies to HP 6114A, 6115A

Ordering Information

HP 6114A Precision Power Supply \$2060

HP 6115A Precision Power Supply \$2060

Opt 910 Extra Operating and Service Manual \$10

POWER SUPPLIES

Special Purpose: Precision Constant Current Sources

Models 6177C, 6181C & 6186C

487

- Continuously variable voltage limit
- Output useful to micro-ampere region

- High output impedance—no output capacitor



HP 6177C, 6181C

HP 6186C

voltage to vary from zero to maximum.

Source effect (line regulation): less than 25 ppm of output + 5 ppm of range switch setting for any change in the line voltage between 104 and 127 V ac at any output current and voltage within rating.

Load effect transient recovery: less than 800 μ s for recovery to within 1% of nominal output current following a full load change in output voltage. (On HP 6186C, recovery time for 100 mA/10 mA/1 mA ranges is 1 ms/1.6 ms/4 ms, respectively.)

Temperature coefficient: output change per degree C is less than 75 ppm of output current + 5 ppm of range switch setting.

Drift (stability): less than 100 ppm of output current + 25 ppm of range switch setting. Stability is measured for eight hours after one hour warm-up under conditions of constant line, load, temperature, and output setting.

Resolution: 0.03% of range switch setting.

Temperature rating: operating 0, to 55°C; storage, -40 to +75°C.

Description

These solid-state constant-current sources are ideal for semiconductor circuit development, component testing, and precision electroplating applications.

Their high-speed remote programming characteristics make these supplies useful in testing and sorting semiconductors, resistors, relays, meters, etc. The ability to superimpose ac modulation on the dc output permits the supplies to be used for measurement of dynamic or incremental impedance of circuit components. When remotely programmed, accuracy, stability and some other specifications change to those of the programming source. The output current is continuously variable with the ten-turn front panel control.

Accessories

Accessories	Price
HP 5060-8764: rack adapter for rack mounting one or two HP 6177C or 6181C supplies	\$150
HP 5060-8762: rack adapter for rack mounting one or two HP 6186C supplies	\$150
HP 5060-8530: filler panel for HP 6177C, 6181C	\$80
HP 5060-8760: filler panel for HP 6186C	\$44

Options

028: 230 Vac \pm 10%, single-phase input.	N/C
910: one additional operating and service manual	add \$7.88

Specifications

Load effect (load regulation): less than 25 ppm of output + 5 ppm of range switch setting for a load change which causes the output

Ordering Information

HP 6177C, 6181C Constant Current Source	\$1855
HP 6186C Constant Current Source	\$2780

Model		HP 6177C	HP 6181C	HP 6186C	
Output Current ††		0-500 mA	0-250 mA	0-100 mA	
Voltage Compliance Δ		0-50 V dc	0-100 V dc	0-300 V dc	
Output Ranges		A 0-5 mA	0-2.5 mA	0-1 mA	
		B 0-50 mA	0-25 mA	0-10 mA	
		C 0-500 mA	0-250 mA	0-100 mA	
AC Input		115V ac \pm 10%, 48-63 Hz; 0.6 A, 55 W at 115 V ac For 230 V ac see Option 028	115 V ac \pm 10%, 48-63 Hz; 0.6 A, 55 W at 115 V ac For 230 V ac see Option 028	115/230 V ac, 48-63 Hz; 0.9 A, 90 W at 115 V ac 115/230 V ac switch	
Constant Current	Voltage Control (accuracy: 0.5% of output current + 0.4% of range)	Range A 200 mV/mA	1 V/mA	10 V/mA	
		Range B 20 mV/mA	100 mV/mA	1 V/mA	
		Range C 2 mV/mA	10 mV/mA	100 mV/mA	
Remote Programming	Resistance Control (accuracy: 1% of output current + 0.04% of range)	Range A 400 ohms/mA	2 k Ω /mA	10 k Ω /mA	
		Range B 40 ohms/mA	200 ohms/mA	1 k Ω /mA	
		Range C 4 ohms/mA	20 ohms/mA	100 Ω /mA	
Voltage Limit Remote Programming	Voltage Control (Accuracy: 20%)	1 V/V	1 V/V	1 V/V	
		Resistance Control	870 ohms/V	435 ohms/V	820 ohms/V
		Accuracy	25%	25%	15%
Typical Output Impedance (R in parallel with C)*		Range A R = 330 Meg, C = 500 pF	R = 1330 Meg, C = 10 pF	R = 10,000 Meg, C = 900 pF	
		Range B R = 33 Meg, C = 0.005 μ F	R = 133 Meg, C = 100 pF	R = 1,000 Meg, C = 700 pF	
		Range C R = 3.3 Meg, C = 0.05 μ F	R = 13.3 Meg, C = 1000 pF	R = 100 Meg, C = 1500 pF	
PARD (Ripple and Noise): rms/p-p (20 Hz to 20 MHz) with either output terminal grounded		Range A 1.6 μ A rms/40 μ A p-p	0.8 μ A rms/20 μ A p-p	0.2 μ A rms/5 μ A p-p	
		Range B 16 μ A rms/200 μ A p-p	8 μ A rms/100 μ A p-p	2 μ A rms/50 μ A p-p	
		Range C 160 μ A rms/1 mA p-p	80 μ A rms/500 μ A p-p	20 μ A rms/500 μ A p-p	
Programming Speed: from 0 to 99% of range switch setting with a resistive load ** (Output Current Modulation)		6 ms	6 ms	10 ms	
Dimensions:		7.75" (W) x 3.44" (H) x 12.38" (D) 197 mm (W) x 88 mm (H) x 315 mm (D)	7.75" (W) x 3.44" (H) x 12.38" (D) 197 mm (W) x 88 mm (H) x 315 mm (D)	7.75" (W) x 3.44" (H) x 12.38" (D) 197 mm (W) x 158 mm (H) x 315 mm (D)	
Weight: (Net/Shipping)		4.53 kg (10 lb)/5.9 kg (13 lb)	4.53 kg (10 lb)/5.9 kg (13 lb)	5.9 kg (13 lb)/7.7 kg (17 lb)	

* This network is a simplified representation of a complex network. The formula $Z = RX_c \sqrt{R^2 + X_c^2}$ is used for frequencies up to 1 MHz by substituting the values given for R and C. Above 1 MHz, the output impedance is greater than the formula would indicate.

** Output current can be modulated 100% up to 50 Hz; percent modulation decreases

linearly to 10% at 500 Hz.

†† For operation above 40°C the maximum output current must be reduced linearly to 80% of rating at 55°C (maximum temperature).

Δ Minimum voltage obtainable with voltage limit control is 0.5 V.

FREQUENCY & TIME STANDARDS

General Information

Hewlett-Packard offers frequency standards and clocks which provide accurate frequency, time interval and timekeeping capabilities. Further, Hewlett-Packard standards provide means for comparing these quantities against national standards such as the National Institute of Standards and Technology (NIST) and the U.S. Naval Observatory. Units of frequency or time cannot be kept in a vault for ready reference. They must be generated for each use, hence be regularly compared against recognized primary standards.

Frequency standards and clock systems manufactured by Hewlett-Packard are used for control and calibration at observatories, national centers for measurement standards, physical research laboratories, missile and satellite tracking stations, communication systems, radio navigation systems, manufacturing plants and radio monitoring and transmitting stations.

Types of Frequency Standards

At the present time, three types of frequency standards are in common use. These are:

1. The cesium atomic beam controlled oscillator.
2. The rubidium gas cell controlled oscillator, and
3. The quartz crystal oscillator.

Hewlett-Packard manufactures all three types of frequency standards. Of these three standards, the first is a primary frequency standard and the last two are secondary frequency standards. The distinction between a primary standard and a secondary standard is that the primary standard does not require any other reference for calibration; whereas the secondary standard requires calibrations both during manufacturing and at intervals during use depending on the accuracy desired.

Cesium Beam Frequency Standard

Cesium beam standards are in use wherever the goal is a very high accuracy primary frequency standard. In fact, the NIST frequency standard itself is of the cesium beam type. The cesium beam standard is an atomic resonance device which provides access to one of nature's invariant frequencies in accord with the principles of quantum mechanics. The cesium standard is a true primary standard and requires no other reference for calibration.

Rubidium Frequency Standard

Rubidium frequency standards feature a high order of both short-term and long-term frequency stability. These are both important in certain fields such as deep-space communications, satellite ranging, and doppler radar.

Rubidium standards are similar to cesium beam standards in that an atomic resonant element prevents drift of a quartz oscillator through a frequency lock-loop. Yet the rubidium gas cell is dependent upon gas mixture and gas pressure in the cell. It must be calibrated and then it is subject to a small degree of drift. The drift is typically 100 times less than the best quartz crystal standard.

TABLE 1 Comparison of Frequency Standards

Standard	Principal construction feature	Principal advantage
Cesium Atomic Beam Resonator Controlled Oscillator.	Beam of free cesium atoms, spatially state selected, is subjected to a microwave signal at resonance frequency.	High intrinsic reproducibility and long-term stability. Designated as primary standard for definition of time interval.
Rubidium Gas Cell Resonator Controlled Oscillator.	Gas buffered resonance cell with optically pumped state selection.	Compact and light weight. High degree of short-term stability.
Quartz Crystal Oscillator.	Piezoelectrically active quartz crystal with electronic stabilization.	Very compact, light and rugged. Inexpensive.

Quartz Crystal Oscillators

Quartz oscillators are used in virtually every frequency control application including atomic standards. The excellent short-term stability and spectral purity of the quartz oscillators used in Hewlett-Packard atomic standards contribute to the high quality of the output signal of these standards. For less demanding applications where some long-term drift can be tolerated, quartz oscillators are used as independent frequency sources.

Frequency Standards and Clocks

Frequency standards and clocks have no fundamental differences—they are based upon dual aspects of the same phenomenon. Time and frequency are intangible quantities which can be measured only with respect to some physical quantity. The basic unit of time, the second, is defined as the duration of 9,192,631,770 periods of transition within the cesium atom. Conversely an unknown frequency is determined by counting the number of cycles over the period of a second. The Master Clock at the U.S. Naval Observatory, one of the world's most accurate clocks, is made of an ensemble of more than a dozen Hewlett-Packard cesium beam frequency standards. The USNO directly controls the distribution of precise time and time interval (frequency) from Naval radio stations, Loran-C (operated by U.S. Coast Guard), Omega and Satellite Navigation Systems. Hewlett-Packard portable cesium standards, "flying clocks," are used to periodically check the synchronization between these stations and the Master Clock.

Hewlett-Packard cesium beam standards are widely used to drive precision clocks because of the extremely good long-term stability and reliability of this primary standard. If a quartz oscillator or other secondary standard is used, it must be evaluated for rate of drift and be corrected periodically.

Time Scale

The time interval of the atomic time scale is the International Second, defined in October 1967 by the Thirteenth General Conference of Weights and Measures. Since January 1972 the frequency offset between UTC and Atomic Time has been zero and the UTC time scale is kept in synchronism with the rotation of the earth to within ± 0.9 second by step-time adjustments of exactly 1 second, when needed (see Hewlett-Packard Application Note 52-2).

The U.S. National Institute of Standards and Technology (NIST) and USNO provide the official basis for Standard Time for the United States. The UTC signal is broadcast from the NBS stations WWV and WWVB and by several other stations throughout the world. (See Hewlett-Packard Application Note 52-1, Fundamentals of Time and Frequency Standards, for a list of stations broadcasting time signals).

Standby Power Supplies

Minimum down-time, important for any system, is vital to a time standard. Its worth depends directly on continuity of operation. Noninterrupted operation is also important to ultra-precise quartz oscillators.

Hewlett-Packard standby power supplies ensure continued operation despite line interruptions, and operate over a range of ac line voltage to supply regulated dc to operate frequency standards and frequency dividers and clocks. The batteries in the supplies assume the full load immediately when ac power fails.

Hewlett-Packard Time and Frequency Standard

The Hewlett-Packard House Standard at the Santa Clara Division consists of an ensemble of five Hewlett-Packard Cesium Beam Standards each with the Option 004 High Performance Tube.

The standard is compared to the U.S. Naval Observatory Master Clock in Washington, D.C. by means of the Global Positioning (GPS) navigation system. It is also compared with the U.S. National Institute of Standards and Technology Frequency Standard (NIST FS) at Boulder, Colorado by means of GPS through the Naval Observatory. The frequency uncertainty of the standard is within a few parts in 10^{13} with respect to the standards maintained by the NIST and the USNO.

Time is maintained relative to the Naval Observatory and the National Institute of Standards and Technology master clocks to an accuracy of better than ± 1.0 microseconds. This accuracy is verified with flying clock trips from the Naval Observatory to both Hewlett-Packard Santa Clara Division and Hewlett-Packard Geneva. Both locations have been designated U.S. Naval Observatory Time Reference Stations.

FREQUENCY & TIME STANDARDS

Primary Standards

Models 5061B

489

- HP 5061B
- Improved accuracy $\pm 3 \times 10^{-12}$
- Primary standard
- Proven reliability

- HP 5061B, Opt 004
- Accuracy $\pm 2 \times 10^{-12}$
- Settability $\pm 1 \times 10^{-13}$
- Time domain stability 5×10^{-12} (1 s avg)

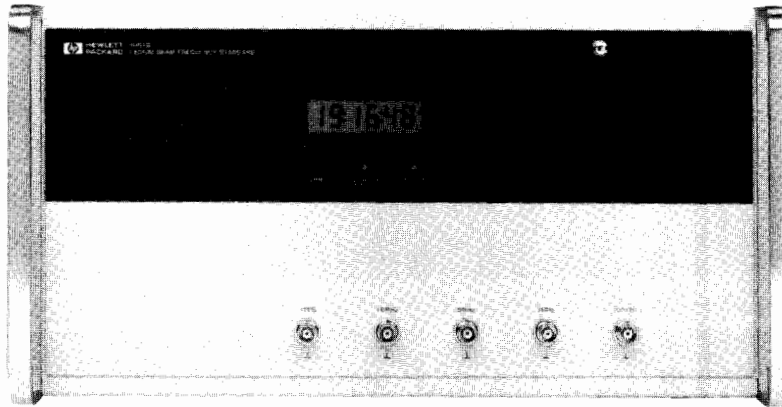

HP 5061B

HP 5061B Cesium Beam Standard

The first Hewlett-Packard Cesium Beam Standard, the HP 5060A, was introduced in 1964. This was followed in 1967 with the improved HP 5061A, in 1973 with the high performance beam tube option for the HP 5061A and in 1986 with the 5061B. Since this time the accuracy and reliability of Hewlett-Packard cesium beam standards continues to be demonstrated and these standards have become the world-wide standard for frequency and time keeping. The HP 5061B has provision for an optional digital divider and reliable, easy-to-read LCD clock (Option 003) and for a battery with $\frac{3}{4}$ hour standby power capacity with automatic charging.

Reliability and warranty: over 100 million operation hours have proven the performance and reliability of Hewlett-Packard cesium beam standards in various world-wide applications. The units have provided dependable microsecond accuracy in aircraft, ship and fixed environments.

A five-year warranty on the HP 5061B standard cesium beam tube is provided as a result of proven field reliability. This warranty includes replacement of the cesium beam tube if it should fail within the warranty period.

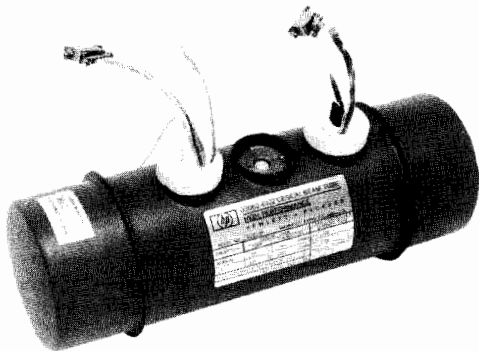

Option 004, High Performance Cesium Beam Tube with three-year warranty

HP 5061B with Opt 004, High Performance Cesium Beam Tube

The Hewlett-Packard 5061B primary frequency standard with the Option 004 Cesium Beam Tube offers increased stability and accuracy in the instrument which has become the worldwide standard of frequency and time keeping since its introduction in 1967. Improvements in magnetic shielding, ruggedization and environmental performance permit improved performance and expansion of navigation and communication systems.

The design concept of the high-performance beam tube includes unique HP designed dual-beam optics with higher beam intensity to accomplish better short-term stability and greater immunity to effects of shock and vibration. A 50 percent increase in resonance cavity length without change in the overall beam tube size contributes to better accuracy and settability because of the high Q of the narrower resonant line width. This tube retains the unique cesium standard feature of virtually no long term instability or aging.

The intrinsic accuracy is improved to $\pm 2 \times 10^{-12}$ which provides an excellent reference standard without need of calibration. If desired, as in many timekeeping applications, two or more units may be calibrated to determine the difference in rate or may be adjusted to the same frequency. With the improved settability specifications of 1×10^{-13} small changes in frequency are accomplished rapidly and accurately. A provision for degaussing the tube without adversely affecting the instrument operation allows removal of any residual magnetic field in the tube. This is important in achieving the settability performance.

The short term stability specification is improved by a factor of ten with this tube. The 5×10^{-12} (1 s avg.) performance compares very favorably with that of rubidium type standards which are noted for their excellent short term stability. An important advantage from the better short term stability is the capability to make measurements to 1 sigma precision of 1×10^{-12} in about one minute compared to the two hours required previously. The HP 5061B with the Option 004 High Performance Tube has the same high reliability as the HP 5061B with the standard tube. The new high performance tube is warranted for three years, but is designed to have the same long life as the standard tube.*

HP E21-5061B Flying Clock

The HP E21-5061B consists of a HP 5061B Cesium Beam Standard with Option 003 LCD Clock and Special Option E21, all fastened to an HP 5089A Standby to form a portable unit. The power supply, which can be operated from 11 to 30 V dc, 85 to 255 V ac, will provide approximately 10 hours standby power (from sealed immobilized electrolyte lead calcium batteries) for the HP 5061B Cesium Beam Standard.

This wide range of operating power capabilities enable the HP E21-5061B to operate on local power in virtually any country in the world. The 10 hours standby capability makes it possible to travel where there is no power available and, of course, allows the HP E21-5061B to conveniently be transported between power sources and operated in almost any air or surface vehicle as a "flying clock" (see Hewlett-Packard Journal, August 1966 and December 1967).

The Option 004 tube, because of the improved shielding, offers a significant increase in accuracy under the varying earth's magnetic field conditions experienced by flying clocks and is a desirable addition to the HP E21-5061B. In addition, the better short term stability permits more accurate and rapid comparison of standards.

*See page 492 for ordering information.

FREQUENCY & TIME STANDARDS

Secondary Standards

Model 5065A

- Compact, high reliability, proven performance
- Long term drift rate $< 1 \times 10^{-11}$ /month
- Time domain stability $< 5 \times 10^{-13}$ (100 s, avg)
- High reliability
- Proven performance
- Compact
- Long-term drift rate $< 1 \times 10^{-11}$ /month
- Time domain stability $< 5 \times 10^{-13}$ (100 s, avg.)

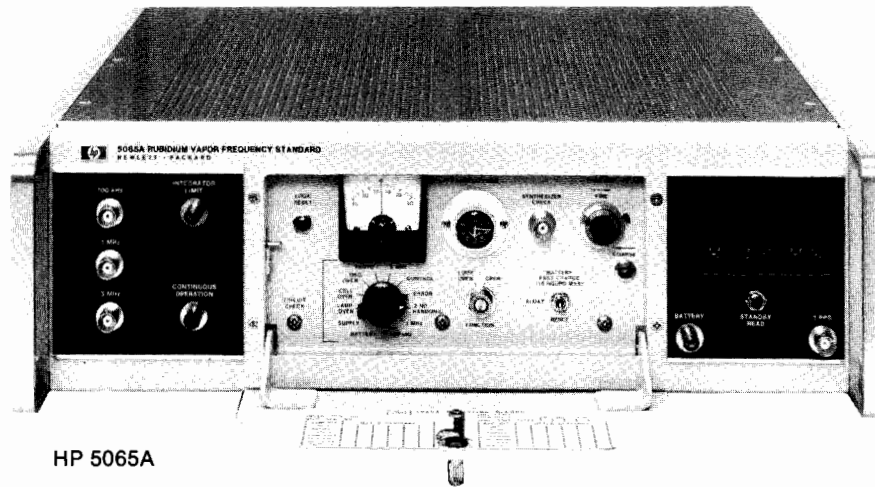

HP 5065A

HP 5065A Rubidium Frequency Standard

The HP 5065A is an atomic-type secondary frequency standard which uses a rubidium vapor resonance cell as the stabilizing element. As a result, it has long-term stability of better than 1×10^{-11} per month which exceeds that of high quality quartz oscillator frequency standards by 50 to 100 times. Furthermore, it has excellent short-term stability. These features contribute to its desirability as a coherent signal source, as a master oscillator for radio and radar systems where special requirements for stability and/or narrow bandwidth must be met, as a precision time keeper where the better performance of a cesium beam primary standard is not required, and as a house frequency standard for improved accuracy with fewer NBS calibrations compared to that required with quartz standards.

Front panel controls and circuit check meter of the HP 5065A are protected by a panel door. The magnetic field control provides fine frequency adjustment with which the frequency can be set to a precision of better than 2×10^{-12} without reference to a chart. The low noise quartz oscillator is phase-locked to the atomic frequency and provides the standard 5 MHz, 1 MHz, and 100 kHz outputs. The circuit check meter with selector switch monitors key voltages and currents for routine maintenance readings, calibration procedures, and fault finding.

The HP 5065A is designed for assured operation—to give the user confidence that the standard output signals are correct and locked to the atomic frequency. Logic within the unit maintains power to a “continuous” operation light on the front panel. If operation is interrupted, even momentarily, for any reason the light goes out and stays out until manually reset. An integrator limit light warns when the frequency correcting servo loop is approaching the limit of its dynamic range.

The HP 5065A is contained in a small-size package and is lightweight in comparison to a cesium beam standard. Additionally the rubidium resonance cell is much more frequency stable than quartz oscillators while subjected to shock and vibration, EMC, humidity, and magnetic field effects.

Reliability and warranty: the most significant module in the HP 5065A in terms of performance is the Rubidium Vapor Frequency Reference (RVFR). This temperature controlled, magnetically shielded unit includes the Rb gas cell and a photo sensitive detector

designed for maximum possible reliability. Field experience, including several million hours of operation, have demonstrated this reliability and the RVFR is now warranted for a period of three years. This increased warranty protects the owner in the event of random failure.

The Option 001 Digital Clock has an easy to read LED time-of-day display. The olive black upper panel provides a dark background around the readout for excellent contrast and readability. Initial clock setting is accomplished by means of pushbuttons easily accessible by removing the top cover. The LED display offers high reliability, freedom from errors due to mechanical shock, and performance over the full environmental range of the HP 5065A. A sync button on the digital divider permits automatic synchronization of this 1 PPS pulse to an external pulse. The clock 1 PPS is adjustable in decade steps from 0.1 μ s to 1 s, with respect to the synchronized reference, with 7 thumbwheel switches.

To conserve battery power, the display is not illuminated when ac power is not available. A STANDBY READ pushbutton below the display is used for readout when operating on the internal battery or external dc.

The Option 002 Standby Battery provides the HP 5065A with a minimum of 10 minutes standby power at 25°C. Switchover from line to battery is automatic so there is no interruption of operation if ac line power should fail. A front panel ac interruption light warns when ac power has failed or has been disconnected. Fast or float charging rates may be selected when ac power is available.

The Option 003 combines the Option 001 Clock and Option 002 Battery and should be specified if both Options 001 and 002 are required.

HP E21- 5065A Portable Time Standard

HP E21- 5065A Portable Time Standard is a complete system for precision timekeeping and for transporting time from one location to another. It consists of the HP 5065A Rubidium Standard with digital clock and divider (Option 001) and the HP 5089A Power Supply with 6 or more hours standby capability. The component units are held together by side bars, and the interconnecting cables are protected by a back cover.

FREQUENCY & TIME STANDARDS

Secondary Standards

Model 105B

491

- High spectral purity
- Well-buffered outputs
- Aging $< 5 \times 10^{-10}$ per day

- Excellent stability
- High reliability
- Built-in 6-hour standby battery

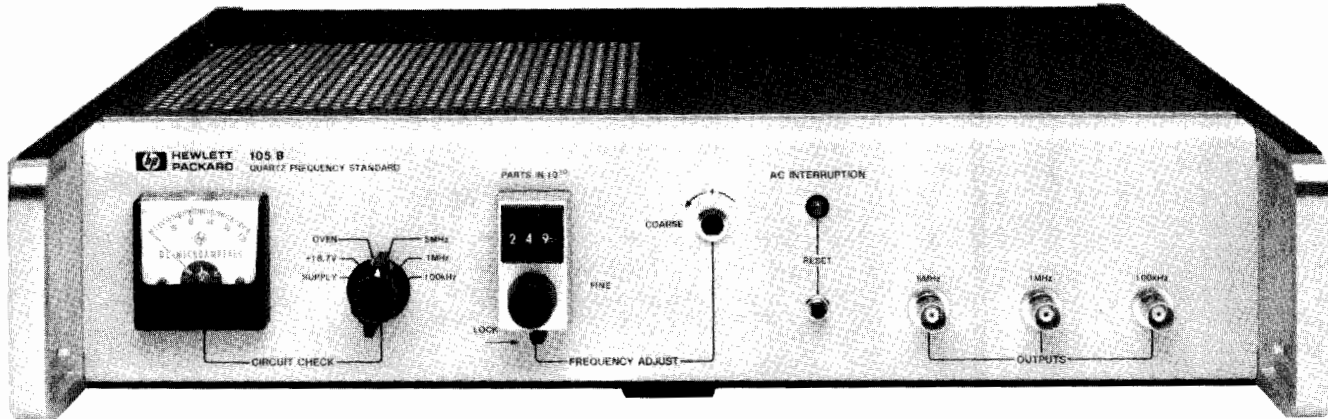

HP 105B

HP 105B Quartz Oscillator

The HP 105B Quartz Oscillator provides state-of-the-art performance in precision frequency and time systems because of its excellent long and short term stability characteristics, spectrally pure output, unexcelled reliability, and ability to operate under a wide range of environmental conditions. The HP 105B fills a need for a small and economical yet highly stable precision quartz oscillator for frequency and time standards. The HP 105B can be operated from the ac line. It also has a built-in 8-hour standby battery for uninterrupted operation should line power fail. The 5 MHz, 1 MHz and 100 kHz buffered sinusoidal outputs have excellent short term stability (5 parts in 10^{12} rms for 1 s averaging time) and aging rate (< 5 parts in 10^{10} per day).

The HP 105B features rapid warm-up. Typically, the oscillator will be within 5 parts in 10^9 of the final frequency in 15 minutes after an "off" period of 24 hours. The basis of these oscillators is an extremely stable "SC" cut quartz crystal developed by Hewlett-Packard. New technologies in the crystal mounting and packaging have resulted in a cleaner crystal which in turn has a lower aging rate. The crystal, oscillator and AGC circuit are all enclosed in a proportional oven which reduces the temperature effects on these components and circuits.

Particular care was taken to provide a spectrally pure 5 MHz output which, when multiplied high into the microwave region, provides signals with spectra only a few cycles wide. Spectra less than 1 Hz wide can be obtained in X-band (8.2 to 12.4 GHz). The stability and purity of the 5 MHz output make it suitable for doppler measurements, microwave spectroscopy, and similar applications where the reference frequency must be multiplied by a large factor.

Specifications

Outputs: 5 MHz, 1 MHz, 100 kHz; 1 V rms into 50 Ω front and rear connectors.

Clock output: 1 MHz or 100 kHz; 0.5 V rms into 1 k Ω , rear connector. Normally supplied wired for 1 MHz output.

Frequency Stability

Aging rate: $< 5 \times 10^{-10}$ per 24 hours.

Short-term stability: for 5 MHz output only.

$\tau(\text{sec})$	$\sigma_{\Delta f}/f(2,\tau)$
10^{-2}	1.5×10^{-10}
10^{-1}	1.5×10^{-11}
10^0	1×10^{-11}

Temperature: $< 5 \times 10^{-9}$ total change 0°C to 50°C .

Load: $< \pm 9 \times 10^{-11}$ open to short circuit, 50 Ω R, L or C load change.

Supply voltage: $\pm 5 \times 10^{-11}$ for 22–30 V dc from 26 V dc reference and for 115/230 V $\pm 10\%$.

Warm-up (at 25°C): to within 1×10^{-7} of final frequency in 15 min.

Distortion (5 MHz, 1 MHz, 100 kHz) Below Rated Output

Harmonic: > 40 dB.

Non-harmonic: > 80 dB.

Frequency Adjustments

Fine: $\pm 5 \times 10^{-8}$ range with digital dial reading parts in 10^{10} .

Coarse: 1×10^{-6} front-panel screwdriver control.

Phase locking: external +5 V to -5 V allows $> 2 \times 10^{-8}$ frequency control for locking to external source.

Environmental

Temperature, operating: 0°C to $+50^\circ\text{C}$.

Temperature, storage: -40°C to $+50^\circ\text{C}$ ($+75^\circ\text{C}$ without standby battery).

Altitude: 15.24 km (50,000 ft.).

Standby supply capacity: 6 hours at 25°C ambient temperatures.

Power requirements: 115/230 V $\pm 10\%$, Hz at 19 W (71 W warm-up) for float charge. Add 12 W for fast charge. 22–30 V dc at 8 W (16 W warm-up).

Size: 88 mm H x 425 mm W x 286 mm D ($3\frac{1}{2}$ in. x $16\frac{3}{4}$ in. x $11\frac{1}{4}$ in.).

Weight: 105B—net, 11 kg (24 lb). Shipping, 14 kg (31 lb).

Ordering Information

HP 105B Quartz Oscillator

Opt 908 Rack Flange Kit

Opt 910 Extra manual

Price

\$8600

+ \$65

+ \$25

FREQUENCY & TIME STANDARDS

Frequency Standards Models 5061B, 5065A, 105B

Specifications — Frequency Standards

Instrument:	HP 5061B Option 004	HP 5061B	HP 5065A	HP 105B
Type of Standard:	Cesium	Cesium	Rubidium	Quartz
Accuracy: maintained in a dc magnetic field to 2 gauss over a temperature range of 0-50°C	$\pm 3 \times 10^{-12}$	$\pm 5 \times 10^{-12}$		
Accuracy: limited temp. range ⁽¹⁾	$\pm 2 \times 10^{-12}$	$\pm 3 \times 10^{-12}$		5×10^{-10} /day
Reproducibility	$\pm 1.5 \times 10^{-12}$	$\pm 3 \times 10^{-12}$		
Retrace	$\pm 5 \times 10^{-13}$	$\pm 3 \times 10^{-12}$		
Settability (frequency)	$\pm 1 \times 10^{-13}$	$\pm 7 \times 10^{-13}$	$\pm 2 \times 10^{-12}$	1×10^{-10}
Long-term Stability	$\pm 2 \times 10^{-12(4)}$	$\pm 2 \times 10^{-12(4)}$	$\pm 1 \times 10^{-11}$ /month	
DC Magnetic Field Stability, freq. change, any orientation in a 2 gauss field	$< \pm 2 \times 10^{-13}$	$< \pm 2 \times 10^{-12}$	$< \pm 5 \times 10^{-12}$ (1 gauss field)	
Time Constant, quartz OSC. control loop	1s	1s		
Warm-up Time at 25°C	30 min	45 min	5×10^{-11} 4 hrs ⁽²⁾	5×10^{-9} /15 min
Tube Warranty	3 yrs.	5 yrs.	3 yrs.	
Sinusoidal Outputs	10 MHz, 5 MHz, 1 MHz, 100 kHz		5 MHz, 1 MHz, 100 kHz	5M, 1M, 100k, Clock (1M)
Output Voltage	1 volt into 50 Ω			
Harmonic Distortion	>40 dB (from rated output)			
Non-Harmonic Distortion	>80 dB (from rated output)			
Temperature, Operating	0-50°C			
Temperature, Non-operating	-40 to 70°C ⁽³⁾			
Power, AC	50, 60 or 400 Hz $\pm 10\%$, 115/230V $\pm 10\%$, 44W (Cesium), 49W (Rb).			19W(71W Warm-up)
Power, DC	22 to 30V, 30W		23 to 30V, 35W	8W (16W Warm-up)
Power, AC/DC with options - add	5 to 16W		0 to 16W	
Dimensions (HxWxD): mm: inches:	221x425x416 8.7x16.7x16.4		133x425x416 5.2x16.7x16.4	88.2x425x286 3 ¹⁵ / ₃₂ x16 ³ / ₄ x11 ¹ / ₄
Weight (lb/kg)	68/30.9	64/29.1	34/15.4 2/0.9 3.5/1.6	24/10.9
Option 002				
Option 003	6/2.7	6/2.7		
Time Standard (Clock)				
1 PPS Outputs: Master:	Front and Rear BNC		Front BNC	
Clock:	10V Peak into 50 Ω load			
Amplitude	20 μ s min.			
Width	<50 ns			
Rise Time	<50 ns			
Fall Time				
Jitter, pulse-to-pulse	<1 ns, rms			
Synchronization	Automatic, 100 \pm 100 ns delay			
Clock Pulse Adjustment Range:	.1 μ s to 1s			
Clock Display:	LCD	LCD	LED	
Standby Power Supply-Capacity at 25°C w/cik	45 min.	45 min.	10 min.	6 hrs
Recharge	Automatic		switch	fast/float
(1) Static mechanical and atmospheric and electromagnetic environment $\pm 2.5^\circ\text{C}$ range at any temperature between 15 and 35°C.				
(2) After 24 hours off @ 25°C.				
(3) If options installed in HP 5065A, Non-Op. Temp -40°C to +50°C.				
(4) For life of Cesium Beam tube.				
NOTE: Tubes are intrinsically capable of meeting these specifications when installed in HP 5061B's currently in production.				

Ordering Information

HP 5061B Cesium Frequency Standard	Price	\$35,200
Opt 003 Clock and Standby Power Supply		\$4,300
Opt 004 High Performance Beam Tube		\$6,200
Opt 908 Rack Flange Kit		\$80
Special Option HP E21-5061B Flying Clock		+\$7,950
Consists of: HP5061B, Opt 003, E21, + 5089A. (The 5061B, + Opt 003 are not included in the E21 price.)		
Weight: 64 kg (141 lb).		
Size: 425 H x 405 W x 546 mm D (16.7 in. x 15.9 x 21.5 inches) includes handles.		
HP 10638A Degausser		\$2,200

Special Option K34-59991A Phase Comparator	\$1,925
HP 5065A Rubidium Frequency Standard	\$33,000
Opt 001 Clock	\$3,800
Opt 002 Standby Power Supply	\$1,600
Opt 003 Clock and Standby Power Supply	\$5,200
Opt 908 Rack Flange Kit	\$90
Special Option HP E21-5065A Portable Standard	+\$8,075
Consists of: HP 5065A, E21, Opt 001 + 5089A Standby power supply. (The 5065A, + Opt 001 are not included in the E21 price.)	
Weight: 50 kg (110 lb).	
Size: 314 H x 425 W x 546 mm D (8.4 x 16.7 x 21.5 inches) includes handles.	



HP 10638A

HP 10638A Degausser

The HP 10638A Degausser is designed for use with the Option 004 High Performance Cesium Beam Tube without interrupting normal operation. The degausser removes residual magnetism in the shields of the beam tube which can build up over time, due to a changing magnetic environment, and can cause a frequency offset. Relaxation of the residual magnetism insures a settability of $\pm 1 \times 10^{-13}$, allowing stable precise changes in output frequency and a reproducibility of $\pm 1.5 \times 10^{-12}$. The degausser should be used when initially setting up the HP 5061B with Option 004 or after the instrument has been moved or adjusted.*

HP 5061B with Option 003, Time Standard and Standby Power Supply

The HP 5061B has provision for an optional digital divider and reliable, easy to read LCD, time-of-day, 24-hour digital clock (Option 003). By including this option, the number of applications and the versatility of the cesium standard is increased. The one-pulse-per-second output can simplify the comparison with other standards (such as portable and secondary standards) as well as GPS and Loran Systems. The techniques for such comparisons are described in Application Note AN-52. Option 003 also includes an internal battery power supply which will provide at least 45 minutes of standby power if the line power should fail. This will prevent phase and frequency interruptions due to intermittent or an extended power failure. Battery power also enables moving the cesium beam standard to locations of other secondary standards without losing time.*

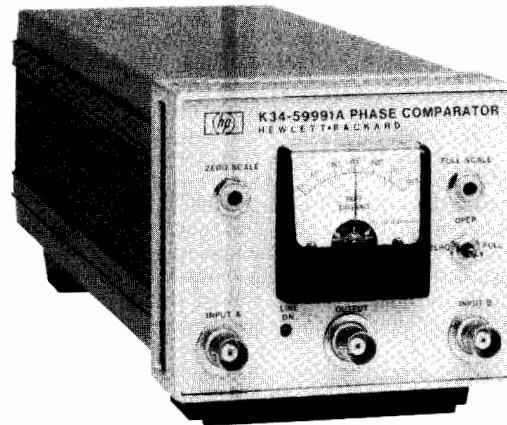

HP K34-59991A

HP K34-59991A Phase Comparator

The HP K34-59991A Broadband Linear Phase Comparator accurately compares the phase relationship of the output signals of two frequency standards having the same nominal frequency. This will enable resolving extremely small differences between precision frequency sources. The Phase Comparator operates over a frequency range of 10 kHz to 50 MHz and input levels between 100 mV and 10 V rms. A linear dc output voltage, proportional to the phase differences between the two standards, is available at both the front and rear panels. This voltage is also monitored on a front-panel meter and is suitable for driving a stripchart recorder, thus allowing longterm monitoring of the frequency standards. By using this comparator, very small frequency differences can be detected and adjustments can be made to frequency standards to correct for timekeeping errors.*

HP J45-5061 Certified Stability of 1×10^{-13}

The HP J45-5061B is a special option which will certify that the Model HP 5061B with standard Options 003 and 004 has stability performance of better than or equal to 1×10^{-13} in a day, when measured each day for any five consecutive days. This means that the cesium standards absolute deviation from the HP Santa Clara Division House Standard is less than or equal to 8.64 ns per day on each of the five consecutive days during the certification. The certification applies only to original shipments and is performed under calibration laboratory conditions with the cesium beam tube degaussed and operating in a stable magnetic environment and over a restricted temperature range of ± 2.5 degrees range at any temperature between 15 and 35 degrees C.

* See page 492 for ordering information.

FREQUENCY & TIME STANDARDS

Accessories (cont'd)

Model 5087A

- Versatile with 3 input and 12 output channels
- Low noise, high stability, and isolation
- Exceptional phase stability
- Plug-in modular construction

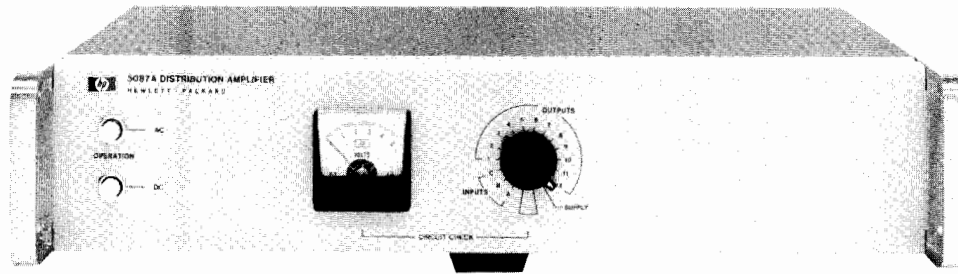

HP 5087A

HP 5087A Distribution Amplifier

The Hewlett-Packard 5087A Distribution Amplifier provides the isolation and flexibility required for distribution of the output of high-quality frequency standards. Low distortion and excellent isolation make it ideal for providing multiple outputs from atomic or crystal frequency standards. The 3 input channels will accept 10 MHz, 5 MHz, 1 MHz or 100 kHz in any combination. The number of outputs for each channel is selectable up to a total of 12 outputs. The output levels are individually adjustable from 0 to 3 V rms. All input and output levels are monitored on a front-panel meter.

The Distribution Amplifier features plug-in modular construction, short circuit isolation, exceptional phase stability, low noise and cross-talk, and uninterrupted switchover to standby dc in event of ac power failure.

The shielding around each input and output plug-in amplifier assures minimum noise and crosstalk. The tuned output amplifiers provide clean signals and high channel-to-channel isolation.

The instrument is designed for maximum versatility and can be supplied to meet a wide variety of special requirements. The standard configuration of input and output amplifiers is shown in Figure 1.

Several other commonly used configurations are also available and special combinations of the various input and output modules can be supplied. Input and output amplifiers can be added or the configuration easily changed at any time.

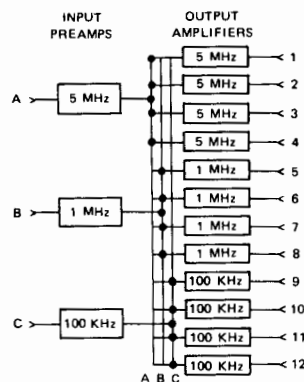

Figure 1. HP 5087A Distribution Amplifier with Option 031, Standard Configuration input and output amplifiers.

Specifications

Inputs: (up to three, rear panel BNC).

Frequencies: 10 MHz, 5 MHz, 1 MHz or 100 kHz.

Level: 0.3 to 3.0 V rms, 50 ohms.

Outputs (up to 12 rear panel BNC).

Frequencies: 10 MHz, 5 MHz, 1 MHz or 100 kHz.

Level: 0–3 V into 50 ohms (screwdriver adjustment).

Harmonic distortion: >40 dB below rated output.

Non-harmonic distortion: >80 dB below rated output.

Isolation

Load (open or short on any other channel)

Amplitude change: 0.1%.

Phase change: <0.1 ns at 5 or 10 MHz.

<0.5 ns at 1 MHz.

<5.0 ns at 100 kHz.

Injected signal: 1 V signal up to 50 MHz applied to any output except 10 MHz, will be down more than 60 dB in all other outputs; 10 MHz output channel will be down more than 50 dB.

SSB phase noise (5 MHz): >145 dB below signal in 1 Hz BW for frequencies > 1 kHz from carrier.

Short term stability degradation (5 MHz): < 1×10^{-12} in 10 kHz band. (1 s average).

Environmental

Temperature: MIL-E-16400, Class 4.

Operating: 0–50°C; storage: –62° to +75°C.

Stability

Amplitude: ±0.5 dB, 0° to 50°C.

Phase: <0.1 ns/°C., 5 and 10 MHz.

Humidity: 95% at 40°C.

Altitude: up to 30,000 ft.

General

Power: 115 or 230 V ±10%, 48 to 440 Hz, 20 VA, max, or 22–30 V dc, 500 milliamperes, max.

Dimensions: 88 mm H x 425 mm W x 286 mm D (3.5 in. x 16.7 in. x 11.3 in.).

Weight: typical, Opt 031–Net 7 kg (15 lb).

Ordering Information

HP 5087A Distribution Amplifier Mainframe \$2500

Normal Configurations (input and output amplifiers)

Opt 031 5, 1 and 0.1 MHz inputs and 4 outputs at each frequency + \$2450

Opt 032 Single 5 MHz input and 12 outputs + \$2200

Opt 033 Single 10 MHz input and 12 outputs + \$2200

Opt 034 Single 5 MHz input, 4 each outputs at 5, 1 and 0.1 MHz + \$2550

Special Configurations

Input Preamplifiers (up to 3 total)

Opt 004 Input Preamplifier (0.1 to 10 MHz) + \$120

Opt 005 5 to 1 MHz Input Divider + \$180

Opt 006 1 to 0.1 MHz Input Divider + \$270

Opt 011 5 to 10 MHz Input Doubler + \$280

Opt 013 10 to 5 MHz Input Divider + \$320

Opt 014 10 to 1 MHz Input Divider + \$320

Output Amplifiers (up to 12 total)

Opt 001 5 MHz Output Amplifier + \$180

Opt 002 1 MHz Output Amplifier + \$180

Opt 003 0.1 MHz Output Amplifier + \$210

Opt 012 10 MHz Output Amplifier + \$180

Opt 908 Rack Flange Kit + \$75

FREQUENCY & TIME STANDARDS

Accessories

Model 5089A

495

- 15 ampere-hour capacity
- Maintenance free lead-calcium batteries

- Used in "Flying Clocks"
- Automatic recharge

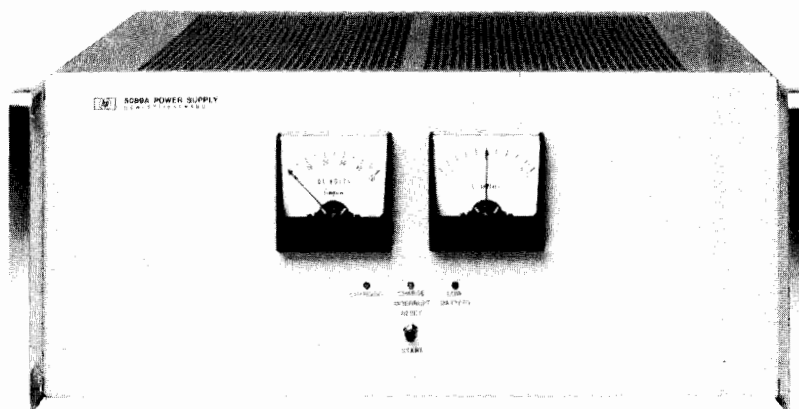

HP 5089A

HP 5089A Standby Power Supply

The HP 5089A Standby Power Supply furnishes dc power to keep frequency or time standard systems operating during extended interruptions of ac line power. For applications where it is essential to maintain continuous operation and avoid loss of precise time, the use of a standby power supply is an absolute necessity. This unit is designed for use with Hewlett-Packard Cesium Beam Standards, Rubidium Vapor Standards, Quartz Standards, and other equipment which will operate from 22 to 28 V dc. No switching is used in transferring power from line to battery operation and back again, thus assuring uninterrupted operation.

Versatility

The HP 5089A is an extremely versatile unit. It was designed both as a portable power supply for the HP 5061B and HP 5065A "flying clocks", and as a standby supply for stationary applications.

Portable Applications

Portable or "flying clock" applications require a power supply to operate from a wide range of power sources, along with the standby capability to maintain continuous operation where no external power is available. A special inverter permits operation from a 12 V dc automobile battery. In addition, the 85 to 255 V ac, and 11 to 30 V dc capability enables the HP 5089A to operate from almost any power source in the world. The 15 ampere-hour standby batteries are the double sealed lead-calcium type, and thus are virtually spillproof. Mounting hardware is available to attach the HP 5089A to either the HP 5061B or the HP 5065A standards to make a portable frequency time standard package. These portable packages are available from Hewlett-Packard under HP E21-5061B and HP E21-5065A.

Stationary Applications

Stationary applications require long periods of power supply operation in a float or standby mode. Then, when an ac supply failure occurs, the supply must provide full standby capability. The charging circuits inside the HP 5089A are designed to charge the batteries in such a way that they will provide both long, trouble-free, reliable operation, and full standby power. After use, when ac power is restored, the HP 5089A will fully recharge its batteries. The double sealed batteries will not leak or require maintenance of any kind. Thus, the HP 5089A allows you to add standby capability to your system with very little increase in maintenance costs.

Ease of Operation

In normal operation there is virtually no required operator intervention. The HP 5089A automatically maintains the batteries in a fully charged state, ready to supply standby power. Should regular line power fail, the HP 5089A will provide uninterrupted dc power (to the limit of its standby capacity) for your equipment. After normal operating power is restored, the HP 5089A will automatically recharge its batteries back to the standby level.

The HP 5089A tells you its operational status at a glance through three LED lamps: GREEN indicates the battery is being charged; YELLOW indicates there has been an ac line failure; a RED lamp lights when the battery is almost fully discharged. Two front-panel meters show battery voltage and charge/discharge current.

Batteries

The HP 5089A utilizes the "immobilized electrolyte" technology in its maintenance-free lead-calcium batteries. The lead-calcium grid gives these batteries longer life with better reliability than conventionally designed batteries. The batteries are double sealed to provide virtually leakproof, and thus maintenance-free operation.

HP 5089A Specifications

Input Voltage

AC charging: 85 V to 130 V ac rms, 48 to 440 Hz, 300 VA max.
85 V to 255 V ac rms, 48 to 66 Hz, 300 VA max.

DC operation: 11 V to 30 V dc, 110 W max.

Output voltage: 22 V to 28 V dc (nominal). 2 A maximum.

Standby capacity: 15 AH at +25°C when fully charged.

Recharge: complete recharge in 24 hours when operating from ac line.

External low battery voltage alarm: floating contact closure at rear-panel barrier block for external visible or audible "low battery" warning. Contact rating is 30 V dc at 2 amperes.

Operating Environment

Temperature: 0°C to 50°C.

Humidity: up to 95% at 40°C (with no internal condensation).

Altitude: 12,000 metres (40,000 feet).

Storage Environment

Temperature: -40°C to +65°C.

Humidity: up to 95% noncondensing.

Altitude: 15,000 metres (50,000 feet).

Dimensions: 177 mmH x 425 mmW x 416 mmD (7 in. x 16.7 in. x 16.4 in).

Weight: net weight 30.5 kg (67 lb).

Accessories Supplied

HP 05061-6091: AC Power Input Cable Assembly
HP 05089-60102: DC Power Input Cable Assembly
HP 05089-60101: DC Output Cable Assembly
HP 5060-0169: Extender Board Assy (Dual 25 Pin)

Ordering Information

	Price
HP 5089A Standby Power Supply	\$6700
Opt 001 Spare AI Board Assembly (HP 05089-60001)	+\$1000
Opt 908 Rack Mounting Adapter Kit	+\$45
Opt 910 Extra Operating and Service Manual	+\$90

TELECOMMUNICATIONS TEST EQUIPMENT

Digital Communications Measurement

PCM Conversion Measurements

Today's circuit-switched integrated digital networks (IDN) are almost all based on 64 kb/s PCM voice channels using either CEPT A-law or Bell μ -law coding formats. These circuits can also carry multiplexed, low-speed or wide-band high-speed data. The key to testing these circuits is the ability to measure PCM voice and analog data transmission performance at both analog and digital access points, that is, in a mixed analog/digital network.

The HP 3776A/B Terminal Test Set, for use mainly in installation and commissioning, can make both PCM voice and analog data measurements in both analog and digital domains. It can also be connected to test ports of digital cross-connect switches. The HP 3779A/B Primary Multiplex Analyzer is optimized for R & D, production test and commissioning of line cards and PCM multiplexers/channel banks.

Digital Transmission (TDM)

The emphasis in measuring the performance of digital transmission systems has shifted to monitoring the end-to-end performance in terms of %error-free seconds and availability. This gives a clearer and more thorough analysis of how faults affect the networks.

CEPT Hierarchy

The CEPT digital hierarchy has four currently defined levels for network interconnection and test: 2, 8, 34 and 140 Mb/s.

The HP 3764A Digital Transmission Analyzer is available in a number of variants to cater for different testing needs: a 2, 8, 34, and 140 Mb/s BER version for general network test; a 140 Mb/s BER only version for high-capacity trunk testing, and a 140 Mb/s BER and jitter version for troubleshooting and manufacturing applications. Versions with an internal synthesizer provide variable frequency operation to 170 Mbit/s and more flexible offset testing.

All versions of the instrument provide G.821 error analysis and there is a choice of built-in printer or cassette for logging measurement and analysis results.

For testing on lower-capacity systems, the HP 3780A Pattern Generator/Error Detector provides flexible operation at rates up to 50 Mb/s in a single package. The HP 3781A Pattern Generator and HP 3782A Error Detector give similar capability with a two-box package that is useful in field trial testing or when multiple generators are needed to test load a system. HP-IB control is provided for system test applications.

Fast, easy measurements of error and jitter performance to 50 Mb/s are possible with the HP 3784A Digital Transmission Analyzer. It has standard CCITT interfaces at 704 kb/s and 2, 8 and 34 Mb/s and optional data circuit testing capability at 64 kb/s. The HP 3788A Error Performance Analyzer is a BERTS for use in the installation and maintenance of digital data circuits, lines and multiplexers. It has CEPT interfaces at 2 Mb/s and 64 kb/s and also caters for 704 kb/s operation. Lightweight and rugged, this

battery-powered instrument is ideal for operation in harsh environmental conditions.

North American Hierarchy

Of the four main levels currently defined, the most important are DS1 (1.544 Mb/s) - used primarily for local distribution - and DS3 (44.736 Mb/s) which is the high-capacity building block for the long-haul toll circuits. DS1C and DS2 (3.152 and 6.312 Mb/s) play a minor role in the network hierarchy. The HP 3781B Pattern Generator and HP 3782B Error Detector cater for measurements at all four levels. The two-box configuration and HP-IB capability give the flexibility required for use in manufacturing test applications and automated measurement systems.

To minimize circuit downtime, cost-effective sectionalization of faults requires in-service measurement of both errors and timing jitter. However, out-of-service measurements are needed for absolute measurement of performance and stress-testing equipment prior to cutover. The HP 3789 DS3 Transmission Test Set satisfies these criteria with two models. The HP 3789A has the basic pattern generation and error detection capability required for installation and network maintenance applications.

The HP 3789B is a more sophisticated set that not only measures BER and jitter on a DS3 signal, but also extracts and measures BER and jitter on each of the component DS1 digroups, making it an ideal troubleshooting aid.

To facilitate the measurement of end-to-end digital path performance, a new framing format for DS3, "C-bit parity", has been introduced. This allows the simultaneous monitoring of both directions of DS3 transmission from one access point and simplifies the maintenance strategy of the net-

work. Optionally, the HP 3789B can provide both measurement and stress-test capability on C-bit parity framed signals.

Digital Leased Service Measurements

In North America, digital leased services include T1 (1.544 Mb/s) and digital data system (2.4/4.8/9.6/56 kb/s). The HP 3787B Digital Data Test Set measures both error and jitter performance on these T1 and DDS services. It has substrate drop and insert capability to allow connection to DS1 cross-connect, Access Switch to Digital Crossconnect Systems (DCS) and can perform measurements on customer substrate primary and secondary channels.

Jitter and Digital Networks

When digital networks were small and transmission paths relatively short, timing jitter was not a major problem to system providers. However, the rapid deployment of digital networks has resulted in jitter-associated problems. For example, faults associated with aging of components and the use of digital transmission equipment from different manufacturers has led to jitter becoming recognized as a major source of errors and other transmission impairments. Dedicated jitter test sets such as the HP 3785 Jitter Generator and Receiver have both jitter generation and measurement capability to help manufacturers design equipment to achieve satisfactory jitter performance. In operational digital networks, jitter accumulation varies with the traffic pattern content. Incorporating jitter measurements into BER test sets such as the HP 3764A, HP 3784A, HP 3787B and HP 3789B couples the analysis of timing jitter with error analysis to pinpoint fault mechanisms efficiently.

	NORTH AMERICAN INTERFACES				CEPT INTERFACES				GENERAL PURPOSE		MEASUREMENTS		DATA LOGGING		REMOTE CONTROL	
	DS1 (1.544 Mb/s)	DS1C (1.544 Mb/s)	DS2 (6.312 Mb/s)	DS3 (44.736 Mb/s)	General (0.1-140 Mb/s)	704 kb/s	2 Mb/s	8 Mb/s	34 Mb/s	140 Mb/s	INSERVICE ERRORS	OUT-OF-SERVICE ERRORS	JITTER	BUILT-IN CASSETTE/DCS DRIVE	BUILT-IN PRINTER	HP-IB
HP 3764A Opt.001																
HP 3764A Opt.002																
HP 3764A Opt.006																
HP 3764A Opt.007																
HP 3776A																
HP 3776B																
HP 3779C																
HP 3779D																
HP 3780A																
HP 3781/82A																
HP 3781/82B																
HP 3784A																
HP 3784A Opt.002																
HP 3784A Opt.006																
HP 3785A																
HP 3785B																
HP 3787B																
HP 3788A																
HP 3789A																
HP 3789B	*															

▲ See options 101, 102, 103
 ■ DS1 access/measurement via built-in demultiplexer
 ■ For printer interface only

TELECOMMUNICATIONS TEST EQUIPMENT

PCM Terminal Test Set, Primary Multiplex Analyzer, Channel Selector

Models 3776A, 3776B, 3779C, 3779D, 3777A

497

HP 3776A/B

- Voice, PCM and data (option 001) measurements in one portable instrument
- Network test of 4 kHz channels at VF and 2 or 1.5 Mb/s PCM interfaces
- A-A, A-D & D-A measurements (for full & half-channel tests)
- Direct output to printer or plotter
- Set and monitor framing and signaling bits

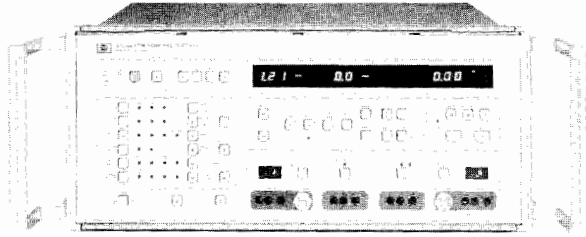

HP 3776A



HP 3779C/D

- Manufacturing/R&D test of digital line cards/channel banks
- A-A, A-D & D-A measurements (for full & half-channel tests)
- Comprehensive PCM in-band and out-of-band measurements (to 40 kHz)
- Limit checking, sequencing, and direct control of printer and channel selector for ease of system integration
- Complex impedance terminations

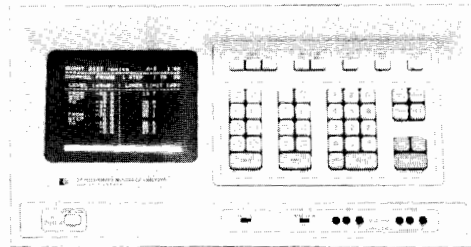

HP 3779C

HP 3776A/B PCM Terminal Test Set

The HP 3776A is designed for CEPT/CCITT compatible networks. Model 3776B is designed for Bell/Japanese/CCITT compatible networks. Full specifications are contained in the specification booklet.

HP 3776A

The HP 3776A has 30/31 channel voice test capability. The VF and PCM interfaces allow multiplexers to be tested to CCITT Recommendations G.712 to G.714. Option 001 provides datacom measurements conforming to the relevant CCITT "O" Series Recommendations.

HP 3776B

The HP 3776B has selectable Bell standard or Bell extended superframe (ESF) capability. Line coding is either AMI or B8ZS (clear channel). HP 3776B Option 002 has modified measurements and I-214 connectors for Japan. The VF and PCM interfaces allow channel banks to be tested to BSTR PUB 43801 specifications. Option 001 provides datacom measurements conforming to IEEE STD 743-1984.

HP 3777A Channel Selector

- DC to 110 kHz
- 2-wire/4-wire balanced switching
- Remote control only (HP-IB)

The HP 3777A is a 4-pole access switch for telecom applications. It may be configured as a single 4-wire switch or as two, independent, 2-wire switches. Channel capacity is arranged by adding standard modules. Unselected channels are switched to 600 ohm terminations. Special options are available with other termination values including none (open circuit).

HP 3777A Options

No. of Channels	Connectors	
	Siemens 3-Pin	WECO 310
6	Opt H07	Opt H16
12	Opt 002	Opt 003
18	Opt H13	Opt H17
24	Opt H14	Opt 001
30	Std	Opt H05

Ordering Information

	Price
HP 3776A PCM Terminal Test Set (CEPT)	\$12,850
HP 3776B PCM Terminal Test Set (Bell)	\$14,200
HP 3777A Channel Selector	\$5,450

HP 3779C/D Primary Multiplex Analyzer

The HP 3779C is designed for CEPT/CCITT compatible networks. Model 3779D is designed for Bell/Japanese/CCITT compatible networks. Full specifications are contained in the specification booklet.

- The standard unit has VF interfaces for A-A measurements and E&M signaling distortion measurement capability.
- An option adds A-D, D-A and D-D measurements and a single-channel TTL-compatible interface for codec and line card testing.

HP 3779C

The HP 3779C performs A-A measurements to CCITT G.712/3 standards. A-D and D-A measurements are performed to CCITT G.714. Multiplex alignment and alarm functions can be tested automatically in D-A mode.

HP 3779D

The HP 3779D tests channel bank performance as specified in BSTR PUB 43801.

Accessories

- HP 15518A/B: dual-port loop-holding accessory for HP 3776A/B
- HP 15515B: loop-holding unit, 24 mA current sink; WECO connectors
- HP 15512A: 1m length 600 ohm bal cable; Siemens 3-pin connector both ends
- HP 15513A: 1m length 600 ohm bal cable; WECO 310 jack plug both ends

Ordering Information

	Price
HP 3779C Primary Multiplex Analyzer (CEPT)	\$23,550
HP 3779D Primary Multiplex Analyzer (Bell)	\$18,200
HP 15512A Cable	\$82
HP 15513A Cable	\$62
HP 15515B Loop Holding Unit	\$330
HP 15518A/B/C Loop Holding Accessory	\$505/505/490

TELECOMMUNICATIONS TEST EQUIPMENT

Digital Transmission Analyzer and Error Performance Analyzer HP 3784A, 3788A

HP 3784A

- G.821 error analysis at 704 kb/s, 2, 8 and 34 Mb/s
- Optional jitter at 2, 8 and 34 Mb/s
- Optional 64 kb/s measurements
- Clock synthesizer from 1 kb/s to 50 Mb/s
- Single key measurement setup using preset memory

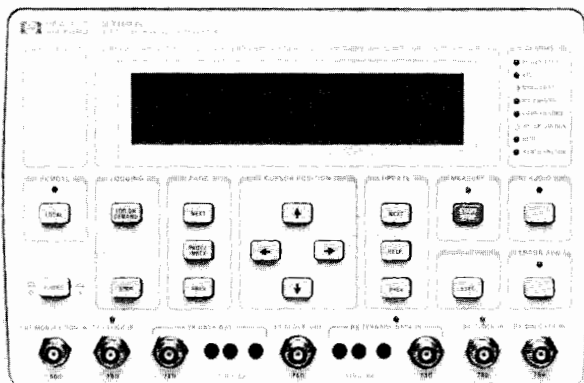

HP 3784A



HP 3784A Digital Transmission Analyzer

The HP 3784A is a BER and jitter test set for manufacturing, commissioning, and maintaining network equipment operating at CEPT telecom interface rates of 704 kb/s, 2, 8 and 34 Mb/s. It has a clock synthesizer and TTL/ECL interfaces for general-purpose BER testing at any rate between 1 kb/s and 50 Mb/s and has optional jitter or 64 kb/s codirectional interfaces.

For network operators, the HP 3784A performs error performance analysis during the installation and maintenance of digital transmission networks and monitors in-service error performance using line code error detection. Long-term measurements can be made unattended and the results logged to an external printer. Several ease-of-use features include measurement presets, automatic receiver set-up and pass/fail thresholds.

For digital equipment manufacturers, the HP 3784A synthesized clock source and binary interfaces allow general-purpose error performance testing of any design that transports or stores digital data. For production test, the HP 3784A can be rack-mounted and automated with HP-IB or RS-232-C remote control.

For manufacturers of telecommunications equipment, the HP 3784A provides a wide range of test patterns and enables flexible frequency offset tests and testing at non-standard rates. The HP 3784A provides fully automated jitter tolerance and transfer function measurements for testing up to and beyond CCITT limits. The jitter analysis facility enables the correlation of jitter hits with error bursts. Through-data jitter modulation allows jitter to be added to a fully-framed test signal passing through the HP 3784A for jitter tolerance testing of demultiplexers. The HP 3784A with option 002 can be paired with the HP 3764A digital transmission analyzer with option 002 or 007, to provide complete error and jitter test capability for manufacturing applications up to 139 Mb/s.

Measurement Summary

Error Analysis: Error count, error ratio, error and error-free intervals (seconds or deciseconds), %unavailability, %errored and %severely errored seconds, %degraded minutes. All measurements are made simultaneously.

Jitter Analysis: Peak-to-peak amplitude, jitter hit count, jitter hit and hit-free seconds or deciseconds.

HP 3788A

- Low cost, lightweight and robust for field use
- Error measurement at 2048, 704 and 64 kb/s CEPT rates
- Basic measurements and G.821 error analysis
- Long-term internal logging of results
- Internal rechargeable battery or ac operation

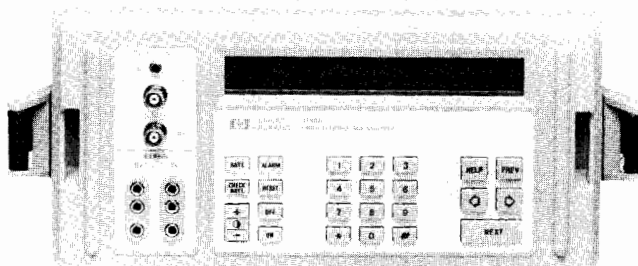

HP 3788A



Ordering Information

HP 3784A Digital Transmission Analyzer

Opt 002 Jitter measurements

Opt 006 64 kb/s measurements

Note: options 002 and 006 are mutually exclusive.

Price

\$10,200

+\$5,800

+\$1,100

HP 3788A Error Performance Analyzer

The HP 3788A error performance analyzer is a low-cost, portable, bit-error-rate test set for installation and maintenance of digital transmission equipment designed to CEPT standards. It uses unframed test patterns to measure binary errors at 2048, 704 kb/s and 64 kb/s (codirectional interface) and code errors at 2048 and 704 kb/s, in digital data circuits, lines and multiplexers.

The HP 3788A is lightweight, portable, and robust for use in harsh field conditions. It operates from an internal battery, with a typical operation time of 10 hours, or a charger/ac adapter. With simple key-stroke operation and only four control keys, the HP 3788A is easy to use.

The HP 3788A performs basic measurements for fast circuit testing, and powerful G.821 error performance analysis for long-term monitoring. CCITT Rec. G.821 analysis provides standard quality-of-service measurements, while user-definable analysis allows G.821 type thresholds to be set appropriately for the transmission medium, for example radio or fiber. Long-term measurement analysis results can be stored internally and then either logged to an RS-232-C-compatible printer or viewed on the display.

Measurement Summary

Error analysis: error count (EC), error ratio (ER)

G.821 Analysis

Maximum and average error rate, error seconds (ES, %ES), severely errored seconds (SES, %SES), degraded minutes (DM, %DM), unavailable seconds (US, %US), alarm seconds (ALMS, %ALMS). All measurements are made simultaneously.

User-defined G.821 Analysis

As above but with selectable analysis interval and error thresholds.

Threshold Analysis:

Provides selectable analysis interval, error count, and error rate logging thresholds. Results: EC, Max ER, Av ER, EI, %EI, SEI, %SEI.

Ordering Information

HP 3788A Error Performance Analyzer

Price

\$3,000

TELECOMMUNICATIONS TEST EQUIPMENT

PCM/TDM Error Measuring Set & Digital Transmission Analyzer

Models 3780A, 3764A

499

HP 3780A

- Easy-to-use portable unit
- Binary and code error measurements
- Clock frequency offset generation and measurement
- Ternary coded and binary interfaces
- Data logging and graphs to external printer

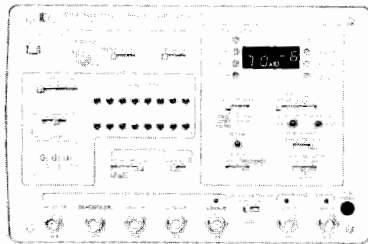

HP 3780A
Option 001

HP 3780A Pattern Generator/Error Detector

The HP 3780A Pattern Generator/Error Detector is a comprehensive error measuring set in one portable package for use in manufacturing, field trials, commissioning and maintenance of digital transmission terminal and link equipment.

The instrument measures binary errors and code errors in digital transmission equipment operating at rates between 1 kb/s and 50 Mb/s. Frequency offset generation and measurement are provided at the standard PCM/TDM transmission rates.

A range of standard PRBS test patterns and automatic pattern recognition/synchronisation are provided for simple performance checks. It also has flexible WORD generation and zero substitution to explore regenerator timing recovery performance and detect systematic errors.

Binary clock and data or ternary coded data interfaces can be selected with automatic equalisation at 2, 8 and 34 Mb/s on the receiver.

Results are displayed as error COUNT or BER over a range of gating periods, and can be logged or presented graphically on an external printer.

Ordering Information

	Price
HP 3780A Standard: internal fixed rates of 2048, 8448 & 1536 kb/s; HDB3/HDB2 ternary coding.	\$10,100
Option 232: RS-232 printer port replaces BCD printer and plotter outputs.	NC

Frequency/Ternary coding Options

Option 100: internal fixed rates of 2048, 8448 & 34368 kb/s; HDB3/HDB2 ternary coding.	\$440
Option 101: internal fixed rates of 1544, 6312 & 44736 kb/s; B6ZS/B3ZS ternary coding.	NC
Option 102: internal fixed rates of 1544, 6312 & 3152 kb/s; B6ZS/B3ZS ternary coding.	NC
Option 103: internal fixed rates of 2048, 8448 & 34368 kb/s; 2 ²³ -1 PRBS replaces 2 ⁹ -1; HDB3 ternary coding.	\$670
Option 104: as option 103 but with Siemens 1.6 mm connectors.	\$1,130

Word/Connector Options

Option 001: all words replaced by a 16 bit front panel programmable word.	\$275
Option 002: Siemens 1.6 mm connectors.	\$226
Option 003: options 001 and 002 combined.	\$330

HP 3764A

- Error analysis at 2, 8, 34 & 139 Mbit/s based on latest G.821 Recommendation or error & jitter measurement and analysis at 139 Mbit/s only
- Powerful data logging facilities
- Single key measurement set-up using preset memory
- Portable single-unit construction

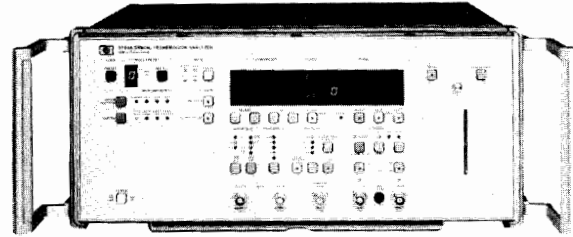

HP 3764A
Option 001



HP 3764A Digital Transmission Analyzer

The HP 3764A Digital Transmission Analyzer is a portable BER and jitter test set covering the European CEPT rates from 704 kbit/s to 139 Mbit/s. It is intended for equipment manufacturers, network installers and operators of digital transmission systems and is available in several versions to cater for different test requirements.

The standard instrument offers a low-cost solution for error measurements at 139 Mbit/s only. Its rugged, portable case is particularly suited to field installation and maintenance applications. A feature of the HP 3764A is a built-in printer for permanent results logging. A real-time clock timestamps the printout to help trap intermittent faults. External events can be logged via special analog and digital inputs to help correlate their occurrence with system error performance. Results can also be passed to an external printer via the HP-IB port. Alternatively, the HP 3764A can be incorporated into an automated remote monitoring or test system using an external controller. This allows fast, repeatable, unattended measurements to improve the efficiency and cost-effectiveness of testing.

For multi-rate error analysis a choice is available. Option 001 can measure on CEPT interfaces at 2, 8, 34 and 139 Mbit/s. This capability may be enhanced with option 005 which adds fixed-frequency offsets to check frequency tolerance limits of equipment. Alternatively, synthesizer-based option 006 offers error performance analysis at CEPT interface rates from 704 kbit/s to 139 Mbit/s plus fixed and variable clock offsets. Binary measurements can be made at any rate between 1 kbit/s and 170 Mbit/s in general-purpose and telecom applications.

Combined error and jitter capability is useful in development and manufacturing applications and this is provided at 139 Mbit/s by options 002 or 007. The synthesizer-based option 007 additionally offers "through-data" jitter modulation for adding jitter to any 139 Mbit/s signal passed through the instrument. This allows testing of jitter tolerance of digital transmission equipment such as demultiplexers with a framed signal.

Measurement Summary

Error analysis: Error count, error ratio, error seconds, error-free seconds, %unavailability, %errored seconds, %severely-errored seconds, %degraded minutes. All measurements are made simultaneously and in accordance with CCITT Recommendation G.821.

Jitter analysis: Peak-to-peak amplitude, jitter hit count, jitter hit seconds, jitter hit-free seconds. Internal filters to CCITT Recommendation O.171 are available for performing selective jitter measurements. Where a greater degree of selectivity is required, a demodulated jitter output allows connection of external equipment such as a spectrum analyzer.

Ordering Information

HP 3764A Digital Transmission Analyzer	\$11,500
---	----------

TELECOMMUNICATIONS TEST EQUIPMENT

Dedicated PCM/TDM Error and Jitter Measuring Sets

HP 3781A, 3782A, 3781B, 3782B, 3785A, 3785B

HP 3781A/82A & HP 3781B/82B

- CEPT or North American bit rates
- Wide choice of test patterns
- Jitter modulation input

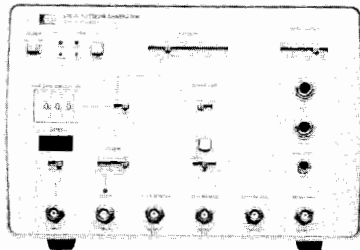

HP 3781B

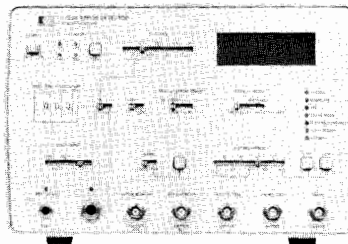

HP 3782B

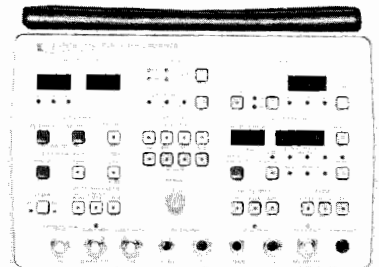

HP 3785B



HP 3785A/B

- CEPT or North American bit rates
- Jitter generation & measurement on data & clock
- Comprehensive jitter analysis

Pattern Generator and Error Detector

The HP 3781A Pattern Generator and HP 3782A Error Detector form a flexible, high-performance error measuring system for digital transmission equipment in the CEPT digital hierarchy. They provide 2, 8, and 34 Mb/s interfaces and binary ECL operation up to 50 Mb/s. The HP 3781B Pattern Generator and HP 3782B Error Detector are the equivalent test sets for use in the North American digital hierarchy. Standard interfaces include DS1, DS1C, DS2, and DS3. Binary ECL operation to 50 Mb/s covers general-purpose requirements.

The test sets are intended for R&D, field trial, and production testing. They include automated or remote measurement capability with HP-IB. Measurements can be made on all types of digital transmission systems including cable, digital radio, satellite, and lightwave.

Both pattern generators provide a wide range of test patterns including PRBS for simulating live traffic and shorter WORD patterns for checking pattern sensitivity in transmission equipment. Binary and code error injection capability is included for stress-testing line terminating equipment. A jitter modulation input is provided to add controlled amounts of jitter to the output test pattern and perform jitter tolerance tests on equipment interfaces. For fully loading multiplexer inputs, 4 additional outputs are available as options.

In-service measurements, using the coding structure of the signal, allow revenue-earning traffic to continue uninterrupted while the system performance is tested. Alternatively, comprehensive bit-by-bit error measurements give the absolute measure of system performance. They use standardized test patterns, and they are performed while the system is out of service. In addition to simple error count and error ratio measurements, the results can be expressed in terms of error seconds and error-free seconds in order to indicate the error distribution. Permanent results logging, including print thresholds and a timestamp from the built-in clock, is available with HP-IB and an external printer.

Jitter Generator and Receiver

The HP 3785A Jitter Generator and Receiver is a dedicated jitter test set for evaluating the performance of digital transmission equipment in the CEPT digital hierarchy. There are interfaces for 2, 8, and 34 Mb/s operation. The HP 3785B is the equivalent test set for the North American digital hierarchy, and it has interfaces at the DS1, DS1C, DS2, and DS3 levels (1.544, 3.152, 6.312, and 44.736 Mb/s). Both models conform to CCITT Recommendation O.171.

The HP 3785A/B is intended for R&D labs, production test, installation, and maintenance of all types of digital transmission equipment and systems, including cable, digital radio, satellite, and lightwave. Results logging, remote monitoring applications, and automated production testing are facilitated with full HP-IB capability.

The jitter generator can modulate the internal crystal clock or an externally applied clock to generate a jittered test signal at one of the interface bit rates. For jitter tolerance testing, the amplitude and frequency of the applied jitter can be set manually, or it can be automatically swept, transient-free, through a jitter tolerance mask programmed into the instrument. A jitter-modulated clock output allows external pattern generators such as the HP 3780A and HP 3781A/B to perform jitter tolerance tests.

A standard four-bit test pattern 1000 covers jitter transfer function measurements. Jitter can be applied in the through-data mode to an external signal passing through the instrument. This allows measurement of jitter tolerance or jitter transfer function in equipment that requires framing and control bits in the signal, for example, a demultiplexer. Jitter can be measured on data signals either out-of-service or in-service. A built-in amplifier facilitates measurements at protected monitor points.

Measurements can also be made on the clock input. The reference clock for jitter measurements can be internally derived from received data or clock, or it can be supplied externally. Unfiltered broadband or a choice of filtering is provided for selective band-limited jitter measurements. A demodulated jitter output is available, for applications such as spectrum analysis.

Jitter measurement results can be expressed as absolute peak or peak-to-peak values, or as the number of jitter hits counted. This is the number of times the received jitter exceeds a user-selectable amplitude, and it is useful in identifying sources of jitter.

Ordering Information

CEPT bit rates (2, 8 & 34 Mb/s)

HP 3781A Pattern Generator	\$10,400
HP 3782A Error Detector	\$9,400

North American bit rates (DS1, DS1C, DS2 & DS3)

HP 3781B Pattern Generator	\$11,200
HP 3782B Error Detector	\$10,300

Price

Ordering Information

CEPT bit rates (2, 8 & 34 Mb/s)

HP 3785A Jitter Generator & Receiver	\$14,900
--------------------------------------	----------

North American bit rates (DS1, DS1C, DS2 & DS3)

HP 3785B Jitter Generator & Receiver	\$17,200
--------------------------------------	----------

Price

TELECOMMUNICATIONS TEST EQUIPMENT

DS3 Transmission Test Sets

Models 3789A/B

501

- Binary bit-by-bit error detection
- Parity, frame and BPV error measurements
- Error analysis to latest recommendations
- Optional DC operation from station batteries
- Single-key measurement setup using preset memory
- Integrated access switch controller

- Built-in DS3 to DS1 demultiplexer (3789B)
- Error & jitter tests at DS1 & DS3 (3789B)
- External events and voltages monitor inputs
- M13 & C-Bit parity generation & measurement (3789B)
- DS3 idle signal generation & detection (3789B)
- Optional built-in data logger

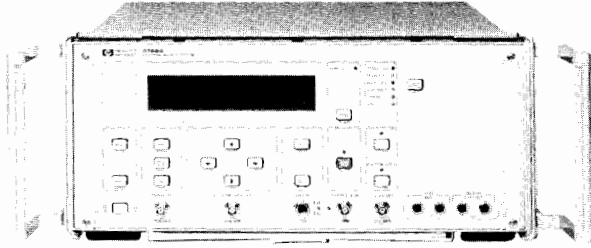

HP 3789A
RS-232-C

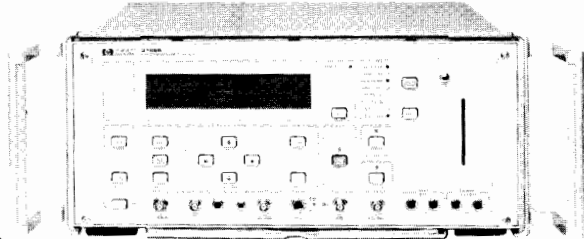

HP 3789B Option 003/010
RS-232-C

HP 3789A DS3 Transmission Test Set

The HP 3789A provides all the basic pattern generation and error measurement capability required for the installation, commissioning and maintenance of DS3 digital transmission equipment including cable, digital radio, satellite and lightwave systems. Its capability can be extended with an optional built-in printer and 24V/48V DC operation. Both RS-232-C and HP-IB remote control capabilities are standard for automated testing or remote monitoring applications. In-service measurements can be performed on systems carrying live traffic and there is a wide choice of test patterns for out-of-service stress testing of equipments and systems.

HP 3789B DS3 Transmission Test Set

The HP 3789B is a more powerful test set offering outstanding monitoring and troubleshooting capabilities. A built-in demultiplexer allows it to perform measurements on both DS1 and DS3 signals from a DS3 access point. On equipment using the new C-bit parity frame format, the HP 3789B can measure the end-to-end performance of a transmission path in both directions simultaneously from a single access point. The instrument can operate with test patterns that are unframed, or framed in M13 or C-bit parity format. A comprehensive error injection facility allows for stress-testing of equipment and interfaces. It can generate and detect the new "DS3 Idle" signal.

Measurements of timing jitter on both the DS3 signal and on any of the twenty-eight embedded DS1 digroups are optionally available. Jitter-induced faults are normally very difficult to fault-find, but the comprehensive error and jitter measurement capability of the HP 3789B diagnoses problems easily and quickly. The built-in access switch controller allows the HP 3789B to selectively measure on a number of DS3 inputs via HP 3756A Access Switches to form a powerful stand-alone monitoring system. An optional built-in disc drive caters for extended data logging applications. Where even more powerful monitoring capability is required, both HP-IB and RS-232-C ports are standard for use with a remote controller.

Applications

- System turn up checks
- Routine testing of trunks
- Fault sectionalization
- Identifying fault mechanisms
- Preventive maintenance
- Service quality verification
- Outage detection & isolation
- Trouble referral verification
- Equipment & route assessment
- Longterm performance monitoring

Product Summary

(Features marked # are available on the HP 3789B only.)
Data Outputs: DS3 Hi, DSX-3, DS3 900' levels, selectable. 6 outputs are provided.
Data Input: Levels; DS3 Hi, DSX-3, DS3 Lo, DSX-3 Lo, 900', 900' Lo.

Measurements

DS3 Errors: Bit (logic), Frame, Parity and Code (BPV) in the form of Error Count, Error Ratio, Error Secs, Error Free Secs.
Error Bursts: The number of bursts with >100 errors is counted.
Error Distribution: Error Seconds containing 1 error, 2 to 10 errors and >10 errors are counted separately.
DS3 Analysis: %Availability, %Unavailability, %Error Secs, %Degraded Mins, Consecutive Severely Errored Secs (CSES). These can

be configured for numeric results or pass/fail results against selectable thresholds.

#DS3 Jitter: Maximum Peak Amplitude; Jitter Hit Count, Hit Bit Count, Hit Bit Ratio, Hit Second Count, Hit Free Second Count.

#DS1 Errors: Bit (logic), Frame, CRC (Extended Superframe Format).

#DS1 Jitter: Maximum pk-pk, Maximum Positive Peak, Maximum Negative Peak, Jitter Hit Count.

#C-Bit Parity Errors: Cp Parity Errors expressed as Error Count, Error Ratio, Error Secs, Error Free Secs, Error Secs Types A, B & C.

#C-Bit Alarms: The Far End Alarm and Control Channel (FEAC) is monitored and decoded. The current alarm status is displayed textually and in bit format.

#FEBC Bits: The Far End Block Error bits are monitored and their information is displayed as Error Ratio, Error Seconds, Error Seconds Types A, B & C.

#DS1 Output

This output provides a selected DS1 digroup signal demultiplexed by the HP 3789B from the input DS3 signal. This output signal may be further demultiplexed by external equipment (such as the HP 3787B Digital Data Test Set) for testing at lower rates.

External Control

Both HP-IB and RS-232-C ports are fitted as standard. Either can be used to control the HP 3789A/B remotely and to pass measurement results to an external printer.

General

Power Supply: AC 115V and 240V, 48 to 66 Hz; DC -22V to -57V (with option 005).

Size: 191mm high; 426mm wide; 559mm deep (7.5 x 16.7 x 22 ins.).

Net Weight: 16kg (35lbs) approx depending on option.

Operating Temperature: 0° to +50°C.

Ordering Information

HP 3789A: The standard package consists of receiver; generator with 6 outputs; both HP-IB and RS-232-C ports fitted; real-time clock; WECO 560A type connectors fitted to Rx and Tx; integral access switch controller. For additional capability select from the following:
Opt 005 Built-in operation from 24/48V DC supplies. \$875
Opt 010 24-col built-in printer. \$565

HP 3789B: The standard package consists of receiver; generator with 6 outputs; built-in demultiplexer to DS1; both HP-IB and RS-232-C ports; real-time clock; WECO 560A type connectors fitted to Tx and Rx (alternative connector types are available); integral access switch controller. For additional capability select from the following:
Opt 002 2nd measurement capability (including C-bit parity generation/measurement and jitter measurements at DS1). \$550

Opt 003 2nd measurement capability (including C-bit parity generation/measurement and jitter measurements at both DS1 and DS3). \$1,490

Opt 004 Delete option - removes DS1 output capability. -\$350

Opt 005 Built-in operation from 24V/48V DC supplies. \$875

Opt 010* 24-column built-in printer. \$565

Opt 011* Built-in 3.5 inch disc drive. \$720

*NOTE: Options 010 and 011 are mutually exclusive.

HP 3789A DS3 Transmission Test Set \$9,800

HP 3789B DS3 Transmission Test Set \$12,050

TELECOMMUNICATIONS TEST EQUIPMENT

A total Solution for Digital Data Services and Equipment Testing

Model 3787B

- ISDN 'B' or 'D' channel Protocol Analyzer interface
- Comprehensive bit error measurements and analysis at DS1C, DS1, DS0 and DDS interfaces.
- Sub-rate drop and insert capability.
- Built-in data logging capability.
- DS1 Jitter analysis.

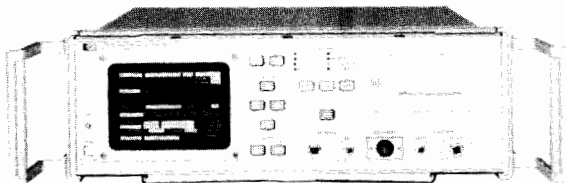

HP 3787B



RS-232-C

HP 3787B Digital Data Test Set

Description

The HP 3787B Digital Data Test Set is a Bit Error Rate Tester (BERT) designed for use on T1 leased, Digital Data System (DDS), 56kbit/s switched and Packet Switched services transmission line and multiplexing equipment.

Digital data circuits are sold with a guaranteed Quality-of-Service (eg DDS circuits offer >99.5% Error Free Seconds in a 24 hour period and 99.95% Availability). To maintain this high quality of service, Service Providers need test equipment that will provide in-service network monitoring and fast out-of-service testing.

The HP 3787B has a comprehensive range of in-service features (eg. Frame, CRC, BPV and Jitter analysis, alarm monitoring, internal printer for data logging etc) which maximizes circuit availability by detecting circuit deteriorations and intermittents, before they seriously affect the service.

The HP 3787B also provides comprehensive out-of-service features (eg Logic (binary) test patterns, Frame Slips, full range of T1/DDS loopback codes etc) which are used to provide qualitative results for circuit troubleshooting and end-to-end test results which relate to actual in-service performance.

Signaling System No. 7 and DMI testing

For the development or maintenance of DMI (Digital Multiplexed Interface) and Signaling Systems No. 7, you can connect a protocol analyzer to the HP 3787B and substitute the BER test pattern with one from the protocol analyzer. In this mode, the HP 3787B acts like a DS1 Channel Access Unit - enabling any 'B' or 'D' channel to be accessed for protocol analysis.

Who needs an HP 3787B?

If you are involved in manufacturing, installing, commissioning or maintaining combined DS1/1C/DDS systems you have the problem of buying test gear to match your test requirements. You need DS1/1C testers, DDS testers and DS1/1C channel access equipment etc.

The HP 3787B solves this problem by satisfying all of these test requirements and more in a single unit. The combination of three test sets in one is not the end of our total solution - we also have a built-in printer, many methods for presenting the error information (e.g. Count, BER, ES, EFS etc) and error analysis (e.g. % Availability, %EFS, %Severely Errored Seconds, Consecutive SES etc.).

Specifications

For details, ask your local HP sales Office for an HP 3787B data sheet and specification booklet.

Drop and Insert

If the Transmitter/receiver signal is suitably framed (eg a DS1 ESF signal), test patterns or control codes can be inserted into/extracted from the following:

An individual customer timeslot (64k and 56kbit/s).

DDS 2.4k, 4.8k, 9.6k, 19.2k and 56 kbit/s primary and secondary channels (DS0A and DS0B).

4kbit/s Datalink (DS1 ESF).

4kbit/s Fs channel (DS1 Ft).

8kbit/s R-channel (DS1 T1DM).

Measurement Capability

Operating Frequency: DS0 (64kbit/s), DS1 (1.544Mbit/s), DS1C (3.152Mbit/s).

Framing: DS1 (SF, ESF, T1DM and Ft only), DS1C and DS0B.

Line Code: B8ZS, AMI.

Error Types: Logic (Binary), Bipolar Violations, Frame Word, CRC-6 Word.

Error Results: Error Count, Error Ratio, Error Seconds, Error Free Seconds, % Error Free Seconds.

Error Analysis: % Availability, % Unavailability, % Severely Errored Seconds, % Error Seconds, % Degraded Minutes, Count Consecutive SES, Count SES, Count ES, Count Deg Min.

Alarm Seconds: Instrument Power Loss Seconds, Signal Loss Seconds, AIS Seconds, Frame Loss Seconds (ie DS1C, DS1 or DS0B), Test Pattern Loss Seconds.

Frame Slips (Controlled): Duplicated frames are indicated as positive frame slips. Deleted frames are indicated as negative frame slips.

Protocol Analyzer Interface: RS-232-C 4-wire synchronous interface. When interfacing at DS1 or DS0, the following channels can be accessed: DDS primary and secondary channels, ISDN 'B' or 'D' channels (64/56 kbit/s), ESF datalink or D4 Fs channel.

DS1/DS1C Signal Voltage: Positive and Negative peak voltage displayed.

DS0 Bit Monitor: Selected received customer bytes displayed.

Signalling Bits: A,B (SF) or A,B,C,D (ESF) signalling bits can be set and displayed when 56kbit/s circuit switched is selected.

DS1 Jitter Measurement (Option 001)

Peak-to-Peak Jitter: Range 0.00 to 10.00 Unit Intervals (UI) pk-to-pk, in 0.01 UI steps.

Jitter Filters: LP=2Hz to 40kHz, HP1+LP=10Hz to 40kHz, HP2+LP=8kHz to 40kHz.

Jitter Hit Threshold: 0.05 to 10.00 UI pk-to-pk in 0.01 UI pk-to-pk increments.

Jitter Hit Measurements: Jitter Hit Count, Jitter Hit Bit Count, Jitter Hit Bit Ratio, Jitter Hit seconds, Jitter Hit Free Seconds.

Ordering Information

HP 3787B Digital Data Test Set.

Prices

\$8,990

HP 3787B Options

001: DS1 Jitter. \$925

002: DC Capability. \$615

909: 19-inch Rackmount. \$154

910: Extra Operating and Service Manuals. \$103

Accessories available

HP 15668A: Front Panel DDS Clock Cable. \$128

HP 15669A: Rear Panel DDS Clock Cable. \$128



Digital Radio System Measurements

Digital microwave systems form part of many communications networks. They are cost effective and simpler to install than cable or fiber. A digital radio carries a stream of digital information by modulating an RF carrier to a number of discrete amplitude and phase states. To handle increasing data requirements, carriers have adopted higher order modulation schemes. More complex schemes such as 64 QAM and 256 QAM are less resilient to impairments than less complex modulation formats. Satellite and military users adopt low order modulation schemes such as QPSK because they are less susceptible to error and data corruption.

Some analog measurements are suitable for digital radio systems, but specific dedicated measurements are also required to fully characterize digital radio performance, such as the evaluation of Bit Error Ratio (BER) performance under flat fade conditions and at residual noise levels. New techniques are now available to allow in-service performance evaluation; Constellation analysis provides detailed information about overall radio performance at a glance, without the need to take the radio out of service. More powerful than eye pattern analysis, constellation analysis provides more information in greater detail.

Simulating Impairments

The HP 3708A Noise and Interference Test Set and HP 11757A Multipath Fading Simulator provide accurate simulation of radio operating conditions. The HP 3708A simulates calibrated C/N and C/I ratios for making out-of-service C/N vs BER and C/I vs BER measurements. These tests simulate noise and interference conditions experienced in radio equipment over radio links. The multipath fading simulator simulates static or dynamic effects of multipath fading, considered by many to be the predominate cause of radio outages. Both products are designed for R&D, manufacturers, and operating companies. Together they provide simulation of all the significant elements of the radio operating environment.

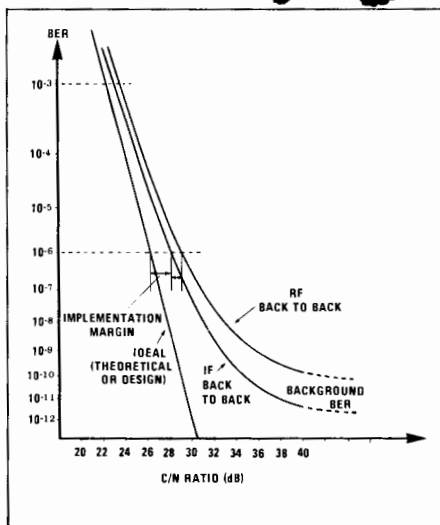

Standard out-of-service measurements made using the HP 3708A

Measuring Digital Radio Modulation

The HP 3709B, Constellation Analyzer, HP 8980A, and HP 8981A Vector Modulation Analyzers bring calibrated modulation measurements to digital microwave radio and satellite communications systems. All three of these analyzers pack the power of constellation analysis. By monitoring the I and Q baseband signals or modulated IF (HP 8981A only) in the receiver, these analyzers quantify subtle distortions such as constellation closure, lock and quadrature angle error, and eye closure. The HP 3709B also provides detailed non-linear distortion measurements, which provide rapid radio pre-distorter and RF amplifier optimization. HP Thinkjet Portable Printer connection provides hardcopy constellation display and measurement output for building radio impairment catalogs. All measurement results are available over the HP-IB bus for automated applications in manufacturing.

A Portable Digital Radio Test Set

Though digital radio is thought to overcome certain disadvantages of its analog ancestors, it is precision analog operation that makes the digital benefits possible. To ensure reliable, quality digital radio system opera-

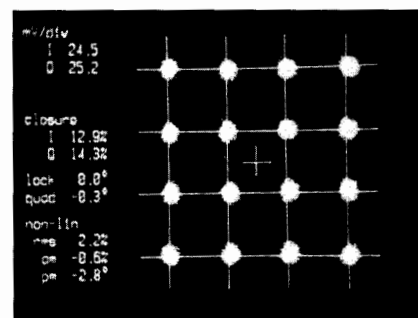

Constellation Pattern from the HP 3709B showing measurements (16 QAM radio)

tion, several analog measurements are necessary in the installation, commissioning, and maintenance of a digital radio system, including spectrum occupancy, flatness, output power and frequency, tolerance to multipath fading, intermodulation distortion, and susceptibility to interference. The HP 11758T Digital Radio Test Set is the first portable measurement solution with all of these measurements in one integrated solution.

FDM Measurements

Frequency Division Multiplex (FDM) systems are the traditional method of transmitting a number of telecommunications channels over a single wideband transmission medium. Each channel is allocated part of the frequency spectrum, from 12-24 channels in narrow satellite or radio systems, to 2700 or 3600 channels in high capacity systems.

The HP 3746A Selective Level Measurement SET (SLMS), developed from the HP 3586A/B, has been optimized for FDM maintenance measurements, particularly in automatic network monitoring systems. Customers expect high network performance levels so rapid fault location and system degradation analysis is necessary. Hewlett-Packard offers two automatic FDM network monitoring systems designed around the HP 3746A SLMS: the HP 37051S based on the HP 9000 series 300, and the HP 37050S system based on the HP 1000 A-series computer. The HP 37051 S is a low-cost measurement system for smaller networks providing control of up to 10 remote measurement subsystems. The system stores database information on the test points and allows running of an automatic measurement system using sequencing files. These can be interrupted at any time for demand measurements.

The HP 37050 S system has all of these features and in addition can control up to 16 remote subsystems per computer. It provides comprehensive data reduction and results reporting - for the larger system this is essential. The computer utilizes powerful Real-Time Executive (RTE) operating system software, so (unlike the HP 37051 S) can provide simultaneous measurements at multiple sites and support several users at local or remote terminals. The HP 37050 S can be readily extended to cover a very large network by linking computers using distributed system software.

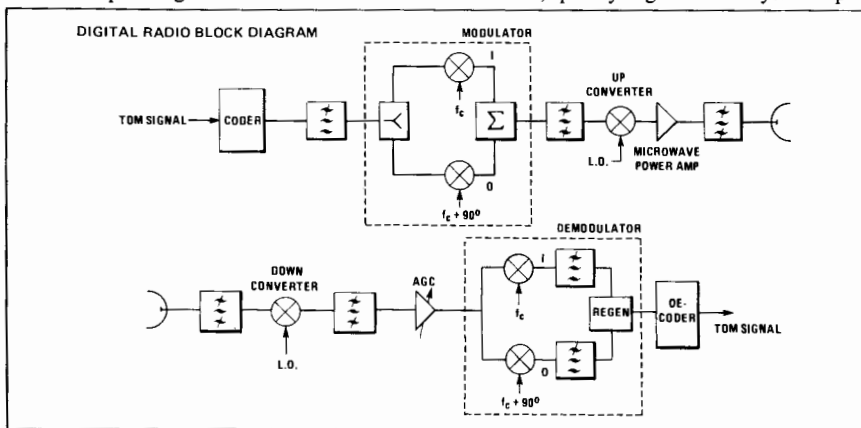

Digital Radio Block diagram

TELECOMMUNICATIONS TEST EQUIPMENT

Selective Level Meter and Synthesizer

HP 3586A/B, 3336A/B

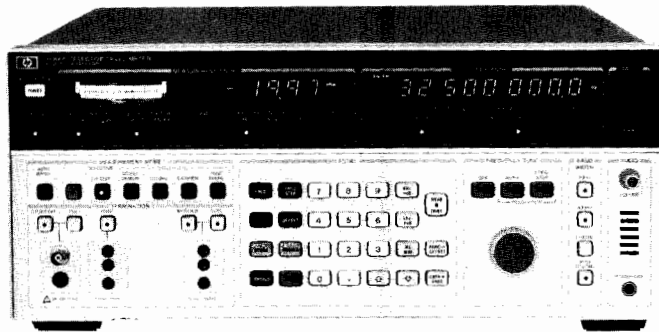

HP 3586A Selective Level Meter (CCITT)



Selective Level Meters and Synthesizer

The HP 3586A/B Selective Level Meters and HP 3336A/B Tracking Synthesizers offer the high performance necessary to meet the demanding requirements in the design, manufacture, commissioning and maintenance of frequency division multiplex (FDM) systems. The HP 3586A and HP 3336A models meet CCITT requirements, and the HP 3586B and HP 3336B models meet North American (Bell) standards. Both are fully programmable over the HP-IB interface bus. The features of the HP 3586A/B selective level meter include wideband power and optional telephone impairment measurement of impulse noise, phase jitter, noise with tone, and signal-to-noise with tone ratio. The wide frequency coverage to 32.5 MHz allows measurements at both voice channel and carrier frequencies. Microprocessor control adds many ease-of-use features such as amplitude offset measurements of tone and noise level in units of dBmO, dBmCO, or dBpWO. Convenience features include simultaneous analog and digital level displays, precise frequency setting with the HP fractional N synthesized local oscillator, accurate frequency counter and tone measurements with automatic channel alignment for 800 Hz (CCITT) or 1004 Hz (Bell) test tone or carrier frequency reference.

The HP 3336A/B Synthesizer/Level Generator is an excellent precision tracking signal source for the HP 3586A/B selective level meters. When the selective level meter (SLM) and synthesizer are in the tracking mode, the frequency of the synthesizer is automatically set to the frequency of the SLM. Frequency coverage is 10 Hz to 20.9 MHz, making the HP 3336 useful for telephone circuit loop testing on most FDM systems, transfer function and distortion measurements in telecommunications manufacturing.

Carrier Frequency and Voice Channel

The HP 3586A/B can make both carrier frequency measurements to 32.5 MHz and voice channel measurements from 50 Hz to 100 kHz.

You can measure tone levels, idle channel noise or weighted noise at voice channel, then compare at carrier frequency.

Transmission Impairments

The transmission impairments capability permits phase jitter, weighted noise, noise-with-tone, signal-to-noise-with-tone ratio, and single level impulse noise measurements. The HP 3586A/B capability to make these transmission impairment measurements at both FDM voice channel and carrier frequencies is unique.

Frequency and Amplitude Precision

The HP 3336A/B provides frequency resolution of one microhertz (.000001 Hz) up to 100 kHz and one millihertz (.001 Hz) to 20.9 MHz. Level accuracy is ± 15 dB at full output over the full frequency range with ± 12 dB optional. Harmonic levels are more than 60 dB down to 1 MHz and more than 50 dB down to 20.9 MHz, performance not previously available in a synthesizer.

FDM Testing

The flexible output section allows different connectors to be provided either by option or special request. Frequency entry is accomplished by keyboard or analog control for manual tuning or frequency stepping of any digit.

The amplitude blanking feature allows testing of operational FDM systems without disturbing adjacent channels while the frequency is changed. The output is blanked to less than -85 dBm until the next desired frequency is reached.

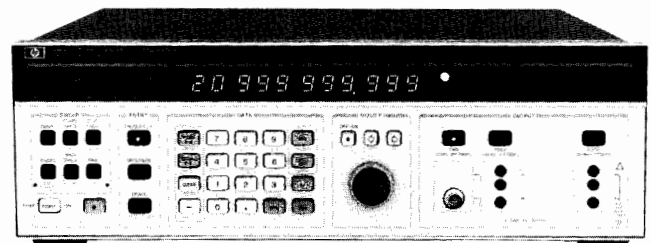

HP 3336A Synthesizer/Level Generator (CCITT)

General-Purpose Synthesizer Features

The HP 3336A/B Synthesizer provides wide band sweep capability — sweep the full frequency range (or as little as two microhertz), log or linear, single or continuous. Single phase lock loop design means the sweep is phase continuous and you can modulate with AM to 50 kHz or PM to 5 kHz. Ten storage registers can be used to keep different test settings available for repetitive test.

North American (Bell) and CCITT Requirements

The HP 3586A/B Selective Level Meter and HP 3336A/B Synthesizer/Level Generator are designed to meet most world-wide connector and impedance requirements for both carrier and voice channel measurements. Special or regional connectors can be provided by option or special request.

HP 3586A/B Specifications

(See data sheet or manual for complete specifications)

Frequency

Signal Input	HP 3586A	HP 3586B
75 Ω Unbalanced	50 Hz to 32.5 MHz	
124 Ω Balanced		4 kHz to 10 MHz
135 Ω Balanced		4 kHz to 1 MHz
150 Ω Balanced	4 kHz to 1 MHz	
600 Ω Balanced	100 Hz to 108 kHz	

The 124 Ω , 135 Ω , 150 Ω and 600 Ω inputs are usable over wider frequency ranges, but are not specified in under and overrange operation.

Frequency resolution: 0.1 Hz

Center frequency accuracy: $\pm 1 \times 10^{-5}$ /year ($\pm 2 \times 10^{-7}$ /yr with option 004)

Counter accuracy: ± 1.0 Hz in addition to center frequency accuracy for signals within the 60 dB bandwidth of the IF filter chosen or greater than -100 dBm (largest signal measured).

Frequency display: 9 digit LED.

Selectivity

3 dB Bandwidth, $\pm 10\%$

HP 3586 (CCITT)	HP 3586B (N. American)
20 Hz	20 Hz
400 Hz	400 Hz
3100 Hz	3100 Hz
Psophometric Noise Weighting	C-Message Noise Weighting

Adjacent channel rejection: 75 dB minimum at ± 2850 Hz, 3100 Hz BW

Passband flatness: ± 0.3 dB

Amplitude

Measurement range: +20 to -130 dBm

Amplitude resolution: .01 dB

Level accuracy: 10 dB autorange, low distortion mode, after calibration.

20 Hz and 400 Hz BW below -80 dBm.

**Dynamic range****Spurious responses**

Image rejection (100-132 MHz): -80 dBc

IF rejection: 15625 Hz, -80 dBc; 50 MHz, -60 dBc

Non-harmonic spurious signals: >1600 Hz offset, -80 dBc; 300 Hz to 1600 Hz offset, -75 dBc.**Distortion****Harmonic distortion:** -70 dB below full scale >4 kHz on 75 Ω and 600 Ω inputs), low distortion mode**Intermodulation distortion:** two-tone second and third order, separation 7 kHz to 1 MHz, 75 dB below full scale. Either tone ≥ 10 MHz, -70 dB.**Wideband power accuracy:** After calibration, 100 dB range, averaging on, -45 to +20 dBm.**Noise floor** (full scale setting -35 to -120 dBm)

Frequency	Bandwidth	Noise Level
100 kHz to 32.5 MHz	3100, 1740, 2000 Hz	-116 dBm
	20 Hz, 400 Hz	-120 dBm
10 kHz to 100 kHz	All	-105 dBm

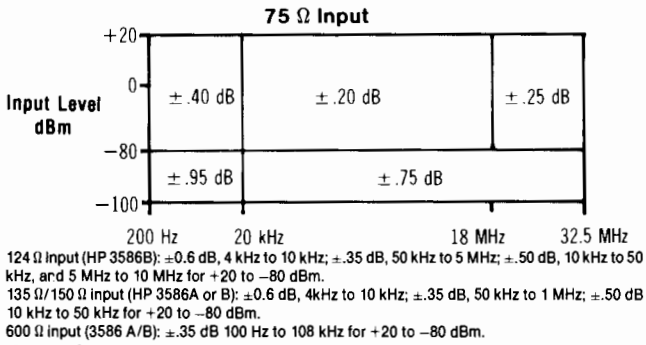
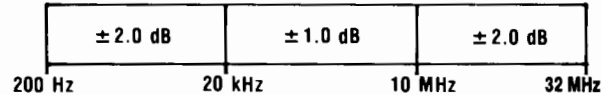
The noise floor for full scale settings of -30 to +25 dBm will be 80 dB below full scale for > 100 kHz, or 60 dB below full scale for 2 kHz-100 kHz.

Signal inputs**Balance**

Input	Frequency	Balance
124 Ω	10 kHz to 10 MHz	-36 dB
135 Ω or 150 Ω	10 kHz to 1 MHz	-36 dB
600 Ω	50 Hz to 108 kHz	-40 dB

Auxiliary signal inputs/outputs**Demodulated audio output:** 0 dBm into a 600 Ω load, adjustable.**Tracking generator:** 0 dBm rear panel tracking output.**External reference input:** 10 MHz ÷ n, where n = 1, 2, 3...10.**Reference output:** 10 MHz, +8 dBm output.**General****Power:** 100/120/220/240 V, +5%, -10% 48 to 66 Hz, 150 VA.**Weight:** net, 23kg (50lb); shipping, 30kg (65lb)**Size:** 177H x 425.5W x 466.7mmD (7" x 16.75" x 18.38")**HP 3336A/B Specifications****Frequency****Frequency range of signal outputs**

Signal Output	HP 3336A	HP 3336B
75 Ω Unbalanced	10 Hz to 20.999 999 999 MHz	
124 Ω Balanced		10 kHz to 10.999 999 999 MHz
135 Ω Balanced		10 kHz to 2.099 999 999 MHz
150 Ω Balanced	10 kHz to 2.099 999 999 MHz	
600 Ω Balanced	200 Hz to 109.999 999 kHz	

All balanced outputs are usable over wider frequency ranges but are not specified in under and overrange operation. Resolution: 1 μHz for frequencies < 100 kHz, 1 mHz for frequencies ≥ 100 kHz.

Amplitude**Range:** 75 and 600 Ω outputs: -72.99 to +7.00 dBm 124, 135 and 150 Ω outputs: -78.23 to +1.76 dBm**Spectral purity****Phase noise:** <-72 dB, HP 3336A and HP 3336B, for a 3 kHz band, 2 kHz either side of a 20 MHz carrier.**Harmonic level:** -35 dB, 10 Hz to 30 Hz; -50 dB, 30 Hz to 50 Hz; -60 dB, 50 Hz to 1 MHz; -55 dB, 1 MHz to 5 MHz; -50 dB, 5 MHz to 20 MHz.**Spurious:** All non-harmonically related signals will be more than 70 dB below the fundamental or -100 dBm (-115 dBm with option 005 except 150 to 600 Ω), whichever is greater.**Phase offset****Range:** ± 719.9° with respect to arbitrary starting phase or assigned zero phase.**Resolution:** 0.1°.**Increment accuracy:** ±0.2°.**Ambient stability:** ±1.0 degree of phase per degree C.**Frequency sweep****Sweep time:** Linear sweep, 0.01 s to 99.99 s; single log sweep, 2 s to 99.99 s; continuous log sweep, 0.1 s to 99.99 s**Maximum sweep width:** specified frequency range of selected output.**Minimum sweep width:** log sweep, 1 decade; linear sweep, minimum sweepwidth (Hz) = 0.1 (Hz/s) x sweep time(s).**Phase continuity:** sweep is phase continuous over full frequency range.**Sweep flatness:** ± 0.15dB, fast leveling, 10 kHz to 20 MHz, 0.03 s sweep time; ± 0.15 dB, normal leveling, 50 Hz to 1 MHz, 0.5 s sweep time.**Amplitude modulation:** modulation depth, 0 to 100%. Modulation frequency range, 50 Hz to 50 kHz.**Phase modulation:** range, 0 to ±850°. Modulation depth, 0 to 100%. Modulation frequency range, 50 Hz to 50 kHz.**Phase modulation:** range, 0 to ±850°. Linearity, ± 0.5% from best fit straight line. Modulation frequency range, dc to 5 kHz.**External leveling:** input from an external voltage source to regulate the signal amplitude at a remote point.**General****Power requirements:** 100/120/220/240 V, +5%, -10%, 48 to 66 Hz, 60 VA, (100 VA with all options), 10 VA standby**Size:** 132.6H x 425.5W x 425.5mmD (5 1/4" x 16 3/4" x 16 3/4")**Weight:** net, 10kg (22lb); shipping, 15.5kg (34lb)**Ordering Information**

	Price
HP 3586A Selective Level Meter (CCITT)	\$11,550
Opt 001 1.6/5.6 mm 75 Ω Connector	+\$103
Opt 004 High Stability Frequency Reference	+\$775
HP 3586B Selective Level Meter (North American)	\$11,550
Opt 001 75 Ω connector mates with WECO 358A and 124 Ω connector mates with WECO 372A	+\$103
Opt 004 Same as HP 3586A	
HP 3336A Synthesizer/Level Generator (CCITT)	\$5470
Opt 001 1.6/5.6 mm 75 Ω Connector	+\$105
Opt 004 High Stability Frequency Reference	+\$685
Opt 005 High Precision Attenuator	+\$685
HP 3336B Synthesizer/Level Generator (N. American)	\$5470
Opt 001 75 Ω WECO 358A, 124 Ω WECO 372A	+\$105
Opt 004, 005 Same as HP 3336A	+\$685
HP 3581C Low Frequency Selective Voltmeter (15 Hz to 50 kHz)	see page 144.

TELECOMMUNICATIONS TEST EQUIPMENT

Selective Level Measuring Set, Down Converter, FDM and Radio Access

HP 3746A, 3754A, 3755A, 3756A, 3757A, 3730B, 3717A

HP 3746A, 3754A, 3755A, 3756A, 3757A

- Fast, accurate measurements on FDM systems
- Automatic tuning to stored frequency plans
- Select one from up to 1000 inputs/outputs

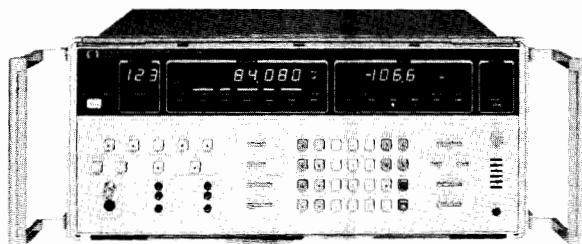

HP 3746A

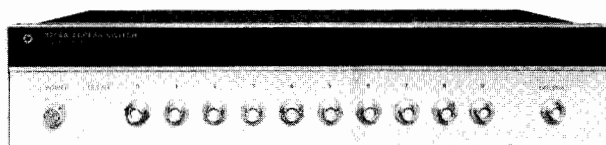

HP 3754A

Selective Level Measuring Set (SLMS)

The HP 3746A Selective Level Measuring Set (SLMS), 50 Hz to 32 MHz, makes fast, accurate selective level measurements. Tuning can be performed by entering a single frequency, stepping between frequency limits, stepping through a set of unrelated frequencies, or by FDM plan description.

The SLMS is optimized for FDM maintenance measurements and network monitoring. It allows for scanning of FDM signals and limit checking of measured levels. Special hot-tone search routines can rapidly detect high-level signals. The SLMS can directly control access switches for system applications. It has a built-in real-time clock and printer control for data logging. It is fully HP-IB programmable, and it can be used as the heart of a self-contained measurement system or integrated into a computer-controlled system such as the HP 37050S FDM Network Monitoring System or HP 37051S FDM Measurement System.

Switches and Switch Controller

The HP 3754A, 3756A, and 3757A access switches and the HP 3755A switch controller allow a single instrument to access multiple test points from dc to 90 MHz. Each switch has 10 inputs. Switches can be cascaded to access up to 1000 points, for example, to feed FDM test points to an HP 3746A SLMS, or DS3 test points to an HP 3789B DS3 Transmission Test Set.

Ordering Information

	Price
HP 3746A Selective Level Measuring Set	\$15,000
Opt 001 Siemens series 1.6/5.6 mm 75 ohm connectors	\$0
Opt 005 WECO 477B/223A (equivalent) connectors	+\$75
Opt 011 48 kHz group filter	+\$1,300
Opt 012 tracking generator	+\$410
Opt 014 high-stability frequency reference	+\$850
Opt 015 channel impairments - CCITT	+\$580
Opt 016 channel impairments - North America	+\$580
HP 3754A 25 MHz Access Switch	\$3,600
HP 3755A Switch Controller	\$3,200
HP 3756A 90 MHz Bi-directional Switch	\$4,200
HP 3757A 8.5 MHz Access Switch	\$1,300

NOTE: The standard versions of these switches have BNC connectors and 75 ohm terminations. Different connectors are available as options on some models.

HP 3730B, 3736B, 3737B, 3738B, 3739B, 3717A

- Down convert to IF from up to 14.5 GHz RF
- Baseband access to 70 MHz IF points
- Test analog and digital radios

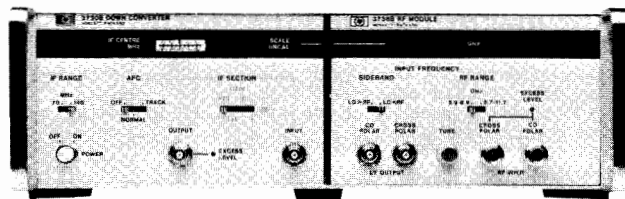

HP 3730B

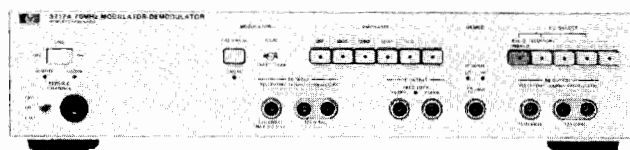

HP 3717A

Down Converter and RF Modules

The HP 3730B Down Converter and RF modules convert 0.7-14.5 GHz RF signals to either a 70 or 140 MHz IF. The down converter combines the convenience of multi-band frequency coverage with excellent residual performance. Four standard RF module plug-ins cover the input frequency range in convenient bands. The instrument minimizes inherent non-flatness in its amplitude response, group delay, differential phase and differential gain characteristics. This enables reliable evaluation of TDMA/FDMA satellite earth station transmitters, for example. It also allows accurate measurement of white-noise loading (NPR).

Modulator-Demodulator

The HP 3717A 70 MHz Modulator-Demodulator is a portable test modem for use on 70 MHz IF microwave radio systems. It has up to five selectable pre-/de-emphasis networks from a choice of sixteen. The main application is providing baseband (BB) signals at non-demodulating repeater stations. The HP 3717A facilitates hop-by-hop measurements such as white-noise loading (NPR) and baseband frequency response. It can also be used with the HP 3746A SLMS to make FDM measurements at IF points on an analog radio system.

Ordering Information

	Price
HP 3730B Down Converter	\$5,550
HP 3736B RF Module 1.7 to 4.2 GHz	\$6,990
HP 3737B RF Module 3.7 to 8.5 GHz	\$8,330
HP 3738B RF Module 5.9 to 11.7 GHz	\$9,870
HP 3739B RF Module 10.7 to 14.5 GHz	\$15,500
HP 3717A 70 MHz Modulator-Demodulator	\$16,050

NOTE: Contact your HP sales representative to get a data sheet with details of connectors, emphasis network, and other options.

TELECOMMUNICATIONS TEST EQUIPMENT

Microwave Radio Noise and Interference Test Set, Multipath Fading Simulator

507

HP 3708A, 11757A

HP 3708A

- Carrier tracking maintains accurate & repeatable C/N & C/I conditions
- Fast, alternative residual BER measurement
- Accurate simulation of radio system interference

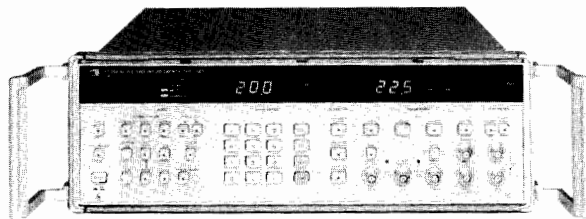

HP 11757A

- Test equalizers and diversity combiners, measure M-curves
- Fixed or moving notch
- Simplified 3-path model
- High performance, lightweight, rugged, easy-to-use

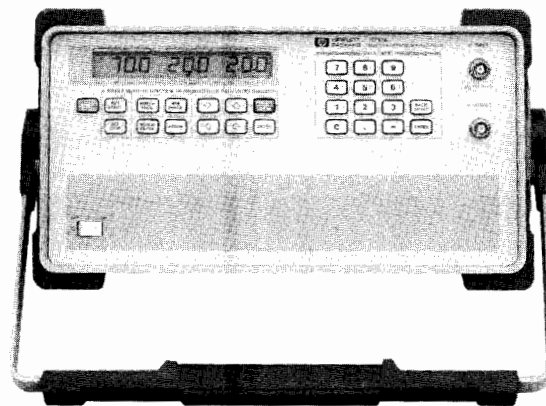

HP 3708A Noise and Interference Test Set

To minimise lost transmission revenue and the cost of equipment repair, an accurate, overall performance assessment of radio systems is required. This allows potential faults to be corrected before they begin to cause problems. The HP 3708A provides an accurate method of assessing performance of microwave radio and satellite modem systems by providing the Carrier to Noise (C/N) and Carrier to Interference (C/I) conditions necessary to make C/N & C/I vs Bit Error Ratio (BER) measurements.

The instrument is designed for easy access to the IF section of the radio system. The carrier level is monitored and calibrated levels of interference and Gaussian noise are added to stress the system in a controlled way. Accurate and repeatable C/N and C/I ratios can be maintained even in the presence of severe signal variations.

The HP 3708A has the flexibility to accommodate a wide variety of radio designs, a selection of calibrated internal filters giving accurately specified Carrier to Noise ratios in any noise bandwidth. The interference facility allows the addition of a wide variety of interference signals to accurately simulate the effects of radio interference on system performance.

CCIR recommendations 594 recognize the importance of residual BER in assessing the overall performance of digital radio systems. The HP 3708A provides the capability to significantly reduce residual BER measurement time, and increase the confidence in measurement accuracy.

The HP 3708A is equally at home in manufacturing, commissioning or maintenance. Its measurement accuracy allows small changes in performance to be identified with confidence, for correct diagnosis of specific impairments.

Options

Std: 75 ohm unbalanced connector, Reference tone oscillator frequency is 70/140 MHz.

001: 50 ohm unbalanced connector.

Special options: Reference tone oscillator frequencies, specifically for portable application of the HP 3708A in determining residual BER, are available on a special order basis.

Ordering Information

HP 3708A Noise and Interference Test Set \$16,750
Opt W30 Extended Repair Service. See page 725. +\$410

HP 11757A Multipath Fading Simulator

The HP 11757A Multipath Fading Simulator tests the equalizers and diversity systems in modern digital microwave radios by inserting a notch in the spectrum. The depth, position, minphase/nonminphase, and delay characteristics of the notch can be adjusted. The notch can be stationary to make measurements such as M-Curves (signatures), or it can be swept in depth and position to test radios under dynamic conditions.

The simulator can also play back tables of realistic fading activity that can be stored in nonvolatile memory in the instrument. The rate of change of the notch characteristics can be set, and all transitions occur without glitches or transients that would disturb a measurement. Multiple units can be synchronized to test diversity systems.

Specifications

Notch Frequency

Range: Standard: 40 MHz to 100 MHz
 Opt 140: 110 MHz to 170 MHz
 Opt 147: both bands

Resolution: 100 kHz

Accuracy: ±150 kHz

Depth

Range: 0 to 40 dB

Resolution: 0.1 dB

Accuracy: Notch Depth Accuracy

1-20 dB ±0.75 dB

21-30 dB ±1.50 dB

31-40 dB ±3.00 dB

Delay

Range: 1 to 25 ns

Resolution: 0.1 ns

Accuracy: 0.5 ns

Attenuation/Gain

Range: 12 dB gain to 50 dB attenuation

Resolution: 0.1 dB

Accuracy: ±2 dB

Sweep

Sweep time: 100 ms to 99.9 s

Max. slew rates: freq: 600 MHz/s
 depth: 450 dB/s

Weight: 9kg (20lbs)

Ordering Information

HP 11757A Multipath Fading Simulator (70 MHz band) \$14,000
Opt 140 140 MHz band \$0
Opt 147 Both 70MHz and 140 MHz bands +\$1,000

TELECOMMUNICATIONS TEST EQUIPMENT

Microwave Radio Noise and Interference Test Set; Digital Radio Constellation Analyzer Vector Signal Generator

Models 8780A, 8980A, 8981A, 3709B, 15709A

HP 8780A

- 10 MHz to 3 GHz synthesizer
- BPSK, QPSK, 8PSK, 16QAM, Optional 64QAM
- Burst digital modulation

HP 8980A

- Analyzes coherent phase and amplitude modulation
- 350 MHz I vs. Q bandwidth
- Markers for measuring phase, amplitude and time
- 12-bit digitizing for HP-IB measurements

HP 8981A

- Adds 50 MHz to 200 MHz I/Q demodulator
- Demodulates up to 70 MHz B.W. communications signals
- $<0.5^\circ$ quadrature error and <0.1 dB amplitude imbalance

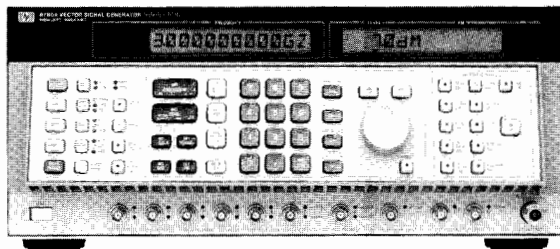

HP 8780A

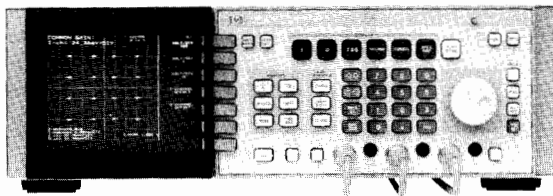

HP 8980A/8981A



HP 8780A Vector Signal Generator

The HP 8780A Vector Signal Generator is a synthesized source with exceptional modulation for modern digital microwave radio and satellite communications testing. The Vector Signal Generator offers a wide variety of modulation using both digital and analog inputs. It generates standard formats from BPSK to 64QAM and traditional modulation like FM, AM, and pulse, as well as sophisticated complex modulation.

HP 8980A Vector Analyzer and HP 8981A Vector Modulation Analyzer

The HP Vector Analyzers are two-channel X-Y sampling oscilloscopes designed to analyze the in-phase (I) and quadrature phase (Q) components of modern digital microwave radio signals such as QPSK, 16QAM, and 256QAM. The HP 8981A adds a 50 MHz to 200 MHz demodulator.

Applications

The vector signal generator, vector analyzer and vector modulation analyzer are well suited to testing modern terrestrial and satellite receivers and transmitters.

The HP 8780A standard modulation patterns — BPSK, QPSK, 8PSK, 16QAM and 64QAM (with Opt. 064) — are easily generated using standard data generators. Asynchronous TDMA modulation can be simulated using the Burst feature along with one of the PSK modulations. A coherent carrier output simplifies quadrature and gain alignment of vector (I/Q) demodulators.

The HP 8980A constellation analysis feature gives non-intrusive measures of closure, quadrature error, and lock angle error for partial response and QAM formats from QPSK to 256QAM. In addition, the HP 8981A extends these measurements to I.F. signals by accurately demodulating them to measure modulators.

For more information about the HP 8780A, HP 8980A and the HP 8981A, refer to the Signal Generator and Signal Analyzer section of this catalog.

HP 3709B

- For troubleshooting, fine-tuning and preventive maintenance
- Identifies digital radio impairments
- Analyzes magnitude of distortions

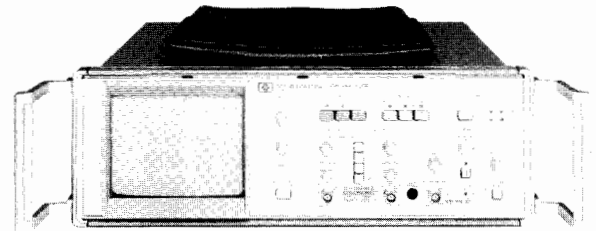

HP 3709B

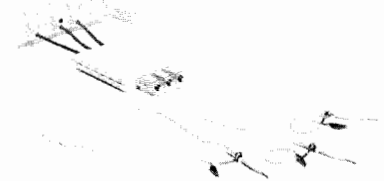

HP 15709A

HP 3709B Constellation Analyzer

The HP 3709B is used to characterize the performance and condition of digital radios both in-service and out-of-service by analysis of constellation patterns. In addition to displaying constellation patterns, the HP 3709B measures the linear and non-linear distortions revealed by the patterns, and can provide a formatted report containing the pattern and measurement results on a ThinkJet printer.

Measurements

Constellation: amplitude, closure, lock- and quad-angle errors, non-linear distortion (rms, am-am, am-pm).

Modulation schemes: QPSK, 16QAM, 64QAM, 256QAM, 9QPR, 25QPR, 49QPR, 81QPR.

Monitor Points

(1) I and Q signals: Any of the above schemes with signal levels in the range 30 to 400 mV p-p across the constellation. (dc offset must be no more than $0.5 \times$ signal amplitude).

(2) Clock: 1 MHz to 80 MHz (100 mV to 1 V p-p)

Impedance level: All HP 3709B inputs are 75 ohm terminated.

Options

001: 50 ohm unbalanced input connectors

003: Siemens series 1.6/5.6 mm input connectors

130: High Impedance Interface Kit. Contains 1 x HP 15709A High Impedance Interface and 3 x HP 10435A 1 metre 10:1 probes

Special Options: A low bit rate version (0.1 – 8 MHz) is available to special order.

HP 15709A High Impedance Interface

This specially designed accessory provides three high impedance, filtered inputs which allow the HP 3709B to be connected to radios without protected 75 or 50 ohm monitor points, using standard oscilloscope passive probes (eg HP 10435A 10:1, 1 metre probe).

Gain: $\times 5$ (= overall $\times 0.5$ gain when used with 10:1 probes)

Impedance: 1 Mohm.

HP 3709B Constellation Display

Option W30: Extended Repair Service.

See page 725

\$12,250

+ \$300

TELECOMMUNICATIONS TEST EQUIPMENT

Digital Radio System, Vector Modulation Signal Generator

HP 11758T, 8782A

509

- Performs 8 different measurements
- Easy to use
- Portable
- 1MHz to 250MHz covers 70 and 140MHz IFs

- BPSK, QPSK, 8PSK, 16QAM, 256QAM, digital modulation and burst
- Internal pseudo random binary sequence (PRBS) generator
- AM/SCALAR modulation to simulate flat fading
- Coherent carrier output

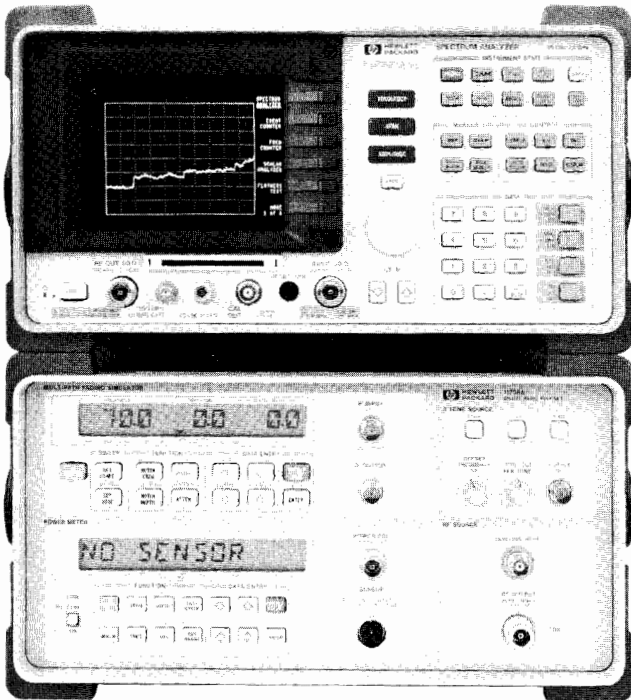

HP 11758T



HP 11758T Digital Radio Test System

The HP 11758T Digital Radio Test System performs the functions that are most commonly used in testing radios in production, installation, and maintenance. The result is a portable, general-purpose radio testing system that performs all of the following measurements:

- Spectral occupancy and purity
- Nonlinear distortion and intermodulation
- Power measurements
- Frequency
- IF-IF, IF-RF, RF-RF, and RF-IF frequency flatness
- Sensitivity to multipath fading
- Antenna return loss
- Signal monitoring and logging

Test Functions

- Spectrum analysis:** 50 kHz to 22 GHz
- Frequency counter:** 10 MHz to 22 GHz,
- IF tracking generator:** 300 kHz to 3 GHz
- Event/interval counters:** dc to 1.6 MHz
- Power meter and sensor:** 10 MHz to 12 GHz
- Multipath fading simulator:** 40 MHz to 170 MHz
- Three tone IF source:** 67, 70 and 75 MHz
- RF source:** 3.5 to 6.5 GHz, 10.7 to 11.7 GHz available

Contact your HP sales representative for more information.

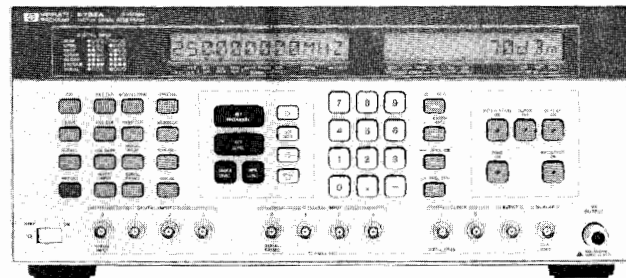

HP 8782A



HP 8782A Low-Cost Vector Generator

The HP 8782A low-cost vector signal generator offers a wide range of built-in digital modulation from BPSK to 256QAM for microwave terrestrial and satellite communication applications. The 1MHz to 250MHz range covers most of the IF frequencies in commercial receivers. An internal pseudo-random bit sequence (PRBS) generator allows digital modulation without external digital data. The HP 8782A provides economical IF signal generation for R&D and manufacturing. The cost is substantially lower than the cost of the HP 8780A Vector Signal Generator.

Applications

Use the HP 8782A to align digital radios in manufacturing. The HP 8782A can be used to provide calibrated constellations with extremely low quadrature error and amplitude imbalance. It can be used to simulate transmitter impairment and to test receiver performance margins.

Ordering Information

	Price
HP 8780A Vector Signal Generator	\$58,000
Opt H02 Analog Phase Modulator	\$4,000
HP 8980A Vector Analyzer	\$25,000
HP 8981A Vector Modulation Analyzer	\$30,000
HP 8782A Vector Signal Generator	Contact Hewlett-Packard

DATA COMMUNICATIONS TEST EQUIPMENT

Protocol Analyzers

Protocol Analyzers

In data communications, protocol can be defined as "rules governing the exchange of information between two pieces of data processing equipment". Different test applications and environments require different protocol analyzers. Hewlett-Packard offers a family of five powerful, general purpose protocol analyzers with software and accessories to meet your special needs. Modern high-speed multivendor, real-time, complex networks make tools for network management a must. A protocol analyzer can make complex testing and network optimization easy with protocol analysis tools for management, installation, maintenance and research and development.

Wide Area Network (WAN) Protocol Analysis

Hewlett-Packard offers a family of three protocol analyzers to meet different wide area networking application requirements. While maintaining family compatibility, each analyzer is tailored for a different environment with different features and characteristics. The **HP 4951C**, **HP 4952A** and **HP 4954A** have common operating, setup, mass store, remote transfer and display characteristics. An overview of the differences can be seen in the chart below.

Local Area Network (LAN) Protocol Analysis

In addition to the family of three WAN protocol analyzers, Hewlett-Packard offers two versatile local area network (LAN) protocol analyzers to assist you with IEEE 802.3, Ethernet, TCP/IP, DECnet, StarLAN and MAP networks.

The **HP 4972A** is a high performance protocol analyzer for managing performance and troubleshooting problems on your IEEE 802.3, Ethernet, TCP/IP, DECnet or StarLan networks. The HP 4972A provides full data capture integrity under high network traffic loads,



and trend analysis with real time network performance statistics, and a complete set of protocol interpreters and performance analysis tools for a number of different protocol stacks. The **HP 4974S** analyzes IEEE 802.4 networks with layer-by-layer decodes of the MAP 3.0 protocols.

Individual product specific information can be found on the following pages.

	HP 4951C	HP 4952A	HP 4954A
Size (HWD-cm) (HWD-inches)	16.0x27.9x34.3 cm 6.3x11.0x13.5 in.	Same As HP 4951C	19.6x42.5x56.5cm 7.7x16.7x22.2 in.
Display Size	5-in. diagonal	Same As HP 4951C	9-in. diagonal
Weight	6.7 kg (14.8 lb)	7 kg (15.4 lb)	21.17 kg (46.7 lb)
Operating Speeds - full functionality - fast capture mode	50 bps-19.2 kbps 64 kbps	50 bps-64 kbps 128 kbps	50 bps-72 kbps 256 kbps
Autoconfigure	Yes	Yes	No
Data Buffer Size	32K byte	32K byte, Opt. 3/4 M byte	256K byte
Mass Storage	3.5-in. floppy	3.5-in. floppy	3.5-in. floppy 20M byte hard disk
BERT	Yes	Yes	No
Protocols	Aysnc, Bisync, SDLC, HDLC X.25, SNA, DDCMP, IPARS	Async, Bisync, SDLC, HDLC, X.25, SNA, DDCMP, IPARS, X.21, ISDN (Q.921 and Q.931)	Async, Bisync, SDLC, HDLC, X.25, SNA, DDCMP, X.21, CCITT #7, ISDN (Q.921, Q.931, Q.932)
SNA Testing	FID 2 data decoded 3270 tester Link Level Statistics	All FID types decoded User-definable data display 3270 tester Link Level Statistics	All FID types decoded SNA development language 3270 device exerciser LU6.2 node exerciser SNA/Bisync network performance analysis (statistics)
X.25 Testing	Complete X.25 decode Link Level Statistics	Complete user-customizable X.25 decode Facilities field decode X.25 test library and link level emulator Link Level Statistics	Complete X.25 decode Facilities field decode X.25 interactive emulation X.25 network performance analysis (statistics)
ISDN Testing		Basic rate access Q.921 and Q.931 monitor and simulate	Basic and PRI rate access Q.921 and Q.931 monitor, simulate and emulation
Programming	Monitor/simulate menus	Enhanced monitor/ simulate menus	Monitor/simulate menus DataCommC (full K & R C programming language) SNA development language X.21 state simulator language
Price (typical)	\$4,590	\$9,120	\$17,450

DATA COMMUNICATIONS TEST EQUIPMENT

Protocol Analyzers

Model HP 4951C and HP 4952A

511

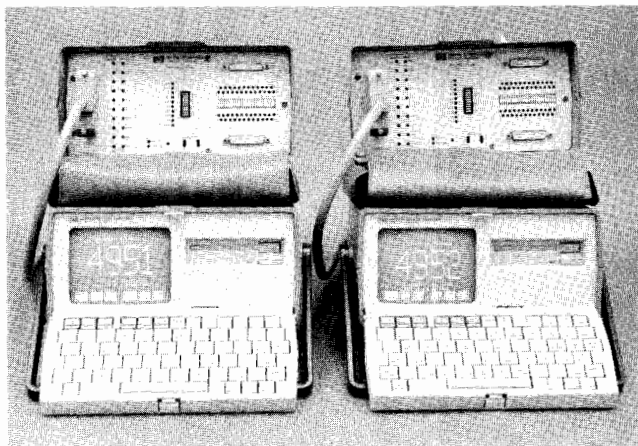

HP 4951C/HP 4952A

HP 4951C and HP 4952A Protocol Analyzers

The HP 4951C (19.2 kbps) and HP 4952A (64 kbps) are portable protocol analyzers used for troubleshooting during installation, maintenance and design of data communication networks and equipment.

Applications

The HP 4951C and HP 4952A allow you to monitor and decode data transmission, test remote facilities from your location, simulate network components, and perform bit error rate tests. They can also be used as asynchronous terminals or to install and maintain 3270 equipment, and to perform link level performance analysis. Protocols that can be tested include Async, BSC, SDLC (NRZI), HDLC, X.25, SNA, DDCMP and user-defined protocols. The HP 4952A also tests X.21 and ISDN.

HP 4951C and HP 4952A Features

- **Autoconfigure** to automatically determine line parameters and to monitor data with the push of a key.
- **3 1/2" microfloppy disk** to store 613K bytes of data, timing, lead status, programs and configurations.
- **RS-170 video port** to view data externally.
- **Printouts** to all RS-232/V.24 ASCII printers via a separate port.
- **Nonvolatile memory** to store data, programs and configurations.

Additional HP 4952A Features

- **64 kbps testing with full functionality**
- **3/4M byte extended volatile capture buffer** (Option 002)
- **128K bytes nonvolatile application storage** (Option 002)
- **Unattended remote testing**
- **Cursor timing** to allow timing measurements to be made on screen
- **Enhanced programming features:** run time user comments, softkey triggering, subroutines
- **Buffer data filtering** to maximize capture buffer
- **Selective store to disk** to capture only events of interest
- **Complete disk copying capability**

Datcomm Testing Solutions

Data Communications Test Library

This library of prewritten tests, is standard with every HP 4951C and HP 4952A at no additional cost. The library contains 58 general purpose monitor and simulate programs on a single 3 1/2" diskette to help you evaluate your network quickly and easily. Programs are written to diagnose common datcomm problems. The tests can be tailored for special configurations and applications. The library also contains installation and acceptance tests for printers and terminals.

X.25 and SNA Link Level Performance Analysis

Link level statistics packages, the HP 18333D for the HP 4951C and the HP 18264A for the HP 4952A, transform the instruments into statistical performance analyzers for the link level (level 2) of SNA and X.25 networks (SDLC and HDLC).

These solutions provide a new way for network troubleshooters to look at data communication links. Key link events indicate the health

of the network and are displayed in columns. Bar charts show line utilization real time. These statistics can be stored to disk and reviewed at a later time.

3270 Installation and Maintenance

If you have IBM 3270 or compatible terminal systems, you know that problems with newly installed or suspect systems can devastate hosts and users. The HP 18332D (HP 4951C) and HP 18263A (HP 4952A) 3270 installation and maintenance software packages provide easy, automatic, offline testing of multiple 3270 clusters by emulating many of the functions of a host computer.

X.25 Troubleshooting

Both analyzers provide X.25 troubleshooting. The HP 4952A also has an enhanced X.25 analysis package (HP 18266A) which allows you to create five custom X.25 decode displays. A display is also provided to decode all components of each packet including facilities, calling/called addresses, cause and diagnostic codes, registration and call user data. The HP 18267A X.25 Test Library and Emulator provides a library of X.25 tests written in a level 2 emulator, and a procedure for using tests to troubleshoot X.25 installations.

ISDN Solutions

The HP 4952A has added ISDN capability to its array of troubleshooting solutions. The HP 18270A ISDN basic rate channel access and analysis package offers capabilities for ISDN troubleshooting in a portable protocol analyzer for those designing or managing ISDN networks. This latest offering provides the ability to monitor and simulate ISDN devices and networks, giving the edge needed to handle the demands of ISDN communication.

Ordering Information

Ordering Information	Price
HP 4951C Protocol Analyzer (interface pod not included)	\$3,940
Opt 102 HP 18180A RS-232/V.24 and RS-449/422A/423A interface pod	\$900
Opt 103 HP 18179A RS-232/V.24 interface pod with full breakout box	\$650
Opt 106 HP 18160A RS-232/V.24 and V.35 interface pod	\$1,350
Opt W30 2 Years additional hardware service	\$100
HP 18331D SNA, DDCMP, X.25 analysis	\$350
HP 18332D 3270 installation and maintenance	\$350
HP 18333D X.25 and SNA link level performance analysis	\$350
HP 4952A Protocol Analyzer (interface pod not included)	\$6,970
Opt 002 Extended memory plus	\$1,500
Opt 101 HP 18174A RS-449/422A/423A interface pod	\$500
Opt 102 HP 18180A RS-232/V.24 and RS-449/422A/423A interface pod	\$900
Opt 103 HP 18179A RS-232/V.24 interface pod with full breakout box	\$650
Opt 104 HP 18260A X.21 and RS-232/V.24 interface pod	\$1,100
Opt 105 HP 18177A V.35 interface pod	\$800
Opt 106 HP 18160A RS-232/V.24 and V.35 interface pod	\$1,350
Opt W30 2 Years additional hardware service	\$175
HP 18260A X.21 and RS 232/V.24 interface pod	\$1,100
HP 18261A SNA analysis	\$350
HP 18263A 3270 installation and maintenance	\$350
HP 18264A X.25 and SNA link level performance analysis	\$500
HP 18265A DDCMP analysis	\$350
HP 18266A Enhanced X.25 analysis	\$500
HP 18267A X.25 test library and emulator	\$500
HP 18269A G.821 BERT	\$500
HP 18270A ISDN basic rate interface and analysis	\$3,500
HP 4951C and HP 4952A Common Accessories	
HP 18340A Video print interface	\$500

DATA COMMUNICATIONS TEST EQUIPMENT

Protocol Analyzer

Model HP 4954A

HP 4954A Protocol Analyzer

The HP 4954A is a high-speed (72 kbps), multiprotocol, expandable protocol analyzer for designing data communication products and analyzing network performance.

Features

High speed state-of-the-art multiprocessor design guarantees reliable sophisticated analysis and simulation of full-duplex bit-oriented protocols to 72 kbps and data capture of half duplex bit-oriented protocols at lower-line utilizations up to 256 kbps.

Multiprotocol testing capabilities allow you to monitor, analyze, and simulate popular protocols such as X.25, SNA/SDLC, bisync, async, DDCMP, X.75, HDLC, BSC-framed X.25, and character-oriented synchronous protocols. X.21 and CCITT# 7/CCS7 support is also available through easy to use application software.

Mass storage with an integral 20 MB hard disk and 613 KB 3.5 inch floppy disk provide easy access to set up menus and buffer data. Any HP 4954A file may be autoloaded at power on to instantly configure the protocol analyzer for your individual needs. Setup menus, user-written programs and buffer data stored to floppy disk may be shared with the HP 4951C and HP 4952A.

The internal 256 KB data capture buffer can be expanded through the integral hard disk up to 20 MB. Even greater data capture buffers are possible with external HP-IB disk drives.

Programming flexibility through high-level protocol analysis and simulation is a standard capability of the HP 4954A. Custom measurements and tests are easy to perform with softkey-driven entry of monitor and simulation programs with triggering based upon data communication events. For more advanced testing, the DataCommC programming language provides a powerful solution to fit a variety of testing needs.

Electromagnetic compatibility: Tested for compliance with VDE 0871 level B, radiated and conducted.

Datacomm Solutions

Expandability is provided with extensive application software memory which makes the HP 4954A one of the most versatile protocol analyzers available. Many software and hardware accessories are now available to broaden the HP 4954A analysis and simulation capabilities.

DataCommC Programming Language

DataCommC supports the Kernighan & Ritchie C language, plus a full set of data communication-specific libraries. DataCommC includes a full-screen windowing text editor, terminal emulator, Kermit file transfer protocol, compiler, linker, and a multitasking operating system.

ISDN Testing System

The ISDN channel access unit and ISDN analysis software applications are designed to aid in the development of ISDN equipment. The ISDN test system provides extensive monitoring, simulation, and emulation capabilities required to fully test the ISDN protocol over a basic rate (BRI) or primary rate (PRI) (1.544 Mbps or 2.048 Mbps) ISDN interface.

X.25 Test Environment

The X.25 test environment provides the ability to emulate an X.25 device and to monitor an X.25 line. The X.25 test environment provides an interactive tester, enhanced X.25 decode, emulation-specific runtime shell, levels 1,2, and 3 emulators, and over 80 X.25-specific library functions.

SNA Development System

The HP 18360A SNA emulation language is an HP 4954A software solution that is designed to aid in the development of SNA-compatible devices. It consists of an SNA-specific programming language plus complete link and path control emulators. The HP 18361A SNA 3270 device exerciser and HP 18362A LU6.2 node exerciser are user-modifiable tests written in the SNA emulation language to thoroughly test 3270 and LU6.2 devices.

X.21 Development System

The HP 18352A X.21 state simulator is an HP 4954A software solution that is specifically designed to aid in the development of X.21 DTEs and DCEs. It consists of an X.21-specific softkey-driven programming language combined with a state level decode. Included with the X.21 state simulator is the X.21 DTE analysis pack; a set of user-modifiable tests written in the X.21 state simulator language that thoroughly tests an X.21 DTE for protocol conformance.

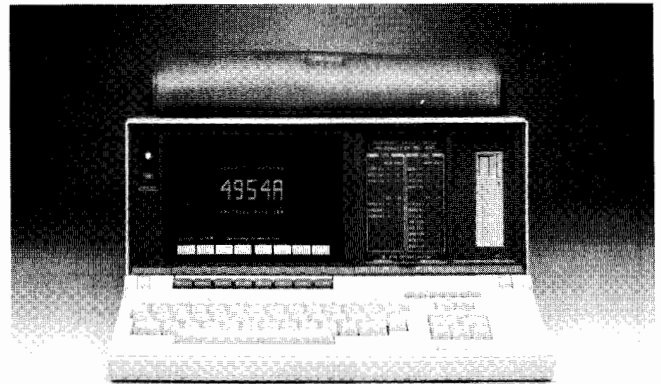

HP 4954A

X.25 Network Performance Analyzer

The HP 18370A X.25 network performance analyzer is an HP 4954A software solution that gathers statistical information about the performance of an X.25 data link. Statistics on throughput, utilization, bad FCSs, reject frames, and many other parameters are available in both tabular and graphical format.

SNA/Bisync Network Performance Analyzer

The HP 18371A SNA/bisync network performance analyzer consists of two software programs designed to aid in the management of IBM and IBM-compatible data networks. Statistical information can be gathered about the performance of an SNA or bisync data link. When analyzing an SNA data link, statistics on session control BIU, link setup, binds, unbinds, and many other parameters are available in both tabular and graphical format. Similar measurements are provided when analyzing bisync data.

Physical Specifications

Dimensions: 19.6 cm x 42.5 cm x 56.5 cm (7.7 in. x 16.7 in. x 22.2 in.) rack mountable

Weight: 21.17 kg (46.7 lb)

Ordering Information

	Price
HP 4954A: Protocol Analyzer (interface pod not included)	\$16,300
Opt. 001 Adds 1.0 MB of RAM	\$1,500
Opt. 100 Adds RS-232C/V.24 interface pod	\$1,150
Opt. 101 Adds RS-449 interface pod	\$1,150
Opt. 102 Adds V.35 interface pod	\$1,450
Opt. 103 Adds MIL-188C interface pod	\$1,150

Application Software

HP 18320A DataCommC programming language	\$2,000
HP 18321A X.25 test environment	\$2,000
HP 18352A X.21 state simulator	\$4,000
HP 18355A CCITT#7/CCS7 analysis	\$1,600
HP 18356A ISDN BRI channel selector and s/w	\$4,800
HP 18360A SNA emulation language	\$2,500
HP 18361A 3270 device exerciser	\$1,000
HP 18362A LU6.2 node exerciser	\$2,000
HP 18363A password security	\$450
HP 18369A asynchronous terminal emulator	\$300
HP 18370A X.25 network performance analysis	\$1,200
HP 18371A SNA/BSC network performance analysis	\$1,200
HP 4954I ISDN WAN protocol analyzer (includes HP 4954A, HP 18320A, and HP 18356A)	\$22,500
Opt. 200 1.544 Mbps primary only access	TBD
Opt. 201 BRI and 1.544 Mbps primary access	TBD
Opt. 202 2.048 Mbps primary only access	TBD
Opt. 203 BRI and 2.048 Mbps primary access	TBD

DATA COMMUNICATIONS TEST EQUIPMENT

LAN Protocol Analyzers

Model HP 4972A

513



HP 4972A

HP 4972A LAN Protocol Analyzer

The HP 4972A Local Area Network protocol analyzer is used for performance management and for troubleshooting problems on IEEE 802.3, Ethernet, or StarLAN local area networks. The HP 4972A provides accurate and complete information under all operating conditions.

The HP 4972A provides a comprehensive, easy to use, troubleshooting tool for fast problem isolation and maintenance. It monitors traffic on the network, generates data frames to test other nodes, and gathers statistics to verify network performance.

Performance Measurement

To assist in the management of network performance, the HP 4972A provides statistical information on network, node, and connection levels. It counts and measures errors and other parameters for each node. Automatic test sequences make it easy to set up long-term tests and repeat the tests at regular intervals. A background traffic generator measures performance under different loading conditions, which allows you to anticipate and plan for future growth. An optional color graphic display makes network activity easy to understand. Performance management software helps fine-tune Ethernet, IEEE 802.3 and StarLAN networks.

Performance Features

Trend Analysis

- Network use can be measured over a user-specified time period for percent utilization, frames per second, and bytes per second, including peak and average.
- Traffic characteristics of frame size, timing distribution, and user-specified filter matches are displayed.

Node Measurements

- Node performance for up to 1000 nodes measures frame count, byte count, and error count for each node.
- Connection information measures frame count, byte count, and error count for each logical connection on the network.

Traffic Generation

- Generates from 0% to 96% of additional network traffic that executes in background mode while other measurements are made by the user.

Alarms and Automatic Sequencing

- User-defined alarm levels for utilization, frames per second, errors, connections, or channel acquisition time notify the user of potential errors on the network.
- Automatic sequencing allows the user to define a set of measurements to be executed and optionally logged to disk, printed, and/or alarmed to notify the user.

Troubleshooting

The HP 4972A is also equipped for troubleshooting when sudden changes or unavoidable circumstances take your network down. The softkey-guided programming language helps test for problem network conditions as they occur. Network events can also be logged to disk and post-processed through the same program to examine for possible problems. A user-definable display format allows you to view only the critical information you need to solve a problem. Protocol interpreters are available for TCP/IP, NFS, XNS, and DECNet protocols.

Troubleshooting Features

- **Softkey-guided programming language** assists in writing programs to selectively capture frames from the network. This makes programming easy, even for the first time user. Network information can be logged to disk and tested/or further evaluated.
- **20 Mbyte internal disk** stores test setups, programs and statistical or frame data.
- **Hardcopy output** of all displays is possible with an optional HP 2225A ThinkJet or HP 3630A PaintJet (color) printer.
- **Optional remote interface** controls the analyzer for file transfer with another HP 4972A or IBM PC-compatible, via RS-232C/V.24 link.

Protocol Analysis Accessories

There is no single standard networking protocol. Different computer vendors use different protocols. Protocol interpreters display data captured by the HP 4972A in a decoded mnemonic format. Software tools available for the HP 4972A allow the user to see an English decode of many protocols. Network performance analysis tools are also available for these protocols. They allow the user to characterize operational performance of the network by testing and making measurements on efficiency and utilization of higher network protocol layers.

HP 18220A Protocol interpreter development environment

HP 18221A TCP/IP protocol interpreter

HP 18222A TCP/IP network performance analyzer

HP 18223A XNS protocol interpreter

HP 18224A DECNet protocol interpreter

HP 18225A DECNet network performance analyzer

HP 18228A NFS protocol interpreter

Physical Specifications

Dimensions: 44.9 x 43.1 x 55.8 cm (7.75 x 17 x 22 in.)

Weight: 19 kg (42 lb)

Ordering Information

HP 4972A Protocol Analyzer

Opt 001 RGB color video outputs

Opt 002 Remote interface (RS-232C/V.24)

Opt 005 StarLAN (daisy-chain interface)

Opt 908 Rack mount kit

Price

\$17,350

\$1,500

\$600

\$500

\$30

DATA COMMUNICATIONS TEST EQUIPMENT

MAP Protocol Analyzers

HP 4974S



HP 4974S

HP 4974S MAP Protocol Analyzer

The HP 4974S MAP Protocol Analyzer is a high-level protocol analyzer for IEEE 802.4 broadband and carrierband networks that run MAP 3.0 protocols. For total HP quality and support, the HP 4974S should be installed in an HP Vectra personal computer. It is also available as a card to be installed in selected IBM-AT compatible personal computers.

The HP 4974S features OSI protocol decodes for all MAP 3.0 protocols, with detailed displays from the logical link control through the application layer of the MAP protocol stack. These decodes and displays provide unprecedented capability to engineers and network managers involved in all aspects of MAP development, installation, and maintenance. Protocol errors are shown in the decode, making problem isolation and resolution faster.

The HP 4974S can capture frames from all of the nodes that are transmitting on a MAP network. In this mode, network activity can be monitored and active nodes can be identified. The HP 4974S can also monitor a single conversation between two MAP devices, filtering out additional network traffic to concentrate efforts on the devices being tested. Convenient directional arrows on the screen assist in recognizing the traffic flow between the two devices.

Flexible formatting options allow display of information in hexadecimal or decode for the level of detail needed to solve the problem at hand.

With the 2 MB buffer memory, which is expandable to 8 MB, long exchanges or large file transfers can be captured. The HP 4974S also has the ability to log data to a large Winchester disk or portable floppy disk file. The HP 4974S provides the ability to examine online data from either a broadband or carrierband MAP network, or data that was previously stored to the buffer or to a file.

The windowed user interface assists in making the HP 4974S MAP protocol analyzer easy to learn and to use. A high-resolution color monitor displays clear and concise protocol information. The displays are color-keyed, layer-by-layer, to make reading easier.

Applications

The HP 4974S MAP protocol analyzer provides an independent, unbiased view of protocol events and a summary representation of protocol data unit header values. This time-saving information is helpful in network troubleshooting situations.

Interoperability testing is easier when protocol data units from two dissimilar devices are viewed in a consistent format.

Communications software debugging is faster when protocol transactions can be seen as they appear on the network.

Configuration and integration of equipment is simplified by viewing exchange negotiation and configuration values as they affect your network.

Common protocol and configuration mismatches are easily identified, often saving hours of guesswork and experimentation.

Protocols supported by the MAP protocol analyzer include IEEE 802.2 Link Layer, ISO Network, ISO Transport Class 4, ISO Session, ISO Presentation, ACSE, FTAM, MMS, DS, and NM.

Ordering Information

The HP 4974S can be ordered as a complete system, or the MAP interface equipment and software can be ordered for installation in your existing HP Vectra ES/12 personal computer, IBM PC-AT computer, or Compaq III portable computer.

HP 4974S MAP Protocol Analyzer System	Price
For protocol analyzer hardware and software order:	
HP 4974A Protocol Analyzer	\$17,000
Includes: MAP protocol analysis software MAP network interface card MAP network broadband and carrierband interface pods	
For complete system, include:	
HP D1346A Vectra ES/12 PC, Model 46	\$3,595
Includes: 640 KB RAM, 5 1/4" 1.2 MB flexible disk, flexible disk controller, 40 MB hard disk, hard disk controller, serial/parallel interface, HP-HIL port, HP terminal program, IBM compatible keyboard, VGA card, system documentation.	
HP 45951D Vectra DOS 3.3	\$135
HP D1182A VGA display	\$749
HP 46060A HP mouse	\$155
HP 45944A Vectra ES/12 expanded memory card	
Opt 001 2 MB expanded memory	\$1,695

DATA COMMUNICATIONS TEST EQUIPMENT

LAN Protocol Analyzers and Distributed Monitoring Systems

HP 4990S

515

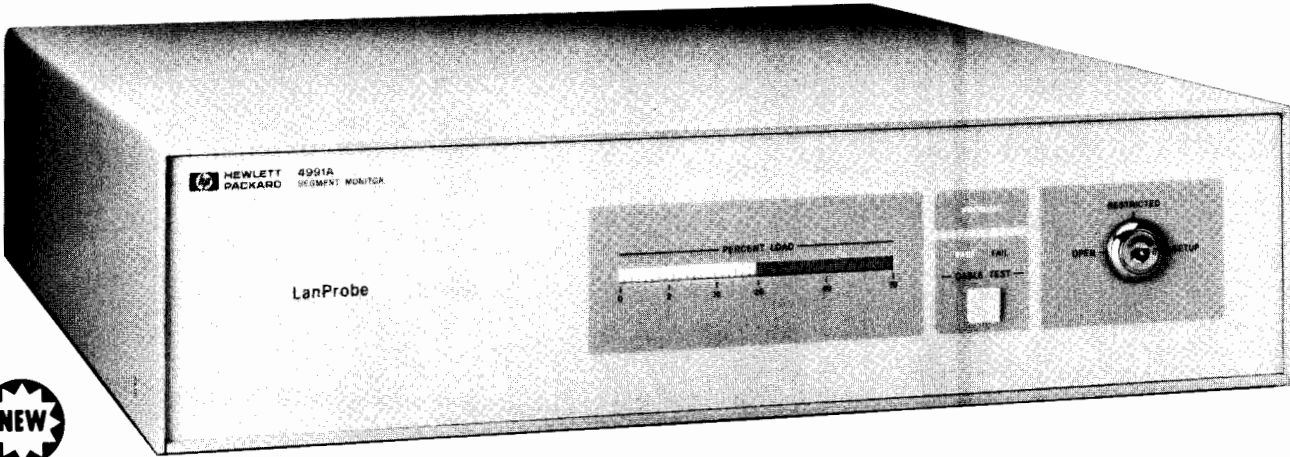

HP 4991A

Dispatched vs Distributed Monitoring

Different Methods to Meet Different Needs

Troubleshooting/ development needs	Maintenance/ installation needs	Trend analysis/ LAN management needs
Hardware testing Protocol development Conformance testing Interoperability testing Performance testing Reliability testing	Initial planning Cabling Device installation System testing Certification Configuration testing	Document network Monitor usage Plan future growth Unattended monitoring Remote monitoring Preventive maintenance

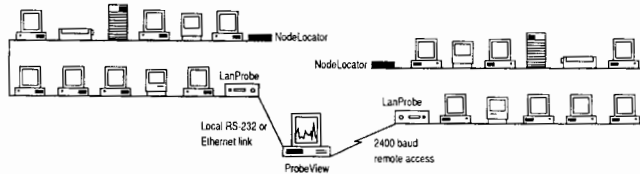

The network is managed locally or remotely

The LanProbe segment monitor attaches to the end of an Ethernet segment and monitors all traffic. Attachment can be direct to a thin or thick coax cable, or via an external transceiver to fiber optic or twisted pair cabling. Network data relating to the segment is transferred to a workstation running ProbeView via RS-232, an Ethernet adapter, or a modem connection.

ProbeView software, which runs on a PC/AT-class workstation, presents network information in graphical displays.

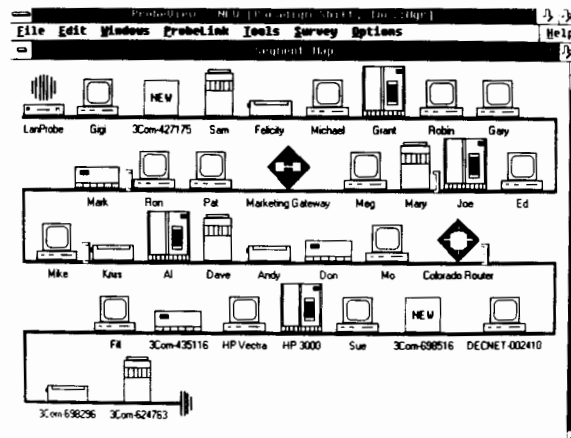

The segment map drawn by ProbeView identifies and displays devices that are active on the monitored segment.

HP 4972A Protocol Analyzer

Dispatched
Attended
As Needed

HP 4990S LanProbe Distributed Analysis System

Distributed
Unattended
Immediate

The network manager chooses the right instrument for the job. Although the features of a protocol analyzer and a distributed management system often overlap, each tool has specific benefits for different applications.

A protocol analyzer, such as the HP 4972A LAN protocol analyzer, is ideal for on-site troubleshooting of network faults during development, installation, and maintenance of network hardware and software. A protocol analyzer provides specific, detailed information about network operations. (See page 513 for more information about the HP 4972A protocol analyzer.)

A distributed monitoring system like the HP 4990S LanProbe distributed analysis system is designed into the network layout. An instrumented network provides continuous, preventive network management information unattended by an operator. This system will give the network manager immediate, up-to-the-minute information about the state of the network. A distributed monitoring system such as LanProbe complements the dispatched HP 4972A protocol analyzer.

HP LanProbe™ Distributed Analysis System

The HP LanProbe distributed analysis system enables a network manager to monitor all critical aspects of a remote or local Ethernet LAN. Completely independent of network equipment or protocols, the LanProbe system monitors, tests, and diagnoses virtually every aspect of the network and presents the findings in clear color graphics. As an integral part of the network, the LanProbe system provides a comprehensive and informative view that is key to confident network management.

The system consists of one or more LanProbe segment monitors and ProbeView™ software running under Microsoft™ Windows.

DATA COMMUNICATIONS TEST EQUIPMENT

LAN Protocol Analyzers and Distributed Monitoring Systems

HP4990S

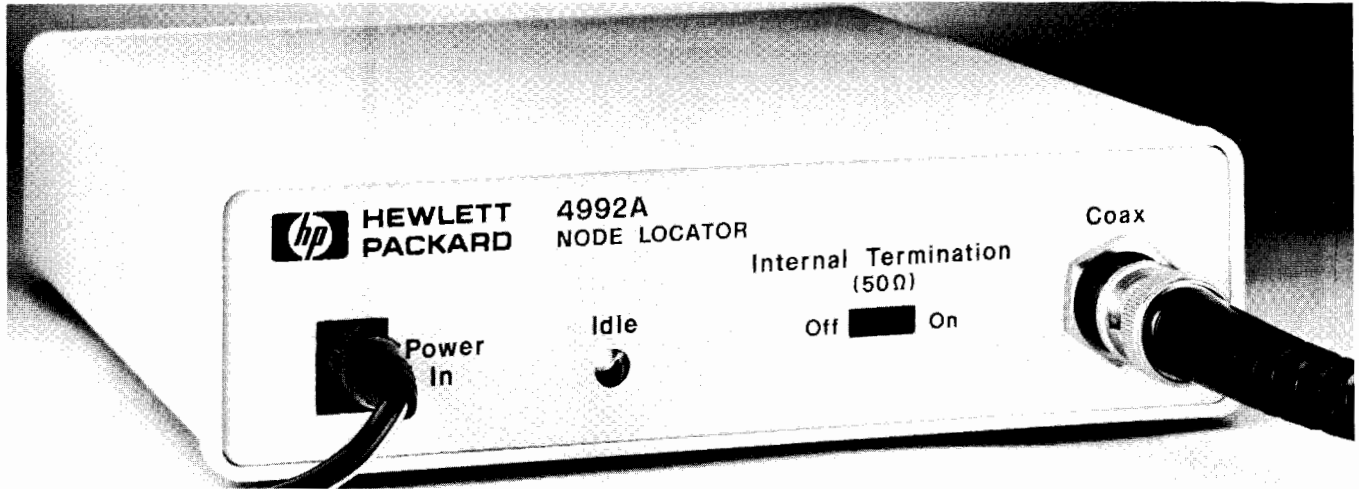

HP 4992A



The HP 4992A NodeLocator option attaches to the opposite end of the cable from the HP 4991A LanProbe segment monitor. It automatically locates the position of nodes on Ethernet networks using coaxial cabling schemes.

Installed in minutes, LanProbe quickly and automatically identifies all active nodes on a segment and displays them, with their adapter card vendor name and Ethernet address, on a map. You can enter additional information about the nodes, such as equipment types and physical location, into the database by clicking on an icon and typing it in.

When the NodeLocator option is used, data on the actual location of the nodes is automatically entered, and the map becomes an accurate representation of the physical layout of the segment. Thereafter, when a new node is installed and becomes active, or when a node is moved or becomes inactive, the change is detected and shown on the map in real time. The system also provides the network manager with precise cable fault information. When a fault is detected the manager workstation is alerted and the precise location of the fault is specified on the map.

The system's interactive capabilities ensure easy LAN management. The LanProbe system continuously monitors vital parameters of the LAN segment. Traffic statistics are gathered and displayed and can be exported in (comma delimited) CSV format for further analysis. In addition, a library of predefined filters and network tests run concurrently, collecting valuable diagnostic information.

The LanProbe system provides an unmatched tool for documenting and monitoring your network.

Features

- Network and segment maps identify nodes, addresses, and position.
- Real-time update of the maps via NodeLocator.
- Cable test option detects and reports breaks, shorts, and faulty termination.
- Statistics chart LAN utilization and performance in real time and over a period of time.
- Traces all packets or specific packets.

- Alerts based on user-definable thresholds and entry into a log.
- Remote access with built-in 2400 baud modem.
- Continuous monitoring of the LAN.
- Concurrent and interactive operation of all tools.

Specifications

HP 4991A LanProbe Segment Monitor

Network Compatibility: Ethernet version 2.0, IEEE 802.3

Dimensions: 10.5 x 41.4 x 44.5cm (4.15" x 16.3" x 17.5")

Weight: 7.26kg (16 lb)

HP 4992A NodeLocator

Network Compatibility: Ethernet version 2.0, IEEE 802.3

Dimensions: 41.7 x 14.15 x 18.29cm (1.64" x 5.57" x 7.20")

Weight: .55kg (1.2 lb)

Ordering Information

	Price
HP 4990S LanProbe distributed analysis system	
HP 4990A ProbeView manager software	\$5,000
HP 18490A ProbeView observer software	\$250
HP 4991A LanProbe segment monitor	\$8,000
HP 4992A NodeLocator	\$975
Options:	
HP 4990A Option 100 Adds ProbeView observer software with ProbeView manager software	\$250
HP 4991A Option 001 LanProbe, deletes cable test, BNC connector and NodeLocator capability	-\$300
HP 4991A Option 002 LanProbe, deletes internal modem	-\$225
HP 4991A Option 003 LanProbe, deletes cable test, BNC connector, internal modem and NodeLocator capability	-\$525

DATA COMMUNICATIONS TEST EQUIPMENT

Signaling Test Sets
HP 37900C, 37900B

517

- Multi-link testers for common-channel Signaling System No.7
- Call tracing
- Text decoding of Level 3 and 4 data (optional user-defined decoding)
- Programmable No.7 device emulation

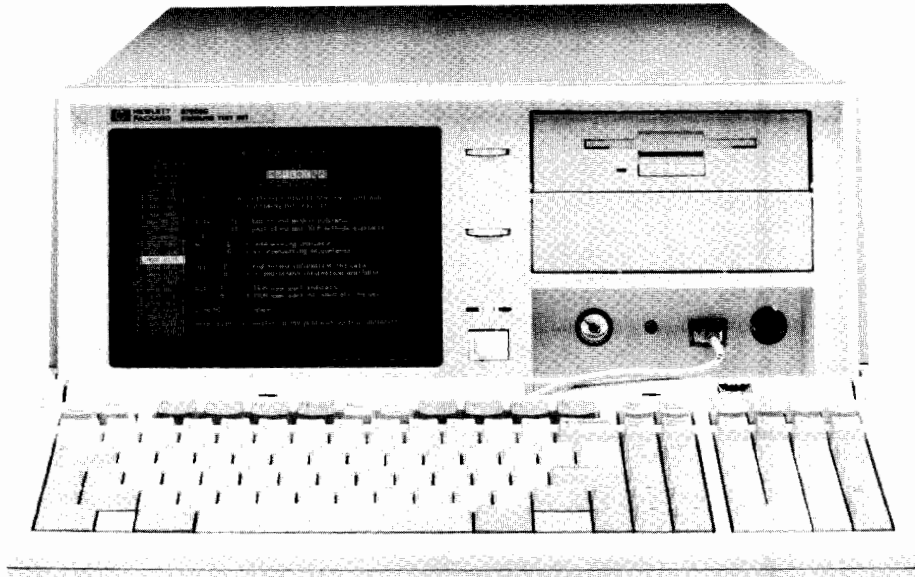

HP 37900C

HP 37900B/C Signaling Test Sets

The HP 37900C Signaling Test Set is a high-performance solution for testing the demanding No.7 common-channel signaling protocol (Signaling System No.7). The HP 37900C is capable of monitoring or emulating on two bi-directional No.7 signaling links.

The HP 37900B is a modular No.7 test set consisting of a workstation, signaling link processors, and dedicated software. The capabilities are similar to the HP 37900C, but the HP 37900B can test up to four bi-directional links simultaneously.

Features

The major features of this testing set include non-intrusive monitoring and recording of signaling messages on signaling links; optional interfaces for datacom and telecom applications; real-time and post-analysis of No.7 data; text decoding of level 3 & 4 data (CCITT red/blue book and, optionally, national variants such as ANSI/BELLCORE SS7, BTNR 167, and applications such as GSM, CLASS and ABS); emulation of No.7 devices for feature testing.

Assessing No.7 Performance

The HP 37900B/C simplifies the manufacture, qualification or maintenance of No.7 equipment or software.

The non-intrusive monitoring capabilities of the HP 37900B/C allow troubleshooting and assessing the performance of No.7 signaling links. For example, real-time analysis of signaling activity, through dynamic display of loading levels and error rates, allows problems to be quickly assessed. Sophisticated data triggers and filters can readily be created to control the logging of data so that only useful data is recorded. In addition, the call trace facilities can obtain the No.7 messages related to a specific call.

Interpretation of logged signaling messages is straightforward; the data is automatically decoded directly to text. (Optional software is available for customized text decodes.) If there is no text decode, hexadecimal or binary decodes are available. Many search and display

facilities aid the examination of logged data, simplify investigations, and minimize troubleshooting.

The HP 37900 saves time during generation and interpretation of emulation tests to check the features of signaling software during conformance, acceptance or regression testing. For example, individually defined and named message signal units (MSUs) are stored in a message catalog and can be used in a number of tests. Test logic uses easy-to-follow Specification and Description Language (SDL) commands, a true subset of the SDL in the No.7 standards. To simplify testing further, the HP 37900 automatically handles level 2 operations (including signaling link alignment) and, optionally, level 3 operations. During a test, the HP 37900B/C generates or responds to signaling messages on the No.7 links, and allows users to follow the progress of the test while it is running. On completion, users obtain a report of the signaling interactions for fault tracing or test performance documentation.

Specifications

RAM buffer for logging: 1.5 Mbyte (expandable to 5.5 Mbyte)

Built-in disc: 20 Mbyte 37900C; 40 Mbyte 37900B

Monitor

Capture performance: 100% MSUs per link (each direction)

Timestamps for logged data: 1 millisecond accuracy

No.7 specific triggers and filters: Include triggering on level 2, 3 or 4 data, and erroneous SUs; and filtering out of FISUs, LSSUs or specified MSUs

Emulate

Message generation performance: 100% MSUs

Messages per catalog: 300

Save/retrieve catalogs from disc: Yes

Ordering Information

Please contact your local Hewlett-Packard Sales & Support Office. See page 739.

DATA COMMUNICATIONS TEST EQUIPMENT

General Information: Voice and Data Testing

Data Network Testing

There are a wide variety of tests that can be made on a data communications system. Depending on the point in the system at which the tests are made, quite different philosophies and techniques apply.

Protocol analysis is usually concerned with overall network performance, determined through monitoring or simulating network software (protocol and/or data). Digital testing involves measuring modem-channel-modem efficiency in terms such as Bit Error Ratio (BER) and Block Error Ratio (BLER). Analog testing measures the tariffed and other key parameters of the transmission line itself.

The interrelationships of these measurement results are complicated and difficult to understand. For example, how is envelope delay distortion of the line related to the BER or the throughput of the system? Generally speaking, the three measurement techniques are related in a hierarchical fashion. Nonintrusive network monitoring by protocol analyzers gives an indication of overall performance and can often isolate problems to the component or section. When monitoring is insufficient, such as during software debugging or systems integration, protocol analyzers also can be used to simulate network components such as front-end processors or terminals. Once sectionalized, BER testers are used to verify and quantify the link disfunction, and analog measurements determine which tariffed parameter is out of specification should the telephone line be the problem.

Combined protocol, digital, and analog tests can be used synergistically to restore the network quickly and efficiently. Protocol Analysis has been previously described. The next sections detail the analog and digital testing.

Digital Measurements

Data error analyzers are used to test the quality of both the modem and the transmission facility. They provide information about the modem and transmission line, but no information about the DTE (data terminal equipment) they replace.

The overall quality of the link is indicated by its BER. A good link will have a bit error ratio better than 1×10^{-5} . This measurement will include the effect of both transmission line impairments and the modem's ability to overcome them. Modems vary widely in their sensitivity to line impairments. Low speed (less than 300 bps) and adaptively equalized modems are less sensitive than high speed (more than 4800 bps) and non-adaptively equalized modems.

Since data communications systems transmit data and control information in blocks, these instruments also measure BLER and Percent Error Free Seconds (%EFS). BER, BLER and %EFS can be used together to examine the statistics of the error mechanism.

If the BER and BLER are both high, and %EFS low, the impairment is random and probably due to noise. If the BER and %EFS are high but the BLER is low, the impairment is more bursty. This happens when lines are switched, synchronization is temporarily lost, or impulse noise is too high.

	In-Service Testing	Bell	CCITT	Basic Testing						Conditioned Circuit Testing			Additional Testing for Complete Troubleshooting							
				V.A. n.F.	Loss Continuity	Noise, Loss vs. Freq.	Signal/Noise Ratio	Impulse Noise	Wideband Impulse Noise	P/AR	Envelope or Group Delay	Attenuation Distortion	NLD or Intermodulation Distortion	Phase Jitter	Amplitude Jitter	Hits Dropouts	Return Loss	Loop Holding	Signalling Testing	Digital Access
Instruments	3551A																			
	4934A																			
	4935A																			
	4937A																			
	4938A																			
	4947A																			
	3776B*																			
	4945A																			
	3552A																			
	4936A																			
	3776A*																			
	4948A**																			

*Information about the HP 3776A and HP 3776B can be found in the Telecommunications Test Equipment section.

**In-service Testing is discussed in the description of the HP 4948A in this section.

Error rates are quantitative checks of the data communications system that can be made in a few minutes. If the system is bad, diagnostic measurements are provided to help isolate the problem. Dropouts, clock slips, error skew, jitter, and total peak distortion indicate some of the problems that can occur with a modem or on a link. These measurements are made simultaneously with the error rate measurements and can be printed out in automatic unattended mode if desired.

Catastrophic failures can usually be found with self-tests and loop-back switches built into the modem. Data error analyzers can find failures that are not illuminated by internal self-tests.

Modem dynamics are another source of data transmission problems. Modern modems have automatic equalization circuits to compensate for telephone line distortions. It is important to let the equalization process settle, particularly with switched carrier modems, so data is not transmitted too soon.

Measurements that verify modem dynamics are RTS-CTS delay and modem start up tests such as ping-pong.

Analog Impairments Affect Performance

Analog impairments on the telephone line can significantly affect the efficiency of data communications. What the user notices is a slow down in throughput (because of frequent retransmission of blocks of data), gar-

bled data or no data at all. These effects are a result of the line impairments distorting the modem signal so that the receiving modem cannot make correct decisions. Data bits and blocks are received in error.

The various modem types are susceptible to each impairment in differing degrees. Low speed modems generally use simple modulation schemes and are mostly affected by problems of *continuity, loss, signal-to-noise ratio, and impulse noise.*

As modem speeds increase, the modulation schemes become more complex and so they are more susceptible to impairments. Automatic equalization helps take care of bandwidth reduction, and envelope (group) delay distortion problems. But to significantly reduce the impairing effects and improve error performance, specially selected and conditioned leased telephone lines are used.

A number of levels of conditioning are available to suit the circuit to the speed of the modem, each tariffed at a different rate. Conditioning can minimize noise, hits, dropouts, phase jitter, non-linear (inter-modulation) distortion, bandwidth reduction and envelope (group) delay distortion.

So there is a need for testing: by the circuit supplier, when he installs or repairs a conditioned circuit, to check if impairment levels are within the agreed limits; by the circuit user, to ensure he is getting the quality of circuit he is paying for.

DATA COMMUNICATIONS TEST EQUIPMENT

Transmission Impairment Measuring Sets

Model 4945A, 4947A

519

HP 4945A

- Complete analog testing to North American standards for: voice grade data circuits, program circuits, metallic digital circuits
- Versatile I/O for systems use
- Master/Slave capability for flexible end-to-end testing

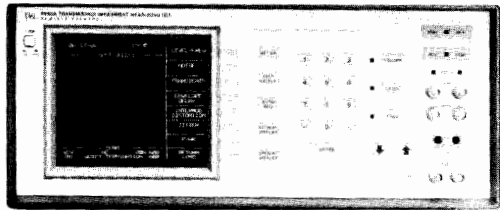

RS 232



HP 4945A

HP 4945A Product Description

In one portable package, the HP 4945A Transmission Impairment Measuring Set provides the complete set of measurements needed to install, maintain and troubleshoot circuits for voice, data or broadcast transmission up to 110 kHz and local distribution of digital data services up to 56 kbit/s. All measurements are compatible with Pub 41009 and IEEE 743-1984 and are listed in the table below. The use of softkeys makes the HP 4945A extremely flexible while maintaining ease of operation.

Full Master/Slave Capability

The HP 4945A has Master/Slave capability for remote control and data collection. Master/Slave saves time and money. This HP pioneered and patented technique allows the master HP 4945A to completely and flexibly control and collect data from the remote slave HP 4945A over the lines under test, so that end-to-end tests can be run automatically from the master instrument.

Versatile Remote Control and Hardcopy

The HP 4945A lends itself to a systems environment by providing three remote control interfaces, HP-IB, HP-IL, and RS-232-C as accessory modules. These modules also provide you with date and time stamped hardcopy results on HP-IB, HP-IL or RS-232-C printers.

Measurement	HP 4945A	HP 4947A
Level/Frequency	to 110 kHz	to 5 kHz
Attenuation Distortion	yes	yes
Intermodulation Distortion*	yes	yes
Envelope Delay Distortion	yes	yes
Gain Slope	yes	yes
Signal-to-Noise & Notched Noise	yes	yes
Message Circuit Noise & Noise-to-Ground	yes	yes
Noise Filters:		
C-Message & 3 kHz	yes	yes
15 kHz, Program, 50 kbit	yes	no
P/AR	yes	yes
2/4-Wire Return Loss:		
ERL, SRL Hi, SRL Lo	yes	yes
Sinewave	yes	no
Equal Level Echo Path Loss	no	yes
Phase Jitter	yes	yes
Amplitude Jitter	yes	no
Gain Hits, Phase Hits, Dropouts	yes	yes
3-Level Impulse Noise	yes	yes
Impedance (ohms)	135/600/900/1200	600/900/1200

* The Intermodulation Distortion technique is licensed under Hekimian Laboratories, Inc. US Patent No. 3862380

HP 4947A

- Voice grade data circuit testing to North American Standards
- High performance at an affordable price
- Automatic sequence for end-to-end testing

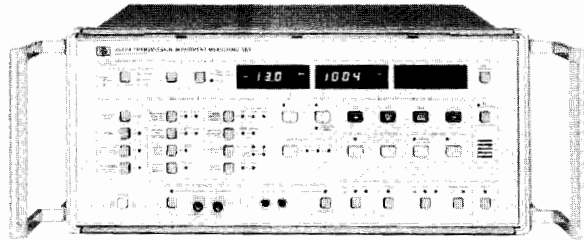

HP 4947A



HP 4947A Product Description

The HP 4947A Transmission Impairment Measuring Set (TIMS) is a test set with the high measurement capability required to test a long distance data circuit. With built-in DTMF dialing and many other time and labor saving features it offers high productivity in line testing. Its operation is modeled on the proven HP 4935A TIMS which makes it simple to use. Its measurement methods are in accordance with IEEE 743-1984. The table below lists the HP 4947A's measurements.

Easy End-to-End Testing

The HP 4947A has a simple solution for fast, trouble-free end-to-end testing. You only need to use two HP 4947As and the circuit under test. With a couple of keystrokes you can run a sequence of tests which measure all the key data transmission parameters. And the system is robust enough to support remote start-up and auto restart on power failure or signal loss. Each HP 4947A stores the results of its own measurements in non-volatile memory. Later, results can be dumped to a printer or controller, or read from the display.

The measurements made in the sequence are: P/AR, Gain Slope, Frequency, Noise with Tone, S/N, Idle Channel Noise, Intermodulation Distortion (both uncorrected and corrected for S/N), Level, Frequency, Phase Jitter, Phase and Gain Hits, Dropouts and Impulse Noise.

Print/Plot to HP ThinkJet

The HP 4947A can print results on a HP ThinkJet, and can even generate plots using its graphics mode. You can record graphs of EDD, level and attenuation vs frequency.

Ordering Information

HP 4945A Transmission Impairment Measuring Set

Option 001: 100/200 Volt operation	\$16,800
Option 101: Adds HP 18162A HP-IB module	N/C
Option 102: Adds HP 18163A RS-232-C module	\$555
Option 103: Adds HP 18165A HP-IL module	\$555
Option 104: Adds HP 18169A 19" rack mount kit	\$390
Option 105: Adds HP 18170A soft vinyl case	\$82
	\$227

HP 4947A Transmission Impairment Measuring Set

Option 908: 19" rack mount kit	\$9,560
Option 910: Extra set of manuals	\$41
	\$57

Accessories for HP 4945A and HP 4947A

HP 18176A: 23" rack mount kit HP 4945A	\$180
HP 18182A: 1.5m cable with WECO 310 to alligator clips	\$67
HP 15513A: 1m cable with WECO 310s on each end	\$62
9211-2650: Hard transit case for HP 4945A or HP 4947A	
(qty 1-4)	\$480
(qty >4)	\$430

DATA COMMUNICATIONS TEST EQUIPMENT

In-Service Transmission Impairment Measuring Set

Model 4948A

- Voice-grade data circuit testing - without disturbing traffic
- True preventive maintenance
- Network management information - without special modems
- Suitable for North American and CCITT environments

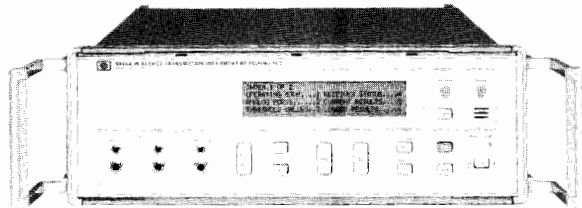

HP 4948A



Description

The HP 4948A is a unique Transmission Impairment Measuring Set (TIMS) which lets you test data circuits carrying voice grade modem traffic while they are still in service. This opens up new cost-saving test strategies for managing data circuits.

A simple connection to the data circuit carrying the modem signal, at a voice frequency access point, is all that is required for the HP 4948A to measure the impairments that have been added between signal generation and the measurement point.

The HP 4948A is very simple to use: with one keystroke the HP 4948A can automatically identify the modem type and measure all the transmission impairments simultaneously. It remembers all the previous test conditions so no time need be wasted setting up a test, and flexible printout capabilities let you document test results with ease.

The HP 4948A Simplifies Testing

The HP 4948A lets you see if the analog signal is good where you are testing. Because you are measuring on the live modem signal, only one instrument need be used, which removes the problem of coordinating an end-to-end test. This helps you quickly establish who has the responsibility to repair a fault in today's multi-vendor networks.

You can respond to trouble reports immediately without taking the line from service. The HP 4948A sees the line like a modem sees it (same bandwidth, same response) letting you identify the impairments that are really causing data errors. All the impairments are measured at the same time so you can quickly recognize the real problem. With the HP 4948A you can implement a preventive maintenance policy and routinely check lines against a benchmark while the circuits are still operating. You will see any degradations and be able to clear problems before they cause data errors. Testing can be done at convenient times, even when the circuits are under most stress.

All the capability of the HP 4948A can be remotely controlled and can be used to build a network monitoring system. The HP 4948A is an economic means of producing accurate data for private network management - even for small networks, or networks using a variety of modem types.

Networks

You can use the HP 4948A at any point along a datacommunications circuit. In multi-point circuits, testing the host-to-slave link is as easy as testing a point-to-point circuit. To test a slave-to-host link, the slave modem must be transmitting data while the HP 4948A analyzes the signal.

Measurement Capability

Level Frequency S/N Phase Jitter {4-20Hz, 20-300Hz} Amplitude Jitter {4-20Hz, 20-300Hz}	Dropouts Gain Hits Phase Hits Impulse Noise	On modem signals only: Attenuation Distortion Delay Distortion
---	--	--

The results are all computed simultaneously, with the received signal constellation available from the rear panel XY outputs.

Compatible Modems

The HP 4948A has been designed to operate with many of the common high speed modems in use to-day.

Data rate	Compatible Modem Types (4-Wire) - Examples
14400 b/s (optional)	CCITT V.33 (Trellis coded) V.33 with 1700 Hz carrier
9600 b/s	CCITT V.29, AT&T 209, AT&T 2096 V.29 with 1800 Hz carrier 4x4 QAM with 1700 Hz carrier
4800 b/s	CCITT V.27, AT&T 208, AT&T 2048
2400 b/s	CCITT V.26 A&B, AT&T 201 B&C

AT&T is a trademark of the American Telephone and Telegraph Company.

Measuring Impairments on a Modem Signal

The HP 4948A measures the effects of the same line impairments that are measured by a conventional, intrusive TIMS. A TIMS measures the effects on a simple known signal (tone) but the HP 4948A measures the effects on the full bandwidth of the transmitted modem signal. In addition, the HP 4948A measures impairments as a modem would see them. From these measurements the HP 4948A predicts conditions on the line and presents its results in conventional form. In most practical situations, the results from the HP 4948A are very similar to those from a TIMS. However, they cannot be directly equated because of the different techniques involved.

Data Logging

Result data can be stored in the test set's own internal non-volatile memory for later interrogation and printout. The HP 4948A can be left unattended for long periods monitoring a line. This lets you trap intermittents or comprehensively characterize a circuit's performance over time.

Out-of-Service Testing

The HP 4948A can transmit and measure on a tone, so it can interwork with tone sources and conventional test sets. It can also transmit a simulation of a high-quality modem signal of each of the compatible modem types. This allows out-of-service testing and circuit benchmarking with another HP 4948A.

Ordering Information

	Transmit & Receive Connectors	
	WECO 310 & Bantam	Siemens 3-pin
Stand-alone front connectors adjustable legs	HP 4948A Standard	HP 4948A Option 003
For rack mounting front connectors flat base	HP 4948A Option 001	HP 4948A Option 004
For rack mounting rear connectors flat base	HP 4948A Option 002	HP 4948A Option 005

Options 001, 002, 004, 005: See table above —\$500

Option 006: 14.4 kbit/s V.33 capability \$1,000

Option 908: 19" rack mount kit \$35

Option 910: Extra set of manuals \$60

9211-2661: Hard transit case (qty 1-4) \$550

(qty >4) \$500

HP 4948A In-Service Transmission Impairment Measuring Set

\$13,550

DATA COMMUNICATIONS TEST EQUIPMENT

Network Circuit Access Test Set, Transmission Impairment Measuring Sets

HP 4938A/4937A, 3551A/3552A

521



HP 4937S

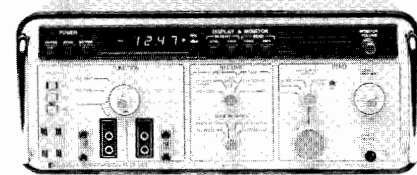

HP 3552A

HP 4937S Network Access Transmission Test Set

The HP 4937S Test Set includes the HP 4937A Transmission Impairment Measuring Set plus the HP 4938A Network Circuit Access Test Set.

Transmission Test Set With Signaling

The HP 4937S Network Access Transmission Test Set provides transmission tests, supervisory signaling simulation, and network access capabilities for installation and maintenance of networks and PBXs. It is a field-service, portable test set designed for craft-level use. All transmission measurements are compatible with current Bell standards.

One Instrument For Installation/Maintenance of PBXs and Networks

The HP 4937A contains a set of voiceband transmission tests - level/frequency measurement, noise, and 2- and 4-wire return loss measurements. It also has the ability to seize and hold three types of E/M lines. In addition, the HP 4937A simulates signaling both from the central office and from the PBX at the network interface.

The HP 4938A provides additional network access and margin testing capabilities. It includes access to 4-wire simplex leads, generating ringing signal, and providing access for loop current and ringing voltage measurement.

HP 4937A Specifications

Level/frequency

Transmitter: -40 dBm to +13 dBm, 20 Hz to 9999 Hz

Receiver: -60 dBm to +13 dBm, 20 Hz to 9999 Hz

Noise measurements

Noise: 0 to 99 dBrn

Noise-with-tone: 10 dBrn to 99 dBrn

Signal-to-noise ratio: 10 to 45 dB

Noise-to-ground: 50 to 99 dBrn

Filters: C-message, 3 kHz flat, 1010 Hz notch

Return loss

Impedances: 600 and 900 ohms

Signal spectra: echo return loss, singing return loss high/low

Return loss, 2-Wire

Transmitter level: -26 dBm to -2 dBm

Receiver range: 0 to 40 dB

Return loss, 4-wire

Transmitter level: -26 dBm to -2 dBm

Receiver range: 0 to 50 dB

Transhybrid loss compensation: -29.9 to +29.9 dB

Supervisory signaling: E/M signaling, loop signaling, battery, hold circuits, wink

General

Battery supply (optional): typically 5 hours of continuous operation at +25 degrees C; complete recharging in 14 hours with unit in STBY

Size: 127H x 279W x 380mmD (5.0" x 11.0" x 15.0")

Weight: 5.3kg (12lb), 7.7kg (17lb) with batteries

HP 4938A Specifications

Ringing voltage generator

Output level: 86 Vrms into REN-3 load

Frequencies: 20 Hz and 30 Hz

Ring trip threshold: 17 mA typical

Ringing termination: REN-3 load, ring trip closure (330 ohms)

Loop signaling network: loop start, 430 ohms; ground start, 550 ohms from ring to ground

4-wire network access: 2 dual center-tapped simplex transformers

Battery simulator: 48 Vdc maximum current 100 mA

General

Size: 126H x 261W x 91mmD (4.9" x 10.3" x 3.6")

Weight: 1.5kg (3.2lb)

HP 3551A/3552A Transmission Test Sets

The HP 3551A Transmission Test Set performs measurements compatible with Bell standards (BSTR 41009) and IEEE standards (IEEE 743-1984). These standards are primarily used in North America. The HP 3552A performs measurements compatible with the recommendations of the CCITT, which are generally used in Europe and the rest of the world.

HP 3551A/3552A Specifications

Measurements: level, frequency, circuit noise, noise-with-tone, noise-to-ground

Filters

3551A:

C-Message

3 kHz flat

Program

15 kHz flat

3552A:

Psophometric

3 kHz flat

Program

15 kHz flat

1010 Hz notch

General

Impedances: 3551A: 135, 600, 900 ohms

3552A: 150, 600, 900 ohms

Size: 159H x 368W x 273mmD (6.3" x 14.5" x 10.8")

Weight: 6.6kg (14lb)

Ordering Information

	Price
HP 4937S Network Access Transmission Test Set	\$6,245
Opt 001 Rechargeable batteries	+\$280
Opt 002 Replace 900 ohms with 150 ohms	\$0
HP 4937A Transmission Impairment Measuring Set	\$5,050
Opt 001 Rechargeable batteries	+\$280
Opt 002 Replace 900 ohms with 150 ohms	\$0
HP 4938A Network Circuit Access Test Set	\$1,300
HP 3551A Transmission Test Set (North American)	\$4,735
HP 3552A Transmission Test Set (CCITT)	\$5,550

DATA COMMUNICATIONS TEST EQUIPMENT

Transmission Impairment Measuring Set (TIMS)

HP 4934A

- Analog testing to North American standards
- Install and maintain voiceband data, wideband data, program and DDS local loop circuits
- Rugged, portable, affordable
- Level/frequency 20 Hz to 110 kHz
- Noise measurements, 3-level impulse noise and P/AR
- Simple operation
- Optional battery operation with built-in recharger

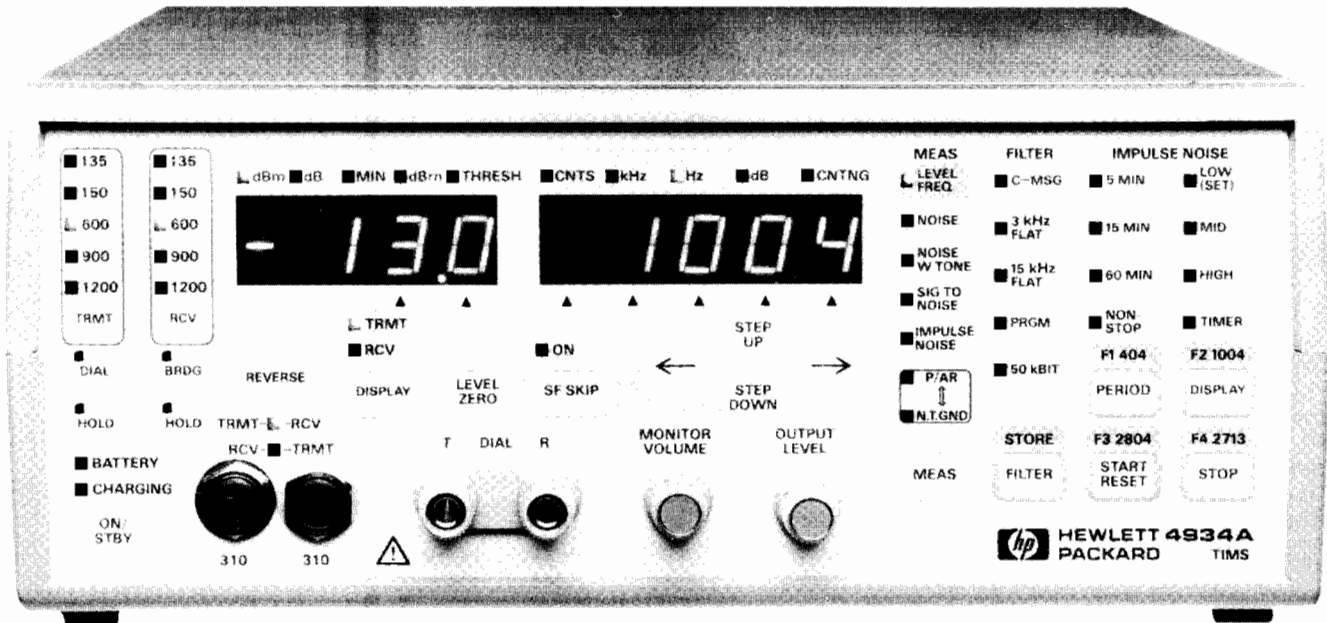

HP 4934A



Transmission Impairment Measuring Set (TIMS)

The HP 4934A Transmission Impairment Measuring Set (TIMS) increases installation and maintenance productivity for telephone companies and service providers through its ease of use, portability, and ruggedness. The HP 4934A covers a wide range of analog circuits with its 110 kHz bandwidth, choice of C-message, 3 kHz flat, 15 kHz flat, program and 50 kbit filters, and choice of impedances.

The HP 4934A uses IEEE 743-1984 measurement methods. It can verify telephone company tariffed parameters and work with other TIMS or automatic test equipment in the telephone network. HP 4934A measurements include the following:

- Level/frequency up to 110 kHz
- Noise and noise-to-ground
- Noise-with-tone and signal-to-noise ratio
- 3-level impulse noise
- P/AR

The HP 4934A is easy to use. You can cut out errors with simple keystrokes and one-button-per-function operations. The front-panel keys are large enough to use easily, and they beep when pressed. The dedicated keys and indicators allow you to see the measurement setup at a glance. Results are easy to read on large, bright displays. There is a built-in operating summary. The manual describes how to do measurements and also describes the principles of each measurement and how to interpret the results.

The HP 4934A is easily carried by hand and stowed in an aircraft cabin. The front cover stores the power cord and the two standard test cords, or they can be stored in an optional soft vinyl carrying case for greater protection and more accessory storage. The tough polycarbonate case has a metal handle. The optional battery operation

provides one day of normal working time, and the built-in charger can fully recharge the battery overnight.

Applications

The HP 4934A is ideal for telephone companies and for service providers for the installation and maintenance of special services using a wide range of analog circuit types. The HP 4934A provides the tests required to qualify the local loop for Digital Data Systems (DDS) up to 56 kb/s.

The features and the low cost make the HP 4934A suitable for data communications users who need to check line performance against tariffs. If there is a fault, the users can quickly determine who is responsible for fixing it. Because the measurement results of the HP 4934A are reliable, they are readily accepted by circuit or equipment vendors and repairs can be made quickly to minimize downtime.

Ordering Information

	Price
HP 4934A TIMS , includes front-panel cover, power cord, 2 HP 15513A test cords (with WECO 310 jack plugs) and manual	\$2,600
Opt 001 battery pack with built-in charger	+\$300
Opt 010 without standard test cords	-\$100

Accessories

HP 15513A 1m audio cable, WECO 310 jack plug each end	\$62
HP 15677A ladder bracket	\$36
HP 15678A 19 inch rack mount	\$190
HP 18134A vinyl carrying case	\$144
HP 18182A 1m audio cable WECO 310 jack plugs to alligator clips	\$67

DATA COMMUNICATIONS TEST EQUIPMENT

Transmission Impairment Measuring Sets (TIMS), Bit Error Rate Test Set HP 4935A/4936A, 4925B

523

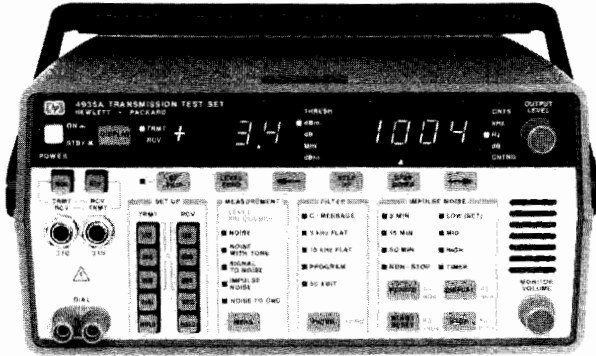

HP 4935A

Transmission Impairment Measuring Sets

The HP 4935A/4936A Transmission Impairment Measuring Sets are rugged, portable test sets that provide the basic analog tests to isolate faults and to qualify circuits for voice, data, and broadcast service. In addition, the HP 4935A, with its 110 kHz bandwidth, performs the required tests to qualify the local loop for Digital Data System (DDS) up to 56 kb/s. The Peak-to-Average Ratio (P/AR) measurement option on the HP 4935A gives users a powerful, yet simple, measure of the combined factors that affect the overall transmission quality of the line. The HP 4935A performs measurements compatible with the Bell standards (BSTR 41009) and IEEE standards (IEEE 743-1984). The HP 4936A is compatible with the recommendations of the CCITT.

Specifications

Measurements: level, frequency, circuit noise, noise-with-tone, signal-to-noise ratio, 3-level impulse noise (quiet) (HP 4936A), 3-level impulse noise (quiet or tone), noise-to-ground (HP 4935A), P/AR (option HP 4935A)

Filters

HP 4935A	HP 4936A
C-message	Psophometric (P.53)
3 kHz flat	275-3250 Hz flat (O.71 impulse noise)
Program	Sound unweighted (J.16)
15 kHz flat	Sound weighted (J.16)
50 kbit	
1010 Hz notch	820 Hz notch (1020 Hz optional)

Size: 127H x 279W x 381mmD (5.0" x 11.0" x 15.0")

Weight: 5.0kg (11lb), 6.5kg (14lb) with battery

HP 4925B Bit Error Rate Test Set

The HP 4925B Bit Error Rate Test Set provides the standard bit and block error tests and also measures errored seconds, percent error-free seconds, timing delay, and parity errors over both RS-232-C/V.24 and V.35. Complete data testing is available from the HP 4925B from 75 b/s to 19.2 kb/s for asynchronous framed or unframed systems. In synchronous systems where the HP 4925B provides the clock, data rates up to 72 kb/s are available, which makes the HP 4925B ideally suited for complete DDS testing.

Increased flexibility is afforded by a complete breakout box. You can manipulate and monitor individual signal lines on the RS-232-C/V.24 interface or crosspatch any line from the DCE side of the interface to the DTE side. The HP 4925B also transmits the FOX message using a 5-bit baudot, 6-bit EBCD, 7-bit ASCII, or 8-bit EBCDIC code to terminals and printers. It includes detection and annunciation of dropouts, clock slips, and RTS-CTS delay time. Three separate start-up tests, end-to-end, loopback and BELL 208B modem, enable dynamic testing of modems, which makes the HP 4925B extremely useful in isolating faults related to automatic equalization.

The HP 4925B is powered by six 9-volt alkaline transistor batteries, allowing greater than 50 hours of RS-232-C/V.24 operation. An ac module (HP 18185A or HP 18194A) is recommended for use with V.35 interfaces.

HP 4935S Data Transmission Test System

The HP 4935S combines the analog test power of the HP 4935A with the compact, yet powerful digital test abilities of the HP 4925B to form a complete data installation and maintenance tool. This is

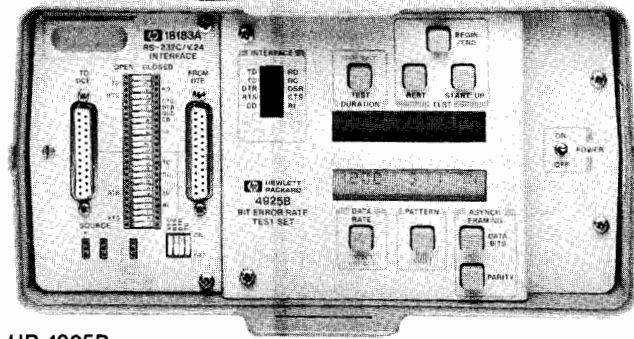

HP 4925B

especially useful for those technicians who have both analog and BERT test needs.

Ordering Information

HP 4935A Transmission Impairment Measurement Sets **Price** \$3,605

Opt 001 Rechargeable batteries +\$380

Opt 002 add P/AR Measurement, delete noise-to-ground +\$155

Opt 003 add opt 001 & 002 +\$465

HP 4936A Transmission Impairment Measuring Sets (CCITT) \$4,830

Opt 001 include 820 Hz tone, add rechargeable batteries +\$535

Opt 002 1020 Hz tone replaces 820Hz \$0

Opt 003 add opt 001 & 002 +\$535

HP 4925B Bit Error Rate Test Set \$1,450

(does not include interfaces)

Opt 001 Carrying Case (HP 18192A) +\$118

Opt 101 RS-232-C/V.24 (HP 18183A) +\$420

Opt 102 V.35 (HP 18184A) and 115V Power Module (HP 18185A) +\$620

Opt 104 V.35 (HP 18184A) and 220V Power Module (HP 18194A) +\$660

HP 4935S Data Transmission Test System \$5,180

Opt 001 Rechargeable batteries +\$385

Opt 002 P/AR, no noise-to-ground on HP 4935A +\$155

Opt 003 add options 001 and 002 +\$465

Opt 101 RS-232-C/V.24 on HP 4925B +\$420

Opt 102 V.35 Interface and 115V Power Module (HP 18185A) on HP 4925B +\$620

Opt 104 V.35 interface and 220V Power Module (HP 18194A) on HP 4925B +\$660

Accessories

HP 4935A/4935S/4936A/4937A Accessories

HP 18132A 19-inch Rack Mount for HP 4935A/4936A/4937A \$170

HP 18134A Soft Vinyl Carrying Case for cords on HP 4935A/4935S \$144

HP 15512A 1m Audio Cable, 3-pin connectors (Siemens type) on both ends - for HP 4936A \$82

HP 15513A 1m Audio Cable, WECO 310 jack plugs on both ends - for HP 4935A, HP 4937A \$62

HP 18182A 1.5m Audio Cable, WECO 310 to alligator clips \$67

HP 18064A Noise-to-Ground Adapter for the HP 4935A; allows opt 002 & 003 instruments to also measure noise-to-ground \$139

HP 18161A ladder bracket for the HP 4935A and HP 4937A \$31

HP 18183A RS-232-C/V.24 Interface \$420

HP 18184A V.35 Interface \$495

HP 18185A 115V Power Module \$124

HP 18191A Rack Mount (19") \$196

HP 18192A Carrying Case \$110

HP 18194A 220V Power Module \$165

SEMICONDUCTOR TEST EQUIPMENT

General Information

Parametric Measurement

Semiconductor Parametric Measurement

Semiconductor parametric measurement instruments are used for measuring and evaluating the electrical characteristics of semiconductors.

Competition within the semiconductor field is fierce, and major goals are: developing new products rapidly, improving yield and reducing costs.

HP semiconductor parametric measurement instruments provide:

1. Precise, high-resolution measurements for accurate and reliable evaluation and
2. Automated operation from measurement through analysis.

Semiconductor measurement applications vary widely, from device R&D to large-volume manufacture on mass-production lines. Measurement equipment must fit the measurement functions required.

In R&D, parametric testers make comprehensive physical and electrical evaluations of new materials, prototype devices and evaluation test patterns. As the integration and performance of semiconductors advance, measurement instruments must have the expandability to adapt to the high resolution and precision demanded by new evaluation methods.

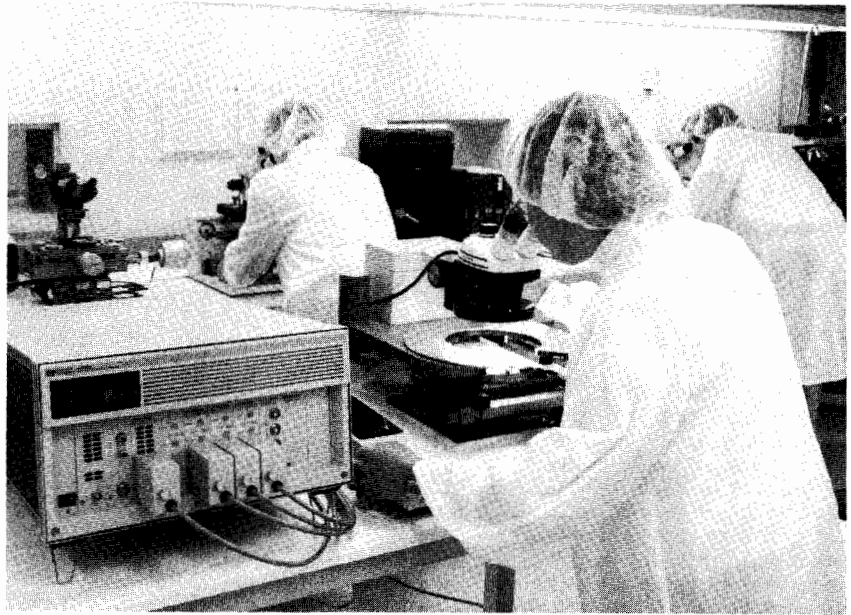

For production departments, parametric testing helps stabilize new processes for mass production and helps make process yield improvements. Functional testing is used mostly

in outgoing inspection. Cost reduction for both types of test requires high-speed, multiple-pin measurements and reduced down-time. The yield of new VLSI devices is less than 10 percent, and bad devices must be discarded. The accurate parametric testing provided by HP parametric testers can help improve processes and raise yields.

Parametric measurements are generally divided into capacitance (C) and DC, AC, and functional measurements. The following summarize each type of measurement.

1. Capacitance measurements include, primarily, capacitance vs voltage (C-V) and capacitance vs time (C-t). These capacitance measurements require correct measurement timing and good capacitance measurement resolution.

2. DC measurements measure the DC current vs voltage (I-V). DC parameter evaluation is based on I-V curve evaluation (eg. threshold voltage, breakdown voltage, leakage current). These measurements require high speed and resolution.

3. AC measurements evaluate the dynamic characteristics of the semiconductor device. With a digital IC, timing measurements such as rise time and propagation delay are the primary ones, so timing resolution is important. Determining the AC gain characteristics of linear ICs requires a wide dynamic range over a wide frequency band.

4. Functional testing evaluates the input/output operation and digital characteristics of semiconductor devices, especially logical devices. This measurement creates an input/output truth table and determines whether the desired output is attained or not.

Table 1 shows the parametric measurements required by each application area, with the HP parametric-measurement products that apply.

		Lab/R&D			Production		User
		Base Technology	Process Development	Circuit Design	Process Engineering	Testing/Quality Assurance	Incoming Inspection
C	C - V	●	●		●		
	C - t	●	●				
D	I - V	●	●	●	●		
C	Parameter	●	●	●	●	●	
AC Parameter				●		●	●
Functional				●		●	●
Instruments	C - V	HP 4274A					
		HP 4275A					
	C - t	HP 4284A					
		HP 4280A					
	I - V	HP 4140B					
		HP 4141B					
HP 4142B							
HP 4145B							
I - V &	HP 4145B						
	HP 4085M						
Systems	I - V	HP 4061A					
		HP 4062B/C/UX					
	Functional	HP 82000 Model D200 Model D50 HP 9480					

Table 1. Measurements and HP instruments/systems by application area.

Parameter Extraction

CAD Software for Parameter Extraction

HP recently enhanced TECAP (Transistor Electrical Characterization and Analysis Program), used with the company's parametric-measurement equipment. This software package greatly simplifies the task of using mathematical models in circuit design. It measures real devices and computes the parameters needed for circuit-simulation programs such as SPICE.

TECAP Automatically Generates Physically Meaningful Parameters

There are three steps to TECAP's model parameter extraction methodology. First, TECAP identifies regions of device operation to be modeled and measures devices in those regions of operation. You may accomplish parameter "weighting" simply by selecting more data points in each region you wish to emphasize. The model parameters are then automatically grouped into subsets that most directly affect the device characteristics in each of the selected regions of operation. TECAP selects the regions of operation and parameter groupings for the UCB Level 2 and 3 MOS Models and the UCB Gummel-Poon Bipolar Model, but you also have the flexibility to tailor these to your own extraction strategy.

In the second step, powerful, pre-defined functions quickly extract model parameters directly from the measured data points. This step ensures that you generate a physically meaningful set of final model parameters. Again, you can tailor these functions to your own extraction strategy if necessary.

Finally, if you wish, you can "fine-tune" your model parameters using TECAP's powerful optimizer. This optimizer determines parameter values that minimize the difference between measured and simulated device characteristics. You have the option of setting "boundaries" on each parameter value prior to optimization. These user-defined constraints decrease optimization time and



HP 82000 IC Evaluation System

guarantee that your final model parameters will be physically meaningful. The non-linear, least-squares-fit algorithm combines the Gauss-Newton and steepest-descent optimization methods for the most accurate fit.

TECAP provides the environment for complete, automated device characterization inside your company. You have the flexibility to use the standard extraction methodologies, or you can customize the program and use TECAP as a "shell" to integrate and automate your own particular extraction strategies. Either way, TECAP provides a practical, universally-satisfying solution to all of your parameter extraction needs. (See page 546.)

Digital IC Test

Digital IC Test

The need for testing occurs several times during the development of digital IC's. First prototypes encounter functional debugging, and critical path analysis to prove what simulation predicted. Afterwards, in volume production, a series of tests is conducted to isolate defective parts. Devices failing as a result of a faulty manufacturing process are subject to thorough failure analysis. Results obtained, can be used to optimize the process for an improved production yield. In addition to established quality control procedures at the manufacturer's site, customers can use test systems to analyze samples in incoming inspection and for vendor qualification.

Application specific IC's create new tester demands

Two products are available to address the requirements created by the growing number of Application Specific IC's (ASICs). One is designed for testing high performance IC's, and a second product is targeted at the mainstream ASIC's, mainly in CMOS technology. Both provide functions for easy in-depth analysis of IC's and are optimized to switch quickly from one prototype test to another.

The HP 82000 IC Evaluation System

The HP 82000 is a compact, fully integrated solution for ASIC prototype verification, IC characterization and low volume production test. IC manufacturers and ASIC users will appreciate the HP 82000's capabilities to reduce time-to-market in IC development. Automated tests combined with superior measurement performance, provide the resources to test high speed, high pin count devices quickly. Please see the next page for details on this product.

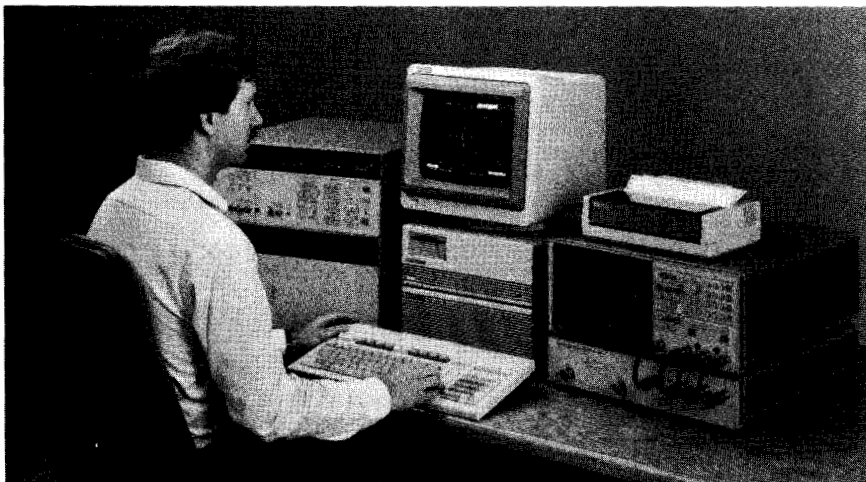

Now, IC designers can save valuable design time by using HP's powerful TECAP system to analyze DC, C-V, and AC behavior of MOS, Bipolar, and Gallium Arsenide devices in an integrated, accurate, and interactive environment.

SEMICONDUCTOR TEST EQUIPMENT

IC Evaluation System

HP 82000 Model D200, Model D50

- 200 MHz vector rate/ ± 250 ps accuracy or
- 50 MHz vector rate/ ± 500 ps accuracy
- Tester-per-pin architecture
- Interactive test control with X Windows
- Automatic functional test generation
- Automatic AC/DC characterization



The HP 82000 standard frame configuration

A family of compatible systems

With the HP 82000, Hewlett-Packard offers systems to satisfy the IC evaluation requirements of both IC manufacturers and end users. To address a wide range of applications, two models are available: The HP 82000 model D50 for a maximum vector rate of up to 50 MHz, and the model D200, with a maximum speed of 200 MHz.

The Model D50

The HP 82000 model D50 is the ideal choice to test mainstream CMOS and bipolar devices. ASICs with up to 512 bidirectional signal pins can be verified and characterized with ± 500 ps accuracy. Critical turnaround times are reduced with the automated characterization software, which is also compatible with the model D200. The extensive use of ASIC technology in this system provides great flexibility with low system costs.

The model D200

The HP 82000 model D200 offers 200 MHz speed and ± 250 ps edge placement accuracy on up to 384 I/O channels. It is designed for manufacturers, design centers and ASIC system designers with high performance requirements. For tasks such as prototype verification, characterization or failure analysis, the HP 82000 is a cost efficient alternative to ATE.

Application examples Prototype Verification

Unlike large and complicated production ATE, the HP 82000 is a personal tester dedicated to your verification requirements. The ability to create a functional test program from the EDA (Electronic Design Automation) workstation database means faster time-to-market in prototype verification.

The earlier that design problems are detected, the lower the overall product development cost. This system enables you to analyze IC function and parameters at the prototype stage of the design cycle. The risk of ASIC problems in later board level integration is minimized.

IC Characterization

To optimize design throughput, Hewlett-Packard developed the automatic characterization functions as standard with every system. There are numerous test functions, which provide test patterns, the appropriate system setup, and automatically sweep test parameters for complete characterization tests. Measurements of AC and DC characteristics such as hold time or leakage current, are started quickly from menus and are completed instantly.

Engineering testing of prototype IC's is the main application area of the characterization functions. Other applications include Incoming Inspection and Failure Analysis of parts rejected by production ATE. For the latter, the HP 82000 can be used as a dedicated system to diagnose the process problems that caused rejection.

Production Testing

If throughput is not a major concern, the HP 82000 can be a very cost efficient alternative to ATE because its high timing and level accuracies allow tight guardbands for higher test yield. Third party products can be integrated with the system to access wafer prober stations and device handlers. With systems in production and in the engineering department, test programs can be shared over a LAN (Local Area Network) without extra effort.

Tester-per-pin architecture provides best accuracy and flexibility

Bidirectional timing and level capabilities are provided for every channel without sharing resources. Each channel also has dedicated memory for the tristate and masking information, and can have its own data format (RZ, R1, DNRZ, and so on). All tester channels can be calibrated individually at the DUT pin. For best results, you can calibrate using the actual test parameter set - giving an accuracy of ± 250 ps with the model D200 and ± 500 ps with the model D50. This is especially useful when performing fast go/no go tests, for example in production.

Best time-to-test with windows software

Productivity is increased with a highly interactive user interface based on the X Window standard. The mouse operated software is used to enter and modify parameters for pin timing and levels, and to modify the vector data. Thanks to the tester-per-pin architecture, parameters can be defined and changed for each channel individually without limitations through shared resources. Error map, timing diagram and shmoo plot displays show results in a graphic form familiar to the engineer. Simultaneous access to different windows lets you see immediately the results of changes made in the setup. "Change and see" avoids recompilation of test programs and gives you the shortest possible debug cycle.

Automatic test program generation

The LAN provides fast access to design workstations from vendors such as Daisy, Mentor, Valid, HP and to FACTOR files. Other formats can be adapted by the user during the translation process or with the EDA programming toolkit. The computing power of a 32-bit workstation, and translation programs optimized for speed, maintain high throughput in the automatic test program generation.

Software fully supporting the testers' hardware resources, generates a functional device test without user programming. Test vectors, timing setup and pin setup are generated automatically.

Test control includes Scan Path testing

To support "Design for testability", a scan path testing mode is integral to the system. The memory of up to 128 tester channels can be serialized via a software command, increasing vector depth on user-selected channels. A programmable vector sequencer has functions such as vector repeat, looping and branching on real time test results or external events.

Minimum DUT wiring

"Instant wired" DUT boards for the popular pin layouts reduce the time for I/O wiring to zero and are available in various sizes to allow you to optimize board size and cost for the pin-count of your DUT. A controlled impedance environment from the testers' I/O circuits to the DUT provides excellent signal fidelity up to 200 MHz. To cover special IC packages, HP also offers boards which give maximum flexibility for user wiring.

Cost efficient configurations

For applications requiring a maximum of 80 I/O pins (160 I/O on the model D50), there is a compact benchtop alternative to the standard size system. The system components, including DUT boards, are compatible for upgrades to higher channel counts. With built-in self test and calibration, on-site board exchange is made easy. Expansion to maximum channel count systems with uncompromised speed and accuracy is possible by adding extra mainframes.

For Ordering and Technical Information, Technical data Sheets and Application Notes, please contact your nearest HP sales office.

System characteristics

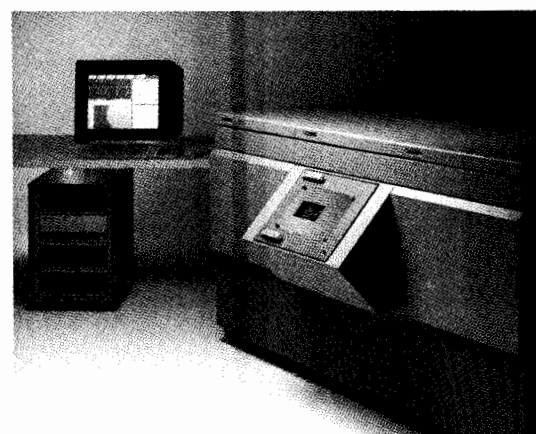
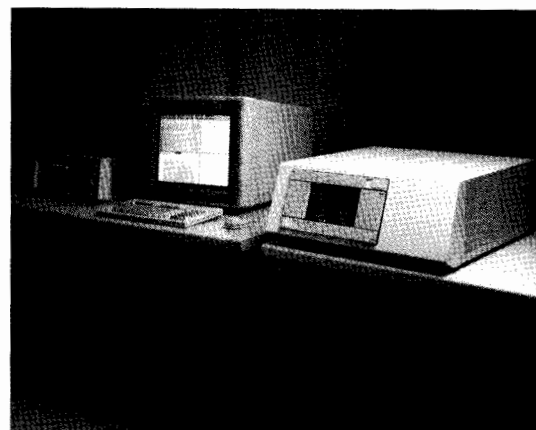
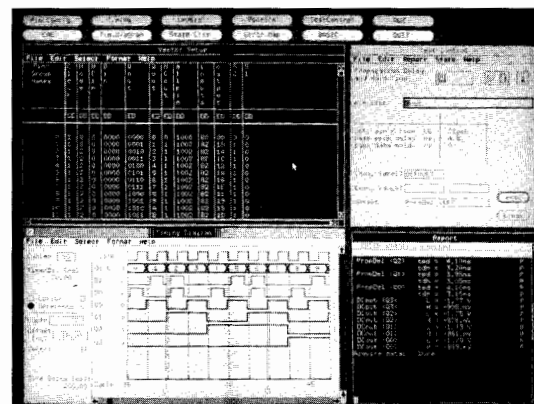

	Model D50:	Model D200:
Vector rate:	50 MHz	200 MHz
Vector depth:	256 K	128 K
Max. I/O pin count:	512	384
Timing resolution:	100 ps	50 ps
Edge placement accuracy at		
- standard calibration:	±800 ps	±500 ps
- calibrated user settings:	±500 ps	±250 ps
Level range:	-2..7V	-4..8V

Architecture: tester-per-pin with individual timing and level resources, including per-pin formatting, compare mode (edge/window), tristate, masking and channel modes.

PMU's: available as plug-in boards, one pair per mainframe.

Software: Interactive X Window environment, automatic tests and AC/DC characterization, color graphics result windows.

SEMICONDUCTOR TEST EQUIPMENT

Analog LSI Test System

Model 9480

- 128 MHz Analog and Digital Synchronized Testing
- 1 GHz Bandwidth, 1 ps Sampling Resolution
- AC Testing at the Wafer Level
- Digital Signal Processing (DSP) Based System
- Flexible Modular Architecture
- Powerful Debugging Tools
- Distributed Workstation Environment

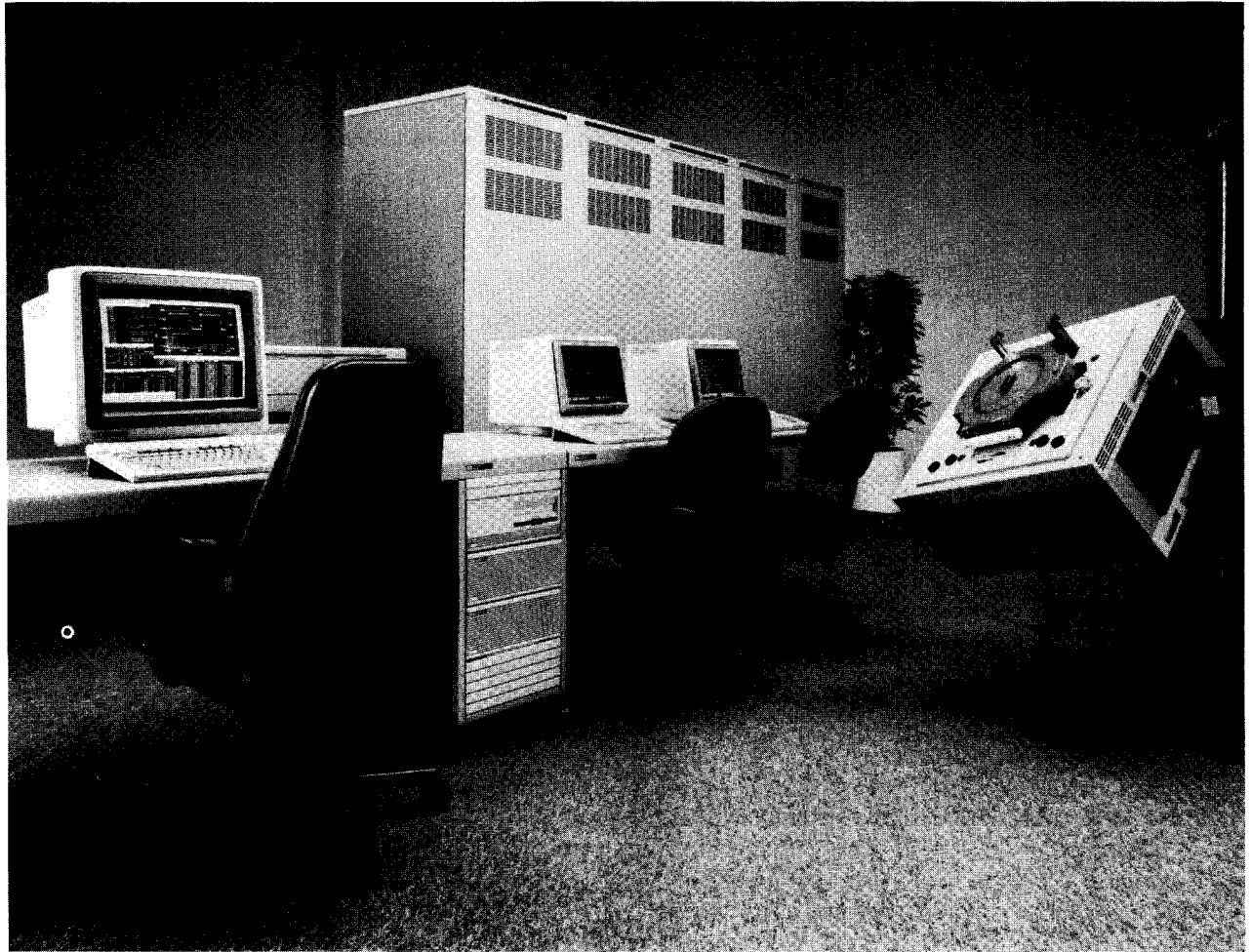

Description

The HP 9480 Analog LSI Test System integrates powerful test hardware and software to perform precise high frequency signal measurements. You can use the HP 9480 to test and characterize a wide variety of devices, from mixed signal devices such as flash ADCs, video DACs, telecommunication devices, etc., to purely analog or purely digital ICs. The HP 9480 provides full data sheet test coverage in a single insertion, thus eliminating the problem of time-consuming and costly multiple insertion testing. The HP 9480 can also perform high frequency AC tests on wafers.

The HP 9480's modular architecture allows you to combine many state-of-the-art hardware and software features into a configuration that best suits your measurement needs. The system can generate digital stimulus patterns and analog stimulus waveforms up to 128 MHz, and can capture DUT digital response patterns up to 128 MHz. For

analog DUT response, the system offers 16 and 12-bit real time waveform digitizers and 1 GHz bandwidth samplers with 1 ps resolution. The system also offers 18 and 10 bit arbitrary waveform generators. Digital patterns, DC voltage, and DC current can be input or output to up to 128 pins. Analog signals can be input or output using up to 4 channels each. Digital Signal Processing (DSP) allows complex waveform generation and high speed signal analysis via a full floating point array processor. The HP 9480's system software is based on the HP-UX operating system. Powerful debugging tools, including an off-line debugger, virtual panel, and virtual scope, significantly minimize debugging time. Further, HP 9480 software is easy to operate because it incorporates menus, a user-friendly multi-window environment, and mouse capability. These features increase test throughput and minimize time spent on program development.

Hardware

Device Testing Under In-circuit Conditions

The HP 9480's analog and digital signal test capability enables you to test the dynamic parameters of devices under their true operating conditions. The HP 9480 can also perform high frequency tests on wafers because of its coaxial cable environment and very low system noise.

For AC signal stimulus, the HP 9480 generates low distortion sine waves (up to 128 MHz), arbitrary waveforms with 10-bit resolution (up to 128 MHz clock rate), and arbitrary waveforms with 18-bit resolution (up to 1 MHz clock rate). For recording high frequency signals up to 1 GHz, with 12 bit resolution, the system offers 4 sampler channels that sample a signal with 1 ps resolution. For recording signals in real time, the system offers two choices—20 MHz/12-bit and 1 MHz/16-bit digitizers. For digital testing, the system offers up to 128 I/O pins, and features 64 kword memory for each pin. The system can generate digital stimulus patterns and clocks, and can analyze response patterns from the test device at a data rate of 128 Mwords/s with 100 ps resolution. And because the HP 9480 can synchronize analog waveforms with digital signals, and can automatically execute timing adjustments, you can perform precise tests on mixed signal devices under actual operating conditions. The HP 9480 allows you to perform DC parametric testing on each pin independently. This allows efficient testing because you can simultaneously perform different tests on different pins.

Digital Signal Processing (DSP) Technology

The HP 9480 uses Digital Signal Processing to generate and analyze analog and digital signals.

For example, you can easily and quickly modify and create waveforms in the frequency domain by using FFT commands. The HP 9480 can easily synchronize analog signals with system clocks because the waveform data is recorded into system memory. Multiple parameters such as THD, SNR, differential nonlinearity, etc., can be extracted from the recorded data without running the test again. A 32-bit full floating point array processor minimizes system controller loading by performing complex matrix computations for digital signal processing. DSP technology shortens test times by allowing multiple parameter extraction from a single test, and minimizes hardware costs because analog and digital processing are performed by the same modules.

Modular Architecture

The modular system architecture of the HP 9480 allows easy adaptability to your changing test needs. This means that the system's usefulness and value are maintained well into the future, because system upgrades and enhancements are easy and cost-effective. Also, maintenance costs are minimized because only faulty modules need to be repaired or replaced in the event of a system malfunction.

Software

HP 9480 software is based on the HP-UX operating system, and operates on HP 9000 Series 300 Engineering Work Stations. HP-UX is fully compatible with standard UNIX systems, and incorporates an advanced multi-window system with a mouse and pop-up menus. This provides graphics oriented test development, testing, and data analysis environments, which facilitate smooth and efficient operation. You can easily set up conditions and values for test execution and data analysis, with the HP 9480's fill-in-the-blanks format. One simply enters the appropriate information into the mask fields displayed on the screen.

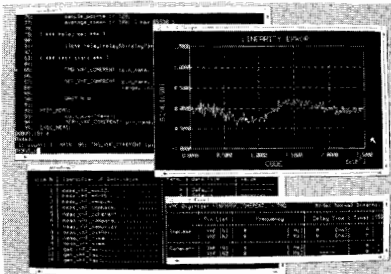

Multi-window Environment

Test Development

The HP 9480 features two debugging modes and three useful tools for you to use the test hardware effectively, and reduce the amount of time spent on test program development.

The debugging modes available are off-line and the standard on-line debugging. A hardware simulator is used with off-line debugging. Therefore, off-line debugging and device test execution can be performed at the same time because the test hardware is not used for off-line debugging. This guarantees efficient system utilization.

Available tools are the symbolic debugger, virtual panel, and virtual scope. The symbolic debugger offers a number of features that enable the user to debug at the source code level. The symbolic debugger decreases debugging time because it allows you to modify test conditions without program recompilation. The virtual panel displays the hardware settings and output conditions in real time when debugging, thereby allowing you to confirm program measurement conditions. The multi-window function displays hardware information on a module-by-module basis. The virtual scope displays the stimulus waveform or pattern data specified in the program, and the response waveform output from the test device. These tools minimize the test development time and maximize engineering productivity.

Testing

The HP 9480 provides easy operation in the test execution environment. The test conditions are set in a fill-in-the-blanks format displayed on the screen, and tests start by the press of a function key or the start button on the operator console. The operator console is a compact terminal to control test execution, such as test start, re-test, and test stop.

For monitoring tests quickly, the virtual scope and summary logging are useful tools. The virtual scope displays waveform output from the test device. The summary logging collects data during device testing, and makes test summary, bin summary, and lot summary reports.

Data Analysis

The HP 9480's software capabilities are complemented by a comprehensive set of data analysis functions. These functions allow you to make effective use of all test data collected during device testing. The following reports can be set up and displayed so that you can easily analyze measurement results: Tabular Reports, Scatter Diagrams, Control Charts, Wafer Maps, X-Y Graphs, Shmoo Plots, and Bar Charts.

Tester Workstations (sold separately)

The HP 9000 Series 300 computer, the HP 9480 system controller, can connect directly to the Ethernet/IEEE802.3 Local Area Network (LAN).

When networked, HP 9480 tasks can be distributed between workstations in the network. This increases system efficiency because tasks previously managed by one computer are now distributed between workstations. For example, you can use a Test Development Station (TDS) as a stand-alone workstation for test program development, such as editing, compiling, and off-line debugging, while testing, without degradation of test performance.

Application Support for Rapid Start Up

HP Semiconductor System Centers (SSCs) offer quality application support for quick start up of your HP 9480 system. Application support packages include consultation with expert HP personnel, and the tailoring of test program software and hardware to your specific test requirements.

System Specification Summary

128 pin I/O, 128 MHz (1 μ Hz resolution) clock rates

Analog signals analysis

16 bit (1MHz)/12 bit (20MHz) real time digitizer
1GHz (12 bit) high frequency sampler

AC signal stimulus

18 bit (1MHz)/10 bit (128MHz) AWG

Digital test

64K word (128MHz) WG/WM
DC test per pin

SEMICONDUCTOR TEST EQUIPMENT

Process Control System

HP 4062UX

- High speed and wide measurement range
- Standard Networking

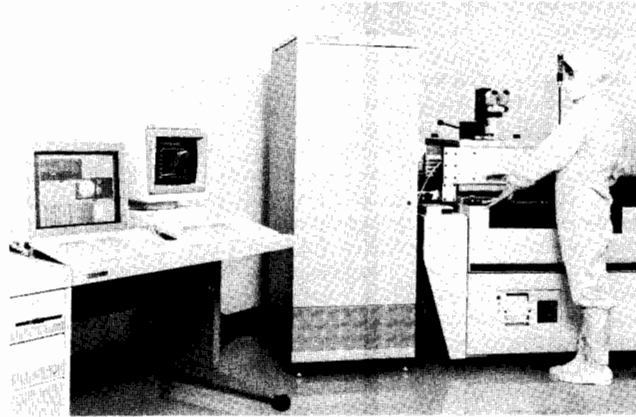

HP 4062UX Semiconductor Process Control System

The HP 4062UX Semiconductor Process Control System is the high-end system of the HP 4062 Semiconductor Parametric Test System family. The HP 4062UX satisfies all of the requirements of the Integrated Circuit Manufacturers for both process monitoring and process development. Since the HP 4062UX uses the same measurement hardware as the HP 4062C, it maintains the same highly accurate and reliable measurement capabilities as the HP 4062C, such as high speed measurements over a wide measurement range. For example, a typical connect-connect-force-measure sequence (resistance) measurement takes less than 17 ms, and measurements can range from 20 fA to 1A and 4 μ V to 200V. Refer to the HP 4062C description on page 632 for more information about the high-speed measurements and wide measurement range that are also possible with the HP 4062UX.

In addition to the sophisticated hardware of the HP 4062C, the HP 4062UX provides powerful software capabilities with the HP BASIC/UX operating environment. HP BASIC/UX combines the most powerful instrument control language, HP BASIC, with all the elements of HP-UX, the Hewlett-Packard implementation of the AT&T System V UNIX* operating system.

Networking

You can easily link the HP 4062UX to other test systems or computers over standard Local Area Networks (LANs). Access to IEEE 802.3/Ethernet using ARPA/Berkeley services, to DECnet using NS/VAX, or to SNA using an SNA gateway is easily accomplished with the HP 4062UX. The HP 4062UX system controller can be integrated into test-area or factory-level management systems. A diskless cluster configuration allows for the sharing of file storage disks and printing peripherals, resulting in low-cost test-area design.

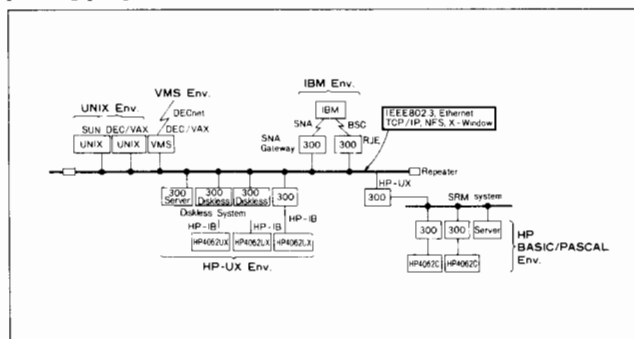

* UNIX is a U.S. registered trademark of AT&T in the U.S.A. and in other countries.

- Multiuser and multimask
- Multiwindow
- Offline debugger

Multitasking and Windowing

The HP BASIC/UX environment brings multitasking and windowing to process control. While a test is running in one window, you can analyze measurement data in another window. Or use the Virtual Front Panel (VFP) in one window to monitor tests running in a second window. These features increase productivity and efficiency.

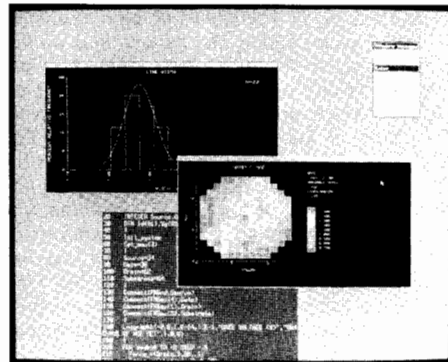

Multiuser

HP BASIC/UX can be executed in a multiuser environment. One or more copies can be run on the system console or display terminals. In a software development environment, this capability provides a very low-cost, multiuser solution.

Off-line Debugger

The HP 4062UX contains a unique offline debugger that lets you write and debug test programs without having to access the measurement hardware. With the multitasking capability, you can create test programs at the same time that you are testing wafers.

Full HP-UX Access

HP BASIC/UX can directly access any HP-UX command. This capability offers you the use of all the powerful tools available for HP-UX, such as the Source Code Control System (SCCS). A full spectrum of HP-UX applications is available, such as:

- Database management systems (Oracle, HP-SQL/300, etc.)
- Data analysis packages (RS/1, SAS, etc.)
- Computer-aided design software

All this power is available on the same computer that controls the HP 4062UX Semiconductor Process Control System.

Specifications

Measurement functions: I, V, I-V, C-G-V, C-G-t, Pulse I/V, Pulse I-V, Analog Search

Switching matrix - Number of pins (to DUT):

12 pins to 48 pins (48-pin matrix)

24 pins to 96 pins (96-pin matrix)

Number of ports (to instrument): 9 ports

High resolution source/monitor unit: 1 port

High power source/monitor unit: 1 port

Source/monitor units: 2 ports

Ground unit: 1 port

Auxiliary: 4 ports (for V sources/V monitors and C meter)

Maximum voltage at each port: ± 200 V (SMU ports)

± 100 V (aux. ports)

Maximum current through ports to pins: ± 1.6 A (GNDU port)
 ± 1 A (SMU ports)

DC source/monitor units (SMUs)

SMU for high resolution port: 1 unit

V: $\pm 40 \mu$ V to ± 100 V

I: ± 20 fA to ± 100 mA

Basic accuracy: $\pm 0.05\%$

Basic accuracy: $\pm 0.2\%$

SMU for high current port

V: $\pm 40 \mu$ V to ± 200 V

I: ± 2 pA to ± 1 A

Basic accuracy: $\pm 0.05\%$

Basic accuracy: $\pm 0.2\%$

SMUs: 2 units - Kelvin

V: $\pm 40 \mu$ V to ± 100 V

I: ± 2 pA to ± 100 mA

Basic accuracy: $\pm 0.05\%$

Basic accuracy: $\pm 0.2\%$

*V force resolution is 100 μ V, I force resolution is 50fA (high res SMU) and 5pA (other SMUs)

Ground unit (GNDU): 1 unit

$\pm 1.6A$

Accuracy: $\pm 1mV$

Voltage sources (VSs): 2 units

$\pm 1 mV$ to $\pm 40V$

Basic Accuracy: $\pm 0.1\%$

Voltage monitors (VMs): 2 units

$\pm 40 \mu V$ to $\pm 40V$

Basic Accuracy: $\pm 0.05\%$

*Differential voltage can be measured with 4 μ V resolution

All SMUs can function as a dc voltage source/current monitor or current source/voltage monitor. Pulse measurements can be made with SMUs and VSs.

Capacitance-Conductance Measurements

HP 4280A

Test frequency: 1 MHz, $\pm 0.01\%$

OSC level: 30 mVrms $\pm 10\%$, and 10 mVrms $\pm 10\%$

Measurement range: (maximum resolution to full scale)

C: 0.001 pF to 1.2 nF Basic accuracy: $\pm 0.5\%$

G: 0.01 μ S to 12 mS Basic accuracy: $\pm 1.5\%$

DC bias voltage: (for capacitance measurements) $\pm 100V$

HP 4284A

Test frequency: 1k, 10k, 100k, 1 MHz $\pm 0.01\%$

OSC level: 30 mVrms $\pm 10\%$

Measurement range:

C: 0.001 pF to 1.2 nF G: 0.01 μ S to 12 mS (at 1 MHz)

C: 0.001 pF to 10 nF G: 0.01 μ S to 100 mS (at 100 kHz)

C: 0.001 pF to 100 nF G: 0.01 μ S to 1000 mS (at 10 kHz)

C: 0.01 pF to 100 nF G: 0.1 μ S to 1000 mS (at 1 kHz)

dc bias voltage for capacitance measurements: $\pm 40V$ (optional)

System controller

Supported controller: HP 9000 series 300 Model 320, 330, 332, 350, 360, or 370. HP 9000 series 300 Model 318M, 319C+ and 340 are supported as a diskless cluster node.

Required main memory: 4 Mbyte

Recommend: 8 Mbyte

Required hard disk memory:

Test execution environment: 80 Mbyte with 15 Mbyte swap

Test execution and development environment: 130 Mbyte with 20 Mbyte swap

Required HP-HIL Device: HP 46084A ID module

Software

Operating system: HP-UX 6.5

Programming language: HP BASIC/UX 5.51

Programming utilities: TIS (test instruction set)

PARA (parameter extraction)

PPG (probing pattern generator)

PCL (prober control library)

Offline debugging: TIS for offline debugging

VFP (virtual front panel)

Data processing: FCL (file creation library)

XYGRAPH (XY graphics)

MAP (wafer map)

Basic statistics and data management

Available networking: NS, ARPA, Berkeley, NFS, SNA

Prober interface

Automatic wafer probers used with the HP 4062UX must be equipped with HP-IB capability. Hardware for mounting the switching matrix on the prober is also required. Contact the prober manufacturer for details concerning necessary mounting hardware. Control software for Electrogras 1034X/2001X and TSK APM6000/7000 probers is furnished.

Reference Data (typical)

Command execution time

Connect (relays): 4 ms

dc source/monitor¹: Force (current or voltage): 4 ms

Measure (current or voltage): 5 ms

Analog search²: 25 ms

¹When integration time is short and range is not 1 nA/10 nA. Excludes wait time set by user.

²Analog search controls the output of one SMU to set the output of another to a given value.

General specifications

Operating temperature: 5°C to 40°C, 55% to 70% RH

Permissible temperature change: $\leq 3^\circ C$ after calibration

Air cleanliness: class 100,000 or higher clean room required

Power requirements: 100V (90V to 110V), 120V (108V to 127V), 220V (198V to 242V), 240V (216V to 252V), 48 Hz to 66 Hz, 1150 VA maximum

Size

Cabinet: 1600H x 600W x 800mm D

48-pin matrix: 210H x 406W x 380mm D

96-pin matrix: 250H x 620W x 600mm D

Weight

Cabinet with instruments: approx. 230kg

48-pin matrix: approx. 22kg (48 pin config.)

96-pin matrix: approx. 55kg (96 pin config.)

HP 4142B power limitation: 32W

Ordering Information

HP 4062UX Semiconductor Process Control System \$25,100

(consists of system cabinet, a license to use the HP 4062UX software, system documentation library, and software installations of HP-UX, HP BASIC/UX and HP 4062UX)

Opt 022 1/4-inch tape media +\$3,600

Opt 050 50Hz power line frequency \$0

Opt 060 60Hz power line frequency \$0

48-pin matrix options

Opt 310 Add HP 4085B 48-pin matrix with 12 pins +\$24,900

(and HP 4085B/16066A/16075A/16076A)

Opt 311 Add 1 pin (HP 16320B) to HP 4085B +\$600

Opt 312 Add test fixtures for packaged devices +\$3,100

(Add HP 16067A through HP 16070A)

Opt 313 Add HP 16077A extension cable fixture +\$1,300

Opt 314 Add HP 16071A universal fixture +\$385

Opt 315 Add HP 16071B universal fixture (kelvin) +\$430

Opt 316 Add HP 16072A personality board (for use with probers other than Electroglas) +\$214

Opt 317 Add HP 16072A with Opt. 001 (for use with Electroglas 1034X/2001X) +\$214

Opt 318 Add HP 16072B personality board (kelvin) +\$240

(for use with probers other than Electroglas)

Opt 319 Add HP 16072B with Opt. 001 (kelvin) (for use with Electroglas 1034X/2001X) +\$240

96-pin matrix options

Opt 330 Add HP 4089A 96-pin matrix with 24 pins +\$53,900

(Add HP 4089A/16370A/16355A/16356A)

Opt 331 Add 1 pin (HP 16320C) to HP 4089A +\$640

Opt 332 Add test fixtures for packaged devices +\$6,600

(Add HP 16371A through 16375A)

Opt 333 Add HP 16378B extension cable fixture +\$2,600

Opt 334 Add HP 16376A universal fixture +\$510

Opt 335 Add HP 16376B universal fixture (kelvin) +\$510

Opt 336 Add HP 16377A personality board +\$520

Opt 337 Add HP 16377B personality board (kelvin) +\$520

Measuring instruments

Opt 400 Add HP 4142B modular DC source/monitor +\$14,900

Opt 405 Field installation kit for HP 4142B +\$3,900

Opt 410 Add HP 41420A 200V/1A SMU +\$4,300

Opt 411 Add HP 41421B 100V/100mA SMU +\$3,540

Opt 414 Add HP 41424A VS/VM unit +\$3,220

Opt 415 Add HP 41425A analog feedback unit +\$1,720

Opt 510 Add HP 4280A 1 MHz C meter +\$13,300

Opt 515 Field installation kit for HP 4280A +\$2,800

Opt 520 Add HP 4274A LCR meter +\$12,900

(100 Hz-100 kHz)

Opt 521 Add $\pm 35V$ bias (Opt. 001-4274A) +\$890

Opt 522 Add $\pm 100V$ bias (Opt. 002-4274A) +\$830

Opt 525 Field installation kit for HP 4274A +\$3,000

Opt 530 Add HP 4284A LCR Meter +\$13,700

Opt 531 Add 40V bias (Opt. 001-4284A) +\$1,150

Opt 535 Field installation kit for HP 4284A +\$3,800

SEMICONDUCTOR TEST EQUIPMENT

Semiconductor Parametric Test System HP 4062C

- 25 ms V_{th}/hFE Extraction (typical)
- ± 20 fA to ± 1 A precise wafer measurements



HP 4062C



(System controller, printer and tables are sold separately.)

HP 4062C Semiconductor Parametric Test System

The HP 4062C Semiconductor Parametric Test System is a high throughput, high resolution computer-controlled system for measuring the dc voltage and current, and 1MHz capacitance and conductance parameters of wafer-state devices, as well as discrete and packaged devices. Based on its predecessor, the HP 4062B, this enhanced system will enable you to significantly improve IC yield and quality, and increase efficiency during new process development.

Precise 20fA, 4 μ V, and 1fF measurements to ± 200 V and ± 1 A are possible through the 4062C's low-noise, reliable switching matrix, which you can configure with up to 96 DUT pins. And specifications are guaranteed at all DUT pins. The heart of the HP 4062C, the high speed HP 4142B Modular DC Source/Monitor, provides fast throughput over a wide measurement range—without sacrificing resolution—for wafer process monitoring and evaluation. Highly reliable wafer measurement results can quickly be fed back to design and process engineers to improve your IC yield and quality.

The HP 4062C's language system is the simple, yet powerful, HP BASIC. Parameter measurements, such as threshold voltage and current gain, can be performed with a simple two-line program thanks to the HP 4062C's measurement utility subprograms.

High Speed Measurements, Wide Measurement Range

In production environments where measurement speed is prerequisite, the HP 4062C comes through. The HP 4062C's DC measurement subsystem provides high speed device/process parameter extractions, while maintaining measurement resolutions down to 20fA and 4 μ V. For example, by using the DC measurement subsystem's Analog Feedback Unit (AFU), such key device parameters as threshold voltage (V_{th}) and forward current gain (hFE) can be obtained in as little as 25ms; roughly 4 times faster than the HP 4062B.

The HP 4062C's switching matrix subsystem enables reliable measurement results by virtually eliminating the effects of environmental noise, while minimizing leakage current and stray capacitance. Also, the HP 4062C's expanded measurement range of ± 20 fA to ± 1 A and ± 4 μ V to ± 200 V is guaranteed to the tip of each switching matrix DUT pin. This exacting performance ensures precise, reliable semiconductor parameter measurements through the switching matrix for each system instrument.

Easy To Program

The HP 4062C's Test Instruction Set (TIS) software makes programming easy, and the fast execution of TIS programs ensures high speed measurements. By using the furnished measurement library, you can quickly create and execute programs. For example, to perform a V_{th} or hFE measurement requires only one or two program lines.

Specifications

Hardware

Same as HP 4062UX

Software

Operating system: HP BASIC 5.1 or later

Programming language: HP BASIC

Programming utilities:

- TIS (test instruction set)
- PARA (parameter extraction)
- PPG (probing pattern generator)
- PCL (prober control library)

Data processing:

- FCL (file creation library)
- XYGRAPH (XY graphics)
- Basic statistics and data manipulation

System controller

Supported controller: HP 9000 Series 300 Model 310, 320, 330, 332, 350, 360 and 370

Required main memory: 2 Mbyte

Required HP-HIL device: HP 46084A ID module

Required interface: in addition to internal HP-IB I/O, 2 extra HP-IB I/O's (98624A) are required.

Ordering Information

	Price
HP 4062C Semiconductor Parametric Test System (consists of HP 4142B modular DC source/monitor, 48-pin matrix with 48 pins, HP 4280A 1MHz C meter, system cabinet, system software, system library and system software installation.)	\$125,000
Opt 050/060 for 50/60 Hz line frequency	\$0
Opt 100/120/220/240 for 100/120/220/240V Line voltage	\$0
Opt 001 12 pin configuration of 48 pin matrix	-\$21,600
Opt 002 24 pin configuration of 48 pin matrix	-\$14,400
Opt 003 36 pin configuration of 48 pin matrix	+\$7,200
Opt 004 Add spare pin board of 48 pin matrix	+\$600
Opt 012 24 pin configuration of 96 pin matrix	+\$10,100
Opt 013 36 pin configuration of 96 pin matrix	+\$17,700
Opt 014 48 pin configuration of 96 pin matrix	+\$25,400
Opt 015 64 pin configuration of 96 pin matrix	+\$35,700
Opt 016 72 pin configuration of 96 pin matrix	+\$40,800
Opt 017 84 pin configuration of 96 pin matrix	+\$48,500
Opt 018 96 pin configuration of 96 pin matrix	+\$56,100
Opt 019 Add spare pin board of 96 pin matrix	+\$640
Opt 020 Replace HP 41420A with HP 41421B	-\$750
Opt 021 Add spare HP 41421B SMU (100V/100mA)	+\$3,540
Opt 022 Add spare HP 41420A SMU (200V/1A)	\$4,300
Opt 023 Add spare HP 41424A V_s/V_m	\$3,220
Opt 024 Delete one HP 41421B SMU (100V/100mA)	-\$3,540
Opt 025 Delete one HP 41420A SMU (200V/1A)	-\$4,300
Opt 026 Delete one HP 41424A V_s/V_m	-\$3,220
Opt 027 Delete one HP 41425A AFU	-\$1,720
Opt 102 Delete HP 4280A	-\$10,600
Opt 110 Delete Package Fixtures for 48 pin Matrix	-\$4,190
Opt 115 Delete Package Fixtures for 96 pin Matrix	-\$7,100
Opt 130 Delete System Rack	-\$3,600
Opt 310 Add HP 4274A	\$12,900
Opt 311 ± 35 V Internal DC Bias for HP 4274A	\$890
Opt 312 ± 100 V Internal DC Bias for HP 4274A	\$830
Opt 320 Add HP 4284A	\$13,700
Opt 321 ± 40 V Internal DC Bias for HP 4284A	\$1,150
Opt 405 HP 4062C's System Software Right-To-Copy	-\$2,250
Opt 503 Personality Board for Electroglas Probers	\$0
Opt 910 Extra System Library	\$320

SEMICONDUCTOR TEST EQUIPMENT

Semiconductor Parametric Test System

Model 4062B

533

- Precise, high speed probed wafer measurements
- 1pA resolution at all 48 pins

- Easy to program with Probing Pattern Generator
- Virtual front panel simplifies operation



HP 4062B
(System controller, printer and tables are sold separately.)

Description

The HP 4062B Semiconductor Parametric Test System will help you improve IC yield and quality in production plus increase engineering efficiency. The system measures DC voltage/current and 1 MHz capacitance/conductance of wafers with high resolution and speed.

Precise 1pA and 1fF measurements are performed using a low noise switching matrix with up to 48 DUT pins. All specifications are guaranteed on these DUT pins. High speed measurement units provide fast throughput of high resolution measurements for wafer process monitoring and evaluation. Highly reliable measurements performed on wafers can be fed back to design and process engineers to improve your IC yield and quality.

The HP 4062B is programmed with the simple and powerful HP BASIC. Parameter measurements such as threshold voltage or current gain can be made by a two line program using the HP 4062B's measurement utility subprograms. Prober control software is supplied to allow users to easily operate a wafer prober with the HP 4062B. The system software features an extensive program library that includes statistical analysis, trend charts, and the Virtual Front Panel (VFP) for convenient manual measurement. The HP 4062B will help you reduce software development time and increase engineering efficiency with easy programming.

Software Library

Virtual Front Panel (VFP)
Test Instruction Set (TIS)
Graphics Library
Parameter Measurement Library
Auto Prober Control Library
Data Processing Library
Diagnostic Program

System Configuration

DC Source/Monitor (HP 4141B)
Switching Matrix (48-pin configuration)
Switching Matrix Controller
1 MHz C Meter/C-V Plotter (HP 4280A)
Rack Cabinet

Specifications

Switching Matrix

Number of pins (to DUT): 48 pins (standard) with options for 12, 24 and 36 pins.

Number of ports (to instrument): 9 ports

DC Source and Monitor Units

High resolution source and monitor unit (SMU1): 1 unit
Output/Measurement Range: Current, $\pm 1\text{pA} - \pm 100\text{mA}$, Basic Accuracy, 0.3%; Voltage, $\pm 1\text{mV} - \pm 100\text{V}$, Basic Accuracy, 0.1%

Source and monitor units (SMU2-4): 3 units
Output/Measurement Range: Current, $\pm 100\text{pA} - \pm 100\text{mA}$, Basic Accuracy, 0.3%; Voltage, $\pm 1\text{mV} - \pm 100\text{V}$, Basic Accuracy, 0.1%

Ground unit: 1 unit
Output Voltage: 0V; Accuracy, $\pm 2\text{mV}$

Voltage source (Vs): 2 units
Output Range: 1mV - $\pm 20\text{V}$; Basic Accuracy, 0.5%

Voltage monitor (Vm): 2 units
Measurement Range: $\pm 100\mu\text{V} - \pm 20\text{V}$, Basic Accuracy, 0.2%

Capacitance-Conductance Measurements

Test frequency: 1 MHz $\pm 0.01\%$
OSC level: 30 mVrms $\pm 20\%$ and 10 mVrms $\pm 20\%$
Measurement range: (Maximum resolution to full scale)
C: 0.001 pF - 1.2 mF; basic accuracy, 0.5%
G: 0.01 $\mu\text{S} - 12\text{mS}$; basic accuracy, 1.5%
DC bias voltage for capacitance measurements: $\pm 100\text{V}$

General Specifications

Operating temperature range: 10°C - 40°C, $\leq 70\%$ RH at 40°C
Power requirements: 100V, 120V, 200V $\pm 10\%$; 240V $+5\% - 10\%$; 48-66 Hz, 510 VA max.
Dimensions: cabinet, 600 mm(W) x 1600 mm(H) x 800 mm(D); switching matrix, 406 mm(W) x 210 mm(H) x 380 mm(D)
Weight: cabinet with instruments, approximately 200 kg; switching matrix, approximately 25.3 kg

System Controller

Required Controller: HP 9000 Series 200 Model 236A, 236C, 236S or 236CS, or Series 300 Model 310, 330, 350, 332, 360 or 370
System Language: BASIC 5.1 or later for Series 200/300

Ordering Information

HP 4062B Semiconductor Parametric Test System (does not include controller)	\$103,920
Opt. 050/060: For 50/60Hz Line Frequency ¹	N/C
Opt. 100/120/220/240: For 100/120/220/240 Line Voltage ²	N/C
Opt. 001: 12-pin Configuration (delete 36 pins)	\$-19,440
Opt. 002: 24-pin Configuration (delete 24 pins)	\$-12,960
Opt. 003: 36-pin Configuration (delete 12 pins)	\$-6,480
Opt. 004: Additional Pin Board	\$575
Opt. 011: SMU Board	\$1,380
Opt. 030: For HP 9000 Series 300 Controller ³	N/C
Opt. 036: For HP 9000 Model 236 A/S/C/CS Controller ⁴	N/C
Opt. 310: Add HP 4274A	\$12,900
Opt. 311: $\pm 35\text{V}$ Internal DC Bias for HP4274A	\$890
Opt. 312: $\pm 100\text{V}$ Internal DC Bias for HP4274A	\$830
Opt. 405: Right-to-copy	\$1,720
Opt. 102: Delete HP4280A	\$-10,600
Opt. 110: Delete Test Fixtures for Packaged Devices	\$-4,190
Opt. 401: SPN Data File Creation Software	\$2,010
Opt. 503: Personality Board for EG 1034X, EG 2001X	N/C
Opt. 920: Extra System Library	\$350

¹Must select Opt. 050 according to the power line frequency used.

²Must select Opt. 100, 120, 220 or 240 according to the power line voltage used.

³Must select Opt. 503 if using an Electroglas Prober.

⁴Must select Opt. 030 or 036 according to the system controller used.

SEMICONDUCTOR TEST EQUIPMENT

Semiconductor/Component Test System Model 4061A

- Ready to use—supplied with 7 turn-key application pacs
- Reliable impedance and current measurements with one probing
- Productivity improvement through accurate and fast measurement over wide range

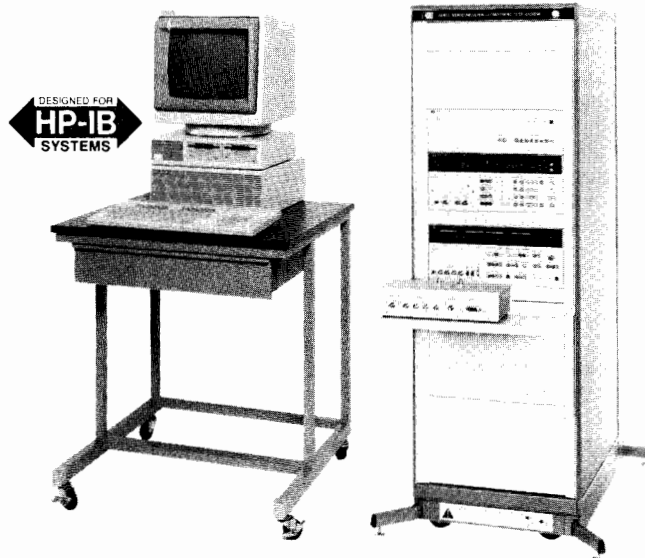

DESIGNED FOR
HP-IB
SYSTEMS

HP 4061A

System controller and table are sold separately

Description

The HP 4061A Semiconductor/Component Test System is a dedicated system for making efficient, automatic evaluation of the fundamental characteristics of semiconductor and electronic components required in R & D and production areas. This system employs reliable, accurate measurements and high speed data processing to perform more reliable evaluations with speed and less manpower. The HP 4061A is supplied with 7 sophisticated applications programs and is flexible in both software and hardware. Thus, the system can output measurement results in nearly any required data format.

The switching subsystem, designed especially for use with the HP 4061A, allows both impedance and current measurement without changing DUT connection. Using this new switching subsystem, and by making impedance measurements, the HP 4061A performs evaluation of Doping profile, Oxide capacitance, Flat band condition, Threshold voltage, Surface charge, and Minority carrier life time/surface generation velocity. The HP 4061A also measures leakage current and reverse/forward current-voltage characteristics. Surface state density evaluation, using both high (e.g., 1 MHz) and low frequency (Quasi-static) C-V measurements and data processing are also possible by making modifications to system software.

The system offers significant improvement in both yield and quality in production through fast and reliable measurements and evaluations. It is also a valuable evaluation tool for the development of new materials and devices. The HP 4061A provides the flexibility to meet the future measurement requirements of the electronics industry.

System Configuration

- pA Meter/DC Voltage Source (4140B)
- Multi-frequency LCR Meter (4275A)
- Switching Subsystem
- Rack Cabinet (29402C)

Furnished Application Software

Semiconductor high/low frequency C-V characteristics, I-V characteristics, C-t characteristics and Zerbst analysis, Impedance Frequency/Bias characteristics, Ideal C-V curve.

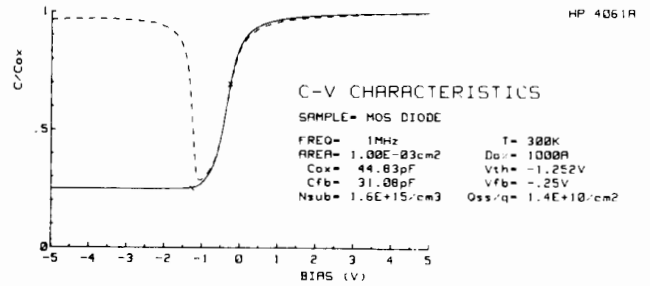

Specification

For detailed specifications on each of the instruments used in the HP 4061A, refer to the individual data sheets.

Switching Subsystem

The switching subsystem consists of a switch control module and switching module with interconnecting cables.

Function: Switches connection from DUT to either Multi-frequency LCR Meter or the pA Meter/DC Voltage source.

System Measurement Range (only deviations from individual instrument specifications are listed.)

Impedance Measurements (HP 4275A)

Frequency range: ≤ 1 MHz

Measurement parameters: C-G

Capacitance: ≤ 2000 pF (with $D \leq 0.1$)

***Accuracy:** (accuracy of HP 4275A) $\times 1.5 + \Delta C$ (at $23^\circ\text{C} \pm 5^\circ\text{C}$).

$$\Delta C = 1.4 \times 10^{-3} C \times f^2 \text{ (pF)} + 5 \text{ counts}$$

Conductance: $\leq 12\text{mS}$ ($D \leq 0.1$)

***Accuracy:** (accuracy of 4275A) $\times 1.5 + \Delta G$ (at $23^\circ\text{C} \pm 5^\circ\text{C}$)

$$\Delta G = 6 \times 10^{-3} C \times f(S) + 5 \text{ counts}$$

* f: frequency in MHz

Cx: Measured capacitance value in pF

At 5°C to 40°C , ΔC and ΔG doubles. Example: Assuming $C_x = 1000$ pF and $f = 1$ MHz, $C = (1.4 \times 10^{-3} \cdot 10^3 \cdot (1)^2) \text{pF} + 5$ counts = 1.4 pF + 5 counts

Current Measurements (HP 4140B)

Accuracy: (accuracy of HP 4140B) $\times 1.5 + 5$ counts

After one-hour warmup and at DUT terminal of switching module

Impedance Measuring Section (HP 4275A)

See the HP 4275A's page 294.

Current Measurement Section (HP 4140B)

See the HP 4140B's page 542.

General Information

Operating temperature: 5°C to 40°C , $\leq 70\% \text{RH}$ at 40°C

Power: 100, 120, 220, and 240V, $+5\% - 10\%$, 48 to 66 Hz, 520 VA

Size: 535mm W x 1635 mm H x 770 mm D

Weight: Approximately 125 kg.

System Controller

HP 9000 Series 200 Model 226A, 226S, 236A or 236S, or Series 300 Model 310 or 330

Ordering Information

HP 4061A Semiconductor/Component Test System (does not include controller)

Price

\$46,500

Opt. 001: ± 100 V dc Bias for HP 4275A

N/C

Opt. 002: 1-3-5 Frequency Steps for HP 4275A

N/C

Opt. 026*: For HP 9000 Model 226 A/S controller

N/C

Opt. 031*: For HP 9000 Model 310 or 330 controller

N/C

Opt. 036*: For HP 9000 Model 236 A/S controller

N/C

*Must order either OPT. 026, 031 or 036.

SEMICONDUCTOR TEST EQUIPMENT

Switching Matrix

Model 4085M

535

- 48 pins with 1pA resolution

- Easy programmable switching

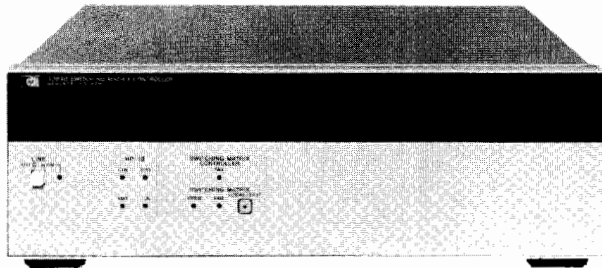

Switching Matrix Controller

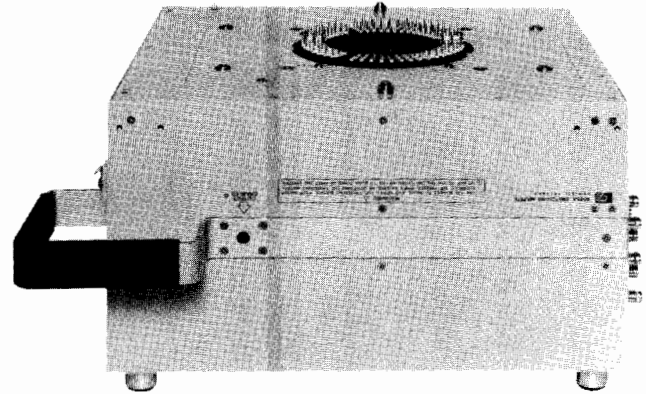

Switching Matrix

HP 4085M

HP 4085M Description

Combining the HP 4085M switching matrix with the HP 4145B Semiconductor Parameter Analyzer produces a 1 pA, 1 mV switching system capable of 48-pin high resolution semiconductor testing.

A design which minimizes both noise and leakage current means exceptional built-in dc measurement capabilities and the realization of 1 pA resolution measurements at any one of the 48 pins.

The software included with the system makes it possible to freely switch any one of the eight instrument ports to any one of the test pins from the system controller. A number of fixtures are available for wafer and various packaged device measurements. The HP 4085M retains the HP 4145B's full measurement capabilities to obtain highly reliable wide range dc parameter measurements.

Specifications

Switching Matrix

DUT Pins: From 12 to 48 pins can be installed.

Instrument Ports:* Eight instrument ports are included.

Low Leakage SMU Port: 1 ea. (Port 1)

SMU Ports : 3 ea. (Port 2 - 4)

Vs Ports : 2 ea. (Vs Port 1 and 2)

Vm Ports : 2 ea. (Vm Port 1 and 2)

*SMU: Stimulus Measurement Unit

Vs : Voltage Source

Vm : Voltage Monitor

Maximum Voltage between Instrument Ports: ± 220 Vdc

Maximum Current at each DUT Pin: ± 500 mA dc

General Specifications

Operating temperature: 10°C to 40 °C; $\leq 70\%$ RH at 40°C

Air cleanliness: class 100,000 or higher clean room required.

Power requirements: 100, 120, 220V $\pm 10\%$; 240V $+5\% - 10\%$; 48 to 66 Hz, 130VA max

Size: Switching Matrix, 406W \times 210H \times 380D mm; Switching Matrix Controller, 426W \times 134H \times 432D mm

Weight: Switching Matrix, approximately 25.3kg; Switching Matrix Controller, approximately 8kg

System Controller

Required Controller: HP 9000 Series 200 Model 216S, 236A or 236S, or Series 300 Model 310, 330, 332, 350, 360 or 370

System Language: Basic 2.0 or later version

Memory Size: ≥ 320 k byte

Ordering Information

HP 4085M Switching Matrix (does not include controller)

Opt. 001: 12-pin system

Opt. 002: 24-pin system

Opt. 003: 36-pin system

Opt. 004: Add one pin

Opt. 016:* For HP 9000 Model 216A/S controller

Opt. 030:* For HP 9000 Model 310 controller

Opt. 036:* For HP 9000 Model 236 A/S controller

* Must select Opt. 016, 030 or 036 according to the system controller used.

Price

\$50,540

\$-19,440

\$-12,960

\$-6,480

\$600

N/C

N/C

N/C

System Configuration Example

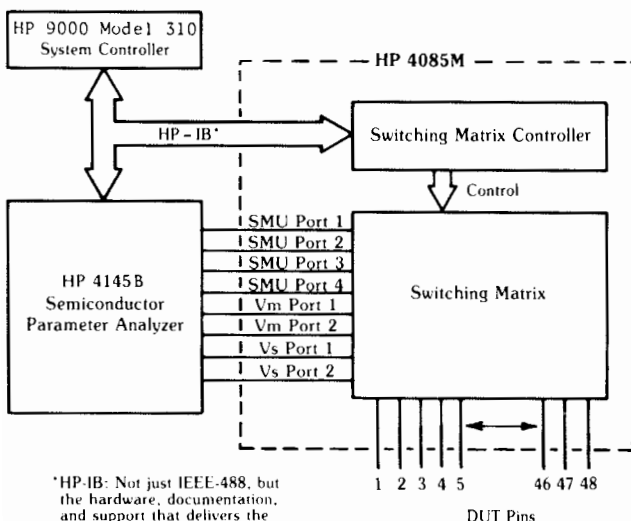

*HP-IB: Not just IEEE-488, but the hardware, documentation, and support that delivers the shortest path to a measurement system.

SEMICONDUCTOR TEST EQUIPMENT

Semiconductor Parameter Analyzer

Model 4145B

- Fully automatic, high-speed dc characterization of semiconductor devices.
- High resolution, wide range sourcing and measurement.
I: 50fA - 100mA, V: 1mV - 100V
- Maximum 1140 measurement and display points for precise measurement and analysis.
- Flexible graphic analysis functions for quick parameter extraction.
- Built-in micro flexible disc drive for storage of 240 user programs or 103 measurement results.

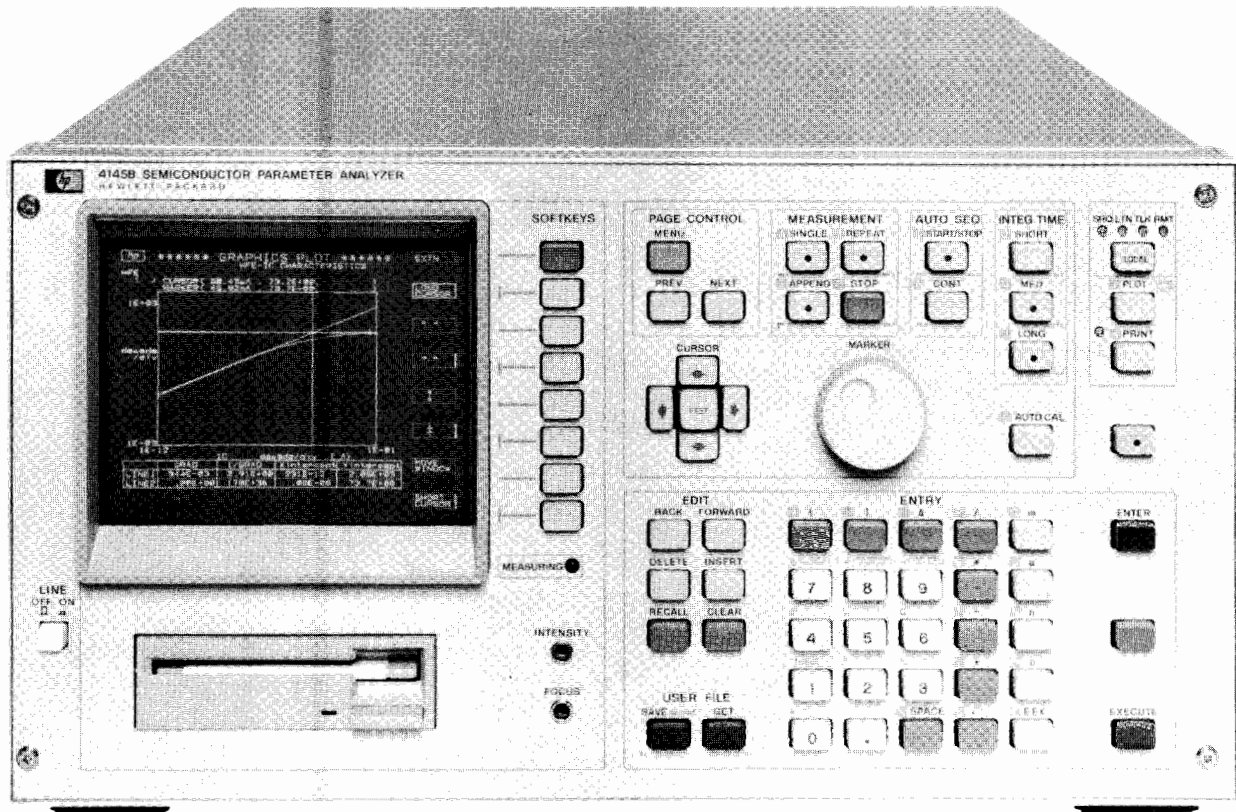

HP 4145B



Description

Designed for production line and laboratory use, the HP 4145B is the electronics industry's first stand-alone instrument capable of complete dc characterization of semiconductor devices and materials. It stimulates voltage and current sensitive devices, measures the resulting current and voltage responses, and displays the results in a user-selectable format (graph, list, matrix or schmo) on a built-in CRT display. An on-board programmable calculator provides real-time calculation of voltage/current dependent parameters, such as the current gain (h_{FE}) and transconductance (g_m) of transistors, which also can be displayed on the CRT. A number of powerful graphic analysis tools—marker, cursor, line function, interpolation—enhance the HP 4145B's basic capabilities and provide fast, accurate analysis of semiconductor devices, leading to increased production yields and improved device quality.

Four built-in source monitor units (SMUs) are the heart of the HP 4145B. Each SMU can be independently programmed to function as either a voltage source/current monitor or a current source/voltage monitor. Thus, a bipolar transistor, for example, can be completely characterized in common-base, common-emitter, and common-collector configurations without changing connections—only changing the SMUs' operating modes is required. The HP 4145B is also equipped with two voltage sources and two voltage monitors for measurements on devices having more than four terminals, such as ICs.

The HP 4145B can be controlled from the front panel, via the HP-IB (standard), or by measurement setups stored on micro flexible discs.

Displayed information—measurement setups, auto-sequence programs, measurement results—can be dumped directly onto an external graphics plotter to obtain publication quality hard copies. Additionally, the built-in $3\frac{1}{2}$ " flexible disc drive enables you to store measurement setups and measured data, which can be accessed by another compatible HP disc drive for further processing.

Auto Sequence Programs

Measurement programs stored on a HP 4145B micro flexible disc can be linked by an auto sequence program, making it possible to perform a series of measurements with just one keystroke.

Four User-Selectable Display Formats to Suit the Evaluation

Measurement results can be displayed in one of four display formats: GRAPHICS, LIST, MATRIX or SCHMOO. After measurement has been made and the results displayed, the softkeys can be used to access various analysis functions for complete device evaluation. These functions include MARKER for numeric readout of measured value at any point along a plotted curve, CURSOR for numeric readout of value at any graphic point and for line positioning, STORE/RECALL for overlay comparisons, AUTO SCALE for optimum graphic scaling, and LINE FUNCTION for direct readout of line gradient and X-Y axes intercept values.

Specifications

Measurement

Source/Monitor unit (SMU): four SMUs are built into the HP 4145B. Each SMU can be programmed to source voltage and monitor current, or conversely to source current and monitor voltage. Each SMU can also be programmed to COM mode. This sets voltage at 0 volts and current compliance at 105 mA.

Output/measurement resolution: voltage, 4½ digits; current, 4 digits

Voltage measurement input resistance/current source output resistance: $\geq 10^{12}\Omega$

Maximum capacitive load: 1000 pF

SMU Voltage Range, Resolution and Accuracy

Voltage Range	Resolution	Accuracy ^{1,2}	Max. Current
±20V	1mV	$\pm(0.1\%+10\text{mV}+0.4\times I_o)$	100mA
±40V	2mV	$\pm(0.1\%+20\text{mV}+0.4\times I_o)$	50mA
±100V	5mV	$\pm(0.1\%+50\text{mV}+0.4\times I_o)$	20mA

* I_o is SMU output current in amps.

SMU Current Range, Resolution and Accuracy

Current Range	Resolution	Accuracy ^{1,2}	Max. Voltage
±100mA	100µA	$\pm(0.3\%+100\mu\text{A}+2\mu\text{A}\times V_o)$	20V(>50mA)
			40V(>20mA)
±10mA	10µA	$\pm(0.3\%+10\mu\text{A}+200\text{nA}\times V_o)$	100V(≤20mA)
±1000µA	1µA	$\pm(0.3\%+1\mu\text{A}+20\text{nA}\times V_o)$	
±100µA	100nA	$\pm(0.3\%+100\text{nA}+2\text{nA}\times V_o)$	
±10µA	10nA	$\pm(0.3\%+10\text{nA}+200\text{pA}\times V_o)$	
±1000nA	1nA	$\pm(0.5\%+1\text{nA}+20\text{pA}\times V_o)$	
±100nA	100pA	$\pm(0.5\%+100\text{pA}+2\text{pA}\times V_o)$	
±10nA	10pA	$\pm(1\%+15\text{pA}+200\text{fA}\times V_o)$	
±1000pA	1pA	$\pm(1\%+6\text{pA}+20\text{fA}\times V_o)$	

* V_o is SMU output voltage in volts.

**50 fA resolution in current monitor mode.

- Accuracy specifications are given as $\pm\%$ of reading or setting value $\pm\%$ of range.
- Accuracy tolerances are specified at 25°C $\pm 5^\circ\text{C}$, after a 40 minute warm-up time, with AUTO CAL on, and specified at the rear panel connector terminals referenced to SMU common. Tolerances are doubled for the extended temperature range of 10°C to 40°C.

SMU Voltage/Current Compliance

Maximum voltage compliance: 20 V, 40 V, or 100 V, depending on the output current range.

Maximum current compliance: 20 mA, 50 mA, or 100 mA, depending on the output voltage range.

Compliance setting resolution: same as current and voltage output/measurement resolution. Maximum current compliance resolution, however, is 50 pA.

Compliance accuracy: voltage compliance accuracy is the same as voltage output/measurement accuracy. Current compliance accuracy is current output/measurement accuracy \pm (1% of range + 10 pA).

Voltage/Current Sweep Characteristics

Output from up to three SMUs or voltage sources can be swept in one of three modes: VAR1, VAR2, or VAR1'.

VAR1: linear or logarithmic staircase sweep

VAR2: linear staircase sweep. Output from the VAR2 source is incremented after completion of each VAR1 sweep.

VAR1': output from the VAR1' source is synchronized with VAR1 but at levels proportional to a user-selectable ratio or offset relative to VAR1.

Ratio: ± 0.01 to ± 10

Offset: any value that will not cause VAR1' to exceed maximum allowable output.

Hold time: 0 to 650 seconds, $\pm(0.5\% + 9\text{ ms})$ with 10 ms resolution

Delay time: 0 to 6.5 seconds, $\pm(0.1\% + 5\text{ ms})$ with 1 ms resolution

No. of Measurement Steps: 1024 for a single VAR 1 sweep, 1140 for a multiple sweep

Voltage Sources (Vs) Characteristics

Number of sources: two

Output resistance: $\leq 0.2\Omega$

Maximum capacitive load: 1000 pF

Voltage Output Range, Resolution and Accuracy

Output Voltage Range	Resolution	Accuracy	Max. Output Current
±20 V	1 mV	$\pm(0.5\%$ of setting + 10 mV)	10 mA

Voltage Monitors (Vm) Characteristics

Number of monitors: two

Input resistance: 1 M Ω \pm 1% shunted by 100 pF \pm 10%

Voltage Measurement Range, Resolution and Accuracy

Measurement Voltage Range	Resolution	Accuracy
± 2 V	100 µV	$\pm(0.5\%$ of reading + 10 mV)
±20 V	1 mV	$\pm(0.2\%$ of reading + 10 mV)

Characteristics Common to SMUs, Voltage Sources & Voltage Monitors

Maximum allowable terminal voltage: 100 V peak across SMU and V_m input terminals, or SMU and V_S output terminals, or between those terminals and guard; and 42 V maximum from Common to Ground.

Display

CRT size and screen resolution: 152.4 mm (6 inch) diagonal; 2048 x 2048 points.

Display modes: Graphics, Schmo, List, Matrix, and Time Domain

External CRT analog output: X, Y and Z outputs of 0 to 1 Vdc into 330 Ω (X and Y) and 240 Ω (Z).

Analysis

Calculation: two user functions can be input and keyboard calculations can be done using the following 11 operators: +, -, *, /, $\sqrt{\quad}$, EXP, LOG, LN, ** (power), ABS (absolute) and Δ (differential).

Constants Available on the Keyboard

q: Electron charge (1.602189×10^{-19} coulomb)

k: Boltzmann's Constant (1.380662×10^{-23} J/°K)

e: Dielectric constant of vacuum (8.854185×10^{-12} F/m)

Analysis functions: overlay comparison with STORE/RECALL, Marker, Interpolate, Cursor, Auto scale, Zoom function (\leftrightarrow , \rightarrow , \leftarrow , \uparrow , \downarrow Line and Move Window.

General Specifications

Operating temperature range: +10°C to +40°C; $\leq 70\%$ RH at 40°C, permissible temperature change $\leq 1^\circ\text{C}/5\text{ min}$.

Power requirements: 100/120/220 V $\pm 10\%$; 240 V - 10% + 5%; 48 to 66 Hz; 270 VA max.

Dimensions: 426 mm W x 235 mm H x 612 mm D (16.75" x 9.06" x 24.1").

Weight: 27 kg (59 lb) approximately.

Reference Data

SMU measurement time: measurement time = response time + ranging time + integration time.

SMU Response Time

Current Range	Setup/Settling Time	SMU Wait Time
100 nA to 100 mA 1 nA and 10 nA	2.7 ms	0.2 ms 47.5 ms

Ranging time: varies from 4 ms to 74 ms

Integration time: SHORT, MED and LONG

	SHORT	MED	LONG
50 Hz	3.6 ms	20 ms	320 ms
60 Hz		16.7 ms	267 ms

Accessories Furnished

HP 16058A Test Fixture

HP 04145-61501 System Disc

HP 04145-60001 Connector Plate

HP 04145-61622 Triaxial Cable (3m), 4 ea.

HP 04145-61630 BNC Cable (3m), 4 ea.

HP 04145-61623 Shorting Connector

Ordering Information

HP 4145B Semiconductor Parameter Analyzer \$26,150

Opt. 050/060: 50Hz/60Hz Line Frequency

SN/C

Opt. W30: Extended Repair Service. See page 725.

SEMICONDUCTOR TEST EQUIPMENT

Modular DC Source/Monitor

Model 4142B

- Flexible, Modular Architecture
- Wide Measurement Range with High Resolution
V: $\pm 4\mu\text{V} - \pm 200\text{V}$, 0.05%
I: $\pm 20\text{fA} - \pm 1\text{A}$, 0.2%
- Pulse Measurement Capabilities
Pulse Width 1ms - 50ms, 100 μs Resolution

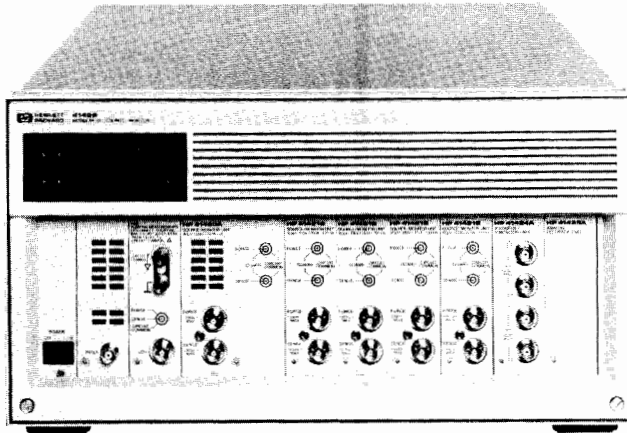

HP 4142B



Description

Offering a wide measurement range and excellent sensitivity, the HP 4142B Modular DC Source/Monitor is a system-use DC measurement instrument especially designed for high throughput DC semiconductor testers. A completely user-definable system component, the HP 4142B's modular architecture allows you to build a custom-configuration to suit your measurement needs.

Eight plug-in module slots can accommodate any combination of the four presently available modules, and as new modules become available, you can upgrade your measurement capabilities with ease. Choose from two types of Source/Monitor Units (SMUs) to force or measure up to $\pm 200\text{V}$ and $\pm 1\text{A}$; a Voltage Source/Voltage Monitor Unit (VS/VMU); and an Analog Feedback Unit (AFU). Also, the HP 4142B's instrument command and measurement data storage capabilities, coupled with the high speed HP-IB interface, minimize computer loading, enhance throughput, and simplify systemization.

Versatile SMUs and Reliable Measurement

For general purpose DC or Pulsed measurement, use the HP 41421B Source Monitor Unit. The equivalent of four instruments, this precision module forces voltage up to $\pm 100\text{V}$ and simultaneously measures currents down to 20fA. It can also force currents up to $\pm 100\text{mA}$ while measuring voltage down to 40 μV .

If you test high power components or desire an extra wide measurement range, apply the HP 41420A Source Monitor Unit. This versatile SMU can source $\pm 200\text{V}$ or ± 1 ampere (14W, DC or pulsed) and still maintain an incredible measurement resolution of 40 μV and 20fA. Both SMUs include a compliance feature which limits output

- High Speed Measurement (Typical)
Sourcing or Monitoring: 4ms
Vth, hFE extracting: 12ms
- Internal Memory
Program Memory: > 500 Commands (Typical)
Data Memory: 4004 Measurement Points

voltage, current, or power to prevent damage to your device. Each SMU (HP 41420A or HP 41421B) acts as either a voltage source/current monitor or current source/voltage monitor. These complimentary operating modes let you change the stimulus on a device without modifying the physical connections. This versatility reduces test time and eliminates instabilities caused by changing connections at the DUT.

High Speed Parameter Extraction by Analog Feedback Technique

To find important parameters that are specified at a given voltage or current, such as V_t or hFE, connect the HP 41425A Analog Feedback Unit to two SMUs. The AFU modulates the output voltage of one SMU while monitoring the current or voltage of the second SMU. Target currents and voltage are found with blazing speed (12ms). This unique analog feedback network rapidly measures V_t , hFE, ΔL , or ΔW ; parameters which would require excessive test times on other parametric testers.

You can also use AFUs for biasing and testing microwave devices. It can be integrated into the Network Analyzer System.

By using AFUs, you can eliminate the effect of device thermal drift and can hold initial setting bias for AC measurement time.

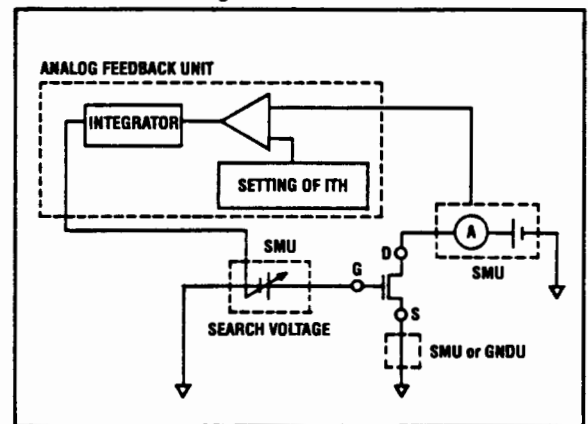

Pulsed Measurements

The HP 4142B performs pulsed spot measurement, pulsed sweeps, or even sweeps with a pulsed bias, over its entire measurement range. Now you can safely evaluate GaAs FETs, power MOSFETs, and bipolar transistors under high power conditions.

The pulsed measurements will not damage your devices or test fixtures, and more importantly, it will reduce thermal drift.

Specifications

4142B Modular DC Source/Monitor Ground Unit (GNDU)

Use as measurement ground.

0V, Kelvin connection

Offset voltage: ±500µV max

Current range: ±1.6 amperes

Maximum cable resistance:

FORCE terminal: ≤1Ω*

SENSE terminal: ≤10Ω*

Maximum capacitive load: 10µF max*

Spot Measurements

Source and monitor DC current or voltage.

Swept Measurements

• One channel (HP 41420A SMU, HP 41421B SMU, or HP 41424A VS/VMU) can sweep current or voltage while up to 8 channels measure current or voltage.

• A second sweep channel can be slaved to the first sweep channel (dual synchronous sweep).

Sweep modes: Linear or logarithmic.

Single or double staircase.

Sweep parameters: Start, stop, number of steps, or steps per decade.

Maximum number of steps: 1000

Hold time: 0 to 655.35 sec, 10 msec resolution

Delay time: 0 to 65.535 sec, 1 msec resolution

Setting accuracy: 0.5% + 1 msec*

Measurement Unit

HP 4142B Modules

Model Number	Slots Req'd	Voltage Range	Current Range	Measurement Resolution	Output Power	Accuracy V	Accuracy I
HP 41420A SMU ¹	2	±100µV to ±200V	±50fA to ±1 amp	40µV 20fA	14W	0.05%	0.2%
HP 41421B SMU ¹	1	±100µV to ±100V	±50fA to ±100mA	40µV 20fA	2W	0.05%	0.2%
HP 41424A VS/VMU	1	±1mV to ±40V	±20mA, ±100mA	4µV ² 20µA	2W	0.05%	3%
HP 41425A AFU	1	Searches for a specified current or voltage on one SMU by controlling the voltage output of another SMU.					

¹Provides Kelvin connections (remote sensing).

²Differential measurement mode (40 µV resolution in normal mode).

SMU Range, Resolution and Accuracy (at 18°C-28°C)

Voltage Range	Set Res.	Meas. Res.	Accuracy	Max. Current
±2V	100µV	40µV	±0.05%±1mV	1A
±20V	1mV	400µV	±0.05%±10mV	1A(V≤14V) 0.7A(V>14V)
±40V	2mV	800µV	±0.05%±20mV	350mA
±100V	5mV	2mV	±0.05%±50mV	125mA
±200V	10mV	4mV	±0.05%±100mV	50mA

Current Range	Set Res.	Meas. Res.	Accuracy	Max. Voltage
±1nA	50fA	20fA	±1%±(0.1+0.2 x Vo/100)%±5pA	200V
±10nA	500fA	200fA		
±100nA	5pA	2pA	±0.5%±(0.1+0.2 x Vo/100)%	
±1µA	50pA	20pA		
±10µA	500pA	200pA	±0.2%±(0.1+0.2 X Vo/100)%	
±100µA	5nA	2nA		
±1mA	50nA	20nA	±0.5%±(0.1+0.2 X Vo/100)%	
±10mA	500nA	200nA		
±100mA	5µA	2µA		
±1A	50µA	20µA	±0.5%±(0.1+0.2 X Vo/100)%	
				100V (I>50mA)
				200V (I≤50mA)
				100V (125mA ≥I>50mA)
				40V (350mA ≥I>125mA)
				20V (0.7A ≥I>350mA)
				14V (I>0.7A)

*Vo is the SMU output voltage, in volts

Pulsed Measurements

Force and measure pulsed current or voltage.

Ranges: 2V range: 10nA to 1A range

20V to 200V range: 100µA to 1 A range

V pulse: 2V range: 1 compliance ≥ 2nA

20V to 200V range: 1 compliance ≥ 20µA

I pulse: 10nA to 10µA range: V compliance ≤ 2V

100µA to 1A range: V compliance ≤ 200V

Pulse width: 1-50 msec, 100µsec resolution

Pulse period: 10-500 msec, 100µsec resolution

Setting accuracy: 0.5% + 100µsec*

Pulsed Sweeps

• Sweep and measure pulsed current or voltage.

• Sweep DC current or voltage while pulsing current or voltage.

Use Pulse and Sweep specification.

Memory

Program memory: Stores approximately 500*

HP-IB commands which can be grouped into 99 subroutines.

Data memory: 4004 measurement points (binary).

1001 points (ASCII format).

General Specifications

Auto Calibration

Automatically calibrates the offset errors in each measurement unit every 30 minutes.*

Environmental Information

Operating Temperature: 5°C to 40°C

Allowable Temperature Drift: ±3°C*

Operating Humidity: 5% to 80% RH

Storage Temperature: -40°C to 65°C

Storage Humidity (at 65°C): ≤90% RH

Operating Inclination: ±20° from horizontal

Power Requirements

100/120/220V ±10%, 240V-10%+5%, 48 to 66Hz, 750 VA max

Dimensions

426 mm W x 235 mm H x 676 mm D

Weight

HP 4142B: Approximately 23kg

HP 41420A: Approximately 4kg

HP 41421B/41424A/41425A: Approximately 2kg

Recommended Computer

HP 9000 Series 200 or 300 computer.

BASIC Operating System (Version 3.0 or later).

Software

Parameter Measurement Library: Current gain, Breakdown voltage (2), Drain current, Threshold voltage (3), and Resistance.

Test Instruction Set: Initialize, Force, Measure, Pulse, Graphics, and Data storage.

* Reference data only.

Ordering Information

HP 4142B Modular DC Source/Monitor \$11,510

Opt. 001: System Cable for Use with 16058A \$226

Opt. 002: Accessory Kit for System Use GDU/ Interlock Cables, Conn. Plate \$361

Opt. 400: Install 41420A (needs 2 slots) \$4,510

Opt. 401: Triaxial Cable for 41420A \$175

Opt. 402: Quadradial Cable for 41420A \$600

Opt. 410: Install 41421B (needs 1 slot) \$3,725

Opt. 411: Triaxial Cable for 41421B \$175

Opt. 412: Quadradial Cable for 41421B \$600

Opt. 440: Install 41424A (needs 1 slot) \$3,390

Opt. 442: Vs/Vm Cables (coaxial) \$340

Opt. 450: Install 41425A (needs 1 slot) \$1,810

HP 41420A Source/Monitor Unit \$4,510

Opt. 402: Quadradial Cable \$600

HP 41421B Source/Monitor Unit \$3,725

Opt. 412: Quadradial Cable \$600

HP 41424A Voltage Source/Voltage Monitor Unit \$3,390

Opt. 442: Vs/Vm Cables (coaxial) \$340

HP 41425A Analog Feedback Unit \$1,810

HP 16058A Test Fixture \$2,820

Opt. 001: System Cable for 4142B \$60

SEMICONDUCTOR TEST EQUIPMENT

Softpanel Interactive Measurement and Analysis Software

HP 16276A

- Full feature parameter analyzer
- Menu-driven softpanels



HP Interactive Measurement and Analysis Software

HP Interactive Measurement and Analysis (IMA) Software makes semiconductor measurements interactively, using the HP 4142B DC Source/Monitor. The IMA software turns the HP 4142B into a fully automatic semiconductor dc parameter analyzer by providing an interactive softpanel user interface.

Now you can use the HP 4142B like the HP 4145B Semiconductor Parameter Analyzer, with the addition of the higher speed, wider dynamic measurement range, and more flexible module configuration of the HP 4142B, and with the enhanced capabilities of IMA software.

Easy to Use Softpanels

The IMA software provides easy-to-use softpanels. You use the mouse to reduce the measurement setup to a simple fill-in-the-blank operation. The mouse is also used to control the graphics analysis routines, the output formats, and the file management of the IMA.

Automatic Measurement and Analysis

You can perform most of the semiconductor analysis functions using the HP IMA softpanels. For automation or customization of measurement and analysis, use the unique Analysis Instruction Set (AIS). The AIS is the subprogram library of HP BASIC and an interface with the HP BASIC program, while the softpanel is the interactive user interface.

Setting up softpanels, triggering measurements, analyzing graphics, extracting data from and sending data to the graphics page, and managing files are made easy using the HP BASIC programming feature of the IMA software. By using the IMA softpanels, you can monitor and analyze program execution and manually reset parameters.

HP 4145B Compatibility

Data file upward compatibility is maintained with the HP 4145B for graphics and list data.

- Powerful graphics analysis for quick parameter retrieval
- Automatic measurement and analysis with HP BASIC subprogram library

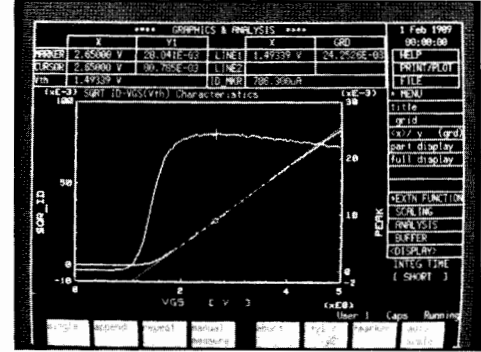

Specifications

Products supported by HP IMA

- HP 4142B Modular DC Source/Monitor Unit
- HP 41420A 200V/1A Source Monitor Unit (SMU)
- HP 41421B 100V/100mA Source Monitor Unit (SMU)
- HP 41424A Voltage Source/Voltage Monitor Unit

Measurement characteristics

Voltage/current sweep parameters

Var1: main sweep, single or double sweep; selectable linear or logarithmic

Var2: subordinate linear staircase sweep

Var1*: staircase sweep synchronized with the Var1 sweep

Time domain sweep: selectable time domain when Var1 is not set

Pulse: every source unit can be set as a pulse source

Constant: every source unit can be set as a constant voltage or current source

Measurement modes: single, append, repeat, or manual

Integration Time: short, medium, or long

Display modes: graphics or list

Analysis capabilities

User functions: up to four user functions can be defined

User display functions: up to two functions can be defined as numeric expressions with the marker, cursor, or line analysis data; results are displayed real time

Marker function: interpolation, marker → min/max, or direct marker

Cursor functions: Cursor → marker, regression line, tangent line, line, fix line, or erase line

Scaling functions: auto scale, move, zoom, init scale, change scale, revise scale, or reset display

Buffer function: four buffers are available: store, recall, recall off, or exchange

Display functions: title, grid/tick, part display, full display, or auto retrieve function

System requirements

HP 9000 series 300 workstations: Model 310/320/330/332/340/350/360/370.

Minimum of 3 Mbyte memory

Graphics boards: HP 98542A/98543A (for 12 inch monitors), HP 98544A/98547A/98548A/98549A/98550A

Language system: HP BASIC 5.13 or later

Security module: HP 46084A

Ordering Information

HP 16276L License to use HP 16276A

HP 16276A HP IMA software media and manuals

Opt 005 5½ inch disks

Opt 006 3½ inch single-sided disks

Opt 007 3½ inch double-sided disks

Opt 910 Extra set of manuals

Price

\$3,750

\$650

\$0

\$0

\$0

+\$107

SEMICONDUCTOR TEST EQUIPMENT

DC Source/Monitor

Model 4141B

541

- High speed measurements down to the pA range
- High reliability at low cost

- High accuracy and resolution
V: $\pm 100\mu\text{V} - \pm 100\text{V}$, 0.1%
I: $\pm 50\text{fA} - \pm 100\text{mA}$, 0.3%

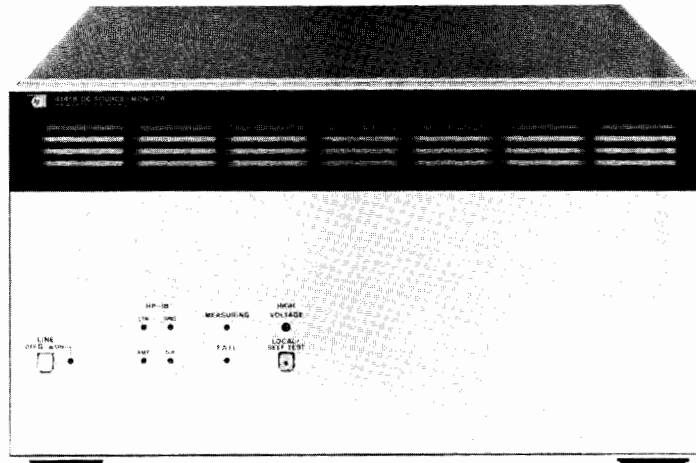

HP 4141B



Description

The HP 4141B DC Source/Monitor is designed for use as a system component in user-designed semiconductor I-V or DC parametric test systems. With its wide DC measurement range, high resolution, high-speed measurement capabilities, remote sensing, and high accuracy, the HP 4141B will contribute towards quality improvement and increased measurement throughput in the lab or on the production line.

High Speed Measurements with High Resolution

Four source/monitor units (SMU's) coupled with two voltage-source units (Vs's), two voltage monitor units (Vm's), and one ground unit (GNDU) make the HP 4141B equivalent to twenty one instruments. A stand-alone instrument capable of measuring dc parameters, the HP 4141B features high resolution measurements (50fA/100 μV) and a built-in timing controller. Typical time for a current or voltage measurement, which includes data transfer, is approximately 25ms. A swept measurement (51 points) takes approximately 490ms. High accuracy and high speed measurements, especially in the low current range, are exclusive features of the HP 4141B.

High Reliability

The HP 4141B's high reliability significantly simplifies maintenance and reduces maintenance costs. To reduce system down time, the HP 4141B is designed for on-site service. Performance verification and diagnostics software for user troubleshooting is also available.

Specifications

Measurement Unit

Source and monitor units (SMU): 4 channels (Kelvin connection)
Each SMU can be programmed to source voltage and monitor current, or conversely to source current and monitor voltage.

SMU Range, Resolution and Accuracy

Voltage range	Resolution	Accuracy	Max. Current
$\pm 20\text{V}$	1mV	0.1% + 0.05%	100mA
$\pm 40\text{V}$	2mV		50mA
$\pm 100\text{V}$	5mV		20mA
Current Range	Resolution	Accuracy	Max. Voltage
$\pm 100\text{mA}$	100 μA	0.3% + (0.1 + 0.2 x Vout*/100)%	20V (I > 50mA)
$\pm 10\text{mA}$	10 μA		40V (20mA < I \leq 50mA)
$\pm 1000\mu\text{A}$	1 μA		100V (I \leq 20mA)
$\pm 100\mu\text{A}$	100nA		
$\pm 10\mu\text{A}$	10nA		
$\pm 1000\text{nA}$	1nA	0.5% + (0.1 + 0.2 x Vout*/100)%	
$\pm 100\text{nA}$	100pA		
$\pm 10\text{nA}$	10pA		
$\pm 1000\text{pA}$	1pA **	1% + (0.1 + 0.2 x Vout*/100)% + 5pA	

*Vout is the SMU output voltage, in volts.

**Max. Measurement Resolution is 50fA.

1. Accuracy specifications are given as % of reading when measuring or % of setting when reading.
2. Accuracy tolerances are specified at 23°C \pm 5°C, after a 40-minute warm-up, with AUTO CAL on, and are specified at the rear panel connector terminals referenced to SMU common. Tolerances double for the extended temperature range of 10°C to 40°C.

Output/Measurement resolution: Voltage - 4 1/2 digits
Current - 4 digits

Voltage source units (Vs): 2 channels

Voltage Range, Resolution, and Accuracy

Output voltage range	Resolution	Accuracy	Max. Current
$\pm 20\text{V}$	1mV	0.5% of setting + 10mV	10mA

Voltage monitor units (Vm): 2 channels

Voltage Range, Resolution and Accuracy

Measurement voltage range	Resolution	Accuracy
$\pm 2\text{V}$	100 μV	0.5% of reading + 10mV
$\pm 20\text{V}$	1mV	0.2% of reading + 10mV

Ground Unit: 1 channel (kelvin connection)

Current range: $\pm 500\text{mA}$

General Specifications

Operating Temperature Range: +10°C to +40°C, $\leq 70\%$ RH at 40°C. Permissible temperature change $\leq 1^\circ\text{C}/5\text{min}$. Maximum wet-bulb temperature is 29°C.

Power requirements: 100/120/220V $\pm 10\%$, 240V-10%+5%, 48 to 66Hz, 240/VA max.

Dimensions: Approximately 426mm (16.77in)W x 235mm (9.25in)H x 612mm (24.1in)D

Weight: Approximately 19kg (41.5 lbs)

Accessories Furnished

HP 04085-61651 Interconnect Cable Assembly

HP 04141-60001 Connector Plate

HP 04145-61630 BNC Cable (3m) 4ea.

Accessories Available

HP 16058A Test Fixture

HP 16059A Adapter (Using with 16058A)

Price

\$2,820

\$660

Ordering Information

4141B DC Source/Monitor

Opt.011: Extra SMU Board

Opt.050/060: *50Hz/60Hz Line Frequency

*Must select Opt. 050 or 060 according to the power line frequency used.

Price

\$23,100

\$1,450

N/C

SEMICONDUCTOR TEST EQUIPMENT

pA Meter/DC Voltage Source

Model 4140B

- 3 basic semiconductor measurements: I, I-V and quasi-static C-V
- Two programmable voltage sources
- Basic accuracy: 0.5%
- High resolution: 0.001×10^{-12} A
- HP-IB standard

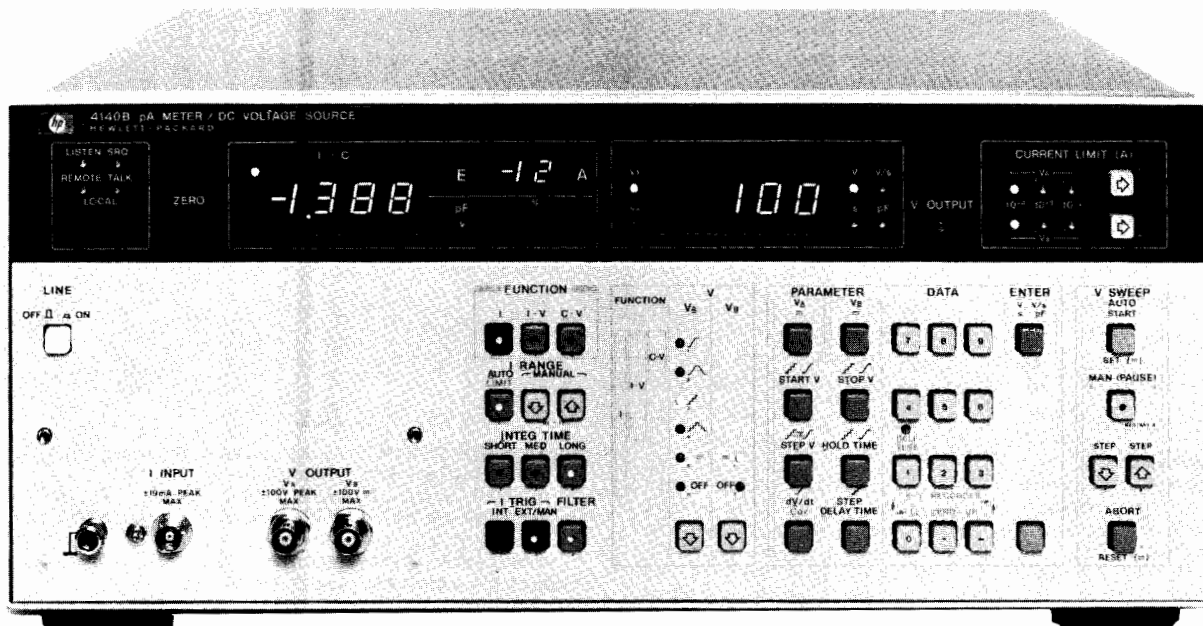

HP 4140B

Description

The HP 4140B pA Meter/DC Voltage Source is another in Hewlett-Packard's new generation of Component Measurement instrumentation. It consists of an extremely stable picoampere meter and two programmable dc voltage sources, one of which operates as a ramp and staircase generator as well as a dc source. These features make the HP 4140B ideal for making dc characteristic measurements such as leakage current, current-voltage characteristics and quasi-static C-V measurements required by the semiconductor industry for new product development and for improving production yields. It is equally useful in measurements of electronic components and materials to determine leakage currents or insulation resistances.

The HP 4140B can contribute to the development, production and quality control of semiconductor devices and to the improvement in the reliability of electronic components and equipment.

Stable pA Measurements

Stable picoampere measurements can be made with the HP 4140B with a maximum resolution of 10^{-15} A. This is made possible by a new measurement technique in conjunction with an offset current capability, low noise test leads, and an electrostatic and light shielded test fixture. These features provide both stable and fast picoampere measurements.

This measurement technique is very useful in making small leakage current measurements and determining dc parameters of semiconductor devices or measuring the insulation resistance and leakage current for dielectric absorption measurements necessary in the analysis of capacitors or insulation materials.

Synchronized I-V Measurements

The HP 4140B makes automatic, synchronized current-voltage measurements that have required a large instrumentation system in the past.

The two voltage sources in the HP 4140B operate over a range of -100 V to $+100$ V with a maximum resolution of 10 mV. One operates only as a stable dc source while the other generates a staircase voltage, a precise ramp or a stable dc level.

By adding precise, programmable timing capability, we can now make fast, accurate I-V and C-V measurements. Device stabilization times, (time between the applied voltage and the subsequent current

measurement) can now be programmed from the front panel of the HP 4140B or via the HP-IB bus.

Quasi-Static C-V Measurements

Automatic quasi-static C-V measurements are easily accomplished by the ramp voltage capability of the HP 4140B. This measurement is highly significant in evaluating basic semiconductor characteristics.

The HP 4140B operates over a capacitance range of 0.1 pF to 1999 pF with a dc voltage ramp rate of 1 mV/s to 1 V/s in 1 mV/s increments. Capacitance, which is calculated from the measured current divided by the ramp rate, can also be provided as a percent of the capacitance of the oxide film (C_{ox}) over a range of 0.0 to 199.9%. By providing the output voltage at each capacitance measurement point, we have the dc (quasi-static) C-V characteristics of the device under test.

HP-IB Capability

Interfacing the HP 4140B to an HP-IB system improves measurement efficiency and takes advantage of its high speed (approx 5 ms) measurement rate. Such a system will minimize measurement time of dc parameters of semiconductors and the insulation resistance and leakage current of electric components and materials. This allows rapid feedback to production for fast evaluation of a new device in the development stage.

Specifications

Measurement functions: I, I-V and C-V

Voltage sources: two separate sources (V_A and V_B)

V_A : ± 100 V programmable source/function generator

V_B : ± 100 V programmable dc voltage source

Measurement Function/Source Selection

Function	V_A	V_B
I		--- (DC)
I-V		--- (DC)
C-V		--- (DC)

Voltage sweep: auto or manual (pause)

Current Measurements

Displays: current, 3½ digits with 2 character annunciator. Voltage, 3½ digits.

Measurement range: $\pm 0.001 \times 10^{-12}$ A to 1.000×10^{-2} A full scale in 11 ranges.

Overrange capability: 99.9% on all ranges.

Range selection: auto (lowest current range is selectable) and manual

Measurement Accuracy/Integration Time

Range	Accuracy* ± (% of rdg. + counts)	Integration Time** (ms)		
		Short	Medium	Long
$10^{-2} - 10^{-9}$	0.5 + 2	20	80	320
10^{-10}	2 + 2			
10^{-11}	5 + 3	80	320	1280
10^{-12}	5 + 8	160	640	2560

* Accuracy for long integration time. 23°C ± 5°C, humidity ≤ 70%. For short and medium integration time, see reference data section.

** Integration times specified at 50 Hz. For 60 Hz operation, multiple time by 1/6.

Zero offset: cancels leakage current of test leads or test fixtures.

Offset range: 0 to $\pm 100 \times 10^{-15}$ A.

Trigger: INT, EXT and HOLD/MAN

Input terminal: triaxial

Capacitance-Voltage (C-V) Measurement

Measurement ranges: 0.0 pF – 100.0 pF and 200 pF – 1000 pF full scale in two ranges; 99.9% overrange

Ranging: auto

%C: capacitance change of device under test is displayed as a percent of the set value of the oxide capacitance (Cox = 100%)

%C range: 0.0% – 199.9%

Cox setting ranges (2 ranges): 0.1 pF – 199.9 pF and 200 pF – 1999 pF

Capacitance calculation accuracy: accuracy is dependent on accuracy of both the current measurement and ramp voltage.



Zero offset: cancels stray capacitances of test fixtures and test leads.

Offset range: 0 to 100 pF

High speed I data output: available with HP-IB interface only. Outputs current measurement data at 4 ms intervals (max rate).

DC Voltage Sources

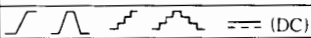
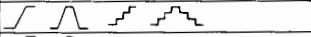
Output Modes, V_A and V_B

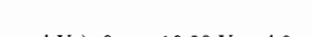
Function	V _A	V _B
I		
I-V		
C-V		

Voltage ranges (V_A and V_B): 0 to ±10.00 V and 0 to ±100.0 V in 2 ranges, auto range only.

Maximum current: 10 mA, both sources.

Voltage sweep: auto and manual (pause), up/down step in manual (pause) mode. Sweep abort standard.

Operating Parameter Setting Ranges

Start voltage and stop voltage: 0 – ±10.00 V, 0.01 V steps; 0 – ±100.0 V, 0.1 V steps

Step voltage: 0 – ±10.00 V, 0.01 V steps; 0 – ±100.0 V, 0.1 V steps

Hold time: 0 – 199.9 seconds in 0.1 s increments; 0 – 1999 seconds in 1.0 s increments

Step delay time: 0 – 10.00 seconds in 0.01 s increments; 0 – 100.0 seconds in 0.1 s increments

Ramp rate (dV/dt): 0.001 V/s – 1.000 V/s in 0.001 V/s increments

Accuracy (at 23°C ± 5°C)

Output voltage: ±10 V, ±(0.07% + 11 mV); ±100 V, ±(0.09% + 110 mV)

Linearity: typically 0.5%, 0 – ±10 V; < 5%, > 10 V.

Current limit: 100 μA, 1 mA and 10 mA, ±10% (V_A and V_B)

Output terminals: BNC; L-GND

Reference Data

Current Measurement

Current Measurement Accuracy*

Range	Integration Time	
	Short	Medium
$10^{-2} - 10^{-8}$	0.5 + 3	0.5 + 2
10^{-9}	0.5 + 3	0.5 + 3
10^{-10}	2 + 4	2 + 3
10^{-11}	5 + 10	5 + 4
10^{-12}	5 + 20	5 + 10

* ± (% of rdg. + counts), 23°C

Current ranging times*: 20 ms to 7.76 s. (longer ranging time needed for large changes in input signal level, especially on lowest current ranges).

*When FILTER is on, current ranging time increases 60 ms (50 Hz power line) or 50 ms (60 Hz power line)

Warm-up time: ≥ 1 hour

Common mode rejection ratio: ≥ 120 dB (≤ 2 counts)

Analog Output I, C and V_A

Accuracy: ±(0.5% + 20 mV)

Low pass filter: 3 position: OFF, 0.22 s ± 20% and 1 s ± 20% applied to both V_A and I/C data outputs

Pen lift output: TTL low level (≤ 0.8V) during sweep period in I-V and C-V functions

Recorder output scaling: pushbutton scaling of lower left and upper right limits of X-Y recorder

HP-IB Interface

Remote controlled functions: measurement function, current range, integration time, I data output trigger, voltage sweep controls, current limit, V_A and V_B voltages, zero (offset), self test and parameter settings (voltages, sweep/hold/delay times)

Data Output

Measured data (I, C and V_A),
Voltage setting (V_A and V_B),
Parameter settings

General Information

Power: 100, 120, 220, V ± 10%, 240 V + 5% – 10%; 48-66 Hz, 135 VA max

Size: 426 mm W x 177 mm H x 498 mm D (16.5" x 7" x 19.6")

Weight: 14.4 kg (31.7 lb)

Accessories Furnished

HP 16053A test leads: consists of one triaxial cable, two each BNC-BNC cables and one connection plate with mating female panel-mount connectors. Cables are one meter in length.

HP 16055A test fixture: for general device measurements. Provides electrostatic and light shielding for stable pA measurements.

Accessories Available

HP 16054A connection selector: provides a simple method to select appropriate connection of low lead for the pA meter section.

HP 16056A current divider (10:1): for use only on the 10 mA range to extend the measurement capability to 100 mA.

Ordering Information

Accessories

HP 16054A Connection Selector \$444

HP 16056A Current Divider (10:1) \$238

Options

Opt 907 Front Handle Kit (HP P/N 5061-0090) \$67

Opt 908 Rack Flange Kit (HP P/N 5061-0078) \$37

Opt 909 Rack & Handle Kit (HP P/N 5061-0084) \$94

Opt 910 Extra Manual \$52

Opt W30 Extended Repair Service. See Page 725.

HP 4140B pA Meter/DC Voltage Source \$10,400

Fast-Ship product — see page 734.

SEMICONDUCTOR TEST EQUIPMENT

1 MHz C Meter/C-V Plotter

Model 4280A

- Built-in sweepable dc bias source and timer for C-V (Capacitance-Voltage)/C-t (Capacitance-Time) measurements
- High speed C-t measurements with minimum measurement interval of 10 ms (10 μ s if an external pulse generator is used)
- Basic C measurement accuracy: 0.1%
- Test lead extension up to 5 m
- 5½-digit display resolution (option) for C measurement

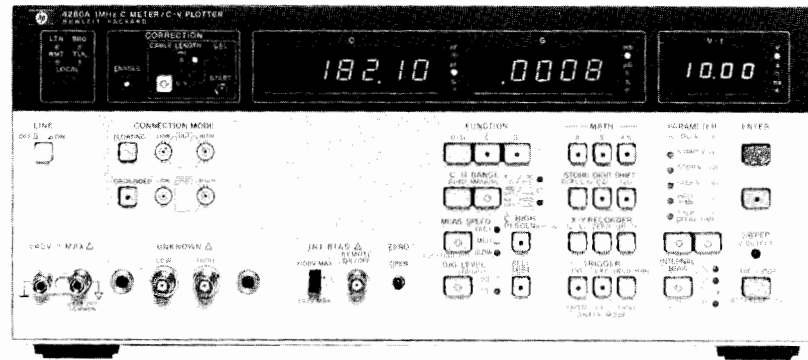

HP 4280A



Description

The HP 4280A 1 MHz C Meter/C-V Plotter measures the capacitance and conductance of semiconductor devices and materials as functions of applied voltage (C-V) or time (C-t). The HP 4280A consists of a precision 1 MHz C-G meter, a programmable dc bias source that can be swept in staircase fashion, and accurate timing control.

C-V and C-t Measurements

The HP 4280's internal dc bias source has a range of 0 V to ± 100 V with 1 mV resolution on the most sensitive range. Various measurement parameters for C-V and C-t measurements—hold time (bias pulse width) and delay time (measurement interval)—can be manually set from the front panel. Or these parameters can be set under program control via the HP-IB. Settable range for C-t measurement interval is 10 ms to 32s with a best case resolution of 10 μ s. If an external pulse generator is used, however, measurement intervals as short as 10 μ s can be set. Up to 9999 readings can be set for a C-t measurement. These capabilities make it possible for the HP 4280A to measure the C-t characteristics of virtually any device.

High Speed C-t Measurement

A special sampling integration technique employed in the HP 4280A provides measurement intervals as short as 10 μ s using an external pulse generator, such as the HP 8112A or HP 8160A, to provide the bias pulse. Short measurement interval makes the HP 4280A applicable to Deep Level Transient Spectroscopy (DLTS) measurements, which are commonly used to analyze the physical characteristics of semiconductors.

Precision, High Resolution Measurements

The HP 4280A measures capacitances up to 1.900 nF, over three ranges, with 0.001 pF resolution on the most sensitive range. Conductance up to 12 mS can be measured with a maximum resolution of 10 μ S.

C and G measurements are made at 1 MHz. AC signal level is selectable between 10 mVrms or 30 mVrms, suitable for semiconductor measurements. Basic measurement accuracy is 0.1%. Maximum display resolution is 4½ digits. With Option 001, however, display resolution for capacitance is 5½ digits.

The accuracy and resolution of the HP 4280A satisfy the stringent requirements of laboratory and R and D measurements, which require the detection of minute changes in device characteristics.

Probed Measurements On Wafers

HP 4280A has an automatic error correction function that makes

it possible to use test leads up to 5 m long (HP P/N 8120-4195). The HP 4280A can measure either floating or grounded devices. Thus, the HP 4280A can be connected to a wafer prober and still provide stable, accurate C and G measurements.

Easy, Low Cost Systemization

HP-IB is standard on the HP 4280A. So, a process evaluation system or a lab automation system capable of evaluating the physical characteristics of semiconductor devices can be easily constructed.

The HP 4280A is equipped with analog outputs to allow users to plot device characteristics on an X-Y recorder or large screen display.

Specifications (refer to data sheet to complete specifications)

Measurement functions: C, C-V and C-t

Function		Available Internal dc Bias Function
Basic Function	Selection	
C	C only, G only C-G only	OFF, --- (DC)
C-V	C-V G-V C & G-V	
C-t	C-t G-t C & G-t	

C Measurement

Test Signal

Frequency: 1 MHz $\pm 0.01\%$

OSC level: 30 mVrms or 10 mVrms $\pm 10\%$

Measurement terminals: two-terminal-pair configuration (High, Low and Guard).

Connection mode: sets connection configuration between DUT (floating/grounded) and measurement circuit.

Ranging: auto or manual

Error Compensation

Cable length: 0 m, 1 m or 0-5 m. The standard cable (HP P/N 8120-4195) up to 5 m can be internally compensated.

Zero open: compensate stray capacitance and conductance at the test fixture.

External error compensation: compensate errors by external computer to eliminate other error factors not listed above.

Measurement speed: FAST, MED or SLOW

Trigger: Internal, External or Hold/Manual

Internal dc bias mode: OFF or --- (DC)

Measurement Range/Resolution/Accuracy

Range ¹	Resolution ²	Max. Display ³	Accuracy ⁴ ±(% of rdg + counts)	
			OSC: 30 mV	OSC: 10 mV
10 pF/100 μS	0.001 pF 0.01 μS	19.000 pF 120.00 μS	±(0.1% + 5) ±(0.2% + 5)	±(0.2% + 5) ±(0.3% + 5)
100 pF/1 mS	0.01 pF 0.1 μS	190.00 pF 1.2000 mS	±(0.1% + 3) ±(0.2% + 3)	±(0.2% + 3) ±(0.3% + 3)
1 nF/10 mS ⁵	0.1 pF 0.001 mS	1.9000 nF 12.000 mS	±(0.1% + 3) ±(1.2% + 3)	±(0.2% + 3) ±(1.2% + 3)

¹ 100 pF/1 mS and 1 nF/10 mS ranges only in grounded measurement.
² When measurement speed is set to FAST (10 mV/30 mV) or MED (10 mV), resolution and Max. display become 1 digit less (3½ digit display).
³ Approx. 50 pF at 100 pF/1 mS range and 1.76 nF at 1 nF/10 mS range in grounded measurement. Error correction to offset residuals will reduce maximum value which can be measured.
⁴ Accuracy is specified at UNKNOWN terminals and at the end of HP 16082A Test Leads (1 m) after warm-up ≥30 min., at temperature 23°C ±5°C, zero open calibration is performed, and CORRECTION is enabled. Front panel settings are C-G, FLOATING and 0 m or 1 m (CABLE LENGTH). Some errors will be added at other settings (refer to data sheet). C accuracy is specified when D < 0.05 and G accuracy is specified when counts of C < 1/100 of range. Error double at 0°C-55°C.
⁵ Add 0.1% of rdg for C and 0.2% of rdg for G when HP 16082A is used.

C-V Measurement

Function: measures C-V, G-V or C & G-V characteristics using internal staircase bias.
Measurement speed: FAST, MED or SLOW

C-t Measurement

Function: measures C-t, G-t or C & G-t characteristics using internal and/or external pulse bias source.
Internal measurement mode: Burst or Sampling Mode automatically selected.

Burst mode: apply one pulse then make repetitive measurement with specified time interval between measurements.
Sampling mode: repeated pulse with single samples between pulses. Delay between application of measure voltage and sample can be specified.

Measurement speed: FAST or MED

DC Bias Source

Output Mode: , , ,  (DC) or OFF
Output Voltage Range/Resolution/Accuracy

Voltage Range	Resolution	Accuracy ⁴ ±(% of setting + volts)
±1.999 V	1 mV	±(0.2% + 0.01 V)
±19.99 V	10 mV	±(0.1% + 0.02 V)
±100.0 V	100 mV	±(0.1% + 0.1 V)

*at 23°C ±5°C, at 0°C -55°C error doubles

Staircase Sweep Parameter Settings (C-V Basic Function Only)

Start/stop voltage: 0 V-±100 V (max. 1 mV resolution)
Step voltage: 0 V-200 V (max. 1 mV resolution)
Hold/step delay time (th/td): 3 ms-650s (max. 1 ms resolution)
Pulse Bias Parameter Settings (C-t basic function only)

DC/pulse/measurement voltage: 0 V-±100 V (max. 1 mV resolution)

Number of readings: 1-9999
Hold time (th): max. 10 μs resolution
Internal bias: 10 ms-32 s
Ext bias slow: 50 μs-32 s
Ext bias fast: 10 μs-32 s

Delay time (td): 10 μs-32 s (max. 10 μs resolution)
Burst Mode

Function	Meas. Speed	Block Mode	Non Block Mode	
			Data Format	
			Binary	ASCII
C-t	FAST	10 ms-32 s	20 ms-32 s	150 ms-32 s
G-t	MED			
C & G-t	FAST	50 ms-32 s		200 ms-32 s
	MED		100 ms-32 s	250 ms-32 s

Sampling Mode

Ext bias slow: 200 μs-5 s
Ext bias fast: 10 μs-5 s
Math functions: displays measured C/G values as differential values (Δ), % ratio (%) or differential % (Δ%) of the reference value.

Other

HP-IB: not just IEEE-488, but the hardware, documentation and support that delivers the shortest path to a measurement system.

Data output format: ASCII or Binary

Block mode output: can make C-V/t characteristics measurement and store measured data (C-V/t or G-V/t Function: 680 data, C & G-V/t Function: 400 data) into the internal data buffer. Then, packed data can be output.

Recorder Output

Output voltage: ±10 V for C, G and V/t data
Accuracy: ±(% of output voltage + V)
C or G: ±(0.5% + 20 mV)
V or t: ±(0.15% + 40 mV)

Self test: verifies normal measurement operations (not including calibration)

Options

Option 001: High Resolution Offset Capacitance Measurement
Function: increase C measurement resolutions by one digit with offset reference value.
C offset range: 0 pF-1023 pF (1 pF increment). C offset value can be set by measured data or numeric key.

General Specifications

Operating temperature range: 0°C to 55°C; 95% RH at 40°C
Power requirements: 100/120/220 V ±10%, 240 V + 5% - 10%; 48 to 66 Hz; 140 V A max.
Dimensions: 426 mm W x 177 mm H x 498 m D (16.5" x 7" x 19.5")
Weight: 15.3 kg (33.7 lb)

Accessories Furnished

HP 16080A: Direct Coupled Test Fixture

**Reference Data
Measurement Time**

MEAS SPEED	Measurement Function		
	C-G	C	G
FAST	30 (70)	10 (30)	10 (30)
MED	70 (110)	40 (60)	35 (55)
SLOW	400 (440)	270 (290)	220 (240)

When measured values are displayed on the front panel and the recorder outputs are used, measurement times in parentheses apply.

Residual L-R compensation: error compensation for residual L-R (max. 19 μH/190 Ω) is available using an external controller.

Internal DC Characteristics of High and Low Unknown Terminals (Without DC Bias)

Maximum offset voltage: ±1 mV
Maximum allowable current: 100 mA

Internal DC Bias

Settling time (99.9% of final value): 0.05 × voltage swing (V) + 1.7 (ms)
Maximum output current: ±6 mA
Hold time/step delay time/th/td: 0.02% (basic accuracy)

Response time of the EXT SLOW bias circuit (99.9% of final value): 100 μs

Option 001

C offset accuracy: ±(2% of reference value + 0.5 pF) can be compensated by CORRECTION ENABLE key.

Ordering Information

HP 16081A Test Leads, 2 m double shielded, BNC	\$760 ☎
HP 16082A Test Leads, 1 m, BNC	\$260 ☎
HP 16083A Pulse Bias Noise Clipper	\$415

HP 4280A 1 MHz C Meter/C-V Plotter

Opt. 001: C-High Resolution (not field installable)	\$10600
Opt. W30: Extended Repair Service. See Page 725.	\$420

☎ Fast-Ship product — see page 734.

SEMICONDUCTOR TEST EQUIPMENT

Parameter Extraction Software TECAP Characterization System

- Shortens IC design time
- Improves circuit designs
- Lowers chip costs
- Maximizes yields
- Accurate circuit simulations
- Device AC and DC measurements

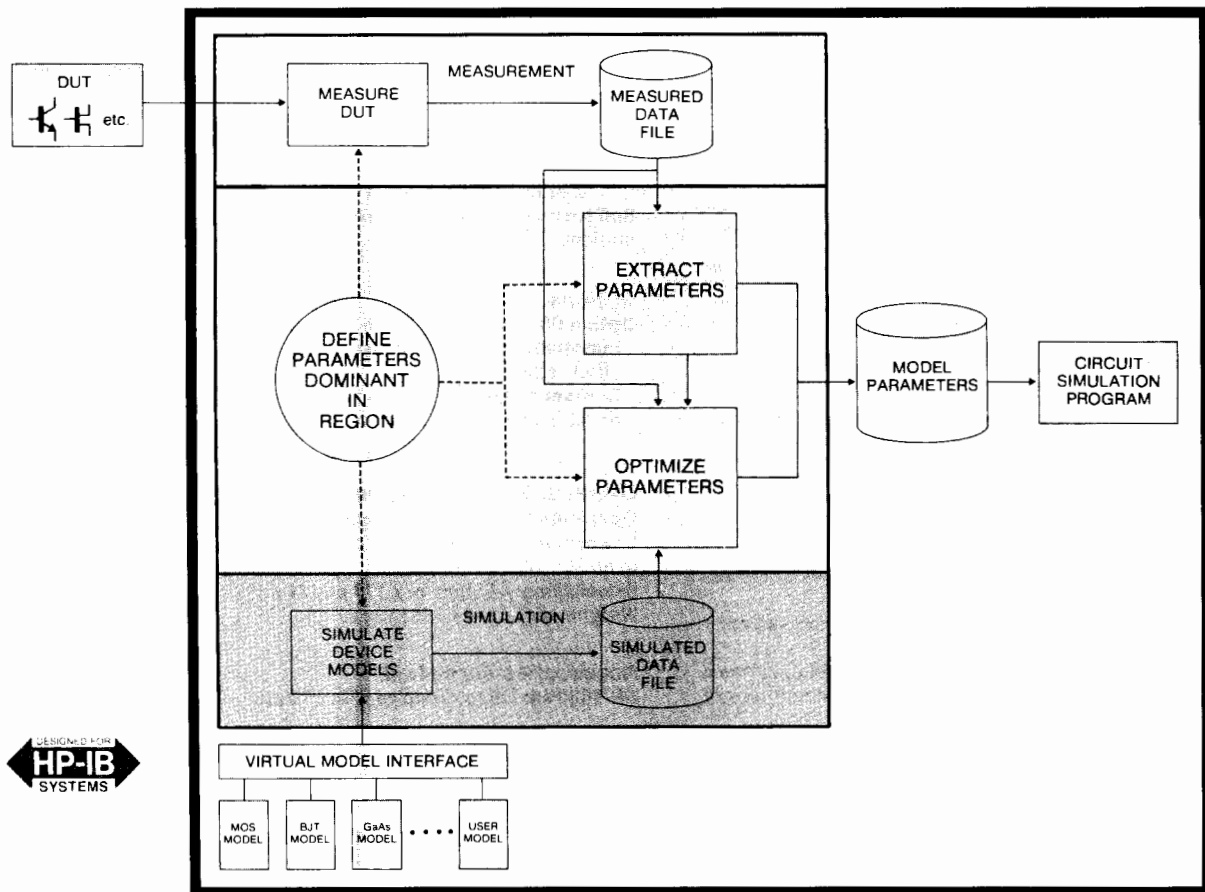

TECAP automatic parameter extraction methodology

TECAP Lets You Design New IC's in Less Time - With Less Cost

Hewlett-Packard's TECAP Characterization System shortens your IC design cycles and lowers design costs. TECAP - Transistor Electrical Characterization and Analysis Program - provides fast, reliable analysis of device behavior. Model parameters generated with the TECAP system will improve your circuit simulation and IC designs.

TECAP provides engineers with a complete system for device characterization. The easy-to-use display environment and extensive set of calibration and measurement drivers streamlines data collection. Simple commands allow you to quickly extract model parameters from measured data. Integrated, powerful simulation tools allow you to perform real-time analysis of your device performance.

Design IC's and New Devices Faster

TECAP lets you perform your design revisions using CAE analysis. Because this approach is more economical and much faster than multiple fabrication runs, you save valuable engineering and production resources. Accurate model parameters form the foundation for error-free circuit simulation and precise IC design. TECAP's integrated measurement, extraction, and simulation tools provide you with accurate model parameters in seconds. Because you can now begin wafer fabrication with a superior design, you minimize passes through the fab line, slash your design cycles, and deliver products to your customers in a timely manner.

TECAP Extracts Model Parameters in Seconds

TECAP software can automatically extract UCB Level 1, 2, 3, 4 MOS, UCB Bipolar, or GaAs model parameters in seconds. These

models can simulate second-order effects, such as channel-length modulation, and offer direct compatibility with the UCB SPICE circuit simulator developed at the University of California, Berkeley.

The TECAP system can also extract parameters for your new transistor models. Newly implemented models have the same parameter extraction, optimization, and simulation capabilities as standard TECAP models. You can even add a custom extraction module to the program to fully automate parameter extraction for your model.

Develop and Understand New Device Models

You can implement your own transistor models into TECAP to be completely compatible with proprietary circuit simulation programs or emerging new semiconductor technologies. You can use the versatile simulation tools to develop and to test new model equations. TECAP gives you the immediate feedback you need to evaluate and understand equation behavior. TECAP replaces pages of batch printouts with vivid, colorful graphics so you may clearly visualize the effects of model parameters and complex, multi-order equations.

Get Maximum Performance From Your Process

TECAP allows you to significantly improve the performance of your existing IC process. With TECAP, you can determine those parameters which have the greatest effects on performance measures such as speed, power, and logic levels. Using TECAP's statistical tools, you can accurately determine worst case performance of your process using those dominant parameters. TECAP gives you the vehicle to construct worst case models which will allow you to increase the performance of your process with minimal process development and lower cost.

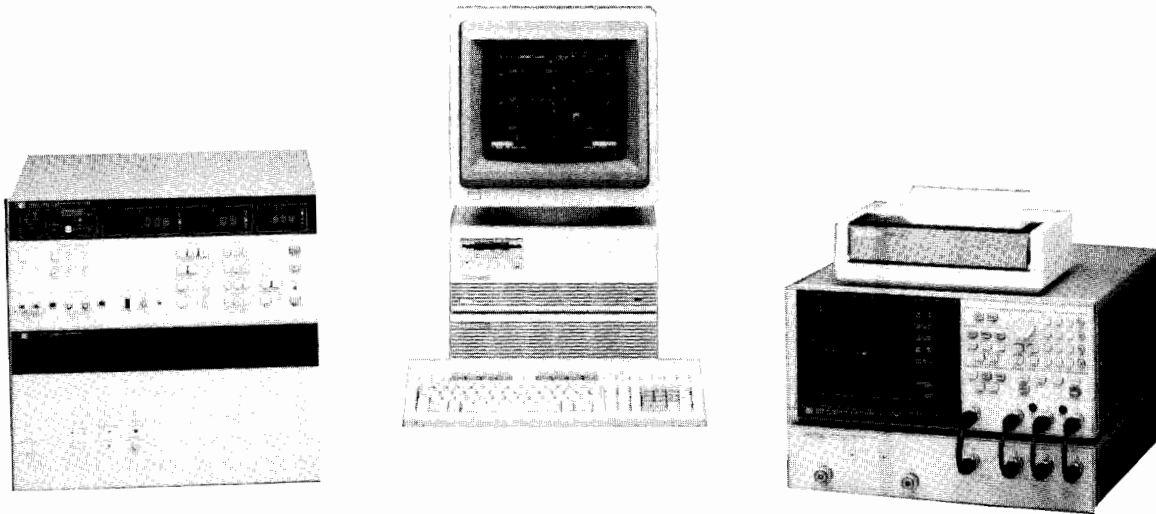

TECAP software is fully compatible with a wide range of standard HP-IB instrumentation.

Configure System Hardware to Satisfy Your Price and Performance Requirements

The TECAP system works with a wide range of standard Hewlett-Packard computers and HP-IB instrumentation, allowing you to choose the equipment which meets your exact needs. TECAP supports not only the ubiquitous HP instruments such as the HP 4145B and HP 8753B, but also new instruments such as the HP 4142B, HP 8720A, and HP 4284A. You can build an entry level system to start with. Then, as your requirements expand, you can add the latest in high performance measurement tools to fit your changing situation.

TECAP Is Easy to Use

TECAP provides both ease-of-use for the occasional user and advanced features and capabilities for the expert user. You can access any TECAP command from one convenient menu - so you don't get lost in menu hierarchies. The "main menu" always displays program status to keep you updated on program action. These human-engineering features have been designed into TECAP to automate the process of parameter extraction and new model development.

To measure a device, extract model parameters, or simulate device performance, you select the appropriate command. If the system needs more information from you, it will supply a diagram or table for you to edit. Every table is already furnished with default values or configurations. The table entry method allows you to have immediate access to all of your characterization routines so you can use the design tools more productively.

Integrated System Saves Time

TECAP's integrated environment lets you concentrate on evaluating results, so you don't waste time figuring out how to get them. You can measure devices, extract parameters, simulate device models, and plot results all with the same program.

TECAP minimizes setup preparation time so each user can immediately begin extracting parameters from their devices. For example, you can save a complete system environment on a disc and use it in seconds. You can retrieve instrument setups, extraction routines, and device models with a single command. You can create system configurations for every process in your company. You can quickly setup an environment to perform characterization on NMOS, CMOS, bipolar, or GaAs devices - using the SAME system.

You can operate the TECAP system without knowledge of the computer hardware, the computer operating system, or the measurement instruments. The system automatically adapts to handle all the

instrument setups and measurements you need for device characterization. To give you maximum flexibility, the software lets you control a wide variety of measurement and computation hardware.

TECAP Software Specifications

Operating system: Pascal Workstation language system, Version 3.22.

Measurement: voltage, current, capacitance, and 2-port ac parameters vs. bias and frequency.

Model Parameter Generation

Extraction:

- direct extraction from measured data
- predefined routines for automatic extraction
- interactive parameter extraction mode
- user-definable extraction routines

Optimization:

- numerical fine tuning of extracted parameters using integrated SPICE-like simulator for highly accurate fits
- compatible with user defined models
- Levenberg-Marquardt algorithm for nonlinear, least-squares fit
- constrained optimization

Simulation: voltage, current, capacitance, and 2-port ac parameters vs. bias and frequency.

Available models:

- UCB MOS Levels 1, 2, 3 and 4 (BSIM)
- UCB bipolar (Gummel-Poon, Ebers-Moll)
- Curtice GaAs MESFET Levels 1 (quadratic) and 2 (cubic)
- UCB GaAs MESFET
- Yaeger-Dutton GaAs HEMT
- UCB JFET
- Diode
- PN Junction Capacitance
- MOS Gate Capacitance
- Classical MOS
- Up to 7 user-definable models

Ordering Information

Please call your local HP Sales Office listed on page 739 for a data sheet, prices, or applications assistance.

BOARD TEST SYSTEMS

Board Test Introduction

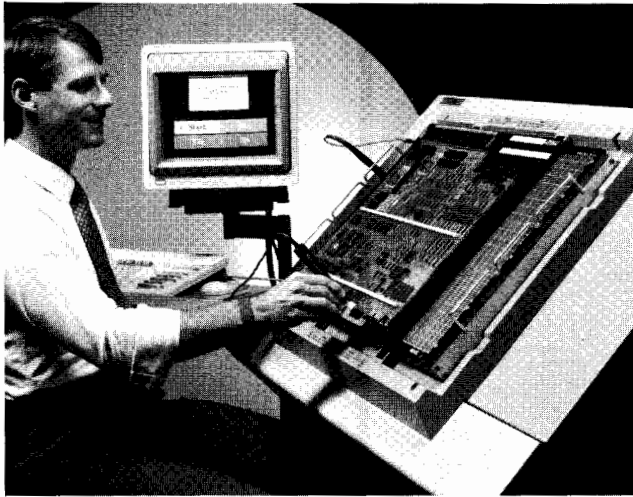

Technological advances and increased worldwide competition place ever-increasing demands on production managers to cut costs, increase productivity, and improve product quality. The use of advanced technologies, including surface-mount devices (SMDs), application-specific integrated circuits (ASICs), and VLSI circuits, give the manufacturer capability, reliability and cost advantages. They also present a unique set of process and test related problems. Automatic test equipment to solve these problems is no longer a luxury; it is a necessity.

Hewlett-Packard, an innovator in the design and use of advanced technologies, provides a full line of affordable board test systems to meet the diverse needs of the electronics manufacturing industry. From the low cost HP 3065ST Standard Technologies in-circuit tester to the new HP 3070 AT-Series combinational test systems, Hewlett-Packard has a system to meet your specific testing requirements.

The Board Test Advantage

In the manufacturing process, board test is the first stage where the entire fault spectrum, from defective components to process faults, can be detected. Since each production operation is unique, the board test system must have the flexibility to meet your future requirements as well as your current needs. In choosing a test system, the four major factors to consider are software, in-circuit/combinational testing capability, fixturing solutions, and reliability/support. Each is of equal importance, similar to the legs of a table. All the legs must be of equal length and long enough to keep the tabletop they support at a usable level. To fall short in any area will throw the entire system out of balance, reducing its overall effectiveness.

In-circuit/Combinational Testing

Hewlett-Packard offers analog and digital testing capabilities in both in-circuit and combinational board test systems. Hewlett-Packard's analog in-circuit testing capabilities have been the industry standard for over 10 years. In digital in-circuit testing, the HP vector processing unit (VPU) makes the current RAM-behind-the-pins technique for pattern application obsolete. With the VPU, the theoretical limit to the pattern depth, without reload or dead time, is approximately 535 million test patterns.

Combinational testing has traditionally been defined as the use of both in-circuit and functional test techniques residing in the same system. This implies that it is merely the sum of the two techniques, each with its advantages and disadvantages. However, combinational testing as a whole can be much greater than the sum of the parts. The key

to accomplishing this is integration. It requires a single architecture, common hardware, and a flexible software environment to reach its full potential. Every HP combinational test system uses integrated hardware and software resources to provide unsurpassed test coverage and flexibility for analog, digital, and mixed-signal circuits.

Software Resources

Hardware features and specifications are most often used as points of comparison between board test systems. However, cost of ownership and return on investment depend more on the software resources of the systems. Test program generation times, fixture development, and fault diagnostics are major contributors to the ongoing costs of the production test department. HP board test systems provide software to make the testing process easier, from start to finish.

HP board test systems provide software to automatically transfer valuable programming information from virtually any CAD and CAE system into menu-driven board forms.

Next, the HP Integrated Program Generator (HP IPG) automatically produces a test program, in which typically over 90% of the tests work the first time. This includes shorts, opens, digital tests using Hewlett-Packard's 5500 part digital library, and 6-wire guarded analog tests. CAE data is used to generate tests for complex devices such as ASICs.

HP Color Graphical Debug allows programmers to easily debug both analog and digital tests with histograms and built-in logic analyzer-like displays. It provides softkey driven interactive control of all parameters, highlighting failing responses.

All of these test development tools, and more, are managed by the HP IPG Test Consultant, a menu-driven, mouse-supported interface. A programmer's actions are based on recognition, not recollection, with desired actions selected from the available pull-down menus. The software relieves the programmers of time-consuming tasks such as file management, revision archiving, and program scheduling. In addition, programmers choose the levels of flexibility and automation to best match their expertise.

Fixturing Solutions

HP offers a full line of mechanical and vacuum-actuated test fixtures and accessories to maximize system performance. In 1986, the HP SimPlate Series was introduced, offering a 10:1 reduction in probing errors over the conventional two-plate design. With the introduction of the HP 3070 family in early 1989, additional vacuum-actuated fixtures and a mechanical fixture and cassette were introduced. These fixtures provide dual-sided, and dual-stage probing, short wire lengths, and improved contact reliability. The mechanical fixturing system readily integrates into automated test environments.

The HP Express Fixture Software automatically designs the test fixture, minimizing wire lengths and close-centered probes, selecting optimum probe locations, and documenting the fixture construction process. The software also generates files to support automatic drilling, wiring, and receptacle installation of the fixture.

Reliability/Support

Since 1983, the HP 3065 testers have been the most reliable systems on the market, but now they have been surpassed by the HP 3070 family, with an MTBF of over 2300 hours. This reliability was achieved through the extensive use of SMT and HP-designed integrated circuits and reduced numbers of electrical parts, cables, connectors and mechanical parts. Improved diagnostics and board-level repair give the system an MTTR of 2 hours. The standard warranty on the HP 3070 System is one year parts and labor.

With over a hundred sales and service offices worldwide, trained HP personnel are there when you need them. Expert programming help is available by phone from the HP Response Center, or locally from over 45 offices with trained HP Systems Engineers. In addition, HP qualifies, trains, and supports a worldwide network of Value-added Suppliers. These suppliers provide fast, local, competitively-priced fixturing and programming services.



- In-circuit test systems
- Combinational test systems

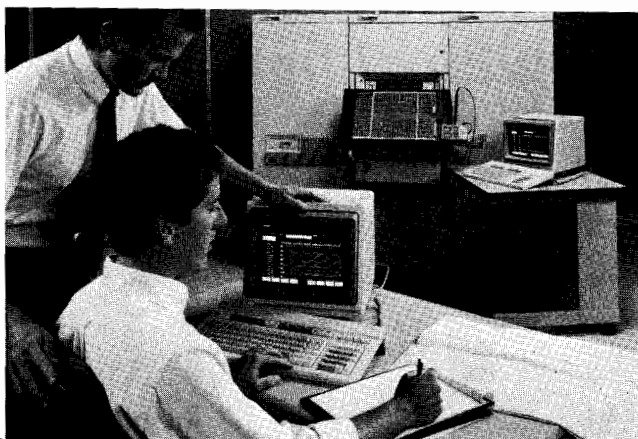

HP 3065 Board Test Family

Hewlett-Packard offers a complete range of affordable, proven board test products for the electronics manufacturing industry. Building on many years of experience in automatic testing and advanced computer technology, the HP 3065 family provides high-speed digital testing, industry-standard analog in-circuit testing, and analog functional testing. Adding the HP Advanced Technologies hardware and software modules to the L- and X-series testers provides high-speed combinational testing capabilities.

A distributed intelligence architecture and a true multitasking environment allow a single HP 3065CX controller to support multiple test stations, multiple programming and repair stations, and a variety of peripherals without sacrificing high throughput in production test. The HP 3065 family consists of two controllers (HP 3065CL/CX PLUS), two test stations (HP 3065HL/HX), the HP 3065ST Standard Technologies tester, the HP 3065AT Advanced Technologies combinational tester, and the HP 3065CT Communications Technologies board test system. The wide selection and varied capabilities of the HP 3065 family allow you to configure a test system to meet the challenge of solving your most complex testing problems... in the challenging environment of worldwide competition and rapidly changing technologies.

New Technologies

Remaining competitive and profitable in today's worldwide marketplace is a problem faced by all electronics manufacturers. To meet these pressures, manufacturers are turning to new technologies and manufacturing processes that promise shorter product development times and increased product flexibility.

The most rapid technological growth is taking place in the use of advanced device technologies, including SMDs, ASICs, and VLSI, in the manufacture of PC boards. These devices place stringent demands on the test system, usually requiring integrated in-circuit and functional (combinational) test capabilities. Surface mount technology is used to increase device density on PC boards, often placing components on both sides of the boards. In the telecommunications industry, the use of Integrated Services Digital Networks (ISDN) is causing a revolution in the design and testing of new products.

As an innovator in the design and use of these advanced technologies, Hewlett-Packard is a leader in the manufacture of design and test systems such as the HP 3065 family to address these problems.

Telecommunications Testing

The telecommunications industry is faced with increased worldwide competition, making product cost and test efficiency major issues. Test managers must reexamine their existing test strategies because existing products and the new ISDN technologies will both be produced and must be tested within the same workcell. The HP 3065CT Communications Technologies test system was designed to solve this problem.

The HP 3065CT is a completely integrated, single-stage test system for the telecommunications industry. It is based on the HP 3065AT combinational tester and the telecommunications software. Additional test instrumentation, new software, and integrated library elements allow the HP 3065CT to perform CCITT specification tests on telecom products. Specification testing on the HP 3065CT requires much less time since production-induced faults are detected with its digital, analog, and combinational test capabilities prior to the CCITT tests.

Digital Testing of Advanced Devices

Advanced technologies, such as surface mount devices (SMDs), application-specific integrated circuits (ASICs), and VLSI circuits, allow the manufacturer to place greater capabilities into smaller geometries. This poses problems, not only in testing the advanced circuitry, but also in accessing the test nodes on the PC board. HP has the test systems, fixturing and applications software to solve these problems.

Fast, repeatable digital testing is required to accurately test these advanced devices. HP's digital test capabilities are on a par with its proven analog testing. Microprocessor bus emulation, clock synchronization, and automatic backtrace capabilities make testing the most complex VLSI circuitry a simple task. ASICs require the ability to access data from CAE/CAD systems for accurate test development. The HP 3065 Pattern Capture Format software provides access to over twenty leading design systems and has an open interface to proprietary in-house systems. In addition, HP's Safeguard In-circuit software analyzes every digital test to minimize the potential for device damage.

HP Q-STAR Network

The HP Q-STAR Test Network offers the basis for implementing SQC in the manufacturing process while providing the optimum solution for your test workcell needs. It provides the HP 3065 user with the tools to implement quality management techniques, paperless repair across the network, and test program management at minimal incremental cost.

Protect Your Investment

The modularity and flexibility of the HP 3065 family of test systems allow the user to keep pace with today's rapidly changing technologies. System compatibility, from the low-cost HP 3065ST to the HP 3065AT combinational tester, ensure that programs and fixtures developed on one system are easily transported to others within the family. Therefore training, test programs, and fixtures are not abandoned when the need for additional capacity arises.

Hewlett-Packard has over 115 board test service offices worldwide, so we are there wherever you are. HP Application Engineering Organization (AEO) and Project Centers can offer complete solutions to your application, hardware, and software support needs anywhere in the world.

HP 3065 Board Test Family

For more information on the HP 3065 board test family, call your local Hewlett-Packard Sales and Service office.

Prices start at \$95,000

BOARD TEST SYSTEMS

HP 3070 Board Test Family

- Combinational testers
- Surface mount technology testers



HP 3070 AT-Series

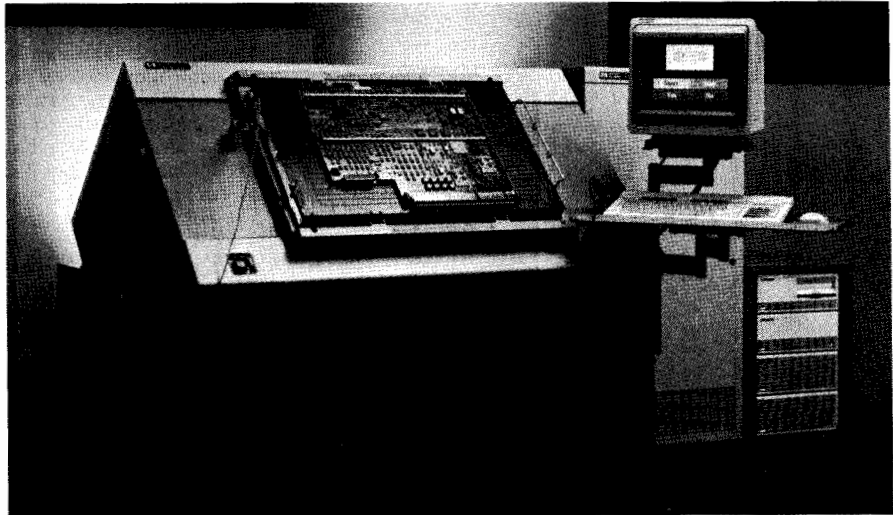

Description

The HP 3070 board test systems combine high-performance functional and in-circuit test capabilities to solve the most complex test problems faced by the electronics manufacturing industry. All HP 3070 systems provide a completely integrated set of powerful resources for testing digital, analog, and mixed-signal circuits, from surface-mounted, application-specific integrated circuits to state-of-the-art microprocessors. With the latest computational and measurement technologies, the HP 3070 family has the flexibility to effectively test the new technologies you face today . . . and tomorrow.

The new family of test systems consists of the HP 3070 AT-Series combinational testers and the HP 3070 SMT-Series testers, which combine the power of the HP 3070 AT-Series test systems with integral mechanical fixtures that meet the needs of automation and surface-mount technology testing.

Flexible Architecture

The HP 3070 system architecture is designed to solve test problems into the 21st century. The testhead uses a parallel architecture that supports up to four expansion modules. Each module has its own analog and digital control systems and provides up to 648 test nodes. For large node count boards, the modules operate synchronously, providing up to 2,592 total nodes for the HP 3070 AT-Series, 1,296 for the HP SMT-Series.

HP HybridPlus pin electronics in each module provide independently programmable control of tester resources on a pin-by-pin basis. Each pin can be used for functional or in-circuit, digital or analog testing. In addition, each pin provides 20 MHz clock signals and access to functional test instrumentation. Drive and receive levels, slew rates, edge placement, pull up/pull down loads, and shorts/opens thresholds are also independently programmable on each pin. In-circuit and functional tests can be applied at 12.5 million patterns per second with typical edge-placement accuracy of ± 5 ns.

Analog Testing

HP analog testing capabilities are the standard in the electronics industry. These field-proven analog testing techniques, such as the automatic generation of 2, 3, 4, and 6-wire guarded in-circuit tests, built-in sources and detectors, and standard HP-IB (IEEE 488) interface for additional analog functional test instrumentation, are retained in the HP 3070 system. Synchronization of the analog and digital subsystems is added for coordinated mixed-signal testing. In addition, the program generator has been greatly improved through advanced analog simulation techniques to nearly eliminate the need for analog debug.

Digital Testing

To meet the challenges of testing ASIC, SMT, and VLSI circuitry, test systems must provide better test development tools and improved testing techniques. The HP 3070 family offers unsurpassed digital test capabilities for these new technologies.

Vector Processing Unit

Hewlett-Packard pioneered the vector processing unit (VPU) concept in the HP 3065 family, and it has been continually improved since that time. The VPU used for digital testing in the HP 3070 family makes obsolete the conventional RAM-behind-the-pins that is used in most other test systems today.

Using the conventional RAM method for pattern application to the DUT, each vector can be used only once before the RAM must be reloaded. Because today's devices require hundreds of thousands of test patterns, the RAM must be reloaded many times. This requires the tests to be segmented and the devices to be re-initialized each time, with dead cycles during reload.

The HP 3070 patented VPU architecture solves this reload problem. It uses a combination of software and hardware for the automatic compression, distributed storage, and application of very deep vector sequences. The theoretical limit to the pattern depth is approximately 535 million vectors before a reload is required.

Digital Test Capabilities

Because they use the VPU, HP 3070 systems can reconstruct long test sequences of millions of test vectors. These vectors can be applied at up to 12.5 million patterns per second with typical edge placement accuracy of ± 5 ns. Over 8000 programmable timing sets are available, and each one can be switched at any time.

Up to 576 independently programmable digital resources are available on the system, consisting of 288 drive channels and 288 receive channels. Synchronization to external clocks of up to 40 MHz is provided via special clock pins. The standard HP HybridPlus pins provide 20 MHz capability.

Integrated Program Generator

The HP Integrated Program Generator (HP IPG), combined with a standard digital library of over 5500 TTL, CMOS, ECL, SMT, ACT, and VLSI devices, automatically generates the digital test program. Typically, over 90% of the generated tests work the first time without debug. HP IPG also provides analog and digital subsystem synchronization for coordinated mixed-signal testing by automatically generating shorts and open tests, and guarded 6-wire analog tests.

HP Safeguard In-circuit Analysis

Every test generated by the HP 3070 system is analyzed by the HP Safeguard In-circuit Analysis software to minimize the potential for device damage in backdriving testing environments. As each test is created, the software analyzes device parameters such as package type, power dissipation, voltage overshoot, and overdrive currents. If unsafe backdrive conditions are detected, the programmer is notified. In addition, adequate cooldown times are automatically imposed for devices that are being overdriven repeatedly within the test. This is especially important when testing boards with large ASIC and VLSI devices that require many thousands of test vectors.

Test Development

Test development is one of the most time-consuming activities in the manufacturing process. The HP 3070 test system provides the software tools needed to shorten your product development cycle.

HP IPG Test Consultant

The HP IPG Test Consultant manages the test development on the HP 3070 test system. It is a color, menu-driven, mouse-supported, easy-to-use interface that guides the programmer through the test development cycle. Based on recognition, not recollection, HP IPG Test Consultant relieves programmers of the burden of remembering the next step. Actions are selected from available pull-down menus, and online help is available when needed. Programmers can choose levels of automation or flexibility, depending on their expertise with the HP 3070 system.

At the same time, HP IPG Test Consultant relieves programmers of time-consuming tasks such as file management, revision archiving, and program scheduling. This allows them to focus on improving tests for their boards, not trying to remember what comes next.

Board Topology Entry

The test development cycle begins by describing the board to the test system. Significant savings in time can be realized if mechanical information about the board (X-Y and connectivity data) can be retrieved from CAD systems. The HP 3070 system comes standard with a CAD format translator (CFT). CFT uses templates to structure the data in a format usable by the HP 3070 tester. It has templates for most commercial CAD systems and can be adapted for proprietary systems.

The board forms editor on the HP 3070 system can be used to enrich the captured CAD data or to enter board descriptions manually. Board forms is a menu-driven editor for entering connectivity and parts information by filling in the blanks of pre-constructed forms.

HP 3070 systems capture, compare, and evaluate data created by any simulator and use that information in generating ASIC, cluster, and edge-connector tests. Simulated test patterns and timing information are transferred to the system via the HP Pattern Capture Format for custom test generation.

After the board topology is loaded in the HP 3070 system, the HP Integrated Program Generator develops the test programs. Both in-circuit and functional tests are written in the same high-level languages, such as HP BT-BASIC and Vector Control Language (VCL).

Fixture Development

HP Express Fixture Software automatically designs fixturing for the board to be tested. In addition to minimizing wire lengths, the software minimizes close-centered probes and selects probing locations to reduce areas of high probe density. Each fixture is documented with clear, concise instructions for fixture construction, resulting in higher fixture quality and reduced costs.

During fixture design, the software creates information files to support automated drilling, wiring, and receptacle installation, saving both time and money. After the fixture is completed, the HP fixture verification software is used to ensure it was properly assembled.

Color Graphical Debug

Once the program is generated by HP IPG, typically 90% of the tests work the first time. For those that do not work, HP Color Graphical Debug displays both digital and analog tests using histograms and logic analyzer-type screens. It is softkey-driven for ease of use.

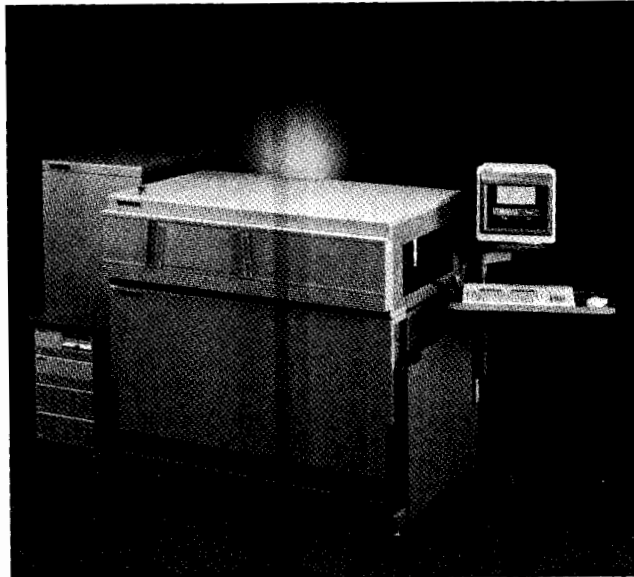

HP 3070 SMT-Series

The software provides interactive control of both digital and analog test parameters including edge placement, slew rates, guard points, drive/receive levels, sources/detectors, and more. Failing responses are highlighted in color. Probing for the debug process can be done through the fixture or via a handheld probe.

Production Testing

After a test is released to production, the HP Pushbutton Q-STATS quality management software assists in detecting production process problems. The software uses SQC techniques on actual test data to generate color graphical displays of histograms, production reports, and failure reports, at the touch of a button.

As the need for SQC analysis grows, the HP 3070 family can be integrated into the HP Q-STAR Network, providing access to HP PR PLUS paperless repair management software and HP Q-STATS II advanced quality management software.

Protect Your Investment

The HP 3070 family offers the flexibility and modularity to grow as your needs grow. It is supported by software, digital/analog combination testing, fixturing solutions, and reliability/support.

The HP 3070 family exceeds the board test industry reliability standards previously held by the HP 3065 test system. The HP 3070 design, using SMT and HP integrated circuits, proves an MTBF of over 2300 hours. The new technologies reduce the number of electronic and mechanical parts required, ensuring unsurpassed system reliability.

When the HP 3070 system fails, its board-level repair strategy simplifies diagnostics and repair. Average mean-time-to-repair (MTTR) is less than two hours.

Hewlett-Packard has over 115 board test service offices, and along with the HP Application Engineering Organization (AEO) and Project Centers, can provide complete solutions to your application, hardware, and software needs throughout the world.

HP 3070 Board Test Family

For more information on the HP 3070 board test family, contact your local Hewlett-Packard Sales and Service office.

Ordering Information

Prices depend on system configuration.

HP 3070 AT-Series prices start at	\$297,100
HP 3070 SMT-Series prices start at	\$332,200

BOARD TEST SYSTEMS

Testing Surface Mount Technology Boards

HP 3070 SMT-Series

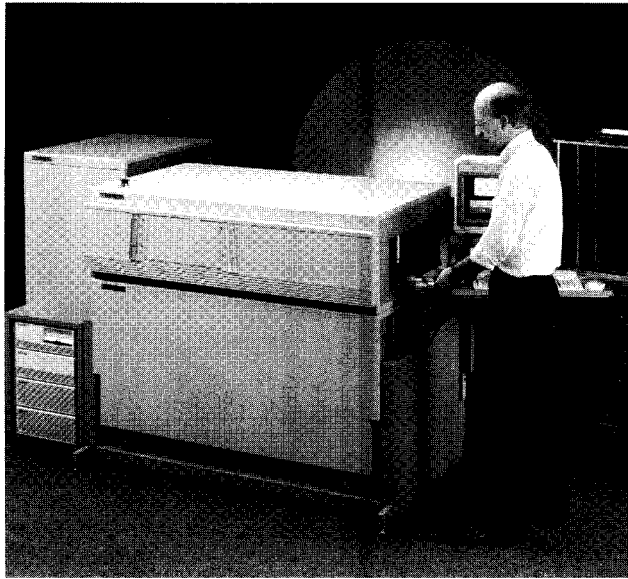

In the last five years, there have been rapid technological advances in the electronics industry. Device technologies like application-specific integrated circuits (ASICs) and VLSI circuitry, which were rarely used five years ago, now appear in the design of almost every PC board. However, the greatest impact on the electronics manufacturing industry has been the exponential growth of surface mount technology (SMT). SMT, ASICs and VLSI offer greater capabilities and flexibility in much smaller packages. Although they have cost and capability advantages, these new technologies also introduced a unique set of process and test related problems that your board test system must solve.

Using SMT in the design of PC assemblies allows higher device densities but results in reduced test pad target size, limited access to test nodes, and dual-sided component placement. Testing these densely packed circuits requires a board test system that has advanced SMT fixturing and test development tools. That system is the HP 3070 SMT-Series tester.

Testing SMT PC Boards

The primary problems in testing SMT boards are the shortage of reliable probing points access for detailed diagnostics and the high component densities that reduce the size of the test pad to be probed. In an attempt to reduce board geometries even further, manufacturers are placing components on both sides of the PC assembly. This poses problems for both the test system and the design of the test fixturing.

Testing PC boards with limited access requires a combinational test system with the capability for both in-circuit and cluster functional testing for sections of the board where probe access is impossible. Automatic backtracing for accurate fault isolation within the cluster is also required. To lower the cost of cluster testing, the HP 3070 SMT-Series has an integrated program generator, library-generated backtrace trees, and HP Color Graphical Debug.

SMT Fixturing

Surface mount technology has had a major impact on test fixture design. The conventional two-plate vacuum fixture design was adequate for through-hole technology that provided large test pads and single-sided access of every test node. Component densities, reduced access, dual-sided boards, and smaller probing targets have changed the probing process.

Close-center probing is frequently required on SMT boards, making smaller probes a necessity. Smaller probes are more difficult to use because they are more flexible and tend to add to the probing errors of conventional fixturing. In addition, there are few acceptable methods

for connecting more than one wire to the .050" probe. On boards where probes are densely packed, it is sometimes necessary to counteract probe spring tension mechanically because vacuum fixtures cause warping that can introduce failures. The HP SimPlate Series of test fixtures, with their single-plate design, solve the problems of close-center probing with a 10:1 reduction in probing errors.

Dual-sided probing is needed when circuit density and component placement make single-side access to test nodes impossible. It requires extremely accurate positioning of the two probe plates relative to each other and to the PC board. Longer wires are needed to connect the upper plate to the system interface, affecting signal quality.

To improve signal quality, it is sometimes necessary to use dual-stage probing. This technique easily removes the in-circuit probe loading from the PC board during functional testing on critical nodes. In the past, special probing requirements meant costly, complex fixturing. Hewlett-Packard's automatic fixture generation software and vacuum-actuated and mechanical fixtures provide specialized probing capabilities at affordable prices.

SMT Testing Solutions

As a major user of SMT, Hewlett-Packard understands the unique demands of testing circuit boards designed with surface mount devices. Each year, Hewlett-Packard designs approximately 150 new products using SMT, requiring placement of over 450 million surface-mount devices yearly on PC boards. The HP 3070 SMT-Series Board Test System combines Hewlett-Packard's expertise in SMT with an extensive background in measurement and computation to provide solutions for SMT test problems.

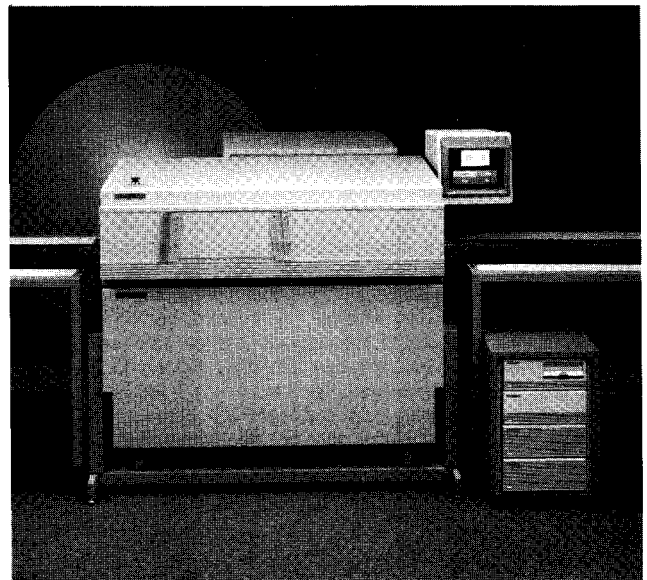

The HP SMT-Series testers provide true combinational test capabilities for testing surface mount devices with an integral mechanical fixturing system to solve the most complex fixturing problems. The HP Integrated Program Generator (HP IPG) automatically develops analog and digital tests, including cluster testing. The HP Express Fixture Software automates the design and construction on the HP SimPlate Express fixtures and HP Express Cassettes for the mechanical fixturing system. The software automatically minimizes top-side probing, fixture wire lengths, and close-center probing.

The HP Express Fixturing System offers unprecedented mechanical accuracy and reliability required for close-center, dual-sided, and dual-stage probing. With its automatic board handling capabilities, the system easily integrates into an automated SMT or other high volume production line.

BOARD TEST SYSTEMS

Test Fixture Products

HP 3065, 3070 Family

553

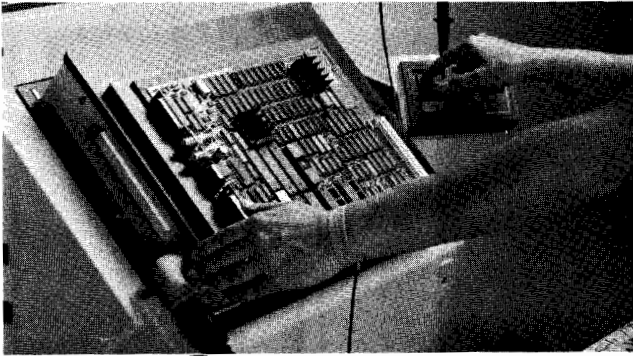

Test Fixtures

The HP 44203 series of vacuum-actuated test fixtures were introduced in 1986. With only a base plate and a removable support plate, the HP 44203 fixtures offered higher probing accuracy, greater reliability, and easier maintenance than the conventional dual-plate design. The elimination of the top plate and associated hardware reduced the part count of a standard test fixture by 35% and reduced the weight by 23%.

The new HP SimPlate 3070 (HP 44202 series) and HP SimPlate Express (HP 44200 series) test fixtures are based on the HP SimPlate design. Solutions for automation and SMT single- and dual-sided access are provided by the mechanical HP Express Fixturing System (HP 44990A) and its HP Express Cassette fixture.

HP SimPlate Series

The HP 44203S/D/L fixture kits are designed for the HP 306X board test systems. The single-plate design allows the probes and tooling pins to be mounted on the same plane, resulting in a ten-fold improvement in probing accuracy and repeatability, making these fixtures an excellent choice for testing both conventional and surface-mount technologies. The removable support plate provides immediate probe access without tools for routine maintenance. Testing can continue during maintenance of PC board gaskets and vacuum seals.

HP SimPlate 3070 Series

The HP 44202S/L fixtures bring the proven technology of the single-plate design to the HP 3070 family of board testers. Other features include space for custom fixture electronics, friction hinges to hold lid open during maintenance, and easy upgrade from the HP 3065 to the HP 3070 interface.

HP SimPlate Express Series

The HP 44200S/L fixtures retain the HP SimPlate top plate interface to the PC board under test. The new design supports automatic fixture wiring, lowering the cost while improving the quality of the fixture. Locating grids allow for easy fixture assembly and debug. Average wire lengths of 75 mm (3") and wire lengths of 25 mm (1") for critical nodes provide the high signal quality necessary to test today's advanced high-speed devices.

HP Express Fixturing System

The HP 44990A Express Fixturing System provides the exceptional mechanical accuracy and reliability needed for close-center, dual-sided probing for SMT boards. Board flatness is controlled by push rods that oppose areas of high probe density, ensuring accurate probe positioning and contact. Programmable dual-stage probing heights make it easy to remove in-circuit probe loading from the PC board during functional testing of critical circuits.

The system is designed for flexible operation to meet the varying demands of production testing. It can be operated manually in a pass-back mode, partially automated, or fully automated in an in-line mode. Automatic board handling requires only six seconds, twelve seconds in the pass-back mode. The HP Express Fixturing System's light curtains and safety sensors protect the operator from injury and the PC board from accidental damage. Electrostatic charge buildup is reduced because mechanical fixturing eliminates air flow across the

board, and automatic loading and unloading minimizes board handling by the operators. The HP 44990A is included with the HP 3070 SMT-Series board test systems. Changing board types on the fixturing system requires only 30 seconds using the HP Express Cassette.

HP Express Cassettes

The rugged design of the HP 44201S Express Cassette fixture makes it ideal for high-volume applications, and its one-piece design makes it easy to handle and store. Even when the cassette is out of the HP 44990A, the test probes and wiring are fully protected. The cassette can be easily converted to a vacuum-actuated test fixture.

HP Express Fixture Software

Automatic fixture generation with the HP Express Fixture Software saves time and money in the design and construction of single- and dual-sided test fixtures. The HP Express Fixture Software is a standard part of the HP 3070 Board Test System. The software automatically minimizes fixture wire lengths; selects optimum probe locations; minimizes close-center probe usage; generates to-from wiring guides; positions the board on the fixture; creates files for use in automatic fixture construction; and designs and documents fixture changes to comply with engineering changes to the PC board. For dual-sided fixtures, the software automatically minimizes top-side probing and assigns transfer pins.

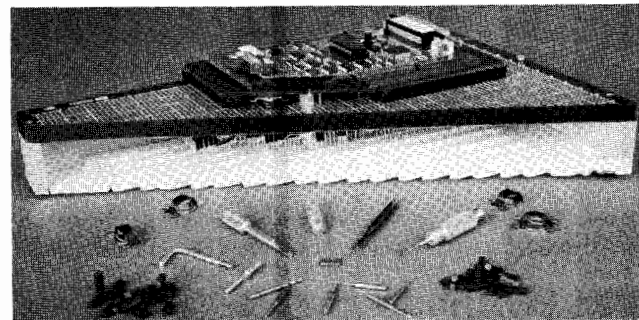

Accessories

A full line of accessories for fixtures is available from Hewlett-Packard. For same-day shipment of the products listed below, call HP Direct at 800-538-8787 or call your local HP sales office.

Ordering Information

	Price
HP 44200S Standard HP SimPlate Express Fixture Kit	\$675 ☎
HP 44200L Large HP SimPlate Express Fixture Kit	\$1,025 ☎
HP 44201S Standard HP Express Cassette	\$705 ☎
HP 44201T Transfer Pin Kit, 20 pins per bag	\$103 ☎
HP 44202S Standard HP SimPlate 3070 Fixture Kit	\$695 ☎
HP 44202L Large HP SimPlate 3070 Fixture Kit	\$1,065 ☎
HP 44202P Interface Pin Blocks	\$65 ☎
HP 44203S HP SimPlate Standard Fixture Kit	\$654 ☎
HP 44203D HP SimPlate Dual-well Fixture Kit	\$963 ☎
HP 44203L HP SimPlate Large Fixture Kit	\$870 ☎
HP 44265B Dual-stage Single Point Probes, 10 per bag	\$36 ☎
HP 44266B Dual-stage Star Point Probes, 10 per bag	\$36 ☎
HP 44274B Dual-stage Receptacles, 10 per bag	\$21 ☎
HP 44274S HP SimPlate Receptacles, 100 per bag	\$37 ☎
HP 44275P Personality Pins, 100 per bag	\$45 ☎
HP 44561L/H Low or High Force Single Point Probe, 100 per bag	\$104 ☎
HP 44562L/H LF or HF Serrated Point Probe, 100 per bag	\$104 ☎
HP 44563L/H LF or HF Star Point Probe, 100 per bag	\$104 ☎
HP 44564L/H LF or HF Spear Point Probe, 100 per bag	\$166 ☎
HP 44265F Spear Point Probes-50 mil, 50 per bag	TBA ☎
HP 44265C Chisel Point Probes-50 mil, 50 per bag	TBA ☎
HP 44266F Star Point Probes-50 mil, 50 per bag	TBA ☎
HP 44274F Receptacle-50 mil, 50 per bag	\$57 ☎
HP 44990A HP Express Fixturing System	\$46,350
☎ Fast-Ship product — see page 734.	

CONTROLLERS

HP 9000 Family Measurement Automation Controllers and Systems General Information



Breadth and flexibility make HP instrument controllers more capable than any other solution available for a broad range of measurement automation needs. HP has more than 16 years of experience in building instrument controllers, more than 1,500 HP instruments, and HP-IB, the industry-standard instrument control interface.

Instrument Controllers

Hewlett-Packard has for many years been a leading supplier of instrument control solutions for data acquisition and electronic test.

In the early 1970's, Hewlett-Packard developed the HP-IB interface, also known as IEEE-488 or GP-IB, to provide an industry-standard bus for instruments and peripherals. Since then, HP-IB has become the standard for communications with instruments in the test and measurement community. With over sixteen years of experience in providing instrument controllers, Hewlett-Packard has optimized these systems to work with over 1500 HP instruments and peripherals through HP-IB.

Hewlett-Packard is also incorporating emerging standards into instrument controllers. Hewlett-Packard has been instrumental in driving the VXI bus standard for development of instruments-on-a-card (see page 597). This standard addresses the need to down-size test systems while providing the performance and flexibility required for advanced test systems. A new member of the HP instrument control family answers the need for a high-performance instrument controller in the VXI mainframe.

Hewlett-Packard is extending the usability of the HP-IB bus by driving the definition of the IEEE-488.2 standard. The Test and Measurement Systems Language (TMSL), which fully supports this IEEE-488.2 standard, is incorporated into a variety of HP instruments. TMSL is a set of generic

commands that are not tied to particular instrument types. For example, any type of instrument that measures frequency can respond to a common command. The primary contribution of TMSL is to provide a hardware upgrade path that does not require reinvesting in software changes.

HP instrument controllers, instruments, and software make it easy to build custom test systems for unattended testing in R&D environments, or for manufacturing test and quality control applications outside R&D. Software packages such as the Interactive Test Generator (see page 616), Functional Test Manager (see page 620), DACQ/300 and DACQ/PC (see page 618) take full advantage of HP instrument controller features to aid in the development and execution of computer-aided test and data acquisition applications.

A Wide Range of Controllers

Hewlett-Packard offers the widest range of instrument controllers in the industry. Each controller system is optimized to meet the needs of test and measurement customers.

Controller solutions are available for price-sensitive users and for applications requiring the highest performance. You have the choice of operating system, computer hardware platform, and form factor that best meets your test system requirements.

Hewlett-Packard offers instrument controllers based on MS-DOS and HP-UX, two

industry-standard operating systems, in addition to HP BASIC, the world's most powerful instrument control environment.

DOS-Based Controllers

For low-cost instrument control, Hewlett-Packard offers controller solutions that provide the advantages of native DOS within its family of instrument controllers. The HP Vectra Personal Computer (see page 653) provides PC compatibility and more for developing test and measurement applications in the DOS environment. A variety of HP Vectra Personal Computers are available in all price and performance ranges to fit your requirements.

The HP-IB interface and command library provides personal computers like the HP Vectra with the ability to perform sophisticated instrument control. Support of a variety of standard MS-DOS programming languages is available from the HP-IB command library (see page 561).

HP-UX Based Controllers

High-performance UNIX workstations are quickly becoming the standard platform for Computer-Aided Design and other engineering applications. Hewlett-Packard's HP-UX is a complete UNIX System V implementation with selected enhancements to provide features necessary for the test and measurement environment. A number of programming languages are available for the development of instrument control applications. Powerful networking and database tools are readily available within HP-UX.

HP 9000 Family Measurement Automation Controllers and Systems (cont'd)

One enhancement made to HP-UX for instrument control applications is the Device I/O library or DIL. This library gives HP-UX systems the capability of providing very high performance instrument control. Direct support of DMA hardware and burst mode I/O is available from DIL. Interrupt response time is minimized in a number of ways. Real-time extensions allow users to specify which programs must run with special priority.

HP BASIC Controllers

Hewlett-Packard instrument controllers used with the HP BASIC language offer a highly productive environment for development and execution of test and measurement applications.

The HP BASIC programming environment is unsurpassed in ease of use and user friendliness. You do not have to be an expert programmer to quickly develop sophisticated instrument control applications. As you type in code, an advanced program editor checks it for syntax errors. You do not have to wait until a program executes to realize that you made a typing error. Advanced commands for moving and copying program lines are fully integrated into HP BASIC, along with other features useful in producing very readable, self-documenting programs. Automatic program indentation, string search and replacement, and automatic renumbering of program lines are standard with HP BASIC.

HP BASIC Controllers provide ready access to the most advanced device I/O system. Full interrupt processing is supported with fifteen levels of user-definable software priorities. Data transfer of various data types is also fully supported. Data formatting is handled automatically for REAL, INTEGER, STRING, and COMPLEX data and for arrays of these data types.

In addition to supporting multiple data types, the HP BASIC I/O system can determine the optimal data transfer method based on system configuration. For example, data transfer automatically takes full advantage of Direct Memory Access if DMA hardware is present in the system; no programming changes are required to take advantage of DMA.

Support of separate context subprograms within HP BASIC allows you to develop modular, reusable program segments to be loaded or unloaded during program execution. This increases productivity because modules are easily reused or replaced with new ones for future controller applications.

HP BASIC provides the capability of using compiled subprograms, or CSUBs, developed with standard language compilers. These CSUBs provide increased performance of many applications while still operating within HP BASIC. An HP BASIC compiler is also available to increase performance of HP BASIC programs without having to develop non-BASIC code.

HP BASIC is available on three platforms: HP BASIC/DOS for operation in the DOS environment on personal computers, HP BASIC/UX for use with powerful HP-UX based workstations, and HP BASIC/WS for high performance operation as a dedicated instrument controller.

HP 9000 Series 300 Controllers

The HP BASIC/WS and HP BASIC/UX systems are based on the HP 9000 Series 300 controller systems. The HP BASIC/WS system incorporates its own operating system with the HP BASIC environment and is highly optimized to provide the best performance platform. The HP BASIC/UX systems are based on the standard HP-UX operating system on the same series 300 hardware platform and provide the additional benefits associated with multi-tasking/multi-user operating systems, including an X windows-based environment and access to HP-UX tools and applications.

The HP 9000 Series 300 instrument controllers are available in a variety of configurations with a wide range of performance. The latest offerings take full advantage of Motorola MC68030 microprocessors. Both HP BASIC/WS and HP-UX operating systems are supported for use with series 300 controller systems, and HP BASIC/UX can be added to series 300 HP-UX systems to provide the best of the HP-UX and HP BASIC worlds.

The model 340 is the lowest cost series 300. It provides good performance in a restricted configuration. It comes standard with 4 MByte RAM, HP-IB, HP-HIL, LAN and RS-232 interfaces and a Motorola MC68882 math coprocessor. One additional DIO I/O slot is available for the addition of SCSI, Fast Disk or other series 300 I/O card. RAM can be expanded to a total of 16 MByte, but no additional I/O slots can be added to the system.

The model 332 controller provides the same performance as the model 340, while offering the ability to add a variety of series 300 interface cards. The model 332 comes standard with 1 or 4 MByte RAM and can be expanded to 8 MByte. This controller also comes standard with HP-IB, HP-HIL, RS-232, and either medium- or high-resolution monochrome display. Two DIO I/O slot pairs are available for additional interfaces such as LAN, SCSI or fast disk interfaces and one optional expander (4 DIO I/O slot pairs can be added to increase I/O capability). The optional Motorola MC68882 math coprocessor increases floating point math, and it is required for HP-UX or HP BASIC/UX operation.

The model 332 is also available in a standard EIA 19" rack-mountable configuration. The series 300 model R/332 provides the

same performance as the modular model 332 system and offers configurations including up to 40 MByte hard disk and floppy drives in a compact rack-mountable package. The model R/332 uses the same processor board as the modular 332 above, except that 4 DIO I/O slot pairs are available. The model R/332 has a medium-resolution monochrome display system and a keyboard.

The model 360 and model 370 are also expandable configurations. Both systems include LAN, HP-IB, HP-HIL, RS-232, MC68882 math coprocessor and optional Fast Disk or SCSI interfaces. The model 360 comes standard with a 25 MHz Motorola MC68030 processor and 4 MByte RAM and can be expanded to a total of 16 MByte. The model 370 comes standard with 33 MHz Motorola MC68030 processor and 8 MByte parity checking. RAM can be expanded to a total of 48 MByte if error-correcting RAM is used (32 MByte total if parity-checking RAM is used). Both the model 360 and model 370 provide the computational power for test and measurement applications requiring the highest performance.

An additional series 300 controller is the V/360 embedded VXI controller (see page 601). This controller system provides the same performance as the model 360, but it is packaged to fit in the series C VXI mainframe. The V/360 controller includes the same HP-IB, HP-HIL, RS-232, LAN and either SCSI or fast disk interface as the modular model 360 above, but no additional DIO I/O cards may be added. As with the modular 360 controller, the model V/360 comes standard with 4 Mbyte RAM and may be expanded to 16 Mbyte. This controller provides direct access to VXI bus structures and provides slot 0 functionality while only occupying 4 C-sized VXI Slots.

PC-300 Controllers

HP BASIC/DOS controllers are based upon a unique combination of the HP Vectra MS-DOS personal computer and HP BASIC Language Processor. This combination offers the HP BASIC user a DOS-based platform at an affordable price.

Hewlett-Packard offers a variety of PC-300 instrument controllers based on a range of HP Vectra MS-DOS personal computers. At the heart of each PC-300 is the HP BASIC Language Processor - Release II. The language processor includes built-in HP-IB, 1 Mbyte RAM (expandable to 4 Mbyte), and software and utilities to run HP BASIC with MS-DOS. Optional DIO I/O cards GPIO (82306A) and Shared Resource Manager (50963A) are available.

The chart on the following page illustrates the general features of each Hewlett-Packard instrument controller.

CONTROLLERS

HP 9000 Family Measurement Automation Controllers and Systems Bundled Systems

Controller Comparison

	HP PC-300 Controllers			HP 9000 Series 300 Controllers					
	ES PC-308	QS PC-312	RS PC-315	340	332	R/332	360	V/360	370
OPERATING SYSTEM									
MS-DOS	•	•	•						
HP BASIC/WS				•	•	•	•	•	•
HP-UX				•	•	•	•	•	•
HP BASIC SUPPORT									
HP BASIC/DOS	•	•	•						
HP BASIC/WS				•	•	•	•	•	•
HP BASIC/UX				•	•	•	•	•	•
PROCESSOR									
Main Processor	80286	80386	80386	68030	68030	68030	68030	68030	68030
Clock Speed (MHz)	12	16/20	25	16.6	16.7	16.7	25	25	33
Math Coprocessor	80287	80387	80387	68882	68882†	68882†	68882	68882	68882
Clock Speed (MHz)	12	16/20	25	16.7	16.7	16.7	25	25	33
HP BASIC Coprocessor	68000	68000	68000						
Clock Speed (MHz)	8	8	8						
MEMORY CAPACITY									
PC Memory (std)	640 Kbyte	1 Mbyte	1 Mbyte						
PC Memory (max)	8 Mbyte	16 Mbyte	16 Mbyte						
680X0 Memory (std)	1 Mbyte*	1 Mbyte*	1 Mbyte*	4 Mbyte	1 Mbyte	1 Mbyte	4 Mbyte	4 Mbyte	8 Mbyte
680X0 Memory (max)	4 Mbyte	4 Mbyte	4 Mbyte	16 Mbyte	8 Mbyte	8 Mbyte	16 Mbyte	16 Mbyte	32 Mbyte°
DISPLAY SYSTEMS‡									
640x480 VGA	M/C	M/C	M/C						
512x400				M/C	M/C	M	M/C	M/C	M/C
1024x768				M/C	M/C		M/C	M/C	M/C
1280x768				M/C	M/C		M/C	M/C	M/C
AVAILABLE SLOTS									
PC CARDS (std/max)	7/7	7/7	7/7						
DIO I/O CARDS (std/max)	2/2*	2/2*	2/2*	1/1	2/6	5/5	1/9	0/0	0/8
EXPANDER SUPPORT					•	•	•		•
COMPUTATION									
PC (MIPS)	1.5	3	4						
680X0 (MIPS)	.6	.6	.6	4	4	4	6	6	8

† - MC68882 Math coprocessor available as an option. MC68882 required for HP-UX or HP BASIC/UX operation.

* - Only Supported from HP BASIC Language Processor. Only available for use from HP BASIC/DOS.

° - Maximum of 48 Mbyte RAM if ECC RAM is used.

‡ - Resolution specified is in Pixels. M=Monochrome, C=Color

HP 9000 Family Measurement Automation Controllers and Systems Bundled Systems

Bundled Instrument Control Systems

Several bundled systems are available to simplify ordering of the best instrument controller for your application. All bundled systems listed below are localized for a variety of international uses. For more information, contact your local HP sales office.

Hewlett-Packard offers six PC-300 instrument controllers based on a range of HP Vectra Personal Computers. Each PC-300 bundle includes the HP BASIC Language Processor - Release II, including built-in HP-IB, 1 Mbyte RAM (expandable to 4 Mbyte), 3 1/2 inch floppy disk drive and HP BASIC/DOS software.

PC-300 Instrument Controllers

HP BASIC/DOS	PC-308ML	PC-308CL	PC-308CM	PC-312CL	PC-312CM	PC-315CN
HP part number	82314E	82315E	82319E	82332E	82333E	82334E
Internal hard disk	20Mbyte	20Mbyte	40Mbyte	40Mbyte	40Mbyte	103Mbyte
VGA display type	Mono*	Color	Color	Color	Color	Color
US list price	\$5,895	\$6,395	\$6,795	\$7,595	\$9,195	\$13,295

*The PC-308ML monochrome display options are Amber, Green, and White.

Seven controller bundles are available for HP BASIC/WS operation. These systems provide the highest performance HP BASIC operation with a variety of price and performance choices. All bundles

include medium resolution (512x400) graphics, keyboard and HP BASIC/WS software.

HP BASIC/WS Controllers

HP BASIC/DOS	332 MMA	332 CMA	R/332	R/332	R/332	360 MMA	360 CMA
HP part number	98580C	98581C	A1303A	A1305A	A1307	98580W	98581W
Internal hard disk	none	none	none	20Mbyte	40Mbyte	none	none
Internal floppy disk	none	none	3.5"	3.5"	none	none	none
Touchscreen	§	§	•	•	•	§	§
Display type	Mono	Color	Mono	Mono	Mono	Mono	Color
US list price	\$6,080	\$8,870	\$10,390	\$12,390	\$13,590	\$14,400	\$14,900

§ - Available as an Additional Product - HP Part Number 35723A

There are four bundled solutions that offer the best of HP-UX and HP BASIC/UX. These bundles include high resolution graphics, mouse, keyboard, and both HP-UX and HP BASIC/UX software. All HP BASIC/UX bundled systems also offer the option of a 152

Mbyte or 304 Mbyte disk drive with HP-UX and HP BASIC/UX installed and optimized for operation. Bundled prices listed below do not include disk options.

HP-UX, HP BASIC/UX Controllers

HP BASIC/UX	332 MMAX	332 CMAX	360 MMAX	360 CMAX
HP part number	98580CX	98581CX	98580WX	98581WX
Display type	Mono	Color	Mono	Color
Display resolution	1024x768	1024x768	1024x768	1024x768
US list price	\$9,500	\$12,500	\$16,665	\$19,995

‡ - Bundled systems for HP BASIC/WS and HP BASIC/UX have also been developed based upon the V/360. For more information about these bundled systems, please contact your local HP Sales Office.

CONTROLLERS

HP 9000 Instrument Controllers and Systems

HP R/332

- Single compact unit - easily mounted in rack
- Full language and enhancement compatibility
- Reliable in extreme environments

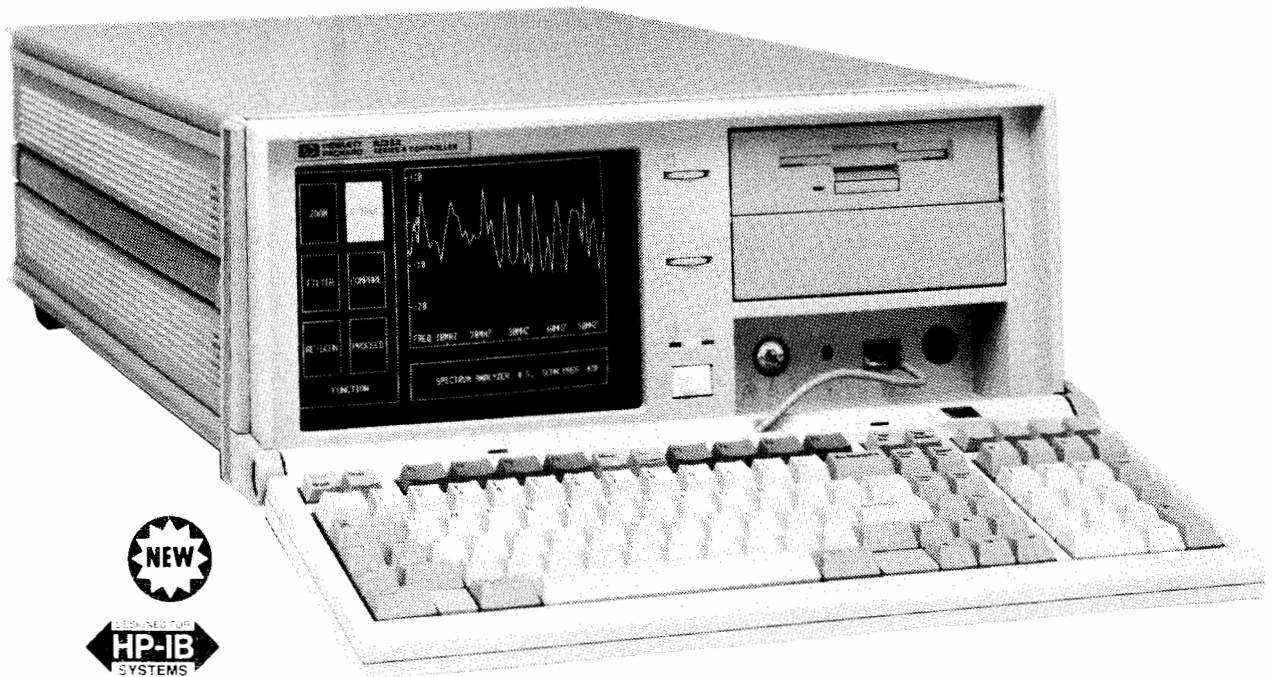

HP R/332

HP R/332 Controller

The R/332 is a compact all-in-one controller designed to tolerate rough handling and meet the toughest requirements. This controller can easily be rack mounted, or used as a benchtop device.

Features

A touch-screen display, keyboard, and disk drives are included within the 7-inch-high R/332. The controller is built inside a strong cast-aluminum frame, and critical components are shock-mounted for maximum reliability. The R/332 is also exceptionally low in electromagnetic transmission and susceptibility because of its double-wall construction throughout.

The R/332 contains the HP 332 CPU board, a single-board computer with the high performance of an MC 68030 CPU, DMA, and cache memory. The optional floating-point processor and memory expansion are also on-board for maximum speed and reliability. Standard interfaces connect to HP-IB (IEEE-488), RS-232-C, and all internal peripherals and user interface devices. Eight internal DIO expansion slots are available for additional interfaces and enhancement accessories.

The hard disk drives are exceptionally rugged. Shock mounting assures failure-free operation beyond the limits of other disk drives. The 3.5-inch flexible disk drive has up to 2 Mbyte of unformatted capacity, and also reads older single- and double-sided formats.

The R/332 display is a 9-inch-diagonal monochrome CRT with 80-column alpha and 512-by-400 graphics resolution. The touch-screen device uses reliable optical technology to locate a finger touch on the display. With the touch menu utilities provided, this input device is easy to access from HP BASIC.

The R/332 includes a keyboard designed for use in a rack. This keyboard swings up to protect the front panel when not in use and can be locked in any of several convenient positions. The keyboard can

also be removed entirely when the touch-screen display or another input device is used.

Designed With Attention to Detail

A 3-position key lock on the R/332 front panel protects the controller from tampering. In the first key position, the power switch and other controls operate as expected. In the second position, power is locked in its present (on or off) state. In the third position, power is locked and the keyboard is disabled; only the touch-screen display is available for user interaction.

Whether installed in a noisy factory or a quiet lab, a front-panel adjustment brings the speaker volume to an appropriate level. The speaker will warn (at full volume) of excessive internal temperature, as will a front-panel indicator light.

Cooling is provided by a high-capacity fan. Positive-pressure air flow allows the use of a washable air filter, or air can be supplied from a central source of clean air.

Meeting Specialized Needs Today and Tomorrow

The R/332 is designed to meet specialized needs without sacrificing compatibility with other HP 9000 Series 300 systems. Programs written for similar HP products can be shared with the R/332, and system software (HP BASIC, HP Pascal or the HP-UX operating system) is identical. The built-in devices (disk drives, display, touch screen, keyboard) are fully equivalent to accessories available for desktop HP 9000 Series 300 systems. And most peripherals and accessories from these systems can be used with the R/332.

The R/332 has eight expansion slots available for enhancements and accessories. A wide selection of standard DIO cards fit into these slots and make the R/332 adaptable to changing needs.

Specifications

CPU: MC 68030 @ 16.7 MHz, MC 68882 optional

Software: HP BASIC 5.13 or later (standard)
HP Pascal 3.22 or later (supported)
HP-UX 6.5 and HP BASIC/UX 5.51 or later (supported)

Built-in interfaces: HP-IB (IEEE-488), RS-232-C, HP-HIL, Video out (normally connected to internal CRT), Audio out (normally connected to internal speaker)

Expansion: 4 DIO slot pairs (8 slots behind 4 panels)
No extra system slots
No DIO-II slots

Size: 189mm x 440mm x 704mmD (7.5" x 17.3" x 27.7") complete with keyboard up
177mm x 425mm x 653mmD (7.0" x 16.7" x 25.7") minimum space within rack

Weight: 20kg (45 lb) typical

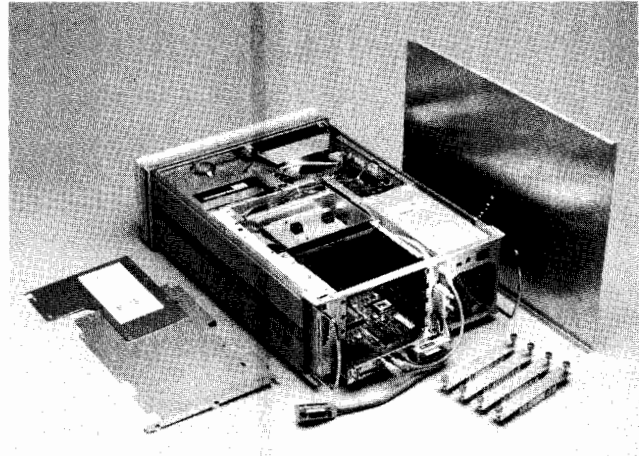

Ordering Information

The R/332 controller always includes the 332 CPU board with at least 1 MByte RAM, standard interfaces, 8 DIO expansion slots, keyboard, and display. The touch-screen input device and HP BASIC are normally included but can be deleted.

	Price
HP A1303A R/332 with single 3.5-inch flexible disk	\$10,390
HP A1305A R/332 with single 3.5-inch flexible disk and 20 MB hard disk	\$12,390
HP A1307A R/332 with single 3.5-inch flexible disk and 40 MB hard disk	\$13,590
Keyboard/language version ABA/ABD/ABF/ABJ/ABK/ABU (1 required)	\$0
Opt 102 Add memory to total 2 MByte	+\$700
Opt 104 Add memory to total 4 MByte	+\$2,500
Opt 105 Add memory to total 5 Mbyte	+\$3,500
Opt 108 Add memory to total 8 MByte	+\$6,500
Opt 882 Add MC 68882 floating-point processor, 16.7 MHz	+\$500
Opt 908 Add A1309A Rack Mount Flange Kit*	+\$50
Opt 001 Delete Touch	-\$400
Opt 100 Delete BASIC reference manuals	-\$90
Opt 613 Delete BASIC entirely	-\$450
* Used in combination with one of:	
HP 1494-0059 Standard Slide Kit	\$100
HP 1494-0063 Standard Tilting Slide Kit	\$190
HP 12679B Stationary Rails for HP rack	\$70

CONTROLLERS

HP 9000 Instrument Controllers and Systems

Entry Level Controllers

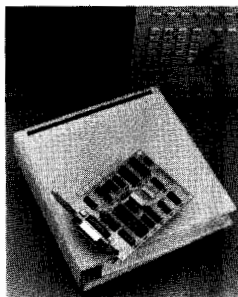

HP 82335A

HP 82335A HP-IB Interface and Command Library For the HP Vectra PC and IBM PC/XT/AT

Compatibles

The HP 82335A HP-IB Interface and Command Library is Hewlett Packard's low-cost PC interface for controlling HP-IB devices with the most popular MS-DOS®-based programming languages. The HP 82335A provides HP-IB interface hardware and command library software for control of HP-IB (IEEE-488) instruments and the use of HP-IB printers and plotters with HP Vectra PCs, IBM PC/XT/AT PCs, and other compatible MS-DOS computers. The HP-IB interface card fits into an 8- or 16-bit slot on industry-standard compatible computers.

The HP 82335A HP-IB Command Library software supports the following languages: Microsoft® QuickBASIC and Compiled BASIC, Hewlett Packard Vectra BASIC, GW BASIC®, IBM BASICA, Borland Turbo Pascal and Turbo C, Microsoft Pascal, Microsoft Quick C and Microsoft C.

The following NEW features have been added to the command library:

The ability to handle interrupts from the BASIC languages using the ON PEN command.

The ability to perform IEEE-488.2 binary transfers and completely unformatted binary transfers. This provides a means of moving large blocks of data with a higher throughput, avoiding the translation of data to and from ASCII format.

In addition, the HP peripheral driver is included to add HP-IB capability directly to MS-DOS applications like Lotus 1-2-3. By using DOS commands, outputs and inputs can be re-directed to HP-IB printers and plotters.

Ordering Information

The HP 82335A includes plug-in HP-IB interface card, HP-IB Command Library and all supported language modules, the HP-IB Peripheral Driver on 5.25-inch and 3.5-inch media, and the User's Manual. Option 001 is the same, but without the HP-IB interface card.

HP 82335A HP-IB Interface and Command Library \$495
Opt 001 HP-IB Command Library Software only -\$200

Price

HP 82300C BASIC Language Processor - Release II For the HP Vectra PC and Other Personal Computers

The HP 82300C BASIC Language Processor-Release II provides the capabilities of HP Series 300 BASIC to owners of HP Vectra CS, ES, QS, and RS personal computers and PC/AT-compatible computers produced by other manufacturers.

The HP 82300C BASIC Language Processor consists of an MC 68000 processor card, HP BASIC, and emulator software. The card is equipped with 1 megabyte of RAM memory, expandable to a maximum of 4 Mbyte of RAM and a built-in HP-IB interface. GPIO and Shared Resource Manager (SRM) are available as options.

The processor card fits into a backplane slot on industry-standard MS-DOS personal computers. Software allows the HP Vectra PC to run HP BASIC providing the capabilities of an HP 310 BASIC workstation while retaining all the capabilities of an MS-DOS personal computer.

Release II features improved performance over earlier versions of the BASIC Language Processor:

Graphics is 3.5 times faster.

Bit-mapped Series 300 display model eliminates graphics clipping.

Disk file access speed is 5 to 6 times faster.

BASIC boots in less than ten seconds, an improvement of 10X.

Uses the DOS file system for easier access and interaction with DOS applications.

Includes a powerful new BASIC-DOS communication feature: Bi-directional communication between HP BASIC, running in background, and DOS applications. Data acquired by BASIC can be transferred simultaneously to running DOS spreadsheets or to many other DOS applications. This capability, offered only on Release II, offers a productivity boost not available on other controllers.

The HP 82300C BASIC Language Processor is supported for use on the following personal computers: HP Vectra CS, ES, QS, and RS; IBM-AT Model 339; AT&T Model 6312; Zenith Model 248; Compaq Portable III and 386/20; Compaq Deskpro 286 and 386/16; and Wyse PC-286.

An upgrade kit, HP model 82323A, is available to provide owners of earlier HP BASIC language processors (models 82300A or 82300B) with a complete upgrade to the enhanced HP 82300C Release II.

Refer to page 561 for ordering information for these products.

Vectra CS, ES, RS and QS are registered trademarks of Hewlett-Packard Company
AT&T 6312 is a registered trademark of American Telephone & Telegraph
Compaq Deskpro 286, Deskpro 386, Portable III, and Portable 386 are registered trademarks of Compaq Computer Corp.
IBM-AT is a registered trademark of IBM Corp.
Lotus and 1-2-3 are U.S. registered trademarks of Lotus Development Corporation.
MS-DOS® is a U.S. registered trademark of Microsoft Corporation.
Zenith 248 is a registered trademark of Zenith Data Systems Inc.

HP 82323A Release II Upgrade Kit For HP BASIC Language Processors

The HP 82323A Release II Upgrade Kit upgrades HP 82300A/B BASIC Language Processors (Viper) to full Release II functionality, including improved boot, graphics, and disk I/O performance. The upgrade consists of new software, documentation, and boot ROMs. Options provide for trade-in of old 82304B BASIC ROMs for required additional RAM memory.

You get all of the performance improvements of the HP 82300C Release II product and protection of your original hardware investment (see ordering information on page 561).

HP 82302A Using HP BASIC for Instrument Control—A Self-Study Course

If you want to use your HP BASIC system to control HP-IB instruments, this self-paced learning course is ideal for you. It will enable you to learn HP BASIC programming techniques quickly and begin writing your own instrument-control programs. Designed to meet the needs of the beginner as well as the more experienced programmer, the course introduces a wide range of HP BASIC techniques.

The course includes practical examples of instrument-control programs, which are described in the lessons and are also provided on flexible disk. These programs control real HP-IB instruments, such as the HP 3456A Digital Voltmeter, the HP 3325A Synthesizer/Function Generator, and the HP 438A Power Meter. You can modify these programs and use them for your own applications.

The course consists of 3 parts, each having 10 lessons:

- **Part I** covers general programming techniques, starting at the beginner's level. You don't need to do all of the lessons if you already have some experience with HP BASIC. You can start at your own level and do the lessons at your own pace.
- **Part II** introduces HP-IB concepts and I/O programming techniques. Topics include outputting data and commands, entering data and device status, formatting data, and bus control techniques. The "top-down" approach to I/O programming is described.
- **Part III** presents some additional I/O programming techniques including handling interrupts, passing parameters, buffered I/O, sending custom bus commands, and optimizing the performance of your program.

You can use the course with any HP BASIC system, such as an HP 82300C BASIC Language Processor installed in an HP Vectra PC, a PC 300 Controller, a Series R Controller or an HP 9000 Series 200 or Series 300 computer. Course materials include two binders containing the 30 lessons (over 800 pages in all), plus 3.5-inch and 5.25-inch flexible disk media. The course can be completed in about 55 hours.

Refer to page 561 for ordering information for this product.



PC-300 Instrument Controller

Hewlett Packard's PC-308, PC-312, and PC-315 families provide a wide range of MS-DOS®-based instrument control and data acquisition systems. The instrument controller in these systems is the HP 82300C HP BASIC Language Processor-Release II.

Users can execute popular MS-DOS application software while running the HP BASIC Language Processor-Release II. This significant increase in user and equipment productivity is brought about by the language processor features that allow it to access the PC's mass storage devices from background. Productivity enhancements are designed into the software installation process.

The PC-300 family includes six standard HP Vectra PC configurations. The newest members of the PC-300 family are the 80386-based controllers. The PC-312CL, based on the HP Vectra QS/16S PC, is the lowest priced model based on the 80386. The next step in performance is the PC-312CM, based on the 20 MHz Vectra QS/20. The highest performance PC-300 controller is the PC-315CN, which uses the RS/25C floor-mount PC as its platform, offers the highest CPU speed and performance, and offers the most I/O and mass storage capacity.

There are three configurations that use 80286-based PCs. The PC-308ML, with monochrome VGA display, is the lowest priced system. The PC-308CL and PC-308CM are color VGA models. The PC-

308CL has a 20 Mbyte hard disk, and the PC-308CM has a 40 Mbyte hard disk.

With each model, from the PC-308ML to the PC-315CN, the overall performance of the HP BASIC Language Processor increases, giving customers a range of price and performance choices.

All PC-300 instrument controllers are localized to meet worldwide demand.

PC-300 System Configurations

PC-308CL Vectra ES/12 with 640 Kbyte RAM, 1.4 Mbyte 3.5" floppy disk drive, 20 Mbyte hard disk drive, color VGA display, serial/parallel interface, BASIC Language Processor board (82300C, 1 Mbyte RAM expandable to 4 Mbyte, HP-IB interface) with HP BASIC, DOS with PAM, tilt/swivel base.

PC-308CM Vectra ES/12 with 640 Kbyte RAM, 1.4 Mbyte 3.5" floppy disk drive, 40 Mbyte hard disk drive, color VGA display, serial/parallel interface, BASIC Language Processor board (82300C, 1 Mbyte RAM expandable to 4 Mbyte, HP-IB interface) with HP BASIC, DOS with PAM, tilt/swivel base.

PC-308ML Vectra ES/12 PC with 640 Kbyte RAM, 1.4 Mbyte 3.5" floppy disk drive, 20 Mbyte hard disk drive, monochrome VGA display, serial/parallel interface, BASIC Language Processor board (82300C, 1 Mbyte RAM expandable to 4 Mbyte, HP-IB interface) with HP BASIC, DOS with PAM.

PC-312CL Vectra QS/16S with 1 Mbyte RAM, 1.4 Mbyte 3.5" floppy disk drive, 40 Mbyte hard disk drive, VGA color display, serial/parallel interface, BASIC Language Processor board (82300C, 1 Mbyte RAM expandable to 4 Mbyte, HP-IB interface) with HP BASIC, DOS with PAM and tilt/swivel base.

PC-312CM Vectra QS/20 with 1 Mbyte RAM, 1.4 Mbyte 3.5" floppy disk drive, 40 Mbyte hard disk drive, VGA color display, serial/parallel interface, BASIC Language Processor board (82300C, 1 Mbyte RAM expandable to 4 Mbyte, HP-IB interface) with HP BASIC, DOS with PAM, and tilt/swivel base.

PC-315CN Vectra RS/25C with 1 Mbyte RAM, 1.4 Mbyte 3.5" floppy disk drive, 1.2 Mbyte 5.25" floppy disk drive, 103 Mbyte hard disk drive, VGA color display, serial/parallel interface, BASIC Language Processor board (82300C, 1 Mbyte RAM expandable to 4 Mbyte, HP-IB interface) with HP BASIC, DOS with PAM, and tilt/swivel base.

Ordering Information

	Price
HP 82315E PC-308CL HP BASIC Controller	\$6.395
HP 82319E PC-308CM HP BASIC Controller	\$6.795
HP 82314E PC-308ML HP BASIC Controller	\$5.895
HP 82332E PC-312CL HP BASIC Controller	\$7.595
HP 82333E PC-312CM HP BASIC Controller	\$9.195
HP 82334E PC-315CN HP BASIC Controller	\$13.295
HP 82300C HP BASIC Language Processor-Release II System with HP-IB, 1 Mbyte RAM, software and documentation	\$2.295
HP 82303A 512K RAM Expansion Kit	\$395
HP 82305A RAM Expansion Board, includes 512K bytes RAM.	\$495
HP 82306A GP-IO Interface	\$510
HP 82307A GP-IO Cable	\$197
HP 82323A Release II Upgrade Kit	\$495
HP 50963A SRM Interface	\$895
HP 82302A Using HP BASIC for Instrument Control, a self-study course	\$395
HP 82312A HP BASIC or HP Pascal Language Processor board with Right-to-Execute	\$1,588
HP 82313A Hierarchical File System	\$395

MEASUREMENT SYSTEMS ARCHITECTURE

General Information

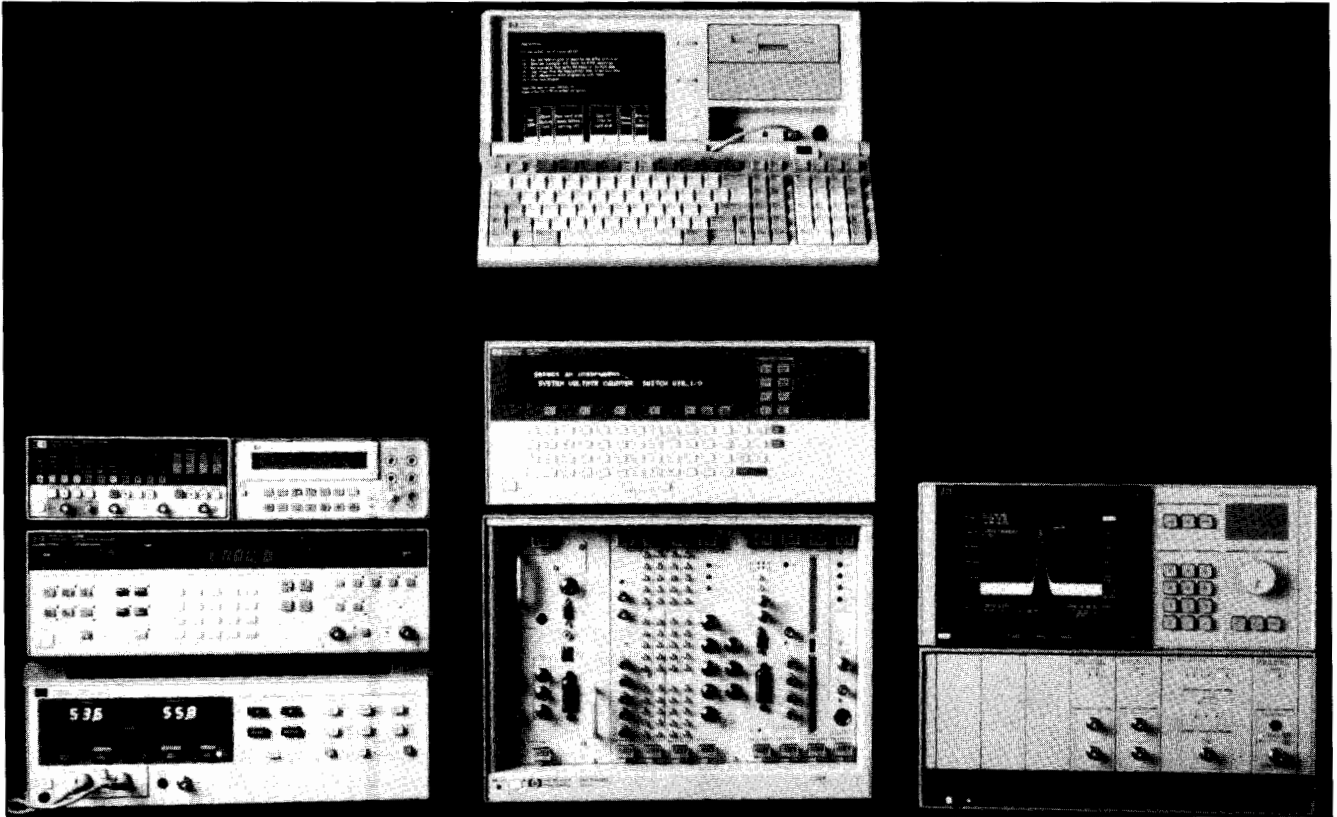

HP-IB, HP VXibus, and HP modular measurement system products, along with controllers and software, are all part of the HP Measurement Systems Architecture

The Measurement Systems Architecture for the '90s

Keeping pace with today's complex, changing measurement needs requires a new approach to automated testing—one that will minimize the time, effort, and risk involved in system design.

Hewlett-Packard meets this challenge with the measurement systems architecture for today and the future. The HP Measurement Systems Architecture is industry's widest, most advanced selection of hardware, software, controller, and support offerings. Products are based on industry standards for greater compatibility. Using this approach you can create cost-effective systems that cover applications from dc to lightwave.

Within the HP Measurement Systems Architecture, new modular product families enhance our traditional HP-IB test equipment. All have measurement functions optimized for automated testing.

The HP 70000 modular measurement system

The HP 70000 modular measurement system (MMS) offers rugged, reliable instrumentation for applications from RF through lightwave. For 1990, we have introduced a powerful new color display/mainframe and a host of new modules.

The HP 75000 VXibus system

The HP 75000 VXibus system is part of this emerging technology with particular strengths in digital and analog measurement. Our new B- and C-sized mainframes and modules share a common human interface and common set of instrument commands.

HP-IB

HP-IB products offer the largest hardware selection for system integrators. New 'smart' HP-IB instruments feature built-in controllers for greater system efficiency.

The standard IEEE-488 bus links MMS, VXibus, and HP-IB products together and links them to a variety of controllers. Software development tools based on MS-DOS®, HP BASIC, and UNIX® operating systems are available to help get your system up quickly.

Controllers

HP controllers include the HP Vectra personal computer and the popular HP 9000 technical computers. New HP-IB rack controllers are more compact and easier to integrate than previous models.

Software

Software development tools include the HP Interactive Test Generator (HP ITG) software for easy generation of code and the versatile HP Functional Test Manager (HP FTM) software, a reusable framework that you customize for production-test systems.

Test and measurement systems language

A new test and measurement systems language (TMSL) provides a single set of instrument commands designed for use in all types of instruments. HP has begun to implement this language in its test instrumentation, including all new HP VXibus products.

System Support

Your investment in HP products, including those in MSA, is protected by our commitment to long-term system support. Our sales and support people have the expertise you need to help put your system together and keep it running smoothly. HP products are backed by excellent warranties and service. And our many training courses help you get the most out of your HP purchase.

Measurement Systems Architecture

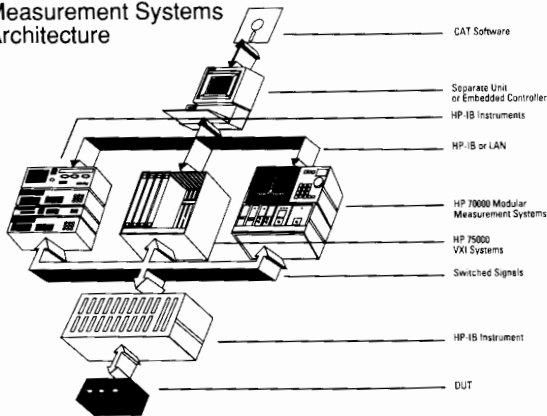

Modular, Open Systems Maximize Your Flexibility

Modularity answers a number of critical issues for the automated-test-system designer. Rack and floor space are saved. There is less duplication of measurement functions. Systems can be reconfigured easily by exchanging modules. HP has taken a leading role in helping establish both the VXIbus and the modular measurement system as fully open, modular standards into which any manufacturer can build.

VXIbus system

The flexible addressing system of the VXIbus system makes the best use of module space within the mainframe. Multiple instruments can be located on one module or card, or one instrument can span more than one slot. Local bus lines allow fast, private communication between a set of cards performing a specific measurement function. The new HP 75000 Series C mainframe delivers high performance while allowing for system downsizing. Modules include a command module, digital multimeters, multiplexers, a function generator, and more. The new HP 75000 Series B mainframe is designed for low-cost computer-aided-test applications, and the modules include a digital multimeter, relay multiplexers, counters, a digital/analog converter, and more. For descriptions of HP 75000 series products, see page 597.

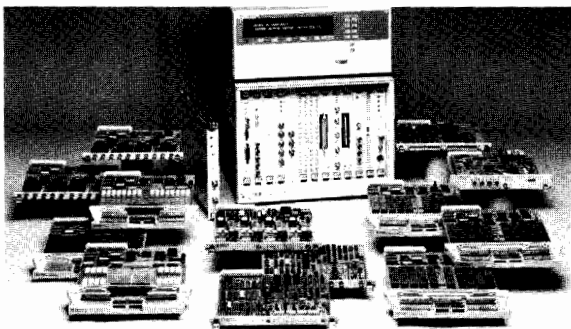

HP 75000 VXIbus mainframes and modules

Modular measurement system

For test systems that require high performance microwave functionality, the HP 70000 modular measurement system provides the needed environment. Mechanical structures are optimized for holding heavy microwave components. Mainframes and modules are designed for the electromagnetic compatibility critical to sensitive high-frequency equipment. Systems are configured and reconfigured easily with interchangeable modules.

The ability to share power supplies and a single display contribute to the system's overall efficiency. A powerful digital backplane provides fast module-to-module communication. A new color display/mainframe turns your MMS into a microwave workstation, and new modules add vector voltmeter, power meter, signal generator, scalar measurement, and other capabilities. See pages 115 and 314.

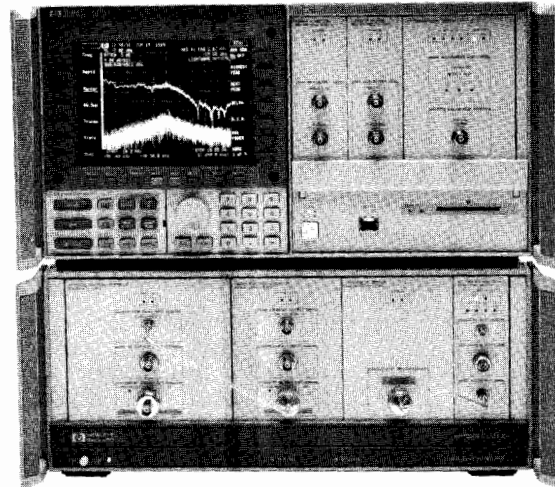

The HP 70000 modular measurement system

HP-IB products

Compatible HP-IB products make the HP Measurement Systems Architecture the largest selection in the industry. These products are listed throughout the catalog, indicated by the HP-IB symbol. General information on HP-IB is found on page 564.

Time-saving Hardware and Software Development Tools

The HP 70000 modular measurement system and HP 75000 VXIbus families offer test equipment and development tools for every step in the design and integration of today's automated test systems. Choose from a wide array of modules and mainframes. Part kits along with design guides and schematics are also available for creating your own VXIbus and modular measurement system products.

HP BASIC

To make software development easier, the powerful HP BASIC has been optimized for instrument control and is available on UNIX® and MS-DOS® operating systems. This popular programming language runs on a wide range of HP computers and workstations. When system rack space is at a premium, you will find HP controllers in rackmount or VXIbus configuration. Details about HP controllers begin on page 554.

Development software

In addition, the HP Interactive Test Generator software accelerates the development of HP BASIC test programs using a windowed, mouse-driven interface designed for generating code and controlling IEEE-488 instruments. The HP Functional Test Manager software gives you a reusable framework for customizing production test systems. Features include standard forms for a uniform approach to test development; flexible, user-written subroutines that are easily integrated into test programs; statistical quality control (SQC) and database management; and more. See pages 597 and 620, respectively.

Test and measurement systems language

A new test and measurement systems language (TMSL) provides a single set of instrument commands for use in all types of instruments. Common commands simplify software development because you no longer need to learn a different programming language for every instrument in your system. Using a common instrument language also increases the compatibility of your software between generations as system hardware is upgraded.

TMSL is based on IEEE Standard 488.2-1987. HP has begun to implement this language in its test instrumentation, including all new HP VXIbus system products. TMSL has also been opened for use by other manufacturers.

HEWLETT-PACKARD INTERFACE BUS

Versatile Interconnect System for Instruments and Controllers
General Information

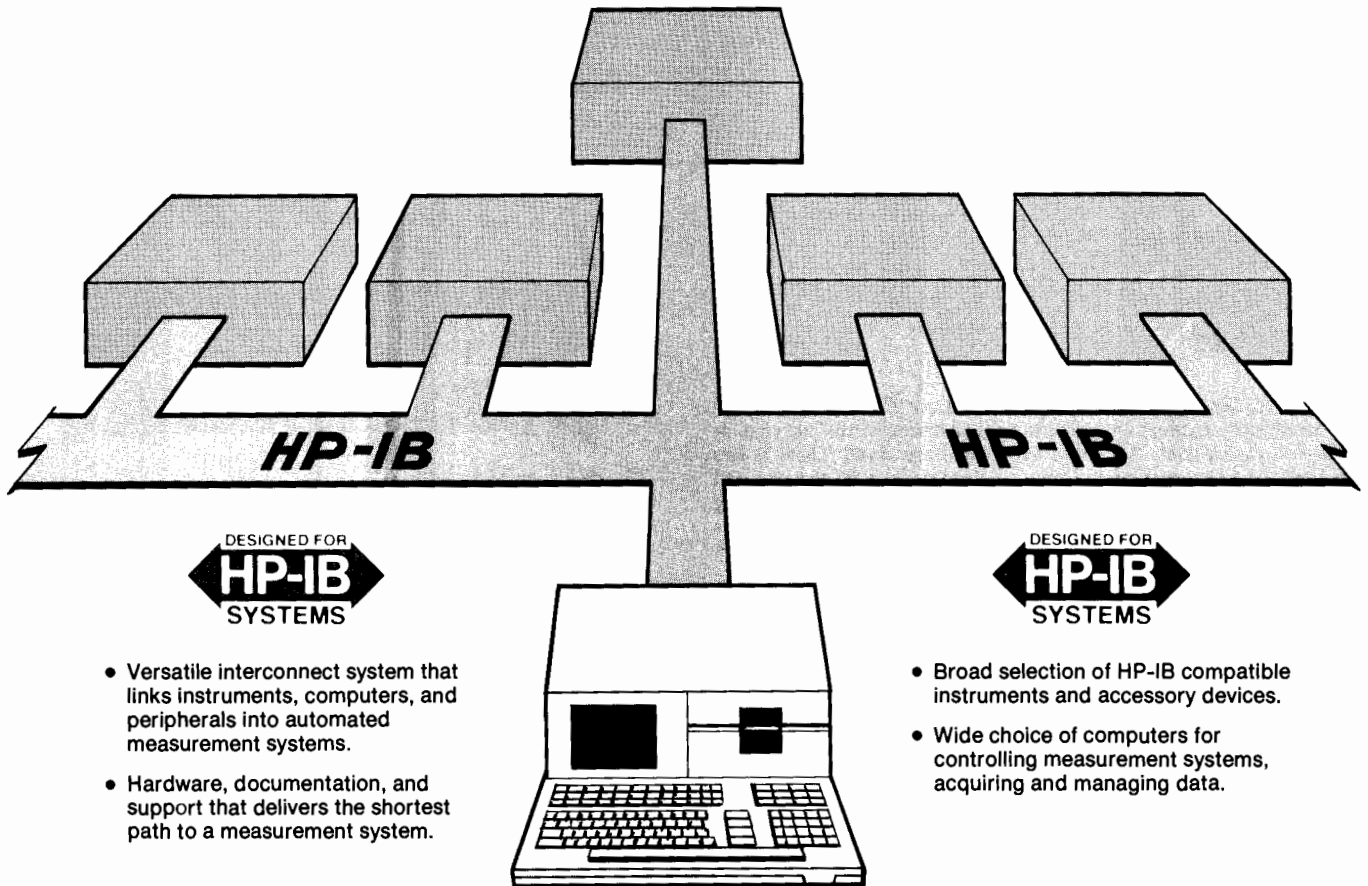

- Versatile interconnect system that links instruments, computers, and peripherals into automated measurement systems.
- Hardware, documentation, and support that delivers the shortest path to a measurement system.

- Broad selection of HP-IB compatible instruments and accessory devices.
- Wide choice of computers for controlling measurement systems, acquiring and managing data.

Advantages of HP-IB Systems

There are many applications where the measurement power of interactive instruments can be further enhanced by desktop computers or minicomputers. Operating in a remote mode can provide more exact, error-corrected results than conventional manual operation techniques.

The following three major parameters combine to reduce significantly the engineering development costs of configuring measurement systems:

1. The Hewlett-Packard Interface Bus, also known as HP-IB
2. Distributed computing through the growing number of "smart" instruments with internal microprocessors
3. The broad choice of computers ranging from friendly, easy-to-program desktop computers to more sophisticated computer systems capable of managing multistation instrument clusters and complex data bases.

Relationship Between HP-IB and Other Interface Standards

Hewlett-Packard is committed to the overall advancement of measurement technology and has for some time been working to simplify and standardize instrumentation interfacing. An example of such an effort is the involvement with the HP-IB from its inception at Hewlett-Packard to its present status as a world instrumentation interface standard (IEEE 488-1978 and IEC 625-1).

In mid-1972, Hewlett-Packard began to participate in various international standardization bodies. The U.S. Advisory Committee, composed of diverse interests represented by both users and manufacturers, first established initial goals, then adopted the interface concept used by the HP Interface Bus as an appropriate starting point. A draft document was subsequently written and evaluated by members of the committee, then submitted as the U.S. Proposal to the IEC (International Electrotechnical

Commission) Working Group in the autumn of 1972. Since then, the interface definition has undergone a number of minor changes to accommodate various needs at the international level.

In September 1974, the parent technical committee, IEC TC66, approved the main interface draft document for a formal ballot among the member nations of the IEC. Balloting took place in 1976, and IEC recommendation 625-1 was adopted. The IEC recommendation, using a different connector, is totally compatible with the present definition of the HP-IB.

Meanwhile, the IEEE Standards Board approved IEEE Standard 488-1975 "Digital Interface for Programmable Instrumentation", first published in 1975 and again published in 1978 with minor editorial changes as IEEE Standard 488-1978. The IEEE standard is also fully compatible with the HP-IB. In January 1976, the American National Standards Institute adopted the

IEEE Standard and published it initially as ANSI Standard MC 1.1.

The standardized interface concept is now widely accepted. Hundreds of manufacturers in more than fourteen countries offer thousands of products that use the HP-IB concepts articulated in IEEE-488. As more instrumentation interface standards evolve from the HP-IB, we will clearly indicate the relationship of the Hewlett-Packard Interface Bus to those standards, just as we have done with ANSI/IEEE Standard 488 and IEC Publication 625-1.

Why the HP Interface Bus Name?

As the list of HP products available with the "new digital interface" grew, our customers sought a convenient way to identify those products having the interface capability. In response, in 1974 we adopted the name "Hewlett-Packard Interface Bus" or simply "HP-IB". We will continue to use the identifying name and this symbol:



Both are used with appropriate HP products to identify their interface capabilities.

The Hewlett-Packard Interface Bus fully complies with IEEE Standard 488. As such, it incorporates the mechanical, electrical, and functional specifications of the standard. A fourth and vital element of any interface system is the operational aspect of a product at both the human-machine interface and the machine-machine interface at the HP-IB port. HP-IB capability provides additional

user benefits that are beyond the scope of IEEE Standard 488. Typical user conveniences include high-level language implementation of interface functions, underscored program codes on instrument front panels for easy programming, convenient data output formats, and designed-in learn modes. In addition, we provide complete support documentation in the form of programming and interfacing guides, application notes and operators' manuals that illustrate the added benefits for users of products with HP-IB capability.

Single-Source Systems Approach

The decision to use a system instead of conventional manual methods must be based on an engineering evaluation of benefits versus costs. The many benefits associated with a systems approach include the following:

- More consistent results in repeated measurements because a system is not subject to operator fatigue.
- Greater throughput because systems are generally faster.
- More thorough testing because system speed allows more parameters to be measured in a shorter time.
- Results expressed in engineering or scientific units because many systems controllers are capable of on-line data manipulation.
- Greater accuracy because system errors can be measured automatically, stored and accounted for in the results.
- Adaptive data acquisition so that a system can be programmed to branch to other measurements to help pinpoint an abnormal condition.
- Measurement results stored in computer memory or on hard copy.

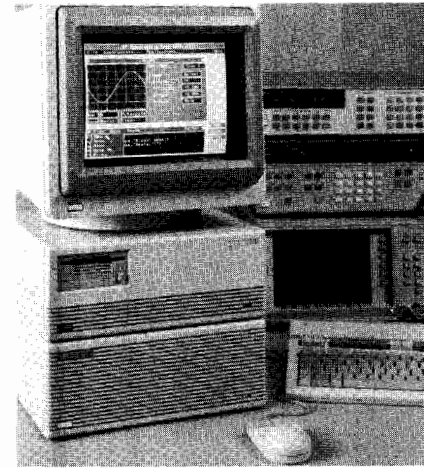

Hewlett-Packard offers a broad range of controllers and software solutions to meet your measurement automation needs. HP E2000A Interactive Test Generator software works with instrument drivers to provide a uniform, user-friendly interface to a wide variety of HP-IB instruments.

It is our objective to make the integration of instrumentation systems easier by providing instruments and computers designed for systems applications. Computers are designed with HP-IB options that allow easy hook-up to the bus and incorporate easy-to-use bus commands in their software. Hewlett-Packard's policy when designing HP-IB compatible instruments is to eliminate interfacing ambiguities associated with controllers and instruments operating per the ANSI/IEEE and IEC standards by adopting guidelines for consistent interface design.

Proper training on system components is very important for efficient use of any interface system. Therefore, we offer training at sales and service offices worldwide on HP desktop computers, computer systems, and instruments as they relate to the HP-IB. In the area of HP-IB support documentation, we offer general interface technical descriptions, operating and service manuals with programming information, instrument/controller introductory operating guides, quick reference guides, and application notes.

Technical assistance during system development is available at most local HP sales and service offices, from resident systems engineers who specialize in desktop computers, computer systems, and instruments.

How the HP-IB Operates

All active interface circuitry is contained within the various HP-IB devices, and the interconnecting cable (containing 16 signal lines) is entirely passive. The cable's role is



Automation provides the speed needed for production environments. This HP 8957S Cellular Test System produces accurate, hard-copy test results in minutes.

HEWLETT-PACKARD INTERFACE BUS

Versatile Interconnect System for Instruments and Controllers (cont'd)

General Information



limited to that of interconnecting all devices in parallel so that any one device can transfer data to one or more other participating devices.

Every participating device (instrument, controller, accessory module) must be able to perform at least one of the roles of TALKER, LISTENER, or CONTROLLER. A TALKER can transmit data to other devices via the bus, and a LISTENER can receive data from other devices via the bus. Some devices can perform both roles. For example, a programmable instrument can LISTEN to receive its control instructions and TALK to send its measurement results.

A minimum HP-IB system consists of one TALKER and one LISTENER, without a CONTROLLER. In this configuration, data transfer is limited to direct transfer between one device manually set to "talk only" and one or more devices manually set to "listen only" for example, a measuring instrument talking to a printer for semi-automatic data logging).

A CONTROLLER manages the operation of the bus system primarily by designating which devices are to send and receive data, and it can also command specific actions within other devices.

The full flexibility and power of the HP-IB become more apparent, however, when one device that can serve as CONTROLLER/TALKER/LISTENER (e.g., calculator or computer) is interconnected with other devices that may be either TALKERS or LISTENERS, or both (e.g., frequency synthesizers, counters, power meters, relay actuators, displays, printers), depending on the application. An HP-IB controller participates in the measurement by being programmed to schedule measurement tasks, set up individual devices so that they can perform these tasks, monitor the progress of the measurement as it proceeds, and interpret the results of the measurement. Hewlett-Packard offers controllers that can be programmed in high-level languages such as BASIC, FORTRAN, HPL, and Pascal.

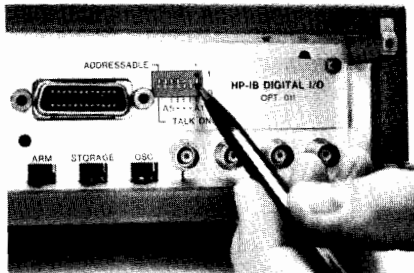

Rear panel switches are set so instrument will either be addressable by controller in a multi-device system, or will simply "talk only" to another device, such as a printer.

HP-IB Connections and Structure

The HP-IB has a party-line structure. All devices on the bus are connected in parallel. The 16 signal lines within the HP-IB cable are grouped into three clusters according to their functions:

1. Data Bus (8 signal lines)
2. Data Byte Transfer Control Bus (3 signal lines)
3. General Interface Management Bus (5 signal lines).

The Data Bus consists of eight signal lines that carry data in bit-parallel, byte-serial format across the interface. These signal lines carry addresses, program data, measurement data, universal commands, and status bytes to and from devices interconnected in a system. Identification of the type of data present on the DIO signal lines is indicated by the ATN (attention) signal. When the ATN signal is true (asserted), either addresses or universal commands are present on the data bus and all connected devices are required to monitor the DIO lines. When the ATN message is false, device-dependent data (e.g., programming data) is carried between devices previously addressed to talk and listen.

Data transfer uses a set of three signal lines: DAV (data valid), NRFD (not ready for data), and NDAC (not data accepted).

These signals operate in an interlocked handshake mode. Two signal lines, NRFD and NDAC, are each connected in a logical AND (wired OR) to all devices connected to the interface. The DAV signal is sent by the talker and received by potential listeners. The NRFD and NDAC signals are sent by potential listeners and received by the talker.

The General Interface Management Lines manage the bus for an orderly flow of messages. The IFC (interface clear) message places the interface system in a known quiescent state. SRQ (service request) is used by a device to indicate the need for attention or service and to request an interruption of the current sequence of events. REN (remote enable) is used to select between two alternate sources of device program data. EOI (end or identify) is used to indicate the end of a multiple byte transfer sequence or, in conjunction with ATN, to execute a polling sequence.

It is not possible in this limited space to go into detail on each signal line's role. But you should note that every HP-IB device need not be able to respond to all the lines. As a practical and cost-effective matter, each HP-IB device usually responds only to those lines that are pertinent to its typical function on the bus. (Details are covered in each device's operating manual.)

HP-IB and the new IEEE 488.2

In June of 1987, the IEEE approved a new standard for programmable instruments called IEEE Std. 488.2-1987 Codes, Formats, Protocols, and Common Commands. It works with the IEEE Standard Digital Interface for Programmable Instrumentation, IEEE 488-1978 (now 488.1). HP-IB is Hewlett-Packard's implementation of IEEE 488.1.

As with IEEE 488.1, Hewlett-Packard was active in the development of IEEE 488.2. Many of the new HP instruments introduced this year already follow this new standard, and many more HP instruments to be introduced in the near future will also follow IEEE 488.2.

This new standard addresses issues involved with sending messages between devices on the bus. Its features include:

- A required minimum set of IEEE 488.1 capabilities.
- Reliable transfer of complete messages between a computer and an instrument.
- A precise description of the syntax in those messages.
- A set of commands useful in all instruments.
- Common status reporting capability using serial poll.
- Techniques for guaranteeing synchronization of application programs with instrument functions.
- A way of automatically assigning addresses.

The desired benefit from these features is to make the job of an instrument system designer easier. IEEE 488 standardized the electrical and mechanical interface. This new standard ensures compatibility at the next higher level.

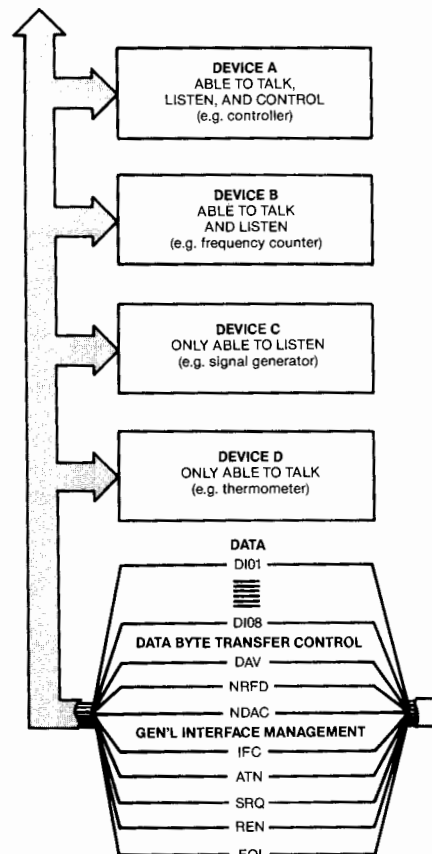

Interface connections and bus structure

488.1 Requirements

The IEEE 488.2 Standard requires that each device provide a minimum set of 488.1 interface capabilities. Each device must be able to source and accept bytes, talk and listen, do service request, and respond to device clear.

IEEE 488.2 allows more freedom by making other capabilities optional. However, it requires a minimum capability when these functions are implemented. This applies to the Remote Local, Parallel Poll, Device Trigger, and Controller capabilities.

Message Exchange

IEEE 488.1 provides a reliable means of transferring bytes between a talker and a listener. In addition, devices need a reliable means of transferring programming commands and measurement results. IEEE 488.2 provides this means.

Syntax

IEEE 488.2 requires that devices listen in a "forgiving" manner. However, the level of forgiveness is precisely defined. The meaning of every data byte is well defined, while several characters sometimes have the same meaning.

Although the listening syntax is forgiving, an instrument is required to talk precisely. Talking precisely greatly increases the chances of a message being accepted by any controller.

Common Commands

Certain functions are useful across all types of instruments. IEEE 488.2 defines a set of commands that all instruments must implement. Required commands include identifying the instrument by manufacturer and model number, resetting the instrument to a known state, and performing a self-test.

Other commands that are useful in some instruments are also described in the standard. They are included so that, if the functions are implemented, they will be done in standard ways. For example, there are commands for calibration, triggering, macros, and passing control. There are a total of 13 required commands and 26 optional commands.

Status Reporting

IEEE 488.1 exactly describes how the Request Service (RQS) message behaves, but it says very little about the status byte, STB. The meanings of the bits are left to the designer. Some instruments clear the status byte after a serial poll, others do not. Many instruments allow the programmer to configure what causes a service request, but here too the techniques for doing so are varied.

IEEE 488.2 describes a hierarchical status reporting model in which the contents of other data structures are summarized in the status byte. It does not specify the exact meaning of all of the bits in the status byte. However, it does describe the meaning of two more of the bits, Message Available (MAV) and Event Status (ESB).

Synchronization

Many instruments can accept commands faster than they can execute them. Although this feature can improve system throughput, it also creates a need to know when the instrument actually completes all of its commands. IEEE 488.2 requires three common commands that enable the application program to detect when all pending operations are complete.

Auto-configuration

Whenever a test system is assembled, the addresses of the instruments must be set to prevent collisions. Additionally, the application has to know the address of every instrument. Currently, addresses have to be set manually from the front panel or a bank of switches. IEEE 488.2 describes a protocol between the controller and all the auto-configurable instruments on the bus, which identifies each instrument and assigns it an address.

Future

Codes, formats, protocols, and common commands cover new ground for instrument-to-computer communication. Most of the concepts involved can be used on any physical interface whether HP-IB, RS232, or VME. If a new physical interface should displace or co-exist with HP-IB, the syntax of messages, the common commands, the status reporting, and the synchronization techniques can all survive.

HP-IB Training and Support

To assist you in configuring HP-IB measurement systems, Hewlett-Packard has field sales people trained in electronic instruments, desktop computers, and computer systems. Also available for technical consultation are computing controller systems engineers and HP-IB instrumentation specialists.

HP-IB training courses on HP-IB controllers and instruments are listed below. Courses are conducted at a convenient HP location. Some courses can be taught at your site with special arrangements.

- HP-IB Theory
- HP-IB for MOS-DOS® Personal Computers
- HP-IB Instrument Control Using HP Series 200/300 BASIC
- HP-IB Instrument Control Using HP 1000E/F Series Controllers

HP-IB Service and Warranty

Hewlett-Packard has dedicated measurement system service people who perform on-site maintenance of HP instrumentation on customer-configured systems as well as HP-configured systems. Service contract coverage is available to meet your specific measurement system service needs and can be tailored to include extended warranty, calibration and extended hours of coverage. Contact your local sales and service office for further information on HP-IB service contract information.

MS-DOS is a U.S. registered trademark of Microsoft Corporation.

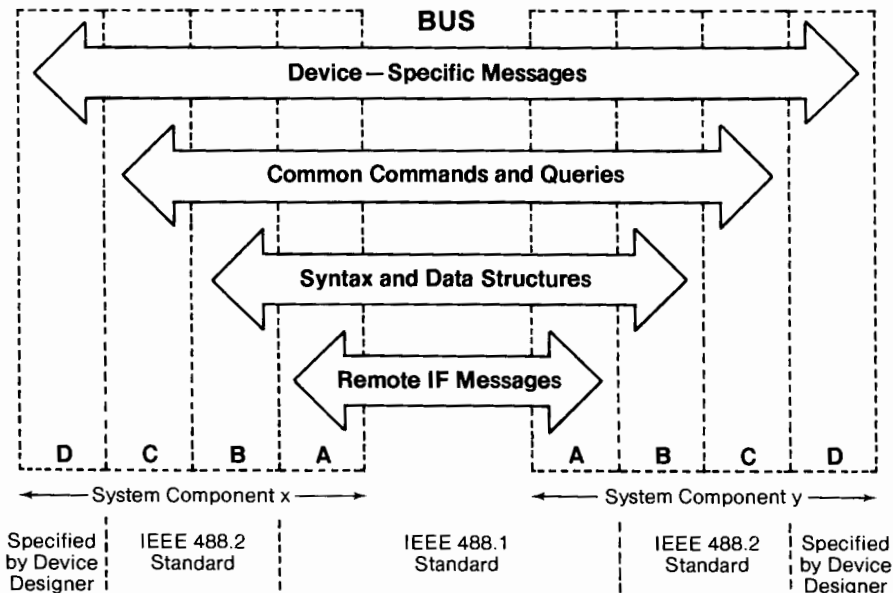

This diagram shows the relationship between the IEEE-488.1 standard and the new IEEE 488.2 standard. The new standard expands and complements IEEE 488.1 by addressing issues involved with sending messages between devices on the bus. Layer D represents device functions, layer C represents common system functions, layer B represents message communications functions, and layer A represents interface functions. Layers D, C and B contain IEEE 488.1 device-dependent messages and layer A contains IEEE 488.1 interface messages.

HEWLETT-PACKARD INTERFACE BUS

Versatile Interface Bus for Instruments and Controllers (cont'd)

General Information



Every HP-IB device and HP-configured system carries a standard Hewlett-Packard warranty appropriate to that product. The warranty period for each product will be provided on request at the time of sale and is specified in documentation supplied with the product. HP takes responsibility for standard HP-IB systems performing as specified. However, software or interfacing that has not been provided by Hewlett-Packard as part of a standard system delivered by HP is not covered by this warranty.

In all cases, overall operational responsibility for those HP-IB systems assembled by a customer from individual HP-IB devices rests with the customer.

HP-IB Specifications Summary

Interconnect Devices

Up to 15 maximum on one continuous bus.

Interconnection Path

Star or linear bus network; total transmission path length 2 meters times number of devices or 20 meters, whichever is less. Operating distances can be extended; see page 571.

Message Transfer Scheme

Byte-serial, bit-parallel asynchronous data transfer using locked 3-wire handshake technique.

Data Rate

One megabyte per second maximum over limited distance; 250-500 Kbytes per second typical over full transmission path (actual data rate depends on individual device characteristics).

Address Capability

Primary addresses, 31 TALK and 31 LISTEN; secondary (2-byte) addresses, 961 TALK and 961 LISTEN. Maximum of 1 TALKER and up to 14 LISTENERS at a time.

Control Shift

In systems with more than one controller, only one can be active at a time. A currently active controller can pass control to another, but only the designated system controller can assume control over others.

Interface Circuits

Driver and receiver circuits are TTL-compatible.

HP-IB Interface Functions

HP-IB functions are the predefined capabilities that can be designed into an HP-IB device. These capabilities and their alphanumeric codes are summarized in the table. Because the codes completely describe interface capability and are therefore particularly useful to system designers and specifiers, they frequently appear in technical data and on system components. On HP system-ready products the capabilities are listed near the HP-IB connector, and they are included in the specifications for most of the HP-IB products in this catalog.

HP-IB Connector Lock Screw Compatibility

HP-IB products delivered now and in recent years are equipped with connectors having ISO *metric-threaded* lock screws and stud mounts. Very early HP-IB products have non-metric parts, but are readily distinguished from the metric by color: metric-threaded parts are black, whereas non-metric parts have a shiny nickel finish. HP-IB Metric Conversion Kit (HP P/N 5060-0138) is available to convert these early instruments.

HP-IB Reference Publications

- *Tutorial Description of the Hewlett-Packard Interface Bus*. This 118-page reference chronicles the development of byte-serial, bit-parallel interface system stan-

dards, describes their relationship to HP-IB, presents a working overview of HP-IB, and includes useful information. Free copies are available from your nearest HP office. Ask for publication number 5952-0156.

- *ANSI/IEEE 488.1-1987, Digital Interface for Programmable Instrumentation, and IEEE Std. 488.2-1987, Codes, Formats, Protocols, and Common Commands*, published by the Institute of Electrical and Electronics Engineers, 345 East 47th Street, New York, NY 10017.
- *IEC 625-1, An Interface System for Programmable Measuring Apparatus (Byte Serial Bit Parallel)*, published by the International Electrotechnical Commission, 1 rue de Varembe, 1211 Geneva 20, Switzerland.

HP-IB Interface Capability Codes for HP Products

Interface Function	Basic Code	Capability Code
Source Handshake	SH	SH0 No capability
		SH1 Full capability
Acceptor Handshake	AH	AH0 No capability
		AH1 Full capability
Talker (Extended Talker)	T(TE)	T(TE)0 No capability
		T(TE)1 Basic talker, serial poll, talk only
		T(TE)2 Basic talker, serial poll
		T(TE)3 Basic talker, talk only
		T(TE)4 Basic talker
		T(TE)5 Basic talker, serial poll, talk only, unaddresses if MLA ¹
		T(TE)6 Basic talker, serial poll, unaddresses if MLA ¹
		T(TE)7 Basic talker, talk only, unaddresses if MLA ¹
Listener (Extended Listener)	L(LE)	L(LE)0 No capability
		L(LE)1 Basic listener, listen only
		L(LE)2 Basic listener
		L(LE)3 Basic listener, listen only, unaddresses if MTA ²
Service Request	SR	SR0 No capability
		SR1 Full capability
Remote Local	RL	RL0 No capability
		RL1 Full capability
		RL2 No local lockout
Parallel Poll	PP	PP0 No capability
		PP1 Remote configuration
		PP2 Local configuration
Device Clear	DC	DC0 No capability
		DC1 Full capability
		DC2 Omit selective device clear
Device Trigger	DT	DT0 No capability
		DT1 Full capability
Driver Electronics	E	E1 Open collector (250kb/s max)
		E2 Tri state (1Mb/s max)
Controller ³	C	C0 No capability
		C1 System controller
		C2 Send IFC and take charge
		C3 Send REN
		C4 Respond to SRQ
		C5 Send interface messages, receive control, pass control to self, parallel poll, take control synchronously

¹MLA: My Listen Address

²MTA: My Talk Address

³There are 29 controller levels. These are the more significant levels.



HEWLETT-PACKARD INTERFACE BUS

Versatile Interconnect System for Instruments and Controllers

569

Models 59401A, 10833A/B/C/D, 10834A

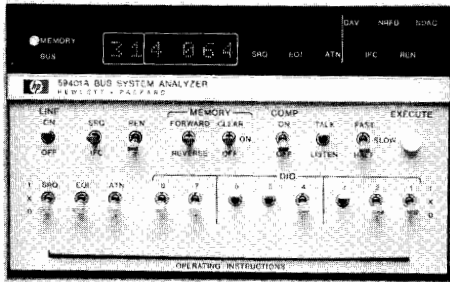

HP 59401A

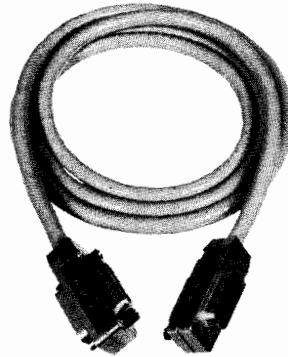

HP 10833A/B/C/D

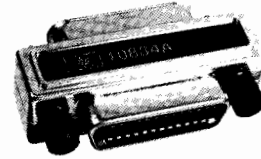

HP 10834A

HP 59401A Bus System Analyzer

The HP-IB (IEEE 488) concept has greatly simplified many of those things which have in the past made instrument interfacing a burdensome task. Even so, software errors can occur if the system designer does not completely understand the bus system or the capabilities of the instruments and other devices being interfaced. Hardware problems can occur if the instruments/devices are not functioning properly, or if they are not completely compatible with the bus standard.

The HP 59401A Bus System Analyzer is especially useful in design and service work. It simplifies and speeds up the diagnosis of software and hardware problems by allowing the user to see the status of all bus lines, including the actual characters on the bus data lines. Because the HP 59401A can also drive all bus lines, it can completely exercise another Talker, Listener or Controller—which is especially useful in verifying compatibility of new or user-designed products with the HP-IB.

There are several choices of analyzer operating speed. It may be operated at one character at a time (useful for software debugging), at 2 characters per second, or at regular bus speed. It may also be operated at a variable rate as determined by the external clock input.

The analyzer's 32 character memory can be used to store bus characters in the Listen mode, or to output characters to the bus in the Talk mode. When the analyzer is in the Compare mode, a stream of bus traffic may be stopped on a pre-selected character—and at that time a trigger pulse is available, which is very useful when analyzing transient or timing problems related to the bus.

HP 59401A Specifications

Display: monitors all bus lines. Represents data lines, any memory location, or DIO front panel switch settings; in octal code and ASCII character.

Listen mode: stores up to 32 characters of bus traffic in memory for real time and repetitive testing. In Compare mode, halts bus traffic when a selected character is present, and user can display any one of the previous 31 characters stored in memory.

Timing: accept <750 ns; ready <750 ns.

Talk mode: bus lines can be driven directly from front panel switches; memory can be loaded from front panel switches for driving bus with a 32 character sequence.

Timing: (1) data changed >500 ns before DAV pulled low; (2) ATN driven low >1 μ s before DAV pulled low; (3) DAV driven high <700 ns after NDAC is false; (4) DAV driven low <700 ns after NRFD is false, if conditions 1 and 2 are met.

Operating speeds: one character at a time, 2 characters per second, regular bus speed, or variable rate determined by external clock input; in either Listen or Talk mode.

External clock input: 1 standard power TTL gate input; \leq 10 MHz repetition rate.

Compare output: provides 1 standard power TTL gate output (LOW TRUE) sync pulse when bus character is same as front panel switches.

HP-IB load: 1 bus load (capable of driving 14 other bus devices).

General

Temperature ranges: operating, 0 to 50°C; storage, -40 to +75°C.

Humidity: 95% relative, 0 to 40°C.

Power requirements: 100, 120, 220, or 240 V +5%, -10%; 48 to 66 Hz; \leq 42 VA.

Size: 145.5 H, 205.1 W, 495.3 mm D (5.730" x 8.075" x 19.500").

Weight: net, 5.64 kg (12.44 lb).

Accessories

HP 5061-9689 (metric) front handle kit

HP 10833B 2 m (6.6 ft) bus cable, furnished

Price
\$55

HP 59401A Bus System Analyzer

\$4170

HP-IB Interconnection Cables

Cables for interconnecting HP-IB devices are available in four different lengths. The connector block at both ends of each HP-IB cable (photo above) has a plug on one side and a matching receptacle on the other, so that several cables may be conveniently connected in parallel, thus simplifying system interconnection. Lock screws provide for secure mounting of each connector block to an HP-IB instrument, or to another cable connector block.

SPECIAL NOTE: HP-IB cables are not always included with individual HP-IB devices, particularly those that normally connect directly to an HP computing controller. (The HP-IB interface for HP computing controllers contains the necessary cable and connector). Product listings in this catalog should be checked to see if HP-IB cables are furnished.

The HP 10833 series of cables feature an improved shielding design to help improve RFI levels in systems. This series of cables, with the RFI shielding, exhibits significantly lower radiated emissions than previous HP-IB cables.

The HP 10834A adapter is a shielded HP-IB to HP-IB adapter. It provides additional clearance (approximately 2.3 cm) between the HP-IB cable and the rear panel of the instrument. This allows easier access to switches, cables, and other connectors that may be in close proximity to the HP-IB connector.

Ordering Information

HP 10833A HP-IB Cable, 1m (3.3 ft)

HP 10833B HP-IB Cable, 2m (6.6 ft)

HP 10833C HP-IB Cable, 4m (13.2 ft)

HP 10833D HP-IB Cable, 0.5m (1.6 ft)

HP 10834A Adapter

☎ Fast-Ship product — see page 734.

Price
\$80 ☎
\$90 ☎
\$100 ☎
\$80 ☎
\$31 ☎

HEWLETT-PACKARD INTERFACE BUS

Versatile Interconnect System for Instruments & Controllers
Models 59306A, 59307A, 59309A, 59501B

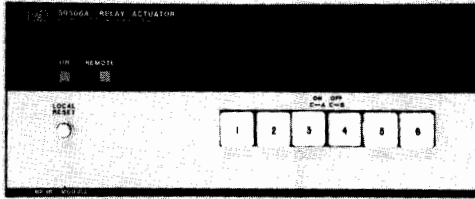

HP 59306A

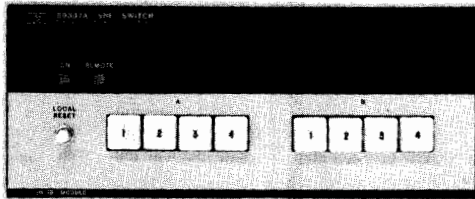

HP 59307A

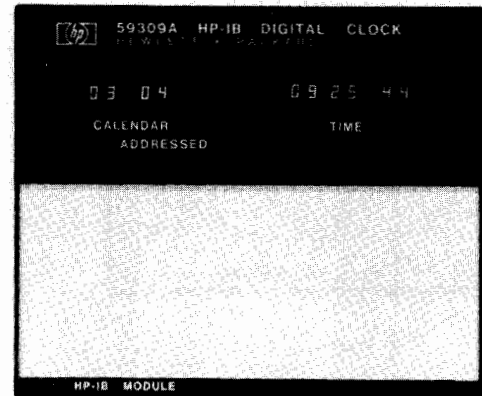

HP 59309A

HP-IB Accessory Modules

Modules in the HP 59300, 59400 and 59500-series are ideal building blocks for use with instruments to extend measurement capabilities. Modules listed here can be interconnected via the HP-IB to HP measuring instruments, signal sources and recording devices capable of operating directly on the HP-IB. In addition, these modules frequently serve as useful ways to interconnect with devices which are not themselves capable of direct HP-IB operation.

HP 59306A Relay Actuator

Has six Form-C relays that provide for control of external devices either manually from front panel pushbuttons or remotely from the HP-IB. Relay contacts are specified to switch 24 V dc or 115 V ac at 0.5 A. Each relay can be programmed independently or multiple relays can be switched together. Front panel pushbuttons light to indicate the state of each relay.

The HP 59306A is ideal for providing control of microwave coaxial switches (HP 8761 A/B) as well as control of microwave programmable step attenuators (HP 8494 through 8496 G/H) using external dc power supplies.

HP 59307A Dual VHF Switch

This module provides two single pole 4-throw switches controlled from front panel pushbuttons or remotely from the HP-IB. The HP 59307A is a dc to 500 MHz 50 Ω switch designed to maintain fast pulse transition times. The switches are independent and bidirectional for optimum use in multiplexing 50 Ω signal lines into measuring instruments. The HP 59307A is ideal to switch a standard delay, frequency, or voltage into a measurement loop for purposes of system calibration.

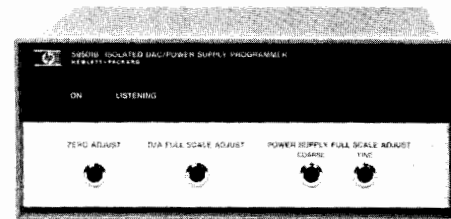

HP 59501B

HP 59309A HP-IB Digital Clock

Displays month, day, hour, minute, and second, and upon command will output time via the interface bus. Time can be set into the clock by local control, or by remote commands received from the HP-IB. The clock accepts a small internal battery which can provide more than a day's standby in case of short power interruptions. Additionally, an auxiliary power supply such as the K10-59992 can sustain the clock for up to one year.

HP 59501B Power Supply Programmer (isolated DAC)

This single-channel digital-to-analog converter can control a wide range of power supplies (output voltage, or current), as well as other analog programmable devices. It may also be used as a low level signal source, depending on the speed of the controller. It has two output ranges (0–1 and 0–10 V dc in unipolar mode; –1 to +1 and –10 to +10 V dc in bipolar mode), as well as photo-isolators which electrically separate HP-IB control and data lines from power supply circuitry by up to 600 V dc. (For additional details see page 473).

HP Model	Description	Dimensions—max. height x width x depth mm (inches)	Net Weight kg (lb)	Shipping Weight kg (lb)	Price
59306A	Relay Actuator	101.6 x 212.9 x 294.6 (4 x 8.38 x 11.6)	2.64 (5.87)	3.23 (7.18)	\$2000
59307A	VHF Switch	101.6 x 212.9 x 294.6 (4 x 8.38 x 11.6)	2.64 (5.87)	3.23 (7.18)	\$1750
59309A	HP-IB Digital Clock	101.6 x 105.9 x 294.6 (4 x 4.17 x 11.6)	1.70 (3.78)	2.84 (6.31)	\$2900
59401A	Bus System Analyzer	145.5 x 205.1 x 495.3 (5.73 x 8.08 x 19.5)	5.64 (12.44)	9.1 (20)	\$4170
59501B	Power Supply Programmer	101.6 x 212.9 x 294.6 (4 x 8.38 x 11.6)	2.61 (5.80)	3.17 (7.04)	\$ 850

HEWLETT-PACKARD INTERFACE BUS

Versatile Interconnect System for Instruments and Controllers

571

Models 37201A, 37204A/B

HP 37204B

- High-speed HP-IB extension up to 1250 metres on coaxial cable and 3000 metres on fiber optic cable
- Cost effective multi-drop capability with up to 30 remote sites
- Extends a system without software changes
- Error-free transmission and chain truncation ensure uninterrupted operation of the controller
- Industry standard fiber optic connectors
- Compatible with 50/125 to 100/140 μm fiber diameters

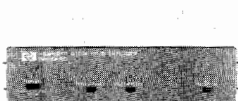

HP 37204A/B

HP 37201A

- Long-distance HP-IB extension over telephone lines (leased or dial-up)
- Data acquisition systems can operate over unlimited distances
- Multi-drop capability (leased lines only)
- Use with full-duplex synchronous/asynchronous modems from 300 to 19,200 bit/s
- RS-366 or CCITT V.25 autodial capability

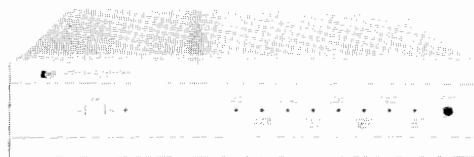

HP 37201A



HP 37204A Multi-point HP-IB Extender

Adding HP 37204As to an HP-IB system allows the 2-metre separation between HP-IB devices to be extended up to 1250 metres/3000 metres. The HP 37204A is "transparent" to HP-IB commands and data, therefore, software changes are not needed to turn a bench-top system into an extended system. Multi-point capability means remote sites can be daisy-chained together, using only one HP 37204A at each site. Chain truncation allows the computer site to continue operation, even in the event of remote power failure or link failure.

The HP 37204A has a maximum HP-IB transfer rate of 60 kbyte/s, however, the maximum achievable rate depends on many factors, such as speed and behaviour of each device connected to the HP-IB, number of remote sites, and distance. Increased absolute transmission delay affects parallel poll response time, and makes HP-IB extension inadvisable for some high-speed memory peripherals.

The following table shows some examples of maximum transfer rate. It should be noted that the serial transmission rate over coaxial cable must be reduced to 1/10th speed for distances greater than 250 metres.

Average Inter-extender Cable Length	Number of Extenders per Chain		
	2	3	5
100 metres - coaxial cable	54 kbyte/s	26 kbyte/s	14 kbyte/s
optical fiber	52 kbyte/s	25 kbyte/s	13 kbyte/s
500 metres - coaxial cable	5.9 kbyte/s	2.8 kbyte/s	1.4 kbyte/s
optical fiber	36 kbyte/s	17 kbyte/s	9 kbyte/s

HP 37204B: The HP 37204B is specifically intended for supported configurations of HP 3000 computers and certain high end printers, e.g. HP 256x A/B, 2680A, providing bus extension up to 250 metres on coaxial cable only.

Ordering Information

HP 37204A: Equipped with dual coaxial ports.	\$1,130
Option 003: Fiber optic interface. Adds a single fiber optic port with SMA connectors.	\$455
Option 004: Fiber optic interface. Adds dual fiber optic ports with SMA connectors. Required for the middle of a multi-drop optical fiber serial link.	\$855
Option 013: Fiber optic interface. Adds a single fiber optic port with ST connectors.	\$455
Option 014: Fiber optic interface. Adds dual fiber optic ports with ST connectors. Required for the middle of a multi-drop optical fiber serial link.	\$855
HP 37204B: Equipped with dual coaxial ports.	\$1,385
Options common to HP 37204A and HP 37204B	
Option W30: Three years of customer return repair service	\$50

☎ Fast-ship product—see page 734.

HP 37201A HP-IB Extender

The HP 37201A allows HP-IB devices to be interconnected over virtually unlimited distances.

The HP 37201A is "transparent" to most HP-IB commands, therefore in most cases, software modifications will not be needed to add HP 37201As into a system. Exceptions are that parallel poll and pass control functions are not supported. Software commands are required to use auto-dial, multi-drop, and idle facilities described below. Error correction ensures trouble-free performance over the worst phone lines. Multi-drop operation is possible using leased lines and modems with transmission (carrier) controlled by "request-to-send". Unlike the HP 37204A, remote sites must be accessed sequentially. The HP 37201A has an idle mode to allow faster operation at the computer site when remote communication is not required.

The data interface is compatible with RS-232-C/CCITT V.24 and V.28 standards. Full-duplex asynchronous or synchronous modems may be used. Asynchronous data rates provided are 150, 300, 600, 1200 bit/s. It should be noted that asynchronous modems must be capable of supporting 11-bit words (9 bits + start & stop bits). Although most asynchronous modems are insensitive to word length, some BELL 212 type modems only support up to 10-bit words, and so must be operated in synchronous mode. Synchronous modems can be operated at any bit rate up to 19.2 kbit/s.

The HP 37201A has an RS-366/CCITT V.25 autodial interface. For many applications, the HP 37212B Modem offers an alternative autodial solution. It requires a spare RS-232-C port on your computer, but obviates the need for a separate RS-366/CCITT V.25 autodialer. Manually-dialled connections are also supported.

The data byte transfer rate of the HP 37201A depends primarily on the serial data rate, data link length, and data link error rate. The following nominal transfer rates are for a short error-free link.

Synchronous modem interface: 744 data byte/s at 19.2 kbit/s, and pro-rata at lower serial rates.

Asynchronous modem interface: 38 data byte/s at 1200 bit/s, and pro-rata at lower serial rates.

Ordering Information

HP 37201A HP-IB Extender	\$2,775
Option 907: Front handle kit	\$59
Option 908: Rack flange kit	\$38
Option 909: Front handle/rack flange kit	\$84
Option W30: Three years of customer return repair service	\$70

DATA ACQUISITION SYSTEMS

General Information

- Reduce Manufacturing Costs
- Reduce Product Development Time
- On-Going Payback

- Improve Product Quality
- Higher Process Throughput
- More Process Up-Time

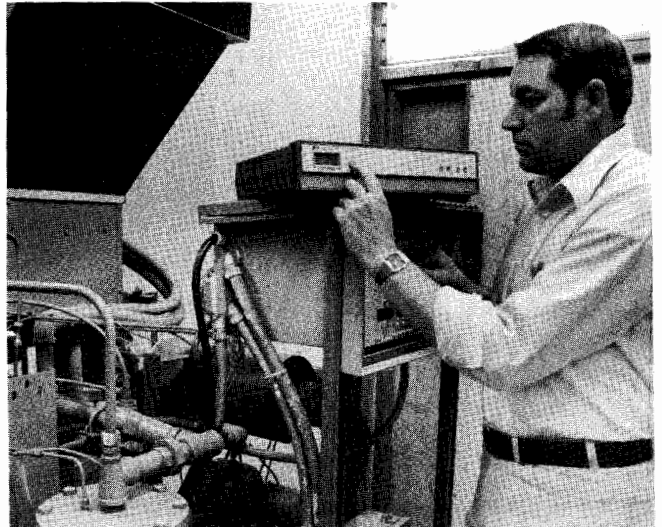

Data Acquisition is the generally accepted term for the procedure of characterizing a product or a process using electronic instruments. A "process" is defined as any procedure used to build a product or provide a service. A product or process is characterized by measuring it in minute detail so that all significant operating parameters are accurately known. Once characterized, improvements can be made that reduce costs and/or increase a product's performance/price ratio. A data acquisition system is a tool for increasing your bottom-line profitability.

Experience has shown that profit robbing inefficiencies are usually caused by many small errors rather than a few large ones. Today's modern electronic data acquisition systems can perform thousands of measurements per second, detect changes smaller than one part in one million and respond to those changes in less than 1/100th of a second. This high performance allows even large products and processes to be characterized in detail so that very high efficiencies can be attained.

The products and processes that can benefit from data acquisition are very broad. Producers of everything from automobiles to zucchini, research and development labs, utilities, educators, and the military services all have found that data acquisition is a cost effective technique.

The block diagram at the right shows how a typical data acquisition system is configured. A test program is stored in the computer. When executed, the program adjusts the product or process to a desired condition through the control functions in the data acquisition instrument. Then the computer directs the data acquisition instrument to take measurements. The measurements are analyzed and a report printed that describes the characteristics being tested. Based on the results, the product or process is modified to improve its performance. This cycle continues until optimization is achieved. Once the

critical control parameters and measurements are determined, the computer can be further programmed to automatically control the process or product at its optimum point.

Hewlett-Packard has been building electronic data acquisition systems for over 20 years. More than 150,000 systems have been installed worldwide. In addition to a broad

range of high quality computers and instruments, Hewlett-Packard has an ever-expanding offering of software and support services that provide a total data acquisition system solution. The following data acquisition system components from Hewlett-Packard can handle most applications in manufacturing, R&D, education, utilities and military/aerospace.

Product/Process Characterization Block Diagram

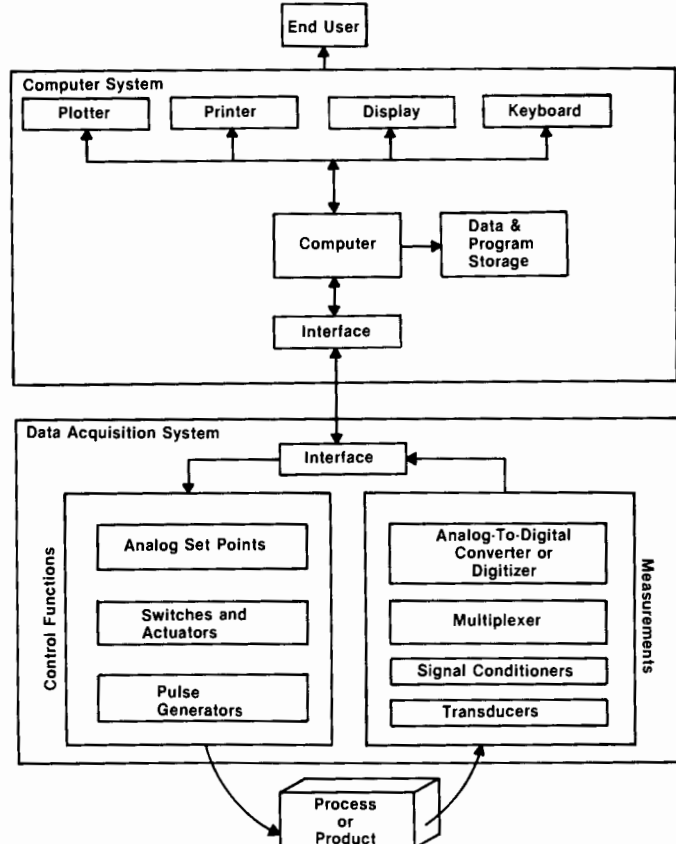

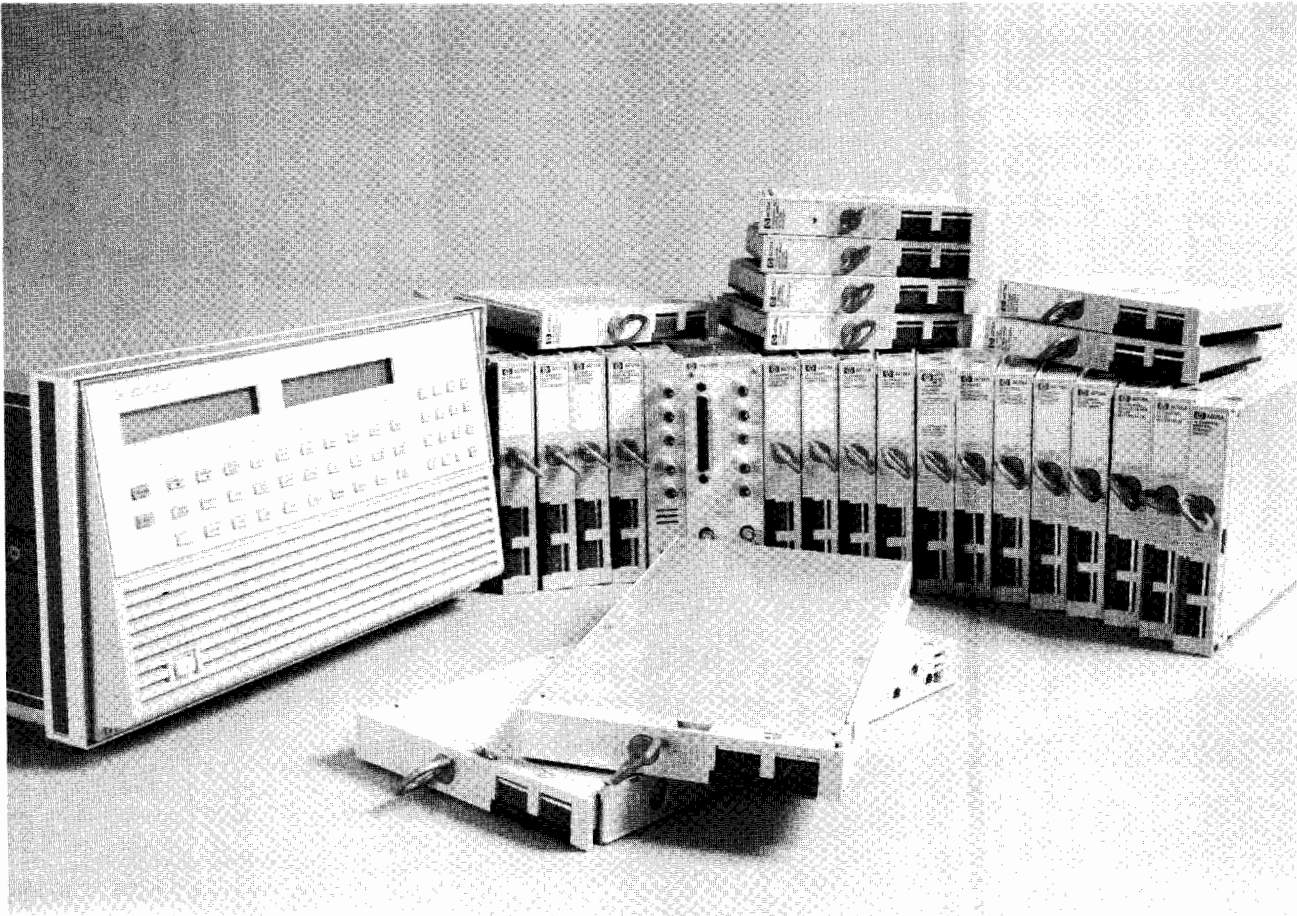

HP Data Acquisition System Components

Instruments

HP 3421A Data Acquisition Unit

- Low Cost
- Portable

HP 3497A Data Acquisition/Control Unit

- Built-in DVM and RS-232
- Large Selection of Plug-in Accessories

HP 3852A Data Acquisition/Control Unit

- Powerful Built-in Operating System
- Broad Functionality with Complete Line of Plug-in Accessories

HP 48000 Remote Terminal Unit

- Designed for Industrial Environments
- Remotely Locatable

Computers

HP Vectra Personal Computer

- IBM PC/AT Compatible
- Independent HP BASIC Language Processor

HP 9000 Series 300 Technical Computer

- High Performance
- Modular

HP 1000 Real-Time Computer

- Real-Time Processing
- Multi-User Operating System

Software

HP DACQ/PC Data Acquisition Manager

- Data Acquisition Software Tools
- Use with HP Vectra PC

HP DACQ/300 Data Acquisition Manager

- Data Acquisition Software Tools
- Use with HP Series 300 Technical Computer

Value Added Suppliers

- Software Packages Available for All HP Computers
- Expanding Selection

The Total Data Acquisition System Solution

Every data acquisition system requires a combination of computers, instruments, transducers and software. The extent to which these pieces are packaged together is dependent upon your individual needs. Whether its a completely integrated turnkey system, system components, plug-in board products or a customized in-house system, Hewlett-Packard can help. Turnkey solutions can be provided by HP's own Customer

Support Group or through an expanding network of independent Systems Integrators and Software Suppliers. Contact your local HP sales office for more information about these programs.

Information on data acquisition plug-in board products for Series 1000 and Series 9000 computers can be found on pages 650 and 656. Data acquisition software products are described on pages 616-619. Information

on instruments and computers for custom-built systems can be found under the headings for those products. The remainder of this section contains detailed information on data acquisition component systems. These systems provide solutions for a very broad range of applications. Contact your local Hewlett-Packard sales office for more information on how these systems can work for you.

DATA ACQUISITION SYSTEMS

Instruments for Measurement and Control

HP Model 3421A

- Up to 30 differential channels, 56 single-ended channels
- Electronic calibration for repeatable answers
- Built-in 5½ digit A/D converter with 1 μ V sensitivity
- HP-IL (standard) and HP-IB (optional) with rear panel switch
- Optional 12 volt remote charging adapter
- "Sleep mode" for extended battery life in remote locations
- Front terminals for convenient DCV, ACV, 2 & 4-wire ohms, frequency and temperature
- Display shows channels closed, digital states and self-test conditions

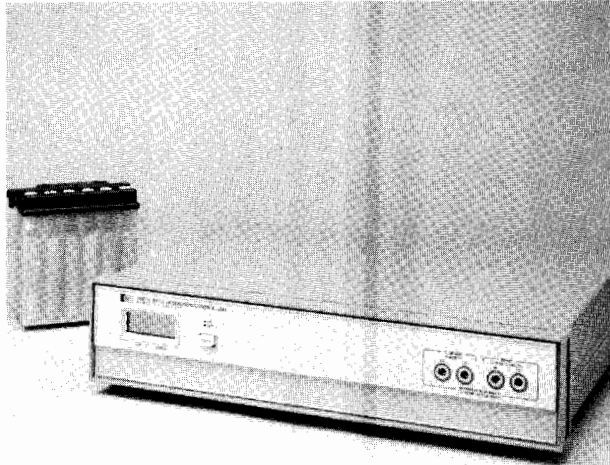

HP 3421A

Description

If your measurement needs exceed the capabilities of plug-in cards but don't quite call for a top-of-the-line data acquisition unit, the HP 3421A is just what you are looking for. The HP 3421A is the instrument that beats the high cost of data logging. Use it for small data acquisition projects with the assurance that it will quickly pay its own way. The HP 3421A can be configured with several different computers into a variety of systems designed for low to medium sized applications.

The HP 3421A with the Vectra Personal Computer

The HP 3421A is an ideal instrument companion for the Vectra Personal Computer. The HP 3421A and Vectra PC containing the BASIC language processor offer lab-quality measurements with PC convenience at an affordable price. DACQ/PC Data Acquisition Manager software (see page 618) provides powerful software tools for gathering, storing, analyzing, and presenting measurement data from more sophisticated data acquisition applications.

The HP 3421A with the Series 300 Technical Computer

For data acquisition applications that are computation intensive, the HP 3421A can be coupled with a Series 300 Technical Computer. DACQ/300 Data Acquisition Manager software (see page 618) offers the same powerful tool set as DACQ/PC with enhanced data transfer, system configuration routines, and color graphics.

The Instrument

The HP 3421A scans up to 30 channels, measuring DCV, ACV, 2- and 4-wire Ohms, Frequency, and Temperature. It also reads and writes digital information and stores up to 30 analog readings. The standard HP 3421A comes with an HP-IL interface for battery-powered flexibility or optionally HP-IB for more computational power.

Up to three of the following assemblies may be added to the HP 3421A mainframe:

- 10-channel analog multiplexer/actuator assembly with thermocouple compensation,
- 8-bit input/8-bit output digital assembly,
- Breadboard assembly for custom circuitry.

Measurement Integrity

With its 5½, 4½, 3½ digit A/D converter, the HP 3421A can resolve 1 μ V out of 300 mV to monitor thermocouples and other low-level transducers. Or it can read higher level signals by auto-ranging up to 300 volts dc.

System Versatility

Each HP 3421A can scan up to 30 differential channels or 56 single-ended channels of analog information. The HP 3421A is battery-powered with latching relays that will not change state when the ac line power is removed. Battery power gives the HP 3421A its own uninterruptible power supply.

The HP 3421A is not limited to portable applications. It is equally useful in laboratory situations, where its 0.01% accuracy, 1 microvolt sensitivity and 5½ digit resolution assure you of reliable answers.

Digital inputs, actuator outputs and a breadboard assembly give the laboratory designer a great deal of instrument flexibility while HP-IB compatibility adds the option of a more powerful instrument controller.

System Specifications

These rates assume 30 readings taken on a fixed range with no function change. Speeds are independent of channel sequence. These rates reflect the time to read and store information in the 30-reading buffer of the HP 3421A. They do not include computer transfer time.

Approximate Maximum Reading Rates (readings/second)

	DVC, Ω		ACV		Frequency	Type T Thermocouple
	Auto Zero On	Auto Zero Off	Auto Zero On	Auto Zero Off		
5½ Digit	2	3.8	—	—	0.1	0.95
4½ Digit	13	18	0.3	0.3	0.9	0.95
3½ Digit	21	24	0.4	0.4	7.0	0.95

HP 3421A Mainframe Specifications

The HP 3421A mainframe comes with:

- A 5½, 4½, and 3½ digit integrating A/D converter
- Thermocouple compensation
- Type T thermocouple linearization built in
- HP-IL
- 30-reading storage buffer
- LCD 30 channel display with power and error indicators
- Electronic calibration
- Rechargeable battery
- High level command set

All specifications apply for relative humidity less than 85% at 30 degrees C.

DC Voltage

Ranges: 300 mV, 3 V, 30 V, 300 V, Autorange
Basic accuracy: $\pm(.009\%$ reading + 3 counts); 5½ digits
Reading rates: 2 to 35 readings/second

Resistance

Ranges: 300 Ω , 3 k Ω , 30 k Ω , 300 k Ω , 3 M Ω , 30 M Ω ; Autorange
Basic accuracy: $\pm(.012\%$ reading + 3 counts); 5½ digits
Reading rates: 2 to 35 readings/second

AC Voltage

Ranges: 3 V, 30 V, (300 V with HP 44469A divider)
Converter type: averaging
Resolution: 3½ or 4½ digits
Basic accuracy: 4½ digits: $\pm(0.5\%$ reading + 60 counts), 45 Hz to 500 Hz; $\pm(1\%$ reading + 60 counts), 30 Hz to 1 kHz; providing the input voltage is at least 10% of range.

Counter

The counter is part of the mainframe circuit, and is multiplexed through the channel relays.
Resolution: 65,535 counts
Frequency: 1 Hz to 10 kHz
Modes: frequency, totalize

Thermocouple Thermometer

Type T thermocouple linearization is built in. For other thermocouple types, the reference junction temperature is available on each multiplexer assembly.

Temperature Errors

These errors include the linearization error of the HP DACQ/PC software, thermal offset voltages, A/D error and reference junction error. They do not include transducer errors.

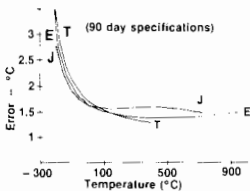
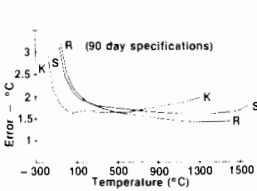
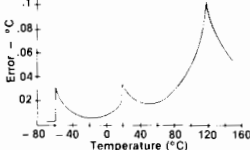
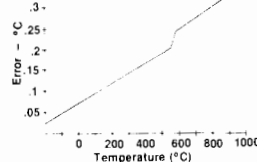
J,E,T Thermocouples**K,R,S Thermocouples****2.2 k Ω Thermistor**
(90 day specifications)**100 Ω Platinum RTD $\alpha = .00385$**
(90 day specifications)**Option 020, 021, 022 Multiplexer/Actuator Assemblies**

The configuration of multiplexer and actuators depends on the option you order. Option 020 has 8 multiplexer/2 actuator channels; Option 021 has 9 multiplexer/1 actuator channels; Option 022 has 10 multiplexer channels. The actuators are capable of switching 252 Vac. One HP 3421A mainframe can hold up to 3 assemblies.

Option 040 Breadboard Assembly

The breadboard assembly is convenient for constructing custom circuitry. It comes complete with a manual describing the circuit that enables the HP 3421A to communicate directly with an 8-bit microprocessor.

Option 050 Digital I/O Assembly

Option 050 has 8 isolated input lines and 8 isolated output lines for both monitoring and controlling external digital devices.

Option 201 HP-IB

The Option 201 adds an HP-IB interface to the HP 3421A. This allows the use of either HP-IB or HP-IL. HP-IB Interface function includes: SH1, AH1, T6, TE0, LE0, L4, SR1, RL0, PP0, DC1, DT1, C0. For more on these codes, see the HP-IB section of this catalog.

Option 214 12 Volt Remote Charging Adapter

This optional assembly provides the necessary isolation and regulation for a 12 volt automotive battery or system to charge the batteries of the HP 3421A, HP 71B Handheld Computer, and peripherals such as the HP 9114B Portable 3½" Microfloppy and HP 2225B Thinkjet Personal Printer. Option 214 is mutually exclusive with Option 201 (HP-IB).

Ordering Information

HP 3421A Data Acquisition/Control Unit \$1,920

Input and I/O Assembly Options

020: 8 Channel Multiplexer/2 Channel Actuator Assembly \$445

021: 9 Channel Multiplexer/1 Channel Actuator Assembly \$445

022: 10 Channel Multiplexer Assembly \$445

040: Breadboard Assembly with connector block \$108

050: 8 bit in, 8 bit out Digital I/O Assembly with connector block \$445

201: add HP-IB interface. Allows use of EITHER an HP-IB or HP-IL controller \$340

214: add 12 volt remote charging adapter. Cannot be added if opt 201 is specified \$460

Rack Mount and Manual Options

401: Side Handle Kit \$44

907: Front Handle Kit \$60

908: Rack Mount Kit \$39

909: Rack Mount with Handle \$88

910: Extra Manuals \$103

Field Installation Kits*

HP 44461A: Add HP-IB interface. Allows use of either an HP-IB or HP-IL Controller (same as Opt 201) \$340

HP 44462A: 8-Channel Multiplexer/2 Channel Actuator Assembly with thermocouple compensation, connector block. (Same as Opt 020. Can be reconfigured to same as Opt 021 or Opt. 022) \$445

HP 44463A: extra connector block for HP 44462A \$55

HP 44464A: Breadboard Assembly with connector block (same as Opt 040) \$108

HP 44465A: 8 bit in, 8 bit out digital I/O assembly with connector block (same as Opt 050) \$445

HP 44466A: Extra connector block for digital or breadboard assembly \$20

HP 44469A: Seven 10:1 dividers for measuring 300 Vac \$20

HP 44469A: Seven 10:1 dividers for measuring 300 Vac \$20

Accessories

HP 11340A: 20-metre HP-IL Cable \$113

HP 11340B: 50-metre HP-IL Cable \$216

HP 11340C: 100-metre HP-IL Cable \$420

Related Products

HP 3468A Digital Multimeter \$820

* Field installation is recommended to be performed only by service trained personnel.

☎ Fast-ship product — see page 734.

DATA ACQUISITION SYSTEMS

Instruments for Measurement and Control

HP Model 48000 RTU Family

- For Industrial Monitoring and Control
- Stand-Alone or System Operation
- Radio/Modem/Wireline Datacom

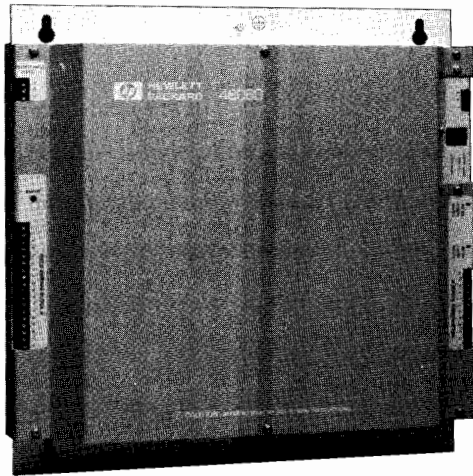

HP 48060A RTU

Description

The HP 48000 Remote Terminal Unit (RTU) are intelligent, microprocessor-based measurement and control units designed to operate in harsh industrial and remote environments. The HP 48000 RTU starts with 16 I/O points which can be increased to 256 I/O points with optional expansion modules.

The HP 48060A RTU is the newest member of the HP 48000 RTU product family, addressing applications that require small point counts. The HP 48060A RTU has 13 I/O points.

Applications for the HP 48000 RTU family include:

- Oil and gas production
- Pipeline SCADA systems
- Water treatment systems
- Electrical utility SCADA systems
- Facility/energy management
- Process monitoring & control

Built-in Intelligence

Intelligent processing is easy to implement on the HP 48000 RTU, because HP provides the right tools: built-in signal-processing functions, along with a built-in BASIC compiler. Both can be accessed through the Application Development Software, which runs on a variety of HP personal computers.

To offload host-computer processing, the HP 48000 incorporates over 50 of the most commonly required signal-processing functions. These include PID loop control, AGA flow calculations, engineering unit conversion, and alarm checking. When the database of the HP 48000 is being configured, these functions can be chained to perform multiple processing of input and output signals.

Easy to Program

The HP 48000 contains a built in BASIC that can be used for more complex signal processing, and for custom control routines. The BASIC is incrementally compiled, providing fast program execution in a multi-tasking environment. Up to eight BASIC tasks may reside in a single HP 48000 RTU.

The HP 48071A/72A menu-driven Application Development Software for the HP 48000 lets system designers quickly configure the RTU database to their own specifications. This software runs on the HP Vectra and the HP Portable Plus. To configure the database, the user simply selects the field on the display screen and keys in values relating to his specific application. (The database can also be configured from the HP 3081A Portable Operator Panel or a host computer.)

- Rugged Design for Harsh Environments
- Menu Driven Configuration
- Multi-Tasking BASIC

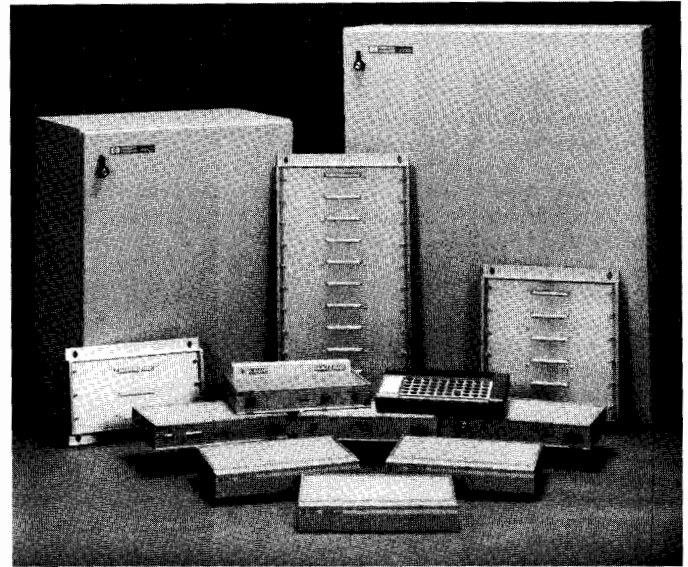

HP 48000 RTU Family

High Quality and Reliability

The HP 48000 RTU family is designed to withstand harsh environments. It is so rugged and reliable that a typical configuration has a Mean Time Between Failures of over five years!

Here are some features that make such performance possible.

- Use of CMOS technology contributes to the wide operating temperature specifications
- Aluminum module enclosures shield circuit boards from physical contact and ESD damage
- Transient voltage suppressors protect the electronics from electrical surges on the power line and field terminal wiring
- I/O modules are internally protected from field-wiring shorts
- Pin-and socket connectors provide reliable interconnection

General Specifications

Temperature Range: -40°C to $+65^{\circ}\text{C}$ (operating); -65°C to $+85^{\circ}\text{C}$ (storage)

Humidity Range: 5 to 95% non-condensing

RFI Susceptibility: 1 volt/meter from 14 KHz to 1 GHz

EMI Emissions: Meets VDE 0871 level B

Vibration: Random vibration 0.30 Grms 5 to 500 Hz (functional). Random vibration 2.41 Grms 5 to 500 Hz (survival).

Shock: Half-sine shock pulse of <3 ms duration with 175 cm/s velocity change (functional). Trapezoidal shock pulse of 30 G with 742 cm/s velocity change (survival).

Transient Protection: Meets IEEE 472/ANSI-C37.90a for ability to withstand surges at all communications and field wiring points. Meets IEEE 587 standards for ability to withstand power-line surges.

Dimensions: 330mm W x 215mm D x 55mm H (13" x 8.5" x 2.17")

Electrical Classification: General Non-Hazardous Area (CSA-, FM- & TUV approved).



Communications Flexibility

The diagram to the right shows some of the typical networks that can be configured with the HP 48000 RTU. Remote data acquisition and control systems are easily implemented using twisted-pair wireline, radio-communication links or telephone company facilities.

The host computer accesses data in a network of remote units in one of three modes:

- Standard poll/response
- Polled Report-By-Exception (PRBX)
- Spontaneous Report-By Exception (SRBX)

This choice of communication modes, and the availability of both HEX ASCII and Radix-64 ASCII protocols, lets users maximize communication efficiency for their applications.

Other data communication features of the HP 48000 RTU products include:

- A Modem Module 202T or CCITT frequency
- A RS232 C port that supports smart auto-dial modems
- A FCC and DOC approved Radio Datacom Module
- A data link Repeaters to extend wireline communications
- Communication Handler software for HP host computer interface
- Multi-drop networking capabilities of up to 90 RTUs over a maximum distance of 3.6 kilometers (2.25 miles)
- The capability of communications protocol emulation

HP 48000 RTU Ordering Information

	Price
HP 48002A 6-Slot Backplane	\$275
HP 48003A 11-Slot Backplane	\$375
HP 48004A NEMA-4 Cabinet (3/6 slot)	\$525
HP 48005A NEMA-4 Cabinet (11 slot)	\$525
HP 48010A Master Controller Module	\$2740
HP 48020A Configurable I/O Module (16 ch)	\$1810
HP 48021A Analog Output Module (4 ch)	\$1675
HP 48022A Low Level Input (16 ch) (with thermocouple compensation)	\$3405
HP 48023A Isolated Digital Relay Output Module (8 ch)	\$1260
HP 48024A Digital Input Module (32 ch)	\$1285
HP 48025A Isolated Digital Input Module (16 ch)	\$1260
HP 48026A Isolated Digital Triac Output Module (8 ch)	\$1365
HP 48028A Digital Input/Output Module (24 ch)	\$1440
HP 48030A Power Supply Module	\$1390
HP 48041A Modem Module	\$890
HP 48085A 48000 Family Manual Set	\$480

Common Accessories

Application Development Software

	Price
HP 48071A HP Portable Plus Version	\$255
HP 48072A HP Vectra PC Version	\$255
HP 48079A User-Defined Code Development Software	\$780

Communication Handlers

	Price
HP 48073A HP 1000 A-Series Version	\$137
HP 48075A HP 9000 Series 200/300 Version	\$76
HP 48076A HP Vectra PC Version	\$76
HP 48077A HP 9000 Series 300 HP/UX Version	\$153
HP 48078A DEC VAX/VMS Version	\$153
HP 48082A Datacommunications Adapter	\$790

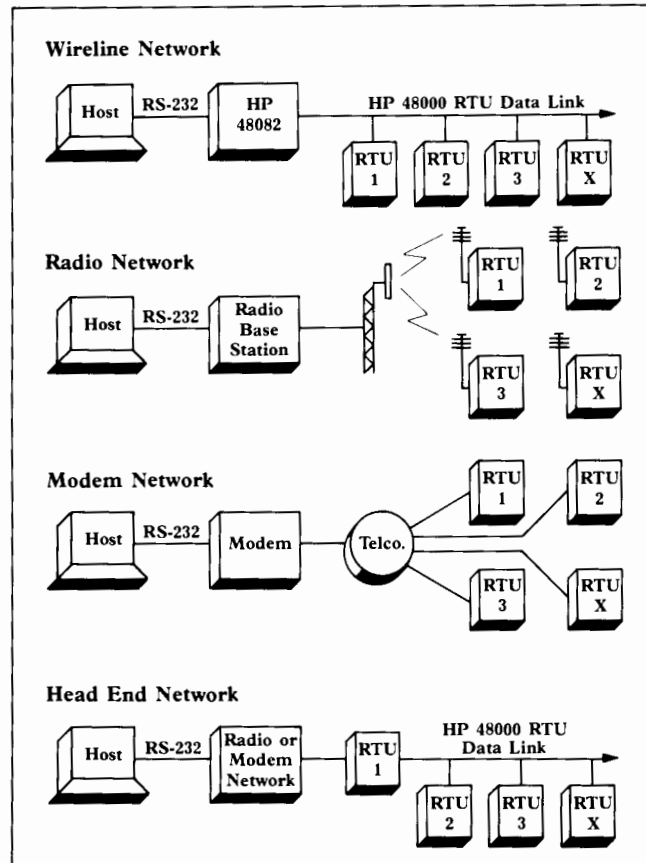

HP 48060A RTU Ordering Information

	Price
HP 48060A Standard Unit with 13 I/O Points	\$1525
Opt 011 Adds RS-232-C/RS-422 Port	+\$395
Opt 012 Adds HP 48000 Datalink Port	+\$350
Opt 013 Adds Bell 202 Modem Port	+\$415
Opt 014 Adds Bell 212/103 Modem Port	+\$415
Opt 022 Adds 128K EPROM (max)	+\$93
HP 48004A NEMA-4 Cabinet	\$525
HP 48033A External Power Supply (+24 VDC)	\$660
HP 48086A 48060A Manual Set	\$380

HP 48050A RTU Ordering Information

	Price
HP 48050A Standard Unit with 23 I/O Points	\$3280
Opt 001 Adds 22 ch I/O Expansion Board	+\$1050
Opt 003 Adds 18 ch I/O Expansion Board	+\$1285
Opt 011 Adds RS-232-C/RS422 Port	+\$400
Opt 012 Adds HP 48000 Datalink Port	+\$350
Opt 013 Adds Bell 202 Modem Port	+\$505
Opt 014 Adds Bell 212/103 Modem Port	+\$655
Opt 022 Adds 128K EPROM	+\$93
Opt 023 Adds 256K EPROM (max)	+\$170
HP 48004A NEMA-4 Cabinet	\$525
HP 48033A External Power Supply (+24 VDC)	\$660
HP 48086A 48050A Manual Set	\$380

DATA ACQUISITION SYSTEMS

Instruments for Measurement and Control

HP Model 3497A

- Relay multiplexing
- DVM
- FET multiplexer
- Real time clock
- Bridge completion

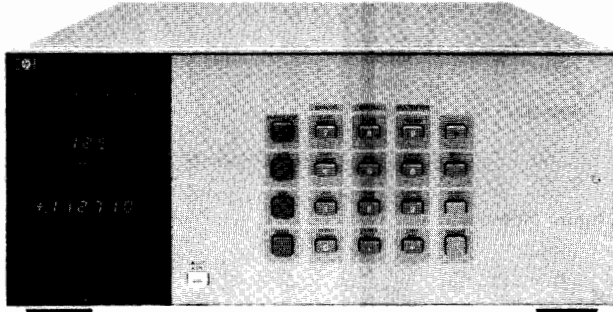

HP 3497A

Description

The HP 3497A Data Acquisition/Control Unit combines the capabilities of several instruments and is a basic building block of an automatic data acquisition and control system. The HP 3497A will be used in an HP-IB automated system and can be viewed as a precision measurement and control computer peripheral.

The HP 3497A has been designed to be a very versatile and very powerful instrument. A basic HP 3497A consists of a mainframe that includes a front panel keyboard and display, a non-volatile real time clock, and an HP-IB interface. Available as an option is a 5½ digit integrating digital voltmeter and current source that occupies a dedicated slot in the HP 3497A chassis. Capability is added to the HP 3497A by using any combination of plug-in assemblies. Available plug-in assemblies are:

- Relay Multiplexers with or without thermocouple compensation
- FET Multiplexer
- Digital Input/Interrupt
- Counters
- Strain gage/bridge completion
- Actuators
- Programmable voltage and current D/As
- Breadboard Assembly

Up to 5 assemblies can be added to a HP 3497A and the HP 3498A Extender chassis can hold up to 10 more plug-in assemblies.

High Performance

The HP 3497A DVM can resolve 1 microvolt signals and is ideal for the precise measurement of the outputs of thermocouples, strain gauges and other transducers. Included on the DVM is a programmable current source that allows four-terminal resistance measurements. The multiplexer assemblies switch 3 wires (Hi, Lo, and Guard) and add less than 2 microvolts of thermal offset to the measured signal.

Flexible Hardware Configuration

The HP 3497A card cage can hold 5 of any combination of the plug-in assemblies. This allows the multiplexing of up to 100 3-wire inputs to the DVM in a single HP 3497A or a single HP 3497A might contain 60 multiplexer channels, 16 digital inputs, 16 actuator outputs, and a DVM. By using HP 3498A Extenders, up to 1000 analog channels or 1360 digital channels can be controlled, all at a single bus address.

Ease of Use

The HP 3497A keyboard and display make the HP 3497A very easy to use and make debugging of a HP 3497A based system easy. The calibration adjustments for the HP 3497A DVM are located behind a hinged front panel; this allows complete calibration of the DVM without removing it from the test rack. Connections to all of the HP 3497A assemblies are made using screw terminals, eliminating the need for soldering.

Real Time Clock

The HP 3497A mainframe includes a quartz-referenced, non-volatile, real-time clock. In addition to providing timing data, the clock can mea-

- Digital inputs/outputs
- Counter
- Programmable D/As
- Optional RS-232C interface

sure elapsed time, interrupt at a presettable time, and output a programmable pulse train.

Clock Format

Month:Day:Hours:Minutes:Seconds (U.S. Format)

Day:Month:Hours:Minutes:Seconds (European Format)

Option 001—5½ Digit DVM and Current Source

The HP 3497A DVM assembly is a systems quality, 5½ digit, 1 microvolt sensitive dc voltmeter. The DVM is fully guarded and uses an integrating A/D conversion technique; this yields excellent common mode noise rejection.

Included on the DVM assembly is a three level programmable current source. The current source, when used simultaneously with the DVM, can be used to make high accuracy four terminal resistance measurements with 1 milliohm resolution. Maximum speed is 300 readings per second in 3½ digit mode.

Buffer size: packed format: 100 readings; ASCII format: 60 readings

Scanning Speeds	Number of Digits Selected	Series 200/300	1000A*
Sequential Channels using external increment	5½ digits	39	39 (25)
	4½ digits	103	108 (79)
	3½ digits	123	127 (99)
Random Channels using software	5½ digits	27	24 (20)
	4½ digits	51	41 (34)
	3½ digits	55	43 (36)

*A600+ speeds in FORTRAN

Option 010—20 Channel Relay Multiplexer

This assembly uses reed relays to multiplex signals to the DVM or other instruments. Each assembly switches 20 channels, each channel consists of Hi, Lo, and Guard lines. Two channels may be closed per assembly and relays may be closed in a random sequence or incremented between programmable limits. The low thermal offset of the relays make it suitable for measuring the outputs of strain gage and other transducers. Each channel can be configured with a filter or current shunt for additional flexibility.

Option 020—Relay Multiplexer with Thermocouple Compensation

The option 020 assembly uses the same relay multiplexer as option 010 but incorporates a special isothermal connector block to allow thermocouple compensation. Two types of compensation (selectable by the user) are available. A temperature-dependent voltage is generated for software compensation; this voltage is then used in a computer program to compensate the thermocouple voltage. Hardware compensation involves inserting a voltage in the measurement circuit that automatically compensates the thermocouple voltage.

Option 030—20 Channel FET Multiplexer Assembly

The option 030 assembly is used to multiplex input signals to a DVM in a manner similar to option 010. The option 030 assembly provides high speed, low level multiplexing. Maximum signal levels are 12 volts peak between any high, low or guard input and any other guard input, guard common or chassis ground.

Maximum sequential scanning rate: 4800 readings/s (at 60 Hz) using an HP 3437A Voltmeter and HP Series 200 computer (4000 readings/s at 50 Hz power).

Option 050—16 Channel Isolated Digital

The option 050 assembly can sense up to 16 channels of digital data. The first 8 channels can also be used as interrupt lines to detect transient signals. The assembly can accept inputs of 5, 12 or 24 volts and all functions and masks are fully programmable. A five-volt supply is provided for driving external contact closures and open collector outputs.

Option 060—100 kHz Reciprocal Counter

This option can be used to measure mechanical and low frequency electronic signals. The counter can measure the period of signals up to 100 kHz and the pulse width of signals down to 18 μ s. The counter can also count up or down from a programmable start point. It can accept inputs of 5, 12, or 24 volts including CMOS, open collector TTL and passive contact closures.

Option 070—120 Ohm Strain Gage/Bridge Completion Assembly**Option 071—350 Ohm Strain Gage/Bridge Completion Assembly**

The option 070/071 assemblies may be used to provide bridge completion for measuring strain gages, RTDs pressure sensors and load cells. Each card uses an internal shared half bridge and can complete 10 channels of $\frac{1}{4}$ and $\frac{1}{2}$ and full bridges in any combination. When used with a +5 V excitation supply (such as the HP 6214A) and the HP 3497A DVM, the assembly provides 0.1 μ e sensitivity with 1 μ e accuracy. Provisions are made for shunt calibration and checking gage leakage and lead resistance.

Option 110—16 Channel Actuator**Option 115—8 Channel High Voltage Actuator**

Option 110 consists of 16 mercury wetted form C (single pole-double throw) relays. Each relay can be individually closed and can switch 1A at 100V. The actuator assembly can be used to switch test fixture power or to actuate alarm bells. This flexibility of this assembly allows it to be used as a digital output or matrix switch.

Option 115 is an 8 channel high voltage actuator assembly that can switch voltages up to 252 Vrms and currents up to 2 amperes. The Option 115 assembly is ideal for switching power line voltages to small motors, alarm bells and lights, motor starters and solenoids.

	Option 110 C	Option 115 A
Switch Form	Mercury Wetted	Dry
Contact Type	16	8
Number of channels	100 V Peak	252 Vrms
Maximum Voltage	1 A	48 Vdc
Maximum Current	100 VA	2 Arms or dc
Maximum Power		500 VA ac 60 VA dc

Option 120—Dual Voltage D/A**Option 130—Dual Current D/A**

Option 120 consists of two 0 to ± 10 V programmable voltage sources. These sources can be used to provide a programmable test stimulus or to control voltage programmed devices like power supplies and VCOs.

Option 130 consists of two 0 to 20 mA or 4 to 20 mA programmable current sources. These sources, especially when using the 4 to 20 mA range, can be used as transmitters in industrial current loops and can drive up to 600 ohms of total loop resistance.

Option 120

Output: 13 bits including polarity

Least significant bit: 2.5 mV

Output range: -10.2375 V to +10.2375 V

Maximum output current: 15 mA (output within specifications)

Option 130

Output: 12 bits

Least significant bit: 5 μ A (0 to 20 mA range)
4 μ A (4 to 20 mA range)

Output range: 0 to 20.475 mA or 4 to 20.380 mA (each source jumper selectable)

Compliance voltage: 12.0 volts

Option 140 Breadboard Card

Option 140 is a breadboard card compatible with the HP 3497A cardage. Using this card, HP 3497A users can construct special purpose assemblies that communicate with the HP 3497A backplane.

Option 232—RS232C Interface

Option 232 to the HP 3497A deletes the standard HP-IB interface and adds an RS232C (CCITT/V.24) compatible interface allowing you to remotely locate the HP 3497A. The option 232 interface is also compatible with the new RS423 (CCITT/V.10) version of the RS449 interface.

Option 298—HP 3498A Extender

The HP 3498A Extender chassis allows low cost expansion of HP 3497A-based systems. Each HP 3498A can hold up to ten HP 3497A

plug-in assemblies. Use of one or more HP 3498As requires an HP 3497A (for control); all required connecting cables are supplied with the HP 3498A. Up to 13 HP 3498As can be controlled by a single HP 3497A.

Software

HP DACQ/PC Data Acquisition Manager (HP 44459A/B/R): Powerful software tools for gathering, storing, analyzing, and presenting measurement data with a Vectra Personal Computer and the BASIC language processor. (see page 618).

HP DACQ/300 Data Acquisition Manager (HP 44458A/B/R): Sophisticated software tools that provide all of the power of HP DACQ/PC plus enhanced data transfer, system configuration routines, and color graphics on Series 300 Technical Computers (see page 618).

General

Size (HP 3497A or HP 3498A): 190.5 mm H x 428.6 mm W x 520.7 mm D (7 $\frac{1}{2}$ " x 16 $\frac{7}{8}$ " x 20 $\frac{1}{2}$ ").

Net weight: HP 3497A, 20.4 kg (45 lb) and 3498A, 20.4 kg (45 lb) with assemblies in all slots.

Shipping weight: HP 3497A and HP 3498A maximum with assemblies in all slots are 26.3 kg (58 lb.)

Operating temperature: 0°C to 55°C

Non-operating temperature: -40°C to 75°C

Humidity: to 95% at 40°C except as noted

Operating power: switch selection of 110, 120, 220 and 240 volts $\pm 10\%$, 48-66 Hz, 150 VA 3497A and 3498A.

Ordering Information**Price**

Each HP 3497A can hold one DVM assembly (Opt 001) and up to 5 plug-in assemblies. Each HP 3498A (Opt 298) can hold 10 additional plug-ins. To order plug-ins without a mainframe, order as 444XXX Field Installation Kits as shown below.

Clock format and power line frequency and voltage will be set at the factory based on the country from which the order was placed.

HP 3497A Data Acquisition/Control Unit	\$3,500
Opt 001 or 44420A: 5 $\frac{1}{2}$ Digit DVM and Current Source	\$1,855
Opt 010 or 44421A: 20 Channel Relay Multiplexer Assembly	\$745
Opt x20 or 44422x: Relay Multiplexer Assembly Substitute A in place of x for software compensation. For hardware compensation, substitute the thermocouple type B, E, J, K, R, S, or T for x.	\$780
Opt 030 or 44423A: 20 channel FET Multiplexer Assembly	\$850
Opt 050 or 44425A: 16 channel Isolated Digital Input/Interrupt Assembly	\$645
Opt 060 or 44426A: 100 kHz Reciprocal Counter	\$720
Opt 070 or 44427A: 120 Ohm Strain Gage/Bridge Completion Assembly	\$1,080
Opt 071 or 44427B: 350 Ohm Strain Gage/Bridge Completion Assembly	\$1,080
Opt 110 or 44428A: 16 Channel Actuator/Digital Output Assembly	\$850
Opt 115 or 44431A: 8 Channel High Voltage Actuator Assembly	\$745
Opt 120 or 44429A: Dual Output Voltage DAC Assembly	\$1,185
Opt 130 or 44430A: Dual Output Current DAC Assembly	\$1,185
Opt 140 or 44432A: Breadboard Card	\$200
Opt 232: Delete HP-IB Interface, add RS232C Interface	\$360
Opt 298: Add HP 3498A Extender & Connecting Cables	\$2,350

DATA ACQUISITION SYSTEMS

Instruments for Measurement and Control

Model 3852A

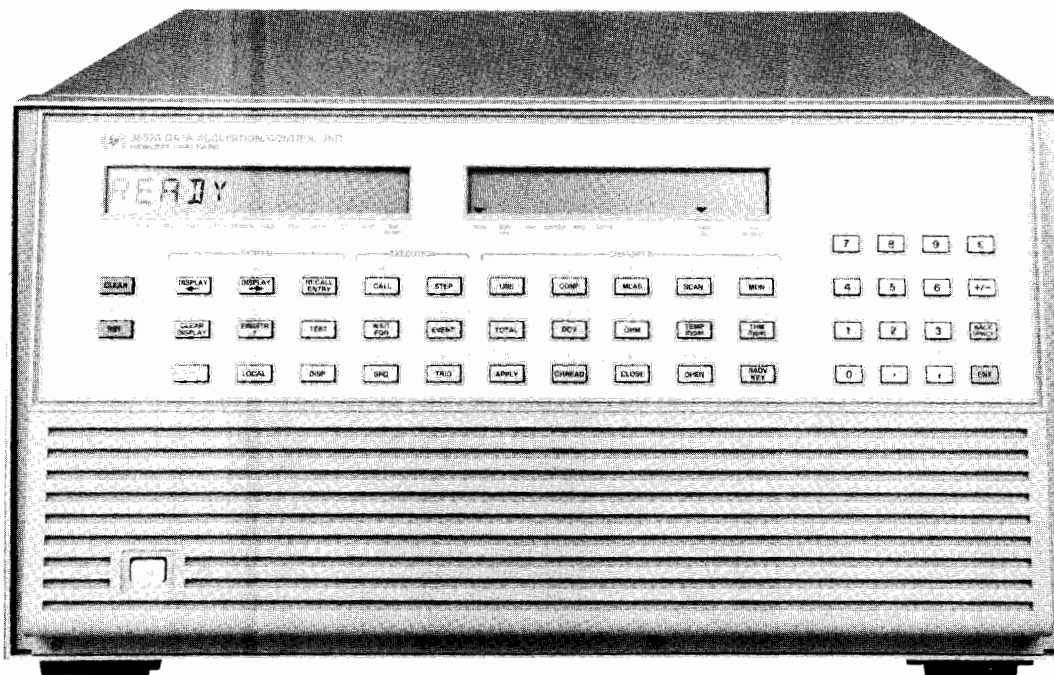

HP 3852A



Configure the Capabilities You Need

You can easily configure an HP 3852S Data Acquisition and Control System to meet your needs for measuring physical parameters through transducers, and for providing control outputs. The HP 3852A Data Acquisition/Control Unit (mainframe) has eight slots for plug-in function modules. If more slots are needed, up to seven extenders can be added, each with ten additional slots. You can choose any combination of capabilities that include precision and high-speed plug-in voltmeters and a variety of analog and digital input/output functions.

A system clock and programmable pacer are built-in to drive your system. The clock — non-volatile for four years; 1 msec resolution—allows data to be time-stamped and events to be timed. The pacer—0.25 μ sec resolution—provides powerful capabilities to initiate and pace measurements, scans, or events.

Include High-Speed and Accurate Analog Measurements in One System

Choose from two digital voltmeters to meet your measurement needs. For applications that require sensitive, accurate measurements in the presence of noise (for example, thermocouples), use the 5 $\frac{1}{2}$ -Digit Integrating Voltmeter and Relay Multiplexers. If you need speed, the 13-Bit High-Speed Voltmeter and High-Speed FET Multiplexers are the answer, providing single-channel bursts, channel-to-channel, random channel, full auto-ranging, and direct DMA transfers to a hard disc at an honest 100,000 readings/sec. The system voltmeters can be used in the mainframe or any extender, and multiple voltmeters are allowed per card-cage.

Add Versatility and Expandability to Your System

With the HP 3852A Data Acquisition and Control System, you'll have available a complete set of input and output plug-in modules for interfacing to measurements and for controlling and sequencing your tests. Modules are available to handle physical measurements of temperature, flow, pressure, level, and strain. The HP-IB controller module gives you the capability to autoboot subroutines stored on a disc and to store data to the disc without computer assistance.

Take Advantage of Extensive Front-End Intelligence

The HP 3852A mainframe has considerable built-in intelligence to increase the speed of collecting measurement and control data. Control decisions can be handled faster using subroutines running within the mainframe. This intelligence can be used to *return only significant data* to the computer, increasing its efficiency.

- Up to 5,500 readings can be stored in the standard HP 3852A mainframe. Expand this memory (used for storage of user routines as well as readings) to 256 kbytes, 1 Mbytes, 2 Mbytes, or 4 Mbytes with an Extended Memory board. Extended memory fits inside the mainframe controller module without using an I/O slot.

The power of this front-end intelligence in combination with an HP Series 300 Computer and the optional data acquisition software adapts easily to testing your complex product or characterizing your process. Of course, the mainframe can be also used with HP 1000 computers, HP Vectra PC, other IEEE-488 controllers and instruments, and a variety of computer peripherals.

Reduce Your Test Development Investment

Optional data acquisition software for an HP Series 300/200 computer or HP Vectra PC gets your application running quickly and easily by providing off-the-shelf solutions for:

- Data base management — store large amounts of data in files that are easy to identify and access later.
 - Graphics presentations — display or plot color graphs, display a real-time strip chart, plot data with linear, log, semilog, or automatic axis scaling.
 - Data analysis — This software provides high-level subroutines as tools to be used in a test system program running with HP BASIC. Ease-of-use is exemplified by:
 - automatic creation of a data base for storing data using only one subroutine,
 - fast access to a single data item or a block of data items using only one subroutine,
 - manipulation and formatting of gathered data any way you wish.
- Program development time is leveraged using this software, while allowing a powerful, highly customized system to be developed. Furthermore, the software can be used with any HP-IB instrument.

Data Acquisition and Control Unit — HP 3852A

Mainframe Supports:

- Eight Function Module Slots
- Data Acquisition Operating System
- System Timer
- Measurement Pacer
- Full Alphanumeric Keyboard, Command and Result Displays

Benefits

- **Make real-time decisions and reduce data without burdening your computer:**
 - Multitasking operating system prioritizes and timeslices tasks
 - Powerful HP 3852A command statements simplify complex measurements.
 - Execution speed of command sequences are enhanced by executing subroutines stored in the HP 3852A memory.
 - Built-in, easy-to-use transducer conversions are supported for thermocouples, thermistors, RTDs, and strain gages.
 - Post-processing and data reduction before transferring results to a computer are achievable by first storing data to the HP 3852A internal memory.
 - Limit checking of analog measurements is performed in real time or after the measurements have been stored in mainframe memory.
- **Optimize measurement timing and throughput to meet your needs:**
 - Real-time interrupts allow higher priority tasks and external inputs to be serviced at any time
 - Asynchronous communication with a computer is achieved through input and output buffering.
 - Control can be timed using built-in clock and alarm capabilities (can cause an interrupt).
 - A built-in pacer simplifies measurement timing and triggering.
 - Multiple voltmeters can be used. The high-speed voltmeter can control scanning, timing, and triggering of its own high-speed FET multiplexer subsystem via ribbon cable. Several of these subsystems can run simultaneously.

Commands:

Powerful data acquisition commands are easy to remember and use. For example, "MEAS TEMPK <channel list>" performs K-type thermocouple measurements, cold-junction compensation, linearization, and channel scanning—ALL AUTOMATICALLY. In addition, <channel list> may be a short list of channels—or possibly the name of an array containing a much longer list.

Down-Loaded Subroutines:

FOR...NEXT, IF...THEN...ELSE, WHILE...ENDWHILE Enhanced BASIC language constructs are available.

User subroutines with variables can be called for execution by a computer, other subroutines, or conditional interrupts.

Transducer Conversions:

Transducer conversions have been optimized to support high system accuracy and speed for these transducers:

- * Thermocouples
- * Thermistors
- * Platinum RTDs
- * Strain Gages

Special Conversions:

A special function permits user-defined tables of X,Y pairs to be used for linear interpolation (at a small price in memory usage, this function will typically execute much faster than high-order polynomial calculations).

Limit Testing:

Perform limit testing in real-time (data is tested as it is measured) or as a post-process (data previously stored in arrays is tested). Limit test failures can cause an interrupt if enabled.

Interrupts:

Time alarms, events that have just occurred, or limit tests of measurements can cause an HP-IB Service Request or a call to a stored subroutine.

Math Operations:

+, -, *, /, <, >, ATN, BINAND, BINCOMP, BINEOR, BINIOR, BIT, COS, EXP, LOG, SIN, SQR

Scaling:

Offset and scale factors (mx + b) can be performed on an entire array using just one command.

Statistics:

An easy-to-use function finds MIN, MAX, MEAN, and SIGMA (standard deviation) of the values stored in arrays.

Data Acquisition Operating System

Multitasking

Several subroutines called "run tasks" can be assigned equal priority and the operating system will timeslice them such that it appears they are running simultaneously. "Queued tasks" can be defined to run after certain conditions are met. Priority assignment allows complete control over front panel, HP-IB, interrupt, and run task execution.

Real-time Interrupts

Interrupts from the front panel, HP-IB, plug-in accessories, or higher priority tasks are serviced immediately after the current command is done executing.

Extender Chassis — HP 3853A

Extender Supports:

- Ten Function Module Slots

Benefit

- **Expand your system with no loss of functional capability:**
 - Up to seven extenders may be used with each HP 3852A mainframe.
 - Any slot can be used for any function module and multiple voltmeters can be used with parallel triggering.
 - All mainframe functions, including interrupts and triggering, are available through the extender control cable.

MULTITASKING OPERATING SYSTEM PRIORITY SCALE



RUN TASKS

- Maximum of 8 run tasks
- All tasks at the same priority will timeslice

QUEUED TASKS

- Maximum of 20 subroutines queued to execute in the run tasks

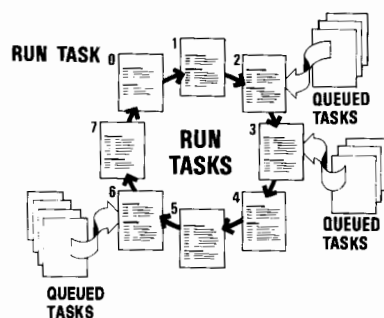

INTERRUPT TASKS

- System alarm
- Limits
- Digital transition
- Counter overflow



HP-IB TASKS

- Commands from a computer over HP-IB



FRONT PANEL TASKS

- Commands entered from instrument front panel

DATA ACQUISITION SYSTEMS

Instruments for Measurement and Control (cont'd)

Model 3852A

5½ to 3½ Digit Integrating Voltmeter -

HP 44701A

Directly Measures:

- DC Voltage
- Resistance
- AC Voltage

Benefits

- **Accurately measure small signal changes in noisy environments:**
 - Integrating A/D rejects normal mode noise at multiples of the power line frequency.
 - Guarded input maximizes common-mode rejection.
- **Choose the resolution, accuracy, and noise rejection needed, while maximizing measurement speed:**
 - Integration selection (number of power line cycles) is key to optimizing these performance parameters.
 - This voltmeter provides the fastest DC reading rates available with power line-related noise rejection.
- **Optimize resistance measurements to the accuracy you need:**
 - Use two-wire ohms for measurements where lead resistance is not critical.
 - Use four-wire ohms where inaccuracies due to measurement leads cannot be tolerated (*most accurate measurement technique for RTDs*).
 - Use offset-compensated ohms to correctly measure resistance in the presence of series voltages (often caused by thermocouple effects).

DC Voltage

Accuracy:

± (% of reading + volts), rear terminal input, one-hour warm-up, specified over time since last calibration, and operating temperature.

90 Days, 18 to 28°C, Auto-zero On

Integration Time in Number of Power Line Cycles (NPLC)

	1	0.1	0.005	0.0005
Range:				
30 mV	0.02% + 6 μV	0.02% + 8 μV	0.02% + 20 μV	0.02% + 60 μV
300 mV	0.008% + 6 μV	0.008% + 10 μV	0.008% + 40 μV	0.008% + 400 μV
3 V	0.008% + 8 μV	0.008% + 40 μV	0.008% + 400 μV	0.008% + 4 mV
30 V	0.008% + 300 μV	0.008% + 700 μV	0.008% + 4 mV	0.008% + 40 mV
300 V	0.008% + 700 μV	0.008% + 4 mV	0.008% + 40 mV	0.008% + 400 mV

Reading Rate/Noise Rejection:

Integration Time in Number of Power Line Cycles (NPLC)

	1	0.1	0.005	0.0005
Integration Time				
60 Hz (50 Hz)	16.7	1.67 (2.0)	100	10
	(20.0)	(2.0)	(100)	(10)
	msec	msec	μsec	μsec
Number of Converted Digits	6½	5½	4½	3½
Reading Rate (readings/sec) with auto-zero, auto-range off 60 Hz (50 Hz)	57 (48)	415 (360)	1350 (1350)	1600 (1600)
Min Noise Rejection (dB)				
Normal Mode Rejection at 50 or 60 Hz ± 0.09%	60	0	0	0
DC Common Mode Rejection with 1 kΩ in low lead	120	120	120	120
Effective Common Mode Rejection, at 50 or 60 Hz ± 0.09% with 1 kΩ in low lead	150	90	90	90

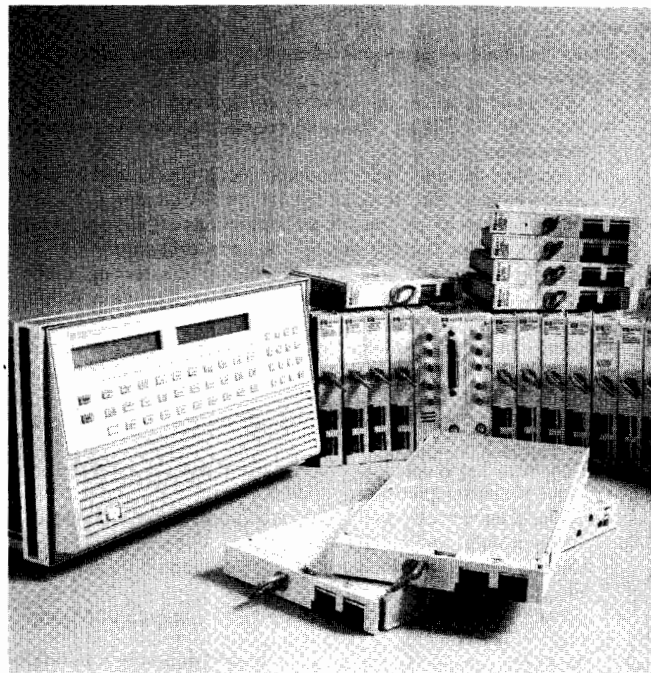

13-Bit High-Speed Voltmeter —

HP 44702A/B

Directly Measures:

- DC Voltage
- DC Resistance

Benefits

- **Collect data quickly:**
 - A measurement rate of 100,000 readings/sec with auto-ranging is achieved by directly controlling up to six (eight in an extender) High-Speed FET Multiplexers through a dedicated ribbon cable.
 - Multiple High-Speed Voltmeters can be triggered simultaneously and operate independently.
- **Maximize your measurement throughput:**
 - On-board buffer is included for over 8,000 readings (HP 44702A) or over 64,000 readings (HP 44702B) that can be transferred to mainframe internal memory or to hard disc via GPIO and a DMA controller while taking measurements.
 - Dedicated triggering is achieved with on-board pacers.
 - Balanced input, equal impedance between high-to-chassis and low-to-chassis, gives good common mode noise rejection.

DC Voltage

Accuracy:

± (% of reading + volts), rear terminal input, one-hour warm-up, specified over time since last calibration, and operating temperature, with auto-zeroing performed within one minute of measurement.

90 Days, 18 to 28°C

	Accuracy
Range:	
40 mV	0.05% + 68 μV
320 mV	0.05% + 234 μV
2.56 V	0.05% + 1.88 mV
10.24 V	0.05% + 7.5 mV

Reading Rates:

100,000 readings/sec with auto-ranging. Proper auto-ranging is ensured as long as a single-channel signal changes no more than 600 volts/sec during auto-ranging.

Noise Rejection:

Min effective common mode rejection specified in dB for DC to 60 Hz with 1 k Ω in low lead; maximum signal (high to low) + common mode voltage (low to chassis) for proper operation is ± 10.24 volts.

ECMR

Range:		
	40 mV	90
	320 mV	80
	2.56 V	70
	10.24 V	70

Relay Multiplexers — HP 44705A/44705H/44706A/44708A/44708H/44717A/44718A

Directly Multiplexes:

- Voltage
- Resistance
- Thermocouples
- Strain Gages

Benefits

- **Reduce the effects of real-world measurement errors in a multi-channel system:**
 - Relay multiplexers minimize errors due to thermal DC offsets, crosstalk, and injected (bias) currents.
 - The relay multiplexers have high, low, and guard terminals to maximize common mode noise rejection.
 - A single-ended multiplexer (HP 44706A) lowers your cost per channel.
 - With shunt and series jumpers in each channel of the HP 44705A/H and 44708A/H multiplexers, you can easily install a one-pole low-pass filter for additional noise rejection, a voltage divider to extend relay lifetime, or a shunt resistor to measure current.
 - Differential or common mode voltages up to 350 V peak or 250 Vdc can be handled by the HP 44705H and 44708H modules.
 - Scanning is break-before-make to prevent inadvertent connections of circuits being measured.
 - Each lead to the back-plane and common terminals has a 100 Ω resistor in series to prolong the lifetime of the relay contacts. Due to placement, these resistors contribute no error when measuring 2-wire ohms resistance using the HP 44701A Integrating Voltmeter. The resistor can be shorted, but this can seriously shorten relay contact life if relatively high voltages or currents are switched.
 - Tree switch relays automatically isolate each bank of relays from the back-plane to reduce crosstalk and improve settling time.
- **Optimize thermocouple measurement accuracy:**
 - Thermocouple types can be mixed on the HP 44708A/H multiplexer to optimize accuracy over the temperature ranges needed.
 - Thermocouple compensation is handled automatically with no extra wiring.
- **Measure strain accurately:**
 - Strain sensitivity can be optimized using finger-moveable jumpers to select between 1/4-, 1/2-, and full-bridge configurations. The HP 44717A and 44718A multiplexers each support 10 bridges for 120 Ω and 350 Ω strain gages.
 - No manual adjustments are required to balance the bridge.
 - Strain accuracy is independent of long-term bridge excitation voltage changes because the excitation voltage is automatically measured and included in the strain calculations.
 - The excitation voltage is always applied, never switched, reducing errors due to dynamic heating and cooling of the gages.
 - Connection to an available Wagner ground reduces errors due to gage leakage current.

Solid State Relay Multiplexers - HP 44705F/44708F

Directly multiplexes:

- Voltage
- 4-wire ohm resistance (HP 44705F only)
- Thermocouples (HP 44708F only)

Benefits

- **Solid state switching is free from wearout normally associated with electromechanical relays:**
 - Solid state relay multiplexers do not rely on a mechanical system to actuate the switching. Switching is performed by an optically coupled field effect transistor.
 - The switching element does not degrade when used within its maximum rating. The solid state relay is free from the damaging arc associated with electromechanical relays.
- **Perform precision measurements of real world electrical signals:**
 - Three wire switching of high, low, and guard is provided to minimize the effects of common mode voltage.
 - Errors due to injected currents and thermal offsets are minimized with the solid state relay multiplexer.
 - Break-before-make switching prevents inadvertent connection of separate channels during scanning.
 - Tree switching isolates the unused multiplexers from the backplane of the HP 3852A.
 - Internally, the solid state relay card is divided into two groups to minimize crosstalk and facilitate 4-wire resistance measurements.
 - The solid state relay becomes a high impedance when powered down thereby isolated each channel in the event of power loss.
- **Optimize thermocouple measurement accuracy with the HP 44708F:**
 - Thermocouple types can be mixed on the HP 44708F multiplexer to optimize accuracy over the temperature ranges needed.
 - Thermocouple compensation is performed automatically by the HP 3852A without external wiring.

HP 44789A Serial Interface

Directly provides:

- Serial programming port for the HP 3852A
- Control port for RS-232 or RS-422 devices

Benefits

- **Interface your computer to the HP 3852A using RS-232 or RS-422.**
 - Use your computer's standard RS-232 or RS-422 interface for complete access to the HP 3852A. The HP 44789A provides an alternative to the built-in HP-IB interface.
- **Locate the HP 3852A long distances from your host computer.**
 - Implement a remote data acquisition design by using the serial interface modems as well as a direct connection.
- **Control RS-232 or RS-422 devices directly from the HP 3852A.**
 - Offload your host computer by using the serial interface to communicate directly with RS-232 or RS-422 devices.
- **Program the HP 3852A from a remote terminal.**
 - Use your standard data terminal to send commands to the HP 3852A. List the data read from the HP 3852A on your terminal's CRT.

Specification

Baud rates: 300, 600, 1200, 2400, 4800, 9600, and 19200

Interrupts: special character, buffer conditions, carrier detect, ring indicator, and receiver error conditions

Handshake: none, XON/XOFF, hardware, and both

Buffer size: user defined up to 8 kbyte on both transmitter and receiver

DATA ACQUISITION SYSTEMS

Instruments for Measurement And Control (cont'd)

Model 3852A

FET Multiplexers — HP 44709A/44710A/ 44711A/44712A/44713A/44719A/44720A

Directly Multiplexes:

- Voltage
- Thermocouples
- Resistance
- Strain Gages

Benefits

- **Maximize your measurement throughput:**
 - A throughput rate of 100,000 readings/sec is realized using High-Speed FET Multiplexers (HP 44711A/44712A/44713A) directly controlled through a dedicated ribbon cable by the 13-Bit High-Speed Voltmeter.
 - Up to six (eight in an extender) High-Speed FET Multiplexers can be controlled through this ribbon cable.
 - The 24-channel multiplexers switch high and low only. Each floating input is balanced (that is, equal impedance between high-to-chassis and low-to-chassis) to provide good common mode noise rejection.
 - For lower costs per channel, single-ended multiplexing of 48 channels (HP 44712A) is also available (has no common mode noise rejection, however).
- **Increase system reliability:**
 - FETs have no mechanical limitations (no wear out due to switching).
 - Similar to their relay counterparts, the HP 44709A/44710A/44719A/44720A FET multiplexers have high, low, and guard connections for better common mode rejection than the high-speed FET multiplexers.

4-Channel Track/Hold with Signal Conditioning - HP 44730A

4-Channel Dynamic Strain Gage Multiplexers -

HP 44732A/44733A

Directly Multiplexes

- Transient DC voltages
- Dynamic strain gages
 - The Track/Hold Multiplexers have powerful capabilities for applications in acoustic analysis, environmental tests and the testing of engines, electromechanical products, mechanical products, rubber belts, elevators, hydraulics, motors, pressure transducers and materials.
 - Dynamic strain applications include seismology/ground characterization, machine control and characterization, and physical tests of engines, aircraft, mechanical products, hydraulics and motors. Tests using strain gages include operating and burst tests, as well as the simultaneous detection of "glitches."

Benefits

- Enhance dynamic signal measurement accuracy by measuring a number of channels simultaneously via internal or external strobes.
- Set gains of 1, 10, or 100 on each channel to amplify low level signals and improve measurement accuracy.
 - Select offset voltage nulling on each channel, minimizing computation time to obtain higher reading rates.
 - Reduces settling errors when switching between low-level and high-level signals.
- Use the analog peak detect/hold feature to capture either positive or negative peaks without having to sample at a high rate of speed.

- Boost system throughput in some applications by reducing the requirements to over-sample. Using the ribbon cable, it connects to the HP 44702 high speed voltmeter for high speed operations.
- Measure dynamic strain accurately.
 - Utilize on-board excitation that is provided separately for each bridge.
 - Select quarter, half, or full-bridge configurations.
 - Eliminate offsets with electronic nulling.

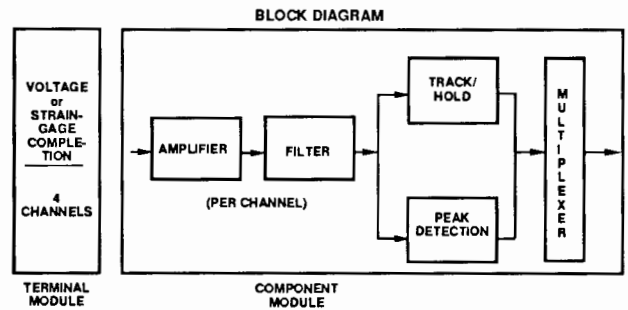

Arbitrary Waveform Digital to Analog Converter -

HP 44726A

Directly Outputs

- Arbitrary Waveforms
- DC Voltages

This 2-channel non-isolated module provides arbitrary waveforms and stimulus signals for product test and characterization applications. Applications include the testing of satellites, engines, electromechanical products, aircraft, automobiles, mechanical products, materials, chemicals and elevators.

Benefits

- Provides a stimulus voltage signal with a step rate of up to 800 kHz.
 - Outputs a DC voltage or any arbitrary waveform stores in its own memory.
 - Output waveforms, once initiated, can run continuously regardless of the activities being performed by the HP 3852A mainframe.
 - Channels have independent timebases that can be synchronized with each other or with external events. External timebases can also be used.
 - Waveforms can be single-shot (one cycle of the waveform) or continuous. Channel 0 can also perform n repetitions of the waveform (n = 1 to 65,536).
 - Sine, triangle and square (50% duty cycle) waveforms can be calculated and loaded from the HP 3852A with one command.
- Random access memory is available for each channel on this accessory.
 - Each channel has enough memory for 32,400 waveform points in which each point is defined as both a voltage level and length of time at that level. As a result, memory is used efficiently.
 - Up to 64 different waveforms on each channel can be stored in memory.
 - Arbitrary waveforms can be loaded from a user-defined array or a real array or high-speed voltmeter readings.

Digital to Analog Converters —

HP 44727A/44727B/44727C

Directly Outputs:

- DC Voltage
- DC Current

Benefit

- **Simplify your test system by providing test or control of devices with one data acquisition control system:**
 - Four channels are provided on each module.
 - Each channel can be configured using finger-movable jumpers to output either unipolar or bipolar voltage, or unipolar current. Reconfiguration may require recalibration of the changed channel. Recalibration consists of adjustments to zero offset and gain potentiometers, and can be performed with the HP 44701A Integrating Voltmeter or equivalent. Three configurations (4-Channel Voltage—HP 44727A; 4-Channel Current—HP 44727B; 2-Channel Voltage, 2-Channel Current—HP 44727C) are available to make reconfiguration unnecessary in most cases.
 - Channels are isolated and can be connected in parallel for current or in series for voltage to expand the usable ranges.
 - Each channel configured for voltage has remote sense capabilities to ensure accurate voltages at the device.

DC Voltage

Ranges: 0 to +10.235 V or -10.235 to +10.235 V

Resolution: 2.5 mV (12 bits plus a sign bit for bipolar range)

DC Current

Ranges: 0 to +20.16 mA or +4 to +20.16 mA

Resolution: 2.5 μ A (13 bits)

3-Channel Stepper Motor Controller - HP 44714A

Directly Provides:

- Stepper Motor Control Signals
- Limit Inputs
- Built-in Quadrature Counters
- Pulse Output

Benefit

- **Completely control three stepper motors with one module:**
 - Output a continuous stream or a fixed number of pulses.
 - Program separate acceleration and deceleration rates for trapezoidal motion profiles.
 - Halt output pulses when limits are reached or from the emergency stop input.
 - Built-in quadrature counter on each channel gives position feedback.
- **Use the module as a pulse generator.**
 - Output a set number of pulses or a continuous stream.
 - Set, accelerate, and decelerate both pulse width and pulse rate.

Trapezoidal Motion Profile

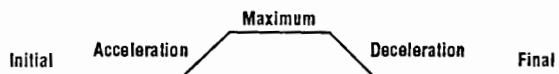

5-Channel Counter/Totalizer — HP 44715A

Directly Provides:

- Count Measurements
- Period Measurements
- Frequency Measurements
- Interrupts

Benefit

- **Reduce your costs by taking advantage of frequency counting versatility:**
 - The counter/totalizer accurately measures logic or RMS inputs with frequencies up to 200 kHz.
 - By multiplexing between five isolated channels and five non-isolated channels, a total of ten connected channels is possible (only five can operate simultaneously).
 - Each DC logic channel independently counts on either positive or negative signal transitions. Non-isolated, low-level RMS inputs are measured using a zero-crossing detector.
 - Any channel that is totalizing can be programmed to set an interrupt for a counter roll-over to zero.
 - For isolated DC inputs, nominal voltages are separately selected for each channel by finger-movable jumpers. For non-isolated inputs, either TTL or low-level RMS inputs are also separately selected for each channel by finger-movable jumpers.
 - Debounce times (common to all channels) can be programmed to prevent false counts.
 - With shunt and series jumpers in each channel, you can easily install a one-pole low-pass filter for rejection of unwanted signals.

Digital Inputs with Totalize and Interrupt -

HP 44721A/44722A

Directly Provides:

- Logic Readings
- Totalize Count Measurements
- Interrupts

Benefit

- **Conveniently read a variety of digital values in your system:**
 - Isolated inputs detect the presence of DC (HP 44721A 16-channel digital input) or AC (HP 44722A 8-channel digital input) inputs based on nominal voltages selected by finger-movable jumpers.
 - Each channel can independently totalize positive or negative (whichever is selected) logic transitions.
 - Voltage selection and function can be set independently on each channel.
 - Any channel can be programmed to set an interrupt for an edge occurrence (positive or negative) or a counter roll-over to zero.
 - Debounce circuitry that is common to all channels prevents erroneous readings on inputs that are still changing after a logic level transition.
 - For detecting whether switches are opened or closed, the HP 44721A has a non-isolated five volt supply at the terminal module with 9.4 k Ω \pm 10% pull-up resistors on each input.

DATA ACQUISITION SYSTEMS

Instruments for Measurement and Control (Cont'd)

HP 3852A

32-Channel High-Speed Digital Sense/Control

-HP 44723A

Directly Provides:

- High-speed Digital Input and Output
- Triggered Input and Output
- Interrupts
- Output Handshaking

Benefit

- Input 16 channels or output 16 channels over 150,000 times per second.
- Capture and load 16-bit patterns with external triggers.
- Interrupt on any input channel on any transition or on a user-specified 16-bit pattern.

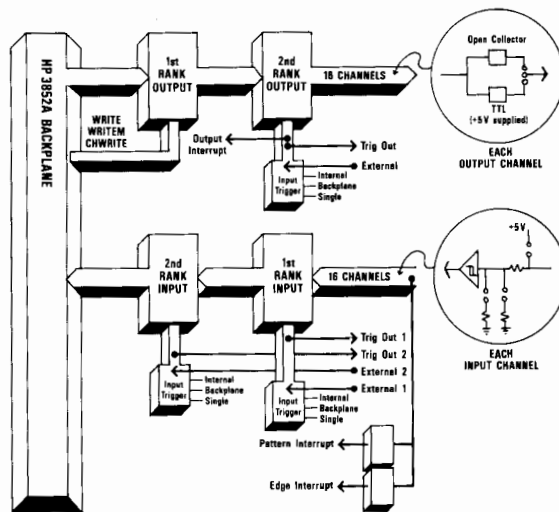

High-Speed Digital Sense/Control

16-Channel Digital Output — HP 44724A

Directly Provides:

- Open Drain Digital Outputs

Benefit

- Conveniently control DC devices or logic levels:
 - Open drain outputs are used to control DC devices with up to 55 V, or drive TTL logic levels. An external power supply and external pull-up resistors are required.

Characteristics

Max Input Voltage:

Between High and Low Terminal of Each Channel — 55 V DC
 Between Channels or Between Any Terminal and Chassis — 354 V peak or 250 V DC

Max Sink Current: 500 mA DC per channel (1 A fuse protection)

Max Reverse Polarity Current: 500 mA DC per channel

TTL Compatibility: 200 mA per channel with $V_{out} \leq 0.4$ volts

Switching — HP 44725A/44728A/44729A

Directly Switches:

- Voltage
- Current
- Power

Benefit

- **Reliability switch the voltage, current, or power you need:**
 - Both the HP 44725A and 44728A use single-pole double-throw (SPDT) Form-C relays that return to their normally

closed positions at power down. The HP 44725A 16-channel general purpose relays are for switching low-level power or moderate voltages and currents in an experiment while minimizing errors due to cross talk and thermal DC offsets. More DC or AC power can be switched with the HP 444728A 8-channel relay actuator.

- The HP 44729A 8-channel AC power controller distributes AC power. It switches “on” at the zero voltage crossing and “off” at the zero current crossing for long device life and low transient generation. Each channel has a relay and solid state switch in parallel to provide an exceptional combination of switch life and low on-resistance.

Characteristics

	Module		
	HP 44725A	HP 44728A	HP 44729A
Max Input Voltage (V_{max}) Per Channel	30 V DC or RMS, 42 V peak	300 V DC, 250 V RMS	— 250 V RMS, 354 V peak
Max Input Current Per Channel	1.5 A DC, 1.5 A RMS	2 A DC, 3 A RMS (5 A fuse protection)	2.5 A RMS (3 A RMS if module is limited to 16 A RMS total; 4 A fuse protection per channel)

Binary Mode Software - HP 44790A

The HP 44790A Binary Mode Software is a collection of special subprograms used to access high speed opcodes within the HP 3852A. This collection helps the system programmer to increase the run time speed of many data acquisition functions up to five times as fast as the standard high-level commands.

The binary mode software is written for the programming professional familiar with opcode programming. HP systems engineers can provide consulting services for those unfamiliar with this type of programming.

The binary mode software accesses over forty high-speed opcodes to support the following functions:

- Analog inputs using the HP 44702A/B High Speed Voltmeter
- Analog outputs using the HP 44727A/B/C DAC
- Digital I/O using the HP 44721/22/23/24A Digital Input/Output
- Data moves between memory, I/O slots, and HP-IB
- Statistics and limit checking
- Microcode instructions such as push, pop and rts

System Requirements

The binary mode software requires HP 3852A firmware revision 3.5 or later. It is supplied on a 3 1/2-inch single-sided disk. The subprograms contained are written in HP BASIC, in modular form, so that they can be ported to other languages.

HP-IB Controller - HP 44788A

Directly controls:

- HP-IB disc drives (CS80/SS80)
- HP-IB printers
- HP-IB instruments

Benefits

- Remote operations without a computer
- At power-up, load subroutines into an HP 3852A from an HP-IB disc drive and start executing them.
- Send data to an HP-IB disc drive without using a computer.
- Print out data stored in the HP 3852A without using a computer.
- Control other HP-IB instruments directly with HP 3852A.

Ordering Information

To order, specify an HP 3852S System with the appropriate software, controller, mainframe, extenders, function modules, racks, and extra terminal modules. The HP 3852S itself has no cost—each component of the system is priced individually.

Data Acquisition Manager

	Price
HP 44458A Data Acquisition and Control Software for Series 300/200 Computers on 3½" Flexible Discs (BASIC 4.0 and 5.0)	\$2055
HP 44458B Data Acquisition and Control Software for Series 200 Computers on 5¼" flexible Discs (BASIC 4.0 and 5.0)	\$2055
HP 44458R License to Reproduce HP 44458A or 44458B. Includes one set of software manuals.	\$1255
HP 44459A Data Acquisition and Control software for HP Vectra Computers on 3½" flexible discs (BASIC 5.0)	\$1530
HP 44459B Data Acquisition and Control software for HP Vectra Computers on 5¼" flexible discs (BASIC 5.0)	\$1530
HP 44459R License to reproduce HP 44459A/44459B. Includes one set of software manuals.	\$955

Mainframe

HP 3852A Data Acquisition and Control Unit	\$4070
HP 44703A Mainframe Extended Memory Card—256 kbytes*	\$725
HP 44703B Mainframe Extended Memory Card—1 Mbyte*	\$1660

*Only one extended memory option may be added per mainframe.

Extended memory cards for 2 Mbytes and 4 Mbytes can be ordered from Infotek Systems, 1400 N. Baxter Street, Anaheim, CA 92806-1201, as AM220B and AM244B, respectively. These products have been *functionally tested, but are not warranted or supported by HP* (no RFI or environmental tests were conducted). Warranty for two years and support of individual cards are provided by Infotek.

Extender Chassis

HP 3853A Extender Chassis with ten additional slots for function modules. A 1-meter extender control cable, and two 1-meter (3 wires each) analog signal extender cables are included. A total of seven extenders may be added to a mainframe. Extender control cables are always needed. Analog signal extender cables are needed if analog voltages must be switched to the mainframe or another extender.	\$2695
---	--------

Voltmeters

HP 44701A 5½ to 3½-Digit Integrating Voltmeter	\$1710
HP 44702A 13-Bit High-Speed Voltmeter (100,000 readings/sec; buffer for over 8,000 readings)	\$2800
HP 44702B 13-Bit High-Speed Voltmeter (100,000 readings/sec; buffer for over 64,000 readings)	\$3375
HP 44703C High Speed Extended Memory Card for expanding HP 44702A Buffer to over 64,000 readings	\$635

Relay Multiplexers

HP 44705A 20-Channel Relay Multiplexer	\$880
HP 44705H 20-Channel High-Voltage Relay Multiplexer	\$1090
HP 44706A 60-Channel Single-Ended Relay Multiplexer	\$1090
HP 44708A 20-Channel Relay Multiplexer with Thermocouple Compensation	\$1025
HP 44708H 20-Channel High-Voltage Relay Multiplexer with Thermocouple Compensation	\$1240
HP 44717A 10-Bridge 120 Ohm Static Strain Gage Relay Multiplexer	\$1155
HP 44718A 10-Bridge 350 Ohm Static Strain Gage Relay Multiplexer	\$1155

FET Multiplexers

HP 44709A 20-Channel FET Multiplexer	\$985
HP 44710A 20-Channel FET Multiplexer with Thermocouple Compensation	\$1090
HP 44719A 10-Bridge 120 Ohm Static Strain Gage FET Multiplexer	\$1245
HP 44720A 10-Bridge 350 Ohm Static Strain Gage FET Multiplexer	\$1245
HP 44711A 24-Channel High-Speed FET Multiplexer	\$1020
HP 44712A 48-Channel High-Speed Single-Ended FET Multiplexer	\$1195
HP 44713A 24-Channel High-Speed FET Multiplexer with Thermocouple Compensation	\$1145
HP 44730A 4-Channel Track/Hold Multiplexer with Signal Conditioning	\$1660
HP 44732A 4-Channel 120 Ohm Dynamic Strain Gage Multiplexer	\$1865
HP 44732A 4-Channel 350 Ohm Dynamic Strain Gage Multiplexer	\$1865

Solid State Relay Multiplexer

HP44705F 20-Channel Solid State Multiplexer	\$1425
HP44708F 20-Channel Solid State Multiplexer T/C	\$1495

Analog Outputs

HP 44726A 2-Channel Arbitrary Waveform DAC	\$2020
HP 44727A 4-Channel Voltage DAC	\$1400
HP 44727B 4-Channel Current DAC	\$1400
HP 44727C 2-Channel Voltage; 2-Channel Current DAC	\$1400

Stepper Motor Controller

HP 44714A 3-Channel Stepper Motor Controller/Pulse Output	\$2070
--	--------

Counter

HP 44715A 5-Channel Counter/Totalizer (200 kHz)	\$1145
--	--------

Digital Inputs/Outputs—Switching

HP 44721A 16-Channel Digital Input with Totalize and Interrupt	\$790
HP 44722A 8-Channel AC Digital Input with Totalize and Interrupt	\$790
HP 44723A 32-Channel High-Speed Digital Sense/Control	\$1065
HP 44724A 16-Channel Digital Output	\$775
HP 44725A 16-Channel General Purpose Switch	\$880
HP 44728A 8-Channel Relay Actuator	\$720
HP 44729A 8-Channel Power Controller	\$1195
HP 44788A HP-IB Controller	\$675

Breadboard

HP 44736A Breadboard	\$420
-----------------------------	-------

High-Speed Accessories

HP 98620B 2-Channel DMA Controller for HP Series 300/200 Computers	\$530
HP 98622A GPIO Interface for HP Series 300/200 Computers	\$390
HP 98625B High-Speed HP-IB Disc Interface for HP Series 300/200 controllers	\$830
HP 44744A 2-Meter GPIO Cable with Mating for HP 44702A/B and HP 98622A	\$310
HP 44744B 4-Meter GPIO Cable with Mating for HP 44702A/B and HP 98622A	\$350
HP 44745A 4-Meter GPIO Cable with Mating for HP 44702A/B and HP 12006A (GPIO interface for HP 1000 Computers)	\$350
HP44790A Binary Mode Software	\$1100

Service and Support Products and Courses

HP 44743F Service Kit consists of specially designed hardware and software for operationally verifying and calibrating the HP 3852A. Fixtures for testing individual plug-in modules should be ordered separately.	\$1685
HP 50011B HP-IB Course for HP Series 300/200 Computers	\$1135
HP 50015A Data Acquisition and Control Fundamentals Course	\$935
HP 50016E HP-IB Course for HP 1000 Computers	\$1200
HP P/N 03852-88706 ROM Update Kit	\$330

DATA ACQUISITION SYSTEMS

PC-Based Data Acquisition

HP 75000 PC Data Acquisition System 10



HP 75000 System 10

HP 75000 System 10

The HP 75000 System 10 is a PC-based data acquisition system that includes the HP 75000 cardcage, three measurement cards, a test block, and data acquisition software. The PC/printer option allows you to add an HP Vectra computer and HP QuietJet printer. Other plug-in measurement cards are also available to be used with this system.

Included in the System 10 are a 5½-digit multimeter, a 16-channel thermocouple relay multiplexer, and a quad 8-bit digital I/O card. These three cards are configured and built into the cardcage. Other measurement cards will be installed at the factory when ordered at the same time as the System 10.

LABTECH® NOTEBOOK is a menu-driven software package for data acquisition applications. The COMPANION software is an on-line job aid to assist you in learning about the software and configuring the hardware to your transducers. Other software like Lotus 1-2-3 can be used with LABTECH® NOTEBOOK for customized analysis of the data.

The Complete Solution

The System 10 is a complete solution to your data acquisition application. The complete system includes measurement hardware, data acquisition software, a personal computer and printer, and on-line documentation. It also includes a test block complete with transducers to help you test your system.

Hewlett-Packard has over 50 years of experience in building test and measurement instruments. With a full line of personal computers, software, and data acquisition equipment, Hewlett-Packard offers complete solutions to your data acquisition applications.

Easy-To-Use Software

The System 10 solution is designed specifically for data acquisition. LABTECH® NOTEBOOK software is menu-driven so that you do not have to write code. Sample software setups are included in the System 10 to get you started quickly. The COMPANION software assists you in learning the software and using the hardware without reading a manual.

Dependable Hardware

The System 10 hardware ensures that you get reliable measurements without effort on your part. Plug-in cards are properly configured at the factory, and the software includes an auto-configuration routine to adapt to your specific configuration. Hewlett-

Packard has a reputation of building quality products with superb reliability. The HP 75000 cardcage and its plug-in cards are rated with a mean-time-between-failures of over 20 years and comes standard with a three-year warranty.

Flexible Solution

No two data acquisition applications are the same. The cardcage architecture allows you to install a variety of different plug-in cards to match almost any type of transducer you have. The software supports any configuration of these cards. A seamless link to Lotus 1-2-3 or user-written code makes the software flexible enough for your most demanding tasks.

Worldwide Support

Hewlett-Packard offers worldwide support for the System 10. The HP sales force is technically-oriented to help you solve your measurement problems, and a highly trained team of HP system engineers is available to help customize these solutions.

Specifications

Multiplexers	Relay	Thermocouple	Single-Ended
Channels	16	16	48
Offset	4 μ V	2 μ V	50 μ V
CMR	100 dB	100 dB	> 80 dB
Isolation	120 V dc	120 V dc	120 V dc
D/A Converter			
Resolution	16 bits (2.5 μ V)		
Accuracy	12 bits		
Isolation	120 V rms, 170 V dc		
Ranges	\pm 10 V, \pm 20 mA		
Digital I/O	TTL		
Isolation			
Counters	Totalizer		Universal
Max count	2**32		2**32
Resolution	9 ½ digits		10 ½ digits
Frequency	4 MHz		100 MHz
Input	\pm 5 V or 42 V		\pm 4 V or 42 V
Form C Switch			
Isolation	250 V dc		
Max current	1A		
Power	30 watts/channel		
Offset	7 μ V		

Typical System Accuracy

Type	Range	Resolution		System Accuracy ¹	
		Aco ²	HS ³	Accurate ²	High Speed ³
DC Voltage					
	0.125 V	120 nV	7.6 μ V	0.023% + 9 μ V	0.115% + 64 μ V
	1V	1.0 μ V	61 μ V	0.013% + 19 μ V	0.1% + 204 μ V
	8V	7.6 μ V	488 μ V	0.01% + 54 μ V	0.1% + 1.5 mV
	64V	61 μ V	3.9 mV	0.015% + 1mV	0.1% + 20mV
	300V	488 μ V	31 mV	0.015% + 5mV	0.1% + 80mV
Thermocouples					
B	+1000 to +1600°C			1.0°C	3.5°C
E	0 to +1000°C			0.8°C	1.5°C
J	+200 to +600°C			0.8°C	1.5°C
K	-200 to +1200°C			0.5°C	1.0°C
N14	+200 to +1200°C			1.0°C	2.0°C
N28	-100 to +300°C			1.0°C	2.0°C
R	+200 to +1600°C			1.2°C	4.0°C
S	+200 to +1600°C			1.5°C	4.0°C
T	0 to +300°C			0.5°C	1.0°C
Thermistors					
2.25K	-80 to +80°C			0.06°C	0.08°C
5000	-50 to 100°C			0.05°C	0.07°C
10000	-80 to 120°C			0.06°C	0.08°C
RTDs (Platinum, alpha @ 100 C)					
.00392	-100 to +400°C			0.3°C	0.6°C
.00385	-100 to +800°C			0.4°C	1.0°C

¹ System accuracy does not take into account the accuracy of transducers. Thermocouples have typical accuracies of 1.5-5°C, thermistors have 0.1 to 1°C, and RTDs have 0.01 to 0.1°C.

² Integrating mode (16.7/20 msec aperture) of multimeter for best accuracy

³ High speed mode (10 μ sec aperture) of multimeter for best speed

Typical System Speeds

Measurement function	Time required 1 Chl (msec)
DC volts (integrating)	65
DC volts (high speed)	25
Thermocouples	110
Thermistors	60
RTDs	70
Read from digital I/O	10
Write to digital I/O	11
Close a Form C switch	30
Write to a D/A output	14
Read a counter total (10 Hz signal)	14
Read a frequency (1 kHz signal)	80

Ordering Information

Price

PC-based Data Acquisition Systems

HP E1390A HP 75000 System 10
Includes LABTECH® NOTEBOOK and COM-PANION software, HP 75000 Series B cardcage, 5 1/2-digit multimeter, 16-channel thermocouple relay, multiplexer, quad 8-bit digital I/O, HP-IB cable, and test block

Contact your
HP sales
office

PC/Printer Option

ADDS the HP Vectra computer, HP QuietJet printer, and cables. The data acquisition software and DOS are installed on the hard disk. The HP Vectra includes an 80286 microprocessor, 640K RAM, 3 1/2" floppy disk drive, 40 Mbyte hard disk drive, VGA color monitor, keyboard, and an HP 82335A HP-IB interface card.

Contact your
HP sales
office

Additional Plug-in Modules

HP E1328A 4-channel D/A converter	\$1100
HP E1330A quad 8-bit digital I/O	\$600
HP E1332A 4-channel counter/totalizer	\$900
HP E1333A 3-channel universal counter	\$900
HP E1345A 16-channel relay multiplexer	\$650
HP E1346A 48-channel single-ended relay multiplexer	\$800
HP E1347A 16-channel thermocouple relay multiplexer	\$750
HP E1364A 16-channel form C switch	\$650

LABTECH® NOTEBOOK is a registered trademark of Laboratories Technology Corporation.
Lotus and 1-2-3 are U.S. registered trademarks of Lotus Development Corporation.

COMPUTER AIDED TEST Switching/Interface Hardware

The philosophy behind Computer Aided Test (CAT) is simple. If you can raise the quality of your product without raising its cost, your customer is happier and your company is more productive. The formula for executing this plan is equally simple: Monitor incoming parts, manufacturing processes and final products in great detail, and make corrections to improve them.

While the philosophy is simple, the implementation can sometimes be complex. That's where HP can help, with a full complement of computers, software, instruments, switches, and interconnect hardware designed specifically to make your CAT task easier.

A good CAT system is designed to improve manufacturing productivity. It minimizes the design time to build fixtures, write software and configure systems, and it also minimizes the time required to test devices.

What to Look for in Hardware Cardcages

Performance is the main criteria in selecting instruments and switches. The switch and instruments must meet your stringent requirements. It's a good idea to select an in-

strument and switch with slightly more performance than the initial specification requires. That way you can easily adapt to changing manufacturing specifications. Another consideration is throughput speed. An intelligent cardcage system, such as the HP 3235A, can run subroutines and make decisions, thereby off-loading the host computer to do the test sequencing and data reporting.

The HP Series 6900 Multiprogrammers are high performance CAT products offering very high-speed stimulus and response functions. The broad function versatility and inter-card communication of its I/O cards give the Multiprogrammer the required adaptability to make time-critical measurements. Series 6900 Multiprogrammer I/O cards can be used in either the HP 6954A, the HP 6944A or the HP 6942A mainframes. These I/O cards give the Multiprogrammer abilities such as digital I/O rates up to 1 MHz and analog acquisition rates up to 500 kHz that can be synchronized with application dependent events.

If your budget or application is relatively small, look to the HP 3488A Switch/Control Unit.

Switching

If your application involves switching signals >1 MHz, you need to look at the HP 3235A for large point counts (>100) and the HP 3488A for low point counts. Both products offer high performance switching in various topologies covering DC to 26.5 GHz.

Interfacing and Cabling

For years, the cabling and fixturing of a CAT system have been neglected by CAT manufacturers. Test engineers and technicians had to build their own connection systems. But, today HP has commercial units to do most of the critical switching and cable management necessary in a CAT system. The availability of these switch units can save hundreds of hours of design time.

The interface system to the HP 3235A standardizes the way you cable your Unit-under-test to the test system. It adapts to complex components, pc boards, subassemblies and systems.

For those who need help in configuring, implementing or supporting a complex CAT system, HP offers the ATS 2000 which provides an integrated solution (including hardware, software, racking, cabling and system-level support).

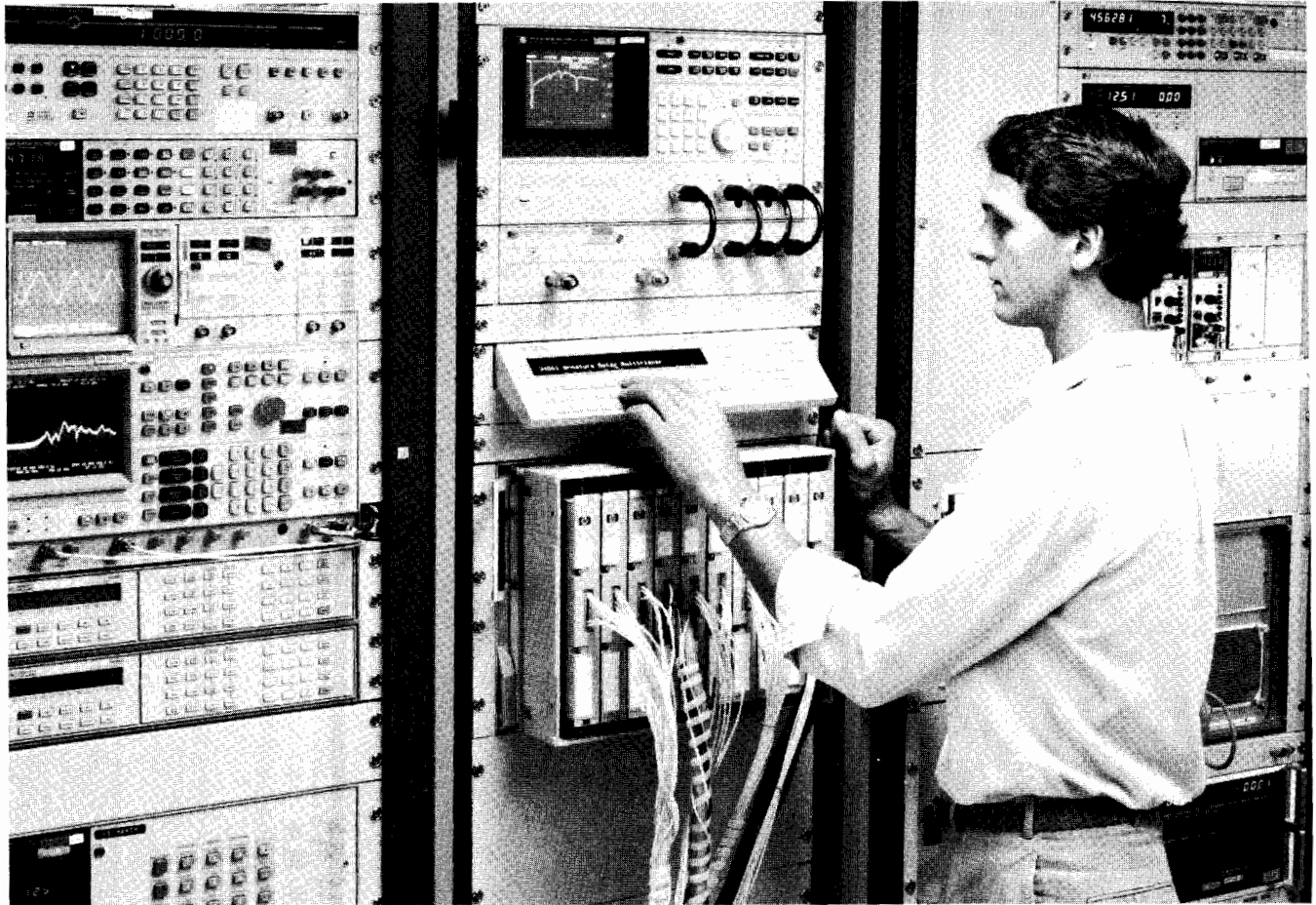

The HP 3235A Switch/Test Unit performs high integrity switching for signals from dc to 26.5 GHz. With its mass interconnected fixture, the HP 3235A can route signals from a multitude of instruments to the device under test, saving the test engineer the chore of designing a custom switch, and greatly simplifying cable management.

Programming the HP 3235A is extremely efficient, with high level BASIC commands. Faster test throughput speed is created by downloading test setups, and by direct communication between the internal switches and the internal 6½ digit multimeter or internal stimulus.

- For Medium to Large Systems
- 10-Slot, Intelligent Card Cage
- 20-Switch Modules for DC to 26.5 GHz Signals

- DMM, AC/DC Source, 4-channel D/A Digital I/O, Breadboard Modules
- Quick Interconnect Fixture
- Control Panel for Debugging

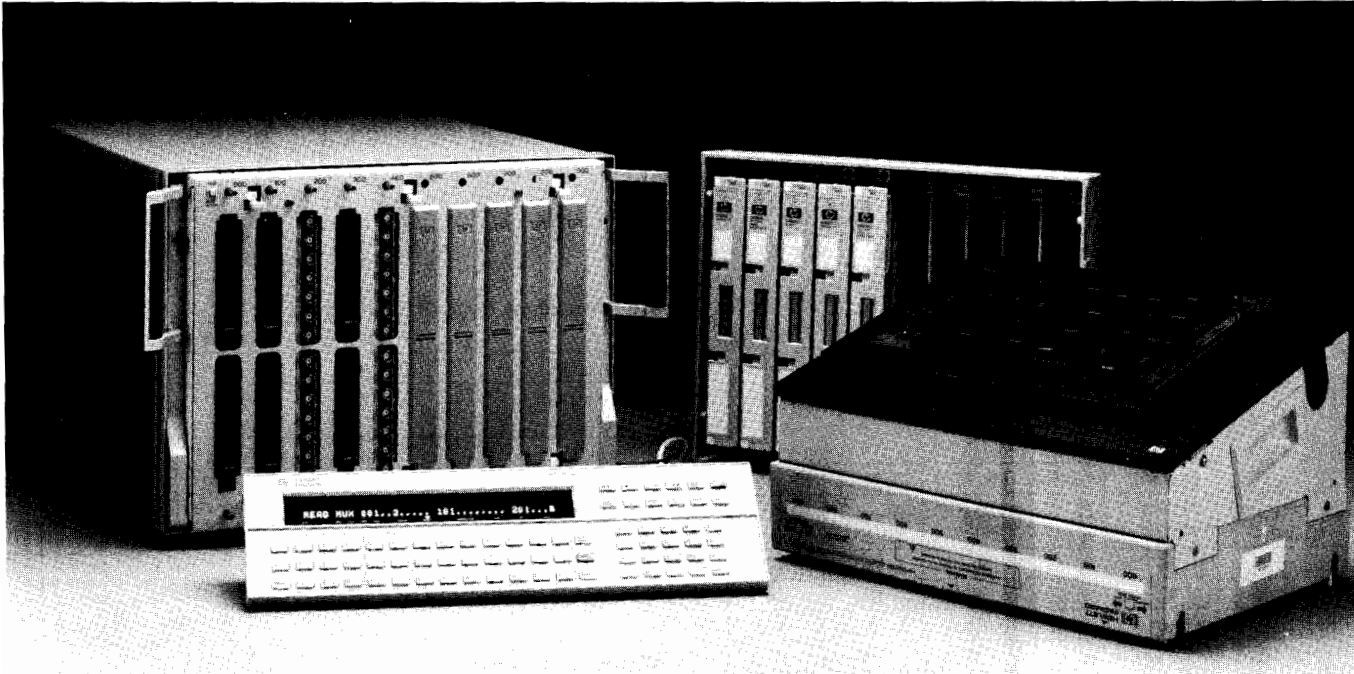

HP 3235A

Description

The HP 3235A Switch/Test Unit reduces test development of HP-IB production test systems by providing high performance off-the-shelf switching and interfacing to a wide variety of Devices Under Test (DUT).

This new Switch/Test Unit routes signals between your DUT and source/receiver instruments such as digital multimeters, counters, signal sources and analyzers.

Speed your test system development with:

- off-the-shelf tools
- easy programming
- reduced cabling

Your test system throughput increases with the HP 3235A's:

- intelligence
- plug-in digital multimeter module
- internal bus structure
- Quick Interconnect Fixture

A Reconfigurable Architecture

The HP 3235A chassis is a 10-slot cardcage driven by a 16-bit processor backed with 256k of firmware. You control the cardcage over HP-IB using high level commands for easy programming. Twenty different switch modules in various matrix and multiplexer topologies switch signals up to 10 Amps and from DC to 26.5 GHz. Also available are digital I/O, breadboard, four-channel D/A, DMM, and AC/DC source modules that are true "instruments-on-a-card."

For applications demanding numerous switch points, up to seven 10-slot HP 3235E Extenders can be slaved to the HP 3235A mainframe. 20,480 two-wire analog points can now be controlled from one HP-IB address.

The Quick Interconnect Fixture allows easy reconfiguration of the customer's test system for different test devices. Operator errors are also reduced by minimizing the number of connections that must be made before starting a new test.

Four analog and two trigger buses link the switch and instrumentation modules. These internal paths provide a "soft-wired" connection

that can be redefined by your test software. Analog signals get routed conveniently from a multiplexer to the digital multimeter module during scanning. Or, a trigger generated by the digital I/O module can be routed to the digital multimeter module.

To aid in system set up and debugging, a control panel with a full alpha-numeric keypad and electro-luminescent display is available.

Intelligence of a Computer

The powerful firmware of the HP 3235A instructs the plug-in modules with high level commands from the host computer. Storage and recall of hundreds of HP 3235A setups saves sending command sequences from the computer. BASIC language commands in the mainframe such as IF . . . THEN and FOR . . . NEXT, plus variables and math functions keep computer to switch interactions to a minimum, thereby increasing throughput. Use up to 480K bytes of mainframe memory for downloaded subroutines and stored values. Downloaded programs, including user defined data conversions or setups, execute rapidly.

Complete Modularity Means In-Rack Service

The HP 3235A is completely in-rack serviceable, so you never need to remove the card cage from the rack. All assemblies, including power supply, controller, and HP-IB, remove easily because of the modular design.

Simple Operational Verification Before Your Test

The HP 3235A offers three levels of internal self-test as well as a fixtured functional test for the individual plug-in modules. The fixtured test is performed using diagnostic terminal blocks that attach to the modules. These diagnostic fixtures, together with the internal DMM module, verify the integrity of the relay contacts in your system.

HP 3235A Plug-in Modules

A full complement of functional plug-in modules is available for use with the HP 3235A 10-slot mainframe or the HP 3235E 10-slot extender.

COMPUTER AIDED TEST

High Performance Switching and Control (cont'd)

Model 3235A

Low Frequency Relay Multiplexers

These modules can be used either as input or output multiplexers to switch signals to and from a device under test (DUT). The multiplexers are two-wire, switching both High and Low. They have different voltage and current switching capabilities, and use different relay types. The HP 34501T/34502T/34507T can also be used with thermocouples. For matrix applications, see below.

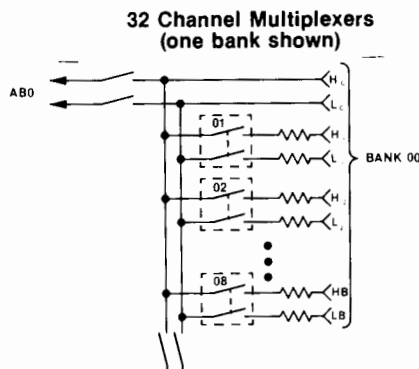

	HP 34501	HP 34502	HP 34507	HP 34511	HP 34515
Max Voltage (AC RMS)	250 VDC 250 VAC	125 VDC 90 VAC	250 VDC 250 VAC	130 VDC 130 VAC	1000 VDC 1000 VAC
Max Current	2A	25 mA	100 mA	1 A	1 A
No. of Channels	32	32	32	64	10
Relay Type	Armature	Reed	Mercury	Armature	Reed
Thermal Offset	<3 uV	<3 uV	<20 uV	<7 uV	<30 uV

High Frequency Relay Multiplexers

These multiplexers provide broadband switching of high frequency analog or digital signals. The HP 34504 switches both the center conductor and the shield. In the HP 34505 and HP 34508, the three multiplexer banks are isolated from each other and from ground, preventing ground loops.

RF Multiplexer (one bank shown)

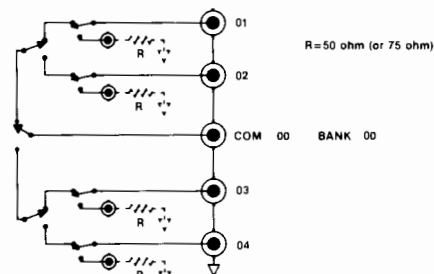

High Frequency Relay Multiplexers

	HP 34504	HP 34505	HP 34508
Bandwidth	100 MHz	1.3 GHz	1.3 GHz
Number of Channels	Dual 1x6	Two 1x4 One 1x3	Two 1x4 One 1x3
Impedance	50 ohms	50 ohms	75 ohms
Maximum Voltage (AC RMS)	42 VDC 30 VAC	42 VDC 30 VAC	42 VDC 30 VAC
Maximum Current	1 A	1 A	1 A
Switched Shield	Yes	No	No

Microwave Switches

These 50 ohm coaxial switches provide excellent electrical performance from DC to microwave frequencies. The HP 34530A goes to 18 GHz, while the HP 34530B goes to 26.5 GHz. The HP 34531A/B 18 GHz multiplexers are configured as 1x6. The HP 34531B has internal 50 ohm terminations for the open channels, while the HP 34531A does not. All of these microwave switches use SMA connectors. A variety of rack panel mounting kits are available. Up to four HP 34530A/B 3-port switches can also be mounted in the HP 34530T terminal block kit.

Switched-Shield Coaxial Multiplexer (one bank shown)

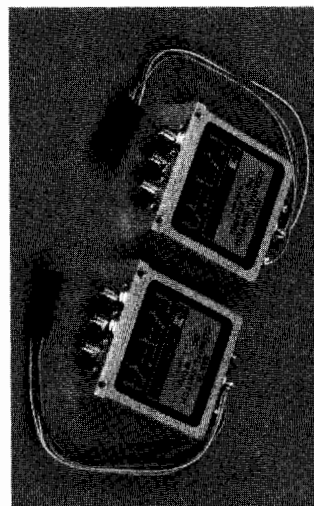
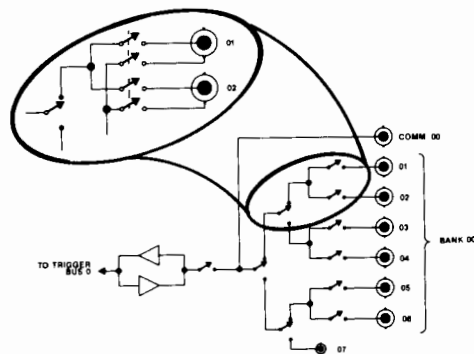

HP 34530A/B



HP 34531A

Relay Matrix Modules

These matrix cards come in a variety of configurations, densities, and bandwidths. For the highest density, consider the HP 34511M or the HP 34516M/N. If low leakage is a requirement, the HP 34512C features 10 pA/volt leakage, 2 pA/V typical. For higher bandwidth applications, look at the HP 34506 Switched Shield Matrix. Finally, for very high frequency applications, consider using the HP 34513C or the HP 34514C General Purpose RF relay modules (described in a later section) to build up your own custom high frequency matrices. Special cable kits allow many of these modules to easily expand into larger matrix configurations.

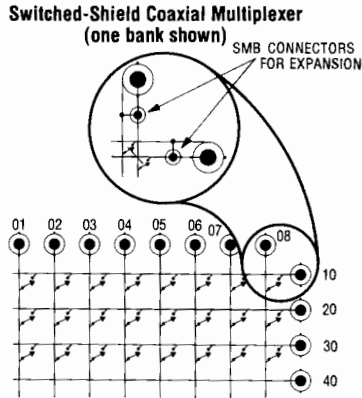

HP 34516N Two-Wire 256 Crosspoint Matrix

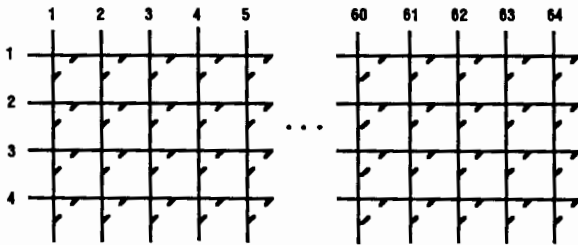

Relay Matrix Modules

	HP 34501M	HP 34506	HP 34511M	HP 34512	HP 34516
Crosspoints	32	32	64	32	256
Matrix Configuration	4x8	4x8	8x8 4x16	4x8	8x32 4x64
Bandwidth	1 MHz	30 MHz	1 MHz	30 MHz	1 MHz
Max voltage (AC RMS)	42 VDC 30 VAC	42 VDC 30 VAC	130 VDC 130 VAC	250 VDC 170 VAC	42 VDC 30 VAC
Max Current	2 A	1 A	1 A	1 A	1 A
Connectors	Two-wire	Coaxial	Two-wire	Triaxial	Two-wire
Switched Shield	No	Yes	No	Yes	No

General Purpose Relay Modules

There are several general purpose modules available for different applications. The HP 34503 has 16 Form C relays. The HP 34510 has 8, but can switch 10 amps per relay. The HP 34513 and HP 34514 are essentially building blocks, allowing you to build up custom switching topologies to fit your requirements. These cards contain 32 independently operated double-pole double-throw high frequency relays. All contacts are brought out to board mounted SMB connectors. Inter-connection between relays are made via coaxial cables.

General Purpose Relay Modules

	HP 34503	HP 34510	HP 34513	HP 34514
Number of relays	16	8	32	32
Contact Config	SPDT (Form C)	SPDT (Form C)	DPDT	DPDT
Maximum Voltage (AC RMS)	250 VDC 250 VAC	125 VDC 250 VAC	42 VDC 30 VAC	42 VDC 30 V AC
Maximum Current	3 A	10 A	1 A	1 A
Bandwidth	1 MHz	1 MHz	1 GHz	300 MHz
Use	General Purpose	Power Actuator	50 ohm RF Switching	75 ohm RF Switching

Digital I/O Modules

The HP 34509 has a total of 32 open-drain MOS-FET outputs available, which can switch voltages up to 42 volts and currents up to 0.5 A. This card also contains two internal power supplies of 15V and 28V, making the module ideal for driving relay coils or other devices. This card is also used in conjunction with the HP 34530 and HP 34531 Microwave switches.

The HP 34522 is a 32 Bit Digital I/O module, featuring 32 bi-directional TTL-compatible data lines, 8 edge-triggered interrupt lines, 16 high-power FET outputs, and a read/write rate > 40 kHz. The 32 data lines are configured as four 8-bit ports, each with their own handshake lines. Each port can be operated independently as a read or write port, or can be combined to handle 16 or 32 bit parallel data.

Analog Source Cards

The HP 34521 AC/DC Source card offers 24-bit (6.5 digit) resolution in the DC voltage mode, highly accurate amplitudes in the AC voltage mode, and versatile high speed outputs in the arbitrary waveform mode. Maximum voltage output is ± 10 volts, while maximum frequency is 1 MHz. Standard AC outputs include sine, square, and triangle waves, with variable duty cycle on both triangle and square waves. AC outputs are generated by direct digital synthesis which provides high accuracy and resolution down to 0.001 Hz. Arbitrary waveform memory depth is 2048 bytes. ARB's can be generated at a full 1 MHz bandwidth.

The HP 34524 contains four completely independent 14-bit plus sign digital-to-analog converters. In the voltage mode, each DAC can supply ± 10.24 volts. In current mode, each can provide ± 20.16 mA. Because the four DACs are isolated from one another, they can be connected in series or parallel for greater output voltages or currents.

Breadboard Module (HP 34523)

The breadboard module furnishes a convenient way to incorporate special purpose circuits into your test system. This module lets you interface directly the HP 3235A's backplane control signals and backplane analog and trigger buses.

6½ Digit Multimeter Module (HP 34520)

With the DMM module, you can integrate a high performance system multimeter into your test system without extensive cabling and software programming. The DMM module offers seven functions:

- DC volts with five ranges from 0.03V to 250V and reading rates >1450 rdgs./sec in the 3½ digit mode.
- AC Volts with 1MHz AC Bandwidth
- Two and four-wire resistance measurements
- DC current up to 1.5A, with reading rates as fast as DC Volts and ohms
- AC Current up to 100kHz and 1A.
- Frequency and period from 10 Hz to 1.5MHz with 6½ digit resolution.

The DMM module combines superb analog measurement capability with powerful system flexibility. Measurement inputs can be switched directly from the front of the module or, with the exception of current inputs, from any of the four internal HP 3235 analog buses.

COMPUTER AIDED TEST

High Performance Switching and Control (cont'd)

Model 3235A

DC Voltage (90 day, Tcal $\pm 5^\circ\text{C}$)

Range	Best 6½ Digit Accuracy ¹ \pm (% of reading + volts)	Input Resistance
30mV	.0053% + 5.40 μV	>10 G Ω
300mV	.0038% + 5.7 μV	>10G Ω
3.0V	.003% + 8 μV	>10G Ω
30V	.0048% + 220 μV	10 M $\Omega \pm 1\%$
250V	.0063% + 700 μV	10 M $\Omega \pm 1\%$

DC Current (90 day, Tcal $\pm 5^\circ\text{C}$)

Range	Best 6½ Digit Accuracy ¹ \pm (% of reading + amps)	Max. Burden Voltage at Fullscale
300 μA	.025% + 15.4 nA	0.35 V
3mA	.025% + 15.4 nA	0.35 V
30mA	.025% + 1.54 μA	0.35 V
300mA	.088% + 25.4 μA	0.6 V
1.5A	.088% + 654 μA	1 V

Resistance (2 and 4-wire ohms)² (90 day, Tcal $\pm 5^\circ\text{C}$)

Range	Best 6½ Digit Accuracy ¹ \pm (% of reading + ohms)	Current Output
30 Ω	.0078% + 5.4m Ω	1mA
300 Ω	.0058% + 5.7m Ω	1mA
3k Ω	.0048% + 9m Ω	1mA
30k Ω	.0048% + 90m Ω	100 μA
300k Ω	.006% + 1 Ω	10 μA
3M Ω	.008% + 15 Ω	1 μA
30M Ω	.032% + 830 Ω	100 nA
300M Ω ³	2.5% + 100k Ω	100 nA
3G Ω ³	25% + 1M Ω	100 nA

- After one hour warm up, integration time 100 PLC. Tcal is the temperature of the calibration environment between 18 and 28°C.
- For two-wire ohms, add 200M Ω to count error specifications.
- For two-wire ohms only accuracy is specified following auto-cal (ACAL), under stable conditions ($\pm 1^\circ\text{C}$).

AC Voltage (RMS AC and RMS AC+DC)

ACV Bandwidth: 20 Hz to 1 MHz

Crest Factor: 3.5 to 1 at fullscale

Common Mode Rejection with 1 k Ω imbalance in the low lead, DC to 60 Hz. Guarded: >86dB; non-guarded >66dB.

AC Volts (90 day, Tcal $\pm 5^\circ\text{C}$)

Range	(100Hz to 20kHz) Best 5½ Digit Accuracy ¹ \pm (% of reading + % of range)		Input Impedance
	AC Coupled	DC Coupled	
30mV	.15% + .0441%	.19% + .169%	1M $\Omega \pm 1\%$ shunted by <90pF
300mV	.15% + .0441%	.19% + .169%	
3.0V	.15% + .0441%	.19% + .169%	
30V	.15% + .0441%	.19% + .169%	
300V	.21% + .053%	.25% + .203%	

- Accuracy specified for sine wave inputs, >10% of range. DC component <10% of AC component after one hour warm up and within one week of autocal. AC band set to <400 Hz.

AC Current (RMS AC and RMS AC+DC)

ACI Bandwidth: 20 Hz to 100 kHz

Crest Factor: 3.5 to 1 at fullscale

Frequency and Period: Measures the frequency or period of the AC component of the AC or DC coupled voltage or current input. The counter uses a reciprocal counting technique to give constant resolution independent of input frequency.

Frequency Range: 10 Hz to 1.5 MHz (voltage input)
10 Hz to 100 kHz (current input)

Period Range: .1 s to 667 ns (voltage input)
.1 s to 3.33 μs (current input)

Sensitivity: 10 mV RMS or 100 μA RMS (sinewave)

Triggering: Triggers and counts on zero crossings.

SimPlate Board Test Fixture (HP 34597A)

The HP 34597A SimPlate Board Test Fixture is a vacuum actuated bed-of-nails test fixture kit for the HP 3235A Switch/Test Unit. SimPlate and the HP 3235A are tools developed for your "rack-and-stack" functional test systems. Unlike an edge connector test, SimPlate gives you access to all component leads to provide more functional test flexibility and improved fault isolation. Because of its unique single plate design, SimPlate can provide the close tolerance probing required for interfacing to Surface Mount Technology (SMT) boards.

SimPlate is delivered as a kit, that you must drill, wire, and assemble. The components in this kit are designed to probe printed circuit boards from a single side, with test pads as small as 0.030" diameter on 0.050" centers. Probes, receptacles and extra HP 3235A terminal blocks are ordered separately.

Environmental:

Operating Temperature: 0-55 C (32-130 F)

Storage Temperature: -40 -75 C (-40 -165F)

Humidity Range: 95% R.H., 0 to 40 C

Power:

Line Voltage: 90-132V (115V) or 192-264 (230V) switch selectable
47-66 Hz. Fused at 5A (115V) or 2.5A (230V).

Size:

HP 3235 Cardcage: 310mm H (without feet) x 426mm W x 594 mm o (12.25"x16.75"x23.4")

Height with Feet: 325mm (12.8")

Depth with Terminal Blocks: 693mm (27.3")

Weight

HP 3235 Cardcage (max.)

Each Module (max.)

Net

21 kg (46 lbs)

5.5 kg (12 lbs)

Shipping

28 kg (61 lbs)

6.6 kg (14.5 lbs)

Ordering Information

HP 3235A Switch/Test Unit

Opt 560 Add System Expansion Card

Opt 580 HPIB Controller

Opt 590 Add Quick Interconnect

Opt 908 Rack Mount Kit (HP P/N 03235-80908)

HP 3235E Switch/Test Unit Extender

HP 34550A Control Panel

HP 34551A Control Panel Rack Mount Kit

Price

\$4900

\$400

\$650

\$845

\$108

\$4085

\$640

\$60

Plug-in Accessories are supplied with your choice of terminal blocks. "A" suffix designates solder lugs, "B" suffix designates screw terminals, "C" suffix deletes the terminal block, "M" and "N" suffixes designate matrices, and "T" suffix is used to measure thermocouples. Prices are shown below for the "B" suffix.

HP 34501A/B/M/T 32-chan Armature Rly Mux/Matrix \$1730

HP 34502A/B/M/T 32-chan Reed Rly Mux/Matrix \$1725

HP 34503A/B General Purpose Relay Module \$1060

HP 34504A/B/C Switched-Shield Coax Mux \$1850

HP 34505A/B/C 50 Ohm RF Mux \$1630

HP 34506A/B/C Switched-Shield Coax Matrix \$2065

HP 34507A/B/M/T 32-chan Mercury Rly Mux/Matrix \$1955

HP 34508A/B/C 75 Ohm RF Mux \$1780

HP 34509A/B/C 32 Channel Relay Driver Module \$1210

HP 34510B 10-amp, 8-Channel Power Actuator \$810

HP 34511B/M 64-channel Relay Mux/Matrix \$2485

HP 34512C Switched-Shield Triaxial Matrix \$2780

HP 34513C General Purpose 50 Ohm RF Module \$2780

HP 34514C General Purpose 75 Ohm RF Module \$3090

HP 34515B 10-channel 1000 Volt Mux \$1955

HP 34516M/N 256-crosspoint Matrix \$4735

HP 34520A/B 6.5 Digit Multimeter Module \$2925

HP 34521A/B AC/DC Source Module \$2865

HP 34522A/B 32 Bit Digital I/O Module \$1400

HP 34523A/B Breadboard Module \$560

HP 34524A/B 4 Channel D/A Converter Module \$1890

HP 34530A/B Microwave Switch \$670

HP 34531A/B 1x6 Microwave Switch \$1455

COMPUTER AIDED TEST

Low Cost, Versatile HP-IB Switching & Control

HP Model 3488A

595

- DC—26.5 GHz signal switching
- Matrix, multiplexer, & general purpose relays
- Digital I/O control & actuation

- Up to 50 channels
- 40 configuration storage registers
- 11 switch & control modules

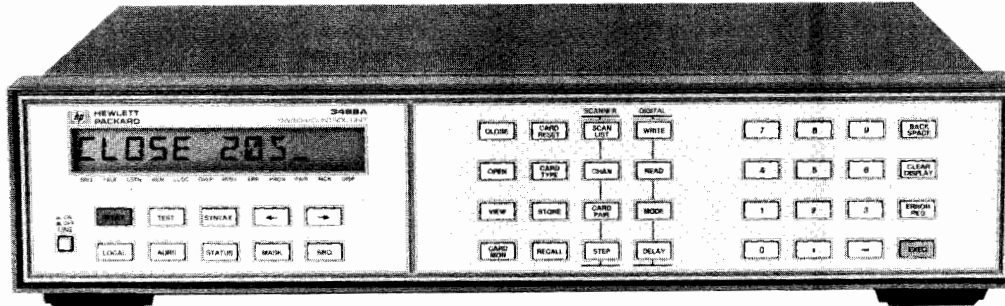

HP 3488A



Description

The HP 3488A Switch/Control Unit brings versatile, HP-IB programmable switching to tests requiring multi-channel measurements. The HP 3488A provides signal switching with the integrity and isolation needed for high performance test systems in production. It also offers a flexible, low cost interconnection solution for automating experiments on the bench and for development testing in the lab. The HP 3488A is designed to hold any combination of up to 5 of the following optional switch and control modules:

- 10 Channel Relay Multiplexer
- 10 Channel General Purpose Relay
- Dual 4 Channel VHF Switch
- 4 x 4 Matrix Switch
- 16 Bit Digital Input/Output
- Breadboard
- 3 Channel 18 GHz Switch
- 7 Channel Form-C Relay
- 2 Channel Microwave Switch
- 1.3 GHz 50 and 75 ohm Multiplexers

Flexible Switching

The HP 3488A offers an economical approach to switching flexibility through plug-in modules. The user can select the right combination of switching functions to meet both performance and budget requirements. Testing is simplified by having one solution for connections of low level DVM inputs, high level dc and ac power, and microwave signals to 26.5 GHz. Additional devices such as microwave relays and programmable attenuators are easily controlled with digital I/O functions. Custom circuitry can also be implemented on breadboard modules.

Versatile Performance

The HP 3488A can store up to 40 complete switch configurations for convenient recall in automated test programs. Switch operation can be with multiple relay closures or with selectable channels in a break-before-make mode. Break-before-make closures and recallable complete switch configurations can be combined in a programmable scan list. The HP 3488A uses removable screw terminal connectors that provide easily interchangeable wiring configurations for each test. Built-in self-test capability assures proper operation.

Multiplexer (Opt. 010/HP 44470A)

Option 010 is a 10 channel multiplexer for scanning or multiple signal connections. Channels switch 2 wires (Hi & Lo) with 2PST relays for DVM inputs and other signals up to 250 V and 2A. This module can also be used to multiplex signals to other switching functions such as the matrix module.

General Purpose Relay (Opt. 011/HP 44471A)

This module consists of 10 SPST independent relays for general signal switching and control of external devices. The quality connections provided make this module ideal for switching signals when multiplexing isn't required or for supplying switchable power to the device under test.

VHF Switch (Opt. 012/HP 44472A)

The VHF module provides broadband switching capability for high frequency and pulse signals. The 2 independent groups of bidirectional 1 x 4 switches can be used for signals from dc to 300 MHz. All channels have 50 ohm characteristic impedance and are break-before-make within a group of 4 channels. Each group is isolated from the other and from ground to prevent ground loops. Excellent isolation makes this module ideal for high frequency signal analyzer measurements requiring a large dynamic range.

Matrix Switch (Opt. 013/HP 44473A)

Option 013 offers highly flexible switching with a 4 x 4, 2 wire matrix. Any combination of 4 input channels may be connected to any combination of 4 output channels. Each cross point or node in the matrix uses a 2PST relay to switch 2 lines (Hi & Lo) at a time. Multiple 4 x 4 modules can be connected to form larger matrices. Multiplexers can be used in conjunction with this module to effectively expand the number of inputs and outputs of the matrix.

Digital I/O (Opt. 014/HP 44474A)

This module offers 16 very flexible bidirectional I/O lines and 4 TTL compatible handshake lines for sensing and control of external devices. The digital inputs can be used to sense contact closures to ground. Each channel provides current sinks for remote switching of external relays such as the HP 33311 series of coaxial switches.

Breadboard (Opt. 015/HP 44475A)

The breadboard module provides a convenient way to implement custom circuits and special functions that interface directly with the HP 3488A's backplane control signals.

Microwave Switch (Opt. 016/HP 44476A)

This microwave switch furnishes three independent SPST 50-ohm coaxial switches with excellent performance from DC to 18 GHz. The 3-mm SMA connector allows the user to easily connect cables for multiple system configurations.

Form-C Relay (Opt. 017/HP 44477A)

This module provides seven separate SPDT channels for general purpose switching and control of external devices. Using a power supply, the module can drive programmable attenuators and non-HP coaxial switches.

COMPUTER AIDED TEST

Low Cost, Versatile HP-IB Switching & Control (cont'd)

HP Model 3488A

Microwave Switch (Opt. 018/HP 44476B)

The module brings multi-port 50-ohm coaxial switching to your test system. The module can mount any two HP 3331XX Coaxial Switches. The HP coaxial relays come in three-, four-, and five-port configurations, different switches for a variety of applications. HP Coaxial Switches that can be used are listed on the following table.

HP Coaxial Switch	Port	Frequency
HP 33311B/Opt.011	3	dc - 18 GHz
HP 33311C/Opt.011	3	dc - 26.5 GHz
HP 33312B/Opt.011	4	dc - 18 GHz
HP 33312C/Opt.011	4	dc - 26.5 GHz
HP 33313B/Opt.011	5	dc - 18 GHz
HP 33313C/Opt.011	5	dc - 26.5 GHz

1.3 GHz 50 ohm Multiplexer (Opt. 019/HP 44478A)

1.3 GHz 75 ohm Multiplexer (Opt. 020/HP 44478B)

These modules bring bi-directional switching of signals from DC to 1.3 GHz, with high channel isolation (>55 dB @ 1 GHz). Each module consists of two groups of 1x4 multiplexers. All test connections are made to BNC's on the module's edge. Off-channels can be resistively terminated.

Specifications for Opt. 010/HP 44470A Multiplexer, Opt. 011/HP 44471A General Purpose Relay, and Opt. 013/HP 44473A Matrix Switch and Opt. 017/HP 44477A Form-C Relay Switch Modules

Input Characteristics

Maximum voltage (terminal-terminal or terminal-chassis): 250 V

dc, 250 Vac rms, 350 Vac peak

Maximum current: 2A dc, 2A ac rms

Maximum power: 60 W dc, 500 VA ac

Thermal offset: < 3 μ V

DC Isolation (40°C, 60% RH)

Channel-channel, open channel: > 10¹¹ Ω

AC Isolation/Performance

(50 Ω termination)	100 kHz	1 MHz	10 MHz
Insertion Loss (dB)	<0.30	<0.35	<0.90
Crosstalk (dB)	<-73	<-53	<-33

Specifications For Opt. 012/HP 44472A VHF Switch Module

Input Characteristics

Maximum Voltage

Center-center, center-low: 250 Vdc, 30 Vac rms, 42 Vac Peak

Low-chassis, low-low: 42 V dc

Maximum current (per channel): 30 mA dc, 300 mA ac rms

Thermal offset: < 15 μ V per channel

Characteristic impedance: 50 Ω

AC Isolation/Performance

	30 MHz	100 MHz	300 MHz
Crosstalk (dB)			
Chan-Chan	<-100	<-85	<-65
Group-Group		<-85	<-50
Insertion Loss (dB)	<0.5	<0.75	<1.25
VSWR	<1.06	<1.12	<1.43

All channels break-before-make within a group of 4 channels.

Specifications for Opt. 014/HP 44474A

Digital I/O Module

I/O Lines

Maximum voltage = +30 Vdc (line-chassis)

Output characteristics: V (high) \geq 2.4 V; V (low) \leq 0.4V

I (low) maximum = 125 mA @ V (low) \leq 1.25 V; fused at 250 mA.

Input characteristics: V (high) \geq 2 V; V (low) \leq 0.8 V

External increment: advances HP 3488A to next programmed configuration on falling edge of TTL pulse.

Channel closed: indicates completion of new configuration; TTL pulse.

Specifications for Opt. 016/HP 44476A

Microwave Switch Module

Frequency Range: dc to 18 GHz

Isolation: >90 dB

Impedance: 50 Ohms

Insertion Loss: <0.05 dB

SWR: 1.40

Specifications for Opt. 018/HP 44476B

Microwave Switch Module

Refer to HP 3331XX specifications.

Specifications for Opt. 019/HP 44478A and Opt. 020/HP 44478B 1.3 GHz Multiplexers

Input Characteristics

Maximum Voltage: 42V DC + AC Peak

Maximum Current per channel: 1 A DC or AC RMS

Maximum Power per channel: 24W, 24VA, or 44 dBm

Impedance: 50 ohms (Opt. 019/HP 44478A)

75 ohms (Opt. 020/HP 44478B)

AC Performance

	\leq 10 MHz	\leq 100 MHz	\leq 500 MHz	\leq 1.3 GHz
Insertion Loss (dB)				
\leq (40°C, 95% RH)	<0.3	<0.7	<1.5	<3.0
\leq (25°C, 40% RH), (Typ.)	<0.2	<0.5	<1.1	<1.9
Crosstalk (dB) ¹				
Channel-Channel				
Channel-Common	<-90	<-80	<-65	<-55
Group-Group, Module-Module	<-90	<-80	<-70	<-60
VSWR	<1.2	<1.25	<1.35	<1.55

General Specifications

Environmental

Temperature: 0 to 55°C; humidity: 95%, 0 to 40°C

Power: 86-132 V/195-250 V, switch selectable; 48 - 440 Hz; 18 VA.

Interface: SH1AH1T6TE0L4LE0SR1RL1PP0DC1DT1E2

Size: 89 mm H (without feet) x 425 mm W x 292 mm D (3.5" x 16.75" x 11.5"). Allow 76 mm (3") additional depth for wiring.

Weight: net: 8.5 kg (18.5 lb). Shipping: 16 kg (36.5 lb).

Connectors Removable screw terminal connector. Each terminal accepts 18-26 gauge (16-40 mils) wire, with strain relief for wiring. Option 012/HP 44472A VHF Switch: BNC connectors. Opt. 016/HP 44476A and Opt. 018/HP 44476B Microwave Switch: SMA connectors.

Ordering and Configuration Information

HP 3488A Switch/Control Unit

Price

\$1,625

Switch Modules-Includes Terminal Connectors

Opt. 010/HP 44470A: 10 Channel Relay Multiplexer Module \$455

Opt. 011/HP 44471A: 10 Channel General Purpose Relay Module \$455

Opt. 012/HP 44472A: Dual 4 Channel VHF Switch Module \$660

Opt. 013/HP 44473A: 4x4 Matrix Switch Module \$560

Opt. 014/HP 44474A: 16 Bit Digital Input/Output Module \$455

Opt. 015/HP 44475A: Breadboard Module \$191

Opt. 016/HP 44476A: Microwave Switch Module \$2,110

Opt. 017/HP 44477A: Form-C Relay Module \$455

Opt. 018/HP 44476B: Microwave Switch Module \$455

Opt. 019/HP 44478A: 1.3 GHz 50 ohm Mux \$825

Opt. 020/HP 44478B: 1.3 GHz 75 ohm Mux \$900

Rack Mounting and Manuals

Opt. 401: Side Handle Kit (HP P/N 5061-1171) \$43

Opt. 907: Front Handle Kit (HP P/N 5061-1170) \$55

Opt. 908: Rack Flange Kit (HP P/N 5061-1168) \$35

Opt. 909: Rack Flange with Handles (HP P/N 5061-1169) \$79

Opt. 910: Extra Operating & Service Manuals \$84

Opt. W30: Three Year Hardware Support \$50

- Two mainframe sizes (Series B and Series C)
- Over twenty-five modules available
- TMSL language for easy programming
- HP Interactive Test Generator Software

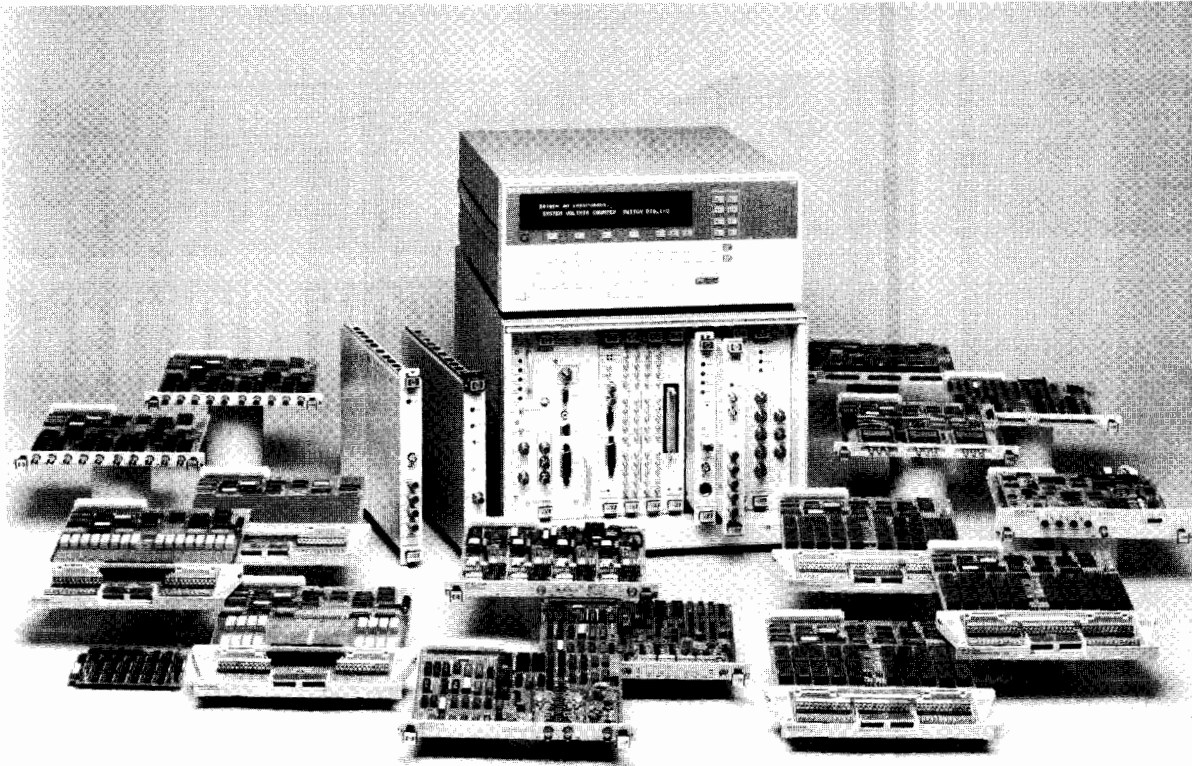

HP 75000 Family

HP 75000 Family Reduces Test System Development Time

The HP 75000 family of VXIbus products is part of the HP measurement-systems architecture (MSA), which provides benefits such as standardization, downsizing, throughput, and flexibility. Developing a test system involves much more than simply selecting hardware; it also requires software, systems integration, and support. The HP 75000 family is a fully compatible line of VXI products that reduces the development time for test systems. It includes computers, software, standardized instrument language, reliability, and services.

Hardware

The HP 75000 family of VXIbus products consists of two mainframe sizes and over twenty-five modules. The HP 75000 Series B Mainframes are designed for low-cost computer-aided-test applications, and include seven B-size VXI slots. The HP 75000 Series C Mainframe is designed for medium-to-high performance computer-aided-test applications, and includes thirteen C-size VXI slots. A broad line of HP 75000 B- and C-size modules such as switching, digital multimeters, counters, sources, power meters, and computers are also available.

Firmware and Software

The HP 75000 products offer compatibility and a broad range of price-performance. All members of the HP 75000 family use the Test and Measurement Systems Language (TMSL), a new instrument-language standard adopted by Hewlett-Packard to simplify programming. With TMSL, users can send commands to instruments in a consistent, readable form. It conforms to IEEE 488.2. For example, to trigger a reading, you would send the command “*TRG” to the appropriate instrument. All HP 75000 family products

support the HP Interactive Test Generator (HP ITG) interface. Hewlett-Packard added these capabilities to the VXI standard to help reduce test system development time.

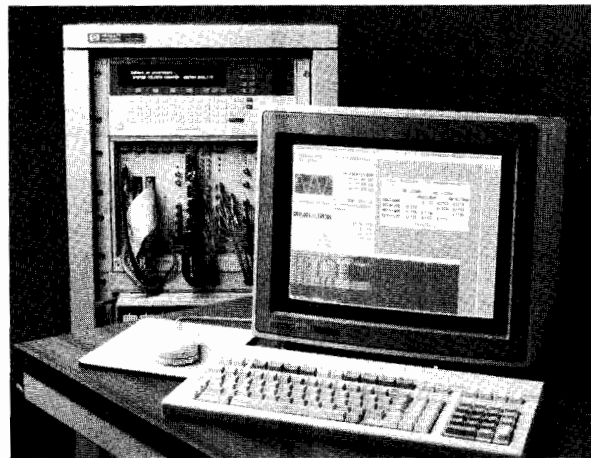

Developing Programs with HP Interactive Test Generator System Support

Because getting a test system running quickly requires a solid base of support, Hewlett-Packard offers support services tailored to user needs. Support services in the U.S. include free 90-day phone-in support and optional 1 year additional support contracts. All HP 75000 Products have a standard 3-year warranty.

COMPUTER AIDED TEST

HP 75000 Family of VXI Products

Series B and Series C Mainframes

Series B Mainframes

- Low-cost switching and measurement
- Built in command module (no slot 0 required)
- Flexible, built-in pacer for timing external devices
- TMSL systems language eases programming

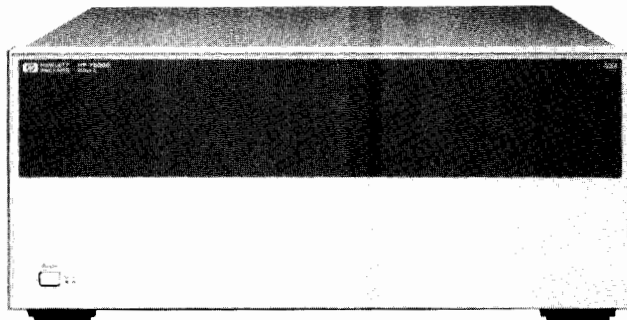
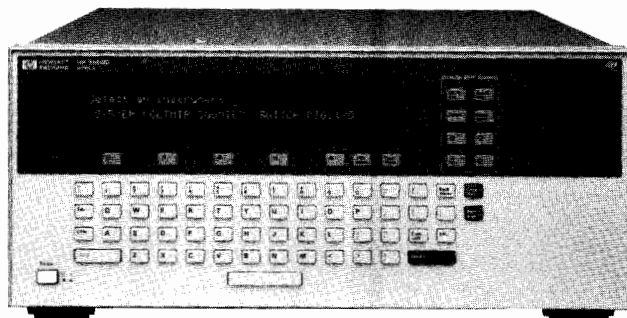

HP 75000 Series B Mainframes

The HP 75000 Series B Mainframes provide a flexible, low cost test system platform. Both include a built in command module, eliminating the need for Slot 0 and resource manager functions and providing an HP-IB (IEEE-488) interface. The Series B Mainframes have 7 B-size and 3 A-size slots. To configure a test system, you plug in the individual instrument and switching modules you want. (The digital multimeter can optionally be mounted inside the mainframe.) The built-in pacer can generate timing and synchronizing signals by sending a TTL signal from the rear panel connector.

The HP model E1300A and E1301A mainframe are identical except that the E1301A also includes a front panel keyboard/display for direct command entry to troubleshoot wiring, connections, and programming. Use the HP E1300A (plain front panel) with turnkey software, such as HP 75000 System 10 Software (see page 588), or to further lower the cost of duplicate systems.

Series C Mainframe

- High-performance computer aided test
- Auto-configuring backplane
- Pressurized air channel for independent slot cooling
- Ultra-reliable power supply

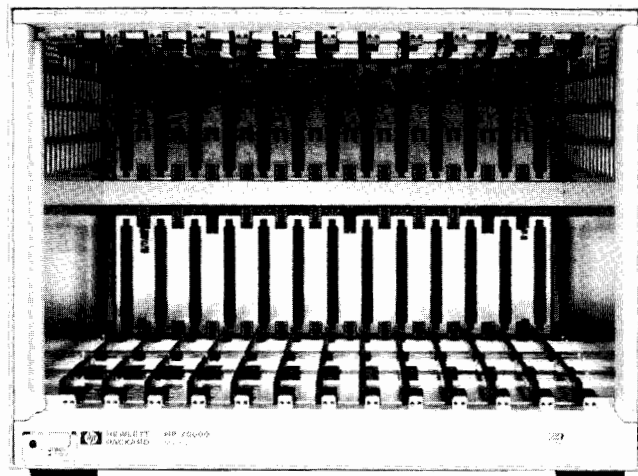

HP 75000 Series C Mainframe

The HP 75000 Series C Mainframe provides high performance while allowing for system downsizing. The Series C Mainframe has thirteen C-size VXI slots. It offers a high-performance platform that becomes the heart of the computer-aided-test system.

With the exclusive HP auto-configuring backplane, all you have to do is plug in a module, and the backplane does the rest. There is no need for jumpers or dip switches to bypass empty slots.

The new HP power supply has a proven track record of greater than 1 million hours MTBF. It also has a third fan to provide up to 45 watts per slot cooling.

With the exclusive HP pressurized air channel system, each slot is cooled independently. A pressurized plenum with channels delivers air to each slot, and ensures adequate cooling with empty slots and with or without faceplates.

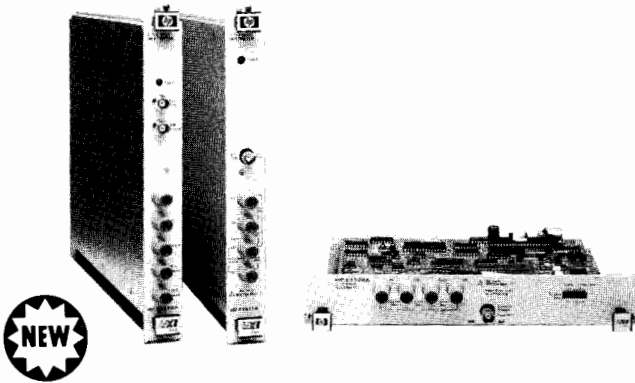

HP E1410A, HP E1411A and HP E1326A

5 1/2-Digit Multimeters (HP E1326A, E1411A)

The HP E1326A and E1411A 5 1/2-digit multimeters are well suited for data acquisition and computer-aided testing. These economical, versatile multimeters meet both high accuracy scanning and high speed measurement needs.

These two multimeters differ only in size; they are identical in electrical design. The HP E1326A multimeter is a 2-slot B-size module that can be plugged into the rear of the HP 75000 Series B Mainframe or mounted internally (saving two module slots) with the internal installation kit (HP E1326-80002). The HP E1411A multimeter is a 1-slot C-size module.

- Dual A/Ds
 - 5 1/2-digit/low noise integrating A/D
 - high speed (14 kHz) sampling A/D
- Balanced differential isolated inputs
- Functions: DCV, ACV, 2 & 4-wire ohms, offset compensated ohms, thermocouples, thermistors, RTDs
- Autozeroing and autoranging
- Flexible triggering with built-in timer/pacer
- Software calibration

Use the integrating A/Ds in these multimeters to make 5 1/2-digit, low-noise measurements. Use the sampling A/Ds to make 14-bit readings at rates up to 14 kHz. The multimeters can be combined with any HP 75000 low-frequency multiplexer to create a multichannel scanning multimeter. A single TMSL command from the Series B Mainframe or HP E1405A Command Module can program both the multimeter and multiplexer channels.

Reading Rates & Resolution

Conditions: Auto zero off, fixed range, default trigger delay, sample source 'TIMER' for rates >15 readings/sec.

Aperture:	320/267 ms	20/16.7 ms	2.5 ms	100 μ s	10 μ s
Typical Reading rates (rdgs/sec)					
DCV/ Ω	3/3.5	49/59	365	3125	14,285
ACV	1.3	1.9	1.9	1.9	1.9
Resolution					
Bits	± 22	± 20	± 18	± 15	± 14
Digits	6 1/2	6	5 1/2	4 1/2	3 1/2

Noise Rejection

Conditions: 50/60 Hz $\pm 0.1\%$, 1 k Ω in both HIGH and LOW leads with 10% imbalance, LOW connected to COMMON at source. Measured with respect to earth ground.

Aperture:	320/267 ms	20/16.7 ms	2.5 ms	100 μ s	10 μ s
NPLCs	16	1	NA	NA	NA
NMR	84 dB	60 dB	0	0	0
DC CMR	150 dB	150 dB	150 dB	150 dB	150 dB

90-Day DC Voltage Accuracy

\pm (% of reading + volts)

Conditions: Autozero on, 1 hour warm up within ± 5 degrees C of cal temp.

Aperture:	320/267 ms	20/16.7 ms	2.5 ms	100 μ s	10 μ s
Range					
125mV	.023%+5.0 μ V	.023%+5.0 μ V	.023%+10. μ V	.065%+30. μ V	.115%+60. μ V
1V	.013%+10. μ V	.013%+15. μ V	.013%+15. μ V	.055%+100 μ V	.100%+200 μ V
8V	.010%+50. μ V	.010%+50. μ V	.010%+80. μ V	.055%+750 μ V	.100%+1.5mV
64V	.015%+1.0 mV	.015%+1.0 mV	.015%+1.0 mV	.055%+5.0 mV	.100%+20. mV
300V	.015%+5.0 mV	.015%+5.0 mV	.015%+5.0 mV	.055%+30. mV	.100%+80 mV

6 1/2-Digit Multimeter (HP E1410A)

The HP E1410A 6 1/2-Digit Multimeter is a full function system DMM in a compact, single-slot C-size module. It is similar in design to the popular HP 3457A multimeter, and it is suitable for a wide variety of computer aided and manufacturing test applications where high accuracy is required.

Programming this message-based multimeter is easy with high-level TMSL commands. The command set is built into the voltmeter module. Make all high accuracy multimeter measurements with this compact system DMM.

- High accuracy/low noise 6 1/2-digit integrating A/D
- 1,450 readings/second at 3 1/2-digits
- Guarded high impedance inputs
- Functions: DCV, ACV (DC & AC coupled), 2 & 4-wire ohms, offset compensated ohms, frequency, period
- Autozeroing and autoranging
- Flexible triggering with built-in timer/pacer
- Software calibration

Reading Rates & Resolution

Conditions: Auto zero off, fixed range, delay \emptyset , AC slow filter on, offset compensation off

Aperture:	200/167ms	20/16.7ms	2/1.67ms	100 μ s	10 μ s
Reading rates (rdgs/sec)					
DCV/ Ω	4	47	312	1250	1450
ACV	.65	1.0	1.0	1.0	1.0
Resolution					
Bits	± 22	± 22	± 19	± 15	± 12
Digits	6 1/2	6 1/2	5 1/2	4 1/2	3 1/2

Noise Rejection

Conditions: 50/60 Hz $\pm .08\%$, 1 k Ω imbalance in low lead.

Aperture:	200/167ms	20/16.7ms	2/1.67ms	100 μ s	10 μ s
NPLCs	10	1	NA	NA	NA
NMR	80 dB	60 dB	0	0	0
DC CMR	140 dB	140 dB	140 dB	140 dB	140 dB

90-Day DC Voltage Accuracy

\pm (% of reading + volts)

Conditions: Autozero on, within ± 5 degrees C of cal temp., 1 hour warmup

Aperture:	200/167 ms	20/16.7 ms	2/1.67 ms	100 μ s	10 μ s
Range					
30 mV	.0053%+5.6 μ V	.0053%+6.75 μ V	.0053%+8.8 μ V	.0053%+21 μ V	.0053%+70 μ V
300 mV	.0038%+5.8 μ V	.0038%+6.8 μ V	.0038%+11 μ V	.0038%+50 μ V	.0038%+400 μ V
3V	.0030%+9.0 μ V	.0030%+9.0 μ V	.0030%+50 μ V	.0030%+400 μ V	.0030%+4 mV
30V	.0048%+230 μ V	.0048%+330 μ V	.0048%+800 μ V	.0048%+4 mV	.0048%+40 mV
300V	.0063%+800 μ V	.0063%+800 μ V	.0063%+4 mV	.0063%+40 mV	.0063%+400 mV

COMPUTER AIDED TEST

HP 75000 Family Of VXI Products

Counters

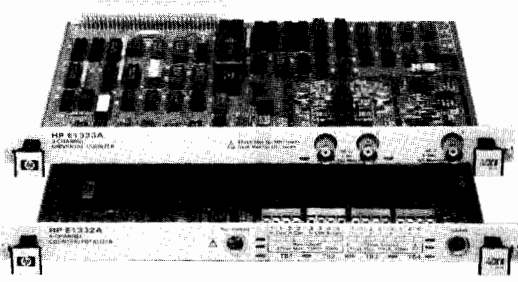

HP E1333A and HP E1332A

3-Channel Universal Counter (HP E1333A)

- Frequency, period average, ratio, pulse width, time interval and totalize to 100 MHz
- 1 GHz frequency measurement available on Channel 3
- Occupies only one B-size slot
- 1 ns time interval resolution with averaging
- Features TMSL command language when used with the HP 75000 Series B Mainframe or HP E1405A Command Module

Specifications

Frequency measurement

Range: 100 MHz (Channels 1 and 2)
75 MHz - 1 GHz (Channel 3)

Resolution: $1/(\text{Gate time})$ (Gate time: 2^n ns, $n = 1$ to 16)

Accuracy: \pm resolution \pm timebase error \pm trigger noise error

Period average measurement: Channels 1 and 2 average 2^N periods of the input signal.

Range of N: 1 to 16

Resolution: $1/(10 \times 10^6 \times 2^N)$ sec

Accuracy: \pm resolution \pm timebase error \pm trigger noise error

Time interval (with average mode)

Range: Up to $6871/(2^N)$ seconds (where 2^N is the number of intervals to be averaged, $N = 0$ to 7)

Resolution: $(100 \text{ ns})/(2^N)$ (where 2^N is the number of intervals to be averaged, $N = 0$ to 7)

Accuracy: \pm resolution \pm timebase error \pm trigger noise error

Pulse width (with average mode)

Range: up to $6871/(2^N)$ seconds (where 2^N is the number of intervals to be measured, $N = 0$ to 7)

Resolution: $100 \text{ ns}/2^N$

Accuracy: \pm resolution \pm timebase error \pm trigger noise error

Frequency ratio

Resolution: $1/(2^N)$ (2^N is the preset number of transitions, $N = 6$ to 36)

Totalizing

Range: 1 to $2^{36} - 1$

Timebase

Frequency: 10 MHz

Accuracy: ± 2 ppm

Temperature drift: ± 5 ppm (0-50°C)

Aging: ± 2 ppm/year

Trigger noise error (RMS) =

$\sqrt{(80 \mu\text{V})^2 + (en)^2}/(\text{input slew rate at trigger point in } \mu\text{V/sec})$
where $en =$ noise on input signal for 150 MHz bandwidth in μV

4-Channel Counter/Totalizer (HP E1332A)

- Totalize, up/down count, gated totalize, pulse width, time interval, period average, and frequency measurement up to 4 MHz
- Programmable direct or isolated inputs
- Programmable digital input filter
- Features HP TMSL command language when used with the HP 75000 Series B mainframe or HP E1405A Command Module

Specifications

Frequency measurement (requires 2 channels)

Range: 4 MHz

Resolution: $1/(\text{Gate time})$ (Gate time: 2^n ns, $n = 1$ to 16)

Accuracy: \pm resolution \pm timebase error \pm trigger noise error

Period measurement (requires 2 channels): Channels 1 and 3 measure 2^N periods of the input signal.

Range of N: 1 to 16

Resolution: $1/(5 \times 10^6 \times 2^N)$ sec

Accuracy: \pm resolution \pm timebase error \pm trigger noise error

Time interval

Measures the time interval between transition from channel 1 to channel 2 or channel 3 to channel 4.

Range: Up to 858 seconds

Resolution: 200 ns

Accuracy: \pm resolution \pm timebase error \pm trigger noise error

Pulse width (requires 2 channels)

Range: Up to 858 seconds

Resolution: 200 ns

Accuracy: \pm resolution \pm timebase error \pm trigger noise error

Totalizing (requires 1 channel)

Range: 1 to $2^{32} - 1$ Counts

Gated totalize (requires 2 channels)

Range: 1 to $2^{16} - 1$

Up/down count (requires 2 channels)

Range: $\pm (2^{31} - 1)$

Timebase

Frequency: 5 MHz

Accuracy: ± 2 ppm

Temperature drift: ± 5 ppm (0-50°C)

Aging: ± 2 ppm/year

Trigger noise error (RMS) =

$\sqrt{(200 \mu\text{V})^2 + (en)^2}/(\text{input slew rate in } \mu\text{V/sec})$ where $en =$ noise on input signal for 5 MHz bandwidth in μV

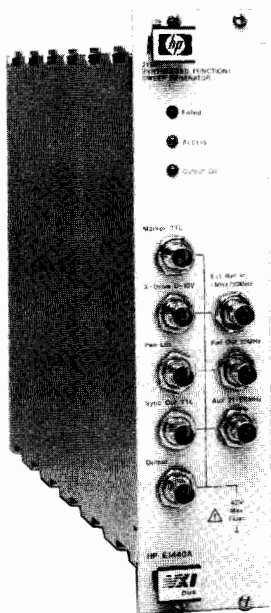

HP E1440A

21 MHz Synthesized Function/Sweep Generator

The HP E1440A 21 MHz Synthesized Function/Sweep Generator is a 2-slot C-size VXI module that offers five different waveforms with synthesizer accuracy. Frequency resolution down to 1 μ Hz, 5 ppm frequency accuracy/stability and outstanding signal purity make this generator the ideal reference source for test equipment. Includes multi-interval sweep and multi-marker mode sweep capabilities.

Specifications

Waveforms: sine, square, triangle, negative and positive ramps, DC, TTL clock

Frequency ranges: sine: 1 μ Hz - 21 MHz
 square: 1 μ Hz - 11 MHz
 triangle/ramps: 1 μ Hz - 11 kHz
 TTL clock: 1 μ Hz - 60 MHz

Frequency resolution: 11 digits

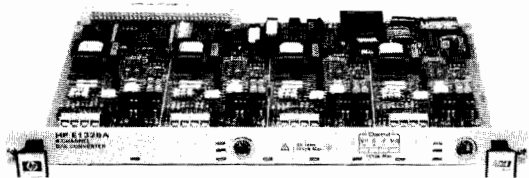

HP E1328A

4-Channel D/A Converter

The HP E1328A 4-Channel D/A Converter is a B-size VXI module that provides four independent, isolated channels of voltage or current output. Each channel is individually selectable for maximum flexibility. Software calibration is provided, eliminating the need to adjust pots.

Specifications

Voltage output range: ± 10.92 V
Voltage accuracy: 24-Hour: $\pm(0.05\% + 3.3$ mV)
 90-Day: $\pm(0.15\% + 29$ mV)
Current output range: ± 21.8 mA
Current accuracy: 24-Hour: $\pm(0.05\% + 7$ μ A)
 90-Day: $\pm(0.15\% + 59$ μ A)
Settling time: 750 μ sec
Isolation: 120 VRMS, 170 VDC/AC Peak
Programmable Resolution: 333 μ V/667 nA

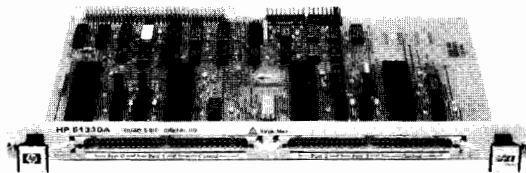

HP E1330A

Quad 8-Bit Digital Input/Output

The HP E1330A Digital I/O is a B-size VXI module that provides digital interfacing to special-purpose circuitry or external devices. Each block has dedicated control and handshake lines. The E1330A supports standard GPIO protocols and different data formats such as decimal, hexadecimal, octal and binary.

Specifications

Data lines: 4 sets of 8 bidirectional lines, TTL compatible, jumper selectable pullups
Handshake lines: 4 sets of 3 lines each; Input/Output Status, Control and Flag
Handshake modes: None, Leading Edge, Trailing Edge, Partial, Pulse & Strobe

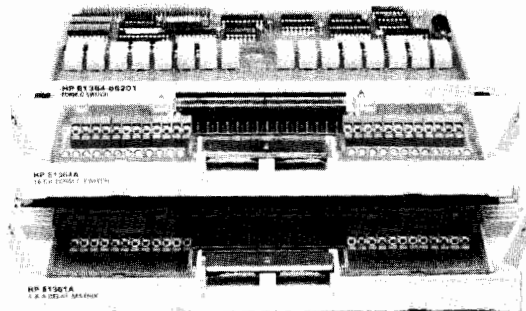

HP E1361A and HP E1364A

4 x 4 Matrix Switch (HP E1361A)

The HP E1361A 4x4 Matrix Switch is a B-size VXI module that provides the highly flexible 4x4 matrix switching capability required by many test systems to connect several instruments at once to several points on a unit under test. Each crosspoint switches two wires with low differential offsets. Larger matrixes such as 4x8 or 4x12 can be formed by linking multiple 4x4 modules.

Specifications

Maximum input voltage: 250 V DC or AC RMS
Maximum input current: 1 A DC or AC RMS
Maximum input power: 40 watts or 40 VA
Thermal offset: < 7 μ V per contact
Bandwidth: -3 dB @ 10 MHz
Crosstalk (Ch to Ch): <-80 db @ ≤ 100 kHz
 <-30 db @ ≤ 10 MHz

16-Channel Form C Switch (HP E1364A)

The HP E1364A 16-Channel Form C Switch is a B-size VXI module that consists of 16 independent Form C relays, allowing a wide variety of devices and signals to be switched. Each channel has Common, Normally Open and Normally Closed terminals for easy configuration. Power up and down states can be chosen because the relays are latching.

Specifications

Maximum input voltage: 250 V DC or AC RMS
Maximum input current: 1 A DC or AC RMS
Maximum input power: 40 watts or 40 VA
Thermal offset: < 7 μ V per contact
Bandwidth: -3 dB @ 10 MHz
Crosstalk (Ch to Ch): <-80 db @ ≤ 100 kHz
 <-30 db @ ≤ 10 MHz

COMPUTER AIDED TEST

HP 75000 Family Of VXI Products
Multiplexers, RF and Microwave Switches

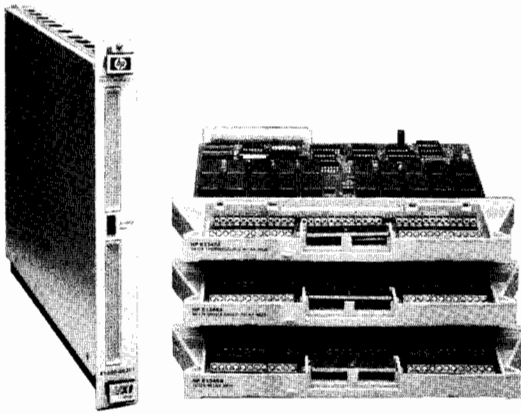

HP E1460A, E1345A, E1346A and E1347A



16-Channel Relay Multiplexers (HP E1345A & E1347A)

The HP E1345A and E1347A 16-Channel Relay Multiplexers connect multiple analog signals to a DMM or other instrument. Three wires are switched per channel with signals up to 170V peak. These modules can be used for switching both two- and four-wire resistance measurements. Both modules feature a removable terminal module for easy wiring. These modules are identical, except that the HP E1347A adds thermocouple compensation.

Specifications

Maximum input voltage: 120V DC, 170V peak AC
Maximum input current per channel: 50 mA non-inductive
Maximum power: 1 VA RMS per channel
Maximum offset voltage per channel: 4 μ V
Bandwidth (-3 dB): >10 MHz

48-Channel Single-Ended Relay Multiplexer (HP E1346A)

The HP E1346A 48-Channel Single-Ended Multiplexer is a B-size VXI module that is designed for applications needing a large number of channels where all the signals have a common ground. It has a removable terminal module for wiring. This module provides a better value per channel in applications where single wire switching is adequate.

Specifications

Maximum input voltage: 120V DC, 170V peak AC
Maximum input current per channel: 50 mA non-inductive
Maximum power: 1 VA RMS per channel
Maximum offset voltage per channel: 50 μ V
Bandwidth (-3 dB): >10 MHz

64-Channel Relay Multiplexer (HP E1460A)

The HP E1460A 64-Channel Relay Multiplexer is a C-size VXI module that is perfect for switching low-frequency voltage, two- and four-wire resistance signals. This module can switch either 64 two-wire or 128 one-wire channels. It can also be configured in several combinations of multiplexers, and can be used in matrix applications. A removable terminal module makes it easy to wire channels. (Terminal module not shown in photo)

Specifications

Maximum input voltage: 220 V DC, 250 V AC RMS
Maximum input current: 1 A DC or AC RMS ($V_{max} < 30$ V DC or RMS)
Maximum power: 40 VA
Maximum offset voltage: 7 μ V

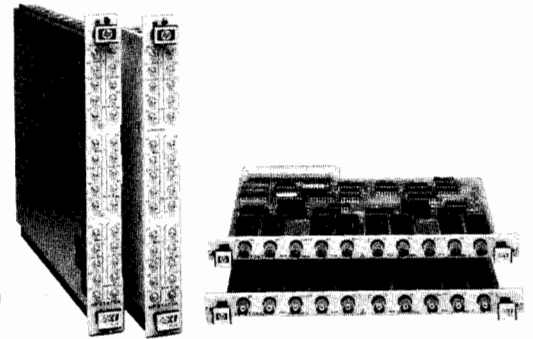

HP E1472A, E1473A, E1366A and E1367A



2x4:1 RF Multiplexers (HP E1366A & E1367A)

The HP E1366A and E1367A RF Multiplexers are B-size VXI modules that provide broadband switching with two independent 1X4 multiplexers for switching signals from DC to 1.3 GHz. BNC connectors make configuration easy. These modules are identical except that the HP E1366A is 50 ohm and the HP E1367A is 75 ohm impedance.

Specifications

Maximum input voltage: 42 V peak
Maximum input current per channel: 1A DC or AC RMS
Maximum power per channel: 24W or 24 VA

AC Performance:	<10 MHz	<100 MHz	<1.3 GHz
Insertion Loss (dB)	<0.3	<0.7	<3.0
Crosstalk (dB)	<-90	<-80	<-40
VSWR	<1.2	<1.25	<1.55

6x4:1 RF Multiplexers (HP E1472A & E1473A)

For larger channel 50 ohm RF switching applications, the HP E1472A and E1473A C-size VXI modules provide six independent 1X4 multiplexers for switching signals from DC to 3 GHz. Each HP E1472A multiplexer module can support up to two HP E1473A expander modules. Both modules use SMB connectors to assure high performance.

Specifications

Maximum input voltage: 42 V DC + AC Peak
Maximum input current per channel: 1 A DC or AC RMS
Maximum power per channel: 24W or 24 VA

AC performance:	<10 MHz	<100 MHz	<1.3 GHz	<3 GHz
Insertion loss (dB)	<.1	<.4	<1.5	<8
Crosstalk (dB)	<-90	<-80	<-50	<-20 (typ)
VSWR	<1.05	<1.15	<1.35	<1.5

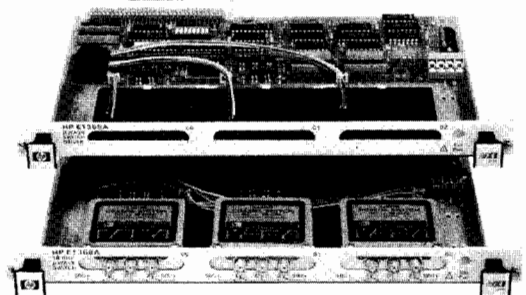

HP E1368A and E1369A



Microwave Switch and Switch Driver

The HP E1368A 18 GHz Microwave Switch and E1369A Microwave Switch Driver are B-size VXI modules that provide microwave switching capability for test systems. The HP E1368A has three independent SPDT 50 Ohm coaxial switches with excellent performance from DC to 18 GHz. The HP E1369A allows you to mount three HP 3331xx coaxial switches for switching up to 26.5 GHz signals (switches not provided).

Specifications for the HP E1368A

Frequency range: DC to 18 GHz
Isolation: >90 dB
Characteristic impedance: 50 ohms
Insertion loss: <0.5 dB
VSWR: <1.4

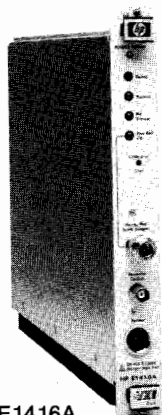

HP E1416A

Power Meter

The HP E1416A Power Meter is a full-feature, message-based, single channel average power meter. It has the capability of the popular HP 437B Power Meter in a single-slot C-size VXI module.

Features:

- High accuracy
- 100 kHz to 50 GHz
- -70 to +44 dBm

The HP E1416A Power Meter combines exceptional meter linearity and low sensor SWR to provide outstanding measurement accuracy in demanding situations. Instrumentation accuracy is specified to be $\pm 0.5\%$ in linear mode or ± 0.02 dB in logarithmic mode, making instrumentation uncertainty a negligible part of total measurement error. Features include automatic calibration and zeroing, frequency (and cal factor) entry, rel, offset, selectable resolution, duty cycle, range hold setting, save/recall of meter settings, and TMSL compatibility for easy programming.

Functions

Frequency: allows entry of test signal frequency for Cal factor selection.

Offset: allows power measurement to be offset by ± 99.99 dB.

Resolution: selectable of 0.1, 0.01, and 0.001 dB or 1%, 0.1% and 0.01% of full scale. Auto filter mode automatically selects the required number of averages for the chosen range and resolution.

Averaging: selectable from 1 to 512 readings (in powers of 2).

Duty cycle: displays peak power representation of measured RMS power for rectangular pulses.

Sensor tables: allows entry and editing of up to 10 frequency versus Cal Factor sensor tables.

Save/recall states: saves and recalls 10 complete HP E1416A operating states.

Specifications

Frequency: 100 kHz to 50 GHz, sensor dependent

Power range: -70 to +44 dBm (100 pW to 25 W), sensor dependent

Power sensors: compatible with all HP 8480 series sensors

Dynamic range: 50 dB in 10 dB ranges

Display units: W, dBm (absolute); %, dB (relative)

Accuracy

Instrumentation: ± 0.02 dB or $\pm 0.5\%$.

Zero set: $\pm 0.5\%$ of full scale on most sensitive range. Divide by 10 for each higher range.

Command Module

The HP E1405A Command Module is a C-size VXI module that has all the Slot 0 and resource manager capabilities required by VXI. This module is an HP-IB to VXI interface, and it makes both register-based and message-based modules appear as HP-IB instruments to an external computer. It's built-in TMSL makes it easy to program HP register-based cards, including all HP B-size modules.

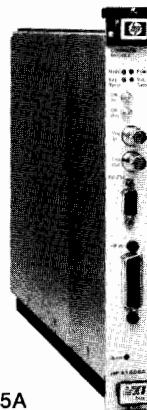

HP E1405A

TMSL provides consistent instrument commands across different types of instruments. The Command Module provides a compatible growth path from the low-cost HP 75000 Series B to the high-performance HP 75000 Series C. Users can issue high-level, IEEE-488.2 compatible TMSL commands to program modules instead of sending binary data to and from registers.

Features

- HP-IB to C-size VXI interface
- Slot 0 plus resource manager
- Use in the HP 75000 Series C Mainframe to provide TMSL capability for all register-based modules

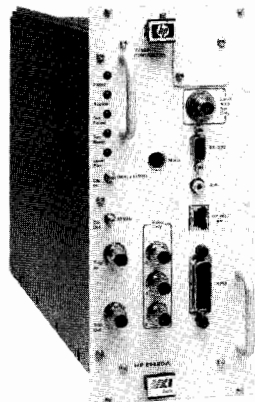

HP E1480A

V/360 Controller

The HP E1480A V/360 Controller occupies four C-size VXI slots and has all the Slot 0 and resource manager capabilities required by VXI. It has built-in HP-IB, RS-232, LAN, keyboard and display ports. This module can access message-based modules on the backplane, or register-based modules by sending TMSL commands through the HP-IB port on the Command Module (HP E1405A).

This module is a Motorola 68030-based computer that can run either the HP BASIC/WS or HP-UX operating systems. With HP BASIC/WS, instrument control for a single-user, single-tasking system is simplified through high-level commands optimized for I/O operations. With HP-UX, industry standard networking, windowing systems and databases can be used with automated test. (Additional Model 360 specific information can be found on page 556.)

Features

- Fast Motorola 68030-based computer
- Runs either HP BASIC/WS or HP-UX (including HP BASIC/UX)
- Built-in HP-IB, RS-232, LAN, keyboard and display ports
- HP ITG compatible
- Disk interface
- 4 slots

COMPUTER AIDED TEST

HP 75000 Family Of VXI Products

Ordering Information

To order VXIbus products, select an HP 75000 mainframe with appropriate plug-in modules, system resources, software, and accessories. Fixturing, cabinets, and rack mounting accessories are also available.

Ordering Information

Series B Mainframes

	Price
HP E1300A HP 75000 Series B Mainframe (plain front panel)	\$2,300
HP E1301A HP 75000 Series B Mainframe with front panel keyboard/display	\$2,800
Opt 907 Front Handle	+\$80
Opt 908 Rack Mount (flanges, rails & hardware)	+\$130
Opt 909 Rack Mount W/Handles (handles, flanges, rails, hardware) ¹	+\$210

Series C Mainframes

HP E1492A HP 75000 Series C Starter System (includes HP E1400B Mainframe with option 908 and HP E1405A Command Module)	\$8,750
HP E1400B HP 75000 Series C Mainframe	\$6,275
Opt 907 Front Handle Kit	+\$170
Opt 908 Rack Mount (flanges, rails & hardware)	+\$180
Opt 909 Rack Mount W/Handles (handles, flanges, rails, hardware) ¹	+\$350

Mainframe Memory

HP E1320A 512 Kbyte Nonvolatile Memory (for Series B Mainframes only)	\$850
HP E1321A 1 Mbyte Nonvolatile Memory (for Series B Mainframes only)	\$1,500

Multimeters

HP E1326A 5 1/2-Digit Multimeter, Series B (includes bus cable)	\$1,200
E1326-80002 Internal Installation Kit For 5 1/2 -Digit Multimeter (HP E1326A)	\$142
HP E1411A 5 1/2-Digit Multimeter, Series C (includes bus cable)	\$1,600
HP E1410A 6 1/2-Digit Multimeter	\$3,500

Counters

HP E1333A 3-Channel Universal Counter	\$900
HP E1332A 4-Channel Counter/Totalizer	\$900

Sources

HP E1328A 4-Channel D/A Converter	\$1,100
HP E1440A 21-MHz Synthesized Function/Sweep Generator	2
Opt 001 High Voltage Output	2

Digital

HP E1330A Quad 8-Bit Digital Input/Output (includes interface cable)	\$600
--	-------

Switches

HP E1361A 4 X 4 Relay Matrix	\$650
HP E1364A 16-Channel Form C Switch	\$650

Relay Multiplexers

HP E1345A 16-Channel Relay Multiplexer (includes bus cable)	\$650
HP E1346A 48-Channel Single-Ended Relay Multiplexer (includes bus cable)	\$800
HP E1347A 16-Channel Thermocouple Relay Multiplexer (includes bus cable)	\$750
HP E1460A 64-Channel Relay Multiplexer (includes bus cable)	\$2,400

RF Multiplexers

HP E1366A 50 Ω RF Multiplexer (2 X 4:1)	\$850
HP E1367A 75 Ω RF Multiplexer (2 X 4:1)	\$850
HP E1472A 50 Ω RF Multiplexer (6 X 4:1)	\$2,500
HP E1473A 50 Ω RF Multiplexer Expander (6 X 4:1) (includes connection cable)	\$1,500
HP E1473-80002 Cable Extension Kit For RF Multiplexer Expander (2 0.8 meter cables)	\$66
HP E1368A 18 GHz Microwave Switch	\$2,100
HP E1369A Microwave Switch Driver (includes 3 switch cables)	\$500

Power Meter

HP E1416A Power Meter	2
-----------------------	---

Command Module & Controller

HP E1405A Command Module	\$2,800
HP E1480A HP V/360 Controller	2

Software

HP E2000A HP Interactive Test Generator (HP ITG)	\$995
HP E2001A HP ITG Instrument Drivers	\$495

Accessories

HP E1399A Register-Based Breadboard, Series B	\$400
HP E1490A Register-Based Breadboard, Series C	\$730
HP E1402A VME Module Adapter	\$500
HP E1408A A/B-Size Module Carrier	\$170
HP E1409A Series C Chassis Shield	\$150

¹The front door of cabinets will not close over rack mount handles.

²The price of this product was not available at time of printing. The product will be available for ordering December 1, 1989.

For more information on the HP 75000 FAMILY OF VXI products contact your local HP Sales Representative and ask for a copy of the HP 75000 Catalog (PN 5953-7097)

COMPUTER AIDED TEST

Multiprogrammer: User-Adaptable Instrumentation

605

Models 6940B, 6942A, 6944A and 6954A

- Build a test system tailored to your specific application
- Broad range of function-oriented I/O cards with a unified design
- Simultaneous and independent functions

- A cost-effective way to automate your test needs
- Isolated power supplies for analog functions
- Mainframe extenders for increased I/O capacity
- High-speed data capture and throughput

Introduction

Hewlett-Packard Multiprogrammer products provide solutions for a variety of data acquisition, control and test applications. The application flexibility is due to the architectural features of these products. The plug-in Multiprogrammer I/O cards allow card-to-card communication, isolated inputs and external triggering and provide a wide range of functions. The HP 6940B coupled with the Multiprogrammer Series I I/O cards offers low-cost solutions when operated on the GP-IO Bus. The HP 6942A Multiprogrammer and the Series II I/O cards are a medium-performance, medium-speed, HP-IB solution. For applications requiring a higher level of performance and more speed, the HP 6944A or HP 6954A Multiprogrammer should be considered for use with the Series II I/O cards.

The I/O cards have many benefits. Multiple-card configurations can be established that provide instrument-like functions. For example: high-speed scanning and multiple simultaneous-buffered analog-to-digital converters. Other features provide precise crystal-controlled timing or pacing of I/O operations. This allows the modular construction of instrumentation functions such as frequency measurement, time interval measurement and programmable pulse generation. The card-to-card communication feature allows the I/O operation of the Multiprogrammer to operate independently of the computer. The computer is then free to perform other tasks until it receives an interrupt from the Multiprogrammer. If the application requires the process to control data collection, it can be accomplished via the external trigger feature. This feature allows the process to time or pace operations independently of the computer. In addition, I/O data can be stored in the Multiprogrammer's plug-in memory system, allowing high-speed operation of other tasks the computer must perform.

HP 6954A Features

- A Rugged Rack-mountable Test System in a Single Unit
- Built-in HP 9000 Series 310 Computer and 20 Megabyte Hard Disc
- Includes BASIC 5.X and HP 14753A CAT Programming Package
- HP-IB, HP-HIL, RS-232, Audio and Video Interfaces
- Local or Remote Control via HP-HIL or RS-232
- Standard HP Multiprogrammer Series II I/O Cards
- HP 9000 Series 200/300 Memory, Accessory, and I/O Cards

HP 6944A Features

- Data transfer rate of 220,000 readings/second
- HP 98633A interface to HP Series 200/300 computers
- Direct to disc at 200,000 words/second
- Requires HP 14753A CAT programming package
- HP Multiprogrammer Series II I/O cards

HP 6942A Features

- Data transfer rate 18,000 readings/second
- HP-IB interface
- HP 14753A CAT programming package
- HP Multiprogrammer Series II I/O cards

HP 6940B Features

- Front panel control
- GP-IO or optional HP-IB interfacing
- Data transfer rate 20,000 readings/second
- HP multiprogrammer Series I I/O cards
- Temperature measurement capability

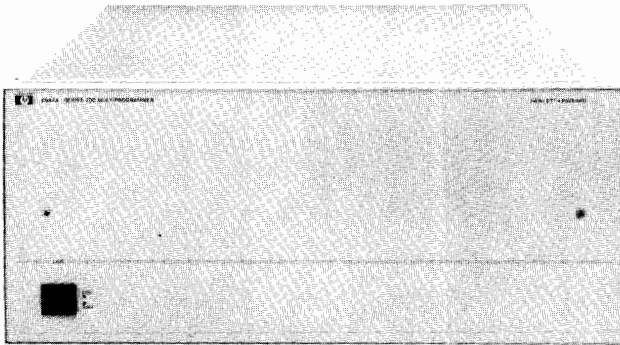

HP 6954A and HP 6944A

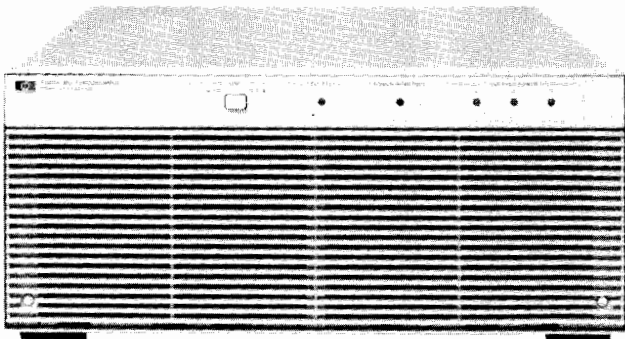

HP 6942A

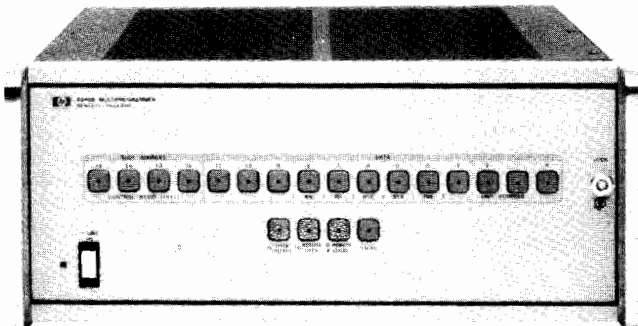

HP 6940B

COMPUTER AIDED TEST

Multiprogrammer: User-Adaptable Instrumentation
Models 6940B, 6942A, 6944A and 6954A

The Power of the Multiprogrammers

HP Multiprogrammers are used mostly for automatic testing applications for many industries including manufacturers of communications products, circuit boards, aircraft instrumentation, electronic ignitions, dashboard electronics and missile guidance systems. Whether it's high speed data gathering that's needed or the ability to perform parallel tasks while the data is being captured, an HP Multiprogrammer can provide the solution.

Testing Final Assemblies and Subassemblies

HP Multiprogrammers let you configure a flexible, reliable and powerful automatic test and control system for the production environment. HP Multiprogrammers test the final product as well as subassemblies at different stages of the manufacturing process.

The increasing level of sophisticated electronic devices and circuits found in today's automobiles challenges the auto manufacturer to explore equally sophisticated test techniques. High-speed measurements and analyses of multiple channels are key requirements in order to keep the constantly moving assembly lines supplied with high-quality components. Multiprogrammer A/Ds and scanning systems provide this high-speed measurement and multiple channel capability. Output functions, such as the Voltage and Current D/A cards and relay cards in matrix configurations, are used to stimulate electronic subassemblies.

Measure Vibration in Machinery

In vibration analysis applications, the ability to capture waveforms in a wide frequency range, analyze the data and present it using a single system is an important requirement. The 500,000 samples/second digitizing capability of the Multiprogrammer and its local memory cards allow a large range of frequencies to be acquired.

For applications such as oil exploration and electrical power generation where large rotating machinery is used, vibration analysis is critical in ensuring trouble-free operation. Multiprogrammers can capture data and store it in memory while the computer analyzes previously captured data. This results in an uninterrupted stream of information being presented to the tester. In addition, the Multiprogrammers can be set to be event-triggered so that an event-related condition starts the data gathering process without operator intervention.

Product Development and Evaluation

Multiprogrammers are used for developing state-of-the-art products for many aerospace and defense applications. These types of industries require powerful and flexible test systems because of their constant stream of new projects with unique requirements. When testing newly developed prototypes, large quantities of data are usually required in order to fully characterize the behavior of a unit when subjected to differing stimuli. The HP 6944A Multiprogrammer captures data and continuously stores it to an external hard disc at rates up to 200,000 samples/second.

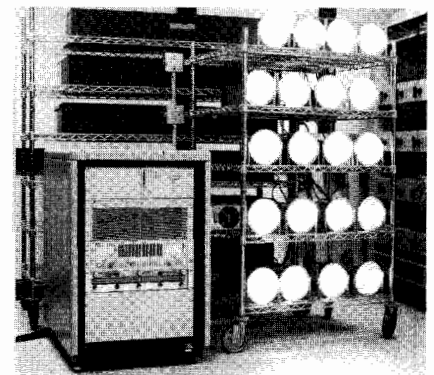
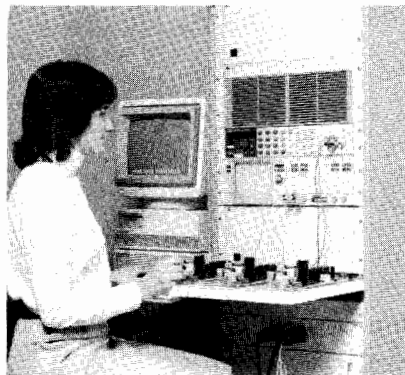
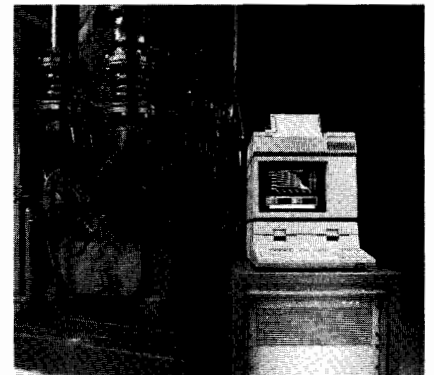
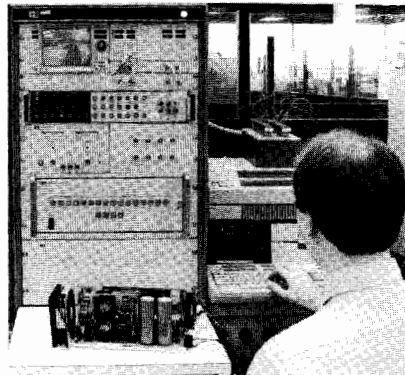
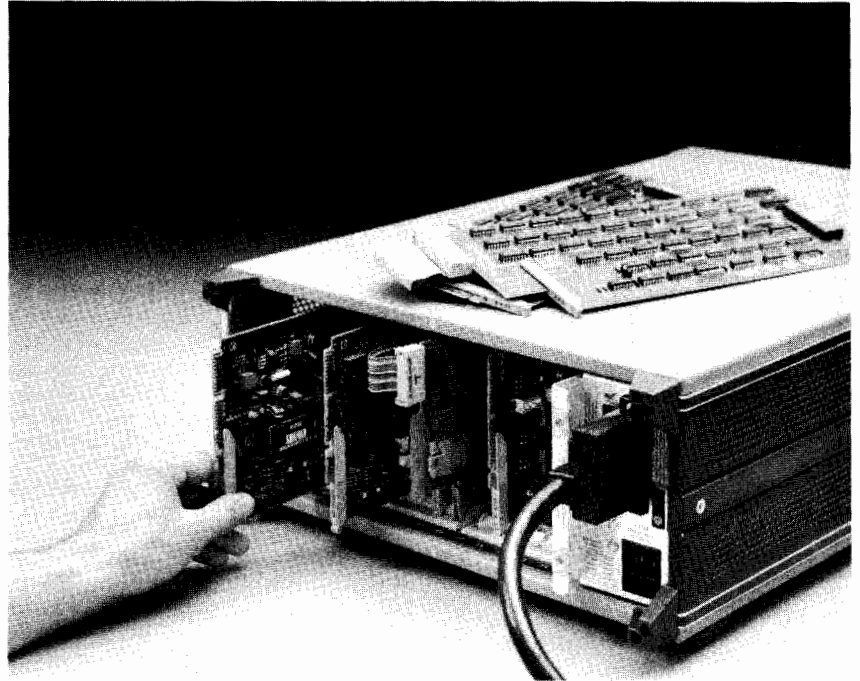

Failure analysis is another important product development process in military applications. A Multiprogrammer system can collect large quantities of data without the presence of an operator. If a failure does occur, the Multiprogrammer can stop the test and signal the operator.

Component Evaluation

There is an increasing push for automation in the production environment to improve efficiency at all stages of the manufacturing process. For example, quality-conscious

manufacturers recognize the importance of thorough incoming component inspection that doesn't sacrifice smooth production flow.

Multiprogrammers satisfy these needs because of their speed and flexibility. Testing can be centrally controlled by a single operator or by several testers by linking a multiple-user computer system, such as the HP 1000 series, to HP 6942A Multiprogrammers. As a result, the manufacturing flow is uninterrupted and enhanced which leads to reduced manufacturing costs.

COMPUTER AIDED TEST

Multiprogrammer: User Adaptable Instrumentation

Model 6954A

607

- Built-in HP 9000 Series 300 Computer and 20 Megabyte Hard Disc
- Includes BASIC 5.X and HP 14753A CAT Programming Package
- Controls up to 14 HP-IB instruments or peripherals

- Local or Remote Control via HP-HIL or RS-232
- Accepts standard HP Multiprogrammer Series II I/O Cards
- Accepts standard HP 9000 Series 200/300 Memory, Accessory, and I/O Cards

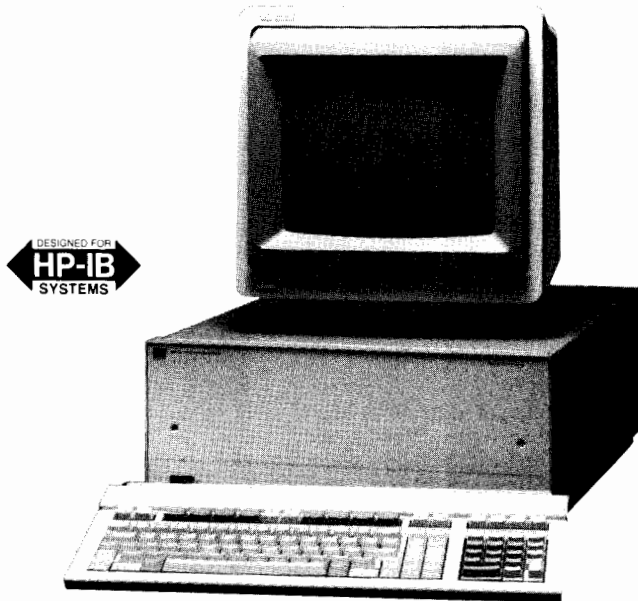

HP 6954A Option 001

Description

The HP 6954A Multiprogrammer is the most powerful addition to HP's family of Computer Aided Test products. The HP 6954A is a complete high speed data acquisition and control system in a single, compact, rack-mountable unit. The HP 6954A Multiprogrammer is suitable for applications in fields such as: electronic production test, automated electronic test, data acquisition, process control, and process/product characterization.

The HP 6954A Multiprogrammer features a built-in HP 9000 Series 300 System Processing Unit, One Megabyte of RAM, a 20 Megabyte Winchester disc drive, HP 98620B DMA card, RS-232, and HP-IB interfaces. The built-in HP-IB interface allows the HP 6954A to control up to 14 HP-IB instruments or peripherals. Connecting a keyboard and monitor to the HP 6954A allows it to be controlled locally. Or, you can control the system remotely via an RS-232 link to a terminal such as the HP 2623A or HP 3082A, a computer running a terminal software package such as The PORTABLE computer, or a host computer such as the HP 1000.

The HP 6954A has two card cages, one that accepts up to eight Multiprogrammer Series II I/O cards, and another that accepts up to three additional Series 200/300 memory, accessory, or I/O cards. You can expand the HP 6954A Multiprogrammer system's I/O capability by adding up to seven HP 6944A Multiprogrammers as extenders to give you 120 slots for standard Multiprogrammer Series II I/O cards. And when HP 6944A Multiprogrammers are used as extenders for the HP 6954A, no extra interface is required because a Multiprogrammer Interface is built into the HP 6954A.

The wide spectrum of capabilities offered by the Multiprogrammer Series II I/O cards gives the Multiprogrammer the capability to digitize analog data at up to 500 KHz, acquire up to 1 Megabyte of 16 bit data at rates up to 760 kHz, or continuously log data directly to internal disc at rates up to 54 kHz. Other I/O card stimulus and response functions include current output, voltage output, pulse output, switching, analog multiplexing, event counting, event sensing, and additional measurement and control functions offered on pages 610 and 611.

The HP 6954A can be used as a development station by simply adding the optional local control kit consisting of an HP keyboard and monitor. HP 9000 Series 200/300 BASIC 5.X and the HP 14753A Computer Aided Test Programming package are included with the HP 6954A to give you one of the easiest to use instrument-oriented program development environments available. The HP 6954A is compatible with HP 9000 Series 200/300 software packages such as the DACQ/300 Data Acquisition Manager (HP 44458A/B) that features data management, data analysis, and data presentation.

HP has integrated and assembled the complete system into one rack-mountable unit: a powerful SPU and HP-IB interface for instrument control, a 20 Mbyte disc drive for program and data storage, 1 Mbyte of RAM, BASIC 5.X and the CAT Programming package for easy program development, and two types of card cages for versatility and a large selection of I/O functions. The HP 6954A is one of the easiest, most cost effective ways to build an automated test system that is tailored to your specific application.

Specifications

Plug in I/O card positions: A maximum of 8 Multiprogrammer Series II I/O card slots and 3 available HP 9000 Series 200/300 interface and accessory card slots (a fourth slot is occupied by the DMA card).

Controller Interface: Not applicable. Controller is built in.

I/O Interfaces: HP-IB, RS-232, HP-HIL, audio and composite video.

Extender units: Up to seven HP 6944A's can be linked to the HP 6954A using HP 14704A, B, or C interface cables.

Maximum length of a link: A link of up to seven HP 6944A's can extend nine meters long, maximum. This maximum length is the sum of all the HP 14704A, B, or C Interface cables.

System Data Acquisition rate: High data acquisition rates can be attained using Multiprogrammer I/O cards. For example, digital acquisition rates up to 1 MHz are possible using the HP 69791A Memory card and analog acquisition rates up to 500 kHz can be attained using the HP 69759A 500 kHz A/D.

Data transfer rate: Using the HP 98620B DMA card (takes up one slot of the four HP 9000 Series 200/300 interface and accessory card slots), data transfer rate between the Multiprogrammer I/O cards and the computer is up to 220,000 readings per second and direct to disc transfer of 200,000 words per second over HP-IB.

Power Supplies: All necessary power supplies for up to eight Multiprogrammer Series II cards, the controller, and up to four HP 9000 Series 200/300 interface and accessory cards are built into the HP 6954A. Three ± 18 V supplies (isolated from each other and from ground) are available for powering isolated I/O cards.

Input Power: 100/120/220/240 Vac (switch selectable), +5% to -10%, 47 to 63 Hz, 630 VA.

Operating Temperature Range: 0 degrees C to +55 degrees C.

Dimensions: 177.0 mm high x 425.5 mm wide x 597.0 mm deep (7 in. x 16.25 in. x 23.5 in.)

Weight (without I/O cards): Net, 26.4 kg (58 lb.) Shipping, 33.6 kg (74 lb.)

Ordering Information

HP 6954A Multiprogrammer

	Price
Option 001: Local Control Kit	\$615
Option 002: Delete BASIC 5.0 and HP 14753A	-\$1000
Option W30: Two Year additional warranty (cannot be ordered with Option W03)	\$200
Option W03: Warranty conversion to 90-day on-site	N/C
Option 908: Rack mount kit	\$46
Option 910: Extra Installation and Service Manual	\$36

COMPUTER AIDED TEST

Multiprogrammer: User Adaptable Instrumentation

Model 6944A

- Data transfer rate 220,000 readings/second
- Dedicated interface (HP 98633A) to HP Series 200/300 Computers

- Direct-to-disc transfer rate of 200,000 words/second
- HP 14753A CAT programming package
- HP Multiprogrammer Series II I/O cards

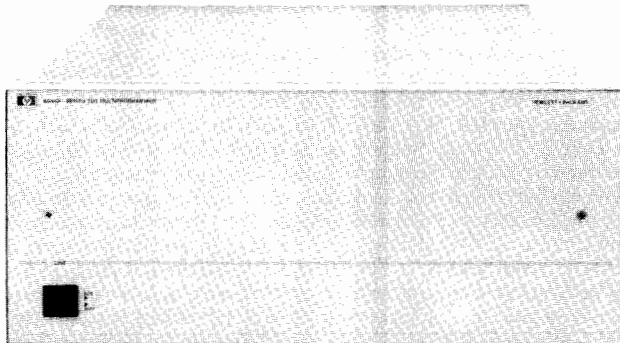

HP 6944A

Description

The HP 6944A Multiprogrammer is a high-speed data acquisition and control system designed exclusively for use with HP Series 200/300 computers. The HP 6944A capitalizes on the HP Series 200/300 computer architecture by using the dedicated HP 98633A Multiprogrammer Interface and the HP 98620B DMA Controller to achieve high-speed data transfers.

The powerful HP Multiprogrammer Series II I/O cards provide a broad variety of I/O functions for the HP 6944A. These cards allow the user to configure the HP 6944A to implement many instrumentation functions such as high-speed scanning, analog waveform synthesis, limit checking and transient analysis.

The HP 6944A is programmed exclusively with the HP 14753A Computer Aided Test Programming Package. This software package effectively couples the flexible hardware architecture of the HP 6944A with the BASIC language system of the HP Series 200/300 Computers. The friendliness of this system is such that the system programmer only needs to be able to program in BASIC. The control statements are test oriented and closely linked to the application by a list of "Names" supplied by the user. An easy-to-use, menu-driven configuration process correlates the user-assigned "Names" to the system's I/O functions automatically from the BASIC program. The software, through the same menu-driven process, then leads the system programmer through the hardware configuration. The net result is fast program development, self-documented programs and the ability to maintain different configuration files on one disc.

Features

The primary features of the HP 6944A evolve around the architecture of the HP 6944A, HP Series 200/300 Computers, and the Multiprogrammer Series II I/O cards.

The key feature of the HP 6944A is high-speed data transfer. With the HP 6944A, HP 69759A 500 kHz A/D, HP 69791A/92A High-Speed Memory I/O System, and the HP 98620B DMA Controller Card, data may be transferred to an HP Series 200/300 Computer at rates of 200,000 readings/second. Without the HP 98620B DMA Controller Card, transfer rates of nine kilowords/second are achieved.

A second key feature of the HP 6944A is its ability to unburden the HP Series 200/300 Computer from controlling each I/O task of the HP 6944A. This allows the HP Series 200/300 Computer time to perform numerical analysis or manage other instruments during these time periods.

HP 6944A Specifications

Plug in I/O card positions: Maximum of 16 plug-in output or input cards per mainframe. Removable rear cover provides access to card slots.

Computer interface: The HP 6944A is connected to an HP Series 200/300 Computer via the HP 98633A Multiprogrammer Interface Card and HP 14704A, B or C cable.

Extender units: Up to eight HP 6944A Multiprogrammers can be connected to the Series 200/300 computer's HP 98633A Multiprogrammer Interface Card by using HP 14704A, B or C Interface Cables.

Maximum length of a link: A link of up to eight HP 6944A Series 200/300 Multiprogrammers can be nine metres long, maximum. This maximum length is the sum of the lengths of all the HP 14704A, B or C Interface Cables in the link.

Power supplies: All necessary power supplies for up to 16 I/O cards are built into each HP 6944A frame. Three ± 18 V supplies are isolated from each other and from ground, and are available for powering isolated I/O card circuits.

Cooling: Built-in forced air cooling draws air in through the side vents and exhausts air through the rear cover.

Operating temperature range: 0 degrees C to +55 degrees C.

Power: 100/120/220/240 Vac (switch, selectable), +5% to -10%, 47 to 63 Hz, 650 VA.

Dimensions: 177.0 mm high x 425.5 mm wide x 597.0 mm deep (7.0 in high x 16.25 in wide x 23.5 in deep).

Weight (without I/O cards): Net, 21 kg (46 lb); shipping, 28.6 kg (63 lb).

Ordering Information

Step 1: Select the necessary quantity of HP 6944As.

HP 6944A Series 200/300 Multiprogrammer	\$4105
Option 908: rack mount kit	\$37
Option 910: extra operating and service manual	\$42
Option W03: converts 1 yr return-to-HP warranty to a 90-day on-site warranty	N/C

Step 2: Select the HP Series 200 Multiprogrammer Interface Card for HP 6944A.

HP 98633A Multiprogrammer Interface Card	\$460
--	-------

Step 3: Select number and lengths of cables required for connecting HP 98633A Interface to first frame.

An additional cable is needed for each HP 6944A frame used as an extender.

HP 14704A Multiprogrammer Interface Cable, 1 m (3.3 ft)	\$210
HP 14704B Multiprogrammer Interface Cable, 2 m (6.6 ft)	\$210
HP 14704C Multiprogrammer Interface Cable, 4 m (13.2 ft)	\$250

Step 4: Select HP 14753A to receive necessary CAT software and documentation (mandatory).

Select the option appropriate for the system controller.	
HP 14753A Computer Aided Test Programming Package	\$2110
Option 044: software provided on 3 1/2" flexible discs	N/C
Option 042: software provided on 5 1/4" flexible discs	N/C
HP 14753R: right to reproduce HP 14753A CAT programming package (documentation provided)	\$1050

COMPUTER AIDED TEST

Multiprogrammer: User Adaptable Instrumentation

Model 6942A

609

- Action-oriented instructions
- Isolated analog inputs and outputs
- Built-in self test

- Overlapped input and output
- Internal or external pacing
- Easy to configure

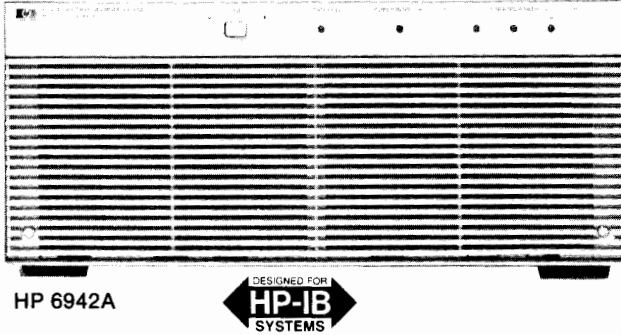

The Multiprogrammer Performs Operations in Parallel

With this one instrument you can control several processes at once. And, while you are controlling the processes, the Multiprogrammer can also be watching for interrupt conditions. The internal microprocessor manages all the parallel operations and monitors the alarm lines; when the operations have completed or if an alarm condition occurs, the Multiprogrammer interrupts the controller.

How does the HP 6942A Connect With Your Controller?

The HP 6942A Multiprogrammer interfaces with your controller (desktop or minicomputer) using the HP-IB, Hewlett-Packard's implementation of IEEE Standard 488 and the identical ANSI Standard MC1.1. Data and status readback make use of the extended bus addressing features of the HP-IB.

Programming Flexibility

Mnemonic, action-oriented instructions make the HP 6942A Multiprogrammer simple to learn and use. For instance, the output instruction "OP" works with all output cards. When you send an instruction, the internal microprocessor checks which type of card you are addressing and automatically converts the data to the proper format for that card. You select the units with which you want to program each card. Whether you want to use volts, millivolts, amps, degrees, feet, or any other units, the Multiprogrammer does the converting for you. The HP 6942A can also be programmed with the HP 14753A CAT Programming Package.

Mainframe Memory Unburdens The Controller

The mainframe memory of the HP 6942A will accept up to 76 instructions from the controller at one time. This leaves your controller free for other processing activities while the Multiprogrammer works on the I/O operations. This mainframe memory may also be used to collect up to 1440 data readings and hold them until the controller is free to take them. (For even more data storage, up to 1 Meg words of data may be stored using the HP 69791A and HP 69792A Memory System Cards.

Real Time Clock

Built-in real-time clock gives you time-of-day readings and pacing of measurements. The clock detects which power line frequency you are using, 50 Hz, or 60 Hz, and automatically synchronizes itself to this frequency. The range of the clock is 65,534 days, with resolution to a tenth of a second.

Computers and Documentation

The HP 6942A can be operated with a wide variety of computers, including the HP Series 80, Series 200, Series 300, Series 1000, 9825, and 9845 computers. Documentation packages are available for these computers. Each one contains a User's Guide with programming examples, a utility program tape or flexible disc, operating and service manuals, and a binder to hold this material. One no-charge documentation option must be specified to select the documentation appropriate for your computer.

Accessories

HP 14700A extender kit: this kit contains the transmission boards which go into the master mainframe (HP 6942A) and the last extender mainframe (HP 6943A) in the chain.

HP 14701A intermediate extender kit: when more than two mainframes are in a chain, the card in this kit must be used in each intermediate extender mainframe.

HP 14702A chaining cable: this is the cable which chains together the master and extender mainframes. One cable is required for each extender mainframe. Length: 1.5 m (5 ft).

HP 14703A card edge connector: extra connectors for the I/O cards may be ordered in addition to the one supplied with each I/O card.

HP 6942A/6943A Specifications

Plug-in I/O card positions: maximum of 16 plug-in output or input cards per mainframe. Removable rear cover provides access to card slots.

Computer interface (HP 6942A only): the Multiprogrammer is connected to a controller via the Hewlett-Packard Interface Bus (HP-IB), Hewlett-Packard's implementation of IEEE Std. 488.

Real time clock (HP 6942A only): the built-in real time clock is automatically synchronized with the 50/60 Hz ac power line frequency. The clock is read and set with data in the form of days, hours, minutes and seconds with a resolution of 0.1 second.

Extender interface kits (HP 6943A only): each HP 6943A Extender requires one HP 14700A or 14701A Interface Kit and one HP 14702A Chaining Cable for operation with the HP 6942A.

Maximum number of mainframes per chain: up to seven HP 6943A Multiprogrammer Extenders may be placed in a chain with one HP 6942A Multiprogrammer.

Maximum chain length: a chain of mainframes can be up to 152 meters (500 feet) long. This maximum length is the sum of the lengths of all HP 14702A Chaining Cables used in one chain.

Power supplies: all power supplies for up to 16 I/O cards are built-in including three ± 18 V supplies isolated from each other and from the ground.

Cooling: built-in forced air cooling draws air in through the front panel and exhausts air through the ventilated rear cover.

Front panel indicators: five light emitting diodes on the front panel indicate power supply and self-test status.

Operating temperature range: 0°C to 55°C.

Power: 100/120/220/240 Vac (selectable), +5%, -10%, 47 to 63 Hz, 600 VA.

Dimensions: 177.0 mm high x 425.5 mm wide x 597.0 mm deep, (6.969 in. high x 16.250 in. wide x 23.500 in. deep).

Weight (without I/O cards): net, 20 kg (45 lb); shipping, 27 kg (60 lb).

Accessories furnished: PC board Extender Card (HP Part No. 5060-2792).

Ordering Information

	Price
Opt 010-233: One Set Documentation/Software	N/C
Opt 908: Rack Flange Kit	\$42
Opt 910: Extra Manual	\$32
Opt W03: Converts 1 yr return-to-HP warranty to a 90-day on-site warranty	N/C
HP 14700A Extender Interface Kit	\$725
HP 14701A Extender Interface Kit	\$835
HP 14702A Chaining Cable	\$385
HP 14703A Spare Card Connector	\$88
HP 6942A Multiprogrammer	\$5700
HP 6943A Multiprogrammer Extender	\$4555







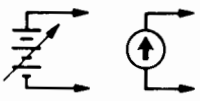
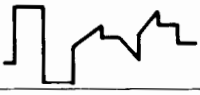
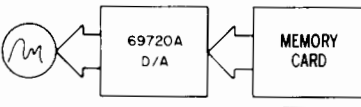
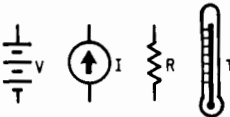

COMPUTER AIDED TEST

Multiprogrammer Series II I/O Cards: Broad Functionality with a Unified Approach

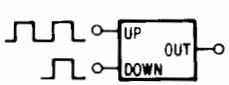
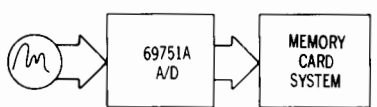
Models 69700A-69793A

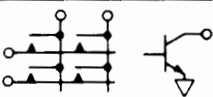
Multiprogrammer Series II I/O Cards for the HP 6954A, 6944A, and 6942A

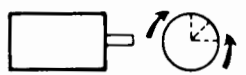
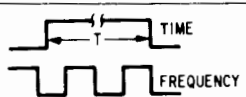
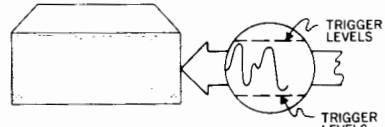
For a complete description of the Multiprogrammer Series II I/O Cards, ask for publication 5952-4175.

	Functions	Applications	Cards Used
STIMULUS	 <p>Programmable DC Voltage and Current</p>	The output voltage (up to 250V) and current (up to 1000A) of forty different HP power supplies can be programmed to provide bias in automatic test systems or control of electromechanical process equipment.	Resistance Output, HP 69700A-69706A; Power Supply Control, HP 69709A.
	 <p>Digital-to-Analog Conversion</p>	Twelve-bit voltage DAC's provide outputs for strip chart, x-y, and analog tape recorders as well as control of analog programmable instruments and stimulus of units under test. Control process equipment with 4-20 mA output.	Voltage DAC, HP 69720A; Current DAC, HP 69721A.
	 <p>Analog Waveform Synthesis</p>	The Memory card can continually supply pre-loaded data to the D/A card at rates of up to 100 kHz. Special waveforms may be loaded into the Memory card from the computer and used as stimuli for test and processes. The analog output is isolated from digital ground.	Memory card, HP 69790B; 69791A, 69792A Voltage DAC, HP 69720A; or Current DAC, HP 69721A.
MEASUREMENT	 <p>Voltage, Current, Resistance, and Temperature Measurements</p>	A/D converters may be used to measure voltages from $\pm 50\mu\text{V}$ to $\pm 100\text{V}$ in the presence of 250 V of common-mode noise. Connecting a resistor across the input permits current measurements for 4-20 mA current loops used in process control. Combine the A/D with the current DAC for resistance measurements.	High Speed ADC, HP 69751A. HP 69759A Integrating DMM HP 69761A
	 <p>Frequency Measurements</p>	The Pulse Counter card accumulates counts over a precise time interval when a Timer card is connected to the enable line of the Counter. The program divides the count by the time interval to measure frequencies from 1 MHz to less than 0.001 Hz.	Counter, HP 69775A; Timer HP 69736A. HP 69774A
	 <p>Pulse Counting Preset Up/Down</p>	The Counter may be preset to any value within the count range of 0 to 65,535 and can cause an interrupt when it rolls over. The Counter may be enabled and disabled by pulses or levels. The computer may read the count without disturbing the counting process.	Counter, HP 69775A. HP 69774A
	 <p>Offline Analog Acquisition</p>	Differential or single-ended signals may be digitized at rates up to 500 kHz by the A/D, and stored in the Memory system. Each Memory system can store up to one megawords. The digitizing process can take place independent of other Multiprogrammer activity.	High Speed ADC, 69751A; Memory cards, 69790B, 69791A/69792B. Integrating DMM HP 69761A.
	 <p>Scanner Systems</p>	Analog measurements from up to 960 channels may be acquired at 25,000 readings per second depending upon the scanner system configuration. Random access to any channel, as well as continuous scanning, are easily accomplished. (See Application Note AN316-3.)	Cards used: Scan Control, HP 69750A; FET Scanners, 69752A or 69755A; Relay Scanner, HP 69754A. Temp-scan HP 69753A; DMM HP 69761A; High Speed ADC HP 69751A; Memory card HP 69790B, or 69791A/92A
CONTROL	 <p>Digital Output and Switching</p>	Sixteen-bits of data in TTL, open collector, or SPST relay-contact form provide digital control of instruments and indicators. AC power, up to 6, can be switched to 12 loads with a HP 69731B, and HP 14570A AC Power Controller.	Digital Output, HP 69731B; Relay Output, HP 69730A; AC Power Controller, HP 14570A.
	 <p>Digital Input</p>	Digital input cards accept 16-bits of data from digital measuring instruments, push-buttons, switches, relays, and other digital devices in the form of logic levels or contact closures. Digital data sources with more than 16-bits of data use several digital input cards.	Digital Input, HP 69771A; Isolated Digital Input, HP 69770A.
	 <p>Stepping Motor Control</p>	The Stepping Motor card can produce from 1 to 32767 pulses at either of two outputs (CW or CCW) to control motor translators. Output pulses are also used for pulse-train update of supervisory control stations. The pulse rate (motor speed) is also programmable.	Pulse Train/Stepping Motor, HP 69735A. HP 69734A
	 <p>Time and Frequency Reference</p>	Crystal controlled timing pulses, programmable from 100 ns to 18 hours, may be used as a time-base reference for control, measurement, and data acquisition. Period, duty cycle, and number of pulses are all programmable.	Timer, HP 69736A or Pulse Train, HP 69735A. HP 69734A
ALARM	 <p>Level Detecting</p>	When signals cross preset levels, the Digital Input card can trigger the interrupt card to interrupt the computer. The alarm trigger levels can be programmed with the D/A or fixed with resistors.	Digital Input HP 69771A; Interrupt card, HP 69776A.
	 <p>Event Sensing</p>	A digital word may be used to trigger quick computer response with the interrupt card. The computer responds to the interrupt with a software routine. The interrupt may also cause immediate local response by triggering a preloaded output card.	Interrupt card, HP 69776A.

Ordering Information continued**HP 69752A 64 Channel FET Scanner Card**

Scans 64 single-ended channels (± 10.24 V input signal range) at up to 25,000 readings per second. Cards cascable to 960 channels in a single mainframe.

HP 69755A 16 Channel FET Scanner Card

Same as 69752A, except scans 16 channels.

HP 69754A 32 Channel Relay Scanner Card

Scans 32 single-ended (16 double-ended) channels with a ± 100 V input signal range at speeds up to 1000 readings per second (625 readings double-ended). Switches currents up to 50 mA.

HP 69750A Scan Control/Pacer Card

Provides all pacing and control functions for the scanner cards listed above. One required for each group of scanner cards (maximum of 15 cards—see data sheet for further clarification).

HP 69709A Power Supply Control Card

Used for full system control of 6024A and 6012A Autoranging Power Supplies.

HP 14728A Buffered A/D Cable

Used to connect 69751A and 69790B in a buffered A/D configuration.

HP 69700A-69706A Resistance output cards: the output of each of these cards is a programmable resistance value. Twelve mercury wetted relay contacts close across binary weighted precision resistors in a series string. The cards are designed to program the voltage or current output of an HP power supply with option 040.

HP 69720A D/A voltage converter card: provides a high speed, bipolar output voltage programmable from -10.240 V to $+10.235$ V up to 5 mA load current.

HP 69721A D/A current converter card: provides a bipolar -20.480 mA to $+20.475$ mA current output.

HP 69730A Relay output card: provides sixteen independent, normally open, mercury wetted relay contacts. Contacts rated at 100 Vdc; or 1 Amp; and 28 VA.

HP 69731B Digital output card: provides sixteen TTL or CMOS compatible outputs, or sixteen 100 mA open-collector switches.

HP 69734A Timebase card: generates pulses from 100 ns to 18.2 hours, or squarewaves from 5 MHz to 7.6 uHz. It has over twenty modes including one-shot, squarewave, pulse, and a variety of triggered modes. Positive and negative true outputs are available with 50-ohm drive capability. When using the HP 14753A CAT Programming Package with this card, version A.01 or newer is required.

HP 69735A Pulse train output/stepping motor control card: generates up to 32767 pulses at a programmable frequency.

HP 69736A Timer/pacer card: outputs a programmable pulse from one microsecond to eighteen hours or a programmable square wave.

HP 69751A A/D converter card: this card measures bipolar dc voltages in one of four ranges, ± 100 mV, ± 1 V, ± 10 V, or ± 100 V, with 12 bit resolution at up to 33,000 readings per second.

HP 69753A Temperature Scanner card: allows 16-channel temperature measurements and is expandable to 240 channels. Performs Hi/Lo 2-wire switching for thermocouple measurements and 4-wire RTD measurements, and has an on-board isothermal block for a temperature reference. When using the HP 14753A CAT Programmign Package with this card, version A.01 or newer is required.

HP 69761A Integrating DMM card: fully programmable, general purpose DMM with 13K of on-board memory and 16-bits of resolution. Optimized for controlling up to 15 HP 69753A Temperature Scanner cards with an on-board pacer. When using the HP 14753A CAT Programming Package with this card, version A.02 or newer is required.

Price

\$1,270

\$580

\$960

\$690

\$1,010

\$330

\$580-635

\$740

\$960

\$625

\$460

\$1,335

\$530

\$530

\$1,010

\$1,230

\$1,820

HP 69770A Isolated digital input card: breaks the path of potential ground loops with an optically coupled isolator in each of the sixteen digital input lines.

\$690

HP 69771A Digital input/analog comparator card: monitors up to sixteen contact closures, switches, TTL signals, CMOS signals, or analog signals. The switching threshold can be set to any value between ± 9.5 volts by a screwdriver-adjustable potentiometer on the card or may be externally programmed.

\$635

HP 69774A Universal Counter card: fully programmable, five function counter for frequency, period, time interval, event counting, and quadrature detection. The three operating modes are 32-bit (for up to 2032-1 counts), dual independent 16-bit, or continuous with no "dead-time". When using the HP 14753A CAT Programming Package with this card, version A.01 or newer is required.

\$1,335

HP 69775A Counter/totalizer card: counts contact closures, TTL or CMOS logic level pulses, or analog waveform transitions in the range of 0 to 65,535.

\$765

HP 69776A Interrupt card: compares up to sixteen logic level or contact closure inputs with a sixteen-bit reference word and interrupts for =, \neq , <, > conditions.

\$580

HP 69790B Memory card (occupies 2 I/O slots): provides 4096 16-bit words for use with the DAC cards or the ADC cards or for other input/output tasks that need to run independent of other Multiprogrammer or computer tasks. Several Memory cards may be used to implement truly simultaneous operations.

\$1,040

HP 69793A Breadboard card: the generalized grid area on this card may be used for mounting custom circuits.

\$170

HP 69759A - 500 kHz A/D

The HP 69759A 500 - kHz A/D converter measures bipolar voltages in four programmable ranges, ± 100 V, ± 10 V, ± 1 V, and ± 100 mV. The digitized values may be read directly by the controller or transferred into HP 69791A and HP 69792A memory buffer cards available for the Multiprogrammer system. Use of memory buffers permits simultaneous digitization at rates up to 500 kHz per channel. Scanning subsystems designed specifically to work with the HP 69759A card provide additional measurement flexibility and permit expansion up to 7168 channels. Timebase and triggering functions may be added using other Multiprogrammer cards to form a complete analog measurement system that is precisely tailored to the requirements of the specific application.

Application Note 316-5, Data Capture, describes several ways that the HP 69759A can be used with other Multiprogrammer cards to solve several different applications. These descriptions include cable diagrams and program listings for both the HP 14752A and the HP 6942A native instructions.

HP 69791A/92 - Memory System

The HP 69791A and HP 69792A Memory Cards form a buffer used to perform input and output tasks without intervention from the controller. A memory card buffer can be used for inputs or outputs, or both. Data can be acquired at up to 760 kilowords/second or sent at up to 400 kilowords/second.

A memory card buffer has one HP 69791A Memory Card and up to five HP 69792A Memory Expansion Cards for a maximum memory size of 1M (1,048,576 16-bit words). The HP 69791A holds 64k (65,536 16-bit words) and the HP 69792A holds 192k (196,608 16-bit words). The memory card buffer functions as a single memory, regardless of how many HP 69792As are added.

The memory card subsystem can be used with the HP 69751A or HP 69759A A/D cards to input digitized analog measurements. Up to eight HP 69759A A/D Cards can be multiplexed into a single HP 69791A/69792A memory buffer. The A/Ds can be triggered by the same timebase for truly simultaneous readings which are then stored in sequential memory locations. This reduces memory costs and the number of mainframe slots required.

Ordering Information**HP 69759A A/D Converter****Price**

\$2,420

HP 69791A Memory Card

\$1,685

HP 69792A Memory Card

\$1,125

COMPUTER AIDED TEST

Multiprogrammer: System Software

Model 14753A Computer Aided Test Programming Package

- Easy to use menu entry
- Faster software development
- Improved HP 6942A performance

Description

The HP 6954A, HP 6944A and the HP 6942A are easy to use computer-aided test systems that improve productivity by enabling you to implement your testing requirements more quickly. This is achieved through the use of a companion software package. The HP 14753A is a powerful CAT programming package which replaces the standard two-letter mnemonics of the HP 6942A Multiprogrammer and is the standard programming language for the HP 6944A and HP 6954A Multiprogrammers.

These systems are friendly and easy to use. Mnemonic-type language is not needed to program either the HP 6954A or the HP 6944A. In addition, the HP 14753A will increase the performance speed of the HP 6942A. The CAT programming package supports all of the Multiprogrammer Series II I/O cards.

CAT Programming Package

The CAT programming package is a comprehensive collection of software routines that provide the ATE system designer with a high-performance linkage between the BASIC language and Multiprogrammer hardware. Both friendliness and higher performance are combined in the software through an architecture which optimizes total system performance.

Friendliness is achieved by replacing traditional "computer language" statements with test-oriented commands. Communication with all supported instrumentation is via "functional names", chosen by the user, which have a close relationship with the function performed. For example, in the menu below, the name "value", is used to program a HP 69720A Voltage D/A Converter. This lets you program in terms that are familiar to you resulting in programs which are virtually self-documenting. Friendliness is further enhanced by convenient menu entries, which make it easy to enter all function names and parameters.

The CAT programming package reduces the amount of software written by the user thus speeding program development. Productivity is improved by shortening test development time. To create test software, the user enters functional names and other data into a series of menus. Then a program is written in Series 200/300 BASIC to handle all sequencing, computational, and decision-making operations. Whenever a stimulus, acquisition or control function is desired, the BASIC program is instructed to call a routine from the CAT programming package.

Features

Some of the CAT programming package features are highlighted in a menu below. The timeout feature can generate an error if an operation has not completed in a specified time. Since the error can be trapped like any other BASIC error, corrective action can be programmed to occur automatically. Limit-checking prevents out of range values from being executed, and data conversion permits programming with user specified units. Initial values can also be specified and, at run time, sent to all instrumentation with a single command.

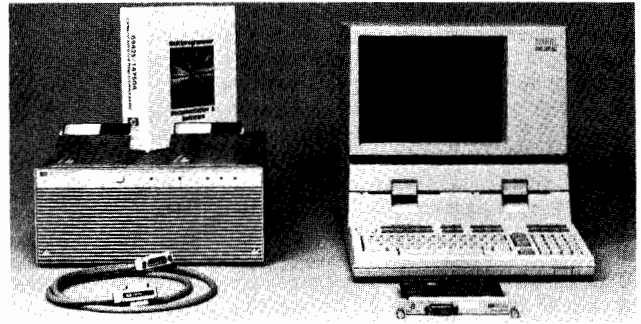
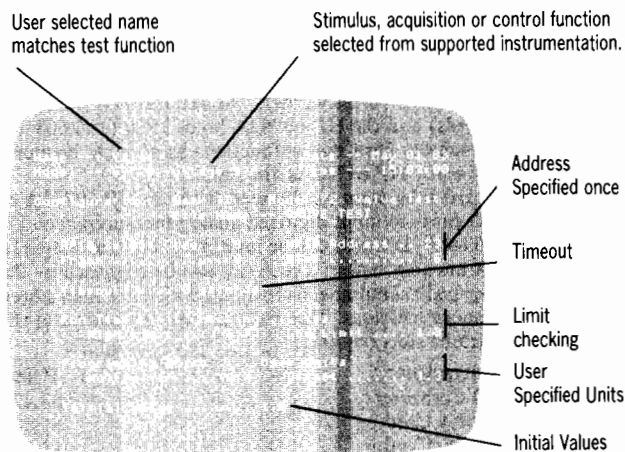

Multiprogrammer Series II I/O Cards

The CAT programming package supports the Multiprogrammer Series II I/O card functions, described on pages 610 and 611, and four popular multiple-card functions. These include combinations such as using a high-speed scanner, A/D, and memory card together.

HP 6900 Series Multiprogrammer

The Multiprogrammer is a high-performance mainframe that provides the necessary interface for up to sixteen plug-in cards. Optional Multiprogrammer Extenders can be added to a system to further expand its capabilities. Up to seven Extenders, each holding up to sixteen plug-in cards, can be chained to one mainframe.

The new HP 6954A is a Multiprogrammer mainframe and controller in a single compact unit that contains an HP Model 310 Computer, a 20 Mbyte hard disc (containing HP BASIC 5.X, 14753A CAT Software, and utilities), built-in HP-IB, RS-232, HP-HIL, and video interfaces. An internal HP 98633A type interface is also included. The HP 6954A, capable of being the system controller in an HP-IB system, comes with a DMA card for high-speed data transfer and supports up to 3 additional DIO cards for flexibility. It accepts up to eight Multiprogrammer Series II I/O cards and, if more card slots are needed, just add up to seven HP 6944A Multiprogrammers as extender units.

The HP 6944A Multiprogrammer is a high-speed mainframe that has 16 slots available for Series II I/O cards. Up to eight HP 6944A Multiprogrammers can be controlled by a Series 200/300 computer via an HP 98633A interface.

The HP 6942A Multiprogrammer has 16 card slots for Series II I/O cards. Up to 128 card slots become available by adding HP 6943A Multiprogrammer Extender units. Although the HP 6942A can be programmed by any HP-IB computer using the HP 6942A internal instruction set, programming the HP 6942A is simplified by using the HP 14753A CAT Programming Package and a Series 200/300 computer.

System Performance Specifications

Mainframe Interface	HP 6942A	HP 6954/44A
CAT Programming Package	HP 98624A	HP 98633A
Single Data Point Input	HP 14753A	HP 14753A
Single Data Point Output	1.9 ms	1.5 ms
Scaling to User Units	2.1 ms	1.4 ms
Interrupt Response Time	add 0.35 ms	add 0.35 ms
Maximum Block Transfer Input	13.7 ms	13.7 ms
Maximum Block Transfer Output	12,500	180,000*
	18,000	30,000

*HP 98620A DMA controller required.

Product Selection Guides

To order the HP 6954A, 6944A or 6942A, it is recommended that technical data sheet 5952-4175 be used.

Ordering Information

Product	Price
HP 14753A Computer Aided Test Programming Package	\$2110
Opt 044 3 1/2" Flexible Discs	N/C
Opt 042 5 1/4" Flexible Discs for 9826/9836	N/C
HP 14753R Right to Reproduce HP 14753A CAT Programming Package (Interface and Documentation provided)	\$1050

COMPUTER AIDED TEST

Multiprogrammer: Automatic Test, Data Acquisition and Control

HP 6940B

613

- Front panel control
- GPIO or HP-IB
- Data transfer rate 20,000 readings/second
- Temperature measurement capability
- Multiprogrammer Series I I/O cards

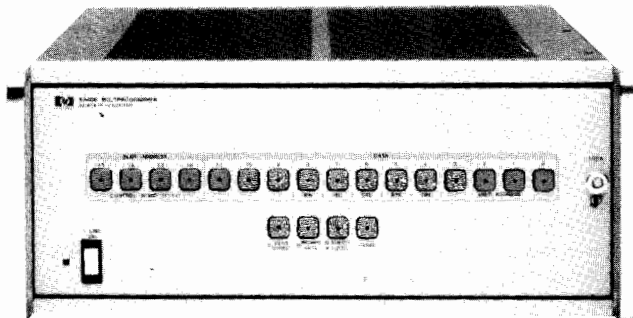

HP 6940B

Multiprogrammer

The HP 6940B Multiprogrammer is a low-cost, medium-speed data acquisition and control system designed to be used with controllers or computers via the GP-IO, a 16-bit parallel interface bus. The HP 6940B is supported by a full complement of I/O cards. These I/O cards provide a broad range of instrumentation functions for acquisition, stimulus, measurement and control.

The HP 6940B is programmed by a set of word formats and octal coding. There are three word formats: a control word that selects the operating mode, a data word used to select and control output cards, and an address word to select and control an input card.

The HP 6940B may also be used as an HP-IB product. This requires an HP 59500A Multiprogrammer Interface Kit. This kit provides conversion of the HP-IB format to 16-bit parallel format.

Features

A full-feature, front-panel switch register permits manual programming of all Multiprogrammer output, input and control functions. Fault isolation or manual system checkout of the computer, multiprogrammer or external devices is accomplished from the front panel.

Another feature of the HP 6940B is isolation of analog cards. Isolation from system ground is provided on analog cards. The HP 6940B has four isolated bias power supplies available to independently power the output circuitry of up to four groups of cards.

The HP 6940B Multiprogrammer has the capability of growing to meet the user's needs. Up to 15 HP 6941B extenders can be added to the system, allowing up to 240 I/O slots to be programmed from a single computer interface. The HP 6941B Multiprogrammer Extender has a blank front panel and all interfacing is provided in the HP 6940B Multiprogrammer.

Specifications

Plug-in I/O card position: Maximum of 15 plug-in input or output cards per mainframe.

Computer Interface: Can be interfaced using the GP-IO, which requires an I/O slot of the computer and a GP-IO interface card. An HP 59500A Multiprogrammer Interface Kit is required for use on the HP-IB.

Extender Units: Up to 15 HP 6941B extenders can be chained together to create 240 programmable I/O slots. Extenders may be separated from one another by up to 30 metres.

Data transfer rate: 20,000 readings/second using the GP-IO interface.

Cooling: Natural convection

Operating temperature range: 0 to +55 degrees Celsius.

Power: 100/120/220/240 Vac (selectable), +5%, -10%, 48 to 440 Hz, 230 watts.

Size: 172.2mm x 425.4mm x 539.8mmD (6.78" x 16.75" x 21.25").

Weight (without I/O cards): net, 15.9kg (35.0 lb); shipping, 19.5kg (43.0 lb).

Ordering Information

HP 6940B - holds up to 15 I/O cards plus one HP 69351C voltage regulator card. **Price** \$4,600

Opt 010 HP-1000 \$0

Opt 085 HP-85B HP-IB \$0

Opt 185 HP-85B GP-IO +\$615

Opt 016 Consists of these four items: \$0

HP 9826A BASIC, HP 9826A HPL,
HP 9836A BASIC, HP 9836A HPL

Opt 908 Rack Mount Hardware for +\$42

HP 6941B Extender, additional 15 I/O slots \$3,910

Opt 908 Rack Mounting Hardware +\$42

Multiprogrammer Series I I/O Cards

HP 69280A Breadboard card \$280

HP 69321B D/A Voltage Converter card \$675

HP 69322A Quad D/A Voltage Converter card \$810

HP 69330A Relay Output card \$545

HP 69331B Digital Output card \$410

HP 69332A Open Collector Output card \$300

HP 69335A Stepping Motor Control card \$475

HP 69336B High Speed Scanner card \$680

HP 69351C Voltage Regulator card \$380

HP 69380A Breadboard Output card \$310

HP 69422A High Speed A/D card \$1,000

HP 69423A Low Level A/D and Scanner card \$1,165

HP 69430A Isolated Digital Input card \$350

One of these options must be specified when ordering this model:

Opt 069 negative-true TTL logic levels \$0

Opt 073 positive-true TTL logic levels \$0

Opt 088 positive-true Hi level = ± 12 to 25 V \$0

HP 69431A Digital Input card \$340

One of these options must be specified when ordering this model:

Opt 069 negative-true TTL logic levels \$0

Opt 073 positive-true TTL logic levels \$0

HP 69433A Relay Output with Readback card \$420

HP 69434A Event Sense card \$1,260

HP 69435A Pulse Counter card \$415

HP 69436A Process Interrupt card \$575

HP 69480A Breadboard Input card \$370

HP 69500A-69613A Resistance Programming cards \$485-650

HP 69520A Power Supply Programming card \$760

HP 69602A Timer/Pacer card \$565

Accessories

HP 14540A Main Input Cable Assembly, 3.6 m (12 ft) \$400

HP 14541A Chaining Cable, HP 6940B to HP 6941B \$225

HP 14550B Multiprogrammer Interface Kit for the HP 1000 \$2,980

HP 14551A Service Kit for the HP 6940B \$4,425

HP 14555A Connector Kit for Series I Multiprogrammer I/O cards \$30

HP 14556A Software Library for the HP 9825A \$240

HP 14557A Power Supply Interconnect Cable for the HP 69520A Programming Card \$365

HP 14558A Termination Panel; with 40 dual-screw terminals \$260

HP 14560A Cable Assembly for Series I I/O cards; 15 conductors \$160

HP 14561A Cable Assembly for Series I I/O cards; 30 conductors \$225

HP 14562A Cable Assembly for Series I analog I/O cards; two shielded conductors \$115

COMPUTER AIDED TEST

Multiprogrammer Technical Publications

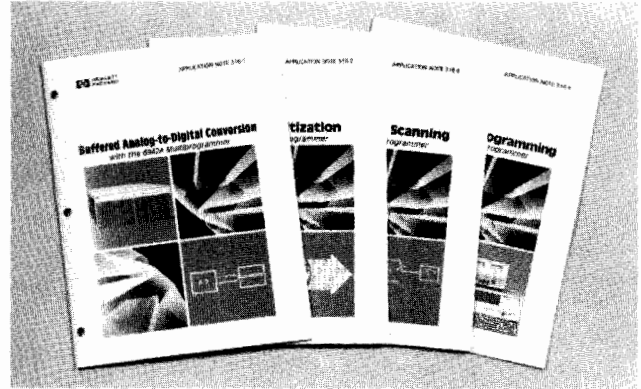
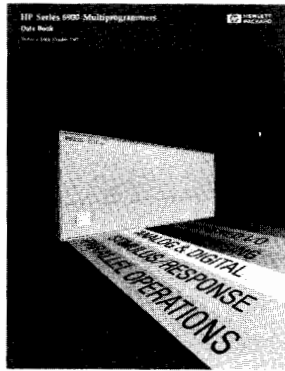
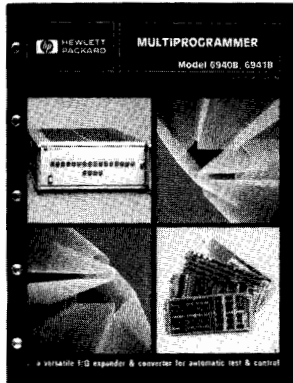

Technical Data

In addition to a broad range of products for integration of data acquisition, control and test systems, Hewlett-Packard provides a selection of technical literature as further support of the Multiprogrammer products. These technical brochures provide detailed operating specifications of the Multiprogrammer product family and are extremely helpful in configuring the best Multiprogrammer package for your application. Other literature available are Product Notes describing a specific product application and Application Notes.

This technical literature will provide information to help you choose the right Multiprogrammer products for your application. The Product Notes augment the Operating and Service Manuals and provide additional information on product configurations and actual applications. The Application Notes are more specific "how to" information aimed at a specific application and product configuration.

This technical literature is provided at no charge upon request. Ask your local Hewlett-Packard field engineer, or use the card at the rear of this catalog.

Publication Title	Publication Number
Multiprogrammer Model 6940B, 6941B	5952-4077
Multiprogrammer Databook	5952-4175
Models 6942A, 6944A & 6954A	

Product Notes

A series of product notes is available for the Multiprogrammers. The first two, 6940B-1 and 6940B-2, are product oriented, and describe how to use particular Multiprogrammer cards. The others are product "Application Stories" which describe how Multiprogrammer customers have implemented specific applications.

6940B-1 Scanning with the 6940B Multiprogrammer

Describes use of the HP 69336B FET scanning card for high-speed data acquisition.

6940B-2 Power Supply Control

Describes use of the HP 69520A power supply programming card to control HP autoranging power supplies.

6940B-3 Subassembly Testing

Details Ford Motor Company's use of a building block approach to increase the flexibility of Ford's systems testing while reducing cost and design times.

6940B-4 Automating Manual Equipment

Describes the implementation of the HP 6940B in a radiation monitoring system.

6940B-5 Basic Research

Describes the interfacing of an HP 6940B and HP 9845A to a scanning electron beam microscope.

6940B-6 Product Evaluation

Describes the use by BF Goodrich of the HP 6940B to test the true effectiveness of tires for the different ice, snow, soil and load conditions.

6942A-1 Production Line Testing

Describes Solitron Devices Inc. use of the HP 6942A for hybrid device testing.

6942A-2 Heavy Industry

Describes Northwest Culvert Company's use of the HP 6942A to control metal pipe production and improve process control.

6942A-3 Instrument Control

Describes the use of an HP 6942A to control RF test equipment in an automatic modem test system.

6942A-4 Research and Development

Describes the use of an HP 6942A as control and data acquisition system for a heavy oil pump development test rig.

6942A-5 Materials Evaluation

Describes the use of an HP 6942A to automate the measurement of fluid viscosities.

Application Notes

A series of application notes introduces a beginner to computer aided test, and makes it easier for any user to implement the most common Multiprogrammer configurations. Each of the notes contains a comprehensive study of an application, and includes theory, wiring information, and software listings for the basic functions. Information on advanced techniques is also provided. Although the programming information is oriented toward the HP 9826A and HP 9836A computers, the concepts are discussed in a general way that allows application to other computers. Copies of these application notes are available through your local HP sales office.

AN316-0 Introduction to Computer Aided Test

This introductory note is designed to take a computer aided test novice through the steps of evaluating, planning, and implementing a sample computer aided test system.

AN316-3 High-Speed FET Scanning

High speed data acquisition from many channels is easily accomplished with the Multiprogrammer scanner system consisting of an HP 69750A or HP 69755A scanner cards. This note covers sequential and random access scanning methods.

AN316-4 Power Supply Programming

Full system control of a power supply, including output voltage and current readback, is possible with a single Multiprogrammer card. The HP 69709A power supply control card is designed for control of HP 6023A, HP 6024A, HP 6011A, and HP 6012A power supplies equipped with Option 002.

AN316-5 Data Capture

This Application Note covers the full range of data capture capability of the HP 6942A, HP 6944A and the HP 6954A Multiprogrammers. The emphasis is on analog data capture but digital techniques are also presented. AN316-5 includes sections on random and burst scanning as well as buffering and multiplexing using the Multiprogrammer Memory system. Examples are presented using the HP 14753A CAT Programming statements, as well as Native Instruction programming for the HP 6942A. This Application Note also covers continuous data acquisition to an external hard disc drive. One section deals with performing accurate analog measurements using the Multiprogrammers' I/O cards.

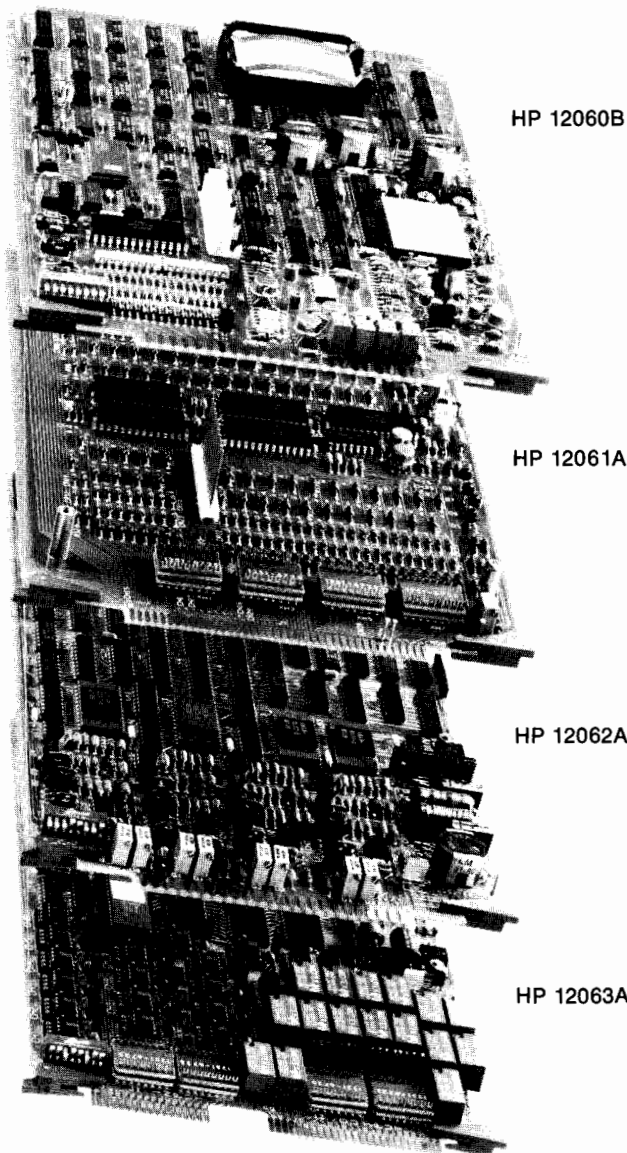

HP 12060B

HP 12061A

HP 12062A

HP 12063A

HP 12061A 32 Channel Analog Input Expansion Card

The HP 12061A provides 32 additional differential inputs for the HP 12060B card. The HP 12061A card fastens directly onto the HP 12060B card, creating a two-board unit that occupies two I/O slots in an HP 1000 A-series computer. Programming information is passed from the HP 12060B directly to the HP 12061A; analog signals on the additional 32 channels are in turn passed back to the HP 12060B for digitizing. The HP 12061A includes removable plug-in headers so the user can add current sense resistors for current loop measurements. These headers allow the board to be adapted to the specific application without soldering components directly on the board and are easily removable for repair purposes.

HP 12062A 4 Channel Analog Output Card

The HP 12062A Analog Output Card provides 4 independent bipolar voltage outputs. Remote sensing per channel provides accurate output voltages to compensate for long distances of field wiring. Undedicated digital outputs may be used in pen up/down control, CRT display, or X-Y plotters. DMA compatibility provides fast analog updates on a per-channel basis or between channels. Programmable time delay between DMA updates provides signal reconstruction capability with a full power bandwidth of 20 kHz.

HP 12063A 32 Channel Digital Multifunction Card

Input Characteristics

The HP 12063A provides 16 fully isolated digital inputs via voltage threshold opto-couplers. Input voltage levels are selectable by the user for each channel by installing the appropriately valued resistors on removable plug-in headers (8 resistors per header = 8 channels). These headers allow the board to be adapted to the specific application without soldering components directly on the board, and are easily removed for repair purposes. Plug-in opto-couplers (supplied) allow user selection of ac or dc coupling for each channel by merely installing the opto-coupler in the ac position or dc position. For ac coupling, a plug-on jumper is provided for each channel to select 60 Hz ac filtering of the rectified input if desired.

Event Detection

In addition to status, any input may be user programmed to function as an interrupt to be generated on the rising edge or falling edge of the input or both (whichever occurs first). This capability is easily activated by the user via loading the appropriate pattern into the three registers. The on-card microprocessor takes over to cause the interrupt to be generated when that event occurs. User programming is required to service the interrupt.

Debounce Delay

The same microprocessor also provides the user-programmable debounce delay up to 246 ms on any input when monitoring contact closures and may be used in both status mode and event sense mode.

Output Characteristics

Sixteen form C (SPDT) relay outputs are provided on the same card. Both the normally open (NO) and normally closed (NC) contacts are available to users. Two removable headers allow for arc suppression devices to be added by the user for each channel without soldering directly to the board. Each header handles 8 output channels. Plug-on jumpers select the arc suppression across the NO or NC contacts. An on-card isolated power supply derived from the 25 kHz ac supply in the A-Series processor provides coil power for the relays. This technique minimizes any coupling of relay contact noise in the computer itself.

Ordering Information

Ordering Information	Price
HP 12060B 8 Channel Analog/Digital Converter	\$2328
HP 12061A 32 Channel Analog Input Expansion	\$1164
HP 12062A 4 Channel Digital/Analog Converter	\$1680
HP 12063A 32 Channel Digital Multifunction Card	\$2136

Description

The HP 12060B, 12061A, 12062A, and 12063A are plug-in cards for HP 1000 A-Series Computers. They provide low cost, high performance, analog and digital I/O for use in distributed measurement and control applications. The A-series product in which these cards are used must have a 25 kHz power supply. Hood connectors with each card allow users to build cables for connection to their applications.

12060B 8 Channel Analog Input Card

The HP 12060B is capable of acquiring up to 55,000 readings per second with 12-bit resolution. Auto scanning or single-channel sampling is possible to 55 kHz. Provisions for external pacing/trigging of sampling and scanning is provided. The HP 12060B includes four programmable full scale ranges from plus or minus 1.28 V to plus or minus 10.24 V. Maximum resolution is 0.625 mV on the 1.28 V range. A separate "zero reference" on the card allows the user to measure actual offset due to temperature drift, and correct readings on all channels for higher accuracy. The card has 8 differential channels.

COMPUTER AIDED TEST

CAT Software

Interactive Test Generator

- Accelerates Test Program Development
- Universal, Mouse-Driven Interface To All HP-IB Instruments
- Eliminates Need To Learn HP-IB Mnemonics
- Generates Code Automatically
- For Series 300 Workstations using HP BASIC.
- For HP-UX Controllers using HP BASIC/UX.
- For DOS Controllers using the HP BASIC Language Processor card, Microsoft C, or Microsoft BASIC.

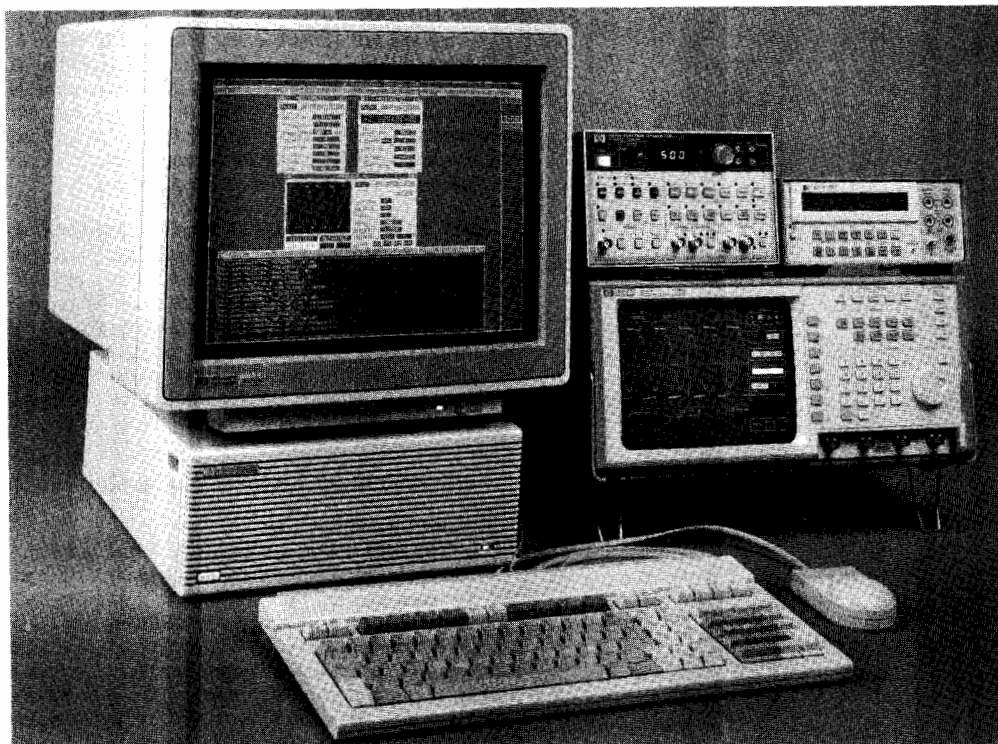

HP Interactive Test Generator (HP ITG) software package accelerates HP BASIC test development with a windowed, mouse driven interface designed specifically for controlling HP-IB instruments.

Designed for test engineers, independent of their programming skill, HP ITG reduces test development time by providing interactive program development with on-screen instrument panels. Menu selections made with the "click" of a mouse prescribe settings of instruments and initiate and display measurements. HP ITG also automatically generates the HP BASIC code necessary to perform these same tasks in your test program.

Hassle Free Instrument Control For Both Beginners And Experienced Professionals

HP ITG simplifies measurement automation because it is no longer necessary to write code that requires knowledge of instrument-specific HP-IB mnemonics or search through volumes of manuals for the right command string. Instead of writing code, you use a mouse to adjust control settings and make measurements. Clicking the mouse on a control pulls down a menu of valid settings, clicking again selects the desired setting. Incorrect instrument settings and data entry errors that lengthen test development time are virtually eliminated through the use of the mouse and menu selections.

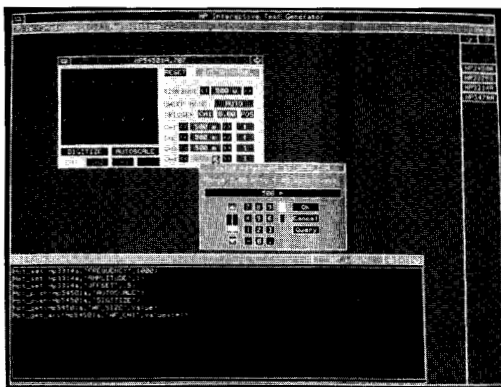

Menu selections expedite instrument setups and reduce costly errors

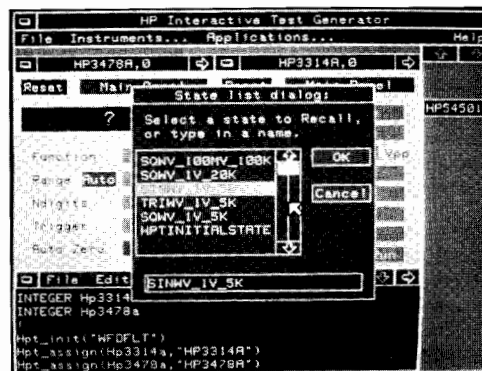

Store and recall instrument states with names you assign. You don't have to remember state names to recall them because HP ITG presents you with a list of valid choices.

*1 Using HP BASIC/UX

*2 Using the HP BASIC Language Processor Card

To avoid setting controls one by one, you can store and recall complete instrument states by names you assign. A library of states is rapidly generated, and states can be browsed and re-used to build new applications with even less effort.

At the "click" of a mouse, on-line help keeps the job moving with information on the operation of HP ITG as well as the specific instruments available. And with instruments connected to the HP-IB bus, immediate feedback on the instrument's operation saves you time debugging your instrument setups.

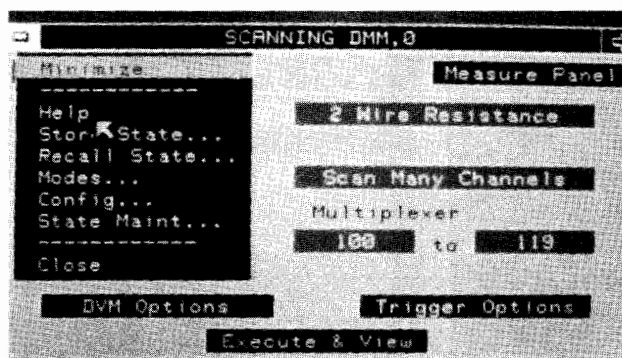

On-line help is available if you happen to have a question.

Automatic Code Generation

Automatic code generation guarantees consistent, structured, error-free programming by even inexperienced software developers. And because the code generated is HP BASIC, it retains the friendliness, power, and high performance test developers have come to expect for instrument control. Full access to all HP BASIC math, graphics, and I/O capability gives HP ITG the edge as a friendly development environment without sacrificing application performance.

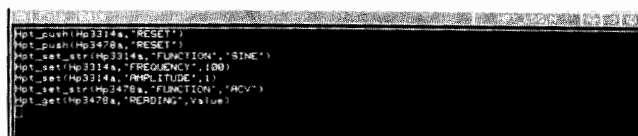

Automatically generate HP BASIC program statements for controlling your instruments and making measurements.

Optimized For Test Throughput

HP ITG optimizes test throughput by automatically providing incremental state programming. HP ITG tracks the current instrument state and sends only the necessary commands to reach the next state. This eliminates time spent sending superfluous commands over HP-IB, as well as the time required for an instrument to interpret and respond to the command. In addition, HP ITG optionally generates ordinary HP BASIC "OUTPUT" and "ENTER" statements that use explicit instrument mnemonics.

Universal Instrument Drivers

ITG instrument drivers provide a uniform and user-friendly interface to all instruments, with complete control being exercised by a mouse or the keyboard, instead of a multitude of different operating methods found on stand-alone instruments.

HP provides instrument drivers for many of the popular HP-IB test and measurement instruments, and provides an update service to make drivers available as they are developed. While HP written drivers address most applications, drivers for custom black-boxes or non-supported instruments are easily created using any text editor. These text files can be easily modified and serve as examples for rapidly creating drivers for new or different models of instruments.

With HP ITG's driver technology, you can also create virtual instruments in software by enhancing or combining the features of several different instruments. For cardage instruments in particular, these alternative user interfaces allow even the inexperienced user to quickly begin making measurements and creating test programs.

Protected Software Investment

Because software development can easily cost as much as the instrumentation in a test system, protecting that software investment is as important as minimizing it.

Whether you use custom written HP BASIC programs or HP's Functional Test Manager software to create new applications, HP ITG serves as an easy and efficient tool for developing the measurement-specific part of your test. Used in conjunction with these programs, HP ITG saves development time without abandoning your present software investment.

Flexible Choice of Operating Systems

In today's competitive business atmosphere, low cost controllers, such as PCs, are highly desirable. But many times, complex test programs are more expediently developed on sophisticated, high-powered machines and then executed on a low-cost target machine. HP ITG's capability to generate code that will run on personal computers (such as the HP Vectra, IBM PC-AT, and compatibles) using the HP BASIC Language processor, on HP's proprietary controllers that use HP BASIC, and on UNIX® controllers, affords a wide choice of controller platforms. This compatibility also assures that you can start small, and as your test needs change you can move to faster, more powerful controllers without having to develop new test software.

System Requirements Development System

Runs on HP BASIC 5.1 or greater for all HP 9000 Series 300 and some Series 200 HP BASIC workstations. Runs on HP BASIC/UX 5.5 or greater for HP 9000 Series 300 HP-UX workstations. Runs on Vectra-compatible PCs with the HP BASIC Language Processor.

Additional requirements: HP-HIL mouse, at least 3 Mbyte RAM (4 Mbyte for HP BASIC/UX), and at least 4 Mbyte of available hard disc space.

Execution System

Code developed with HP ITG requires HP BASIC 5.1 or greater and at least 1.5 Mbyte RAM for execution on any HP 9000 Series 200 or 300 HP BASIC workstation or Vectra-compatible PC that supports the HP BASIC Language Processor card. Series 300 HP BASIC/UX workstations require at least 4 Mbyte RAM.

HP ITG Moves Onto DOS PCs

The unique structure of HP ITG allows the instrument drivers to be independent of specific programming languages, operating systems, or applications. HP ITG is the first in a family of software products which use these drivers. HP ITG will be available for PC software developers working with standard DOS languages such as Microsoft Quic/BASIC and Microsoft C. This version of HP ITG for the PC does not require an HP BASIC Language Processor card.

Ordering Information

	Price
E2000A HP Interactive Test Generator.	
Includes software and manuals.	\$995
AA0 Software on 1/4-inch tape cartridge	
AA6 Software on 5 1/4 disc	
AA7 Software on 3 1/2 inch single-sided discs	
AA8 Software on 3 1/2 inch double-sided discs	
E2001A HP Instrument Drivers. (One set of all available)	\$495
AA0 Software on 1/4 inch tape cartridge	
AA6 Software on 5 1/4 disc	
AA7 Software on 3 1/2 inch single-sided discs	
AA8 Software on 3 1/2 inch double-sided discs	

COMPUTER AIDED TEST

Software Solutions

Data Acquisition Manager - DACQ/300 and DACQ/PC, HP Model 44458A/B and 44459A/B

- Reduce Your Software Development Time
- Customize Your Data Management Needs
- Optimize Your Software Performance

- Use With the Controller of Your Choice: Either HP 9000 Series 200/300 or HP Vectra PC
- Use With Any HP-IB Instrument

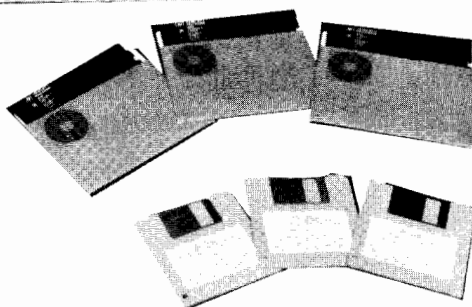
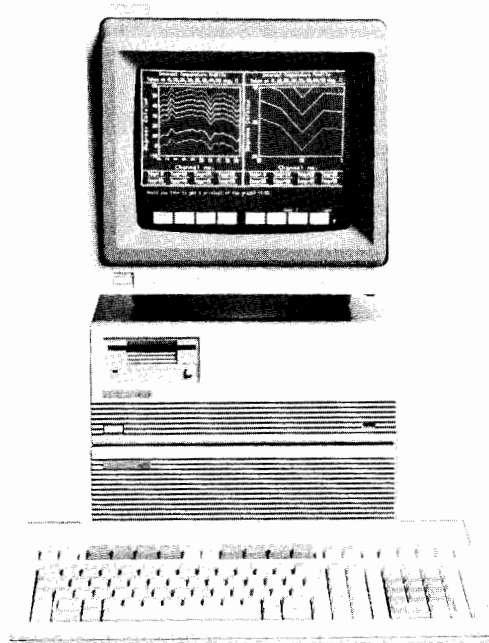
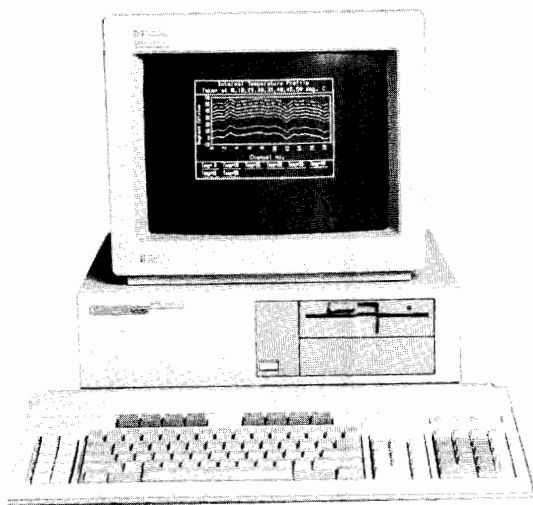

Description

HP Data Acquisition Manager is a general-purpose subroutine library for the HP 9000 Series 200/300 controllers (HP DACQ/300) or the HP Vectra Personal Computer equipped with the HP BASIC language processor (HP DACQ/PC). The software reduces your development time by providing you with software tools (subroutines written in HP BASIC and compiled Pascal) that you can add to your HP BASIC program to handle up to 90% of your data management functions. Customize your data management programs by adding these subroutines to match your final application needs. Optimize your software performance through HP Data Acquisition Manager's compiled subroutines and use of memory volumes (electronic disc). Eliminate the need to have several software packages because HP Data Acquisition Manager provides you with subroutines that cover a wide range of data acquisition and control tasks and works with any HP-IB instrument. Use HP Data Acquisition Manager with the controller of your choice - either the HP 9000 Series 200/300 controller or the HP Vectra Personal Computer. Both controllers offer you the HP BASIC language (on the HP Vectra PC through use of the HP BASIC Language Processor - HP 82300B) for one of the most powerful and easy-to-use programming environments available for instrument control.

Data Management

Use HP Data Acquisition Manager to:

- Set up a data base organized into archives, books and pages
- Specify the format of books and pages
- Collect data over HP-IB, GPIO, from the program, or the keyboard
- Time-stamp and store the data into the data base
- Document the data
- Retrieve the data from the data base to display, analyze or transmit it elsewhere

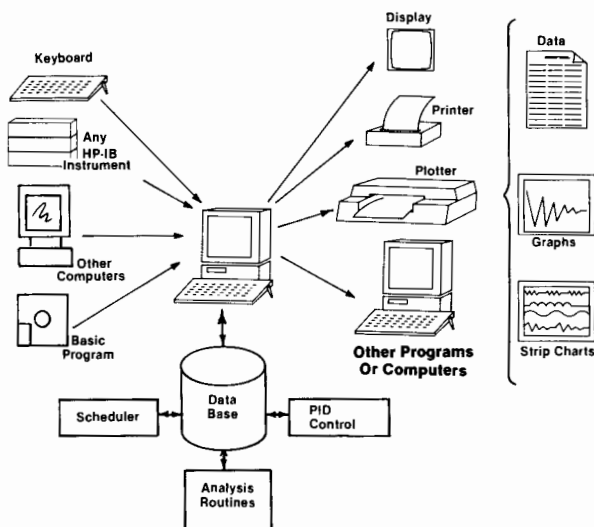

Data Analysis

Entire arrays of data captured over HP-IB or retrieved from the data base can be analyzed quickly using the data analysis subroutines. Analysis functions available are:

- Scaling ($mx+b$)
- Limit checking
- Statistics (high, low, mean, standard deviation)
- Math (+, -, *, /)
- FFT and inverse FFT
- Temperature conversions (thermocouples, thermistors, RTDs)
- Strain gage conversions
- User-defined look-up tables
- Unpacking packed HP 3852 high speed voltmeter readings

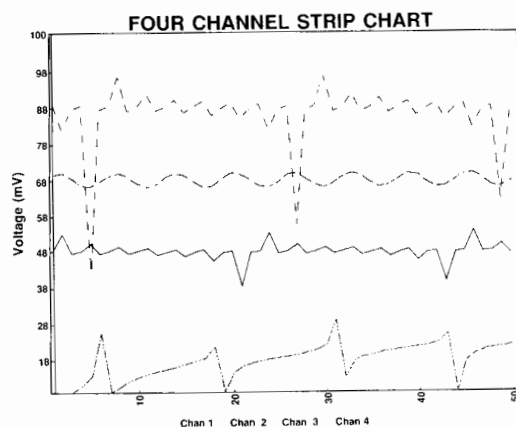
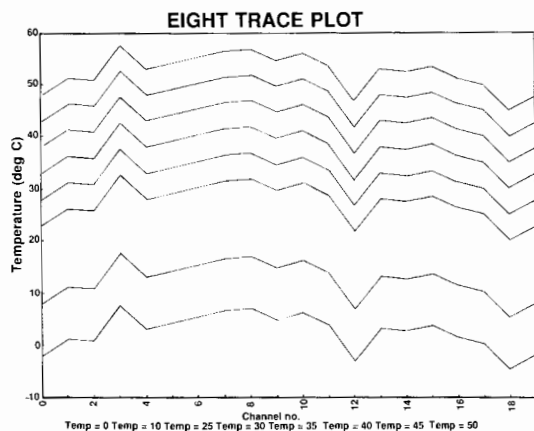

Data Presentation

Printing:

Captured data and sections of the data base can be formatted and printed on the controller display or to a supported printer.

Plotting:

Plot subroutines allow you to plot up to eight traces per chart on either the controller display or an HP plotter. Labels, size, location, color (HP DACQ/300 only), and orientation of the chart are programmable, allowing you to have more than one chart per screen or page. Linear and logarithmic scaling (with or without grid lines) are available as well as auto-scaling of the entire chart.

Real-time Stripcharting:

The stripchart subroutines allow you to plot up to four traces on the controller display as the readings are being received from the instrument (color traces for HP DACQ/300, monochrome for HP DACQ/PC). Once the screen is full, the data scrolls on the display from right to left. A file can be reserved to store values that scroll off the display. Data from the instrument can be plotted versus time or a user-defined array. If a hard copy of the stripchart is desired, the data can be saved and later sent to an HP plotter with the Plot subroutines.

Data Transmission

Transmit data from the data base to another computer over RS-232 using the data transmission subroutines. These subroutines can be used to set up the HP 9000 Series 200/300 Datacomm Card (HP 98628A) with the desired protocols. The ENQ/ACK and X-ON/X-OFF protocols, baud rate, handshaking and the use of modems are all supported with these subroutines. Files of data can be transmitted using a default ASCII format or you can create your own format. When the default format is used, the files transferred can be used by Lotus 1-2-3™ or Wordstar™. The transferred ASCII file can also be transmitted to other computers using the HP Vectra PC's Advance-Link software.

Process Control

Calculate up to 10 PID algorithms with one HP Data Acquisition Manager subroutine call. You specify the PID constants and send the measured values from your process to the subroutine. The subroutine performs the PID calculation and returns the final values. "Bumpless" control allows a smooth transition from manual to automatic control of your process using the PID subroutines. You can cascade two or more of the PID loops and adjust the PID constants ("tune your process control loops") while the process is still under automatic control.

Task Scheduling

The scheduler subroutine assists you in scheduling tasks (in the form of subroutines) within your program. The software creates a table of up to 99 tasks and allows you to designate each task name and number, starting time, time interval between task runs, number of times the task is to be run and its priority. When the scheduler subroutine is called, it returns the number of the task with the highest priority scheduled for that time. Your program can then run that task by calling the appropriate subroutine.

Configuration/Verification (HP DACQ/300)

The HP 9000 Series 200/300 version of HP Data Acquisition Manager (HP DACQ/300) also contains a menu-driven program that you can use to help document your equipment set-up and application. The program allows you to write a description of your application and prompts you to list the peripherals and instruments attached. The program automatically reads the configuration (processor, memory, plug-in interface cards, operating system) of the HP 9000 Series 200/300 controller and an HP3852 data acquisition unit (if present). When you are finished, the entire set-up and description will be saved in a file. The program even contains a routine to verify that the present configuration matches a configuration stored in a file.

Summary

HP Data Acquisition Manager is a powerful software package that provides you with "tools" to handle up to 90% of your data acquisition/control program. This leaves you time to concentrate on other aspects of your application. Collecting, storing, analyzing, transmitting, and scheduling data collection and subroutines are all handled by this software. Add only the routines that you need to customize your program and allow HP Data Acquisition Manager to optimize your software performance. Use this software with any HP-IB instrument on the controller of your choice, either the HP 9000 Series 200/300 or the HP Vectra PC, with the HP BASIC language processor, for virtually all of your data acquisition data management needs.

Recommended and Supported Hardware

Controllers For HP DACQ/300: HP 9000 Models 310, 320, 330, 350, 216, 217, 220 and 236* Controllers running BASIC 5.x equipped with 1 Mbyte RAM.

Controllers For HP DACQ/PC: HP Vectra or 100% compatible computer equipped with the HP 82300B BASIC Language Processor.

The following HP Vectra based bundles contain the HP 82300B, 640 kByte DOS memory, Vectra SPU, 1.44 MByte 3.5" flexible and 20 MByte hard disc drives (PC-308CM has 40 MByte hard disc drive), HP BASIC 5.x, serial and parallel interfaces, display, keyboard and Vectra DOS.

Color* PC Systems

HP 82315D Model PC-308CL
HP 82319D Model PC-308CM

Monochrome PC Systems

HP 82317D Model PC-305ML
HP 82314D Model PC-308ML

Peripherals: Any supported by the HP Vectra or HP Series 300 running BASIC 5.x (plotters must use HP-GL)

Instruments: Any HP-IB instruments

Ordering Information

	Price
HP 44458A: HP DACQ/300 on 3 1/2" disc	\$2055
HP 44458B: HP DACQ/300 on 5 1/4" disc	\$2055
HP 44458R: HP DACQ/300 right-to-reproduce	\$1255
HP 44459A: HP DACQ/PC on 3 1/2" discs	\$1530
HP 44459B: HP DACQ/PC on 5 1/4" discs	\$1530
HP 44459R: HP DACQ/PC right-to-reproduce	\$955

*Stripcharting not supported on HP Model 236C or in color on the HP PC-308CL and PC-308CM. The HP 98627A RGB Color Video Board is not supported.

COMPUTER AIDED TEST

Functional Test Manager Software

HP FTM/300 and FTM/PC

- Substantially reduce your test system development time.
- Available on HP 9000 Series 300 BASIC workstations and HP-UX workstations running HP BASIC/UX, and on HP Vectra PC with HP BASIC Language Processor.
- Improve functional test processes with statistical analysis.

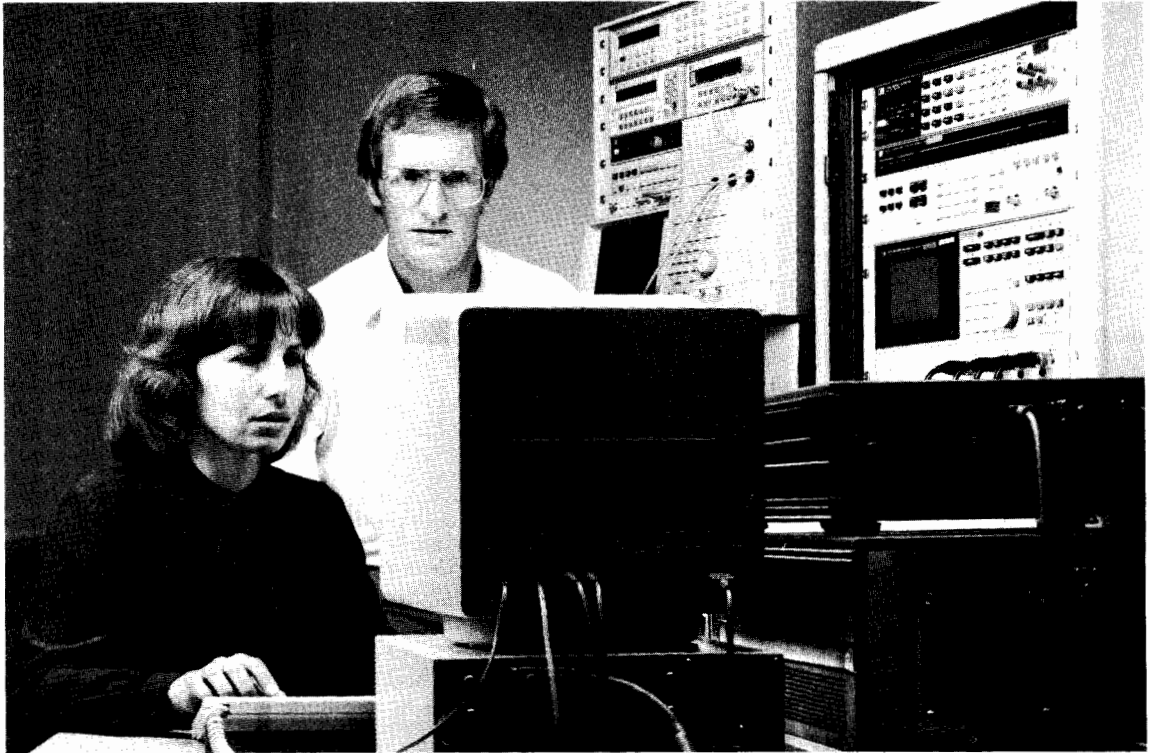

Developing functional test software on an HP Series 300 using HP FTM/300

HP FTM Functional Test Manager

HP FTM functional test manager software is a test executive that improves the functional test process by reducing time to market and reducing test station downtime. HP FTM includes powerful turnkey features, so you write less code. Turnkey user password security and HP-HIL bar code wand compatibility keep operators from accidentally modifying test programs. Turnkey statistical analysis improves the test process.

HP FTM fits well into the test development process. It provides a standard test development environment. The bulk of the programming is done with forms that are very easy to fill out and self-documenting to save time.

Powerful Turnkey Features

Start your functional test system software development with HP FTM, and start out "already finished" with many of your most difficult development tasks. HP FTM provides you with up to 65% of your test system software. It does this by taking care of the non-application specific portions of the system software; parts that are typically the same from one test system to another. Develop your next test system quicker using all of HP FTM's powerful turnkey features:

- Turnkey System Security
- Turnkey Test Scheduling
- Turnkey Test Sequencing
- Turnkey Test Debug Mode
- Turnkey Database Management
- Turnkey SQC Data Analysis
- Turnkey Networking

Standardize On The Complete Set Of HP FTM Turnkey Features

Use these flexible features to quickly build test systems that will do more than most custom-coded systems. Many customers have already standardized on HP FTM's turnkey features for all their functional test systems.

Test Development And System Configuration Tools

Using HP FTM's turnkey tools means you can concentrate harder on your application specific tasks. Application specific tasks typically include defining tests and test parameters and coupling HP FTM's turnkey features into your overall application environment. HP FTM has system configuration and test development tools to help you in these application specific areas.

HP FTM development tools are both easy to use and extremely powerful. They combine the friendliness of menus and forms with the ultimate power and flexibility of HP BASIC programming language. Quickly finish the application specific portion of your functional test software using HP FTM:

• Menu of Forms

Use HP FTM's forms to conveniently document, access and modify your test parameter and test system configuration data.

• Library of Optimized Subs

Use these subs and quickly build individual tests tailored to your specific needs.

• Full Access to HP BASIC

With HP BASIC, add custom test capabilities to HP FTM or use your existing subprograms.

Combining HP FTM's turnkey features with its development tools, you retain all the advantages of writing custom software while substantially reducing your development time and effort.

Optimized For Test Throughput

While HP FTM provides high level testing capabilities in real time (e.g., HP-IB driver I/O, pass/fail limit testing, data archiving, test sequencing, test progress reporting, etc.), HP FTM still executes HP-IB I/O and test sequencing just as fast as most custom written test software. However, for even faster program speed or higher flexibility, custom code critical test segments using powerful HP BASIC. HP FTM's structure allows straight forward integration of HP BASIC callable custom code.

Further optimize your overall testing speed by taking advantage of HP FTM's intelligent test sequencer. Set up HP FTM's Test Plan Form so that certain tests are executed only under certain conditions. For example, execute an overall functional test first. Whenever this test fails, then execute a set of troubleshooting tests to gather more information on the cause of the failure. You don't need to execute the troubleshooting tests every time. Or, specify a lengthy set of tests as "audit tests" to be executed only on every Nth device under test. With HP FTM's intelligent test sequencer you get more of your product out the door faster.

Flexible Test Program Scheduling

Your test system tasks may need to be executed upon specific events or at specific times. With HP FTM, schedule your tasks to be executed upon the wave of a barcode wand, at specific times of day, or upon operator menu selection. At the same time HP FTM will save important information with your test result data, information such as serial numbers, time of test, operator information and networked test station #.

For your less sophisticated operators, use HP FTM's security levels to tailor HP FTM's operator menu to each operator, allowing only specific menus to be seen and executed by specific operators. HP FTM's turnkey security and scheduler features give you flexibility to display, schedule and initiate tasks the way you want.

Data Analysis and Report Generation

Analyze and improve your production process in addition to testing your products. Use HP FTM to monitor trends in your process with its turnkey statistical quality control (SQC) analysis features. Improve your process and your profits by monitoring test result trends as you tune your production process. And HP FTM will generate important SQC reports and graphs. Use HP FTM's SQC overview page as your management summary. It lists yield, units passed or failed, and presents information graphically. For more detailed reporting, use HP FTM to produce the following SQC charts and graphs:

- Pareto charts for failure analysis
- Histograms of test results
- Control Charts (p, X-bar and s) as process monitors

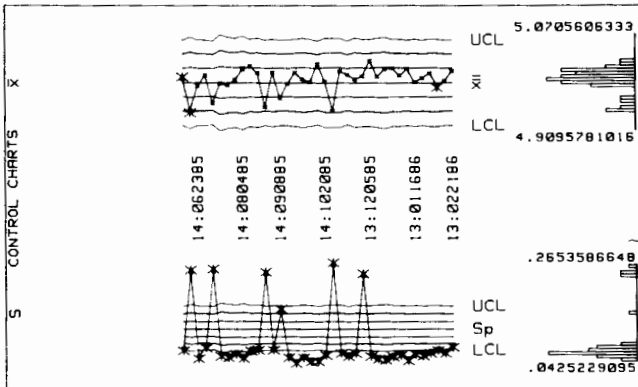

Networking and Data Transfers to Other Computers

Format your test results and transfer them to other computing environments for further analysis or archiving. HP FTM formats test data files in the standard ASCII formats (CSV and DIF) used by nearly all major software packages.

HP FTM networking features let you use any common file transfer means including RS-232, HP-IB, HP's Shared Resource Manager (SRM), or IEEE 802.3 (using HP's SRM network and a co-existing HP-UX environment). Use HP AdvanceLink and HP FTM for total turnkey transfers of data over RS-232C to DOS computers. The resultant DOS files are ready for access by spreadsheets such as Lotus 1-2-3 and database managers such as dBASE III Plus.

HP FTM software is specially designed to take full advantage of HP's SRM network. Multiple HP FTM systems can be linked to share a common data base for data storage and SQC analysis. HP FTM's SRM networking can also be used to transfer test data from HP FTM to HP Q-STATS II area-wide information manager. HP Q-STATS II, working with the HP 306X Board Test Systems and HP FTM at functional and final test provides a comprehensive "board-test-to-final-test" statistical quality control solution.

Standardize On HP FTM For All Your Test Systems

Implement just one test system using HP FTM and see the time saving benefits of reduced software development time, maintenance and documentation. Standardize on HP FTM and experience the additional effect of having your newer test engineers understand and maintain both new AND old systems. Using and training your new test engineers on HP FTM's standard database, data structures and other turnkey features gives them a big headstart in understanding and maintaining all your HP FTM based systems. Examining the information in HP FTM's forms will complete the picture, making it easy and quick for new engineers to grasp the inner application specific elements of any previously unfamiliar system.

Summary

HP's Functional Test Manager is a sophisticated, comprehensive and flexible software package fine tuned for functional test applications in production environments using HP-IB test instrumentation. It provides the set of features most needed to run a modern, versatile production operation. HP FTM has the breadth and depth needed to be considered as your standard test system executive.

Use HP FTM to beat your functional test software development deadlines while simultaneously expanding the functionality and flexibility of your test systems.

Product Requirements

Supported Computers

HP 9000 Series 200*/300 controllers and HP Vectra (or 100% IBM AT compatible) PC equipped with the HP BASIC Language Processor.

Operating System

HP BASIC 5.X or greater and HP BASIC/UX 5.X or greater. Must order HP BASIC HFS binary (HP 82313A) separately for HP FTM/PC unless using SRM.

Memory

3 Mbytes recommended for development system (2.25 Mbytes minimum), 2 Mbytes for run-only. For HP FTM/PC this memory must reside on the HP BASIC Language Processor.

Hard Disc

Local hard disc required unless using SRM. Recommend 20 Mbytes (40 Mbytes for HP FTM/PC if hard disk is shared with DOS applications).

Printer

Optional. HP-IB, RS-232 or Centronics (on PC) interfaces with HP Raster Interface Standard capability. For example, HP ThinkJet, HP LaserJet and HP PaintJet.

Plotter

Optional. HP-IB, HPGL (automatic sheet feed desirable).

Bar Code Reader

Optional. Use HP 92916A (HP-HIL).

32-Button Box

Optional. Use HP 46086A (HP-HIL).

Ordering Information

Product	Price
HP FTM/300 (for HP 9000 Series 200/300 Computers under HP BASIC 5.X or greater)	
HP 34806A FTM/300 on 3 1/2 inch disk. Includes one seat in training class.	\$4950
Opt 001 Delete training	-\$900
HP 34806B FTM/300 on 5 1/4 inch disk. Includes one seat in training class.	\$4950
Opt 001 Delete training	-\$900
HP FTM/PC (for HP Vectra PCs (and compatibles) with HP BASIC Language Processor)	
HP 34806C HP FTM/PC on 3 1/2 inch disk. Training not included.	\$3350
HP 34806D HP FTM/PC on 5 1/4 inch disk. Training not included.	\$3350
HP FTM/300 for HP-UX (for HP 9000 Series 300 computers with HP BASIC/UX 5.5 or greater)	
HP 34806E HP FTM/300 on 1/4 inch tape. Includes one seat in training class.	\$4950
Opt 001 Delete training	\$900

Multiple Copy/Right-To-Use Licenses, Upgrade Kits, Training & Support Materials

Economical multiple copy/right-to-use licenses, upgrade kits for Rev 1.0 and 2.0, user training and Software Materials Subscription (SMS) are available for HP FTM/300 and HP FTM/PC. For more information on these products ask your local HP Sales Representative.

Lotus and 123 are registered trademarks of Lotus Development Corporation. MS-DOS is a registered trademark of Microsoft, Incorporated.

*HP Models 216 and 220 require display enhancements. HP Model 226 not supported.

AUTOMATIC TEST

System Integration

HP ATS 2000



- Modular Systems Using Standard Test Instrumentation for Cost Reduction and Configuration Flexibility
- Manufacturing and Maintenance Applications
- Complete Integration, Installation and Support Services
- Single-vendor Solution

A Modular Approach to Solving Test Problems

With ATS 2000, HP provides a customized solution for complex functional test needs. Based upon the integration of standard HP instruments and controllers, HP ATS 2000 offers test solutions for manufacturing and maintenance of boards and modules in communications systems, PBX, radar, navigational/guidance and other avionics, and pre-flight satellite checkout.

HP's broad range of computation and instrumentation resources is backed up by 20 years of experience in providing fully-integrated systems to meet the requirements of commercial and military testing applications, with the added benefits of a single-vendor solution.

HP works with each customer to configure a system to custom-fit the test application, and then performs all the many hardware and software functions to fully integrate the system. In addition, HP offers user training and long-term support of the customer's system.

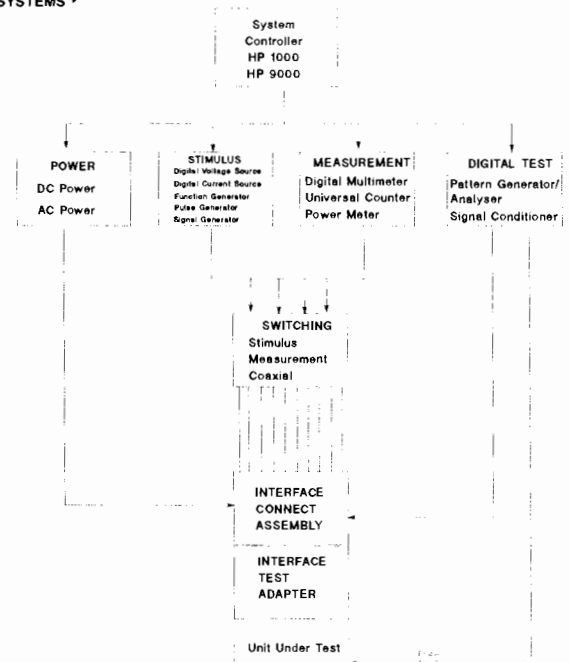

ATS 2000 Block Diagram

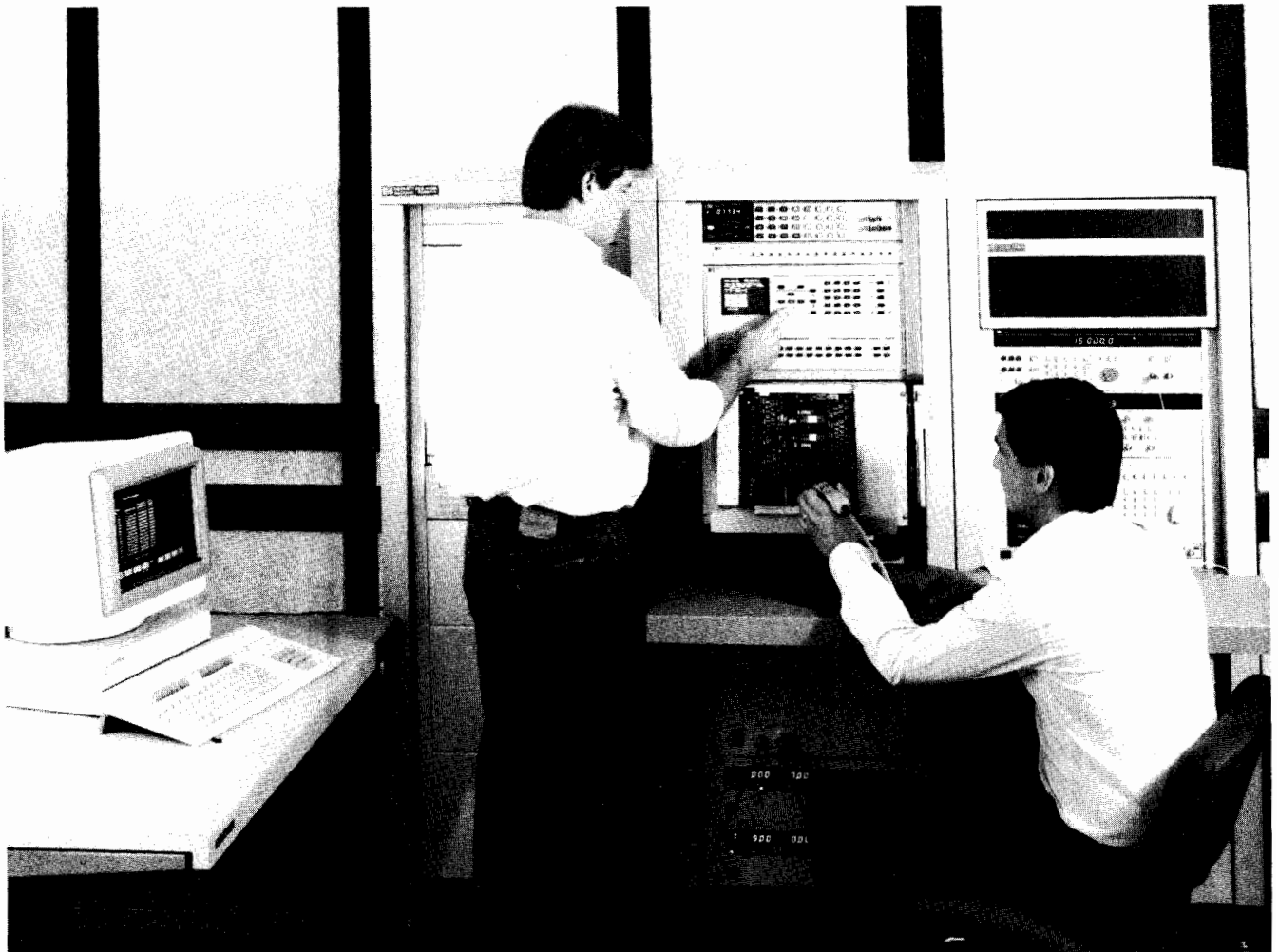

System Controller

A host controller drives the test system. The choice of a controller is based upon current computing and testing requirements as well as anticipated future expansion of the system. The ATS 2000 offers two standard HP offerings:

The HP 1000 is supported by a powerful real-time operating system (RTE-A), and features fast efficient handling of I/O. The HP 1000 controller has a complete device subroutine library supporting over 200 instruments.

The HP 9000 is supported by HP-UX, Hewlett-Packard's UNIX-based operating system. HP-UX allows up to 84 independent virtual processes to execute simultaneously, but this number can be modified according to the user's particular application requirements.

Standard HP Stimulus and Response Instrumentation

HP brings to the ATS 2000 a wealth of standard, programmable instruments for UUT stimulus and response measurement, such as digital multimeters, counters, signal sources, and analyzers together with a selection of programmable power supplies. Integration of off-the-shelf instruments substantially reduces system cost and facilitates modifications to the system configuration to accommodate changes in the customer's application that may occur with time.

Switching

The switching module routes signals between the UUT and analog stimulus/response instruments. The HP 3235A Switch/Test Unit is used for switching in the ATS 2000 systems. This switch comprises a 10-slot intelligent card-cage, with 13 different switch modules available in various matrix and multiplexer topologies to switch signals up to 10 Amps and from DC to 26.5 GHz.

Digital Test Unit

Required for digital test capability, a digital test unit (DTU) generates input patterns to the UUT and analyzes the output responses at real-time functional speeds. Two major components comprise the ATS 2000 DTU: a pattern generator analyzer and a signal conditioner.

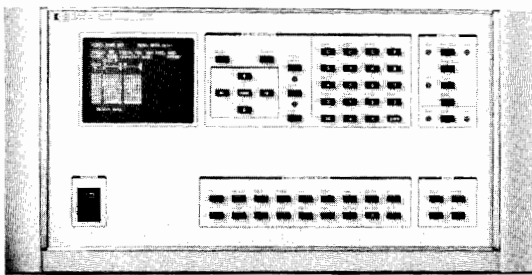

The HP 9417A Pattern Generator/Analyzer controls digital testing, performing stimulus and response analysis functions. From 64 to 128 non-multiplexed, bi-directional channels are provided by the HP 9417A, which may be expanded to 512 channels with the HP 9418A Expansion Chassis. Up to five independent 4K memories (output, expected, tristate, mask, response) are provided per channel for real-time response comparison. Linear or algorithmic stimulus and response allows efficient test programming. Measurement accuracy is enhanced through adjustable skews for compensation of all propagation delays. An HP 94180A Guided Probe is available for backtracing and fault diagnosis.

The HP 9419A Signal Conditioner serves as the interface between the HP 9417A and the test adapter or UUT, providing multiple logic levels with maximum signal integrity. The HP 9419A supports logic families in the range of $\pm 15V$, including TTL, ECL, CMOS, and DTL.

Digital Test Software

The DTU is controlled by the Digital Test Executive (DTE), a modular family of software components which integrates various simulators with the DTU hardware for simulator-based testing. The DTE consists of a run-time analyzer, file configurator, file reporter, and a file generator if simulator-based testing is required.

The HP 9423A Run-Time Analyzer extracts test data, such as stimulus and response vectors, circuit topology, node state, timing information and fault diagnosis data, from the user's circuit simulation software.

The HP 9425A File Reporter allows access to the DTE file at any time during the test process for the test pattern verifications.

A variety of file generators are available to map simulator output into a DTE-compatible format.

User programming of the ATS 2000 DTU is simplified using a set of over 120 subroutines in the HP 9426A Digital Device Subroutine Library.

System Resource Interface

A unit-under-test interface provides the signal path between a test system and a UUT. The ATS 2000 System Resource Interface (SRI) provides a well-defined, high-integrity interconnect path for digital, analog, and RF stimulus and response signals between the test system and the UUT.

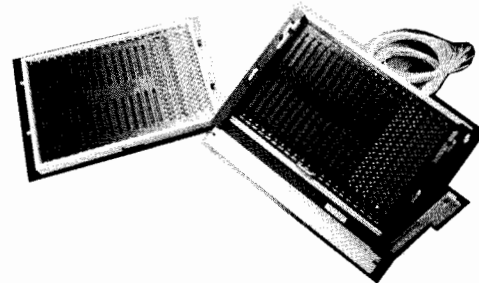

The SRI consists of two subassemblies: the HP 9420A Interface Connect Assembly (ICA), and the HP 9421A Interface Test Adapter (ITA).

The SRI is offered in 4,000-pin (single-tier) and 8,000-pin (dual-tier) configuration. A single customized ICA is used with multiple low-cost ITAs for different UUTs or families of UUTs.

System Software

System software includes the operating system, a device subroutine library for programming more than 200 HP instruments from Pascal, BASIC or FORTRAN, and a system functional test program.

System Integration

Integration services for the ATS 2000 are initiated with a study of the customer's test application to arrive at a system configuration. The integration process includes system design hardware and software configuration, system assembly, racking and cabling, design of a system functional test program and hardware adapter, optional pre-shipment customer acceptance, site preparation and installation, on-site testing, comprehensive system-level documentation, and other support services. ATS 2000 Customer Training Courses are also available.

Ordering Information

Each ATS 2000 system is designed specifically to meet individual customer needs. For more information, consult your local HP Sales Office.

DESIGN AUTOMATION

HP DesignCenter

General Information

Design Automation

Design automation is the process of using computer-automated productivity tools to improve the quality of new products and the speed with which they can be moved through the design cycle and into manufacturing. When implemented effectively, design automation has a powerful, positive effect not only on quality and time to market, but on production costs, product reliability and other factors that ultimately affect the competitive position and profitability of your company.

Design automation has become something much greater than an opportunity for aggressive firms looking for a competitive edge. It is now crucial for survival in a growing number of markets.

Hewlett-Packard's approach to design automation is to integrate best-of-class applications from HP and Value Added Businesses into a design environment that enables engineering teams in electronic, mechanical, and software projects to link their efforts through the entire design process, from concept through manufacturing.

HP DesignCenter

HP DesignCenter is an integrated design environment for electronic, mechanical and software engineers, where tasks can be planned, executed and managed more effectively. HP DesignCenter includes tools for data management, documentation and communication, not just design automation software. It runs on a family of powerful workstations that link, through industry-standard networks, to computers from Hewlett-Packard and other vendors.

In addition to offering integrated sets of tools from Hewlett-Packard and from Value Added Businesses, the HP DesignCenter environment provides assistance for mixing a variety of alternative tools to fit in with standards-based design automation installations. HP DesignCenter comes with the support, documentation, and training to ensure productive use of the tools right from the start.

HP Design Automation Products

HP Distributed Computer Foundation 650

HP DesignCenter Engineering Documentation Products

HP FrameMaker 637

HP DesignCenter Software Engineering Products

HP SoftBench 634

HP Encapsulator 636

HP Teamwork SW Analysis and Design Environment 628

HP 64000-Embedded Microprocessor Development Environment 630

HP 64700 Series Emulators/Analyzers 632

HP 64700 Series Emulators/Analyzers 632

HP 64700 Series Emulators/Analyzers 632

HP 64700 Series Emulators/Analyzers 632

HP 64700 Series Emulators/Analyzers 632

HP 64700 Series Emulators/Analyzers 632

HP 64700 Series Emulators/Analyzers 632

HP 64700 Series Emulators/Analyzers 632

HP 64700 Series Emulators/Analyzers 632

HP 64700 Series Emulators/Analyzers 632

HP 64700 Series Emulators/Analyzers 632

HP 64700 Series Emulators/Analyzers 632

HP 64700 Series Emulators/Analyzers 632

HP 64700 Series Emulators/Analyzers 632

HP 64700 Series Emulators/Analyzers 632

HP 64700 Series Emulators/Analyzers 632

HP 64700 Series Emulators/Analyzers 632

HP 64700 Series Emulators/Analyzers 632

HP 64700 Series Emulators/Analyzers 632

HP 64700 Series Emulators/Analyzers 632

HP 64700 Series Emulators/Analyzers 632

HP 64700 Series Emulators/Analyzers 632

HP 64700 Series Emulators/Analyzers 632

HP 64700 Series Emulators/Analyzers 632

Computer System Platforms

Hewlett-Packard provides the full range of industry-leading workstations and the graphics, networking, and peripheral products necessary to effectively implement computer-aided engineering systems. Graphics capability provides the processing speed and shading capability for the most demanding 3D solids modeling applications or for 2D drafting and design. Application software runs on the HP-UX operating system or on MS-DOS. Industry standard, multi-vendor networking and a broad range of workstations allow computer-aided engineering applications to be used by individual users, engineering workgroups, engineering departments, and site-wide computer centers. See page 650.

Value Added Solutions

To increase the breadth and variety of solutions available, Hewlett-Packard seeks out and relies upon the expertise of Value Added Software Suppliers. There are more than 1000 applications available on HP computer platforms from over 500 independent software vendors, and the HP sales and support force works closely with these suppliers to match the right solution with each customer's needs. See page 627.

Knowledge Sharing

Hewlett Packard has developed engineering tools and processes for over 50 years and applies that experience to the design automation solutions we offer in the marketplace. In order to help customers improve their own engineering and manufacturing processes, HP offers to share experiences and knowledge in that area. This is done through a series of Executive and Engineering Seminars in addition to technology seminars, consulting services, and user training courses. See your local Hewlett Packard sales representative for more information on these programs.

HP DesignCenter CASE/CAE/CAD Solutions

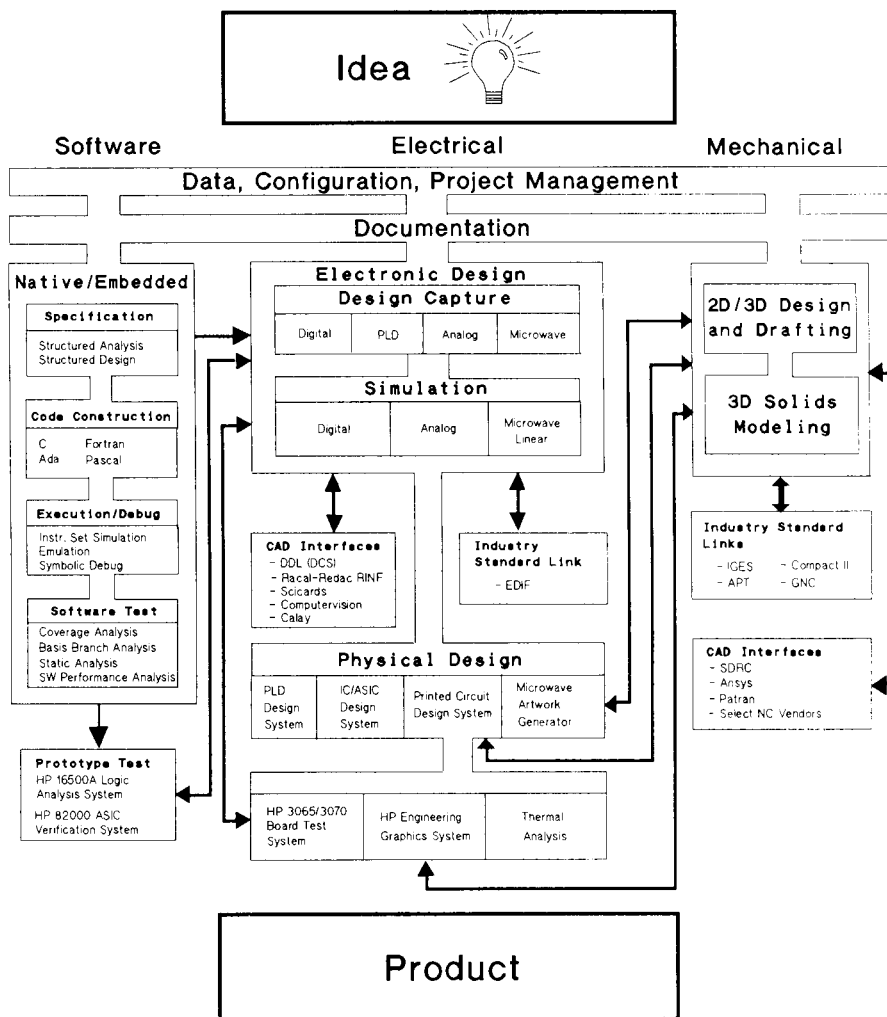

HP DesignCenter Mechanical Engineering Products

HP ME Series 10 & 30 646

ME Value Added Business Products 648

Value-Added Solutions

HP Technical Software Catalog 627

CASE Products

HP SoftBench is a set of integrated software development tools that facilitate rapid, interactive program development in a distributed computing environment. HP SoftBench is easy to learn, easy to use, and it simplifies the tasks of program porting and maintenance. A language-sensitive editor and program building tool help in writing source code and then compiling it into an executable program. A symbolic debugger and static code analyzer are used to gain an in-depth understanding of that program. The version management tools allow you to manage the software throughout the development process. HP Encapsulator allows users to integrate their own programming tools into the HP SoftBench environment. See page 634.

Teamwork Software Specification and Design Environment helps software engineers develop and manage software specifications and designs. Teamwork/SA,SD, RT, and ACCESS provide tools for structured analysis with realtime extensions, structured design, and integration of the resulting database with other software development tools. These teamwork products help to reduce the costs of software development by allowing rapid capture and maintenance efforts for software applications including embedded microprocessor systems, measurement automation, instrument control, and general scientific. See page 628.

HP 64000 Microprocessor Development Environment is a set of integrated tools for embedded system development. These tools provide support for the entire software life-cycle. The HP 64000 environment is fully integrated into the HP DesignCenter family, uses the same computer platform, and provides links to other HP DesignCenter solutions. It provides versatile networking to popular software on systems such as DEC VAX, and the IBM PC. In-circuit emulators, language systems, and analysis tools are available for 8-, 16-, and 32-bit microprocessors. A broad selection of price/performance options helps to select the best system for your needs. See page 628.

Electronic CAE/CAD Products

HP Electronic Design System provides integrated tools for all phases in the development of digital, analog, and microwave circuitry. The system includes more than 7000 logic and analog component library parts, a powerful schematic editor, HILO-3 logic simulation, analog simulation through the Analog Workbench, links to the HP 16500A prototype test, to HP's PLD Design System, and to physical layout systems, and

a user interface that simplifies interaction with the design and verification tools. The HP Electronic Design System is available as a high-end system for use on the HP 9000 Series 300 technical workstation. See page 638.

HP Microwave Design System is a powerful tool for designers of hybrid- and microwave-integrated circuits. The system consists of three fully integrated modules for schematic entry of the circuit, linear-circuit simulation and optimization, and circuit-artwork generation. Extensive capabilities for documenting the design also are integrated into the program. The system also links to other HP electronic- and mechanical-engineering design systems. See page 642.

HP's Programmable Logic Device Design System is a device-independent design tool that supports the entire design process of Programmable Logic Devices (PLDs) — from conceptual and functional design, through device selection, pin/resource assignment, to debugging and fusemap generation. The system automatically fits designs into the most efficient PLD and automatically partitions large designs into multiple PLDs to shorten design time. A bidirectional link with HP's Electronic Design System allows schematics to be transferred to the HP PLD Design System for PLD realization. Once the design has been fitted into one or more PLDs, the system will automatically generate HILO®-3 models for design verification on the HP Electronic Design System. See page 641.

HP Printed Circuit Design System couples printed-circuit-board layout to electrical engineering design, manufacturing and test. Tightly coupled with HP's Electronic Design System, the Printed Circuit Design System allows PCB designers to create highly manufacturable boards that perform as the design engineer intended. HP Printed Circuit Design System provides packing, placing and routing features to automatically lay out digital, analog and mixed digital/analog boards with through-hole and surface-mount technologies, with facilities for thick-film hybrid design. The system has links to HP's ME Series products and to schematic capture systems from a variety of EDA vendors. The system also generates a complete range of manufacturing and test reports. See page 643.

HP Engineering Graphics System (EGS) provides powerful tools for thick-film hybrid circuit design, interactive printed circuit board layout and schematic drawing, as well as mechanical drafting for the enclosures to house PCB designs. The product also includes a general drawing module for artwork

such as overhead slides, project planning diagrams and floor plans. HP EGS can be easily customized to perform specialized CAD tasks. All HP EGS modules run on HP 9000 Series 200 and 300 workstations. See page 645.

HP Design Data Controller provides flexible data management and file security for HP Electronic and Printed Circuit Design System data. This data includes schematic drawings, simulation stimulus and results, documentation, board layout graphics, back annotation and engineering changes, material lists, and manufacturing and tooling files. Large design teams can keep track of data revision, control access to files, and lock data at project checkpoints to prevent unauthorized or unsynchronized updates. The HP Design Data Controller is available on HP 9000 Series 300 and 800 computers. See page 643.

HP EE Test solutions are the most highly rated in the business. HP is a leading supplier of logic analyzers, digitizing oscilloscopes, radio and microwave frequency sources and analyzers, low-frequency dynamic signal analyzers, board test systems and other products. For example, test vectors generated for HILO-3 simulation within the HP Electronic Design System can be sent to the HP 16500A Logic Analyzer for use with a design prototype, to the HP 82000 IC Design Verification System for verification of ASIC designs, or to an HP 3065/3070 Board Test System as ready-to-use board test programs. See the alphabetical index of this catalog for the specific instruments of interest to you.

Mechanical CAD/CAM Products

HP Series 10 & 30 Mechanical Engineering Systems are a family of CAD products for mechanical drafting, 2D design and 3D solids modeling. Both use the same user interface, developed to dramatically reduce system learning time to quickly improve designer productivity. ME Series 10 & 30 provide a range of functions for design through modeling and drafting of complex mechanical parts and assemblies. The result is reduced prototyping requirements and faster creation and modification of drawings. See page 646.

HP Mechanical Engineering Test Products have grown out of the company's longstanding involvement with state-of-the-art instrumentation for vibration and structural analysis and test. In addition to the CAD/CAM products listed below, HP offers a large family of mechanical testing solutions. See page 139.

HILO is a U.S. registered trademark of GenRad, Inc.

DESIGN AUTOMATION

HP DesignCenter (cont'd)

General Information

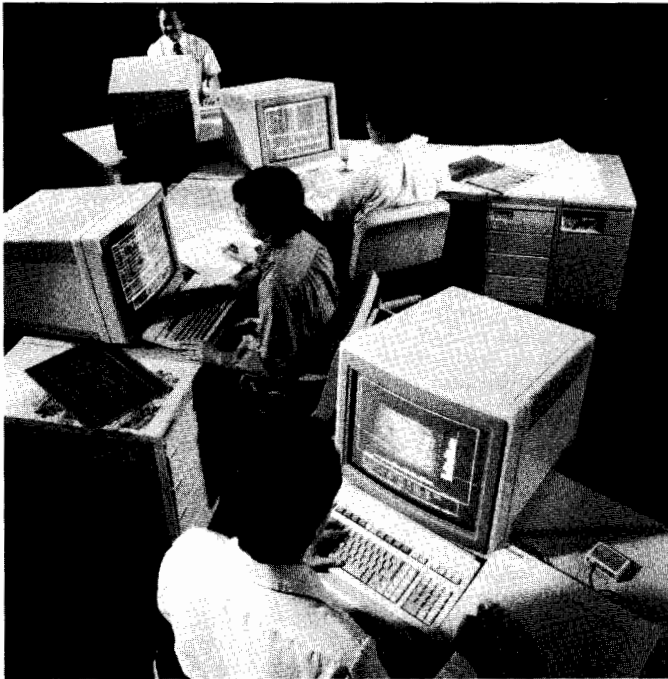

Lots of Links

Ideally, a new product design should work right the first time, but many companies average six iterations. Integration is the key to reducing the number of times designs must be reworked. HP DesignCenter products can be tightly linked. See diagram on page 624.

HP Electronic Design System provides strong links to HP Technical Office Automation, HP EGS, HP 64000-UX Microprocessor Development Environment, HP Printed Circuit Design System, HP Programmable Logic Device Design System, and the HP 3065/3070 Board Test System, with additional links to Racal Redac, RINF, Calay, Computervision, GenRad HiChip physical modeling and ASIC foundry links to NEC, Motorola, TI and others. HP Printed Circuit Design System not only receives net lists and parts information from HP Electronic Design System, but sends back engineering changes and back-annotation data.

Sensitivity of Profits Over Product Life

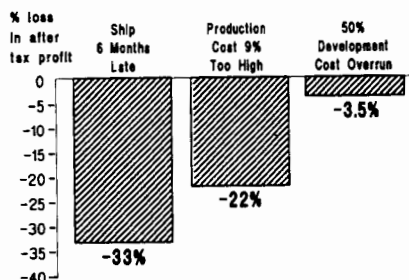

Why Design Automation?

During the past few years, several factors have influenced the typical product design process in ways that make the design engineer's task more demanding. Increasing global competition has compressed product development time as well as product life cycles, making the time saved in development even more critical than in the past.

The shorter the development time, the sooner the product goes to market and the longer the sales life of the product. A recent electronics industry study compared the impacts on product profitability of development costs, product costs and late product introduction.*

Using a representative high-growth market with 5-year product life, 12% annual price erosion, and 20% growth per year, an overrun of 50% in product development costs will decrease after-tax profits by 3.5%. In contrast, a production-cost overrun of only 9% results in a 22% decrease in after-tax profits. Even more significant, a six-month delay in introduction costs 33% of the after-tax profits.

(* Figure from Donald Reinstein, McKinsey & Co, Los Angeles, CA, Electronic Business, July 1983, P. 86. Copyright 1983, Cahners Publishing Company)

Design Automation A Strategic Decision

Purchase of any computer system is an important decision that requires looking beyond today's needs and currently available product features to expected future requirements and growth paths. This is especially true in CASE/CAE/CAD/CAM since the user's entire design-to-manufacturing cycle can be linked to the selection of a CAE vendor. With technology and design requirements changing at an ever-increasing pace, the strategic directions of alternative CAE vendors

are an important factor in the selection process.

HP's product strategy is founded on a major corporate commitment to the design automation business. The company's engineering expertise, reputation for quality and experience in test, measurement and technical computing, as well as its respected worldwide support organization, all contribute to HP's position as a leading supplier of design automation solutions.

Summary

Hewlett-Packard has for many years been a leading supplier of computers and engineering workstations for measurement automation, data acquisition, automatic test, factory automation and many other technical applications.

Today, by combining its expertise in technical computers with its experience in state-of-the-art electronic design, HP supplies high-quality design systems to help improve the productivity of electronic, mechanical and software engineers.

Computer-aided engineering and design capabilities applied throughout the design cycle improve efficiency and quality at each step in the process and enhance communication and coordination between steps. With the increased capabilities and lower costs of technical workstations, peripherals, test equipment and application software, it is becoming feasible for every area of the factory to use these tools in collaboration so each can truly influence products in appropriate stages of design and development.

With the HP DesignCenter, an engineer will have access to a comprehensive offering of CASE/CAE/CAD/CAM solutions for electronic, mechanical and software development. Along with this comes the support, training and service that has distinguished Hewlett-Packard over the years, and that is so important to the successful use of these complex systems.

To ensure that the best solutions are available to customers, HP cultivates relationships with other design automation market leaders to make their products available on HP computer systems. This combination of the HP DesignCenter offerings complemented by renowned third-party products, provides the customer with the widest possible range of design automation solutions.

HP is committed to a technical and business relationship with CASE/CAE/CAD/CAM customers, which begins when the HP field engineer helps to define and analyze the customers' specific needs. This continues through system installation and implementation and extends through the life of the system and beyond as needs expand and new products become available.

Contact HP

HP's design automation offerings are continually expanding as new products are introduced at a rapid pace. The products on the following pages represent the current state of the HP DesignCenter family, but are by no means the whole story.

Contact your nearest Hewlett-Packard sales office (see page 739) for more detailed information on HP's growing family of products for design automation solutions in CASE/CAE/CAD/CAM.

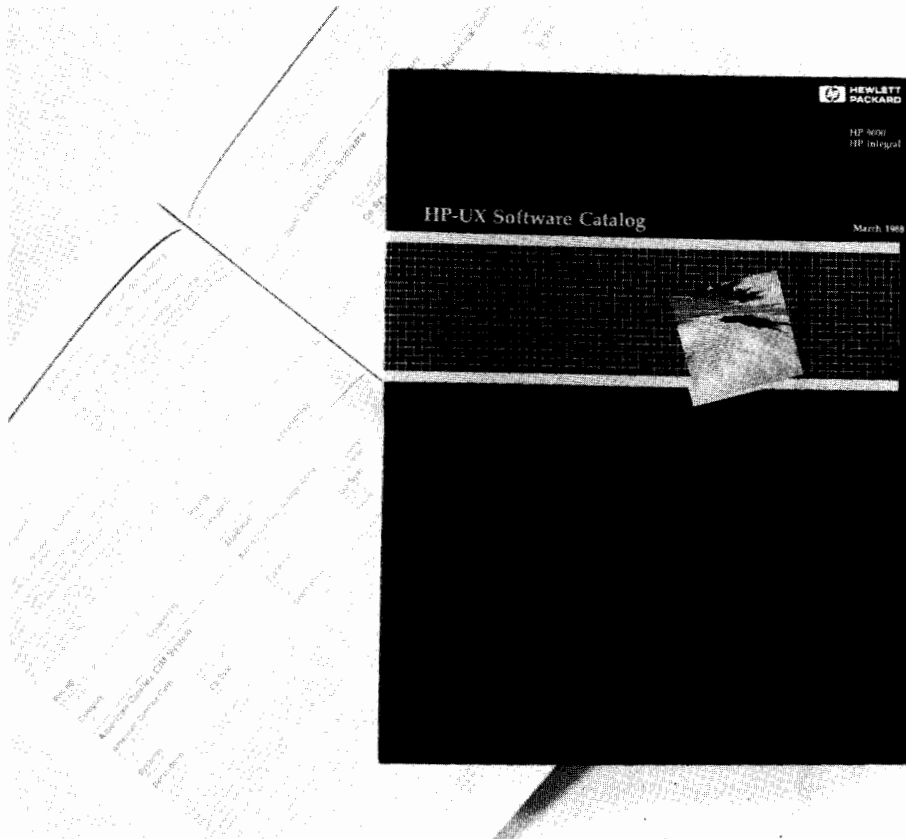

Value-Added Software Solutions for HP Computer Owners

Hewlett-Packard publishes several software catalogs that list business and technical solutions for the full line of HP computers. The software listed in these catalogs comes from two sources:

1. Software submitted by independent software suppliers or value-added resellers (VARs) to the HP Value Added Channels HP PLUS Program. There are more than 2500 products from over 800 vendors currently involved in this third party software program - from aerospace simulators to water utility operations.

2. HP Proprietary software, which offers a broad selection of HP-proven technical applications, utilities, and integrated solutions.

Applications areas in these catalogs range from engineering graphics systems to ac circuit analysis, and from accounting to data communications. Software from fourteen different HP manufacturing divisions is also included in these catalogs. Specific information on HP-created software can be found in other sections of this Catalog.

Software products listed in these catalogs run on the HP 9000, HP 1000, HP 3000, and HP Vectra hardware families. The operating systems include BASIC, Pascal, HP-UX, RTE, MPE, MPE-XL, and MS-DOS.

HP Software Solutions Catalog (for BASIC, Pascal and RTE Operating Systems)

Published annually in July/August. Contains more than 500 software solutions for HP 9000, HP 1000 and other HP technical computers running BASIC, Pascal, RTE, and MS-DOS operating systems. Includes product descriptions, vendor information and pricing.

HP Software Solutions Catalog (for HP-UX Operating Systems)

Published semi-annually in Nov. and May. Contains more than 1000 products specifically designed to run on the HP-UX operating system. These listings include both technical and commercial products.

HP Software Solutions Catalog (for MPE, MPE-XL Operating Systems)

Published annually in Oct./Nov. Contains more than 1500 products specifically designed to run on the MPE and MPE-XL operating systems. These listings are primarily for commercial applications.

HP PLUS Program

To serve its more than 800 software suppliers and VARs, Hewlett-Packard relies on a third-party vendor program called HP PLUS. This program is administered by the HP Field Sales organizations.

HP PLUS offers software in three different categories: Listed, Referenced, and National Accounts. The Listed category is for the suppliers or VARs with the lowest level of HP involvement in marketing their products. The Referenced category is for those products on which Hewlett-Packard has received favorable user feedback, and HP is providing some merchandising assistance. The National Account status is for software which Hewlett-Packard has elected to provide assistance in marketing, merchandising and selling.

Contact your local HP Sales Office for complete details on the HP PLUS Program.

Ordering Information

Hewlett-Packard software solution catalogs are offered free of charge to HP customers, software vendors, and VARs. For your copy of the BASIC/Pascal/RTE Catalog, please contact your local HP Sales Office and ask for the HP publication number 5952-6696. For the HP-UX Software Catalog, ask for the HP publication number 5952-7010. For the MPE/MPE-XL Catalog, ask for HP publication number 5953-6396.

DESIGN AUTOMATION

HP DesignCenter

HP 64000 AxCASE Microprocessor Development Environment



HP 64000 AxCASE Development Environment

The HP 64000 AxCASE development environment offers a powerful solution to the development of embedded microprocessor systems. Because the HP 64000 system is modular, you can select the subsystems needed for a cost-effective solution to embedded microprocessor development applications. You can select any combination from single-user, PC-based, real-time emulation to large team installations with a network of several HP 9000 series 300 workstations to develop the software and hardware necessary for multiprocessor systems.

The HP 64000 is an effective solution for reducing the embedded microprocessor-based system design cycle. It combines advanced software development, real-time emulation for 8-, 16-, and 32-bit processors, sophisticated hardware and software analysis, and the power of the UNIX* operating system. Hewlett-Packard development solutions have kept pace with the needs of embedded system design. HP AxCASE solutions are an example of Hewlett-Packard's commitment to help manage the increasing complexity of software development processes. This integrated framework of powerful software development tools in an open environment enhances the entire development process.

The openness of the HP AxCASE environment is an important part of the software life cycle support. Hewlett-Packard's support of industry standards for networking, such as ARPANET and Berkeley services, NFS, and X Window System, makes it possible to integrate other vendors' tools into the HP development environment. HP workstations, Vectra PCs, and superminis can communicate easily with other computer systems from Hewlett-Packard or other vendors over the IEEE 802.3 LAN using ARPANET and Berkeley services through the use of TCP/IP protocols.

The HP 64000 development system includes several significant features for management of complex embedded systems designs. Teamwork specification products help you create more accurate designs and identify the correct modules and module interfaces for a system. Software engineers benefit from the tightly coupled high-level development, debug, and analysis tools. Performance analysis tools quickly point to system bottlenecks allowing significant improvements in performance in a fraction of the time required using conventional techniques. Powerful, interactive, yet easy-to-use emulation and timing analysis speeds hardware development.

Teamwork - Tools Optimized for Embedded Design

The structured methods supported by the Teamwork family of products allow you to create a clear definition of the project requirements and a design that fulfills those requirements.

At the conceptual level, models of entities, relationships, and attributes can be created with Teamwork/IM and made accessible to all Teamwork applications through a common database. System requirements are defined at the structured analysis phase. Teamwork/SA automates this process and provides consistency and completeness checking. Data flow diagrams and text descriptions are documented for thorough review of functional specifications. Automatic calculation of DeMarco's Bang Metric provides information on the size and complexity of the proposed project. This helps you develop schedules and allocate resources to the project.

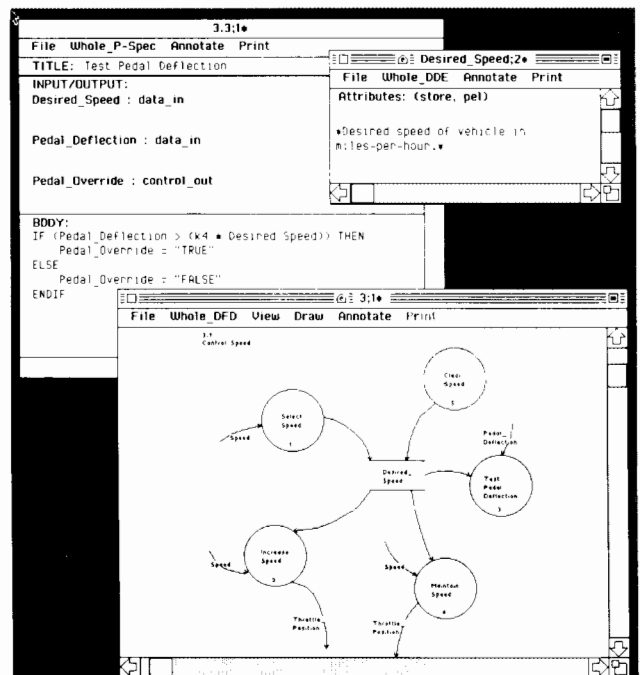

Teamwork/SA allows you to rapidly construct data flow diagrams. Graphically depicted elements such as data flows, processes, and data stores are assembled to present a "picture" of the system with a context-sensitive editor.

*UNIX is a registered trademark of AT&T in the U.S.A. and in other countries



Especially useful for real-time embedded systems is Teamwork/RT real-time extensions to structured analysis to help deal with real-time issues of sequence, timing, and control.

An alternate analysis tool is prototyping with X11 widgets to create the pictorial equivalent of a context diagram. This picture provides a mockup of physical input/output devices, such as buttons, sensors, and switches, making it easy to assess how a product will work from a user's point of view.

Design

Structured design describes how the system will perform the functions defined in the analysis phase. Teamwork/SD automates, checks, and documents this process using the same information generated in previous stages of the life cycle.

Again, documentation is produced on structure charts, textual descriptions of data elements, and module specifications for presentation at the design review stage.

Structured design promotes good software design practices such as modularity, well defined and consistent interfaces between modules, and code reusability.

Teamwork/ADA provides Ada software engineers with support for object-oriented design and automatic DoD-Std-2167A documentation.

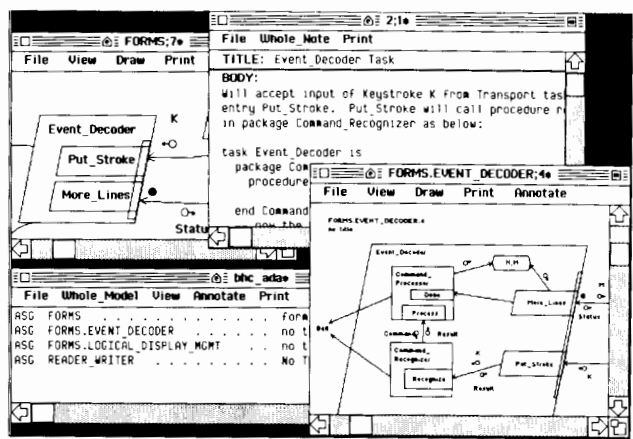

Teamwork/ADA is used by software designers to clearly describe their designs prior to construction. System designers can quickly and accurately build, revise, store, review, and maintain complex Ada designs. The intelligent Ada structure graph editor understands and helps with the syntax of the methodology.

Access Data, Documentation

This work is made accessible to other tools in the software life cycle through Teamwork/ACCESS. Use this tool to create interfaces to documentation production tools to satisfy requirements such as DoD-Std-2167A; for extraction of information for project status reporting; for specialized project management tools.

Documentation Production Interface (DPI) automates documentation of Teamwork analysis and design models. DPI directly supports DoD-Std-2167A documentation requirements. Teamwork files can be exported directly into FrameMaker for final, high-quality documentation and printing.

With ACCESS, Teamwork is integrated with tools for configuration management, performance analysis, and code generation. This allows increased efficiency in implementing, testing, and managing system design to conform to the requirements documented during the analysis and design phases.

At this point in development, many costly and time-consuming defects have already been avoided. The required functionality of the system design is described and documented; it is implemented in the design and verified by design reviews before a single line of code is written. This gives you control over large, complex designs. You have a specific guide for dividing the project among designers; the designers have an overview of how their work fits into the whole and how it must interface with the other parts. You have established a means for team communication.

Construct

With the definitions and outline provided by the structured design, your team can begin the actual writing of source code, such as C or Ada, using their favorite editors. For smaller, simpler designs, the development process might begin at the code generation stage.

For C programmers, source code syntax is checked against draft ANSI standard C and compiled into highly space- and time-efficient executable code by Hewlett-Packard's optimizing Advanced C Cross Compilers. Each microprocessor-specific compiler makes full use of the microprocessor's instruction set and address modes with features not available in most native compilers.

The quality and reliability of these compilers is ensured through a comprehensive process emphasizing object-oriented design and exhaustive testing with four independent test suites. Working tightly with corresponding assemblers and linkers, HP compilers generate symbolic code that is directly usable by debuggers and by integration and test tools in the succeeding phases of the development cycle.

Integrate Software

Hewlett-Packard's Advanced Cross Debug System provides clear insight into microprocessor programs from the beginning of coding through system integration. C and assembly code can be debugged simultaneously. The code, stack, and variables are displayed and updated at every step or break in execution.

		MICROPROCESSOR		
		HP 64100	HP 64120	HP 64100
AMD	80C521/80C321			■
Fairchild	F9450		■	■
Hitachi	HD 6301V/6303R	■	■	
	HD6303R/X/Y	■	■	
	64180	■	■	
	647180X			■
	H16			■
Intel	8048/8049	■	■	
	8051/8751/8031	■	■	■
	8085	■	■	
	8086/80C86/8087	■	■	■
	8088/80C88/8087	■	■	■
	80186	■	■	
	80C186			■
	80188	■	■	
	80C188			■
	80C196			■
	80286	■	■	
	80386			■
Motorola	6800/68A00/68B00	■		
	6802/6808	■		
	6801/6803	■		
	6809/68A09/68B09	■	■	
	6809E/68A09E/68B09E	■	■	
	68000	■	■	■
	68HC000			■
	68008	■	■	
	68010	■	■	
	68020	■	■	
	68HC11	■	■	
NEC	70116/70216	■	■	
	70108/70208	■	■	
	V25			■
National	NSC32532/32GX32			■
PACE	PACE 1750	■	■	
Texas Instruments	TMS32010/320M10	■		
	TMS320C15/320E15	■		
	TMS32020			■
	TMS320C25			■
Zilog	Z8001	■	■	
	Z8002	■	■	
	Z80	■	■	
	User Definable	■	■	

Summary of processors supported by HP 64000 microprocessor development system emulators.

DESIGN AUTOMATION

HP DesignCenter (cont'd)

HP 64000 AxCASE Microprocessor Development Environment

Using the simulator, you can run and debug programs without any hardware external to the host computer. When you use the debugger with an emulator, your program runs full-speed on the real microprocessor with real memory. With in-circuit emulation, prototype memory is also available.

A powerful software test environment can be built using command files to run the debugger (in background) and using a journaling feature to record all input and capture the resulting output.

Simulated input/output capabilities of the HP 64000-UX integration tools provide access from inside the microprocessor to the active resources of HP-UX. This makes it possible to connect interactively with a running process such as the functions of a pictorial prototype of I/O devices.

Emulation 8, 16, and 32 Bit

High-quality, real-time emulators are the base on which Hewlett-Packard built support for the microprocessor software development process. Full-speed execution of microprocessor code can be traced and analyzed nonintrusively with or without functional prototype hardware. With emulation of multiple processors, you can make interactive measurements and coordinate the execution starts of complex designs.

Emulators provide an essential link between the software development environment and the target system. Programs developed on the HP 64000 development environment are run on the emulation subsystem for real-time debug and analysis. The HP 64302A emulation bus analyzer provides the displays and triggering conditions for the emulator and serves as the access point for interactive emulation/analysis. Processor run controls in the emulator allow you to single-step, display, and modify memory. Modifications and improvements to software are made quickly and easily in the early design phases; emulation gives you the flexibility to experiment before committing a product to firmware. For microprocessors that are not presently supported with a dedicated HP 64000 series emulator, a custom emulator can be developed using the HP 64274S user-definable emulator. This user-definable emulator is a powerful alternative tool for applications using processors designed for specific applications.

Analysis

You can obtain highly sophisticated views of source code during execution with logic timing analyzers, software performance analyzers, and state analyzers. These analysis tools are installed in the HP 64120A card cage that is controlled by the HP 9000 series 300 workstation running on the HP-UX operating system.

Basis Branch Analyzer

Hewlett-Packard's basis branch analyzer (BBA) is a test coverage tool that provides an integrated, straightforward way to measure the effectiveness of software tests in the cross-development environment. The BBA uses the actual prototype hardware, running the program under test, to produce test metrics. Comprehensive reports provide detailed feedback on the thoroughness of test cases for an embedded microprocessor.

Software Performance Analysis

The HP 64310A software performance analyzer provides overview measurements to aid in evaluating total system effectiveness of programs operating in real time. Global measurements let software designers determine where resources are being used, in terms of execution times, memory usage, and interaction traffic. Software per-

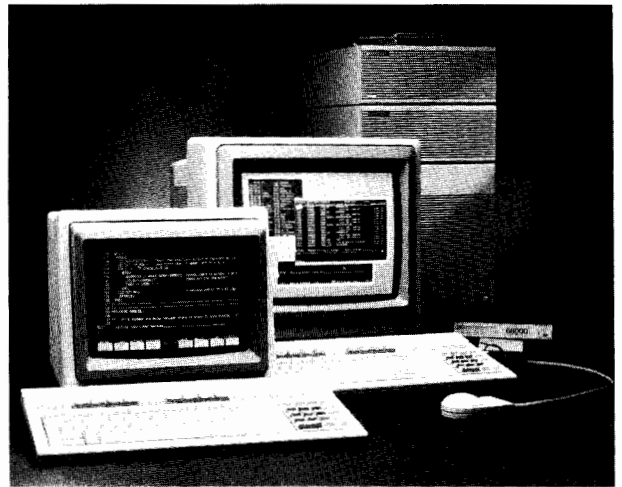

The HP 64000-UX Microprocessor Development Environment is a natural evolution of the HP 64000 family and is compatible with existing 64000 systems. The development environment offers many capabilities, and shares a common workstation platform with many HP DesignCenter products.

formance measurements aid in determining where to focus optimization efforts for maximum effect on system performance.

- Histogram displays for quick comparisons of software activity
- Tabular displays with continually updated means and standard deviations on current measurement
- Measurement modes of memory and program activity
- Measurement modes of event duration
- Measurement modes of intermodule linkages

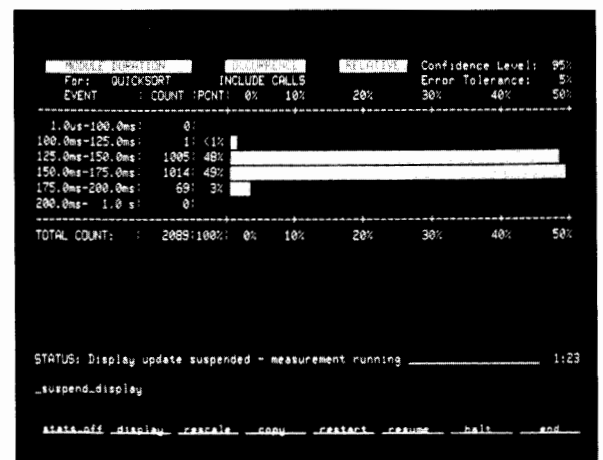

The HP 64310A software performance analyzer verifies and benchmarks both high-level and assembly-level code, even when they are mixed. With this analyzer, you can measure entire program activity (activity), locate the most active modules and determine if they are being called too often (linkage), and measure how long any subroutine takes to execute (duration).

Logic State Analysis

The HP 64620A logic state/software analyzer offers real-time, transparent state/software analysis for microprocessor systems. A modular system, the analyzer consists of cards that plug into the HP 64120A card cage. The analyzer can be configured for 20 to 120 input channels, with probes for connection to various locations in your system, or with a preprocessor for direct connection to the system processor.

- Multiple trigger parameters using symbols, ranges, NOT, and "don't care" terms as well as file names and line numbers
- Selective data storage for edited state listings
- Powerful 15-level sequencer that may also be used to form one or two measurement windows
- Extensive symbolic tracing for quick setups and interpretation
- Real-time nonintrusive analysis feature set supports debug for high-level programming languages
- Two software performance overview modes for code optimization

Preprocessors and interface modules tailor the HP 64620A for use with specific microprocessors. Control software and inverse assemblers are included with the processor-specific interface modules that are installed in a general-purpose preprocessor. The interface modules contain interface circuits and cabling to connect to the target system processor. Both processor-specific and user-definable modules are available.

```

Label: LOG_ADDR CPU_DATA 50020 Mnemonic
Base: hex hex decimal ($ + hex)
Name: ADDR_MSP ADDR_MSP
Trigger: CONTROL1 7FFF7FFF $7FFFxxxx user data write
+001 CONTROL2 FFFF7FFF $FFFFxxxx user data write
+002 PRINTER C4C4C4C4 $C4xxxxxx user data write
+003 TST+00000474 00000002 $00000002 user prgm read
+004 TST+00000478 EFF2325F BFIN$ D3, (#12, R2, D3, L) (09:31)
+005 TST+0000047C 30122C3C MOVE.L $#00000000, D6
+006 TST+00000480 00000000 $00000000 user prgm read
+007 MEM+00000000 007FFFFF $x7FFFFF user data read
+008 MEM+00000003 FF000000 $FFxxxxxx user data read
+009 MEM+00000000 00000000 $x00xxxx user data write
+010 MEM+00000001 00000000 $0000xxxx user data write
+011 MEM+00000003 82628282 $82xxxxxx user data write
+012 TST+00000484 EFED296C BFIN$ D2, (#1234, R5) (D6:12)
+013 TST+00000488 12345600 BRA, W NOCALLM1

STATUS: Awaiting state command - userid _____ 10:33
_disassemble from_line 0 high_word

_display (LINE #) disassemble source _____ show _____ execute _____

```

The HP 64620S software/state analyzer uses all the symbols, labels, procedure/function names, and line numbers available from the software synthesis database. The analyzer allows triggering and storing on ranges and sequences, software performance measurements, cross triggering with other analyzers, and selective storage based on external control signals.

Timing Analysis

The HP 64610S high-speed timing/state analyzer subsystem offers high resolution, asynchronous and synchronous analysis with extensive postprocessing capabilities. The HP 64610S is a modular system. The analyzer consists of boards that plug into the HP 64120A card cage and can be configured for 8 to 32 channels. Many triggering modes allow precise positioning of the display window to locate timing margin, state, execution, and interaction problems. Postprocessing adds another dimension to timing/state analysis with the ability to perform operations on acquired data, such as automated compare and statistical analysis of raw data.

- Asynchronous sampling from 2 Hz to 400 MHz for excellent resolution
- Synchronous sampling to 125 MHz
- Compare level, range, and fault qualifications for state and timing listings
- Memory depth of 4060 samples in wide sample mode and 8140 samples in fast sample mode
- Glitch capture and trigger for glitches as narrow as 3 ns to locate transients
- Dual threshold mode for checking transition times, loading problems, and noise margins

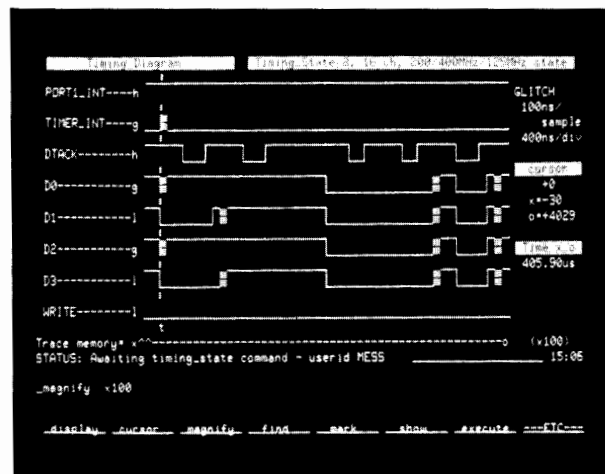

The HP 64610S high-speed timing/state analyzer helps you detect hardware/system problems with the ability to probe up to 32 channels at 200 MHz with a trace of 4060 states per channel. For those hard-to-find problems, there is a fast-sample mode of 400 MHz, a glitch mode that can trigger on and store glitches as small as 3 ns, and a dual threshold mode that reveals slow transition times.

DESIGN AUTOMATION

HP DesignCenter (cont'd)

HP 64000 AxCASE Microprocessor Development Environment

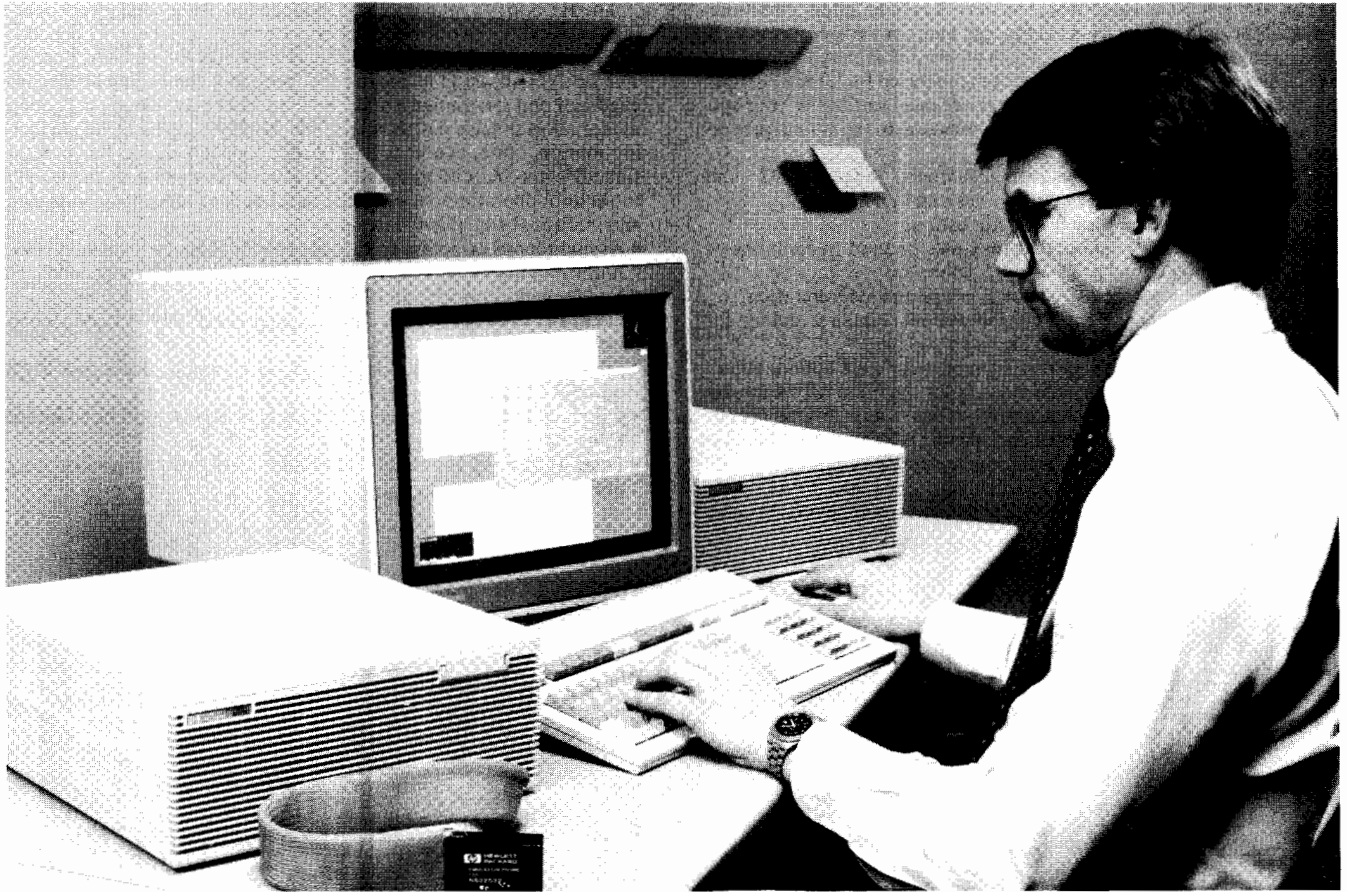

Real-time, transparent emulation and analysis

HP 64700 series emulators/analyzers provide real-time, transparent emulation and analysis for popular microprocessors. The HP 64700 series are self-contained emulation and analysis tools that can be controlled from a terminal, an optional HP 9000 Series 300-hosted softkey interface, or PC-hosted interface. This choice of interface, plus high-speed program download, makes for efficient microprocessor based system development.

High Performance

- Real-time, transparent emulation at full processor speeds
- Triggering capabilities in an emulation bus analyzer support eight-level sequencing, time tags, prestore analysis for establishing software interrelationships
- An optional 16-channel external analyzer that can function as a fully independent 100 MHz timing analyzer as well as a 25 MHz state analyzer
- Synchronized operation and cross triggering between multiple emulators for multiple processor designs
- Real-time code coverage analysis for efficient, thorough software testing and design
- A high-speed RS-422 interface greatly improves emulator download and upload times
- Dual-bus architecture and dual-port emulation memory to ensure nonstop, real-time emulation
- Fully tested to rugged electrical, temperature, and shock standards to ensure continued reliability and performance
- Meets international requirements for RFI/EMI emissions

Choice of Design Environments

HP 64700 Series Emulators/Analyzers offer several flexible configuration options. These host-independent emulation and analysis vehicles can be controlled from a simple terminal, or the emulator can be hosted on an IBM PC-compatible computer such as the HP Vectra PC. For large team-oriented or complex designs, the HP 64000-UX integration environment on HP 9000 Series 300 computers provides a powerful development solution.

Terminal Operation

A firmware-resident ASCII terminal interface is embedded in the emulator, supplying commands for all emulation and analysis features. Commands are ASCII strings; file transfers using industry-standard formats are accepted. Since a terminal can access these commands, host independence is realized. This interface is ideal for remote field applications, use of portable computers, field service, or other applications where a host is impractical or unavailable.

PC-hosted Environment

A PC-based development environment provides the solution for the microprocessor software development and analysis needs of individual engineers and small design teams. High-performance tools include an IBM PC-compatible, HP 64700 series emulator, windowed user interface, combined with software development tools. These tools constitute a development environment tailored for small design teams and those desiring personal development systems.

Hewlett-Packard's MS-DOS-based PC Interface windows provide views of several areas of interest at once, eliminating time wasted in repeatedly switching contexts or running commands. The interface supports color and monochrome displays and uses directed syntax with menus and submenus for quick selection of commands.

HP 64000-UX Integration Environment

HP 64700 series emulators are fully hardware and software compatible with the high-end development tools of the HP 64000-UX integration environment. Based on the HP 9000 series 300 workstations, this development environment is geared toward team-oriented designs that need powerful hardware and software integration tools. The softkey interface provides a simple means of executing commands for emulation and analysis functions. The interface works within the HP X Window System for simultaneous viewing of multiple emulation activities.

Emulation memory

Each HP 64700 series emulator contains an emulation memory that runs at maximum processor speeds with no wait states, for accurate duplication of target system performance. The dual-port memory allows emulation displays and modifications of emulation memory without halting the processor during emulation. Memory can be mapped in 256-byte, 512-byte, or 1-kbyte blocks, depending on the processor, and configured as either emulation or target RAM, emulation or target ROM, or guarded memory. The emulator checks for writes to ROM or guarded memory.

Popular File Formats

Popular absolute file formats are accepted by the HP 64700 series emulators — extended Tektronix hexadecimal, Intel hexadecimal, Motorola S record formats, HP absolute format and Intel OMF-86, OMF-51 file format. The HP absolute format is a binary format that provides added upload and download speed over typical ASCII absolute file formats.

Simple connection to target systems

HP 64700 series emulators offer real-time execution with no wait states at full processor speeds. Target system connection is made with flexible, slim emulator probes, which are up to three feet long. This is accomplished without bulky, active circuits at the probe tip, aiding plug-in to tight, hard-to-reach target systems. Full signal fidelity is maintained at maximum-rated processor speeds. Multiple package types are supported where applicable. For example, both PGA and DIP packages for the Motorola 68000 along with LCC and PGA packages for the Intel 80186 are supported.

Comprehensive Logic Analysis Emulation bus analysis

Each HP 64700 Series emulator includes an emulation bus analyzer for tracing microprocessor code flow. Based on the same logic-analyzer-on-a-chip used in the HP 1650A/1651A Logic Analyzers and the HP 16500A Logic Analysis System, the analyzer has abundant resources for solving the most complex system problems. Up to eight hardware resources, each consisting of address, data, and status event comparators, can be combined in several fashions.

Those resources can be grouped to establish complex sequential trace specifications using "find A, followed by B . . ." constructs up to eight levels deep. A range comparator can be applied to address or data events at any one of the levels. Each event is tagged with an execution time, for easy measurement of code execution times. A dual-bus architecture allows all traces to be set up and reviewed without breaking processor execution. A prestore function allows tracking of relationships between a given software element and one or more other software events that influence that element. For example, prestore helps pinpoint which of several different tasks accessing a variable is responsible for corrupting it.

Software Coverage Analysis

HP 64700 Series emulators have code coverage analysis implemented in hardware. Code coverage analysis is valuable during initial coding and software test. Coverage analysis provides a history of the

memory addresses that are either written to or read from during program execution. For example, you can quickly determine how exhaustive a test suite is by using coverage analysis to measure what percentage of code is being accessed. Since the coverage analyzer is built into hardware, it does not rely on statistical sampling of code space and allows running in real time.

Logic Analysis

An optional 16-channel, state/timing analyzer can be included in the HP 64700 series emulator. The analyzer can be configured as a 100 MHz timing analyzer with 5 ns glitch detection or as a 25 MHz state analyzer. In state mode, the analyzer can be clocked by the microprocessor clock or by an independent synchronous source. Based on the same logic analyzer chip as the emulation bus analyzer, the logic analyzer also has full triggering and qualification capabilities. The analyzer can serve as a stand-alone logic analyzer or can be coupled with the emulation bus analyzer for correlation of microprocessor activity with other target system activity. The two analyzers can cross trigger or arm each other on the basis of hardware or software events that one analyzer detects. Target system probing is through a 1.4 meter cable with 18 probe leads (16 data channels and two clock channels). There are 36 miniature probe tips included for easy connection of both signal and ground lines of each lead to target system ICs or test points.

Coordinated Measurements

Designs involving multiple microprocessors are often quite complex in their interactions. The coordinated emulation of several target system processors can greatly enhance the efficiency of designers doing system integration. Synchronized execution (start/stop) of multiple emulators enables users to finely control the interactions while watching the behavior of the system. To allow the user to understand and isolate the relationships between the various processors, the emulators and analyzers can be set up to cross trigger one another. HP provides these capabilities by allowing up to 32 HP 64700 series emulators to be interconnected over a dedicated Coordinated Measurement Bus (CMB).

Ordering Information

The HP 64000 AxCASE development environment is a dynamic family of software and hardware development tools for embedded micro-processor-based systems. With development support for over forty 8-, 16-, and 32-bit microprocessors, there are many combinations of solutions available. Contact your HP sales representative for a suggested system configuration that will fit your application. For a copy of the latest HP 64000 AxCASE development environment brochure, in the U.S., call 1-800-447-3282; in Colorado, call collect 719-590-5540 (please call between 8:00 am and 5:00 pm mountain time). Outside the U.S., call your local HP sales office.

Following are the workstations that support the HP 64000 embedded microprocessor development environment. These workstations allow you to select the performance needed to fit small to large development teams.

The price ranges listed are examples of complete emulation subsystems for 8- through 32-bit processors.

Workstation	Price
HP 9000 Series 360MH	\$47,400 to \$56,500
HP 9000 Series 370MH	\$61,200 to \$85,300
HP 9000 Series 340M	\$37,300 to \$60,500
HP Vectra ES/12 Model 46 PC	\$20,200 to \$28,300

What Is CASE?

The CASE acronym is most commonly interpreted as Computer Aided Software Engineering. "Software engineering" refers to a set of disciplined engineering processes used to improve the quality and productivity of software. "Computer aided" refers to the use of tools to facilitate the use of the engineering disciplines.

There are as many interpretations of CASE as there are acronyms. The conservative interpretation includes only structured analysis and design tools or front-end tools. Further expansion of the definition of CASE includes any computerized tool that automates an aspect of the software development process. The move to a systems perspective of CASE is driving the development of integrated tool sets that will offer tools for design, source code generation, documentation, compilation, and testing into a single seamless environment. In a seamless environment, the tools are able to communicate with each other in a way that is transparent to the user.

A fully integrated environment, encompassing the entire software development life cycle is the goal and vision of CASE. It has yet to be realized. What is the current state of software development and how can the goal be reached?

The Full CASE Environment

What is needed is a software development process that provides for a full CASE environment:

- Formulation and analysis of the problem to be solved.
- Automation of specification, design, implementation, testing, debugging and maintenance.
- Reuse of software to improve the resulting systems.
- Management of personnel and other resources used in all of these activities.

The goal of CASE is to provide better quality software with less effort. We can consolidate the list of potential benefits and objectives of CASE as follows:

- Develop systems which meet users needs.
- Improve the quality of existing systems.
- Provide proven, repeatable methodologies for software development.
- Speed up the software development process and reduce software costs through automation of tasks in the development process.
- Provide quantitative information about the software development process and about the progress in product development.

Software Life Cycle Models and Methodologies

The most common models used to represent the software life cycle range from the traditional waterfall approach to the evolutionary or spiral approach offered by Barry Boehm, or the circular model preferred by James Martin. Regardless of the software life cycle model used in the development process, there are common activities that can be identified.

Requirements definition - understanding and representing user and system requirements.

System analysis - Specification of WHAT the system will do. The translation of requirements results in a precise external specification of the system.

Design - HOW the system will meet the requirements or solve the problem. Results in a reasonable design or internal specification to implement the system.

Construction/coding - implementing the design, largely coding and conducting unit tests on modules of code.

Integration and testing - linking the modules, determining if the design meets the requirements.

Maintenance - making necessary updates and improvements to the system as the requirements change over time. Ideally, the life cycle is repeated in this phase in order to avoid introducing new errors.

Key Components of the Integrated Environment

The following key components deserve special attention due to their importance for attaining a "true" software development environment. These activities are present in every phase of software development regardless of the life cycle model or the methodologies used.

Configuration management - coordinating software development to minimize the inevitable confusion involved with a team project. It is identifying, organizing, and controlling modification to the software being built by a programming team. The goal is to maximize productivity by minimizing mistakes.

Project management - the effective use of the resources necessary to complete the project. This includes planning, budgeting, staffing, estimating, and tracking.

Documentation - the production of documents required throughout the systems life cycle related to the overall project management standards.

Setting Expectations

CASE is still evolving and moving towards a fully integrated environment. The focus needs to be on developing the underlying process and the enabling environment if CASE is to realize its full potential. But some of the components are available today to organizations who want to prepare themselves to take advantage of a totally integrated CASE environment. While examining their software development process and defining appropriate life cycle models, companies can bring in point tools that are presently on the market. Many experts think it unadvisable to change the existing development process all at once. Currently organizations can formulate a plan to evolve their processes, as a standard software development environment becomes a reality.

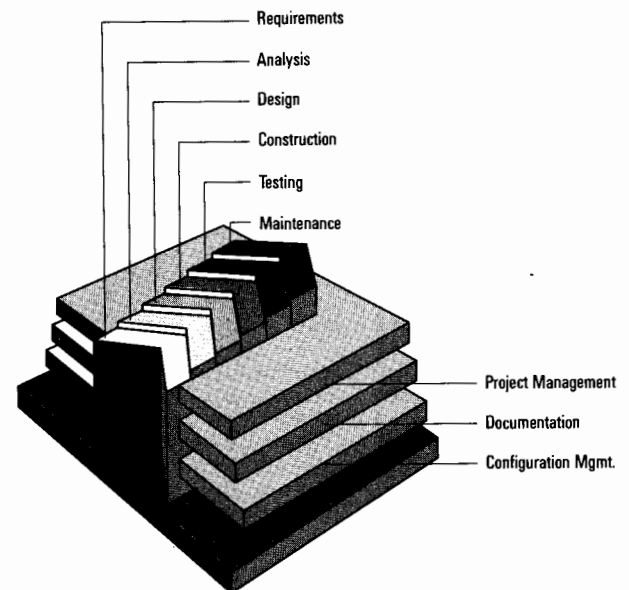

The Full CASE Environment

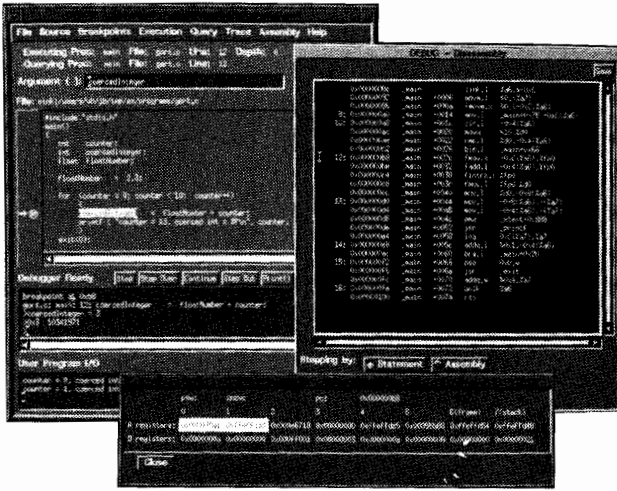

HP SoftBench 1.0 - Debugger Screen

HP CASEEdge

HP CASEEdge is the program name for Hewlett-Packard's Computer Aided Software Engineering (CASE) products. There are three categories of products in this family:

- CASEEdge/Tools - stand-alone CASE tools for different areas of the software life cycle.
- CASEEdge/Environments - integrated sets of tools that target different areas of software development.
- CASEEdge/Knowledge - software engineering consulting services, covering assessment, metrics, education, methods, and implementation assistance, designed to help software organizations improve their development and management processes.



HP SoftBench 1.0 for the HP 9000 Series 300 and Series 800

HP SoftBench is a software development environment consisting of both an integrated set of program development tools and a Tool Integration Platform. Program development in both C and FORTRAN is supported. HP SoftBench is based on HP-UX operating system and the industry-standard X Window System, Version 11. HP SoftBench provides five tools for the program construction, test and maintenance phases of software development.

Integrated Program Development Tools

Program Editor - The Program Editor is a language-sensitive, mouse/menu based source file editor that can be customized for specific needs. It is easy to learn and use, and it is designed to minimize syntax errors. The following features are supported:

- Customizability
- Alternate editors
- Synchronized file views
- Querying

Program Builder - The Program Builder automates the process of compiling a program composed of many different source files. The following features are supported:

- Efficient builds
- Error browsing
- Remote builds

Program Debugger - The Program Debugger is a multi-window debugger designed to enhance the understanding of the dynamic execution of programs. The following features are supported:

- Multi-view interface
- Breakpoints
- Program tracing
- Register tracing
- Querying
- Record/playback

Static Analyzer - The Static Analyzer provides information regarding the structure of a program. It provides cross-reference queries such as: 'where declared,' 'where defined,' 'where used,' 'where modified'; function queries such as: 'what functions are defined,' 'what calls are made in this function'; and general pattern searching calls. The Static Analyzer's features make it a particularly valuable tool while porting or maintaining code. The following features are supported:

- Code browsing
- Recompiling
- Scoping
- Query history

Development Manager - As a manager for all of the files related to a software project, the Development Manager acts as a 'home base,' the place from which other tools in the environment can be executed. The following features are supported:

- Version control
- Access from other tools

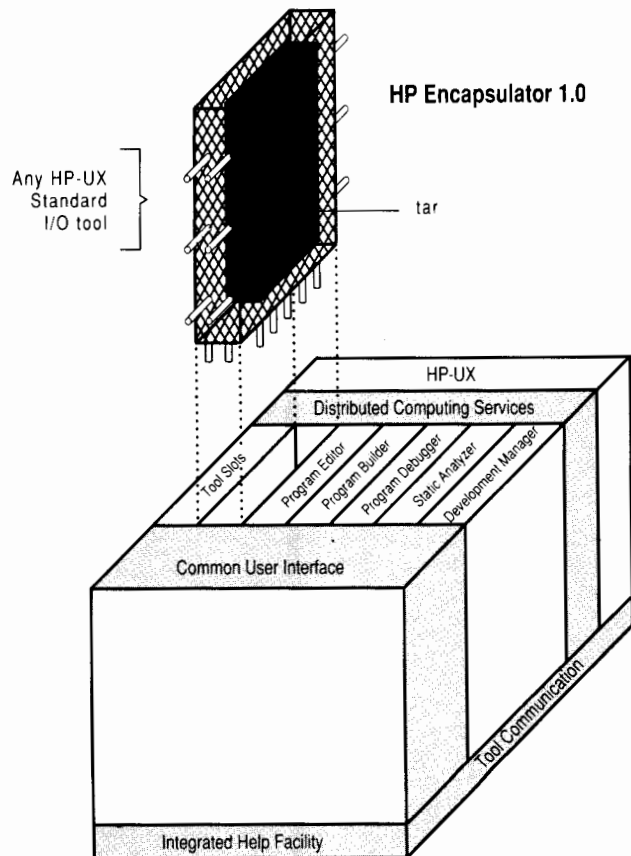

Encapsulating tar into HP SoftBench using Encapsulator 1.0

DESIGN AUTOMATION

SW DesignCenter

HP CASEdge

Tool Integration Platform

HP SoftBench includes a Tool Integration Platform, which forms a framework for tool communication, distributed computing support, a common user interface, and an integrated help facility. The Tool Integration Platform provides an architecture designed to support a powerful new generation of software tools that are highly interactive, task-oriented, interchangeable, yet tightly integrated.

Tool communication - The HP SoftBench tools communicate in a networked, heterogeneous environment via a broadcast communication facility designed to support close communication of independent tools. Tools provide compatible user and programmatic access to functionality; anything accessible from the user interface is accessible programmatically. Message requests allow one tool to invoke the functionality of another tool, and notification messages allow tools (or the user) to define triggers which respond to events and initiate other actions. Triggers are cause/effect relationships; they can be caused by system events, and can in turn cause a user-defined action to occur. In this manner, triggers link one or more tools together to support a task or process.

Distributed computing services - The HP SoftBench environment supports distributed execution, distributed data, and distributed display.

Distributed execution: The HP SoftBench tools can execute on any host in the network, if that host has HP SoftBench installed.

Distributed data: With HP SoftBench, data can reside on any host in the network. For data access, HP SoftBench uses either Network File System (NFS) or HP Remote File Access (RFA), depending on which is available on the system.

Distributed display: Allows programs to execute on one system and display and support user I/O on another. Distributed display allows access to HP SoftBench from anywhere on the network, including non-HP computers.

User interface - HP SoftBench provides a multi-window graphical user interface. Productivity is increased by having a consistent user interface across all tools. HP SoftBench implements the OSF/Motif appearance and behavior adopted by OSF as an industry standard.

Integrated help facility - The help facility cooperates with the other tools in the environment to respond to requests for help. Help can be obtained for general information, context-sensitive information, and definitions of terms used by any of the HP SoftBench tools.



HP Encapsulator 1.0 for the HP 9000 Series 300 and Series 800

HP Encapsulator allows users to extend and customize the HP SoftBench development environment. The HP SoftBench environment can be extended by using HP Encapsulator to add user-developed tools without source code modification. It can be customized by using HP Encapsulator to automate development processes by establishing communication links between HP SoftBench tools and user-added tools. The result of this process for the new tool is a consistent user interface based on the OSF/Motif appearance and behavior, and the ability for that tool to communicate with the other HP SoftBench tools.

Tool encapsulation is a means to provide the Tool Integration Platform features in HP SoftBench to tools that were developed in the standard UNIX pipe model and are non-screen oriented.

The model on the previous page shows the capability of replacing the command line interface of the UNIX utility *tar* with a newly defined graphical window-based interface named "ARCHIVE". Once encapsulated, *tar* can now communicate with the other HP SoftBench tools.

Configuration Information

System Components	Series 300	Series 800
Software	See your HP Sales Rep. for software configuration	See your HP Sales Rep. for software configuration
System Models	340/350/360/370	825/835/840/850/855
Physical Memory	Minimum 8 MB RAM recommended 12 MB	Minimum 16 MB RAM recommended 24 MB
Display	High-resolution (1024 x 768 min.) bit-mapped display	High-resolution (1024 x 768 min.) bit-mapped display
Input Devices	Keyboard and mouse	Keyboard and mouse
Disk	307 MB (typical)	571 MB (typical)

Ordering Information

HP SoftBench must be purchased for each workstation that will be used to run one or more of its programming tools. In order to customize HP SoftBench by adding additional tools or by automating development processes, both HP SoftBench and HP Encapsulator must be purchased. HP Encapsulator is only required for development. Runtime support is provided by HP SoftBench.

Product	Product Number
Series 300	
HP SoftBench License-to-Use	B1621A
HP Encapsulator License-to-Use	B1625A
HP SoftBench Media and Manuals	B1622A
HP Encapsulator Media and Manuals	B1626A
media options: option AA0 - 1/4 inch tape cartridge	
HP SoftBench Documentation Kit	B1629A
HP Encapsulator Manual - HP Encapsulator: Integrating Applications into HP SoftBench	B1626-90000
Series 800	
HP SoftBench License-to-Use	B1623A
HP Encapsulator License-to-Use	B1627A
HP SoftBench Media and Manuals	B1624A
HP Encapsulator Media and Manuals	B1628A
media options: option AA0 - 1/4 inch tape cartridge option AA1 - 1/2 inch 1600 9-track tape	
HP SoftBench Documentation Kit	B1629A
HP Encapsulator Manual - HP Encapsulator: Integrating Applications into HP SoftBench	B1626-90000

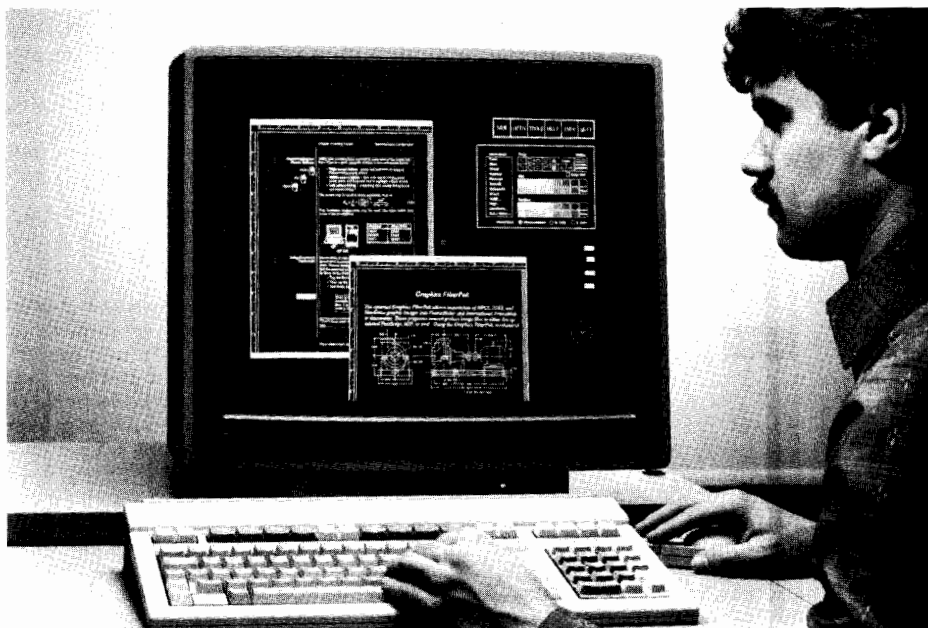

FrameMaker

FrameMaker® brings professional quality publishing to HP 9000 Series 300 workstations. It is easy to use for those who create documents occasionally, yet sophisticated enough for full-time publishing professionals. FrameMaker runs the industry standard X.11 Windows and allows multiple document windows to be opened simultaneously. FrameMaker can print to the HP LaserJet and Apple® LaserWriter® PostScript® printers.

FrameMaker provides full-featured tools, including a complete word processor, a graphics toolbox for creating and manipulating technical graphics, importing capabilities for text and graphics, and easy-to-use page and document design.

FrameMaker can be used to produce professional results for large or small documents such as software documentation, technical papers and reports, presentations, proposals, specifications, manuals, and newsletters. Text and graphics can be merged with ease. FrameMaker delivers greater control over document design and allows the creation of higher quality documents than traditional cut and paste methods.

Users can choose a standard template or create a custom page and paragraph format, including multiple columns. Essential features such as footnotes, index, and table of contents are all generated automatically. Pagination is also automatic, and it is updated as the text is edited.

International FrameMaker makes it easy to generate multilingual documents. Users get all the advanced FrameMaker features plus spell checking, fonts, and hyphenation in 5 languages — U.S. English, U.K. English, Parisian French, Dutch, and German, definable on a paragraph-by-paragraph basis. User interfaces are available in English, French, and German.

For manufacturing environments where guided, on-line access to the most recent process drawings, specifications, and instructions is required, FrameViewer® provides economical, view-only access to FrameMaker and International FrameMaker documents created with FrameMaker's locked document capabilities. Electronic view-only documents replace cumbersome, hard-copy manuals.

Features

WYSIWYG interface — With the WYSIWYG (What You See Is What You Get) interface, text and graphics can be integrated without embedded commands. Accurate screen fonts give documents the

same quality and readability on screen as on the printed page. The guesswork of page composition and graphics placement is eliminated.

Full-featured text processor — The text processor helps to easily create documents that include math equations or other scientific notations. A customizable spelling checker is included, as well as automatic paragraph and section numbering for easy organization of complex documents.

Import, capture, manipulate, and create graphics — Graphics can quickly be copied or pasted from other document windows or imported from other programs with the optional Graphics FilterPak for HPGL and IGES files. Once the image is captured, it can be scaled, cropped, and annotated to fit any document. Creating graphics is easy with FrameMaker's graphics toolbox. The user just selects a tool, chooses a fill and border pattern, and draws.

Easy-to-use page and document design — When six pull-down menus and a single graphics toolbox are mastered, the complete software is accessible through mouse, keyboard macros, or EMACS-like editing commands. Created or imported text and graphics can be easily combined in a readable, visually-appealing document.

Mathematical equation composition — Quick access to the proper mathematical symbols for documenting complex equations makes mathematical equation composition easy in FrameMaker.

Hypertext capabilities — Create links between related information, such as customized on-line help or locked FrameViewer documents for viewing only.

On-line help — Hypertext hot spots quickly guide the reader to relevant information.

The Demonstration Program allows users to experience the full features of FrameMaker or International FrameMaker before purchasing the complete application. (Only the file saving feature is disabled.) With the on-line tutorial and help menus, new users are up and running quickly.

Ordering Information

	Price
HP 74350A FrameMaker	\$3,060
HP 74351A International FrameMaker	\$3,660
HP 74352A FrameViewer	\$600
HP 74353A Graphics FilterPak	\$1,205
HP 74354A Document FilterPak	\$1,205

FrameMaker® and FrameViewer® are registered and unregistered trademarks of Frame Technology Corporation. Contact your local Hewlett-Packard sales office for detailed price and ordering information (see page 739 for sales offices).

DESIGN AUTOMATION

EE DesignCenter

HP Electronic Design System

Electronic Design Automation

Electronic design automation (EDA) tools are key accelerators in the development of high-quality, complex application specific integrated circuits (ASICs) or printed circuit boards. HP, in conjunction with an array of value-added businesses supplies a full breadth of solutions to meet the broad range of digital, analog and microwave design automation needs.

HP Electronic Design Automation

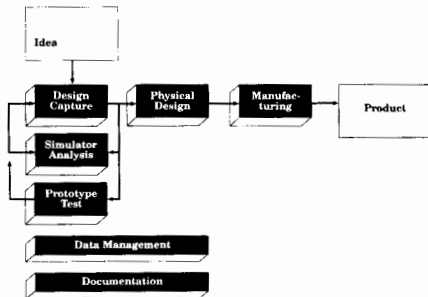

HP's EDA solutions for ASICs and printed circuit boards automate every aspect of the design process from initial idea capture to product delivery. These tools integrate physical layout, design capture, simulation, prototype and manufacturing test, data management and documentation.

The combination of Hewlett-Packard and its new Appollo subsidiary adds up to the world's leading workstation supplier and the number one supplier of design automation systems and software.

HP will continue to expand the applications available for electronic design automation by aggressively managing this industry-leading portfolio and by working closely with value-added solution suppliers and internal product development. EDA solutions from HP include HP-developed EDA products and those of important value-added partners such as Mentor Graphics, Cadence and others.



HP Design Capture System

HP Electronic Design System

Hewlett-Packard's computer-aided engineering system for electronic design provides tightly integrated tools for all phases in the development of digital, analog, and microwave circuitry — design capture, verification, netlist generation for physical layout, links to test, and documentation. The easily-learned interface to these tools ensures that valuable time is spent creating designs instead of learning the syntax and operation of a computer system. Using a mouse and pop-up menus simplifies command entry. Multiple windows provide simultaneous views of different parts of a design and access to other tools in the design and verification environment.

Available on the HP 9000 Series 300 workstations, the HP Electronic Design System includes the following: HP Design Capture System, Design Verification System with System HILO™, Parts Libraries, Design Interfaces to physical layout systems, and links to HP's Programmable Logic Device Design System and to prototype and manufacturing test systems. This integrated set of tools addresses the total electronic product development process.

Design Capture System

The HP Design Capture System is the cornerstone of HP's Electronic Design System, providing schematic capture and design database management capabilities to improve the electronic design process. It forms the database and user interface foundation upon which other elements of the HP Electronic Design System are built. Engineers can use this same intuitive user interface to access a variety of tools for entering and editing schematics for digital, analog, and microwave circuits.

The HP Design Capture System also provides on-line checking of design parameters such as fan-out, incompatible outputs, unused pins, unconnected wires, wire loops, and symbol pin mismatch. Finding design errors as soon as they are entered helps avoid costly rework at later stages of the design cycle. Additional features designed to enhance productivity include automatic orthogonal routing of signals and the use of color to help organize complex circuits by highlighting different signal types or different areas of functionality on a circuit.

With full support for top-down, bottom-up, or flat circuit design, the HP Design Capture System provides the flexibility for you to work the way you want. For top-down design, you can create symbols "on the fly" without leaving the circuit page on which you are working. An automatic symbol-creation facility speeds the process of bottom-up design. Flat designs spread over several pages become easier to handle with automatic part or signal locating functions.

Regardless of the design methodology you choose, the advanced database structure provides access to other design information such as physical references. This access makes interfaces with physical layout systems faster, more complete, and reliable. It also makes comparison of simulation data with a prototype or production device quick and easy.

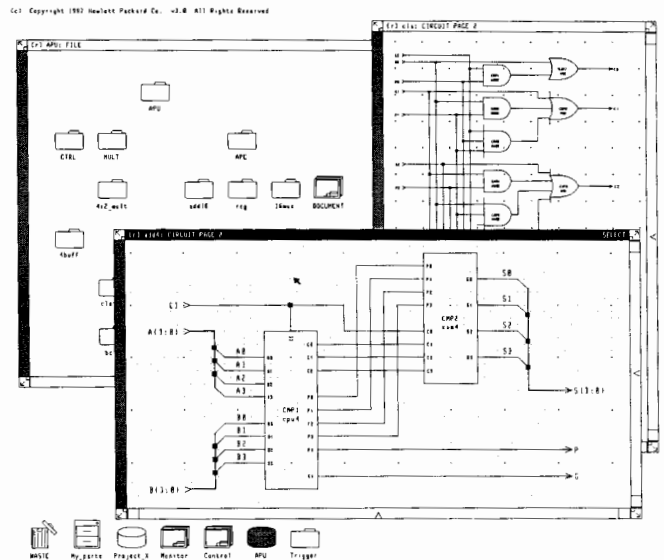

Hierarchical design techniques allow easy segmentation of complex circuits.

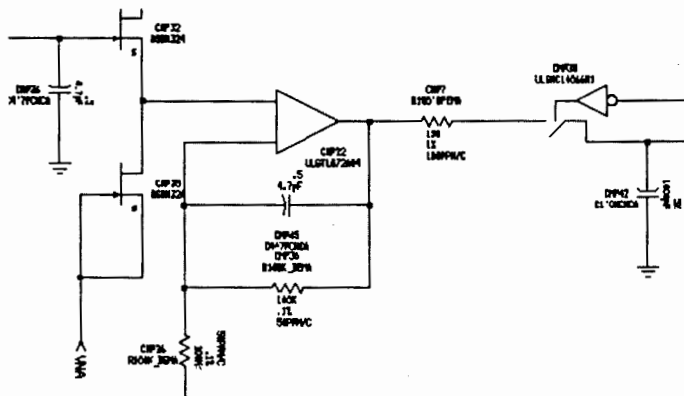

Libraries of over 5,500 digital parts and 3,700 analog parts are available.

Comprehensive Parts Libraries

Extensive, ANSI-compatible parts libraries support a wide variety of digital and analog design requirements. These libraries contain both symbolic and parametric information for more than 5,500 digital and 3,700 analog parts, including off-the-shelf TTL, ECL, MOS, microprocessor, and passive and active analog devices. In addition to providing a graphical symbol for schematic drawing, each part entry contains information used in other functions of electronic design, including titles and revision levels, load information, scions or related parts, and physical design information.

In addition, you can associate custom information such as cost, availability, power requirements, or capacitance to any graphical element in the database. This information can be displayed visibly or hidden until called, or accessed and formatted via the Design Database Language to create custom reports. This user-defined information, together with the variety of pin types, symbol shapes, and text heights that can be stored in the database, allows you to address virtually any documentation standard.

The object-oriented structure of the HP Design Capture System database simplifies access and increases the speed at which information can be found, extracted, updated, or created. With object-oriented structure wires, components, pins, symbols, and other elements used in electrical design are not merely graphics inside the database but "objects" containing all the connective or textual information to define a wire, component, pin, or symbol.

In addition to the Design Database Language, HP's support of the Electronic Design Interchange Format (EDIF) standard provides further capability for interfacing with the HP Design Capture System database. A bidirectional EDIF link transfers designs and symbols between the internal database format and other CAE systems that support EDIF version 200.

Design Verification System

HP's Design Verification System, based on industry-proven System HILO simulation products, provides logic simulation, extensive model libraries, timing analysis, fault simulation, and physical modeling capabilities.

By using the intelligent database, connectivity information of the complete circuit is maintained at all times. Because this electrical circuit representation is available on line, it is easy to move back and forth between design and simulation when making circuit modifications. You don't need to flatten the schematic before beginning a new simulation. When this capability is combined with the streamlined data flow and common user interface between design and verification tools, the design cycle time is shortened and engineering productivity is improved.

The flexible simulator interface provides a choice of waveform or textual formats for input specification and output display. A Simulation Data File Comparator can be used to compare any two user-

created or simulated trace files, or to compare measured files from the HP 16500A logic analyzer. The logic simulator incorporates a five-state, fifteen-value logic strength algorithm to accurately model MOS bidirectional gates, wired ANDs, wired ORs, or tristate pullups and pulldowns.

Simulation models are mapped one-to-one with the symbols in the HP Design Capture System parts libraries, which provide the graphic and parametric information for the design. This close coupling of the graphics and the simulation models provides complete and consistent access to commercially available parts throughout the logic design cycle, including TTL, ECL, and MOS parts as well as a many complex microprocessors such as the Intel 8086 or the Motorola 68000. In addition, ASIC design kits containing programs, symbols, and models are available for specific ASIC vendors such as Fujitsu, Mitsubishi Electronics, National Semiconductor, NEC and Toshiba.

Flexible Constructs for Functional Modeling

System HILO's modeling provides flexible, functional modeling constructs such as event expressions, register transfer functions, Boolean and arithmetic operators, loop constructs, and conditionals. Since the modeling language is an event-driven, nonprocedural language, asynchronous signals such as interrupts can be modeled exactly as they occur in hardware. Multilevel support in System HILO allows simulation of designs, even when some parts are specified at a functional level only.

Link Hardware and Software Design Tools

Designs containing a microprocessor with associated RAM/ROM models can be checked for hardware/software integration problems through the tight linkage of HP 64000-UX software development tools and the System HILO simulator. The HP Software Link (see page 628) provides an effective means to test software and hardware interaction while still in the simulation phase of development.

Save Modeling Effort with Hardware Modeling

The HICHIP® Hardware Modeling System provides an efficient method for modeling complex LSI/VLSI devices within the HP Electronic Design System. HICHIP simplifies board-level simulation by integrating hardware models, using the actual device, into logic simulation.

In simulations involving microprocessors, other hardware modeling systems merely help model the complex device, which requires many cumbersome, error-prone tasks to simulate even simple hardware/software interaction. As an integrated part of the HP Electronic Design System, HICHIP combines with the HP Software Link to simulate the hardware device running software developed in the HP 64000-UX environment.

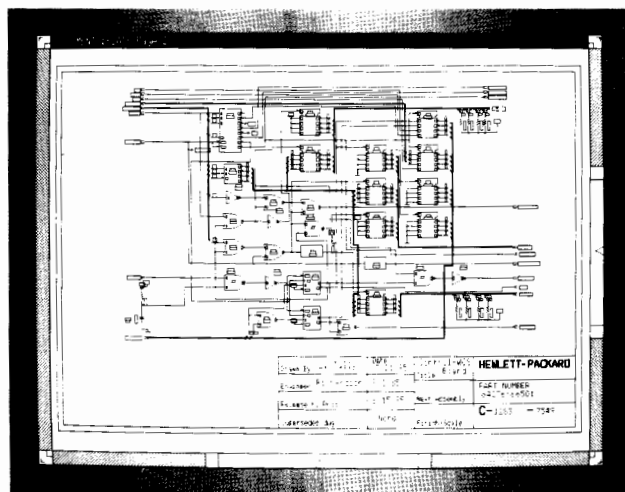

Schematics in a document are automatically updated when the original design is modified.

DESIGN AUTOMATION

EE DesignCenter
HP Electronic Design System

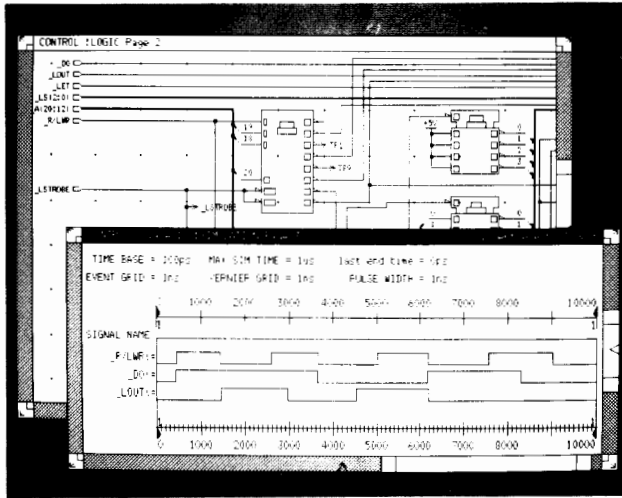

HP logic design verification tools, based on the System HILO simulator, are tightly coupled to the HP Design Capture System.

Analog Simulation

With integrated analog design you can perform analog design from the same design environment rather than changing environments. For analog designs, you can use the advanced simulation capabilities of Analog Workbench from Valid Logic Systems or Analog's Saber Simulator. A bidirectional schematic interface allows the analog design engineer to take advantage of the specialized analysis tools while maintaining the powerful schematic editing, documentation, and data management capabilities of the HP Design Capture System. The Analog Workbench System can reside either on the same workstation as the HP Design Capture System or on a networked system.

Links to Test and Instrumentation

The HP EDS/16500A CAE Link lets you send simulation test vectors to the HP 16500A logic analyzer (see page 636) to use in debugging a prototype of the design. This link eliminates the manual test generation and typing in of test vectors into the HP 16500A analyzer. After the test vectors are run through the prototype, measured results can be sent back to the simulation environment to be compared against simulated results using the HP Simulation Data File Comparator. All data translation and instrument configuration occurs within the HP Electronic Design System environment.

You can achieve more efficient testing of ASIC prototypes by transferring System HILO test vectors to the HP 82000 IC Design Verification System (see page 639).

Links to Physical Layout

Design interfaces link the HP Electronic Design System with SCICARDS®, Calay, Racal-Redac RINF, and Prime/Computervision printed-circuit CAD systems. Interface capabilities between the HP Design Capture System and the HP Printed Circuit Design System (see page 643) are built into both systems. This combination provides automatic transfer of design information, including back annotation

or the initiation of engineering change orders. The HP Design Capture System also includes an interface to the HP Engineering Graphics System (see page 645) as a standard feature.

Hardware Configurations

The HP Design Capture System is available on a wide range of HP 9000 Series 300 workstations. For larger design teams that need to share information across systems, these workstations can be networked together using NS/ARPA or Network File System services and supporting either IEEE 802.3 or Ethernet LAN standards. In addition, such networks can include HP 9000 Series 800 Precision Architecture computers dedicated to compute-intensive tasks such as simulation or printed circuit board routing.

Ordering Information

HP Design Capture System	HP 74210A	\$8,160
HP Design Verification Sub-System	HP 74230S	\$23,000
HP Design Verification Interface (includes HP Software Link)	HP 74230A	\$6,000
System HILO Logic Simulator	HP 74230B	9,000-45,000
System HILO Simulation Models	HP 74236	8,000-15,300
System HILO Fault Simulator	HP 74230D	9,000-45,000
HICHIP Hardware Modeling System	HP 74231A	\$49,000
HP EDS/16500A CAE Link	HP 74240A	\$2,000
Simulation Data File Comparator	HP 74240B	\$2,000
Analog Workbench	HP 74610A	\$14,550

System HILO and HICHIP are registered trademarks of GenRad.
Analog Workbench is a trademark of Analog Design Tools, Inc.
SCICARDS is a registered trademark of Scientific Calculations, Inc.

Contact your local Hewlett-Packard sales office for current prices and ordering information (see page 739 for sales offices).

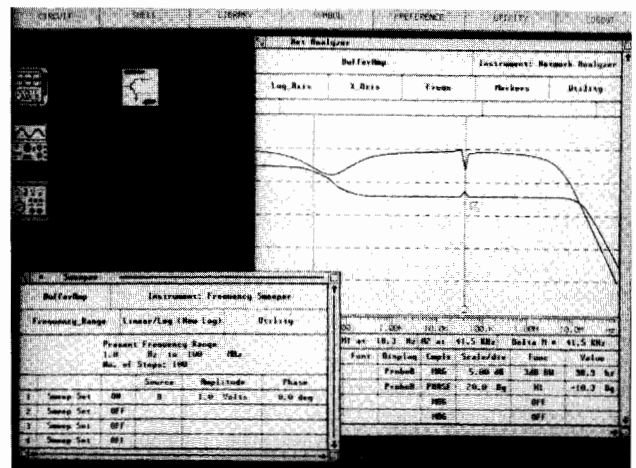

Analog design information can be transferred to the Analog Workbench module for analog simulation and analysis.

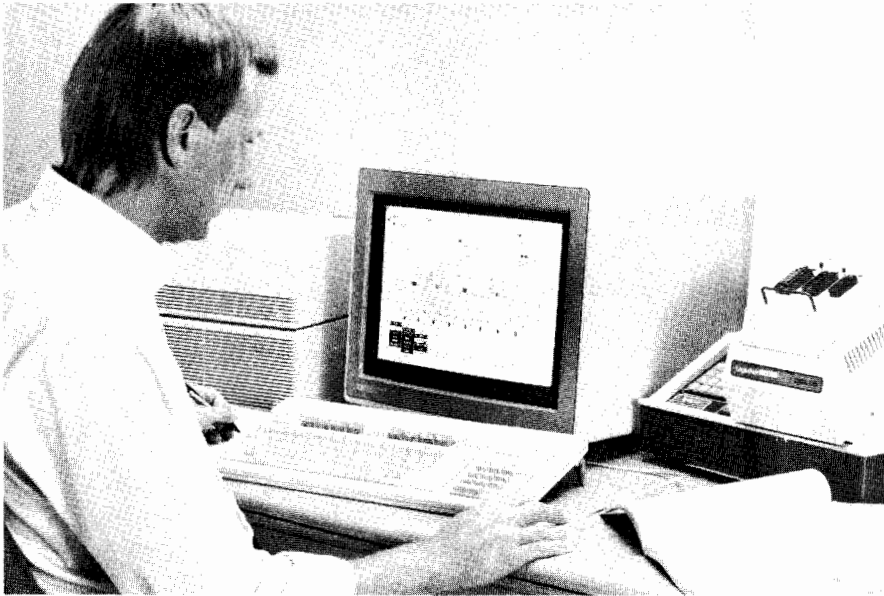

HP PLD Design System picks the most appropriate device or sets of devices for a design.

HP PLD Design System

Hewlett-Packard's PLD Design System provides new capabilities in adapting PLDs (programmable logic devices) to electronic designs. A new breed of PLD design tool, HP PLD Design System provides a device-independent design environment. Designers can develop and verify logic without the constraints of a particular PLD architecture. The system automatically fits complex designs into the most efficient PLD, and if necessary, partitions designs into multiple devices. HP PLD Design System supports the entire design process of PLDs — from conceptual and functional design, through automatic device selection and pin/resource assignment, to debugging and fusemap generation.

As part of HP DesignCenter, HP PLD Design System is available on the full range of HP 9000 Series 300 workstations, and is closely linked with HP's Electronic Design System. A design or part of a design can be transferred from the HP Electronic Design System and submitted to HP PLD Design System for PLD realization. After device selection, this information can be transferred back to the HP Electronic Design System for design layout and documentation. In addition, HP PLD Design System automatically creates System HILO® models for more thorough system simulation of printed circuit boards containing PLDs.

PLD Design Entry and Verification

Without considering the target device, engineers enter designs with schematic symbols, graphical state diagrams, truth tables, waveforms, or Boolean equations. PLD debuggers specific to each design entry method are tightly integrated to quickly verify PLD designs at the same level of abstraction.

The HP PLD Design System also supports hierarchical design to allow complex PLD designs to be split into sub-designs or blocks. Each block can be described according to the most appropriate design method: state diagram or waveform entry. Once designed and verified, the blocks can be interconnected and the entire design simulated. A design block also can be entered into the library for future use in other designs.

Waveform Entry

In the design of asynchronous circuits, a timing diagram often exits showing the desired functionality in terms of certain input activity causing output activity. The HP PLD Design System automatically

creates the necessary logic from this timing diagram. The waveform debugger checks all causalities for any contradictions and then reports contradictions along with inconsistent waveforms.

Device Independence

The HP PLD Design System automatically selects the most appropriate PLD — or multiple PLDs — from a prioritized list of the most efficient devices for your design. Devices for this list come from a comprehensive part library that includes over seventy popular architectures from the leading PLD vendors. You can also modify the system's choice of devices.

You can implement an existing PLD design on a new, perhaps more efficient device, by simply re-compiling the design rather than having to modify it. A Foreign Tool Interface (FTI) allows you to transfer PLDs designed on other systems via the JEDEC standard for PLD fusemaps.

Programming and Test Generation

For device programming, the HP PLD Design System transfers fusemap information in JEDEC standard format directly to a variety of PLD programmers, eliminating the need for programmer commands. The system automatically creates electrical test patterns to evaluate the behavior of programmed devices before designs are released to production. In addition, the PLD timing-analysis tools include state machine-glitch detection. Automatically generated test patterns can be merged with the fusemap and downloaded for programming and testing.

Ordering Information

HP PLD Design System, complete software **HP 74150A** \$13,700 including editor, compiler, programming modules, FTI, and HP EDS design interface
Advanced PLD Utilities, includes automatic test generation capabilities, timing, estimator and glitch sweeper **HP 74153A** \$4,100

Options are also available for individual copies of the editor and other software modules. Discounts are available for additional copies. Contact your local Hewlett-Packard sales office for information on related products and for detailed configuration and ordering information (see page 739).

DESIGN AUTOMATION

EE DesignCenter

HP 85150B Microwave Design System

- Design with mainframe power on a desktop
- Interact with the schematic, analysis, and artwork simultaneously
- Minimize prototyping with advanced nonlinear simulator and verified models
- Generate artwork from schematic, automatically
- Document designs effortlessly

Integrated CAE Tools for Microwave and RF Designers

The HP 85150B Microwave Design System is a set of fully integrated CAE tools for microwave designers. It combines microwave circuit simulation and optimization with schematic entry, artwork generation, and documentation utilities into one cohesive system.

Entering the Schematic

With the Design Capture System, you enter circuits in an intuitive, visual manner. Using a mouse, you place the circuit elements onto a window and connect them with transmission lines or wires. The schematics are used for simulating circuits, generating artwork, and documenting the design. Schematics are more intuitive than other forms of data entry, and save considerable effort over the life of a design because they are used throughout the design process.

Simulating the Circuit

Circuits can be analyzed and optimized directly from the schematic. Hewlett-Packard's Microwave Linear and Nonlinear Simulators calculate a wide variety of performance parameters and analyze oscillators, mixers, or amplifiers, even under highly nonlinear conditions. Advanced numerical techniques and microwave models ensure fast, accurate results.

Generating artwork

The Microwave Artwork Generator helps designers create the mask and process the information necessary to build a design. It can be used as a standalone graphics editor, or it can be used to translate schematics into artwork automatically. Either way, the convenience of having artwork tools in the same environment as the simulation and documentation tools results in higher productivity and higher quality designs.

Documenting the Design

The Microwave Design System has a self-updating central documentation facility that tracks changes to schematics, response plots, artwork, and text. This allows the designer to document a design as it progresses through the development cycle. Documentation can be complete, timely, and professional and allows designs to be readily leveraged.

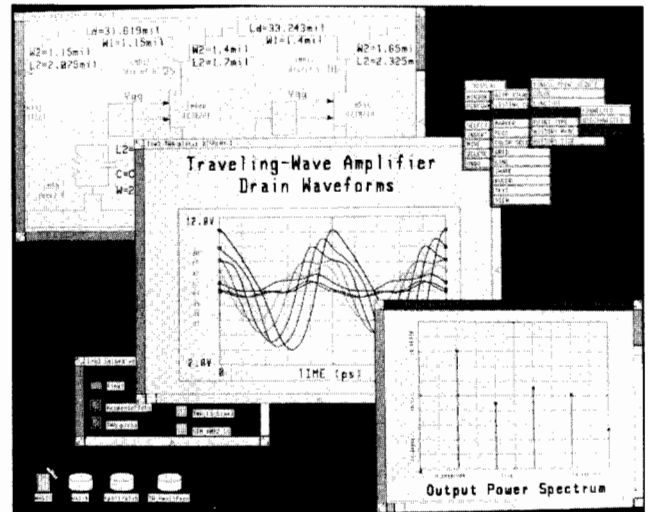

The HP 85150B Microwave Design System brings mainframe power to a desktop workstation by using advanced numerical algorithms for the analysis of components, circuits, and systems.

Ordering Information

Software	Price
HP 85150B Microwave Design System The HP 85150B includes the following: Design Capture System Microwave Linear Simulator Microwave Nonlinear Simulator Microwave Artwork Generator Two enrollments to the MDS User's Course	\$44,000
HP 85150BR Right-to-Reproduce the MDS software The right-to-reproduce allows current owners of the Microwave Design System to purchase additional copies at a reduced price. It does not include additional tapes or MDS User Course enrollments.	\$37,400
HP 85153A GDS-II Stream File Translator Artwork created with the Microwave Artwork Generator can be easily translated into the GDS-II stream file format for use on other drafting and manufacturing systems. The translator is bidirectional.	\$5,000

Configured systems

Configured systems are available that contain, under a single model number, the hardware and software needed to use the MDS system. They each contain an HP 9000 Series 300 color workstation, hard disk, HP-UX operating system, and HP 85150B Microwave Design System software. Additional peripherals, such as printers or plotters, can be added. The software is factory installed so that designers can be more productive from the day the system arrives. To obtain more information on these configured systems, contact your local sales representative.

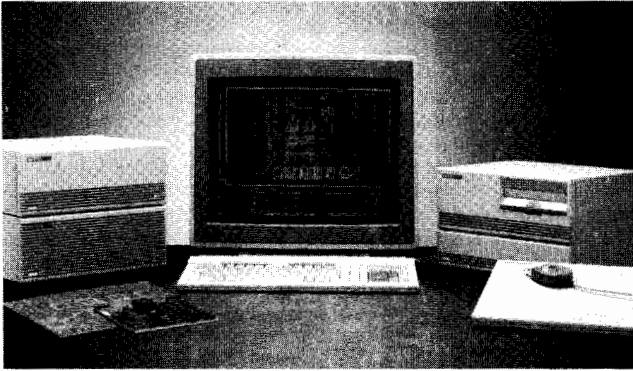

HP Printed Circuit Design System

HP Printed Circuit Design System

Hewlett-Packard's Printed Circuit Design System (HP PCDS) is a computer-aided design (CAD) solution that combines printed circuit board layout with electrical engineering design, manufacturing, and test. HP PCDS is a part of HP DesignCenter, an integrated design environment for electrical, mechanical, and software engineering teams.

With HP PCDS running on the modular HP 9000 Series 300 technical workstations and HP-UX operating system, individual workstations and total systems can be configured for specific applications in a powerful local area network. HP-UX is derived from the UNIX* System V interface definition.

HP PCDS puts all of the functionality of a mainframe-based system in a networked workstation environment. It is the physical design link between logic design and manufacturing that allows printed circuit board designers to create highly manufacturable boards that perform as the electrical engineer intended. HP PCDS provides a number of ways to enter circuit data and extract manufacturing data. The design file format is open and completely documented, so users can also customize ways to input or output data. Access routines are provided. Because the design file contains all of the data for a particular design, redundant data entry is eliminated and chances for errors are reduced.

HP PCDS has an extensive set of features for enhancing the productivity of designers of printed circuit boards that use surface mount technology (SMT). The autorouter allows the designer to control how a track enters the pad of a pin, providing tight control of a critical manufacturing parameter. The autorouter also includes algorithms for rip-up and re-try technology, enabling higher completion rates on the dense and double-sided printed circuit boards associated with SMT. The HP PCDS internal design representation scheme allows user-defined units, supporting both metric and mixed-English/Metric dimensions. User productivity for all types of design activities are further maximized by full support of HP's 2-D Integer-based Graphics Accelerator (HP 98556A).

Features and Capabilities

HP Printed Circuit Design System packing, placing, and routing features can automatically lay out digital, analog, and mixed digital/analog boards with through-hole and surface-mount technologies.

Designers use either a four-button puck and A- or B-size graphics tablet or a mouse to step through a dynamic, hierarchical menu. Projects can be quickly initiated by using or modifying the many spacing and placement rules, manufacturing parameters, and router strategies provided by HP PCDS. On-line design rule checking notifies board designers of violations as they occur, and immediate correction is optional to allow opportunities for subsequent layout adjustment. To ensure that all violations are corrected eventually, a batch design rule checker can assess a completed board, automatically noting all previously uncorrected violations.

Entering Circuit Data and Board Blank Information

Fully automatic transfer of netlist and part information is available for schematics created on the HP Electronic Design System (see page 638). This link also features automated back annotation and bidirectional engineering change.

Synchronization of logical and physical parts libraries eliminates the need for translation files. Automatic parts transfer eliminates redundant data entry. Designers also can bring in circuit data from the HP Engineering Graphics System (HP EGS) — see page 645. HP PCDS can also accept netlist data from products that support the Electronic Design Interchange Format (EDIF), such as OrCAD, P-CAD, and ViewLogic. With the EDIF link, engineers can develop schematics on HP Vectra personal computers and then transfer the netlist for layout and routing to the high performance workstation and HP PCDS. In addition to common EDIF features, HP Printed Circuit Design System EDIF format also supports packaging information and parts mapping between data bases.

Circuit data can also be entered interactively through the Schematic Netlist Editor. This function-key, menu-driven editor allows easy, error-free entry of part and connection information.

Design teams with special board blank requirements can begin to design their boards on ME 10, HP's 2-D mechanical design system, and then transfer the board blank to HP Printed Circuit Design System. ME 10 allows designers to specify precise dimensioning, custom shapes, and pre-defined locations for mechanically significant information such as connectors or transformers. Once transferred, these board blanks can be saved as separate designs and reused across a family of products with similar board specifications.

After initial design on HP PCDS, the placement of the printed circuit board can be tested against environmental constraints through links to HP products and to products from value-added businesses. Designers can transfer PCB board and part height information to the HP ME Series 30 system for 3D viewing and interference checking. They can also transfer the placement to the PCB Thermal package from Pacific Numerix to perform thermal analysis of the layout.

Flexible System and Data Management

Management of system and network resources through the HP Design System Manager provides easy access to application software, data files, and peripheral devices.

The HP Design Data Controller provides flexible data management and file security for users of HP Electronic and Printed Circuit Design Systems. Large design teams can control data revisions, and file access, and also lock data at project checkpoints to prevent unauthorized or unsynchronized updates.

Modular Software Design

HP Printed Circuit Design System is functionally divided into three modules: Design Module, Autorouter Module, and Library Module and Parts Library. This flexible structure allows easy tailoring to specific networked environments.

Design Module

Most of a designer's interaction with HP Printed Circuit Design System is through the Design Module, which includes powerful automatic tools to aid the designer during printed circuit board layout. Among these tools are the automatic packer, placer, and design rule checker, as well as routines for improving parts placement to ensure the highest possible router completion. To speed interactive tasks, designers can move across the board and zoom in on a particular area as quickly as they can move their pointing device. Rubberbanding and trace-snapping make it easy to manually route selected traces. Designers can also add dimensions in their choice of design units, including metric units.

For manual routing, designers can define grids on-the-fly so that analog, ECL, and critical board areas can be routed independently. At any time, designers can interrupt automatic routing, check on its progress, and restart the routing as needed. Manual routing also includes a stretch command, the ability to move a via, and automatic redundant copper removal.

The Design Module includes routines for creating highly manufacturable boards. For example, the Tidy routine improves the manufacturability of boards by tear-dropping traces into pads to ensure solid electrical connections, widening traces to increase electrical reliability, and eliminating unnecessary vias to reduce costs.

The HP Printed Circuit Design System includes special features for placing, part swapping, and routing of surface mount devices (SMDs). Physical descriptions of over 800 SMDs are available in the Parts Library. Placement on both sides of a board and swapping between sides decreases logic length and ensures higher autorouter completion. Breakouts to power and ground planes, and a user-definable routing grid also aid the routing task. Definable SMD spacing parameters increase reliability and manufacturing yields.

Autorouter Module

The multiple-pass Autorouter Module routes through-hole and/or surface-mount technology designs with 90- and 45-degree angles to create easier-to-manufacture boards. Users can specify automatic routing and via grids to allow zero, one, two, or more traces between IC legs or SMD pads. A look-ahead algorithm preplans the most effective routing strategy for both through-hole and surface-mount devices. The Autorouter Module can handle areas of surface mount technology on both sides of the board, including hidden or buried vias, and will route signals on buried layers.

Rip-up and re-try technology can improve completion, and adaptive gridding technology allows the autorouter to bend traces around obstacles such as off-grid pins. The designer controls when the Automatic Router employs rip-up and re-try technology to provide the highest completion rate. A user-operated knob allows designers to use rip-up and re-try routing. The HP PCDS Autorouter Module can also be used as a placement analysis tool because of its short and predictable routing times.

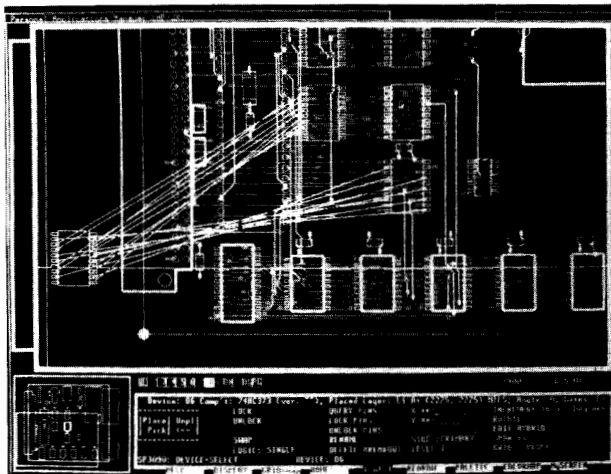

The Design Module provides special features for placing, part swapping, and routing of surface mount devices.

Library Module and Parts Library

More than 9,000 physical parts are included in the starter library. Designers can create, modify, validate, store, and access these parts quickly and easily. HP Printed Circuit Design System provides strict centralized control over component use to ensure data integrity and standardization of parts.

Manufacturing and Test Links

HP Printed Circuit Design System does not stop with physical layout. HP PCDS helps ensure that the design is accurately transferred to manufacturing by automatically generating a range of reports and files such as photoplotter command files, drill tapes for numerical control machines, and production reports.

HP PCDS provides generic pick and place machine support, allowing designers to format data for specific machines. In addition, an output file in Board Configuration Format (BCF) can be sent to the HP 3065 board test family to verify board connectivity and component values. The BCF file also lists X, Y locations of device pins and test pads for the board test operator.

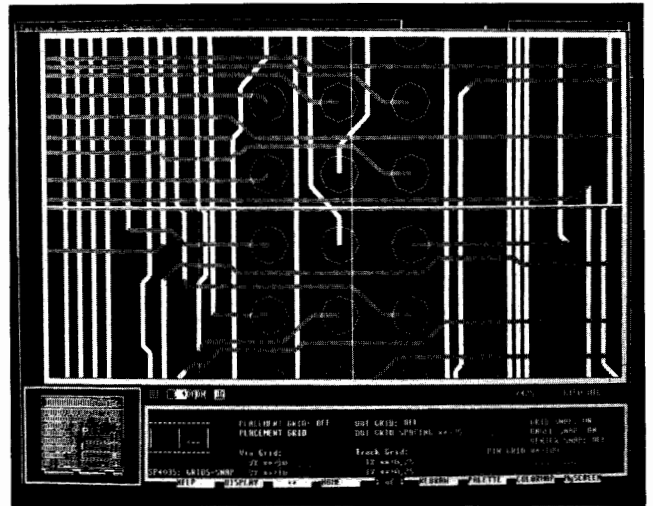

The Autorouter Module provides a user-definable routing grid to allow fineline technology.

For additional documentation or development of production drawings, designs can be transferred to HP ME 10 (see page 646), a 2-D mechanical design package for more complex assembly drawings. Once transferred to HP ME 10, HP PCDS drawings can move through an Initial Graphics Exchange Specification (IGES) link to any other CAD system which supports the IGES 3.0 standard.

Configuration

The flexibility of the modular HP 9000 Series 300 technical workstations and HP Printed Circuit Design System allow a design team to configure a particular system, then upgrade and extend individual workstations or add to the overall system in a local area network.

Workstations can be stand-alone or nodes on an industry standard (IEEE 802.3) local area network (LAN). These nodes can include the Design Module, the Autorouter Module, and/or the Library Module and Parts Library, in addition to other HP electronic design automation products.

Teams that combine board-layout with 3-D mechanical design can maximize their hardware resources by using both HP Printed Circuit Design System and HP ME 30 (see page 646) on a single high-performance solids modeling display system.

Ordering Information

HP Printed Circuit Design System
HP 74400A Complete software
 for HP 9000 Series 300

Price

\$37,770

In addition to the complete software, you can order the Design, Library, and Autorouter modules separately, and order right-to-copy options for each module. The Autorouter Module is available on both Series 300 and Series 800 computers. Support products are also available. Contact your local Hewlett-Packard sales office for current price and ordering information (see page 739 for sales offices).

*UNIX is a registered trademark of AT&T in the U.S.A. and other countries.

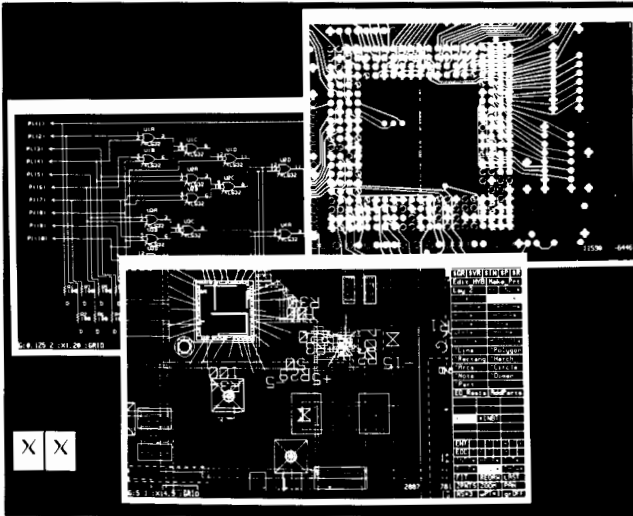

HP Engineering Graphics System

Hewlett-Packard offers a two-dimensional, highly customizable, artwork-based family of entry-level, computer-aided design (CAD) modules for complete product design in electronic, mechanical, and general engineering applications. The HP Engineering Graphics System (HP EGS) consists of several modules that let users create schematic drawings, perform interactive PCB layout, design thick-film hybrid circuits, and generate general artwork ranging from floor plan layouts to hi-tech manuals.

Developed for use on the HP 9000 Series 300 technical workstations, HP EGS is now available on HP-UX, X Windows, and Pascal platforms. The standard HP-UX operating system offers a true multitasking environment that allows interactivity with many design applications. Along with LAN and WAN (Wide Area Network) capabilities, HP EGS combines integrated engineering applications with sophisticated graphics to create highly interactive design applications. HP EGS can be used as a stand-alone system or in a networked diskless environment. The network improves productivity by letting HP EGS users easily share data such as drawings and library parts. The network also reduces system costs dramatically by letting multiple workstations share disk drives, printers, and plotters.

The modular product structure of HP EGS lets designers use workstations as multipurpose design systems that provide several applications for a project. Because all modules share a common data structure and user interface, they are automatically linked. Links are also available between HP EGS and HP Printed Circuit Design System (HP PCDS), HP Electronic Design System (HP EDS), and HP Mechanical Engineering Series 10 (HP ME 10). In addition, links to industry-standard EDIF (Electronic Design Interchange Format) and IGES (Initial Graphics Exchange Specification) let designers move HP EGS artwork to non-HP systems.

HP EGS provides several built-in productivity tools including on-line HELP, customizable screen and tablet menus, and user-definable macros. Users can also develop entire custom modules for their own applications.

Features and Capabilities

HP EGS provides five specialized work environments, or modules, consisting of schematic drawing, hybrid circuit design, printed circuit board layout, mechanical drafting, and a general engineering graphics module. Each module can be purchased and used independently for a specific task, and each has the same user interface. Data can be shared through a common data structure. All of the HP EGS modules are based on the graphics editor, a command-driven tool used to generate drawings on the screen and provide the basic environment, artwork components, and commands for HP EGS. The graphics editor also allows complex, frequently used shapes to be stored as custom library parts.

The Schematic Drawing Module is the vehicle for initiating electronic designs in HP EGS. This module includes a library of common electronic schematic symbols, and users can create additional parts or modify existing parts, as needed.

The Hybrid Circuit Design Module combines interactive and automatic tools for designing thick-film hybrid circuits. Designers can move quickly from manual and other methods of hybrid circuit layout to this menu-driven CAD environment. Automatic tools include resistor shape and size generation from paste curve and real estate data, connection list and compare, area calculation, and material list generation including ink use. Adding parts to a design is automated when using a connection list or material list derived from a schematic.

The Printed Circuit Board Layout Module facilitates creation of printed circuit board artwork for electronic designs. It includes designs for surface-mounted devices (SMDs) and grid or gridless layout. The Rat's Nest Generator and Route macros, connection lists, and manufacturing outputs aid PCB design.

The Mechanical Drawing Module assists engineers and draftspeople in preparing 2-D mechanical drawings. The isometric grid capability allows the user to easily create 2-D representations of 3-D objects.

The Engineering Graphics Module is the basic graphics editor of HP EGS and can be used for a multitude of applications: floor plans, overhead slides, project scheduling diagrams, complex artwork for technical manuals, and many other general artwork applications.

Additional Products

Photoplot/NC Drill: HP offers an optional photoplot/NC drill feature that converts PCB and hybrid designs to Gerber photoplotter format or provides PCB drilling information for Excellon drill machines.

IGES Translator: with the HP IGES Translator, conforming to Initial Graphics Exchange Specification (IGES 3.0), users move HP EGS drawings to other CAD systems or move drawings from other systems to HP EGS. HP EGS can be used as a low-cost front end to expensive CAD systems.

Ordering Information

	Price
Standard, modular HP EGS on HP-UX platform	\$4,000
Standard, modular HP EGS on Pascal workstation	\$6,000

For other design modules and utilities, current prices, and detailed ordering information, contact your local HP sales office (see page 739).

DESIGN AUTOMATION

ME DesignCenter
ME Series 10 and 30



HP's DesignCenter Series 10 and 30 offer advanced drafting, 2D design, and solids modeling systems for mechanical engineering applications. These CAD systems run on a distributed computing environment of HP workstations.

ME Series 10 & 30

HP DesignCenter Series 10 and 30 offer the full functionality required for drafting, documentation, 2D design and solid modeling. Both products use the same, easy-to-use user interface that drastically reduces the learning time to allow greater designer productivity. The systems operate on a complete range of hardware platforms and under the major industry standard operating systems.

Functionality Overview

Drafting and Documentation

The ME Series 10 provides comprehensive drafting functionality and extensive 2D design capabilities. It also provides a complete set of functions to accelerate the production of drawings and other engineering documentation, while ensuring a standard of accuracy.

Design

ME Series 10 offers users an advanced set of tools for 2D design. Powerful creation and modification commands, combined with interactive variational design for creation of families of parts, enhance the design process. An on-line design checking capability enables designers to quickly and easily develop accurate designs from a given set of constraints.

Major features of ME Series 10 include:

- Full dimensioning capabilities according to international standards (ANSI, ISO, DIN, etc.)
- Automated detail creation
- Full text input and editing capability
- Comprehensive set of drafting symbols
- Semi-automatic isometric drawing creation
- Parts and assembly creation
- Unlimited number of layers available for drawing organization
- Parametric design capability
- Advanced geometry modification for adapting designs
- Associated information and attributes for material specifications and pricing details

Modeling

The ME Series 30 Modeling, Design, and Drafting system integrates full solid modeling with 2D design. Design accuracy within the 3D models provides the ability to simulate real prototypes. This substantially reduces the need for design modifications as a result of errors in prototypes, thus allowing greater design department throughput.

ADDITIONAL major features of ME Series 30 include:

- "Workplane" technique allows 3D model creation from 2D geometry
- Machining functions for model creation, including mill and stamp to support use of 2D geometry for model creation
- Full assembly modeling capability
- Extensive design checking capability, including mass properties and interference

Data Management

Manage all design engineering information with HP's mechanical engineering data management solution. Based on relational database management technology, data management gives CAD users the tools needed to locate, retrieve, manage and control the design office information — with the same, easy to use, ME CAD user interface.

View-only Stations

View-only stations provide instant access to graphical and textual information on the shop floor and at the manager's desk. Timely and accurate information minimizes the risk of costly miscommunications.

User Interface

The key to success with computer tools is complete functionality and convenient access to that functionality. Computer tools must present functionality in a form understandable to the user.

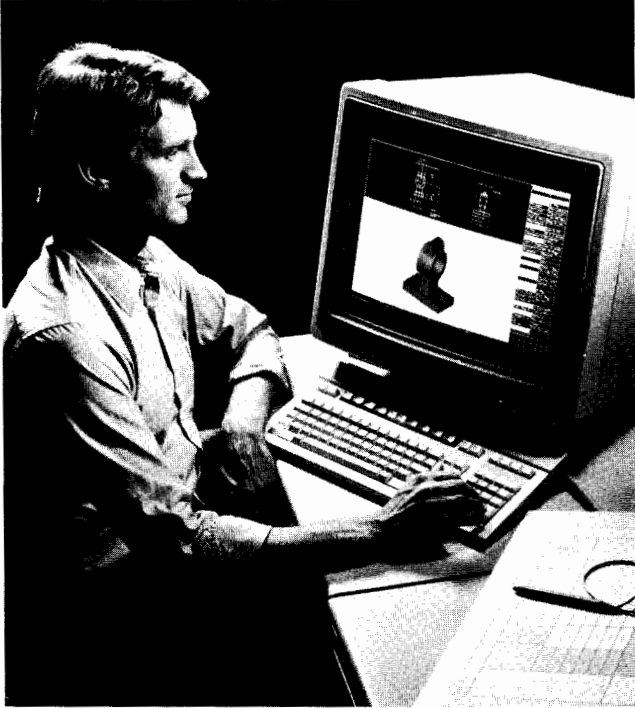

HP's DesignCenter ME Series 30 is an integrated 3D solid modeling, 2D design and drafting system for mechanical engineering applications. The system shown is operating on an HP 9000 Model 350SRX which provides dynamic rotation of hidden line and shaded models.

Nowhere is this more important than in the design environment where years of experience have led to the development of well proven design techniques.

Short learning cycles and friendly system handling are essential for engineering productivity. The HP ME Series products are menu-driven and provide the ease of use beginners require. In addition, they provide customizing capabilities for special applications.

The ME Series 10 and 30 user interface was specifically designed to ease user interaction by emulating traditional design techniques. As a result, the combined tablet and screen menu interface provides easy access to commands that use standard mechanical engineering terminology - commands such as fillet and mill are easy to understand and use. Interaction is further simplified by grouping the commands into functional blocks and the use of descriptive prompts. An on-line HELP facility is included to provide detailed descriptions of commands whenever necessary.

In both products, the user interface is optimized for mechanical design:

- System functions are directly accessible from the graphics tablet, complemented by screen menu subfunctions
- Multi-viewport capability eases handling of large and complex models, designs, and drawings
- On-line HELP facility provides detailed explanation of the use of commands
- Feedback mechanisms such as rubber banding and dynamic component tracking aid creation and modification operations

Integrating and Interfacing Your CAD System

The CAD system is an important place of your total Computer Integrated Manufacturing concept. It is the foundation for the product development that allows a range of capabilities to grow around it. With the HP ME Series CAD systems, that foundation can be easily built upon, allowing you to add expanded capability as your requirement grows.

ME Series integration capabilities include:

- Parts list information for stock control systems
- Drawing data included in documentation systems
- 2D geometry link to NC programming systems

- IGES 2D bidirectional translator
- DXF bidirectional translator
- ME Series 30 ADDITIONAL integration capabilities include:
 - 3D geometry link to finite element analysis systems
 - IGES 3D output

HP's Proven Platform: Hardware and Support

The HP ME Series CAD systems support a complete set of price/performance leading computers. These networkable systems range from the MS-DOS*-based HP Vectra RS to the UNIX**-based HP 9000 Series 300 and 800 workstations and superworkstations. Complemented with a large selection of peripherals and graphics displays, HP offers a complete CAD solution.

Networking capabilities such as LAN enables users to set up a distributed system featuring both products to address the full range of mechanical engineering CAD requirements. Networking capabilities also allow further integration of CAD stations into manufacturing environments.

Training

A complete set of training courses is available for the ME Series 10 and 30 to help your engineers become increasingly productive. Structured to match the increasing capability of the ME Series CAD family, the courses allow you to choose the correct level of training for each engineer. Additional training in your environment is supported by engineering consulting and a comprehensive set of documentation.

HP offers a range of services to ensure that the initial period after system delivery is trouble free. HP engineers are available to install all components of your CAD system. They also will tailor the system to your specific needs.

Your local HP sales office has full details of the training and support programs available in your area. Contact them for details.

Ordering Information

For up-to-date ordering and pricing information you should contact your local HP sales office (see page 739).

* MS-DOS is a trademark of Microsoft Corporation

**UNIX is a trademark of AT&T Bell Laboratories

HP's DesignCenter ME Series 10 is an advanced 2D design and drafting system for mechanical engineering applications. ME Series 10 runs on HP 9000 Series 300 32-bit engineering workstations under the HP-UX operating system and, as shown here, HP Vectra RS 32-bit PC workstations under the MS-DOS operating system.

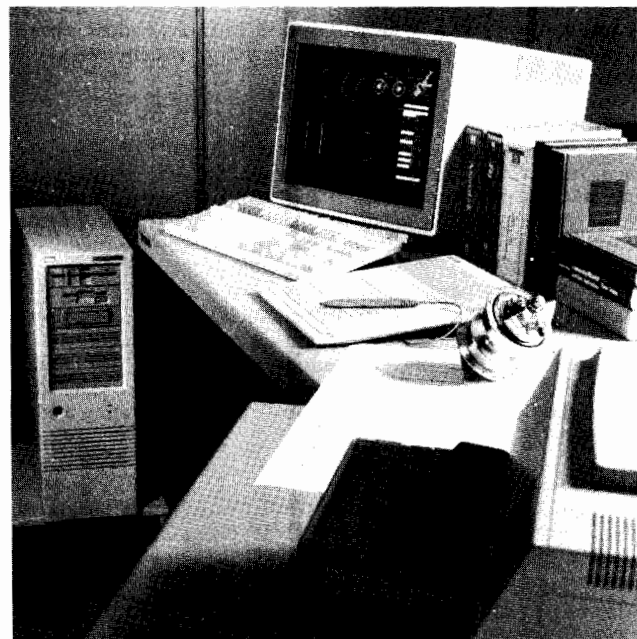

DESIGN AUTOMATION

ME DesignCenter
ME VAB Products

UNIGRAPHICS

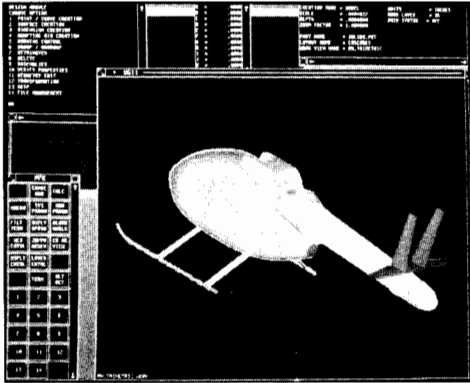

UNIGRAPHICS®

UNIGRAPHICS, a product of McDonnell Douglas, is a 3-dimensional, interactive, fully integrated set of solutions for the engineering, design, and manufacturing of mechanical parts and/or assemblies. Backed by a company with over 20 years of experience in the development of interactive graphics systems for CAE/CAD/CAM, UNIGRAPHICS is based on a single engineering and manufacturing database, providing for a seamless flow from concept to finished product.

UNIGRAPHICS includes a fully integrated product line from 2-D design and drafting, to 3-D wireframe/surfaces/solids, to manufacturing/factory production. It provides state-of-the-art, complex, 3-D N.C. machining capability and an integrated, solid modeler that supports free-form surfaces. It includes integrated quality control and shop floor management software from Valisys Corporation. World-wide sales and support is available.

ABAQUS

ABAQUS is a general-purpose, finite element program for advanced linear and nonlinear engineering analysis. The program has general geometric modeling capabilities, a library of materials, and a range of procedures. It is designed for complex problems and has a simple input language and a range of postprocessing options.

ADAMS

ADAMS (Automatic Dynamic Analysis of Mechanical Systems), a product from Mechanical Dynamics, Inc., is a linear and nonlinear program for analysis of systems that move. ADAMS computes kinematic, static, dynamic, and modal behavior of mechanical systems by computing displacements, forces, velocities and accelerations. The results can be plotted or graphically animated to visually review the analysis.

ANVIL-5000*

ANVIL-5000, a product from Manufacturing and Consulting Services, Inc., is a complete system for design, drafting, finite element pre- and post-processing, and manufacturing. Modules include 3D design/drafting, surface modeling, solids, finite elements, graphics programming language and numerical control manufacturing.

BEASY

BEASY, a product of Computational Mechanics, Inc., is a general-purpose computer aided engineering package for the solution of a wide range of problems in heat transfer, stress analysis, and electrostatics. Fully interactive, color pre- and postprocessors are supplied as part of the BEASY system, to assist the tasks of generating models and interpreting results.

CIM CAD/CAM/SURF

CIM CAD/CAM/SURF from CIMLINC provides integrated, interactive, graphical solutions for 2D/3D design and manufacturing. The graphical NC Programming solutions provide 2½-5 axis contouring to multi-surface avoidance.

UNIGRAPHICS is a registered trademark of McDonnell Douglas
*ANVIL-5000 is a trademark of Manufacturing and Consulting Services, Inc.

COSMOS/M

COSMOS/M, a product of Structural Research Analysis Corp., is a general-purpose finite element analysis program that consists of a set of interrelated modules for fast and optimal operation. COSMOS/M performs linear static, linear dynamic buckling, and heat transfer analysis on one-, two- and three-dimensional structural and thermal models.

DADS

DADS, a product of CADSI, is a mechanical computer aided engineering (MCAE) software package that performs static, dynamic, inverse dynamic, and kinematic analyses. It provides a cost-effective computer simulation tool for predicting the real world behavior of complex mechanical systems without the need to construct physical prototypes.

FIDAP

FIDAP, a product from Fluid Dynamics International, is a general-purpose program that uses the finite-element method to simulate many classes of incompressible fluid flows. FIDAP supports isothermal and non-isothermal Newtonian and non-Newtonian flows, turbulent flows, free, forced or mixed atmospheric flows, swirling and creeping flows, flows in rotating frames of reference, flows with a free or moving surface, and surface tension gradient driven thermal flows.

FLUENT®

FLUENT, a product of Creare Inc., is a fluid flow simulation program that models behaviors of fluid flow and heat transfer. Applications include combustion, aerodynamics, particulates, computer chip manufacturing, electronic equipment cooling, heat exchangers, and chemical and process operations.

ICAM

ICAM Technologies Corp. supports a variety of CAM applications to model, generate up to 5 axis tool paths, and create custom post-processors. ICAM can simulate and graphically verify an NC path for visual inspection and completeness.

PATRAN



PATRAN®

The PATRAN system, a product of PDA Engineering, is an open 3D Mechanical Computer Aided Engineering (MCAE) system for modeling, analysis and results evaluation. It uses a common geometric database and user interface for all design, imaging, finite element modeling and analysis requirements. Industry application areas include aerospace, automotive, defense and electronics. The PATRAN system offers complete analysis capabilities in thermal, structures, fluids, kinematics, and large displacement dynamics. It provides gateway interfaces to all major design and analysis codes, accurate analytical functionality, and efficient post-processing for rapid design interpretation. Superior worldwide training and support ensures customer satisfaction.

FLUENT is a registered trademark of Creare Inc.
PATRAN is a registered trademark of PDA Engineering

I-DEAS

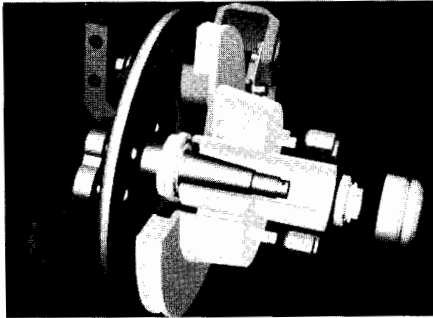

I-DEAS™

The I-DEAS™ (Integrated Design Engineering Analysis Software) system from SDRC is solids-based and simulation-driven to address the product development activities of an entire engineering organization. I-DEAS contains software modules for solid modeling, design, finite element modeling and analysis, drafting, testing and manufacturing. Each module is a market leader, providing the high functionality needed to be on the critical path of your product development process.

I-DEAS for Design is the module for solid modeling, system assembly, mechanism design, & drafting/documentation

I-DEAS for Analysis is the module for finite element pre- and post-processing, model solution, laminate composite material & thermal modeling, plastic mold analysis, and system noise and vibration analysis.

I-DEAS for Test is the module for general test data management and analysis, specialized signal processing, rotating machinery, model, fatigue and system dynamic analysis.

MARC

MARC™ is a general-purpose finite element program that performs both linear and nonlinear analysis. The program handles large strain and displacement problems such as creep and buckling, and incompressible material behavior. MENTAT™ Interactive Graphics pre- and postprocessor for MARC provides an integrated set of tools for model development and verification, and for results presentation.

MOLDFLOW

Moldflow, a product from Moldflow Australia Pty. Ltd, analyzes the flow of thermoplastics into an injection mold at the instant of filling by calculating the heat transfer and fluid flow equations inherent in the injection of hot plastics into a cold mold. MOLDFLOW programs are a tool that enables injection mold and part designers to design molds and parts by predicting the flow pattern of the plastics into the mold.

MSC/NASTRAN

MSC/NASTRAN, a product of MacNeal-Schwendler Corp., is a large-scale general purpose finite element program that solves a wide variety of engineering analysis problems. Nastran solves static and dynamic structural analysis, material and geometric nonlinearity, heat transfer, aeroelasticity, acoustics, electromagnetism and other types of field problems.

NISA II

NISA II, a product of Engineering Mechanics Research, provides extensive linear and nonlinear analysis of static, dynamic and heat transfer problems. The NISA family also includes NISA-Composites, NISA/3D fluid, and NISAOPT, a structural and shape optimization program.

PROBE

PROBE, a product from Noetic Technologies, is a p-version finite element analysis system for elastic, thermoelastic, fracture, modal, and heat transfer analyses. PROBE allows repeated design/analysis iterations, increasing the efficiency of the engineering process.

MARC and MENTAT are trademarks of MARC Software International, Inc. MOLDFLOW is a registered trademark of Moldflow Australia Pty. Ltd.

™ SDRC and I-DEAS are trademarks of Structural Dynamics Research Corporation.

PROMPT CAD/CAM

PROMPT CAD/CAM, a product of Weber Systems, Inc., is an interactive color graphics, CAD/CAM system offering CIM solutions for manufacturing drawings, N/C part programming, and 3-D sculptured parametric, feature-based solid modeling system that supports surfaces. CAD interfaces via IGES and other standards add improving data integrity.

Pro/ENGINEER

Pro/ENGINEER, a product from Parametric Technology Corporation, is parametric, feature-based solid modeling system that supports interactive design modifications to models of mechanical assemblies and parts, including tooling and fixtures. Other features include ANSI standard drafting, assembly management, advanced modeling tools, CAD/CAM translators, and automatic finite element meshing.

SABRE-5000

SABRE-5000, a product of Gerber Systems Technology, Inc., is a turnkey, high performance CAD/CAM system for improving manufacturing productivity in a wide range of aerospace, automotive, heavy machinery, tool and die, and modeling applications. The system includes interfaces to finite element modeling/analysis packages and translators for exchanging design and manufacturing information between different data bases including IGES, Ford, GM, Chrysler and VDA/Bezier data converters.

SMP-81

SMP-81, a product of Merry Mechanization, is a sheet metal specific CAD/CAM package for assisting fabricators in developing the flat layout and NC punching information needed to manufacture parts by turret punching and brake forming operations.

UAI/NASTRAN

UAI/NASTRAN, a product from Universal Analytics, is a large-scale, general-purpose finite element analysis program for static and dynamic structural analysis, buckling, and steady state and transient heat transfer analysis including modeling of conduction, convection, and radiation.

VersaCAD DESIGN

VersaCAD DESIGN, a product of Versacad Corporation, is a fully programmable, interactive computer aided design and drafting software package. Features include interactive 2D drafting or 3D modeling, light source color shading, bill of materials reports, and two-way CAD translators.

ANSYS®

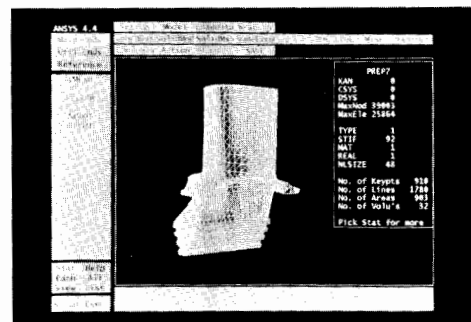

ANSYS®

ANSYS, a product of Swanson Analysis Systems, Inc., is a general-purpose finite element analysis program for solving structural, thermal, fluid, electrical, and electromagnetic applications. ANSYS integrates preprocessing, solution, and postprocessing in one package. The program includes solids modeling, design optimization, coupled analyses, fluid flow, and multifield elements, and provides an easy-to-learn user interface. It is used worldwide for a variety of applications, including automotive, aerospace, electronics, manufacturing, medical, and transportation. ANSYS is available on PCs, workstations, and compute servers, and it can be ported between platforms.

ANSYS is a registered trademark of Swanson Analysis Systems, Inc.

TECHNICAL COMPUTER SYSTEMS

HP 9000 Technical Computers

HP 9000 Workstations

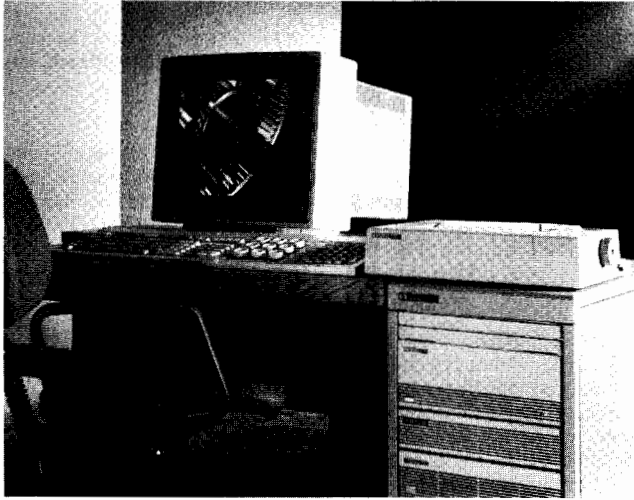

HP 9000 Model 370 TurboSRX

The HP 9000 workstations combine high-performance computational capabilities with advanced graphics subsystems to meet the demanding needs of applications ranging from computer-aided engineering and software development to financial analysis.

The HP 9000 family is based on two different processor families — the Motorola MC680X0 for the Series 300 and HP Precision Architecture for the Series 800 — providing a range of processing power and system expandability to meet your design and budget requirements.

Object-code compatibility within the Series 300 and Series 800 families and source code compatibility between families facilitate choosing the levels of system processing power and graphics appropriate for your application environment.

Both series are based on the HP-UX operating system, an excellent environment for advanced graphics applications requiring a powerful and flexible operating system. The HP-UX operating environment offers much of the technology included in the Open Software Foundation (OSF) Level 0 specifications. It also incorporates UNIX® System V Interface Definition (SVID) and X/Open™ specifications, standards on which the OSF operating system and application environment will also be based.

The HP 9000 Series 300

The HP 9000 Series 300 is a flexible, scalable computer system that offers a wide range of price/performance alternatives. Two levels of product structure are available. Pre-configured systems easily automate a wide range of design and measurement automation tasks. For users with more customized requirements, a full range of individual component products are available to build a system matched exactly to their specific needs.

The HP 9000 Models 340, 360, and 370 workstations are based on the Motorola MC68030 32-bit microprocessor and its companion MC68882 floating point processor. These Series 300 models offer mid-level performance ranging from 4 to 8 MIPS. The Series 300 also provides for system expansion, I/O, high-resolution displays and optional graphics accelerators for faster computation and high performance 2D and 3D graphics.

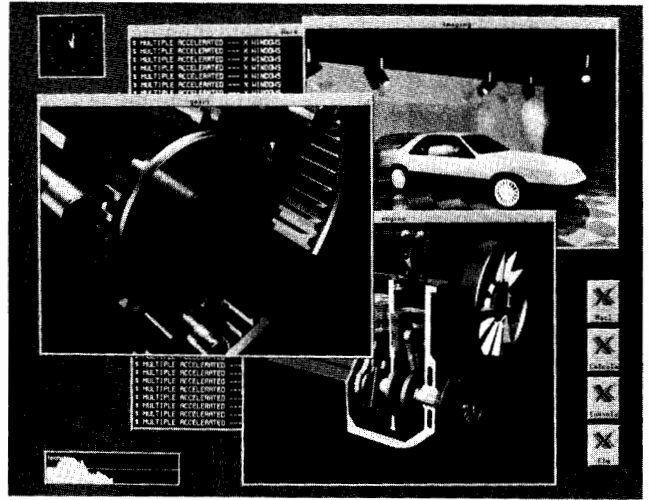

3D design application window screen*

The HP 9000 Series 800

The Series 800 Models 825, 834 and 835 workstations use HP Precision Architecture (RISC-based). In the Series 800, Hewlett-Packard has applied very large scale integrated (VLSI) technology to deliver fast, reliable computing and high-performance graphics. As with the Series 300, the Series 800 provides the system processing power needed to match the graphics of the SRX and TurboSRX 3D graphics subsystems.

Broad Choice of Performance

Model 340

The Model 340 workstation offers advanced 4 MIPS performance and configurability at an entry-level price. It is based on Motorola's MC 68030 processor and MC 68882 floating point coprocessor both running at 16.7 MHz. The Model 340 is well suited for engineering and design groups that run mechanical design and drafting applications or software development applications. The Model 340 provides a large 19-inch display for CAD and other applications that require high display resolution.

Model 360

The Model 360 is a mid-performance system designed to meet the requirements of many electrical engineering and mechanical computer-aided engineering applications. The performance of the Model 360 is provided by the 25 MHz MC68030 with integrated memory management and the built-in, 33 MHz MC68882 floating point coprocessor. It has 4 Mbytes RAM (expandable to 16 Mbytes).

Model 370

The Model 370 is a high-performance system well suited for software engineering and AI application development, analog circuit design and logic design, and simulation. It uses the 33 MHz MC68030 processor and 33 MHz 68882 floating-point coprocessor. It has 8 Mbytes RAM (expandable to 48 Mbyte with ECC RAM) and a 64 Kbyte cache. A high-resolution 19-inch monochrome monitor is standard.

UNIX is a registered trademark of AT&T in the U.S.A and in other countries.

X/Open™ is a trademark of X/Open Company Limited in the U.K. and other countries.

*Data for automobile courtesy of Chrysler Corporation.

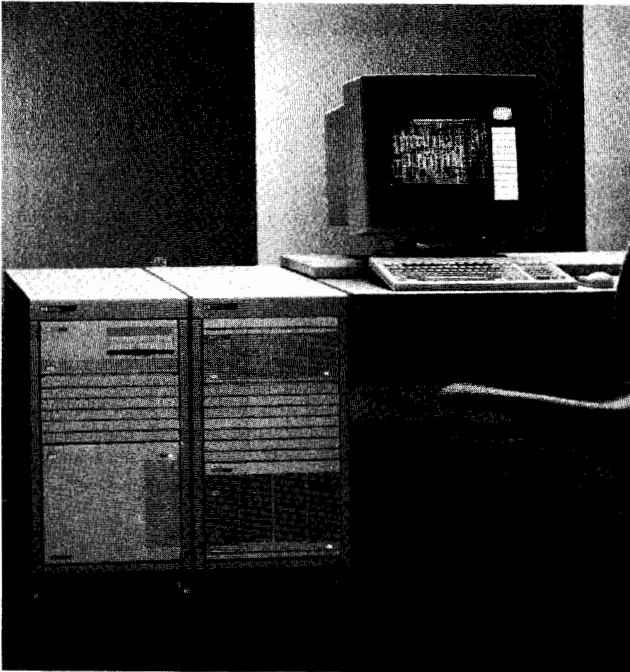

HP 9000 Model 835CHX

Model 825

The Model 825 uses the 32-bit HP Precision Architecture RISC-based 825 CPU with floating point coprocessor. It offers 8 Mbytes RAM (expandable to 96 Mbytes) and a 16K byte cache. It includes a high-resolution, 19-inch color monitor. The Model 825 is upgradable to the Model 835.

Model 834

The Model 834CH is a high-performance, low-priced 2D graphics workstation based upon HP's Precision Architecture. The Model 834CH offers 14 MIPS performance combined with superior 2D color graphics. It offers 8 Mbytes RAM (expandable to 48 Mbytes) and a 128 kbyte cache.

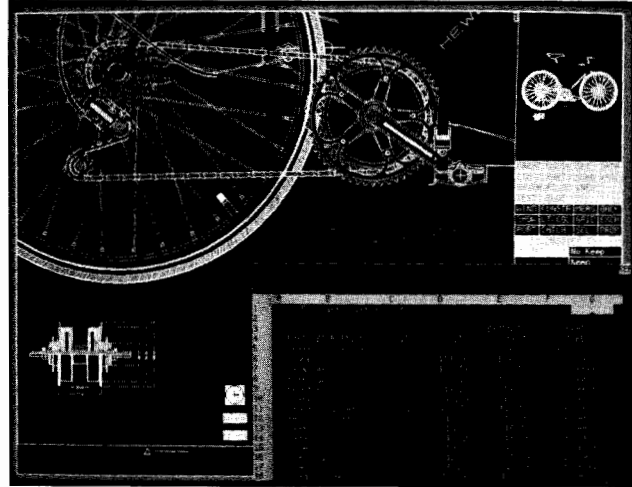

HP 9000 Model 340C+
ME 2D design application screen

Model 835

The Model 835 provides 50% more System Processing Unit (SPU) power than the Model 825 for integer calculations and more than three times the floating point performance. Each model also features an integer-based graphics accelerator.

The Model 835 uses the 32-bit HP Precision Architecture RISC-based CPU, which is clocked at 15 MHz and includes a floating-point coprocessor. The Model 835 has 8 Mbytes RAM (expandable to 96Mb) and a 128 Kbyte cache. It includes a high-resolution 19-inch color monitor.

- HP-UX (with FORTRAN, C, Pascal, Ada, Common LISP, HP-PROLOG & assembly language)
- MS-DOS (Series 300/800 require optional DOS coprocessor/SoftPC)
- BASIC & Pascal

HP 9000 Series 800 Workstations

825CHX 825SRX 834CH 835CHX 835SRX 835 TurboSRX

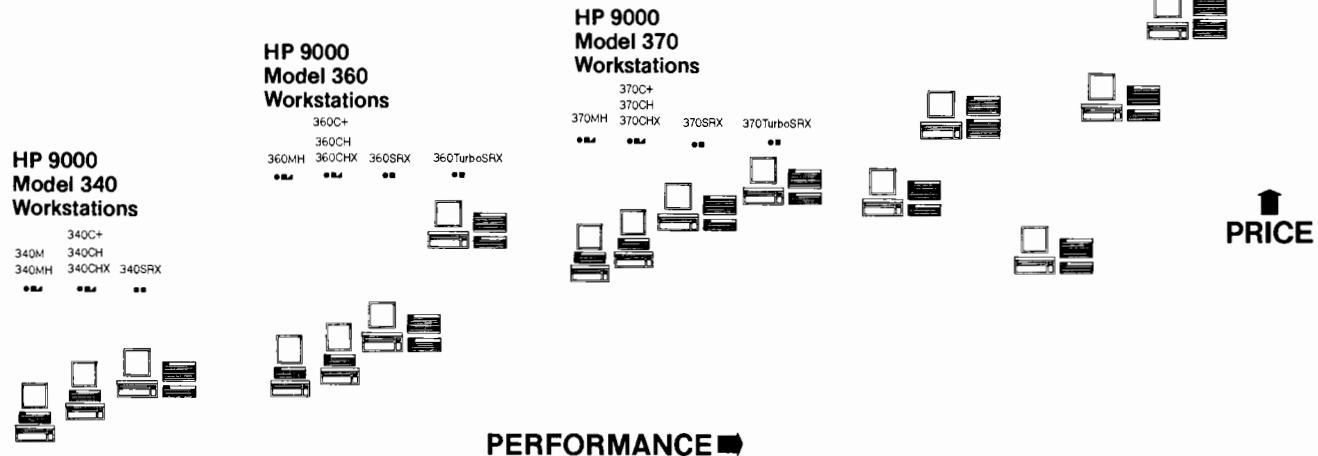

PERFORMANCE →

↑ PRICE

TECHNICAL COMPUTER SYSTEMS

HP 9000 Technical Computers

HP 9000 Workstations

HP offers a variety of graphics subsystems for the Model 9000 workstations that allow users to customize the workstation to provide the desired graphics performance.

The modularity of the HP workstations allows the system to be configured with different subsystems providing medium- and high-resolution graphics on either monochrome or color displays. Each increase in graphics power moves more elements of graphics processing from the system CPU to specialized graphics processors for increased speed and interactivity.

HP 9000 2D Graphics Subsystems

Entry-level Monochrome (M)

The M graphics subsystem (HP 98544B) is an entry-level monochrome system that handles applications such as software engineering and electrical engineering logical design. It features a 17-inch medium-resolution monitor, and is available on the HP Model 340 workstation.

High-performance Monochrome (MH)

The MH graphics subsystem (HP 98548A) is a high-resolution 1280 x 1024 monochrome graphics board ideally suited for applications such as computer-aided software engineering and computer-aided publishing. The 98548A contains a hardware scan converter for high-speed generation of vectors, polygons, and circles. A 19-inch high-resolution monitor is included, and it can support either byte-per-pixel or bit-per-pixel addressing for fast movement of screen images. It is available on HP Models 340, 360 and 370 workstations.

Mid-range Color (C+)

The C+ graphics subsystem (HP 98549A) is a mid-range 1024 x 768 color graphics board with 2D graphics hardware support. The 98549A contains a hardware scan converter for high-speed generation of vectors, polygons, and circles. It provides six color planes for sixty-four colors; these planes can be used alternatively as four color planes and two overlay planes. It includes a 16-inch or 19-inch medium-resolution color monitor. It is available on HP Models 340, 360 and 370 workstations.

High-performance Color (CH)

The CH graphics subsystem (HP 98550A) is a high-resolution (1280 x 1024) color graphics system that also supports an optional graphics accelerator. It excels in 2D design applications such as electrical engineering logical and physical design, as well as in mapping and mechanical engineering drafting. Eight color planes provide 256 colors from a palette of over 16 million hues. The planes can be used as four planes double-buffered for interactive pan-zoom of 16-color images. A 16-inch or 19-inch, high-resolution color monitor is included, and the subsystem is available on HP Models 340, 360, 370, and 834 workstations.

Accelerated Color (CHX)

The CHX graphics subsystem includes a display controller (HP A1020H) and an integer-based graphics accelerator (HP 98556A). The display controller provides two overlay planes as well as the resolution and number of displayable colors necessary for high-end 2D graphics applications. The integer-based graphics accelerator sharply improves performance for 2D vector-intensive graphics applications that use integer data. The CHX is available on the Models 340, 360, 370, 825 and 835.

HP 9000 3D Graphics Subsystems

Entry-level 3D (SRX)

The HP 9000 3D graphics subsystems are designed to render realistic images with a high degree of user interactivity using industry-standard software implementations. The SRX graphics subsystem includes a display controller (HP 98720A) and a graphics accelerator (HP 98721A). The SRX is available on the Models 340, 360, 370, 825 and 835 workstations.

High-performance 3D (TurboSRX)

The TurboSRX graphics subsystem includes a display controller (HP 98730A) and three optional graphics accelerators with a full 16-bit Z-buffer (HP 98732A). The TurboSRX provides advanced rendering techniques such as ray tracing and radiosity that allow you to create realistic images. Ray tracing provides accurate displays of reflective surfaces. Radiosity provides highly realistic lighting, shading, and shadows. The TurboSRX is available on the Models 360, 370, 825 and 835 workstations.

Ordering Information

The following languages and operating systems are available for all models except as noted.

- MS-DOS (Series 300/800 require optional DOS coprocessor/SoftPC)
- HP-UX (with FORTRAN, C, Pascal, Ada, Common LISP, HP-PROLOG, and assembly language)
- BASIC and Pascal

Price

HP 98563E HP 9000 Model 340M	\$5,495
HP 98563G HP 9000 Model 340MH	\$7,995
HP 98564C HP 9000 Model 340C+	\$8,495
HP 98564G HP 9000 Model 340CH	\$10,995
HP 98564G HP 9000 Model 340CHX	\$10,995
Opt 556 Add graphics accelerator	+\$5,000
HP 98573C HP 9000 Model 340SRX ¹	\$14,900
HP 98589W HP 9000 Model 360MH	\$14,400
HP 98583W HP 9000 Model 360C+	\$14,900
HP 98588W HP 9000 Model 360CH	\$16,900
HP 98588W HP 9000 Model 360CHX	\$16,900
Opt 556 Add graphics accelerator	\$5,220
HP 98587W HP 9000 Model 360SRX ¹	\$19,900
HP 98587T HP 9000 Model 360 TurboSRX ¹	\$35,995
HP 98589G HP 9000 Model 370MH	\$24,500
HP 98583G HP 9000 Model 370C+	\$28,000
HP 98588G HP 9000 Model 370CH	\$31,900
HP 98588G HP 9000 Model 370CHX	\$31,900
Opt 556 Add graphics accelerator	+\$5,220
HP 98587G HP 9000 Model 370SRX ¹	\$41,900
HP 98587H HP 9000 Model 370 TurboSRX ¹	\$44,250
HP A1008A HP 9000 Model 825CHX ¹	\$42,500
HP A1005A HP 9000 Model 825SRX ¹	\$56,500
HP A1056A HP 9000 Model 834CH	\$22,500
HP A1050A HP 9000 Model 835CHX ¹	\$59,500
HP A1045A HP 9000 Model 835SRX ¹	\$69,500
HP A1055A HP 9000 Model 835 TurboSRX ¹	\$63,500
HP A1055A HP 9000 Model 835 TurboSRX Animation ¹	\$63,500
Opt 747 Replace standard graphics interface with graphics animation interface	+\$4,100

For more information on configuring the best systems for your application needs, please contact your local HP sales office.

¹BASIC and Pascal not available for these models



Vectra RS25C Personal Computer

HP Vectra PC Workstations

The HP Vectra RS PC workstations are based on the Intel 80386 processor running at 25 MHz with memory cache. Each workstation includes a hard disk controller; one 5.25-inch, 1.2-megabyte flexible disk drive; a flexible disk controller; serial, parallel, and HP-HIL ports; HP Expanded Memory Manager/386; HP disk cache software; HP Volume Expansion Utility; the Enhanced Vectra PC keyboard; and system documentation. System memory and hard disk storage are included as indicated (See Ordering Information).

HP Vectra RS System Software

Microsoft Window/386 Presentation Manager. 5.25-inch flexible discs. Requires HP Vectra DOS 3.2 or higher. For HP Vectra RS PCs only.

Monitors and Video Adapters

VGA:

14-inch HP Video Graphics Display (HP Video Graphics Adapter required)

Monochrome:

14-inch monochrome monitor (HP Video Graphics Adapter required)

High Resolution Color:

1024 x 768 graphics interface card featuring sixteen colors from a palette of 4096 colors and an optional EGA graphics compatibility card (emulation module).

Ordering Information

HP Vectra RS/25C

Model 10E PC — 1 megabyte RAM, no hard disk	HP 2021A	\$7,349
Model 100E PC — 1 megabyte RAM, 103 megabyte hard disk	HP 2022A	\$9,549
Model 150E PC — Same as Model 100 with VGA Adapter	HP 2023A	\$10,149
Model 154E PC — 4 megabyte RAM, 155 megabyte hard disk	HP 2024A	\$12,549
Model 304E PC — 4 megabyte RAM, 310 megabyte hard disk	HP 2025A	\$14,399

Monitors and Video Adapters

VGA:

HP Video Graphics Adapter	HP D1180A	\$495
Additional 256 Kbytes RAM for VGA	Opt. 1A7	\$225
14-inch HP Video graphics display	HP D1182A	\$749

Monochrome:

14-inch VGA monochrome display	HP D1181A	\$349
--------------------------------	------------------	-------

High Resolution Color:

Intelligent Graphics Controller	HP 82328A	\$1,400
16-inch color monitor (1024 x 768)	HP D1188A	\$2,795
20-inch color monitor (1024 x 768)	HP D1189A	\$3,695
EGA Emulation Module	HP 82329A	\$395

A Strategy for Integrated Networked Solutions

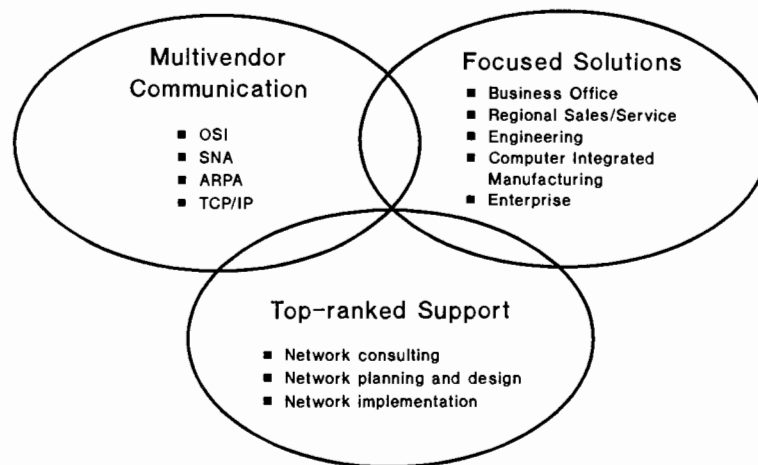

HP AdvanceNet

HP AdvanceNet: Flexible Network Solutions

HP AdvanceNet networking strategy can make sure that people get all of the information they need, when they need it. It addresses these fundamental user needs:

Multivendor networking based on the key architectures: OSI (Open Systems Interconnection), IBM SNA (Systems Network Architecture), Department of Defense ARPA protocol, and TCP/IP (Transmission Control Protocol/Internet Protocol).

Focused solutions that provide distributed information processing within office, engineering, and manufacturing environments and across the entire enterprise.

Quality customer services and support, including specialized network consulting, to help plan, design, implement, and maintain the network.

Networks That Keep You Successful

To make a company more profitable, people need fast access to vast amounts of information that can be distributed throughout the company. Whether the network links users across a room or around the world, HP AdvanceNet delivers the following features and benefits:

Flexible networking that controls costs. HP AdvanceNet can connect all the parts of the organization, no matter how dispersed or diverse the operation is. Hewlett-Packard's full range of price/performance options provides cost-effective solutions.

Investment protection and a smooth growth path. HP AdvanceNet's strong multivendor communications allow the most efficient use of a customer's current information systems.

Industry experience and focus. Hewlett-Packard offers the extensive knowledge of many industries gained through experience with hundreds of diverse customers.

Standards-based networking. Standards facilitate the implementation of network applications, maximize the return on information systems investments, and allow growth for evolving needs.

Comprehensive communications with IBM. Hewlett-Packard provides batch and interactive communications as well as electronic mail exchange between HP and IBM systems, in both stand-alone and gateway configurations.

Focused Solutions From HP AdvanceNet

HP AdvanceNet includes five focused solutions to meet networking needs in key business areas of service and manufacturing companies. The solutions provide both internal communications and links to external sites.

The business office solution cuts costs and improves decision-making through the integration of PCs, terminals, and minicomputers into flexible multivendor networks. It provides a set of scalable, multivendor solutions for individuals, work groups, and departments.

The engineering solution enables companies to improve product quality while shortening time-to-market. Because the solution is based on industry and de facto standards, it integrates easily with current networks and provides a foundation for future growth.

The computer integrated manufacturing solution increases productivity and reduces costs by integrating planning and control, financial systems, production processes, manufacturing engineering, and product design. It incorporates de facto and OSI standards, emphasizing MAP (Manufacturing Automation Protocol) and TCP/IP.

The regional sales/service solution provides alternatives for network communications between sales and service people on the road and branch or regional offices. Salespeople are able to spend more time with customers and prospects, and less time on office paperwork.

The enterprise network solution provides fast and effective communications among all parts of an organization. It supports communications between operations for applications such as Electronic Data Interchange (EDI). The HP Private Packet Network (PPN), based on the X.25 international standard for wide area networking, is the heart of this solution. HP PPN delivers strong multivendor connectivity, flexibility to tailor and change a network, high reliability, and extensive network management and control.

Multivendor Network Management

HP Openview is a family of network management products and services to provide total network management capability. HP Openview will support a wide range of communications protocols. It will provide links to IBM NetView network manager, and it will include a user interface.

Top-ranked Customer Support

Customer support is an important component of HP AdvanceNet. Specialized network consulting is available to help design and implement your network. The NetAssure support program provides multivendor problem management to maximize network uptime and increase the effectiveness of network operations.

TECHNICAL COMPUTER SYSTEMS

HP 9000 Technical Computers

The X Window System

655

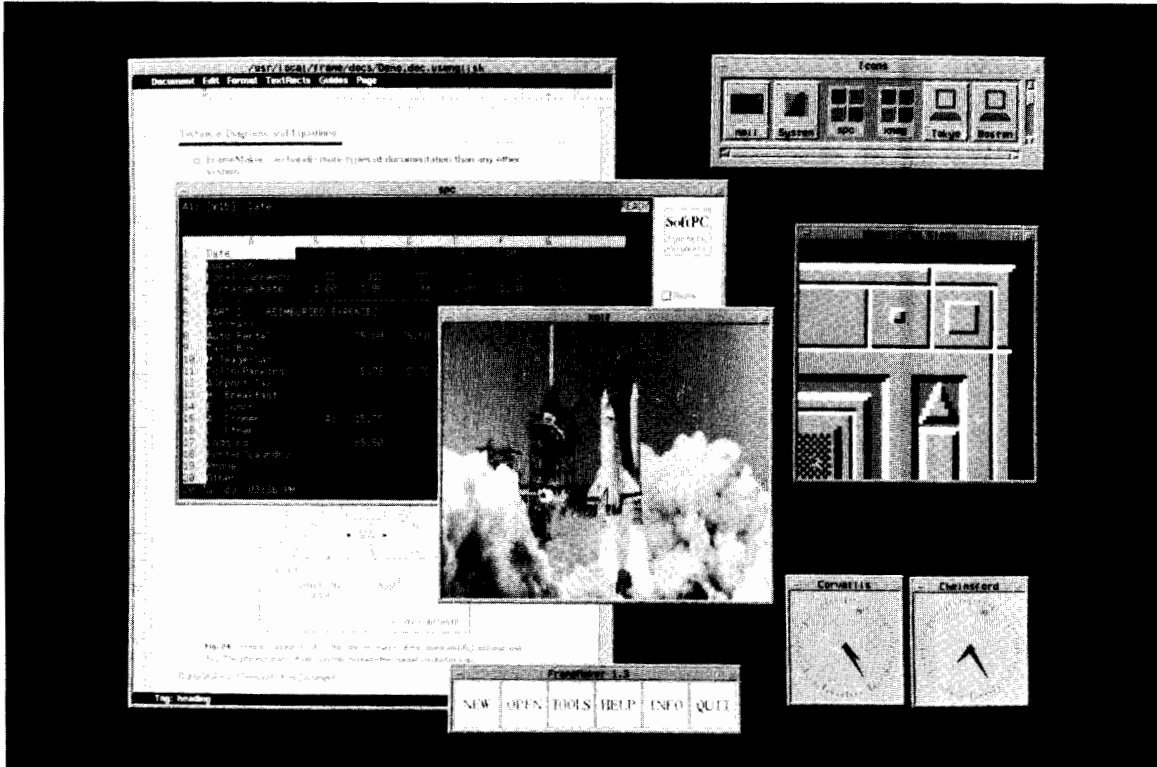

The X Window System

The X Window System provides HP Series 300, Series 800, and Vectra PC family with a network-compatible windowing system that allows interconnection of HP computers and computers from other vendors.

With the X Window System, you can create multiple windows on your computer display to interact with programs running on your computer, another HP computer, or computers from other vendor's, connected to your system over a network. Programs compiled on another vendor's computer to use X can use the X windowing software on HP computers for input and output - and the reverse.

User Interface

HP-UX supports the X Window System Version 11 Release 3 (referred to as X), which provides a window system for the HP9000 Series 300 and Series 800 computers. X includes the display server, a group of programs (clients), a library of functions (Xlib), and a standard tool kit (X Toolkit Intrinsics) for constructing applications.

The HP OSF/Motif™ user environment*, HP's offering of the OSF/Motif user environment, is included as HP's standard user interface on all of HP's open-systems products. The OSF/Motif environment is based on MIT's X Window System and is consistent with Presentation Manager behavior, the defacto standard for behavior in the PC world. The OSF/Motif environment provides a consistent behavior for the user interface. By providing consistent behavior, user productivity is maintained as people move from system to system and application to application. (Imagine what driving a car would be like if the steering wheel and pedals changed functions from model to model.

The HP X Window System also allows programs written in the GKS, Starbase, and other graphics libraries to have full access to HP graphics capabilities, thus combining the power of these graphics libraries with an easy-to-use interface.

X Window Systems for a Wide Range of Systems

HP X Window System products are available for the HP 9000 Series 300 and Series 800 computers, as well as for the HP Vectra PC. The AXDS/PC X11 product for the Vectra PC runs on the Intelligent Graphics Controller card. This software provides the display and input functions of X11 and can integrate the Vectra into the X environment.

*Certification of conformance with OSF/Motif user environment pending. OSF/Motif is a trademark of the Open Software Foundation, Inc. in the U.S. and other countries.

Because X Window Systems are supported on a wide price/performance range of hardware platforms, application developers can have a broader platform base for their applications, and end users enjoy more freedom and flexibility in their choice of hardware.

For More Information

Please contact your nearest HP technical sales representative.

Ordering Information

	Price
Vectra PC Family (PC-AT bus compatible)	\$500
D2300A AXDS/PC	
Accelerated X Window display server software for the PC with X11 R2/R3 fonts on 5.25-inch and 3.5-inch media and installation guide. Requires the Intelligent Graphics Controller card, part number HP 82328A.	
Series 300	
X Window System is included as part of Series 300 X11	N/A
Series 800	
B1153A X Window System Version 11 for model 808/815	\$1000
Opt AA0 Software on 1/4-inch tape cartridge	\$0
Opt AA1 Software on 1/2-inch 1600 cpi 9-track tape	\$0
B1155A X Window System Version 11 for model 825/835	\$2,100
Opt AA0 Software on 1/4-inch tape cartridge	\$0
Opt AA1 Software on 1/2-inch 1600 cpi 9-track tape	\$0
B1157A X window System Version 11 for model 840	\$3,295
Opt AA0 Software on 1/4-inch tape	\$0
Opt AA1 Software on 1/2-inch 1600 cpi 9-track tape	\$0
B1159A X Window System Version 11 for model 850/855	\$4,500
Opt AA0 Software on 1/4-inch tape cartridge	\$0
Opt AA1 Software on 1/2-inch 1600 cpi 9-track tape	\$0
Delete manual set	-\$50
Documentation	
B1161A User Documentation for Series 300 and 800	\$160
B1162A Programmer Documentation for Series 300 and 800	\$440

TECHNICAL COMPUTER SYSTEMS

HP 1000 Computers for Real-Time Applications

- Computer-aided manufacturing
- Computer-aided test
- Real-time monitoring and control
- Real-time data acquisition

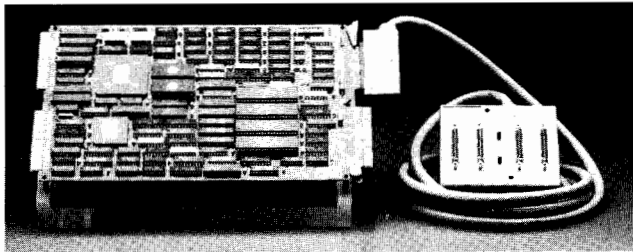

HP 12100A A400 Minicomputer packs a complete A-Series CPU, 0.5 megabyte of memory, and a four-port serial I/O multiplexer on one card

Versatile Design for Real-Time Uses

HP 1000 open architecture computers are modular machines that are designed for real-time multiprogramming, multi-user applications in manufacturing, communications, research, and other fields that require real-time response. A choice of processors and a wide variety of interfaces and software equips HP 1000 computers to solve many different applications, taking advantage of the following HP 1000 real-time performance features:

Fast, Efficient Handling of I/O. External sensors, measurement instruments, and other I/O devices connect to HP 1000 systems via I/O interfaces and an I/O system with multi-level, vectored hardware interrupts that expedite I/O. Each I/O channel has its own interrupt priority level, from which interrupts directly initiate service programs. Direct memory access controlled under a distributed intelligence I/O design speeds data transfers to and from memory with minimal involvement of the CPU.

Fast Processing of Data. HP 1000 systems can process data at base instruction rates up to 1.3 MIPS and floating point processing speeds up to 820 KWIPS-BID. This minimizes the time needed to process input data, evaluate results, and initiate real-time action.

Clocked Operations Timing is provided by time base generator interrupts that maintain a real-time clock.

Large Main Memory Capacity. Up to 32 megabytes of main memory can be provided to keep most critical programs resident and ready to execute quickly, avoiding the delays inherent in moving programs to and from disc.

A Powerful Real-Time Operating System. The RTE-A system supports memory-based or disc-based real-time multiprogramming operation with easy, efficient inter-process communication, and priority-based scheduling of programs in response to event interrupt, time-of-day, program, or user requests. RTE-A manages sharable memory-resident data arrays up to 2 megabytes and virtual data arrays up to 128 megabytes in main memory and on disc. With its VC+ extension, RTE-A supports execution of programs as large as 7.75 megabytes.

A Choice of Processors for Diverse Applications

Performance Level	HP 1000 Processor	Base Speed (MIPS)	Floating Point Speed (KWIPS-BID)	I/O B/W (MB/Sec)
1	A400	0.4	120	4.3
	A600+	0.4	110	4.3
2	A900	1.3	820	3.7

The A400 Minicomputer packs a 0.4 MIPS CPU, double precision floating point firmware, 0.5 megabyte of memory, and a four-port serial I/O multiplexer on a single plug-in board computer (SBC). At a price close to what you'd expect to pay for a personal computer, the A400 SBC delivers full A-Series functionality, including support under the RTE-A real-time executive operating system and complete compatibility with all other members of the A-Series family.

The A600+ Minicomputer offers 0.4 MIPS base execution speed and double-precision floating point firmware. Unlike the A400 minicomputer, the A600+ can support ECC memory as well as parity memory. The A600+ processor consists of a CPU card and a memory controller card.

The A900 Computer incorporates a pipeline implementation and a cache memory scheme providing three times the base performance of the A400/A600+ computer and over seven times the floating point performance. The A900's floating point processor and scientific and vector instruction sets are built-in. ECC memory is standard for maximum system integrity. The five-board A900 is the ultimate computation machine designed to meet the most demanding needs of OEMs, system designers, and end users.

Exceptional Applications Flexibility. Programs can be developed on any member of the A-Series family and executed without change on any other member, from the A400 on up to the A900. Processing power, capacity, and cost can be closely matched to application requirements with the guaranteed ability to grow as and whenever necessary. When upgrading, A400, A600+, (and the obsoleted A700) computers can receive trade-in credit toward the purchase of A900 computers.

Flexible Packaging — from Board Computers to System Processor Units

HP 1000 A-Series processors are available in a variety of packaging configurations to meet the requirements of many different applications. see the photo on the next page and summary below.

Processor	A400	A600+	A900
Board Computer	12100A	2106CK/DK	Not Avail.
Micro 14/16 6-Slot Box Computer	2424A	2426G/H	Not Avail.
Micro 24/26/29 14-Slot			
- Box Computer	2434A	2436G/H	2439B
- System Proc. Unit	2484B	2486B/C	2489B
20-Slot Box Computer	2134A	2156C/D	2139B
Model 26/29 System Proc. Unit	Not Avail.	2196G/H	2199E

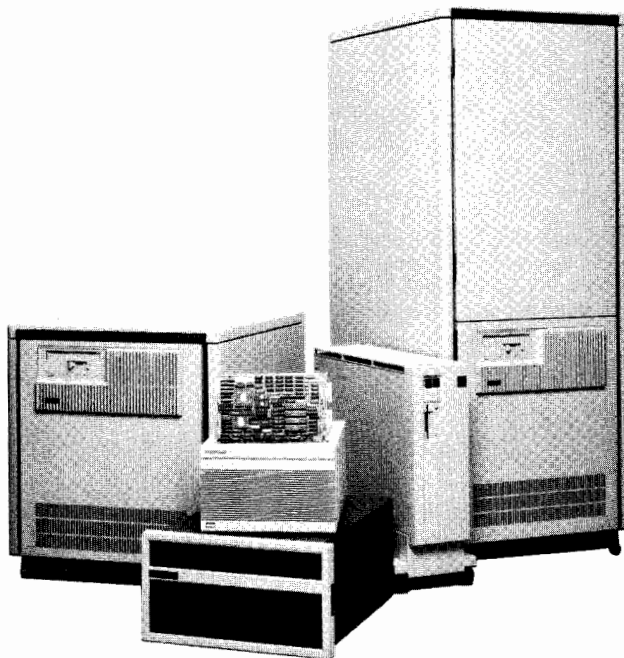

Board Computers make the A400 and A600+ processors available to OEMs or system designers in a space-conserving package for embedded controller applications, or other uses in which custom integration is required to either fit within defined physical constraints or to meet cost objectives.

Box Computers incorporate the CPU card(s) and memory in a fully-powered card cage that can be installed in a rack cabinet. Because a system console and system disc are not prerequisite to purchase, the box computer offers OEMs and system designers more configuration flexibility than the System Processor Unit.

System Processor Units (SPUs) include a box computer, interface to the system disc, the RTE-A operating system and diagnostics, site prep consultation and installation/checkout services, and 90-day on-site warranty. The higher level of SPU integration simplifies design, ordering, and implementation of systems that use a system console and a system disc. The SPU also complies with FCC and VDE EMI regulations.

The Micro 14/16 Box Computer provides the A400 or A600+ processor in a low-cost 6-slot box for low-end systems. Exceptionally efficient cooling makes possible operation in ambient temperatures to 60°C. This and a 1.5G operating shock spec make the Micro 14/16 ideal for use in tough environmental conditions.

The Micro 24/26/29 Box Computer or System Processor Unit provides the A400, A600+, or A900 processor in the versatile 14-slot Micro/1000 package. The Micro/1000 package can be placed on a table or bench, installed in a space-saving vertical floor mount with roll-about mobility (as shown in the photo above), or rack-mounted in a larger cabinet. In addition to its compactness and convenience, the Micro/1000 package can incorporate integrated mass storage (a 20 megabyte mini Winchester disc and a 630 kilobyte microfloppy disc).

The 20-Slot Box Computer provides the A400, A600+, or A900 processor in the largest available package for applications that need more card cage slots than the Micro/1000 package provides.

The Model 26/29 System Processor Unit provides either the A600+ or A900 processor in the 20-Slot box configuration that is intended to be rack mounted in either a tall or a short rack cabinet (HP 29431G or HP 29429A, respectively).

High Density Memory

HP now offers HP 1000 memory using 1M bit DRAMs: Available are 2, 4, and 8 megabyte parity memory boards for the A400 and A600+ computers, and an 8 megabyte ECC memory board for the A900 computer. Four 8MB memory boards can give 32 megabytes of memory to A-Series computers or SPUs.

A400 and A600+ computers typically incorporate the less-expensive parity memory as the preferred memory system. For large systems in critical applications, Error Correcting Code (ECC) memory, which detects and corrects all single-bit errors and detects all double-bit errors to provide the best possible system integrity is preferred. All A900s utilize ECC memory. ECC memory is optional for the A600+.

HP 1000 Software

HP 1000 software products for program development, data base management, graphics, distributed systems networking, quality decision management, programmable controller communications, and process monitoring and control are supported in all HP 1000 A-Series computers. This universality of HP 1000 software helps you to tailor comprehensive, coherent solutions to your specific application needs. Further help is available from a growing array of HP 1000 software products offered by third party suppliers under the HP PLUS software program.

Program Development

With a hard disc and optional software, HP 1000 systems can be used to develop programs in BASIC, FORTRAN 77, Pascal, and Macro/1000 Assembly language. Symbolic Debug/1000, program profiling, and user microprogrammability (of the A900 processor) provide extra capability that can be used to gain extra performance.

Plant Automation

HP's wide range of hardware and software supports automation of instruments and machines as well as monitoring and control of real-time processes. The HP 1000 can help improve productivity and reduce costs. For low point-count data acquisition, A-Series Measurement and Control Cards provide many analog interfacing functions right in the computer, without the need for an add-on peripheral device.

Computer Networking

HP's AdvanceNet networking software makes it easy to connect HP1000 systems across a city or a continent, sharing vital information throughout the network. LAN link is now available for fast Local Area communications with other HP systems or with DEC VAX systems.

Compatibility with HP 9000 Series 800 Systems

PORT/RX applications migration consulting services are available from HP to promote compatibility of HP 1000 systems with HP 9000 Series 800 systems. Multiple HP 1000 systems used as factory floor cell controllers can thus benefit from supervision and support by HP 9000 Series 800 systems used as Area Managers at Level 2 in the CIM hierarchy, or in similar supporting host roles.

Automated Test Systems

HP Automated Test Systems can be configured from HP 1000 A-Series computers and a wide range of electronic instruments to perform virtually any electronic test application.

Prices

Range from \$2600 for an HP 12100A A400 Single Board Computer with 0.5 MB parity memory and four-port multiplexer to \$41,540 for an HP 2489B A900 Micro/1000 system with 3 MB ECC memory, RTE-A/VC+ operating system, 20 MB integral disc, and system console connected via an eight-port multiplexer.

SOLID STATE DEVICES

Components

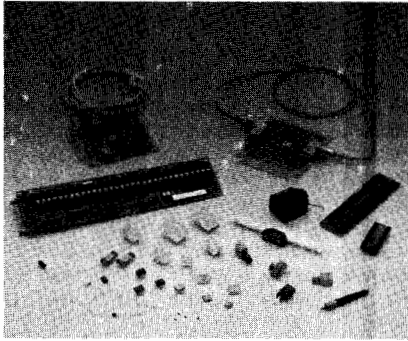

HP's Growing Optoelectronic Family

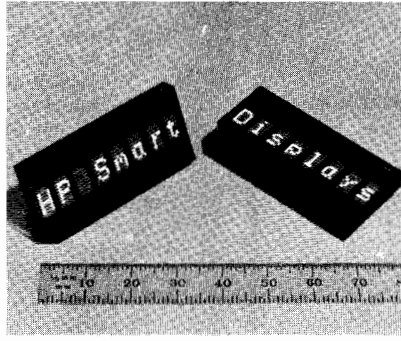

Intelligent Displays

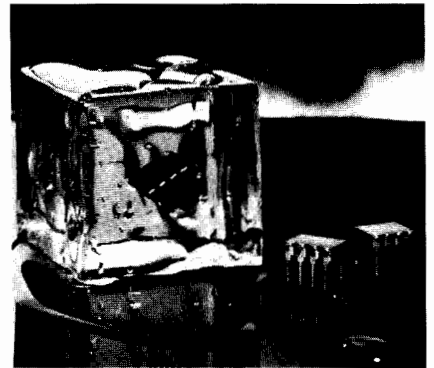

Hermetic Optocouplers

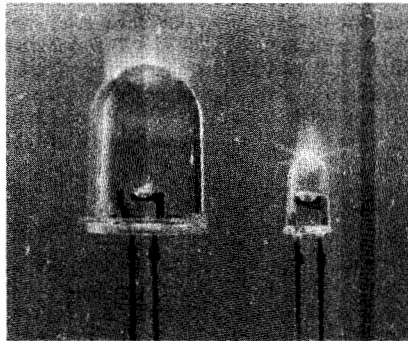

TS AlGaAs LEDs

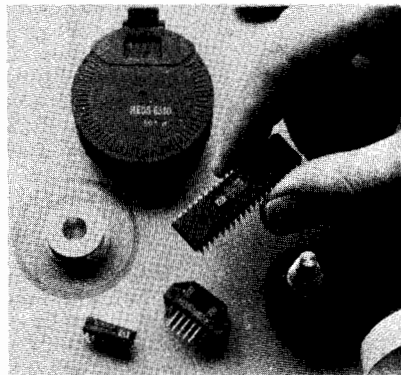

Motion Control Components

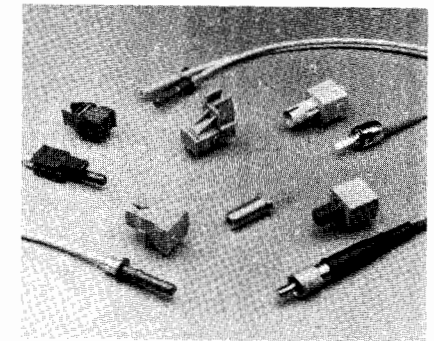

Fiber Optic Components

LED Solid State Lamps, Light Bars & Arrays

Hewlett-Packard is a world leader in LED technology and offers a broad variety of LED indicator products. Products are available in high-performance green, yellow, orange, high-efficiency red, and standard red. Recent advances in fundamental semiconductor material development have allowed new areas of contribution. New AlGaAs red materials are the basis for recent low current and very high brightness (1 candela at 20 mA) additions to the product line. New hermetic products include infrared-secure lamps intended for advanced military applications.

Solid State Displays

Hewlett-Packard offers a complete line of seven-segment displays in AlGaAs red, standard red, high-efficiency red, yellow, and high-performance green in a wide variety of package sizes. The newest members are low-current micro bright displays in red, yellow, and green.

LED alphanumeric displays in monolithic and dot matrix versions are also available. Recent developments used on-board integrated circuits (OBIC) to provide more sophisticated functions and capabilities to these displays. Some of these rugged displays are screened and tested for use in military applications and harsh environments.

The aesthetic appearance and reliable performance of LED displays make them appropriate for use in instruments, point-of-sale terminals, appliances, automobiles, telephones, moving message panels, and other high-ambient light front-panel displays.

Motion Control Components

Hewlett-Packard's developments in III-IV materials, integrated circuits, lenses, and packaging allow for a natural expansion of these efforts into development of optical incremental shaft encoders. The first HP shaft encoder was introduced in 1981. Since then, the product line has expanded to include a broad range of motion-sensing and control components.

HP's motion-sensing products include 2- and 3-channel kit encoders for commercial and industrial applications, 2-channel encoder modules for high-volume computer peripheral applications and digital potentiometers to replace analog potentiometers for manual data entry in medical and measurement instrumentation.

HP's motion control products include a quadrature decoder/counter integrated circuit for easy interface of an encoder to a microprocessor and a general-purpose motion control IC, which acts as a slave processor in closed-loop servo systems.

Optocouplers

Hewlett-Packard's family of logic compatible, high-performance optocouplers provides solutions to problems caused by ground loops and induced common mode noise for both analog and digital applications in commercial, industrial and military products.

Types of optocouplers available include high-speed and high-gain devices ac/dc to logic interface optocouplers, and optocouplers which interface directly with microprocessors.

Fiber Optic Components

Hewlett-Packard offers three families of fiber optic components which include transmitters, receivers, cable, connectors and connector assembly tools.

Plastic Snap-In Link Components

Low cost and ease of use make this family of link components well-suited for applications connecting computers to terminals, printers, plotters and industrial-control equipment. These links use rugged, 1 millimetre diameter plastic fiber cable. Assembling the plastic snap-in connectors onto the cable is extremely easy. The HFBR-0500 evaluation kit contains a complete working link including transmitter, receiver, 5 metres of connected cable, extra connectors, polishing kit and technical literature.

Miniature Link Components

The miniature link family of components offers a wide range of price/performance choices for local area network, computer, industrial-control, and military applications. The unique design of the lensed optical coupling system makes this family of components very reliable. The low-cost miniature line features a dual-in-line package that requires no mounting hardware or receptacle for use with SMA-style and ST*-style connectors. Evaluation kits are available for this line. The HFBR-0400 kit contains an SMA-styled transmitter and receiver, two meters of connected cable, and technical literature. The HFBR-0410 kit contains an ST*-styled transmitter and receiver, three meters of connected cable, and technical literature.

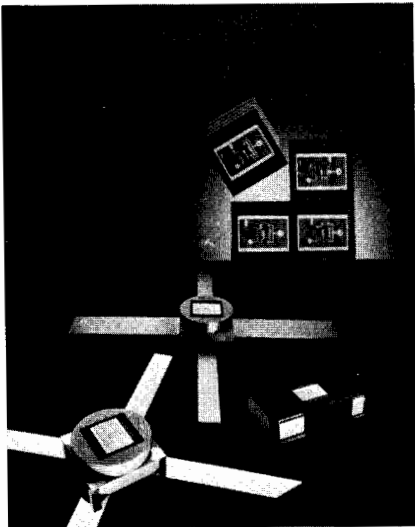

Hybrid Cascadable Amplifiers

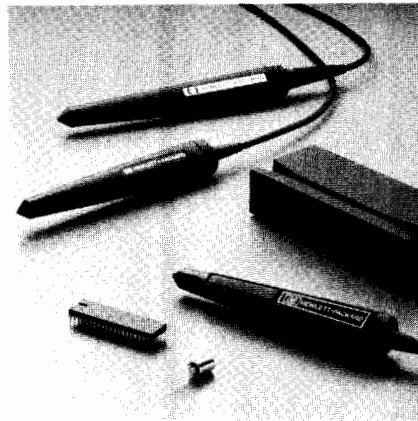

Bar Code Components

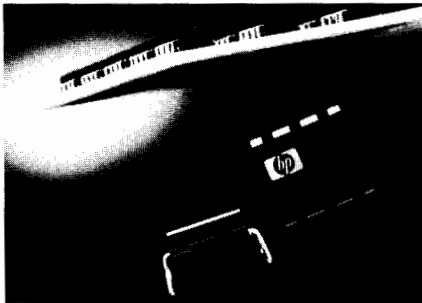

Surface Mount Optocouplers

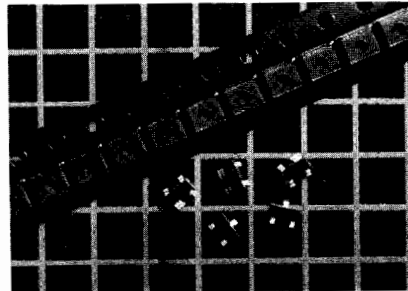

Bipolar Transistors

Silicon Bipolar Transistors

Device-to-device uniformity and superior performance are combined in the HXTR series of microwave transistors which have been individually designed for low noise (HXTR-6000 series), high gain (HXTR-2000 series), low distortion linear power (HXTR-5000 series). With guaranteed RF performance specifications from 1000 to 4000 MHz, these devices are well suited for high-reliability, space military, and industrial applications at frequencies up to 6000 MHz.

Diodes

Schottky Barrier Diodes: Schottky Barrier Diodes combine extremely high rectification efficiency with picosecond switching speeds, low series resistance, and low noise characteristics. This combination makes the Schottky an excellent mixer/detector diode.

PIN Diodes: PIN diodes function as variable resistors at microwave frequencies. By controlling the dc bias, the RF resistance of a PIN diode can be varied from 1 ohm to about 10 ohms. This property of the PIN diode makes it extremely useful as a switch attenuator, modulator, phase shifter, limiter, or AGC element at all frequencies from 1 MHz to 18 GHz and above.

Step Recovery Diodes: The step recovery diode is most graphically described as a charge-controlled switch. That is, a forward bias stores charge and a reverse bias depletes

this stored charge. When fully depleted, the SRD ceases to conduct current.

Diodes for Hybrid Integrated Circuits: These diodes are used to achieve circuits with light weight, small size, operation to high frequencies, repeatable characteristics, and lower end-product costs. HP offers a wide range of PIN, Schottky and SRD single diodes in beam lead and chip configurations as well as Schottky silicon and GaAs beam lead pair and quad diodes.

Integrated Products: Hewlett-Packard manufactures a broad line of components for the control, conversion, and generation of RF and microwave signals. This line of integrated products (combinations of chip and beam lead diodes with hybrid thin film circuit technology) includes SPST switches, attenuators, comb generators and double-balanced mixers. In addition, Hewlett-Packard manufactures monolithic silicon RF amplifiers and GaAs attenuator modules.

Bar Code Products

Designed to meet the OEM's bar code needs, Hewlett-Packard's bar code line includes digital bar code wands, two decoder IC's, optical reflective sensors, slot readers, and bar code readers. The expanding line of digital wands contains HP's Low Current Digital Bar Wand, which draws less than 5 mA of current at 5 volts, and the HP Smart Wand, an optical programmable contact bar

code reader that provides bar code capability to host systems supporting a 5V serial interface. The Digital Slot Reader, introduced in 1986 and available in both an infrared (880 nm) and a visible red (660 nm) version, is ideal for use in security or industrial applications. The Multi-Purpose Decoder IC offers a simple and inexpensive solution of adding bar code decoding capabilities to OEM products.

High Reliability Testing

Many Hewlett-Packard components are space qualified. The reliability of these devices is established by one of the finest high reliability testing facilities in the component industry. Hewlett-Packard's High Reliability Test Groups maintain military-approved parts in stock and can recommend HP standard screening programs, patterned after MIL-S-19500, MIL-M-38510, or MIL-D-87157 for any HP component.

Write For More Information

Specifications of Hewlett-Packard's component products are available in individual data sheets or complete designer catalogs. These are available free of charge from your local HP sales office or authorized distributor, or return the Information Request Card located at the back of this catalog.

ANALYTICAL INSTRUMENTS FOR CHEMISTRY

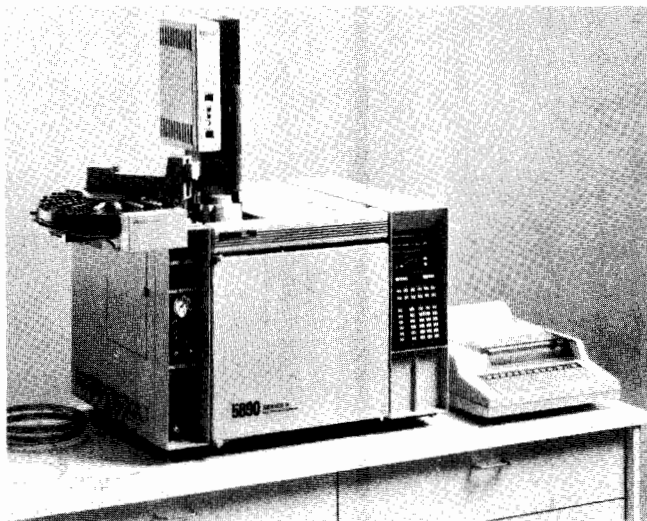

HP 5890A Series II Gas Chromatograph

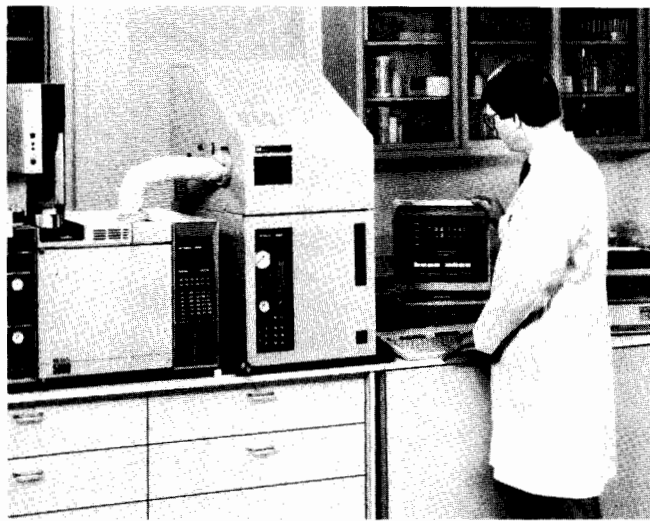

HP 5921A Atomic Emission Detector



HP 3359A Worksystem

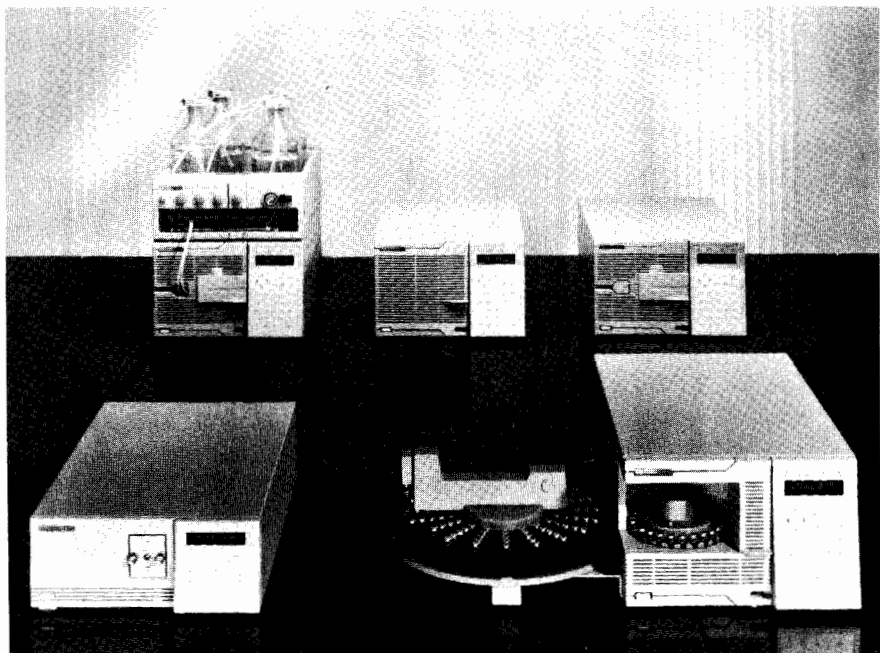

HP 1050 Series HPLC Modules

Hewlett-Packard, a manufacturer of both laboratory instruments and computers, can meet the needs of most labs—from instruments for routine analysis, to multi-instrument, multi-user systems.

Integrators. The HP family covers a wide range on the first rung of the data handling ladder. The HP 3396A low-priced integrator lists advanced software and permanent inkjet printing among its standard features.

Workstations. If your analysis techniques include GC, LC, GC/MS, FTIR, UV/VIS Spectrophotometry or LC/MS, there is a powerful HP workstation to control your instruments and handle your data.

Laboratory Data Systems. Multi-user, multi-instrument lab automation and lab information management systems. Based on computer systems, they provide easy-to-use, yet sophisticated data acquisition, data reduction and control, with a flexible upgrade path. They help you manage the flow of samples, information and materials throughout your lab.

Gas Chromatographs. The HP 5890A GC earned its place as the pacesetter of the industry. The new HP 5890 Series II continues this tradition with major enhancements. Used with the HP 3365 Chem-Station, it is a powerful tool for research and development.

GC/FTIR. The HP 5965B Infrared Detector makes routine GC/FTIR faster, easier, and more powerful. It is also designed to take advantage of the powerful combination of GC/FTIR plus GC/MS.

GC Sample Identification. The new HP 18587A Bar Code Identification System can be added to your HP 7673A Automatic Sampler, to greatly reduce errors in tray loading and sample number entry.

The new HP 5921A Atomic Emission Detector (AED) is the first fully automated AED system capable of detecting any element in gas chromatography effluents at picogram levels. Initially, the capability to detect the most frequently chromatographed elements is built in. So you can now selectively detect up to 15 elements with one detector.



HP AminoQuant, Amino Acid Analyzer

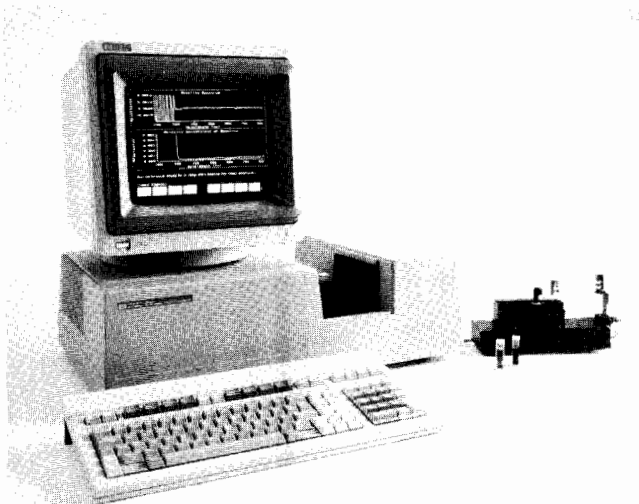

HP 8452A UV/VIS Spectrophotometer

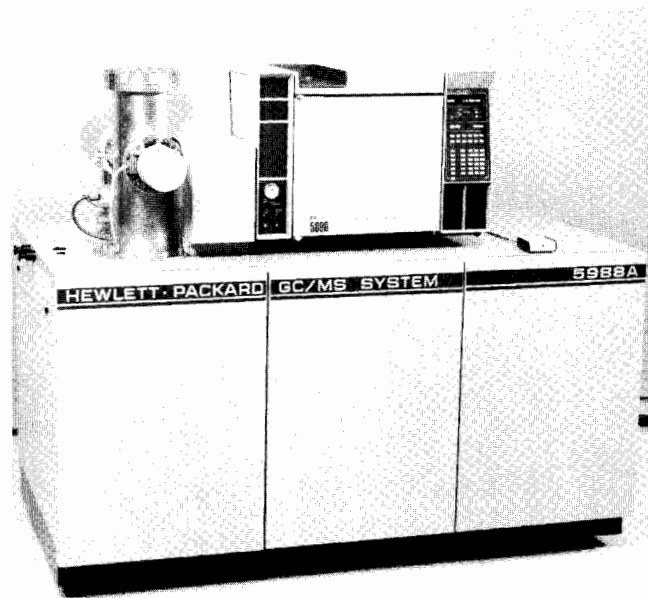

HP 5988A GC/MS System

Liquid Chromatography. Adding to the proven capabilities of the HP 1090 integrated LC system, and the HP 1040 series of HPLC detectors—HP recently introduced the HP 1050 Series of HPLC Modules. It includes an isocratic pump, a quaternary pumping system, an autosampler, a variable wavelength detector and a multiple wavelength detector.

If you need a fully integrated system, the HP 1090 Series is the choice. It offers some powerful and convenient data handling options.

Amino Acids Analysis. HP AminoQuant, an HP 1090-based system, performs automated analysis of 17 primary and secondary amino acids. It includes extensively tested chemistries and methodologies which provide biochemists with precise, accurate and sensitive results.

GC/MS and LC/MS. Hewlett-Packard is leading the way in making mass spectrometry available in economically priced, compact systems. First, the new HP 5971A Mass Selective Detector (MSD). It is smaller than any previous MSD, and offers surprising capability at a low price. It fits against the side of the HP 5890A GC, taking only seven linear inches of counter space.

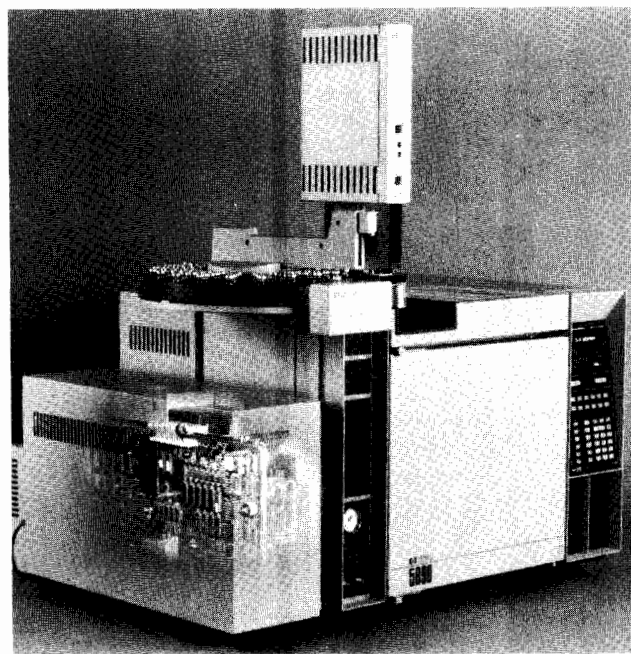

HP 5971A Mass Selective Detector

The HP 5970B MSD is the most widely used, most proven MSD. It comes with a wide range of data system options. It takes only 18 inches of counter space.

The HP 5988A is HP's most powerful research-grade system. It comes in many configurations, including LC/MS.

Drug analysis is only one of the demanding applications addressed by HP's GC/IRD/MSD system. It combines the HP 5890A GC, the HP 5965A Infrared Detector, and the HP 5970 MSD. Therefore it provides three dimensions of data: retention times, infrared spectra and mass spectra. Data handling is provided by two HP ChemStations.

UV/VIS Spectrophotometry. The HP 8452 UV/VIS Spectrophotometer makes diode array technology accessible to labs where budgets are tight. It works with a variety of controllers, including the HP UV/VIS ChemStation, HP Vectra PC, and the IBM PC, XT or AT.

For further information write to Hewlett-Packard Company, Analytical Products, 1820 Embarcadero Road, Palo Alto, CA 94303.

MEDICAL INSTRUMENTATION

Diagnostic Cardiology and Echocardiography

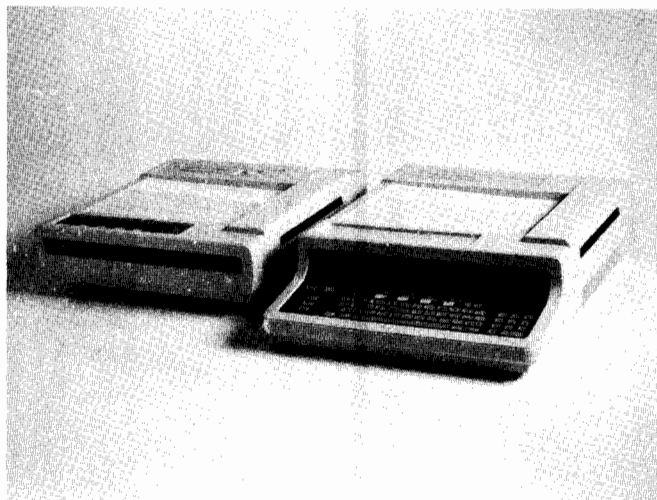

Cardiography Instrumentation

- HP 4765A PageWriter II Interpretive Cardiograph
- ECG Management Systems for computer-aided management of electrocardiograms
- ECG Workstations for PC-based ECG department management



Ambulatory ECG

- True, two-channel analysis and ST-segment measurement
- System includes HP Vectra PC, custom software, two patient analyzers and an HP LaserJet Series II printer
- Optional HP 43405A Memory Module for full disclosure

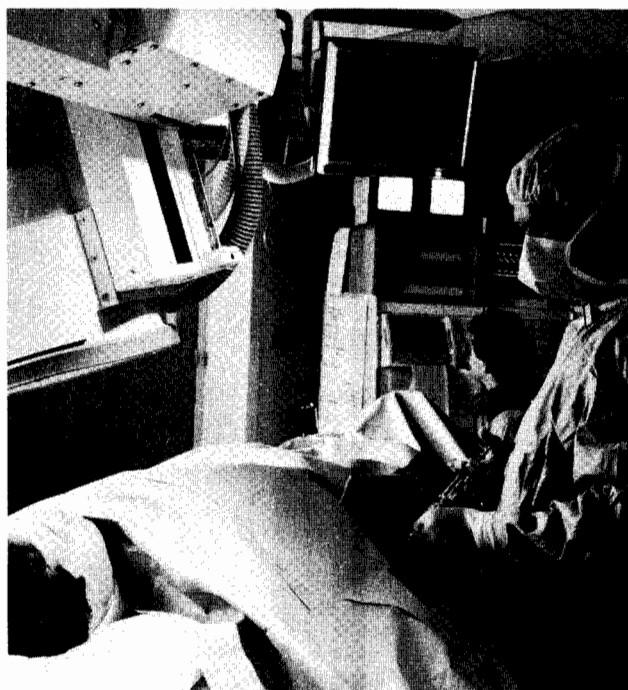

Cardiovascular Instrumentation

- Computerized catheterization data analysis system automates on-line data collection analysis
- Comprehensive data base for generating both clinical and administrative reports
- Complete choice of plug-in signal conditioners and transducers

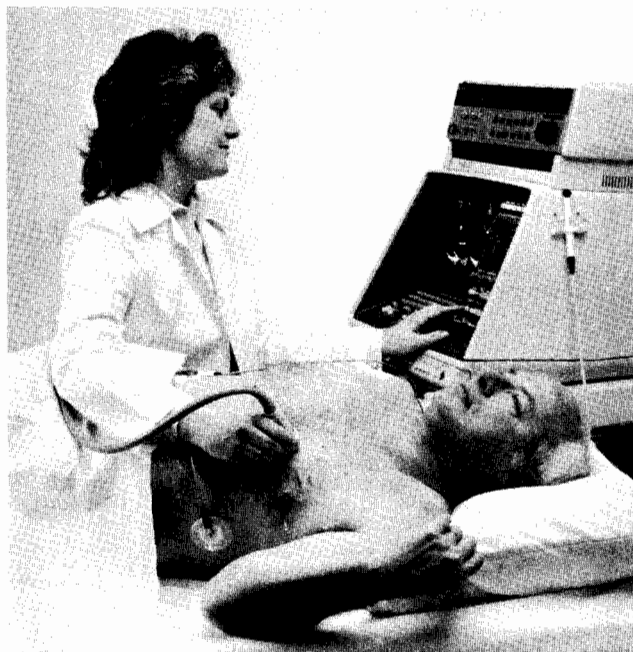

HP SONOS 1000 Cardiovascular Imaging System

- The most advanced HP phased array ultrasound imaging system
- HP Precision Imaging technology and wide-aperture transducers
- Peripheral vascular imaging with 7.5 MHz linear array transducer
- Next-generation color flow imaging
- Steerable PW/CW Doppler
- Transesophageal imaging capability
- Sophisticated image review and analysis capabilities

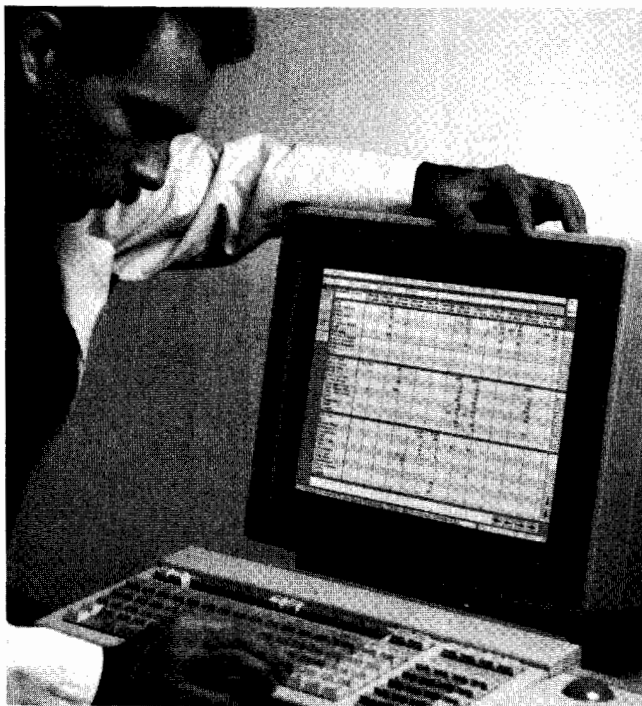

HP CareVue 9000 Clinical Information System

- Bedside-oriented system for critical care
- Replaces paper-based charting process
- Easily adapted to each unit's specific needs
- Advanced human interface
- Collects information directly from bedside monitors and other bedside devices
- Uses local area network to incorporate information directly from ancillary departments
- Applications include flowsheet, nursing/physician notes, nursing care plans, patient acuity, severity of illness and more



Obstetrical Information Management System

- Display and Alert
- Remote overview screens
- Bedside data entry
- Configurable admission/discharge forms
- 25-year storage, retrieval and archiving
- Flexible system configurations

Other Obstetrical products include:

- Antepartum fetal monitors
- Intrapartum fetal monitors
- Fetal ultrasound telemetry
- Fetal trace transmission system
- Fetal/maternal ultrasound imaging system

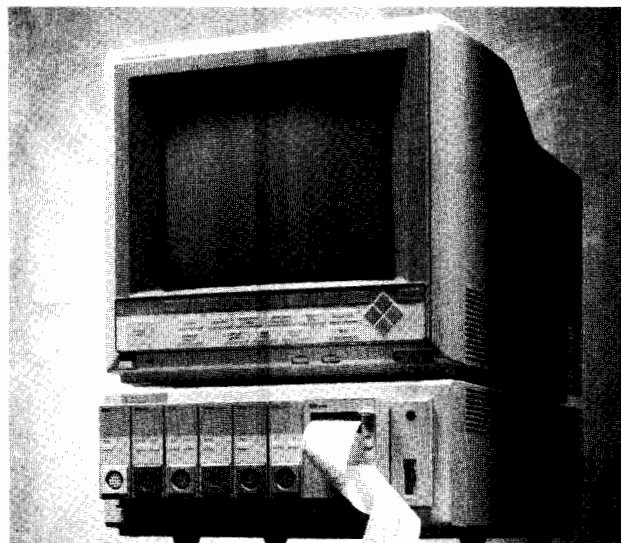

HP Component Monitoring System

- Patient monitoring system for the OR, CCU, and ICU
- Monitors up to 16 parameters simultaneously
- Choose 4, 6, or 8 waveforms, color or monochrome
- Intuitive, 2-levels of operation
- Comprehensive data management
- Interface to HP Critical Care Network



Resuscitation

- Easy to use, 3-step operation
- Lightweight, reliable design

For Additional Information on HP Medical instrumentation, write to INQUIRIES MANAGER, Hewlett-Packard, 3000 Minuteman Road, Andover, MA 01810, and request literature in any of the following categories:

- Patient Monitoring Systems
- OR Monitoring
- Arrhythmia Central Stations
- Clinical Information Systems
- Ultrasound Imaging
- Cardiography Instrumentation/Ambulatory ECG
- Cardiovascular Instrumentation
- Obstetrical and Neonatal Instrumentation
- Resuscitation
- Healthcare Information Systems
- Supplies, Consumables, Pressure Transducers

We invite you to receive ADVANCES FOR MEDICINE, the Hewlett-Packard medical products magazine, free of charge.

Simply write to: ADVANCES FOR MEDICINE

Hewlett-Packard
3000 Minuteman Road
Andover, MA 01810

X-RAY EQUIPMENT

Cabinet X-Ray Systems

Models 43855A, 43855B and 43856A

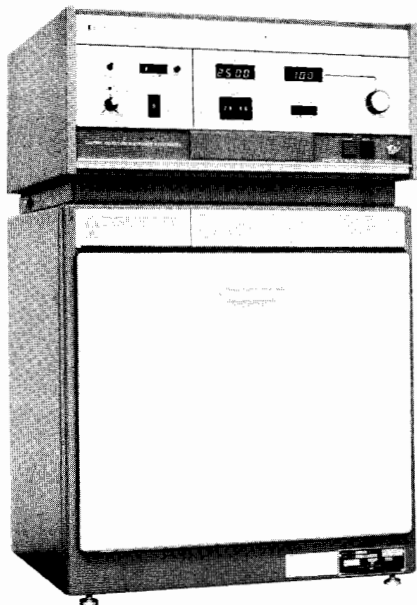

FAXITRON MODEL 43855A
WITH OPTION A02



FAXITRON MODEL 43856A



FAXITRON MODEL 43855B

Faxitron® Cabinet Systems

Radiography, the art and science of making pictures with X-rays, has an important place in modern technology. It is one of the major nondestructive test methods available to industry, provides an indispensable tool in scientific investigations and is a valuable aid to law enforcement agencies. Hewlett-Packard makes a major contribution to these activities with X-ray equipment that offers a "better way" through advanced technology and design. This equipment makes radiographs easier and safer to take.

Scientific Applications

Oceanography, geology, marine biology, paleontology, pathology, botany, forestry and agricultural research are a few examples of scientific disciplines that use X-rays. Applications range from the study of the interior anatomy of fossils to determining the viability of seeds.

These are among the many applications served by HP Faxitron Cabinet X-ray Systems. They offer a unique combination of high quality radiographic capability, simplicity of operation and convenience of use which is expanding the capabilities of scientific and industrial concerns throughout the world.

Industrial Inspection

Industrial quality control and inspection procedures, especially in the field of electronics, benefit from nondestructive testing by radiography. The advantages of a testing method which does not harm the test objects are obvious. Radiography, therefore, offers benefits in design engineering, incoming inspection, production quality control, product reliability and failure analysis. X-rays are used to detect misregistration or plate-thru problems in multi-layer P.C. boards; porosity, poor substrate bonding and wiring or lead location in transistors and integrated circuits; voids and other encapsulation problems in potted components; and solder balls or other defects in sealed relays.

Die casting is another industry that benefits from the nondestructive aspects and ability to "see inside" provided by radiography. Porosity, gas void, trapped metal inclusion and other common defects can be easily detected and the cause determined. Expensive machining time can be avoided for castings found to be defective through X-ray inspection. The integrity of welds, alignment of connectors, inspection for proper assembly and mechanical defects are further examples of tests which radiography performs for industry. The benefits of X-ray testing are reduced production costs, better quality assurance and product safety. The results are increased profits.

Medical Applications

HP Faxitron Cabinet X-ray Systems are used by the medical profession for specimen radiography in support of diagnostic surgical procedures and in biological research. Specimen radiographs of biopsy samples are correlated with preoperative mammograms, for example, and in the evaluation of mastectomy specimens. Typical research applications include microradiography of thin bone specimens and microangiographic studies of vasculature.

X-RAY EQUIPMENT

Flash X-ray Systems

Models 43703B, 43710A, 43731A, 43733A, 43734A

665

MODEL 43731A
150kV

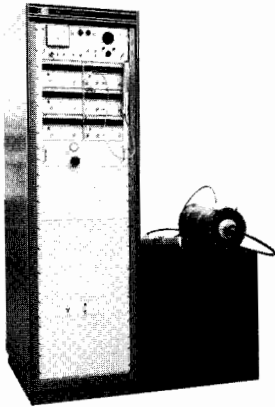

MODEL 43733A
300kV

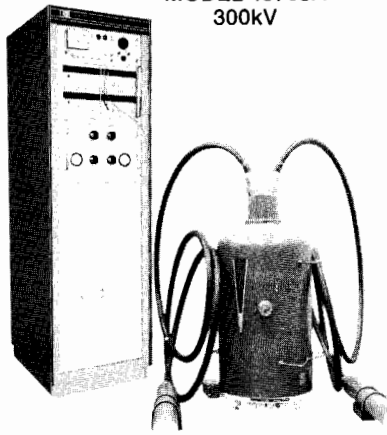

MODEL 43734A
450kV

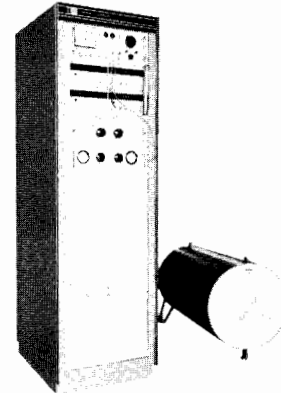

Option 035 - Dual Remote Tubehead

High-speed (flash) radiography is used to record and study dynamic events where interposed material, smoke, flame, debris, or pressure variations exclude the use of high-speed cameras. Typical events include ballistics, shaped charges, explosives, behind-armor studies, shock waves in solids, aerospace phenomena, and crash-injury studies.

The basic performance requirement of a flash X-ray system used for the study of transient mechanisms is to provide high resolution radiographs with exposure times short enough to eliminate motion blur. HP series 43700 Flash X-ray systems produce X-ray pulses of sub-microsecond duration and are designed specifically for "stop motion" radiographic applications. All HP 43700 series systems utilize the same basic components, the same electrical theory, and are modular in concept. Standard systems include 150 kV, 300 kV, 450 kV, 1 MV, and 2.3 MV models.

An HP basic single "channel" flash X-ray system, composed of a pulse generator, high voltage power supply, cold-cathode field emission X-ray tube, and associated controls, provides a single radiograph per event. Additional pulser/X-ray tube sets (add-on channels) may be combined with the initial single-channel system to provide multiple-channel "systems." Multiple channel systems may be of identical output voltage or may use varied output voltage pulser/tube combinations.

For specific information and consultation regarding HP X-ray systems, contact Hewlett-Packard, 1700 S. Baker Street, McMinnville, Oregon 97128. Telephone (800) 952-2212.

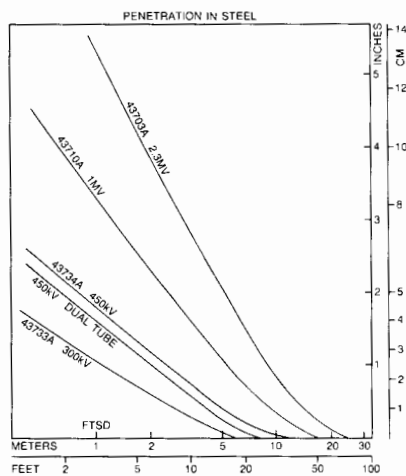
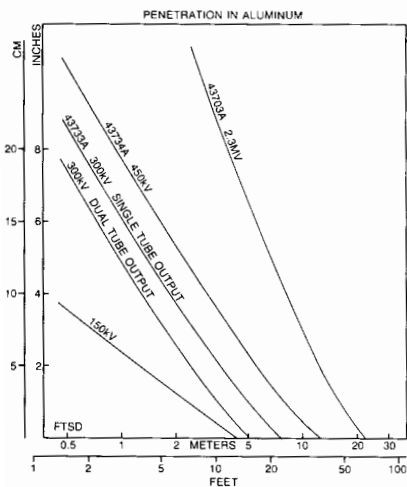

ROCKVILLE (Sales)
#2 Choke Cherry Road
Rockville, Maryland 20850
Telephone (301) 948-6370

ALBUQUERQUE
7801 Jefferson Street, N.E.
Albuquerque, New Mexico 87109
Telephone (505) 823-6100

IRVINE
9800 Muirlands Avenue
Irvine, California 92718
Telephone (714) 472-3000

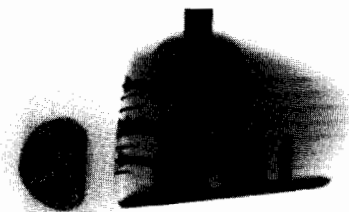

Compression of golf ball
when hit with club

CALCULATOR PRODUCTS

Personal Computation

Models HP 10B, HP 12C, HP 14B, HP 17B, HP 19B, HP 20S

Whatever field you are in—science, engineering, mathematics, business, or education—Hewlett-Packard calculators are the best for your success. And they provide the sense of pride that comes from owning computational tools designed, in every detail, to be the finest of their kind.

Business calculators include the HP 12C, HP 14B, HP 17B, HP Business Consultant II, and the new HP 10B. The HP 12C features HP's traditional RPN (Reverse Polish Notation) entry system; others are designed for people who prefer algebraic entry calculators. Scientific calculators that feature RPN include the HP 32S, HP 42S, HP 41CV/CX, and HP 28S. The HP 22S, HP 27S, and the new HP 20S and HP 21S have algebraic entry systems.

The HP 17B, HP Business Consultant II, HP 27S, HP 42S, and HP 28S have menus and softkeys for easy access to functions. These models, and the HP 22S and HP 32S, also feature HP Solve to make working with equations easier.

An optional infrared printer can be used with the HP Business Consultant II, HP 17B, HP 28S, HP 27S, HP 42S and HP 41CV/CX. A wide range of peripherals, plug-in modules and software allow customization of the HP 41 for personalized application solutions.

Business Calculators

HP 10B Business Calculator

The HP 10B entry-level calculator provides business essentials plus HP quality and a variety of features that provide ease of use. An auto-increment feature makes amortization schedules quicker to generate. Label descriptors make it easy to enter cash flows and to understand them, and to see which values in an amortization schedule are interest, principal, and remaining balance. There is no need to shift modes to access functions; all functions on the HP 10B are available all of the time without the need to shift modes. Because the HP 10B does not use a COMPUTE key, it eliminates keystrokes and saves time. The HP 10B has a numeric one-line, 12-digit LCD.

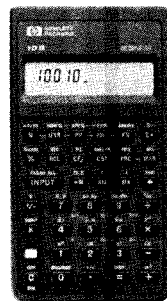

HP 10B

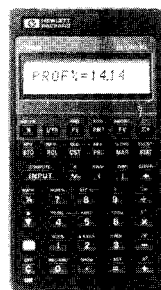

HP 14B

HP 12C RPN Programmable Financial Calculator

The HP 12C calculator is the standard for real estate and finance. It features business and financial functions plus math and statistics for calculating mortgages, balloon payments, depreciation, bond yields, and more. The HP 12C has a numeric one-line, 10-digit LCD and 20 storage registers. Application books are available.

HP 14B Business Calculator

The HP 14B calculator offers the most frequently needed functions for business students and small business owners at an economical price. It also has extras such as ROI, break-even and inventory analysis, forecasting using four different curve fits with a best-fit feature, and list-based cash flows. Other features include TVM with amortization; two-variable statistics with linear regression; interest rate conversions; margin and markup; percent change and percent of total; and an alphanumeric display. The HP 14B has a one-line, 12-character dot-matrix LCD. An application book is available.

HP 17B Business Calculator

The function-packed HP 17B calculator is designed for easy use by professionals. It is the only calculator in its class that offers more than 250 business functions plus features like HP Solve, menus and softkeys, the most powerful bond calculations in any hand-held calculator, clock and alarm, and list-based statistics and cash flows. The HP 17B has a 2-line by 22-character alphanumeric display, 6500 bytes of RAM, and an infrared printer interface. Application books are available.

HP 19B HP Business Consultant II Professional Calculator

The HP 19B is the ultimate business calculator for professionals. It has the most comprehensive set of business and financial functions found in any calculator, yet it is easy to use because of its menu and softkey approach to problem solving. It offers a graphics package that plots histograms, scatter diagrams, and four different curve-fitting models for statistics and forecasting, plus net present value versus interest rate for investment analysis. In addition, the HP Business Consultant II offers HP Solve; data- and time-management functions, including an application to manage name and address lists, a clock and calendar, and an appointment scheduler with alarms; number lists with running totals and subtotals; conversion applications for 39 world currencies and 63 different unit measurements; advanced math; and a built-in ROM that allows messages and prompts to be displayed in German, Spanish, French, Italian and Portuguese, in addition to English. The calculator has a 4-line by 23-character alphanumeric display with separate keyboards for numbers and letters, 6500 bytes of RAM and an infrared printer interface. Application books are available.

Scientific Calculators

HP 20S Scientific Calculator

With the HP 20S calculator, engineers, technicians, and students get an entry-level machine with all the functions other scientific calculators in the same price range offer, plus a library containing six of the most-used programs for math, science, and engineering. The HP 20S program library provides a set of functions including root finder, numerical integration, complex-number operations, curve fitting, 3x3 matrix operations, and the quadratic formula. In addition to its program library, the HP 20S has keystroke programming with conditional tests and a comprehensive set of base-conversion and base-arithmetic operations. The HP 20S has a one-line, 12-character numeric display.

CALCULATOR PRODUCTS

Personal Computation

Models HP 21S, HP 22S, HP 32S, HP 27S, HP 42S

667

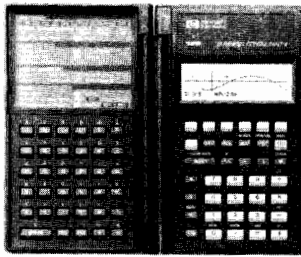

HP 19B

HP 21S Stat/Math Calculator

The HP 21S calculator is designed for college students in disciplines such as social sciences, agriculture, life sciences, psychology, and business, who are required to take statistics courses. The HP 21S, which eliminates the need to use statistics tables, calculates the most common statistics distribution values and their inverses, and includes a statistical program library. Sample test statistics can be used to perform hypothesis testing and to construct confidence intervals. In addition to its statistics functions, the HP 21S has all the essential math functions for college math classes and time-value-of-money functions for business calculations. The HP 21S has a one-line, 12-character numeric display.

HP 22S Scientific Calculator

The easy-to-use HP 22S gives science students fast solutions to classroom problems. It has built-in equations, and HP Solve lets users solve for any variable without re-entering an equation. It also has a library of 16 commonly-used equations including roots of a quadratic equation, pressure of a fluid and kinetic energy. Alpha labels, prompts, and messages appear in the one-line, 12-character dot-matrix LCD. The HP 22S also has 16K bytes of ROM, 371 bytes of user RAM and 26 storage registers. An application book is available.



HP 20S

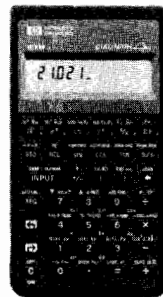

HP 21S

HP 32S RPN Scientific Calculator

The HP 32S calculator for technical professionals and students gives the RPN advantage at the lowest price. It is an excellent next step from the HP 11C. It has a complete set of math and science functions, RPN HP Solve, which solves for any variable without reprogramming, numerical integration and complex number functions and programming capabilities for solving repetitive problems. It incorporates labeled variables for input and output, and looping, tests and flags for problems that require logical decision making. The HP 32S has a one-line, 12-character dot-matrix LCD, 390 bytes of user RAM and 27 storage registers. An application book is available.

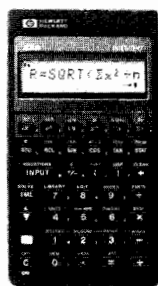

HP 22S

HP 27S Scientific Calculator

The HP 27S is a two-in-one calculator for technical managers who need to perform business and scientific calculations. It offers scientific functions, including logarithms, trigonometry and hyperbolics; financial functions for TVM and amortization schedules; number lists with running totals for statistics, forecasting and adding columns of numbers; base conversions; HP Solve; appointments and time calculations. The HP 27S has a 2-line by 22-character alphanumeric display, 6.5K bytes of RAM and an infrared printer interface. Application books are available.

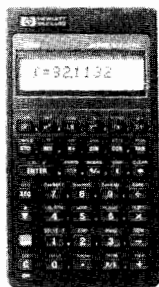

HP 32S

HP 42S RPN Scientific Calculator

The powerful HP 42S is the engineer's best bet for matrix math. It is an excellent HP-15C upgrade and has a complete set of math and science functions. A sophisticated matrix editor prompts for input, which is useful for solving simultaneous equations. The matrix editor also allows complex numbers to be used as matrix elements. Variables, including real and complex numbers and matrixes, can be named. A variable and function catalog keeps track of them, and they can be used directly from the catalog. Access to and use of all functions, programs and variables in the calculator are possible via the catalog by simply scrolling to the desired function and executing it. The HP 42S also features RPN Solve and numerical integration functions. Custom menus can be created and assigned to the top-row

CALCULATOR PRODUCTS

Personal Computation

Model HP 41CV/CX, HP 28S, Enhancements & Peripherals

keys. The HP 42S also runs thousands of keystroke programs available for the HP 41C/CV calculators. The HP 42S has a 2-line by 22-character dot-matrix LCD, 64K bytes of ROM, 8K bytes of RAM and an infrared printer interface. Application books are available.

HP 41CV and HP 41CX RPN Advanced Programmable Calculators

The HP 41CV and HP 41CX provide the heart of expandable computational systems. In addition to input/output capability, they provide portability and touch-key simplicity.

In addition to all the built-in functions of the HP 41CV, the HP 41CX features built-in Time and Extended Functions/Memory modules, a text-file editing function and 19 other functions.

A broad range of HP-written application pacs and solutions books is available. The HP 41CV/CX have 2,233 bytes of RAM (319 registers) built in, with 6,433 bytes (919 registers) maximum. The HP 41CX has 868 bytes (124 registers) of built-in extended memory. The optional HP 82180A Extended Functions/Memory Module adds 868 bytes (124 registers) to the HP 41CV and the optional HP 82181A Extended Memory Module adds 1,666 bytes (238 registers) to the HP 41CV/CX. There are over 200 built-in functions in the HP 41CX and over 128 in the HP 41CV. Both calculators can be used with the HP 82240B Infrared Printer (HP 82242A Infrared Printer Interface Module required) and have 10-digit, 12-alpha character (scroll to 24) LCDs.

HP 28S Advanced Scientific Calculator

The HP 28 is the first scientific calculator to offer symbolic solutions for technical professionals and students in math and engineering. It can perform symbolic algebra and calculus computations, and it can plot equations on its display. It has 32K bytes of RAM; memory management features for organizing information stored in memory; an advanced graphics package with graphics storage and recall; matrix, vector and complex-number arithmetic; and advanced programmability through a high-level programming language. Other features include menus and softkeys that make access to functions faster and easier, HP Solve for use in personalizing the HP 28S without programming, and enhanced RPN with optional algebraic entry. The HP 28S has a 4-line by 23-character alphanumeric display with separate keyboards for numbers and letters and a wireless infrared printer interface. Application books are available.

Ordering Information

HP 10B Business Calculator	\$49.95
HP 12C RPN Programmable Financial Calculator	94.95
HP 14B Business Calculator	79.95
HP 17B Business Calculator	110.00
HP 19B HP Business Consultant II Professional Calculator	175.00
HP 20S Scientific Calculator	49.95
HP 21S Stat/Math Calculator	49.95
HP 22S Scientific Calculator	59.95
HP 32S RPN Scientific Calculator	69.95
HP 27S Scientific Calculator	79.95
HP 42S RPN Scientific Calculator	120.00
HP 41CV RPN Advanced Programmable Calculator	175.00
HP 41CX RPN Advanced Programmable Calculator	249.00
HP 28S Advanced Scientific Calculator	235.00

Enhancements and Peripherals

HP 17B, HP 19B, HP 27S, HP 42S, HP 41CV/CX and HP 28S

HP 82240B Infrared Printer

An infrared light beam provides a cordless connection to the calculator from up to 18 inches away. The HP 82240B prints 24 characters per line in 5x8 dot matrix, using the ECMA 94-character set for ease in reading output. This thermal printer turns itself off after 10 minutes of inactivity and has a power indicator. It uses batteries or an optional ac adapter. An HP 82242A Infrared Printer Interface Module is required to use this printer with the HP 41 calculator.

☞Fast-Ship product—see page 734



HP 42S

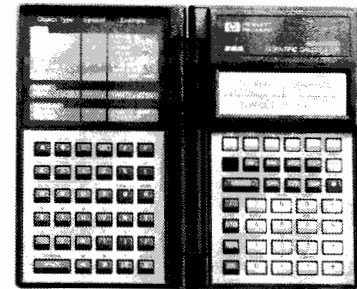

HP 28S

HP 41

HP 82182A Time Module

With this module (built into the HP 41CX), the HP 41CV can become a time-scheduled system controller, alarm clock, appointment reminder, calendar, timer or even an advanced stopwatch.

HP 82160A HP-IL Interface Module

Plugs into any one of the four ports in the HP 41, connecting it with HP-IL peripherals and instruments, and to HP-IB and RS-232C devices using interface converters. Gives the HP 41 control of up to 30 devices on the loop. Typical HP 41 transfer rate: 150 bytes/second.

HP 82183A Extended I/O Module

Provides 59 I/O functions beyond those provided by the HP 82160A HP-IL Module.

HP 82242A Infrared Printer Interface Module

Provides an interface that allows the HP 41 to be used with the HP 82240A/B Infrared Printers. Permits numeric, upper- and lower-case alpha, double-wide characters, high-resolution plotting capabilities and intensity control. Allows user-defined special characters to be transmitted to the printer.

HP 82161A Digital Cassette Drive

Uses a digital-quality mini-cassette to store up to 128K bytes of information. Number of tracks, 2; density, 335 bits/cm (850 bits/inch); format, 256 bytes/record (8 bits/byte); formatted capacity, 512 records (131,072 bytes).

HP 2225B ThinkJet Personal Printer

See numerical index for page number.

HP 9114B Disk Drive

See numerical index for page number.

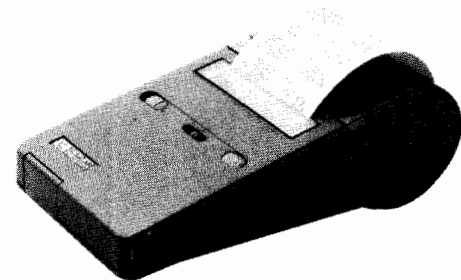

HP 82240B



CALCULATOR PRODUCTS

Personal Computation

Interfaces, Accessories & Software

669

Ordering Information

HP 19B, HP 17B, HP 41CV/CX, HP 28S, HP 27S and HP 42S:

HP 82240B Infrared Printer (110V) \$135.00 ☎
HP 82241A Adapter, U.S. (110V) 15.00 ☎

HP 41:

HP 82240B Infrared Printer (110V) 135.00 ☎
HP 82242A Infrared Printer Interface Module 65.00 ☎
HP 82180A Extended Functions/Memory Module 75.00 ☎
HP 82181A Extended Memory Module 75.00 ☎
HP 82182A Time Module 75.00 ☎
HP 82160A HP-IL Interface Module 125.00 ☎
HP 82183A Extended I/O Module 75.00 ☎
HP 82161A Digital Cassette Drive 250.00 ☎

Interfaces

HP 41

HP 82164A HP-IL/RS-232C Interface

Translates HP-IL signals into RS-232C signals, and vice versa, for connection of HP-IL systems with RS-232C systems. Provides bit-serial asynchronous data communication. AC adapter included.

HP 82169A HP-IL/HP-IB Interface

Permits linkage of HP-IL systems with HP-IB (IEEE 488, 1978) computers and lab equipment. When a controller is used, it can be either an HP-IL or HP-IB device. AC adapter included.

HP 82242A Infrared Printer Interface Module

Permits the HP 41CV/CX to be used with the HP 82240B Infrared Printer.

Ordering Information

HP 41

HP 82164A HP-IL/RS-232C Interface \$295.00 ☎
HP 82169A HP-IL/HP-IB Interface 395.00 ☎
HP 82242A Infrared Printer Interface Module \$65.00 ☎

Accessories

Accessories such as owner's manuals, programming pads, magnetic cards, thermal paper, battery packs, rechargers and software manuals are readily available for all types of HP calculators. To order, call your **HP Direct** office. In the U.S., call 800-538-8787.

Software

HP offers software packages as application pacs, solutions books and application booklets. Application pacs come with a manual, plug-in module, and when applicable, prerecorded magnetic cards, a keyboard overlay and quick reference card. Solutions books come with complete documentation. Application booklets stand alone. Available from dealers and HP sales representatives.

HP 14B

Application Book
 00014-90021 Business Student \$9.95 ☎

HP 19B, HP 17B and HP 27S

Application Books

00017-90019 Real Estate, Banking, and Leasing \$9.95 ☎
 00017-90020 Business Finance and Accounting 9.95 ☎
 00017-90021 Marketing and Sales 9.95 ☎
 00017-90022 Personal Investment and Tax Planning 9.95 ☎

HP 19B and HP 27S

Application Book
 00027-90044 Technical Applications \$9.95 ☎

HP 22S

Application Book
 00022-90034 Science Student Applications \$9.95 ☎

HP 32S

Application Book
 00032-90057 Engineering Applications \$9.95 ☎

HP 42S

Application Books

00042-90020 Programming Examples and Techniques \$9.95 ☎
 00042-90021 Electrical Engineering 9.95 ☎
 00042-90022 Mechanical Engineering 9.95 ☎

HP 41

Application Pacs

00041-15055 HP 41 Advantage \$49.00 ☎
 00041-15006 Circuit Analysis 45.00 ☎
 00041-15004 Financial Decisions 45.00 ☎
 00041-15049 Math/Statistics 45.00 ☎
 00041-15022 Games 45.00 ☎
 00041-15016 Real Estate 45.00 ☎
 00041-15019 Thermal & Transport Science 45.00 ☎
 00041-15039 Petroleum Fluids 75.00 ☎
 00041-15001 Standard Applications 45.00 ☎
 00041-15027 Stress Analysis-Mechanical Engineering 45.00 ☎
 00041-15021 Structural Analysis-Civil Engineering 45.00 ☎
 00041-15005 Surveying 45.00 ☎
 00041-15020 Machine Design 45.00 ☎

Solutions Books*

Business:

00041-90094 Business Statistics/Marketing/Sales 15.00 ☎
 00041-90096 Home Construction Estimating 15.00 ☎
 00041-90086 Lending, Savings, & Leasing 15.00 ☎
 00041-90136 Real Estate 15.00 ☎
 00041-90137 Small Business 15.00 ☎

Engineering:

00041-90093 Antennas 15.00 ☎
 00041-90100 Chemical Engineering 15.00 ☎
 00041-90089 Civil Engineering 15.00 ☎
 00041-90092 Control Systems 15.00 ☎
 00041-90088 Electrical Engineering 15.00 ☎
 00041-90139 Fluid Dynamics & Hydraulics 15.00 ☎
 00041-90140 Heating, Ventilating & Air Conditioning 15.00 ☎
 00041-90090 Mechanical Engineering 15.00 ☎
 00041-90138 Solar Engineering 15.00 ☎
 00041-90441 Structural Design (cassette-based) 35.00 ☎

Computation:

00041-90084 Geometry 15.00 ☎
 00041-90083 High-Level Math 15.00 ☎
 00041-90082 Test Statistics 15.00 ☎

Other:

00041-90102 Chemistry 15.00 ☎
 00041-90099 Games I 15.00 ☎
 00041-90443 Games II 15.00 ☎
 00041-90142 Physics 15.00 ☎
 00041-90141 Surveying 15.00 ☎
 00041-90395 Time Module Solutions I 15.00 ☎

*As originals are depleted, photo copies will be supplied at same prices

HP 28

Application Books

00028-90111 Mathematical Applications (HP 28S) \$9.95 ☎
 00028-90105 Vectors and Matrices (HP 28C/S) 9.95 ☎
 00028-90101 Algebra and College Math (HP 28C/S) 9.95 ☎
 00028-90102 Calculus (HP 28C/S) 9.95 ☎
 00028-90104 Probability and Statistics (HP 28C/S) 9.95 ☎

For additional information or a demonstration of Hewlett-Packard professional calculators, visit your nearest HP dealer.

☎ Fast-Ship product—see page 734.

BUSINESS COMPUTER SYSTEMS

Integrated Information Solutions

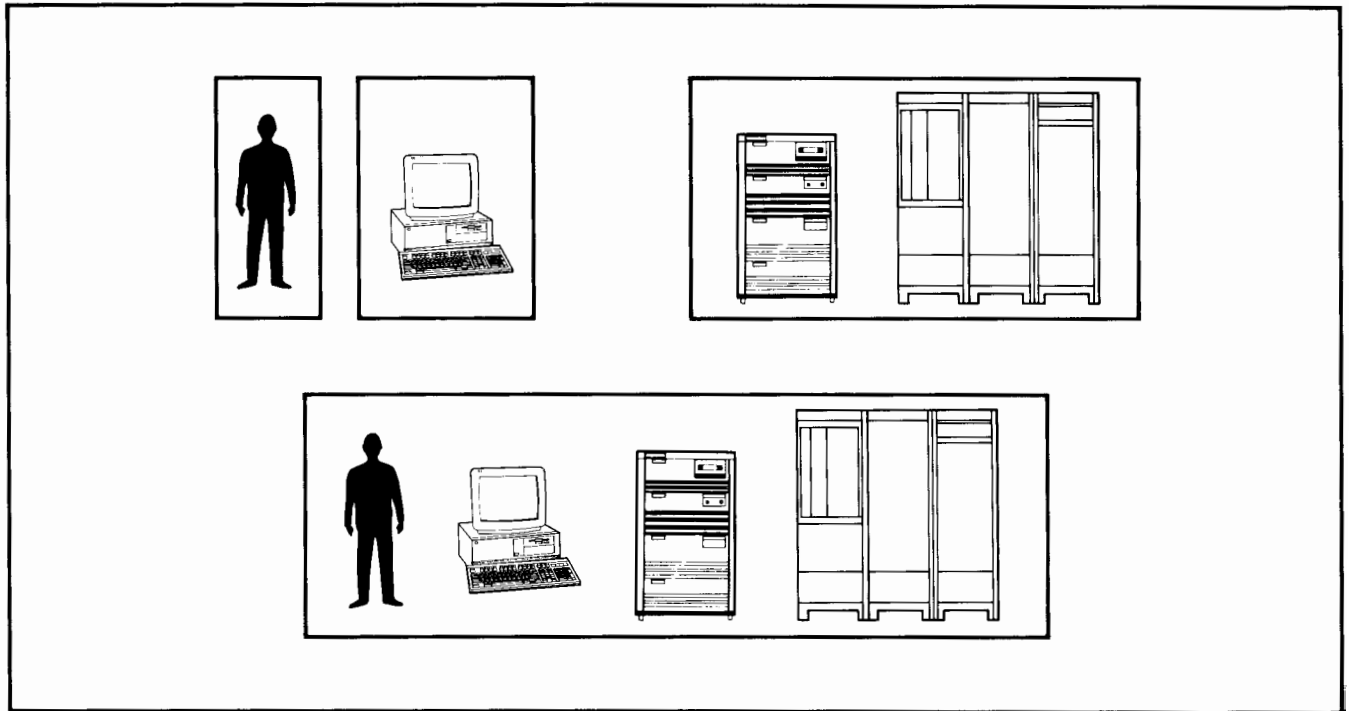

Hewlett-Packard integrates your company's information resources into a single, tightly knit information network.

Better Use of Information and Computing Resources

By making information more useful and HP 3000 systems more effective, Hewlett-Packard's Integrated Information Solutions enhance your entire investment in information resources. The solutions combine products that utilize the advantages of personal computing, networking, and HP 3000 distributed data processing into one complete integrated business system.

Furthermore, HP's Integrated Information Solutions are completely tied to your organization's application environment, providing immediate access to departmental, corporate and even global information resources. Functional end users at all levels are better able to access, analyze, manipulate, share, and distribute vital information.

The HP NewWave Environment

The HP NewWave environment is an advanced personal computer application environment providing a single window, or view, into your entire network of information and computing resources. This open environment is based on industry standards and is designed to allow the end user to focus on completing tasks rather than on learning and using individual applications. Furthermore, the HP NewWave environment presents a major opportunity for the developer to deliver greater benefits to customers.

Users working in the HP NewWave environment can move quickly and easily from one application to another because applications are integrated seamlessly. The Object Management Facility (OMF) allows end users to link, combine, or manipulate different forms of data such as text, spreadsheets, graphics, scanned images and voice by treating it as a single object; to the end user, these objects are represented as "icons." By manipulating the icons, a user can create compound objects by using the mouse to move one icon on top of another.

Once completed, these objects can be electronically mailed to other users in the organization.

In addition, the HP NewWave environment also provides the user with services such as computer-based training and context-sensitive help.

HP NewWave Developer Products

There are three key products designed to enable developers to begin immediate design work on new applications or to integrate their current applications with the HP NewWave architecture: the Developer Kit, Developer Training and Technical Support.

The HP NewWave Developer Kit

The HP NewWave Developer Kit contains all the HP components needed to write applications for this new environment. It includes the HP NewWave environment software, software development tools, and documentation.

HP NewWave Developer Training

This is an invaluable course for software developers who will be writing applications under the HP NewWave environment. Although the HP NewWave environment is based upon Microsoft Windows, it consists of many extensions to Windows. This course provides the concepts and information on both Microsoft Windows and those extensions needed by any HP NewWave application developer.

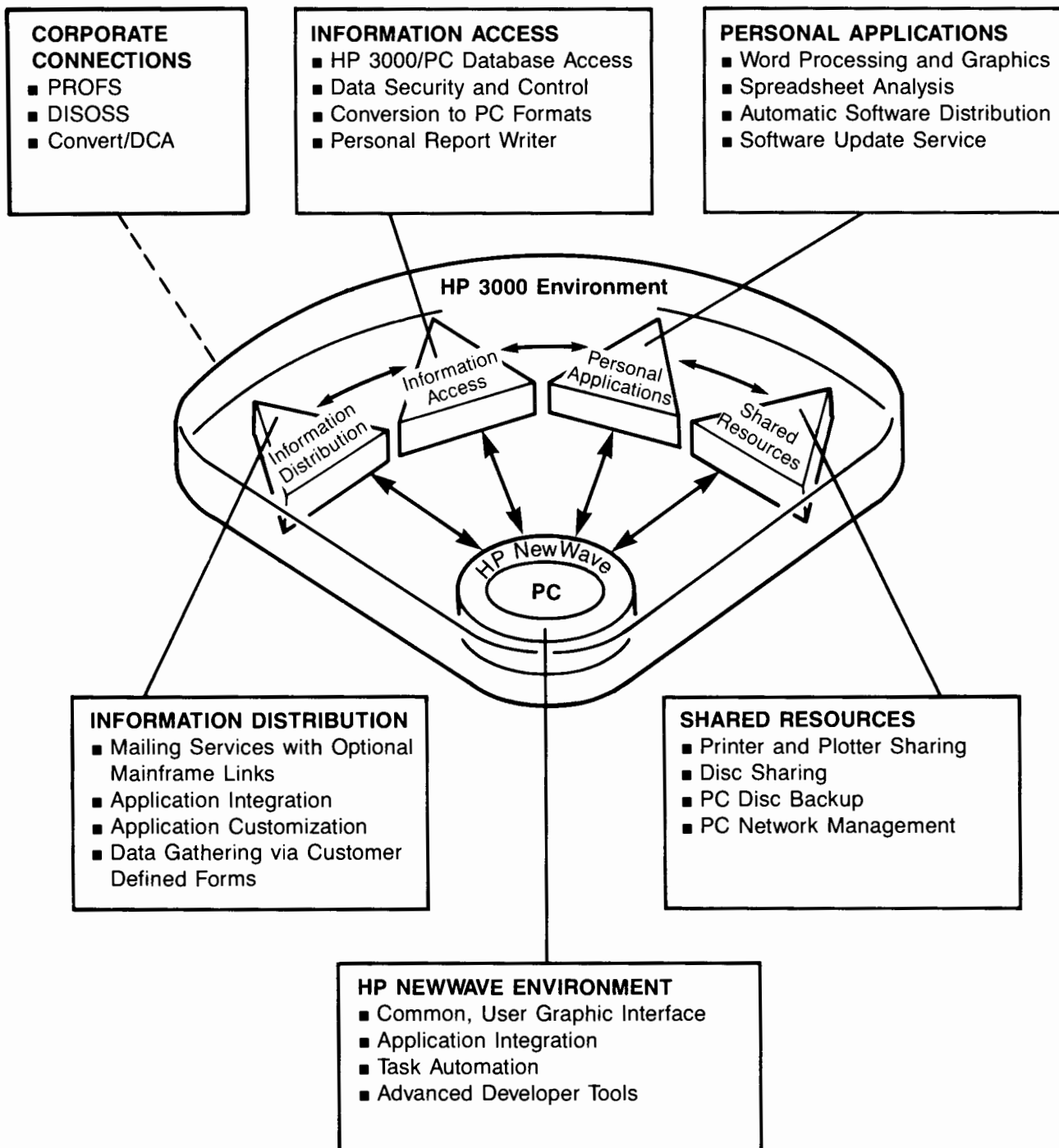

Hewlett-Packard's Integrated Information Solutions framework.

BUSINESS COMPUTER SYSTEMS

Integrated Information Solutions (cont'd)

PC Integration and Departmental Services

PC integration and specific departmental services, such as access to information, system-wide communication, and shared resources, increase the effectiveness of workgroups by linking personal computers, terminals, minicomputers, mainframes and peripherals. Shared printers, plotters and disc storage maximize return on peripheral investments. Backing up PC hard discs to HP 3000 systems increases data security, and centralized distribution of PC applications increases MIS control.

Integrating PC resources with the HP 3000 minicomputer concentrates the power of each computer on the tasks it performs best. For example, the HP 3000 is designed for transaction-based processing and the PC is designed to enhance individual productivity.

HP Business System Plus

HP's Business System Plus incorporates these PC integration and departmental service capabilities into a centrally managed system. Business System Plus, which is a single-software product, enhances the HP 3000 environment with resource sharing, information access, information distribution and popular PC applications capabilities. For example, with Business System Plus, users can extract data from HP 3000 applications, analyze and describe the information on their PC, and distribute the results electronically throughout the organization. The result: significantly improved use of computer resources and more timely, accurate decision making.

Specific features of Business System Plus include:

- PC Backup
- Information Distribution
- Printer and Plotter Sharing
- Disc Sharing
- Centralized PC Software Distribution
- Access to Information
- PC Network Management
- Advanced PC Applications

In addition, customers who do not need the complete capabilities of Business System Plus can purchase the departmental services of information access and information distribution, as well as PC application components individually.

Departmental Services Components

Information Access

Information Access is a unique information management software package that provides access to information, facilitates reporting and data exchange, and coordinates distribution between personal computers, HP 3000 minicomputers and IBM mainframes. It is an information server that extends the reach of your data processing systems by delivering key business data throughout your organization. Information Access provides the means for end users to make better-informed decisions based on up-to-the-minute information by providing simple, yet secure, access to information wherever it resides.

Information Access provides the most current information to PC users by allowing access to local and remote HP 3000 systems as well as PCs and databases. Results can be output directly to many popular PC applications, including Lotus 1-2-3. Additionally, MIS professionals are no longer burdened by requests for custom reports because end users have direct access to the crucial information they require.

Information Distribution

HP DeskManager manages the flow of information throughout your network via electronic mail, and lets you integrate data processing applications such as for finance, payroll and order processing functions. It simplifies administration of the electronic mail system with central directory keeping, and provides security features such as password protection, access limitation, and message scrambling.

With HP DeskManager, data processing reports can be sent automatically to predefined distribution lists, forms can be circulated and returned, and financial data can be collected from multiple locations. All types of messages, from simple tax files to complex documents, programs and data files, can be sent and received as near as down the hall or as far away as around the world.

Additional Departmental Services Products

The following products augment the standard departmental services with advanced capabilities to further enhance the effectiveness of workgroups, departments or entire companies. These products can be added to systems that already have Business System Plus or its individual components.

HP File/Library

HP File/Library is a complete electronic filing solution for the entire department. Any file, even a paper file, can be indexed in the HP File/Library catalog. Users can access documents wherever they are located, thus eliminating the need to duplicate files in multiple locations and saving valuable disc space by archiving documents onto inexpensive cartridge or tape.

HP Schedule

HP Schedule keeps track of schedules and coordinates the busy calendars of an entire department or even a group of departments. It sets up meetings and can schedule resources located anywhere on the network — from conference rooms and audio-visual equipment to corporate jets.

PROFS

HP OfficeConnect to PROFS provides a transparent electronic mail link between HP systems running DeskManager and IBM's Professional Office System, allowing users of these two systems to communicate with each other through their own electronic mail systems.

DISOSS

HP OfficeConnect to DISOSS provides a transparent electronic mail link between these two systems and IBM's Distributed Office Support System. Users on either system can communicate with each other using their standard address formats. Also, users on both systems have open access to distribution lists and DISOSS document libraries.

CONVERT/DCA

HP Convert/DCA enables HP and IBM users to exchange and edit documents in both Final and Revisable Form Text DCA (Document Content Architecture). IBM PC users with DisplayWrite can exchange revisable documents with HP Vectra PC users using AdvanceWrite and Executive MemoMaker software.

Cooperative Services

Cooperative Services is a software development tool designed to create cooperative processing applications between personal computers and an HP 3000 minicomputer. The product comprises an MS-DOS procedure library and an HP 3000 intrinsic server, and it supports popular PC development languages.

HP AdvancePrint

AdvancePrint provides low-cost, shared printing for PC users by allowing HP Vectra, IBM, and HP 150 PC users to share printers and plotters connected to an HP 3000 system. AdvancePrint takes advantage of low-cost basic serial connections; no expensive networking is required. With AdvancePrint, PC users can print to shared devices as if the printers or plotters were directly attached to their PCs (including full graphics support).

PC Applications

Hewlett-Packard PC applications provide users access to a wide range of word processing, database management, and graphics capabilities. Designed for easy integration, these PC applications, combined with any of Hewlett-Packard's industry-leading printers and plotters, provide professionals with high-quality memos, reports, presentations and sophisticated documents.

Graphics Gallery Collection

The Graphics Gallery Collection provides professional quality presentation capabilities to PC users. Users are able to create colorful pie, bar and line charts as well as complex text charts, flow charts, organization charts, logos and presentation slides.

AdvanceMail

AdvanceMail is a personal computer mailing application that enhances the integration of PCs with HP DeskManager. End users are able to utilize the full range of electronic mail capabilities while remaining entirely in their PC environments.

AdvanceLink

AdvanceLink provides terminal emulation and file transfer capabilities to a host computer across a variety of data communication links. AdvanceLink terminal emulation enables users to run applications on HP 3000, HP 1000, and HP 9000 systems. AdvanceLink file transfer functions allow users to share data, text files, memos, and even graphics between the PC and host computers. With the AdvanceLink command language, users can build macros to coordinate and automate routine tasks.

Executive MemoMaker

Executive MemoMaker (EMM) is a full-functioned, easy-to-use word processor designed for business professionals and managers. EMM includes features such as on-screen graphics integration, a spelling checker, and search and replace functions, allowing the user to create professional-quality memos and reports.

Executive Card Manager

Executive Card Manager (ECM) is a file management program designed with a Rolodex-like card file interface. Users can manage almost any kind of information, from addresses and phone numbers to client contact records and purchase histories. Each file can contain up to 64,000 cards and each card can contain up to 11 screens of information. ECM also provides a built-in report writer that lets users present information in a variety of formats, including mailing labels.

AdvanceWrite Plus

AdvanceWrite Plus is designed for individuals who require the advanced functionality of a sophisticated word processor with text, graphics and image integration. Providing a level of performance and functionality traditionally found only in dedicated word processors, AdvanceWrite Plus includes capabilities such as table of contents and index generation, equation processing, forms processing and integrated spreadsheets.

Implementation and Support

To help you get the most out of your Integrated Information Solutions system, Hewlett-Packard offers a consulting service called HP OFFICE-ASSIST. The HP OFFICE-ASSIST program provides an experienced systems engineer and a day of customer education to help you implement your company's goals through the use of the appropriate office applications.

PERSONAL COMPUTERS & TERMINALS

Overview and Matrix

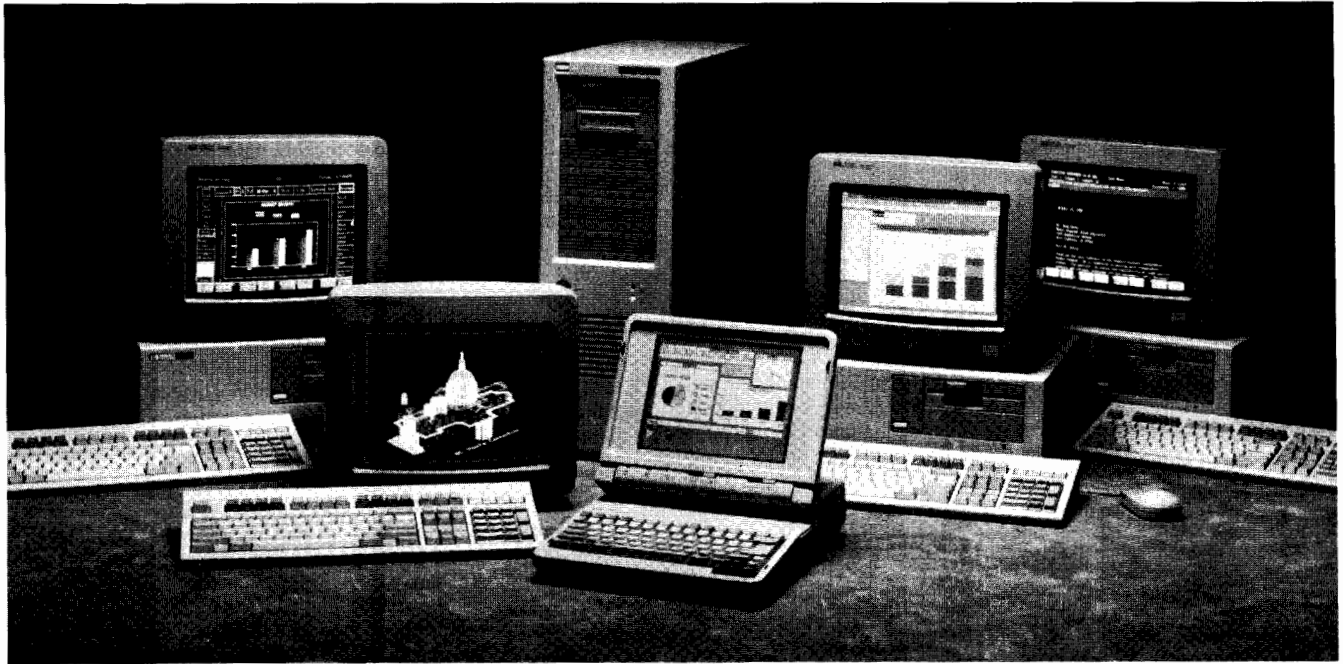

The HP Vectra PC family offers high performance at every price level to meet your individual needs.

Products for Every Need

Hewlett-Packard's PC and terminal product lines offer a broad range of excellent price/performance choices to meet a wide variety of needs, from entry-level ASCII terminals to advanced 386™ PCs.

The top-of-the-line HP Vectra RS/25C and HP Vectra RS/20C PCs provide exceptional power and expansion capabilities, and are suited for business, engineering, or scientific application. These high-performance, desktside systems are ideal for single-user, multiuser, PC-based LAN and CAD environments. They use the full power of the 32-bit Intel 386™ microprocessor and high-speed cache memory to meet your needs.

The HP Vectra QS/16S and HP Vectra QS/20 PCs apply state-of-the-art technology to deliver the speed and power you need for sophisticated office applications. These Intel 386 machines are ideal for running applications such as desktop publishing, large databases and complex spreadsheets, as well as PC-based CAD.

As stand-alone desktop units or as components of a networked system, the HP Vectra ES and ES/12 PCs are designed to meet the ongoing challenges of your office environment. Operating at 8 and 12 MHz, these 286-based machines improve productivity as they speed through almost any aspect of business, from accounting to project management, desktop publishing to entry-level CAD. For professionals on-the-go, the HP Vectra LS/12 Laptop PC combines the performance of a desktop with the flexibility of a

portable. All HP Vectra PCs are fully compatible with the PC/AT industry standard architecture (ISA) and run popular operating systems such as MS-DOS®, OS/2® and SCO™ XENIX. Hewlett-Packard's commitment to industry standards ensures a smooth growth path to next-generation operating systems and applications.

If your computing environment requires terminals, Hewlett-Packard has a complete line for all your system needs within HP, DEC, IBM and other system environments. These products are designed with state-of-the-art ergonomics, including keyboards with tactile feedback, tilt and swivel displays, and a choice of phosphor colors.

Hewlett-Packard's new graphics subsystems meet the graphics-intensive demands of CAD applications. The 16- and 20-inch high-resolution displays deliver unequalled display quality. The multiscanning display technology allows you to readily switch between CAD applications, which take advantage of a high-resolution graphics card, and office applications, which use a VGA card. This wide range of resolution support (VGA through 1280 by 1024) provides extensive flexibility and growth, and protects your display investment. For users who only require VGA resolution, the HP industry-standard solution provides display performance up to three times faster than others available.

HP Personal Computers

Hewlett-Packard has a personal computer system to match any application need. From the midrange 286-based PCs up to the top-

of-the-line 386™-based systems, HP personal computers excel in their class.

HP Vectra LS/12 Laptop PC

- 12-MHz, 80L286 microprocessor
- Up to 2 Mbyte of 16-bit memory
- Electroluminescent backlit supertwist LCD screen
- Detachable long-life battery pack

HP Vectra ES and ES/12 PCs

- 8- and 12-MHz, 286-based desktop PCs
- Up to 8 Mbyte of 16-bit memory
- 7 I/O slots

HP Vectra QS/16S and QS/20 PCs

- 16- or 20-MHz, 386™-based desktop PCs
- Up to 8 Mbyte of 32-bit memory (HP Vectra QS/16S PC)
- Up to 16 Mbyte of 32-bit memory (HP Vectra QS/20 PC)

- 7 I/O slots
- 3 half-height mass storage shelves support up to 152 Mbyte of storage

HP Vectra RS/20C and RS/25C PCs

- 20- or 25-MHz, 32-bit, 386™-based desktside PCs
- Cache memory architecture
- Up to 16 Mbyte of 32-bit memory
- Optional 80387 coprocessor or Weitek 3167 floating point accelerator
- High-performance ESDI disk drives (as fast as 17-ms seek time)
- 8 I/O slots
- 6 half-height mass storage shelves support up to 620 Mbyte of storage

386™ and Intel 386™ are trademarks of the Intel Corporation. MS-DOS® and OS/2® are U.S. registered trademarks of Microsoft Corporation. SCO™ is a trademark of Santa Cruz Operation, Inc.



Hewlett-Packard's PC-based CAD products deliver the performance, reliability and full industry-standard compatibility you need for demanding CAD applications.

Personal Computer Matrix

HP Vectra PC	Model number ^{1,2}	Product number	Processor	Standard Memory	Package type ³	Flexible disk size (Mbyte)	Hard disk (Mbyte)	Video adapter	Price
ES	Model 10	D1210A	80286	640 Kbyte	DT	5.25-in (1.2)	None	None	\$2,199.00
	Model 15	D1215A	(8 MHz)	640 Kbyte	DT	3.5-in (1.44)	None	None	\$2,199.00
	Model 20	D1220A		640 Kbyte	DT	5.25-in (1.2)	20	None	\$2,699.00
	Model 26	D1226A		640 Kbyte	DT	5.25-in (1.2)	20	VGA	\$2,999.00
	Model 27	D1227A		640 Kbyte	DT	3.5-in (1.44)	20	VGA	\$2,999.00
ES/12	Model 10	D1310A	80286	640 Kbyte	DT	5.25-in (1.2)	None	None	\$2,495.00
	Model 15	D1315A	(12 MHz)	640 Kbyte	DT	3.5-in (1.44)	None	None	\$2,495.00
	Model 20	D1320A		640 Kbyte	DT	5.25-in (1.2)	20	None	\$2,895.00
	Model 26	D1326A		640 Kbyte	DT	5.25-in (1.2)	20	VGA	\$3,195.00
	Model 27	D1327A		640 Kbyte	DT	3.5-in (1.44)	20	VGA	\$3,195.00
	Model 40	D1340A		640 Kbyte	DT	5.25-in (1.2)	40	None	\$3,295.00
	Model 46	D1346A		640 Kbyte	DT	5.25-in (1.2)	40	VGA	\$3,595.00
Model 47	D1347A		640 Kbyte	DT	3.5-in (1.44)	40	VGA	\$3,595.00	
QS/16S	Model 10	D1460A	80386SX	1 Mbyte	DT	5.25-in (1.2)	None	None	\$3,295.00
	Model 46	D1462A	(16 MHz)	1 Mbyte	DT	5.25-in (1.2)	40	VGA	\$4,395.00
	Model 47	D1464A		1 Mbyte	DT	3.5-in (1.44)	40	VGA	\$4,395.00
QS/20	Model 10e	D1420A	80386	1 Mbyte	DT	5.25-in (1.2)	None	None	\$4,495.00
	Model 15e	D1427A	(20 MHz)	1 Mbyte	DT	3.5-in (1.44)	None	None	\$4,495.00
	Model 46	D1422A		1 Mbyte	DT	5.25-in (1.2)	40	VGA	\$5,995.00
	Model 47	D1424A		1 Mbyte	DT	3.5-in (1.44)	40	VGA	\$5,995.00
	Model 100e	D1425A		1 Mbyte	DT	5.25-in (1.2)	108	None	\$6,999.00
RS/20C	Model 10e	D2001A	80386	1 Mbyte	DS	5.25-in (1.2)	None	None	\$5,699.00
	Model 100e	D2002A	(20 MHz)	1 Mbyte	DS	5.25-in (1.2)	103	None	\$7,595.00
	Model 150e	D2003A		1 Mbyte	DS	5.25-in (1.2)	155	None	\$8,195.00
	Model 154e	D2004A		4 Mbyte	DS	5.25-in (1.2)	155	None	\$10,145.00
RS/25C	Model 10e	D2021A	80386	1 Mbyte	DS	5.25-in (1.2)	None	None	\$7,349.00
	Model 100e	D2022A	(25 MHz)	1 Mbyte	DS	5.25-in (1.2)	103	None	\$9,549.00
	Model 150e	D2023A		1 Mbyte	DS	5.25-in (1.2)	155	None	\$10,149.00
	Model 154e	D2024A		4 Mbyte	DS	5.25-in (1.2)	155	None	\$12,549.00
	Model 304e	D2025A		4 Mbyte	DS	5.25-in (1.2)	310	None	\$14,399.00
LS/12	Model 24	D1024A	80L286	1 Mbyte	L	3.5-in (1.44)	20	CGA	\$4,999.00
	Model 44	D1044A	compatible (12/6 MHz)	1 Mbyte	L	3.5-in (1.44)	40	CGA	\$5,599.00

¹ A language option must be specified when ordering an HP Vectra PC (that is, option ABA for U.S. English).

² "e" denotes models with ESDI hard disk controller.

³ DT = Desktop DS = Deskside L = Laptop

PERSONAL COMPUTERS & TERMINALS

Computer Peripherals, Monitors and Accessories

Models D1181, D1180, D1182, D1187A, D1188A, 35723, D1183



The D1182A Color VGA Display is a 14-inch, medium-resolution monitor that offers excellent graphics display and very high quality text character formation.



The D1181 A/G/W Monochrome VGA Display is a 14-inch, medium-resolution monitor that offers the user 640 x 480 graphics, 64 shades of gray and a choice of amber, green or white phosphor.



The 20" D1187A and 16" D1188A Color Displays are multiscanning displays with superior display quality.

HP D1180A Video Graphics Adapter

The HP Video Graphics Adapter (D1180A) is the driving component for Hewlett-Packard's Video Graphics Subsystem. This IBM VGA register-compatible video card features software compatibility with MDA, Hercules, CGA, EGA and VGA video standards. The HP Video Graphics Adapter is fully compatible with the HP Video Graphics Color Display, the HP Monochrome Video Graphics Display, and other monitors compatible with IBM's VGA video interface.

The HP Video Graphics Adapter (HP VGA) offers a number of modes beyond the IBM VGA definition. These modes include 800 x 600 graphics resolution, 132-column text, and 640 x 480 graphics resolution with 256 colors. In each mode, colors can be selected from a palette of 262,144 colors.

HP D1181A Monochrome Video Graphics Display

The HP Monochrome Video Graphics Display (HP D1181) is specifically designed for use with the Vectra family of personal computers. It is plug-compatible with the industry-standard VGA monochrome monitors. HP's Monochrome Video Graphics Display is designed for use with the HP Video Graphics Adapter (D1180A).

The Monochrome Display offers a choice of screen colors, including amber, green and soft-white. The display supports resolutions varying from 320 x 200 to 640 x 480 and can display up to 64 shades of gray. It is ideal for text, graphics and image applications.

HP D1182A Color Video Graphics Display

The HP D1182 Color Video Graphics Display is a 14-inch, medium-resolution color display. It is designed for use by business professionals or by low-end CAD users. The high quality of the screen and the fine resolution of the display tube are ideal for use in environments requiring a high daily system utilization. This combination provides both excellent graphics (in resolutions up to 640 x 480) and very high quality text character formation.

The D1182 display offers an optional tilt/swivel mechanism (PN 82959S) for enhancing ease of use.

HP D1183A Touchscreen Plus

The HP D1183A Touchscreen Plus is a touchscreen interface designed for use with the HP D1182A Color Video Graphics Display. It transforms the display into an interactive touchscreen and provides an easy and comfortable method for interacting with the system.

HP 35723A Touch Accessory

The 35723A HP Touch Accessory is a 12-inch, user-installable touchscreen bezel. Adding the HP Touch Accessory to an HP-HIL-supported terminal transforms an ordinary screen into an interactive touchscreen and provides an easy and comfortable way of interacting with the system.

HP Touch has a maximum resolution of 2,451 touch points (43 vertical by 57 horizontal), which allows users to define touch areas of various shapes and sizes and allows programming flexibility for a wide range of applications.

HP D1187A/D1188A Color Displays

The HP D1187A, 20", and D1188A, 16", Color Displays provide superior display performance for personal computer and high-performance workstation users who need large screen and/or high resolution displays for various applications including: CAD, DTP, or windowing environments.

Through the use of multiscanning (multiple resolution) capability, both Color Displays work with a wide variety of video adapters providing video resolutions from VGA (640X480) through 1280X1024. In addition, automatic synchronization allows the displays to automatically sense and synchronize on resolutions pre-programmed into the digital, microprocessor controlled memory.

For convenience and ease of access, digital controls that provide repeatability and accuracy of adjustments are located on the front panel; plus each display offers an optional tilt and swivel base which gives the user control of the display's viewing angle, and allows adjustment for room lighting.

Ordering Information

		Price
HP D1182A/B	VGA Color Monitor	\$695
HP D1183A	HP Touch Accessory	\$530
HP 35723A	Touch Accessory	\$530
HP D1184A	VGA Cable	\$60
HP 35731A	Monochrome Monitor	\$350
HP 35731B	Monochrome International	\$370
HP 35741A/B	Color Monitor	\$1290
HP D1180A	HP Video Graphics Adapter	\$495
HP D1181A/G/W	Monochrome Monitor	\$298
HP D1187A	20" Color Display	\$3,695
HP D1188A	16" Color Display	\$2,795

PERSONAL COMPUTERS & TERMINALS

677

Terminals should provide a comfortable interface with the computer. Hewlett-Packard terminals are designed to work in harmony with the user, offering features like crisp, clear characters, smooth tilt/swivel positioning and excellent tactile feedback from keyboards to add to your comfort and increase your productivity.

To select the right terminal to meet your needs (whether it's an HP, IBM, DEC or other ASCII system), refer to the matrix below.

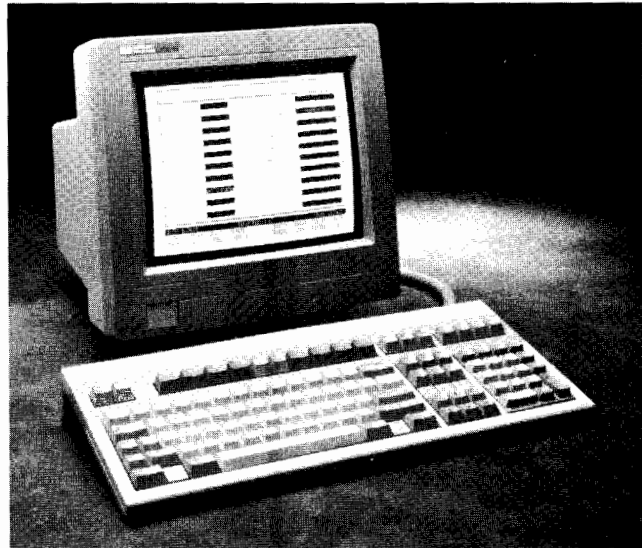

	HP SYSTEMS		ASCII SYSTEMS		PC SYSTEMS	DEC SYSTEMS	DEC SYSTEMS	IBM SYSTEMS	HP SYSTEMS (GRAPHICS)	
	HP 700/92	HP 700/94	HP 700/41	HP 700/43	HP 700/44	HP 700/22	HP 700/32	HP 700/71	2393A	2397A
Compatibility Modes	2392A DEC VT220 DEC VT100 DEC VT52	2394A DEC VT220 DEC VT100 DEC VT52	Wyse 30 TV905,910+,925E ADM 3A,5 Hazeltine 1500 ADDS VP A2 Qume 101	Wyse 30,50 TV905,910+,925E, 950, ADM 3A,5,31 Hazeltine 1500 ADDS VP A2 Qume 101	PC Term DEC VT220 DEC VT100 DEC VT52	DEC VT220 DEC VT100 DEC VT52	DEC VT320 (VT220) DEC VT100 DEC VT52	IBM 3191 Model A,B	TEK 4010/4014 ANSI x 3.64	TEK 4010/4014 ANSI x 3.64
Phosphor Colors	Green, Amber, Soft White	Green, Amber, Soft White	Green, Amber	Green, Amber, Soft White	Green, Amber, Soft White	Green, Amber, Soft White	Green, Amber, Page White	Green, Amber, Soft White	Green	Color 8/64
Pages of Memory	8	16	1	4	4	4	4	1	9	9
132 Column	yes	yes	no	yes	yes	yes	yes	no	Scrolled	Scrolled
Printer Port	yes	yes	yes	yes	yes	yes	yes	no	Opt: serial,HP-IB Centronix Parallel	
Keyboard Layout	HP	HP	ASCII	ASCII	PC AT2	DEC VT220	DEC VT320	IBM 3191, 102 or 122 Typewriter ASCII Data Entry	HP	HP
Warranty	1 Year	1 Year	1 Year	1 Year	1 Year	1 Year	1 Year	1 Year	90 Day	90 Day
Additional Features	VPLUS Compatible Barcode reader support	VPLUS Compatible Forms Cache Local Edit checks Modified data tag Barcode reader support	58 Programmable keys	58 Programmable keys Bidirectional printer port	IBM PC character set Bidirectional printer port 75 Programmable function keys in PC term mode	30 Programmable keys in VT220 mode Barcode reader support	Full overscan, 27, 44 or 55 lines 60 Programmable Keys	Keylock	I/O Device Support: Touch Screen, Graphics Tablet, Mouse, Barcode reader	
Price	\$895	\$1150	\$429	\$499	\$599	\$529	\$575	\$745	\$2500	\$3925

DEC VT220, DEC VT320, VT100 and VT52 are products of Digital Equipment Corporation.
IBM is a registered trademark of International Business Machines.
WY-30 and WY-50 are products of Wyse Technologies Systems.
TeleVideo 905, 910+, 925E and 950 are products of TeleVideo Systems, Inc.

ADM3A, ADM5 and ADM 31 are products of Lear Siegler Corporation.
Hazeltine 1500 is a product of Esprit Systems, Inc.
ADDS Viewpoint A2 is a product of Applied Digital Data Systems, Inc.
QUME QVT-101 is a product of Qume Corporation.

COMPUTER PERIPHERALS

Terminals - Rugged

Industrial Touch Display Terminal

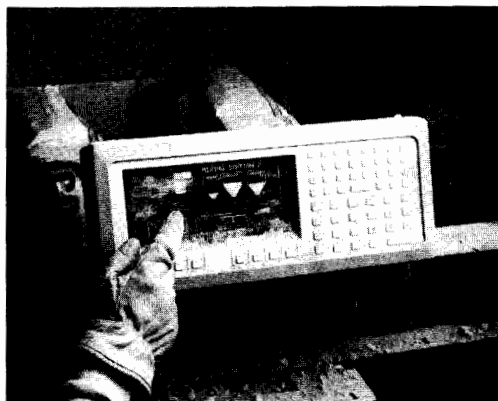

HP 3082B

Description

The HP 3082B Industrial Touch is a compact, sealed, and rugged display terminal designed for factory-floor use in process and discrete manufacturing industries.

Applications for the HP 3082B range from process monitoring and statistical quality control to batch tracking and barcode data entry.

The HP 3082B operates with Hewlett-Packard's complete line of HP 1000, HP 9000, and HP 3000 computer systems. It also operates on Digital Equipment Corporation's computer systems while in VT100 emulation mode.

The HP 3082B is easy to use, takes minutes to install, has built-in screen editors to make custom screens easy to create, and is highly reliable in the harsh environment on the factory-floor.

It features a full-screen display with character-graphics capability, an alphanumeric keypad, and a set of programmable, screen-labelled function keys. The HP 3082B is available with optional touchscreen and an internal barcode decoder that allows a range of barcode devices to operate with the terminal.

A mounting bracket is included with the HP 3082B so that it can be installed in minutes. The compact size and tilt-adjustable display allow it to be located and positioned for operator efficiency. It can be secured to a swing-arm, a railing, a wall, or an I-beam, and optional brackets are available for 19-inch rack mounting.

The HP 3082B withstands high levels of shock and vibration and is completely sealed against water, oil, and dust contamination (NEMA 4, 4X, 12 and 13 rated - excluding freezing). The terminal operates from 0 deg C to 50 deg C (32 deg F to 122 deg F) and contains no fans or moving parts.

The compatibility of the HP 3082B terminal allows it to operate with a range of existing software packages. For custom applications, a set of firmware-based screen editors allow forms, touch targets, or character graphics to be generated quickly using an HP mouse or an HP QWERTY keyboard. A Value-Added Business (VAB) bundled development kit is also available to allow third-parties to create software solutions for the HP 3082B Industrial Touch terminal.

- Compact
- Sealed
- Rugged

Features

- Easy to Use
 - Touchscreen and barcode input
 - Data entry from built-in keypad
 - Programmable function keys
 - Character graphics display
- Easy to Install
 - Emulates HP 2392A terminal
 - Emulates DEC VT100/VT52 terminal
 - Compact and light weight
 - Adjustable mounting bracket
- Easy Application Development
 - Firmware-based screen editors
 - Forms, touch, and graphics
 - Quick screen design with mouse
- High Quality and Reliability
 - Designed for harsh environments
 - Water, oil, and dust resistant
 - Fan and filter-free enclosure
 - Withstands high levels of shock and vibration

Ordering Information

	Price
HP 3082B Industrial Touch Terminal	\$3575
Opt 001 Add touchscreen	+\$565
Opt 002 Add barcode decoder	+\$310
Opt 003 Add touchscreen and barcode decoder	+\$830
Opt 801 Conduit kit (Canada)	\$0
Opt 802 Water-tight kit (U.S.)	\$232
Opt 803 Water-tight kit (other countries)	\$129
Opt 908 19-inch rack mount kit	\$62
Opt 910 Host programmer's & user and screen designer's manuals	\$87
Opt W03 Substitute 90-day on-site for 1-year return to HP warranty	\$0
HP 3082U Value-Added Business Development Kit	\$4795
Includes: 3082B with options 003 and 910, HP-HIL mouse, HP-HIL keyboard (US) & cable, and a barcode wand	

COMPUTER PERIPHERALS

Dial-Up Modem

Model 37212B

679

- 2400/1200/300 bps full duplex
- Error correcting (MNP) protocol
- Auto-dial/auto-answer

- PSTN or leased line selection
- Synchronous or asynchronous
- Alternative control channel for DS and synchronous applications

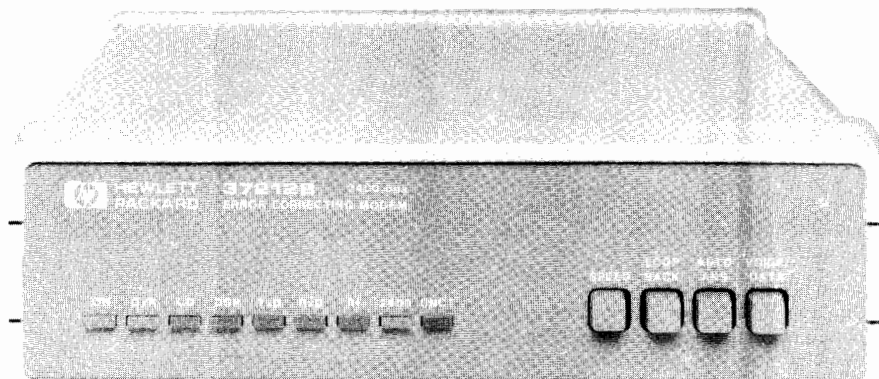

HP 37212B

Universal V22 Bis Modem

The new HP37212B modem is a high performance multi-function modem offering a wide range of features to suit virtually any application. Numerous configuration options ensure optimum performance for both HP and non-HP systems.

For Corruption Free Data Links

Without error control, transmission on a typical 2400 bps line would probably result in an error every minute. The HP 37212B uses the industry standard MNP error correcting protocol which allows data to be transferred reliably and without errors regardless of noisy phone lines.

With error correction enabled, the HP 37212B can automatically drop back to transparent communication when connecting to a non-error correcting modem. Alternatively it can be set to lock-out communication with non-error correcting modems.

Given an error free line, no noticeable degradation of speed results from using error correction. There is a choice of Flow control methods CTS, ENQ/ACK or XON/XOFF.

Three Command Modes

Terminal mode provides a user friendly way to operate the HP 37212B directly from the keyboard of a terminal or PC. The user is prompted for correct key sequences to obtain particular functions and status information.

Computer mode is optimized to simplify the programming required for a computer to control the modem automatically. Commands are accepted by the modem, but it will not echo or reply unless specifically requested to do so. This ensures that the computer will not receive any unexpected characters from the modem. Status information is represented by a string of eight ASCII characters instead of descriptive text.

Manual command mode allows the HP 37212B to be operated using front panel control switches.

Two Control Channels

Normally, the control channel is through the RS-232-C (CCITT V.24) data interface, however, some computers or devices (eg. DS cards) are unable to output configuration or dialing commands through their data channel. For this reason, the HP 37212B offers an alternative control channel to be selected on the RS-232-C port. A 'Y' cable (Part number HP 15614A) can be used to break out the secondary control channel onto a separate RS-232-C port.

Four Modulation Standards

Can communicate with a broad spectrum of industry standard modems.

Bell 103 (FSK) at 300 bps	Asynchronous
Bell 212A (DPSK) at 1200 bps	Asynchronous/Synchronous
CCITT V.22 (DPSK) at 1200 bps	Asynchronous/Synchronous
CCITT V.22 bis (QAM) at 2400 bps	Asynchronous/Synchronous

Worldwide Regulatory Approvals

The HP 37212B conforms to the regulations of telephone approval authorities in several countries. The local HP field office will be able to provide up-to-date information on the connection approval status in your country.

Flexible Telephone Connection

Both North American and UK style telephone sockets are provided. In addition to sockets for the modem/telephone line, extra sockets are provided for use with an adjacent telephone. This allows telephone communication to take place while the modem is not in use and also enables manual-dial or manual-answer operation.

Convenience Features

NON-VOLATILE MEMORY stores telephone numbers, log-on strings and modem configuration for speedy operation.

PULSE OR TONE DIALING ensures dialing compatibility with most telephone systems.

LEASED LINE OPERATION a single modem for both leased line (2-wire) or dial-up operation.

INTEGRAL LOUDSPEAKER monitors call progress without requiring an adjacent telephone.

DIAGNOSTIC AND SELF TESTS allow users to verify both line quality and modem operation without the need for special equipment.

INTEGRAL 120/240V POWER SUPPLY eliminates the need for an external transformer.

RACK MOUNT KIT allows one or two HP 37212Bs to be mounted in standard 19" equipment racks.

DC POWER OPTION simplifies incorporation into systems isolated from an AC (line) supply.

SHORT-HAUL APPLICATIONS For applications up to 3000m. connecting computers, instruments or printers on HP-IB, consider the HP 37204A/B HP-IB bus extenders. See page 571 for further information.

Ordering Information

HP 37212B Stand Alone Modem

Opt W30 Three years of customer return repair service

Price

\$985

+ \$50

COMPUTER PERIPHERALS

Personal Data Storage

Models 9122C, 9127A, 9153C

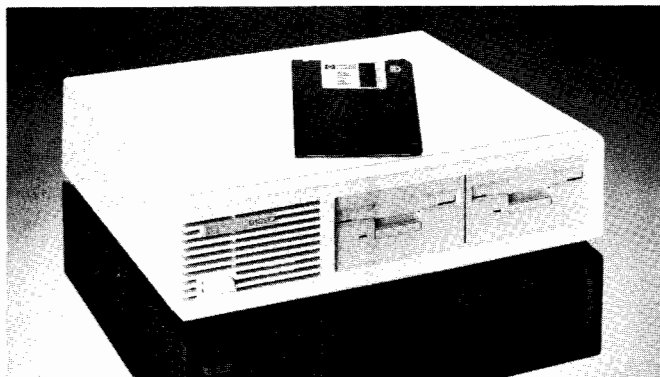

HP 9122C

Hewlett-Packard offers a full line of data storage solutions to fit a wide range of personal or technical computer requirements. HP's disk drives cover a variety of prices, capacities and performance levels.

3.5" Microfloppy Personal Data Storage Solution

HP 9122C 3.5" Drive

The HP 9122C is a 3.5" microfloppy disk drive with an unformatted capacity size of 2 megabytes (1.42 megabytes, formatted). It is tailored for the measurement automation and technical system markets and comes in a single - or dual - drive configuration.

The 2 megabyte capacity size is twice that found in previous models but is offered at the same price. It is ideal for backup, increased storage and file transfers among systems of the same type.

The HP 9122C employs an ANSI-standard format-sensing mechanism to differentiate 2-megabyte diskettes from those of other capacities. Existing 1-megabyte and 0.5-megabyte media can be used in the HP 9122C, but new 2-megabyte media must be used only in 2-megabyte drives.

Features

- 2-megabyte (unformatted) 3.5" microfloppy
- Doubled capacity at yesterday's price
- Quiet operation
- Reliable design
- Supported on HP 9000 Series 200/300
- Supported on HP 1000 A Series

Hard Disk Personal Data Storage Solution

HP 9153C - 10, 20 and 40 Megabyte Winchester Hard Disks

The HP 9153C is a highly reliable and rugged desktop disk drive offering users a choice of capacities, ability to expand storage size and optional 2-megabyte 3.5" microfloppy.

The drive is well-suited for industrial, office automation, factory-floor and low-end CAD environments.

By offering the HP 9153C in 10, 20 and 40 megabytes, HP lets customers choose the capacity size most beneficial to their needs. Customers initially purchasing the 10 or 20 megabytes models may elect to expand their capacities to 30 or 40 megabytes, respectively, with the HP 9153M. This product is a 20-megabyte upgrade kit that is installed on the original HP 9153C package. The HP 9153M mechanism is priced less than a disk subsystem of equal capacity.

The exceptional design of the HP 9153C is due to the integration of HP's own 3.5" Winchester disk mechanism which has proven its resiliency in even the harshest environments.

An optional 2-megabyte (unformatted) 3.5" microfloppy is available with any hard disk model.

Features

- 10, 20 or 40 megabytes
- Optional 2-megabyte (unformatted) 3.5" microfloppy
- Integrates HP's own 3.5" Winchester
- HP 9153M expands capacities of 10- and 20-megabyte models

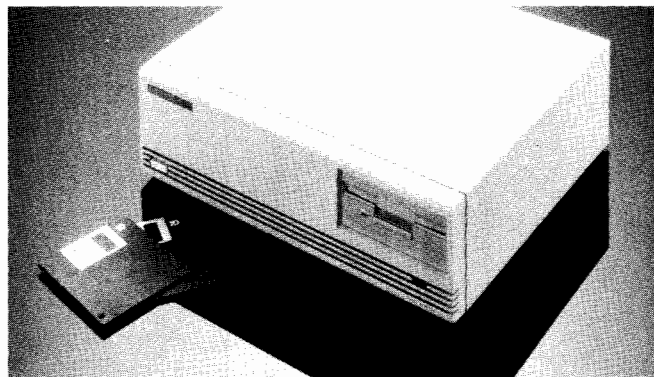

HP 9153C

- Rugged and reliable
- Data protection
- Supported on HP 150C
- Supported on HP 9000 Series 200/300 and HP 1000 A Series
- Supported on HP 64000

Safety

The HP 9122C and HP 9153C disk drives meet all applicable safety standards of the following

- UL 478 fifth Edition
- IEC 380 and 435
- CSA C22.2 No 220 (HP 9153C)
- CSA C22.2 No 154 (HP 9122C)

Data Interchange

HP 9127A—Single 5.25" Flexible Disk Drive

The HP 9127A is a single 5.25" disk drive that gives the HP Touchscreen and Touchscreen II data compatibility with the IBM-PC via 5.25" disks. Connected by HP-IB to the Series 300 (via DOS coprocessor card) and Touchscreen computers, the drive can read, write, and initialize disks in IBM-PC format as well as HP format. The disks can be moved between IBM and HP computer systems for easy data exchange. The 9127A can also read copy-protected DOS software with the HP Series 300 DOS coprocessor card.

Ordering Information

	Price
HP 9122C Dual 2 Mbyte 3.5" Microfloppy	\$1,465
Opt 001 Deletes one microfloppy mechanism	\$-315
HP 9127A Single-sided 5.25" Flexible Disk Drive	\$1,090
HP 9153C	
Opt 010 10 Mbyte hard disk plus floppy	\$1,980
Opt 011 10 Mbyte hard disk only	\$1,725
Opt 020 20 Mbyte hard disk plus floppy	\$2,795
Opt 021 20 Mbyte hard disk only	\$2,435
Opt 040 40 Mbyte hard disk plus floppy	\$3,640
Opt 041 40 Mbyte hard disk only	\$3,305
WO 3 Subs 90-day on-site warranty for 1-year return to HP warranty	\$0
HP 9153M 20 Mbyte mechanism Upgrade Kit	\$1,015
HP 88500A IBM Disk/Tape Interface	\$410
HP 91290A 5.25" HP Qualified Media (Box of 10)	\$25
HP 92192A 3.5" 1.0-Mbyte Double-sided Microfloppy (Box of 10)	\$39
HP 92192X 3.5" 2.0-Mbyte Double-sided Microfloppy (Box of 10)	\$79
HP 19500B Rack Slide Kit to mount 9122C or 9153C in 19" EIA cabinet	\$125
☎ Fast ship product see page 734	

- High reliability
- Self-test compatibility
- Compact design



HP 7959S

HP 7957S, 7958S, and 7959S Disk Drives

The HP 7957S, 7958S, and 7959S are the first Hewlett-Packard disk drives to employ the Small Computer System Interface (SCSI). The HP SCSI bus can transfer data asynchronously at up to 1.5 Mbytes per second between the disk controller buffer and host. Their compact size and high performance make these disk drives ideal for technical workstation applications. These drives are currently supported only on the HP 9000 Series 300 SCSI computers (running HP-UX).

The reliability of the HP 7957S, 7958S, and 7959S disk drives is based on seven generations of disk drive design and manufacturing experience at Hewlett-Packard. The HP-designed and built 5.25-inch Winchester mechanism is the foundation of the drives. Their average seek time is 17.5 milliseconds.

Service of these disk drives is enhanced by extensive self-test capabilities, error logging, and a package design that allows quick access to replaceable assemblies. The result is lower overall cost of ownership.

Features

- 107 megabytes (formatted), HP 7957S
- 161 megabytes (formatted), HP 7958S
- 323 megabytes (formatted), HP 7959S
- 17.5 ms seek time
- 1.5 megabytes/second burst transfer rate
- Compact packaging (132Hx325Wx285mmD)
- Quiet operation
- Integrates Hewlett-Packard's own 5.25" Winchester mechanism
- Quick access to all replaceable assemblies

Safety

The HP 7957S, 7958S and 7959S disk drives meet all applicable safety standards of the following:

- IEC 380 and IEC 478 compliant
- UL listed 114 and 478
- CSA 22.2 No. 154 and No. 220
- VDE 0730 Part II

Electromagnetic Emissions

Radiated and magnetic interference:

- For U.S.A., complies with FCC docket 20780 for Class B computing peripheral devices.
- For Europe, designed to meet EMI level FTZ 1046/84 and provide a Manufacturer's Declaration.

Refer to your local HP office for more information.

Ordering Information

Price

The HP 7957S, 7958S, and 7959S include a hard disk drive, integral controller, power supply, power cable, and standalone cabinet. The SCSI cable and bus terminator are included with the HP 9000 Series 300, Option 011 products. Additional SCSI cables must be ordered separately if more than one disk drive is connected.

HP 7957S Disk Drive (107 megabytes)	\$3,875
HP 7958S Disk Drive (161 megabytes)	\$4,325
HP 7959S Disk Drive (323 megabytes)	\$7,225
Opt 015 for non-U.S. shipments, voltage set for 230V operation	\$0
Opt W03 Extended Repair Service. See page 725.	\$0
HP 19500B Rack mount kit for mounting in a standard 19-inch EIA cabinet	\$125
HP 92211R Desk-high cabinet	\$585
1252-2297 SCSI terminator	\$0
92222A 0.5 m SCSI peripheral interface cable	\$49
92222B 1 m SCSI peripheral interface cable	\$55
92222C 2 m SCSI peripheral interface cable	\$59
92222D 1 m SCSI extender cable	\$55

COMPUTER PERIPHERALS

Data Storage for Technical/Commercial Systems

HP 7957B, 7958B, 7959B, 7962B, 7963B

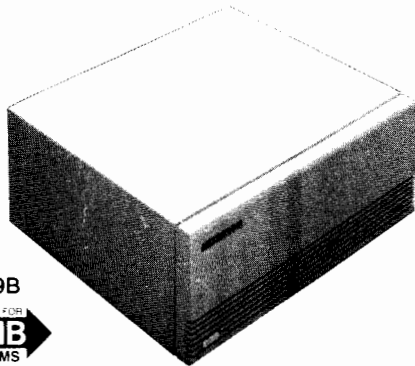

HP 7959B



HP 7957B, 7958B and 7959B Disk Drives

The HP 7957B (81 megabytes), 7958B (152 megabytes) and 7959B (304 megabytes) are 5.25" disk drives that offer the capacity and performance demanded by today's commercial and technical multi-user systems and engineering workstations. These disk subsystems each feature an average seek time of 17 ms and burst data transfer rate of 1.25 megabytes per second.

The compact packaging of the HP 7957B, 7958B and 7959B allows them to be tucked away in HP's attractive mini-rack cabinetry, or placed unobtrusively on a desktop. There is, of course, a rack-mount kit available for 19" EIA cabinetry, and, with a sound power level of 52 dB(A), each drive is suitable for the office or lab environment.

The foundation of this new product family is HP's own designed and built 5.25" Winchester mechanism. This high performance mechanism features a special track positioning system that essentially eliminates seek errors. Plus, it enhances read/write accuracy over the entire operating range. The ability to service the products is enhanced by error-logging, autosparing and self-test capabilities. And low monthly maintenance costs contribute to low overall cost of ownership.

Features

- 81 megabytes (formatted), HP 7957B
- 152 megabytes (formatted), HP 7958B
- 304 megabytes (formatted), HP 7959B
- 17 ms average seek time
- 1.25 megabyte/second burst transfer rate
- Compact packaging (132H x 325W x 285mmD)
- Quiet operation
- Integrates HP's own 5.25" Winchester
- Automatic error correction and error logging
- Quick access to all replaceable assemblies
- CS/80 instruction set

Available in initial configurations of 152 and 304 megabyte capacities, the HP 7962B and 7963B disk drives provide lasting value at an affordable price.

The efficient package design accommodates up to three HP Winchester mechanisms. Users initially purchasing a subsystem with one mechanism can later install as many as two additional stand-alone mechanisms - all to the original package.

These stand-alone mechanisms are available as 152 or 304 megabyte upgrade kits. Both upgrade kits are attractively priced to provide a growth path that's lower in price than equivalent, but separately packaged, disk drive subsystems.

The HP 7962B and 7963B integrate HP's own designed and manufactured 5.25" Winchester mechanism. This mechanism provides a fast seek time, high reliability and excellent performance.

Channel optimization is another key feature of this disk family. Similar to rotational position sensing, channel optimization increases performance by allowing multiple disks to better utilize a single HP-IB channel.

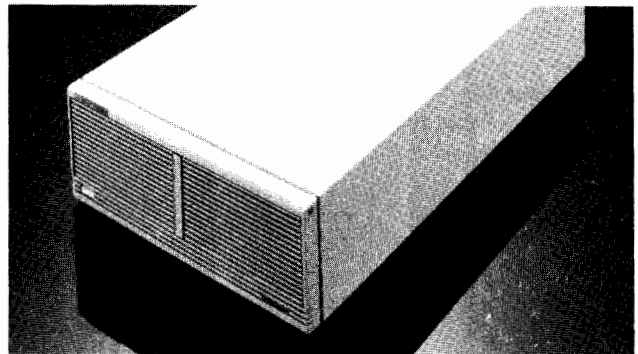

HP 7963B



Features

- 152 megabytes (formatted), HP 7962B
- 304 megabytes (formatted), HP 7963B
- Additional capacity can be placed in original package at a later date
- 152 and 304 megabyte upgrade kits available
- Integrates HP's own 5.25" Winchester
- 17 ms average seek time
- 1.25 Mbyte/s burst transfer rate
- Compact size (132H x 325W x 554mmD)

Electromagnetic Emissions

Radiated and conducted interference:

- For U.S.A., meets FCC docket 20780 for Class B computing peripheral devices.
- For Europe, meets EMI level FTZ 1046/84 and provides a Manufacturer's Declaration.

For more information, contact your local HP office.

Safety

The HP 7957B, 7958B, 7959B, 7962B and 7963B meet all applicable safety standards of the following (the HP 97962B and 97963B upgrade kits meet the same standards when installed in the HP 7962B or 7963B):

- IEC 380 and 435
- UL 114 and 478
- CSA C22.2 no. 154
- CSA C22.2 no. 220 (7957B, 7958B, 7959B)

Ordering Information

	Price
HP 7957B (81 megabytes)	\$3,575
HP 7958B (152 megabytes)	\$4,775
HP 7959B (304 megabytes)	\$7,725
HP 7962B (152 megabytes with upgrade capability)	\$5,275
HP 7963B (304 megabytes with upgrade capability)	\$8,575
Opt 015 for non-U.S.A. shipments, voltage set for 230V operation	\$0
Opt 550 Delete 1-metre HP-IB cable	\$-80
Opt W03 Converts 1-year return-to-HP warranty to 90-day on-site warranty	\$0
HP 97962B (152 megabyte upgrade kit with controller)	\$3,750
HP 97963B (304 megabyte upgrade kit with controller)	\$6,000
Opt D02 Deletes HP installation	\$-100
Opt W03 Converts 1-year return-to-HP warranty to 90-day on-site warranty	\$0
HP 19500B Rack kit for mounting HP 7957B, 7958B or 7959B in 19" EIA rack enclosure	\$125
HP 19560B Rack kit for mounting HP 7962B or 7963B in 19" EIA rack enclosure (HP 12679C rack rails required)	\$125

COMPUTER PERIPHERALS

Data Storage for Technical/Commercial Systems

Models 7936H, 7937H, 7936XP, 7937XP, 7936FL and 7937FL

683

- High reliability
- Compact size
- Low power consumption
- Choice of controllers

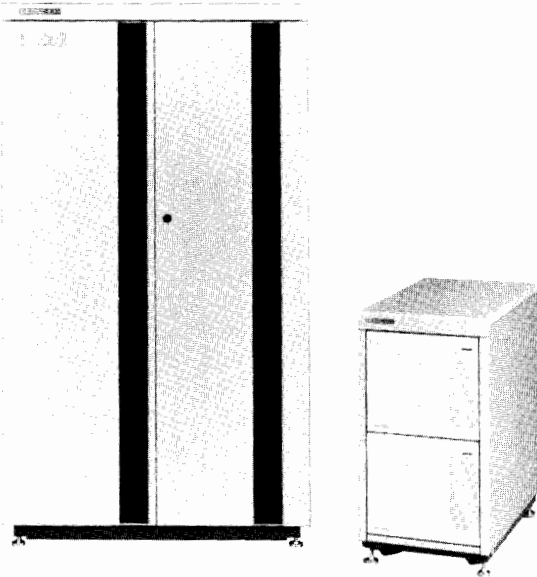

The HP 19524 subsystem (holding 8 HP 7937s) and the HP 19521 subsystem (holding 2 HP 7937s)

HP 7936H and HP 7937H

The HP 7936H and HP 7937H disk drives are fixed media storage devices that provide formatted storage capacity of 307 and 571 megabytes, respectively. These Winchester disk drives incorporate sealed head/disk assembly (HDA), extensive VLSI, and HP-developed sputtered thin film media. As a result, excellent performance, reliability, and floorspace utilization are available at an attractive price.

Designed to meet the performance demands of present as well as future computer systems, the HP 7936H and HP 7937H disk drives offer high density storage and compact size. Ideal for a broad range of multi-user computer systems, these disk drives provide low per-megabyte storage costs and require low power consumption. Compatibility with the basic standard of HP-IB and CS/80 guarantees operations on existing and future HP 3000, HP 9000, and HP 1000 computers.

HP 7936XP and HP 7937XP

These disk drives are the same as those described above, but contain controller cache as an included feature. The cache contains two megabytes DRAM for read cache coupled with a single-instruction write cache. Performance can increase 10-20% on most systems.

HP 7936FL and HP 7937FL

These disk drives integrate the new HP-FL controller, one of four components found in the HP-FL fiber-optic link. This link is supported only on HP Precision Architecture Systems and is made up of the disk drive controller, CPU interface card, a fiber-optic cable, and PBus cable to daisychain multiple disks. The HP-FL link provides support of large mass storage configurations (up to 32 drives on some models), and cable lengths of up to 500 meters. In addition, the CPU interface to disk controller burst transfer rate is 5 megabytes per second. And because data is transmitted via light, the fiber-optic cable is

immune to electromagnetic interference and does not emit radio frequency energy.

Features

- 307 megabytes, (formatted) HP 7936
- 571 megabytes, (formatted) HP 7937
- 20.5 ms seek; 8.33 ms ave latency
- Modular packaging
- Choice of controllers
- Available in large mass storage configurations
- MTBF of 70,000 hours

HP 19521, 19522 and 19524

You can order the HP 19521, 19522, and 19524 which combines multiple 7937s plus a cabinet as one product. Standard ("H"), cache ("XP"), or fiber-optic ("FL") models can be purchased in 1.1-Gbyte, 2.2-Gbyte and 4.5-Gbyte solutions.

Electromagnetic Emissions

Radiated and conducted interference:

- For U.S.A., designed to meet FCC Docket 20780 for Class B computing peripherals devices.
 - For Europe, designed to meet EMI level FTZ 1046/84 requirements and provides a Manufacturer's Declaration.
- For more information, call your local HP office.

Safety

The HP 7936H/7937H, HP 7936XP/7937XP and HP 7936FL/7937FL meet all applicable safety standards of the following:

- IEC 380 and 435
- UL 114 and 478
- CSA C22.2 no 143 and 154

Ordering Information

	Price
HP 7936H (307 megabytes)	\$14,250
HP 7937H (571 megabytes)	\$15,700
HP 7936XP (307 megabytes + 2 Mbytes cache)	\$15,050
HP 7937XP (571 megabytes + 2 Mbytes cache)	\$16,500
HP 97520XP (Controller cache upgrade)	\$3,315
HP 7936FL (307 Mbytes + HP-FL controller)	\$14,800
HP 7937FL (571 Mbytes + HP-FL controller)	\$16,250
HP 97522FL (HP-FL controller upgrade)	\$3,315
HP 19511A (Cabinet for 2 HP 7936/37 drives)	\$1000
HP 19512A (Mounting kit for 19" EIA cabinet)	\$265
HP 19514A (Cabinet for 8 HP 7936/37 drives)	\$5,000
HP 19521H (2 7937H drives with 19511A cabinet)	\$31,825
HP 19522H (4 7937H drives with 19514A cabinet)	\$65,300
HP 19524H (8 7937H drives with 19514A cabinet)	\$125,600
HP 19521XP (2 HP 7937XP drives with HP 19511A cabinet)	\$33,425
HP 19522XP (4 HP 7937XP drives with HP 19514A cabinet)	\$68,500
HP 19524XP (8 HP 7937XP drives with HP 19514A cabinet)	\$132,000
HP 19521FL (2 HP 7937FL drives with HP 19511A cabinet)	\$32,925
HP 19522FL (4 HP 7937FL drives with HP 19514A cabinet)	\$67,500
HP 19524FL (8 HP 7937FL drives with HP 19514A cabinet)	\$130,000
Opt 015 (50 Hz operation)	\$0
Opt 017 (230 VAC operation)	\$0

COMPUTER PERIPHERALS

Data Storage, Rewritable Optical

HP Series 6300, Models 650/A, 20GB/A

- High capacity
- Durable, removable media
- ANSI/ISO standard continuous composite format
- Reliable, rugged design

Direct Access Secondary Storage

Hewlett-Packard's rewritable optical disk drive products for the HP 9000 Series 300 fill the gap between high-performance hard disks and low-cost tape storage. This is the perfect storage solution for information that consumes large portions of expensive hard disk space but is needed for immediate access and revision. The optical drive is approximately three times slower than a high performance hard disk drive, but more convenient than tape backup because the optical disk provides random access and does not require an operator.

ANSI/ISO Standards

In keeping with industry standards, the rewritable optical products implement Small Computer Systems Interface (SCSI) and ANSI/ISO accepted continuous composite format.

Durable, Removable Media

Hewlett-Packard's rewritable optical products feature reusable media that is compact and removable, making storage and transport simple. Because the data resides on the disk's inner recording layer, it is not threatened by finger prints or minor damage to the outer surface. Data is not susceptible to head crashes, most magnetic interference, and damage from common office mishandling. The media accepts unlimited read-write passes without data degradation and can be stored for at least 10 years. The 5.25-inch disk cartridge slips easily into a briefcase for transport or into a safe for security.



HP Series 6300 Model 650/A

HP Series 6300 Model 650/A Rewritable Optical Disk Drive

High Capacity

The standalone rewritable optical drive is supported by HP-UX 6.5. It provides 650 megabytes of storage, 325 megabytes per side. The storage capacity is infinitely expandable without additional drives by purchasing more media.

Ordering Information

The Series 6300 Model 650/A standalone drive includes the disk drive, controller, power supply, subsystem package, user guide, power cord and one 1024-byte sector rewritable optical disk cartridge, which holds 650 megabytes of formatted data.

HP C1701A Rewritable Optical Disk Drive with one optical disk cartridge

Opt 1AK delete optical disk cartridge

Opt 1BB add 3 optical disk cartridges

Opt AF3 add 1 meter SCSI cable

See technical data sheet 5959-9906 for specific information.

Price

\$6,435

-\$245

+\$700

+\$55

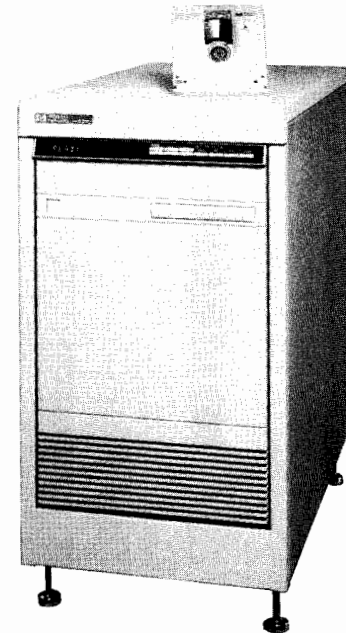

HP Series 6300 Model 20GB/A



The HP 6300 Model 20GB/A Optical Disk Library System

High Capacity

The library system is supported on HP-UX 7.0. It provides unattended access to 20.8 gigabytes of data. This direct access secondary storage library holds up to 32 rewritable optical disks. An autochanger delivers the disk cartridges to two rewritable optical drives, allowing unattended access to previously operator-intensive offline data.

Reliable, Rugged Design

The Model 20GB/A optical disk library system also meets Hewlett-Packard's high standards for reliability. The unique autochanger minimizes motors, sensors, and cables. This uncluttered design accounts for the projected 20,000 hours mean-time-between-failures, or one million cartridge exchanges.

Ordering Information

The Model 20GB/A includes two 5 1/4-inch rewritable optical disk drives, an autochanger, 32 rewritable optical disk cartridges, and a mobile mini cabinet.

Price

TBA

HP C1711A Optical Disk Library System with 32 optical disk cartridges

Opt 231 delete 31 optical disk cartridges

Opt AFJ add 2 meter SCSI cable

Opt W30 Extended Repair Service. See page 725.

Opt W31 On-site Repair Service. See page 725.

See Product Brief PN 5952-0328 for more information

TBA

TBA

TBA

TBA

COMPUTER PERIPHERALS

Tape Drives

Models 35401A, 9144A, 9145A, 7980XC, 7980A, 7979A

685

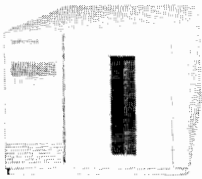

HP 35401A 1/4-inch Cartridge Autochanger Tape Drive



HP 9144A 1/4 inch Cartridge Tape Drive

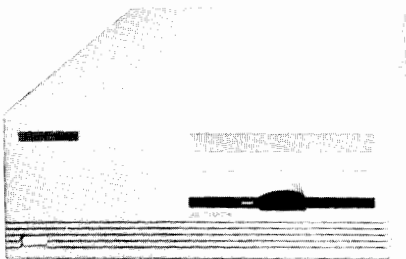

HP 9145A 1/4 inch Cartridge Tape Drive

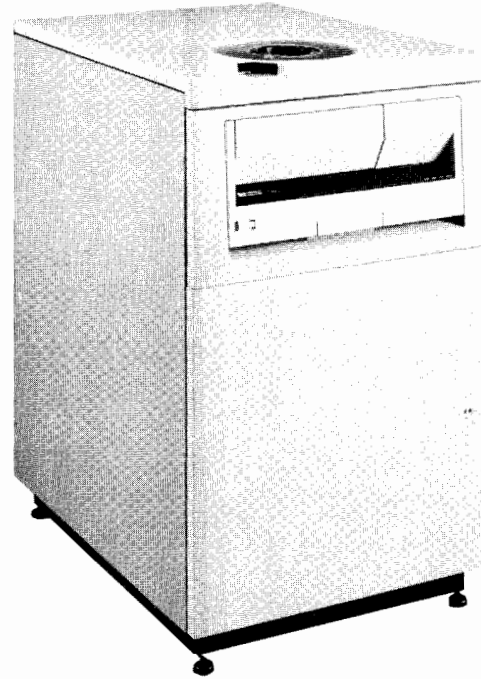

HP 7980XC, HP 7980A and HP 7979A 1/2-inch Magnetic Tape Backup Systems

1/4-inch Tape Backup Solutions

HP offers a range of 1/4-inch cartridge tape drive solutions which are suitable PCs, technical and business systems. Products are available which offer low cost, high performance and high capacity.

HP 9144A 1/4-inch Cartridge Tape Drive

The HP 9144A provides a low-cost backup solution for technical and small business systems, providing 67 Mbytes of data storage on each 16-track cartridge tape. The HP 9144A provides a more convenient and reliable backup alternative to multiple floppy disks.

HP 9145A 1/4-inch Cartridge Tape Drive

The HP 9145A is a high performance cartridge tape drive for technical and small business systems. The HP 9145A has a transfer rate of 4 Mbytes per minute and stores 133 Mbytes of data per cartridge tape. The HP 9145A reads and writes data to 32-track cartridges but can read only 16-track cartridges maintaining compatibility with existing 1/4-inch cartridge tape drives.

HP 35401A 1/4-inch Cartridge Autochanger Tape Drive

The HP 35401A provides a high capacity unattended backup solution for business systems and technical workstation networks.

This 1/4-inch cartridge drive can store up to 536 Mbytes of data with no operator intervention necessary. It uses 16-track cartridge tapes and has the same cartridge and data format as the HP 9144A.

The HP 9144A and HP 9145A are available in built-in versions for Micro 3000 GX/LX systems.

Ordering information

Model	Price
HP 9144A 1/4-inch cartridge tape drive (16-track)	\$2600
HP 9145A 1/4-inch cartridge tape drive (32-track)	\$4055
HP 35401A 1/4-inch cartridge autochanger tape drive (16-track)	\$8150

1/2-inch Tape Backup Solutions

HP 7980XC, HP 7980A and HP 7979A 1/2-inch Tape Drives

These compact autoloader tape drives offer high reliability, reducing basic monthly maintenance costs as much as 50%. The drives are mounted horizontally in a one-meter high, standard 19-inch wide rack. Another tape drive or disc drive can be mounted beneath the existing drive. The HP 7979A provides a low-cost backup solution for systems requiring between 100 and 500 megabytes of disc backup. It offers 1600 cpi density for industry standard interchange. The HP 7980A provides backup solution for systems in the 400 megabyte to 2 gigabyte range. It operates with both 6250 cpi and 1600 cpi industry-standard densities. The HP 7980XC has an advanced method of data compression built into the tape drive electronics allowing more information to be stored on standard 1/2-inch tape reels. It writes and reads tapes in industry-standard 1600 and 6250 cpi densities. The compressed format, not an industry standard, is an option on the 6250 cpi density only. Backup times for large systems can be dramatically reduced by pairing two or more HP 7980XC tape drives with HP's TurboSTORE backup utility program. TurboSTORE, available with HP 3000 systems, gathers data from discs and writes it to one or more tape drives simultaneously. The entire line of tape drives is field upgradeable. Select the one to meet your current needs and upgrade as your system's disc capacity increases. Support is provided on most HP 3000, HP 1000, and HP 9000 systems.

Ordering Information

Model	Price
HP 7980XC 1/2 inch tape drive (1600/6250/6250XC cpi)	\$32,200
HP 7980A 1/2 inch tape drive (1600/6250 cpi)	\$23,200
HP 7979A 1/2 inch tape drive (1600 cpi)	\$13,400
HP 88703A Field Upgrade Kit (HP 7979A-to-HP 7980A)	\$11,400
HP 88705A Field Upgrade Kit (HP 7980A-to-HP 7980XC)	\$11,000
Opt W30 Extended Repair Service	See Page 725
Opt W31 On-Site Repair Service	See Page 725

See technical data sheet #5953-6897 for detailed product information.

COMPUTER PERIPHERALS

Tablet—A-size Graphics Tablet HP SketchPro, RS-232-C Model

- New technology for unparalleled reliability
- Includes stylus and four-button cursor
- Supported by major PC CAD software on the HP Vectra PC, IBM AT, IBM PC/XT, and compatibles
- Competitive Price
- Compact design with overlay hold-down/protector
- Superior resolution - up to 1200 lines per inch
- Multifunction softkeys with Mouse Mode

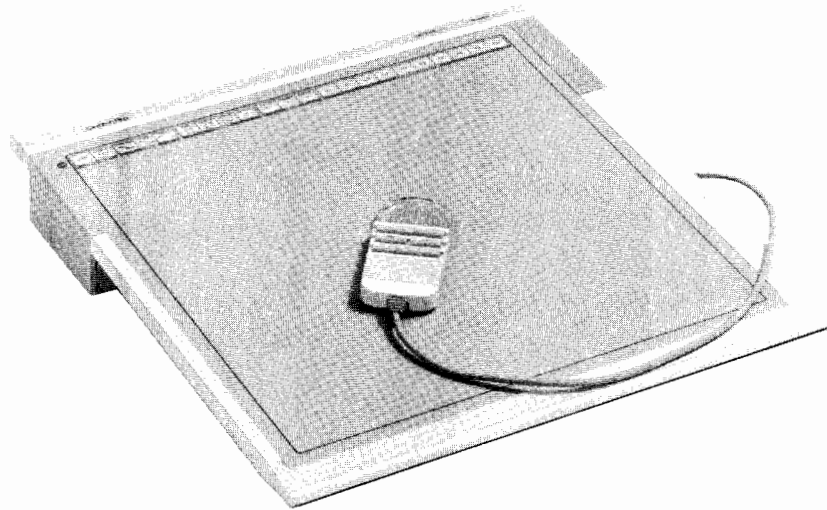

The HP 7060A SketchPro Graphics Tablet is a small format (11 x 11 in.) tablet for personal CAD systems. It is used for quick menu selection, and rapid cursor movements, as well as tracing and drawing. Primary applications include mechanical, electrical, and electronics CAD, and AEC (Architecture/Engineering/Construction). Secondary applications include business graphics and desktop publishing (DTP).

Unparalleled Reliability

Due to a patent-pending Permuted Trace Ordering (PTO) technology, Hewlett-Packard can minimize parts, making the HP SketchPro tablet one of the most reliable tablets on the market. The SketchPro tablet meets HP's standards, at a low price.

Supports Top PC CAD Packages

The HP SketchPro tablet is designed to work with the software and hardware you have selected. The HP SketchPro tablet's industry-standard RS-232-C/CCITT V.24 interface enables users to connect the SketchPro tablet to the HP Vectra PC, IBM AT, IBM PC/XT, and compatibles.

The HP SketchPro tablet has four operating modes: Hewlett-Packard, Summagraphics Bit Pad 2 (emulation), Hitachi HDG1111B (emulation), and Microsoft Mouse (emulation). With these modes, the SketchPro tablet supports the most popular CAD and graphics software, such as AutoCAD, VersaCAD, and CADKEY.

A Complete Package

The HP SketchPro tablet provides everything you need in the box - For operation, both a comfortable stylus and four-button cursor; for interfacing, an RS-232-C/CCITT V.24 cable for the HP Vectra PC or the IBM AT and compatibles, a cable adapter for the IBM PC/XT and compatibles, and set-up instructions for configuring your software; for tablet menus, a clear anti-static overlay to hold menus securely in place without tape.

Intelligent Design

The HP SketchPro has been designed with special attention to ergonomics and aesthetics. The tablet's slope and shape provide maximum user comfort. The anti-static overlay and recessed menu area mean menus without messy tape. Plus the small footprint saves valuable desk space. Both a power on/off LED and a point-digitizing LED provide positive feedback.

Superior Resolution

The HP SketchPro tablet has a resolution that is programmatically selectable up to 480 lines per cm (1219 lines per in.), and is accurate up to within 0.5 mm (0.02 in.) of the selected point. The HP SketchPro tablet's resolution meets the most stringent requirements.

Multifunction Softkeys

The HP SketchPro tablet includes several softkeys to provide commonly used functions; variable active areas, aspect ratio adjustments, and mouse mode. These softkeys are predefined. Additional, programmable softkeys are provided for future software vendor support.

Specifications

Size: height, 50 mm (2.0 in.); width, 325 mm (12.8 in.); depth, 343 mm (13.5 in.); tablet tilt, 7 degrees

Net weight: 1.8 kg (4 lbs)

Power requirements: source, 110-120 V or 230-240 V (depending on country); frequency, 60 Hz or 50 Hz (depending on country); power, 1.8 Watts

Resolution: 480 lines per cm (1219.05 lines per in.)

Accuracy: ± 0.5 mm (0.02 in.); repeatability, ± 0.25 mm (0.01 in.)

Proximity: 2.5 mm (0.01 in.); jitter, 0 pixels

Stylus tilt: any degree $< 90^\circ$

Active area: 278 mm x 278 mm (11 in. x 11 in.)

Technology: capacitive with Permuted Trace Ordering (PTO)

Data output rate: up to 120 pairs per second

Baud rate: up to 92,000 baud

Product regulations: safety, UL Listed, CSA certified; RFI, tested at system level to FCC class B and VDE level B; Acoustics, less than 40 db sound per A-weighted scale

Environmental range: operating temperature, 0° to 55° C; non-operating, -40° to 70° C; relative humidity, 5% to 95%; shock, $\frac{1}{2}$ sine shock pulse < 3 m duration, 160 in./sec delta V, non-operating Trapezoidal pulse, 30 g, 292 in./sec delta V

Ordering Information

HP 7060A HP SketchPro Graphics Tablet

Price
\$599

COMPUTER PERIPHERALS

Tablets — A-size Graphics Tablet

HP 45911C, HP-HIL Model

687

- Low cost
- Works with HP Vectra, Touchscreen, and HP 9000 Series 300 systems

- High-resolution: up to 1200 lines/inch
- Easy connection using HP-HIL

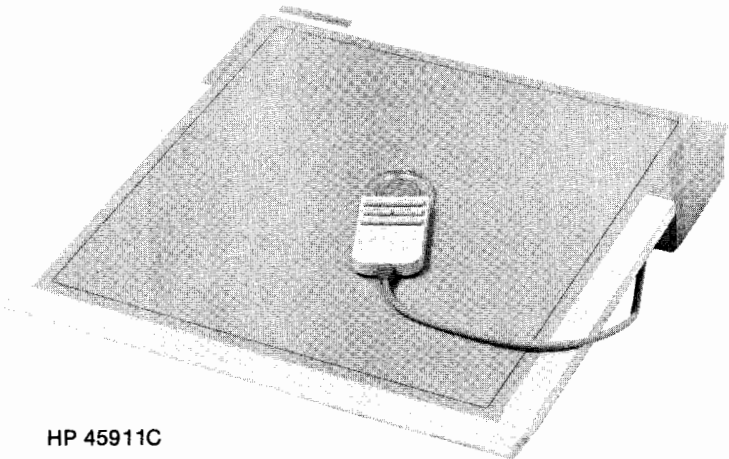

HP 45911C

The HP 45911C is a high-performance, low-cost graphics tablet. When it is installed on a computer supporting the Hewlett-Packard Human Interface Link (HP-HIL), you have a very effective pointing device to increase your productivity with interactive graphics applications such as mechanical, electrical, and electronics CAD, AEC (architecture/engineering/construction), business graphics, and desktop publishing (DTP).

The HP Graphics tablet is ideal for tasks such as menu picks, graphics placement, drawing, and tracing. Overlays, like the ones provided with many software packages, can be used on the tablet allowing you to choose menu items conveniently without using screen space. With the tablet's stylus you can make fast movements and create complex drawings as easily as with a pencil and paper.

Unparalleled Reliability

Due to a patent-pending new Permuted Trace Ordering (PTO) technology, Hewlett-Packard can minimize parts, making the HP 45911C one of the most reliable tablets on the market. The tablet meets the reliability standards you expect from Hewlett-Packard, at a low price.

Excellent Performance

The HP Graphics tablet has very high resolution, up to 1200 lines per inch. And its fast response time and high accuracy make it easy to use. The tablet is based on capacitive technology and is immune to the effects of magnetic fields.

Easy to Install and Use

The stylus is as easy to use as a pencil. Movements of the stylus tip on the tablet surface will be tracked on the computer monitor. The stylus tip can be activated by a gentle push of its tip onto the tablet surface.

The HP Graphics tablet can be used with computers and applications which support the HP-HIL interface. HP-HIL allows you to daisy chain up to 7 input devices (such as a mouse, tablet, bar code reader, keyboard, and others) without using a serial port. Simply plug the HP Graphics tablet into the keyboard, HP-HIL port, or another input device. The HP-HIL interface provides power from the host computer or terminal, eliminating the need for additional power cords.

Saves a Serial Port

Since HP-HIL input devices have their own port and they daisy chain together, your serial ports are free so you can use other peripherals, such as plotters and printers. If you want to use input devices and output devices at the same time, you won't need multiple serial port cards or costly switch boxes.

Software Support

The HP Graphics tablet is supported by many popular software packages including ME 10, Graphics Gallery, AutoCAD™ (version 2.52 and above), and Versacad (version 5.1 and above).

Superb Design

The HP Graphics tablet has been designed with special attention to ergonomics and aesthetics. The tablet slope and stylus shape have been chosen to make it comfortable in use. And the tablet is so compact in size it uses less desk space than most tablets with equivalent active area.

Specifications

Size: height, 50 mm (2.0 in.); width, 325 mm (12.8 in.); depth, 343 mm (13.5 in.)

Active area: 278 mm x 278 mm (11 in. x 11 in.)

Tablet tilt: 7 degrees

Net Weight: 1.8 kg (4 lbs)

Power requirements: voltage, 12 Vdc (supplied by HP-HIL); current 200 mA maximum; power, 1.8 Watts

Resolution: 480 lines per cm (1219.05 lines per in.)

Accuracy: ±0.5 mm (.02 in.)

Repeatability: ±0.25 mm (.01 in.)

Proximity: 2.5 mm (.1 in.)

Stylus tilt: any angle <90°

Data output rate: up to 120 pairs per second

Document material: non-conductive

Product regulations: safety, UL Listed, CSA certified; RFI, tested at system level to FCC class B and VDE level B; Acoustics, less than 4.0 Bels sound per A-weighted scale

Environmental range: operating temperature, 0° to 50° C; non-operating, -55° to 70° C; relative humidity, 6% to 95%; shock, ½ sine shock pulse <3 msec duration, 140 in./sec delta V, non-operating Trapezoidal pulse, 30 G, 292 in./sec delta V

Accessories Supplied

Stylus: 16 cm with .75 m attached cable

Cursor: 4 button with .75 m Cable

Overlay Protector: 295 mm x 295 mm (11½ in. x 11½ in.) HP-HIL Cable

Ordering Information

HP 45911C Graphics Tablet
AutoCAD is a trademark of Autodesk, Inc.

Price
\$599

COMPUTER PERIPHERALS

Printers — Versatile Color Graphics and Text Printers

HP PaintJet Series Printers

- Eight standard colors and up to thousands of shades and hues
- Near-letter-quality text; 167 characters per second at 10 pitch
- One-year warranty

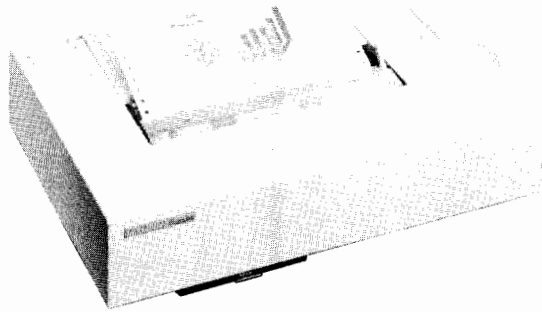

HP PaintJet

- Print on paper and transparency film
- Automatic sheet feed with PaintJet XL
- A/A4-size PaintJet; B/A3-size PaintJet XL

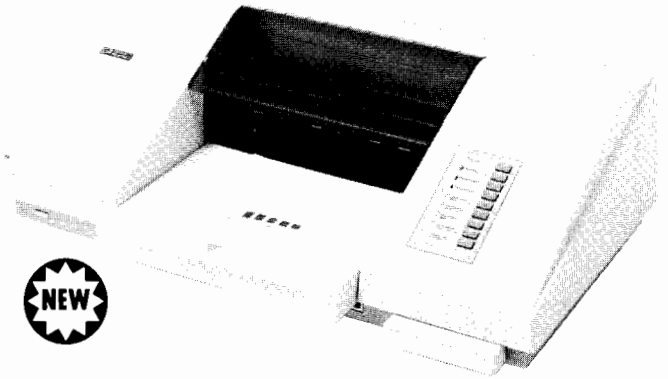

HP PaintJet XL

Two Versatile Color Graphics Printers

Choose from two printer models. The HP PaintJet color graphics printer prints color graphics and text on A/A4-size Z-fold and cut-sheet paper, and also prints on A/A4-size transparency film for powerful presentations. The desktop size makes the HP PaintJet printer convenient for personal use in a wide range of applications.

The HP PaintJet XL printer offers added speed and unattended operation for higher volume and shared environments. The B/A3-size print capability is an added advantage for spreadsheets and technical graphics. The built-in paper tray automatically feeds up to 200 sheets of A/A4- or B/A3-size paper and up to 70 sheets of A/A4-size transparency film. Manual feed is available for non-standard media, including untrimmed ISO sizes¹.

Quality Color Graphics

Convenient, disposable print cartridges make it easy to create bold color graphics and text on both paper and transparency film. The cartridges are reliable and virtually maintenance free.

For eye-catching transparencies, HP PaintJet Series printers print an extra layer of dots in transparency mode. For highest quality output on paper, the HP PaintJet XL has a built-in presentation mode for brighter, more dense colors.

The HP PaintJet prints eight standard colors and up to thousands of color shades and hues, depending on software color capabilities. The HP PaintJet XL has built-in image enhancement features to add up to over a million shades.

The HP PaintJet color graphics printer prints an average A/A4-size page of graphics on paper in just four minutes. When teamed with a workstation or personal computer, the HP PaintJet XL can print the same page in just 1.5 minutes. Actual print times vary according to software, computer, and interface limitations.

Fast Near-Letter-Quality (NLQ) Text

HP PaintJet and PaintJet XL print black near-letter-quality (NLQ) text at 167 characters per second (10 characters per inch),

using any of three internal fonts. The HP PaintJet prints a typical A/A4-size page of text on paper in 30 to 40 seconds, and the HP PaintJet XL can print the same page in even less time. Text can also be printed in six other colors.

In the Windows environment, *HP Color PrintKit for Microsoft® Windows* gives you 12 scalable and 16 hand-tuned fonts for the HP PaintJet and PaintJet XL printers.

An optional *font cartridge* provides hand-tuned, proportional and fixed space TmsRmn, Helv, and Prestige Elite typefaces in bold, italic, underline, and a variety of sizes. The larger buffer in the HP PaintJet XL lets you download soft fonts, too — including the HP type director font library. With some software packages, the PaintJet XL can print text in both portrait and landscape modes.

Hardware and Software Compatibility

A choice of interfaces makes it easy to connect an HP PaintJet series color graphics printer to most personal computers, including HP Vectra, IBM XT/AT and compatibles, IBM PS/2, Apple Macintosh, and Amiga.

HP PaintJet series printers are supported by leading PC CAD, productivity, word processing, utility, and presentation packages.

Add Power and HP-GL/2 Compatibility

An optional HP-GL/2 cartridge, compatible with the industry's leading graphics language will be available in the spring of 1990. When you run HP-GL/2 programs, the cartridge acts as a vector-to-raster converter. You can also use the cartridge's two megabyte page buffer to make multiple copies of your output. For word processing applications, the HP-GL/2 cartridge contains the same fonts as the optional *font cartridge*.

¹ Non-standard sized media is not available from Hewlett-Packard. Use HP PaintJet Series media for best results.

Technical Information

Printing process: thermal inkjet drop-on-demand printing.

Text print speed: 167 characters per second at 10 pitch, 200 characters per second at 12 pitch.

Graphics resolution: 180 x 180 dots per inch.

Printing styles: Courier 12 point (10 cpi), Letter Gothic 12 point (10 cpi), Letter Gothic 8 point (18 cpi); also bold, underline, superscript, and subscript.

Media types: paper, transparency film.

Media handling capability

HP PaintJet: manual feed for cut-sheet paper and transparency film; sprocket feed for Z-fold paper

HP PaintJet XL: manual feed for cut-sheet paper and transparency film; automatic sheet feed for paper and transparency film.

Media sizes

HP PaintJet: A/A4

HP PaintJet XL: A/A4 and B/A3.²

Graphics print speed³

HP PaintJet: A/A4-size paper, 4 minutes or less; A/A4-size film, 8 minutes or less

HP PaintJet XL: A/A4-size paper, 1.5 minutes or less; A/A4-size film, 6 minutes or less.

Print cartridges

HP PaintJet: 1 black and 1 multicolor

HP PaintJet XL: 1 black, 1 cyan, 1 magenta, and 1 yellow.

Command language

HP PaintJet: HP PCL with extensions

HP PaintJet XL: HP PCL III with Imaging Extensions⁴

Internal character sets

HP PaintJet: HP Roman8, PC8, PC8 (Danish/Norwegian), ECMA94, US ASCII: ISO 7-bit languages; German, French, Italian, Norwegian, Swedish, Spanish, United Kingdom

HP PaintJet XL: HP Roman8, PC8, PC8 (Danish/Norwegian), PC850, ECMA94: ISO 7-bit languages; German, French, Italian, Norwegian, Swedish, United Kingdom, Spanish, US ASCII.

Buffer size

HP PaintJet: 500 to 8000 bytes⁵

HP PaintJet XL: 70 to 1920 Kbytes

Interfaces

HP PaintJet: RS-232-C/CCITT V.24 serial, HP-IB (IEEE 488-1978), and Centronics parallel options

HP PaintJet XL: RS-232-C/CCITT V.24 serial, Centronics parallel, and HP-IB (IEEE 488-1978) standard

Environmental ranges

Operating temperature: 15 to 30 degrees C (59 to 86 degrees F)

Storage temperature: -40 to 70 degrees C (-40 to 158 degrees F)

Humidity: paper, 20 to 80% RH (at 10 to 30 degrees C);

transparency film, 20 to 50% RH (at 10 to 35 degrees C)

Acoustics: (per ISO DP 7779 standard) sound pressure level-L_{wa} 5.7 bels(A) sound pressure level-L_{pa} 45 dB(A) @ 1 meter bystander position.

Power requirements

Source: 100, 120, 220, 240 Vac (±10%)

Frequency: 50-60 Hz

HP PaintJet

Consumption: 20W maximum

HP PaintJet XL

Consumption: 65 W maximum, continuous

Physical specifications

HP PaintJet

Size: 98H x 442W x 302mmD (3.86" x 17.40" x 11.89")

Weight: net, 5kg (11lb); shipping, 10.6 Kg (23.3 lb)

HP PaintJet XL

Size: 230H x 750W x 441mmD (9.06" x 29.53" x 17.36")

Weight: net, 38kg (17lb); shipping, 24 kg (53 lb)

CSA Certified; UL Listed; TUV GS Licensed; NEMKO Approved; IEC 950/EN 60950 Compliant; FCC Certified, Class B; VDE 0871-B/P Radio Protection Mark (FTZ 1046/84); Registered VCCI, Class 2

Ordering Information

Ordering Information	Price
HP 3630A PaintJet Color Graphics Printer	\$1395
Opt 001 RS-232-C/CCITT V.24 serial interface	\$0
Opt 002 HP-IB (IEEE 488-1978) interface	\$0
Opt 004 Centronics parallel interface	\$0
HP C1602A PaintJet XL Color Graphics Printer	\$2495
Opt 1AX RS-232-C/CCITT V.24 serial interface/ Centronics parallel interface	\$0
Opt 1A8 HP-IB (IEEE 488-1978) interface	\$0

Note: Interface cables must be ordered separately.

Accessories Supplied

HP PaintJet and PaintJet XL: User documentation, power cord, HP PaintJet paper, HP PaintJet transparency film, brush.

HP PaintJet also includes: Power module and two print cartridges (black, color).

HP PaintJet XL also includes: 4 print cartridges (black, cyan, yellow, magenta), A/A4-size media tray, and A/A4-size transparency film stacker⁶, documentation holder.

Accessories Available

Description	Part Number
HP PaintJet and PaintJet XL	
Black print cartridge	51606A
A-size cut-sheet paper, 8.5 x 11 in, 200 sheets	51630Y
A4-size cut-sheet paper, 210 x 297 mm, 200 sheets	51630Z
A-size transparency film, 50 sheets with plastic sleeves	51630Q
A4-size transparency film, 50 sheets with plastic sleeves	51630S
HP Color PrintKit for Microsoft® Windows	17390A
HP Color PrintKit for Macintosh Computers (English fonts) ⁷	17305B
HP Color PrintKit for Macintosh Computers (French fonts) ⁷	17306B
HP Color PrintKit for Macintosh Computers (German fonts) ⁷	17307B
HP PaintJet only	
Color print cartridge	51606C
Z-fold paper, 8.5 x 11 in, 250 sheets	51630P
Z-fold paper, 210 x 350 mm, (12 in), 250 sheets	51630R
HP PaintJet XL only	
Cyan print cartridge	51606B
Magenta print cartridge	51606R
Yellow print cartridge	51606Y
B-size cut-sheet paper, 11 x 17 in, 200 sheets	51631A
A3-size cut-sheet paper, 297 x 420 mm, 200 sheets	51631B
HP PaintJet XL Font Cartridge (CG Times, CG Triumvirate,™ and Prestige Elite typefaces)	C1607A
HP-GL/2 Cartridge with two megabyte page buffer and fonts (available Spring 1990)	C1608A
A-size media tray (for automatic sheet feed)	C1609A
A4-size media tray	C1610A
B-size media handling kit (tray and 200 sheets of paper)	C1611A
A3-size media handling kit (tray and 200 sheets of paper)	C1612A

² Also uses intermediate paper sizes, including untrimmed ISO; these sizes are not available from HP.

³ Output times vary depending on image complexity, application software, model of computer, and interface.

⁴ Imaging extension capability is software dependent. PCL III is compatible with the HP PaintJet programming language.

⁵ Varies depending on the use of downloaded characters.

⁶ Size depends on destination.

⁷ Requires RS-232-C interface.

Macintosh is a trademark of Apple Computer.

Microsoft is a U.S. registered trademark of Microsoft Corporation.

COMPUTER PERIPHERALS

Personal, Departmental, and System Printers

HP 2225, 2227, 2228, 2235, 2276, 2277, 2278, 2934

HP ThinkJet Portable Printers HP 2225A/B/C/D/P

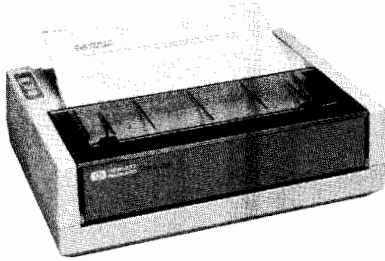

HP ThinkJet

The HP ThinkJet printer is a quiet, compact desktop printer that is very efficient (150 cps) and delivers crisp, easy-to-read text and graphics for letters, reports, and spreadsheets in draft or quality mode. Print cartridges are disposable, and there is excellent software support. Battery-powered versions for HP-IL and Centronics-type interfaces offer 200 page prints between recharges.

HP QuietJet and QuietJet PLUS Printers HP 2227A/B, HP 2228A

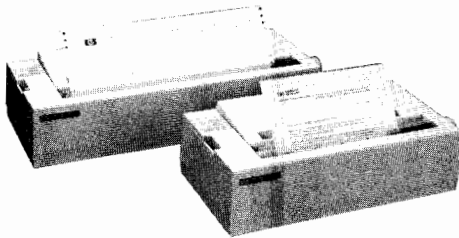

HP QuietJet

The HP QuietJet printers offer quality desktop printing at 192 cps draft and 48 cps NLQ for word processing, data base management, and computer graphics. The HP QuietJet handles standard 8.5 x 11-inch and A-4 size paper. The HP QuietJet PLUS also handles 15-inch wide paper. Both printers have excellent software support and use disposable print cartridges.

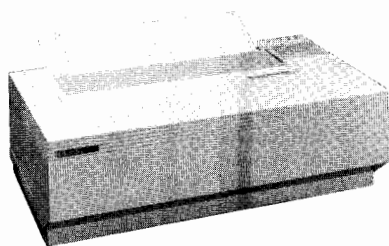

HP RuggedWriter 480

The wide-carriage HP RuggedWriter is a 24-wire impact dot-matrix printer that offers top-quality printing at 480 cps for draft and 240 cps letter quality. It has three independent paper paths and built-in I/O, and it can print 6-part forms.

HP DeskJet and DeskJetPLUS Family Printers HP 2276A, 2277A

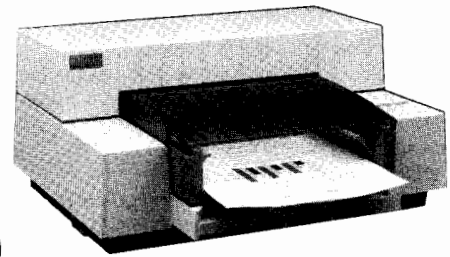

HP DeskJet PLUS

The HP DeskJet printers offer laser-quality text and graphics at a low price. These printers are quiet and compact, and they offer affordable quality that is superior to dot-matrix print. The DeskJet PLUS printer is up to two times faster in text and five times faster in graphics than the original DeskJet. It offers built-in landscape mode and more font capability. Choose the original DeskJet printer for the home office or the new DeskJet PLUS for business use. Both have a built-in sheet feeder.

HP DeskWriter Printer HP 2278A

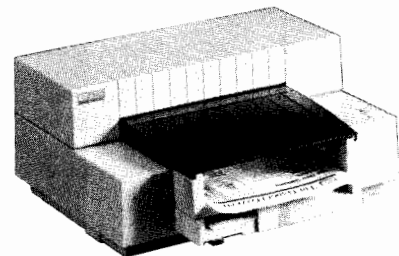

HP DeskWriter

The HP DeskWriter printer gives Apple Macintosh® computer users laser-quality output and affordable desktop printing convenience. It works with popular Macintosh text and graphics applications. It comes with four font families and the option to expand to eleven. All font families include plain, bold, italic, and bold italic versions. They provide smooth, crisp text in any size up to 250 points. Using the printer is plug-and-go easy. It uses standard Apple user interface standards and printer cables.

HP 2934A Impact Printer

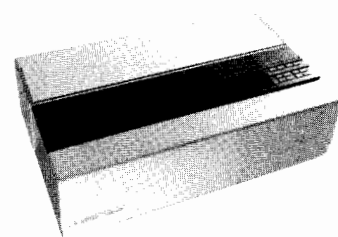

HP 2934A Impact Printer

Speed, reliability, simplicity of operation, and unlimited duty cycle allow the HP 2934A 136-column impact printer to meet heavy printing needs (up to 12,000 pages/month). It prints 200 cps and offers near letter quality (NLQ), font cartridges, bar codes, OCR, large character generation, and 6-part forms printing.

*Macintosh is a registered trademark of Apple Computer, Inc.

COMPUTER PERIPHERALS

Personal, Departmental, and System Printers

HP LaserJet Printer Family, Dot Matrix Printers

691



HP LaserJet Printer Family

All HP LaserJet printers provide publication-quality print, quiet operation, up to 4.5 Mbytes memory (5.5 Mbytes for HP LaserJet 2000), text and graphics at 300 x 300 dpi, correct-order output, downloadable fonts/forms, a wide range of software support, and LCD control panel. They operate with virtually all PCs and PC networks, and all popular PC software and print on letter, legal, executive, and A4 paper sizes (LaserJet 2000 also uses A3 and 11 X 17 paper.)

HP LaserJet IIP printer HP 33471A

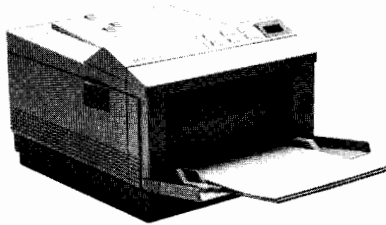

HP LaserJet IIP

The personal, affordable HP LaserJet IIP desktop printer prints up to 4 pages/minute. It includes one font cartridge slot, an input tray that holds either 50 sheets or 5 envelopes, and 14 standard fonts. The printer also offers auto-rotation of fonts and fast graphics formatting. Options include a 250-sheet paper cassette for dual-bin functionality, an envelope tray, and expandable memory.

HP LaserJet Series II printer HP 33440A

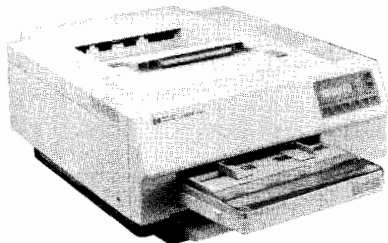

HP LaserJet Series II

The HP LaserJet Series II desktop printer prints up to 8 pages/minute. It includes two font cartridge slots, a 200-sheet input tray, and 6 standard fonts. This printer is ideal for word processing, spreadsheets, reports, forms, and desktop publishing.

HP LaserJet IID printer HP 33447A

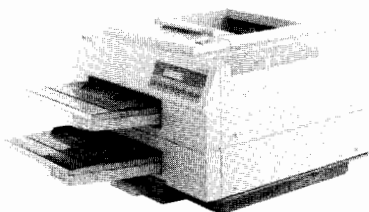

HP LaserJet IID

The LaserJet IID desktop printer prints up to 8 pages/minute. Two 200-sheet input trays and an optional 50-envelope tray add the flexibility and capacity to serve several users or one high-volume user. Two-sided printing affords the user significant savings in paper purchase, filing, storage and mailing costs. The printer has 2 font cartridge slots and 24 standard fonts.

HP LaserJet 2000 Printer HP 2684A/D/P

The HP LaserJet 2000 printer prints up to 20 pages/minute for high-volume, high-speed printing for minicomputers and PC networks. Two 250-sheet input trays, a 1500-sheet correct-order output stacker, 3 font cartridge slots, and 34 resident fonts are standard. Options include two-sided printing and a 2000-sheet paper tray.

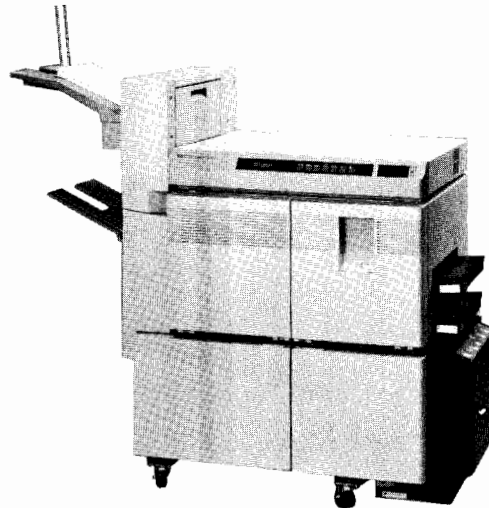

HP LaserJet 2000

HP LaserJet Master Type Library and Memory

A large selection of HP LaserJet printer font cartridges, downloadable soft fonts, and scalable typeface products are available. All LaserJet printers offer upgradeable memory for increased font and graphics capability. For information on these products, contact your HP sales representative.

HP TEMPEST Printer Family

TEMPEST versions of selected printers are available for government applications requiring security protection. International distribution is limited; contact your HP sales representative for availability and ordering information.

Dot Matrix Printers

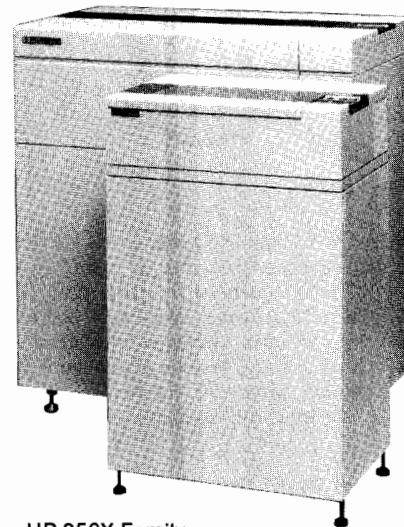

HP 256X Family

HP 256X Dot Matrix Printer Family

The HP 256X family of impact dot-matrix printers (300, 600, 900, or 1200/1600 lpm) is fully supported for minicomputer, microcomputer, or mainframe systems. All feature high-density and compressed text, graphics, bar code, and OCR capabilities, multiple character sets, multi-part forms printing, 16-channel vertical format control, and 55 dBA cabinets for standard HP 2563/64B models. High reliability is ensured through memory backup, microprocessor control, and few moving parts. Enhanced bar code options are available.

COMPUTER PERIPHERALS

Personal, Departmental and System Printers

HP 2562C, 2680A, HP 2685C Laser Print Station

HP 2562C Printer

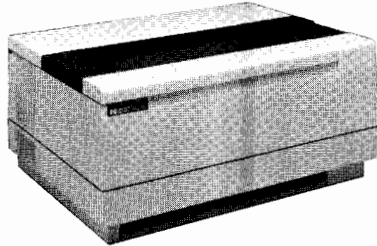

HP 2562C Printer

The HP 2562C (300/420 lpm) is a fully supported line impact dot-matrix printer for minicomputer, microcomputer, or mainframe systems. It features the 6 most popular character sets: 13.3 cpi compressed, standard Roman 8 USASCII, line draw, large block, bar codes, and high-density NLQ. It includes multi-part forms printing and a 16-channel vertical format control. The sound level is 64 dBA. Enhanced barcode options are available. High reliability is ensured through memory backup, microprocessor control, and few moving parts.

HP 2680A Laser Printing System

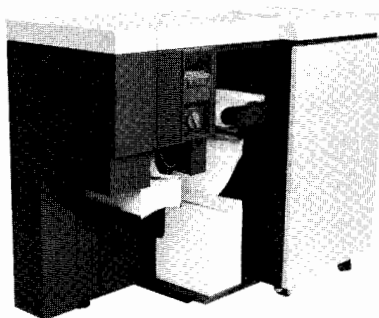

HP 2680A

The HP 2680A Laser Printing System serves HP 3000 and Precision Architecture systems, providing 45 ppm, up to 1,000,000 sheets/month. It features continuous paper feed (8.5 x 11-inch fanfold paper), non-contact fusing, and a data control system that handles variable-size characters and up to four pages of print on one sheet of paper. Other features include high-volume label printing, merged text, graphics, electronics forms capabilities IFS/3000, IDSF0RM/3000, and other applications.

HP 2685C Laser Print Station

The HP 2685C Laser Print Station is a local or remote print system for mainframe systems. It includes the HP 2680A laser printer, system controller, terminal, and disk and tape drives.

HP QuietJet Family Printers

HP 2227A QuietJet Printer, dual I/O (Centronics/RS-232), wide carriage \$799

HP 2227B QuietJet Printer, HP-IB, wide carriage \$799

HP 2228A QuietJet Printer, dual I/O (Centronics/RS-232) \$599

HP DeskJet Family Printers

HP 2276A DeskJet Printer, dual I/O (Centronics/RS-232) \$795

HP 2277A DeskJet Printer, dual I/O (Centronics/RS-232) \$995

HP DeskWriter Printer

HP 2278A DeskWriter Printer, serial I/O to Macintosh \$1195

HP LaserJet Family Printers

HP 33471A LaserJet Series IIP Printer \$1495

HP 33440A LaserJet Series II Printer \$2695

HP 33447A LaserJet Series IID Printer \$4295

HP 26847A/D/P LaserJet 2000 Printer \$19,995-\$25,695

HP 88141A JetScript Accessory Kit \$2795

HP 2934 Printer

HP 2934A Printer, RS-232/RS-422 \$2595

Opt 042 Centronics-type interface \$50

Opt 046 HP-IB interface \$150

HP RuggedWriter 480 Printers

HP 2235A RuggedWriter Printer, dual I/O (Centronics/RS-232) \$1695

HP 2235B RuggedWriter Printer, dual I/O (HP-IB/RS-232) \$1895

HP 2235C RuggedWriter Printer, dual I/O (Centronics/RS-232) w/ sheet feeder \$1945

HP 2235D RuggedWriter Printer, dual I/O (HP-IB/RS-232) w/ sheet feeder \$2145

Accessories

HP 12239A sheet feeder - US letter-size \$250

HP 12239B sheet feeder - EUR A4 size \$250

HP 12235A font cartridge - 4 fonts and 16K RAM \$150

Line Impact Dot-Matrix Printers

HP 2563B Line Impact Dot-Matrix Printer 300 lpm \$7990

HP 2564B Line Impact Dot-Matrix Printer 600 lpm \$11,750

\$13,250

HP 2566B Line Impact Dot-Matrix Printer 900 lpm \$24,950

HP 2567B Line Impact Dot-Matrix Printer \$32,000

1200/1600 lpm

Opt 024 HP Label Card \$2325

HP 2562C Line Impact Dot Matrix Printer, 300/420 lpm \$5500

High Volume Laser Printers

HP 2680A Laser Printer System \$95,470

HP 2685C Laser Print Station \$97,800

Ordering Information

HP ThinkJet Family Printers

HP 2225A ThinkJet Printer, HP-IB \$495

HP 2225B ThinkJet Printer, HP-IL, battery power \$495

HP 2225C ThinkJet Printer, Centronics \$495

HP 2225D ThinkJet Printer, RS-232 \$495

HP 2225P ThinkJet Printer, Centronics, battery power \$495

Accessory HP 922197 Cable +\$49

Price

- Designer color system

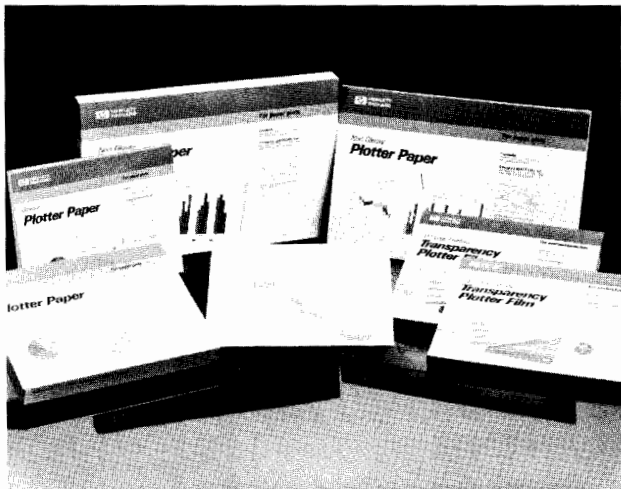

Hewlett-Packard offers a complete line of pens, drawing media, and accessories for both business and technical graphics applications. And all these supplies are manufactured in the HP tradition of quality — quality that you'll see reflected in your work.

Designer Color System

HP's family of compatible plotter supplies consists of fiber-tip paper pens and transparency pens, plotter paper, glossy plotter paper and transparency plotter film. The fiber-tip pens are available in 10 matching colors so that you can create paper duplicates of your transparencies. Pen colors are black, green, aqua, blue, violet, red-violet, red, orange, yellow and brown. Pens are available in narrow and wide line widths (0.3 mm and 0.7 mm for paper pens; 0.3 mm and 0.6 mm for transparency pens).

Paper pens can be used on all plotters. You can obtain high quality results with HP plotter paper for graphs and large quantities. Use HP glossy paper for reports and presentations. Transparency pens can be used on the HP ColorPro, DraftPro DXL and EXL, DraftMaster, 7475, 7550, and 7090, plotters with HP transparency film for overhead presentations or with HP glossy paper for presentation hand-outs.

Quality color overheads help you make a point, sell a product or idea, enhance an image. Research proves that:

- presentations using visual aids are 43% more effective than unaided presentations,
- color is more persuasive than black and white for visuals,
- an average speaker using visuals can be as effective as a better speaker using no visuals.

Overall, presenters using color overheads were rated as more credible and more interesting by the audience.

Technical Drafting Applications

Hewlett-Packard offers three different types of pens and four different types of media so you can select the pen/media combination that's right for your application. Fiber-tip pens are available in ten colors for use on plotter paper. Roller-ball pens come in four colors. In addition to four line widths for disposable drafting pens, HP offers long-body and short-body drafting pens in six line widths.

Sheets of plotter paper, vellum, tracing bond, and polyester film, are available in a range of sizes, both English (A to E) metric (A4 to A0) and architectural (C-E). Polyester film, vellum, and plotter paper come in 914.4 mm (36 in.) and 609.6 mm (24 in.) rolls for use with the HP 7586B and DraftMaster II roll-feed drafting plotters.

- Disposable drafting pens

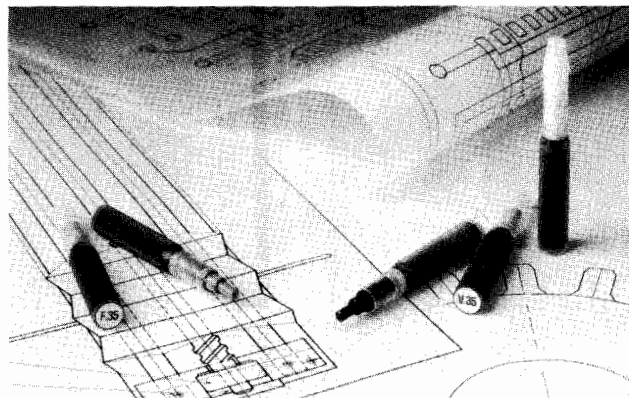

Disposable Drafting Pens

These pens are designed especially for preliminary drawings and checkplots on plotter paper or final drawings on vellum. Disposable drafting pens come in four line widths and eight colors. Our pens for use with polyester film produce the same, final plot, archival drawings you've come to expect with a refillable drafting pen but without the messy cleaning or refilling.

Ordering Information

Plotter supplies may be ordered through HP's direct telephone ordering service, from any HP sales and support office, or from your local retail dealer. The HP Computer User's Catalog (P/N 5953-2450) describes the complete range of plotter supplies and accessories.

For Best Results

	Paper	Glossy Paper Transparency Film	Tracing Bond	Vellum	Polyester Film
Fiber-tip pens (paper)	ColorPro 7475 7550 DraftPro DraftPro DXL DraftPro EXL DraftMaster 7580 7585 7586				
Fiber-tip pens (transparency)		ColorPro 7475 7550 DraftPro DXL DraftPro EXL DraftMaster			
Roller-ball pens			7550 DraftMaster 7580 7585 7586		
Disposable drafting Pens	7550 DraftMaster 7580 7585 7586			7550 DraftPro DraftPro DXL DraftPro EXL DraftMaster 7580 7585 7586	7550 DraftPro DraftPro DXL DraftPro EXL DraftMaster 7580 7585 7586
Refillable drafting pens				7475 7550 DraftPro DraftPro DXL DraftPro EXL DraftMaster 7580 7585 7586	7475 7550 DraftPro DraftPro DXL DraftPro EXL DraftMaster 7580 7585 7586

COMPUTER PERIPHERALS

Plotters—Scientific Measurement/Business Plotter

ColorPro Plotter

- 8-pen carousel
- Handles A4/A-size* paper, transparency film



The HP ColorPro eight-pen plotter is designed to provide quick, presentation-quality color visuals for business and scientific applications. It draws with fiber-tip pens on overhead transparency film and regular plotter paper and glossy plotter paper.

The ColorPro plotter is designed for professionals who make decisions from numbers and make presentations with numbers. Whether you're drawing overheads for a meeting or recording data from a smart instrument, output quality is important. The exceptional line quality of the ColorPro plotter makes drawings and charts perfect for most professional presentations or reports.

High-Quality Output

With an addressable step size of 0.025 mm (0.001 in.), the ColorPro plotter can draw up to 1000 points in a 1-inch line. That means you get ruler-straight lines, even on the diagonal. And when commanded to return to the same point with no pen change, the plotter achieves this repeatability within 0.1 mm (0.004 in.). This precision helps ensure that circles are closed and bar and pie charts are properly aligned.

Eight-pen Carousel for Color and Convenience

Once you load the ColorPro plotter's eight-pen carousel, you have access to a spectrum of colors in two different widths — thick pens for headings, thin pens for details. And the pens are capped when not in use to prolong pen life.

Programming Features

If you plan on creating your own graphics programs, you can utilize the HP-GL instructions resident in the ColorPro plotter. HP-GL (Hewlett-Packard Graphics Language) is a simple but powerful command set that controls plotting functions such as pen movement, labeling, character set selection, and axis placement. Order the HP ColorPro Programming Manual (Part No. 07440-90001) for complete explanations and examples of the plotter's graphics and interfacing instructions.

*A4 Size is 210 x 297 mm; A Size is 8½ x 11 in.

- High-quality output
- ROM cartridge slot

Compatibility

With a choice of two interfaces, RS-232-C/CCITT V.24 or HP-IB (IEEE 488-1978), the HP ColorPro plotter works with virtually all personal computers. It can also be connected to a variety of HP and non-HP minicomputers or mainframes, but does not provide eavesdrop capability in these environments.

ROM Cartridge Slot

To keep up with your expanding needs (such as emerging graphics standards), the ColorPro plotter has a ROM cartridge slot. HP offers a Graphics Enhancement Cartridge as an accessory to the ColorPro plotter. The cartridge adds more advanced capabilities to your ColorPro plotter such as additional HP-GL instructions to draw arcs, circles and polygons; a larger RS-232-C buffer (1024 bytes); and 14 ISO character sets.

Graphics Software

The ColorPro plotter is supported by a wide variety of graphics application packages for HP as well as non-HP computer systems. Details are available from any HP sales and support office.

Specifications

Resolution: smallest addressable step size, 0.025 mm (0.001 in.)

Repeatability: with a given pen, 0.1 mm (0.004 in.)

Pen velocity (each axis): pen up, approx. 52.0 cm/s (20.5 in./s); pen down, maximum, approx. 40.0 cm/s (15.7 in./s); programmable, 1.0 to 40.0 cm/s in 1.0 cm/s increments

Acceleration: approximately 1.2 g's

Environmental range: operating, 0°C to 55°C, 5% to 95% Rh (at 40°C), non-operating, -40°C to 75°C

Maximum plotting area: pen axis, 191 mm (7.5 in.) for A and A4*; paper axis, 272 mm (10.7 in.) for A4, 257 mm (10.1 in.) for A

Interfaces: HP-IB (IEEE 488-1978) interface which implements IEEE 488-1978 standards; RS-232-C/CCITT V.24, asynchronous serial ASCII with switch selectable baud rates of 75, 110, 150, 200, 300, 600, 1200, 2400, 4800, 9600; 60-byte buffer

Power requirements: source, 100, 120, 200, 240 V ~ -10%, +5%; frequency, 48-66 Hz; consumption, 20 W maximum

Size: height, 125 mm (4.9 in.); width, 460 mm (18.1 in.); depth, 308 mm (12.1 in.)

Weight: net, 5.5 kg (12.0 lb); shipping, approx. 8.6 kg (19.0 lb)

FCC: FCC certified to conform to limits set for radio frequency interference when used with a class B computing device. Meets or exceeds IEC-380, IEC-435, UL-478

Accessories Supplied

HP ColorPro Graphics Plotter Operating Manual

Power supply

An assortment of pens and media are also supplied with the plotter. The media size and appropriate power supply are determined by plotter destination.

NOTE: Interface cables are not supplied with the plotter. They must be ordered separately.

Ordering Information

HP 7440A ColorPro Plotter \$1295.00 ☎

HP 17440A Graphics Enhancement Cartridge \$165.00 ☎

Options

001 RS-232-C/CCITT V.24 (cable not included) N/C

002 HP-IB (IEEE 488-1978) (cable not included) N/C

Interface Cables

HP 13242G M-M special RS-232-C cable for use with \$69.00 ☎

Option 001, HP 150 Personal Computers, HP Vectra PC with HP 24541A interface

HP 17255D M-F special RS-232-C cable for use with \$44.00 ☎

Option 001, IBM PC, AT&T Personal Computers

HP 24542G M-M special RS-232-C cable for use with \$60.00 ☎

Option 001, HP Vectra PC with HP 24540A interface, IBM AT

HP 10833A HP-IB 1-metre cable for use with Option \$80.00 ☎

002

☎ Fast-Ship product — see page 734.

COMPUTER PERIPHERALS

Plotters—Technical/CAD Professional Plotter

Model 7475A

695

- High-quality output
- Drafting capability
- Choice of A3/B** and A4/A* media sizes

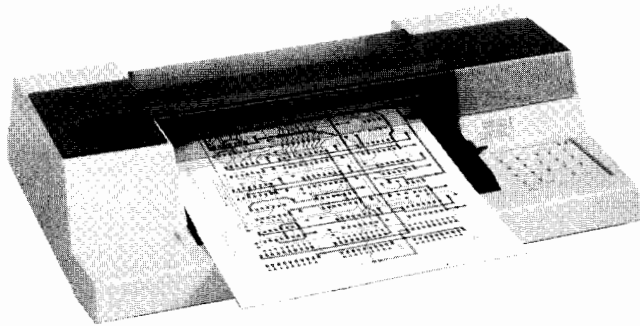

The HP 7475A is a low-cost plotter that provides the kind of graphics excellence and versatility you would expect to find in a much more expensive plotter. The HP 7475A produces fast, high-quality drawings for business, design, and measurement professionals.

With the HP 7475A, you have your choice of two media sizes — A4/A-size* for colorful report and presentation graphics, and A3/B-size** plots for PERT charts, schematics, engineering drawings, and design applications. You can switch chart sizes with the push of a button.

If you need a vertical format, you can use the front panel keys to rotate the chart 90 degrees. And if you need to digitize, you can do that from the front panel, too.

The HP 7475A accepts four different types of media — regular plotter paper, glossy presentation paper, overhead transparency film and double-matte polyester film. And you have a choice of two different pen types — fiber-tip pens for paper and overhead transparencies and liquid-ink drafting pens for high-quality drawings on polyester film. Fiber-tip pens are available in ten colors and two tip widths. Refillable short-body drafting pens come in three different tip widths.

Applications

Business: The A3/B-size** capability of the HP 7475A makes it the ideal plotter for PERT charts, organization charts, flow charts, or small flip charts. And the HP 7475A produces colorful A4/A-size* charts for reports, meetings, and presentations.

Design: Perfect as an entry level drafting plotter or an inexpensive companion to your design system, the HP 7475A creates liquid-ink drawings on polyester film for frequently handled archival copies or check plots using fiber-tip pens on paper.

Measurement: The HP 7475A adds hardcopy graphics capability to intelligent instruments and instrument systems with an HP-IB (IEEE 488-1978) interface. Many systems (with or without display screens) can have the benefits of high-quality, hardcopy graphics plotted directly from measured data.

High-Quality Output

With an addressable step size of 0.025 mm (0.001 in.), the HP 7475A can plot up to 1000 points in a 1-inch line. When commanded to return to the same point with no pen change, the plotter achieves this repeatability within 0.1 mm (0.004 in.). Because of the outstanding resolution and repeatability, the HP 7475A produces straight, professional-quality lines.

* A4 Size is 210 x 297 mm; A Size is 8½ x 11 in.

** A3 Size is 297 x 420 mm; B Size is 11 x 17 in.

Special Programming Features

If you create your own graphics programs, you'll be glad to learn that the HP 7475A contains over 50 HP-GL (Hewlett-Packard Graphics Language) instructions to control such functions as arc and circle generation, and area fill in pie and bar charts. Plus, the HP 7475A has 19 internal character sets, including ISO European sets, Katakana, ASCII, and Roman 8 extensions.

- Six-pen carousel
- Plots on paper, transparency film, polyester film
- Plots using fiber-tip and liquid-ink pens

Interface Options

The HP 7475A is easy to interface with most HP and non-HP computers because you have the choice of two interface options — either RS-232-C/CCITT V.24 or HP-IB (IEEE 488-1978). By adding an eavesdrop cable you can connect the HP 7475A in series with a computer and a terminal.

Graphics Software

The HP 7475A is supported on a wide variety of business and design graphics application packages for HP as well as non-HP computer systems. Details are available from any HP sales and service office.

Specifications

Resolution: Smallest addressable step size, 0.025 mm (0.001 in.)

Repeatability: with a given pen, 0.1 mm (0.004 in.); from pen to pen, 0.2 mm (0.008 in.)

Pen velocity (each axis): pen up, 50.8 cm/s (20 in./s); pen down, maximum, 38.1 cm/s (15 in./s); programmable, 1 to 38 cm/s in 1 cm/s increments

Acceleration: approximately 2 g's

Environmental range: operating, 0°C to 55°C; non-operating, -40°C to 75°C

Plotting area: x-axis, 258 mm (10.2 in.), A/B; 275 mm (10.8 in.), A4/A3; y-axis, 198 mm (7.80 in.), A; 192 mm (7.56 in.), A4; 414 mm (16.3 in.), B; 402 mm (15.8 in.), A3

Interfaces: HP-IB (IEEE 488-1978) implements the following functions as defined in IEEE 488-1978 — SH1, AH1, T2, TE0, LE0, SR1, RL0, DC1, DT0, L2, PP0 (listen only or address less than 7, otherwise PP2); RS-232-C/CCITT V.24, asynchronous serial ASCII with switch selectable baud rates of 75, 110, 150, 200, 300, 600, 1200, 2400, 4800, 9600. External clock input capabilities with intermediate baud rates of up to 9600 baud; 1024 byte buffer

Power requirements: source, 100, 120, 220, 240 V ~ -10%, +5%; frequency, 48-66Hz

Size: height, 127 mm (5 in.); width, 568 mm (22.4 in.); depth, 367 mm (14.5 in.)

Weight: net, 7 kg (16.0 lb); shipping, approx. 11 kg (24.0 lb)

FCC: FCC certified to limits set for radio frequency interface when used with a class B computing device

Accessories Supplied

HP 07475-90002 Operation and Interconnection Manual

HP 07475-90003 Reference Card

Power cords and an assortment of pens and drawing media are also supplied with the plotters. The media size and appropriate power supply are determined by plotter destination.

NOTE: Interface cables are not supplied with the plotter. They must be ordered separately.

Accessories Available

HP 07475-90001 Interfacing and Programming Manual

Price

\$20

Ordering Information

Options

001 RS-232-C/CCITT V.24 (cable not included)

N/C

002 HP-IB (IEEE 488-1978) (cable not included)

N/C

HP 7475A Six-pen Graphics Plotter

\$1895

Available from Instruments Direct 800-523-2121 (U.S. only)

☛ Fast-Ship product — see page 734.

COMPUTER PERIPHERALS

Plotters — High Speed/High Performance Plotter

Model 7550A

- Ideal for high-volume, shared environments
- Requires minimum operator supervision
- Uses drafting media, pens
- High throughput
- 6 g acceleration, 80 cm/s (31.5 in./s)
- Accepts A3/B- and A4/A-size media

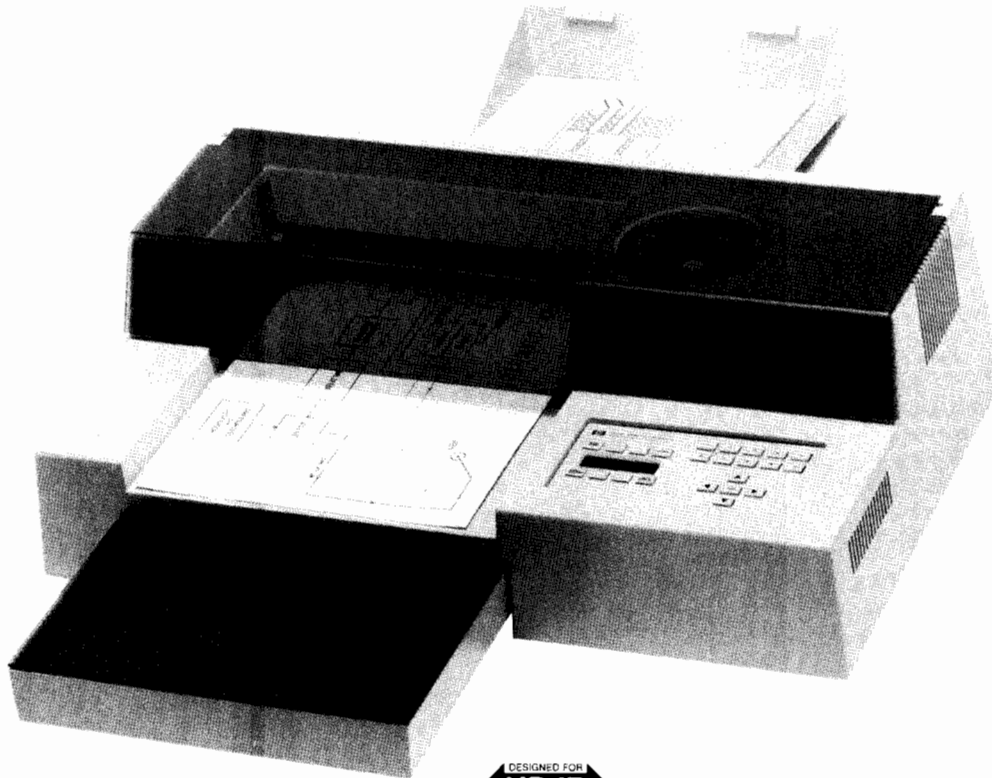

HP 7550A



Hewlett-Packard's sheet feed 7550A plotter is an innovative graphics tool for business and technical users alike. Automatic cut sheet feed capability for regular plotter paper and transparencies makes the HP 7550A ideal for unattended plotting or multiple color copies. With an unmatched 6 g of acceleration, the HP 7550A can produce quick graphs for problem-solving or decision making, or working drawings for drafting or design systems. And the HP 7550A meets Hewlett-Packard's high performance standards, so it creates professional-looking graphs for reports and presentations.

Fast Throughput

The HP 7550A's fast acceleration and pen speed mean shorter plotting time. The HP 7550A draws in any direction at 80 cm/s (31.5 in./s) and letters at approximately 7-9 characters per second. It uses the powerful MC68000 16-bit microprocessor. The HP 7550A is also equipped with a replot capability so if an entire plot will fit in the replot buffer (\approx 12K bytes), the HP 7550A can produce up to 99 original color copies without rerunning the program, freeing your computer to go on with other tasks.

Minimum Operator Supervision

The HP 7550A eliminates manual paper handling of A3/B- and A4/A- size sheets of paper, and transparency film. The carousel allows eight pens to be loaded at once, and the plotter caps the pens when not in use to keep ink fresh. The HP 7550A automatically senses the type of carousel loaded, then sets the optimal pen speed and force. It also senses what paper size is being used.

High Quality Output

With an addressable resolution of 0.025 mm (0.001 in.) and mechanical resolution of 0.006 mm (0.00025 in.), the HP 7550A makes smooth arcs and draws lines that meet precisely. It also has a curved line generator which can be invoked when exceptionally smooth curves are required.

With 20 character sets, the HP 7550A is ideal for international business. Choices include Katakana and ISO European languages for Denmark, France, Germany, Italy, Norway, Portugal, Spain, Sweden, and the United Kingdom. The HP 7550A letters in two fonts: arc font with proportional spacing for maximum readability and stick font with fixed character spacing for speed.

Features

The front-panel display and function keys guide users through each plotter setup, report plotter status, and give program messages. The HP 7550A rotates graphs 90 degrees for a choice of either horizontal or vertical formats, and aligns graphs to pre-printed forms and grids, all from the front panel.

The HP 7550A accepts standard A4/A- and A3/B-size regular plotter paper, and glossy plotter paper double-matte polyester film, vellum, and A4/A-size transparency film. Pen choices include liquid-ink, roller-ball, paper, and transparency pens. Because of its complete device control command set and dual interface - HP-IB (IEEE488-1978) and RS-232-C/CCITT V.24, the HP 7550A is adaptable to most system environments.

Technical Applications

The drawing quality, media flexibility, automatic sheet feed and fast plotting time of the HP 7550A make it ideal for quick working drawings or small format final drawings in computer-aided design, or for technical graphics in manufacturing, testing, or research and development. The HP 7550A is supported by many technical graphics software packages; the HP 7550A can draw A3/B-size check plots and working drawings to help relieve overburdened drafting plotters, produce quick, problem-solving graphs or engineering analyses, and plot charts and graphs on transparency film for technical presentations. And the HP 7550A does it all quickly and easily.

Business Applications

The HP 7550A is suited to business graphics users who appreciate the value of color hardcopy graphics, need quality graphics in quantity, and want a plotter that requires a minimum of operator supervision. Financial graphs, project schedules, forecasts and text charts are typical uses for a HP 7550A in a business environment. And both HP and non-HP graphics software packages make it easy for anyone to use the HP 7550A.

Software

Software support is available for the HP 7550A on many HP and non-HP computer systems, as well as HP and non-HP personal computers. In addition to HP's Industry Standard Plotting Package, a variety of graphics packages for nonprogrammers is available. These software packages cover both business and technical applications. Complete information is available from any HP Sales and Support office.

Specifications

Media sizes: accommodates ISO A4 (210 x 297 mm), ANSI A (8.5 x 11 in.), ISO A3 (297 x 420 mm), and ANSI B (11 x 17 in.)

Maximum plotting area: pen axis, 254 mm (9.97 in.) for A/B, 272 mm (10.65 in.) for A4/A3; paper axis, 411 mm (16.12 in.) for B, 399 mm (15.65 in.) for A3, 196 mm (7.68 in.) for A, 190 mm (7.45 in.) for A4.

Resolution: smallest addressable step size is 0.025 mm (0.001 in.); mechanical resolution is 0.006 mm (0.00025 in.)

Repeatability: with a given pen, 0.1 mm (0.004 in.)

Pen velocity: pen down, maximum, 80 cm/s (31.5 in./s) in increments of 1 cm/s, from the front panel 10 to 80 cm/s (4 to 31.5 in./s) in increments of 5 cm/s; pen up 80 cm/s (31.5 in./s)

Acceleration: maximum approximately 6 g's; programmable from 1 to 6 g's in increments of 1 g.

Pen force: 15 to 66 grams

Power requirements: source, 100, 120, 220, 240 V, -10%, +5%; frequency, 48 - 66 Hz; consumption, 100 W maximum

Interfaces: HP-IB implements the following HP-IB functions as defined in IEEE 488-1978: SH1, AH1, T6, L3, SR1, RL0, DC1, DT0, C0, PP0, for listen only, PP1 for address greater than 7, and PP2 for address of 7 or less, device address front panel selectable, default value - 5; RS-232-C/CCITT V.24, asynchronous serial ASCII with front panel selectable baud rates of 75, 110, 150, 200, 300, 600, 1200, 2400, and 9600, default value - 2400

Buffer size: default, 1024 bytes; from the program expandable to 12K bytes

Character sets: 20 sets, each in two character fonts, including, the following ISO registered sets: International Reference Version (002); United Kingdom (004), U.S. ASCII (006), Swedish (010), Swedish for Names (011), Katakana (013), JIS ASCII (014), Italian (015), Portuguese (016), Spanish (017), German (021), French (025), Norwegian (060), Norwegian II (061), plus HP 9825 character set, French/German, Scandinavian, Spanish/Latin America, Special Symbols, and Roman 8 Extensions

Environmental range: operating, 0°C to 55°C; nonoperating, -40°C to 75°C; automatic sheet feeder, operating with paper, 10 - 40 C and 0 - 80% RH, with transparency film, 15 - 35°C and 25 - 75% RH

Size: height, 215 mm (8.5 in.); width, 670 mm (26.4 in.); depth with A4/A loading tray/no catcher, 432 mm (17.0 in.), A4/A loading tray with catcher, 682 mm (26.8 in.), A3/B loading tray/no catcher, 635 mm (25.0 in.), A3/B loading tray with catcher, 896 mm (35.3 in.)

Weight: net approximately 17.3 kg (38.0 lb), shipping approximately 25.0 kg (55.0 lb)

Pens: 8 per carousel: fiber-tip, roller-ball, and liquid-ink

Media: manual feed, chart paper, high-gloss paper, transparency film, vellum, double-matte polyester mylar film; automatic sheet-feed, chart paper and transparency film.

Accessories Supplied

	HP Part Number
Operation and Interconnection Guide	07550-90002
Pocket Guide	07550-90003
A-size Media Loading Tray	17561A
A4 Media Loading Tray	17562A
A4/A Paper Catcher	17563A
Pen carousel for fiber-tip transparency pens	07550-60050
Pen carousel for fiber-tip paper pens	07550-60051

A power cord and an assortment of fiber-tip pens, paper and transparency media are also supplied with the plotter. The media size and appropriate power cord are determined by destination. Drafting pens and drafting media are available; please refer to the Computer Users Catalog for a complete listing.

Ordering Information

	Price
Interface cables	
HP 17355D Male-female RS-232-C/CCITT V.24 cable for use in remote modem environments; pins 1-25 wired end-to-end	\$66 ☎
HP 17255F Female-female RS-232-C/CCITT V.24 cable, adapted for use with IBM personal computer interface	\$44 ☎
HP 17255D Male-female RS-232-C/CCITT V.24 cable, adapted for use with HP 150 personal computer interface	\$44 ☎
HP 17855A RS-422-A adapter cable	\$220 ☎
HP 10833A or 45529A HP-IB 1-metre cable; RFI shielded	\$80 ☎
HP 10833B or 45529B HP-IB 2-metre cable; RFI shielded	\$90 ☎

Accessories Available

HP 17526A A3-size Media Handling Kit, including media loading tray, media catcher, 50 sheets A3-size plotter paper	\$176 ☎
HP 17525A B-size Media Handling Kit, including media loading tray, media catcher, 50 sheets B-size plotter paper	\$176 ☎
HP 17564A B-size Loading Tray	\$121
HP 17565A A3-size Loading Tray	\$121
HP 17566A B-size Media Catcher	\$46
HP 07550-90001 Interfacing and Programming Manual	\$35

HP 7550A Graphics Plotter

☎ Fast-Ship product — see page 734.

\$3995

COMPUTER PERIPHERALS

Plotters—Low-cost, Eight-pen Drafting Plotters

HP DraftPro Series Plotters

- Compatible with popular hardware and software
- Powerful HP-GL command set
- Wide variety of pen/media choices
- One- and two-megabyte buffer options for HP DraftPro DXL and EXL
- HP quality and reliability

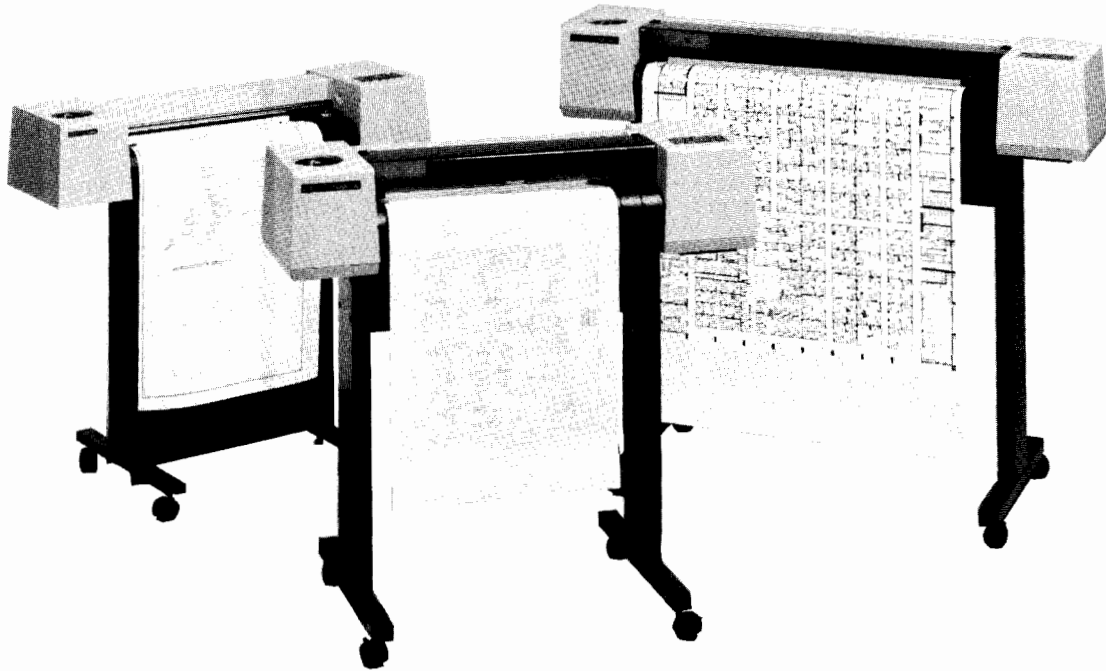

The HP DraftPro series plotters meet the needs of CAD professionals. The HP DraftPro plotter accepts C/A2 and D/A1 media; HP DraftPro DXL accepts A/A4 through D/A1 media; and the HP DraftPro EXL accepts A/A4 through E/A0 media (all standard ISO, ANSI, and architectural sizes including 30 x 42-in media).

Line Quality

With a mechanical resolution of 0.0125 mm (0.0005 in) and an addressable resolution of 0.025 mm (0.001 in), the HP DraftPro series plotters draw well defined lines, smooth curves, and crisp characters that help you and your designs look their best. The 0.10 mm (0.004 in) repeatability means your drawings have the professional quality you need.

For many applications, accuracy is important. The HP DraftPro series plotters are accurate to within 0.5 mm (0.02 in) or 0.2% of the specified line length, whichever is greater.

Medium Throughput

The HP DraftPro series plotters have 2.8 g maximum (diagonal) acceleration and 80 cm/s (32 in/s) velocity (40 cm/s (15.7 in/s) for the HP DraftPro). In addition, a pen-sorting feature that minimizes pen changes for more efficient plotting.

Two Extended Buffer Options

Two extended buffer options are available as accessories for both the HP DraftPro DXL and EXL plotters.

The easy-to-install cartridges are available in one- and two-megabyte options to let you quickly download an entire plot, freeing your computer for other tasks. (For use with RS-232-C interface only.)

Hardware and Software Compatibility

HP DraftPro series plotters connect easily to most HP and other personal computer/workstations. An RS-232-C serial interface is standard; HP-IB (IEEE 488-1978) can be ordered as an accessory.

Quiet operation makes these plotters a good fit in an office environment. Because HP DraftPro series plotters have wheels, they are easy to move and share.

Over 100 software packages work with HP DraftPro series plotters, including all leading architectural, mechanical, and electronic PC CAD software.

Powerful Command Set

The HP DraftPro series plotters use HP-GL (Hewlett-Packard Graphics Language). With just a few commands you can label, draw lines, arcs, and circles, or select one of 21 international character sets (20 for the standard HP DraftPro model).

Although most plotter manufacturers claim to have HP-GL compatibility, only HP plotters have the original HP-GL tested and approved by Hewlett-Packard.

Output for Every Application

The HP DraftPro series plotters have the necessary pen and media flexibility to get the job done. Each plotter can plot on paper, vellum, and polyester film. They draw with fiber-tip paper pens, disposable drafting pens, and refillable drafting pens. For presentations, the HP DraftPro DXL and EXL can use glossy paper or transparency film with transparency pens.

From the front panel you can select the pen speed that optimizes performance and line quality for your pen/media combination. The eight-pen carousel lets you use a variety of colors and line widths with ease. Pens are changed automatically during plotting, and they are automatically capped when not in use to increase the life of the pens.

HP Quality and Reliability

Equipment downtime costs time and money. That is why the HP DraftPro series plotters meet the same tough standards for quality and reliability that have made HP pen plotters leaders in the industry.

The HP DraftPro series plotters have a one-year warranty. After the first year, on-site service contracts are available at the lowest prices in the industry.

The combination of reliability, quality, performance, flexibility, and support makes these plotters an excellent value and a smart choice in drafting plotters.

Technical Information

Media Sizes

The HP DraftPro series plotters accommodate the standard ISO, ANSI, and architectural sizes listed below:

HP DraftPro

C/A2 to D/A1, including widths from 550 mm to 640 mm (21.65 in to 25.20 in), lengths from 400 mm to 1000 mm (15.75 in to 39.37 in)

HP DraftPro DXL

A/A4 to D/A1, including widths from 205 mm to 485 mm (8.07 in to 19.09 in) and from 555 mm to 645 mm (21.85 in to 25.39 in), lengths from 215 mm to 1140 mm (8.46 in to 44.88 in)

HP DraftPro EXL

A/A4 to E/A0, including widths from 207 mm to 634 mm (8.15 in to 24.96 in) and from 729 mm to 927 mm (28.70 in to 36.50 in), lengths from 215 mm to 1230 mm 8.46 in to 48.43 in)

Number of Pens: 8 in carousel

Pen Type

HP DraftPro

Fiber-tip paper, disposable drafting, refillable drafting

HP DraftPro DXL/EXL

Fiber-tip paper, fiber-tip transparency, disposable drafting, refillable drafting

Media

HP DraftPro

Paper, vellum, double-matte polyester film

HP DraftPro DXL/EXL

Paper, vellum, double-matte polyester film, glossy paper, transparency film

Character Sets

French/German, HP 9825, Scandinavian, Spanish/Latin American, Roman Extensions, Special Symbols, Drafting, Kanji, and these ISO registered sets: ANSI ASCII (006), French (025), German (021), International Reference Version (002), Italian (015), JIS ASCII (014), Katakana (013), Norwegian I (060), Norwegian II (061), Portuguese (016), Spanish (017), Swedish (010), Swedish for Names (011), United Kingdom (004); HP DraftPro DXL/EXL also use ECMA 94 Extensions (100); Kanji is available with an optional cartridge.

Resolution

Addressable: 0.025 mm (0.001 in)

Mechanical: 0.0125 mm (0.0005 in)

Repeatability

0.10 mm (0.004 in) for the same pen on 0.08 mm (0.003 in) double-matte polyester film at 10-30 degrees C, 20-80% relative humidity

Accuracy

0.5 mm (0.02 in) or 0.2% of the specified line length, whichever is greater, on 0.08 mm (0.003 in) double-matte polyester film at 10-30 degrees C, 20-80% relative humidity

Maximum Pen Velocity

HP DraftPro: 40 cm/s (15.7 in/s)

HP DraftPro DXL/EXL: 80 cm/s (32 in/s)

Maximum Acceleration

Diagonal 2.8g

Axial 2.0g

Pen Cycle Time

HP DraftPro: 100 ms

HP DraftPro DXL/EXL: 67 ms

Margins

Expanded mode: 5.0 mm (0.2 in) on three edges, 31.0 mm (1.2 in) on the fourth

Normal mode: 15.0 mm (0.59 in) on three edges, 39.0 mm (1.5 in) on the fourth

Buffer Size

HP DraftPro: 7.2 Kbyte

HP DraftPro DXL/EXL: 31 Kbyte standard buffer (shared between user-definable polygon and pen sort buffers). Optional one- and two-

megabyte expandable buffers are available as accessories (for use with RS-232-C interface only).

Environmental Ranges

Temperature

Operating: 0 to 55 degrees C (32 to 131 degrees F)

Storage: -40 to 75 degrees C (-40 to 167 degrees F)

Humidity: 5 to 95% (in 0 to 40 degrees C)

Acoustics¹

Operating pressure: 58 dB(A)

Idle pressure: 42 dB(A)

(These specifications are typical sound pressures at one-meter bystander position.)

Power Requirements

Source: 100, 120, 220, 240V, $\pm 10\%$

Frequency: 47.5-66 Hz

Consumption: less than 80W maximum

Physical Specifications

HP DraftPro

Size: 1,030H x 1,140W x 520mmD (40.6" x 44.9" x 20.5")

Weight: net, 30kg (66lb); shipping, 45kg (100lb)

HP DraftPro DXL

Size: 1,105H x 1,145W x 570mmD (43.5" x 45" x 22.5")

Weight: net, 34kg (76lb); shipping, 54kg (120lb)

HP DraftPro EXL

Size: 1,210H x 1,450W 620mmD (47.5" x 57" x 24.5")

Weight: net, 41kg (91lb); shipping, 61kg (135lb)

Certifications

FCC certified, Class B; meets or exceeds IEC-380, IEC-435, VDE 0806/08.81, UL-478, and CSA C22.2 No. 220.

Accessories Supplied

User's Guide

Power cord (appropriate to plotter destination)

Media sample kit

5 sheets of metric A1-size paper (594 x 841 mm)

Fiber-tip pens (0.3 mm)

Package of 5 (black, blue, green, red, and yellow)

Disposable drafting pens (0.35 mm)

Package of 4 (black, blue, red, and green)

Carousels

Fiber-tip pen carousel

Drafting pen carousel

Grit wheel brush

Supplies catalog

Ordering Information

HP 7570A DraftPro plotter

Price

\$3,995

HP 7575A DraftPro DXL plotter

\$4,995

HP 7576A DraftPro EXL plotter

\$6,495

Accessories Available

Description	Part Number
HP-IB Installation Instructions	07570-90014
HP DraftPro Programmer's Reference Manual (English only)	07570-90001
HP DraftPro DXL/EXL Programmer's Reference Manual	07575-90001
HP DraftPro Hardware Support Manual	07570-90000
HP DraftPro DXL/EXL Hardware Support Manual	07575-90000
HP-IB Interface Cartridge	17570A
HP-IB Interface Cartridge with Kanji	17571A
One-Megabyte extended buffer (for DraftPro DXL and EXL) ²	17573A
Two-Megabyte extended buffer (for DraftPro DXL and EXL) ²	17574A

¹ HP DraftPro DXL and EXL only. Data not available for HP DraftPro.

² Available for RS-232-C interface only.

COMPUTER PERIPHERALS

Plotters—High Performance, A4/A through A0/E size Drafting Plotters

HP DraftMaster I and DraftMaster II

- High throughput; up to 5.7 g acceleration
- Built-in intelligence
- Superb line quality
- Triple interface: RS-232-C, RS-422-A, HP-IB
- HP 758XB emulation
- Accepts eight standard media sizes

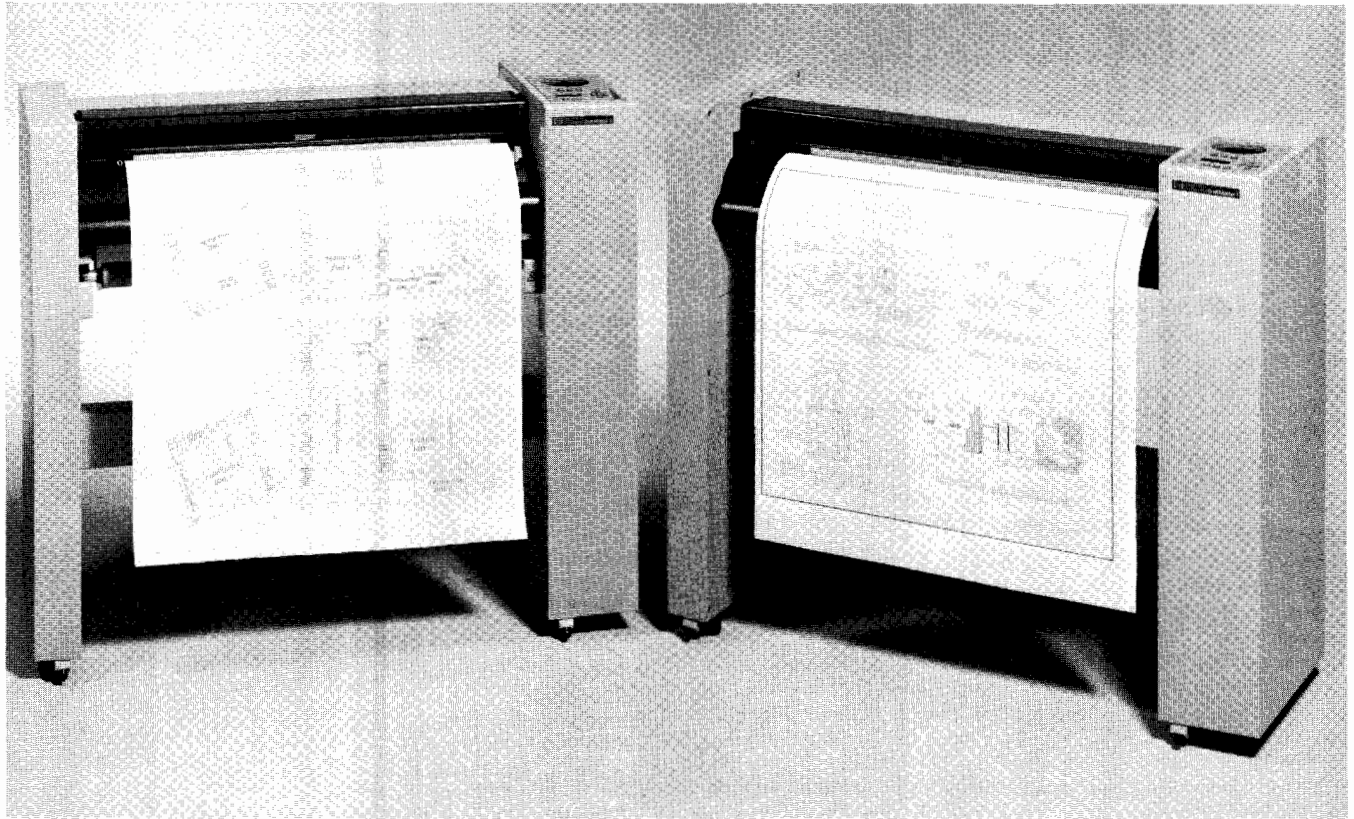

Hewlett-Packard has created a new generation of drafting plotters to meet the high-performance requirements that today's CAD environments demand — the DraftMaster I and the roll-feed DraftMaster II plotters. HP DraftMaster plotters combine state-of-the-art hardware with the latest in drafting technology at a price that's less than you'd expect.

Exceptional Performance

Your drafting productivity is directly affected by plotter throughput. With a maximum pen speed of 60 cm/s (24 in./s) acceleration of up to 5.7 g, and a host of built-in intelligence features, the HP DraftMaster's plotting power gets the job done fast to keep you on schedule.

HP's pen sorting function trims plotting time by minimizing pen changes. The DraftMaster plotter scans your entire plot program to combine pen-up moves wherever possible. The bi-directional plotting feature further increases drawing efficiency by automatically starting the next line segment at its nearest endpoint. And the powerful 10 MHz 16-bit microprocessor enables the HP DraftMaster to draw numerous short lines quickly, a real advantage for lettering.

High throughput is essential in shared environments, especially when several users who share a plotter are facing the same deadlines. HP DraftMaster is designed to meet the increased demands of a multi-user system.

Superb Line Quality

No matter how demanding your application — a complex IC or PCB plot, a precise mechanical part design, a detailed architectural drawing — HP DraftMaster showcases your work with the best line quality available. With an addressable resolution of 0.025 mm (0.00098 in.) and repeatability of 0.10 mm (0.004 in.), you can be sure your design will have a first-class presentation.

Roll-feed Capability on HP DraftMaster II Plotter

HP DraftMaster II is designed for high-volume, continuous feed, and long-axis plotting. HP DraftMaster II's roll-feed capability keeps productivity humming at peak levels when several users share a plotter. You can store the completed drawings neatly on the take-up roll, or cut them off one at a time with the built-in media cutter.

When your work requires unattended roll-feed plotting, you can use the DraftMaster plotter's "group pen" function. You can plot up to eight times longer on single-color plots (or four times longer on two-color plots) without stopping to reload the pen carousel. After the first pen has plotted a preset distance, the DraftMaster plotter automatically switches to the next pen in that group. A roll-feed upgrade kit is available for the HP DraftMaster I.

Simple Operation

HP DraftMaster plotters are designed for fast and convenient operation with easy, common-sense controls. The 32-character liquid crystal display (LCD) presents easy-to-follow command menus in six major languages.

A convenient loading lever makes media handling fast and uncomplicated. Plus, HP DraftMaster senses media size and automatically scales plot size to fit, so there's no worry about pens drawing off the page. DraftMaster's generous eight-pen carousels eliminate time-consuming manual pen changes. And pens are always capped automatically to prevent ink from drying out. You won't have to reset pen speed and force when you change carousels, either — HP DraftMaster plotters have a unique adjustable carousel. Simply twist the barrel to the desired setting. DraftMaster senses the type of carousel and automatically adjusts speed and force for optimum results.

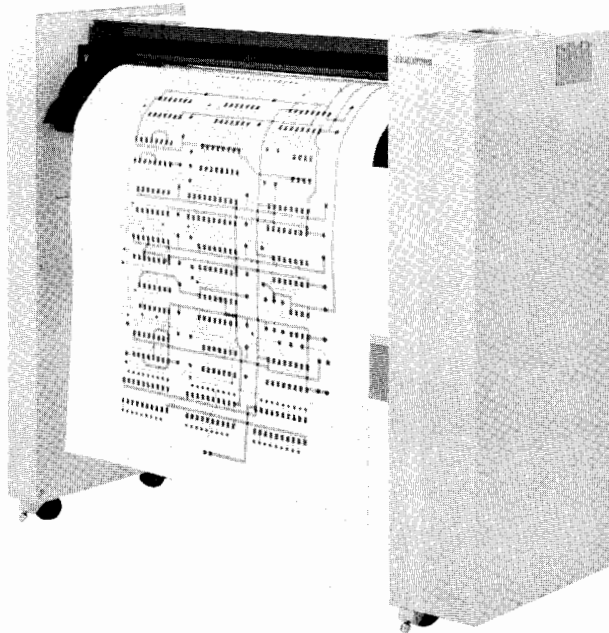

Pen, Media Flexibility

With the HP DraftMaster Plotter, you can choose from vellum, polyester film, tracing bond, paper, and even transparency film and glossy paper, in A4/A through A0/E-size cut sheets. The HP DraftMaster II also plots on continuous rolls for high-volume, unattended operation, as well as long-axis plotting.

All HP pens and media are carefully designed and tested to give you top-quality results from your HP plotter. HP pens are available in a wide variety of point sizes and colors; the DraftMaster plotter accepts your choice of fiber-tip, roller-ball, and drafting pens (both disposable and refillable).

Compatibility

Whether you have a personal computer, technical workstation, minicomputer, or mainframe, you can add an HP DraftMaster plotter to your system. For maximum hardware compatibility, all HP DraftMaster plotters come with a triple interface — both RS-232-C/CCITT V.24 and HP-IB (IEEE 488-1978), as well as RS-422-A for longer distance computer connections. And HP DraftMaster plotters have full eavesdrop capability (dual serial I/O for terminal configurations).

HP 758XB Emulation Mode

There's a tremendous amount of software already available for the DraftMaster plotters because all of the software written for the HP 7585B and 7586B drafting plotters will run on the HP DraftMaster I and II. Just the touch of a button engages HP's proprietary software emulation feature.

International Design

The LCD menu can prompt in any of six languages: English (default), French, German, Italian, Spanish, and Japanese. The front-panel buttons are labeled with symbols instead of words. And when programming with HP-GL (Hewlett-Packard Graphics Language) commands, users can select from over 20 international character sets in three fonts.

Specifications

Media sizes: ranges include ISO sizes A0 through A4, ANSI sizes A through E, and architectural sizes, as well as oversized media. DraftMaster I (sheets only); acceptable media widths; 207-381 mm (8.15-15 in.), 539-713 mm (21.22-28.07 in.), 753-927 mm (29.65-36.5 in.). DraftMaster II (same sheet sizes as listed above, plus these roll sizes); width, 609.6 mm (24 in.), 914.4 mm (36 in.); length, 46

metres (150 ft). Maximum frame lengths, 609.6 mm (24 in.) rolls, 914.4 mm (36 in.), 938.4 mm (36.9 in.) rolls, 1243.2 mm (48.9 in.)

Margins (sheets only): normal mode; three margins approx. 15 mm (0.59 in.) each, fourth margin approx. 39 mm (1.54 in.). Expanded mode; three margins approx. 5 mm (0.2 in.) each, fourth margin approx. 29 mm (1.14 in.)

Resolution: smallest addressable step size, 0.025 mm (0.00098 in.)

Repeatability (for a given pen): 0.1 mm (0.004 in.)

Accuracy: 0.09% of the move or 0.25 mm (0.0098 in.), whichever is greater.

Pen velocity: pen up/down, 60 cm/s (24 in./s) independent of vector direction

Acceleration: maximum, 5.7 g (55.6 m/s²) on diagonal; 4 g per axis; programmable, 2 or 4 g (19.4 or 39 m/s²)

Pen force: programmable or front panel selectable; 15-66 grams

Power requirements: Source, 100, 120, 220, 240, V \sim \pm 10%; frequency 48-66 Hz; consumption, 105 W maximum.

Interfaces: HP-IB (IEEE 488-1978), RS-232-C/CCITT V.24, RS-422-A

Buffer size: 25 K (configurable)

Environmental range: operating temperature, 0° to 55° C; non-operating temperature, -40° to -75° C; relative humidity, sheets, 5-95% (in 0° to 40°C); rolls, 30-70% (in 10° to 30°C).

Size: height, 119.4 cm (47 in.); width, 134.6 cm (53 in.); depth, 50.8 cm (20 in.)

Weight: DraftMaster I, 73 kg (160 lb); DraftMaster II, 75 kg (164 lb)

Pens: 8 in carousel; automatic pen changing and capping; automatic setting. Fiber-tip (paper and transparency), roller-ball, long-body drafting (refillable or disposable)

Media: Vellum, double-matte polyester film, tracing bond, plotter paper, transparency film, and glossy paper.

Accessories Supplied

Description	HP Part No.
User's Guide	07595-90002
Pocket Guide (available in English only)	07595-90003
Drafting Supplies Catalog	5957-3776D
	5957-3777
Paper sampler, Architectural D size (5)	9280-9050
Adjustable carousel (2)	5062-1576
Disposable pen adapters (4)	5061-7578
Disposable vellum pens (4)	5061-7566
Roller-ball pens (4)	5061-5037
Fiber-tip pens (10)	17845P
Grit-wheel brush	07595-20085
Power cord (appropriate cord supplies based on destination)	

Additional Accessories Supplied with DraftMaster II

Description	HP Part No.
914.4 mm (36 in.) paper spool	9300-1069
Paper roll sampler, 914.4 mm (36 in.) wide, 1143 mm (45 ft) long	9280-0736
Media cutters (5)	07596-60008

Ordering Information

	Price
HP 7595A DraftMaster I plotter (sheet feed only)	\$8,495
HP 7596A DraftMaster II plotter (sheet feed and roll-feed)	\$10,995

Accessories Available

Description	HP Part No.
Programmer's Reference (available in English only)	07595-90001
Roll-feed Upgrade Kit (HP DraftMaster I only; must be installed by qualified serviceperson)	17520A
Kanji Retrofit Kit (must be installed by qualified serviceperson)	17521A
HP Industry Standard Plotting Package (software)	17580C

COMPUTER PERIPHERALS

Plotters—Monochrome Electrostatic Plotters

Models 240D and 240E

- Fast plotting speed
- Excellent resolution
- Built-in vector-to-raster converter
- Three standard interfaces and HP-GL compatibility
- Optional take-up reel
- Installation included

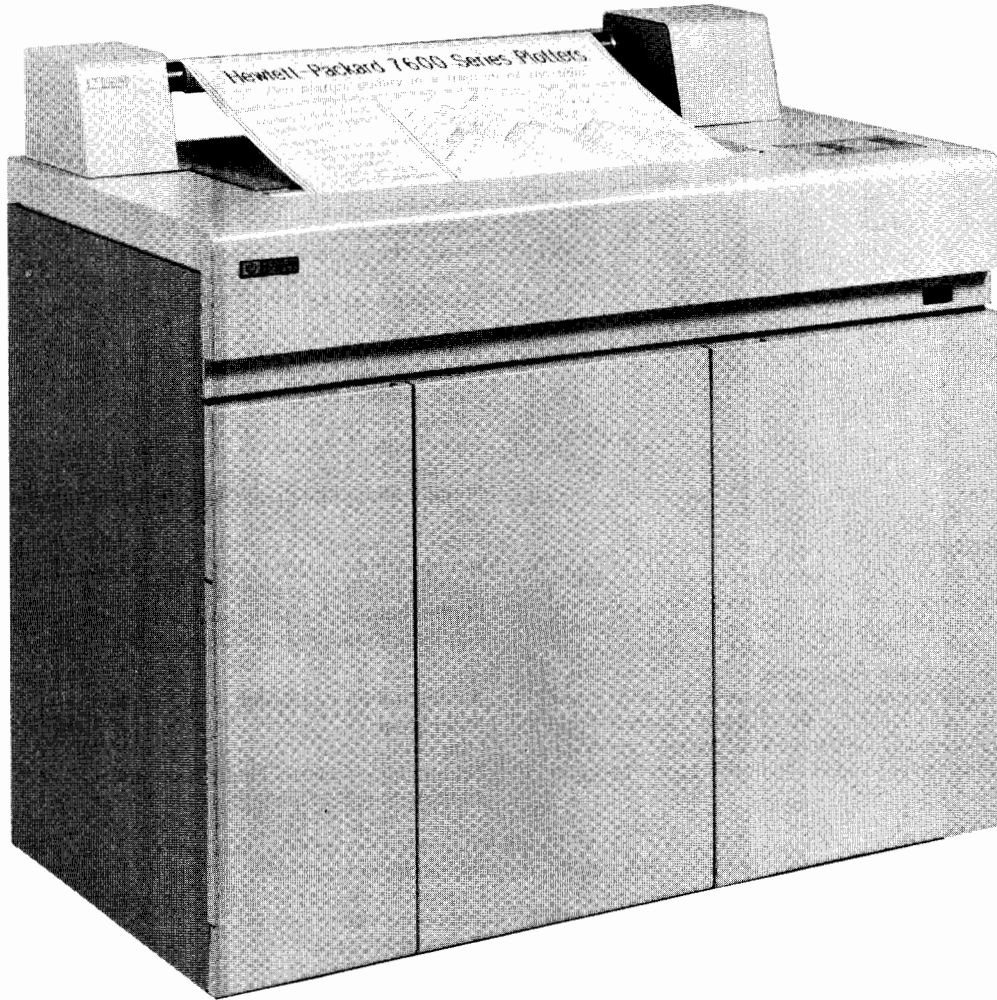

The HP 7600 Series, Models 240D and 240E monochrome electrostatic plotters are designed to meet the high performance and volume demands of a department using computer-aided-design (CAD). The HP 7600 Series plotters are also well suited for any CAD user in an application involving complex, intricate images or large amounts of area fill. The HP 7600 Series plotters meet the same stringent standards for quality and reliability that have made HP pen plotters leaders in the industry.

The HP 7600 Series, Model 240D accepts media 609 mm (24 in.) wide, and the Model 240E uses media 914 mm (36 in.) wide. And one low price includes the plotter, the vector-to-raster converter (VRC), and installation by a qualified representative.

Fast Plotting Speed

Whether you need final drawings to meet a tight deadline or quick working plots for immediate feedback during the design process, the HP 7600 Series plotters can meet the challenge.

The HP 7600 Series electrostatic plotters have a fast print speed—actual plotting time for a typical full-size drawing is less than one minute, including the vector-to-raster conversion time. And the powerful VRC keeps rasterization time short to help maximize total throughput.

Top Quality Output

With a resolution of 406 dots per inch (160 dots per cm), the HP 7600 Series plotters produce well-defined lines, smooth curves, and crisp characters that help you and your designs look their very best.

Our media and toner products are completely compatible and have been extensively tested together to make sure you get clear, sharp, smudge-resistant drawings every time you plot.

For users with special needs, the plotters have two special features—"Enhance" for thicker, bolder lines; and "Darker" for plots requiring the blackest possible black.

Meant to be Shared

One HP 7600 Series plotter can easily serve the needs of an entire department. It has a high-volume setup and is designed to run with minimal operator supervision.

Add the optional take-up reel for true unattended or overnight plotting. A single roll of paper can produce as many as 150 A1/D-size plots on the Model 240D or 125 A0/E-size drawings on the Model 240E.

A simple, straightforward control panel minimizes the need for user/plotter interaction. Even in a shared work group, you can be sure the HP 7600 Series plotter will be properly configured and ready to go. The control panel has a series of LEDs, so it only takes a quick glance to check on the paper supply.

Powerful, Built-in VRC

Since most graphics software programs output data in vector formats and electrostatic plotters are raster devices, we've included a built-in vector-to-raster converter (VRC) with each HP 7600 Series plotter. The HP 7600 Series VRC is based on the powerful 32-bit Motorola 68020 processor. It was designed with performance as the number one goal—and it shows!

For typical plots, rasterization and printing are performed simultaneously. The VRC is so efficient that the print engine doesn't have to stop mid-plot and wait for input, so you get consistent plot quality.

Easy System Integration

HP 7600 Series electrostatic plotters connect easily to almost any computer system—personal computers, workstations, and large systems. Every HP 7600 plotter comes with three standard interfaces—RS-232-C, Centronics Parallel, and HP-IB. The HP 7600 Series also has RS-422-A capability for long-distance communication.

Like our drafting pen plotters, HP 7600 Series plotters are HP-GL (Hewlett-Packard Graphics Language) compatible, making them ready to use on hundreds of software packages. The HP 7600 plotters also introduce the next generation of the HP-GL command language, HP-GL/2. HP-GL/2 offers higher throughput and greater overall performance, plus compatibility for the future.

Output for Every Application

An extra wide plotting width [600 mm (23.6 in.) for the Model 240D and 896 mm (35.3 in.) for the Model 240E] enables these plotters to accommodate architectural drawings, in addition to standard ISO A1 and A0 and ANSI D and E sizes.

With the built-in 40-megabyte hard disc, you can produce long-axis plots up to 15.3 m (50 ft) in length—perfect for “life-size” parts. And the disc automatically stores the current drawing so you can redraw the plot with the touch of a button or a simple software command when you need multiple copies.

The media set for the HP 7600 Series includes report grade paper, premium grade paper, translucent paper, vellum, and clear and matte polyester film, so you have media for all your plotting needs: working copy, final output, or archival drawings.

Designed to Fit Right In

A sturdy, compact design makes these plotters an easy addition to almost any department. Set on casters, the HP 7600 Series plotters can be moved from one place to another. The convenient narrow width helps the plotters slide easily through all standard doorways.

A wide range for environmental specifications makes the HP 7600 Series plotters appropriate for many work area settings. Departments can keep the plotter close by for on-the-spot output.*

Simple Maintenance

Maintenance procedures are simple and take only a few minutes. HP 7600 Series maintenance supplies are designed to help keep the toner system and writing head clean and trouble-free for the life of the plotter. All mechanical and electrical adjustments are set at the factory, and no special periodic maintenance requiring outside service personnel is necessary.

Installation Included

When you buy an HP 7600 Series plotter, a qualified representative will come out to your site to install and test the product to make sure you get up and running. You'll even get tips on media and toner loading, built-in confidence plots, control panel functions, maintenance procedures, and plotter operation.

* Optimal plot quality achieved at 23°C (73°F), 40 to 60% RH. Extremes in temperature or humidity can affect plot quality. See “Specifications” for acceptable environmental ranges.

Specifications

Media width: Model 240D, 609 mm (24 in.); Model 240E, 914 mm (36 in.).

Plot width: Model 240D, 600 mm, ±2.4 mm (23.6 in., ±0.1 in.); Model 240E, 896 mm, ±3.6 mm (35.3 in., ±0.1 in.).

Toner capacity: 5 litres (1.3 gal)

Interfaces: RS-232-C/CCITT V.24, HP-IB (IEEE 488-1978), and Centronics parallel.

Print speed: Model 240D: normal mode, 1.6 cm per second (0.64 inches per second); high density mode, 0.8 cm per second (0.32 inches per second). Model 240E: normal mode, 2.2 cm per second (0.86 inches per second); high density mode, 1.1 cm per second (0.43 inches per second).

Resolution*: mechanical, 160 dots per cm (406 dots per inch); addressable, 0.025 mm (0.00098 in.)

Maximum accumulated error*: ±0.2%

Pin electrodes: configuration, dual array; diameter, 0.0060 cm (0.0024 in.); spacing, 0.00625 cm (0.0025 in.).

Environmental ranges: heat dissipation, 1200 BTUs/hour maximum; operating temperature, 10 to 35°C (50 to 95°F)**; operating humidity, 30 to 80% RH**. Hardware: storage temperature, -10 to 60°C (14 to 140°F)**; storage humidity, 15 to 85% RH**. Media: storage temperature, -10 to 40°C (14 to 104°F)**; storage humidity, 30 to 80% RH**, high temperature, no more than 48 hours over 40°C (104°F)**. Toner: storage temperature, 5 to 40°C (41 to 104°F)**; high temperature, no more than 72 hours over 50°C (122°F); no more than 48 hours over 60°C (140°F)**.

Power requirements: Voltage: source—100 VAC, range—90-110 VAC, frequency—47-53, 57-63 Hz; source—120 VAC, range—108-132 VAC, frequency—47-53, 57-63 Hz; source—220 VAC, range 198-242 VAC, frequency—47-53, 57-63 Hz; source—240 VAC, range 216-252 VAC, frequency—47-53, 57-63 Hz. Consumption: operating, 365 W max (1245 BTUs/hour); standby, 200 W max (682 BTUs/hour)

Size: Model 240D, height, 900 mm (35.4 in.); width, 1100 mm (43.3 in.); depth, 620 mm (24.4 in.). Model 240E, height, 900mm (35.4 in.); width, 1400 mm (55.1 in.); depth, 620 mm (24.4 in.).

Weight: Model 240D, net weight—plotter, 185 kg (407 lb), VRC, 17.3 kg (38 lb); shipping weight—plotter, 220 kg (484 lb), VRC, 20 kg (45 lb); accessories, 16 kg (35 lb). Model 240E, net weight—plotter, 220 kg (484 lb), VRC, 17.3 kg (38 lb); shipping weight—plotter, 260 kg (572 lb), VRC, 20 kg (45 lb); accessories, 21.8 kg (48 lb)

Product certifications: safety approvals, CSA approved, CSA C22.2 No. 220; UL listed, UL-478, 5th edition; Compliance with IEC-380, TUV approval in progress (GS-Mark). electromagnetic interference, FCC Verified Class A; FTZ 1046/84 VDE 0871-B/with Manufacturer Declaration; VCCI registered, Class 1

* At 23°C (73°F), 40 to 60% RH with dimensionally stable media, no take-up reel

** Non-condensing (Note: Never operate the plotter in the presence of condensation or damage will occur to the writing head.)

Ordering Information

HP Part No.	Description	Price
C1600A	HP 7600 Series Model 240D A1/D-size electrostatic plotter	\$22,900
C1601A	HP 7600 Series Model 240E A0/E-size electrostatic plotter	\$27,500
C1621A	Take-up reel for Model 240D	\$1,500
C1622A	Take-up reel for Model 240E	\$1,750

Note: Interface cables must be ordered separately

Accessories Included

User's Guide, Programmer's Reference, Power cord (appropriate to plotter destination), Premium Grade Paper (one roll), Pre-mixed Liquid Toner, Writing Head Cleaner, Writing Head Polish, Lint-free Cleaning Wipes, Media Cutter, Empty 5 litre (1.3 gal) bottle.

COMPUTER PERIPHERALS

Furniture

Design Plus

- Furniture that fits your Hewlett-Packard system like a glove.

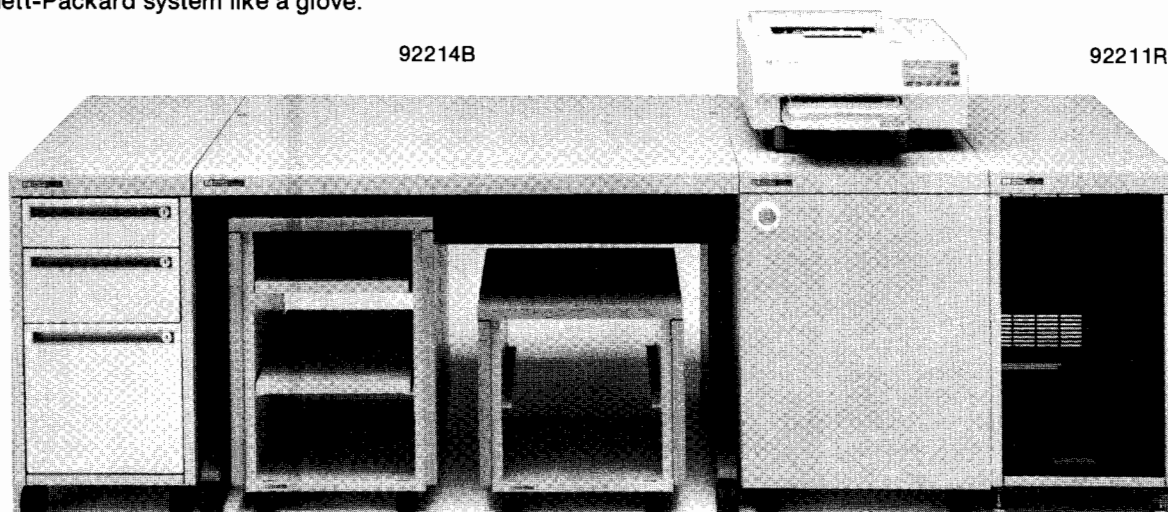

92211N

92211L

92211M

92211D

Shown from left to right: Mobile Drawer Unit, System Table with Mobile Support Cabinet tucked underneath, Mobile LaserJet Cabinet and Mini-Rack Cabinet. For complete details, see chart on the next page.

Design Plus

Design Plus fits HP computers and peripherals perfectly, becoming an integral part of your total computer solution.

It's constructed of the highest quality materials. Die-cast metal legs withstand the weight of your equipment and the pressure of normal office moves, without danger of buckling or breaking. Matte surfaces resist scratches and stains, while protecting your eyes from the glare of overhead lighting.

Mini-Rack Cabinet

Designed to hold the CPU and disc drive of your HP 9000 Series 200, 300 or 500 computer, also the HP 3000 Series 37, HP 260 or MICRO 3000. It matches the height and depth of our tables and can be locked into place. This results in additional work surface, flush-fitted and without troublesome gaps or height discrepancies.

Mobile Drawer Units

Store your files, documentation and other valuables. These units match the height of our tables exactly.

Mobile Support Cabinets

Storage for hard-disc drives and tape back-up systems that fit conveniently under our tables.

Mobile Sound Enclosure Cabinet

Choose this cabinet for HP serial impact dot matrix printers.

Universal Support Stand

Printers and small plotters are supported, and rolled about easily on self-locking casters.

HP Ergonomic executive chair with arm support

Part no.	Color	Seat	Chair back	Price
92208M	Gray	Height 16.25-19 in. (413-483 mm)	Height 18-20.25 in. (457-514 mm)	(1-2) \$475.00 ea.
92208N	Blue	Depth 18 in. (457 mm)	Width 17.5 in. (445 mm)	(3+) 440.00 ea.
92208P	Beige	Width 19 in. (483 mm)		(1-2) 40.00 ea.
92208Q	Cylinder for 92208M/N/P			(3+) 37.00 ea.

HP Ergonomic workstation/managerial chair

Part no.	Color	Seat	Chair back	Price
92208E	Gray	Height 16.25-20.75 in. (413-527 mm)	Height 10.50-15.50 in. (267-394 mm)	(1-2) \$245.00 ea.
92208F	Blue	Depth 18 in. (457 mm)	Width 16 in. (406 mm)	(3+) 225.00 ea.
92208G	Beige	Width 18.50 in. (470 mm)		(1-2) 79.00 ea.
92208K	Dk Brown	Arm set		(3+) 69.00 ea.
92208H	Cylinder for 92208E/F/G			(1-2) 40.00 ea.
				(3+) 37.00 ea.

HP Ergonomic workbench chair

Part no.	Color	Seat	Chair back	Price
92208S	Blue	Height 19.25-50 in. (483-648 mm)	Height 10.50-15.50 in. (267-394 mm)	(1-2) \$365.00 ea.
		Depth 18 in. (457 mm)	Width 16 in. (406 mm)	(3+) 340.00 ea.
		Width 18.50 in. (470 mm)		(1-2) 39.00 ea.
92208L	Dk Brown	Caster set/5 per set		(3+) 35.00 ea.
92208U	Cylinder for 92208S			(1-2) 55.00 ea.
				(3+) 51.00 ea.

Part number	Description	Height	Width	Depth	Price
92214A	<i>Design Plus</i> Mobile terminal support and transport system table. Designed to safely move terminals and small systems.	28.4 in. (720 mm)	29.5 in. (750 mm)	28.0 in. (711 mm)	(1-2 tables).....\$475.00 ea. (3+)..... 445.00 ea.
92214B	Medium <i>Design Plus</i> System table. Comes with cable management, locking casters, and is same height as 92211R mobile rack system cabinet.	28.4 in. (720 mm)	44.3 in. (1125 mm)	28.0 in. (711 mm)	(1-2 tables).....\$525.00 ea. (3+)..... 495.00 ea.
92214C	Large <i>Design Plus</i> System table. Comes with cable management, adjustable leveling glides, and is same height as 92211R mobile rack system cabinet.	28.4 in. (720 mm)	59.0 in. (1500 mm)	28.0 in. (711 mm)	(1-2 tables).....\$585.00 ea. (3+)..... 545.00 ea.
92213B	<i>Design Plus</i> CAD Mini-workstation. For use with the HP 9000 Series 300/500 computers. Comes with 14.25-in. (362 mm) wide raised monitor platform, pull-out work surface that extends to 36-in. (914 mm) deep, pull-out keyboard drawer and cable management. Same height as 92211R mobile mini-rack; 92211L/M fits underneath.	28.4 in. (720 mm)	44.3 in. (1125 mm)	28.0 in. (711 mm)	(1-2 units).....\$849.00 ea. (3+)..... 799.00 ea.
92213F	<i>Design Plus</i> CAD workstation is designed for use with HP CAD systems. It comes with a pull-out work surface, keyboard drawer, raised monitor platform and cable management. It attaches to other <i>Design Plus</i> Furniture.	28.4 in. (720 mm)	59.0 in. (1500 mm)	28.0 in. (711 mm)	(1-2 tables).....\$899.00 ea. (3+)..... 849.00 ea.
92213Q	<i>Design Plus</i> ergonomic task lamp. Specifically designed for computer workstations. Two nine-watt emitters produce the same light as 80-watts incandescent. Lamp stem fits <i>Design Plus</i> tables. UL listed and CSA approved.	N/A	N/A	N/A	(1-2 units).....\$280.00 ea. (3+)..... 260.00 ea.
92213R	<i>Design Plus</i> clamp. Designed for the <i>Design Plus</i> lamp (92213Q.) For use on non- <i>Design Plus</i> table tops. Maximum clamp opening is 5 inches, (127 mm.) Use this clamp for HP standard tables.	N/A	N/A	N/A	(1-2 units).....\$28.00 ea. (3+)..... 26.00 ea.
92213D	"C" and "D" sized drawing holder. Mounts to workstation and system tables. Two-section arm for height and tilt position extends from 13.0 in. (330 mm) to 22.25 in. (565 mm).	20.0 in. (508 mm)	30.0 in. (762 mm)	2.6 in. (6 mm)	(1-2 units).....\$219.00 ea. (3+)..... 199.00 ea.
92214J	90-degree <i>Design Plus</i> Corner turn. Used for joining two system tables together for a larger work area. NOTE: not intended to support CAD monitors.	Each side	28.0 in. (711 mm)		(1-2 units).....\$295.00 ea. (3+)..... 270.00 ea.
92214K	<i>Design Plus</i> CAD corner workstation. Perfectly fitted for use with HP CAD systems. Workstation comes with a keyboard drawer and cable management. It can be joined to <i>Design Plus</i> furniture.	28.4 in. (720 mm)	44.3 in. (1125 mm)	44.3 in. (1125 mm)	(1-2 tables).....\$899.00 ea. (3+)..... 849.00 ea.
92211U	<i>Design Plus</i> joining bracket kit. For use on all <i>Design Plus</i> furniture pieces to anchor one to another. Comes with needed screws and instructions for assembly and use.	N/A	N/A	N/A	(1-2 units).....\$40.00 ea. (3+)..... 37.00 ea.
92211C	<i>Design Plus</i> Mobile sound enclosure cabinet. For use with all 293X serial impact dot matrix printers.	28.4 in. (720 mm)	29.5 in. (750 mm)	19.7 in. (500 mm)	(1 unit).....\$585.00 ea. (3+)..... 545.00 ea.
92211L	<i>Design Plus</i> Mobile support cabinet. Rolls easily under the 92214B/C <i>Design Plus</i> system tables. Can be used as a stand-alone system cabinet for the HP 9000 Series 200/300/500, has open back. Comes with two sets of mounting rails, a cable routing kit (92199F), and two storage shelves. Internal dimensions are 12.8 in. (325 mm) wide x 20.40 in. (520 mm) high.	24.4 in. (620 mm)	16.7 in. (425 mm)	20.7 in. (525 mm)	(1-2 units).....\$310.00 ea. (3-9)..... 290.00 ea. (10+)..... 270.00 ea.
92211M	<i>Design Plus</i> small Mobile support cabinet. Rolls easily under the 92214B/C <i>Design Plus</i> system tables. Can be used as a stand-alone system cabinet for the Series 200, Model 237 or 300. Comes with one set of mounting rails, a cable routing kit (922199F), and a pad to put under the Model 237. Internal dimensions are 12.8 in. (325 mm) wide x 13.26 in. (338 mm) high.	17.1 in. (435 mm)	16.7 in. (425 mm)	16.7 in. (425 mm)	(1-2 units).....\$250.00 ea. (3-9)..... 230.00 ea. (10+)..... 210.00 ea.
92211N	<i>Design Plus</i> Mobile drawer unit. Rolls easily and sits next to all <i>Design Plus</i> system tables (also same height as tables). Comes with three drawers, 4 in., 6 in. and 12 in. (104 mm, 156 mm, and 312 mm).	28.4 in. (720 mm)	14.8 in. (375 mm)	28.0 in. (711 mm)	(1-2 units).....\$745.00 ea. (3-9)..... 705.00 ea. (10+)..... 665.00 ea.
92211R	<i>Design Plus</i> Mobile mini-rack system cabinet for HP modular peripherals and systems. Comes fully assembled with casters. Back opens for easy access. Accessories available are the 92211S mounting rail and module lock kit, 92211T filler panel kit, and 92199B power strip. Internal dimensions are 12.8 in. (325 mm) wide x 22.44 in. (572 mm) high.	28.4 in. (720 mm)	14.8 in. (375 mm)	28.0 in. (711 mm)	(1-2 racks).....\$585.00 ea. (3-9)..... 550.00 ea. (10+)..... 515.00 ea.
92211E	Small (4 inch) drawer unit for 92211R Mobile mini-rack system cabinet.	4 in. (102 mm)	12.75 in. (324 mm)	18.62 in. (473 mm)	(1-2 units).....\$139.00 ea. (3+)..... 129.00 ea.
92211F	Medium (6 inch) drawer unit for 92211R Mobile mini-rack system cabinet.	6 in. (152 mm)	12.75 in. (324 mm)	18.62 in. (473 mm)	(1-2 units).....\$149.00 ea. (3+)..... 139.00 ea.
92211G	Large (12 inch) drawer unit for 92211R Mobile mini-rack system cabinet.	12 in. (305 mm)	12.75 in. (324 mm)	18.62 in. (473 mm)	(1-2 units).....\$159.00 ea. (3+)..... 149.00 ea.
92211S	Rail kit for 92211R Mobile mini-rack cabinet. Comes with four sets of rails and module locks. Used to mount up to four HP computer and peripheral equipment modules.			Rail length—25.1 in. (638mm)	(1-2 kits).....\$50.00 ea. (3-9)..... 45.00 ea. (10+)..... 40.00 ea.
92211T	Filler panel kit for 92211R mobile mini-rack cabinet. Kit contains 20 snap-in panels used to fill empty space not occupied by computer equipment modules.	0.9 in. (23 mm)	12.8 in. (325 mm)	0.9 in. (23 mm)	(1-2 kits).....\$40.00 ea. (3-9)..... 35.00 ea. (10+)..... 30.00 ea.
92214P	<i>Design Plus</i> Universal support stand. For use with HP LaserJet, HP 2932/33/34, HP 2563A printers and small HP plotters. Comes with printout catcher shelf, casters and leveling glides. Has slot in top for bottom feeding and slot in door top for front feeding. Also has sound control pad.	28.4 in. (720 mm)	23.6 in. (600 mm)	17.7 in. (450 mm)	(1-2 units).....\$295.00 ea. (3+)..... 265.00 ea.
92211D	<i>Design Plus</i> Mobile LaserJet Printer cabinet. Comes fully assembled with a storage shelf for paper trays and space for toner cartridges and other supplies.	28.3 in. (720 mm)	20.0 in. (508 mm)	28.0 in. (711 mm)	(1-2 units).....\$385.00 ea. (3+)..... 365.00 ea.

COMPUTER PERIPHERALS

Furniture

HP Standard Furniture

- Solid, Expandable, Economical





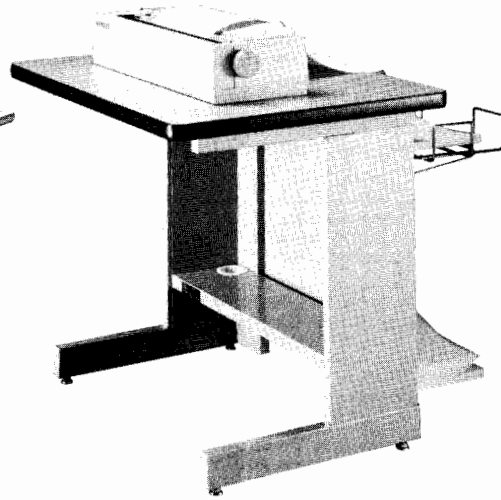

92210T Mobile workstation table

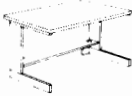
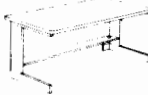

92210P Printer stand

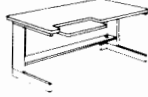
HP Standard furniture

	Part no.	Description	Height	Width	Depth	Price
	92210A	Compact workstation table, with leg levelers and modesty panel. 7-in. (178 mm) shelf standard. See 92210L casters next page to adapt table height to 28.4 in. (720 mm).	27.0 in. (686 mm)	48.0 in. (1220 mm)	30.0 in. (762 mm)	(1-2 units).....\$325.00 ea. ☎ (3 +)..... 305.00 ea. ☎
	92210B	Standard workstation table, with leg levelers and modesty panel. 7-in. (178 mm) shelf standard. See 92210L casters next page to adapt table height to 28.4 in. (720 mm).	27.0 in. (686 mm)	60.0 in. (1524 mm)	30.0 in. (762 mm)	(1-2 units).....\$380.00 ea. ☎ (3 +)..... 360.00 ea. ☎
	92210C	Workstation table with right-hand adjustable keyboard section. Leg levelers, modesty panel and 7-in. (178 mm) shelf standard. Keyboard section starts 3 in. (76 mm) from the right side, adjusts down a total of 2.1 in. (53 mm) from table top and can be tilted 10 degrees from the horizontal. Manual adjustments. See 92210L casters next page to adapt table height to 28.4 in. (720 mm).	29.0 in. (736 mm)	60.0 in. (1524 mm)	30.0 in. (762 mm)	(1-2 units).....\$455.00 ea. ☎ (3 +)..... 405.00 ea. ☎ Adjustable keyboard dimensions 1.2 in. 24.0 in. 10.0 in. (30 mm) (610 mm) (254 mm)
	92210D	Workstation table with left-hand adjustable keyboard section. Leg levelers, modesty panel and 7-in. (178 mm) shelf standard. Keyboard section starts 3 in. (76 mm) from the left side, adjusts down a total of 2.1 in. (53 mm) from the table top and can be tilted 10 degrees from the horizontal. Manual adjustments. See 92210L casters next page to adapt table height to 28.4 in. (720 mm).	29.0 in. (736 mm)	60.0 in. (1524 mm)	30.0 in. (762 mm)	(1-2 units).....\$445.00 ea. ☎ (3 +)..... 405.00 ea. ☎ Adjustable keyboard dimensions 1.2 in. 24.0 in. 10.0 in. (30 mm) (610 mm) (254 mm)
	92210U	The standard CAD corner workstation is perfectly fitted for use with HP CAD systems. Workstation comes with a keyboard drawer. Part of the HP standard furniture line.	29 in. (736 mm)	45 in. (1143 mm)	45 in. (1143 mm)	(1-2 tables).....\$599.00 ea. ☎ (3 +)..... 559.00 ea. ☎
	92210V	Workstation tabletop connector. 90-degree triangle. Joins two 92210A/B/C/D tables together.	Each side	30.0 in. (763 mm)		(1-2 units).....\$155.00 ea. ☎ (3 +)..... 145.00 ea. ☎









COMPUTER PERIPHERALS

Furniture

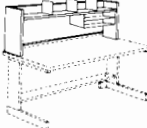
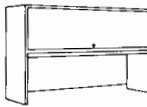
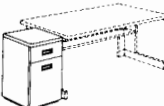
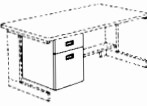
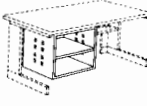
HP Standard Furniture

707

HP Standard furniture (continued)

Part no.	Description	Height	Width	Depth	Price
 92210F	Desktop storage shelf for 92210A workstation table. Includes two book supports and back-wall message board. 11 in. (279 mm) storage shelf adjusts from 15 in. (381 mm) to 21 in. (533 mm) above work surface of table. Convenient paper/storage shelf included.	23.0 in. (584 mm)	47.0 in. (1194 mm)	12.0 in. (305 mm)	(1-2 units) \$265.00 ea. (3+) 245.00 ea.
 92210G	Desktop storage shelf for 92210B/C/D workstation table. Includes three book supports and back-wall message board. 11 in. (279 mm) storage shelf adjusts from 15 in. (381 mm) to 21 in. (533 mm) above work surface of table. Convenient paper/storage shelf included.	23.0 in. (584 mm)	59.0 in. (1499 mm)	12.0 in. (305 mm)	(1-2 units) \$285.00 ea. (3+) 265.00 ea.
 92210Z	Newly revised desktop wide-flipper door storage unit for 92210B/C/D workstation table. Includes lockable flipper door and back-wall fabric-covered message board. Space from table top to shelf bottom is 19.5 in. (495 mm).	34.0 in. (864 mm)	59.0 in. (1499 mm)	14.0 in. (356 mm)	(1-2 units) \$495.00 ea. (3+) 455.00 ea.
 92210N	Mobile drawer unit, on casters. Two drawers, with identical key lock all units. Deep bottom drawer like 92210Q below. Unit rolls easily to any workstation; top same height as 92210A/B .	27.0 in. (686 mm)	15.4 in. (391 mm)	20.0 in. (508 mm)	(1-2 units) \$335.00 ea. (3+) 305.00 ea.
 92210Q	Suspended drawer unit. Two drawers, with identical key lock units. Deep bottom drawer can store three types of hanging files: letter-size, legal-size, and computer printout binders. Fits right or left side of 92210A/B/C/D tables.	21.0 in. (533 mm)	14.8 in. (375 mm)	19.4 in. (493 mm)	(1-2 units) \$245.00 ea. (3+) 225.00 ea.
 92210R	Storage module unit, with three-position adjustable shelf. Rear of module is open for ventilation and access to 92210A/B/C/D cable management system, when module used to hold electronic equipment. Fits right or left side of 92210A/B/C/D tables.	19.0 in. (483 mm)	21.0 in. (534 mm)	19.4 in. (493 mm)	(1-2 units) \$115.00 ea. (3+) 105.00 ea.
	Inside module dimensions	17.0 in. (432 mm)	19.4 in. (493 mm)	19.4 in. (493 mm)	
 92210E	Work surface extension (return), with leg levelers and modesty panel. Fits right or left side of 92210B table, left side of 92210C , right side of 92210D . Requires use of 'Z' bracket (included) when mounting on 92210C/D . Not for 92210A .	27.0 in. (686 mm)	40.0 in. (1016 mm)	24.0 in. (610 mm)	(1-2 units) \$235.00 ea. (3+) 215.00 ea.
 92210W	Task light unit. Screws into place underneath the 92210F/G/Z desktop storage units. Includes 20-watt fluorescent bulb, lens and power cord wire management clips. UL listed and CSA approved.	2.0 in. (50.8 mm)	24.0 in. (610 mm)	6.6 in. (168 mm)	(1-2 units) \$119.00 ea. (3+) 109.00 ea.
 92210L	Set of four heavy-duty, double-wheel casters. Use in place of leg levelers on 92210A/B/C/D tables or 92210P stand where mobility is desired. Caster height 1.75 in. (45 mm). Adapts height of tables to 28.4 in. (720 mm).				(1-2 units) \$29.00 set (3+) 27.00 set
 92210P (see photo previous page)	Printer stand. Design matches HP 92210 series workstation system. Convenient paper feed slot (4 x 19 in., 102 x 483 mm) in top allows bottom paper feed. Also features rear printout catcher with 1.5-in. (38 mm) slot to allow paper transport to rear feed printers. Cable management slots, 7-in. shelf standard.	27 in. (686 mm)	Work surface 30 in. (762 mm)	24 in. (610 mm)	(1-2 units) \$285.00 ea. (3+) 265.00 ea.
		18.5 in. (470 mm)	Printout catcher 17 in. (432 mm)	13.5 in. (343 mm)	
 92210T (see photo previous page)	Mobile workstation table for terminals. Design matches HP 92210 series workstation system. Features a dropped, pull-out keyboard surface. Cable management slots, locking casters and 7-in. (178 mm) shelf standard.	28.3 in. (720 mm)	Work surface 30 in. (762 mm)	28 in. (712 mm)	(1-2 units) \$330.00 ea. (3+) 305.00 ea.
		26.4 in. (670 mm)	Keyboard surface 23.5 in. (597 mm)	12 in. (305 mm)	

Fast-ship product - see page 734

CABLES & ADAPTERS

Cables, Adapters & Typical SWR Performance

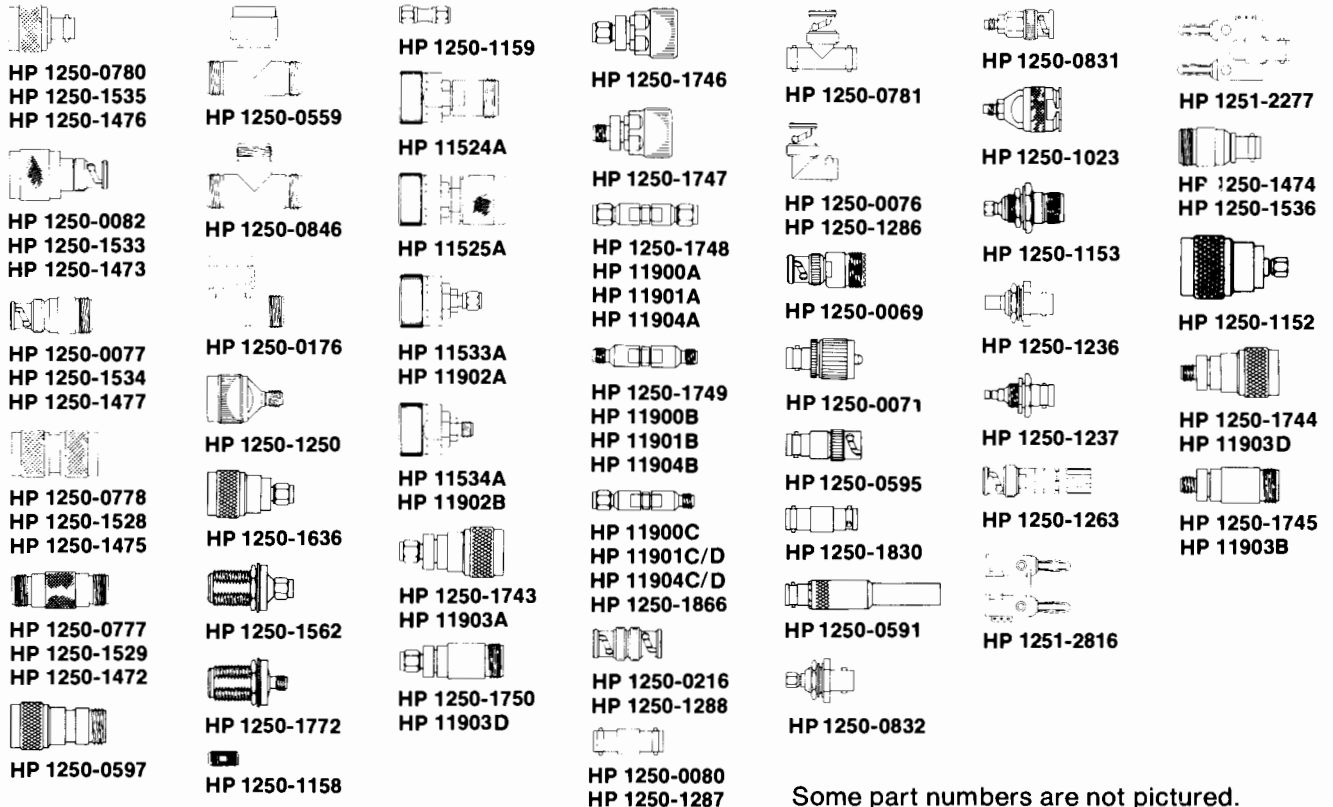
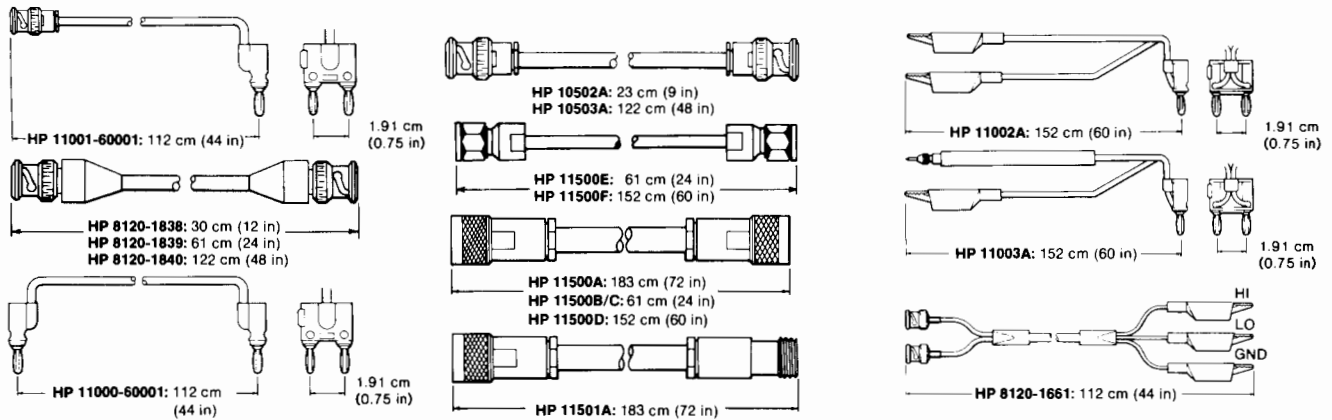

Some part numbers are not pictured.

Coaxial Connector & Adapter Performance

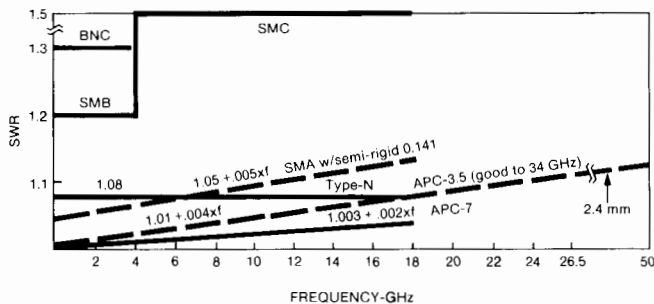

Typical SWR for connector pairs.

The performance curves in the graph will help you in choosing and applying HP cables, connectors and adapters. SWR curves show design specifications for mated pairs of connectors of the type indicated. You can expect typical performance in that range.

For cross-series adapters, use the curve with the highest SWR in each case. For applications of Tee-adapters such as HP 1250-0559, 1250-0846 and 1250-0781, be sure to consider the extra shunt capacitance of the Tee.

Of course when HP mounts various connectors onto RF and microwave products, the product specification predominates and SWR is often far superior to that shown in these utility curves. For example, the HP "precision" Type-N adapters shown on these pages are for high accuracy use dc-1.3 GHz where SWR < 1.03.

For more information on history and performance of various coax connectors, see HP's *Coaxial & Waveguide Measurement Accessories Catalog*. (Lit # 5954-6401).

HP Part Number

Cable Assemblies

HP 10501A: 112 cm 50Ω coax with one UG-88C/U BNC (m) connector	\$37.50 ☞
HP 10502A: 23 cm 50Ω coax with UG-88C/U BNC (m) connectors	\$32.50 ☞
HP 10503A: like HP 10503A, but 122 cm	\$35.00 ☞
HP 8120-1838: 30 cm 50Ω coax with two BNC (m) connectors	\$19.50 ☞
HP 8120-1839: like HP 8120-1838, but 61 cm	\$20.00 ☞
HP 8120-1840: like HP 8120-1838, but 122 cm	\$23.50 ☞
HP 11000-60001: 112 cm 50Ω coax with dual banana plugs	\$30.00 ☞
HP 11001-60001: 112 cm 50Ω coax, UG-88C/U BNC (m) to dual banana plug	\$30.00 ☞
HP 11002A Test Leads: 152 cm, alligator clips to dual banana plug	\$21.00 ☞
HP 11003A Test Leads: 152 cm, probe and alligator clip to dual banana plug	\$21.00 ☞
HP 8120-1661: 112 cm, dual BNC (m) to alligator clips	\$90.00 ☞

HP Model	Frequency Range (GHz)	Length cm (in)	Connectors	SWR	Ins. Loss (dB)	Price
11500A	dc - 12.4	183 (72)	N(m) (2)	—	—	\$110
11500B	dc - 12.4	61 (24)	N(m) (2)	—	—	110
11501A	dc - 18	183 (72)	N(m)-N(f)	—	—	110
11500C	dc - 18	61 (24)	Precision N(m) (2)	1.4	1.5	625
11500D	dc - 18	152 (60)	Precision N(m) (2)	1.4	3.0	700
11500E	dc - 26.5	61 (24)	APC-3.5 (m) (2)	1.4	2.0	650
11500F	dc - 26.5	152 (60)	APC-3.5 (m) (2)	1.4	4.0	750

Adapters, 2.4 mm

(See page 00.00 for technical description and performance)

11900A 2.4 mm (m) to 2.4 (m)	\$450.00
11900B 2.4 mm (f) to 2.4 (f)	\$450.00
11900C 2.4 mm (m) to 2.4 (f)	\$450.00
11901A 2.4 mm (m) to APC-3.5 (m)	\$375.00
11901B 2.4 mm (f) to APC-3.5 (f)	\$375.00
11901C 2.4 mm (m) to APC-3.5 (f)	\$375.00
11901D 2.4 mm (f) to APC-3.5 (m)	\$375.00
11902A 2.4 mm (m) to APC-7	\$425.00
11902B 2.4 mm (f) to APC-7	\$425.00
11903A 2.4 mm (m) to Type N (m)	\$450.00
11903B 2.4 mm (f) to Type N (f)	\$450.00
11903C 2.4 mm (m) to Type N (f)	\$450.00
11903D 2.4 mm (f) to Type N (m)	\$450.00
11904A 2.4 mm (m) to K (m) ^[5]	\$500.00
11904B 2.4 mm (f) to K (f) ^[5]	\$500.00
11904C 2.4 mm (m) to K (f)	\$500.00
11904D 2.4 mm (f) to K (m)	\$500.00

Adapters Type N, Standard 50 Ω

1250-0077 N(f) to BNC(m)	\$13.25 ☞
1250-0082 N(m) to BNC(m)	\$14.75 ☞
1250-0176 N(m) to N(f) right angle (use < 12 GHz)	\$21.00 ☞
1250-0559 N tee, (m)(f)(f)	\$38.00 ☞
1250-0777 N(f) to N(f)	\$13.25 ☞
1250-0778 N(m) to N(m)	\$12.00 ☞
1250-0780 N(m) to BNC(f)	\$14.25 ☞
1250-0846 N tee (f)(f)(f)	\$20.25 ☞
1250-1250 N(m) to SMA(f)	\$35.00 ☞
1250-1562 N(f) to SMA(m)	\$67.50 ☞
1250-1636 N(m) to SMA(m)	\$130.00 ☞
1250-1772 N(f) to SMA(f)	\$72.50 ☞

Adapters Type N, Precision 50 Ω^[1]

1250-1472 N(f) to N(f)	\$45.00 ☞
1250-1473 N(m) to BNC(m)	\$45.00 ☞
1250-1474 N(f) to BNC(f)	\$30.00 ☞
1250-1475 N(m) to N(m)	\$60.00 ☞
1250-1476 N(m) to BNC(f)	\$41.00 ☞
1250-1477 N(f) to BNC(m)	\$35.00 ☞

Adapters Type N, Standard 75 Ω^[2]

1250-0597 N(m) (50Ω) to N(f)(75Ω)	\$30.00 ☞
1250-1528 N(m) to N(m)	\$60.00 ☞
1250-1529 N(f) to N(f)	\$40.00 ☞
1250-1533 N(m) to BNC(m)	\$41.00 ☞
1250-1534 N(f) to BNC(m)	\$40.00 ☞
1250-1535 N(m) to BNC(f)	\$42.00 ☞
1250-1536 N(f) to BNC(f)	\$38.00 ☞

HP Part Number

Adapters APC-3.5

1250-1743 APC-3.5(m) to N(m)	\$135.00 ☞
1250-1744 APC-3.5(f) to N(m)	\$165.00 ☞
1250-1745 APC-3.5(f) to N(f)	\$115.00 ☞
1250-1746 APC-3.5(m) to APC-7	\$150.00 ☞
1250-1747 APC-3.5(f) to APC-7	\$160.00 ☞
1250-1748 APC-3.5(m) to APC-3.5(m)	\$170.00 ☞
1250-1749 APC-3.5(f) to APC-3.5(f)	\$185.00 ☞
1250-1750 APC-3.5(m) to N(f)	\$135.00 ☞
1250-1866 APC-3.5(mm) to APC-3.5(f)	\$320.00 ☞

Adapters SMA

1250-1158 SMA(f) to SMA(f)	\$18.00 ☞
1250-1159 SMA(m) to SMA(m)	\$18.50 ☞
1250-1249 SMA Right angle (m) (f)	\$32.00 ☞
1250-1397 SMA Right angle (m) (m)	\$40.00 ☞
1250-1462 SMA(m) to SMA(f)	\$24.50 ☞
1250-1698 SMA tee(m) (f) (f)	\$50.00 ☞
1250-1787 SMA(m) to BNC(m)	\$35.00 ☞
1250-2015 SMA(f) to BNC(m)	\$36.00 ☞

Adapters APC-7[®]

11524A APC-7 to N(f)	\$170.00 ☞
11525A APC-7 to N(m)	\$170.00 ☞
11533A APC-7 to SMA (m)	\$235.00 ☞
11534A APC-7 to SMA (f)	\$235.00 ☞

Adapter Banana Plug

1251-2816 Dual banana plug	\$6.00 ☞
-----------------------------------	----------

Adapters BNC, Standard 50 Ω

1250-0069 BNC(m) to UHF(f)	\$30.00 ☞
1250-0071 BNC(f) to UHF(m)	\$15.00 ☞
1250-0076 Right angle BNC(UG-306/D)	\$10.75 ☞
1250-0080 BNC(f) to BNC(f) (UG-914/U)	\$6.50 ☞
1250-0216 BNC(m) to BNC(m)	\$10.50 ☞
1250-0591 BNC(f) to WECO Video (m)	\$23.50 ☞
1250-0595 BNC(f) to BNC Triaxial (m)	\$20.00 ☞
1250-0781 BNC tee(m)(f)(f)	\$12.00 ☞
1250-1263 BNC(m) to single banana plug	\$55.00 ☞
10110B BNC(m) to dual banana plug	\$27.00 ☞
1250-1830 BNC(f) to BNC Triaxial (f)	\$60.00 ☞
1251-2277 BNC(f) to dual banana plug	\$15.50 ☞

Adapters BNC, Standard 75 Ω^[3]

1250-1286 Right angle BNC	\$20.25 ☞
1250-1287 BNC(f) to BNC(f)	\$10.25 ☞
1250-1288 BNC(m) to BNC(m)	\$13.25 ☞

Adapters SMB, SMC^[4]

1250-0670 SMC tee(m) (m) (m)	\$30.00 ☞
1250-0671 SMB(m) to N(m)	\$57.50 ☞
1250-0672 SMB(f) to SMB(f)	\$14.50 ☞
1250-0674 SMB(m) to SMA(f)	\$37.00 ☞
1250-0675 SMC(m) to SMA(f)	\$33.00 ☞
1250-0813 SMB(m) to SMB(m)	\$62.50 ☞
1250-0827 SMC(m) to SMC(m)	\$8.25 ☞
1250-0831 SMC(m) to BNC(m)	\$26.00 ☞
1250-0832 SMC(f) to BNC(f)	\$30.00 ☞
1250-0837 SMC tee(m) (m) (m)	\$27.00 ☞
1250-0838 SMC tee(f) (m) (m)	\$23.00 ☞
1250-1023 SMC(m) to N(m)	\$37.00 ☞
1250-1113 SMC(f) to SMC(f)	\$12.50 ☞
1250-1152 SMC(f) to N(m)	\$55.00 ☞
1250-1153 SMC(f) to N(f)	\$65.00 ☞
1250-1236 SMB(f) to BNC(f)	\$32.00 ☞
1250-1237 SMB(m) to BNC(f)	\$37.00 ☞
1250-1391 SMB tee(f) (m) (m)	\$31.00 ☞
1250-1857 SMB(f) to BNC(m)	\$57.50 ☞

[1] "Precision": typically ≥36 dB return loss to 1.3 GHz.

[2] Type N outer conductor; center pin sized for 75 Ω characteristic.

[3] BNC outer conductor; center pin sized for 75 Ω characteristic.

[4] SMB & SMC are used often inside HP instruments for inter-module RF connections.

SMB is snap-on configuration. SMC is screw-on configuration.

[5] The K-connector is developed & manufactured by the Wiltron Co, Morgan Hill, CA.

© APC-7 is a registered trademark of the Bunker Ramo Corporation

☞ Fast-Ship product—see page 734.

TRANSIT CASES

Rugged Protection for Instruments

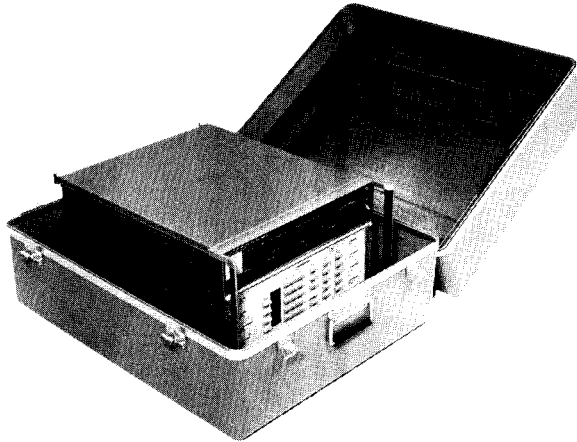

Typical System II Transit Case

Hewlett-Packard transit cases are rugged protective outer shells for use when instruments must be frequently transported or used away from laboratory conditions. HP cases protect your instruments from hostile environments, shock, vibration, moisture and impact, while providing a secure enclosure for shipping. The cases are molded from a structural composite which is 65% lighter than aluminum, yet provides excellent strength and durability. Tests of the composite show tensile and compressive strength exceeding 33,000 PSI and flexural strength exceeding 45,000 PSI.

Typical Uses

Transit cases are a necessity whenever equipment is frequently transported from one operating location or test site to another, or is shipped for testing and calibration. Transit cases are particularly valuable for instruments used by service and repair personnel. For example, telephone companies frequently use transit cases for the

instruments they use to repair line faults. Transit cases are also valuable when instruments must be transported over rough roads, or are used in dusty environments or outdoors.

Product Detail

HP transit cases are pressure-molded of an extremely strong and light fiberglass and resin laminate which provides an excellent strength-to-weight ratio. All cases seal tightly with O-ring gaskets and clamping latches. They are rainproof under the test conditions of MIL-STD-108. Carrying handles are conveniently placed and fold flat when not in use.

Transit cases are typically provided with foam cushions that are designed to cradle the instrument securely. Maximum protection is provided against damage from handling, dropping or crushing. The cushion inserts are typically molded polyurethane, or are fabricated from slabs of polyurethane or polyethylene flexible foams. Each case/cushion unit is designed as its own shock and vibration damping system.

Hewlett-Packard's standard transit cases provide effective protection from all but the most abusive treatment. To ensure maximum protection for your instrument, transit cases are also available in versions that meet the specified requirements of MIL-STD-108, MIL-T-21200, MIL-T-28800, MIL-T-4734 and MIL-C-4150.

Removable swivel casters are available as an option on certain HP transit cases. These cases are identified with an asterisk (*) in the case selection tables on pages 712 and 713.

How to Select the Proper Transit Case

Transit cases are available for almost all HP instruments. If you are ordering a case for one of HP's 80 most popular instruments and computation products, you can use the quick cross-reference table below. To order a case for any other instrument, please refer to "Accurate Measurements Assure Proper Fit", and use the tables for ordering System I and System II style cases.

HP Product Number to Transit Case Number Cross-Reference

Product	Transit Case	Product	Transit Case	Product	Transit Case	Product	Transit Case	Product	Transit Case
141T	9211-1294	3586A/B/C	9211-2650	4328A	9211-1318	8341A/B	9211-2662	8662A	9211-2662
853A	9211-5439	3708A	9211-2661	4934A	9211-1288	8349A/B	9211-2667	8663A	9211-2662
11713A	9211-2671	3709B	9211-2661	4935A	9211-1290	8350B	9211-2649	8671A/B	9211-2661
11729C	9211-2654	3717A	9211-2654	4937A	9211-1289	8403A	9211-1292	8672A	9211-2661
1630A	9211-1294	3730B	9211-0839	4945A	9211-2650	8405A	9211-1293	8673B/E	9211-2661
1725A	9211-2459	3746A	9211-2656	4947A	9211-2650	8445B	9211-1292	8673C/D	9211-2663
1740A	9211-2459	3764A	9211-2650	4948A	9211-2661	85B	9211-4120	8683A/B/D	9211-2649
1741A	9211-2459	3776A/B	9211-2650	4951C	9211-1291	8501A	9211-2660	8684A/B/D	9211-2649
197B	9211-2675	3777A	9211-2644	4952A	9211-1291	8505A	9211-2665	8702A	9211-2656
262X Series	9211-4677	3779C/D	15514A	4953A	9211-2645	8508A	9211-2649	8720A	9211-2658
264X Series	9211-4676	3780A	18055A	4954A	9211-2657	8508A (opt. 001)	9211-2655	8753A/B	9211-2656
2671G	9211-2649	3781A/B	18055A	4955A	9211-2663	8510A/B ¹	9211-2661	8754A	9211-2661
2673G	9211-2649	3782A/B	18055A	4972A	9211-2657	8511A-8515A	9211-2661	8756A	9211-2656
2816A	9211-1315	3784A	18055A	5061A	9211-1294	8555A	9211-2671	8757A	9211-2656
334A	9211-1289	3785A/B	18055A	5065A	9211-0839	8562A/B	9211-5604	8770A	9211-2663
339A	9211-2643	3787B	9211-2655	5150A	9211-2673	8565A	9211-2656	8780A	9211-2662
3325A	9211-2655	3789A/B	9211-2656	5316A	9211-2681	8566A/B ¹	9211-2655	8901A/B	9211-1293
3336A/B/C	9211-2655	3787B	9211-2656	5328A	9211-2648	8566A/B ²	9211-2661	8970A/B	9211-2649
3421A	9211-2642	3852A	9211-2657	5334A	9211-2642	8567A	9211-2665	8971B	9211-2648
3455A	9211-2654	3964A	9211-2557	5335A	9211-2643	8568A/B	9211-2655	8980A	9211-2661
3456A	9211-2654	3968A	9211-2557	5340A	9211-1292	8569B	9211-2656	8981A	9211-2661
3457A	9211-2642	432A/B	9211-1318	5342A	9211-2682	8570A	9211-2656	8901A/B	9211-1293
3478A	9211-2676	435B	9211-1318	5343A	9211-2682	8620C	9211-1289	9826A	9211-2662
3488A	9211-2642	436A	9211-2667	5423A	9211-2661	8640B	9211-1296	9836A ¹	9211-2652
3561A	9211-2459	436B	9211-2671	59306A	9211-2667	8642A/B	9211-2661	9836A ²	9211-2662
3562A	9211-2663	438A	9211-2676	59313A	9211-2671	8654A	9211-1895	9876A	9211-4679
3577A	9211-2663	4145A	9211-2663	59401A	9211-2682	8654B	9211-1290	11713A	9211-2671
3582A	9211-2656	4191A	9211-2663	82509B	9211-4684	8656B	9211-2661	11720A	9211-2671
3585A	9211-2663	4192A	9211-2663	8340A/B	9211-2662	8660A/C	9211-2662		

¹Top half ²Bottom half ³Instrument requires two cases

Instrument Cabinet System Styles

Hewlett-Packard produces two styles of cabinet systems: System I and System II. The most visible difference is handle configuration; the handles on System I instruments are a part of the instrument side frame, and project at 90 degrees from the instrument face. The handles on System II modules also project at 90 degrees from the instrument face, but are not a part of the instrument frame, are easily removable, and are turned outward at the handle grip. Each of the cabinet styles requires a different cushion insert configuration. This difference makes it important to order your case from the correct selection table.

Transit Case Styles

Each transit case is coded according to its style in the following tables: Valise (V), hinged with the handle opposite the hinge; Transit (T), a completely removable cover with a handle at each end; and Valise Transit (VT), a hinged transit case with a handle opposite the hinge and a handle at each end. Each case is designed and manufactured in the style that best suits the configuration of its instrument. If a style other than the standard is more appropriate for your application, a special case can be ordered.



Typical transit (T) style case

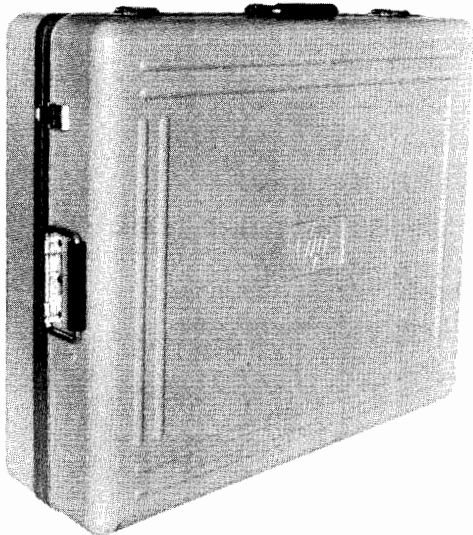

Typical valise transit (VT) style case



Typical valise (V) style case

Special or Custom Transit Cases

When HP began providing standardized cases, it was understood that there would be certain instruments that would not fit into the standard cases. For that reason, special or custom cases are available.

Proper fit is very important in protecting your instrument, and the dimensional measurements of your instrument are critical. It is recommended, when ordering a custom case, that you provide your Hewlett-Packard sales office with the instrument's exact height, width and depth, the serial and model number, and any other pertinent information that may affect the design of the case or cushions. In designing your own case, you may wish to have additional space available for the protected storage of materials necessary for your instrument's on-site operation. Space can be provided for storing power/data cables, operating supplies, accessories, additional printed circuit boards and documentation or manuals. All specifications and measurements should be on hand when discussing your needs with a representative from your local HP sales office.

Colors

HP transit cases are produced in "Hewlett-Packard Pearl Gray Cabinet," a standard color used in whole or in part on a majority of the instruments HP produces. Transit cases in any other color must be a special order at additional cost.

Accurate Measurements Assure Proper Fit

To assure proper fit, each instrument must be measured carefully. The three measurements necessary are:

WIDTH: The distance across the entire body of the instrument, not including rack mounting accessories. Instruments set up to be rack mounted require special cushion designs (custom transit cases).

DEPTH: The depth of the instrument from the front panel face to the rearmost projection at the back of the instrument. On a System II instrument, add two inches if the instrument has handles.

HEIGHT: The actual instrument height from the base to the top of the cabinet.

The selection tables include American standard and metric measurements. The addition of any options, accessories or standoff devices will affect the instrument's overall configuration and must be taken into consideration when ordering a transit case.

TRANSIT CASES

Rugged Protection for Instruments (cont'd)

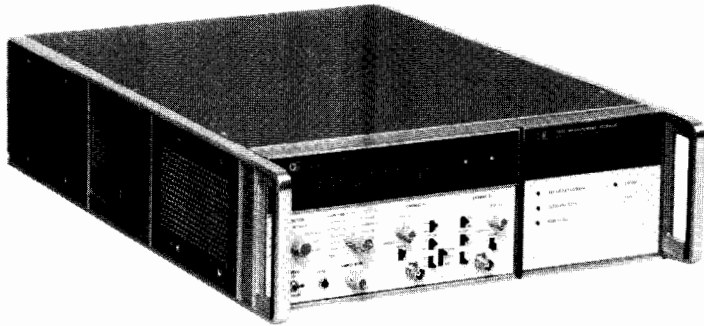

Typical full module System I style cabinet

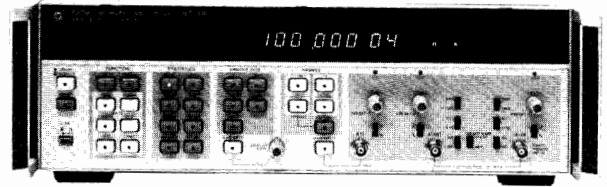

Typical full module System II style cabinet

System I Cabinet Style Transit Cases

Full Module Width Instruments					
Instrument Width - 16.75 in. 425.5 mm					
Instrument Depth - 11.25 in. 285.8 mm					
Inst. Height		Style	HP Part Number	**Price	
in.	mm			1-4	5-49
3.50	88.9	VT*	9211-1288	\$370	330
5.25	133.4	VT*	9211-1289	\$380	340
7.00	177.8	VT*	9211-1290	\$390	360
8.75	222.3	T*	9211-1291	\$420	380
Instrument Depth - 16.25 in. 412.8 mm					
Inst. Height		Style	HP Part Number	**Price	
in.	mm			1-4	5-49
3.50	88.9	VT*	9211-1292	\$400	370
5.25	133.4	VT*	9211-0839	\$420	380
7.00	177.8	VT*	9211-1293	\$430	390
8.75	222.8	VT*	9211-1294	\$430	390
10.50	266.7	T*	9211-1295	\$430	390
12.25	311.2	T*	9211-1313	\$450	410
Instrument Depth - 19.25 in. 489.0 mm					
Inst. Height		Style	HP Part Number	**Price	
in.	mm			1-4	5-49
5.25	133.4	VT*	9211-1296	\$440	400
7.00	177.8	VT*	9211-1735	\$450	410
Instrument Depth - 22.25 in. 565.2 mm					
Inst. Height		Style	HP Part Number	**Price	
in.	mm			1-4	5-49
12.25	311.2	T	9211-1297	\$480	430

*Removable casters are an option.

Two-thirds Module Width Instruments					
Instrument Width - 10.50 in. 266.7 mm					
Instrument Depth - 11.00 in. 279.4 mm					
Inst. Height		Style	HP Part Number	**Price	
in.	mm			1-4	5-49
6.5	165.1	V	9211-1895	\$330	300

Half Module Width Instruments					
Instrument Width - 7.75 in. 196.9 mm					
Instrument Depth - 8.00 in. 203.2 mm					
Inst. Height		Style	HP Part Number	**Price	
in.	mm			1-4	5-49
6.5	165.1	V	9211-1316	\$300	270
Instrument Depth - 11.00 in. 279.4 mm					
Inst. Height		Style	HP Part Number	**Price	
in.	mm			1-4	5-49
6.5	165.1	V	9211-1315	\$310	280
Instrument Depth - 16.00 in. 406.4 mm					
Inst. Height		Style	HP Part Number	**Price	
in.	mm			1-4	5-49
6.5	165.1	V	9211-1734	\$330	300

**Prices shown are subject to change.

One-third Module Width Instruments					
Instrument Width - 5.125 in. 130.2 mm					
Instrument Depth - 8.00 in. 203.2 mm					
Inst. Height		Style	HP Part Number	**Price	
in.	mm			1-4	5-49
6.5	165.1	V	9211-1317	\$290	260
Instrument Depth - 11.00 in. 279.4 mm					
Inst. Height		Style	HP Part Number	**Price	
in.	mm			1-4	5-49
6.5	165.1	V	9211-1318	\$300	270

System II Cabinet Style Transit Cases

Full Module Width Instruments					
Instrument Width - 16.75 in. 425.5 mm					
Instrument Depth - 15.25 in. 387.4 mm					
Inst. Height		Style	HP Part Number	**Price	
in.	mm			1-4	5-49
3.50	88.9	VT	9211-2642	\$430	390
5.25	133.4	VT	9211-2643	\$430	390
7.00	177.8	VT	9211-2644	\$430	390
8.75	222.3	VT	9211-2645	\$430	390
10.50	266.7	T*	9211-2646	\$430	390
12.25	311.2	T*	9211-2647	\$430	390
Instrument Depth - 18.25 in. 463.6 mm					
Inst. Height		Style	HP Part Number	**Price	
in.	mm			1-4	5-49
3.50	88.9	VT	9211-2648	\$480	430
5.25	133.4	VT	9211-2649	\$480	430
7.00	177.8	VT	9211-2650	\$480	430
8.75	222.3	T*	9211-2651	\$480	430
10.50	266.7	T*	9211-2652	\$480	430
12.25	311.2	T*	9211-2653	\$480	430
Instrument Depth - 21.50 in. 546.1 mm					
Inst. Height		Style	HP Part Number	**Price	
in.	mm			1-4	5-49
3.50	88.9	VT	9211-2654	\$520	470
5.25	133.4	VT	9211-2655	\$520	470
7.00	177.8	VT	9211-2656	\$520	470
8.75	222.3	T*	9211-2657	\$520	470
10.50	266.7	T*	9211-2658	\$520	470
12.25	311.2	T*	9211-2659	\$520	470
Instrument Depth - 24.50 in. 622.3 mm					
Inst. Height		Style	HP Part Number	**Price	
in.	mm			1-4	5-49
3.50	88.9	VT	9211-2660	\$550	500
5.25	133.4	VT	9211-2661	\$550	500
7.00	177.8	T*	9211-2662	\$550	500
8.75	222.3	T*	9211-2663	\$550	500
10.50	266.7	T*	9211-2664	\$550	500
12.25	311.2	T*	9211-2665	\$550	500

*Removable casters are an option.



Typical System II half module instrument

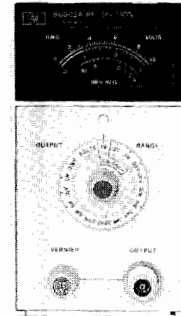

Typical System II quarter module instrument

System II Cabinet Style Transit Cases (Continued)

Half Module Width Instruments					
Instrument Width – 8.50 in. 215.9 mm					
Instrument Depth – 9.75 in. 247.7 mm					
Inst. Height		Style	HP Part Number	**Price	
in.	mm			1-4	5-49
3.50	88.9	V	9211-2666	\$330	300
5.25	133.4	V	9211-2667	\$330	300
7.00	177.8	V	9211-2668	\$330	300
8.75	222.3	V	9211-2669	\$330	300
10.50	266.7	V*	9211-2670	\$330	300
Instrument Depth – 12.75 in. 323.9 mm					
Inst. Height		Style	HP Part Number	**Price	
in.	mm			1-4	5-49
3.50	88.9	V	9211-2671	\$390	350
5.25	133.4	V	9211-2672	\$390	350
7.00	177.8	V	9211-2673	\$390	350
8.75	222.3	V	9211-2674	\$390	350
10.50	266.7	V	9211-2675	\$390	350
Instrument Depth – 15.75 in. 400.1 mm					
Inst. Height		Style	HP Part Number	**Price	
in.	mm			1-4	5-49
3.50	88.9	V	9211-2676	\$400	360
5.25	133.4	V	9211-2677	\$400	360
7.00	177.8	V	9211-2678	\$400	360
8.75	222.3	V	9211-2679	\$400	360
10.50	266.7	V	9211-2680	\$400	360
Instrument Depth – 18.75 in. 476.3 mm					
Inst. Height		Style	HP Part Number	**Price	
in.	mm			1-4	5-49
3.50	88.9	V	9211-2681	\$400	360
5.25	133.4	V	9211-2682	\$400	360
7.00	177.8	V	9211-2683	\$400	360
8.75	222.3	V	9211-2684	\$400	360
10.50	266.7	V	9211-2685	\$400	360

* Removable casters are an option.
 ** Prices shown are subject to change.

Quarter Module Width Instruments					
Instrument Width – 4.125 in. 104.8 mm					
Instrument Depth – 9.75 in. 247.7 mm					
Inst. Height		Style	HP Part Number	**Price	
in.	mm			1-4	5-49
3.50	88.9	V	9211-2686	\$280	250
5.25	133.4	V	9211-2687	\$280	250
7.00	177.8	V	9211-2688	\$280	250
Instrument Depth – 12.75 in. 323.9 mm					
Inst. Height		Style	HP Part Number	**Price	
in.	mm			1-4	5-49
3.50	88.9	V	9211-2689	\$290	260
5.25	133.4	V	9211-2690	\$290	260
7.00	177.8	V	9211-2691	\$290	260
Instrument Depth – 15.75 in. 400.1 mm					
Inst. Height		Style	HP Part Number	**Price	
in.	mm			1-4	5-49
3.50	88.9	V	9211-2692	\$350	310
5.25	133.4	V	9211-2693	\$350	310
7.00	177.8	V	9211-2694	\$350	310

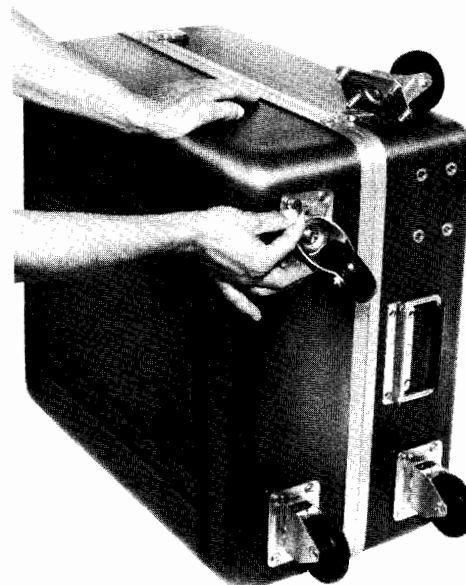

Field-installed swivel caster kit. HP part number 1490-0913

OPERATING CASES

Rugged Protection for Instruments

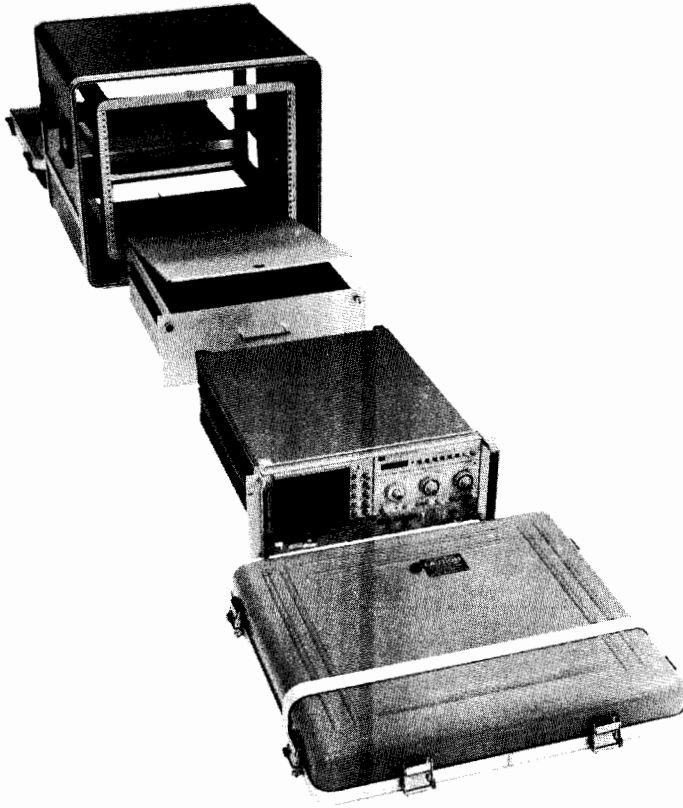

Exploded view of an Operating Case with an instrument and drawer ready for mounting.

Operating Cases

Hewlett-Packard operating cases are rugged protective enclosures, used when instruments are transported and used on-site. They are constructed of the same pressure-molded fiberglass/resin laminate as Hewlett-Packard transit cases. Hewlett-Packard's standard hardware provides excellent protection from damage and the elements. Conveniently placed handles fold flat when not in use. Front and back covers seal with O-ring gaskets and clamping latches. All transit cases are rainproof under MIL-STD-108.

Interior Configuration

Operating cases are equipped with shock-mounted aluminum frames that accept any standard 19-inch rack mounting instrument (EIA-RETMA standard) up to the height of the frames. Most full-sized instruments and modular combinations of instruments can be rack mounted in one of our operating cases. The frame arrangement and the ability to remove the front and back covers allows the convenience of operation without removing the instrument. As a result, the instrument can be set up for operation with a minimum of delay. At the same time, environmental protection is afforded. Both Hewlett-Packard System I and System II cabinet styles can be mounted in operating cases (including System I module combining cases).

Rack mounting offers a number of conveniences. Total systems configured of individual instruments and accessories can be combined in one or more operating cases. Patch cable, HP-IB and HP-IL connections can be left in place within the case, so that instruments are ready to be put into use with a minimum of delay.

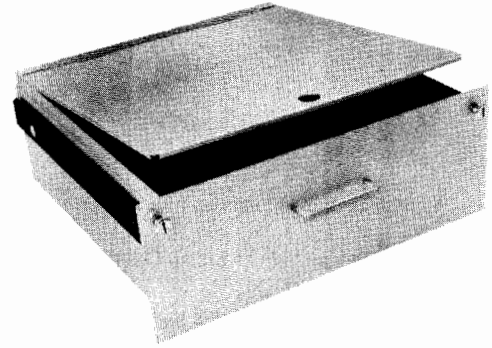

Sturdy drawers that accommodate various HP accessories and operating supplies are available in three sizes and come with smooth-operating ball bearing slides.

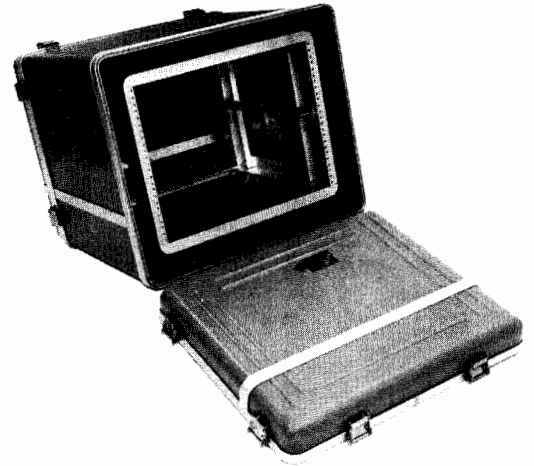

Elastomeric shock-mounted frames provide outstanding shock and vibration attenuation. A set of standard shock mounts can be provided for any equipment weight and fragility.

Accessories and Options

A number of accessories and options are available to provide maximum flexibility. Drawers are available in three heights, so that small accessories, supplies and tools can be kept inside the case with the instrument (cut foam cushions can be designed to accommodate any of these items). Aluminum skids, stacking feet, internal power receptacles and many other items are available as options on special orders, or as accessories for customer installation when ordered separately.

How to Order

Operating cases, like transit cases, are ordered through your local HP sales office. Because of the wide variety of options available and the number of configurations possible, it is recommended that you discuss your needs with an HP representative before you order.

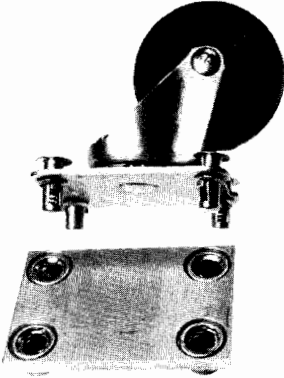

Heavy-duty removable caster and mounting plate

Operating Case Selection Guide

Case Width = 24.00 in./609.6 mm (standard)

Case Depth = 28.50 in./723.9 mm (standard)

Nominal Rack Height in. ISO	Instrument Weight				Case Height in. mm	HP Part Number	*Price	
	maximum lbs kg	minimum lbs kg					1 4	5 49
5.25 3U	75 34.0	20 9.1	10.75 273.1	9211-1302	\$1,350	1,080		
8.75 5U	75 34.0	20 9.1	15.20 386.1	9211-1303	\$1,450	1,160		
10.50 6U	130 59.0	30 13.6	17.00 431.8	9211-2635	\$1,650	1,320		
12.25 7U	130 59.0	30 13.6	18.87 479.3	9211-1163	\$1,750	1,400		
14.00 8U	130 59.0	30 13.6	20.50 520.7	9211-1241	\$1,800	1,450		
15.75 9U	130 59.0	30 13.6	22.25 565.2	9211-1242	\$1,800	1,450		
17.50 10U	130 59.0	30 13.6	24.00 612.1	9211-1243	\$1,800	1,450		
19.25 11U	130 59.0	30 13.6	25.75 654.1	9211-1244	\$1,800	1,450		
21.00 12U	250 113.4	50 22.7	28.00 711.2	9211-1245	\$1,800	1,450		
22.75 13U	250 113.4	50 22.7	29.75 755.7	9211-2636	\$1,800	1,450		
24.50 14U	250 113.4	50 22.7	31.50 800.1	9211-1911	\$2,200	1,750		
26.25 15U	250 113.4	50 22.7	33.25 844.6	9211-2637	\$2,200	1,750		
28.00 16U	250 113.4	50 22.7	35.00 889.0	9211-2638	\$2,200	1,750		
29.75 17U	250 113.4	50 22.7	36.75 933.5	9211-2639	\$2,200	1,750		
31.50 18U	250 113.4	50 22.7	38.50 977.9	9211-2640	\$2,200	1,750		
33.25 19U	250 113.4	50 22.7	40.25 1022.4	9211-1713	\$2,200	1,750		
47.25 27U	320 145.2	70 31.8	53.88 1368.6	9211-2641	\$2,700	2,150		

*Prices shown are subject to change.

Standard Features

Inner rack frame with provision for infinitely adjustable T-bar instrument support bracket. Standard 20" depth.

Inner rack frame with RETMA hole pattern drilled in rear rails.

Standard color: pearl grey cabinet.

Manual pressure relief valve.

Special Features Available

- A. Mating feet for stacking one case on top of another. \$50
- B. Special color. Please specify. \$40
- C. Modified inner rack frame depth. Standard depth 20" from front panel mounting surface to rear surface of frame. This option includes an appropriate change in the overall depth of the enclosure. Please specify desired inner frame depth. Maximum 23", minimum 12". \$300
- D. Instrument slide pair to mount on either side of inner frame using RETMA hole pattern drilled in front and rear rails. \$90
- E. Special shock mounts for unusual instrument weights. Please specify weights. \$40
- F. Increased front cover depth. Maximum depth 6". Please specify. \$250
- G. Increased rear cover depth. Maximum depth 6". Please specify. \$250
- H. Latches recessed into the surface of the case. \$250
- I. Handles recessed into the surface of the case. \$90
- J. Hermetically-sealed case tested by the hot water method. \$90
- K. MIL-C-4150 certification with the exception of design and preproduction testing. Case will have increased wall thickness, hardware anodized to military specification, and will be hermetically tested using the hot water method. \$290
- L. Automatic pressure relief valve. \$50
- M. Addition of four permanently mounted, 3½" diameter swivel casters. \$120
- N. Addition of four removable, 3½" diameter swivel casters. Also available in kit form. \$250
- O. Addition of two aluminum hat-section skids to the case bottom. \$120
- P. Addition of lift rings to either side of the case. \$50
- Q. 3½ H (88.9 mm) Drawer with ball bearing slides. \$330
- R. 5¼ H (133.4 mm) Drawer with ball bearing slides. \$350
- S. 7 H (177.8 mm) Drawer with ball bearing slides. \$370
- T. Pair of T-Bar instrument support brackets. \$30
- U. AC power receptacle strip with four outlets mounted on bottom rear of inner rack frame. Power cord 1 meter (3' 3") long, NEMA connectors. \$50

Accessories (when ordered separately)

- 9211-1164** 3½ H (88.9 mm) Drawer with ball bearing slides. \$380
- 9211-1165** 5¼ H (133.4 mm) Drawer with ball bearing slides. \$400
- 9211-1166** 7 H (177.8 mm) Drawer with ball bearing slides. \$480
- 0950-0122** AC power receptacle strip with four outlets mounted on bottom rear of inner rack frame. Power cord 1 meter (3'3") long, NEMA connectors. \$50
- 9211-1173** Pair T-Bar instrument support brackets. \$46
- 1490-0913** Caster kit, four removable, 3½" (88.9 mm) swivel casters. For transit cases only. Recommended to be removed before transit. \$210
- 5081-5831** Operating Case Latch. \$7.75 each
- 5081-5832** Aluminum hat-section skids (2) for case bottom. \$155
- 5081-5834** Caster kit, four removable, 3½" (88.9 mm) swivel casters. Heavy duty for Transit or Operating Cases. Recommended to be removed before transit. \$300

On request, cases can be fabricated that meet the environmental requirements of military specifications. Specifications other than military are subject to change without notice.

CABINETS & CABINET ACCESSORIES

System II Plus—Handles and Rack Flanges, Bail Handle Kit

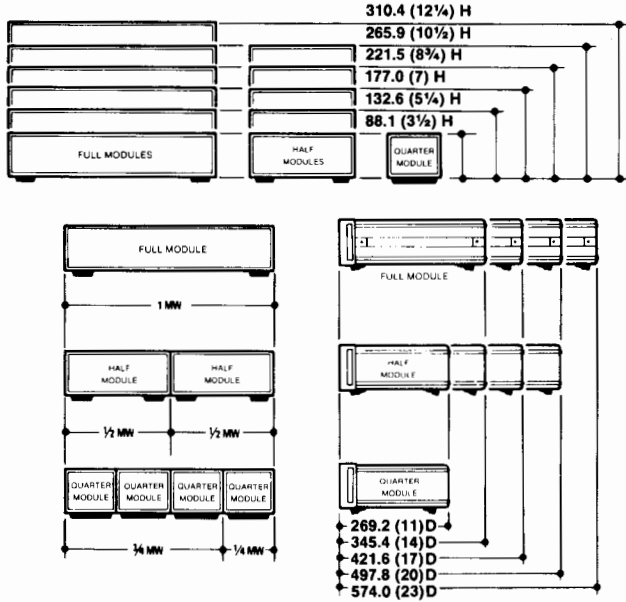

System II Cabinet Design

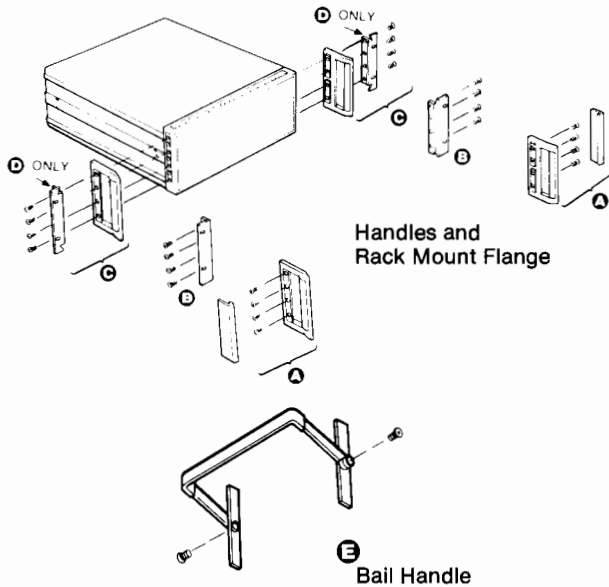

NOTICE—Most of the cabinet accessory kits shown on these pages include both inch and metric fasteners to make them compatible with the new metric-fastener-cabinets, as well as the older inch-fastener-cabinets which are still in service. It is most important for the user to be aware of these different fasteners to avoid thread damage when attaching the accessory kits. Metric-fastener-cabinets are identified with a yellow label on the rear which reads "Caution—metric and inch hardware", a "metric" embossment in the front bezel casting under the plastic trim strip, and on the middle of the rear bezel casting.

System II and System II Plus Cabinet Design

HP's modular cabinet system offers bench-stacking and rack mounting versatility. These cabinets are designed for compatibility with EIA and IEC standards, both in width and height.

System II Plus cabinets and accessories are identical in form, fit, and function as System II, but are different colors for improved visual continuity. This catalog lists System II Plus part numbers only. Old System II parts are available until May 1989. For old part numbers, refer to previous edition of this catalog.

Handles and Rack Mount Flanges

Handles and rack flanges are available for all System II cabinets, although they find most use on full width modules or combinations of narrower modules locked together to form 1 MW (module width).

Certain instruments are supplied with front handles as part of the selling price. Handles and rack flanges can be supplied with most instruments by specifying the appropriate option from the following list, at the time of order. The extra cost of each option is usually specified on the instrument data sheet.

- Option 907 Front Handles
- Option 908 Rack Mount Flanges
- Option 909 Handles with Rack Flanges
- Option 913 Rack Mount Flanges (If handles already furnished) (HP 5062-4069 Version)

The table below describes kits available for use after receipt of equipment. Field installation is very straight-forward. A plastic trim strip is easily removed and the handle or flange attached with screws supplied in the kit. Before rack mounting, bottom feet must be removed.

Bail Handle Kit

For 1/2 MW cabinets, you can attach this front bail handle for easy portability. Attaching hardware furnished.

HP Part No.	Name	Price
5062-4001	Bail Handle Kit for 88.1 (3 1/2) Module	\$38.00
5062-4002	Bail Handle Kit for 132.6 (5 1/4) Module	35.00
5062-4003	Bail Handle Kit for 177.0 (7) Module	33.00

Handle and Rack Flanges

Instrument Module Height mm (inch)	A Front Handle Kit		E Rack Mount Flange Kit [3]		C Rack Mount Flange Kits with Handles		D Rack Mount Flange Kit for Instruments With Previously Supplied Handles	
	HP Part No.	Price	HP Part No.	Price	HP Part No.	Price	HP Part No.	Price
88.1 (3 1/2)H	5062-3988	\$ 50.00	5062-3974[1]	\$31.00	5062-3975[1]	\$ 72.50	5062-4069[1]	\$21.00[4]
88.1 (3 1/2)H	—	—	5062-3976[2]	31.00	5062-3982[2]	72.50	5062-4070[2]	36.00[4]
132.6 (5 1/4)H	5062-3989	55.00	5062-3977	33.50	5062-3983	82.50	5062-4071	28.00
177.0 (7)H	5062-3990	65.00	5062-3978	36.00	5062-3984	95.00	5062-4072	32.00
221.5 (8 3/4)H	5062-3991	75.00	5062-3979	40.00	5062-3985	105.00	5062-4073	36.00
265.9 (10 1/2)H	5062-3992	95.00	5062-3980	45.00	5062-3986	120.00	5062-4074	40.00
310.4 (12 1/4)H	5062-3993	140.00	5062-3981	50.00	5062-3987	160.00	5062-4075	49.00
Kit includes	2 Handles + 2 Trim Strips + Mtg. Screws		2 Flanges + Mtg. Screws		2 Handles + 2 Flanges + Mtg. Screws		2 Flanges + Mtg. Screws	

[1] HP 5062-3974/3975/4069 Kits use standard flanges with 1.75" hole spacing.
[2] HP 5062-3976/3982/4070 Kits use special flange with 3.00" hole spacing.

[3] Will not fit onto instruments with previously supplied handles.
[4] Option 913 ordered on instruments supplies HP 5062-4069. For 3.00" spacing order HP 5062-4070 instead of Opt. 913.

CABINETS & CABINET ACCESSORIES

System II Plus—Support Shelves, Filler Panels

717

NOTICE—Most of the cabinet accessory kits shown on these pages include both inch and metric fasteners to make them compatible with the new metric-fastener-cabinets, as well as the older inch-fastener-cabinets which are still in service. It is most important for the user to be aware of these different fasteners to avoid thread damage when attaching the accessory kits. Metric-fastener-cabinets are identified with a yellow label on the rear which reads "Caution—metric and inch hardware", a "metric" embossment in the front bezel casting under the plastic trim strip, and on the middle of the rear bezel casting.

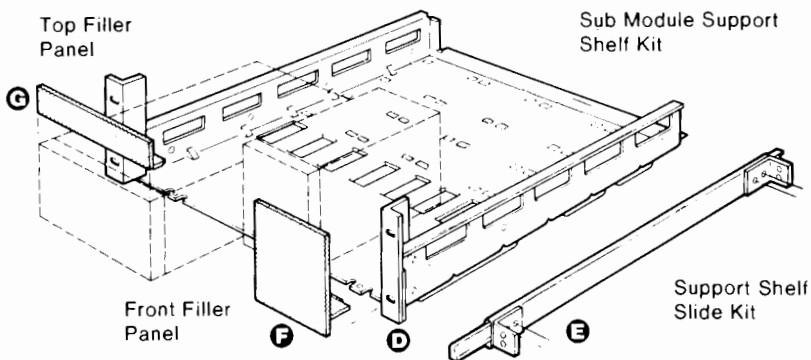
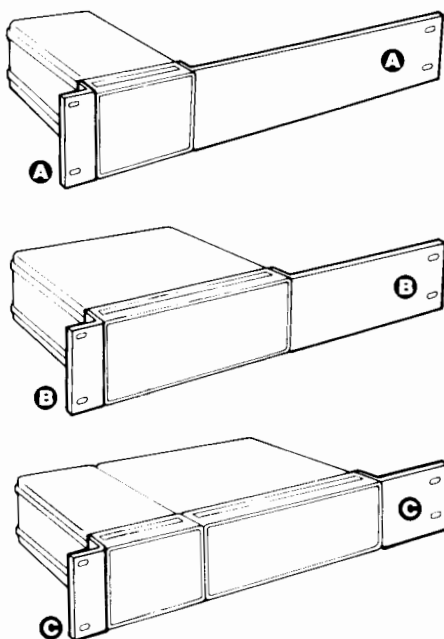

Rack Mount Adapter Kits

Modules of less than 1 MW can be rack mounted using these kits. Individual ¼ MW or ½ MW modules use the kits shown below directly. Combinations of ¼ MW and ½ MW (of equal depth) are first joined side-by-side with the Lock Link Kit (HP 5062-3994) (following page), then have end flanges applied. Combinations adding to 1 MW use regular rack flange kit (previous page). Kits include attaching screws but not front panel rack mounting screws. Hole patterns conform to EIA and IEC standards.

Rack Mount Adapter Kits

Module Height mm (inch)	A Mounts ¼ MW Module		B Mounts ½ MW or 2 ea. ¼ MW[2] Modules		C Mounts ¾ MW (3 ea. ¼ MW[1] or ¼ & ½ MW side-by-side[2])	
	HP Part No.	Price	HP Part No.	Price	HP Part No.	Price
88.1 (3½)H	5062-3973	\$56.00	5062-3972	\$51.00	5062-3971	\$43.00
132.6 (5¼)H	—	—	5062-3957	62.00	5062-3958	50.00
177.0 (7)H	—	—	5062-3960	67.00	5062-3961	70.00
265.9 (10½)H	—	—	5062-3966	77.50	5062-3967	72.50
Kit includes	1 ea. rack flange 1 ea. ¼ MW extension adapter flange and screws		1 ea. rack flange 1 ea. ½ MW extension adapter flange and screws		1 ea. rack flange 1 ea. ¼ MW extension adapter flange and screws	

[1] ¼ MW can be center mounted using 2 of these kits.

[2] Side-by-side modules of equal depth require lock link kit (HP 5062-3994).

Support Shelf, Slide, and Filler Panels

Submodules of differing heights, widths, and depths (up to 20 D) may be rack-mounted using these support shelves. Any combination of ¼ MW and ½ MW will fit side-by-side up to 1 MW. Filler panels close up vacant spaces either on top of short modules or side-by-side. The slide kit provides ready access to internal shelf areas and is designed for HP racks with 24-inch depth vertical support rails. Slide kit includes brackets and mounting screws.

HP Part No.	Name	Price
5062-3996	D Support Shelf for 88.1 (3½)H Modules	\$195.00
5062-3997	E Support Shelf for 132.6 (5¼)H Modules	195.00
5062-3998	D Support Shelf for 177.0 (7)H Modules	210.00
1494-0015	E Slide Kit (2 ea slides, brackets, hardware)	120.00

Filler Panels

Description	Size	HP Part No.	Price
F For 88.1 (3½) H support shelf partially filled with instruments, and having the following front panel space to fill:	¼ MW to fill	5062-4021	\$67.50
	¾ MW to fill	5062-4023	92.50
F For 132.6 (5¼) H support shelf, and having the following front panel space to fill:	¼ MW to fill	5062-4024	\$80.00
	½ MW to fill	5062-4025	87.50
F For 177.0 (7) H support shelf, and having the following front panel space to fill:	¼ MW to fill	5062-4066	\$75.00
	½ MW to fill	5062-4027	110.00
G For ¼ MW and having the following vertical space to fill:	43.2 (1¾)H	5062-2035	\$50.00
	87.6 (3½)H	5062-2036	50.00
G For ½ MW and having the following vertical space to fill:	43.2 (1¾) H	5062-2037	\$50.00
	87.6 (3½) H	5062-2038	50.00

Fast-Ship product. See page 734

CABINETS & CABINET ACCESSORIES

System II Plus—Lock Link Kits, Rack Mount Slide Kits

NOTICE—Some of the cabinet accessory kits shown on these pages include both inch and metric fasteners to make them compatible with the new metric-fastener-cabinets, as well as the older inch-fastener-cabinets which are still in service. It is most important for the user to be aware of these different fasteners to avoid thread damage when attaching the accessory kits. Metric-fastener-cabinets are identified with a yellow label on the rear which reads "Caution—metric and inch hardware", a "metric" embossment in the front bezel casting under the plastic trim strip, and on the middle of the rear bezel casting. Due to design considerations, the slide-mount kits shown on this page are offered in both inch and metric fastener versions.

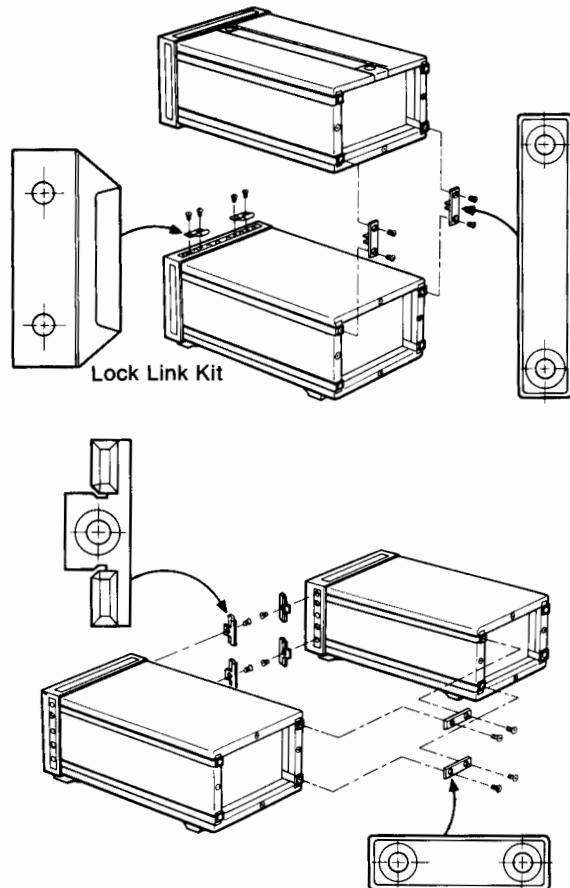

Lock Link Kits HP 5062-3994 (includes inch screws)

All sub-module cabinets of *equal depths* can be linked together over-under or side-by-side with hardware in the lock link kit. Cabinet frames are already pre-threaded to allow quick assembly. For side-by-side connections the kit contains 12 front hooks and six rear links, enough for 3 side-by-side joints. For vertical connections, the kit also contains four front hooks and four rear links enough for two over-under joints. Kit includes screws. Locking cabinets together horizontally in a configuration wider than 1 MW is not recommended.

If the over-under linked combination is to include rear standoff feet (HP 5062-4009), then the over-under locking feet kit HP 5062-3999 (next page) should be used for over-under connection.

The HP 5062-3994 Lock Link Kit is not recommended for full module over/under combinations. Use Kit HP 5061-9699 Locking Feet Kit (next page) to handle those larger weights.

Slide Kits and Rack Brackets

Rack slides are available for full-width System II cabinets to permit easy access to internal spaces. Each kit consists of two slides which mount directly to System II cabinet side handle recess spaces (after removing side handles). The slides also mount directly to vertical support rails in HP-racks. HP 1494-0060 mounts 345.4D and 421.6D depth System II cabinets. HP 1494-0059; 497.8D and 574.0D.

Standard weight slides carry 38.6 kg (85 lbs) max. load. Tilting versions are available in standard duty only. (HP 1494-0062 and 1494-0063.)

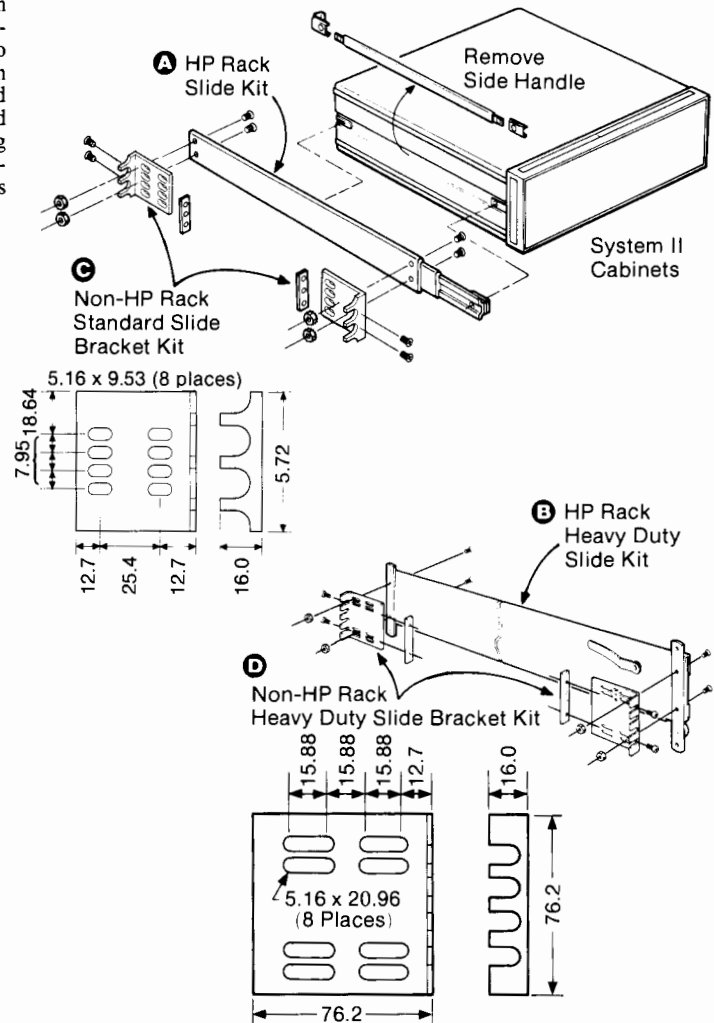

For non-HP-racks, end bracket kits are available for both standard and heavy duty slide kits. Slotted hole arrays in the brackets provide for front-to-back rack rail spacing of 24, 26, and 28-inch nominal centers. They also allow choice of two vertical positions. Each kit of four brackets includes screws and four bar nuts. These general purpose mounting brackets fit most common non-HP-racks such as GE, Honeywell, etc.

HP Part No.	Name	Price
Metric (Inch)		
5062-3994	Lock Link Kit	\$ 25.00 ☎
1494-0060 (1494-0018)	A Non-Tilting, Std. Slide Kit, Fits 345.4D & 421.6D Cabinets	100.00 ☎
1494-0059 (1494-0017)	A Non-Tilting, Std. Slide Kit, Fits 497.8D & 574.0D Cabinets	100.00 ☎
1494-0062 (1494-0025)	Tilting, Std. Slide Kit, Fits 345.4D & 421.6D Cabinets	190.00 ☎
1494-0063 (1494-0026)	Tilting, Std. Slide Kit, Fits 497.8D & 574.0D Cabinets	190.00 ☎
1494-0058 (1494-0016)	B Non-Tilting, Heavy Duty Slide Kits (497.8D & 574.0D Cabinets Only)	290.00 ☎
1494-0061 (1494-0023)	C (4) End Brackets for Non-HP Racks, Std. Slides	46.00 ☎
1494-0064 (1494-0042)	D (4) End Brackets for Non-HP Racks, Heavy Duty Slides	70.00 ☎

☎ Fast-Ship product. See page 734

CABINETS & CABINET ACCESSORIES

System II Plus—Cabinet Feet

719

NOTICE—Most of the cabinet accessory kits shown on these pages include both inch and metric fasteners to make them compatible with the new metric-fastener-cabinets, as well as the older inch-fastener-cabinets which are still in service. It is most important for the user to be aware of these different fasteners to avoid thread damage when attaching the accessory kits. Metric-fastener-cabinets are identified with a yellow label on the rear which reads "Caution—metric and inch hardware", a "metric" embossment in the front bezel casting under the plastic trim strip, and on the middle of the rear bezel casting.

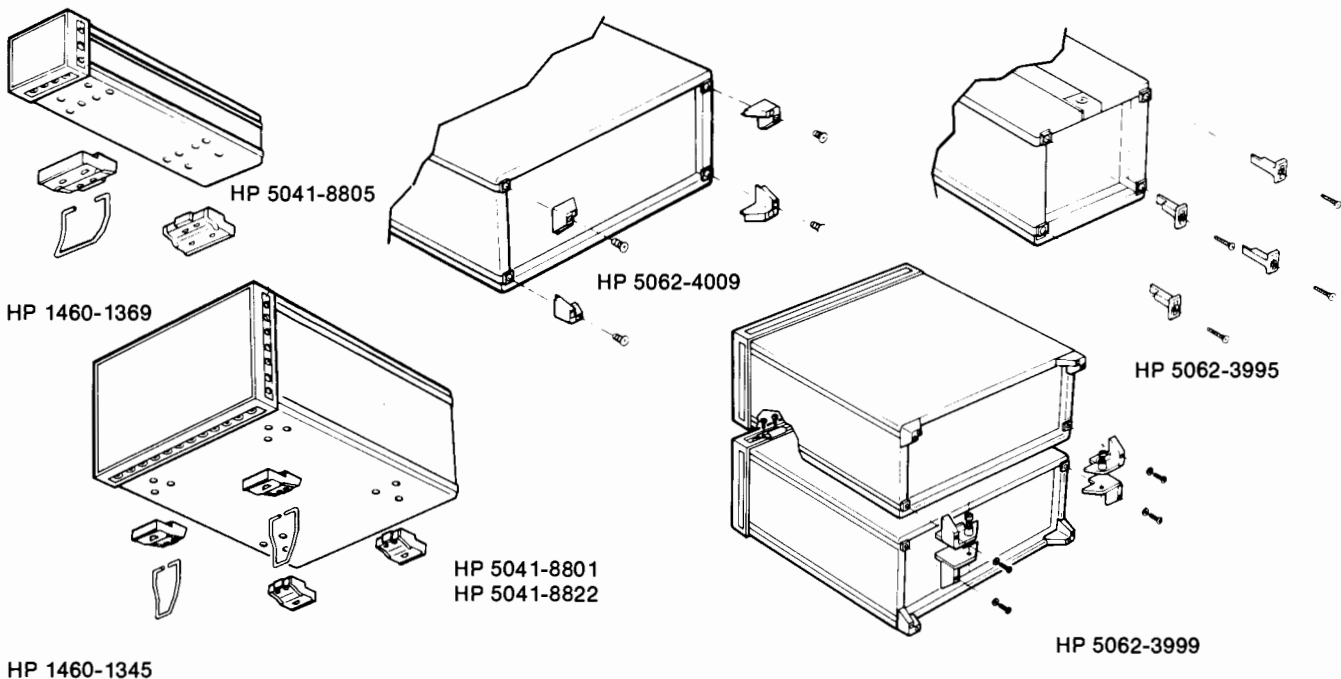

Bottom and Rear Cabinet Feet

Cabinet Rear Standoff Feet HP 5062-4009 (includes inch screws)

Kit HP 5062-4009 provides four corner feet which give 25.4 mm (1-in.) stand-off protection to the rear panel of instruments. It is used when instruments are to be operated or stored vertically on their rear panels. (Fits all but 1/4 MW by (88.1) 3½H). Includes mounting screws.

Cord Wrap Feet Kit HP 5062-3995 (includes inch screws)

Kit HP 5062-3995 contains four ribbed corner posts on which you can wrap power cords or signal cables for transport or storage. (Recommended for 1/4 MW and 1/2 MW cabinets weighing less than 11 kg, (24 lbs). Includes mounting screws.

Cabinet Bottom Feet and Tilt Stands

The standard foot HP 5041-8801 fits the bottom of full width and 1/2 MW cabinets. It fits front or rear and four are required. HP 5041-8822 foot is a non-skid version. Used in pairs it can prevent bench-top creeping. Tilt-stand HP 1460-1345 fits into the standard or non-skid foot and is used in pairs (front or rear) to tilt the instrument up or down for better viewing.

For 1/4 MW cabinets, foot HP 5041-8805 fits front or rear (two required). Tilt stand HP 1460-1369 fits the standard 1/4 MW foot and can be used front or rear depending on whether you want an upward or downward display.

Rear Panel Locking Foot Kit

When full module cabinets are to be linked vertically, and rear standoff feet are planned, use this kit. It consists of right and left foot linking pairs and 2 front hooks, enough for one over-under joint.

Also requires one HP 5062-4009 foot kit to supply the remaining 4 corner feet.

HP Part No.	Name	Price
5062-4009	Rear Standoff Feet Kit (4 Feet)	\$8.75 ☞
5062-3995	Cord Wrap Feet Kit (4 Feet)	\$25.00 ☞
5041-8801	Standard Foot	\$1.30 ☞
5041-8822	Non-Skid Foot	\$4.00 ☞
1460-1345	Tilt Stand	\$4.00 ☞
5041-8805	1/4 MW Foot	\$7.00 ☞
1460-1369	1/4 MW Tilt Stand	\$10.00 ☞
5062-3999	1 MW Cabinet Lock-Foot Kit	\$60.00 ☞

☞ Fast-Ship product - See page 734

CABINETS & CABINET ACCESSORIES

SYSTEM 1—Rack Hardware and Accessories

System 1 Cabinet Design

System 1 Cabinets are still used on older HP instruments. System 1 can be identified by its front handles being integral with the side casting frame. These two pages describe accessories for use with System 1 Cabinets and small modular instruments.

HP 1051A

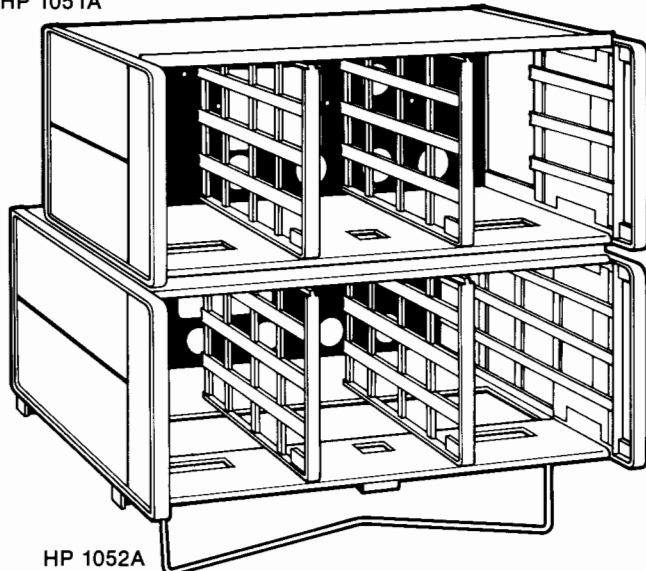

HP 1052A

Combining Cases, HP 1051A, 1052A

HP 1051A and HP 1052A combining cases conveniently rack or bench mount combinations of small modular Hewlett-Packard SYSTEM 1 instruments. Both cases accept $\frac{1}{3}$ or $\frac{1}{2}$ instrument modules, 130mm or 198 mm wide ($5\frac{1}{8}$ or $7\frac{25}{32}$ inches). The basic difference is that the HP 1052A is 130 mm ($5\frac{1}{8}$ in.) deeper and will accept modules up to 416mm deep ($16\frac{3}{8}$ in.). The HP 1051A accepts instruments up to 286mm deep ($11\frac{1}{4}$ in.). Each case is furnished with two dividers.

Accessory drawer HP 5060-8756 supplies storage space $\frac{1}{3}$ width and 77 mm ($3\text{-}1\frac{1}{32}$ ") high. Use an HP 5060-8758 filler panel above or below.

HP 1051A, 1052A, 5060-8756 Specifications

Size	Price
HP 1051A: 178 H x 482.6 W x 337 mm D (7" x 19" x 13 $\frac{1}{4}$).	\$750.00
HP 1052A: 178 H x 482.6 W x 467 mm D (7" x 19" x 18 $\frac{3}{8}$).	\$750.00
Weight	
HP 1051A: net, 4.5 kg (10 lb). Shipping, 6.7 kg (15 lb).	
HP 1052A: net, 5.4 kg (12 lb). Shipping, 8.1 kg (18 lb).	
Opt 908: Rack Mount Kit	\$40.00
Opt 910: Extra Manual	\$1.00

Rack Mounting Kits, HP 5060-8739 to 5060-8744

With these kits all Hewlett-Packard products in full rack-width cabinets of the integral side frame-handle style (see HP 1051A, 1052A, Combining Cases above) can be easily prepared for rack mounting. Each kit contains two flanges, a filler strip, and mounting screws.

Rack Mounting Kit Ordering Information

HP Part Number	Nominal Cabinet Height		Price
	Millimetres	Inches	
5060-8739	88.1	3 $\frac{1}{2}$	\$40.00 ☎
5060-8740	132.6	5 $\frac{1}{4}$	\$40.00 ☎
5060-8741*	177	7	\$40.00 ☎
5060-8742	221.5	8 $\frac{3}{4}$	\$45.00 ☎
5060-8743	265.9	10 $\frac{1}{2}$	\$45.00 ☎
5060-8744	310.4	12 $\frac{1}{4}$	\$50.00 ☎

*Also used to rack mount Combining Kits HP 1051A & 1052A shown above.

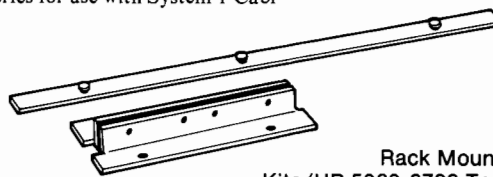

Rack Mounting
Kits (HP 5060-8739 To 5060-8744)

HP 5040-6678



HP 5060-8764

HP 5060-8762

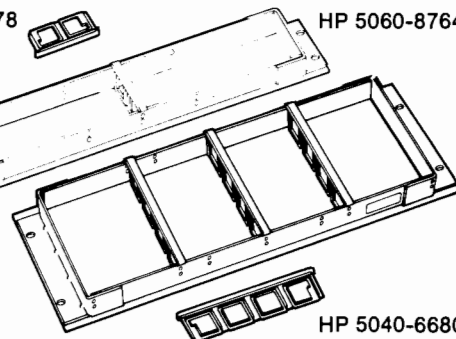

HP 5040-6680

Rack Adapter Frames, HP 5060-8762, 5060-8764

These frames can be used to hold combinations of $\frac{1}{3}$ and $\frac{1}{2}$ module-width HP instruments. Each frame is furnished with mounting hardware and three dividers. Two models are available for different instrument heights. Adapter frames are for permanent or semi-permanent rack mounting. Where quick removal and reinstallation of instruments is desirable, the HP 1051A and HP 1052A should be used.

HP 5060-8762 is 178 mm (7 in.) high and accepts instruments heights of $\frac{1}{4}$ H, $\frac{1}{2}$ H, and 1H. HP 5060-8764 is 89 mm ($3\frac{1}{2}$ in.) high and accepts instruments of $\frac{1}{4}$ H and $\frac{1}{2}$ H.

HP Part No.	Name	Price
5060-8762	Rack Adapter 178mm (7-in)	\$150.00 ☎
5060-8764	Rack Adapter 89mm (3 $\frac{1}{2}$ -in)	\$150.00 ☎
5040-6678	Extra Vertical Dividers for 5060-8764	\$28.00 ☎
5040-6680	Extra Vertical Dividers for 5060-8762	\$12.00 ☎

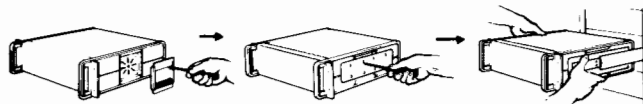

Remove Handles
and Feet

Attach
Adapter

Mount
Slides

Rack Mount Slide Kits and Cabinet Adapters

By removing the side handle of full width system 1 cabinets, rack mount slides can be attached for easy access to internal space. Both tilting and non-tilt are available, while max. load factor is 31.7 kg (70 lb). The cabinet adapter plate attaches to the handle recess then to the slide. Slide kits include four angle brackets which mount to rack rails with front-to-back nominal spacings of 24, 26 and 28-inches.

Cabinet Adapters

HP Part No.	Name	Price
1490-0722	Adapter plate for 88.9mm H(3 $\frac{1}{2}$ in.) cabinets	\$135.00 ☎
1490-0721	Adapter plate for 133mm H(5 $\frac{1}{4}$ in.) and higher cabinets	\$260.00 ☎

☎ Fast-Ship product. See page 734

CABINETS & CABINET ACCESSORIES

System 1 - Slide Kits, Fans, Joining Brackets, Cases

Rack Mount Slide Kits, HP 1490-0713 to 1490-0720

HP Part Number ¹	Slide Type	Cabinet Depth	Extension Length	Price
1490-0713	fixed	All Sizes	482.6 (19) ²	\$140.00 ☎
1490-0714	fixed	All Sizes	635.0 (25) ³	\$160.00 ☎

1. Cabinet Adapters, below, must be added to slides
2. Slide's stationary mounting depth: 406.4 (16)
3. Slide's stationary mounting depth: 558.8 (22)

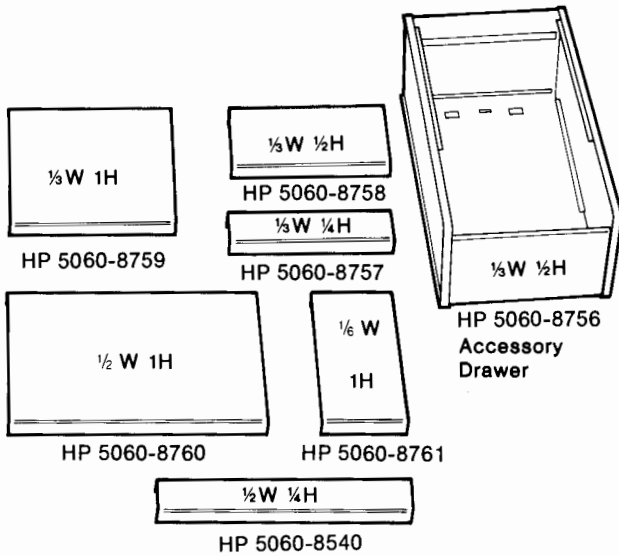
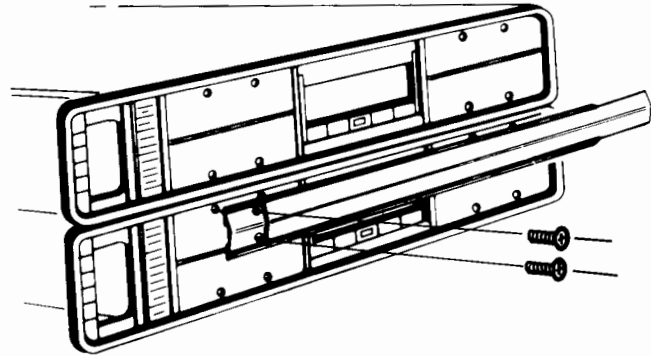

Joining Bracket Kits, HP 5060-8541 to 5060-8545

These kits join HP System 1 instruments of the same width and length into easily handled single stacks. Each kit consists of two brackets, mounting hardware and trim. They are available to fit the three most common instrument depths:

HP Part Number		Price
5060-8541:	279 mm (11 in.) EIA panel depth	\$160.00 ☎
5060-8543:	406 mm (16 in.) EIA panel depth	\$160.00 ☎
5060-8545:	480 mm (19 in.) EIA panel depth	\$170.00 ☎

Filler Panels, HP 5060-8540, 5060-8757 to 5060-8761

Filler panels can be used to close off any leftover space after instruments are mounted in combining cases (left) or adapter frames (below). Panels are available in a variety of widths and heights.

HP Part No.	Module Case Height x Width	Filler Panel Dimensions		Price
		Millimetres	Inches	
5060-8540	1/4 x 1/2	38 x 198	1 1/2 x 7 25/32	\$54.00 ☎
5060-8757	1/4 x 1/3	38 x 130	1 1/2 x 5 1/8	\$75.00 ☎
5060-8758	1/2 x 1/3	77 x 130	3 1/32 x 5 1/8	\$43.00 ☎
5060-8759	full x 1/3	155 x 130	6 3/32 x 5 1/8	\$43.00 ☎
5060-8760	full x 1/2	155 x 198	6 3/32 x 7 25/32	\$44.00 ☎
5060-8761	full x 1/6	155 x 63	6 3/32 x 2 31/64	\$70.00 ☎

☎ Fast-Ship product. See page 734.

CABINETS & CABINET ACCESSORIES

EIA Racks HP 46298-Series

- Functional fit with HP instruments
- Same design as HP Design Plus work station furniture
- Quality construction

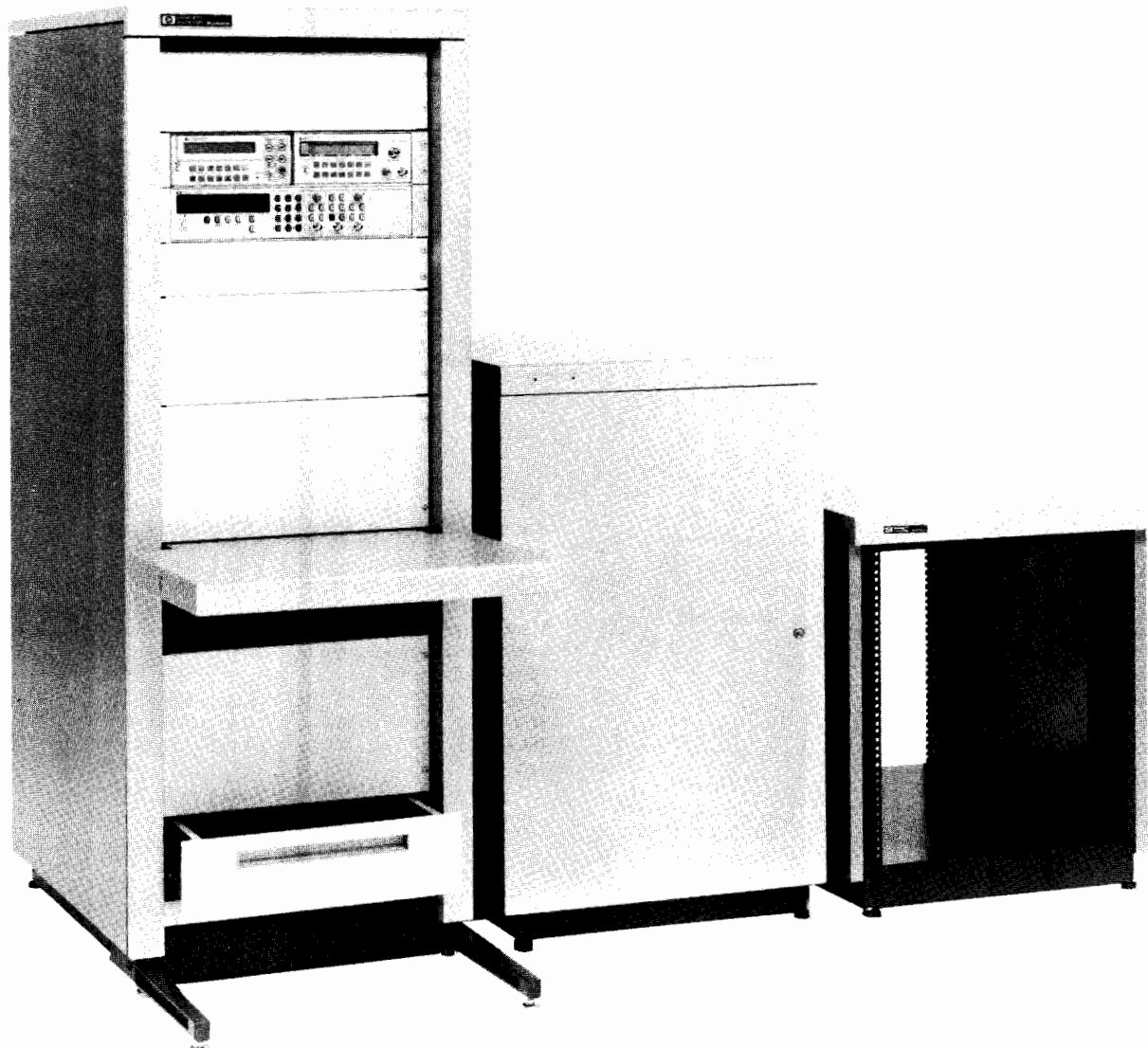

Modularity lets you select only the parts you really need: doors, anti-tip feet, a work surface or a convenient drawer for small system parts.

With the addition of these racks, Hewlett-Packard can now offer you a total system of test instruments, rack cabinets, computers and work stations. All these pieces are designed to be compatible — both in form and function.

These 19-inch commercial/industrial EIA rack cabinets easily accommodate HP test instruments and incorporate the same design elements as HP's Design Plus work station furniture (see page 704). You can create work places which are easy to install, look good and incorporate the latest in ergonomic features.

The rack system is modular. Choose from three heights: 1600mm (63.0"), 1000mm (39.4") or 720mm (28.4"). Then purchase doors, filler panels or other products only as you need them. You can select from blank front doors, ventilated rear doors, front caps, blank filler panels, a sliding drawer and anti-tip feet. We can even provide you with the proper mounting hardware.

The basic rack consists of the frame, two side panels and a top panel. The frame includes a base plate, the four corner struts, to which

the instruments are attached, and a top plate. Everything is manufactured from folded, welded steel. This all-steel, one-piece construction offers incredible strength compared to racks which are merely bolted together. The colors are selected to blend with old and new HP instrumentation. The HP custom paint matches perfectly the newer instrument colors (known as System II Plus).

The racks offer many additional features:

- Convenient lift hooks are included with all cabinets. Use them to lift the empty cabinet into place.
- If you have a large system you can mount instruments both from the front and the rear, since the EIA hole pattern appears on all four corner struts.
- The leveler pads are located at the extreme outer corners of the frame to provide the largest base possible for safety.
- Swivel casters mounted to the base let you roll the racks easily into position.

Lockable doors

Blank front and louvered rear doors come in three different sizes for each of the rack heights. Both are lockable with a key, so that the instruments can be protected from unauthorized access. Even with the rear door closed, power to the system can still be furnished.

The rear door is fully ventilated for maximum convection cooling. However, some configurations will require additional ventilation from user supplied fan units.

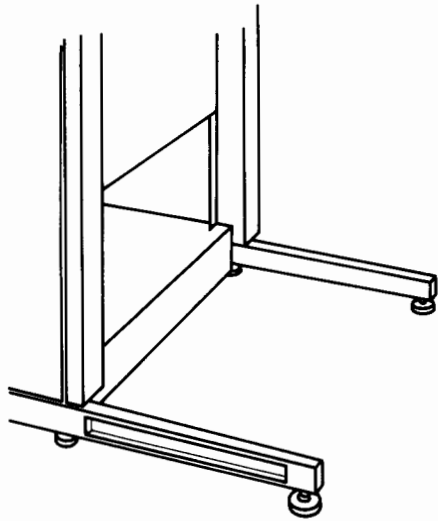

Anti-tip foot kit

Each kit contains two feet with leveler pads. The cast steel feet can be mounted either to the front or the rear using existing holes. Bolting the feet to the frame is easy with a wrench and the hardware supplied.

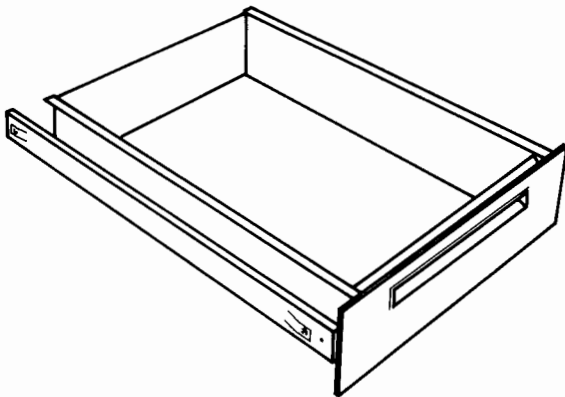

Sliding drawer

Keep your instrument manuals or system software close to you in this convenient 5¼" high drawer.

Construction is folded, painted sheet metal and it glides easily out on a set of slides. A plastic bezel in the front recess protects your fingers.

Front caps

The front caps visually "clean up" the front of the rack by covering the corner struts and the edge of the side panels. You will still have complete access to the instruments and the mounting ears.

The caps are made of folded, painted steel and only a wrench is necessary for mounting. Mounting hardware is included.

Name plate and mounting hardware

If you wish, you can attach a Hewlett-Packard system nameplate in the existing indentation in the upper left corner of the racks. The plate features the HP logo, the words "Hewlett-Packard" and "System". These labels are furnished with each rack.

A kit of sheet metal nuts and 10-32 screws is all you need to complete the system. Each rack mount kit comes with hardware to mount the rack ears to the instruments. These screws and nuts mount the ears to the frame. There is enough in the kit to mount the maximum number of instruments in the tallest (1600mm) rack.

Specifications

Exterior height: 720mm (28.4"), 1000mm (39.4"), or 1600mm (63.0")

Usable rack height: 553mm (21.8"), 833mm (32.8"), or 1433mm (56.4")

Exterior depth: 800mm (31.5")

Max. instrument depth: 710mm (28")

Exterior width: 600mm (23.6")

Net weights: 720mm: 51kg (113lb)

1000mm: 59kg (130lb)

1600mm: 75kg (166lb)

Hole spacing: EIA standard

Caster load weight: 180kg (400lb) each

Ordering information

HP 46298A Rack, 720mm	\$850
HP 46298B Rack, 1000mm	\$900
HP 46298C Rack, 1600mm	\$975
HP 46298E Front door for 720mm rack	\$175
HP 46298F Front door for 1000mm rack	\$190
HP 46298G Front door for 1600mm rack	\$215
HP 46298H Rear door for 720mm rack	\$175
HP 46298J Rear door for 1000mm rack	\$190
HP 46298K Rear door for 1600mm rack	\$215
HP 40112A Front Cap Kit, 720mm	\$85
HP 40113A Front Cap Kit, 1000mm	\$90
HP 40115A Front Cap Kit, 1600mm	\$95
HP 40101A Filler panel, 1.75"	\$36
HP 40102A Filler panel, 3.50"	\$37
HP 40103A Filler panel, 5.25"	\$38
HP 40104A Filler panel, 7.00"	\$40
HP 40105A Filler panel, 8.75"	\$41
HP 40106A Filler panel, 10.50"	\$42
HP 40107A Filler panel, 12.25"	\$43
HP 46298M Drawer and slides	\$235
HP 46298N Work surface	\$270
HP 40100A Anti-tip foot kit	\$130
HP 46298R Mounting hardware	\$70

☞ Fast-Ship product — see page 734.

Price

CUSTOMER SUPPORT

General Information

Supporting Your Success

You're developing a system built on HP's equipment because it best meets your test, measurement, and computing needs. HP wants you to be successful and we're committed to helping you achieve the best results from your system for years to come. We don't stop serving you once the sale is complete. Our flexible support solutions—in hardware, software, customer education, and consulting services—bring you many benefits. Our support services will:

- Shorten the period between purchase and effective use of an HP product.
- Deepen your understanding of your HP equipment and its capabilities.
- Customize hardware and software for application-specific requirements.
- Make available unique resources for maintenance and troubleshooting.

Measure the results in greater overall productivity and lower cost of ownership.

Maximizing the return from your equipment investment can be seen as a three-phase process of planning and design, implementation, and operation. Hewlett-Packard offers support services to ensure that you obtain maximum performance from your measurement system during each of these phases.

Performance by Design

A thorough design will ensure that your test and measurement system performs to your expectations and meets your needs. Whether you're planning a single instrument system or a complete factory, HP can offer you technical assistance through consulting services or design the system for you through project services.

Support Life Cycle

Planning and Design

- Project services
- Consulting

Implementation

- Customer education
- Consulting
- Installation services
- Project services

Operation

- Hardware support
- Software support

Smooth Implementation through Knowledge

A thorough understanding of your equipment's capabilities is essential to achieving maximum performance from your investment. That's why we back our products with education courses and materials to ensure that you learn the best way to apply our equipment to your environment.

We also offer installation services to ensure that your system is installed correctly and quickly.

Continuous Operation through Maintenance

To help you minimize equipment downtime, Hewlett-Packard maintains a worldwide customer service organization staffed with trained engineers and technicians who are backed by factory designers and a large inventory of replacement parts. We will focus the necessary resources to keep your equipment operating at peak performance.

With computers playing a larger role in today's measurement systems, software support plays an essential role in maintaining

your system's performance. HP keeps you up-to-date on the latest software improvements to ensure your system continues performing to its maximum potential.

Support Life

To help you maximize your product's useful life, HP will continue to offer standard support services for as long as feasible. To continue offering these services means managing our trained staff and repair parts inventories to match your needs.

In any event, HP offers support services on all of our products for at least 5 years beyond end of production. Furthermore, on most test and measurement equipment, services are available for at least 10 years beyond the end of production.

In addition, we will make our best effort to repair or calibrate any HP product, whatever its age, even if the product has passed through its support life. Charges will be made on a time and materials basis.

Support for Your Needs

The following pages provide more details on Hewlett-Packard's wide range of support services. Ask your local HP representative to help you select the services that best meet your needs in maximizing your measurement system's performance.

Service Selection Guide

Services	Major Benefits	Best Fit
Hardware Support (pg. 725) <ul style="list-style-type: none"> • HP Customer Return service • On-site service • W30: 3-year customer return repair coverage • W31: 3-year on-site repair coverage • W32: 3-year customer return calibration coverage 	<ul style="list-style-type: none"> • Fast turnaround time • Cost savings • Dependable measurement accuracy • Peak instrument performance 	<ul style="list-style-type: none"> • Most instruments, especially those in critical applications or frequently used
Customer Education (pg. 728) <ul style="list-style-type: none"> • Wide variety of courses covering latest HP products and technology 	<ul style="list-style-type: none"> • Fast learning • Time and cost savings over learning independently • Up-to-date instruction 	<ul style="list-style-type: none"> • Whenever new products or technology are introduced in your environment
Software Support (pg. 731) <ul style="list-style-type: none"> • HP Software Update Materials service • HP Software Notification service • HP ResponseLine software support service • HP BasicLine software support service 	<ul style="list-style-type: none"> • New software releases • Up-to-date software information • Fast, accurate support • Personalized support 	<ul style="list-style-type: none"> • Instruments with software • Instrument controllers
Consulting Services (pg. 732) <ul style="list-style-type: none"> • HP-ASSIST • Installation services • Project services • HP Time and Materials Consulting service 	<ul style="list-style-type: none"> • Expert implementation assistance • Quick startup of instrument systems • Increased productivity 	<ul style="list-style-type: none"> • Fast, efficient implementation of instrument system required

HP Support Options

The HP Support Options program is a family of services that fits in with your hardware purchasing process. HP Support Options coverage adds to your product's warranty, providing you with HP's quality support for 3 years.

These easily ordered services demonstrate HP's commitment to quality service and low cost of ownership. Competitively priced, they are also more economical than per-incident services. Furthermore, by purchasing HP Support Options coverage, you lock in your cost savings for an extended period.

Option W30. Adds to product warranty to provide a total of 3 years of HP Customer Return Repair service from the time of hardware delivery.



Option W31. This option adds to product warranty to provide a total of 3 years of HP Next Day On-Site repair service from the time of hardware delivery.



Option W32. This option provides 3 years of HP Customer Return calibration service from the time of hardware delivery. Coverage includes scheduled calibration at HP's recommended calibration cycle, as well as calibration after a required repair performed by HP.

Ordering Information

HP Support Options coverage is available for most HP test and measurement products. These options represent your best opportunity to extend the benefits of product warranty and lock in low support costs for a specified time. They are available at the time of hardware purchase, so you can make one buying decision for both hardware and support, using the same product purchase order. Ask your HP sales representative for more information.

Customer Return Hardware Support Services

We are committed to maintaining your Hewlett-Packard equipment in peak condition so that it continues to work for you in years to come. Industry experts highly respect our wide range of quality support. If you want to learn more about how we can keep your hardware performing now and in the future, simply take a look at our HP Customer Service Center offerings.

Technical Expertise

Our maintenance and repair technology comes right out of the original design centers for our products. We know all the inner workings and when things do go wrong we correct them quickly and cost-effectively.

Our technicians have an average of 14 years experience in servicing HP products. They receive factory training on all new products and technologies regularly, and are backed by well-supplied, highly automated service centers.



Extensive Automation

HP Customer Service Centers rely on automated processes to calibrate instruments and diagnose problems. Our investment in automation enhances the quality of repair and repeatability of calibration. This efficiency results in savings for you.

High In-stock Inventory

Each HP Customer Service Center manages its spare parts inventory so that over 85 percent of required parts are immediately available. We can usually get any other required part within 24 hours.

Efficient Problem Escalation Management

Most of the time we solve hardware problems quickly. In the few cases that require special attention, we will call upon our worldwide technical and managerial network to quickly develop a lasting solution.

Minimum Downtime

We know turnaround time is important to you. No one wants a production line disabled because an instrument is out for service. HP strives to reduce downtime by working quickly and accurately, so you get back to business promptly. We're even willing to specify our turnaround time. Here are our commitments:

Five-day Service for Instruments

We will repair or calibrate any HP instrument covered by an HP service agreement in most parts of the world within 5 working days of receiving it.

Three-day Service for Workstations

We will repair any HP workstation covered by a repair agreement usually within 3 working days of receiving it.

For more information, please contact your HP Customer Service Center.

An Outstanding Array of Services

Whatever your needs we aim to be as flexible as possible in meeting them. We offer repair and calibration, to commercial or military requirements, on a per-incident basis and under each of our agreement services:

- HP Support Option coverage
- Repair agreement
- Calibration agreement
- Full service agreement

In summary, HP's service programs offer the benefits of factory support, highly trained technicians, automated repair and calibration, problem escalation management, engineering upgrades, and fast turnaround time. We're proud of our capabilities and customer service record.

CUSTOMER SUPPORT

Hardware Support (cont'd)

A Variety of Service Agreements

Comprehensive and Economical

Our services maximize the performance of your HP equipment. You can choose an HP support agreement that best fits your application and type of equipment. With HP's service agreements you:

- Know in advance exactly what you'll be paying for an entire year of support.
- Get your equipment calibrated according to factory-recommended procedures and timetables.
- Enjoy the security of continuous coverage by experienced HP personnel.

Take a look at the ways HP's service agreements can keep your equipment at peak performance.

Repair Agreement

Our repair agreement covers equipment failures. Similar to an extension of your product's warranty, it is significantly more economical than equivalent per-incident repairs on instruments and workstations. Products covered under the agreement are sent to the nearest HP Customer Service Center, where they are repaired within the timespan stated in the agreement, generally 3 to 5 days. Return freight, parts, and labor are included. [Please note: agreements do not cover failures resulting from abuse or damage.]

Calibration Agreement

Periodic calibrations at factory-recommended intervals lead to confidence in measurements. The factory-suggested timetable of our calibration agreement results in a history of more accurate measurements. In addition, the agreement is much more economical than purchasing per-incident calibration. If you change instrument use or operating conditions often, we can provide calibrations at an interval you request. Return freight is included, of course.

Full Service Agreement

If you want both repair and scheduled calibration, we have combined them in our full service agreement. This agreement is about 10 percent less expensive than repair and cal agreements purchased separately, and about 15 percent less expensive than equivalent per-incident service.

Military Standard Agreements

Military standard calibration and full service agreements are also available for approximately 1,300 HP instrument products in the United States. Other government certification programs are available in other parts of the world.

Volume Service Agreement Discounts

You may be eligible for a volume service agreement discount. Call your local HP Customer Service Center for details.

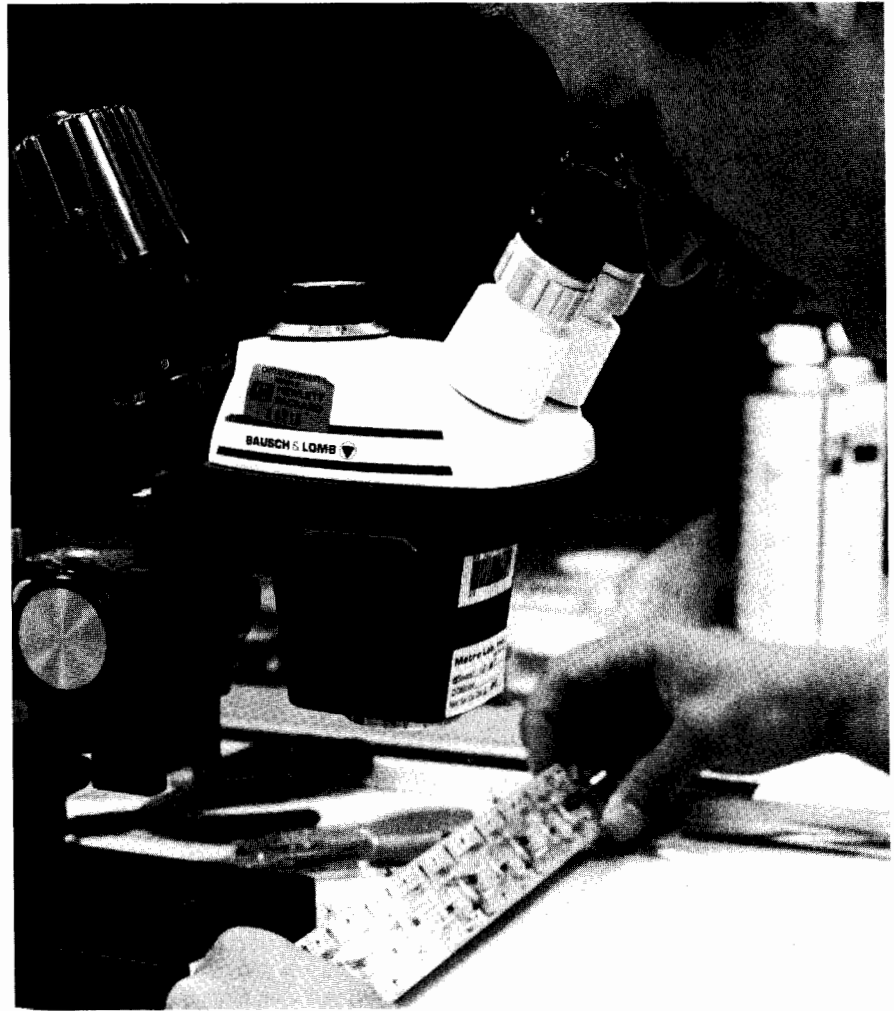

Service Agreement Selection Guide

	Features	Major Benefits	Best Fit
Repair Agreement	<ul style="list-style-type: none"> • Complete repair coverage • Fixed annual price • No parts exclusions • Preventive maintenance and engineering upgrades when appropriate • Return surface shipment included • Priority service, 5 days or less 	<ul style="list-style-type: none"> • Single, budgetable expense • Typically 10% lower price than equivalent per-incident service • Elimination of quotation approval delays 	<ul style="list-style-type: none"> • Instruments not requiring calibration • Frequently used products • Critical applications • Workstations requiring cost-effective coverage
Calibration Agreement	<ul style="list-style-type: none"> • Periodic calibration at HP-recommended intervals • Fixed annual price • NBS traceability • Military standard option • Return surface shipment included • Customer-specified cal cycle for an adjusted price • Priority service, 5 days or less 	<ul style="list-style-type: none"> • Dependable measurement accuracy • Typically 15% lower price than annual Standard Cal 	<ul style="list-style-type: none"> • Accuracy critical applications • Traceability required • All instruments requiring regular calibration • Military standard compliance required
Full Service Agreement	<ul style="list-style-type: none"> • Features of Repair and Cal Agreement combined • Military standard option • Priority service, 5 days or less 	<ul style="list-style-type: none"> • Peak instrument performance • Typically 20% lower price than equivalent per-incident service • 3% to 9% lower price than other agreements combined • Lower self-support parts inventory and training costs • Less demand on self-support personnel 	<ul style="list-style-type: none"> • Most instruments • Critical applications

On-site Hardware Support HP Basic System Maintenance Service

This service agreement provides next day, on-site service coverage from 8 am to 5 pm Monday through Friday (excluding HP holidays) for customers within 100 miles of an HP Support Responsible Office. Service includes an account-assigned customer engineer (CE) who becomes familiar with your environment and takes personal responsibility for managing your measurement system's maintenance program.

Also, your CE will perform preventive maintenance on a regular basis, scheduled in advance, to maintain your system at its optimal performance specifications.

Desktop computers configured with measurement systems gain the account management and system support essential for those configurations.

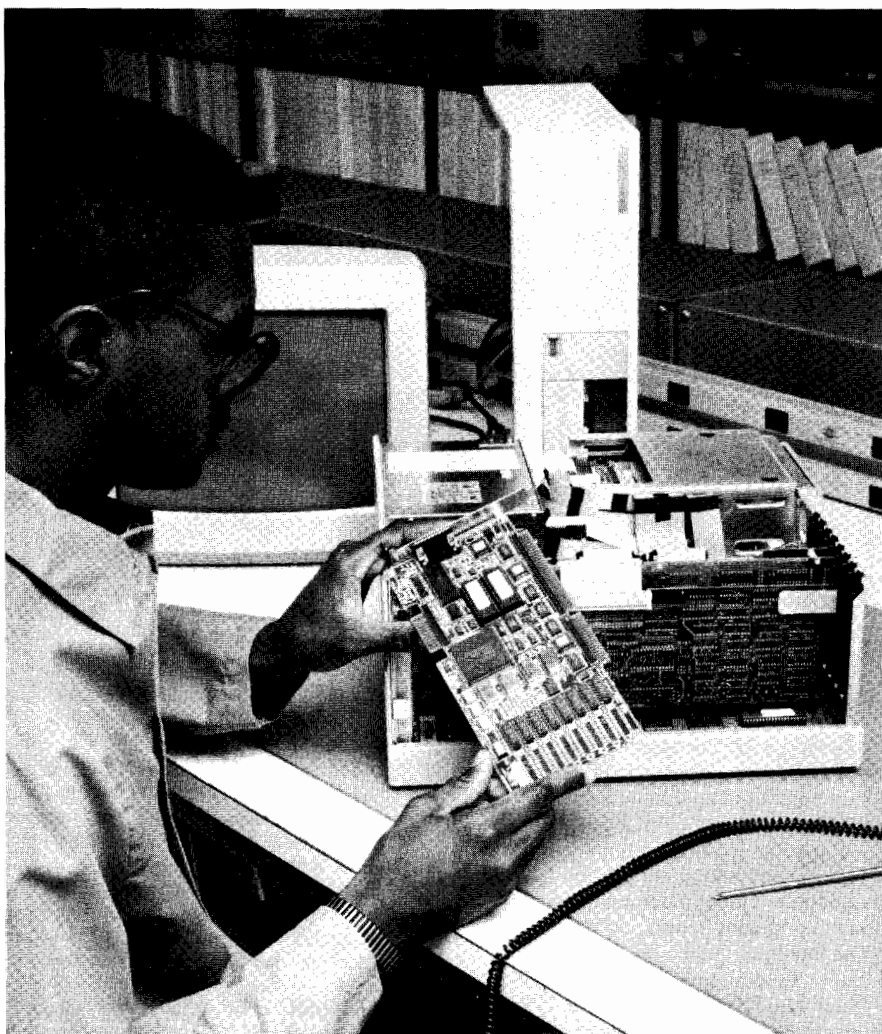
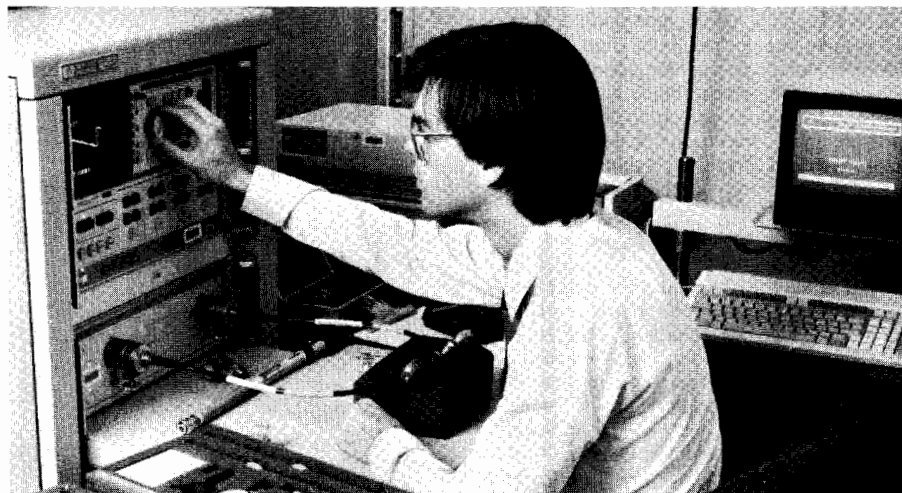

HP Standard System Maintenance Service

This service agreement provides coverage from 8 am to 9 pm, Monday through Friday (excluding HP holidays). This coverage allows all scheduled maintenance services to be performed after normal working hours. Customers within 100 miles of an HP Support Responsible Office will receive an on-site visit within 4 hours. Extended coverage options can provide service up to 7 days per week, 24 hours per day.

HP Measurement System Calibration Service

For HP instrument products configured into measurement systems, calibration service can be added to the standard or basic system maintenance agreements. Some products can be calibrated at your site; others will need to be returned to an HP Customer Service Center by your customer engineer. Measurements made during calibration of your equipment are traceable to the U.S. National Institute of Standards and Technology (or other international standards organization, where applicable).

System Installation Services

When you purchase an HP computer or measurement system, support services begin even before system installation. A customer engineer routinely provides site planning, site environmental survey, and installation services.

CUSTOMER SUPPORT

Customer Education

HP Customer Education

We are committed to offering training that will permit you to get the best possible use of HP equipment. We recognize that both initial instruction and ongoing education contribute to your success: that's why we offer courses in operation, applications, and software and hardware maintenance for HP instrument and computer products.

Quality Training Our Instructors Understand Your Industry

They speak the language. We make sure our instructors have a deep understanding of the subject and can effectively explain—in clear, concise terms—everything you need to know, from specialized test techniques to the physics behind the measurements.

Backing them up are HP class-development teams. Product specialists, industry experts, curriculum engineers, course writers, and instructors develop training materials and design courses with the goal of maximizing your learning experience.



Courses That Work for You

Our courses are consistently updated to keep pace with evolving technology and industry changes. HP designs instructional materials—including student manuals and lab and instructor materials—to serve as long-term references. A course can't cover everything, but it can help guide your thinking on the subject matter. Our texts will help you keep in focus long after the class has ended.

Limited Class Sizes

Classes are limited to six to ten students. We believe small classes encourage closer in-

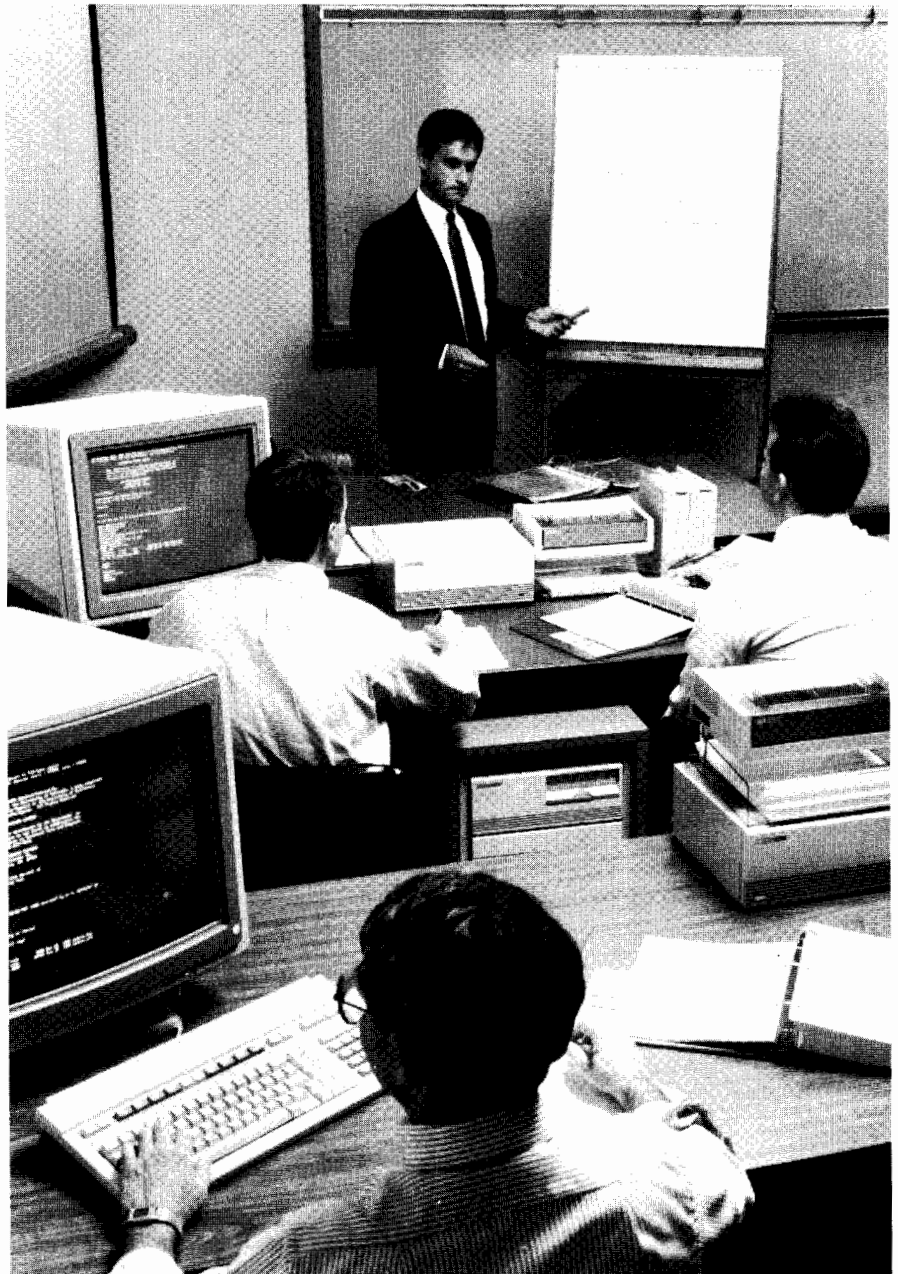

teraction with the teacher and other students, thus permitting them to share learning experiences and applications expertise.

It's Not All Books

Hands-on training is important to your success. That's why we provide lab equipment in our classes. Each course has lab time as a key training benefit.

The Payback

Our experience shows that you'll learn faster with HP education courses. The benefits are twofold: the equipment can be used sooner and the time you would have spent on independent learning can be used for other opportunities.

Worldwide Training

Worldwide Training Center Network

HP has training centers throughout the world, with classes in continuous progress. Training schedules are published regularly.

On-site Training

All HP courses can be scheduled and taught at your site. This option may prove more attractive to you, bringing the advantages of training in a familiar environment with your own equipment.

Off-schedule Training

Additional HP classroom courses can be arranged beyond those published in the local training schedule. These classes can accommodate your emerging training needs.

HP Customer Education Center Locations



- Argentina
- Australia
- Austria
- Belgium
- Canada
- China
- Denmark
- Finland
- France
- France
- Germany
- Hong Kong
- Italy
- Japan
- Korea
- Malaysia
- Mexico
- Netherlands
- Norway
- Saudi Arabia
- Singapore
- Spain
- Sweden
- Switzerland
- Taiwan
- United Kingdom
- Venezuela
- United States -Atlanta
- United States -Boston
- United States -Chicago
- United States -Dallas
- United States -Detroit
- United States -Los Angeles
- United States -New York
- United States -San Francisco
- United States -Seattle
- United States -Washington, DC

Customized Classes

We can meet special training needs by developing custom training classes. These changes may include modification of class materials, development of special labs, integration of new sections in the course, and even the development of entirely new classes.

Specialized Training Materials

HP education is typically based on classroom training, led by professional instructors with solid engineering experience. Other HP training formats include computer-based training, videotape sessions, satellite-broadcast instructions, and self-paced training modules.



Test and Measurement Curriculum

HP-IB Instrument Control and Data Acquisition

HP 05096A	3 days	SA/SD for Test and Measurement Software
HP 34800A+24D	3 days	Developing Test Plans Using FTM/300
HP 50011C	4 days	HP-IB Instrument Programming Using Series 200/300 BASIC
HP 51409A	1 day	HP-IB Theory
HP 51412A	1 day	HP-IB for MS-DOS® Personal Computers
HP 51473A	2 days	Architecture for Test and Measurement Software

Languages

HP 31112A	5 days	Introduction to Pascal
HP 31113A	5 days	HP Pascal for Advanced and System Programming
HP 31124A	5 days	Introduction to Ada/300 DS
HP 35130B	5 days	Programming in C Language
HP 50698A	5 days	Programming in FORTRAN 77
HP 98501B	5 days	Introduction to Workstation BASIC
HP 98510D	5 days	Series 200/300 BASIC Operating and Advanced Programming
HP 98511C	5 days	Series 200/300 Pascal Operating and Advanced Programming
HP 98880A	3 days	HP BASIC/UX Programming and Operating

General Purpose Instrumentation

HP 1631D+24D	2 days	HP 1631A/D Logic Analysis Measurement Techniques
HP 18347A	1 day	HP 4951C Protocol Analyzer Users Course
HP 35629A	3 days	HP 3562A Users Course
HP 3852A+24D	4 days	HP 3852S User Training Course
HP 50015A	3 days	Data Acquisition and Control Fundamentals
HP 55280A+24D	1 day	Basic Laser Measurement Training
HP 55283A+24A	1 day	Advanced Laser Measurement System Training
HP 6944S+24D	3 days	Multiprogrammer System Users Course

Microwave

HP 11776A+24D	2 days	HP 11776A Waveform Generation Language Users Course
HP 3048A+24A	2 days	HP 3048A Phase Noise Measurement System
HP 50740B	4 days	Microwave Fundamentals Course
HP 8510B+24D	3 days	Basic Network Measurements Using the HP 8510B Network Analyzer
HP 85101B+24D	2 days	Advanced Programming for the HP 8510 Network Analyzer
HP 85150A+24D	2 days	Discovering the HP Microwave Design System
HP 85668A	4 days	HP 8566/67/68 Spectrum Analyzer Operating and Programming Course
HP 8753B+24A	1 day	HP 8753B RF Network Analyzer Course

HP-UX

HP 50710A	5 days	Programming with HP-UX System Calls
HP 51432A	5 days	HP-UX Fundamentals for General Users
HP 51433A	5 days	HP-UX Shell Programming for General Users
HP 51434B	5 days	HP-UX Fundamentals
HP 51435A	5 days	HP-UX Text Editing Tools
HP 51438A	2 days	SCCS and make
HP 51439A	1 day	Advanced Editing with vi
HP 51440A	3 days	Document Preparation
HP 51489A	2 days	HP-UX Basics for Application Users

CUSTOMER SUPPORT

Customer Education (cont'd)

HP-UX System Administration

HP 22861B	2 days	ARPA/Berkeley Services for the HP 9000 Series 300 and Series 800 Systems
HP 22862A	2 days	Administration of NFS and Yellow Pages
HP 35073A	3 days	HP-UX System Administration for the HP 9000 Series 200
HP 35129B	3 days	HP-UX System Administration for the HP 9000 Series 500
HP 50722A	3 days	HP-UX System Administration for Application Users
HP 51436B	5 days	HP-UX System Administration for the HP 9000 Series 300
HP 51482A	5 days	HP-UX System Administration for the HP 9000 Series 800

Board Test/Semiconductor Test

HP 4062C+24A	3 days	HP 4062C Operating and Programming Training
HP 44531A	10 days	HP 3060A/61A/62A Users Course
HP 44584+24A	1/2 day	HP 3060 Enhancement Training
HP 44850A	5 days	HP 3065 Advanced Users Course
HP 44852A	10 days	HP 3065 Board Test System Users Course
HP 44853A	8 days	HP 3065 AT Training
HP E1022A	5 days	HP 3070 Users Fundamentals Class
HP E1024A	5 days	HP 3070 Advanced Digital Class
HP E1025A	5 days	HP 3070 Training for Experienced HP 3065 Users

Microprocessor Development

HP 64100A+24D	2 days	HP 64000 System Concepts and Measurements
HP 64120T	2 days	HP DesignCenter 64000-UX Users Course
HP 64121T	1 day	HP-UX for HP 64000-UX Users
HP 64310A+24D	1 day	HP 64000 Software Performance Analysis
HP 64600S+24D	1 day	HP 64000 Timing/Hardware Analysis
HP 64620S+24D	1 day	HP 64000 State/Software Analysis
HP 64810A+24D	2 days	Pascal/64000 on 8080/8085
HP 64812A+24D	2 days	Pascal/64000 on Z80
HP 64814A+24D	2 days	Pascal/64000 on 8086/8088
HP 64815A+24D	2 days	Pascal/64000 on 68000
HP 64817A+24D	3 days	HP 64000 Host Pascal Programming

Design Systems

Design Capture and Simulation

HP 74001A	3 days	HP EE DesignCenter System Administration
HP 74201A	2 days	HP Design Capture System Overview
HP 74202A	3 days	HP Design Verification Interface Users Course
HP 74203A	3 days	Introduction to HILO Modeling

Printed Circuit Board (PCB) Design

HP 50959A	1 day	Using SRM from BASIC and Pascal
HP 74300A	3 days	Introduction to HP EGS
HP 74301A	2 days	PCB Design with HP EGS
HP 74302A	3 days	Customizing with HP EGS
HP 74491A	2 days	Building Parts with HP PCDS
HP 74492A	3 days	PCB Design with HP PCDS

Mechanical Design (ME)

HP 74836T	5 days	HP ME Series 30 Users Course
HP 98363B+24D	4 days	HP ME Series 10 Users Course
HP 98365U+24D	3 days	Customizing HP ME Series 10

Telecommunications

HP 37050S+24A	5 days	HP 37050S User and System Manager Course
HP 37190A	8 days	HP 37100S Operator and Management Course
HP 37191A	3 days	HP 37100S Operator Training

Refer to the *Education Catalog* for detailed descriptions of the above classroom courses as well as available self-paced training and hardware maintenance training.



HP Education . . . Engineered for Your Success

Schedules and Literature

Course schedules are published three times a year (for regularly scheduled classes). Contact your Hewlett-Packard sales office or HP Customer Education Center for a copy of local training schedules.

Your sales office can also provide the following training literature:

Course Data Sheets. Every HP class has a data sheet that describes the course in detail. Included are key topics, target audience, course outline, prerequisites, and ordering information.

Education Course Schedule. HP training schedules are published throughout the world and list class schedules for each HP Customer Education Center, by country.

Education Catalog. The EPG presents information on the entire HP course range, including curriculum flow diagrams, course objectives, outlines, and course content. It is your tool for planning the best possible education for yourself and other members of your organization.

Curriculum Path Brochures. These brochures show the curriculum layout and give class descriptions for the following markets:

- Test and measurement
- Engineering systems
- HP-UX
- Technical computing
- Personal computers

Maximize Your Training Dollars. This brochure highlights the benefits of HP customer education in terms of accelerated learning, productivity gains, and time and cost savings. A worksheet is included to help you quantify the payback available to your organization from HP training.

How to Order

Call your local sales office or contact the nearest HP Customer Education Center to register for any HP class.



HP Software Support Services

Ongoing success with instrumentation products requires up-to-date information and software. Year after year, industry experts rate Hewlett-Packard as a leader in high-quality product service and customer support. Hewlett-Packard offers two levels of software support for instrumentation products. HP BasicLine software support is a new, basic level of support. HP ResponseLine software support provides Response Center level of support.

HP BasicLine

HP BasicLine software support for instrument products delivers current, comprehensive support information, with electronic access to information and the right to use HP software updates.

You can use the electronic databases to stay current on the latest HP products, support programs, and training classes. You can also use powerful search mechanisms to solve support problems for many HP instrument products. The combination of valuable support data and powerful search mechanisms adds up to increased productivity.

Increase System Productivity through Software Updates

Hewlett-Packard continuously enhances HP software products through periodic software updates, which include known defect repairs and may include additional functional and performance improvements. HP BasicLine software support includes the right to use updates for all licensed software on a single system. This ensures that your software and manuals keep current and that you benefit from any fixes or enhancements that Hewlett-Packard has provided.

Increase System Uptime through Access to HP's Worldwide Support Network

Hewlett-Packard's electronic support information has been developed through the worldwide HP Response Center network, which is also tied back to HP manufacturing divisions. This means that information developed halfway around the world, which could prevent a problem in your system, is available to you through a dial-up modem and HP-compatible ASCII character mode terminal or HP-compatible terminal emulator.

In addition, your system and operations staff can tap into knowledge gathered from throughout the HP organization. The on-line *News Page* brings you the latest news on product announcements, support services, new programs, and training classes. This information, along with service alerts on critical problems, stays current through weekly updates by HP's worldwide support, sales, manufacturing, research and development, and marketing organizations.

Obtain Direct Access to Valuable Problem-solving Information

HP's *Software Status Bulletin*, *Engineering Notes*, and *Application Notes* are all available electronically. The bulletin provides a complete listing of all reported software and manual defects and information for repair or workarounds. *Engineering Notes* feature HP's recommended solutions to customers' problems, to help you solve problems quickly. *Application Notes* present

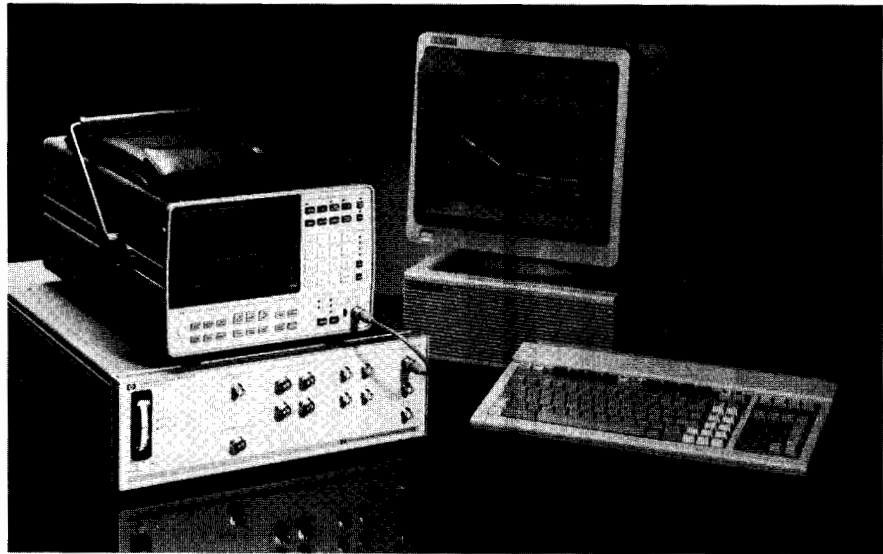

usage assistance and configuration information. Regular database updates provide you with current problem-solving and application information.

Reduce Time Locating Essential Information

The database access software allows you to explore interactively all product and application information. Whether you are using the powerful keyword search or the menu-driven browse facility, you quickly get to the appropriate reference. And, because the databases consolidate information from multiple sources, one search brings you everything on your topic of interest.

HP ResponseLine

HP ResponseLine software support for instruments provides comprehensive software maintenance. In addition to all the features of HP BasicLine software support, you receive telephone assistance to resolve software problems and questions about product usage. You also receive electronic access to HP's electronic support information services. The HP Response Center network brings together the worldwide resources of HP for software maintenance.

Obtain Rapid Response to Problems and Questions

HP ResponseLine software support service offers unlimited telephone assistance for normal software usage, clarification of documentation, and resolution of software problems. With timely answers to questions, you gain full advantage of your HP software's features and functions. In addition, HP ResponseLine support entitles you to the convenience of electronically submitting questions to the HP Response Center during your on-line HP SupportLine sessions.

Increase System Uptime through Support

Escalation management program. In the event that the HP Response Center cannot solve your software problem remotely, HP's well-defined escalation procedure mobilizes resources necessary to resolve the problem quickly. Using advanced-tech-

nology diagnostics and worldwide problem information databases, HP specialists isolate and analyze your software problems and then develop and implement the best solutions.

Specific Support Services

Your local HP systems engineer will be happy to check on the availability of HP software support services for your specific instrument software. Here are some of the popular instrument products for which HP offers software support services:

Microwave/Communications

HP 85150 microwave design system
HP 3048A phase noise measurement system
HP 11805A transceiver test system

Metrology

HP 11806B attenuator test system
HP 11808A signal generator test system

General Instrumentation

HP 5180T waveform recorder
HP 5183A waveform recorder
HP Transistor Characterization (TECAP)
HP 11776A waveform generation language
HP 35630 VISTA signal processing
HP 35680 instrument-BASIC
HP 35681 analysis pack

Telecommunications

Datacommunications

HP 4954 protocol analyzer
HP 4972A protocol analyzer
HP 4991 LanProbe system
HP 37011A telecom system software

Computer-aided Test

Data Acquisition

HP 34800A functional test manager
HP 44458A DAC manager
HP 3852A DAC unit
HP 3235A switch/test unit

Semiconductor Test

HP 4062B/C/UX parametric test system
HP 16269A test management shell/
TekBase
HP 82000 IC evaluation system
HP 9480 LSI test system

CUSTOMER SUPPORT

Consulting Services

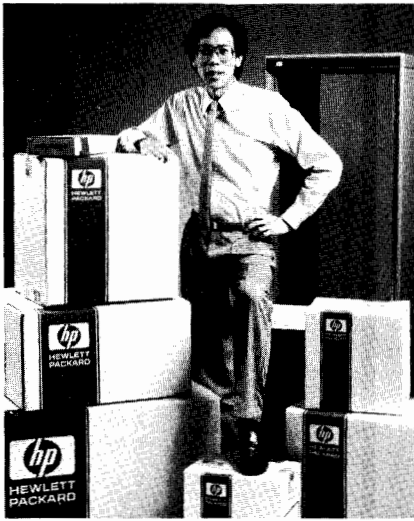

Consulting Services

As measurements and technology have become more complex, HP's equipment has become more sophisticated. Now that you've selected the best hardware that money can buy, let HP help you put it to work. Our wide range of consulting services helps you fully take advantage of your equipment's capabilities. We help you quickly advance from installation to optimal system use. Whether you need a few hours of guidance from an experienced consultant or a complete custom plan, our Application Engineering Organization and HP Project Centers are ready to help, through the following services.

Installation Services

HP's installation services, available for selected products, allow you to concentrate on your new system's applications, not the process of installation. We'll set up your HP 9000 hardware and ensure that your operating system and application software are up and ready to run.



Installation Services Products

HP 98595A+42A	HP-UX Application Execution Environment Installation
HP 98597B+42A	HP-UX Programming Environment Installation
HP 74210A+42A	HP Electronic Design System Installation
HP 74400A+42A	HP Printed Circuit Design System Installation
HP 64801S+42A	HP 64000-UX Microprocessor Development Environment Installation
HP 64710S+42A	HP Teamwork Products Installation
HP 98366A+42A	HP ME-5, 10, & 30 CAD System Installation
HP 35630A+42A	HP Signal Processing System Installation

HP 35630A

HP Signal Processing System—One Additional Installation
85150A Microwave Design System Installation Service
Additional Time and Materials Consulting
HP-UX BASIC Installation

HP 85150A+42A

HP 51414A

HP 98796A+42A

HP Project Center Services

When your requirements are unique, investigate custom solutions from HP Project Centers. Backed by the full resources of Hewlett-Packard, HP Project Center teams deliver on-time, on-budget solutions to your specifications. Look to our experts to save the time, expense, and worry of devising custom solutions yourself.

HP Project Centers have a proven track record in providing cost-effective, reliable, and supportable solutions. We use structured methodologies for project analysis, design, development, and management.

Technical Expertise

HP Project Centers integrate the broad range of HP products, ranging from schematic capture and simulation to manufacturing test. HP's project services offer you a one-vendor solution backed by experience and quality.

HP Project Center expertise in measurement automation results from extensive experience in test-system analysis and design. HP Project Center engineers are also adept in the design of other applications, including data acquisition and control, in-circuit and functional circuit testing, semiconductor testing, and microwave/RF testing.

General Consulting Problem Solving

Sometimes a few hours of time with an expert can help you overcome what seems to be an insurmountable roadblock. Consulting can be used to help you develop, customize, or optimize your instrument system. On-site consulting is available on an hourly, weekly, and off-hours basis. Ask for HP 51414A consulting.

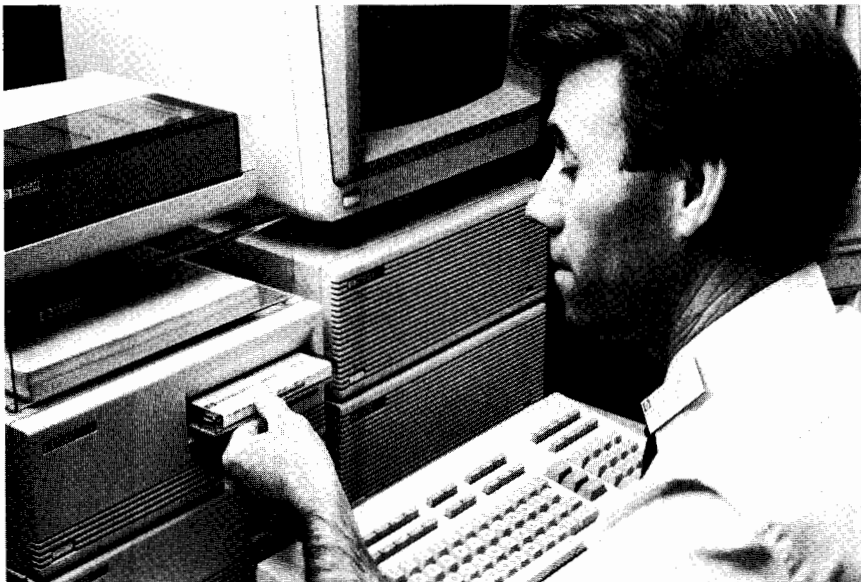

Consulting Services Compared

When You Need:	Ask for:	Applications:	Features:	Benefits:
Installation of hardware, software, or operating system	Installation services	HP-9000 UX and applications	Customized operating system, system verification and review	Quick startup
Implementation assistance for HP's computer-aided applications	HP-ASSIST	ME-CAD, quality management, manufacturing	Active planning, tools, consulting, training, structured process	Quick startup, efficient use of system, less risk
Additional resources, custom coding, performance improvement, general help	HP Time and Materials consulting service	All	Flexible uses, experienced and trained resources	Quick access to expertise, efficient use of system
Integrated custom solutions, project management, third-party management, custom software development, functional specs, requirements definition	Project services	Measurement automation, computer-aided test, factory automation, and design systems integration	HP quality and alliance, custom solutions, proven performance, single-vendor solution, added expert resources	Specific needs reliably met, time and cost savings, productivity increase

HP-ASSIST

Our years of proven success in system implementation are packaged in HP-ASSIST, a structured consulting framework. This distillation of wisdom gained from implementing hundreds of systems becomes available to you in the form of consulting, tools, and training.

Teamwork Spells Success

Your people bring their knowledge of your business; HP applications engineers bring specific expertise and years of implementation experience. Jointly we plan ahead, using HP-ASSIST checklists and recommended activity guidelines to cover analysis, training, and final implementation. Taken together these ensure a smooth transition. If you are looking for an efficient, cost-effective startup, one backed by Hewlett-Packard's consulting resources, then the HP-ASSIST implementation service is for you.

HP-ASSIST Products

HP 98365A+60A	ME-5/10 ASSIST Base Unit (1st workstation)
HP 98365A+60B	ME-5/10 ASSIST Two Additional Workstations
HP 98365A+60C	ME-ASSIST Network
HP 98365A+60D	ME-ASSIST Add to Network
HP 98365A+65Z	ME-5/10 ASSIST Additional Service Units
HP 74836A+60A	ME-30 ASSIST Base Unit (1st workstation)
HP 74836A+60B	ME-30 ASSIST Two Additional Workstations
HP 74836A+60C	SRX-ASSIST
HP 74836A+65Z	ME-30 ASSIST Additional Service Units
HP 44672A+60A	HP Q-STATS II/HP PR PLUS ASSIST
HP 44672A+65Z	HP Q-STATS II ASSIST Additional Service Units

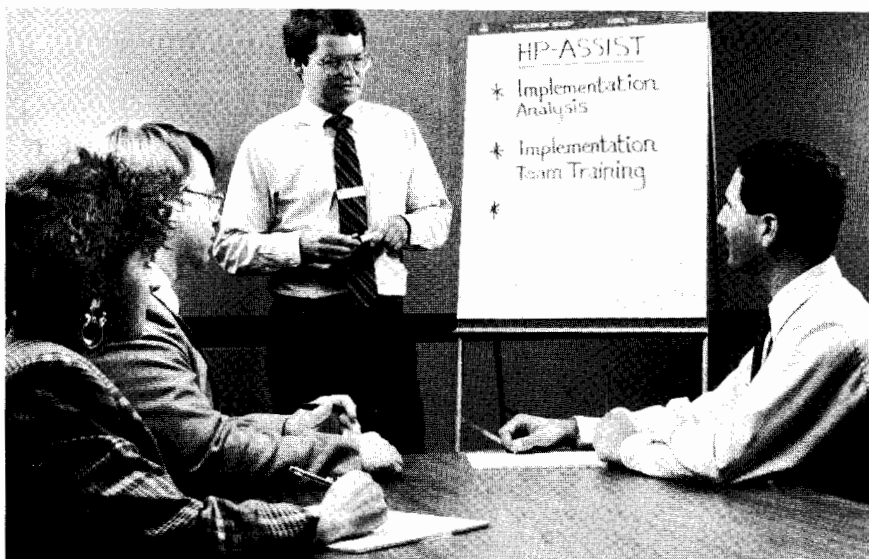

How to Order

Your HP sales representative can help you select a combination of support services to help you gain maximum use from your new HP system in the minimum time possible. Ask your local HP sales representative for more details.

CUSTOMER SUPPORT

Fast-Ship Service

- Convenient catalog shopping
- Computer supplies/accessories
- Test & measurement accessories
- Quick, easy telephone ordering
- Fast shipment



What Is Fast Ship Service?

Fast-Ship Service is the quick way for you to choose from thousands of HP products, order them by phone and receive expedited delivery. Three catalogs offer an array of supplies and accessories, add-on peripheral devices and test instruments.

Now, with **Fast-Ship Service**, you can call **HP DIRECT** distribution centers (see opposite page) and receive fast shipment from our complete stock of supplies, accessories and add-on products.

Computer Users Catalog (Worldwide)

This biannual publication provides a fast, easy way for HP customers to shop for nearly 2,000, supplies, accessories and add-on products. These products are HP manufactured, tested or approved to operate at maximum efficiency with HP equipment. Detailed descriptions, charts, full-color photographs and equipment guides provide all the information necessary to select the best products for your application.

Information is easily accessible, with new products grouped together in front and three convenient indexes for easy referencing.

To Get A Catalog

In the U.S.: Call 800-538-8787 or call your local HP Sales Office and request publication #5953-2450D.

Outside the U.S.: In the following countries, call the listed phone number (see below) and request the appropriate publication:

- U.K. 5953-2450UK
- Germany 5953-2450GE
- France 5953-2450FR
- Italy 5953-2450IT

In Japan request publication #9320-0761 from your local HP Sales Office. In all other countries, call HP DIRECT or ask your local HP Sales Office for publication #5953-2450.

HP Direct Order Phones (Worldwide)

In the U.S. call: 800-538-8787

Outside the U.S. call:

Australia	(03) 895-2645
Austria	(0222) 25 00614/615/616
Belgium	(02) 761 3111
Canada	(416) 671-8383
Denmark	(043) 01 640
Finland	(90) 887 2361
France	(01) 69 8617 25
German Federal Republic	01 30 3322
Greece	(01) 6726090
Italy	(02) 92 103301
Japan	0120-091321 06 300 3150
Netherlands	(020) 547 6606
Norway	(02) 246090
Spain	(91) 6374013 (91) 6370011
Sweden	(08) 7502400
Switzerland	(057) 3124 91/94/95
United Kingdom	(0734) 44 1212

In countries where HP DIRECT is not yet available, order from your HP Sales Office.

Documentation Index (Worldwide)

More than 2500 manuals, binders, books and guides for HP computer systems and peripherals as well as instruments are listed in this annual publication. For ease of use, the index is conveniently divided into three sections. You can find a manual easily — even if you don't know the part number — because the first two sections list the publication under the computer or peripheral to which they belong. The third section lists the publications in numerical order and includes the title, latest print date and the latest update (if this information is available).

To Get an Index

In the U.S.: Call 800-538-8787 or contact your local HP Sales Office and request publication #5953-2460D.

Outside the U.S.: Call your local HP Sales Office. Request publication #5953-2460.

Test & Measurement Accessories Catalog (Worldwide)

This catalog features a broad line of electronic test and measurement accessories, such as oscilloscope probes, rack mount hardware, logic probes, and microwave power sensors, detectors and attenuators.

It is designed to make selection of accessories as easy as possible and features full-color photographs, detailed descriptions, and selection guides. Three different indexes make products easy to find.

The catalog also contains a selection of HP's most popular test instruments — all available off-the-shelf and shipped the same day if your order is received by 4 PM.

To Get a Catalog

In the U.S.: Call 800-538-8787 or call your local HP Sales Office and request publication #5954-0193D.

Outside the U.S.: In the following countries, call the listed phone number (see HP Direct Order Phones Worldwide) and request the appropriate publication:

- U.K. 5954-0193UK
- France 5954-0193FR
- Germany 5954-0193GE
- Italy 5954-0193IT

Fast-Ship Service in the U.S.

Throughout the pages of this catalog you will notice the telephone symbol. This symbol identifies a wide variety of products available to you through the U.S. **Fast-Ship Service**, as well as through your local HP Sales Office:

- Test and Measurement Accessories
- Cables and adapters
- Microwave Accessories
- Basic Instruments
- Rack Mount Hardware & Cabinets
- Data communications
- Handheld calculators and computers
- Personal computers and software
- Peripherals and terminals
- Furniture and accessories
- Printers
- Plotters and their supplies
- Magnetic media.

What Makes Fast-Ship Convenient?

When you call our HP Direct Phone Order Service weekdays between 6 AM and 5 PM Pacific Time, from anywhere in the U.S., you receive immediate confirmation of product availability, pricing and delivery. And remember, our prices include regular UPS or truck delivery. Expedited air service is also available. We usually can charge your order with an HP DIRECT Open Account (P.O.'s), or with your VISA, MasterCard or American Express credit card. We want you to be absolutely satisfied with our products. All supplies and accessories are designed and tested to meet the high quality standards you expect from Hewlett-Packard. All products in our catalogs come with our guarantee of satisfaction. Any product in our catalogs not meeting your expectations can be returned — no questions asked.

INSTRUMENT FINANCING

Rental, Lease and Gradual Purchase Plans

Leasing-vs.-Buying

Cost Savings

To decide if you should lease or buy your equipment, start by comparing costs.

Figure 1, for example, shows the after-tax cost in today's dollars of instruments leased vs. purchased outright.

It also shows how HP Financing's low rates always make leasing more attractive than buying. Whether you keep the equipment or return it.

Four More Advantages

Leasing also can help you:

- **Acquire new technology without a large cash outlay.**
Simply pay in affordable, monthly payments.
- **Solve short-term project needs.**
Rentals and leases allow you to quickly complete temporary projects — and assign expenses precisely.
- **Upgrade and add-on with ease.**
By leaving ownership in the hands of HP, you can upgrade and add-on smoothly. This provides a hedge against obsolescence and an easy avenue for growth.
- **Obtain new technology in spite of tight capital budget restrictions.**
"Off-balance sheet" financing allows you to expense your monthly payments. Reducing the strain on your capital budget.

Why HP Financing?

Excellent Rates

Compare our rates with anyone in the marketplace. HP uses its low cost of funds to offer you extremely competitive rates. And these rates are fixed — they will not vary throughout your lease term.

Backed 100% by HP

Your equipment is installed and supported by the company that knows it best — Hewlett-Packard.

Generous Equity Accrual

As a manufacturer, HP is motivated to help you acquire your equipment. Nearly two-thirds of every payment accrues towards purchase. This provides buyout terms that make very good sense for lessees.

Flexibility

HP Financing helps you match your payment stream with your revenue stream. We understand that every organization has individual needs.

Lease-vs.- Buy Comparison

After-tax cost of \$100,000 instrument acquisition, using a 10% discount rate.

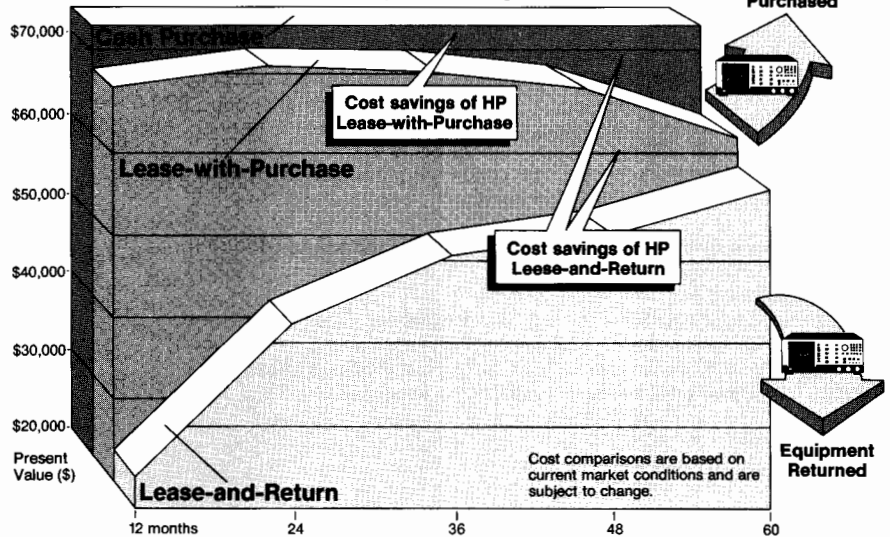

Figure 1

A Full Range of Plans

HP EasyRent

This plan provides HP's lowest rental rate and excellent flexibility. This low rate has been created by using a 36-month term—that can be discontinued at 12 or 24 months. HP rents only new equipment. Nearly two-thirds of every payment accrues towards purchase.

HP Rental Plan

This plan is designed for shorter-term needs or transition purposes. Take advantage of a low, 12-month fixed term, then rent month-to-month as needed. Nearly two-thirds of every payment accrues towards purchase.

HP Operating Lease

This longer-term plan offers an excellent avenue for hedging against obsolescence and for financing "off-balance sheet." HP Financing offers nearly two-thirds equity accrual. Some plans even provide the flexibility to discontinue. 12-48 month terms.

HP Lease With Option to Purchase

This 60-month plan offers our lowest rates and the option to buy the equipment at term-end — for just 10% of the amount financed.

HP Payment Plan

Similar to a bank loan — at rates many banks can't match. No down payment is needed. 36- to 60-month terms.

HP State and Local Government Plan

Low rates offered to eligible customers. Structured as a \$1 lease or an installment contract. Permits cancellation if funding is discontinued. 12-60 month terms.

HP Federal Government Lease to Ownership Plan

This plan is designed for Federal agencies and authorized contractors. "Pass-through" of GSA purchase discounts available. Permits cancellation for convenience. 12-60 month terms for "off-GSA" leases. "On-schedule" terms, too.

HP Financial Advisors

HP Financing provides professional advisors to help you analyze and tailor a plan for your individual needs.

For a Quote

To compare a lease versus cash purchase for your instruments, simply contact your closest HP sales office.

Just ask an HP Financing representative to help you weigh your options and structure a plan that's best for you.



Communicating With HP

Hewlett-Packard is committed to providing convenient local support and the best possible attention to customer needs on a worldwide basis. There are more than 440 HP sales and support offices and distributorships in 93 countries. A listing of these offices starts on page 739.

Your entry point to the resources of Hewlett-Packard is through the HP office nearest you. Our sales representatives and order support specialists there are well-equipped to provide you with pre-sale assistance in product selection, as well as related business information such as current product availability and price delivered to your location. You can also call our Customer Information Centers for the same information, or for the location of your nearest Hewlett-Packard office. Locations of these centers are included in the listing of offices that starts on page 739.

Most HP sales offices are tied into a sophisticated intra-company communications system. This not only means prompt transmission of orders to any HP product responsible division, it also speeds the flow of regular messages among HP sales offices and factories. The objective, of course, is to provide the fastest possible response to your product interests.

Pricing and Quotations

Prices in this catalog are U.S. list prices at the time of approval for printing. Hewlett-Packard reserves the right to change prices, and the prices for an order are determined by

the prices prevailing at the time the order is received. Therefore, the prices in this catalog are intended only as budgetary information.

To obtain destination prices, formal quotations, pro forma invoices, or other information you need before ordering, just contact the Hewlett-Packard office, distributorship, or Customer Information Center serving your area.

Placing Your Order

Because many products or configurations are changed or improved during the life of this catalog, we suggest that you always contact your nearest HP sales office for current product and pricing information prior to placing your order.

The HP representatives at the sales office nearest you will be pleased to provide assistance in selecting the HP equipment most appropriate to your needs, and to help you prepare your order.

The information in this catalog will, in many cases, be sufficient for you to decide to buy a particular HP product. In those instances, a telephone call to the nearest HP office will provide you with information on the product's availability and price.

To ensure maximum satisfaction with HP products and services, we ask that you order in the country of end use. Orders for end use inside the USA may be placed with your nearest U.S. sales office. Orders for end use outside the USA should be placed with an HP sales office or distributorship in the country of end use. More information on placing

such orders is available from the HP headquarters offices listed on page 739.

HP wants to be sure the product delivered to you is exactly the one you want. Therefore, when placing your order, please specify the product's catalog (model, accessory, or part) number, as well as the product's name. Be as complete as possible in specifying exactly what you want, including standard options.

If you want special features or capabilities, such as different color or a non-standard power line voltage, ask your HP sales representative about availability and cost first. Then, to prevent misunderstandings, include special instructions and specification details with your order.

Terms of Sale

Inside the USA: Hewlett-Packard's standard credit terms for established customers in the USA are net 30 days from invoice date.

Leasing and extended financial terms are available. However, the associated costs are not included in any product prices furnished with this catalog. Your nearby HP office will be pleased to discuss your requirements and work with you in setting up an appropriate program.

Outside the USA: Please contact the nearest Hewlett-Packard international sales office or an authorized HP subsidiary or distributor regarding terms for orders placed with them.

U.S. Government Sales

Many products in this catalog are covered on GSA federal supply schedule multi-award contracts.

Product Changes

Although product information and illustrations in this catalog were current at the time it was approved for printing, Hewlett-Packard, in a continuing effort to offer excellent products at a fair value, reserves the right to change specifications, designs, and models without notice.

Shipping Methods

Inside the USA: All prices include HP standard transportation and routing to any U.S. destination. If a different shipping method is needed, we will gladly ship to satisfy your requirements. In this case, the shipment will typically be sent freight collect.

Outside the USA: Shipments to destinations outside the USA are made by either surface or air, as requested.

OPERATING ENVIRONMENTS & WARRANTY

Operating Environments

Hewlett-Packard provides solutions to customer needs through products that must operate in the expected environmental conditions. In an attempt to meet customer needs effectively, all new hardware designs are tested to internal HP standards on operating environments before they are released for sale. These internal HP standards are derived from our experience with existing environments at customer installations and from other well-known standards, such as IEC, ISO, ANSI, and MILITARY standards. These internal HP standards provide guidance to all divisions producing new hardware products and systems. The classification codes, used to identify expected environments where HP products or systems may be used, are as follows:

- A1 - Rugged Environment
- A2 - Outdoor Environment (Portable)
- B1 - Portable General Purpose Environment
- B2 - General Purpose Environment
- C1 - Controlled Office Environment
- C2 - Controlled Computer Room Environment

The classes range from the severe environments found in heavy industrial areas unsuitable for operating personnel (Class A1) to the controlled environments found in dedicated computer rooms (Class C2). Most HP hardware products are designed to meet Class B2, applying test limits commonly found in general purpose applications of light industrial and commercial facilities.

Several parameters of the operating environment are evaluated during the design process. The major ones are as follows:

- Operating temperature
- Storage temperature
- Humidity
- Altitude
- Shock
- Vibration
- Power line variation (frequency and voltage)
- Power line surge
- Power line sag and dropout
- Power line distortion susceptibility (THD)
- Electromagnetic interference (radiated and conducted)
- Magnetic interference
- Magnetic susceptibility
- Radiated susceptibility
- Electrostatic discharge
- Acoustics

Although the details of these internal HP standards are the property of HP and are treated as proprietary material, information on the classes and the test limits appropriate for each class is available for those considering the use of HP equipment at their own facility. To obtain this information contact your HP sales representative. If you are considering a specific product, ask your sales representative what environmental class it was designed to (A1,A2,B1, B2,C1,C2) and the limits it met for the environmental parameter of concern. The information you receive must not be construed as an implied warranty because the classification codes are used for guiding the design of new products and not for evaluation of production units. Only those specific parameters identified in the technical data sheet (specifications) for the model number of interest will be warranted by Hewlett-Packard according to the terms of the published warranty information.

Support Life

Hewlett-Packard offers support services for all products for at least 5 years beyond the end of production. On most test and measurement equipment, support services are available for at least 10 years.

Warranty

As an expression of confidence that our products will continue to meet the high standards of reliability and performance that our customers expect, Hewlett-Packard products carry the following warranty:

HP hardware products are warranted against defects in materials and workmanship. If HP receives notice of such defects during the warranty period, HP shall, at its option, either repair or replace hardware products which prove to be defective.

HP software and firmware products which are designated by HP for use with a hardware product, when properly installed on that hardware product, are warranted not to fail to execute their programming instructions due to defects in materials and workmanship. If HP receives notice of such defects during the warranty period, HP shall repair or replace software media and firmware which do not execute their programming instructions due to such defects. HP does not warrant that the operation of the software, firmware or hardware shall be uninterrupted or error free.

If HP is unable, within a reasonable time, to repair or replace any product to a condition as warranted, Buyer shall be entitled to a refund of the purchase price upon return of the product to HP.

a. **SUPPLEMENTAL STATEMENT:** Supplemental statements setting forth the duration and implementation of warranty and installation are available for most product types. These statements, if applicable to purchased products, are attached hereto and incorporated herein.

b. **DURATION AND COMMENCEMENT OF WARRANTY PERIOD:** The warranty period for each product is specified in the supplemental statement of warranty and installation attached hereto and incorporated herein. The warranty period begins either on the date of shipment or, where the purchase price includes installation by HP, on the date of installation. If Buyer schedules or delays installation more than thirty (30) days after delivery, the warranty period begins on the thirty-first (31st) day from the date of shipment.

c. **PLACE OF PERFORMANCE:** Within HP service travel areas, warranty and installation services for products installed by HP and certain other products designated by HP will be performed at Buyer's facility at no charge. Outside HP's service travel areas, warranty and installation services will be performed at Buyer's facility only upon HP's prior agreement and Buyer shall pay HP's round trip travel expenses and applicable additional expenses for such services.

On-site warranty services are provided only at the initial installation point. If products eligible for on-site warranty and installation services are moved from the initial installation point, the warranty will remain in effect only if Buyer purchases additional inspection or installation services at the new site.

Installation and on-site warranty services are available outside the country of initial purchase only if Buyer pays HP international prices. If Buyer transports a product from the country of initial purchase without having paid HP international prices, any remaining warranty covers just parts and labor and applies only if the product is returned to the country of initial purchase. Warranties requiring return to HP are limited to the country of purchase unless the product is portable (battery powered) or the customer paid HP international prices.

For product warranties requiring return to HP, products must be returned to a service facility designated by HP. Buyer shall prepay shipping charges (and shall pay all duties and taxes) for products returned to HP for warranty service. Except for products returned to Buyer from another country, HP shall pay for return of products to Buyer.

d. **LIMITATION OF WARRANTY:** The foregoing warranty shall not apply to defects resulting from:

1. Improper or inadequate maintenance by Buyer;
2. Buyer-supplied software or interfacing;
3. Unauthorized modification or misuse;
4. Operation outside of the environmental specifications of the product; or

5. Improper site preparation and maintenance.

THE WARRANTY SET FORTH ABOVE IS EXCLUSIVE AND NO OTHER WARRANTY, WHETHER WRITTEN OR ORAL, IS EXPRESSED OR IMPLIED. HP SPECIFICALLY DISCLAIMS THE IMPLIED WARRANTIES OF MERCHANTABILITY AND FITNESS FOR A PARTICULAR PURPOSE.

EXCLUSIVE REMEDIES

The remedies provided herein are Buyer's sole and exclusive remedies. In no event shall HP be liable for direct, indirect, special, incidental or consequential damages (including loss of profits) whether based on contract, tort, or any other legal theory.

Please send directory corrections to:

Test & Measurement Catalog
Hewlett-Packard Company
3200 Hillview Avenue
Palo Alto, CA 94304
Tel: (415) 857-4706
Fax: (415) 857-3880

HEADQUARTERS OFFICES

If there is no sales office listed for your area, contact one of these headquarters offices.

ASIA

Hewlett-Packard Asia Ltd.
22/F Bond Centre, West Tower
89 Queensway, Central
HONG KONG
G.P.O. Box 863, Hong Kong
Tel: 5-8487777
Telex: 76793 HPA HX
Cable: HPASIAL TD

CANADA

Hewlett-Packard (Canada) Ltd.
6877 Goreway Drive
MISSISSAUGA, Ontario L4V 1M8
Tel: (416) 678-9430
Fax: (416) 678-9421

EASTERN EUROPE

Hewlett-Packard Ges.m.b.h.
Lieblgasse 1
P.O. Box 72
A-1222 VIENNA, Austria
Tel: (222) 2500
Telex: 13 4425 HEPA A

NORTHERN EUROPE

Hewlett-Packard S.A.
V. D. Hooplaan 241
P.O. Box 999
NL-118 LN 15 AMSTELVEEN
The Netherlands
Tel: 20 5479999
Telex: 18919 hpnr

SOUTH EAST EUROPE

Hewlett-Packard S.A.
World Trade Center
110 Avenue Louis-Casai
1215 Cointrin, GENEVA, Switzerland
Tel: (022) 98 96 51
Telex: 27225 hpser
Mail Address:
P.O. Box
CH-1217 Meyrin 1
GENEVA
Switzerland

MIDDLE EAST AND CENTRAL AFRICA

Hewlett-Packard S.A.
International Sales Branch
Middle East/Africa
7, rue du Bois-du-Lan
P.O. Box 364
CH-1217 Meyrin 1
GENEVA
Switzerland
Tel: (41/22) 780 7111
Fax: 783 7535

European Operations
Hewlett-Packard S.A.
150, Route du Nant d'Avril
1217 Meyrin 2
GENEVA, Switzerland
Tel: (41/22) 780.8111
Fax: (41/22) 780.8542

UNITED KINGDOM

Hewlett-Packard Ltd.
Nine Mile Ride
WOKINGHAM
Berkshire, RG113LL
Tel: 0344 773100
Fax: (44/344) 763526

UNITED STATES OF AMERICA

Customer Information Center
(800) 752-0900
6:00 AM to 5:00 PM Pacific Time

EASTERN USA

Hewlett-Packard Co.
4 Choke Cherry Road
ROCKVILLE, MD 20850
Tel: (301) 670-4300

MIDWESTERN USA

Hewlett-Packard Co.
5201 Tollview Drive
ROLLING MEADOWS, IL 60008
Tel: (312) 255-9800

SOUTHERN USA

Hewlett-Packard Co.
2015 South Park Place
ATLANTA, GA 30339
Tel: (404) 955-1500

WESTERN USA

Hewlett-Packard Co.
5161 Lankershim Blvd.
NORTH HOLLYWOOD, CA 91601
Tel: (818) 505-5600

OTHER INTERNATIONAL AREAS

Hewlett-Packard Co.
Intercontinental Headquarters
3495 Deer Creek Road
PALO ALTO, CA 94304
Tel: (415) 857-5027
Telex: 034-8300
Cable: HEWPACK

Hewlett-Packard Trading S.A.
Bureau de Liaison/Bureau de Sport
Villa des Lions
9, Hai Galloul
DZ-BORDJ EL BAHRI
Tel: 76 02 07
Fax: 281 0387

ANGOLA

Telectra Angola LDA
Empresa Técnica de Equipamentos
16 rue Cons. Julio de Vilhema
LUANDA
Tel: 35515,35516
Telex: 3134

ARGENTINA

Hewlett-Packard Argentina S.A.
Montaneses 2140/50
1428 **BUENOS AIRES**
Tel: (54/1) 781 4059
(54/1) 781-4090

Laboratorio Rodriguez
Corsawant S.R.L.
Misiones, 1156 - 1876
Bernal, Oeste
BUENOS AIRES
Tel: 252-3958, 252-4991

Argentina Esanco S.R.L.
A/ASCO 3238
1416 **BUENOS AIRES**
Tel: 541-58-1981, 541-59-2767
Telex: 22796 HEW PAC-AR

AUSTRALIA

Customer Information Centre
Tel: (008) 033821

Adelaide, South Australia Office

Hewlett-Packard Australia Ltd.
PARKSIDE, S.A. 5063
153 Greenhill Road
ADELAIDE (Parkside) Sales
Tel: (61-8)-272-5911
Fax: (61/8) 373-1398

Brisbane, Queensland Office

Hewlett-Packard Australia Ltd.
10 Payne Road
THE GAP, Queensland 4061
Tel: 61-7-300-4133
Telex: 42133
Cable: HEWPARD Brisbane

Canberra, Australia Capital Territory Office

Hewlett-Packard Australia Ltd.
Thynne Street, Fern Hill Park
BRUCE, A.C.T. 2617
P.O. Box 257,
JAMISON, A.C.T. 2614
Tel: 61-62-51-6999
Telex: 62650
Cable: HEWPARD Canberra

Melbourne, Victoria Office

Hewlett-Packard Australia Ltd.
31-41 Joseph Street
P.O. Box 221
BLACKBURN, Victoria 3130
Tel: (61/3) 895-2895
Fax: (61/3) 898-7831
Cable: HEWPARD Melbourne

Perth, Western Australia Office

Hewlett-Packard Australia Ltd.
Herdsman Business Park
Cnr. Haster & Gould Strs.
Osborne Park
CLAREMONT, W.A. 6017
Tel: (61/9) 242 1414
Fax: (61/9) 242-1682
Cable: HEWPARD Perth

Sydney, New South Wales Office

Hewlett-Packard Australia Ltd.
17-23 Talavera Road
P.O. Box 308
NORTH RYDE, N.S.W. 2113
Sydney, Australia
Tel: (61/2) 888-4444
Fax: (61/2) 888-9072
Cable: HEWPARD Sydney

AUSTRIA

Hewlett-Packard GmbH
Verkaufsbuero Graz
Grottenhofstrasse 94
A-8052 **GRAZ**
Tel: 43-316-291-5660
Telex: 312375

Hewlett-Packard GmbH
Liebigasse 1
P.O. Box 72
A-1222 VIENNA
Tel: (43/222) 2500
Fax: (48/222) 2500 Ext 444

BAHRAIN

Modern Electronic
Establishment
Hewlett-Packard Division
P.O. Box 22015
RIYADH 11495
SAUDI ARABIA
Tel: (966/1) 4763030
Telex: 595 (0495) 202049

Wael Pharmacy

P.O. Box 648
MANAMA
Tel: 256123
Telex: 8550 Wael BN

BELGIUM

Hewlett-Packard Belgium S.A./N.V.
Blvd de la Woluwe, 100
Woluwedal
1200 **BRUSSELS**
Tel: (32/2) 761.31.11
Fax: (32/2) 763.06.13

BENIN

S.I.T.E.L.
Immeuble le General
Av. General de Gaulle
P.O. Box 161
ABIDJAN 01
Ivory Coast
Tel: 32 12 27
Telex: 22149

BERMUDA

Applied Computer Technologies
Atlantic House Building
P.O. Box HM 2091
Par-La-Ville Road
HAMILTON 5
Tel: 295-1616
Telex: 380 3589/ACT BA

BOLIVIA

Arrellano Ltda
Av. 20 de Octubre #2125
Casilla 1383
LA PAZ
Tel: 368541

Siser Ltda. (Sistemas de
Importacion y Servicios Ltda.)
Gabriel Gozalvez 221
Casilla 4084
LA PAZ
Tel: (591/2) 340962/
363365/343245
Fax: 35-9268

BRAZIL

Hewlett-Packard do Brasil S.A.
Praia de Botafago 228-A-614
6. AND.-CONJ. 601
Edificio Argentina - Ala A
22250 **RIO DE JANEIRO**, RJ
Tel: (55/21) 552-6422
Telex: 21905 HPBR BR
Cable: HEWPACK Rio de Janeiro

BRUNEI

Komputer Wisman Sdn Bhd
G6, Chandrawaseh Cmplx,
Jalan Tutong
P.O. Box 1297,
BANDAR SERI BEGAWAN
NEGARA BRUNI DARUSSALAM
Tel: 673-2-2000-70/26711

BURKINA FASSO

S.I.T.E.L.
Immeuble le General
Avenue General de Gaulle
P.O. Box 161
ABIDJAN 01
Ivory Coast
Tel: 32 12 27
Telex: 22149

CAMEROON

R.T.I.
175 Rue Blomet
75015 **PARIS**
France
Tel: (1) 45 31 0906
Telex: 203376
Fax: (1) 45 31 09 18

CANADA

Alberta
Hewlett-Packard (Canada) Ltd.
3030 3rd Avenue N.E.
CALGARY, Alberta T2A 6T7
Tel: (1/403) 235-3100
Fax: (1/403) 272-2299

Hewlett-Packard (Canada) Ltd.
11120-178th Street
EDMONTON, Alberta T5S 1P2
Tel: (1/403) 486-6666
Fax: (1/403) 489-8764

SALES OFFICES

Arranged alphabetically by country (cont'd)

CANADA (Cont'd)

British Columbia

Hewlett-Packard (Canada) Ltd.
10691 Shellbridge Way
RICHMOND,
British Columbia V6X 2W8
Tel: (1/604) 270-2277
Fax: (1/604) 270-0859

Manitoba

Hewlett-Packard (Canada) Ltd.
1825 Inkster Blvd.
WINNIPEG, Manitoba R2X 1R3
Tel: (204) 694-2777

New Brunswick

Hewlett-Packard (Canada) Ltd.
814 Main Street
MONCTON, New Brunswick E1C 1E6
Tel: (506) 855-2841

Nova Scotia

Hewlett-Packard (Canada) Ltd.
201 Brownlow Avenue
DARTMOUTH, Nova Scotia B3B 1W2
Tel: (1/902) 469-7820
Fax: (1/902) 468-2817

Hewlett-Packard

(Canada) Ltd.
475 Hood Rd., Unit #2
MARKHAM, L3R 8H1
Tel: (416) 479-1770

Ontario

Hewlett-Packard (Canada) Ltd.
552 Newbold Street
LONDON, Ontario N6E 2S5
Tel: (1/519) 686-9181
Fax: (1/519) 686-9145

Hewlett-Packard (Canada) Ltd.

6877 Goreway Drive
MISSISSAUGA, Ontario L4V 1M8
Tel: (1/416) 678-9430
Fax: (1/416) 673-7253

Hewlett-Packard (Canada) Ltd.

2670 Queensview Dr.
OTTAWA, Ontario K2B 8K1
Tel: (1/613) 820-6483
Fax: (1/613) 820-0377

Hewlett-Packard (Canada) Ltd.

3790 Victoria Park Ave.
WILLOWDALE, Ontario M2H 3H7
Tel: (1/416) 499-2550

Quebec

Hewlett-Packard (Canada) Ltd.
17500 Trans Canada Highway
South Service Road
KIRKLAND, Quebec H9J 2X8
Tel: (1/514) 697-4232
Fax: (1/514) 697-6941

Saskatchewan

Hewlett-Packard (Canada) Ltd.
#1, 2175 Airport Rd.
SASKATOON, Saskatchewan S7L 7E1
Tel: (306) 242-3702

CHILE

Ricardo Borzutzky
Avanzados Sistemas de
Conocimientos S. A.
Austria 2041
SANTIAGO
America del Sur
Tel: (562) 223-5946/6148

CHINA, People's Republic of

China Hewlett-Packard Co., Ltd.
22/F Bond Centre, West Tower
89 Queensway, Central
HONG KONG
Tel: (852/5) 8487777
Fax: (852/5) 868 4997

China Hewlett-Packard Co., Ltd.
P.O. Box 9610, Beijing
38 Bei San Huan X1 Road
Shuang Yu Shu, Hai Dian District
BEIJING
Tel: 256-6888
Fax: 256-3207

China Hewlett-Packard Co., Ltd.
23/F Shanghai Union Building
100 Yan An Road
SHANG-HAI
Tel: 203-240
Fax: 202-149

COLOMBIA

Instrumentación
H. A. Langebaek & Kier S.A.
Carrera 4A No. 52A-26
Apartado Aereo 6287
BOGOTA 1, D.E.
Tel: 212-1466
Tel: 44400 INST CO
Cable: AARIS Bogota

CONGO

Sema-Metra
16-18 Rue Barbes
92126 Montrouge Cedex
FRANCE
Tel: (1) 657/300
Telex: 200601 Semetra
Fax: (1) 46 56 96 53

COSTA RICA

Científica Costarricense S.A.
Avenida 2, Calle 5
San Pedro de Montes de Oca
Apartado 10159
SAN JOSÉ
Tel: 9-011-506-243-820
Telex: 3032367 GALGUR CR

Continex S.A.

Avenida 10C
Apartado 746-1000
34-36 **SAN JOSE**
Tel: (506) 33-0933
Telex: 2310 Continex CR
Fax: 21-6905

O. Fischel R. Y. Cia. S.A.
Apartados 434-10174
SAN JOSE
Tel: 23-72-44
Telex: 2379
Cable: OFIR

CYPRUS

Hellamco - M. Cotoyannis
2, Sikelianou St. & Kifissias Av.
P.O. Box 65074
N. Psyhiko 15410
ATHENS
Greece
Tel: 647 79 426, 647 79 427
Telex: 224903

Telerexa Ltd.
P.O. Box 1152
Valentine House
8 Stassandrou St.
NICOSIA
Tel: 45 628, 62 698
Telex: 5845 tlrx cy

DEMSTAR Ltd.

P.O. Box 2260
NICOSIA
Cyprus
Tel: 44 10 64
Telex: 3085
Fax: 46 46 35

DENMARK

Hewlett-Packard A/S
Kongevejen 25
3460 **BIRKEROD**
Tel: (45/42) 816640
Fax: (45/42) 815810

Hewlett-Packard A/S
Rolighedsvej 32
DK-8240 **RISSKOV**, Aarhus
Tel: 45-06-17-6000
Telex: 37409 hpas dk

DOMINICAN REPUBLIC

Microprog S.A.
Juan Tomás Mejía y Cotes No. 60
Arroyo Honda
SANTO DOMINGO
Tel: 565-6268
Telex: 4510 ARENTA DR (RCA)

ECUADOR

CYEDE Cia. Ltda.
Avenida Eloy Alfaro 1749
y Belgica
Casilla 6423 CCI
QUITO
Tel: 9-011-593-2-450975
Telex: 39322548 CYEDE ED

EGYPT

International Engineering Associates
6 El Gamea Street
Agouza
CAIRO
Tel: 71-21-681 348 0904
Telex: 93830 IEA UN
Cable: INTEGASSO

EL SALVADOR

IPESA de El Salvador S.A.
29 Avenida Norte 1223
SAN SALVADOR
Tel: 9-011-503-266-858
Telex: 301 20539 IPESA SAL

ETHIOPIA

R.T.I.
175 rue Blomet
75016 **PARIS**
France
Tel: (1) 45 31 09 06
Telex: 203376
Fax: (1) 45 31 09 18

FINLAND

Hewlett-Packard Finland
Field Oy
Niittyanpolku IO
00620 **HELSINKI**
Tel: (90) 757-1011
Telex: 122022 Field SF

Hewlett-Packard Oy
Piispankallontie 17
02200 **ESPOO**
Tel: (358/0) 88721
Fax: (358/0) 887 2277

Hewlett-Packard Oy
Väinönkatu 9 C
40100 **JYVASKYLÄ**
Tel: (358/41) 21 85 11

Hewlett-Packard Oy
Valtatie 57
90500 **OULU**
Tel: (358/81) 340 144

FRANCE

Hewlett-Packard France
Z.I. Mercure B
Rue Berthelot
13763 Les Milles Cedex
AIX-EN-PROVENCE
Tel: 33-42-59-41-02
Telex: 410770F

Hewlett-Packard France
ZA Kergaradec
Rue Fernand Forest
29239 **GOUEESNOU** (Brest)
Tel: (98) 41-87-90

Hewlett-Packard France
Chemin des Mouilles
Boite Postale 162
69131 **ECULLY** Cedex (Lyon)
Tel: (33) 72-29-32-93
Telex: 310617F

Hewlett-Packard France
Z.I. Mercure B
Rue Berthelot
F-13763 **LES MILLES** Cédex
Aix-en-Provence
Tel: (33/42) 59-41-02
Telex: 410770
Fax: 594872

Hewlett-Packard France
Parc Club des Tanneries
Batiment B4
4, Rue de la Faisanderie
67381 **LINGOLSHEIM** (Strasbourg)
Tel: (88) 76-15-00
Telex: 890141F

Hewlett-Packard France
Parc d'activités Cadéra
Quartier Jean-Mermoz
Avenue du Président JF Kennedy
33700 **MÉRIGNAC** (Bordeaux)
Tel: (33) 56-34-00-84
Telex: 550105F

Hewlett-Packard France
Miniparc-ZIRST
Chemin du Vieux Chêne
38240 **MEYLAN** (Grenoble)
Tel: (76) 90-38-40

Hewlett-Packard France
Ru de l'Hôtellerie
Le Petit Bel Air
44470 **CARQUEFOU** (Nantes)
Tel: 40-30-38-38
Telex: 711085F

Hewlett-Packard France
Parc Tertiaire Héliopolis
Route de Micy
45380 **La CHAPELLE ST MESMIN**
(Orléans)
Tel: 38-43-93-56
Telex: 783 497F

Hewlett-Packard France
Zone Industrielle de Courtaboeuf
1, av. du Canada
91947 **LES ULIS** Cedex (Orsay)
Tel: 69-82-60-60
Telex: 600048F

R.T.I. (Realisations
Telematiques Internationales)
175, rue Blomet
F-75015 **PARIS**
Tel: (33/1) 45310906
Telex: 42/203376

Hewlett-Packard France
Parc d'activités de la Poterie
Rue Louis Kerautel-Botmel
35000 **RENNES**
Tel: 99-51-42-44
Telex: 740912F

Hewlett-Packard France
45, rue des 3 Soeurs
Centre d'Affaires Paris Nord II
F-93420 Villepinte
B.P. 60020
F-95971 **ROISSY**
CHARLES DE GAULLE Cédex
Tel: (33/48) 91-68-00
Telex: 232366
Fax: 632183

Hewlett-Packard France
P.A.T. Lavatine
3, rue Jacques Monod
BP 185
76136 **MONT-ST-AIGNAN** (Rouen)
Tel: 35-59-19-20
Telex: 770035F

Hewlett-Packard France
Innoparc
BP 167 - Voie n°7
31328 **LABEGE** Cedex (Toulouse)
Tel: 61-39-11-40
Telex: 531639F

Hewlett-Packard France
Les Cardoulines
Batiment B2
Route des Dolines
Parc d'activité de Valbonne
Sophia Antipolis
06560 **VALBONNE** (Nice)
Tel: 93-65-39-40

Hewlett-Packard France
Parc d'activité des Prés
1, Rue Papin Cedex
59658 **VILLENEUVE D'ASCO**
Tel: 20-91-41-25
Telex: 160124F

FRENCH WEST INDIES (Antilles)

R.T.I.
175, Rue Blomet
75015 PARIS
FRANCE
Tel: (1) 45 31 09 06
Telex: 203376
Fax: (1) 45 31 09 18

GABON

R.T.I. Cameroon
Distribution/Services
B.P. 3899
DOULA, CAMEROON
(Please contact R.T.I. France.)
Tel: (237) 423291
Telex: 970/5385

R.T.I.
175, rue Blomet
75015 PARIS
France
Tel: (1) 45 31 09 06
Telex: 203376
Fax: (1) 45 31 09 18

GERMAN FEDERAL REPUBLIC

Hewlett-Packard GmbH
Vertriebszentrale Deutschland
Hewlett-Packard-Strasse
Postfach 1641
D-6380 **BAD HOMBURG v.d.H**
Tel: (06172) 400-0
Telex: 410 844 hpbhg

Hewlett-Packard GmbH
Geschäftsstelle
Keithstrasse 2-4
D-1000 **BERLIN 30**
Tel: (030) 21 99 04-0
Telex: 018 3405 hpbln d

Hewlett-Packard GmbH
Verbindungsstelle Bonn
Friedrich-Ebert-Allee 26
5300 **BONN**
Tel: (0228) 234001
Telex: 8869421

Hewlett-Packard GmbH
Vertriebszentrum Südwest
Schickardstrasse 2
D-7030 **BÖBLINGEN**
Postfach 1427
Tel: (49/7031) 645
Fax: (49/7031) 645-429

Hewlett-Packard GmbH
Zentralbereich Mktg
Herrenberger Strasse 130
D-7030 **BÖBLINGEN**
Tel: (49/7031) 14-0
Fax: (49/7031) 14-2999

Hewlett-Packard GmbH
Geschäftsstelle
Schleefstr. 28a
D-4600 **DORTMUND-41**
Tel: (0231) 45001
Telex: 822858 hepdod

Hewlett-Packard GmbH
Reparaturzentrum Frankfurt
Bernier Strasse 117
6000 **FRANKFURT/MAIN 60**
Tel: (069) 500001-0
Telex: 413249 hpffm

Hewlett-Packard GmbH
Vertriebszentrum Nord
Kapstadttring 5
D-2000 **HAMBURG 60**
Tel: 49-40-63-804-0
Telex: 021 63 032 hphh d

Hewlett-Packard GmbH
Geschäftsstelle
Heidering 37-39
D-3000 **HANNOVER 61**
Tel: (49/511) 5706-0
Fax: (49/511) 5706-126

Hewlett-Packard GmbH
Geschäftsstelle
Rosslauer Weg 2-4
D-6800 **MANNHEIM**
Tel: 49-0621-70-05-0
Telex: 0462105 hpmhm

Hewlett-Packard GmbH
Geschäftsstelle
Messerschmittstrasse 7
D-7910 **NEU ULM**
Tel: 49-0731-70-73-0
Telex: 0712816 HP ULM-D

Hewlett-Packard GmbH
Geschäftsstelle
Emmericher Strasse 13
D-8500 **NÜRNBERG 10**
Tel: (0911) 5205-0
Telex: 0623 860 hpnbg

Hewlett-Packard GmbH
Vertriebszentrum Ratingen
Berliner Strasse 111
D-4030 **RATINGEN**
Postfach 31 12
Tel: (02102) 494-0
Telex: 589 070 hprad

Hewlett-Packard GmbH
Vertriebszentrum Muchen
Eschenstrasse 5
D-8028 **TAUFKIRCHEN**
Tel: 49-89-61-2070
Telex: 0524985 hpmch

Hewlett-Packard GmbH
Geschäftsstelle
Ermisallee
7517 **WALDBRONN 2**
Postfach 1251
Tel: (07243) 602-0
Telex: 782 838 hepck

GREAT BRITAIN See United Kingdom

GREECE

Hewlett-Packard Hellas
32, Kiffissias Avenue
15125 Amaroussion
ATHENS
Greece
Tel: 6828811
Telex: 216588 hpat gr
Fax: 6832978

GUATEMALA

IPESA DE GUATEMALA
Avenida Reforma 3-48, Zona 9
GUATEMALA CITY
Tel: 316627, 317853, 66471/5
9-011-502-2-316627
Telex: 3055765 IPESA GU

GUINEA

R.T.I.
175, Rue Blomet
75015 PARIS
France
Tel: (1) 45 31 09 06
Telex: 203376
Fax: (1) 45 31 09 18

HONG KONG

Hewlett-Packard Asia, Ltd.
22/F, West Tower Bond Centre
89 Queensway Central
HONG KONG
Tel: (852/5) 848-7777
Fax: (85215) 868-4997
Cable: HEWPACK HONG KONG

ICELAND

Hewlett-Packard Iceland
Hoefdabakka 9
112 **REYKJAVIK**
Tel: 354-1-67-1000
Telex: 37409
Fax: 354-1-673031

INDIA

Computer products are sold through
Blue Star Ltd. All computer repairs
and maintenance service is done
through Computer Maintenance Corp.

Blue Star Ltd.
B. D. Patel House
Near Sardar Patel Colony
AHMEDABAD 380 014
Tel: 403531, 403532
Telex: 0121-234
Cable: BLUE FROST

Blue Star Ltd.
40/4 Lavelle Road
BANGALORE 560 001
Tel: 57881, 867780
Telex: 0845-430 BSLBIN
Cable: BLUESTAR

Blue Star Ltd.
Sahas
414/2 Vir Savarkar Marg
Prabhadevi
BOMBAY 400 025
Tel: 422-6155
Telex: 011-71193 BSSS IN
Cable: FROSTBLUE

Blue Star Ltd.
Kalyan, 19 Vishwas Colony
Alkapuri, **BARODA, 390 005**
Tel: 65235, 65236
Cable: BLUE STAR

Blue Star Ltd.
7 Hare Street
P.O. Box 506
CALCUTTA 700 001
Tel: 230131, 230132
Telex: 031-61120 BSNF IN
Cable: BLUESTAR

Blue Star Ltd.
13 Community Center
New Friends Colony
NEW DELHI 110 065
Tel: 682547
Telex: 031-2463
Cable: BLUEFROST

Blue Star Ltd.
2-2-47/1108 Bolarum Rd.
SECUNDERABAD 500 003
Tel: 72057, 72058
Telex: 0155-459
Cable: BLUEFROST

Blue Star Ltd.
T.C. 7/603 Poornima
Maruthunkuzhi
TRIVANDRUM 695 013
Tel: 65799, 65820
Telex: 0884-259
Cable: BLUESTAR

Hewlett-Packard India
Meridian Commercial Complex
6th Floor
8 Windsor Place
Janpath
NEW DELHI 110 001
Tel: 91-11384911
Telex: 31-4935 HPNDIN

INDONESIA

BERCA Indonesia P.T.
P.O.Box 496/Jkt.
Jl. Abdul Muis 62
JAKARTA
Tel: 21-373009
Telex: 46748 BERSAL IA
Cable: BERSAL JAKARTA

BERCA Indonesia P.T.
P.O.Box 2497/Jkt
Antara Bldg., 12th Floor
Jl. Medan Merdeka Selatan 17
JAKARTA-PUSAT
Tel: 21-340417
Telex: 46748 BERSAL IA

BERCA Indonesia P.T.
Jalan Kutai 24
SURABAYA
Tel: 67118
Telex: 31146 BERSAL SB
Cable: BERSAL-SURABAYA

IRAQ

Hewlett-Packard Trading S.A.
Service Operation
Al Mansour City 609/10/7
BAGHDAD
Tel: 551-49-73
Telex: 212-455 HEPAIRAQ IK

IRELAND

Hewlett-Packard Ireland Ltd.
Temple House, Temple Road
Blackrock, Co. **DUBLIN**
Tel: (353/1) 883399
Telex: 30439

Hewlett-Packard Ltd.
75 Belfast Rd, Carrickfergus
Belfast BT38 8PH
NORTHERN IRELAND
Tel: 09603-67333
Telex: 747626

ISRAEL

Eidan Electronic Instrument Ltd.
P.O. Box 1270
JERUSALEM 91000
16, Ohaliav St.
JERUSALEM 94467
Tel: 533 221, 553 242
Telex: 25231 AB/PAKRD IL

Computation and Measurement
Systems (CMS) Ltd.
11 Masad Street
67060
TEL-AVIV
Tel: 388 388
Telex: 33569 Motil IL

ITALY

Hewlett-Packard Italiana Spa
Via G. di Vittorio 10
20094 **CORSICO (MI)**
Tel: 02/4408351
Fax: 02/4409964

Hewlett-Packard Italiana Spa
Via Nuova Rivoltana 95
20090 **LIMITO (MI)**
Tel: 02/75761
Fax: 02/7576230

Hewlett-Packard Italiana Spa
Via Emilia 51/C
40011 **ANZOLA**
DELL'EMILIA (BO)
Tel: 051/731061

Hewlett-Packard Italiana Spa
Via M. Ricci 17 - Palombina Nuova
60100 **ANCONA**
Tel: 071/883782

Hewlett-Packard Italiana Spa
Traversa 99C Giulio Petroni 19
70124 **BARI**
Tel: 080/410744
Fax: 080/417891

Hewlett-Packard Italiana Spa
Via Principe Nicola 43G/C
95126 **CATANIA**
Tel: 095/371087
Fax: 095/388569

Hewlett-Packard Italiana Spa
Via G. Di Vittorio 9
20063 **CERNUSCO S/N (MI)**
Tel: 02/923691
Fax: 02/9237746

Hewlett-Packard Italiana Spa
Via Sacco e Vanzetti 1/A
50145 **FIRENZE**
Tel: 055/318533
Fax: 055/373965

Hewlett-Packard Italiana Spa
Viale Brigata Bisagno 2
16129 **GENOVA**
Tel: 010/541141
Fax: 010/591733

Hewlett-Packard Italiana Spa
Via Orazio 16
80122 **NAPOLI**
Tel: 081/7611444
Fax: 081/680164

Hewlett-Packard Italiana Spa
Via Pellizzo 15
35128 **PADOVA**
Tel: 049/8070166
Fax: 049/773097

Hewlett-Packard Italiana Spa
Via Del Tintoretto 200
00144 **ROMA**
Tel: 06/54831
Fax: 06/5408710

SALES OFFICES

Arranged alphabetically by country (cont'd)

ITALY (Cont'd)

Hewlett-Packard Italiana Spa
Corso Svizzera 185
10149 **TORINO**
Tel: 011/744044
Fax: 011/7710815

IVORY COAST

Ste Ivoirienne des Techniques
de l'Informatique
Immeuble C.N.A. - 5e etage
Avenue General de Gaulle
P.O. Box 161

ABIDJAN 01
Tel: 32 12 27
Telex: 22149

Engineering Business Concept (E.B.C.)
Angle Avenue J. Anoma et Bd.
République
08 B.P. 323 **ABIDJAN 08**
Tel: 32 50 24, 41 48 70
Fax: 35 37 90

JAPAN

Yokogawa-Hewlett-Packard Ltd.
Nihon-Seimei Akita
Chuo-Dori Bldg.
4-2-7 Naka-dori
AKITA, 010
Tel: (81/188) 36-5021

Yokogawa-Hewlett-Packard Ltd.
152-1, Onna
ATSUGI, Kanagawa, 243
Tel: (81/462) 25-0031
Fax: (81/462) 25-0064

Yokogawa-Hewlett-Packard Ltd.
3-1 Motochiba-Cho
CHIBA, 280
Tel: (81/472) 25-7701
Fax: (81/472) 21-0382

Yokogawa-Hewlett-Packard Ltd.
Dai-3 Hakata-Kaisei Bldg.
1-3-6 Hakata-eki Minami
Hakata-Ku, **FUKUOKA 812**
Tel: (81/92) 472-8731

Yokogawa-Hewlett-Packard Ltd.
Nihon-Dantai-Seimei-
Koriyama Bldg.
21-10 Toramaru-Cho,
Koriyama **FUKUSHIMA, 963**
Tel: (81/249) 39-7111

Yokogawa-Hewlett-Packard Ltd.
Yasuda-Seimei Hiroshima Bldg.
6-11, Hon-dori, Naka-ku
HIROSHIMA, 730
Tel: (81/82) 241-0611
Fax: (81/82) 241-0619

Yokogawa-Hewlett-Packard Ltd.
Issei Bldg.
2-3-17 Takezono, Tsukuba
IBARAGI, 305

Yokogawa-Hewlett-Packard Ltd.
Mito Mitsui Bldg.
1-4-73, Sanno-maru
Mito, **IBARAKI 310**
Tel: (81/292) 25-7470

Yokogawa-Hewlett-Packard Ltd.
Towa Building 2-2-3
Kaigan-dori, Chuo-ku
KOBE, 650
Tel: (81/78) 392-4791
Fax: (81/78) 392-4839

Yokogawa-Hewlett-Packard Ltd.
Kumagaya Asahi 82 Bldg.
3-4 Tsukuba
KUMAGAYA, Saitama 360
Tel: (81/485) 24-6563
Fax: (81/485) 24-9050

Yokogawa-Hewlett-Packard Ltd.
Shin-Kyoto Center Bldg.
614 Higashi-Shiokoji-cho
Karasuma-Nishi-Iru, Shiokoji-Dori
Shimogyo-Ku, **KYOTO, 600**
Tel: (81/75) 343-0921
Fax: (81/75) 343-4356

Yokogawa-Hewlett-Packard Ltd.
Mito Mitsui Bldg.
1-4-73, Sanno-Maru
MITO, Ibaraki 310
Tel: (81/292) 25-7470
Fax: (81/292) 31-6589

Yokogawa-Hewlett-Packard Ltd.
Nagano-Tokyo-kaijyo Bldg.
1081, Minamiagata-Machi
Nagano-Shi, **NAGANO, 380**
Tel: (81/262) 24-8012
Fax: (81/262) 24-8016

Yokogawa-Hewlett-Packard Ltd.
Nagoya Kokusai Center Building
1-47-1, Nagano, Nakamura-ku
NAGOYA, AICHI 450
Tel: (81/52) 571-5171
Fax: (81/52) 565-0896

Yokogawa-Hewlett-Packard Ltd.
Sai-Kyo-Ren Building
1-2 Dote-cho
OOMIYA-SHI SAITAMA 330
Tel: (0486) 45-8031

Yokogawa-Hewlett-Packard Ltd.
Chuo Bldg., 5-4-20 Nishi-Nakajima
4-20 Nishinakajima, 5 Chome,
Yodogawa-ku
OSAKA, 532
Tel: (81/6) 304-6021
Fax: (81/6) 304-0216

Yokogawa-Hewlett-Packard Ltd.
1-27-15, Yabe
SAGAMIHARA Kanagawa, 229
Tel: (81/427) 59-1311

Yokogawa-Hewlett-Packard Ltd.
Hamamtsu Motohiro-Cho Daichi
Seimei Bldg 219-21, Motohiro-Cho
Hamamatsu-shi
SHIZUOKA, 430
Tel: (81/534) 56-1771
Fax: (81/534) 552371

Yokogawa-Hewlett-Packard Ltd.
Shinjuku Daiichi Seimei Bldg.
Nishi Shinjuku 2-7-1,
Shinjuku-ku, **TOKYO 163**
Tel: (81/3) 348-4611
Fax: (81/3) 348-7969

Yokogawa-Hewlett-Packard Ltd.
9-1, Takakura-cho
Hachioji-shi, **TOKYO, 192**
Tel: 81-426-42-1231

Yokogawa-Hewlett-Packard Ltd.
Tokyo-Nissam-Minato Bldg.
1-6-34 Konan, Minato-Ku
TOKYO 108
Tel: (81/3) 458-5411

Yokogawa-Hewlett-Packard Ltd.
29-21 Takaido-Higashi, 3-chome
Suginami-ku **TOKYO 168**
Tel: (03) 331-6111
Telex: 232-2024 YHPTOK

Yokogawa Hokushin Electric Corp.
(YEW)
Shinjuku-NS Bldg. 10F
9-32 Nokacho 2 Chome
Shinjuku-ku
TOKYO, 163
Tel: (03) 349-1859
Telex: J27584

Yokogawa-Hewlett-Packard Ltd.
Toyoda-Tokyo-Kaijo Bldg.
1-179 Miyuki-Hon-Cho
TOYODA 473
Tel: (81/565) 27-5611

Yokogawa-Hewlett-Packard Ltd.
Chiyodaseimei-Utsunomiya Bldg.
2-3-1, Ohdori, **UTSUNOMIYA**, Tochigi-
Shi 320
Tel: (81/286) 33-1153
Fax: (81/286) 33-1175

Yokogawa-Hewlett-Packard Ltd.
No. 2 Yasuda Bldg.
2-32-12, Tsuruyo-cho
Kanagawa-ku, **YOKOHAMA 221**
Tel: (81/45) 312-1252
Fax: (81/45) 311-8328

KENYA

ADCOM Ltd., Inc., Kenya
P.O. Box 30070
NAIROBI
Tel: 331955
Telex: 22639

KOREA

Samsung Hewlett-Packard Co. Ltd.
Dongbang Yeoeuido Building
36-1 Yeoeui Do-Dong
Youngdeungpo-Ku
SEOUL, 150
Tel: (82/2) 784-4666, 784-2666
Fax: (82/2) 784-7084
Telex: 25166 SAMSAN K

KUWAIT

Al-Khaldiya Trading & Contracting
P.O. Box 830
SAFAT 13009
Tel: 242 49 10, 241 17 26
Telex: 22481 AREEG KT
Cable: VISCOUNT

LEBANON

Computer Information Systems S.A.L.
Chammas Building
P.O. Box 11-6274
DORA BEIRUT
Tel: 89 31 13, 58 18 35
Telex: 42309 chaxis le
Fax: 58 18 34

LUXEMBOURG

Hewlett-Packard Belgium S.A./N.V.
Blvd de la Woluwe, 100
Woluwedal
B-1200 BRUSSELS
Tel: (32/2) 761-3111
Telex: 23-494 paloben bru

MADAGASCAR

R.T.I.
175, Rue Blomet
75015 Paris
FRANCE
Tel: (1) 45 31 09 06
Tlx: 203376
Fax: (1) 45 31 09 18

MALAWI

Systron (Private) Ltd.
Manhattan Court
61 Second Street
P.O. Box 3458
HARARE
Zimbabwe
Tel: 739881/739885
Telex: 4122
Fax: 70 20 08

MALAYSIA

Hewlett-Packard Sales (Malaysia)
Sdn. Bhd.
9th Floor
Chung Khaiw Bank Building
46, Jalan Raja Laut
50350 **KUALA LUMPUR, MALAYSIA**
Tel: (60/3) 298-6555
Fax: (60/3) 291-5495
Protel Engineering
P.O. Box 1917
Lot 6624, Section 64
23/4 Pending Road
Kuching, **SARAWAK**
Tel: 36299
Telex: 70904 PROMAL MA
Cable: PROTELENG

MALTA

R.T.I.
175, Rue Blomet
75015 **PARIS**
France
Tel: (1) 45 31 09 06
Telex: 203376
Fax: (1) 45 31 09 18

MAURITANIA

R.T.I.
175, Rue Blomet
75015 **PARIS**
France
Tel: (1) 45 31 09 06
Tlx: 203376
Fax: (1) 45 31 09 18

MAURITIUS

R.T.I.
175, Rue Blomet
75015 **PARIS**
France
Tel: (1) 45 31 09 06
Telex: 203376
Fax: (1) 45 31 09 18

MEXICO

Hewlett-Packard de Mexico,
S.A. de C.V.
Rio Nio No. 4049 Desp. 12
Cordoba
JUAREZ, Mexico
Tel: 161-3-15-62

Hewlett-Packard de Mexico,
S.A. de C.V.
Condominio Kadereyta
Circuito del Mezon No. 186 Desp. 6
Col. Del Prado - 76030
QRO, Mexico
Tel: 463-6-02-71

Hewlett-Packard de Mexico,
S.A. de C.V.
Fraccionamiento Loma Bonita 45060
GUADALAJARA, Jalisco
Tel: (52/36) 31 46 00
Telex: 0684 186 ECOMEX

Hewlett-Packard de Mexico,
S.A. de C.V.
Monte Pelvoux No. 111
Lomas de Chapultepec
11000 **MEXICO, D.F.**
Tel: (52/5) 596 79 33
Fax: (52/5) 596 42 08 (Ext 3231)

Hewlett-Packard de Mexico,
S.A. de C.V.
Czda. del Valle
409 Ote. 4th Piso
Colonia del Valle
Municipio de Garcia
66220 **NUEVO LEON**
Tel: 83-78-42-40
Telex: 382410 HPMY

Hewlett-Packard Co.
Latin America Region
Customer Support Center
7208 N.W. 31st St.
MIAMI, FL 33122
United States
Tel: (305) 599-0465
Telex: 441603 HPMIAMI
Fax: 599-0277

Hewlett-Packard de Mexico,
S.A. de C.V.
Blvd. Independencia No. 2000 Ote.
Ote Zerpiso
Co 1 Estrella
27010 **TORREON, COA.**
Tel: (52/171) 8 22 01

MOROCCO

Sicotel
Complexe des Habous
Tour C, avenue des Far
CASABLANCA 01
Tel: 31 22 70
Telex: 27604

R.T.I.
175, Rue Blomet
75015 **PARIS**
France
Tel: (1) 45 31 09 06
Tlx: 203376
Fax: (1) 45 31 09 18

Socofren Maroc
164, Boulevard D' Anfa
CASABLANCA
Tel: 36 08 84, 36 01 77
Telex: 23940

NETHERLANDS

Hewlett-Packard Nederland
Startbaan 16
1187 XR **AMSTELVEEN**
Tel: (31/20) 5476911
Telex: 13 216 HEPANL
Fax: (31/20) 471825

Hewlett-Packard Nederland B.V.
Bongerd 2
NL 2900AA **CAPELLE A/D IJSSEL**
Tel: 31-20-51-6444
Telex: 21261 HEPAC NL

Hewlett-Packard Nederland B.V.
Pastoor Petersstraat 134-136
P.O. Box 2342
NL 5600 CH **EINDHOVEN**
Tel: 31-40-32-6911
Telex: 51484 hepae nl
Fax: (31/40) 446546

NEW ZEALAND

Hewlett-Packard (N.Z.) Ltd.
5 Owens Road
P.O. Box 26-189
Epsom, **AUCKLAND**
Tel: (64/9) 605-651
Fax: (64/9) 600-507

Hewlett-Packard (N.Z.) Ltd.
186-190 Willis Street
P.O. Box 9443
WELLINGTON
Tel: (64/4) 820-400
Fax: (64/4) 843-380

NIGER

S.I.T.E.L.
Immeuble le General
Avenue General de Gaulle
PO Box 161
ABIDJAN 01
Ivory Coast
Tel: 32 12 27
Telex: 22 149

NIGERIA

Management Information Systems Ltd.
3 Gerrard Road, Ikoyi
LAGOS
Tel: 68 08 87
Telex: 23582
Fax: 68 54 87

NORTHERN IRELAND

See United Kingdom

NORWAY

Hewlett-Packard Norway A/S
Oesterdalen 16-18
P.O. Box 34
N-1345 **OEËTERAAS**
Tel: (47/2) 24-6090
Telex: 76621 HPNAS N

Hewlett-Packard Norway A/S
Boemergt. 42
Box 2470
N-5037 **SOLHEIMSVIK**
Tel: (5/29) 10 72

OMAN

Suhail & Saud Bahwan
P.O.Box 169
MUSCAT/SULTANATE OF OMAN
Tel: 79 37 41
Telex: 3585 mb
Fax: 79 61 58

Imtac LLC
P.O. Box 9196
MINA AL FAHAL/SULTANATE OF OMAN
Tel: 70-77-27, 70-77-23
Telex: 3865 Tawoos On

PAKISTAN

Mushko & Company Ltd.
House No. 16, Street No. 16
Sector F-6/3
ISLAMABAD
Tel: 824545
Telex: 54001 Muski Pk
Cable: FEMUS Islamabad

Mushko & Company Ltd.
Oosman Chambers
Abdullah Haroon Road
KARACHI 0302
Tel: 524131, 524132
Telex: 2894 MUSKO PK
Cable: COOPERATOR Karachi

PANAMA

Electronico Balboa, S.A.
Calle Samuel Lewis, Ed. Alfa
Apartado 4929
PANAMA CITY
Tel: 9-011-507-636613
Telex: 368 3483 ELECTRON PG

PERU

Cia Electro Médica S.A. (ERMED)
Los Flamencos 145, Ofc. 301/2
San Isidro
Casilla 1030
LIMA 1 Peru
Tel: 9-011-511-4-414325, 41-3705
Telex: 39425257 PE PB SIS

PHILIPPINES

The Online Advanced Systems Corp.
2nd Floor, Electra House
115-117 Esteban Street
P.O. Box 1510
Legaspi Village, Makati
Metro **MANILA**
Tel: 815-38-10 (up to 16)
Telex: 63274 ONLINE PN

PORTUGAL

Mundinter Intercambio
Mundial de Comercio
Avenida Antonio 2761
LISBON
Tel: 53 21 31, 53 21 37
Telex: 16691

CPC Instrumentacao
Torre de Santo Antonio
rue Gregorio Lopes, Lote
Restelo
1400 **LISBON**
Tel: 617343/44/45/46
Telex: 27432/26054
Fax: 617345

C.P.C.S.I.
Rua de Costa Cabral 575
4200 **PORTO**
Tel: 493122
Telex: 26054, 27432
Fax: 48 87 21

PUERTO RICO

Hewlett-Packard Puerto Rico
Box 4048
Aguadilla, PR 00605
Tel: (809) 891-5235

Hewlett-Packard Puerto Rico
101 Munoz Rivera Avenue
Esu. Calle Ochoa
HATO REY, 00918
Tel: (809) 754-7800

QATAR

Qatar Datamation Systems
P.O. Box 350
DOHA
Tel: 41 32 82
Tlx: 4833
Fax: 42 63 78

REUNION ISLAND

R.T.I.
175, Rue Blomet
75015 **PARIS**
France
Tel: (33/1) 45310906
Telex: 42/203376

RWANDA

R.T.I.
175, Rue Blomet
75015 **PARIS**
France
Tel: (33/1) 45310906
Telex: 42/203376
Fax: (1) 45 31 09 18

SAUDI ARABIA

Modern Electronics Establishment
P.O. Box 281
Thuobah
AL-KHOBAR 31952
Tel: 895-1760, 895-1764
Telex: 671 106 HPMEEK SJ
Cable: ELECTA AL-KHOBAR

Modern Electronics Establishment
P.O. Box 1228
Redec Plaza, 6th Floor
JEDDAH
Tel: 644 96 28
Telex: 4027 12 FARNAS SJ
Cable: ELECTA JEDDAH

Modern Electronics Establishment
P.O. Box 22015
RIYADH 11495
Tel: 4763030
Telex: 402040 MEERYD SJ

SCOTLAND

See United Kingdom

SENEGAL

2SC
10, rue Tolbiac
B.P. 3716
DAKAR R.P.
(Please contact R.T.I. France.)
Tel: (221) 222248
Telex: 906/671

R.T.I.
175, Rue Blomet
75015 **PARIS**
France
Tel: 45310906
Telex: 203376
Fax: (1) 45 31 09 18

SINGAPORE

Hewlett-Packard Singapore Ltd.
1150 Depot Road
SINGAPORE, 0410
Tel: (65) 273 7388
Fax: (65) 278 8990

SOUTH AFRICA

Hi Performance Systems (Pty.) Ltd.
P.O. Box 120, Howard Place
CAPE TOWN 7450
Tel: (27/21) 53-7954
Fax: (27/21) 53-5119

Hi Performance Systems (Pty.) Ltd.
Private Bag Wendywood

SANDTON 2144
Tel: (27/11) 802-5111
Fax: (27/11) 802-6332

SPAIN

Hewlett-Packard Española, S.A.
Avda. Diagonal, 605
08028-**BARCELONA**
Tel: (34/3) 401 91 00
Telex: 52603 hpbee

Bilbao (Vizcaya) Sales
Hewlett-Packard Español, S.A.
Avda. Zugazarte, 8
48930 - Las Arenas - **VIZCAYA**

Hewlett-Packard Española, S.A.
Crta. N-VI, Km. 16, 500
Las Rozas
E-MADRID
Tel: (34/1) 6370011
Telex: 23515 HPE

Hewlett-Packard Española, S.A.
Avda. S. Francisco Javier, S/N
Planta 10. Edificio Sevilla 2
E-SEVILLA 5, SPAIN
Tel: (34/54/64) 4454
Telex: 72933

Hewlett-Packard Española, S.A.
Isabel La Catolica, 8
46004 **VALENCIA**
Tel: (34/6) 351 59 44
Telex: 63435
Fax: (34/6) 351 59 44

Hewlett-Packard Española, S.A.
Avda. de Zugazarte, 8
48930 - Las Arenas
VIZCAYA
Tel: (34/4) 464 32 55
Telex: 33032

SUDAN

Mediterranean Engineering &
Trading Co., Ltd.
P.O. Box 1025
KHARTOUM
Tel: (249) 41184
Telex: 24052

R.T.I.
175, Rue Blomet
75015 **PARIS**
France
Tel: (1) 45 31 09 06
Tlx: 203376
Fax: (1) 45 31 09 18

SWEDEN

Hewlett-Packard Sverige AB
Östra Tullgatan 3
20011 **MALMÖ**
Box 6132
Tel: (46/40) 702 70
Telex: (854) 17886 (via Spånga office)
Fax: (46/40) 97 74 18

Hewlett-Packard Sverige AB
Elementvagen 16
S-7022 7 **ÖREBRO**
Tel: (49/19) 10 48 80
Telex: (854) 17886 (via Spånga office)

Hewlett-Packard Sverige AB
Skalholtsgatan 9, Kista
P.O. Box 19
S-16493 **KISTA**
Tel: 46/8/750-200
Telex: (854) 17886
Telefax: (08) 7527781

Hewlett-Packard Sverige AB
Box 266
Topasgatan 1A
S-42123 **VÄSTRA-FRÖLUNDA**
(Gothenburg)
Tel: (031) 891000
Telex: (854) 17886 (via Spånga office)

SWITZERLAND

Hewlett-Packard (Schweiz) AG
Clarastrasse 12
CH-4058 **BASEL**
Tel: (41/61) 681 59 20
Fax: (41/61) 681 98 59

Hewlett-Packard (Schweiz) AG
7, rue du Bois-du-Lan
Case postale 365-1366
CH-1217 **MEYRIN 1**
Tel: (41/22) 7804111
Telex: 27333 HPAG CH

Hewlett-Packard (Schweiz) AG
Allmend
CH-8967 **WIDEN**
Tel: (41/57) 321 111
Telex: 53933 HPAG CH
Fax: (41/57) 321 475

SYRIA

Middle East Electronics
P.O.Box 2308
Abu Rumaneh
DAMASCUS
Tel: 33 45 92
Telex: 411 771 Meesy

TAIWAN

Hewlett-Packard Taiwan Ltd.
Taipei Office
8th Floor, Hewlett-Packard Building
337 Fu Hsing North Road
TAIPEI
Tel: (02) 712-0404
Telex: 24439 HEWPACK
Cable: HEWPACK Taipei

Hewlett-Packard Taiwan Ltd.
THM Office
2, Huan Nan Road
CHUNG LI, Taoyuan
Tel: (034) 929-666

SALES OFFICES

Arranged alphabetically by country (cont'd)

TAIWAN (Cont'd)

Hewlett-Packard Taiwan Ltd.
Taichung Office
5FL, 67, Sec. 3,
Wen-Hsin Road,
TAICHUNG
Tel: (04) 254-1201

Hewlett-Packard Taiwan Ltd.
Kaohsiung Office
11/F, 456, Chung Hsiao 1st Road
KAOHSIUNG
Tel: (07) 2412318

TANZANIA

Adcom Ltd, Inc. Kenya
P.O. Box 30070

NAIROBI

Kenya
Tel: 33 19 55
Telex: 22639

THAILAND

Unimesa Co. Ltd.
2540 Sukumvit Avenue
Bangna

BANGKOK 10260

Tel: 662-398-6953
Telex: 84439 Simonco TH
Cable: UNIMESA Bangkok

TOGO

S.I.T.E.L.

Immeuble le General
Avenue General de Gaulle
P.O. Box 161
ABIDJAN 01
Ivory Coast
Tel: 32 12 27
Telex: 22149

Societe Africaine De Promotion
Immeuble Sageb
Rue d'Atakpame
P.O. Box 4150
LOME
Tel: 21-62-88
Telex: 5357

TRINIDAD & TOBAGO

Caribbean Telecoms Ltd.
Corner McAllister Street &
Eastern Main Road, Laventille
P.O. Box 732
PORT-OF-SPAUN
Tel: 624-4213
Telex: 22561 CARTEL WG
Cable: CARTEL, PORT OF SPAUN

Computer and Controls Ltd.
P.O. Box 51
1 Taylor Street
PORT-OF-SPAUN
Tel: (809) 622-7719/622-7985
Telex: 38722798 COMCON WG
LOGOO AGENCY 1264

TUNISIA

Precision Electronique
5, rue de Chypre
Mutuelleville
1002 TUNIS BELVEDERE
Tunisia
Tel: 78 50 37
Tlx: 13238

TURKEY

E.M.A.
Mediha Eldem Sokak No. 41/6
Yenisehir
ANKARA
Tel: 131 4695, 131 9175
Telex: 46912n emsetr
Cable: EMATRADE ANKARA

Hewlett-Packard Bilgisayar Ve Olcum
Sistemleri A.S. (Headquarter)
Mesrutiyet Mah. 19 Mayıs Cad.
Nova-Baran Plaza Kat: 11-12
SISLI / ISTANBUL
Tel: 175 29 70
Telex: 39150
Fax: 175 29 92

Hewlett-Packard Bilgisayar Ve Olcum
Sistemleri A.S.
Paris Caddesi No 3
Diare 9
06670 **ANKARA**
Tel: 125 83 13
Telex: 46180
Fax: 125 47 45

UGANDA

Adcom Ltd, Inc. Kenya
P O Box 30070
NAIROBI
Kenya
Tel: 33 19 55
Telex: 22639

UNITED ARAB EMIRATES

Emitac Ltd.
P.O. Box 1641
SHARJAH
Tel: 591181
Telex: 48710 EMITAC EM
Cable: EMITAC SHARJAH

Emitac Ltd.
P.O. Box 2711
ABU DHABI
Tel: 820419-20
Cable: EMITACH ABUDHABI

Emitac Ltd.
P.O. Box 8391
DUBAI,
Tel: 377591

Emitac Ltd.
P.O. Box 473
RAS AL KHAIMAH
Tel: 28133, 21270

UNITED KINGDOM**ENGLAND**

Hewlett-Packard Ltd.
Customer Information Centre
King St. Lane
Winnersh, Wokingham
GB-BERKSHIRE RG11 5AR
Tel: (44/734) 784774
Telex: 847178
Fax: 777285

Hewlett-Packard Ltd.
Miller House
The Ring, **BRACKNELL**
Berkshire RG12 1XN
Tel: (44/344) 424-898
Fax: (44/344) 860015, Ext 56023

Hewlett-Packard Ltd.
Customer Sales & Support
Building 1, Filton Road
Stoke Gifford
BRISTOL, BS12 6QZ
Tel: (44/272) 236000

Hewlett-Packard Ltd.
Oakfield House, Oakfield Grove
Clifton **BRISTOL, Avon BS8 2BN**
Tel: 44-272-736 806
Telex: 444302

Hewlett-Packard Ltd.
9 Bridewell Place
LONDON EC4V 6BS
Tel: (44/583) 6565
Fax: (44/583) 6565, Ext 4713

Hewlett-Packard Ltd.
Heathside Park Rd.
Cheadle Heath, Stockport
GB-MANCHESTER SK3 ORB
Tel: (44/61) 428-0828
Telex: 668068
Fax: 4955009

Hewlett-Packard Ltd.
Harman House
No. 1 George St.
Uxbridge,
GB-MIDDLESEX UB8 1YH
Tel: (44/895) 72020
Telex: 893135
Fax: 73684

Hewlett-Packard Ltd.
Pontefract Road
NORMANTON,
West Yorkshire WF6 1RN
Tel: (44/924) 895-566
Fax: (44/924) 896-691
Telex: 557355

Hewlett-Packard Ltd.
The Quadrangle
106-118 Station Road
REDHILL, Surrey RH1 1PS
Tel: 44-737-686-55
Telex: 947234

Hewlett-Packard Ltd.
Avon House
435 Stratford Road
Shirley, **SOLIHULL, West Midlands**
B90 4BL
Tel: 44-21-745-8800
Telex: 339105

Hewlett-Packard Ltd.
Heathside Park Road
Cheadle Heath, Stockport
Cheshire SK3 ORB
Tel: (44/61) 428-0828
Fax: (44/61) 495-5009
Telex: 668068

Hewlett-Packard Ltd.
Harman House
No. 1 George Street
UXBRIDGE, Middlesex UB8 1YH
Tel: (44/895) 72020
Fax: (44/895) 73684

Hewlett-Packard Ltd.
King Street Lane
Winnersh, **WOKINGHAM**
Berkshire RG11 5AR
Tel: (44/734) 784774
Fax: (44/734) 777285 Ext 52285

NORTHERN IRELAND

Hewlett-Packard (Ireland) Ltd.
Carrickfergus Industrial Centre
75 Belfast Road, Carrickfergus
CO. ANTRIM BT38 8PM
Tel: 09603 67333

Unit 5
Bridgewood House
Newforge Lane
Malone Road
BELFAST BT95 NW
Tel: (353/232) 664-851
Fax: (353/232) 665-619

SCOTLAND

Hewlett-Packard Ltd.
1/3 Springburn Place
College Milton North
EAST KILBRIDE, G74 5NU
Tel: 035-52-49261
Fax: 03552-35929
Telex: 779615

Hewlett-Packard Ltd.
SOUTH QUEENSFERRY
West Lothian, EH30 9TG
Tel: 031-331-1188
Fax: 031-331-7412

UNITED STATES

Hewlett-Packard Co.
Customer Information Center
Tel: (800) 752-0900
Hours: 6:00 AM to 5:00 PM
Pacific Time

Alabama

Hewlett-Packard Co.
2100 Riverchase Center
Building 100 - Suite 118
BIRMINGHAM, AL 35244
Tel: (205) 988-0547
Fax: (205) 988-5308

Hewlett-Packard Co.
620 Discovery Dr.
HUNTSVILLE, AL 35806
Tel: (205) 830-2000
Fax: (205) 830-1427

Alaska

Hewlett-Packard Co.
4000 Old Seward Highway
Suite 101
ANCHORAGE, AK 99503
Tel: (907) 563-8855
Fax: (907) 561-7409

Arizona

Hewlett-Packard Co.
8080 Pointe Parkway West
PHOENIX, AZ 85044
Tel: (602) 273-8000
Fax: (602) 273-8080

Hewlett-Packard Co.
3400 East Britannia Dr.
Bldg. C, Suite 124
TUCSON, AZ 85706
Tel: (602) 573-7400
Fax: (602) 573-7429

Arkansas

Hewlett-Packard Co.
10816 Executive Center Dr
Conway Bldg. Suite 116
LITTLE ROCK, AR 72211
Tel: (501) 225-7178
Fax: (501) 221-3614

California

Hewlett-Packard Co.
26701 W. Argoura Rd.
CALABASAS, CA 91302
Tel: (818) 880-3400
Fax: (818) 880-3437

Hewlett-Packard Co.
353 Lakeside Dr
FOSTER CITY, CA 94404
Tel: (415) 378-8400
Fax: (415) 378-8405

Hewlett-Packard Co.
1907 North Gateway Blvd.
FRESNO, CA 93727
Tel: (209) 252-9652
Fax: (209) 456-9302

Hewlett-Packard Co.
1421 S. Manhattan Av.
FULLERTON, CA 92631
Tel: (714) 999-6700
Fax: (714) 778-3033

Hewlett-Packard Co.
7408 Hollister Ave. #A
GOLETA, CA 93117
Tel: (805) 685-6100
Fax: (805) 685-6163

Hewlett-Packard Co.
9800 Muirlando Ave.
IRVINE, CA 92718
Tel: (714) 472-3000
Fax: (714) 581-3607 (Direct Dial only)

Hewlett-Packard Co.
2525 Grand Avenue
LONG BEACH, CA 90815
Tel: (213) 498-1111
Fax: (213) 494-1986

Hewlett-Packard Co.
5651 West Manchester Ave.
LOS ANGELES, CA 90045
Tel: (213) 337-8000
Fax: (213) 337-8338

Hewlett-Packard Co.
321 E. Evelyn Ave.
Bldg. 330
MOUNTAIN VIEW, CA 94039
Tel: (415) 694-2000
Fax: (415) 694-0600

Hewlett-Packard Co.
5161 Lankershim Blvd.
NORTH HOLLYWOOD, CA 91601
Tel: (818) 505-5600
Fax: (818) 505-5875

Hewlett-Packard Co.
5725 W. Las Positas Blvd.
PLEASANTON, CA 94566
Tel: (415) 460-0282
Fax: (415) 460-0713

Hewlett-Packard Co.
4244 So. Market Court, Suite A
SACRAMENTO, CA 95834
Tel: (916) 929-7222
Fax: (916) 927-7152

Hewlett-Packard Co.
9606 Aero Drive
SAN DIEGO, CA 92123
Tel: (619) 279-3200
Fax: (619) 268-8487

Hewlett-Packard Co.
50 Fremont St. Suite 200
SAN FRANCISCO, CA 94105
Tel: (415) 882-6800
Fax: (415) 882-6805

Hewlett-Packard Co.
3003 Scott Boulevard
SANTA CLARA, CA 95054
Tel: (408) 988-7000
Fax: (408) 988-7103

Hewlett-Packard Co.
5280 Valentine Rd. Suite 205
VENTURA, CA 93003
Tel: (805) 658-6898
Fax: (805) 650-0721

Colorado
Hewlett-Packard Co.
2945 Center Green Court South
Suite A
BOULDER, CO 80301
Tel: (303) 938-3065
Fax: (303) 938-3025

Hewlett-Packard Co.
24 Inverness Place, East
ENGLEWOOD, CO 80112
Tel: (303) 649-5000
Fax: (303) 649-5787

Connecticut
Hewlett-Packard Co.
3 Parkland Dr.
DARIEN, CT 06820
Tel: (203) 656-0040
Fax: (203) 656-5563

Hewlett-Packard Co.
115 Glastonbury Blvd
GLASTONBURY, CT 06033
Tel: (203) 633-8100
Fax: (203) 659-6087

Florida
Hewlett-Packard Co.
5900 N. Andrews, Suite 100
FORT LAUDERDALE, FL 33309
Tel: (305) 938-9800
Fax: (305) 938-2293

Hewlett-Packard Co.
6800 South Point Parkway
Suite 301
JACKSONVILLE, FL 32216
Tel: (904) 636-9955
Fax: (904) 636-9955

Hewlett-Packard Co.
255 East Drive, Suite B
MELBOURNE, FL 32901
Tel: (407) 729-0704
Fax: (407) 723-4557

Hewlett-Packard Co.
6177 Lake Ellenor Drive
ORLANDO, FL 32809
Tel: (407) 859-2900
Fax: (407) 826-9309

Hewlett-Packard Co.
4700 Bayou Blvd.
Building 5
PENSACOLA, FL 32503
Tel: (904) 476-8422
Fax: (904) 476-4116

Hewlett-Packard Co.
5550 Idlewild, #150
TAMPA, FL 33634
Tel: (813) 884-3282
Fax: (813) 889-4445

Georgia
Hewlett-Packard Co.
2015 South Park Place
ATLANTA, GA 30339
Tel: (404) 955-1500
Fax: (404) 980-7669

Hewlett-Packard Co.
3607 Parkway Lane
Suite 300
NORCROSS, GA 30092
Tel: (404) 448-1894
Fax: (404) 246-5206

Hawaii
Hewlett-Packard Co.
Pacific Tower
1001 Bishop St.
Suite 2400
HONOLULU, HI 96813
Tel: (808) 526-1555
Fax: (808) 536-7873

Idaho
Hewlett-Packard Co.
11309 Chinden Blvd.
BOISE, ID 83714
Tel: (208) 323-2700
Fax: (208) 323-2528

Illinois
Hewlett-Packard Co.
2205 E. Empire St.
BLOOMINGTON, IL 61704
Tel: (309) 662-9411
Fax: (309) 662-0351

Hewlett-Packard Co.
525 W. Monroe St., Suite 1308
CHICAGO, IL 60606
Tel: (312) 930-0010
Fax: (312) 930-0986

Hewlett-Packard Co.
1200 East Diehl Road
NAPERVILLE, IL 60566
Tel: (312) 357-8800
Fax: (312) 357-9896

Hewlett-Packard Co.
5201 Tolview Drive
ROLLING MEADOWS, IL 60008
Tel: (312) 255-9800
Fax: (312) 259-5878

Indiana
Hewlett-Packard Co.
11911 N. Meridian St.
CARMEL, IN 46032
Tel: (317) 844-4100
Fax: (317) 843-1291

Hewlett-Packard Co.
111 E. Ludwig Road
Suite 108
FT. WAYNE, IN 46825
Tel: (219) 482-4283
Fax: (219) 482-9907

Iowa
Hewlett-Packard Co.
4050 River Center Court
CEDAR RAPIDS, IA 52402
Tel: (319) 393-0606
Fax: (319) 378-1024

Hewlett-Packard Co.
4201 Corporate Dr.
WEST DES MOINES, IA 50265
Tel: (515) 224-1435
Fax: (515) 224-1870

Kansas
Hewlett-Packard Co.
North Rock Business Park
3450 N. Rock Rd.
Suite 300
WICHITA, KS 67226
Tel: (316) 636-4040
Fax: (316) 636-4504

Kentucky
Hewlett-Packard Co.
305 N. Hurstbourne Lane,
Suite 100
LOUISVILLE, KY 40222
Tel: (502) 426-0100
Fax: (502) 426-0322

Louisiana
Hewlett-Packard Co.
160 James Drive East
ST. ROSE, LA 70087
Tel: (504) 467-4100
Fax: (504) 467-4100 x 291

Maryland
Hewlett-Packard Co.
3701 Koppers Street
BALTIMORE, MD 21227
Tel: (301) 644-5800
Fax: (301) 362-7650

Hewlett-Packard Co.
2 Choke Cherry Road
ROCKVILLE, MD 20850
Tel: (301) 948-6370
Fax: (301) 948-5986

Massachusetts
Hewlett-Packard Co.
1775 Minuteman Road
ANDOVER, MA 01810
Tel: (508) 682-1500
Fax: (508) 794-2619

Hewlett-Packard Co.
29 Burlington Mall Rd.
BURLINGTON, MA 01803-4514
Tel: (617) 270-7000
Fax: (617) 221-5240

Michigan
Hewlett-Packard Co.
3033 Orchard Vista S.E.
GRAND RAPIDS, MI 49546
Tel: (616) 957-1970
Fax: (616) 956-9022

Hewlett-Packard Co.
39550 Orchard Hill Place Drive
NOVI, MI 48050
Tel: (313) 349-9200
Fax: (313) 349-9240

Hewlett-Packard Co.
560 Kirks Rd.
Suite 101
TROY, MI 48064
Tel: (313) 362-5180
Fax: (313) 362-3028

Minnesota
Hewlett-Packard Co.
2025 W. Larpenteur Ave.
ST. PAUL, MN 55113
Tel: (612) 644-1100
Fax: (612) 641-9787

Mississippi
Hewlett-Packard Co.
800 Woodland Parkway, Suite 101
RIDGELAND, MS 39157
Tel: (601) 957-0730
Fax: (601) 957-2515

Missouri
Hewlett-Packard Co.
13001 Hollenberg Drive
BRIDGETON 63044
Tel: (314) 344-5100
Fax: (314) 344-5273

Hewlett-Packard Co.
6601 Winchester Ave.
KANSAS CITY, MO 64133
Tel: (816) 737-0071
Fax: (816) 737-4690

Montana
Hewlett-Packard Co.
13001 Hollenberg Drive
BRIDGETON, MT 63044
Tel: (314) 344-5100
Fax: (314) 344-5273

Nebraska
Hewlett-Packard
11626 Nicholas St.
OMAHA, NE 68154
Tel: (402) 493-0300
Fax: (402) 493-4334

New Jersey
Hewlett-Packard Co.
120 W. Century Road
PARAMUS, NJ 07653
Tel: (201) 599-5000
Fax: (201) 599-5382

Hewlett-Packard Co.
10 Sylvan Way
PARSIPPANY, NJ 07054
Tel: (201) 682-4000
Fax: (201) 682-4031

Hewlett-Packard Co.
20 New England Av.
PISCATAWAY, NJ 08854
Tel: (201) 562-6100
Fax: (201) 562-6246

New Mexico
Hewlett-Packard Co.
7801 Jefferson N.E.
ALBUQUERQUE, NM 87109
Tel: (505) 823-6100
Fax: (505) 823-1243

Hewlett-Packard Co.
1362-C Trinity Dr.
LOS ALAMOS, NM 87544
Tel: (505) 662-6700
Fax: (505) 662-4312

New York
Hewlett-Packard Co.
5 Computer Drive South
ALBANY, NY 12205
Tel: (518) 458-1550
Fax: (518) 458-1550 x 0393

Hewlett-Packard Co.
130 John Muir Dr.
AMHERST, NY 14228
Tel: (716) 689-3003
Fax: (716) 636-7034

Hewlett-Packard Co.
200 Cross Keys Office Park
FAIRPORT, NY 14450
Tel: (716) 223-9950
Fax: (716) 223-6331

Hewlett-Packard Co.
7641 Henry Clay Blvd.
LIVERPOOL, NY 13088
Tel: (315) 451-1820
Fax: (315) 451-1820 x 255

Hewlett-Packard Co.
No. 1 Pennsylvania Plaza
55th Floor
34th Street & 7th Avenue
MANHATTAN NY 10119
Tel: (212) 971-0800
Fax: (212) 330-6967

Hewlett-Packard Co.
2975 Westchester Ave
PURCHASE, NY 10577
Tel: (914) 935-6300
Fax: (914) 935-6497

Hewlett-Packard Co.
Executive Square Office Bldg.
66 Middlebush Rd.
WAPPINGERS FALLS, NY 12590
Tel: (914) 298-9125
Fax: (914) 298-9154

Hewlett-Packard Co.
3 Woodways Park West
WOODBURY, NY 11797
Tel: (516) 682-7800
Fax: (516) 682-7806 (2)

North Carolina
Hewlett-Packard Co.
305 Gregson Dr.
CARY, NC 27511
Tel: (919) 467-6600
Fax: (919) 460-2296
(919) 460-2297

Hewlett-Packard Co.
P.O. Box 240318
CHARLOTTE, NC 28224
Tel: (704) 527-8780
Fax: (704) 523-7857

Hewlett-Packard Co.
7029 Albert Pick Rd. #100
GREENSBORO, NC 27409
Tel: (919) 665-1800
Fax: (919) 668-1797
Mailing Address
PO Box 26500
Greensboro, NC 27426

Ohio
Hewlett-Packard Co.
2717 S. Arlington Rd.
AKRON 44312
Tel: (216) 644-2270
Fax: (216) 644-7415

Hewlett-Packard Co.
4501 Erskine Road
CINCINNATI, OH 45242
Tel: (513) 891-9870
Fax: (513) 891-0033

SALES OFFICES

Arranged alphabetically by country (cont'd)

UNITED STATES (Cont'd)

Hewlett-Packard Co.
Moutroffe West Ave.
COPLEY, OH 44321
Tel: (216) 666-7711
Fax: (216) 666-6054

Hewlett-Packard Co.
7887 Washington Village Dr.
DAYTON, OH 45459
Tel: (513) 433-2223
Fax: (513) 433-8633

Hewlett-Packard Co.
9080 Springboro Pike
MIAMISBURG 45342
Tel: (513) 433-2223
Fax: (513) 433-3633

Hewlett-Packard Co.
15885 Sprague Road
STRONGSVILLE, OH 44136
Tel: (216) 243-7300
Fax: (216) 234-7230

Hewlett-Packard Co.
One Maritime Plaza, 5th Floor
720 Water Street
TOLEDO, OH 43604
Tel: (419) 242-2200
Fax: (419) 241-7655

Hewlett-Packard Co.
675 Brookside Blvd.
WESTERVILLE, OH 43081
Tel: (614) 891-3344
Fax: (614) 891-1476

Oklahoma
Hewlett-Packard Co.
3525 N.W. 56th St.
Suite C-100
OKLAHOMA CITY, OK 73112
Tel: (405) 946-9499
Fax: (405) 942-2127

Hewlett-Packard Co.
6655 South Lewis,
Suite 105
TULSA, OK 74136
Tel: (918) 481-6700
Fax: (918) 481-2250

Oregon
Hewlett-Packard Co.
9255 S. W. Pioneer Court
WILSONVILLE, OR 97070
Tel: (503) 682-8000
Fax: (503) 682-8155

Pennsylvania
Hewlett-Packard Co.
Heatherwood Industrial Park
50 Dorchester Rd.
P.O. Box 6080
HARRISBURG, PA 17112
Tel: (717) 657-5900
Fax: (717) 657-5946

Hewlett-Packard Co.
111 Zeta Drive
PITTSBURGH, PA 15238
Tel: (412) 782-0400
Fax: (412) 963-1300

Hewlett-Packard Co.
2750 Monroe Boulevard
VALLEY FORGE, PA 19482
Tel: (215) 666-9000
Fax: (215) 666-2034

South Carolina
Hewlett-Packard Co.
Brookside Park, Suite 122
1 Harbison Way
COLUMBIA, SC 29212
Tel: (803) 732-0400
Fax: (803) 732-4567

Hewlett-Packard Co.
545 N. Pleasantburg Dr.
Suite 100
GREENVILLE, SC 29607
Tel: (803) 232-8002
Fax: (803) 232-8739

Tennessee
Hewlett-Packard Co.
One Energy Center Suite 200
Pellissippi Pkwy.
KNOXVILLE, TN 37932
Tel: (615) 966-4747
Fax: (615) 966-8147

Hewlett-Packard Co.
889 Ridge Lake Blvd.,
Suite 100
MEMPHIS, TN 38119
Tel: (901) 763-4747
Fax: (901) 762-9723

Hewlett-Packard Co.
44 Vantage Way,
Suite 160
NASHVILLE, TN 37228
Tel: (615) 255-1271
Fax: (615) 726-2310

Texas
Hewlett-Packard Co.
9050 Capital of Texas Highway, North
#290
AUSTIN, TX 78759
Tel: (512) 346-3855
Fax: (512) 338-7201
Mailing Address
PO Box 9431
Austin, TX 78766-9430

Hewlett-Packard Co.
5700 Cromo Dr
EL PASO, TX 79912
Tel: (915) 833-4400
Fax: (915) 581-8097

Hewlett-Packard Co.
10535 Harwin Drive
HOUSTON, TX 77036
Tel: (713) 776-6400
Fax: (713) 776-6495

Hewlett-Packard Co.
3301 West Royal Lane
IRVING, TX 75063
Tel: (214) 869-3377
Fax: (214) 830-8951

Hewlett-Packard Co.
109 E. Toronto, Suite 100
McALLEN, TX 78503
Tel: (512) 630-3030
Fax: (512) 630-1355
Hewlett-Packard Co.
930 E. Campbell Rd.
RICHARDSON, TX 75081
Tel: (214) 231-6101
Fax: (214) 699-4337

Hewlett-Packard Co.
14100 San Pedro Ave., Suite 100
SAN ANTONIO, TX 78232
Tel: (512) 494-9336
Fax: (512) 491-1299

Utah
Hewlett-Packard Co.
3530 W. 2100 South
SALT LAKE CITY, UT 84119
Tel: (801) 974-1700
Fax: (801) 974-1780

Virginia
Hewlett-Packard Co.
840 Greenbrier Circle
Suite 101
CHESAPEAKE, VA 23060
Tel: (804) 424-7105
Fax: (804) 424-1494

Hewlett-Packard Co.
4401 Water Front Dr.
GLEN ALLEN, VA 23060
Tel: (804) 747-7750
Fax: (804) 965-9297

Hewlett-Packard Co.
2800 Electric Road Suite 100
ROANOKE, VA 24018
Tel: (703) 774-3444
Fax: (703) 989-8049

Washington
Hewlett-Packard Co.
15815 S.E. 37th Street
BELLEVUE, WA 98006
Tel: (206) 643-4000
Fax: (206) 643-8748

Hewlett-Packard Co.
N. 1225 Argonne Rd
SPOKANE, WA 99212-2657
Tel: (509) 922-7000
Fax: (509) 927-4236

West Virginia
Hewlett-Packard Co.
501 56th Street
CHARLESTON, WV 25304
Tel: (304) 925-0492
Fax: (304) 925-1910

Wisconsin
Hewlett-Packard Co.
275 N. Corporate Dr.
BROOKFIELD, WI 53005
Tel: (414) 792-8800
Fax: (414) 792-0218

URUGUAY
Pablo Ferrando S.A.C. e I.
Avenida Italia 2877
Casilla de Correo 370
MONTEVIDEO
Tel: 59-82-802-586
Telex: 398802586

Olympia de Uruguay S.A.
Maquinas de Oficina
Avda. del Libertador 1997
Casilla de Correos 6644
MONTEVIDEO
Tel: 91-1809, 98-3807
Telex: 6342 OROU UY

VENEZUELA
Analytical Supplies, CA
Quinta #103 Impermes
Av El Centro
Los Chorros
Apartado 75472
CARACAS
Tel: 364904, 2394047
Telex: 26274 CABIC
Hewlett-Packard de Venezuela C.A.
Residencias Tia Betty Local 1
Avenida 3 Y con Calle 75
MARACAIBO, Estado Zulia
Apartado 2646
Tel: 586175669
Telex: 62464 HPMAR

YUGOSLAVIA
Do Hermes
General Zdanova 4
YU-11000 BEOGRAD
Tel: (011) 342 641
Telex: 11433

Do Hermes
Celovska 73
YU-61000 LJUBLJANA
Tel: (061) 553 170
Telex: 31583

ZAIRE
C.I.E.
Computer & Industrial Engineering
25 Ave. de la Justice Gombe
Boite Postale 10976
KINSHASA
Tel: 32 063, 32 633, 28 251
Telex: 21552
Fax: 22 850

ZAMBIA
R.J. Tilbury (Zambia) Ltd.
P.O. Box 32792
LUSAKA
Tel: 21 55 80
Telex: 40128

ZIMBABWE
Field Consolidated (Private) Ltd.
Systron Division
Manhattan Court
61 Second Street
P.O. Box 3458
HARARE
Tel: 73 98 81
Telex: 26241
Fax: 70 20 08

Please send directory corrections to:
Test & Measurement Catalog
Hewlett-Packard Company
3200 Hillview Avenue
Palo Alto, CA 94304
Tel: (415) 857-4706
Fax: (415) 857-3880

APPLICATION & PRODUCT NOTES

Free Aids to Solving Your Test and Measurement Problems

747

Application Notes



Application Notes

Application Notes help you use HP instruments to solve measurement problems. They are application-specific and typically include generic techniques with families of products.

Product Notes

Product Notes describe measurement techniques that are product-specific and often show extensions of performance outside normal lab environments, including performance data and explanations of specifications.

Application Note Index

The listing of Application Notes and Product Notes on the following pages is condensed from HP's Application Note Index, which contains a comprehensive list of all Application Notes, Application Briefs, Application Bulletins, Product Notes and Programming Notes available from Hewlett-Packard.

How to Order

To obtain a free copy of the HP Application Note Index and any of the Application Notes or Product Notes listed on the following pages, just call your HP Customer Information Center (CIC) or contact your nearest HP office. Locations and phone numbers of HP CICs and offices are listed on the back pages of this catalog. You may also order the AN index, Application Notes, and Product Notes with the information request card inside the rear cover of this catalog. When requesting these publications, please include the boldface ordering numbers (e.g., **5952-7250**).

Application Notes

A to D Converters

Fundamentals of the z-Domain and Mixed Analog/Digital Measurements

AN 243-4/**5952-7250**

Rotation Simulation and ADC Testing with Synthesized Signals

AN 373/**5952-9693**

Using the HP 5183T to Characterize Sonar Transducers and Systems

AN 340-1/**5952-7805**

Air Navigation

Control System Development Using Dynamic Signal Analyzers

AN 243-2/**5952-5136**

Amplifiers

Accurate Mixer/Amplifier Compression Measurement Using the 8901A Modulation Analyzer

AN 286-2/**5952-8245**

Amplifier Measurements Using the Scalar Network Analyzer

AN 345-1/**5954-1599**

Complete S-Parameter and Distortion Measurement for Wide Band Video Amplifiers with the HP 4195A

AN 357-2/**5950-2932**

Extended Dynamic Range of Scalar Transmission Measurements Using the HP 8757A, 8756A or 8755C Scalar Network Analyzers

AN 327-1/**5953-8882**

Fundamentals of RF and Microwave Noise Figure Measurement

AN 57-1/**5952-8255**

Harmonic Distortion Measurements

AN 378-1/**5952-7253**

Noise Figure Measurement Accuracy

AN 57-2/**5952-3076**

S-Parameter Techniques for Faster, More Accurate Network Design

AN 95-1/**5952-1130**

Antenna Measurements

Antenna Pattern Measurements Using the HP 8510B

AN 374-1/**5952-6675**

Audio

Fundamentals of the z-Domain and Mixed Analog/Digital Measurements

AN 243-4/**5952-7250**

Harmonic Distortion Measurements

AN 378-1/**5952-7253**

High Speed Measurement of Semiconductor Devices from Sub-PA to 1A

AN 356/**5950-2930**

Log Sweep with the HP 3582A Spectrum Analyzer

AN 245-5/**5952-8805**

Measuring the Coherence Function with the HP 3582A Spectrum Analyzer

AN 245-2/**5952-8768**

The Fundamentals of Signal Analysis

AN 243/**5953-8898**

Third Octave Analysis with the HP 3582A Spectrum Analyzer

AN 245-3/**5952-8800**

Automatic Test Systems

Appliance Testing

AN 421-24/**5954-9654**

Automated Reverse Recovery Time Measurements of Diodes

AN 297-2/**5952-9542**

Battery Testing

AN 372-2/**5952-4191**

Communications Cable Testing

AN 421-8/**5954-9638**

Data Capture with the 6942A/6944A Multiprogrammers

AN 316-5/**5952-4116**

8161A Programmable Pulse Generator

AN 297-1/**5952-9540**

Environmental/Autoclave Testing

AN 421-7/**5954-9637**

Introduction to Computer Aided Test

AN 316-0/**5952-4102**

Jet Engine Controller Testing

AN 421-5/**5954-9635**

Jet Engine Testing

AN 421-16/**5954-9646**

Large Product Characterization

AN 421-18/**5954-9648**

Low Phase Noise Applications of the HP 8662A and 8663A Synthesized Signal Generators

AN 283-3/**5952-8435**

Machine Monitoring and Control

AN 421-20/**5954-9650**

Materials Development

AN 421-12/**5954-9642**

Microwave Switching from SPDT to Full Access Matrix

AN 332/**5953-6466**

Missile System Testing

AN 421-19/**5954-9649**

Novel Combinations of Microwave Switches and Step Attenuators

AN 332-1/**5954-8892**

Parametric Characterization of Digital Circuits up to 50 MHz

AN 319/**5952-9549**

Power Supply Testing

AN 372-1/**5952-4190**

Practical Test System Signal Switching

AN 328-1/**5953-6962**

Receiver Testing with the HP 8770S Arbitrary Waveform Synthesizer System

AN 314-1/**5954-6358**

Reducing Fixture-Induced Test Failures

AN 340-1/**5952-7805**

Synthesizing Magnetic Disc Read and Servo Signals with the HP 8770S Arbitrary Waveform Synthesizer System

AN 314-2/**5954-6357**

Using the HP 5183T to Characterize Sonar Transducers and Systems

AN 340-1/**5952-7805**

Using the HP 3497A to Control Industrial Wastewater Treatment

AN 290-2/**5953-6921**

Battery Charging/Discharging

Battery Charging/Discharging

AN 250-2/**5952-4033**

Battery Testing

AN 372-2/**5952-4191**

Battery Testing

AN 421-14/**5954-9644**

Board Test Systems Networking

Synthesizing Magnetic Disc Read and Servo Signals with the HP 8770S Arbitrary Waveform Synthesizer System

AN 314-2/**5954-6357**

Bode Plot

Control System Development Using Dynamic Signal Analyzers

AN 243-2/**5952-5136**

Cable

Communications Cable Testing

AN 421-8/**5954-9638**

Direct Radio Frequency Impedance Measurements Using the 4191A RF Impedance Analyzer

AN 302-1/**5952-8853**

How Vector Measurements Expand Design Capabilities - 1 to 1,000 MHz

AN 91/**5952-0917**

Measuring the Characteristic Impedance of Balanced Cables Using the HP 4194A

AN 339-4/**5950-2918**

Measuring Electrical Length Delay of Cables

AN 174-10/**5952-7326**

Precise Cable Length and Matching Measurements Using the HP 5370B Universal Time Interval Counter and HP 5363B Time Interval Probes

AN 191-6/**5952-7568**

TDR Fundamentals for use with HP 54120T Digitizing Oscilloscope and TDR

AN 62/**5954-2681**

APPLICATION & PRODUCT NOTES

Free Aids to Solving Your Test and Measurement Problems

Application Notes

Calibration

Applications and Operation of the 8901A Modulation Analyzer

AN 286-1/5952-8208

Automatic Zero Calibration of the HP 5359A Time Synthesizer at a Designated Remote Location

AN 191-1/5952-7487

Calibrated Signal Simulation System Utilizing I/Q Modulation Techniques

AN 343-5/5952-6471

Characterization of Frequency Agile Sources with the HP 5371A Frequency and Time Interval Analyzer

AN 358-1/5952-7924

Effective Machinery Maintenance Using Vibration Analysis

AN 243-1/5953-5113

Fundamentals of RF and Microwave Power Measurement

AN 57-2/5952-3076

High Frequency Swept Measurements

AN 183/5952-9200

HP 8640A/B Signal Generator Output Level Accuracy

AN 170-1/5952-1218

Jitter and Wander Analysis in Digital Communication with the HP 5371A Frequency and Time Interval Analyzer

AN 358-2/5952-7925

Measurement of Complex Impedance 1 - 1000 MHz

AN 77-3/5952-0991

Measuring the Coherence Function with the HP 3582A Spectrum Analyzer

AN 245-2/5952-8768

Microwave Switching from SPDT to Full Access Matrix

AN 332/5953-6466

Performance of the HP 8620C Sweep Oscillator Under Remote Programming

AN 187-6/5952-9271

Simulating Sensor Signals

AN 341-2/5952-9651

Using the HP 5183T to Characterize Sonar Transducers and Systems

AN 340-1/5952-7805

Coaxial Systems

Configuration of a Two-tone Sweeping Generator

AN 312-1/5952-9316

Extended Dynamic Range of Scalar Transmission Measurements Using the HP 8757A, 8756A or 8755C Scalar Network Analyzers

AN 327-1/5953-8882

High Frequency Swept Measurements

AN 183/5952-9200

How Vector Measurements Expand Design Capabilities - 1 to 1,000 MHz

AN 91/5952-0917

Measurement of Complex Impedance, 1 - 1000 MHz

AN 77-3/5952-0991

Microwave Switching from SPDT to Full Access Matrix

AN 332/5953-6466

Novel Combinations of Microwave Switches and Step Attenuators for Programming Applications

AN 332-1/5953-8892

Performance of the HP 8620C Sweep Oscillator Under Remote Programming

AN 187-6/5952-9271

Principles of Microwave Connector Care (for Higher Reliability and Better Measurements)

AN 326/5954-1566

Protocol Converters: Linking HP Graphics Peripherals with IBM Networks/Systems

AN 229-11/5953-9874

TDR Fundamentals for use with HP 54120T Digitizing Oscilloscope and TDR

AN 62/5954-2681

Communications

A Guide to Microwave Upconversion

AN 314-5/5953-2342

An Introduction to Signaling

AN 336/5952-5034

Characterization of Frequency Agile Sources with the HP 5371A Frequency and Time Interval Analyzer

AN 358-1/5952-7924

Communications Cable Testing

AN 421-8/5954-9638

Exceptionally Complex Signal Simulation for Multi-Signal Environments in Radar/EW Test

AN 314-4/5952-3702

High Speed Timing Acquisition and Statistical Jitter Analysis Using the HP 5370B Universal Time Interval Counter

AN 191-7/5952-7908

How to Measure Return Loss of Connectorized Optical Components

AN 366-2/5952-9661

Integrated Services Digital Network (ISDN) 23B&D Primary Access Rate (PAR) and Digital Multiplexed Interface (DMI) Testing Using the HP 3787B and Protocol Analyzer

AN 368/5959-8215

Jitter and Wander Analysis in Digital Communication with the HP 5371A Frequency and Time Interval Analyzer

AN 358-2/5952-7925

Large Product Characterization

AN 421-18/5954-9648

Low Phase Noise Applications of the HP 8662A and 8663A Synthesized Signal Generators

AN 283-3/5952-8435

Measuring Digital Microwave Radio M-Curves/Signatures

AN 379-1/5959-7859

Measurements Applications for Digital Microwave Radio

AN 343-1/5954-6365

Microwave Switching from SPDT to Full Access Matrix

AN 332/5953-6466

Missile System Testing

AN 421-19/5954-9649

Phase/Frequency Modulated Services and Bit Error Rate Test Sets

AN 360/5954-9564

Receiver Testing with the HP 8770S Arbitrary Waveform Synthesizer System

AN 314-1/5954-6358

Selecting a Jitter Test Set

AN 359/5954-9563

The Benefits of P/AR

AN 318-1/5952-4996D

Voltage Controlled Oscillators Characterization Using the HP 5350B, 5351B, 5352B CW Microwave Frequency Counter

AN 181-2/5952-7852

X.25 Data Communications

AN 422/5954-8579

Component Test

A Guideline for Designing External DC Current Bias Circuits for the HP 4192A, HP 4194A, HP 4274A, HP 4275A, HP 4276A, and HP 4277A

AN 346/5950-2912

Accurate Mixer/Amplifier Compression Measurement Using the 8901A Modulation Analyzer

AN 286-2/5952-8245

A Test Set-Up for Characterizing High-Speed Logic Devices

AN 381/5953-6329

Advanced Filter Evaluation and Limit Testing with the HP 4195A

AN 357-3/5950-2933

Amplifier Measurements Using the Scalar Network Analyzer

AN 345-1/5954-1599

Analysis of Semiconductor Capacitance Characteristics Using the HP 4280A 1 MHz C Meter/C-V Plotter

AN 322/5953-6939

Automated Characterization of Microwave Voltage Controlled Oscillators Using the HP 5361A Pulse/CW Microwave Counter

AN 377-2/5952-7988

Biasing Three-Terminal Devices for Test

AN 376-1/5952-4193

Characteristic Impedance Measurement of PC Board Circuit Patterns Using the HP 4194A Impedance/Gain-Phase Analyzer

AN 339-2/5950-2908

Characterization of Frequency Agile Sources with the HP 5371A Frequency and Time Interval Analyzer

AN 358-1/5952-7924

Complete S-Parameter and Distortion Measurement for Wide Band Video Amplifiers with the HP 4195A

AN 357-2/5950-2932

Constant Current Measurements Using the HP 4194A

AN 339-8/5950-2923

Crosstalk and Impedance Measurements of PC Board Patterns - HP 4194A Application Information

AN 339-3/5950-7863

Data Capture with the 6942A/6944A Multiprogrammers

AN 316-5/5952-4116

Disk Drive Servo-Track Writing with Laser Interferometers

AN 325-11/5952-7984

Direct Radio Frequency Impedance Measurements Using the 4191A RF Impedance Analyzer

AN 302-1/5952-8853

Dynamic Component Test Using Vector Modulation Analysis

AN 343-2/5954-6367

Efficient Evaluation of LISNs and Voltage Probes for EMI

AN 339-7/5950-2922

Filter Test for Production and Incoming Inspection - HP 4194A Impedance/Gain-Phase Analyzer

AN 339-11/5952-7887

Fundamentals of RF and Microwave Noise Figure Measurement

AN 57-1/5952-8255

Harmonic Distortion Measurements

AN 378-1/5952-7253

How to Measure Return Loss of Connectorized Optical Components

AN 366-2/5952-9661

How Vector Measurements Expand Design Capabilities - 1 to 1,000 MHz

AN 91/5952-0917

HP-IB Programming Hints for the HP 4194A

AN 339-12/5952-2929

Impedance Characterization of High Q Devices from 1 MHz to 1000 MHz with 1 Hz Resolution

AN 302-2/5952-8872

Impedance Characterization of Resonators Using the HP 4194A

AN 339-1/5950-2882

Impedance Measurement for Incoming Inspection - HP 4284A Application Information

AN 369-4/5950-2952

Input/Output Impedance and Reflection Coefficient Measurements using the HP 4194A

AN 339-10/5950-2925

Magnetic Head Measurement Using a Constant Test Current - HP 4284A Application Information AN 369-3/**5950-2951**

Measurement of Propagation Delays Using the HP 5370B Time Interval Counter and HP 5363B Time Interval Probes AN 191-5/**5952-7563**

Measuring the Characteristic Impedance of Balanced Cables Using the HP 4194A AN 339-4/**5950-2918**

Measuring the Dielectric Constant of Solid Materials - HP 4194A Impedance/Gain-Phase Analyzer AN 339-13/**5950-2935**

Microwave Switching from SPDT to Full Access Matrix AN 332/**5953-6466**

Mixer Measurements Using the Scalar Network Analyzer AN 345-2/**5954-8369**

Multi-frequency C-V Measurements and Doping Profile Analysis of Semiconductors Using the HP 4194A AN 339-5/**5950-2919**

Multi-frequency C-V Measurements of Semiconductors - HP 4284A Application Information AN 369-5/**5950-2953**

Negative Impedance Measurements of Crystal Oscillators Using the HP 4194A AN 339-9/**5950-2924**

Network, Spectrum, and Impedance Evaluation of IF Circuits - HP 4195A Network/Spectrum Analyzer AN 357-1/**5950-2931**

Noise Figure Measurement Accuracy AN 57-2/**5952-3076**

Parametric Analysis for Electronic Components and Circuit Evaluation Using the HP 4194A AN 339/**5950-2856**

Parametric Characterization of Digital Circuits up to 50 MHz AN 319/**5952-9549**

Power Component Testing AN 372-3/**5952-4192**

Power Supply Programming with the 6942A Multi-programmer AN 316-4/**5952-4075**

Practical Design and Evaluation of High Frequency Circuits Using the HP 4193A Vector Impedance Meter AN 317/**5953-6910**

Role of DC Parametric Test in High Speed Digital and Microwave Component Manufacturing AN 339-20/**5952-7936**

Rotation Simulation and ADC Testing with Synthesized Signals AN 373/**5952-9693**

Semiconductor Measurements with the HP 4140B Picoammeter/DC Voltage Source AN 238/**5952-8840**

Static Head Testing for Disc Drives - HP 4194A Application Information AN 339-6/**5952-7871**

Tantalum Capacitor Measurement - HP 4284A Application Information AN 369-2/**5950-2950**

Ultra Low Current Semiconductor DC Parameter Measurement System Using HP 4140B AN 238-1/**5953-8873**

Using Impedance Measurement to Evaluate Electronic Components and Materials - HP 4284A Application Information AN 369-1/**5950-2949**

Voltage Controlled Oscillators Characterization Using the HP 5350B, 5351B, 5352B CW Microwave Frequency Counter AN 181-2/**5952-7852**

Computer Aided Engineering - EE

EPROM Card Troubleshooting for the HP 9000 Series 200/300 Pascal and BASIC Workstations AN 420/**5954-8292**

Line Quality and Accuracy - What They Are and How to Achieve Them AN 350-4/**5954-7132**

Using your Plotter or Printer with Peripheral Sharing Devices, Buffers, and Spoolers AN 350-6/**5959-9713**

Computer Aided Engineering - ME

Line Quality and Accuracy - What They Are and How to Achieve Them AN 350-4/**5954-7132**

The Fundamentals of Modal Testing AN 243-3/**5952-7957**

Using your Plotter or Printer with Peripheral Sharing Devices, Buffers, and Spoolers AN 350-6/**5959-9713**

Computer Aided Test

See *Data Acquisition*

Computer Crystals

Crystal Testing with the 8640A/B and 8405A AN 171-1/**5952-8117**

Direct Radio Frequency Impedance Measurements Using the 4191A RF Impedance Analyzer AN 302-1/**5952-8853**

Fundamentals of Quartz Oscillators AN 200-2/**5952-7507**

How Vector Measurements Expand Design Capabilities - 1 to 1,000 MHz AN 91/**5952-0917**

Impedance Characterization of High Q Devices from 1 MHz to 1000 MHz with 1 Hz Resolution AN 302-2/**5952-8872**

Practical Design and Evaluation of High Frequency Circuits Using the HP 4193A Vector Impedance Meter AN 317/**5953-6910**

Crystal Filters

Crystal Testing with the 8640A/B and 8405A AN 171-1/**5952-8117**

Efficient Evaluation of LISNs and Voltage Probes for EMI Tests Using the HP 4194A AN 339-7/**5950-2922**

Filter Test for Production and Incoming Inspection - HP 4194A Impedance/Gain-Phase Analyzer AN 339-11/**5952-7887**

How Vector Measurements Expand Design Capabilities - 1 to 1,000 MHz AN 91/**5952-0917**

Negative Impedance Measurements of Crystal Oscillators Using the HP 4194A AN 339-9/**5950-2924**

Data Acquisition

Air Frame Testing AN 421-25/**5954-9655**

Appliance Testing AN 421-24/**5954-9654**

Battery Testing AN 372-2/**5952-4191**

Battery Testing AN 421-14/**5954-9644**

Bed of Nails Test: DA Converter AN 421-29/**5954-9659**

Biasing Three-Terminal Devices for Test AN 376-1/**5952-4193**

Canning Process Characterization AN 421-10/**5954-9640**

Communications Cable Testing AN 421-8/**5954-9638**

Data Acquisition and Computer Aided Test Application Notes for 32 Industries in Series AN 421-1/**5954-9631**

Data Capture with the 6942A/6944A Multiprogrammers AN 316-5/**5952-4116**

Environment Test Electrical Sub-assembly AN 421-32/**5954-9662**

Environmental/Autoclave Testing AN 421-7/**5954-9637**

Environmental Test Auto Radio AN 421-30/**5954-9660**

Explosion Testing AN 421-11/**5954-9641**

Facility Management AN 421-17/**5954-9647**

Fan Testing AN 421-2/**5954-9632**

High Speed Timing Acquisition and Statistical Jitter Analysis Using the HP 5370B Universal Time Interval Counter AN 191-7/**5952-7908**

Internal Combustion Engine Testing AN 421-6/**5954-9636**

Introduction to Computer Aided Test AN 316-0/**5952-4102**

Jet Engine Controller Testing AN 421-5/**5954-9635**

Jet Engine Testing AN 421-16/**5954-9646**

Large Product Characterization AN 421-18/**5954-9648**

Machine Monitoring and Control AN 421-20/**5954-9650**

Materials Development AN 421-12/**5954-9642**

Microwave Switching from SPDT to Full Access Matrix AN 332/**5953-6466**

Missile System Testing AN 421-19/**5954-9649**

On-Road Vehicle Testing AN 421-26/**5954-9656**

Paper Process Control AN 421-22/**5954-9652**

Pharmaceutical Process Control AN 421-21/**5954-9651**

Pilot Plant Monitoring AN 421-15/**5954-9645**

Plating Line Control AN 421-13/**5954-9643**

Power Component Testing AN 372-3/**5952-4192**

Power Supply Programming with the 6942A Multiprogrammer AN 316-4/**5952-4075**

Power Supply Testing AN 372-1/**5952-4190**

Practical Strain Gauge Measurements AN 290-1/**5952-8880**

Practical Temperature Measurements AN 290/**5952-8801**

Pumping Station Control AN 421-27/**5954-9657**

Receiver Testing AN 421-28/**5954-9658**

Receiver Testing with the HP 8770S Arbitrary Waveform Synthesizer System AN 314-1/**5954-6358**

Residential Facility Monitoring AN 421-9/**5954-9639**

Role of DC Parametric Test in High Speed Digital and Microwave Component Manufacturing AN 339-20/**5952-7936**

Rolling Mill AN 421-23/**5954-9653**

APPLICATION & PRODUCT NOTES

Free Aids to Solving Your Test and Measurement Problems

Application Notes

Sonar System Testing

AN 421-31/5954-9661

Sub-Micro Positioning with the HP 5527A Laser Position Transducer System

AN 325-10/5952-7942

Synthesizing Magnetic Disc Read and Servo Signals with the HP 8770S Arbitrary Waveform Synthesizer System

AN 314-2/5954-6357

Testing a Complex LSI/VLSI IC with a Low-Cost Measurement Set-up

AN 341-1/5952-9572

The Fundamentals of Modal Testing

AN 243-3/5952-7957

Using the HP 3497A to Control Industrial Wastewater Treatment

AN 290-2/5953-6921

Vehicle Body Testing

AN 421-3/5954-9633

Waste Water Treatment

AN 421-4/5954-9634

DC

Ultra Low Current Semiconductor DC Parameter Measurement System Using HP 4140B

AN 238-1/5953-8873

Digital Communications

Characterization of Frequency Agile Sources with the HP 5371A Frequency and Time Interval Analyzer

AN 358-1/5952-7924

Digital Radio Theory and Measurements

AN 355/5954-9554

High Speed Timing Acquisition and Statistical Jitter Analysis Using the HP 5370B Universal Time Interval Counter

AN 191-7/5952-7908

Integrated Services Digital Network (ISDN) 23B&D Primary Access Rate (PAR) and Digital Multiplexed Interface (DMI) Testing Using the HP 3787B and Protocol Analyzer

AN 368/5959-8215

Jitter and Wander Analysis in Digital Communication with the HP 5371A Frequency and Time Interval Analyzer

AN 358-2/5952-7925

Jitter Tolerance Testing Using Phase/Frequency Modulated Services and Bit Error Rate Test Sets

AN 360/5954-9564

Measurements Applications for Digital Microwave Radio

AN 343-1/5954-6365

Measuring Demodulator Image Rejection Using the HP 8980A Vector Analyzer

AN 343-4/5952-3703

Receiver Testing with the HP 8770S Arbitrary Waveform Synthesizer System

AN 314-1/5954-6358

Selecting a Jitter Test Set

AN 359/5954-9563

Simulating Sensor Signals

AN 343-5/5952-6471

Testing a Complex LSI/VLSI IC with a Low-Cost Measurement Set-up

AN 341-1/5952-9572

Digital Data Transmission

High Speed Timing Acquisition and Statistical Jitter Analysis Using the HP 5370B Universal Time Interval Counter

AN 191-7/5952-7908

Integrated Services Digital Network (ISDN) 23B&D Primary Access Rate (PAR) and Digital Multiplexed Interface (DMI) Testing Using the HP 3787B and Protocol Analyzer

AN 368/5959-8215

Jitter and Wander Analysis in Digital Communication with the HP 5371A Frequency and Time Interval Analyzer

AN 358-2/5952-7925

Jitter Tolerance Testing Using External Phase/Frequency Modulated Sources and Bit Error Rate Test Sets

AN 360/5954-9564

Measuring Digital Microwave Radio M-Curves/Signatures

AN 379-1/5959-7859

Selecting a Jitter Test Set

AN 359/5954-9563

Testing a Complex LSI/VLSI IC with a Low-Cost Measurement Set-up

AN 341-1/5952-9572

The Benefits of P/AR

AN 318-1/5952-4996D

Digital Troubleshooting

A Manager's Guide to Signature Analysis

AN 222-3/5952-7592

An Index to Signature Analysis Publications

AN 222-0/5952-7625

Determining Digital Circuit Timing Tolerance to Optimize Adjustment or Design

AN 191-2/5952-7488

Guidelines for Signature Analysis: Understanding the Signature Measurement

AN 222-4/5952-7595

Jitter and Wander Analysis in Digital Communication with the HP 5371A Frequency and Time Interval Analyzer

AN 358-2/5952-7925

Jitter Tolerance Testing Using External Phase/Frequency Modulated Sources and Bit Error Rate Test Sets

AN 360/5954-9564

Integrated Services Digital Network (ISDN) 23B&D Primary Access Rate (PAR) and Digital Multiplexed Interface (DMI) Testing Using the HP 3787B and Protocol Analyzer

AN 368/5959-8215

Measurement of Propagation Delays Using the HP 5370B Time Interval Counter and HP 5363B Time Interval Probes

AN 191-5/5952-7563

New Techniques of Digital Troubleshooting

AN 163-2/5952-7558

Reducing Fixture-induced Test Failures

AN 340-1/5952-7805

Testing a Complex LSI/VLSI IC with a Low-Cost Measurement Set-up

AN 341-1/5952-9572

Selecting a Jitter Test Set

AN 359/5954-9563

Troubleshooting with Composite Signatures

AN 222-6/5952-7684

Understanding Your Test Fixture

AN 324-1/5953-6951

Distortion

Harmonic Distortion Measurements

AN 378-1/5952-7253

Optimizing the Dynamic Range of the HP 3585A Spectrum Analyzer

AN 246-1/5952-8815

Spectrum Analysis . . . Distortion Measurements

The 8640A/B Third Order Intermodulation Product Characteristics

AN 170-2/5952-8129

Electrical Length

Precise Cable Length and Matching Measurements Using the HP 5370B Universal Time Interval Counter and HP 5363B Time Interval Probes

AN 191-6/5952-7568

Electronic Warfare (EW)

A Guide to Microwave Upconversion

AN 314-5/5953-2342

Applications & Performance of the HP 8671A and 8672A Microwave Synthesizers

AN 218-1/5952-8219

Automatic Frequency Profiling of Chirped Radar Pulses Using the HP 5361A Pulse/CW Microwave Counter

AN 377-1/5952-7987

Characterization of Frequency Agile Sources with the HP 5371A Frequency and Time Interval Analyzer

AN 358-1/5952-7924

Coherent Pulsed Tests of Radar and EW Systems

AN 343-3/5954-6366

Dynamic Component Test Using Vector Modulation Analysis

AN 343-2/5954-6367

Exceptionally Complex Signal Simulation for Multi-Signal Environments in Radar/EW Test

AN 314-4/5952-3702

High Speed Timing Acquisition and Statistical Jitter Analysis Using the HP 5370B Universal Time Interval Counter

AN 191-7/5952-7908

Microwave Switching from SPDT to Full Access Matrix

AN 332/5953-6466

Obtaining Leveled Pulse-Modulated Microwave Signals from the HP 8672A

AN 218-5/5952-8251

Practical Strain Gauge Measurements

AN 290-1/5952-8880

Voltage Controlled Oscillators Characterization Using the HP 5350B, 5351B, 5352B CW Microwave Frequency Counter

AN 181-2/5952-7852

EMI

Automatic CISPR EMI Testing for Conducted Emissions

AN 331-1/5954-2724

Emulation, Microprocessors

Testing a Complex LSI/VLSI IC with a Low-Cost Measurement Set-up

AN 341-1/5952-9572

Error Analysis

Direct Radio Frequency Impedance Measurements Using the 4191A RF Impedance Analyzer

AN 302-1/5952-8853

Fundamentals of RF and Microwave Power Measurement

AN 64-1/5952-8178

High Frequency Swept Measurements

AN 183/5952-9200

High Speed Timing Acquisition and Statistical Jitter Analysis Using the HP 5370B Universal Time Interval Counter

AN 191-7/5952-7908

HP 8640A/B Signal Generator Output Level Accuracy

AN 170-1/5952-1218

Integrated Services Digital Network (ISDN) 23B&D Primary Access Rate (PAR) and Digital Multiplexed Interface (DMI) Testing Using the HP 3787B and Protocol Analyzer AN 368/5959-8215

Jitter and Wander Analysis in Digital Communication with the HP 5371A Frequency and Time Interval Analyzer AN 358-2/5952-7925

Measurement of Complex Impedance, 1 - 1000 MHz AN 77-3/5952-0991

Fiber Optics

See *Lightwave*

Fourier Analysis

Accessing the HP 3582A Memory with HP-IB AN 245-4/5952-8804

Control System Development Using Dynamic Signal Analyzers AN 243-2/5952-5136

Effective Machinery Maintenance Using Vibration Analysis AN 243-1/5953-5113

Fundamentals of the z-Domain and Mixed Analog/Digital Measurements AN 243-4/5952-7250

Log Sweep with the HP 3582A Spectrum Analyzer AN 245-5/5952-8805

Measuring the Coherence Function with the HP 3582A Spectrum Analyzer AN 245-2/5952-8768

The Fundamentals of Modal Testing AN 243-3/5952-7957

The Fundamentals of Signal Analysis AN 243/5953-8898

Third Octave Analysis with the HP 3582A Spectrum Analyzer AN 245-3/5952-8800

Frequency

Applications and Operation of the 8901A Modulation Analyzer AN 286-1/5952-8208

Crystal Testing with the 8640A/B and 8405A AN 171-1/5952-8117

Frequency Profile Using an HP 5345A Time Synthesizer AN 287-2/5952-7530

Frequency Profile Using an HP 5370A Universal Time Interval Counter and an HP 5359A Time Synthesizer AN 287-3/5952-7549

Fundamentals of Microwave Frequency Counters AN 200-1/5952-7484

Fundamentals of Quartz Oscillators AN 200-2/5952-7507

Measuring Fractional Frequency Standard Deviation (Sigma) Versus Averaging Time (TAU) AN 174-7/5952-7344

Measuring Frequency Sweep Linearity of Sweep Generators AN 174-12/5952-7328

Measuring Phase Noise with the HP 3585A Spectrum Analyzer AN 246-2/5952-8838

Performance of the HP 8620C Sweep Oscillator Under Remote Programming AN 187-6/5952-9271

Radar System Characterization and Testing Using the HP 5345A/55A/56A,B,C,D Counter AN 174-14/5952-7892

The Fundamentals of Modal Testing AN 243-3/5952-7957

Understanding Frequency Counter Specifications AN 200-4/5952-7522

Voltage Controlled Oscillators Characterization Using the HP 5350B, 5351B, 5352B CW Microwave Frequency Counter AN 181-2/5952-7852

Frequency Multiplication

External Frequency Doubling of the 8662A Synthesized Signal Generator AN 283-2/5952-8217

Frequency Stability (Short-Term)

High Speed Timing Acquisition and Statistical Jitter Analysis Using the HP 5370B Universal Time Interval Counter AN 191-7/5952-7908

Measuring Fractional Frequency Standard Deviation (Sigma) Versus Averaging Time (TAU) AN 174-7/5952-7344

Voltage Controlled Oscillators Characterization Using the HP 5350B, 5351B, 5352B CW Microwave Frequency Counter AN 181-2/5952-7852

Frequency Standards

Contribution of HP Clocks to the DII I's International Atomic Time Scale AN 52-4/5952-7855

Crystal Testing with the 8640A/B and 8405A AN 171-1/5952-8117

Measuring Fractional Frequency Standard Deviation (Sigma) Versus Averaging Time (TAU) AN 174-7/5952-7344

Frequency Synthesizers

Applications & Performance of the HP 8671A and 8672A Microwave Synthesizers AN 218-1/5952-8219

Digital Phase Modulation (PSK) and Wideband FM AN 164-4/5952-8143

8672A Synthesized Signal Generator - HP 1000 HP-IB Programming AN 401-15/5953-2814

External Frequency Doubling of the 8662A Synthesized Signal Generator AN 283-2/5952-8217

How Vector Measurements Expand Design Capabilities - 1 to 1,000 MHz AN 91/5952-0917

Jitter Tolerance Testing Using External Phase/Frequency Modulated Sources and Bit Error Rate Test Sets AN 360/5954-9564

Low Phase Noise Applications of the HP 8662A and 8663A Synthesized Signal Generators AN 283-3/5952-8435

Performance of the HP 8620C Sweep Oscillator Under Remote Programming AN 187-6/5952-9271

Spectral Purity Characteristics of HP Microwave Signal Sources AN 329/5954-8349

Using the HP 5183T to Characterize Sonar Transducers and Systems AN 340-1/5952-7805

Graphics

Line Quality and Accuracy - What They Are and How to Achieve Them AN 350-4/5954-7132

Protocol Converters: Linking HP Graphics Peripherals with IBM Networks/Systems AN 229-11/5953-9874

Using Your HP Plotter with an IBM Mainframe - For ISSCO Software Users AN 350-1/5954-7174

Using your Plotter or Printer with Peripheral Sharing Devices, Buffers, and Spoolers AN 350-6/5959-9713

Using Your Plotter with an IBM Mainframe - For SAS/Graph Software Users AN 350-3/5954-8748

Group Delay

Floating Measurements and Guarding AN 123/5952-2153

IC Testing

A Test Set-Up for Characterizing High-Speed Logic Devices AN 381/5953-6329

High Speed Timing Acquisition and Statistical Jitter Analysis Using the HP 5370B Universal Time Interval Counter AN 191-7/5952-7908

Role of DC Parametric Test in High Speed Digital and Microwave Component Manufacturing AN 339-20/5952-7936

Testing a Complex LSI/VLSI IC with a Low-Cost Measurement Set-up AN 341-1/5952-9572

Impedance

Analysis of Semiconductor Capacitance Characteristics Using the HP 4280A 1 MHz C Meter/C-V Plotter AN 322/5953-6939

Characteristic Impedance Measurement of PC Board Circuit Patterns Using the HP 4194A Impedance/Gain-Phase Analyzer AN 339-2/5950-2908

Circuit Evaluation Using the HP 4194A Crosstalk and Impedance Measurements of PC Board Pattern AN 339-3/5952-7863

Constant Current Measurements Using the HP 4194A AN 339-8/5950-2923

Crosstalk and Impedance Measurements of PC Board Patterns - HP 4194A Application Information AN 339-3/5952-7863

Direct Radio Frequency Impedance Measurements Using the 4191A RF Impedance Analyzer AN 302-1/5952-8853

Dynamic Component Test Using Vector Modulation Analysis AN 343-2/5954-6367

High Frequency Swept Measurements AN 183/5952-9200

High Speed Measurement of Semiconductor Devices from Sub-PA to 1A AN 356/5950-2930

Impedance Characterization of High Q Devices from 1 MHz to 1000 MHz with 1 Hz Resolution AN 302-2/5952-8872

Impedance Characterization of Resonators Using the HP 4194A AN 339-1/5950-2882

Impedance Measurement for Incoming Inspection - HP 4284A Applications Information AN 369-4/5950-2952

Improving Time Domain Network Analysis Measurements AN 62-1/5954-2682

Input/Output Impedance and Reflection Coefficient Measurements using the HP 4194A AN 339-10/5950-2925

Magnetic Head Measurement Using a Constant Test Current - HP 4284A Application Information AN 369-3/5950-2951

Making Telecommunication Measurements in Complex Impedances AN 231-3/5953-5484

Measurement of Complex Impedance, 1 - 1000 MHz AN 77-3/5952-0991

APPLICATION & PRODUCT NOTES

Free Aids to Solving Your Test and Measurement Problems

Application Notes

Measuring the Characteristic Impedance of Balanced Cables Using the HP 4194A
AN 339-4/5950-2918

Measuring the Dielectric Constant of Solid Materials — HP 4194A Impedance/Gain-Phase Analyzer AN 339-13/5950-2935

Multi-frequency C-V Measurements and Doping Profile Analysis of Semiconductors Using the HP 4194A AN 339-5/5950-2919

Multi-frequency C-V Measurements of Semiconductors — HP 4284A Application Information AN 369-5/5950-2953

Negative Impedance Measurements of Crystalline Oscillators Using the HP 4194A
AN 339-9/5950-2924

Parametric Analysis for Electronic Components and Circuit Evaluation Using the HP 4194A AN 339/5950-2856

Practical Design and Evaluation of High Frequency Circuits Using the HP 4193A Vector Impedance Meter
AN 317/5953-6910

S-Parameter Design AN 154/5952-1087
Static Head Testing for Disk Drives
AN 339-6/5952-7871

Static Head Testing for Disk Drives — HP 4194A Application Information
AN 339-6/5952-7871

Tantalum Capacitor Measurement — HP 4284A Application Information
AN 369-2/5950-2950

TDR Fundamentals for use with HP 54120T Digitizing Oscilloscope and TDR
AN 62/5954-2681

Using Impedance Measurement to Evaluate Electronic Components and Materials — HP 4284A Application Information
AN 369-1/5950-2949

Using the HP 5183T to Characterize Sonar Transducers and Systems
AN 340-1/5952-7805

Insertion Gain/Loss

Advanced Filter Evaluation and Limit Testing with the HP 4195A
AN 357-3/5950-2933

Amplifier Measurements Using the Scalar Network Analyzer AN 345-1/5954-1599

Extended Dynamic Range of Scalar Transmission Measurements Using the HP 8757A, 8756A or 8755C Scalar Network Analyzers AN 327-1/5953-8882

Fundamentals of RF and Microwave Noise Figure Measurement AN 57-1/5952-8255

High Frequency Swept Measurements
AN 183/5952-9200

How to Measure Return Loss of Connectorized Optical Components
AN 366-2/5952-9661

Mixer Measurements Using the Scalar Network Analyzer AN 345-2/5954-8369

Network, Spectrum, and Impedance Evaluation of IF Circuits - HP 4195A Network/Spectrum Analyzer
AN 357-1/5950-2931

Noise Figure Measurement Accuracy
AN 57-2/5952-3076

S-Parameter Design AN 154/5952-1087

Interface Bus (HP-IB)

8672A Synthesized Signal Generator - HP 1000 HP-IB Programming

AN 401-15/5953-2814
Microwave Switching from SPDT to Full Access Matrix AN 332/5953-6466

Jitter

High Speed Timing Acquisition and Statistical Jitter Analysis Using the HP 5370B Universal Time Interval Counter
AN 191-7/5952-7908

Jitter and Wander Analysis in Digital Communication with the HP 5371A Frequency and Time Interval Analyzer
AN 358-2/5952-7925

Jitter Tolerance Testing Using External Phase/Frequency Modulated Sources and Bit Error Rate Test Sets
AN 360/5954-9564

Selecting a Jitter Test Set
AN 359/5954-9563

Synthesizing Magnetic Disc Read and Servo Signals with the HP 8770S Arbitrary Waveform Synthesizer System
AN 314-2/5954-6357

Time Domain Characterization of Magnetic Disc Drives AN 358-3/5952-7928

Lightwave

Bit Error Rate Measurements on Optical Fiber Systems AN 362/5952-9650

Characterization of High-Speed Optical Components with an RF Network Analyzer AN 351/5954-8352

High Speed Timing Acquisition and Statistical Jitter Analysis Using the HP 5370B Universal Time Interval Counter
AN 191-7/5952-7908

How to Make Accurate Fiber Optic Power Measurements AN 1034/5952-9646

How to Measure Return Loss in Optical Links AN 366-3/5952-9662

How to Measure Return Loss of Connectorized Optical Components
AN 366-2/5952-9661

Jitter and Wander Analysis in Digital Communication with the HP 5371A Frequency and Time Interval Analyzer
AN 358-2/5952-7925

Lightwave Measurements with the HP 71400 Lightwave Signal Analyzer
AN 371/5954-9137

Logic, Logic Test

A Manager's Guide to Signature Analysis AN 222-3/5952-7592

A Test Set-Up for Characterizing High-Speed Logic Devices AN 381/5953-6329

An Index to Signature Analysis Publications AN 222-0/5952-7625

Determining Digital Circuit Timing Tolerance to Optimize Adjustment or Design
AN 191-2/5952-7488

8161A Programmable Pulse Generator
AN 297-1/5952-9540

Guidelines for Signature Analysis: Understanding the Signature Measurement
AN 222-4/5952-7595

New Techniques of Digital Troubleshooting AN 163-2/5952-7558

Parametric Characterization of Digital Circuits up to 50 MHz AN 319/5952-9549

Testing a Complex LSI/VLSI IC with a Low-Cost Measurement Set-up
AN 341-1/5952-9572

Troubleshooting with Composite Signatures AN 222-6/5952-7684

Loop Gain

Control System Development Using Dynamic Signal Analyzers AN 243-2/5952-5136

Log Sweep with the HP 3582A Spectrum Analyzer AN 245-5/5952-8805

Manufacturing

See *Production Test and Data Acquisition*

Materials Measurements

Canning Process Characterization
AN 421-10/5954-9640

Explosion Testing AN 421-11/5954-9641
Materials Development
AN 421-12/5954-9642

Paper Process Control
AN 421-22/5954-9652

Rolling Mill AN 421-23/5954-9653

Measurement and Control

See *Data Acquisition*

Microprocessors

A Manager's Guide to Signature Analysis AN 222-3/5952-7592

An Index to Signature Analysis Publications AN 222-0/5952-7625

Guidelines for Signature Analysis: Understanding the Signature Measurement
AN 222-4/5952-7595

Troubleshooting with Composite Signatures AN 222-6/5952-7684

Microwave Component

Measurements

Amplifier Measurements Using the Scalar Network Analyzer AN 345-1/5954-1599

Dynamic Component Test Using Vector Modulation Analysis AN 343-2/5954-6367

Mixer Measurements Using the Scalar Network Analyzer AN 345-2/5954-8369

Voltage Controlled Oscillators Characterization Using the HP 5350B, 5351B, 5352B CW Microwave Frequency Counter
AN 181-2/5952-7852

Microwave Signal Sources

Spectral Purity Characteristics of HP Microwave Signal Sources
AN 329/5954-8349

Voltage Controlled Oscillators Characterization Using the HP 5350B, 5351B, 5352B CW Microwave Frequency Counter
AN 181-2/5952-7852

Microwaves

Accurate Mixer/Amplifier Compression Measurement Using the 8901A Modulation Analyzer AN 286-2/5952-8245

Applications and Operation of the 8901A Modulation Analyzer
AN 286-1/5952-8208

Automated Characterization of Microwave Voltage Controlled Oscillators Using the HP 5361A Pulse/CW Microwave Counter
AN 377-2/5952-7988

Automatic Frequency Profiling of Chirped Radar Pulses Using the HP 5361A Pulse/CW Microwave Counter
AN 377-1/5952-7987

Characterization of Frequency Agile Sources with the HP 5371A Frequency and Time Interval Analyzer
AN 358-1/5952-7924

Configuration of a Two-tone Sweeping Generator AN 312-1/5952-9316

Direct Radio Frequency Impedance Measurements Using the 4191A RF Impedance Analyzer AN 302-1/5952-8853

8672A Synthesized Signal Generator - HP 1000 HP-IB Programming AN 401-15/5953-2814

Extended Dynamic Range of Scalar Transmission Measurements Using the HP 8757A, 8756A or 8755C Scalar Network Analyzers AN 327-1/5953-8882

Frequency Profiling Without a Pulse Generator AN 377-3/5952-7991

Fundamentals of Microwave Frequency Counters AN 200-1/5952-7484

Fundamentals of RF and Microwave Noise Figure Measurement AN 57-1/5952-8255

Fundamentals of RF and Microwave Power Measurement AN 64-1/5952-8178

High Frequency Swept Measurements AN 183/5952-9200

How Vector Measurements Expand Design Capabilities - 1 to 1,000 MHz AN 91/5952-0917

Improving Time Domain Network Analysis Measurements AN 62-1/5954-2682

Measurement of Complex Impedance, 1 - 1000 MHz AN 77-3/5952-0991

Microwave Switching from SPDT to Full Access Matrix AN 332/5953-6466

Performance of the HP 8620C Sweep Oscillator Under Remote Programming AN 187-6/5952-9271

Practical Strain Gauge Measurements AN 290-1/5952-8880

Principles of Microwave Connector Care (for Higher Reliability and Better Measurements) AN 326/5954-1566

Quality Gains in Telecom Australia's Digital Microwave Network AN 364-1/5954-9572

Radar System Characterization and Testing Using the HP 5345A/55A/56A,B,C,D Counter AN 174-14/5952-7892

Role of DC Parametric Test in High Speed Digital and Microwave Component Manufacturing AN 339-20/5952-7936

S-Parameter Design AN 154/5952-1087

S-Parameter Techniques for Faster, More Accurate Network Design AN 95-1/5952-1130

Spectral Purity Characteristics of HP Microwave Signal Sources AN 329/5954-8349

Spectrum Analysis . . . AM and FM AN 150-1/5954-9130

Spectrum Analyzer Basics AN 150/5954-9130

TDR Fundamentals for Use with HP 54120T Digitizing Oscilloscope and TDR AN 62/5954-2681

The 8640A/B Third Order Intermodulation Product Characteristics AN 170-2/5952-8129

User's Guide to the 5355/56 Automatic Frequency Converter AN 291-1/5952-7541

Voltage Controlled Oscillators Characterization Using the HP 5350B, 5351B, 5352B CW Microwave Frequency Counter AN 181-2/5952-7852

Mixers

Accurate Mixer/Amplifier Compression Measurement Using the 8901A Modulation Analyzer AN 286-2/5952-8245

Configuration of a Two-tone Sweeping Generator AN 312-1/5952-9316

Fundamentals of RF and Microwave Noise Figure Measurement AN 57-1/5952-8255

Harmonic Distortion Measurements AN 378-1/5952-7253

Mixer Measurements Using the Scalar Network Analyzer AN 345-2/5954-8369

Network, Spectrum, and Impedance Evaluation of IF Circuits - HP 4195A Network/Spectrum Analyzer AN 357-1/5950-2931

Modulation

A Calibrated Signal Simulation System Utilizing I/Q Modulation Techniques AN 343-5/5952-6471

Accurate Mixer/Amplifier Compression Measurement Using the 8901A Modulation Analyzer AN 286-2/5952-8245

Applications and Operation of the 8901A Modulation Analyzer AN 286-1/5952-8208

Characterization of Frequency Agile Sources with the HP 5371A Frequency and Time Interval Analyzer AN 358-1/5952-7924

Coherent Pulsed Tests of Radar and EW Systems AN 343-3/5954-6366

Digital Phase Modulation (PSK) and Wideband FM AN 164-4/5952-8143

Digital Radio Theory and Measurements AN 355/5954-9554

Dynamic Component Test Using Vector Modulation Analysis AN 343-2/5954-6367

Exceptionally Complex Signal Simulation for Multi-Signal Environments in Radar/EW Test AN 314-4/5952-3702

Frequency Profiling Without a Pulse Generator AN 377-3/5952-7991

How Vector Measurements Expand Design Capabilities - 1 to 1,000 MHz AN 91/5952-0917

Jitter and Wander Analysis in Digital Communication with the HP 5371A Frequency and Time Interval Analyzer AN 358-2/5952-7925

Jitter Tolerance Testing Using External Phase/Frequency Modulated Sources and Bit Error Rate Test Sets AN 360/5954-9564

Lightwave Measurements with the HP 71400 Lightwave Signal Analyzer AN 371/5954-9137

Measuring Demodulator Image Rejection Using the HP 8980A Vector Analyzer AN 343-4/5952-3703

Measurements Applications for Digital Microwave Radio AN 343-1/5954-6365

Power Component Testing AN 372-3/5952-4192

Practical Strain Gauge Measurements AN 290-1/5952-8880

Quality Gains in Telecom Australia's Digital Microwave Network AN 364-1/5954-9572

Radar System Characterization and Testing Using the HP 5345A/55A/56A,B,C,D Counter AN 174-14/5952-7892

Using the HP 8980A Vector Analyzer AN 343-4/5952-3703

Receiver Testing with the HP 8770S Arbitrary Waveform Synthesizer System AN 314-1/5954-6358

Selecting a Jitter Test Set AN 359/5954-9563

Simulating Sensor Signals AN 343-5/5952-6471

Spectrum Analysis . . . AM and FM AN 150-1/5954-9130

Voltage Controlled Oscillators Characterization Using the HP 5350B, 5351B, 5352B CW Microwave Frequency Counter AN 181-2/5952-7852

Motion Control

Control System Development Using Dynamic Signal Analyzers AN 243-2/5952-5136

Fundamentals of the z-Domain and Mixed Analog/Digital Measurements AN 243-4/5952-7250

Missile System Testing AN 421-19/5954-9649

Sub-Micro Positioning with the HP 5527A Laser Position Transducer System AN 325-10/5952-7942

Network Analysis

Advanced Filter Evaluation and Limit Testing with the HP 4195A AN 357-3/5950-2933

Amplifier Measurements Using the Scalar Network Analyzer AN 345-1/5954-1599

Antenna Pattern Measurements Using the HP 8510B AN 374-1/5952-6675

Characterization of High-Speed Optical Components with an RF Network Analyzer AN 351/5954-8352

Complete S-Parameter and Distortion Measurement for Wide Band Video Amplifiers with the HP 4195A AN 357-2/5950-2932

Control System Development Using Dynamic Signal Analyzers AN 243-2/5952-5136

Crystal Testing with the 8640A/B and 8405A AN 171-1/5952-8117

Direct Radio Frequency Impedance Measurements Using the 4191A RF Impedance Analyzer AN 302-1/5952-8853

Dynamic Component Test Using Vector Modulation Analysis AN 343-2/5954-6367

How Vector Measurements Expand Design Capabilities - 1 to 1,000 MHz AN 91/5952-0917

Log Sweep with the HP 3582A Spectrum Analyzer AN 245-5/5952-8805

Measurement of Complex Impedance, 1 - 1000 MHz AN 77-3/5952-0991

Measuring the Coherence Function with the HP 3582A Spectrum Analyzer AN 245-2/5952-8768

Microwave Switching from SPDT to Full Access Matrix AN 332/5953-6466

Mixer Measurements Using the Scalar Network Analyzer AN 345-2/5954-8369

Network, Spectrum, and Impedance Evaluation of IF Circuits — HP 4195A Network/Spectrum Analyzer AN 357-1/5950-2931

S-Parameter Design AN 154/5952-1087

APPLICATION & PRODUCT NOTES

Free Aids to Solving Your Test and Measurement Problems

Application Notes

S-Parameter Techniques for Faster, More Accurate Network Design

AN 95-1/5952-1130

The Fundamentals of Signal Analysis

AN 243/5953-8898

Using the HP 5183T to Characterize Sonar Transducers and Systems

AN 340-1/5952-7805

Noise

Fundamentals of RF and Microwave Noise Figure Measurement

AN 57-1/5952-8255

Noise Figure Measurement Accuracy

AN 57-2/5952-3076

Quality Gains in Telecom Australia's Digital Microwave Network

AN 364-1/5954-9572

Time Domain Characterization of Magnetic Disc Drives

AN 358-3/5952-7928

Using the HP 5183T to Characterize Sonar Transducers and Systems

AN 340-1/5952-7805

Non-Linear Systems Measurements

Role of DC Parametric Test in High Speed Digital and Microwave Component Manufacturing

AN 339-20/5952-7936

Oscillators

Applications and Operation of the 8901A Modulation Analyzer

AN 286-1/5952-8208

Automated Characterization of Microwave Voltage Controlled Oscillators Using the HP 5361A Pulse/CW Microwave Counter

AN 377-2/5952-7988

Fundamentals of Quartz Oscillators

AN 200-2/5952-7507

Harmonic Distortion Measurements

AN 378-1/5952-7253

Measuring Fractional Frequency Standard Deviation (Sigma) Versus Averaging Time (TAU)

AN 174-7/5952-7344

Measuring Warm-Up Characteristics and Aging Rates of Oscillators

AN 174-11/5952-7327

Network, Spectrum, and Impedance Evaluation of IF Circuits - HP 4195A Network/Spectrum Analyzer

AN 357-1/5950-2931

S-Parameter Techniques for Faster, More Accurate Network Design

AN 95-1/5952-1130

Spectral Purity Characteristics of HP Microwave Signal Sources

AN 329/5954-8349

Oscilloscopes

Bandwidth and Sampling Rate in Digitizing Oscilloscopes

AN 344/5954-2631

TDR Fundamentals for Use with HP 54120T Digitizing Oscilloscope and TDR

AN 62/5954-2681

Voltage and Time Resolution in Digitizing Oscilloscopes

AN 348/5954-2652

Phase Linearity

Complete S-Parameter and Distortion Measurement for Wide Band Video Amplifiers with the HP 4195A

AN 357-2/5950-2932

Direct Radio Frequency Impedance Measurements Using the 4191A RF Impedance Analyzer

AN 302-1/5952-8853

Voltage Controlled Oscillators Characterization Using the HP 5350B, 5351B, 5352B CW Microwave Frequency Counter

AN 181-2/5952-7852

Phase Shift

Crystal Testing with the 8640A/B and 8405A

AN 171-1/5952-8117

Jitter and Wander Analysis in Digital Communication with the HP 5371A Frequency and Time Interval Analyzer

AN 358-2/5952-7925

Making Automatic Phase Measurements with the HP 5345A Electronic Counter

AN 174-9/5952-7325

Using the HP 5183T to Characterize Sonar Transducers and Systems

AN 340-1/5952-7805

Phase Stability

Communications Cable Testing

AN 421-8/5954-9638

Jitter and Wander Analysis in Digital Communication with the HP 5371A Frequency and Time Interval Analyzer

AN 358-2/5952-7925

Power Measurement

Battery Testing

AN 372-2/5952-4191

Biasing Three-Terminal Devices for Test

AN 376-1/5952-4193

Fundamentals of RF and Microwave Power Measurement

AN 64-1/5952-8178

High Frequency Swept Measurements

AN 183/5952-9200

How to Make Accurate Fiber Optic Power Measurements

AN 1034/5952-9646

Power Component Testing

AN 372-3/5952-4192

Power Supply Testing

AN 372-1/5952-4190

Power Supplies

Battery Charging/Discharging

AN 250-2/5952-4033

DC Power Supply Handbook

AN 90B/5952-4020

Power Supply Programming with the 6942A Multiprogrammer

AN 316-4/5952-4075

Power Supply Testing

AN 372-1/5952-4190

Power Supplies

AN 250-2/5952-4033

Environmental/Autoclave Testing

AN 421-7/5954-9637

Introduction to Computer Aided Test

AN 316-0/5952-4102

Machine Monitoring and Control

AN 421-20/5954-9650

Materials Development

AN 421-12/5954-9642

Paper Process Control

AN 421-22/5954-9652

Pharmaceutical Process Control

AN 421-21/5954-9651

Pilot Plant monitoring

AN 421-15/5954-9645

Plating Line Control

AN 421-13/5954-9643

Power Supply Programming with the 6942A Multiprogrammer

AN 316-4/5952-4075

Role of DC Parametric Test in High Speed Digital and Microwave Component Manufacturing

AN 339-20/5952-7936

Rolling Mill

AN 421-23/5954-9653

Using the HP 3497A to Control Industrial Wastewater Treatment

AN 290-2/5953-6921

Waste Water Treatment

AN 421-4/5954-9634

Production Test

Accessing the HP 3582A Memory with HP-IB

AN 245-4/5952-8804

Appliance Testing

AN 421-24/5954-9654

Battery Testing

AN 421-14/5954-9644

Battery Testing

AN 372-2/5952-4191

Biasing Three-Terminal Devices for Test

AN 376-1/5952-4193

Data Capture with the 6942A/6944A Multiprogrammers

AN 316-5/5952-4116

Disk Drive Servo-Track Writing with Laser Interferometers

AN 325-11/5952-7984

Environmental/Autoclave Testing

AN 421-7/5954-9637

Fan Testing

AN 421-2/5954-9632

Harmonic Distortion Measurements

AN 378-1/5952-7253

Introduction to Computer Aided Test

AN 316-0/5952-4102

Internal Combustion Engine Testing

AN 421-6/5954-9636

Jet Engine Controller Testing

AN 421-5/5954-9635

Jet Engine Testing

AN 421-16/5954-9646

Large Product Characterization

AN 421-18/5954-9648

Missile System Testing

AN 421-19/5954-9649

Parametric Analysis for Electronic Components and Circuit Evaluation Using the HP 4194A

AN 339/5950-2856

Power Component Testing

AN 372-3/5952-4192

Power Supply Programming with the 6942A Multiprogrammer

AN 316-4/5952-4075

Power Supply Testing

AN 372-1/5952-4190

Power Supplies

AN 250-2/5952-4033

Practical Strain Gauge Measurements

AN 290-1/5952-8880

Receiver Testing with the HP 8770S Arbitrary Waveform Synthesizer System

AN 314-1/5954-6358

Reducing Fixture-Induced Test Failures

AN 340-1/5952-7805

Role of DC Parametric Test in High Speed Digital and Microwave Component Manufacturing

AN 339-20/5952-7936

Synthesizing Magnetic Disc Read and Servo Signals with the HP 8770S Arbitrary Waveform Synthesizer System

AN 314-2/5954-6357

Understanding Your Test Fixture

AN 324-1/5953-6951

Using the HP 5183T to Characterize Sonar Transducers and Systems

AN 340-1/5952-7805

Protocol Analysis

AN 424/5952-5131

Keeping Your Big Blue Network in the Pink

AN 425/5952-5132

The Care and Feeding of Your X-25 Network

AN 425/5952-5132

Pulse Measurements

Automated Reverse Recovery Time Measurements of Diodes AN 297-2/**5952-9542**
Automatic Frequency Profiling of Chirped Radar Pulses Using the HP 5361A Pulse/CW Microwave Counter AN 377-1/**5952-7987**

Characterization of Frequency Agile Sources with the HP 5371A Frequency and Time Interval Analyzer AN 358-1/**5952-7924**

Dynamic Component Test Using Vector Modulation Analysis AN 343-2/**5954-6367**

Frequency Profiling Without a Pulse Generator AN 377-3/**5952-7991**

Radar System Characterization and Testing Using the HP 5345A/55A/56A,B,C,D Counter AN 174-14/**5952-7892**

Radar

Amplifier Measurements Using the Scalar Network Analyzer AN 345-1/**5954-1599**

Automatic Frequency Profiling of Chirped Radar Pulses Using the HP 5361A Pulse/CW Microwave Counter AN 377-1/**5952-7987**

Characterization of Frequency Agile Sources with the HP 5371A Frequency and Time Interval Analyzer AN 358-1/**5952-7924**

Coherent Pulsed Tests of Radar and EW Systems AN 343-3/**5954-6366**

Dynamic Component Test Using Vector Modulation Analysis AN 343-2/**5954-6367**

Exceptionally Complex Signal Simulation for Multi-Signal Environments in Radar/EW Test AN 314-4/**5952-3702**

Frequency Profiling Without a Pulse Generator AN 377-3/**5952-7991**

Low Phase Noise Applications of the HP 8662A and 8663A Synthesized Signal Generators AN 283-3/**5952-8435**

Microwave Switching from SPDT to Full Access Matrix AN 332/**5953-6466**

Mixer Measurements Using the Scalar Network Analyzer AN 345-2/**5954-8369**

Radar System Characterization and Testing Using the HP 5345A/55A/56A,B,C,D Counter AN 174-14/**5952-7892**

Receiver Testing with the HP 8770S Arbitrary Waveform Synthesizer System AN 314-1/**5954-6358**

User's Guide to the 5355/56 Automatic Frequency Converter AN 291-1/**5952-7541**

Voltage Controlled Oscillators Characterization Using the HP 5350B, 5351B, 5352B CW Microwave Frequency Counter AN 181-2/**5952-7852**

Receivers

Applications & Performance of the HP 8671A and 8672A Microwave Synthesizers AN 218-1/**5952-8219**

Configuration of a Two-tone Sweeping Generator AN 312-1/**5952-9316**

Digital Phase Modulation (PSK) and Wideband FM AN 164-4/**5952-8143**

Exceptionally Complex Signal Simulation for Multi-Signal Environments in Radar/EW Test AN 314-4/**5952-3702**

Fundamentals of RF and Microwave Noise Figure Measurement AN 57-1/**5952-8255**

HP 8640A/B Signal Generator Output Level Accuracy AN 170-1/**5952-1218**

Measurements Applications for Digital Microwave Radio AN 343-1/**5954-6365**

Measuring Demodulator Image Rejection Using the HP 8980A Vector Analyzer AN 343-4/**5952-3703**

Receiver Testing with the HP 8770S Arbitrary Waveform Synthesizer System AN 314-1/**5954-6358**

The 8640A/B Third Order Intermodulation Product Characteristics AN 170-2/**5952-8129**

Reflectometers

High Frequency Swept Measurements AN 183/**5952-9200**

How to Measure Return Loss of Connectorized Optical Components AN 366-2/**5952-9661**

Measurement of Complex Impedance, 1 - 1000 MHz AN 77-3/**5952-0991**

S-Parameter Design AN 154/**5952-1087**

Remote Control

Performance of the HP 8620C Sweep Oscillator Under Remote Programming AN 187-6/**5952-9271**

Using the HP 3497A to Control Industrial Wastewater Treatment AN 290-2/**5953-6921**

RFI Testing

Automatic CISPR EMI Testing for Conducted Emissions AN 331-1/**5954-2724**

Automatic MIL-STD EMI Testing Using the HP 85864A/B EMI Measurement Software AN 330-1/**5954-2705**

Semiconductors

Analysis of Semiconductor Capacitance Characteristics Using the HP 4280A 1 MHz C Meter/C-V Plotter AN 322/**5953-6939**

Automated Reverse Recovery Time Measurements of Diodes AN 297-2/**5952-9542**

Automation of Semiconductor Parameter Analysis AN 334/**5952-7765**

8161A Programmable Pulse Generator AN 297-1/**5952-9540**

High-Speed DC Characterization of Semiconductor Devices from Sub pA to 1A AN 356-1/**5950-2930**

Parametric Characterization of Digital Circuits up to 50 MHz AN 319/**5952-9549**

Role of DC Parametric Test in High Speed Digital and Microwave Component Manufacturing AN 339-20/**5952-7936**

Semiconductor Measurements with the HP 4140B Picoammeter/DC Voltage Source AN 238/**5952-8840**

Sub-Micro Positioning with the HP 5527A Laser Position Transducer System AN 325-10/**5952-7942**

Techniques and Applications for High Throughput and Stable Characterization AN 356-1/**5950-2954**

Ultra Low Current Semiconductor DC Parameter Measurement System Using HP 4140B AN 238-1/**5953-8873**

Signal Sources

Applications & Performance of the HP 8671A and 8672A Microwave Synthesizers AN 218-1/**5952-8219**

Configuration of a Two-tone Sweeping Generator AN 312-1/**5952-9316**

Crystal Testing with the 8640A/B and 8405A AN 171-1/**5952-8117**

Exceptionally Complex Signal Simulation for Multi-Signal Environments in Radar/EW Test AN 314-4/**5952-3702**

Extended Dynamic Range of Scalar Transmission Measurements Using the HP 8757A, 8756A or 8755C Scalar Network Analyzers AN 327-1/**5953-8882**

External Frequency Doubling of the 8662A Synthesized Signal Generator AN 283-2/**5952-8217**

HP 8640A/B Signal Generator Output Level Accuracy AN 170-1/**5952-1218**

Low Phase Noise Applications of the HP 8662A and 8663A Synthesized Signal Generators AN 283-3/**5952-8435**

Obtaining Leveled Pulse-Modulated Microwave Signals from the HP 8672A AN 218-5/**5952-8251**

Obtaining Millihertz Resolution from the 8671A and 8672A AN 218-2/**5952-8184**

Performance of the HP 8620C Sweep Oscillator Under Remote Programming AN 187-6/**5952-9271**

The 8640A/B Third Order Intermodulation Product Characteristics AN 170-2/**5952-8129**

Using the HP 5183T to Characterize Sonar Transducers and Systems AN 340-1/**5952-7805**

Signature Analysis

A Manager's Guide to Signature Analysis AN 222-3/**5952-7592**

An Index to Signature Analysis Publications AN 222-0/**5952-7625**

Guidelines for Signature Analysis: Understanding the Signature Measurement AN 222-4/**5952-7595**

Troubleshooting with Composite Signatures AN 222-6/**5952-7684**

Smith Chart

Measurement of Complex Impedance, 1 - 1000 MHz AN 77-3/**5952-0991**

S-Parameter Design AN 154/**5952-1087**

S-Parameter Techniques for Faster, More Accurate Network Design AN 95-1/**5952-1130**

S-Parameters

Complete S-Parameter and Distortion Measurement for Wide Band Video Amplifiers with the HP 4195A AN 357-2/**5950-2932**

S-Parameter Design AN 154/**5952-1087**

S-Parameter Techniques for Faster, More Accurate Network Design AN 95-1/**5952-1130**

Spectrum Analysis

Accessing the HP 3582A Memory with HP-IB AN 245-4/**5952-8804**

Complete S-Parameter and Distortion Measurement for Wide Band Video Amplifiers with the HP 4195A AN 357-2/**5950-2932**

Effective Machinery Maintenance Using Vibration Analysis AN 243-1/**5953-5113**

Harmonic Distortion Measurements AN 378-1/**5952-7253**

APPLICATION & PRODUCT NOTES

Free Aids to Solving Your Test and Measurement Problems

Application Notes & Product Notes

Log Sweep with the HP 3582A Spectrum Analyzer AN 245-5/5952-8805

Measuring Phase Noise with the HP 3585A Spectrum Analyzer AN 246-2/5952-8838

Measuring the Coherence Function with the HP 3582A Spectrum Analyzer AN 245-2/5952-8768

Network, Spectrum, and Impedance Evaluation of IF Circuits - HP 4195A Network/Spectrum Analyzer AN 357-1/5950-2931

Optimizing the Dynamic Range of the HP 3585A Spectrum Analyzer AN 246-1/5952-8815

Spectrum Analysis . . . AM and FM AN 150-1/5954-9130

Spectrum Analyzer Basics AN 150/5952-1213

The Fundamentals of Modal Testing AN 243-3/5952-7957

The Fundamentals of Signal Analysis AN 243/5953-8898

Third Octave Analysis with the HP 3582A Spectrum Analyzer AN 245-3/5952-8800

Using the HP 3585A Spectrum Analyzer with the HP 9825A Computing Controller AN 246/5952-8765

Stripline Device Measurements

TDR Fundamentals for use with HP 54120T Digitizing Oscilloscope and TDR AN 62/5954-2681

Swept-Frequency Measurements

Amplifier Measurements Using the Scalar Network Analyzer AN 345-1/5954-1599

Characterization of High-Speed Optical Components with an RF Network Analyzer AN 351/5954-8352

Configuration of a Two-tone Sweeping Generator AN 312-1/5952-9316

Extended Dynamic Range of Scalar Transmission Measurements Using the HP 8757A, 8756A or 8755C Scalar Network Analyzers AN 327-1/5953-8882

Harmonic Distortion Measurements AN 378-1/5952-7253

How to Measure Return Loss of Connectorized Optical Components AN 366-2/5952-9661

Low Phase Noise Applications of the HP 8662A and 8663A Synthesized Signal Generators AN 283-3/5952-8435

Mixer Measurements Using the Scalar Network Analyzer AN 345-2/5954-8369

Optimizing the Dynamic Range of the HP 3585A Spectrum Analyzer AN 246-1/5952-8815

Performance of the HP 8620C Sweep Oscillator Under Remote Programming AN 187-6/5952-9271

Spectral Purity Characteristics of HP Microwave Signal Sources AN 329/5954-8349

Spectrum Analyzer Basics AN 150/5952-1213

Using the HP 5183T to Characterize Sonar Transducers and Systems AN 340-1/5952-7805

Switching

Data Acquisition and Computer Aided Test Application Notes for 32 Industries in Series AN 421-1/5954-9631

Missile System Testing

AN 421-19/5954-9649

Novel Combinations of Microwave Switches and Step Attenuators for Programming Applications AN 332-1/5953-8892

Practical Test System Signal Switching AN 328-1/5953-6962

SWR

Extended Dynamic Range of Scalar Transmission Measurements Using the HP 8757A, 8756A or 8755C Scalar Network Analyzers AN 327-1/5953-8882

Measurement of Complex Impedance, 1 - 1000 MHz AN 77-3/5952-0991

Synthesizers/Signal Generators

A Stimulus for Automatic Test AN 289/5952-9517

Digital Phase Modulation (PSK) and Wideband FM AN 164-4/5952-8143

8672A Synthesized Signal Generator - HP 1000 HP-IB Programming AN 401-15/5953-2814

Exceptionally Complex Signal Simulation for Multi-Signal Environments in Radar/EW Test AN 314-4/5952-3702

External Frequency Doubling of the 8662A Synthesized Signal Generator AN 283-2/5952-8217

Jitter Tolerance Testing Using External Phase/Frequency Modulated Sources and Bit Error Rate Test Sets AN 360/5954-9564

Low Phase Noise Applications of the HP 8662A and 8663A Synthesized Signal Generators AN 283-3/5952-8435

Rotation Simulation and ADC Testing with Synthesized Signals AN 373/5952-9693

Spectral Purity Characteristics of HP Microwave Signal Sources AN 329/5954-8349

Tap Recording

Synthesizing Magnetic Disc Read and Servo Signals with the HP 8770S Arbitrary Waveform Synthesizer System AN 314-2/5954-6357

Time Domain Characterization of Magnetic Disc Drives AN 358-3/5952-7928

Telecommunications

Amplifier Measurements Using the Scalar Network Analyzer AN 345-1/5954-1599

An Introduction to Signaling AN 336/5952-5034

Applications & Performance of the HP 8671A and 8672A Microwave Synthesizers AN 218-1/5952-8219

Characterization of High-Speed Optical Components with an RF Network Analyzer AN 351/5954-8352

Detection of High Level Signals In FDM Networks AN 323/5953-5411

Digital Radio Theory and Measurements AN 355/5954-9554

Exceptionally Complex Signal Simulation for Multi-Signal Environments in Radar/EW Test AN 314-4/5952-3702

High Speed Measurement of Semiconductor Devices from Sub-PA to 1A AN 356/5950-2930

High Speed Timing Acquisition and Statistical Jitter Analysis Using the HP 5370B Universal Time Interval Counter AN 191-7/5952-7908

How to Measure Return Loss of Connectorized Optical Components AN 366-2/5952-9661

Integrated Services Digital Network (ISDN) 23B&D Primary Access Rate (PAR) and Digital Multiplexed Interface (DMI) Testing Using the HP 3787B and Protocol Analyzer AN 368/5959-8215

Jitter Tolerance Testing Using External Phase/Frequency Modulated Sources and Bit Error Rate Test Sets AN 360/5954-9564

Making Telecommunication Measurements in Complex Impedances AN 231-3/5953-5484

Measurements Applications for Digital Microwave Radio AN 343-1/5954-6365

Mixer Measurements Using the Scalar Network Analyzer AN 345-2/5954-8369

Quality Gains in Telecom Australia's Digital Microwave Network AN 364-1/5954-9572

Receiver Testing with the HP 8770S Arbitrary Waveform Synthesizer System AN 314-1/5954-6358

Return Loss and the HP 4937A AN 335/5952-5033

Selecting a Jitter Test Set AN 359/5954-9563

The Benefits of P/AR AN 318-1/5952-4996D

Television

High Speed Measurement of Semiconductor Devices from Sub-PA to 1A AN 356/5950-2930

Temperature Measurement

Appliance Testing AN 421-24/5954-9654

Battery Testing AN 421-14/5954-9644

Communications Cable Testing AN 421-8/5954-9638

Environmental/Autoclave Testing AN 421-7/5954-9637

Explosion Testing AN 421-11/5954-9641

Facility Management AN 421-17/5954-9647

Internal Combustion Engine Testing AN 421-6/5954-9636

Jet Engine Controller Testing AN 421-5/5954-9635

Jet Engine Testing AN 421-16/5954-9646

Large Product Characterization AN 421-18/5954-9648

Machine Monitoring and Control AN 421-20/5954-9650

Materials Development AN 421-12/5954-9642

Missile System Testing AN 421-19/5954-9649

Paper Process Control AN 421-22/5954-9652

Pharmaceutical Process Control AN 421-21/5954-9651

Pilot Plant Monitoring AN 421-15/5954-9645

Residential Facility Monitoring AN 421-9/5954-9639

Rolling Mill AN 421-23/**5954-9653**
 Waste Water Treatment
 AN 421-4/**5954-9634**

Throughput Analysis

High Speed Timing Acquisition and Statistical Jitter Analysis Using the HP 5370B Universal Time Interval Counter
 AN 191-7/**5952-7908**

Time-Interval

Automated Reverse Recovery Time Measurements of Diodes AN 297-2/**5952-9542**
 Automatic Zero Calibration of the HP 5359A Time Synthesizer at a Designated Remote Location AN 191-1/**5952-7487**
 Determining Digital Circuit Timing Tolerance to Optimize Adjustment or Design
 AN 191-2/**5952-7488**
 Measurement of Propagation Delays Using the HP 5370B Time Interval Counter and HP 5363B Time Interval Probes
 AN 191-5/**5952-7563**

Precise Cable Length and Matching Measurements Using the HP 5370B Universal Time Interval Counter and HP 5363B Time Interval Probes AN 191-6/**5952-7568**

Radar System Characterization and Testing Using the HP 5345A/55A/56A,B,C,D Counter AN 174-14/**5952-7892**

Time Domain Characterization of Magnetic Disc Drives AN 358-3/**5952-7928**

Time Interval Measurement Using an Electronic Counter AN 200-3/**5952-7561**

Understanding Frequency Counter Specifications AN 200-4/**5952-7522**

Transistor Parameters

Automation of Semiconductor Parameter Analysis AN 334/**5952-7765**

Biasing Three-Terminal Devices for Test AN 376-1/**5952-4193**

Fundamentals of RF and Microwave Noise Figure Measurement AN 57-1/**5952-8255**

Power Component Testing AN 372-3/**5952-4192**

Role of DC Parametric Test in High Speed Digital and Microwave Component Manufacturing AN 339-20/**5952-7936**

S-Parameter Techniques for Faster, More Accurate Network Design
 AN 95-1/**5952-1130**

Transmission Lines

Improving Time Domain Network Analysis Measurements AN 62-1/**5954-2682**

TDR Fundamentals for use with HP 54120T Digitizing Oscilloscope and TDR
 AN 62/**5954-2681**

Troubleshooting

A Manager's Guide to Signature Analysis AN 222-3/**5952-7592**

An Index to Signature Analysis Publications AN 222-0/**5952-7625**

Guidelines for Signature Analysis: Understanding the Signature Measurement
 AN 222-4/**5952-7595**

New Techniques of Digital Troubleshooting AN 163-2/**5952-7558**

Principles of Microwave Connector Care (for Higher Reliability and Better Measurements)
 AN 326/**5954-1566**

Troubleshooting with Composite Signatures AN 222-6/**5952-7684**

Vector Measurements

HP 8640A/B Signal Generator Output Level Accuracy AN 170-1/**5952-1218**

Quality Gains in Telecom Australia's Digital Microwave Network AN 364-1/**5954-9572**

S-Parameter Design AN 154/**5952-1087**

S-Parameter Techniques for Faster, More Accurate Network Design
 AN 95-1/**5952-1130**

AN 95-1/**5952-1130**

Voltage

Applications and Operation of the 8901A Modulation Analyzer AN 286-1/**5952-8208**

Voltage-Controlled Oscillators (VCOs)

Measuring Warm-Up Characteristics and Aging Rates of Oscillators
 AN 174-11/**5952-7327**

Wave Analysis

Bandwidth and Sampling Rate in Digitizing Oscilloscopes AN 344/**5954-2631**

Understanding and Using Phase Noise in the Frequency Domain AN 207/**5952-8708**

Voltage and Time Resolution in Digitizing Oscilloscopes AN 348/**5954-2652**

Product Notes

1631A/D-1/**5954-2618**
 A Guide to Cross-Domain Analysis

3065-2/**5954-5971**

Safeguard In-circuit

3065-3/**5954-5979**

Adding Remote Fixturing Capability to the HP 3065

3065-4/**5954-8670**

Fixturing for High-speed Integrity on the HP 3065 at Combinational Test System

3235-1/**5953-7023**

Programming Guide to the HP 3235A Switch/ Test Unit and the HP System 1000

3314A-1/**5953-5102**

Operator's Introduction to the HP 3314A

3324A/**5952-9693**

Rotation Simulation and ADC Testing with Synthesized Signals Using the HP 3324A

3325B-1/**5954-7987**

Remote Operation of the HP 3325B via RS-232

3326A-1/**5953-5134**

Introductory Operating Guide to the HP

3326A Two-channel Synthesizer

3421A-2/**5953-6987**

The 3421A Data Acquisition/Control Unit

3458-1/**5953-7058**

Optimizing Throughput and Reading Rate

3458-2/**5953-7059**

High Resolution Digitizing with the HP 3458A

3458-3/**5953-7060**

Electronic Calibration of the HP 3458A

3468A-1/**5953-6902**

Using the HP 3468A

3478A-1/**5953-6901**

Using the HP 3478A

3488A-1/**5953-6959**

Using the HP 3488A

3561A/**5953-5186**

HP-IB Programming Commands for the HP 3561A Dynamic Signal Analyzer

3561A-1/**5953-5114**

Using the HP 3561A Dynamic Signal Analyzer

3561A-2/**5952-4819**

Acoustic Measurements with the HP 3561A 3562/**5953-5183**

Programming Guide for the HP 3562A Dynamic Signal Analyzer with the HP 9000 Basic Workstation

3562A-1/**5954-7973**

Operator's Introduction to the HP 3562A Dynamic Signal Analyzer

3562A-2/**5953-5191**

Signal Switching and Multi-channel Measurements with the HP 3562A Dynamic Signal Analyzer

3577A-1/**5953-5119**

User's Guide to the HP 3577A Network Analyzer

3577A-2/**5953-5131**

Loop Gain Measurements with the HP 3577A Network Analyzer

3585A/**5952-8764**

Understanding the HP 3585A Spectrum Analyzer

3708-1/**5953-5487**

Noise and Interference Effects in Microwave Radio Systems

3708-2/**5953-5489**

Using the HP 3708 on Microwave Radio Testing

3708-3/**5953-5490**

Determination of Residual Bit-Error Ratio in Digital Microwave Systems

3708-4/**5954-9551**

Demonstration Guide: How to Win with the HP 3708A

3708-5/**5954-9555**

Testing Satellite Systems with the HP 3708A

3730-1/**5953-5468**

High Accuracy RF Measurements Using the HP 3730B

3776-1/**5953-5440**

Measurement Principles

3776-3/**5953-5461**

Getting the Most Out of Your Group Delay/Envelope Delay Measurement

3776-4/**5953-5462**

Getting the Most Out of Your End-to-End Measurements

3776-5/**5953-5463**

Simulation of Line Signaling and Dialing with the HP 3776A

3776-6/**5953-5464**

Simulation of Line Signaling and Dialing with the HP 3776B

3785-1/**5953-5429**

Practical Jitter Measurements

3800/**5952-5138**

SNA Network Performance Analysis

3852-1/**5953-7011**

Programming Guide to the HP 3852A and the HP 1000

3852-3/**5953-7043**

Multitasking on the HP 3852A Data Acquisition/Control Unit

APPLICATION & PRODUCT NOTES

Free Aids to Solving Your Test and Measurement Problems

Product Notes

- 3585A/5952-8764
Understanding the HP 3585A Spectrum Analyzer
- 4835A-1/5952-4988
Datacom Channel Testing with an HP 4935A
- 4937S/5952-5032
HP 4937S Product Note
- 4945A/5952-5025
HP 4845A Master/Slave Product Note
- 4948A-1/5954-7913
Measurement Principles
- 4948A-2/5954-9552
Network Monitoring System Demonstration Software for the HP 4948A
- 4954A-1/5952-5138
SNA Network Performance Analysis
- 4954A-2/5952-5120
X.25 Network Performance Analysis
- 4972A-1/5952-5103
LAN Performance Analysis
- 5180A-2/5952-7629
Dynamic Performance Testing of A-to-D Converters
- 5180A-3/5952-7643
General Purpose Subroutines for the HP 5180A Waveform Recorders
- 5182A-1/5952-7733
Understanding the HP 5182A Waveform Recorder/Generator
- 5334A-1/5952-7699
Remote and Front Panel Operation of the HP 5334A Universal Counter
- 5335A/5952-7604
HP 5335A Universal Counter User's Introduction
- 5370B-2/5952-7834
Better than 100 ps Accuracy in HP 5370B Time Interval Measurements
- 5370B-3/5952-7769
High Throughput Picosecond Characterization of Pulse Parameters
- HP 5384A/5385A-1/5952-7700
5384A and 5385A Frequency Counter User's Guide
- 5527A-1/5952-7946
Rapid Data Collection with the HP 5527A Laser Position Transducer System
- 5527A-2/5952-7973
Achieving Maximum Accuracy and Repeatability with the HP 5527A Laser Position Transducer System
- 6940B-1/5952-4076
Scanning with the 6940B
- 6940B-3/5952-4086
Subassembly Testing
- 6940B-4/5952-4094
Automating Manual Equipment
- 6940B-4/5952-4094
Basic Research
- 6940B-6/5952-4097
Product Evaluation
- 6942A-1/5952-4080
A Multiprogrammer Application Story in Production Line Testing
- 6942A-2/5952-4095
A Multiprogrammer Application Story in Heavy Industry
- 6942A-3/5952-4096
A Multiprogrammer Application Story in Instrument Control
- 8340-2/5954-1595
Generating Phase-Coherent Microwave Signals with the HP 8340 and 8341 Synthesized Sweepers
- 8340-3/5954-8389
Typical Performance of the 8340 and 8341 Synthesized Sweepers
- 8340A-1/5953-8870
Increasing the Frequency Switching Speed on the HP 8340A Synthesized Sweeper
- 8349-1/5954-1516
Achieving Calibrated Output Power with the HP 8350 Sweep Oscillator/8349 Broadband Amplifier Combination
- 8350-4/5954-1505
Pulse Modulation Characteristics of the HP 83500 Series Sweep Oscillator RF Plug-ins
- 8350-6/5952-9345
Reduced Harmonic Distortion Using the Integra TMF-1800H Tracking Filter with the 8350 Sweep Oscillator
- 8350-8/5954-1507
Leveling the HP 8350B Sweep Oscillator with an HP 430 Series Power Meter
- 8350-9/5954-8344
Improving the Output Power Flatness from the HP 8350B Sweep Oscillator
- 8350-1/5952-9328
Using the HP 8350A Sweep Oscillator with the Wiltron-560 Scalar Network Analyzer
- 8350A-2/5952-9330
Improved Frequency Accuracy by Calibrating HP 83590 Series RF Plug-ins to HP 8350A Sweep Oscillator Mainframe
- 8350A-7/5952-9344
Microwave Noise Figure Measurements Using the HP 8350A Sweep Oscillator with the HP 8970A Noise Figure Meter
- 8408B-1/5953-8851
Building Your Own HP 8408B Automatic Network Analyzer
- 8510-2/5954-1522
Radar Cross-Section Measurements with the HP 8510 Network Analyzer
- 8510-3/5954-1535
Measuring Dielectric Constant with the HP 8510 Network Analyzer
- 8510-5A/5956-4352
Specifying Calibration Standards for the HP 8510B Network Analyzer
- 8510-6/5954-1579
On-wafer Measurements Using the HP 8510 Network Analyzer
- 8510-7/5954-8379
Amplitude and Phase Measurements of Frequency Translation Devices with the HP 8510B
- 8510-8/5954-8382
Applying the HP 8510B TRL Calibration for Non-coaxial Measurements
- 8510-9/5956-4333
Pulsed RF Network Measurements Using the HP 8510B
- 8510-10/5954-8367
An Introduction to Operating the HP 8510B Network Analyzer
- 8510-12/5956-4331
Millimeter-wave Measurements Using the HP 8510B Network Analyzer
- 8510-13/5956-4373
Measuring Noninsertable Devices
- 8510-14/5952-6674
Using Multiple Test Sets with the HP 8510B
- 8566B/68B-1/5954-2701
Third-Order Intermodulation Distortion Measurements
- 8620C-1/5952-9327
Using the HP 8620C Sweep Oscillator with the Wiltron 560 Scalar Network Analyzer
- 8642A/B-1/5953-8453
The Benefits and Use of the HP 8642A/B
- 8642A/B-2/5953-8452
Using Sweep Functions on the HP 8642A/B
- 8644A/5951-6727
Series 200/300 HP-SL Programming Guide
- 8645-1/5951-6711
Agile Operation of the HP 8645A
- 8645-2/5951-6712
A Catalog of HP 8645A Information
- 8665A/5951-6727
Series 200/300 HP-SL Programming Guide
- 8673A-1/5952-8290
Reducing HP 8673A Signal Generator Harmonically Related Spurious with Integra TMF-1800K Tunable Microwave Filter
- 8683/4-1/5952-8260
Applications and Performance of the 8683A/B and 8684A/B Microwave Signal Generators
- 8683/4-2/5952-8298
Performance and Applications of the HP 8683/4D Microwave Signal Generators
- 8753-1/5956-4361
Amplifier Measurements Using the HP 8753 Network Analyzer
- 8753-2/5956-4362
Mixer Measurements Using the HP 8753B Network Analyzer
- 8756-2/5954-1506
Using the HP 11664C Detector Adapter to Make Millimeter-wave Scalar Measurements
- 8756-4/5953-8894
How to Automate the HP 5344S Source Synchronizer, the HP 8350B Sweep Oscillator, and the HP 8756 Scalar Analyzer with an HP Series 200 Computer
- 8756A-1/5953-8869
Automating the HP 8756A Scalar Network Analyzer
- 8757-1/5954-8386
Using AC Detection with the HP 8756/8757 Scalar Network Analyzers to Make More Accurate Measurements
- 8757-2/5954-8380
V and W Band Millimeter Scalar Measurements Using the HP 8757 Scalar Network Analyzer
- 8757-5/5954-1537
Measuring Voltage-Controlled Devices with the HP 8757A Scalar Network Analyzer
- 8757-6/5954-8347
Automated Amplifier Measurements Using the HP 8756/8757 Scalar Network Analyzers

- 8770S-2/**5954-6360**
Effective Use of the HP 8770S Signal Simulator System
- 8780A-1/**5954-6368**
Introductory Operating Guide to the HP 8780A Vector Signal Generator
- 8901A-1/**5952-8248**
Extending the Frequency Range of the 8901A Modulation Analyzer
- 8902A-2/**5953-8436**
Accurate Signal Characterization at Millimeter-wave Frequencies
- 8903A-1/**5952-8246**
Operating the 8903A Audio Analyzer Below 20 Hz
- 8904A/**5951-6715**
A Book of Ideas for Creating Waveforms with the HP 8904A
- 8904A-1/**5953-8489**
Using the HP 8904A Multifunction Synthesizer as a Communications Signaling Source
- 8904A-2/**5953-8487**
Using the HP 8904A Multifunction Synthesizer as an FM Stereo Composite Generator
- 8904A-3/**5953-8488**
Using the HP 8904A Multifunction Synthesizer as a Modulation Source for Navigation Applications
- 8904A-4/**5951-6731**
Using the HOP RAM Sequence Mode Special Option H-08 for the HP 8904A Multifunction Synthesizer
- 8970B/S-2/**5954-8896**
Applications and Operation of the HP 8970B Noise Figure Meter and HP 8970S MW Noise Figure Measurement System
- 8970B/S-3/**5952-6639**
Noise Parameter Measurement Using the HP 8970B Noise Figure Meter and the ATN Model NP4 Noise Parameter Test Set
- 8980A-1/**5954-6369**
Introductory Operating Guide to the HP 8980A Vector Analyzer
- 8980A-2/**5952-3704**
Dynamic Range Considerations of the HP 8980A Vector Analyzer
- 11729B-1/**5952-8286**
Phase Noise Characterization of Microwave Oscillators (Phase Detector Method)
- 11729C-2/**5953-6497**
Phase Noise Characterization of Microwave Oscillator (Frequency Discriminator Method)
- 11970-71/**5954-9100**
HP 11970-71 Series Harmonic Mixers
- 34800-1/**5953-7028**
Programming and Demo Guide to the HP FTM/300 Functional Test Manager Software Package
- 35650/**5954-7965**
Introduction to Programming the HP 35650 Series Hardware
- 35651A-1/**5954-7965**
Introduction to Programming the HP 35650 Series Hardware
- 35660A-1/**5954-7996**
Production Testing with the HP 35660A Dynamic Signal Analyzer
- 35660A-2/**5954-7997**
Single-plane Balancing with the HP 35660A Dynamic Signal Analyzer
- 44458A/**5953-7022**
Using HP DACQ/300 Programming Guide
- 54110 A/D/**5954-2644**
Precision Time-Interval Measurements with the HP 54100/110 Digitizing Oscilloscope
- 54110D/**5954-2643**
Dual Delayed Sweep Versus Random Repetitive Sampling
- 54120-1/**5954-2693**
Histograms and Statistical Analysis of Signals for Use with the HP 54120T Digitizing Oscilloscope
- 54201A/D/**5954-2642**
Solving Measurement Problems in the Communications Industry
- 70000-1/**5954-9135**
HP 70000 System Design Overview
- 85016-1/**5954-1600**
Making Measurements and Configuring Run-only Tests Using the HP 8328A/85016B

FREE PUBLICATIONS

Aids to Selecting, Using & Maintaining HP Products



Free aids to selecting, using and maintaining HP products

Hewlett-Packard offers a variety of free publications to help you choose the products that best fill your needs, to help you benefit from applications knowledge acquired by users inside and outside of Hewlett-Packard, and to help you maintain your HP products. These publications range from new-product announcements, catalogs, product family brochures, and single-product technical data through application notes, product notes, and programming aids to service notes and general maintenance periodicals. The number and types of free publications vary with product family. A summary of available publications is provided here. Brief descriptions of some publications follow the summary.

Instruments and Systems

Product information

Test & Measurement News

Data sheets and brochures

Catalogs

Test & Measurement Accessories
Catalog (5954-0193)

DC Power Supply Catalog with Electronic
Loads (5952-4195)

RF, Microwave, & Millimeter Wave
Measurement Catalog (5953-2346)

Documentation Index (5954-2460)

HP DesignCenter magazine

HP Journal

Application information

Application Note Index (5954-0203)

Application Notes

Product Notes

Programming Notes

Service information

Service Notes

Bench Briefs

Computers, Peripherals & Calculators

Product information

Test & Measurement News

Data sheets & brochures

Selection guides

Catalogs

Computer Users Catalog (5953-2450)

Documentation Index (5953-2460)

HP Technical Catalog (5952-6696)

Software Solutions Catalog (5952-7010)

Business Solutions Catalog (5953-6396)

Supplies Catalog for HP Plotters and the
HP PaintJet Color Graphics Printer
(5957-3776, 5957-3777)

Software and Hardware Solutions for the
HP Plotter Family (5954-8835)

HP Journal

Application Information

Application Note Index (5954-0203)

Application Notes

Application Briefs

Plotter Notes

Set-Up Instructions (for plotters)

Components

Product information

Catalogs

Coaxial Components Catalog (5959-7861)

Microwave and RF Designer's Catalog
(5954-2238)

Optoelectronics Designer's Catalog
(5954-8450)

Data sheets

HP Journal

Application information

Application Note Index (5954-0203)

Application Notes

Application Bulletins

Periodicals

Test & Measurement News

Six times a year *Test & Measurement News* announces the latest HP electronic measuring instruments and accessories; computer/controller, component, and telecom products; and new no-charge literature such as catalogs and application notes.

HP DesignCenter

HP DesignCenter is published for users of HP systems for electronic design, printed circuit board layout, microprocessor-based development, and mechanical design. This full-color magazine features information on new value-added business partners, customer application stories, answers to common customer questions, and announcements of new product enhancements.

Hewlett-Packard Journal

The *Hewlett-Packard Journal* is published six times a year to communicate technical information from the laboratories of Hewlett-Packard to all of the fields served by HP. It contains in-depth design descriptions of current hardware and software products, research papers, and more general information such as advances in technology.

Application Information

Application Note Index

The *Application Note Index* lists and describes the contents of all Application Notes, Programming Notes, and Product Notes on electronic instruments, instrument systems, and solid-state components.

Application Briefs, Bulletins, and Notes

These aids to solving your measurement, computation, and design problems offer the benefit of the applications research and experience of both HP customers and HP engineers. Some are tutorial, others describe how-to procedures. All are generic or multiple-product oriented.

Product Notes

Product Notes are product-specific and augment the operating and service manuals supplied with HP instruments. They cover applications of the specific instrument and analyze specifications and characteristics with the goal of obtaining improved performance over limited operating conditions and narrower environmental limits.

Programming Notes

Programming Notes provide product-specific information on the use and operation of instruments in HP-IB systems. Some notes address the needs of inexperienced users and cover basic operation of an HP-IB instrument using a specific HP desktop computer. Others address the needs of experienced users.

Service Information

Service Notes

Service Notes contain product-specific service information for HP electronic products. Subjects include product improvements, modifications, and procedures for troubleshooting, maintenance, and repair. Service Notes are published as appropriate throughout the life of a product. All new Service Notes are announced in *Bench Briefs*.

Bench Briefs

Bench Briefs provides those who maintain HP instruments with timely information that has both specific and general application. Subjects include troubleshooting tips and descriptions of new technologies, components, tools, and equipment. Also, new Service Notes are listed in *Bench Briefs* as they become available.

How to Obtain Free Publications

To obtain any of the publications described on this page, contact your Customer Information Center (CIC) or nearest HP office. Locations of HP offices and CICs are listed on the back pages of this catalog.

When requesting any of the catalogs listed on this page, please include the number in parenthesis following the catalog's title.

Dear HP Customer,

Let me introduce you to an important benefit that starts working for you even before you buy from Hewlett-Packard.

The HP Customer Information Center (CIC) is your single point of contact for information about any Hewlett-Packard product or service. At the CIC, you will find helpful, friendly people with the knowledge to get you the information and answers that you need. If we don't have the answers we can put you in touch with someone who does.

To take advantage of the CIC, just call 1-800-752-0900.

Our customer representatives staff this phone number every working day of the year. Plus, our customer representatives are available to serve you from 6:00 a.m. to 5:00 p.m. PST. These hours make it possible for you to get information conveniently from Hewlett-Packard no matter where you are in the United States.

What are the services that you can expect to find?

Here are some of the benefits offered by the CIC:

- Fast, convenient ordering of sales literature on HP products and services.
- Easy location of your nearest HP sales office.
- Accurate, responsive answers to your product information questions.

Why not call the CIC soon? When you do, I am sure that you will find the CIC is another important reason to do business with Hewlett-Packard.

Sincerely,
Hewlett-Packard



Dick Knudtsen
CIC General Manager

P.S. Remember, the key to using the CIC is 1-800-752-0900.

Test &
Measurement
Catalog
1990

