

# Guidebook to: DATA COMMUNICATIONS

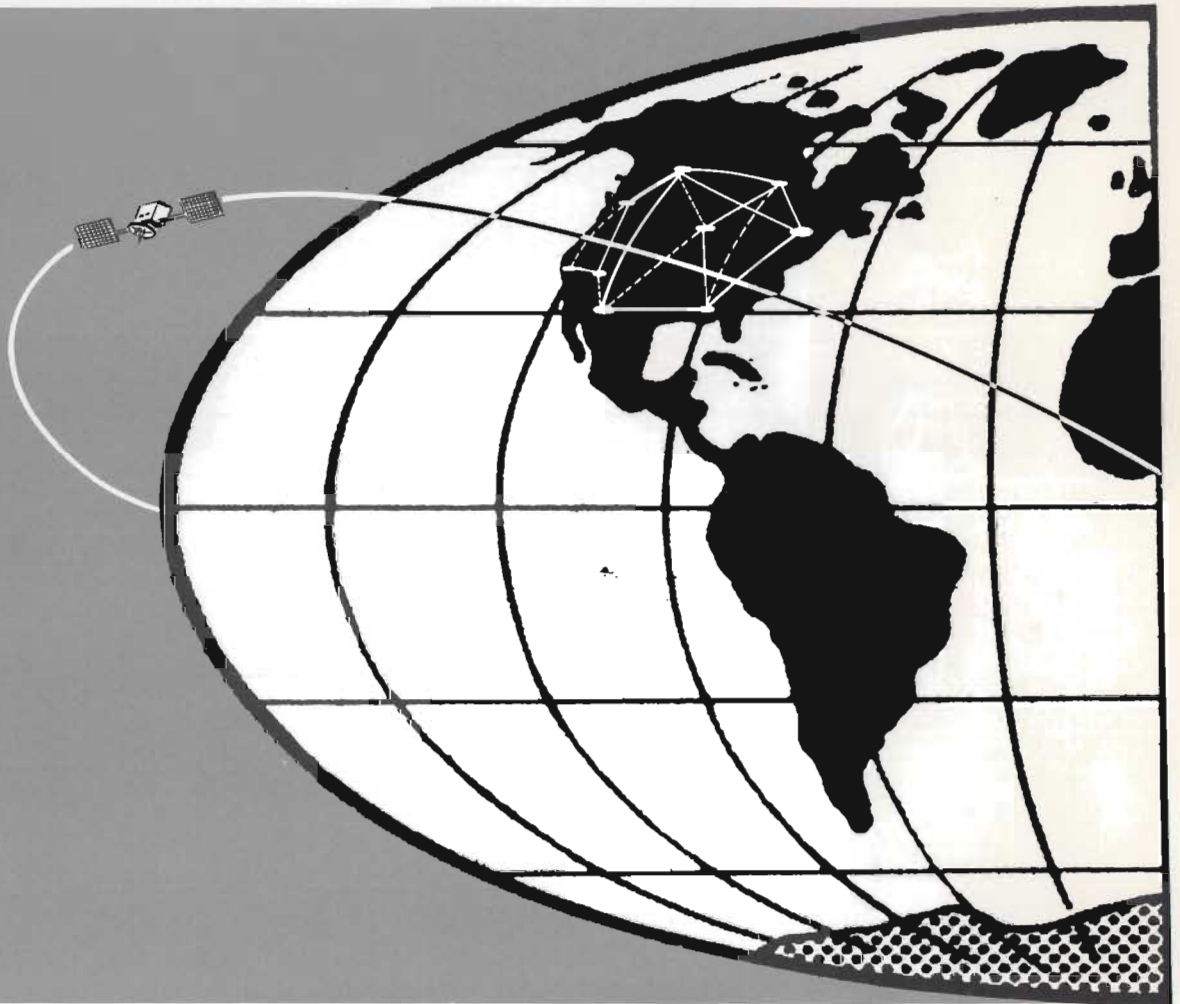

**HP Internal**

COLMAN A. McDONOUGH (HP Ret.)  
WRITER

- TECHNICAL
- MANUALS, HDW & SFW
- REPORTS
- PROPOSALS

- PROMOTIONAL
- ARTICLES
- SCRIPTS
- SALES LITERATURE

(408) 245-5778

730 BLUE SAGE DRIVE  
SUNNYVALE, CA 94086

Retiree  
Volunteers



415/857-2410  
415/852-8548

Sep. 20, 2007

Glenn -

This book represents some of the best work I did at HP. It was quite a hit in its time. My division management were impressed enough to say I should be listed as the author, at least in the first printing.

I cannot get past page 1 at your web site. Could you mail me a copy of your documentation listing?  
Colman

**TRAINING MANUAL**

# **Guidebook to Data Communications**

by

Colman A. McDonough

**HP INTERNAL**



General Systems Division/5303 Stevens Creek Boulevard/Santa Clara, California 95050/Telephone (408) 249-7020

Manual Part No. 5955-1715

Printed in U.S.A. 1/77

FORWORD

TRAINING MANUAL

Handbook of Data Communications

Copyright © 1977 by Hewlett Packard

Copyright © 1977 by Hewlett Packard  
First Edition  
Printed in U.S.A.

# FOREWORD

In terms of growth and ultimate potential, the union of computers and telecommunications to allow data processing at a distance is one of the world's most dynamic industries. Each partner in this union has to learn something about the other partner. Telecommunications people must know something about the digital data formats of computers: Computer people must know something about telecommunications equipment and techniques. This manual is for those with a background in digital equipment and computers, and it describes the data communications machinery, methods and modes for moving digital data.

This manual will not tell you everything you need to know about data communications; that would require many detailed textbooks. What it does is give you a general understanding of the concepts for each aspect of data communications with some simplified examples. It describes the data communications picture today plus some of the newer concepts that will find increasing use in the future.

- Chapter one describes the technical and economic reasons for the growth of data communications networks, and the roles played by computers and minicomputers.
- Chapter two contains an overall view of a basic network and its components, then defines the types and configurations of communications lines.
- Chapter three describes the equipment and techniques used to transmit data over a distance.
- To obtain an orderly interchange of data it is necessary to have a line protocol — a traffic manager. Chapter four describes the functions of line protocols.
- Characters — letters, numbers and symbols — must be encoded into a machine language for transmission and processing. Chapter five covers the main codes used by computers and telecommunications.
- Minicomputer roles in networks, both as information transfer and data processing, are described in chapter six.
- Communications common carriers are used for the lines, switching, and for most interfacing equipment in a data communications network. The traditional carriers, the newer specialized carriers and some typical costs are covered in chapter seven.

[Faint, illegible text in the upper section of the page]

[Faint, illegible text in the lower section of the page]

# CONTENTS

Chapter I					
<b>INTRODUCTION</b>					
Electrical Communications . . . . .	1-1				
Telecommunications + Computer Power . . . . .	1-2				
Computer Development . . . . .	1-2				
Minicomputers . . . . .	1-2				
Overview of a Minicomputer Network . . . . .	1-2				
Data Link . . . . .	1-2				
Minicomputer Roles . . . . .	1-2				
Terminals . . . . .	1-3				
Datacomm Networks . . . . .	1-3				
Cluster Networks . . . . .	1-4				
Distributed Networks . . . . .	1-4				
National Networks . . . . .	1-5				
Minicomputers: More for Less . . . . .	1-5				
Summary . . . . .	1-6				
Chapter II					
<b>TELECOMMUNICATIONS AND NETWORK COMPONENTS</b>					
Terminals . . . . .	2-1				
I/O Control . . . . .	2-1				
Input Control . . . . .	2-1				
Output Control . . . . .	2-2				
Error Checking . . . . .	2-2				
Validity Checking . . . . .	2-2				
Redundancy Checking . . . . .	2-2				
Polynomial Checking (CRC) . . . . .	2-2				
Synchronization . . . . .	2-2				
Interface . . . . .	2-2				
Modem (Data Set) . . . . .	2-2				
Terminal Controller . . . . .	2-2				
Communications Links . . . . .	2-3				
Channels . . . . .	2-3				
Transmission Modes . . . . .	2-3				
Simplex . . . . .	2-3				
Half Duplex . . . . .	2-3				
Full Duplex . . . . .	2-4				
Echo-Plex . . . . .	2-4				
Circuits . . . . .	2-4				
Two Wire and Four Wire . . . . .	2-4				
Switched . . . . .	2-4				
Leased (Dedicated) . . . . .	2-4				
Grade . . . . .	2-6				
Sub-Voice . . . . .	2-6				
Voice . . . . .	2-6				
Wideband (Broadband) . . . . .	2-6				
Lines . . . . .	2-6				
Wire Pairs . . . . .	2-6				
Coaxial Cable . . . . .	2-6				
Microwave Relay . . . . .	2-6				
Tropospheric Scatter . . . . .	2-7				
Satellite . . . . .	2-7				
Other Media . . . . .	2-7				
Line Components . . . . .					2-7
Pads . . . . .					2-7
Companders . . . . .					2-7
Echo Suppressors . . . . .					2-8
Line Interference . . . . .					2-8
Noise . . . . .					2-8
Distortion . . . . .					2-8
Crosstalk . . . . .					2-8
Echo . . . . .					2-8
Types of Line Configurations . . . . .					2-8
Point-to-Point . . . . .					2-8
Multipoint (Multidrop) . . . . .					2-9
Polling . . . . .					2-9
Broadcast Polling . . . . .					2-10
Selection . . . . .					2-10
Tributary-Tributary Transmission . . . . .					2-10
Summary . . . . .					2-10
Chapter III					
<b>MODEMS, INTERFACES AND MODULATION</b>					
Hard-Wired Direct Connection . . . . .					3-1
Acoustic Modem (Coupler) . . . . .					3-1
Modem (Data Set) . . . . .					3-1
Asynchronous Modems . . . . .					3-2
Synchronous Modems . . . . .					3-2
Serial-Parallel Bit Streams . . . . .					3-3
Bits and Bauds . . . . .					3-3
Bandwidth . . . . .					3-3
Modem Features . . . . .					3-3
Reverse Channel . . . . .					3-4
Soft Carrier Disconnect . . . . .					3-4
Automatic Adaptive Equalizer . . . . .					3-4
Testing . . . . .					3-4
Transmit Only-Receive Only . . . . .					3-4
Originate Only-Answer Only . . . . .					3-4
Attended-Unattended Operation . . . . .					3-4
Bell System Modem Numbering . . . . .					3-4
Non-Bell Modems . . . . .					3-4
Data Access Arrangement (DAA) . . . . .					3-8
Automatic Calling Unit (ACU) . . . . .					3-8
Interface . . . . .					3-8
Contact Closure Interface . . . . .					3-8
CCITT V24 Interface Standard . . . . .					3-8
EIA RS232C Interface Standard . . . . .					3-8
Mechanical . . . . .					3-8
Electrical . . . . .					3-10
Bell 103A Operation . . . . .					3-10
Frequency Modes . . . . .					3-10
Signal Description . . . . .					3-10
Protective Ground . . . . .					3-10
Signal Ground . . . . .					3-11
Clear to Send . . . . .					3-11
Transmitted Data . . . . .					3-11

# CONTENTS (continued)

	Page		Page
Carrier Detector . . . . .	3-11	Transmission States . . . . .	4-8
Received Data . . . . .	3-11	Active State . . . . .	4-8
Data Set Ready . . . . .	3-11	Transient State . . . . .	4-9
Data Terminal Ready . . . . .	3-11	Idle State . . . . .	4-9
Ring Indicator . . . . .	3-11	Secondary Station Modes . . . . .	4-9
Channel Establishment Sequence . . . . .	3-12	Normal Response Mode . . . . .	4-9
Disconnect Sequence . . . . .	3-13	Asynchronous Response Mode . . . . .	4-9
Modulation . . . . .	3-14	Initialization Mode . . . . .	4-9
Amplitude Modulation . . . . .	3-14	Frames . . . . .	4-9
Vestigial Sideband Transmission (VSAM) . . . . .	3-14	Flag . . . . .	4-9
Frequency Modulation . . . . .	3-14	Station Address . . . . .	4-9
Phase Modulation (PSK) . . . . .	3-14	Control Field . . . . .	4-10
Phase Shifting . . . . .	3-15	Control Field Information Format . . . . .	4-10
Four Bit States . . . . .	3-15	Control Field Supervisory Format . . . . .	4-10
Pulse Modulation . . . . .	3-15	Control Field Nonsequenced Format . . . . .	4-11
Mixed Modulation . . . . .	3-15	Information Field . . . . .	4-11
Multiplex . . . . .	3-15	Frame Check Sequence (Block Check) Field . . . . .	4-12
Time Division Multiplexing (TDM) . . . . .	3-16	Flag . . . . .	4-12
Frequency Division Multiplexing (FDM) . . . . .	3-16	Protocol Extension . . . . .	4-12
Digital Data Links . . . . .	3-17	SDLC Operation . . . . .	4-12
Summary . . . . .	3-17	Full Duplex . . . . .	4-12
		Half Duplex . . . . .	4-13
		Error Recovery . . . . .	4-14
		Summary . . . . .	4-14
<b>Chapter IV</b>			
<b>LINE PROTOCOL</b>			
Binary Synchronous Communications (BSC) . . . . .	4-1	<b>Chapter V</b>	
Synchronization Sequence . . . . .	4-1	<b>CODES</b>	
Message Fields . . . . .	4-2	ASCII . . . . .	5-1
Message Block . . . . .	4-2	Numerical Values . . . . .	5-7
Header . . . . .	4-2	EBCDIC . . . . .	5-7
Text . . . . .	4-2	Hollerith . . . . .	5-7
Trailer . . . . .	4-2	Six Bit Transcode (SBT) . . . . .	5-7
Long Messages . . . . .	4-2	Hexadecimal . . . . .	5-7
Alternating Positive Acknowledgment . . . . .	4-4	Fixed Ratio ( <i>N</i> of <i>M</i> ) Codes . . . . .	5-7
Timeouts . . . . .	4-4	Baudot . . . . .	5-7
Transmit Timeout . . . . .	4-4	Summary . . . . .	5-7
Receive Timeout . . . . .	4-4		
Disconnect Timeout . . . . .	4-4	<b>Chapter VI</b>	
Continue Timeout . . . . .	4-4	<b>NETWORKS AND MINICOMPUTERS</b>	
Transparency . . . . .	4-4	Network Information Transfer . . . . .	6-1
Limited Conversational Mode . . . . .	4-5	Message Switching . . . . .	6-1
Retransmission . . . . .	4-6	Packet Switching . . . . .	6-1
Codes . . . . .	4-6	Remote Job Entry (RJE) . . . . .	6-1
Error Checking . . . . .	4-6	Terminals . . . . .	6-1
VRC . . . . .	4-6	Interactive Terminals . . . . .	6-2
LRC . . . . .	4-6	Buffered Interactive Terminals . . . . .	6-2
CRC . . . . .	4-6	"Intelligent" Interactive Terminals . . . . .	6-2
BBC Accumulation . . . . .	4-7	Response Time . . . . .	6-2
High Level Data Link Control (HDLC) . . . . .	4-8	Communications Controller . . . . .	6-2
Centralized Control . . . . .	4-8		
Loop Configuration . . . . .	4-8		



# CONTENTS (continued)

	<b>Page</b>		<b>Page</b>
Remote Concentrator . . . . .	6-3	Operating System . . . . .	6-8
Store-and-Forward . . . . .	6-4	Processing . . . . .	6-8
Hold-and-Forward . . . . .	6-4	Summary . . . . .	6-8
Processing Data . . . . .	6-4		
Error Control . . . . .	6-4		
Interactive Mode . . . . .	6-4		
Front End Processor . . . . .	6-4	<b>Chapter VII</b>	<b>Page</b>
Communications Control . . . . .	6-5	<b>COMMON CARRIERS AND COSTS</b>	
Computer Operations . . . . .	6-5	Domestic Carriers . . . . .	7-1
Host Computer . . . . .	6-5	International Carriers . . . . .	7-1
HP 3000 . . . . .	6-5	Bell System . . . . .	7-1
HP 1000 . . . . .	6-6	Dataphone . . . . .	7-1
IBM 370/158 . . . . .	6-7	Wide Area Telephone Service (WATS) . . . . .	7-1
Peripherals . . . . .	6-7	Interstate Leased (Private) Lines . . . . .	7-2
Software Operating System . . . . .	6-7	Intrastate Leased Lines . . . . .	7-3
Software . . . . .	6-7	Dataphone Digital Service (DDS) . . . . .	7-3
Interface . . . . .	6-7	Specialized Carriers . . . . .	7-4
Line Control . . . . .	6-7	Value Added Networks (VAN) . . . . .	7-4
Network Control . . . . .	6-7	Satellite Carriers . . . . .	7-5
Channel Interface . . . . .	6-7	Summary . . . . .	7-5

# ILLUSTRATIONS

Title	Page	Title	Page
Minicomputer-Based Network . . . . .	1-2	Sine Wave Phase Shifting . . . . .	3-15
Remote Concentrator in Network . . . . .	1-3	180° Forward Phase Modulation . . . . .	3-15
Clustered Network . . . . .	1-4	Time-Division Multiplexing by Bit . . . . .	3-16
Distributed Network . . . . .	1-4	Terminal-Computer Time Division Multiplexing . . . . .	3-16
Distributed and Clustered National Networks . . . . .	1-5	Frequency Division Multiplexing . . . . .	3-17
Cost-per-16K-of-Memory Trend . . . . .	1-5	Terminal-Computer Frequency Division Multiplexing . . . . .	3-17
Cost-per-Bit Trend . . . . .	1-5		
Basic Components of a Datacomm Network . . . . .	2-1	Simplified Handshaking Sequence . . . . .	4-1
Datacomm Transmission Modes . . . . .	2-3	BSC Handshaking Sequence . . . . .	4-1
Local and Intercity Voice Loops . . . . .	2-4	BSC Message Block Format . . . . .	4-2
Four Wire Line . . . . .	2-4	Multiblock Long Message . . . . .	4-2
Voice Frequency Range on Telephone Lines . . . . .	2-6	Inprocess Acknowledgments . . . . .	4-4
Simplified Electromagnetic Spectrum . . . . .	2-7	No Response To Message . . . . .	4-4
Compunder Changes in Signal Volume . . . . .	2-7	Transparent Text Message Blocks . . . . .	4-5
Echoes in Telephone Lines . . . . .	2-8	Limited Conversational Mode . . . . .	4-5
Point-to-Point Configuration . . . . .	2-9	VRC/LRC Checking (Odd Parity) . . . . .	4-6
Multipoint or Multidrop Configuration . . . . .	2-9	Cyclic Redundancy Checking . . . . .	4-7
Bell 202-Type Data Set (DATAPHONE 1200) . . . . .	3-1	BCC Accumulation . . . . .	4-7
Bell 209A Data Set (DATAPHONE 9600) . . . . .	3-1	Transparent Mode BCC Accumulation . . . . .	4-7
Functions of Modems or Acoustic Couplers in a Network . . . . .	3-2	Loop Configuration . . . . .	4-8
Asynchronous and Synchronous Bit Flows . . . . .	3-2	HDLC Frame Format . . . . .	4-9
Serial and Parallel Bit Transmission . . . . .	3-3	Comparison of SDLC Frame with SNAP Frame . . . . .	4-12
Two-State Digital Code . . . . .	3-3	SDLC Full Duplex Operation . . . . .	4-13
Four- and Eight-State Digital Codes . . . . .	3-3	SDLC Half Duplex Operation . . . . .	4-13
Bell 202 Data Sets Channel Frequency Assignments . . . . .	3-4	Error Corrected by Retransmission (Half Duplex) . . . . .	4-14
Automatic Calling Unit Function . . . . .	3-8	Error Corrected by Timeout and Retransmission (Half Duplex) . . . . .	4-14
Interface Location . . . . .	3-8		
Bell 804-Type Data Auxilliary Set and Bell 103A Data Set . . . . .	3-10	ASCII Code Speed vs Bit Time . . . . .	5-1
Bell 103A Simplified Interface Block Diagram . . . . .	3-11		
Bell 103A Channel Establishment Sequence . . . . .	3-12	HP 21MX Minicomputers . . . . .	6-1
Bell 103A Long Space Disconnect Sequence . . . . .	3-13	Microprocessor . . . . .	6-2
Amplitude Modulation . . . . .	3-14	Communications Controller in a Network . . . . .	6-3
Vestigial Sideband . . . . .	3-14	Remote Concentrator in a Network . . . . .	6-4
Frequency Modulation . . . . .	3-14	Front End Processor in Computer Center . . . . .	6-4
Sine Wave Phases . . . . .	3-14	HP 3000 Series II In-plant System . . . . .	6-5
		HP 1000 Distributed System . . . . .	6-6
		Front End Processor Communications Software . . . . .	6-7

# TABLES

Title	Page	Title	Page
Summary of Leased Line Specifications . . . . .	2-5	Processor vs Communications Software . . . . .	6-7
Bell Data Sets Numbering Series . . . . .	3-5	Monthly Mileage Charges Between Two A Rate Centers . . . . .	7-3
Bell Data Sets Characteristics . . . . .	3-5	Monthly Mileage Charges Between an A and a B Rate Centers . . . . .	7-3
EIA RS232C Interchange Circuits by Category . . . . .	3-9	Monthly Mileage Charges Between Two B Rate Centers . . . . .	7-3
EIA RS232C Interface Connector Pin Assignments . . . . .	3-9	California Monthly Mileage Charges . . . . .	7-3
EIA RS232C Interface Voltages . . . . .	3-10	Example of Telenet Installation Charges . . . . .	7-5
BSC Control Characters . . . . .	4-3	Example of Telenet Monthly Costs . . . . .	7-5
BSC Transparent Mode Control Characters . . . . .	4-5		
SDLC Control Field Nonsequenced Format Commands and Responses . . . . .	4-11		
ASCII Character Set . . . . .	5-1		
EBCDIC Character Set . . . . .	5-6		
Hexadecimal Number System . . . . .	5-7		

Periodically, a civilization is faced with a problem of such magnitude that its future development hinges upon finding a solution. Today we have an ongoing development in information which is called an explosion of knowledge. The sheer amount of information being generated and transactions conducted is exceeding the ability of people to use it. This is true in most areas, be it scientific research, business management, manufacturing, banking, medical services, libraries and education. Our limits have become our ability to comprehend information coming from different sources, to control, merge and restructure it, to store it, and to send meaningful portions to those individuals needing it.

Two advances in recent technology are capable of bringing this explosion under control. These are:

- Computers — electronic devices that accept information, manipulate it according to prescribed processes and supply the processed information.
- Telecommunications — the transmission of information over a distance by electromagnetic means, such as telephone, radio, microwave relay and satellites.

The combination of these two developments is called Data Communications or Datacomm: the interchange and processing of encoded information between distant locations connected by telecommunications. It's a fast-growing technology that will revolutionize the way information is handled and processed.

A computer can perform millions of operations per second. It can handle vast amounts of information with ease, collecting, analyzing and reporting results in seconds that otherwise would require weeks and months. The problem was that not everyone can have their own personal computer programmed for their particular situation.

Telecommunications reduced the need for a personal computer with a local terminal. Telecommunication allows computers to be operated from remote terminals, hundreds and thousands of miles away, so information can be sent to the computer for processing and the results returned in a format designed for maximum usefulness. A remote terminal has become as necessary to any sizeable organization as a telephone.

An operations manager no longer has to sift through a stack of paperwork to obtain needed facts. Instead of paperwork, the information can be stored in a computer, processed to extract the required facts and instantly presented in an easily read format. Libraries can keep track of books and set up data banks, where entering a few key words can immediately provide a list of current references on a topic. Large scientific calculations are required for research and engineering, and there may be only a few locations with the required computing power to solve some types of problems.

Telecommunications provides access to the remote location and allows many users to cost-share expensive equipment.

Computers have been around for 30 years. The past decade has seen the development and growth of minicomputers. These are used in Datacomm networks for local processing and telecommunications control, and are linked to computers which provide a large processing and storage capability. Using minicomputers for these tasks means they do not have to be performed by a large computer, thus freeing the computer for the processing tasks it performs best. Minicomputers also meet the need for a personal computer, in that they are small, low-cost and can be located in an office or factory work area.

## ELECTRICAL COMMUNICATIONS

Communications means the exchange of information: in our sense it refers to the transmission of encoded representation of information between two or more locations. Until the last century communication was accomplished by voice, writing or line-of-sight signals such as flags, smoke signals and shutter telegraph. The telephone and telegraph greatly increased the range and speed of communication. This was accomplished by converting information into electrical signals for transmission, then reconvert to voice or writing at the receiver. In this century radio performed the same function, but with an instantaneous, world-wide range. In our context, we can consider the hand-operated telegraph, conveying information in Morse code, as the forerunner of Datacomm.

The teleprinter made the telegraph an automated device. Instead of the operator encoding information, it could now be performed by a machine at many times the speed of a telegraph key. In addition, it did not require an operator skilled in a code, only in typing.

Starting with local systems serving a community, telephone and telegraph grew into networks linking communities, then nations and continents. Many technological innovations in the 19th and 20th centuries evolved when devices were interconnected to form complex networks.

Today we are seeing another type of network coming into being: a network which may be more revolutionary than any developed in the past century. It has the potential to tie together all aspects of Western civilization in a manner hitherto inconceivable. It will not be as visible to the general public as telegraphs and telephones, but it will have a massive impact in terms of lower costs, planning and resource management. The name of this type of network is Data Communications and it consists of a number of points or nodes interconnected by telecommunications facilities. The purpose of an individual network is to exchange and manipulate a specific type of information — such as daily banking operations or science information.

## TELECOMMUNICATIONS + COMPUTER POWER

Telecommunications is the transmission of information by electromagnetic processes, such as wires, cables, microwave relay and satellite. Datacomm is the transmission, processing and distribution of information in data format using computers and telecommunications facilities. Datacomm represents the union of computer power with telecommunications to eliminate distance and time as major factors in the gathering and use of information.

## COMPUTER DEVELOPMENT

Until the mid-1960's a computer was used for the purpose for which it was originally invented: computation. An operator sat at a console and data was entered, manipulated and transformed, and the result output to the operator. Then discs and drums came into use, providing a huge storage capacity for data. With this mass storage capability, a memory of millions of "bits", the computer's role shifted to data processing — the manipulation of pieces of information into a usable or storable format.

With mass storage, the new techniques of time-sharing, multiprogramming and data management provided more efficient use of computer time. Time-sharing allowed intervals of computer time to be allocated to various tasks. This meant that many users could simultaneously access a computer and, given the computer's speed of millions of operations per second, to each it would seem that that individual was the only user.

Multiprogramming allowed a computer to process a number of programs simultaneously by interleaving their execution. This provided a much more efficient use of computer time.

Data management gave users access to data in storage. They could interrogate, add to, subtract from and manipulate the data base. These developments in data processing were first used with large computers, but were also applied to minicomputers when these became commercially available.

By the mid-1960's semiconductor and integrated circuit technology had reached the point where a fully functional computer could be housed in a desk-top package. This was called a minicomputer and provided low cost data processing that could be located in a work area.

## MINICOMPUTERS

Minicomputers became commercially available in the late 1960's and proved to be especially well suited for Datacomm use:

- As an integral part of the telecommunications system — routing, concentrating and storing data, as well as reformatting for maximum processing efficiency.
- As a data processor, relieving the large central computer of some of the processing chores.

Telecommunications costs were reduced since information could be stored and processed closer to the user. When required, greater processing efficiency was obtained by dedicating a minicomputer to one clearly defined task. It became easier to set up a network since one leg at a time

could be phased into operation. Without minicomputers, large data communications networks could not function as efficiently and would be much more costly.

By the late 1960's the stage was set for large-scale data communications. In the 1970's networks containing computers that "talked" to each other and to people were in operation, providing the rapid interchange of data over vast distances, and opening the door to a spectrum of computer-based services.

## OVERVIEW OF A MINICOMPUTER NETWORK

A small network could consist of a number of remote terminals connected to a minicomputer as shown in Figure 1-1. This provides users in remote locations with a relatively low cost access to computational power not available locally. This access can be made over thousands of miles. Computational cost is reduced since many users share the same facility, yet to each user it is the same as a personal computer dedicated to his use.

## DATA LINK

Data or communications link describes the telecommunications equipment and procedures for transmitting information between locations in the network. Originally cables were the only means for transmitting digital information, but were relatively expensive and limited to distances under 10,000 feet. There were no "public" methods for transmitting computer information in the sense that highways and telephones are available for commercial use.

The quantum jump to low cost transmission and network development came in the 1960's, when it became possible to transmit computer-type data over telephone lines. This opened the way for national and world-wide Datacomm networks using efficient, reliable and low cost telephone systems.

## MINICOMPUTER ROLES

Figure 1-1 shows a minicomputer-based network. When a large computer is used in the network, there are other roles a minicomputer can play to enhance a network's effectiveness.

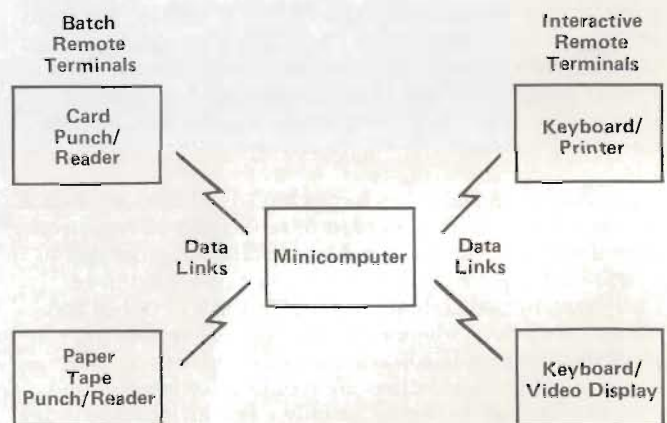

Figure 1-1 Minicomputer-Based Network

As the number of terminals and data links increase, so the cost of communications can increase to the point where some form of traffic management will greatly lower this factor. One of the best ways to do this is by using a minicomputer as a "front end processor" or a "remote concentrator." Figure 1-2 shows a minicomputer used as a remote concentrator, eliminating the need for a link to each terminal and reducing link usage time.

Instead of using the link each time a terminal has information ready for transmission, the remote concentrator collects and stores the messages. It packs and reformats as necessary for transmission in a single short burst. This allows one link to serve many terminals, and reduces line costs by reducing the amount of time the link is in use. It also provides more efficient use of computer time by reducing the computer's "waiting" periods. Terminals are serviced when the computer has time available, not on a demand basis from the terminal. This generally requires more waiting time by an individual terminal user (than if individual lines for each terminal), but line costs are lower.

### TERMINALS

Most terminals fall into one of two general classifications:

- Interactive Terminals
- Batch Terminals

Prior to the appearance of interactive terminals, entering data into a computer required a skilled operator to perform a rigid sequence and format. This was akin to shifting automobile gears before the clutch was invented — it required a skilled hand. With an interactive terminal, the operator is prompted and instructed and the information entered is checked for correct format. This allows unskilled operators, such as a warehouse clerk, production floor worker and hospital personnel, to enter and receive data.

Batch terminals transmit and receive information in short bursts. The operator collects a group of records and treats them as a single unit for transmission, loading them into the terminal for transmission in a single burst.

There are probably a greater number of types of terminals available than any other type of network component. Some operate automatically, collecting information from sensors or instruments, while some require human operators. Others can draw graphs and drawings which can be used for graphic design. Most can be located anywhere a telephone line can be used.

### DATACOMM NETWORKS

A Datacomm network is an intricate aggregate of many types of equipment and software, with the whole being greater than the sum of the parts. One significant feature of a network is resource sharing, with all elements capable of being accessed by any other element in the net. These elements would include computers, minicomputers with mass storage devices (disc, drum and tape) and terminals located in such places as production plants, warehouses, weather stations, air traffic control centers and banks. A network may contain:

- A number of computers — clustered and distributed
- Many remote terminals — interactive and batch
- A web of communications links — wire, cable, microwave, satellite.

Using a number of computers in a single network, where possible, is preferable to having a number of individual systems, each with a single computer. By pooling available resources, expensive equipment can be better utilized. With computer-to-computer communications, a lengthy program can be segmented and the parts simultaneously run on two or more computers. Greater processing efficiency is obtained when individual computers are dedicated to a specific type of processing; any work of a certain type within the network is routed to a computer programmed for that type of work. A computer could specialize in batch processing, real time or working with output-only terminals.

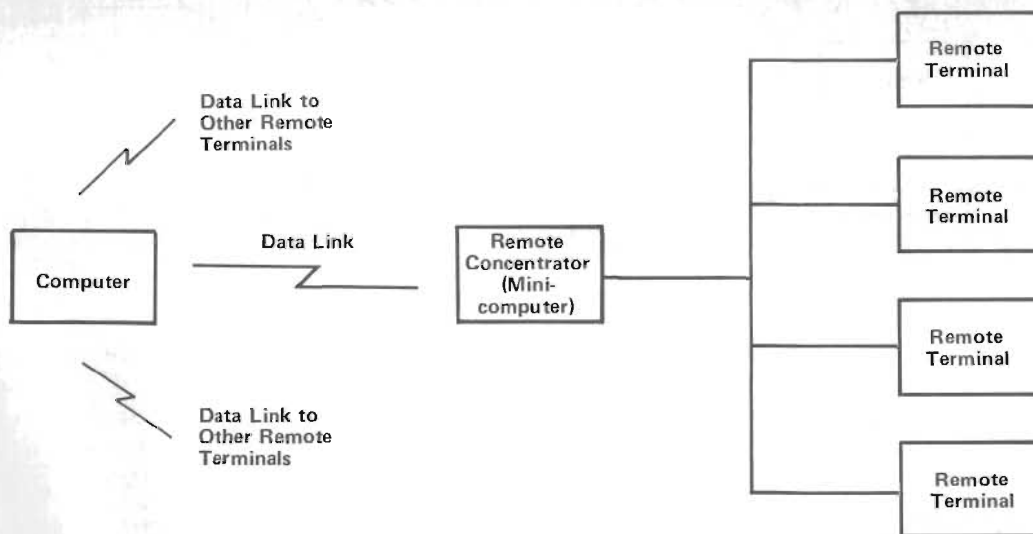

Figure 1-2 Remote Concentrator in Network

## CLUSTER NETWORKS

In a cluster network, a large computer is called a host processor or host computer, and when the computers are all located in one geographic location they are described as clustered (figure 1-3). To understand the advantages of a cluster it is necessary to know about computer "files".

Data is collected and stored at a specific geographical site in files. A file may contain a designated type and amount of data. The overall data collection might contain the operational records for a manufacturing plant, with a file for inventory control. In this file one line of an invoice would be an item, a complete invoice would be a record, and a complete set of records would comprise the file.

Generally, each computer in a cluster has the same configuration and each computer shares files. This gives high availability for processing under peak load conditions. Sharing loads also reduces processing time.

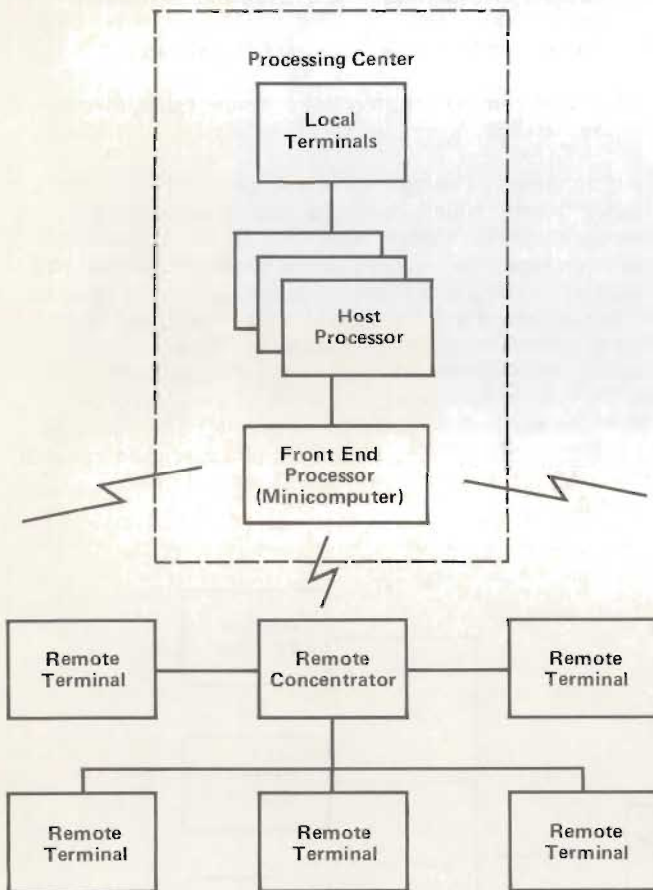

Figure 1-3 Clustered Network

## DISTRIBUTED NETWORKS

A main factor in the growth of distributed systems was the emergence of inexpensive, but powerful and versatile, minicomputers.

Rather than upgrade an existing large computer to handle an increased work load, it was better to add minicomputers to share the processing load and handle the data communications functions. Figure 1-4 shows a distributed network.

A geographically distributed network allows much flexibility for future growth. One advantage it has over the cluster network is protection against a major disaster. Earthquakes, fires and floods do occur each year, causing severe damage. A network with a number of computing centers is less vulnerable than a cluster network.

When the network is nation-wide, peak loading periods will occur at different hours for each time zone. A distributed network can shift loads between time zones for better utilization of equipment.

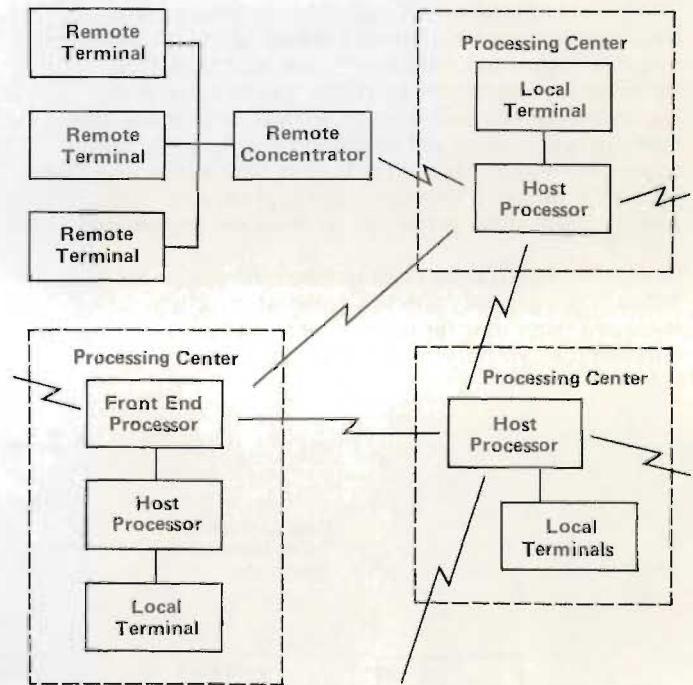

Figure 1-4 Distributed Network

## NATIONAL NETWORKS

Two examples of a national network are shown in figure 1-5. In the cluster network all application processing and information files are kept in a single center. The network traffic consists exclusively of the communications between remote terminals and the host processor.

Distributed networks are more complicated because application, processing and information files are kept in two or more sites. The network traffic consists of communications from computer to computer as well as computer to terminal and terminal to computer.

In a large network a significant amount of the host processor's capacity can be required for traffic management, this reducing the available processing capacity. Minicomputers, located at various points in the network, can assume the traffic management role, allowing the host's full capacity to be used for processing.

## MINICOMPUTERS: MORE FOR LESS

Minicomputers are the key to cost-effective Datacomm networks, and Hewlett Packard is a leader in minicomputer development. We are also a leader in price reduction. While other communication costs such as mail and telephone — and just about everything else — are rising, the prices of HP minicomputers have been steadily dropping at an average rate of 30% per year.

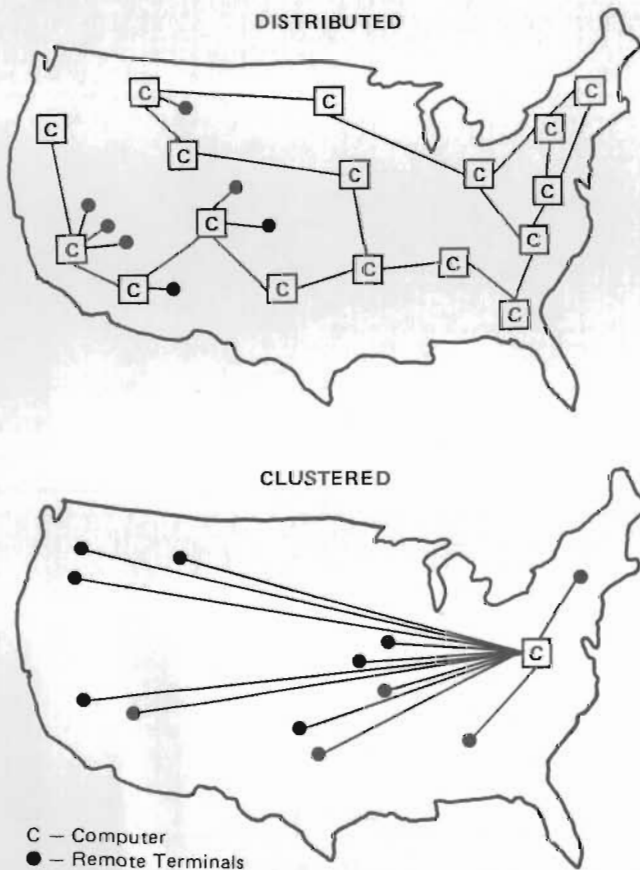

Figure 1-5 Distributed and Clustered National Networks

Figure 1-6 shows the drastic price drop since 1968, when HP produced its first minicomputer. The prices shown are based upon 16 thousand (16k) words of main memory, since that was the capacity of the early HP 2116A minicomputer. Today's HP 21MX minicomputer has a million words of addressing in main memory, plus it can access other millions of words of mass storage on a drum or disc.

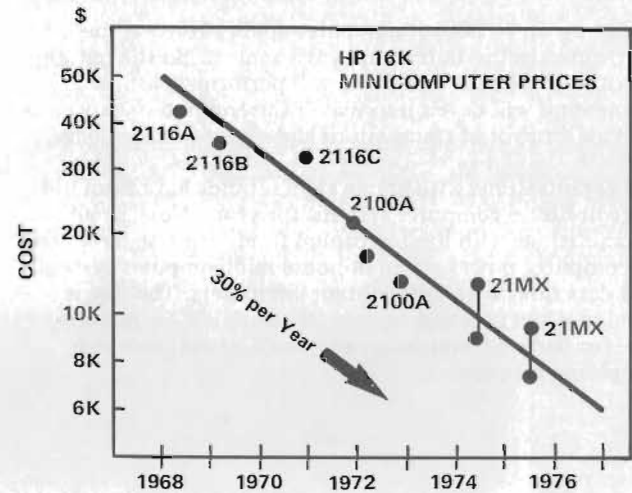

Figure 1-6 Cost-per-16K-of-Memory Trend

A computer word is composed of a number of bits. HP minicomputers have a 16-bit word. Here the drop in cost-per-bit has been even more dramatic than the drop in mass memory cost. In 1968 this cost was close to 1/10 cent per bit — today it is under 1/1000 cent per bit. Figure 1-7 shows the cost trends for bit cost on a cartridge disc.

This great reduction in cost is mainly accomplished through advances in semiconductor technology, where increasingly intricate components can be made smaller and cheaper with improved techniques and materials. Future minicomputers should continue this trend for more and more processing power at less and less cost.

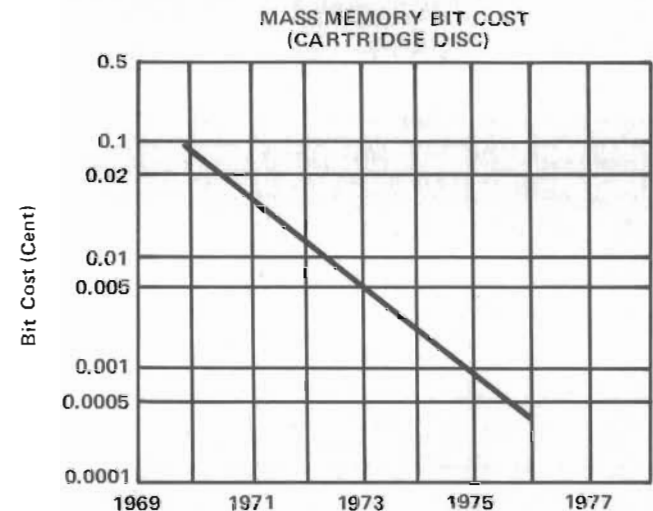

Figure 1-7 Cost-per-Bit Trend



## SUMMARY

"But who will use the telephone?" This was one of the first questions asked Alexander Graham Bell when he publicly displayed his invention. Radio had been in use for many years before the concept of a small, low cost receiver for the home was developed. Datacomm may have an even greater impact than either of these inventions: the future will be exciting, fast-moving and exceed our imagination.

Certainly up to 90% of computer applications can be performed in the Datacomm environment. So the question is not how well the computer will perform, it is how Datacomm will develop to match the computer's power, to provide control of transactions and access to knowledge.

Big organizations with ample capital funds have been using large in-house computer systems for years. Now, small organizations with limited capital funds can also have access to computer power via an in-house minicomputer system and data links with large distant computers. The day is coming when personal remote terminals will be in home use, for banking, education and work, as available as a telephone is today.

To understand the role of telecommunications in Datacomm usage it is necessary to have an understanding of the basic components used to generate and process data outside the communications link. Later chapters will discuss these components in more detail. This chapter will deal with the most common methods in use today.

The most common situation is a computer interacting with a remote terminal over voice telephone lines. This allows users at remote locations to use the computer for data processing — any location accessible by telephone can receive and transmit data to and from a computer which can be located thousands of miles away. The equipment used to perform this interaction has two general classifications:

- Data Communications Equipment (DCE) — the equipment used to convey information between locations.
- Data Terminal Equipment (DTE) — the remote terminal, where information enters and exits from the data link for a user, and the computer, where information is processed and stored.

## TERMINALS

Strictly speaking, a terminal is any location in a network where information can enter and exit. This means that a computer can be classed as a terminal. However, for clarity, we will call a user's input/output (I/O) device a terminal and the other end of the line will be called a computer. A simplified Datacomm arrangement is shown in Figure 2-1. This shows the main components used to provide a path between the computer and terminal.

There are a variety of types of terminals, and some of the main types in use today are:

- Keyboard-Printer
- Paper Tape Reader-Punch
- Keyboard-Video Display
- Card Reader-Punch
- Line Printer

Some terminal types can only input, some only output and some do both. For the purposes of this description we will use a keyboard-printer as an example, since this is the most common type in use today. The following functions described would also be performed at other terminals, but there would be wide range in complexity, scope of operation and cost. The typical user is aware of the keyboard-printer and its use but is frequently unaware of the other I/O control and synchronization functions required to receive and transmit data. The circuitry that performs these functions can be integral to the terminal or can be a separate unit.

## I/O CONTROL

As shown in figure 2-1, there are three functions performed which regulate the flow of information in and out of the terminal: input control, output control, and error checking.

## INPUT CONTROL

When the computer has information to be transmitted to the terminal, it sends a signal telling the input control. The input control then accepts the message, stores it in a buffer and then has it printed out on the keyboard-printer.

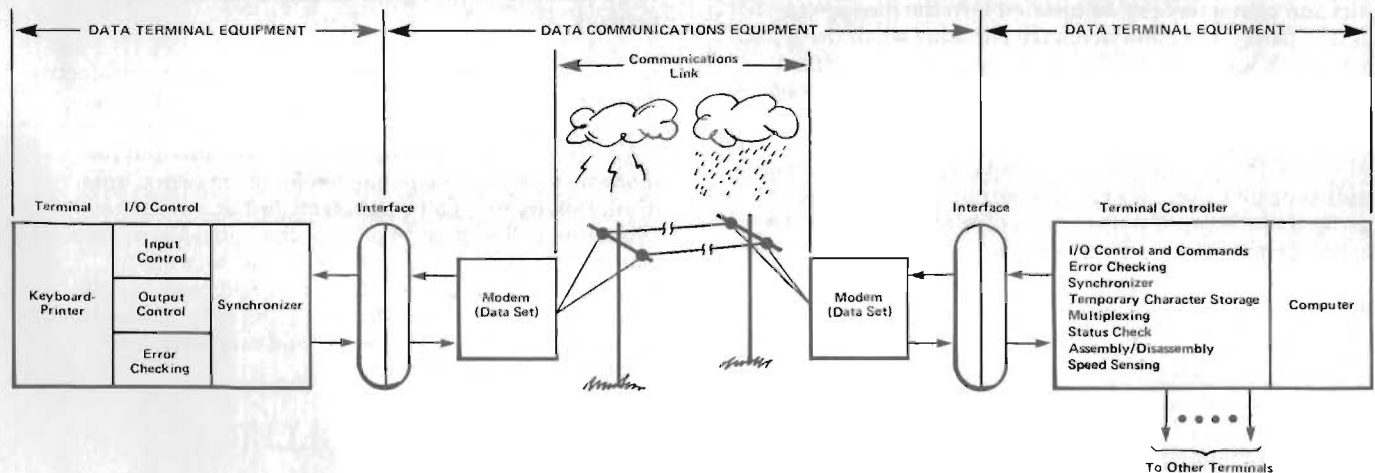

Figure 2-1 Basic Components of a Datacomm Network

Storage is required since the communications line and the terminal have different speeds of operation. Messages are received as a serial stream of bits and assembled into characters in a serial-to-parallel conversion.

## OUTPUT CONTROL

Output control accepts information from the keyboard-printer and stores it in a buffer. The buffers could be solid state memory, a tape cassette or a paper tape. Depending upon operation mode and equipment type, buffer capacity can vary from a couple of characters to an entire message. The important thing is that, given the buffer capacity, the information be prepared beforehand and be ready for transmission to the computer in a short burst. Upon receiving a signal from the computer, the output control transmits the information as a sequential (serial) stream of bits.

## ERROR CHECKING

The incoming and outgoing information may be checked for errors, depending upon the software used. With some types of terminals the message may be retransmitted when an error is detected. There are three types of error checking:

- Validity Checking
- Redundancy Checking
- Polynomial Checking

### Validity Checking

A character can be checked as valid when its bit configuration comprises a predefined legitimate character set. Each character must contain the same number of bits — the most common is four-of-eight where each character is always represented by four bits located in four of eight possible positions. An error is present when a character has other than four bits. This type of checking provides low-cost yet effective error control. Because of its limitations it is not commonly used with computer-controlled operations.

### Redundancy Checking

Bits and characters can be inserted into the message to obtain parity and allow accuracy checking when the message is received. The insertions are called redundant because they can be removed from the message without loss of information. Parity means that the bit count of a character or message should be either all odd or all even. An all odd count per character is called odd parity. An all even count is called even parity. The output device supplies parity and the input device checks for parity. This is the most common error checking method in use today.

### Polynomial Checking (CRC)

The most efficient method of checking is a polynomial error code check, also known as Cyclic Redundancy Check (CRC). The polynomial is an algebraic function used to create a constant from the message bit pattern. This constant, generated and accumulated in both the transmitter and receiver, is used to divide the binary numeric value of the character. The quotient is discarded and the remainder added to the next character, which is again divided. This continues until the last character, when the

remainder is transmitted to the receiver for comparison with the receiver's remainder. An equal comparison indicates no errors, while an unequal comparison indicates an error in the transmission. Chapter four contains a more detailed discussion of error checking.

## SYNCHRONIZATION

Once transmission of a message commences, the transmitter and receiver must maintain synchronization for the duration of the message. This is required for the receiver to recognize which is the first bit of a character, as an example. Synchronization can be maintained by clock circuitry or by timing information inserted into the message.

## INTERFACE

The type and levels of signals used by the data link are regulated by a number of standards, with the Electronic Industries Association (EIA) RS-232-C being the most common in this country. This standard specifies the electrical characteristics and functions of 25 control functions and signal paths, along with connector pin assignments. The purpose is to provide standardized signal levels and control sequences in the data link regardless of the type or make of modems and DTE's. Interfaces are discussed in more detail in chapter three.

## MODEM (DATA SET)

Data terminal equipment (DTE) transfers information in a digital format, a two-level voltage, while telephone lines carry information in an analog format, continuously varying in voltage and frequency. Thus, it is necessary to convert the digital data into analog format for transmission over telephone lines. This is performed by a modem, the word being a contraction of the two functions performed by it — modulation and demodulation. The Bell System uses the term "data set" to describe this piece of equipment. Information entering the communications link is impressed on (modulates) a carrier wave. Information leaving the communications link is demodulated so that only the original signal exits from the modem. In effect, the information is piggybacked on the carrier wave to allow it to be transmitted over great distances via the telephone network.

In the USA and Canada, switched lines require a protective device called a Data Access Arrangement (DAA) when non-Bell modems are used. Leased lines do not require a DAA. This device is inserted between the line and the modem to protect the public telephone network from disruption by non-Bell equipment. In Datacomm use, it allows the Bell System to control the signal levels, voltages and currents introduced into the public network by non-Bell modems. In the future, non-Bell modems can operate without a DAA when they meet specified standards or have a built-in DAA. Modems and modulation are described in chapter three.

## TERMINAL CONTROLLER

A terminal controller does everything the I/O control previously discussed does plus in addition it performs more functions and is capable of controlling many remote terminals. The main functions it performs are as follows:

- Synchronizing
- Error Checking
- I/O Control and Commands
- Temporary Character Storage
- Multiplexing
- Status Checking
- Assembly/Disassembly
- Speed Sensing

The first three functions listed above are similar to those performed by a remote terminal's I/O control. Temporary character storage is provided for a few characters at a time. Since the terminal controller operates at the same speed as the computer, a large buffer is not required.

Multiplexing allows the terminal controller to handle a number of simultaneous inputs or outputs. It converts them into a single serial stream for input to the computer, or receives a single serial stream from the computer and converts it into multiple outputs. This is necessary since it must operate over one I/O computer channel (port). A status check keeps the computer informed of the status of remote terminals.

The assembly/disassembly function is performed by serial-to-parallel (assembly) and parallel-to-serial (disassembly) buffers, where bits representing incoming characters are assembled before entry to the computer and outgoing characters are disassembled for transmission as a series of bits. Speed sensing by the terminal controller allows changes in input speeds from remote terminals to be detected.

## COMMUNICATIONS LINKS

Figure 2-1 shows a metallic wire pair used to carry the information between modems. However, a "line" may start and end with a wire pair but in between other types of equipment, such as microwave relay and cables, may be used. Whatever the type of telephone equipment, it is collectively described as a line.

"Channel" is a term also used to describe communications links. To avoid confusion we will define these two terms which describe the physical and functional means for electrically transmitting information between two or more points:

- Channel — a path within a line through which information flows.
- Line — the physical equipment and configuration used in telecommunications.

## CHANNELS

Channels are described in terms of transmission type and grade/category of information capacity. Type identifies the mode used for back and forth message flow, while grade refers to the number of bits per second (bps) a channel can handle. The bps speed is determined by the channel's frequency range (bandwidth). A single wire pair circuit may carry many channels.

## TRANSMISSION MODES

As illustrated in figure 2-2, there are three main types of transmission modes available for Datacomm use. These are:

- Simplex
- Half Duplex
- Full Duplex

### SIMPLEX

The message flow in a simplex channel is always in one direction. An input terminal can only receive, never transmit; an output terminal can only transmit, never receive. It is not in general use since it is not possible to send error or control signals back down the channel to the data source. Simplex is similar to a one-lane, one-way bridge.

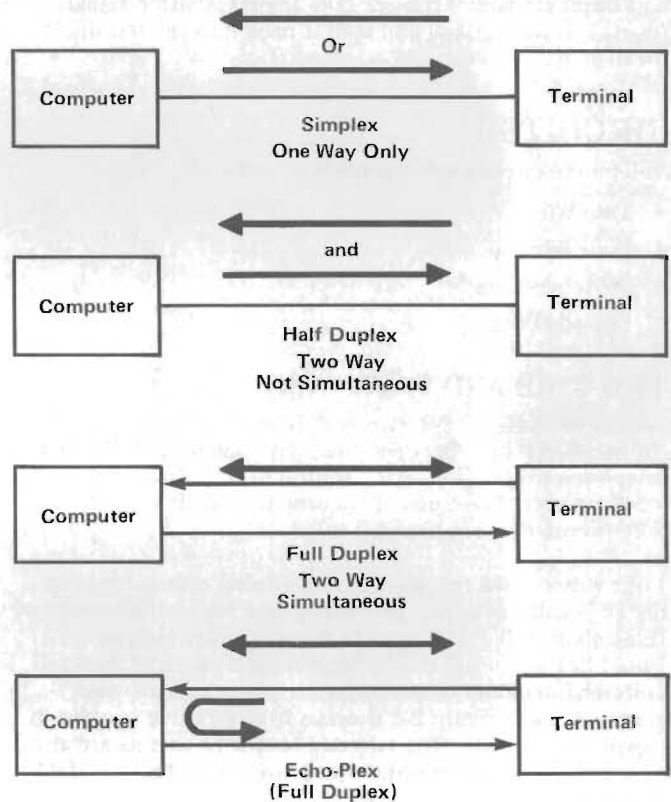

Figure 2-2 Datacomm Transmission Modes

### HALF DUPLEX

A half duplex channel can transmit and receive but not simultaneously. It is similar to a one-lane, two-way bridge where traffic must be stopped before the direction can be reversed. This is the most common channel mode in use today.

The transmission flow must be halted each time the direction of travel is reversed. This halt is called "turn-around time" and typically requires from 50 to 250 milliseconds (ms), depending upon line mileage. The halt is required to reverse direction of echo suppressors in the telephone line (devices for maintaining voice quality) and allow the modems to stabilize.

## FULL DUPLEX

Information can travel in both directions simultaneously between two locations over a full duplex channel. It is similar to a two-lane, two-way bridge. No turnaround time is required. Not all terminal equipment can, or is required to, transmit/receive in a full duplex mode, but may be installed in this mode to eliminate the turnaround time required with half duplex.

## ECHO-PLEX

Echo-plex is a submode available with full duplex operation. When the operator presses a key and transmits a character to the computer or another terminal, it is echoed back to appear on the printer or video display. The operator can see what the computer or terminal is receiving and make any necessary corrections. It cannot be used with half duplex; many terminals take the transmitted signal from their output line and feed it back into the terminal for display.

## CIRCUITS

Telephone circuits are described in terms of:

- Two Wire
- Four Wire
- Switched (Public)
- Leased (Private)

## TWO WIRE AND FOUR WIRE

As shown in figure 2-3, two wire is usually in the "subscriber loop", between the telephone set and the local telephone exchange (serving central office). One wire is used for both directions of transmission while the other wire is common or ground.

Four wire is used between serving central offices for long distance calls, with one pair being used for each direction of transmission. It is also used in the subscriber loop as a leased line when full duplex operation is required. Several voice channels can be packed onto one four wire voice grade channel. Figure 2-4 shows a four wire line encased in a protective sheath. The two and four wire circuits are also called single-ended or unbalanced circuits, in that the data is carried over one wire of a pair.

Confusion arises when wire terms are used in the Datacomm context. It should be remembered that four wire is a term derived from the early days of telephones and that

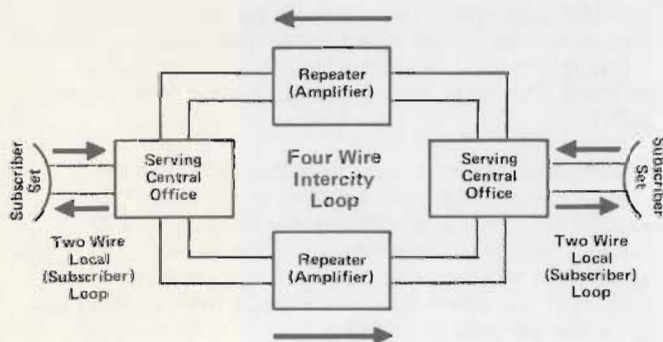

Figure 2-3 Local and Intercity Voice Loops

today it may not mean four physical wires. Two wires can form an equivalent four wire circuit when different frequencies are used to convey information back and forth in the channel. In this way simultaneous transmission both ways is possible without the frequencies interfering with each other, the two directions being separated in frequency rather than in space.



Figure 2-4 Four Wire Line

In summary: Two and four wire are telephone terms — half and full duplex are Datacomm terms for describing the mode of operation of a terminal or channel. Two wire can be used to describe half duplex operation, but full duplex can mean four wire or two wire (four wire equivalent) operation.

## SWITCHED

The voice telephone network used by the public is a switched network. It is called switched because a call is automatically switched through to its destination after dialing has been completed. It has the advantage of being universally available, and is cheaper than leased lines when usage is low. A different circuit path is selected each time a call is placed. When a number is dialed, the call goes to the local serving central office where it is connected to the called location or transferred to another serving central office for completion.

## LEASED (Dedicated)

A leased line is a permanent circuit for private use within a Datacomm network, with the line directly between the two locations or routed through a serving central office. In this office, which contains one or more "wire centers", the leased line is physically connected in the wire center, independent of the public switching and signaling equipment in the office. Where usage is high, leased lines are cheaper than switched lines. The cost crossover point between switched and leased lines varies with line mileage, but it is in the range of one to several hours per day.

For some applications, the biggest advantage of a leased line is that no setup time is required. Just pick up a phone or throw a switch and the connection is made. This eliminates the setup time required on a switched line for addressing (dialing), switching (call routing), ringing and obtaining billing information. Since the circuit is permanent, the same path is always used and conditioning can be applied to the circuit to improve transmission quality.

While speeds of up to 4800 bps are possible without conditioning, generally at speeds above 1200 bps some form of conditioning is required to overcome the effects of delay and attenuation distortion. Table 2-1 contains a summary of leased line specifications.

Table 2-1 Summary of Leased Line Specifications<sup>1</sup>

	Non-Conditioned 3002 Channel	With C1 Conditioning	With C2 Conditioning	With C4 Conditioning
Frequency Range in Hertz (Hz)	300-3000			300-3200
Frequency Response (Net Loss at 1000 Hz)	Frequency Range    Decibel Variation 300-3000    -3 to +12 500-2500    -2 to +8	Frequency Response    Decibel Variation 300-2700    -2 to +6 1000-2400    -1 to +3 300-3000    -3 to +12	Frequency Response    Decibel Variation 300-3000    -2 to +6 500-2800    -1 to +3	Frequency Response    Decibel Variation 300-3200    -2 to +6 500-3000    -2 to +3
Delay Distortion in Microseconds ( $\mu$ s)	Less than 1750 $\mu$ s from 800 to 2600 Hz.	Less than 1000 $\mu$ s from 1000 to 2400 Hz. Less than 1750 $\mu$ s from 800 to 2600 Hz.	Less than 500 $\mu$ s from 1000 to 2600 Hz. Less than 1500 $\mu$ s from 600 to 2600 Hz. Less than 3000 $\mu$ s from 500 to 2800 Hz.	Less than 300 $\mu$ s from 1000 to 2600 Hz. Less than 500 $\mu$ s from 800 to 2800 Hz. Less than 1500 $\mu$ s from 600 to 3000 Hz. Less than 3000 $\mu$ s from 500 to 3000 Hz.
Maximum Impulse Noise	15 counts in 15 minutes			
Type of Service	Point-to-Point (two points) or Multipoint			Point-to-Point (two or three points)
Channel Mode	Half or Full Duplex			
Local Loop Termination	Two or Four Wire			
Maximum Frequency Error	$\pm$ 5 Hz			
Maximum Bit Error	Approximately 1 bit error per 100,000 bits transmitted			
<sup>1</sup> D1 conditioning improves several Type 3002 transmission parameters that are not improved by C1 conditioning. This is also called High Performance Data Conditioning (HPDC) and is optional with two-point, leased 3002 channels without or with C conditioning.				

The Bell System calls this C-conditioning, which guarantees specified levels of transmission parameters, and it provides either a reduction in data errors or a higher transmission rate or a combination of both. There are five levels of conditioning, C1 through C5, of which C1, C2 and C4 are available for commercial use; C3 and C5 are reserved for government lines. The level of conditioning required is a function of bit speed and distance. A lower grade of conditioning than normal might be used for a given bit speed where a short distance is involved. For intraexchange connections, a metallic wire pair may be the only medium used. Since this is an excellent medium for transmission, the parameters may be at least equal to that obtained by conditioning, and conditioning may not be required.

The Bell System refers to a voice line used for data transmission as a "Type 3002." A voice line conditioned at

a C3 level would be described as a "Type 3002 with C3 conditioning."

In addition to no setup time and conditioning, there are other advantages to leased lines. Because there is little possibility of interference with the public switched voice network, a DAA is not required for non-Bell modems. Not having the central office switching gear in the circuit removes one cause of impulse noise. When there are a number of lines coming into a location, such as a large number of terminals connecting to a computer, a private switchboard can be installed to provide the advantages of switching. This switchboard can be in-house or in the serving central office.

## GRADE

Transmission speed is the most important characteristic of a communications channel, and this is determined by bandwidth, the frequency range of the channel. Bandwidth is the difference in Hertz (Hz) or cycles per second between the lowest and highest frequencies in a channel. Thus, a frequency range of 5 to 10 Hz and another of 15 to 20 Hz have the same bandwidth — 5 Hz, the difference between the high and low frequencies. There are three grades of channels that are defined in terms of bandwidth:

- Sub-voice (Narrow) Band — 0 to 300 Hz
- Voice Band — 300 to 3000 Hz
- Wideband — Over 3300 Hz

These frequency ranges are general classifications and the actual bandwidth may overlap in many cases. The speed of transmission increases as bandwidth and frequency increases. Thus, a narrow band is considered low speed service, voice band medium speed service, and wideband high speed service.

## SUB-VOICE

A sub-voice channel has the narrowest bandwidth and slowest speed of the three grades. Normal transmission speeds range for 45 to 150 bps. This is also called telegraph grade, since it is frequently associated with telegraph and similar type equipment. It is asynchronous in operation, with the bits of each character individually synchronized but the characters themselves generated at random intervals.

## VOICE

Voice grade allows the entire 3 kHz bandwidth used for voice transmission to be used for data (figure 2-5). Most voice grade services operate from 60 to 4800 bps. Speeds of up to 10,800 bps are possible with some modems, but at increased cost. Voice grade provides a flexible, economical and good quality means for the transmission of data up to 4800 bps.

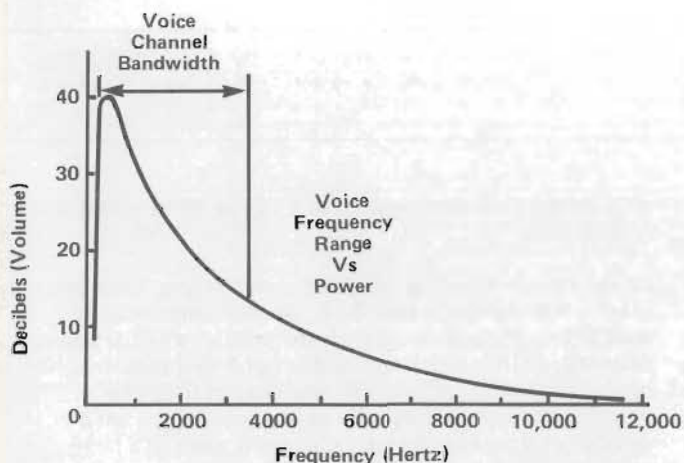

Figure 2-5 Voice Frequency Range on Telephone Lines

The Bell System, which refers to voice grade as Type 3002, can channelize their lines into sub-channels. This means that more than one signal can be transmitted over the same

physical line. Human speech transmitted over voice grade telephone lines represents only a portion of the total speech spectrum. However, this is sufficient for speech to be understandable. Figure 2-5 shows the bandwidth of the speech spectrum used for voice communications.

## WIDEBAND (BROADBAND)

Because of the great bandwidth available with wideband grade, up to 240 kHz with leased lines, data can be passed at speeds from 19,200 to 500,000 bps. Even higher speeds are possible for special applications. Wideband grade is used when it is necessary to transmit large volumes of data at high speed. The major drawback of this grade is cost, which can be prohibitive for normal applications.

The equipment used with wideband transmission must be able to perform three main functions:

- Channelize — divide the available bandwidth into multiple usable subsets.
- Modulate — impress data signals upon a carrier waveform.
- Provide various modulation techniques.

## LINES

The media, facilities and types of connections used by Datacomm have changed rapidly in the past decade. The main media in use today is still the Bell System equipment: wires, cables and microwave relay, with submarine cables and satellites used for international communications. However, regardless of the equipment used, a line can be considered as a connection between two or more points over which data is transmitted. Figure 2-6 shows a simplified electromagnetic spectrum and the frequency ranges used by the various types of telecommunications equipment.

## WIRE PAIRS

Most telephone wires in local use are twisted-wire pairs encased in a protective sheath. The most common example of this is the twisted-wire pair connecting a telephone's handset to the dial unit.

## COAXIAL CABLE

A coaxial tube usually consists of a copper wire suspended by insulation in the center of a copper tube. It is called coaxial because both the wire and the tube have the same center (axis). A coaxial cable consists of up to 20 tubes bundled inside a protective sheath, with perhaps a center core of wire pairs. They are typically used along with microwave relay to handle most of today's long-distance traffic.

## MICROWAVE RELAY

The microwave relay system consists of towers spaced an average of 30 miles apart which crisscross the country. Microwave transmissions travel in straight lines, so the towers must be in "line-of-sight" of each other. Each tower amplifies and retransmits the signals until they reach their destination. It is called microwave because of the short wavelength (distance between waves or energy pulses), typically about 1 to 3 inches.

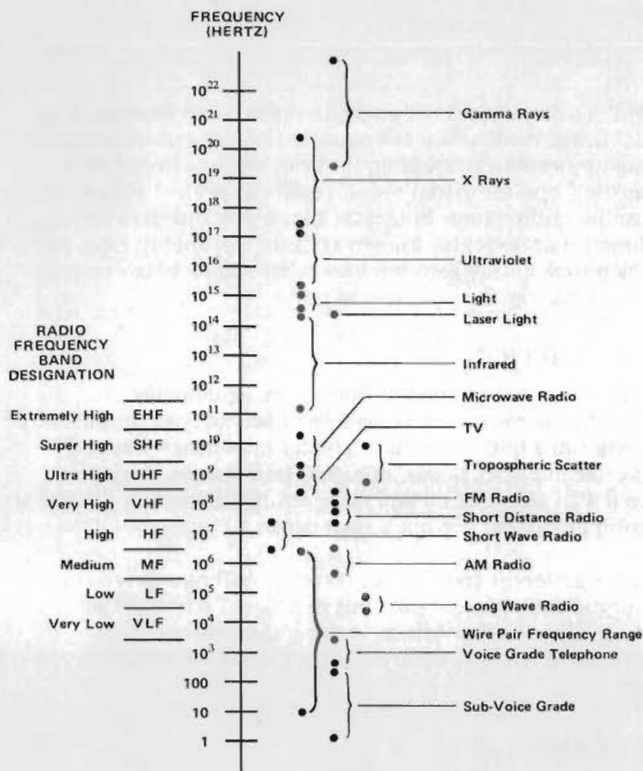

Figure 2-6 Simplified Electromagnetic Spectrum

### TROPOSPHERIC SCATTER

The troposphere is that portion of the earth's atmosphere extending up to 10 miles from the earth's surface. The scatter method is capable of transmitting microwave signals up to 600 miles through "bouncing" of the troposphere, but is limited by transmission loss due to atmospheric conditions.

### SATELLITE

A communications satellite can be considered as performing the same function as a microwave relay tower, except at a distance of over 20,000 miles. Ground antennas beam signals to the satellite, which amplifies and retransmits them to another ground station that can be almost half-way around the world from the first ground station. Unlike

terrestrial communications equipment, the cost per call remains the same regardless of the ground distance covered.

### OTHER MEDIA

There are a number of other methods for transmission of information that are for specialized use or are being developed. Some of these are:

- Laser
- Cable TV
- Fiber Optics
- Infrared
- Waveguides
- Short Distance Radio
- High Frequency Radio
- Submarine Cable

### LINE COMPONENTS

There are a number of small components in a telephone line, but three — pads, echo suppressors and companders — can have an adverse effect on data when it is transmitted over voice lines.

### PADS

"Pads" are used in both switched and leased lines to obtain correct power levels. A pad is an impedance device to lower the decibel (volume) level and adjust it to the user's interface.

### COMPANDERS

As described further in this chapter, a line contains background or white noise. This is always present, but at a lower average level than the signal. However, when the signal is amplified by repeaters in the line, strong (high-amplitude) signals may overload the amplifier while weak (low-amplitude) signals may be lost in the noise. A compander corrects this situation by improving the voice signal-to-noise ratio in the line, but this action may adversely affect some types of data signals.

As shown in figure 2-7, a compander contains a compressor and an expander. At the transmitter, the compressor reduces the volume range by lowering the high amplitude signals while raising the low amplitude signals. At the expander the process is reversed and the signal restored to its original range. Since noise is not present in the transmitter, the noise level is not raised by the compressor. However, at the expander the noise level is lowered below its line level.

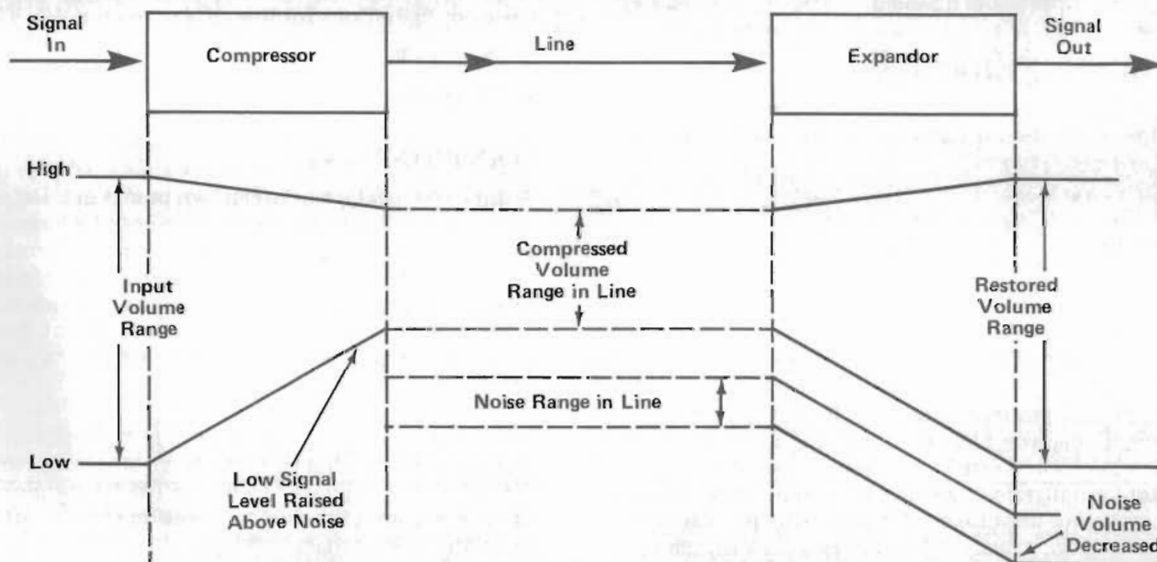

Figure 2-7 Compander Changes in Signal Volume



## ECHO SUPPRESSORS

An echo of a transmitted signal is created when a change of impedance is encountered in the line (figure 2-8). This condition is found in long distance lines and those with more than one local station (multipoint). The line impedance acts as a mirror to reflect the signal, sending it back down the line with reduced amplitude. Echo suppressors are used to stop this effect, by inserting loss into the return path and attenuating the echo. This works well for voice communications but causes delays when data is transmitted in the half duplex mode with two-wire modems.

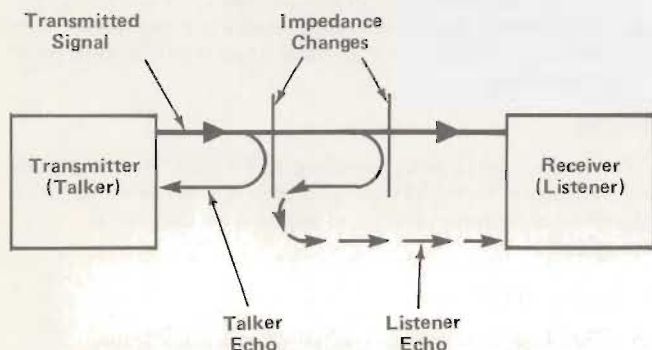

Figure 2-8 Echoes in Telephone Lines

When a call is placed and a connection first established, the echo suppressors must be disabled before data transmission can commence. This is done by the terminal equipment, such as a modem, transmitting a frequency tone of 2000 to 2250 Hz for 400 ms. The tone can be heard as a high-pitched whistle and means the line is ready for data transmission. When the direction of transmission is reversed during half duplex operation, 50 to 250 ms may be required for the echo suppressors to reverse direction; this is called "turnaround" time. There is no turnaround time during full duplex operation.

Echo suppressors will be reenabled when the carrier tone is absent for 100 ms. During turnaround time or when data is absent, most modems will transmit a tone over the line to keep the echo suppressors disabled.

## LINE INTERFERENCE

Data transmission over public telephone lines can be degraded by a number of factors. The main factors are as follows:

- Noise
- Distortion
- Crosstalk
- Echo

## NOISE

Noise can be background or impulse. Background noise, also known as electron hiss or white noise, is present in all electronic circuits and usually maintains a constant level. It causes problems in voice transmission and to a less extent in data transmission. Impulse noise causes little problems in voice transmission, usually it is heard as a click or crack,

but is a major cause of errors in data. It can be caused by lightning, mechanical telephone switching equipment, and high-powered electrical equipment, such as found in medical and industrial use; it results in peaked pulses, which can be milliseconds in length, that block out data signals. Impulse noise is also known as "hits", probably from early telephone days when two bare wires strung between poles could hit together and create noise.

## DISTORTION

Distortion can be in amplitude or in signal delay. Amplitude distortion is the loss of intensity or amplitude of signals in a line. Lines have greater impedance, causing greater intensity losses, at higher frequencies. A circuit called an attenuation equalizer can be inserted in the line to compensate for the line's impedance.

Since different frequencies travel at different speeds in normal cables, some portions of a signal arrive at their destination before others, causing signal delay. This condition is corrected by inserting delay equalizers in the line.

## CROSSTALK

Crosstalk is a greater problem in voice communications than in data communications. It is caused when adjacent circuits are not balanced in inductance and capacitance, either through aging of components or improper installation and service.

## ECHO

When a voice signal in a line meets an impedance change an echo is created which can interfere with speech. This condition is corrected by the echo suppressors previously described.

## TYPES OF LINE CONFIGURATIONS

The previous discussion described the variety of telecommunications equipment used to transmit data over what is collectively called "lines". A line can contain any of the transmission methods described above. There are two basic configurations for lines in Datacomm use. These are:

- Point-to-Point
- Multipoint

## POINT-TO-POINT

A direct connection between two points in a Datacomm network is called point-to-point and can be leased or switched. The two points connected can be terminal-terminal, terminal-computer or computer-computer. As shown in figure 2-9, there can be many individual lines connecting a single location to other locations, but each terminal location has its own line: each link is independent of the others.

Either location at the end of the line in a point-to-point configuration can bid and obtain control of the line without being requested to do so. The location obtaining the line becomes the primary location and the other location the secondary.

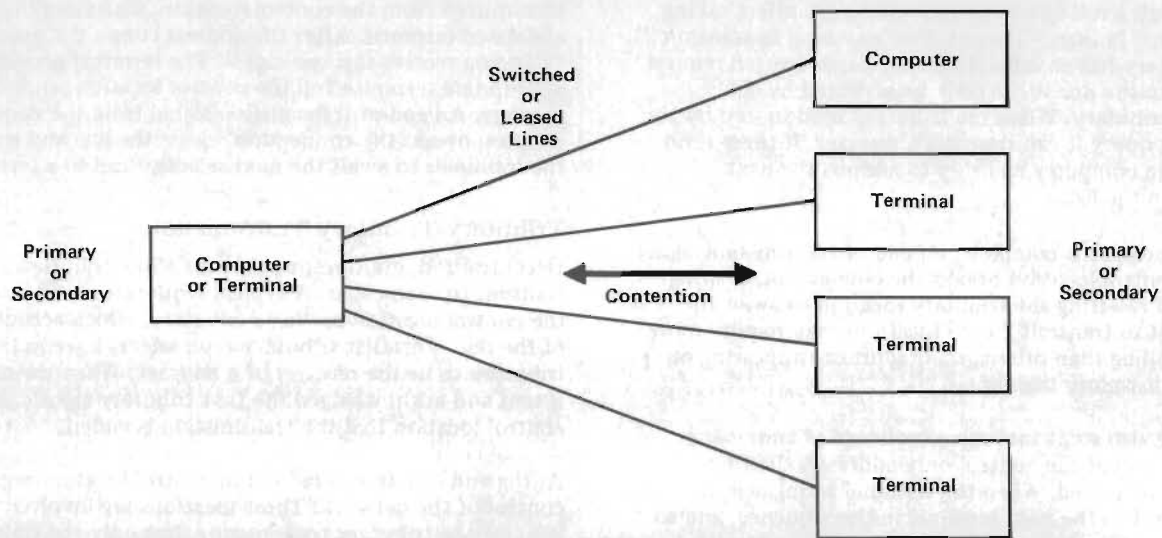

Figure 2-9 Point-to-Point Configuration

With a switched line, the sequence is initiated when the call is made, manually or automatically, by the primary location and the called location goes "off-hook," becoming the secondary. Going off-hook means the telephone has been lifted off its handle, or the modem has automatically responded to ringing signals. The primary initiates the call, transmits or receives a message, terminates the sequence, goes on-hook and the connection broken.

With a leased line, which is a permanent connection, either location at the ends of the line may "contend" for use of the line without going through the dialup sequence. In a situation where both were to bid simultaneously, then both would be waiting for an acknowledgment response from the other. There would be no response since both would have been transmitting at the same time and neither would have "heard" a bid. This situation is resolved by the primary location having a shorter "timeout" (listening) period than

the secondary location. Timeouts are a means of making more efficient use of the line by limiting the listening period. In this situation the location with the shorter timeout will obtain control by retransmitting the line request before the other location timeouts. Where the bid for leased line use is not simultaneous and the other location is listening, the location making the bid becomes the primary and the other the secondary.

### MULTIPOINT (MULTIDROP)

Back in the early days of telephones and still in many rural areas a number of subscribers would be connected to a single wire pair — this was called a party line and was a boon to those busybodies wishing to know their neighbor's business. Today in Datacomm when we do the same thing (without the eavesdroppers) we call it multipoint, and the lines are usually leased. The concept is shown in figure 2-10. One location is designated for control (master), usually a computer, and the remaining locations are called tributaries (slaves).

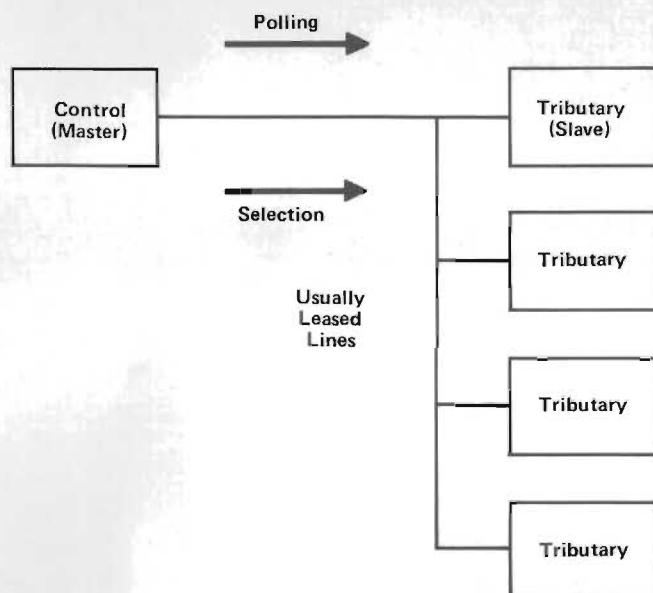

Figure 2-10 Multipoint or Multidrop Configuration

Multipoint networks can be centralized or decentralized. In a decentralized multipoint network, messages can be transmitted between tributary locations under the management of the control location, as well as between the control and tributary locations. In a centralized multipoint network, messages are only transmitted between the control and tributary locations: The tributary locations, which can be computers or terminals, cannot transmit to each other. Two methods are used by the control location to regulate traffic in the line. These are:

- Polling — an "invitation to send a message."
- Selection — a "command to receive a message."

Tributaries have three addresses: one each for selection, polling and broadcast polling.

### Polling

There are two main modes of polling, list and hub, with a broadcast submode, and only the control station can perform polling. With a polling list, the control location

steps through a roll call of the tributaries, in effect asking each terminal in turn, "Do you have anything to transmit?" Each tributary has an individual address, so as each request is sent down the line it can only be accepted by the addressed tributary. When the tributary is addressed by the computer's query it can transmit a message. If there is no message, the computer will step to address the next tributary on the list.

When the message is complete, an end-of-transmission signal from the control location breaks the connection, clearing the line and resetting the tributary location to await the next request to transmit. Some locations may require more frequent polling than others, their addresses appearing on the polling list more than once.

Hub polling also steps through a sequence of addressing tributaries, except the control only addresses the first terminal to be polled. When the terminal is finished, it passes control to the next terminal in the sequence, and so on until all terminals have been polled. The last terminal returns the polling function to the control. This is an advantage on long-mileage lines with many terminals, where if the control individually polled each terminal it would cause excessive turnaround time.

### **Broadcast Polling**

A submode of polling is the ability to address a number of terminals simultaneously. When addressed by a broadcast code, some or all of the terminals on the multipoint line will be commanded to accept a message, with only one terminal designated to answer for all others.

### **Selection**

The control location can selectively pick out one of the terminals and demand that the terminal receive a message. Thus, the terminals are passive until an individual address is

transmitted from the control location, activating the addressed terminal. After the address comes the question, "Can you receive this message?" The terminal provides the appropriate response and the control location sends the message. An end-of-transmission signal from the control location breaks the connection, clears the line and resets the terminals to await the next selective call to a terminal.

### **Tributary-Tributary Transmission**

Decentralized, multipoint networks allow tributaries to transmit to each other. A typical sequence would start by the control location polling a tributary, which accepts use of the line. This first tributary then selects a second tributary to be the receiver of a message. When the message is sent and acknowledged the first tributary signals the control location that the transmission is ended.

At the end of a transmission the control location regains control of the network. Three locations are involved in a tributary-to-tributary transmission, but only the transmitting and receiving tributaries are linked as master and slave.

## **SUMMARY**

In this chapter we have seen the main components of a network — terminal, modem, interface and data link. In dealing with communications terminology it is important to remember that there are two types of terms: telephone company terms — such as two wire — and data communications terms — such as half duplex. A line is a communications path that can contain many types of equipment, from two wire to satellite, and in the future may contain more exotic technology — such as lasers. Armed with this general picture, we can now proceed to look in more detail at the parts and processes of data communications.

There are many types of modems and several types of modulation. Of the over 500,000 modems estimated in use today, about half are Bell System products, with the remainder being products of around 200 manufacturers. A modem is required for any but the shortest of analog transmission links, where a hardwired connection can be made. For new and future networks using digital transmission links, a modem is not required, but today it is the most common single item in Datacomm use.

A network can be composed of many types of equipment from different manufacturers. A standard interface with designated voltages and signals provides the common ground for interaction between these diverse equipments.

## HARD-WIRED DIRECT CONNECTION

In many situations the terminals and computers are remote in terms of hundreds of feet to over a mile. For these short distances a direct wire connection is practical using copper wire pairs or coaxial cable. Signals are transmitted in digital format, eliminating the need for modems or acoustic couplers. In terms of cost, hard-wiring is the lowest cost data link available. However, digital signals cannot travel very far over wires or cables, but they can travel thousands of miles when converted to an analog format by an acoustic coupler or modem.

## ACOUSTIC MODEM (COUPLER)

An acoustic coupler accepts the serial stream of binary data from a terminal or computer, modulates it into audio tones, then transmits the tones over the phone line via a telephone handset. At the destination, the audible tones are demodulated into a serial stream of binary data. It is used for applications with terminals operating at 1200 bps or lower.

Acoustic couplers have a cradle and form-fitting rubber cups to hold the telephone handset. Suspension of the handset in the cups dampens vibration, at the work area or desk, from affecting the handset and generating false data. Some couplers have a lid which can be closed to eliminate background noise.

To transmit data, the user makes the connection as a normal phone call, places the telephone handset in the coupler, then operates the terminal. When finished, the user takes the handset from the coupler and hangs up. Data can be transmitted and received from any location with a telephone.

Couplers are portable, coming in portable typewriter sizes with a keyboard-printer (built-in terminal) and small shoebox sizes that require a terminal. Some have an automatic answering ability which senses the telephone's ringing, and automatically go off-hook to commence transmission.

Because of the carbon microphones used in telephones, the data speed of most couplers is limited to under 30 characters per second. A few have speeds of over 100 characters per second, but their cost approaches that of a modem. With an acoustic coupler, an engineer can take work home and tie into a nation-wide Datacomm network, a salesman on the road can transmit orders directly into a firm's order processing network and a field engineer can use a distant computer to troubleshoot equipment.

## MODEM (DATA SET)

Whereas an acoustic coupler converts digital format into an audible tone, a modem converts it into electrical signals. The name modem is derived from the function it performs: modulation and demodulation. Telephone companies also use the term "data set" to describe this device.

Figures 3-1 and 3-2 show two of the newer Bell data sets, a 202-type and the 209A. The 202-type will transmit and receive in simplex, half and full duplex modes. It is asynchronous, handles bit serial data and operates over switched lines. The 209A can transmit and receive two or four separate serial bit streams simultaneously over leased lines, and provide backup service over switched lines. The user can select from a number of speeds, or can easily change speed selections when required.



Figure 3-1 Bell 202-Type Data Set (DATAPHONE 1200)

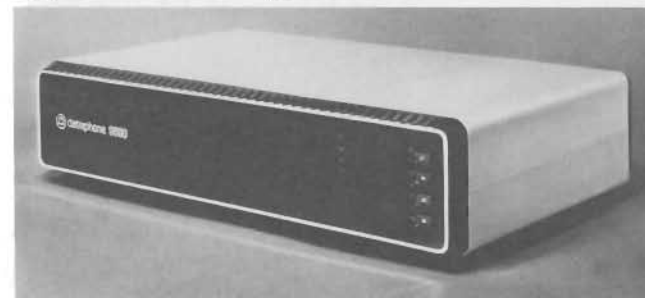

Figure 3-2 Bell 209A Data Set (DATAPHONE 9600)

Courtesy of AT&T

The modulation portion of a modem converts the square digital pulses into analog waveforms for transmission over telephone lines. The demodulation portion reconverts them back to a stream of digital pulses for transmission to a terminal or computer. Figure 3-3 illustrates the concept of a modem's role in a network.

While most modems operate over telephone lines, some use other types of data links to obtain high speeds not possible over voice channels. Hardware units can operate over short distances, such as within a plant or building, at speeds over 1.544 megabits/sec. Others use multiplexing techniques for long distances in computer-to-computer communications to obtain speeds of up to 250,000 bps. Voice line modems operate at speeds up to 9600 bps.

Physically, modems can be stand-alone, such as the 209A, or integral, built into a terminal as a printed circuit card. They can also be packaged; typically this is done by a computer services organization. The service organization purchases a card modem from one manufacturer and the terminal from another, then packages them in a custom-designed housing.

There are two main transmission modes for modem operation:

- Asynchronous
- Synchronous

## ASYNCHRONOUS MODEMS

Asynchronous modems operate at random speeds, depending upon the speed of the stream of digital pulses coming from the terminal. They typically operate with nonbuffered keyboard terminals, where the speed of character generation is random, and varies with the operator's skill. This is also called start-stop transmission because one character is transmitted at a time, with a start bit and one or two stop bits before and after each character. Speed is typically 2400 bps or less. The bit flows in each mode are compared in figure 3-4.

## SYNCHRONOUS MODEMS

Synchronous modems transmit characters in a continuous stream, with no intervals between each character. Because both transmitting and receiving modems must maintain the exact timing, usually a high-precision crystal oscillator is used as a clock to maintain the timing. Timing is usually internally generated by the modem, which the telephone companies call "internal sync option". If the timing is external to the set, in the terminal, it is called an "external sync option". The speed can be up to 9600 bps over voice grade lines.

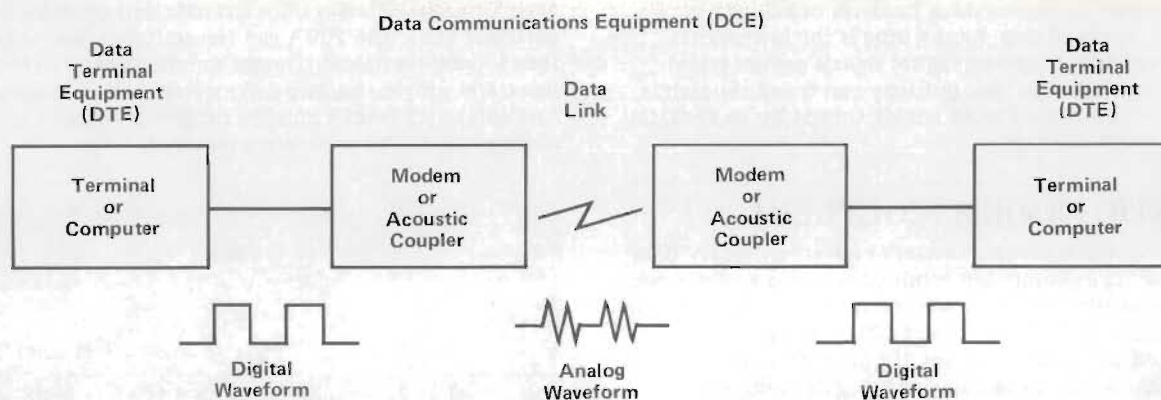

Figure 3-3 Function of Modems or Acoustic Couplers in a Network

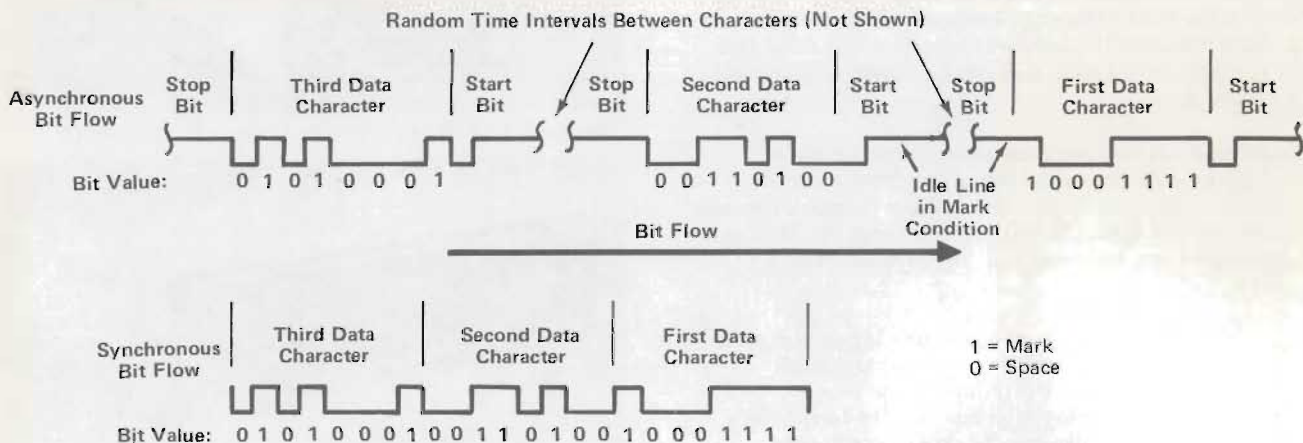
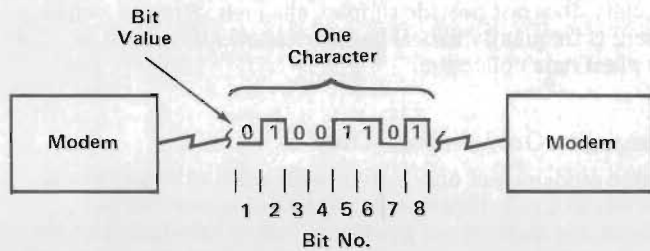

Figure 3-4 Asynchronous and Synchronous Bit Flows

## SERIAL-PARALLEL BIT STREAMS

The bit stream can be in a serial or parallel form (figure 3-5). In serial, one bit is transmitted on each clock interval: thus with an eight-bit code, it would require eight clock intervals to transmit eight bits of a character. In parallel, each bit has its own line and the eight bits would be transmitted on one clock interval (one character at a time).

The most significant characteristic of a modem is its speed. This is usually stated as bits per second (bps) or bauds (code events per second).



Serial: Character is Transmitted one Bit at a Time

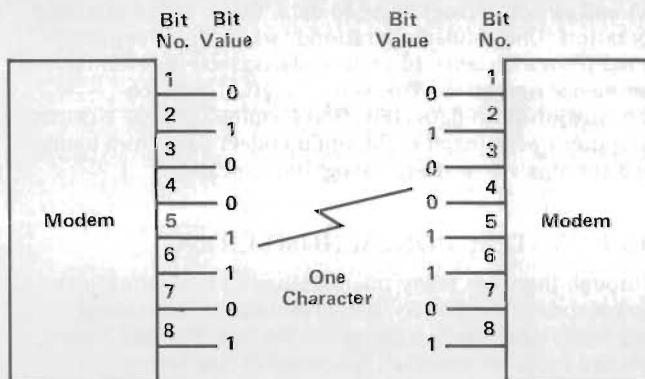

Parallel: Entire Character is Transmitted in One Bit Time

Figure 3-5 Serial and Parallel Bit Transmission

## BITS AND BAUDS

The yardstick for measuring modems is bits per second. The term "bit" is a contraction of binary digit, which means a two-state signal, either 1 (mark) or 0 (space), the 1 state usually having a higher voltage than the 0 state. It is represented by a square wave as shown in figure 3-6.

"Baud" refers to the speed of signal units. Where one bit is used as a signal unit, baud speed and bps are the same. When two bits are combined to form a signal unit, then the baud rate would be half the bps as shown in figure 3-7. The signal unit is called a "dibit" (double bit), and has four levels or states. When three bits form one signal unit, it is called a "tribit" (triple bit) and has eight possible states. However, most modems handle serial binary (two-state) bits.

## BANDWIDTH

Bandwidth is the difference in Hertz (cycles per second) between the lowest and highest frequencies of a band. In the Datacomm context, there are three general ranges of frequencies for transmission over data links. This is a general classification and the actual bandwidths overlap in many cases. The bandwidths are:

- Narrow band — 0 to 300 Hz (Hertz)
- Voice band — 300 to 3000 Hz
- Wide band — over 3300 Hz

The wider the bandwidth and the greater the frequency, the higher the speed of transmission. Thus, narrow band is considered low speed service, voice band medium speed service and wide band high speed service.

## MODEM FEATURES

While all modems perform the prime function of modulation-demodulation, there are other functions that can add to their capability or in some situations restrict performance to better accomplish a specialized task. Some of these features are:

- Reverse channel
- Soft carrier disconnect
- Automatic adaptive equalizer
- Testing
- Transmit only-receive only
- Originate only-answer only
- Attended-unattended operation

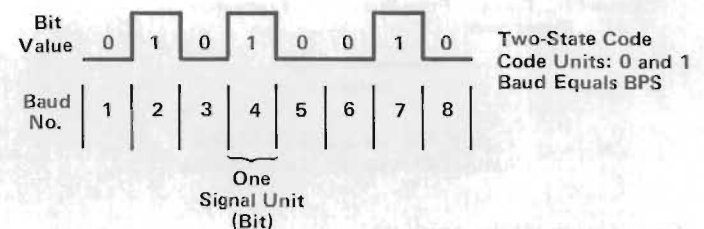

Figure 3-6 Two-State Digital Code

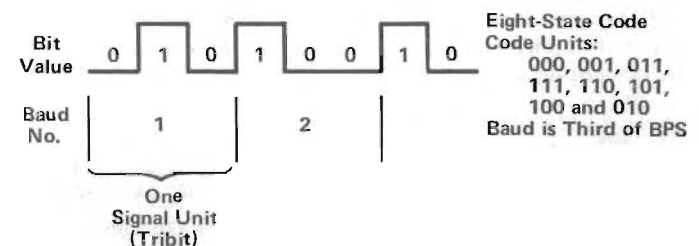
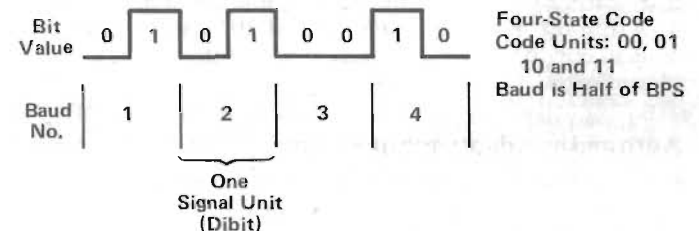

Figure 3-7 Four- and Eight-State Digital Codes

## Reverse Channel

A feature with some modems is an optional reverse channel, for use during half duplex operation. While the transmitting modem is operating, the receiving modem generates a signal which by being on or off indicates a go or no-go condition to the transmitting modem. The signal is usually at a lower frequency, well removed from the mark and space frequencies.

The reverse channel allows simultaneous two-way transmission during half duplex operation, and is usually a supervisory signal for error detection and control. Other purposes are to inform the transmitting modem that the signal is being received, or that the receiving modem is inoperable, as, for example, a paper tape reader that has run out of tape.

A reverse channel is offered with the Bell 202 data sets. As shown in figure 3-8, 1200 Hz is used to transmit a binary 1 or mark, while 2200 Hz represents a binary 0 or space. The reverse channel is 387 Hz with a maximum bit rate of 5 bps.

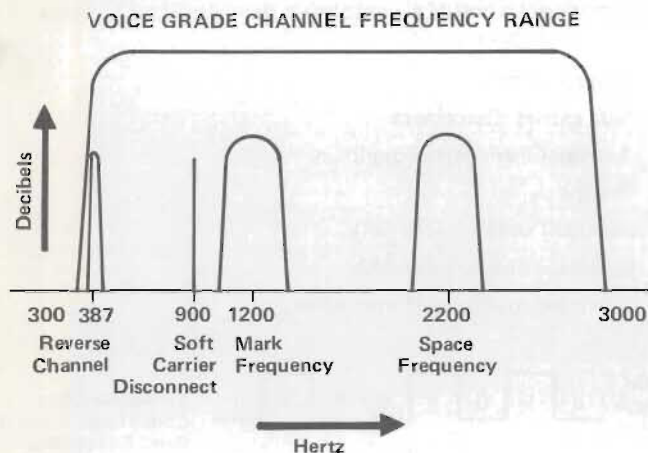

Figure 3-8 Bell 202 Data Sets Channel Frequency Assignments

## Soft Carrier Disconnect

Available with Bell 202-type modems, this option shifts the mark carrier frequency from 1200 to 900 Hz to provide a slow turn-off. It is used where the Bell 202-type receiving modem may be sensitive to false signals at the end of a transmission.

## Automatic Adaptive Equalizer

Line conditioning is only available with leased lines. However, some modems are self-equalizing, providing some of the benefits of line conditioning, and can operate on switched and leased lines. They have an adaptive equalizer that automatically adjusts for variations in line parameters by developing a "mirror image" of the line characteristics.

## Testing

Three types of testing, when available, can be performed with modems. These are self-test, remote test and loopback test, with the test enabling keys located on the modem.

Self-test allows the operator to check out the modem, and uses a built-in word generator and comparator to check for errors. Remote test enables the modem to be tested from a telephone company test center. For a loopback test, the modem's transmitter output is connected to its receiver input. Both self-tests and loopback tests can also be performed end-to-end with another modem or a terminal.

## Transmit Only-Receive Only

There are modems that can only transmit or receive, not both. While this is equivalent to simplex mode, they actually use a half duplex channel since the Bell System usually does not provide simplex channels. Simplex, where used, is frequently a local hardware application, such as in-plant data collection.

## Originate Only-Answer Only

Some modems can only initiate calls while others can only answer to a call. However, once the call is received or placed, the modem can operate in full or half duplex mode.

## Attended-Unattended Operation

When a modem requires an operator to place or receive a call and switch it from voice to data, this is called attended operation. Unattended operation is when a modem can be called from a distance to turn on its associated terminal and commence operation. This is very useful for batch transmission from data collection terminals, where a central computer operating at night could collect data from many such terminals at scattered geographic locations.

## BELL SYSTEM MODEM NUMBERING

Although there are many manufacturers of modems in the market today, the Bell System invented this device and their equipment predominates the market. For this reason, non-Bell modems are often described in Bell terms.

Bell has an open-ended number classification for their modems. This allows for future growth and describes the general characteristics of the modem by the "100" series of its number; this numbering system is shown in table 3-1. For example, the 100 series modems operate at up to 300 bps and the 200 series at up to 9600 bps and both have bit serial asynchronous operation. The 400 series have bit parallel asynchronous operation with speeds up to 75 characters per second. The 600 series accepts analog inputs, rather than digital, and are used for facsimile data transmission such as handwriting, photographs, drawings and electrocardiograms.

Table 3-2 contains a listing of Bell modems by model. This shows the main features of each set and its options.

## NON-BELL MODEMS

Modem manufacturers relate their products to Bell modems, using the terms "equivalent" and "compatible". Equivalent means it is similar to a specified Bell modem but may not be capable of communication with that modem. Compatible means it can communicate with the specified modem.

Table 3-1 Bell Data Sets Numbering Series

SERIES	BANDWIDTH	TRANSMISSION SPEED	DATA TRANSMISSION	SIGNAL
100	Narrow and Voice	Up to 300 Bit/Second	Serial	Digital
200	Voice	Up to 9600 Bit/Second	Serial	Digital
300	Wide	Up to 460k Bit/Second	Serial	Digital
400	Narrow	0-75 Character/Second	Parallel	Digital
500	Experimental Models Only	19.2k Bit/Second 230.4k Bit/Second	Parallel	Analog
600	Voice	DC to 900 Character/Second	Facsimile	Analog
800	Data Auxiliary Sets		Automatic Calling Unit	
900	Telephone Company Data Test Equipment			

Table 3-2 Bell Data Sets Characteristics<sup>1</sup>

Model No.	Max. Bit Speed	Chan. Mode		Reverse Chan.	Timing		Modulation			Interface		Recom. Cond.	Comments
		HDX	FDX		Sync	Async	FSK	PSK	VSAM	EIA	Contact Closure		
103A	300	X	X			X	X			X			Switched lines only.
103E	300	X	X			X	X			X			Switched lines only. Up to 40 in a cabinet. Used with time share computers requiring many I/O lines.
103F	300	X	X			X	X			X			Leased lines only. Remote test key and lamp.
113A	300	X	X			X	X			X			Switched lines only. Status lamps. Handset for placing calls. Can only originate calls. Used with remote access time share computer service. One interface signal is non-EIA.
113B	300	X	X			X	X			X			Switched lines only. Remote test. Can only answer calls. Used with time share computer ports. Up to 60 in a cabinet.
201A	2000 (Fixed)	X	X		X			X		X	X	C2	
201B	2400 (Fixed)	X	X		X			X		X	X	C2 or C4	Leased lines, but can use switched lines as backup.
201C	2400 (Fixed)	X	X		X			X		X	X	C2 or C4	Same as 201B with additional features of status lamps and test keys. Up to 30 in a cabinet.

<sup>1</sup>Unless otherwise stated, data sets are single channel, can transmit and receive and operate with leased or switched lines. Receive only and transmit only data sets use a half duplex channel. Except for 202R, all data sets are capable of automatic answering.



Table 3-2 Bell Data Sets Characteristics<sup>1</sup> (Continued)

Model No.	Max. Bit Speed	Chan. Mode		Reverse Chan.	Timing		Modulation			Interface		Recom. Cond.	Comments
		HDX	FDX		Sync	Async	FSK	PSK	VSAM	EIA	Contact Closure		
202C	1200 1800	X	X			X	X			X	X	C1 above 1000 bps C2 above 1400 bps	Handset for placing calls  Switched lines - up to 1200 bps. Leased lines - up to 1800 bps.
202D	1200 1800	X	X			X	X			X	X	Same as 202C	Same as 202C without handset.
202E	1200 1800	X	X	X		X	X			X		Same as 202C	Same as 202C except can only Transmit. Optional reverse channel.
202R	1200 1800	X	X			X	X			X		Same as 202C	Provides minimum capability for leased line service, but can also be used with switched lines. Otherwise same as 202C
202S	1200	X		X		X	X			X			Switched lines only. Optional reverse channel. Status lamps, remote and self-test.
202T	1200 1800	X	X			X	X			X		C2 above 1200 bps	Leased line only. 1200 bps with reverse channel. 1800 bps with out reverse channel. Status lamps, remote and self-test.
203A, B, C	1800 to 10,800	X	X	X	X				X			C2	Five speed group options, each option with three fixed speeds. 203B is transmit only. 203C is receive only.
208A	4800 (Fixed)	X	X		X			X		X			Leased lines only. Automatic equalization. Status lamps, remote and self-test.
208B	4800 (Fixed)	X			X			X		X			Switched lines only. Automatic equalization. Status lamps, remote and self-test.
209A	See Comments	X	X		X			X		X		D1	Leased line and point-to-point only. Automatic equalization. Five fixed speed groups: One 9600 bps channel One 7200 bps and one 2400 bps channel Two 4800 bps channels One 4800 bps and two 2400 bps channels Four 2400 bps channels. Status lamps, remote and self-test.
303 Type	18.75k to 460.8k	X	X	X	X	X	X			X			Leased line only. 303 type is a family of high speed wideband data stations housed in cabinets. A common use is in computer-to-computer communications.
401A	20 char/sec	X				X	X				X		Handset for placing calls. Transmit only. Uses 2 out of 8 code to represent 24 characters. Multi-frequency tones represent char

<sup>1</sup>Unless otherwise stated, data sets are single channel, can transmit and receive and operate with leased or switched lines. Receive only and transmit only data sets use a half duplex channel. Except for 202R, all data sets are capable of automatic answering.

Table 3-2 Bell Data Sets Characteristics<sup>1</sup> (Continued)

Model No.	Max. Bit Speed	Chan. Mode		Reverse Chan.	Timing		Modulation			Interface		Recom. Cond.	Comments
		HDX	FDX		Sync	Async	FSK	PSK	VSAM	EIA	Contact Closure		
401E	20 char/sec	X				X	X				X		Same as 401A except uses 3 out of 14 code to represent 99 characters.
402C	75 char/sec	X		X		X	X				X	C1	Handset for placing calls. Transmit only. Eight parallel channels for digital data. Remote testing key.
402D	75 char/sec	X		X		X	X				X	C1	Same as 402C except receive only and no handset.
403D	10 char/sec	X				X	X			X	X		Multiple installation in a cabinet. Receive only. Input is 2 out of 8 audio code.
403E	10 char/sec	X				X	X			X	X		Same as 403D except stand-alone.
601A	Analog	X				X					X	As reqd.	Analog inputs from telewriting terminal. Two channels. Handset for placing calls. Remote test key.
601B	Analog	X				X					X	As reqd.	Same as 601A except three channels.
602C	Analog	X		X		X					X	As reqd.	Transmit only of facsimile or similar analog signals. Handset for placing calls. Optional reverse channel. Remote test key.
603A	Analog	X				X					X	As reqd.	Transmit only of electrocardiographic information. Handset for placing calls. Remote test keys.
603B	Analog	X				X					X	As reqd.	Same as 603A except receive only.
603D	Analog	X				X					X		Portable, battery-operated acoustic coupler. Battery test key.
604A	Analog	X				X					X	As reqd.	Transmit only of medical analog inputs. Handset for placing calls. Remote test keys.
604B	Analog	X				X					X	As reqd.	Same as 604A except receive only.
801A										X			Automatic Calling Unit (ACU). Allows a computer to automatically originate calls through rotary dial facilities.
801C										X			Same as 801A except places calls through multifrequency tone facilities.

<sup>1</sup> Unless otherwise stated, data sets are single channel, can transmit and receive and operate with leased or switched lines. Receive only and transmit only data sets use a half duplex channel. Except for 202R, all data sets are capable of automatic answering.

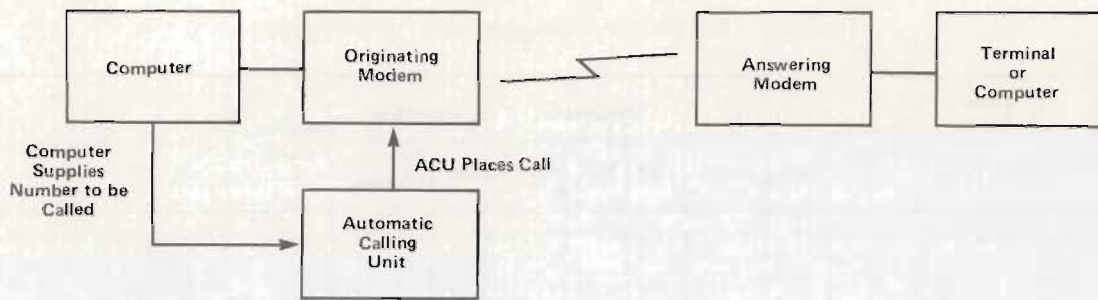

Figure 3-9 Automatic Calling Unit Function

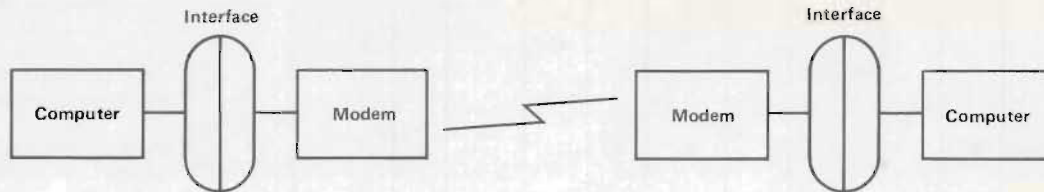

Figure 3-10 Interface Location

### DATA ACCESS ARRANGEMENT (DAA)

Where a non-Bell modem is used, a DAA device must be used to make a connection over the switched network. This is a network protection device, supplied and maintained by the Bell System, and can be manual or automatic. It is not required for leased lines. Some non-Bell modems may be authorized by the telephone company for use without a DAA, if they have a suitable protective device similar to a DAA.

### AUTOMATIC CALLING UNIT (ACU)

Bell 801-type Automatic Calling Units (ACU) work with a computer, which provides the called number, to allow automatic dialing connect and disconnect in a switched network. The ACU assumes control of the line until a valid connection is established, indicated by a tone received from the distant (answering) modem. The line is then transferred from the ACU to the originating modem, which goes into data mode. Figure 3-9 shows the ACU function.

### INTERFACE

In Datacomm usage, the term "interface" refers to the connection between the terminal or computer and the data communications equipment, as shown in figure 3-10. There are two main types of interface: contact closure and voltage. Most voltage interfaces conform to the Electronic Industries Association (EIA) standard RS232C. There are several other interface standards designed for special purpose applications. A CCITT standard regulates interfaces in international usage. Hardwire, cable and acoustic couplers do not require a modem but do have an interface.

### CONTACT CLOSURE INTERFACE

A mechanical, relay-type interface, contact closure is used with bit-parallel data transmission. It operates at a relatively slow speed, usually under 100 characters per second, and is also called a "carrier" interface. There is no standard covering this type of interface other than the voltage and current limits specified by the Bell System. Within the Bell

limits the user determines his own electrical requirements. Contact closure is an option on many Bell bit serial modems.

### CCITT V24 INTERFACE STANDARD

International Telegraph & Telephone Consultative Committee (CCITT) is an international consultative body for setting international communication standards. Their interface standard is CCITT V24, which closely resembles RS232C, and is the standard in common European use. Table 3-3, which shows the RS232C-designated circuits by category, also shows the equivalent numbered CCITT V24 circuit.

### EIA RS232C INTERFACE STANDARD

Most voltage interfaces in North America conform to EIA RS232C. This specifies a 25-pin connector as the standard interface in Datacomm networks, with lettered pin assignments for ground, data, control and timing circuits. It also specifies the mechanical and electrical requirements of an interface, within an operating range of 0 to 20,000 bps in bit-serial operation, synchronous and asynchronous. It provides a common meeting ground, allowing interaction between many types of equipment and manufacturers, providing great flexibility in the selection of equipment for a Datacomm network.

### Mechanical

The signal interface between the Data Communications Equipment (DCE), usually a modem, and the Data Terminal Equipment (DTE), the remote terminal or data processor, is located at the RS232C-specified connector located between the two equipments. The female is connected to the DCE and the male to the DTE. Short cables of less than 50 feet (15 meters) are recommended, but longer cables may be used if the load capacitance is suitable. The pin assignments shown in table 3-4 must be used, and unassigned pins may carry additional circuits determined by mutual agreement between the communicating parties.

Table 3-3 EIA RS232C Interchange Circuits by Category

INTERCHANGE CIRCUIT	CCITT V24 EQUIVALENT	DESCRIPTION	GND	DATA		CONTROL		TIMING	
				FROM DCE	TO DCE	FROM DCE	TO DCE	FROM DCE	TO DCE
AA	101	Protective Ground	X						
AB	102	Signal Ground/Common Return	X						
BA	103	Transmitted Data			X				
BB	104	Received Data		X					
CA	105	Request to Send					X		
CB	106	Clear to Send				X			
CC	107	Data Set Ready				X			
CD	108.2	Data Terminal Ready					X		
CE	125	Ring Indicator				X			
CF	109	Received Line Signal Detector				X			
CG	110	Signal Quality Detector				X			
CH	111	Data Signal Rate Selector (DTE)					X		
CI	112	Data Signal Rate Selector (DCE)				X			
DA	113	Transmitter Signal Element Timing (DTE)							X
DB	114	Transmitter Signal Element Timing (DCE)						X	
DD	115	Receiver Signal Element Timing (DCE)						X	
SBA	118	Secondary Transmitted Data			X				
SBB	119	Secondary Received Data		X					
SCA	120	Secondary Request to Send					X		
SCB	121	Secondary Clear to Send				X			
SCF	122	Secondary Received Line Signal Detector				X			

Table 3-4 EIA RS232C Interface Connector Pin Assignments

Signal Direction		Pin Number	Circuit	Description
Terminal	Modem			
		1	AA	Protective Ground
	→	2	BA	Transmitted Data
←		3	BB	Received Data
	→	4	CA	Request to Send
←		5	CB	Clear to Send
	→	6	CC	Data Set Ready
←		7	AB	Signal Ground (Common Return)
	→	8	CF	Received Line Signal Detector
		9	—	(Reserved for Data Set Testing)
		10	—	(Reserved for Data Set Testing)
		11	—	Unassigned
←		12	SCF	Secondary Received Line Signal Detector
←		13	SCB	Secondary Clear to Send
	→	14	SBA	Secondary Transmitted Data
←		15	DB	Transmission Signal Element Timing (DCE Source)
←		16	SBB	Secondary Received Data
←		17	DD	Receiver Signal Element Timing (DCE Source)
		18	—	Unassigned
	→	19	SCA	Secondary Request to Send
	→	20	CD	Data Terminal Ready
←		21	CG	Signal Quality Detector
←		22	CE	Ring Indicator
	→	23	CH/CI	Data Signal Rate Selector (DTE/DCE Source)
	→	24	DA	Transmit Signal Element Timing (DTE Source)
		25	—	Unassigned

## Electrical

Except for protective and signal grounds, all circuits carry bi-polar low-voltage signals that are suitable for electronic circuits. All voltages are measured at the connector with respect to Signal Ground (AB) and cannot exceed  $\pm 25$  V. The significance of the bi-polar signals is summarized in table 3-5, with the region between  $\pm 3$  V defined as the transition region.

Control circuits can be designated as fail-safe. This means that when power is lost at the transmitter the receiver interprets the signal condition as OFF.

While RS232C designates 23 circuits, the number actually in use depends upon the type of modem. In the case of the Bell 103A, only nine circuits are required for operation. However, this modem can provide a good example of the back-and-forth signal flow across the interface.

Table 3-5 EIA RS232C Interface Voltages

		Negative Voltage (-3 to -25)	Positive Voltage (+3 to +25)
Data	Binary State	1	0
Circuits	Signal Condition	Mark	Space
Control Circuits		OFF	ON

## BELL 103A OPERATION

The Bell 103A is designed for DATA-PHONE service over switched lines with user-provided DTE. It is asynchronous, can originate and receive calls, operates at speeds up to 300 bps in half duplex (HDX) and full duplex (FDX) and uses frequency shift keying (FSK), described later in this chapter. During operation it is in the data mode, otherwise it is in the auto, local, test or talk modes (figure 3-11).

These modes can be selected by the operator on push buttons located on the Bell 804-type Data Auxiliary Set, which operates in conjunction with the Bell 103A. The AUTO push button allows the modem to automatically answer incoming calls and then go into the data mode,

however, it cannot place a call automatically unless it has a Bell 801-type Automatic Calling Unit (ACU). To manually place a call, the operator presses the TALK push button, dials the number, listens for a tone, then presses the DATA push button to set the modem in data mode when the tone arrives. The modems then communicate with each other in a series of frequencies or tones.

## FREQUENCY MODES

A modem has two frequency modes — one for originating (placing) calls and one for answering calls. Normally it is in the originating mode. When a ringing signal is received, indicating an incoming call, the modem switches to the answering mode. It remains in this mode for the duration of the call.

Two frequency bands, designated as F1 and F2, are used in each mode, with F1 the lower frequency band and F2 the higher frequency band. The originating modem transmits F1 and receives F2. The answering modem transmits F2 and receives F1. Within each band two frequencies are used — one for MARK and one for SPACE.

With the Bell 103 in the following example, the originating frequency mode (F1) transmits a MARK (F1M) as 1270 Hz, and a space as 1070 Hz. The answering frequency mode (F2) transmits a MARK (F2M) as 2225 Hz, and a SPACE (F2S) as 2025 Hz.

## SIGNAL DESCRIPTION

Figure 3-12 is a block diagram of the signals going between the Bell 103A and the DTE. While the interface has 23 RS232C-designated circuits, 9 of the circuits are used in this example. Note that the circuits CB, CF, BB, CC and CE carry signals from the modem to the DTE, while the remaining circuits BA and CD carry signals from the DTE to the modem.

## Protective Ground

Circuit AA is tied to the modem frame and back to the power system ground. If it is also tied to the DTE, then the DTE should have the same reference.



Figure 3-11 Bell 804-Type Data Auxiliary Set (left) and Bell 103A Data Set (modem)

Courtesy of AT&T

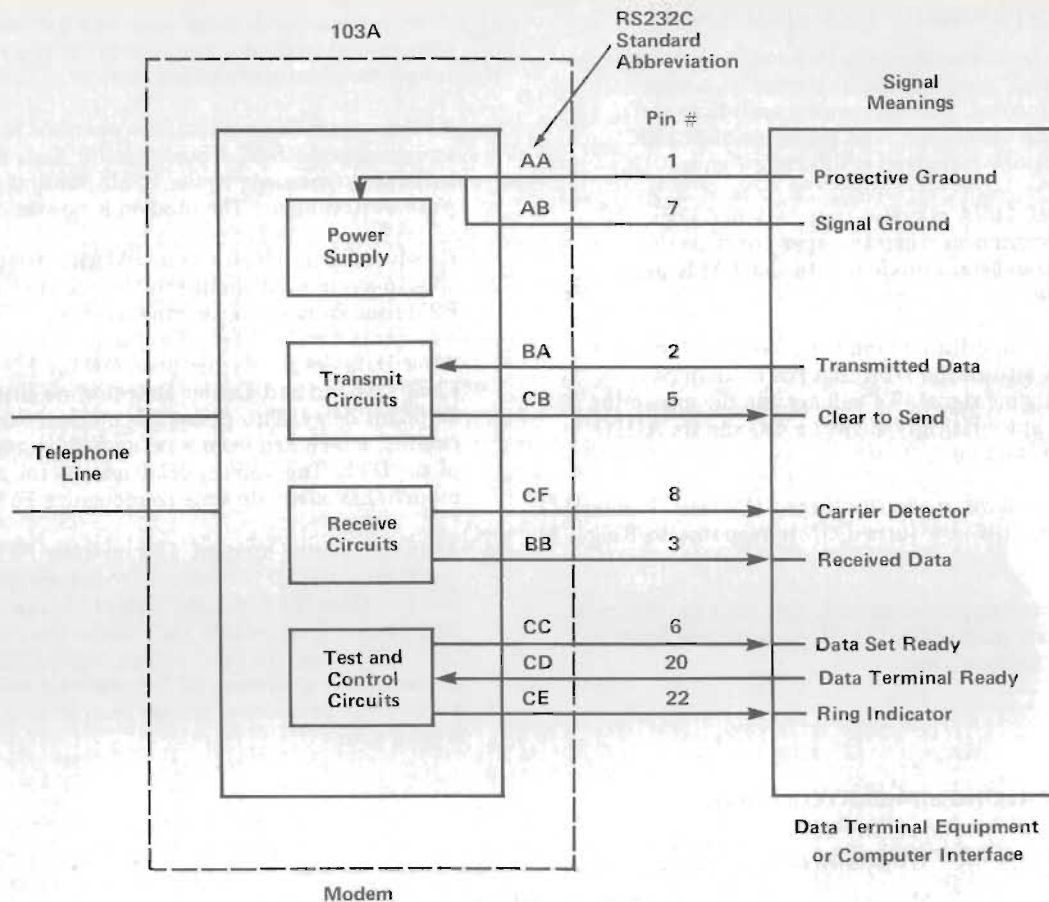

Figure 3-12 Bell 103A Simplified Interface Block Diagram

### Signal Ground

Circuit AB is the ground reference for interface signals. With the Bell 103A it is tied to the modem frame, and may also be tied to the DTE frame.

### Clear to Send

Circuit CB (modem to DTE) is ON when the originating modem has established connection with the distant modem and the Transmitted Data circuit can be used. On modems other than the Bell 103A, this circuit is the delayed Request to Send.

### Transmitted Data

Circuit BA (DTE to modem) is used to send data to the distant modem. It can be active only when Clear To Send is ON.

### Carrier Detector

Circuit CF (modem to DTE), when ON, shows that the data carrier is being received from the distant modem. With the Bell 103A, this circuit and Clear To Send (CB) carry simultaneous signals.

### Received Data

Circuit BB (modem to DTE) delivers the data received at the modem to the DTE. This circuit is held to a MARK when the modem is idle or when Carrier Detector (CF) is OFF.

### Data Set Ready

Circuit CC (modem to DTE), when ON, shows the modem is in the data mode and connected to the telephone line.

### Data Terminal Ready

Circuit CD (DTE to modem) is provided by the DTE to allow the modem to enter and remain in the data mode. When ON it allows the modem to automatically answer an incoming call (if AUTO push button is down), or be manually placed in the data mode (by pressing the DATA push button). When it goes OFF, it commands the modem to disconnect the line at the end of the call.

### Ring Indicator

Circuit CE (modem to DTE) goes ON to inform the DTE that a ringing signal has been received by the modem.

## CHANNEL ESTABLISHMENT SEQUENCE

Before data can be transmitted the two modems must be in the data mode and "channel establishment" — a tone exchange — performed. This is repeated each time the modems enter the data mode. The sequence of MARK tones for establishing a channel is shown in figure 3-13.

- ① Since the Bell 103A operates over switched lines, the sequence commences when the operator dials the number of the distant modem with the TALK push button down.
- ② At the answering (distant) modem, the Ring Indicator turns ON to inform the DTE that the modem has received a ringing signal. We will assume the answering modem can automatically answer a call and its AUTO push button is down.
- ③ The DTE may have previously turned ON Data Terminal Ready; if not, it is now turned ON in response to Ring Indicator.
- ④ When the answering modem turns ON Data Set Ready it enters the data mode. The DATA push button lights to indicate the modem's status.

- ⑤ After a 1.5 seconds delay time an F2M tone is transmitted to disable echo suppressors and initialize the telephone company's billing devices.

At the originating modem, the operator hears the tone and presses the DATA push button. Data Set Ready turns on in response to the F2M tone and the DATA push button lights. The modem is now in data mode.

Received Data, which was in a MARK HOLD condition, goes to a non-hold condition 150 ms after receiving the F2M tone from the answering modem.

After Data Set Ready has been ON for 1.5 seconds, Clear To Send and Carrier Detector are turned ON after a 265 ms delay. This places the modem's transmit circuits, which had been sending F1M, under the control of the DTE. The 265 ms delay assures the answering modem has adequate time to recognize F1M.

- ⑥ At the answering modem, 150 ms after F1M is received, the MARK HOLD is removed from Received Data. After 265 ms, Clear To Send and Carrier Detector are turned ON, placing Transmitted Data under the control of the DTE. With Clear To Send signals turned ON at both modems, the answering DTE can send a coded "go ahead" line protocol character indicating it is ready to receive data.

### CALLING (ORIGINATE) MODEM

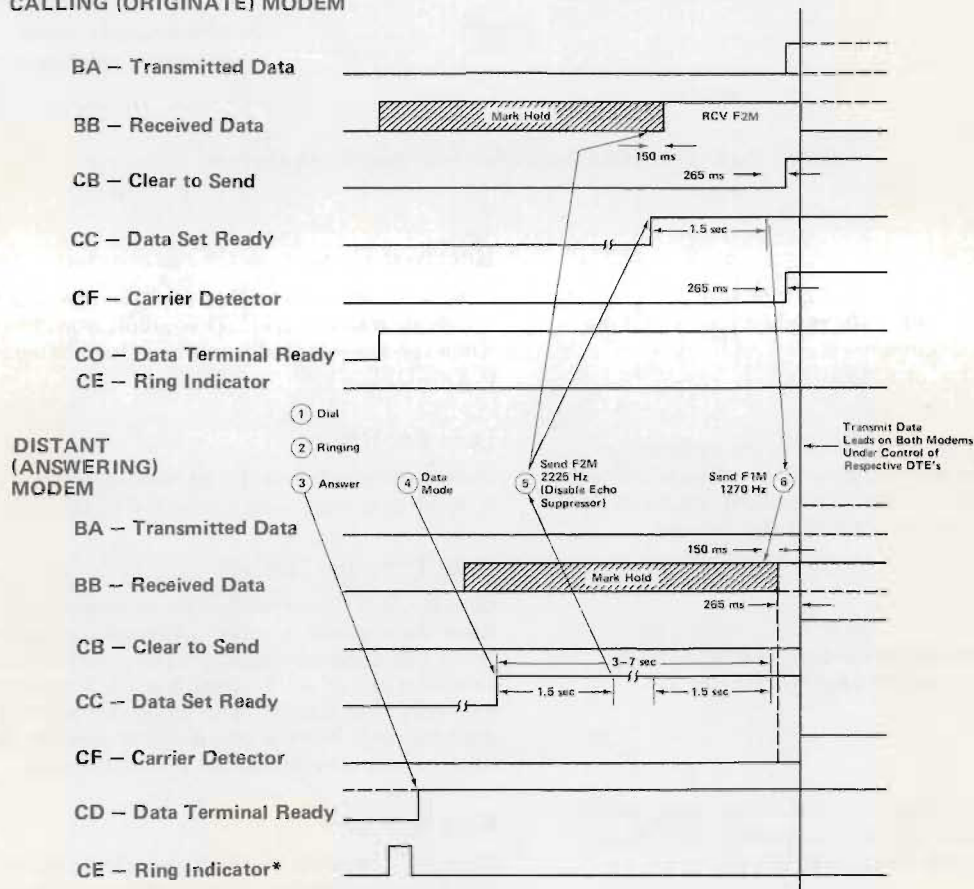

\*Some DTE's do not wait for Ring Indicator to turn ON Data Terminal Ready.

Figure 3-13 Bell 103A Channel Establishment Sequence

## DISCONNECT SEQUENCE

At the completion of a call the operator, if attended operation, or the ACU on a signal from the DTE, if unattended operation, breaks the connection and goes on-hook. Since we have assumed the distant modem is in AUTO mode, it will automatically break the connection. With attended operation at both modems, the operator can end the data mode but maintain the connection for voice communication by pressing the TALK push button.

A disconnect can be a "long" or a "short" space. With a long space, the modem will disconnect and return to idle condition after receiving a 1.5 second spacing signal. With a short space, it will disconnect after a 400 ms spacing signal. We will describe a long space as an example of a disconnect, as shown in figure 3-14.

- ① A long space disconnect sequence starts when the initiator DTE turns OFF Data Terminal Ready for at least 50 ms. Three seconds later, Data Set Ready will be turned OFF.

- ② Transmitted Data goes to a three-second SPACE.
- ③ After 1.5 seconds of the above SPACE, the responder modem releases the line and turns OFF Data Set Ready.
- ④ Thirty ms after Data Set Ready goes OFF, Clear To Send and Carrier Detector turn OFF, disconnecting the responder modem. Received Data goes to a MARK HOLD.
- ⑤ Three seconds after initiation, the initiator's Data Set Ready turns OFF when the line is released.
- ⑥ Thirty ms later, Clear To Send and Carrier Detector turn OFF, disconnecting the modem.

Both modems are now in a non-data mode, sending a continuous MARK HOLD over the Transmitted Data circuits.

### RESPONDING MODEM

BA — Transmitted Data  
 BB — Received Data  
 CB — Clear to Send  
 CC — Data Set Ready  
 CF — Carrier Detector  
 CD — Data Terminal Ready

### INITIATING MODEM

BA — Transmitted Data  
 BB — Received Data  
 CB — Clear to Send  
 CC — Data Set Ready  
 CF — Carrier Detector  
 CD — Data Terminal Ready

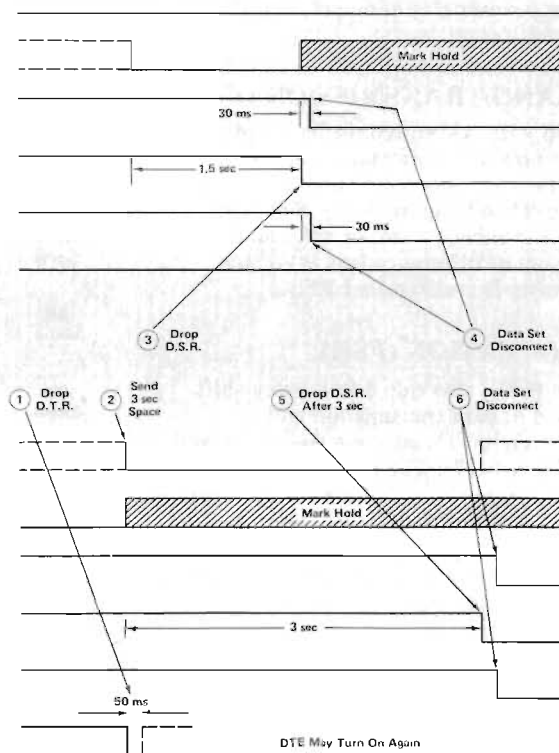

Note: Other Disconnect Sequences are similar and can be initiated by the DTE dropping CF or CC or returning the Data Set to TALK and going ON-HOOK.

Figure 3-14 Bell 103A Long Space Disconnect Sequence



## MODULATION

Computers and terminals handle data in a digital format, as dc voltage levels, while telephone lines carry information in an analog format as on ac frequency. Thus, it is necessary to convert (modulate) the digital data into analog format, usually in a modem, for transmission over telephone lines.

Modulation is performed by impressing digital dc pulses upon a "carrier wave", so the carrier wave pattern is altered to correspond to the digital pattern. The frequency range of the signal impressed on the carrier is called "baseband". At the receiver, demodulation is performed by detecting the changes in the carrier wave to reconstruct the digital pattern. There are four types of modulation:

- Amplitude
- Frequency (Frequency Shift Keying – FSK)
- Phase (Phase Shift Keying – PSK)
- Multi-level pulse

### AMPLITUDE MODULATION

Amplitude modulation (AM) is the descendant of the telegraph – where a circuit was keyed on and off to generate a series of dots and dashes. When a digital 1 is present (a mark), the carrier wave is transmitted. When a digital 0 is present (a space), the carrier wave is absent (figure 3-15). Thus, the receiver would detect a continuous carrier wave as a series of 1's.

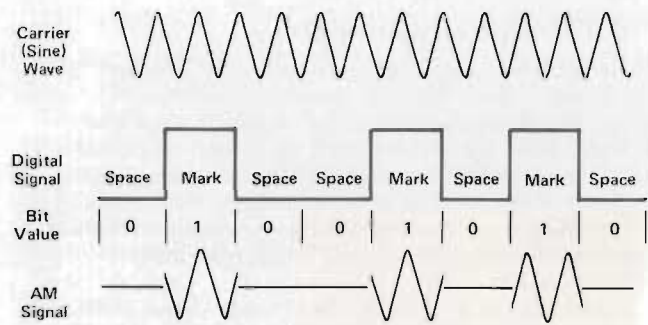

Figure 3-15 Amplitude Modulation

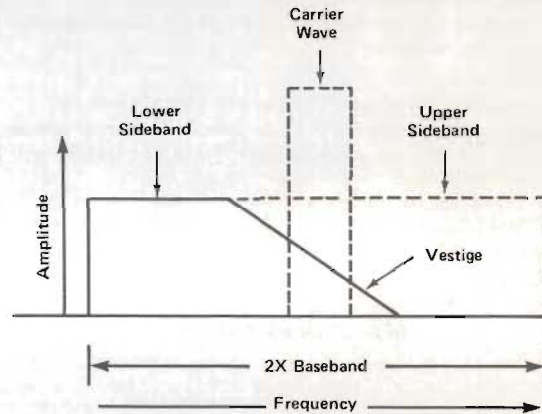

Figure 3-16 Vestigial Sideband

### VESTIGIAL SIDEBAND TRANSMISSION (VSAM)

This is a technique used with AM to reduce bandwidth requirements, conserve power and increase speed. It does this by using most of the lower sideband and a small part (vestige) of the upper sideband (figure 3-16). Sideband frequencies exist on either side of a carrier wave and represent the sum (upper) or difference (lower) of the baseband and carrier wave. It is also called VSB.

### FREQUENCY MODULATION (FSK)

Frequency modulation (FM), also called frequency shift keying (FSK) when used in data transmission and telegraphy, converts the digital 1's into one frequency and the 0's into another (figure 3-17). The carrier wave amplitude does not change, only the frequency, and there is a continuous signal being transmitted. Zero (space) has the higher frequency in Bell 202-type modems. The receiver detects the higher frequency as a 0 and the lower frequency as a 1. (See figure 3-8.)

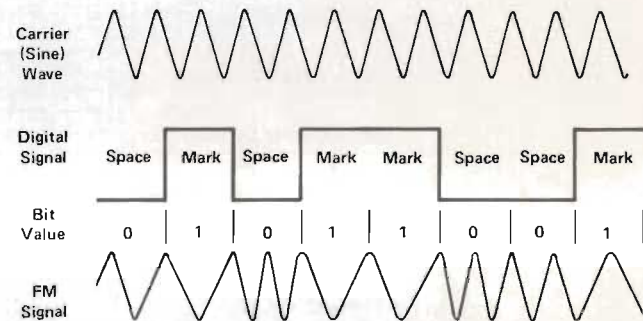

Figure 3-17 Frequency Modulation

### PHASE MODULATION (PSK)

Phase modulation is performed by forward or backward shifting of the phase of the carrier wave. It is also known as phase shift keying (PSK). A complete sine wave cycle covers 360 degrees of phase. Figure 3-18 shows the phases of a one cycle in a sine wave.

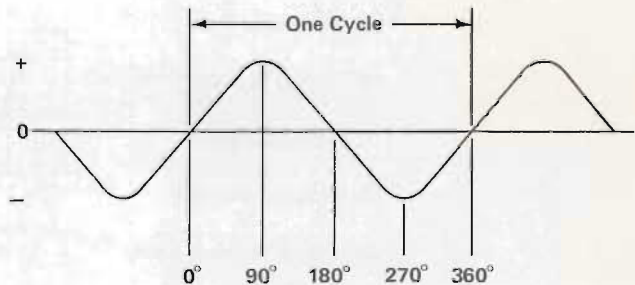

Figure 3-18 Sine Wave Phases

## Phase Shifting

The phase shifts shown in figure 3-19 are for a four-phase modulation — the phases can be changed at  $90^\circ$ ,  $180^\circ$ ,  $270^\circ$ , and  $360^\circ$  or  $45^\circ$ ,  $135^\circ$ ,  $225^\circ$  and  $315^\circ$ . In two-phase modulation the phases are shifted  $180^\circ$  apart. In eight-phase modulation they are shifted  $45^\circ$  apart. With two-phase modulation, a 1 might be represented by advancing the phase  $90^\circ$  and a 0 by retarding the phase  $90^\circ$ . It is the phase shift, not the point it occurs, that contains the digital signals.

The receiving device detects the phase shift as a mark or space, and the carrier wave amplitude remains constant. If a mark is detected during one bit time interval and no phase change occurs during the following bit time, then that bit time will also be detected as a mark. Figure 3-20 shows  $180^\circ$  forward phase modulation.

## Four Bit States

In four-phase modulation it is possible to transmit four-state bits instead of the two-state (1 and 0) used in AM and FM. This is possible by using a different phase for each of the four bits. These four-state bits are called dibits and are 00, 01, 10, 11 — four combinations of two bits. This is also called four-phase differential coding.

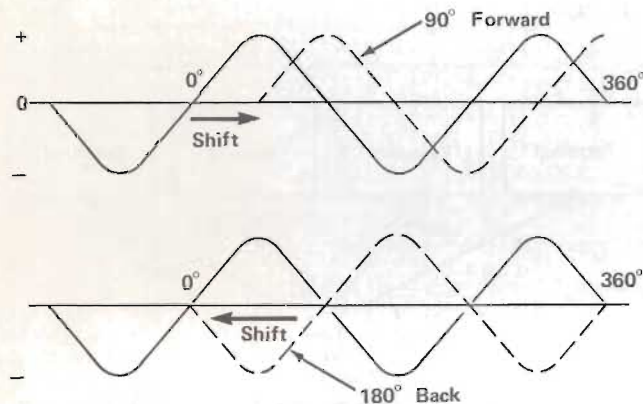

Figure 3-19 Sine Wave Phase Shifting

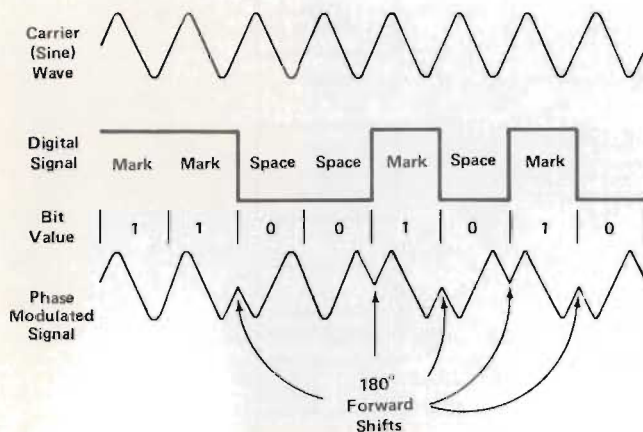

Figure 3-20  $180^\circ$  Forward Phase Modulation

## PULSE MODULATION

Unlike other types of modulation, pulse modulation is not used for voice facility transmission or in modems designed for use with such lines. It is used with data links which handle digital signals, a type of digital network coming into use.

The baseband signal is sampled at short successive time intervals (8000 samples per second) and the result coded as dc pulses. There are four methods of coding amplitude. The first three listed below vary the pulse shape, using amplitude position and duration (width) to describe the signal. The last uses a quantized wave that tracks the shape of the signals as a series of dc pulses: the receiver detects pulse changes, not pulse shapes. The four methods are:

- Pulse Amplitude Modulation (PAM)
- Pulse Position Modulation (PPM)
- Pulse Duration Modulation (PDM)
- Pulse Code Modulation (PCM)

With PAM, each sample of the signal is converted into a pulse amplitude. All pulses have the same width and leading edge position.

With PDM, the signal sample alters the width of the pulse. Pulse amplitude and leading edge position remain constant.

With PPM, the pulse leading edge shifts back and forth, depending upon the signal sample. Width and amplitude remain constant.

With PCM, the absolute amplitudes of the signal are quantized into discrete steps. Each step is a dc level which is maintained until there is a significant change in the signal. The number of steps is a function of the rate of change in the signal. A fast-changing signal would require many steps, a slow-changing signal would require fewer steps. Pulses can vary in width, amplitude and leading edge position.

## MIXED MODULATION

Some methods of modulation combine two or more of the types described here. The mixture used depends upon the characteristics of the signal being modulated and the speed, efficiency and type of the data link.

## MULTIPLEX

The speed of transmission possible over a data link may greatly exceed the speed of a terminal. Were this data link to be used with one terminal, the cost would be high relative to the amount of data transmitted. One way to correct this speed imbalance is multiplexing — to simultaneously send data from a number of terminals over the same line. To multiplex means to divide the link into slots, with each division containing information from a separate source. These slots can be divided in time or frequency. Multiplexers are usually stand-alone hardware devices.

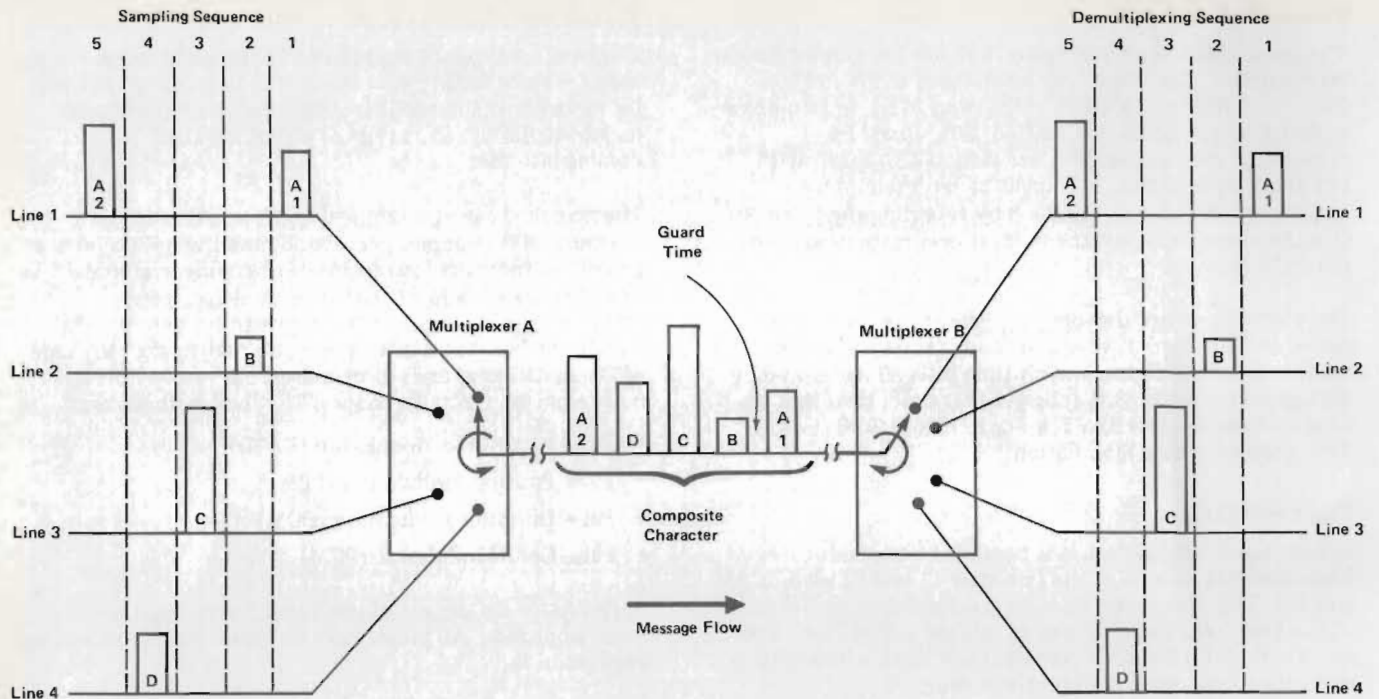

Figure 3-21 Time-Division Multiplexing by Bit

### TIME DIVISION MULTIPLEXING (TDM)

Time division multiplexing can be compared to a switch that rapidly samples a number of lines. These samples are sent across the data link, then routed back to their original sequence by another switch at the receiver, as shown in figure 3-21. The four parallel inputs to multiplexer A become a serial stream for transmission, then are switched back to their original parallel positions at multiplexer B. Data can be interleaved by bit or character.

In the example, a 1200 bps data link could handle four terminals each operating at around 250 bps. It could not operate at 1200 bps since a guard (separation) time must be allowed between the bit time slots. This method is usually used with slow-speed terminals, such as paper tape punches and card readers. PCM is used with this type of multiplexing.

An example of a time division terminal to computer connection is shown in figure 3-22. Where a number of similar terminals are in one location, the number of modems required can be reduced by using TDM. However, the modem used would have to have a much higher speed to perform the same work as the replaced modems.

### FREQUENCY DIVISION MULTIPLEXING (FDM)

Unlike time division, in frequency division the data maintains its identity for transmission and is not merged with other data to form a composite character. The principle is the same as a radio receiver. There are many radio stations simultaneously broadcasting on different frequencies, but the listener tunes into the one station he wishes to hear.

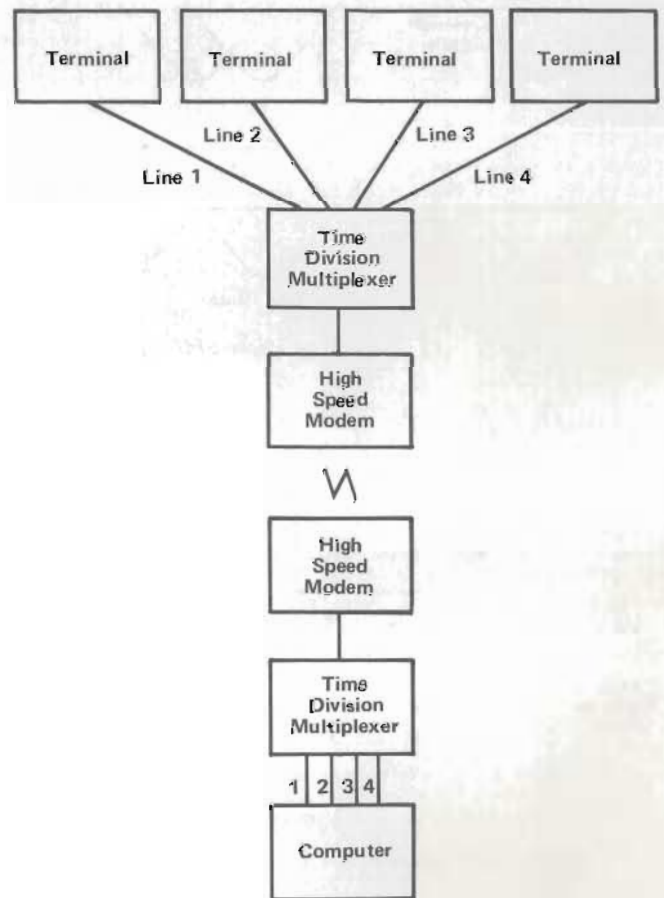

Figure 3-22 Terminal-Computer Time Division Multiplexing

Each line is assigned its own individual frequency, allowing simultaneous transmission of many data streams over a single line. The receiver contains demodulators, each looking for a particular frequency, as shown in figure 3-23.

The example in figure 3-24 shows a modem performing its normal function plus the multiplexing function. Instead of generating one carrier, it generates multicarriers, one for each of the data streams travelling in parallel across the data link.

## DIGITAL DATA LINKS

Frequency bandwidth — the range of frequencies a communications link can carry — is the key to higher data speeds. Because telephone lines were designed for voice transmission, they have a 3000 Hz frequency range, allowing a maximum practical data rate of 9600 bps. Considering that a computer spews out millions of bits per second, it can be seen that there is a mismatch between what a computer can produce versus line speed.

Currently, most Datacomm functions are performed over wires, cables and other telephone equipment. For city-to-city use this analog method will be increasingly displaced by all-digital data networks dedicated to Datacomm use. Some now in limited service are Bell's Dataroute in Canada and Dataphone Digital Service (DDS) in the United States. Companies are being formed that deal solely in digital data transmission.

These services offer both cost reductions and higher speed, and the main factor providing this is the use of microwave

transmission between cities. Using microwave expands the frequency bandwidth available, allowing future speeds of up to 1.544 million bps. Voice communications costs have steadily increased while computer costs have steadily fallen. Eliminating voice lines removes the biggest factor in increasing costs.

Analog links will continue to see growing use at speeds of 9600 bps and lower, both in network use and as "legs" providing access to digital networks. Analog lines can carry both voice and data whereas digital lines can carry only data.

## SUMMARY

In this chapter we have looked at the equipments located between the line and the DTE. We have seen how digital, square-wave data is converted into analog waveforms for transmission over a telephone line, and the types of modulation used to do this. A standard interface between the DTE and DCE allows many types of diverse equipment to be used in a network, providing a common meeting ground at a specified location.

The Bell 103A provided us an example of channel establishment and disconnecting, the interaction between a calling modem and an answering modem. The calling signal sequence described the modems interaction up to the point where data could be transferred. However, once the connection is complete, then the line protocol takes over as the traffic manager to regulate the message flow. Chapter four describes the uses and types of line protocol.

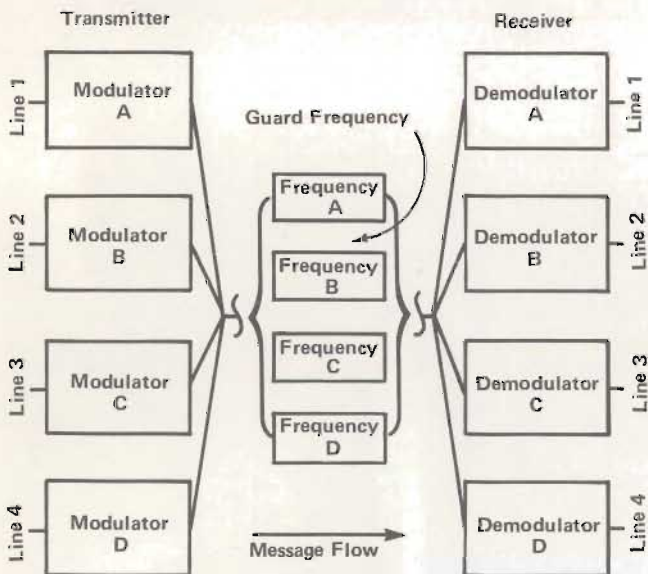

Figure 3-23 Frequency Division Multiplexing

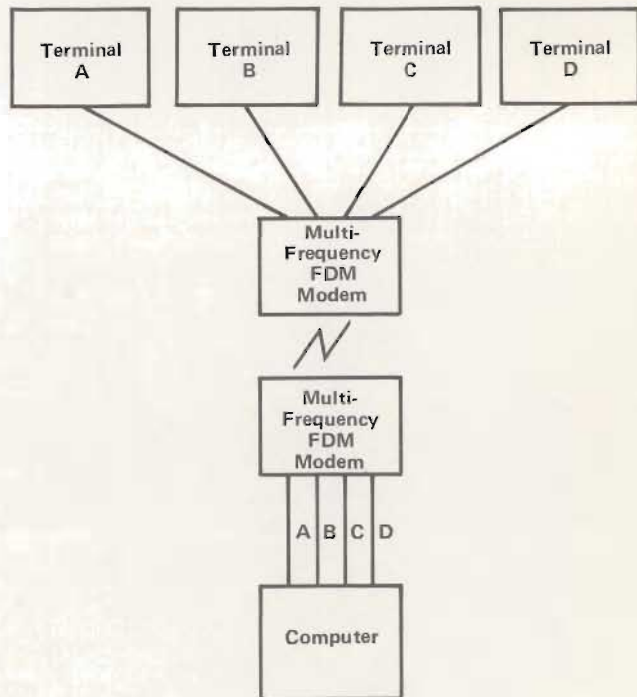

Figure 3-24 Terminal-Computer Frequency Division Multiplexing

Line protocol is another name for data link control, a method for management of a data link. It provides a grammar by which machines can converse with each other and serves as a vehicle for the transmission of information. Were information transfer to always be between two locations in a point-to-point dedicated data link there would be no need for a complex line protocol, a simple control procedure would suffice. However, as we have seen in previous chapters, data communications uses a variety of facilities and configurations and a complex line protocol is required. There are a number of line protocols in use today but IBM's Binary Synchronous Communications (BSC), first introduced in 1966, has become the *de facto* industry standard for medium- and high-speed data communications. BSC in effect stabilized what had been a confused situation in data communications.

New transmission facilities, such as digital networks and satellites, created a need for a more-efficient line protocol than BSC. This need was met by the International Standard Organization (ISO) High Level Data Link Control (HDLC). It allows a much greater volume of information to be transmitted in a given time period and is fast becoming accepted as an international standard. Information can be handled at less cost per unit volume with greater reliability and more flexibility of application.

## BINARY SYNCHRONOUS COMMUNICATIONS (BSC)

With BSC and other line protocols of this type, "handshaking" is the term commonly used to describe the interaction between stations. Typically the following information is exchanged:

- Message available for transmission
- Start of text transmission
- Acknowledgment or rejection of the text
- Detection of errors
- Retransmission after error detection
- End of transmission

A simplified handshaking sequence is summarized in figure 4-1. In this sequence, a terminal tells a computer it has a message to transmit. The computer recognizes the terminal and tells it to proceed with the message. When the computer receives the message, it detects an error in the text and requests a retransmission. The retransmission is error-free and the computer asks the terminal for another message. The terminal does not have anything more to transmit and so informs the computer. If the computer had a message to transmit to the terminal it could now do so. Since it does not, it disconnects from the terminal.

## SYNCHRONIZATION SEQUENCE

Before transmitting any control/message block, the sending location transmits synchronizing characters (SYN) to synchronize the two locations. A message exchange is initiated when a location sends an enquiry (ENQ) to another location. If the other location can accept a message it acknowledges (ACK) the enquiry. Throughout the handshaking sequence, each acknowledgment is alternately numbered one and zero.

As shown in figure 4-2, SYN followed by ENQ is transmitted to synchronize and initiate the exchange and the response is ACK 0, even positive acknowledgment. The sender then transmits SYN characters, followed by the message block.

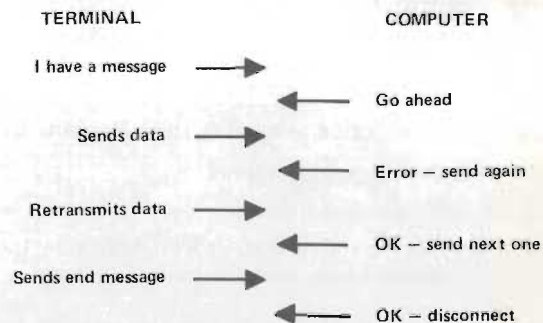
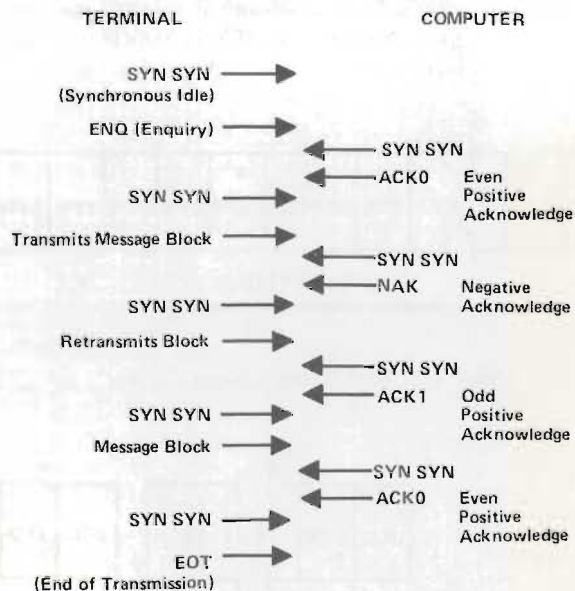

Figure 4-1 Simplified Handshaking Sequence



Note: Leading and trailing pads not shown.

Figure 4-2 BSC Handshaking Sequence

When the computer looks at the message block it detects an error and transmits a negative acknowledgment (NAK). The terminal then retransmits the message block. This time it is error-free and the computer transmits ACK 1, odd positive acknowledgment. Synchronization is performed at the start of each message block, and the terminal sends SYN SYN followed by the message. The transmission is error-free and the computer responds with ACK 0, even positive acknowledgment. Since the terminal has no more messages to transmit it sends the end of transmission (EOT) character. Unless the computer has something to transmit to the terminal, this completes the exchange and the computer disconnects from the terminal.

The line protocol characters used in the above example represent only a few of the BSC control characters. Table 4-1 lists character mnemonics along with their meaning and function.

### MESSAGE FIELDS

A message block format is shown in figure 4-3. Each transmission can contain up to three elements:

- An optional header
- The text
- A trailer

The control characters used to identify these elements are:

- SOH, indicating the header follows
- STX, indicating the text follows
- ETX, indicating the end of text, or ETB, indicating the end of the message block, with the trailer following.

As previously described, SYN characters, two or more, are used to establish character synchronization between sender and receiver. The number of SYN characters used varies with different networks and applications, and the four shown in figure 4-3 are one accepted pattern. The message block follows the SYN characters. (SYN characters are not shown in the illustrations following figure 4-3.)

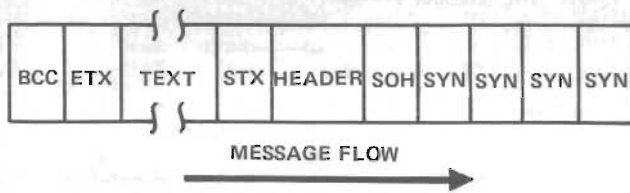

Figure 4-3 BSC Message Block Format

### MESSAGE BLOCK

A message consists of one or more blocks of information. Each block would contain a text and trailer and the first block would contain the header.

#### Header

Typically a header contains a character, or characters, that identify the originating or receiving location — this could be called the address. In multipoint links, a separate control message, not the header, may be used for addressing. An SOH character identifies the characters that follow as the header.

#### Text

The text portion of the message block is identified by a preceding STX character. A short message may only require a single block but a long message will be broken into a number of blocks. In the example shown in figure 4-3, the message consists of a single block and is followed by the end of text (ETX) control character. In a multi-block message the last block of text is followed by ETB.

#### Trailer

The trailer consists of the block check character (BCC). This character contains a count for error checking. As the block is transmitted, both sender and receiver each generate a count from the block. At the end of the block the receiver compares its block count with the sender's BCC character. If the two do not agree, a NAK character is transmitted to the sender, requiring the block to be retransmitted. If the error persists, a preset number of attempts will be made to obtain an error-free block, then the transmitter will abort. (How the BCC is obtained is in the description of error control.)

### LONG MESSAGES

Long messages are broken into a series of blocks for transmission, as illustrated in figure 4-4. Each block of text, except the last, is followed by an end of transmission block (ETB) character or an end of intermediate transmission block (ITB) character. ETB requires a response from the receiver and causes line turnaround and the BCC to be sent and compared. ITB divides the message for error checking purposes and does not require a response from the receiver. After the first ITB, an SOH is not required before each text block. The last intermediate block is followed by an ETX or ETB character. As each intermediate block arrives, its BCC is compared with the receiver's BCC. If an error is detected in any intermediate block, no action can be taken until ETB is received, then all intermediate blocks must be retransmitted.

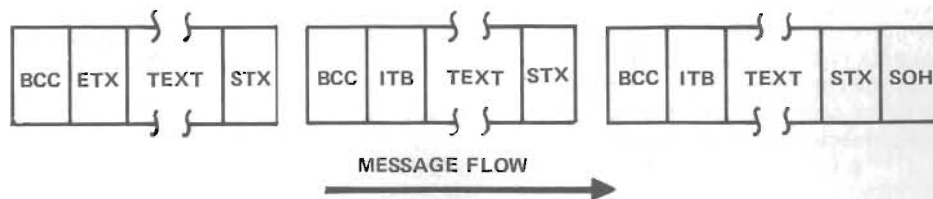

Figure 4-4 Multiblock Long Message

Table 4-1 BSC Control Characters

Character	Meaning	Functions
SYN	Synchronizing Character	Establishes and maintains character synchronization prior to the message block and during transmission. Also used as time fill in the absence of control characters and data.
STX	Start of Text	Transmitted before the first data characters.
ETB	End of Transmission Block	Indicates the end of the text block starting with STX or SOH. BCC is sent after ETB, requiring the receiver to respond with ACK, NAK or optionally WACK or RVI.
US/ITB	End of Intermediate Transmission Block	Divides a message for error checking purposes without the turnaround required by ETB. BCC follows ITB and resets the block-check count to zero. STX or SOH is not required for following text blocks, but STX is required if a header is followed by text.
ETX	End of Text	Terminates a block begun with SOH or STX and the end of a sequence of blocks. BCC immediately follows ETX, requiring a receiver status reply.
EOT	End of Transmission	Concludes transmission, resets all stations to control mode (neither transmitter nor receiver). Also a non-transmit response to a poll and an abort signal for a malfunction.
ENQ	Enquiry	Bids for the line in a point-to-point and multipoint connection, and requests last acknowledgment retransmission or a preceding block to be ignored.
*ACK	Affirmative Acknowledgment	Previous block accepted and error-free, receiver ready for next block. Also a positive response to selection (multipoint) or line bid (point-to-point).
SOH	Start of Heading	Transmitted before the header characters. These contain information such as the routing and priority of the message.
NAK	Negative Acknowledgment	Previous block unacceptable and retransmission required. Also a negative response to a selection or line bid.
*TTD	Temporary Text Delay	Transmitter not ready to commence transmission but wants to maintain connection. Sent two seconds after message received to avoid three second timeout, also initiates an abort.
*RVI	Reverse Interrupt	Sent to a transmitter by a receiver in place of ACK, indicating the receiver has a high priority message waiting transmission.
*WACK	Wait Before Transmit Positive Acknowledgment	Previous block accepted and error-free, but receiver not ready for next block. Will continue to respond with WACK until ready to receive. Also a positive response to a text or heading block selection sequence (multipoint), line bid (point-to-point) or identification line bid sequence (switched network).
DLE	Data Link Escape	Prefix for control characters during transparent mode. Control characters have no control meaning unless prefixed by DLE.
DLE EOT	Disconnect Sequence for a Switched Line	Transmitted on a switched line when all message exchanges are complete. Can be transmitted at any time to cause a disconnect.
Pad( $\phi$ )		Added before (leading pad) and after (trailing pad) a transmission. This ensures the first character is not sent until the other station is prepared to receive, and the last character is properly transmitted before turnaround is initiated or the transmitter turns off.

\*Two-character sequence.

## ALTERNATING POSITIVE ACKNOWLEDGMENT

An ACK0 is the affirmative reply to a polling-selection (multipoint) or a contention line bid (point-to-point). The next affirmative reply would be ACK1. Thereafter, ACK0 and ACK1 alternate to inform the sender that the previous block was accepted without error and the receiver is ready for the next block. The normal sequence of inprocess messages and acknowledgments is shown in figure 4-5.

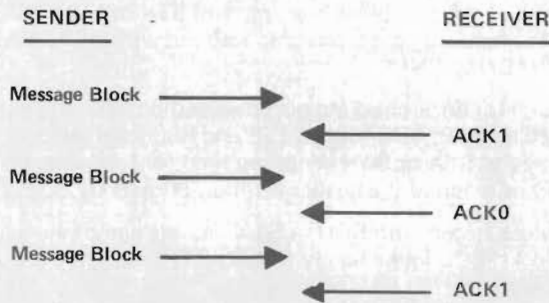

Figure 4-5 Inprocess Acknowledgments

The use of odd and even ACK's provides a sequential check for the series of replies. If an ACK is not received, the sender transmits an ENQ to the receiver. In the responses shown in figure 4-6, the sender has not received an ACK1 after the second message block was transmitted. After a nominal three seconds receive timeout, the sender transmits an ENQ. If the receiver responds with ACK0, then the message was lost, since the receiver is still acknowledging the first message block. If the receiver responds with an ACK1, then the message was received but the acknowledgment lost. In the first case the sender would retransmit the second message block, and in the second case would continue with the transmission.

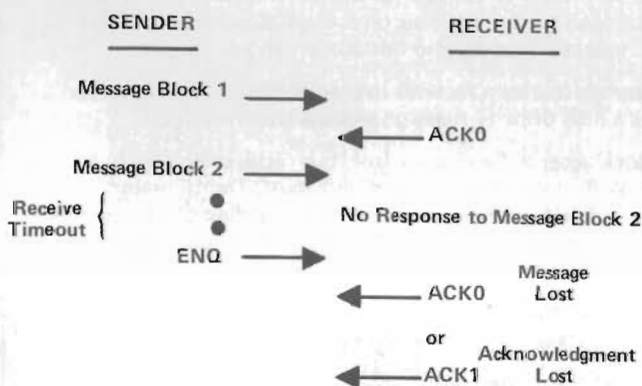

Figure 4-6 No Response To Message

## TIMEOUTS

In the previous example, there was no response to a message block. Were a response not to be returned to repeated ENQ's, a tie up of the link would result until a timeout broke the connection. There are four timeout functions:

- Transmit
- Receive
- Disconnect
- Continue

## Transmit Timeout

Once a second during transmission, one SYN character is automatically inserted into the message. This is for timing and, in the absence of a message, as a "timefill" to keep the link open, and inform the receiver that transmission is still in progress. When they are inserted in a message they do not affect the message contents and are deleted at the receiver. With transparent data, one DLE SYN is inserted every second.

The receiving location looks for the sync-idle characters, indicating continuing transmission. If text is absent for three seconds, the receiver ceases waiting for a transmission and disconnects.

## Receive Timeout

The receive timeout allows any receiving or monitoring stations to check the data line for sync-idle characters, indicating transmission is in progress. If they are absent for three seconds, a timeout occurs.

## Disconnect Timeout

This is an adjustable timeout used in switched network data links. When a station has been inactive for a specified time, it will disconnect itself from the network.

## Continue Timeout

This is a two-second timeout used to prevent a three-second timeout from occurring. It indicates that transmission or reception is delayed but will continue and the link should be maintained. It consists of a temporary text delay (TTD) sequence transmitted within two seconds of receiving acknowledgment of the previous block. A receiving station transmits a wait before transmit positive acknowledgment (WACK) sequence to prevent further transmission until it is ready to receive again.

## TRANSPARENCY

In the previous discussion of control characters, no text could have included control characters since the receiver would detect it as a control character and not text. The transparent mode removes this code restriction for line and message control characters and allows transmitting many forms of raw data within the standard message format. This provides greater versatility in the variety of coded data that can be handled. Raw data that contains a character identical to a control character is recognized as data by the receiver and it does not see (transparent) a control character.

However, some type of line protocol is needed in any type of data communications. This is accomplished by prefixing the previously discussed control characters with a data link escape (DLE) character. Only when the DLE prefix is present will the receiver recognize a control character.

Figure 4-7 illustrates the format for blocks of transparent text. The transmission is initiated and synchronized as before, but DLE STX is transmitted instead of STX. Upon receiving DLE STX, the receiver handles the text as pure binary data, with control characters being ignored unless prefixed by DLE. When a DLE appears, the control character that follows is recognized and the appropriate action performed. When a binary bit pattern equals DLE, a



DLE is inserted before it to show the second DLE is data and not the start of a control sequence. The receiver discards the first DLE and recognizes the second as data.

All replies, enquiries and headers are transmitted in normal mode. SYN SYN appears before the message to establish synchronization, and DLE SYN may occur in the message as required for fill or timeout purposes. SYN SYN may also appear after DLE ITB to establish synchronization prior to the next message block. If the next intermediate block is transparent, it must start with DLE STX. Table 4-2 shows the control characters used in transparent mode. Note that DLE ETB and DLE ETX cancel transparency.

Table 4-2 BSC Transparent Mode Control Characters

Character Sequence	Function
DLE STX	Starts the transparent mode for the following message.
DLE ETB	Terminates a transparent block, returning the data link to normal mode, and requests a reply.
DLE ETX	Terminates the transparent text, returning the data link to normal mode, and requests a reply.
DLE SYN	Maintains sync and provides a time fill to prevent a timeout.
DLE ENQ	"Disregard this block of transparent data." Returns the data link to normal mode.
DLE DLE	A data bit pattern may appear in transparent text that is identical to DLE. A DLE character is inserted to identify the data bit pattern. The first DLE is discarded and the second is treated as data.
DLE ITB	Terminates an intermediate transparent block, returning the data link to normal mode, and does not request a reply. BCC follows DLE ITB. If the next intermediate block is transparent, it must start with DLE STX.

### LIMITED CONVERSATIONAL MODE

With both normal and transparent text, a conversational reply can be sent to a block of text ending with ETX or DLE ETX (not ETB). This replaces an ACK affirmative reply, with the receiver interpreting SOH or STX as an affirmative reply to the last message. However, a conversational reply cannot be transmitted in response to a conversational reply. Figure 4-8 shows a conversational reply to a message block.

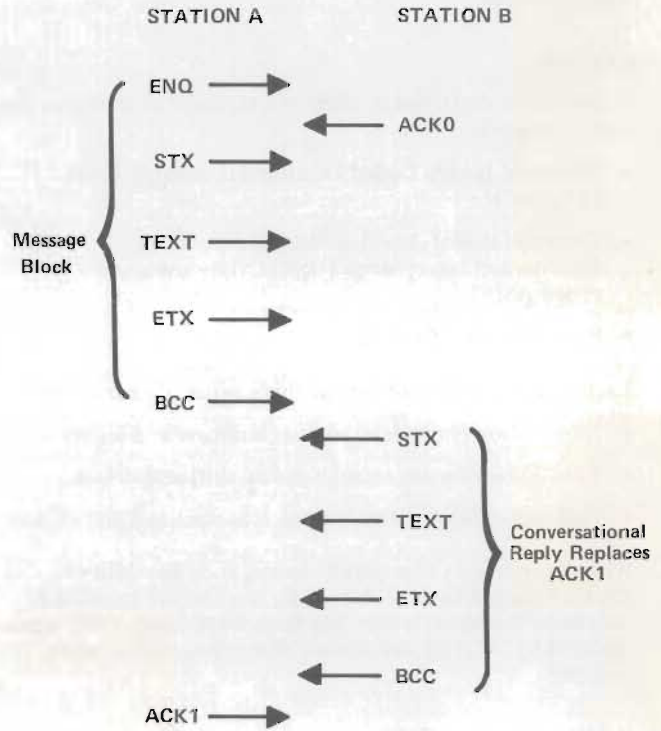

Figure 4-8 Limited Conversational Mode

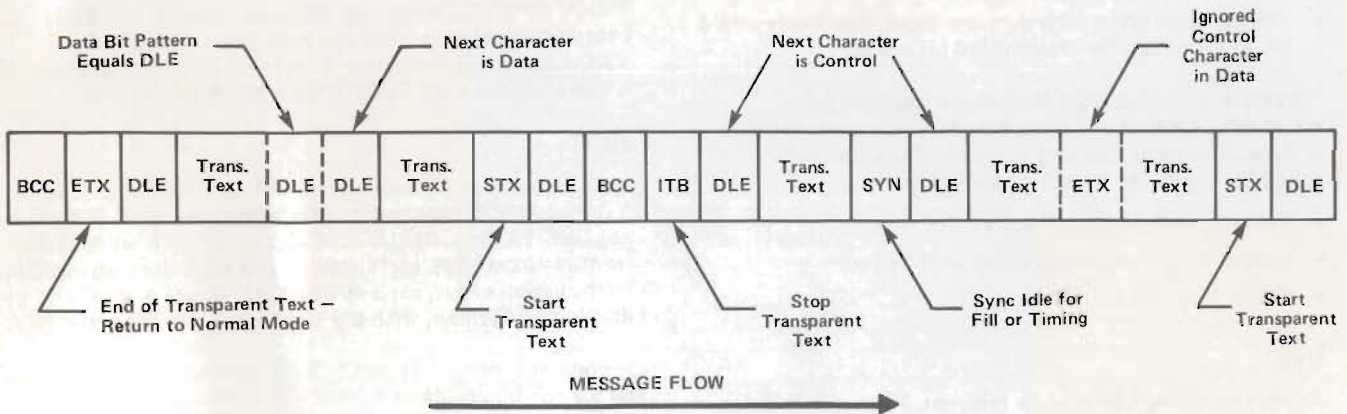

Figure 4-7 Transparent Text Message Blocks

## RETRANSMISSION

Normally, a receiver replies to a transmission with ACK — data accepted, continue sending. When an error is detected the response is NAK — data not accepted, retransmit previous block. Retransmission of the previous block is normally attempted three or four times.

When the transmitter sends a message block and receives no reply, or a garbled reply, the transmitter can send ENQ, requesting a retransmission. When there is no reply, a timeout will occur three seconds after the last response from the receiver.

## CODES

Of the codes described in chapter five, three of them can be used with BSC:

- Extended Binary Coded Decimal Interchange Code (EBCDIC)
- United States of America Standard Code for Information Interchange (USASCII) — usually called ASCII
- Six Bit Transcode (SBT)

Each of these codes consists of three types of characters:

- Information characters, such as numbers and letters
- Functional characters, such as line shift and delete
- Protocol control characters, such as start and end of text

When operating in transparent mode, code flexibility is greatly enlarged since all bit configurations are handled as data once the transparency has been established. Only when prefixed by DLE do the control characters assume their meaning.

## ERROR CHECKING

While error checking is often assumed to be a bit counting process, BSC actually uses three error detection methods:

- Format detection — a check for control characters in proper sequence.
- Timeout sequences — a check for continued transmission to prevent an indefinite tieup.
- Transmission error detection — a check that the received bit count equals the transmitted bit count.

Format detection and timeout sequences have been described. Transmission error detection allows each block of data to be error-checked by one of three methods, depending upon the functions and code:

- Vertical Redundancy Check (VRC)
- Longitudinal Redundancy Check (LRC)
- Cyclic Redundancy Check (CRC)

### VRC

As each incoming character is received, VRC checks it for odd parity. (BSC ASCII uses odd parity.) Odd parity means that there is always an odd number of "1" bits in the bit pattern for each character. Outgoing characters are

checked prior to transmission for an odd bit count, and if it is even the transmitter inserts a "1" bit in the MSB position to make it odd. Thus, all characters transmitted have an odd bit count. A receiver detects an error when a character contains an even number of "1" bits. Figure 4-9 illustrates both VRC and LRC checking. With VRC the "1" bits are added vertically and the extra bits, if required, added at the bottom.

### LRC

Where VRC checks characters for odd parity, LRC checks an entire horizontal line within a block for odd parity, the count being made at both the transmitter and receiver. When the control characters ITB, ETB or ETX appear, this count becomes the BCC and is transmitted to the receiver. In figure 4-9 the extra bits, where required, are shown on the right of the illustration. In turn, the LRC parity character is checked for VRC parity.

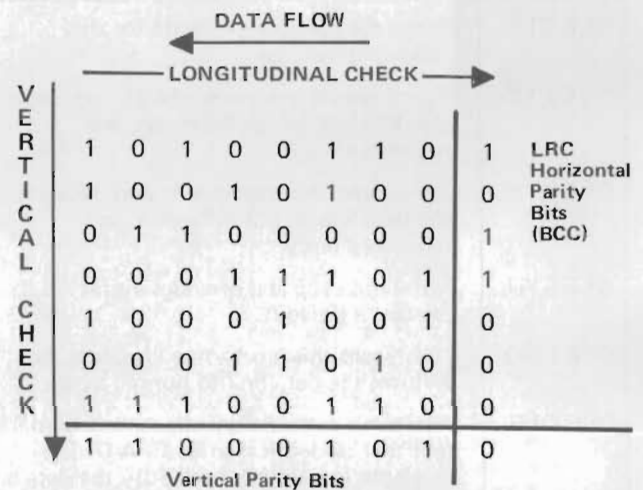

Figure 4-9 VRC/LRC Checking (Odd Parity)

At the receiver, the BCC count is compared with the transmitter's BCC count. When they are equal the previous block was error-free. When they are unequal the receiver requests a retransmission of the previous block.

The receiver's LRC count is reset to zero by the first SOH or STX character received after line turnaround. Thereafter, except for SYN characters, all characters are included in the count accumulation until the next line turnaround. VRC/LRC is only available with the ASCII character set. It is not available with EBCDIC or SBT character sets.

### CRC

A more comprehensive method of block checking than VRC/LRC, CRC has two modes when used with BSC: these are CRC-12 and CRC-16. CRC-12 is also used with six-bit transmission codes, such as SBT, and CRC-16 with eight-bit transmission codes, such as EBCDIC. Figure 4-10 shows the division performed, with the remainder becoming the BCC.

A constant, derived from the CRC polynomial, is used to divide the binary numeric value of the character. The quotient is discarded and the remainder added to the next character, which is again divided. This continues until a checkpoint character is received (ITB, ETB or ETX), when the remainder is transmitted as the BCC.

The receiver compares the transmitted BCC to its own BCC, derived from the incoming message block, and if they are equal the message is error-free. Inequality would require retransmission of the previous message block. CRC is the only method of error checking used in the transparent mode.

### BCC Accumulation

With both LRC and CRC, ETB, ETX and ITB reset the BCC count to zero, except after the first intermediate text block when following ITB's with text need not be preceded by STX or SOH. Figure 4-11 shows the portions of a transmission used to obtain the BCC count for text blocks and intermediate text blocks. Figure 4-12 shows the transmission portions used to obtain BCC in transparent mode. SYN characters are not included in the BCC count.

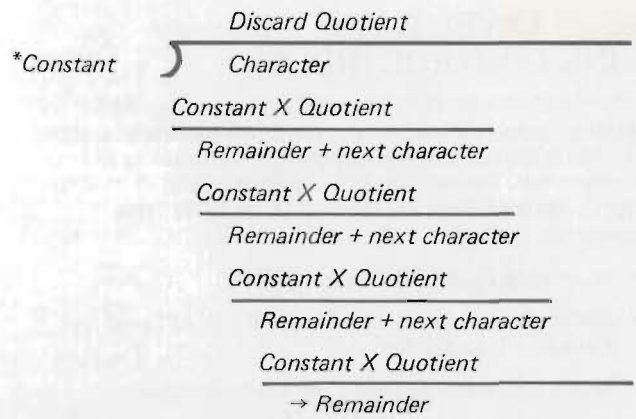

Check character at any time ITB, ETB or ETX appears

\*Note: For CRC 16 (8-bit) constant is  $(X+1)(X^{15} + X + 1)$   
 For CRC 12 (6-bit) constant is  $(X+1)(X^{11} + X^2 + 1)$

Figure 4-10 Cyclic Redundancy Checking

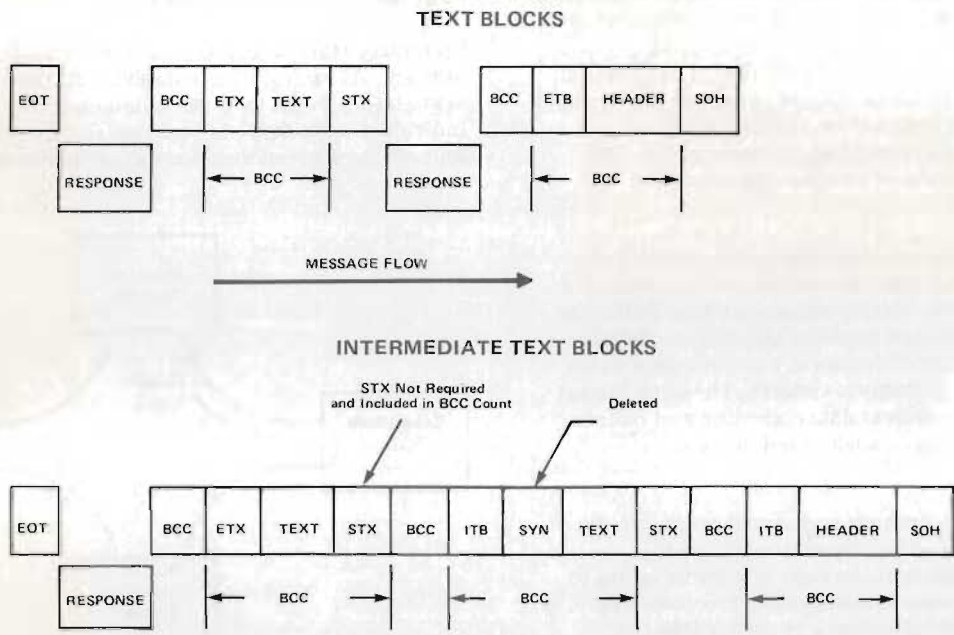

Figure 4-11 BCC Accumulation

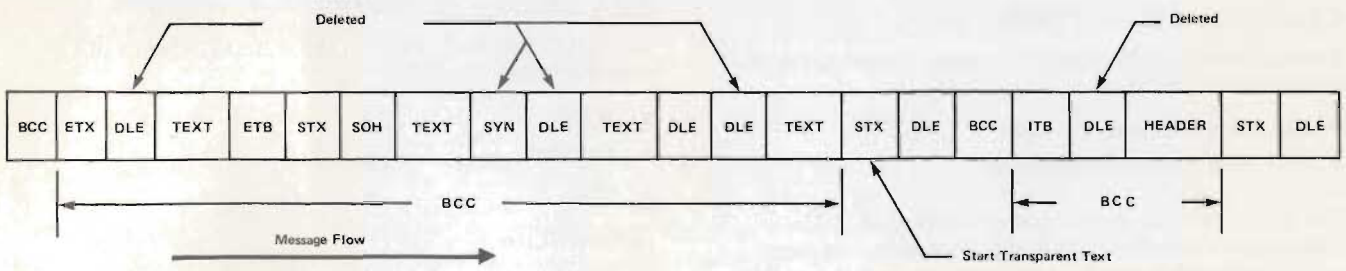

Figure 4-12 Transparent Mode BCC Accumulation

## HIGH LEVEL DATA LINK CONTROL (HDLC)

Where BSC is a handshaking line protocol designed for half duplex operation, HDLC-type protocols eliminate much of the handshaking, and consequent time-consuming line turnarounds, and operate in both full and half duplex. In North America there are three of these HDLC-type protocols:

- Burroughs Data Link Control (BDLC)
- Standard Network Access Protocol (SNAP) used by Canadian Datapac Network
- IBM's Synchronous Data Link Control (SDLC)

These three protocols are not identical but are compatible. Within each protocol, as an example, it would be possible to add control characters to an information field that are only recognized by that protocol: they would be transparent to the other protocols.

These new protocols differ from previous data link controls in that they are bit oriented, rather than character oriented, and are naturally transparent. A data bit's significance is determined by its position in the bit stream, and transparency allows unrestricted bit patterns to appear in the data. The bit patterns of control functions are fixed but currently use only a small number of the potential available, and new commands can be easily added. This means that many special or custom commands can be added as required.

With BSC, a large message is broken up into a series of smaller blocks: HDLC does not determine the length of a message except in very lengthy messages where buffering and frame check sequence capacity may impose limits. There can be a number of frames in a single transmission and the length of each frame is variable. The same format serves long messages, such as data collection and remote batch, and short messages, such as inquiry and conversational.

In chapter three, synchronous and asynchronous modes of transmission were described. Synchronous used synchronizing characters at the start of a transmission to establish timing between the sender and receiver. With asynchronous, a start bit before a character tells the receiver a character is going to be transmitted, and a stop bit follows the character. HDLC-type protocols can use either method. Each message, called a frame, is opened and closed by start-frame and stop-frame characters, called flags, similar to SYN in BSC.

### CENTRALIZED CONTROL

For purposes of traffic regulation, there are two types of stations in a HDLC data link:

- Primary (commanding) station
- Secondary (responding) station

The primary station is responsible for the data link, retaining control of the link at all times, initiating error recovery procedures, and all transmission flow to and from the primary. The primary station could be a host computer, a remote concentrator or a front end processor.

All other stations on the data link, but not the overall network, are designated as secondary stations. The primary station sends them commands and information, to which they react with responses to the commands and information, if required and available.

HDLC is structured to perform in a polling mode, where the primary station initiates and controls transmission. It does not operate in a full demand mode, where either a secondary or primary can authorize a transmission. However, individual protocols such as SDLC have asynchronous response modes where a secondary can initiate a transmission when authorized by the central control.

### LOOP CONFIGURATION

In addition to point-to-point and multipoint, described in chapter two, HDLC also operates in a loop configuration, as shown in figure 4-13. All transmissions flow in the same direction around the loop (down-loop), and pass through the secondary stations. The secondaries inspect each transmission, and when one finds its address in a frame it captures that frame for its use.

Secondary stations can transmit when authorized by the primary. As each station completes its transmission, the next station down-loop can commence transmission. Individual secondary stations can also be polled by the primary, and a response is always required to a specific poll.

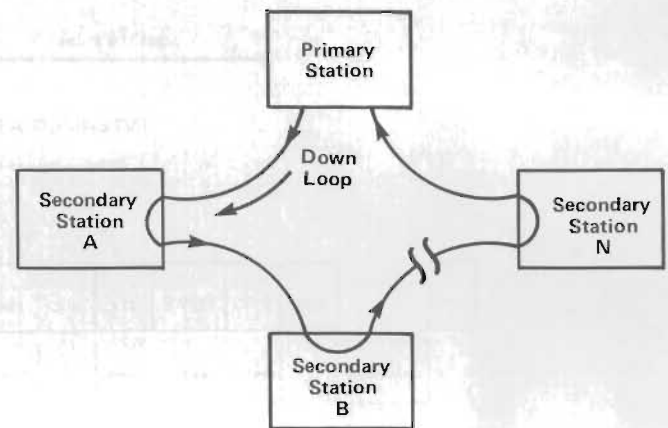

Figure 4-13 Loop Configuration

### TRANSMISSION STATES

An HDLC data link can be in three states in terms of communications activity:

- Active
- Transient
- Idle

#### Active State

A station is active when it is transmitting or receiving. A full duplex channel can be in idle state in one direction and active in another.

## Transient State

When a station is going from idle state or preparing to transmit, or when a line turnaround is in process, it is considered in the transient state. The terminal has initiated a request to send and is waiting for a clear to send signal to commence transmission. With a half duplex channel, turnaround time is required for the line to reverse direction of transmission, and for modem adaptive equalizers to adjust to the changed line characteristics.

## Idle State

When the transient state is finished and a succession of more than 14 binary 1's are received, the station detects this as an idle condition.

## SECONDARY STATION MODES

A secondary station that is off-line is considered to be disconnected from the primary. It goes into this mode in situations such as after a disconnect command and when power is turned on. While disconnected, a station will only recognize a mode-changing command from the primary. Typically, there are three operating modes for secondary stations:

- Normal Response
- Asynchronous Response
- Initialization

### Normal Response Mode

A secondary station is in normal response mode when it cannot initiate a transmission. It transmits only when directly polled by the primary station.

### Asynchronous Response Mode

Asynchronous response mode allows a secondary to initiate a transmission without being requested to do so by the primary. In half duplex operation, when a secondary receives fifteen 1 bits in sequence (idle state) it can commence transmission. In full duplex operation the secondary can commence transmission at any time.

### Initialization Mode

Normal disconnected and asynchronous disconnected are two methods which can be used under certain conditions to start a secondary into operation. Usually this is when the secondary is neither equipped or ready to operate in the normal or asynchronous response modes. In effect, the initialization modes suspend the normal protocol procedures to bootstrap the secondary into operation.

## FRAMES

All transmissions in a data line follow the format shown in figure 4-14. A frame always contains control characters but may or may not contain information (data). All frames are numbered in sequence, and each frame contains the sender's count of frames transmitted to a specific station, along with the number of the next frame the sender expects to receive from that station. The frame consists of the following fields:

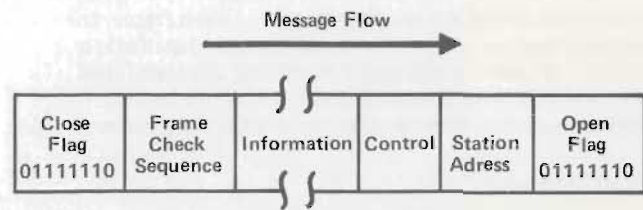

Figure 4-14 HDLC Frame Format

- Flag — the opening flag for the start of a frame.
- Station Address — identifies the outlying station that is in communication with the primary.
- Control — used by the primary to control secondary operation, and by the secondary to respond to the primary.
- Information — the field containing the data to be transmitted, without constraints on length or bit patterns.
- Frame Check Sequence (Block Check) — used to detect transmission errors.
- Flag — the closing flag for the end of a frame.

### Flag

With a protocol that uses positional significance, not control characters, to identify the various elements of a message, the start of a frame sets the starting position for the following bit stream. The flag field is the first character of a frame and the receiver uses it to count down the incoming bit stream to identify the fields within the frame.

The flag is a unique sequence of bits which never appear in a frame other than at the start and end of a frame. As shown in figure 4-14, it consists of eight bits — a 0, six 1's and a 0.

Zero's are inserted and deleted as required to prevent a flag bit pattern from appearing within the frame. When five 1's appear, a 0 is inserted in the bit stream after the last 1. The receiver detects the five 1's followed by a 0 and deletes the 0. The inserted and removed zero's are not included in the frame check sequence.

Each station in the data link is continuously looking for the flag bit sequence followed by the station's address. During lulls in message flow, a series of flags can be transmitted to keep the link active and synchronized, keep the primary's command over transmission and prevent station timeouts.

### Station Address

Before a secondary station can accept a frame it must recognize its valid address in that frame. A primary station will only accept frames with addresses of those secondaries the primary has authorized to transmit. The address field always contains addresses of secondary stations, never a primary station.

Since the address always appears within each frame, the primary station can interleave accepting frames from a number of stations without intermixing the transfer of information. With straight binary coding, up to 256 terminals can be addressed by the 8-bit address field.

### Control Field

The eight-bit control field contains the commands and responses required for control of a data link. The primary station uses the field to command a secondary, selected by the address field, to perform an operation. A secondary station uses it to respond to the primary. The control field has three formats, indicating the contents and purpose of the frame:

- Information — the frame contains information.
- Supervisory — the frame contains commands and responses, but no information. Frames are not counted.
- Nonsequenced (Unnumbered) — the frame contains commands and responses and may contain information. Frame sequences are not counted, even when they contain information.

### Control Field Information Format

The information format is used when data is transmitted between primary and secondary stations. It contains the count of frames sent (Ns), the count of frames received (Nr), and tells if the frame is polling (P) or a final (F) frame in a sequence. Ns and Nr are used for error checking by frame and are generated by both primary and secondary stations. P is used by a primary station to poll a secondary station and initiate transmission. F is used by a secondary station to inform a primary station when a frame is the last one in a transmission.

Ns represents the number of the frame currently being transmitted from either a primary or secondary station. It tells the receiver that "the number of this frame that I am now sending you is N." Nr represents the number of the frame that the sender next expects to get from the receiver. It tells the receiver that "the frames you sent me prior to N were error-free, and your number of the next frame you send me will be N."

This method of frame sequence counting provides for the detection of duplicated, missing or erroneous frames, and frames detected as incorrectly received are retransmitted.

An eight-bit control field allows up to eight (0 to 7) frames to be transmitted without a response from the receiver, then transmission must halt until the receiver acknowledges correct reception of the frames. BDLC can have a 16-bit control field which extends the potential number of unacknowledged frames to 127. The sender stores unacknowledged frames in buffers (for possible retransmission) until they are acknowledged as being correctly received.

When a frame is received at a station, the Ns is compared with the station's Nr, the frame count the station is expecting to receive. If they are equal, and the frame check sequence does not indicate an error, the frame is accepted and the station's Nr is updated. The Nr in the received frame is compared with the station's Ns (the count of the last frame transmitted by the station) and if they are equal,

indicating correct transmission, the station clears its buffers. An incorrect transmission is corrected by retransmission of the frame.

When a primary station polls (P) a secondary station it requests a response or a series of responses from that station. Final (F) is sent by the secondary station with the final frame transmitted as a response to a poll command. If a final frame is not accepted by a primary or secondary station, the primary station performs a timeout and waits for a response to the poll. When there is no response it again polls the secondary station.

### Control Field Supervisory Format

A frame with a supervisory format in the control field contains no information, and this format is used to regulate traffic and request retransmission. The frame format is the same as shown in figure 4-14, except the information field is interpreted to be of zero length. Frames containing this format are not included in the Ns or Nr frame count sequence.

Of the six commands and responses contained in the supervisory format, three (Nr, P and F) perform the same functions as previously described for the information format. These functions are as follows:

- Receive Ready (RR)
- Receive Not Ready (RNR)
- Reject (REJ)
- Received Frame Count (Nr)
- Poll (P)
- Final (F)

**Receive Ready.** When a station has received error-free information frames through the frame prior to Nr, it sends RR. This indicates it is ready to receive additional frames starting with frame Nr.

**Receive Not Ready.** RNR is sent by the receiving station to indicate a busy condition. For example, this could happen when the station's buffers are full and it cannot accept frames requiring buffer space. Frames with counts prior to Nr are accepted, but frame number Nr and subsequent frames cannot be accepted.

The station receiving RNR cannot send any more information frames until the other station has cleared the busy condition. When the busy station is ready for additional information, it can send RR or an information format frame with a zero length information field.

**Reject.** REJ is transmitted to request retransmission of a sequenced frame or frames. This occurs when a frame is received out of sequence, or contains an error in the frame check sequence. When a frame is received with an Ns count not equal to the station's Nr count, all frames prior to Nr are accepted but the Nr frame is not.

No more than one REJ can be outstanding at any given time, and REJ is transmitted only once for each incorrect condition. The condition is cleared when the receiving station accepts an information frame with an Ns count equal to the station's Nr count.

### Control Field Nonsequenced Format.

A station's Ns and Nr counts are not changed when the control field uses the nonsequenced format, but the frame can contain information without regard to the send and receive sequence counts. Commands which change modes reset the frame sequence counts to zero. Of the commands and responses previously discussed, only P and F are contained in this format. Table 4-3 contains a list of commands and responses available with SDLC, in addition to P and F.

Some examples of nonsequenced command functions are commanding a secondary station in a switched network to go off-hook, exchanging identification between primary and secondary stations and polling secondary stations without changing frame sequence numbers. This format provides data link management, activating and initializing secondary stations, reporting of procedural errors not recoverable by retransmission and controlling response of secondary stations.

### Information Field

An information frame is the vehicle for moving data between stations. It is considered as unrestricted in content and format, and the line protocol does not recognize (transparent) its contents. However, buffering considerations and frame check sequence capacity may place practical limits on very long information fields. Information format frames are the only frames with Ns and Nr counts. The particular control format transmitted in a frame identifies when the frame contains information.

The length of each information field is variable, and in a single multi-frame transmission each frame may have different lengths. Any type of code can be conveyed, including EBCDIC, ASCII, Baudot, binary coded decimal, packed decimal and straight binary. The specific code used is identified as the operational code of the station addressed by the address field.

Table 4-3 SDLC Control Field — Nonsequenced Format Commands and Responses

Mnemonic	Meaning	Function
NSI	Nonsequenced Information	A command and response to identify a nonsequenced information frame. It is not acknowledged.
SNRM	Set Normal Response Mode	A command to set the receiving secondary station into normal response mode. It stays in this mode until it receives a DISC or SIM command. The expected response is NSA. The Ns and Nr counts are set to zero. No unsolicited transmission is allowed.
DISC	Disconnect	This command places the receiving station off-line and terminates other modes. It stays off-line until an SNRM or SIM command is received. The expected response is NSA. While disconnected, the secondary station cannot receive or transmit information frames.
NSA	Nonsequenced Acknowledgment	The affirmative response to SNRM, DISC and SIM. The primary station controls further transmission from the secondary station.
RQI	Request for Initialization	A response from a secondary station requesting a SIM command from the primary station. It is repeated if any command other than SIM is received.
SIM	Set Initialization Mode	A command to start certain procedures at the secondary station that will initialize the data link functions. The expected response is NSA. Nr and Ns counts in both stations are reset to zero.
ROL	Request On-Line	A response from a secondary station to show it is disconnected.
ORP	Optional Response Poll	A command inviting transmission from the addressed secondary station. A frame with ORP cannot contain information.
CMDR	Command Reject	A response from a secondary station in normal response mode indicating an incorrect command or that it cannot execute a correct command. It cannot act upon the command that caused the condition. In further responses it repeats CMDR except when a mode-setting command is received. The frame containing CMDR has an information field containing the status information needed by the primary station to correct the condition.
GA	Go Ahead	A command used in the loop configuration that sequentially requests each station in the loop to transmit if it has anything to transmit. ORP GA is selective in the stations it asks to transmit but still travels around the loop.

In addition to data the information field can contain control characters for peripheral devices for starting, operating and stopping. An HDLC-type protocol can also use the information field for non-information functions which are recognized by the line protocol, as is the case with SNAP.

With no restriction on bit patterns, it is possible for six sequential bits to be 1's, simulating a flag bit pattern, which the line protocol would see (non-transparent) as a closing flag to terminate the frame. This is prevented by the transmitter inserting a 0 after the fifth 1. The inserted 0 is then deleted by the receiver.

### Frame Check Sequence (Block Check) Field

This field is 16 bits in length and precedes the closing flag. When information is present in the frame, it follows the information field, otherwise it follows the control field. Its purpose is to detect errors that occur during transmission.

All bits appearing between the opening and closing flags are included in the checking accumulation, except for the 0 bits inserted and deleted to prevent spurious closing flags. Both transmitter and receiver perform a cyclic redundancy check (CRC) on the frame. The transmitter sends its computation to the receiver in the frame check sequence field. The receiver compares the computation with its own computation, and if they are equal the frame is error-free. When they are not equal, the receiver does not accept the frame, does not advance its Nr count and at the first opportunity requests retransmission of the frame.

CRC is performed by a mathematical computation on the bit values contained within the frame. This method was previously described as part of BSC line protocol.

### Flag

The closing flag has the same bit configuration as the opening flag. This terminates the frame and completes the frame sequence check.

## PROTOCOL EXTENSION

One of the attractive features of an HDLC-type protocol is its capacity for extension. This allows individual computer manufacturers and industrial groups to add extensions to the standard protocol which would tailor it for their use. SNAP is an example of this type of extension. BSC can also be used with SNAP.

Figure 4-15 compares a SNAP frame with a standard HDLC frame. The dotted lines link the fields necessary for compatibility. The additional fields in SNAP are the extended control functions. When a SNAP frame is processed by an HDLC protocol, the extended control fields would be transparent and treated as information, thus the two protocols are compatible. The extended control fields would have meaning only when SNAP protocol was the data link control, such as the Datapac Network where processors and communications controllers would read them and perform the appropriate actions.

## SDLC OPERATION

To better understand operation of an HDLC-type protocol, following are some examples of IBM's SDLC protocol in action.

### Full Duplex

An example of SDLC operation is shown in figure 4-16. The sequence shows an in-progress full duplex transmission between two stations. The sequence starts with the primary station in the process of sending information frame zero (I0), the Ns count, and seeking for frame seven (Nr) to arrive from the secondary station. The message contained in the primary station's Ns and Nr counts is, "I am sending you my frame number zero, your frame six was accepted by me and I am now looking for your frame seven."

The secondary station is in the process of sending information frame seven (I7), the Ns count, to the primary station, and is expecting a frame number seven (Nr) to

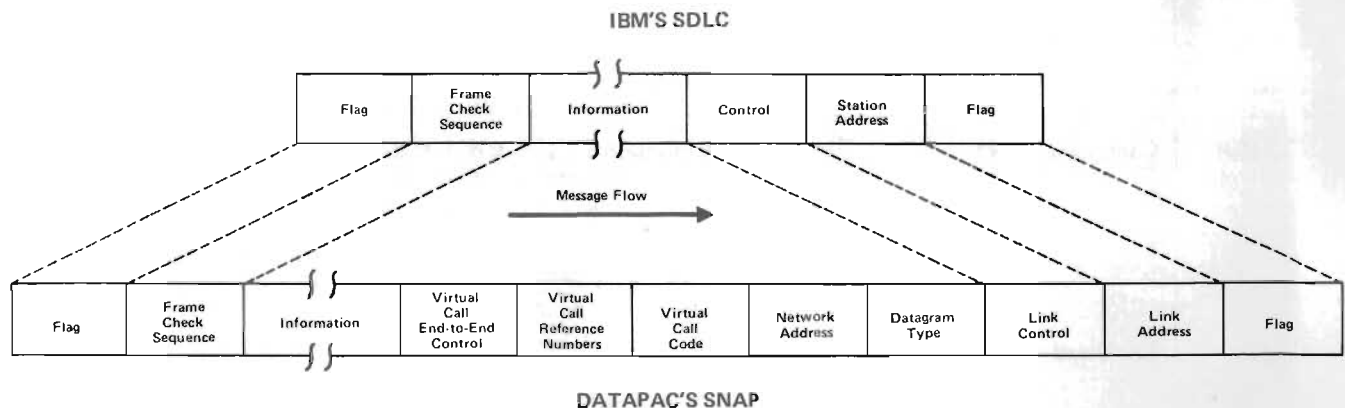

Figure 4-15 Comparison of SDLC Frame with SNAP Frame



arrive from the primary station. The message contained in the Ns and Nr counts is, "I am sending you my frame number seven, your frame six was accepted by me and I am now looking for your frame seven."

Secondary frame seven ends while primary frame zero is still in transmission. Since SDLC frames are numbered from zero to seven, the primary station updates its Nr count to zero, indicating secondary frame seven was accepted and it is now looking for secondary frame zero; the Ns count is also updated to information frame one (I1). Secondary frame zero (I0) ends while primary frame one is in progress. The primary accepts secondary frame zero, and at the end of primary frame one it updates the Nr count to one, indicating it is now looking for secondary frame one.

Frames can still be transmitted even if prior frames are unacknowledged. An example of this occurs during primary frame I3. While this frame is in transmission, the secondary station is transmitting two frames, I3 and I4, both with an Nr count of three. When primary frame I3 ends it updates its Nr by two counts, from two to four, acknowledging acceptance of secondary frames I2 and I3. The same procedure would be followed if there were more than two unacknowledged frames, however, SDLC limits the number of unacknowledged frames to seven. Beyond seven, the station with the unacknowledged frames would halt further transmission until an acknowledgment was received. All unacknowledged frames are retained by the sender in buffers, since it may be necessary to retransmit incorrectly received frames.

## Half Duplex

An example of half duplex operation is illustrated in figure 4-17. The sequence starts when the primary station transmits a supervisory frame to the secondary. The frame contains a receive ready (RR) command, an Nr of one and a poll command. There is no Ns since this is a non-information frame. The message conveyed to the secondary station says, "I am ready to receive, I have accepted your frames through frame count zero and I am waiting for frame one, this is a poll command for you to initiate transmission."

After a wait for line turnaround, the secondary station commences transmission. It sends frame I1 and an Nr count of four, indicating the next transmission from the primary station containing information will be a frame number four. Since the primary station had no information to transfer it used a supervisory frame to initiate transmission from the primary. On the third frame the secondary station includes a final (F) response, indicating the last frame in the transmission.

The primary station then polls another station, this time looking for a frame five to arrive from the station. The station has no information to transmit and responds with a supervisory frame saying, "I am ready to receive and am looking for your information frame zero, since I have no information to send to you this is a final frame."

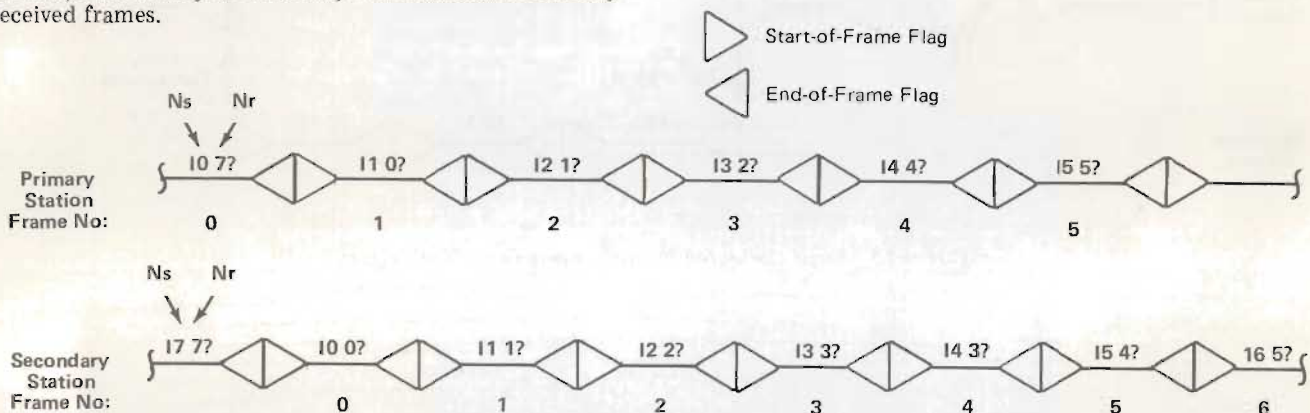

Figure 4-16 SDLC Full Duplex Operation

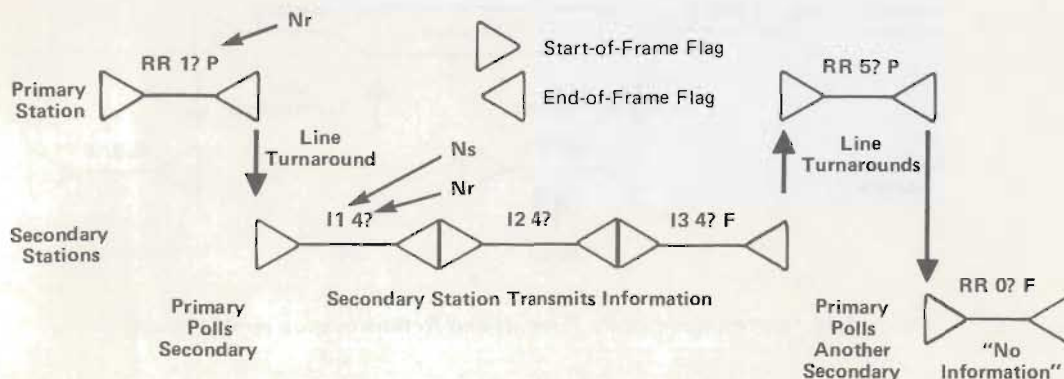

Figure 4-17 SDLC Half Duplex Operation

## Error Recovery

In the situation shown in figure 4-18, primary frame I1 contained an error and could have been lost or garbled in transmission. Since the frame check sequence checks the entire message as a unit the receiver would not know if the error occurred in an information or non-information field. The only way to recover the error is by complete retransmission of the message. Transmitted frames are stored in the primary stations buffers until acknowledged by the secondary station.

When the secondary station starts transmission its Nr count is one, telling the primary station that it has accepted frames through zero and requesting retransmission of subsequent frames. When the primary station again transmits, it starts with frame one and clears its buffers of frames prior to one.

Figure 4-19 illustrates the use of a timeout to recover an error. The polled secondary responded with frame I5, but

the frame was lost or incorrectly received. Since this frame contained an F response, no further frames are transmitted as in the previous example, and the primary station sees no response to its poll command. It could wait indefinitely for a response except for a timeout, which cuts in to stop the waiting and retransmit the frame.

## SUMMARY

In Datacomm, the line protocol allows the user to access the network. With a widely accepted protocol, users with many types of terminals can access a network to communicate with each other. IBM's BSC is the most common protocol in North American use today, with HDLC-type protocols now coming into use.

Up to this point we have looked at the vehicles — equipment and protocols — used to move information between locations in a network. The actual data going through the network is coded as a series of electrical signals, and chapter five describes some of the codes in common use today.

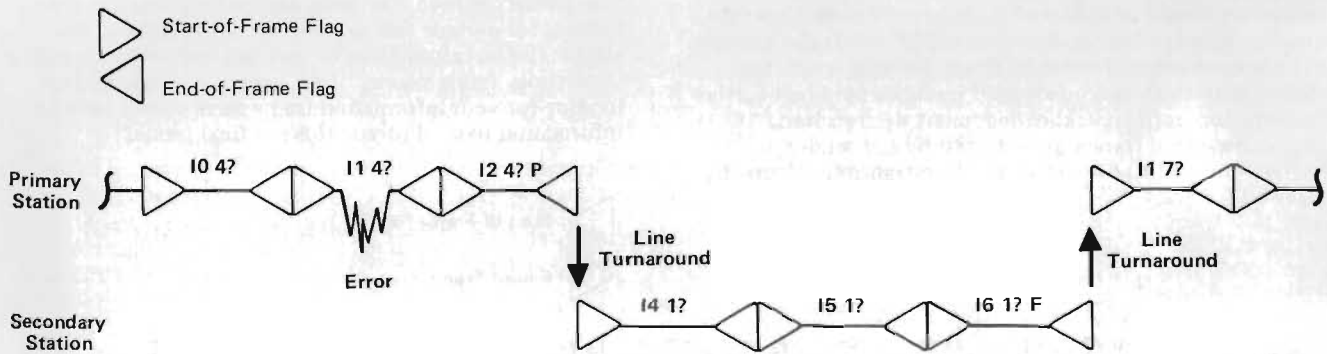

Figure 4-18 Error Corrected by Retransmission (Half Duplex)

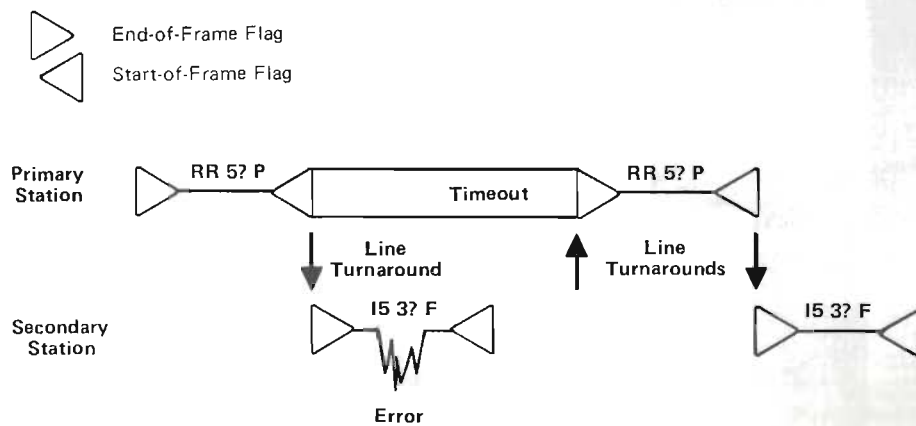

Figure 4-19 Error Corrected by Timeout and Retransmission (Half Duplex)

A code can be considered as a specified set of mark-space patterns where each pattern represents a value. It is also called a machine language since a machine translates human language characters into serial bit patterns of 1's and 0's. The coding can be seen on a paper tape or card, where a punched hole represents a 1 and the lack of a hole represents a 0. With magnetic tape, bits are represented by changes of magnetic flux on the tape.

There are a number of codes in use, but the two most significant for data communications are the American Standard Code for Information Interchange (ASCII) and the Extended Binary Coded Decimal Information Code (EBCDIC). ASCII is published by the American National Standards Institute (ANSI) and is based upon a seven-bit code developed by the International Standards Organization (ISO). EBCDIC was developed by IBM and is an eight-bit code; it fits neatly into computer operation by being processed as an eight-bit byte (a byte is a portion of a computer word).

## ASCII

Most terminal equipment and computer manufacturers conform to the ASCII code, allowing code compatibility between different makes of devices. ASCII characters are coded in seven bits, with an eighth bit available for use as a parity bit. Depending upon the application, parity may or may not be used and can be odd or even. The parity method of error checking is described in chapter four. A

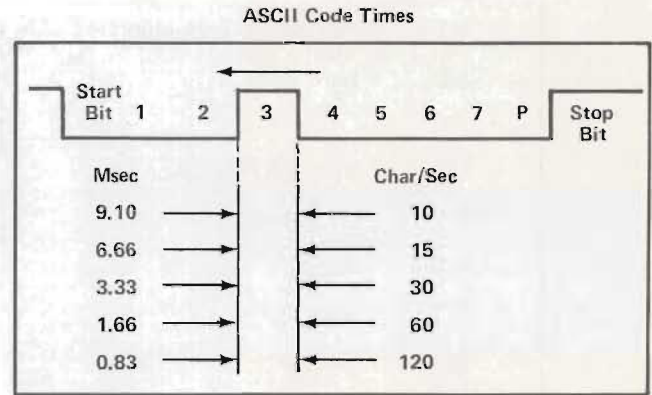

Figure 5-1 ASCII Code Speed Vs Bit Time

seven-bit code allows 128 unique bit patterns for characters.

The time required for a character to be generated varies with the speed of the terminal device. Figure 5-1 shows the ASCII time intervals for bit periods at various machine speeds from 10 characters per second to 120 characters per second. To determine the time requirement for a character to be generated, multiply the number of bits in a character by the bit width in milliseconds (msec). Table 5-1 contains a tabulation of the ASCII characters and bit patterns as well as numerical values of the bit patterns.

Table 5-1 ASCII Character Set

ASCII Character	Meaning	ASCII Bit Pattern							Decimal Value	Octal Value	
		B8	B7	B6	B5	B4	B3	B2			B1
NUL	Null	P	0	0	0	0	0	0	0	0	0
SOH	Start of Heading	R	0	0	0	0	0	0	1	1	1
STX	Start of Text	I	0	0	0	0	0	1	0	2	2
ETX	End of Text	T	0	0	0	0	0	1	1	3	3
EOT	End of Transmission	B	0	0	0	0	1	0	0	4	4
ENQ	Enquiry	I	0	0	0	0	1	0	1	5	5
ACK	Acknowledge	T	0	0	0	0	1	1	0	6	6
BEL	Bell		0	0	0	0	1	1	1	7	7
BS	Backspace		0	0	0	1	0	0	0	8	10

Table 5-1 ASCII Character Set (Continued)

ASCII Character	Meaning	ASCII Bit Pattern								Decimal Value	Octal Value
		B8	B7	B6	B5	B4	B3	B2	B1		
HT	Horizontal Tabulation	P A R I T Y  B I T	0	0	0	1	0	0	1	9	11
NL	New Line		0	0	0	1	0	1	0	10	12
VT	Vertical Tabulation		0	0	0	1	0	1	1	11	13
FF	Form Feed		0	0	0	1	1	0	0	12	14
RT	Return		0	0	0	1	1	0	1	13	15
SO	Shift Out		0	0	0	1	1	1	0	14	16
SI	Shift In		0	0	0	1	1	1	1	15	17
DLE	Data Line Escape		0	0	1	0	0	0	0	16	20
DC1	Device Control 1	0	0	1	0	0	0	1	17	21	
DC2	Device Control 2	0	0	1	0	0	1	0	18	22	
DC3	Device Control 3	0	0	1	0	0	1	1	19	23	
DC4	Device Control 4	0	0	1	0	1	0	0	20	24	
NAK	Negative Acknowledgement	0	0	1	0	1	0	1	21	25	
SYN	Synchronous Idle	0	0	1	0	1	1	0	22	26	
ETB	End of Transmission Block	0	0	1	0	1	1	1	23	27	
CAN	Cancel	0	0	1	1	0	0	0	24	30	
EM	End of Medium	0	0	1	1	0	0	1	25	31	
SUB	Substitute	0	0	1	1	0	1	0	26	32	
ESC	Escape	0	0	1	1	0	1	1	27	33	
FS	File Separator	0	0	1	1	1	0	0	28	34	
GS	Group Separator	0	0	1	1	1	0	1	29	35	
RS	Record Separator	0	0	1	1	1	1	0	30	36	
US	Unit Separator	0	0	1	1	1	1	1	31	37	
SP	Space	0	1	0	0	0	0	0	32	40	
!	Exclamation Point	0	1	0	0	0	0	1	33	41	
"	Quotation Mark	0	1	0	0	0	1	0	34	42	

Table 5-1 ASCII Character Set (Continued)

ASCII Character	Meaning	ASCII Bit Pattern								Decimal Value	Octal Value
		B8	B7	B6	B5	B4	B3	B2	B1		
#	Number Sign	P	0	1	0	0	0	1	1	35	43
\$	Dollar Sign	A	0	1	0	0	1	0	0	36	44
%	Percent Sign	R	0	1	0	0	1	0	1	37	45
&	Ampersand	I	0	1	0	0	1	1	0	38	46
'	Apostrophe	Y	0	1	0	0	1	1	1	39	47
(	Opening Parenthesis	B	0	1	0	1	0	0	0	40	50
)	Closing Parenthesis	I	0	1	0	1	0	0	1	41	51
*	Asterisk	T	0	1	0	1	0	1	0	42	52
+	Plus		0	1	0	1	0	1	1	43	53
,	Comma		0	1	0	1	1	0	0	44	54
-	Hyphen (Minus)		0	1	0	1	1	0	1	45	55
.	Period (Decimal)		0	1	0	1	1	1	0	46	56
/	Slant		0	1	0	1	1	1	1	47	57
0	Zero		0	1	1	0	0	0	0	48	60
1	One		0	1	1	0	0	0	1	49	61
2	Two		0	1	1	0	0	1	0	50	62
3	Three		0	1	1	0	0	1	1	51	63
4	Four		0	1	1	0	1	0	0	52	64
5	Five		0	1	1	0	1	0	1	53	65
6	Six		0	1	1	0	1	1	0	54	66
7	Seven		0	1	1	0	1	1	1	55	67
8	Eight		0	1	1	1	0	0	0	56	70
9	Nine		0	1	1	1	0	0	1	57	71
:	Colon		0	1	1	1	0	1	0	58	72
;	Semi-colon		0	1	1	1	0	1	1	59	73
<	Less Than		0	1	1	1	1	0	0	60	74
=	Equals		0	1	1	1	1	0	1	61	75
>	Greater Than		0	1	1	1	1	1	0	62	76
?	Question Mark		0	1	1	1	1	1	1	63	77
@	Commercial At		1	0	0	0	0	0	0	64	100
A	Uppercase A		1	0	0	0	0	0	1	65	101
B	Uppercase B		1	0	0	0	0	1	0	66	102

Table 5-1 ASCII Character Set (Continued)

ASCII Character	Meaning	ASCII Bit Pattern							Decimal Value	Octal Value	
		B8	B7	B6	B5	B4	B3	B2			B1
C	Uppercase C	P A R I T Y  B I T	1	0	0	0	0	1	1	67	103
D	Uppercase D		1	0	0	0	1	0	0	68	104
E	Uppercase E		1	0	0	0	1	0	1	69	105
F	Uppercase F		1	0	0	0	1	1	0	70	106
G	Uppercase G		1	0	0	0	1	1	1	71	107
H	Uppercase H		1	0	0	1	0	0	0	72	110
I	Uppercase I		1	0	0	1	0	0	1	73	111
J	Uppercase J		1	0	0	1	0	1	0	74	112
K	Uppercase K		1	0	0	1	0	1	1	75	113
L	Uppercase L		1	0	0	1	1	0	0	76	114
M	Uppercase M		1	0	0	1	1	0	1	77	115
N	Uppercase N		1	0	0	1	1	1	0	78	116
O	Uppercase O		1	0	0	1	1	1	1	79	117
P	Uppercase P		1	0	1	0	0	0	0	80	120
Q	Uppercase Q		1	0	1	0	0	0	1	81	121
R	Uppercase R		1	0	1	0	0	1	0	82	122
S	Uppercase S		1	0	1	0	0	1	1	83	123
T	Uppercase T		1	0	1	0	1	0	0	84	124
U	Uppercase U		1	0	1	0	1	0	1	85	125
V	Uppercase V		1	0	1	0	1	1	0	86	126
W	Uppercase W		1	0	1	0	1	1	1	87	127
X	Uppercase X		1	0	1	1	0	0	0	88	130
Y	Uppercase Y		1	0	1	1	0	0	1	89	131
Z	Uppercase Z		1	0	1	1	0	1	0	90	132
[	Opening Bracket		1	0	1	1	0	1	1	91	133
\	Reverse Slant		1	0	1	1	1	0	0	92	134
]	Closing Bracket	1	0	1	1	1	0	1	93	135	
^	Circumflex	1	0	1	1	1	1	0	94	136	
_	Underscore	1	0	1	1	1	1	1	95	137	
`	Grave Accent	1	1	0	0	0	0	0	96	140	
a	Lowercase a	1	1	0	0	0	0	1	97	141	
b	Lowercase b	1	1	0	0	0	1	0	98	142	
c	Lowercase c	1	1	0	0	0	1	1	99	143	

Table 5-1 ASCII Character Set (Continued)

ASCII Character	Meaning	ASCII Bit Pattern								Decimal Value	Octal Value
		B8	B7	B6	B5	B4	B3	B2	B1		
d	Lowercase d	P	1	1	0	0	1	0	0	100	144
e	Lowercase e	A	1	1	0	0	1	0	1	101	145
f	Lowercase f	R	1	1	0	0	1	1	0	102	146
g	Lowercase g	I	1	1	0	0	1	1	1	103	147
h	Lowercase h	T	1	1	0	1	0	0	0	104	150
i	Lowercase i	Y	1	1	0	1	0	0	1	105	151
j	Lowercase j	B	1	1	0	1	0	1	0	106	152
k	Lowercase k	I	1	1	0	1	0	1	1	107	153
l	Lowercase l	T	1	1	0	1	1	0	0	108	154
m	Lowercase m	B	1	1	0	1	1	0	1	109	155
n	Lowercase n	I	1	1	0	1	1	1	0	110	156
o	Lowercase o	T	1	1	0	1	1	1	1	111	157
p	Lowercase p	B	1	1	1	0	0	0	0	112	160
q	Lowercase q	I	1	1	1	0	0	0	1	113	161
r	Lowercase r	T	1	1	1	0	0	1	0	114	162
s	Lowercase s	B	1	1	1	0	0	1	1	115	163
t	Lowercase t	I	1	1	1	0	1	0	0	116	164
u	Lowercase u	T	1	1	1	0	1	0	1	117	165
v	Lowercase v	B	1	1	1	0	1	1	0	118	166
w	Lowercase w	I	1	1	1	0	1	1	1	119	167
x	Lowercase x	T	1	1	1	1	0	0	0	120	170
y	Lowercase y	B	1	1	1	1	0	0	1	121	171
z	Lowercase z	I	1	1	1	1	0	1	0	122	172
[	Opening Brace	T	1	1	1	1	0	1	1	123	173
	Vertical Line	B	1	1	1	1	1	0	0	124	174
]	Closing Brace	I	1	1	1	1	1	0	1	125	175
~	Tilde	T	1	1	1	1	1	1	0	126	176
DEL	Delete	B	1	1	1	1	1	1	1	127	177

Table 5-2 EBCDIC Character Set

Character	Bit Pattern	Character	Bit Pattern	Character	Bit Pattern	Character	Bit Pattern
NUL	0000 0000	SP	0100 0000		1000 0000	[	1100 0000
SOH	0000 0001		0100 0001	a	1000 0001	A	1100 0001
STX	0000 0010		0100 0010	b	1000 0010	B	1100 0010
ETX	0000 0011		0100 0011	c	1000 0011	C	1100 0011
PF	0000 0100		0100 0100	d	1000 0100	D	1100 0100
HT	0000 0101		0100 0101	e	1000 0101	E	1100 0101
LC	0000 0110		0100 0110	f	1000 0110	F	1100 0110
DEL	0000 0111		0100 0111	g	1000 0111	G	1100 0111
	0000 1000		0100 1000	h	1000 1000	H	1100 1000
RLF	0000 1001		0100 1001	i	1000 1001	I	1100 1001
SMM	0000 1010	ç	0100 1010		1000 1010		1100 1010
VT	0000 1011	∠	0100 1011		1000 1011		1100 1011
FF	0000 1100	∧	0100 1100		1000 1100	⌈	1100 1100
CR	0000 1101	(	0100 1101		1000 1101		1100 1101
SO	0000 1110	+	0100 1110		1000 1110	⌋	1100 1110
SI	0000 1111		0100 1111		1000 1111		1100 1111
DLE	0001 0000	&	0101 0000		1001 0000	}	1101 0000
DC1	0001 0001		0101 0001	j	1001 0001	J	1101 0001
DC2	0001 0010		0101 0010	k	1001 0010	K	1101 0010
DC3	0001 0011		0101 0011	l	1001 0011	L	1101 0011
RES	0001 0100		0101 0100	m	1001 0100	M	1101 0100
NL	0001 0101		0101 0101	n	1001 0101	N	1101 0101
BS	0001 0110		0101 0110	o	1001 0110	O	1101 0110
IDL	0001 0111		0101 0111	p	1001 0111	P	1101 0111
CAN	0001 1000		0101 1000	q	1001 1000	Q	1101 1000
EM	0001 1001		0101 1001	r	1001 1001	R	1101 1001
CC	0001 1010	!	0101 1010		1001 1010		1101 1010
CU1	0001 1011	¢	0101 1011		1001 1011		1101 1011
IFS	0001 1100	£	0101 1100		1001 1100		1101 1100
IGS	0001 1101	)	0101 1101		1001 1101		1101 1101
IRS	0001 1110	]	0101 1110		1001 1110		1101 1110
IUS	0001 1111		0101 1111		1001 1111		1101 1111
DS	0010 0000	/	0110 0000	~	1010 0000	\	1110 0000
SOS	0010 0001		0110 0001	s	1010 0001		1110 0001
FS	0010 0010		0110 0010	t	1010 0010	S	1110 0010
	0010 0011		0110 0011	u	1010 0011	T	1110 0011
BYP	0010 0100		0110 0100	v	1010 0100	U	1110 0100
LF	0010 0101		0110 0101	w	1010 0101	V	1110 0101
EOB/ETB	0010 0110		0110 0110	x	1010 0110	W	1110 0110
PRE/ESC	0010 0111		0110 0111	y	1010 0111	X	1110 0111
	0010 1000		0110 1000	z	1010 1000	Y	1110 1000
	0010 1001		0110 1001		1010 1001	Z	1110 1001
SM	0010 1010	..	0110 1010		1010 1010		1110 1010
CU2	0010 1011	%	0110 1011		1010 1011		1110 1011
	0010 1100		0110 1100		1010 1100		1110 1100
ENQ	0010 1101	~	0110 1101		1010 1101		1110 1101
ACK	0010 1110	∨	0110 1110		1010 1110		1110 1110
BEL	0010 1111	∩	0110 1111		1010 1111		1110 1111
	0011 0000		0111 0000		1011 0000	0	1111 0000
	0011 0001		0111 0001		1011 0001	1	1111 0001
SYN	0011 0010		0111 0010		1011 0010	2	1111 0010
	0011 0011		0111 0011		1011 0011	3	1111 0011
PN	0011 0100		0111 0100		1011 0100	4	1111 0100
RS	0011 0101		0111 0101		1011 0101	5	1111 0101
UC	0011 0110		0111 0110		1011 0110	6	1111 0110
EOT	0011 0111		0111 0111		1011 0111	7	1111 0111
	0011 1000		0111 1000		1011 1000	8	1111 1000
	0011 1001		0111 1001		1011 1001	9	1111 1001
	0011 1010	..	0111 1010		1011 1010		1111 1010
CU3	0011 1011	#	0111 1011		1011 1011		1111 1011
DC4	0011 1100	@	0111 1100		1011 1100		1111 1100
NAK	0011 1101		0111 1101		1011 1101		1111 1101
	0011 1110		0111 1110		1011 1110		1111 1110
SUB	0011 1111	;	0111 1111		1011 1111		1111 1111



## NUMERICAL VALUES

The numerical value of a 1 bit is determined by its position in the pattern. A mark in the first bit position (B1) has a decimal value of one. A mark in the B2 position has a numerical value of two, a mark in B3 is four, B4 is eight, B5 is sixteen, B6 is thirty two and B7 is sixty four. A mark in the eighth EBCDIC bit position has a decimal value of 128. For example, in ASCII the dollar sign (\$) is coded as:

B7	B6	B5	B4	B3	B2	B1
0	1	0	0	1	0	0

A mark in B3 position (above) has a decimal value of four and a mark in position B6 has a decimal value of 32, giving a total decimal value of 36.

## EBCDIC

EBCDIC has an 8-bit code that allows 256 characters. Since the eighth bit is part of the code, there is no provision for parity error checking by character. The EBCDIC code characters are shown in table 5-2.

## HOLLERITH

The Hollerith code is used for punched card applications. It contains 12 bit positions that represent the numbers 1 to 9 and the letters of the alphabet. No control characters or symbols are represented. Cards can be punched hole or mark sense, where the 1 bits are entered as pencil marks on the card. A card reader "senses" the pencil marks and changes them into punched holes or electrical values.

## SIX BIT TRANSCODE (SBT)

Many commercial applications do not require the character set available with an eight-bit code such as EBCDIC, and the extra transmission time required for an eight-bit code increases line costs. IBM developed SBT to meet this need. It is similar to EBCDIC but has 6 bits, allowing 64 characters. It provides a greater efficiency of encoding that allows a communications link to serve a maximum number of stations. This is a significant cost reduction where a number of long distance lines are involved.

## HEXADECIMAL

The hexadecimal number system (table 5-3) uses the values 1 through 9 and A through F to obtain the equivalent of a decimal 16 base. Its value for computer operation is that it allows any ASCII or EBCDIC character to be represented by two hexadecimal digits.

## FIXED RATIO (N OF M) CODES

A fixed ratio code always has the same number of marks and spaces in each bit pattern representing a character. A common ratio is a Four-of-Eight code where the total number of bit positions is eight, of which four are always

Table 5-3 Hexadecimal Number System

Hexadecimal Value	Decimal Value	Binary Value
0	0	0000
1	1	0001
2	2	0010
3	3	0011
4	4	0100
5	5	0101
6	6	0110
7	7	0111
8	8	1000
9	9	1001
A	10	1010
B	11	1011
C	12	1100
D	13	1101
E	14	1110
F	15	1111

Hexadecimal numbers 10 through 1F equal 16 through 32 decimal.  
Hexadecimal numbers 20 through 2F equal 33 through 48 decimal.  
Higher numbers follow the same pattern.

marks and four are spaces. Any character with other than four 1's and four 0's is not valid. This provides a very accurate but simple method of error control. Not in general use with computers, fixed ratio codes can be used with relatively inexpensive equipment but still provide high reliability of transmission.

The Bell Touch-Tone is an example of a multifrequency fixed ratio tone code. Pushbuttons are used to place a call and the number is coded as a series of 2-of-8 tones.

## BAUDOT

A five-bit paper-tape code, Baudot was the first serial asynchronous code developed for telegraph equipment, such as keyboard-printers and paper tape punch-readers. It is the most widespread code today, being used by most of the world's printing telegraphy communications networks.

Normally a 5-bit code provides 32 combinations for characters. By using a shifting technique, Baudot code allows 60 characters to be coded.

## SUMMARY

When you press a key at a terminal the graphic human language character becomes a bit pattern of marks and spaces, usually a seven-bit ASCII code or an eight-bit EBCDIC code. This code is the language of the machine. The encoded character then travels through the network as an electrical signal and reappears in its graphic form when it is printed or displayed at the receiving terminal. Most terminal equipment and computer manufacturers conform to the ASCII code.

Minicomputers serve a variety of roles in a Datacomm network to provide computational power, savings in line costs, reductions in programming and equipment expenses, and increasing line efficiency thereby increasing the line's volume capacity. In distributed systems, minicomputers serve as the host computer in a central station, with other minicomputers at satellite locations performing local processing functions. Hewlett Packard 21MX Series minicomputers are shown in figure 6-1.

A terminal is a location on a Datacomm network for the input or output of information. A remote terminal means it is physically located away from the host computer. It can be a stand-alone device, connecting directly to the data link, or a controller device, regulating other nearby terminals, or a minicomputer-based intelligent terminal. Of all the components in a network, probably terminals offer the greatest variety and can be the most confusing in selection. A large number and variety of all basic types are offered by many manufacturers. In addition, a single stand-alone terminal may combine a number of operations, such as keyboard-printer, paper tape punch, paper tape reader and video display.

## NETWORK INFORMATION TRANSFER

Switched and leased lines were discussed in chapter two, where a direct connection was set up between locations and messages went directly from one location to the other — a relatively simple type of information transfer. A network also uses other more complex techniques of information transfer, such as:

- Message Switching
- Packet Switching
- Remote Job Entry (RJE)

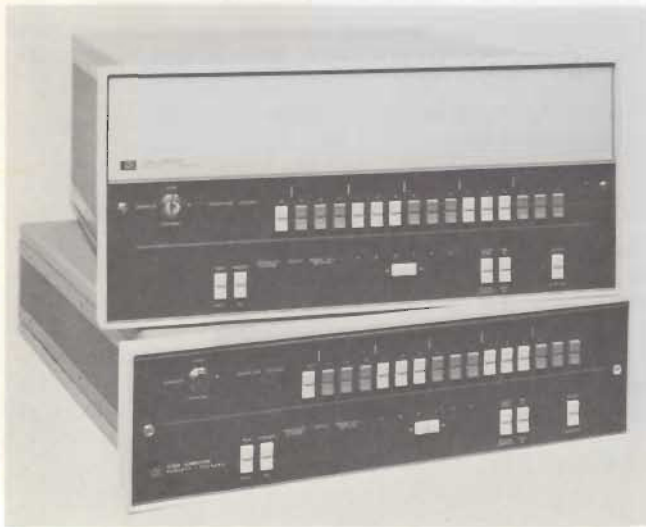

Figure 6-1 HP 21MX Minicomputers

## MESSAGE SWITCHING

With message switching no direct connection is set up between locations, and each message transmitted may take a different path. A message is sent as a unit to a switching center where it is held until it can be sent to another switching station or its destination; this is also called store-and-forward. A header attached to each message tells each station the destination.

In today's networks the switching control is usually handled by a minicomputer. It accepts messages and stores them in memory, then takes them from memory and sends them to their appropriate destination. Typically, message switching is performed over multipoint lines with many terminals.

When switched lines become overloaded it may become impossible to make connections, and several retries may be required before a connection can be made. When a message switching network is overloaded it just means longer delivery times, but the message is only sent once and always delivered.

## PACKET SWITCHING

Packet switching is a more-formatted but faster method of message switching. Messages are transmitted in relatively short, fixed-length units called packets, the length being determined by the needs of each application. Each packet is treated individually and sent over the fastest available route to its destination. Long messages are broken up into packets and each packet may take a different route, with the channels between packet switching centers shared between many users on a demand basis. A long message can travel faster through a network because the various packets may actually travel in parallel, instead of serial as with message switching.

## REMOTE JOB ENTRY (RJE)

RJE allows programs to be entered at a remote terminal, sent to the host computer for processing and the results sent back to the terminal. A distributed system with minicomputers in central and satellite locations expands this concept. Programs can be entered at the satellite location and processed at the central location under remote control from the satellite, without assistance from the central operator.

## TERMINALS

While some terminals can only receive or transmit information, most are capable of both functions. Teletype Corporation terms have been used to describe terminals as receive only (RO), keyboard send-receive (KSR) and automatic send-receive (ASR). In Datacomm use, these functions are also referred to as output (from a device), input (to a device) and input-output (I/O).

A terminal is considered on-line when it is connected to the host computer. It is considered off-line when it is not connected to the computer, but may be connected to another terminal or a local minicomputer.

Terminal devices range in size from a simple hard-copy (printing) machine, small enough to fit under an airplane seat, through sophisticated graphic video displays, to minicomputer-based "intelligent" terminals. The type of terminal device selected for a particular application depends upon the volume and type of information to be handled, required code, maintenance considerations and cost-performance figures.

Microprocessors are the most significant new development in terminal operation. These are semiconductor integrated circuits, also known as "chips," that can be programmed to direct the terminal to perform a complex series of functions. The programming is performed at the factory and not by the user. It can be reprogrammed or easily replaced when, for example, a terminal is required to work with a different computer or has to be adapted to a new line protocol.

Figure 6-2 shows the microprocessor used with the HP 2640 Video Display terminal. This contains 8000 words and is programmed to perform a series of self-test functions on the terminal.

In the Datacomm environment, remote terminals can be broadly classed into two functional types:

- A batch terminal that is loaded off-line with previously encoded information. This is then output over the data link in a single burst. Input information is received in a single burst.
- An interactive terminal operating on-line, allowing an operator to conduct a dialogue with a computer or another terminal. Buffering allows an interactive terminal to operate in a batch mode.

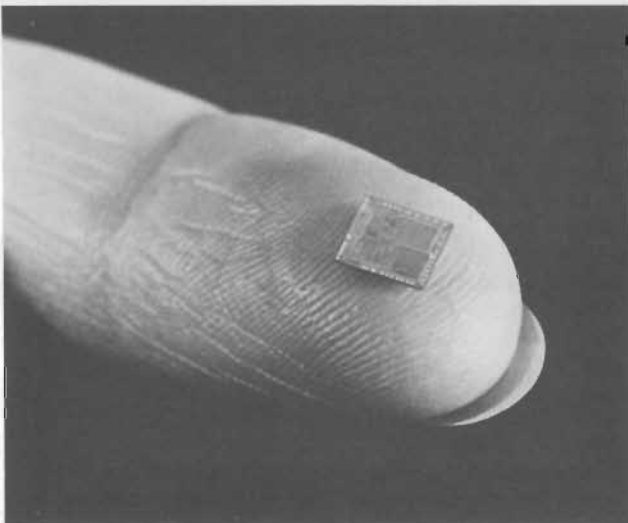

Figure 6-2 Microprocessor

Courtesy of Intel Corp.

## INTERACTIVE TERMINALS

An interactive terminal can be either hard-copy (printed) or soft-copy (video display) and has a keyboard. It can also include a paper or magnetic tape to provide an encoded permanent record and off-line message preparation. These terminals are for minute-to-minute inputs of a transactional nature, such as a bank teller or a point-of-sale location at a store checkout stand; or of a conversational nature, such as reviewing test results or responding to a computer's questions.

Specialized keyboards are used for specific applications such as industrial data collection, sales orders, spare parts inventory, airline traffic and trucking operations.

## BUFFERED INTERACTIVE TERMINALS

Buffering (storage) enables an operator to enter, check and correct a number of transactions or messages off-line. This means the information can be transmitted in a fraction-of-a-second burst versus minutes if the information was entered on-line. This reduces line costs, increases operating speed, and allows more terminals to share the line. The storage device used as a buffer can be paper or magnetic tape, or a built-in electronic memory.

## "INTELLIGENT" INTERACTIVE TERMINALS

These are a new type of terminal coming into general use that use a built-in or nearby minicomputer. They perform processing functions that otherwise would have to be performed by the host computer. If the host computer goes off-line, the minicomputer can assume some of its functions and continue terminal operation for a limited time.

## RESPONSE TIME

A major factor in the operation of interactive terminals is response time. This is the time interval required for the computer to respond to an inquiry from a terminal. A sales clerk with customers standing in line would want a one-second response time. A lab technician entering test results would not be bothered by a 30-second response time.

The more terminals sharing the line, the slower the response time, but cost-per-user is reduced; more terminals also make more efficient use of the computer. The less terminals sharing the line the faster the response time, but the cost-per-user is higher.

## COMMUNICATIONS CONTROLLER

A communications controller is usually a hardware device that cannot perform processing. Unlike a minicomputer, its control functions are limited, and it is restricted to managing terminals with similar protocols and codes, closely related and located. It is designed for a specific application in a particular industry. It cannot be upgraded into a larger network handling various types of terminals, as can a minicomputer. Its main advantage is initial cost. Some of the main functions of controllers are:

- Serialization and deserialization of data
- Interrupts to computer
- Code conversion
- Error checking
- Synchronous and asynchronous formatting and timing

The types of controllers available from various manufacturers vary widely in capability. There is a large range of models in terms of lines serviced and terminals controlled, transmission modes handled and speed. Figure 6-3 shows a controller working with two types of terminals.

## REMOTE CONCENTRATOR

A remote concentrator is usually a minicomputer, performing the functions of a communications controller but in addition is very flexible and programmable. Its main benefit is to reduce data link costs by accepting information from many terminals over slow speed lines and

transmitting it over a single high-speed line. A remote concentrator can handle situations where terminals temporarily generate information at a faster surge rate than it can be transmitted over the data link. It smooths out the peaks and valleys of information, doing this by two methods:

- Store-and-forward
- Hold-and-forward

In addition, it may perform some or all of the following functions:

- Local control of terminals
- Buffering (smoothing) and queuing (holding) of messages
- Authorizing message senders and receivers
- Routing of messages between stations
- Message editing and formatting

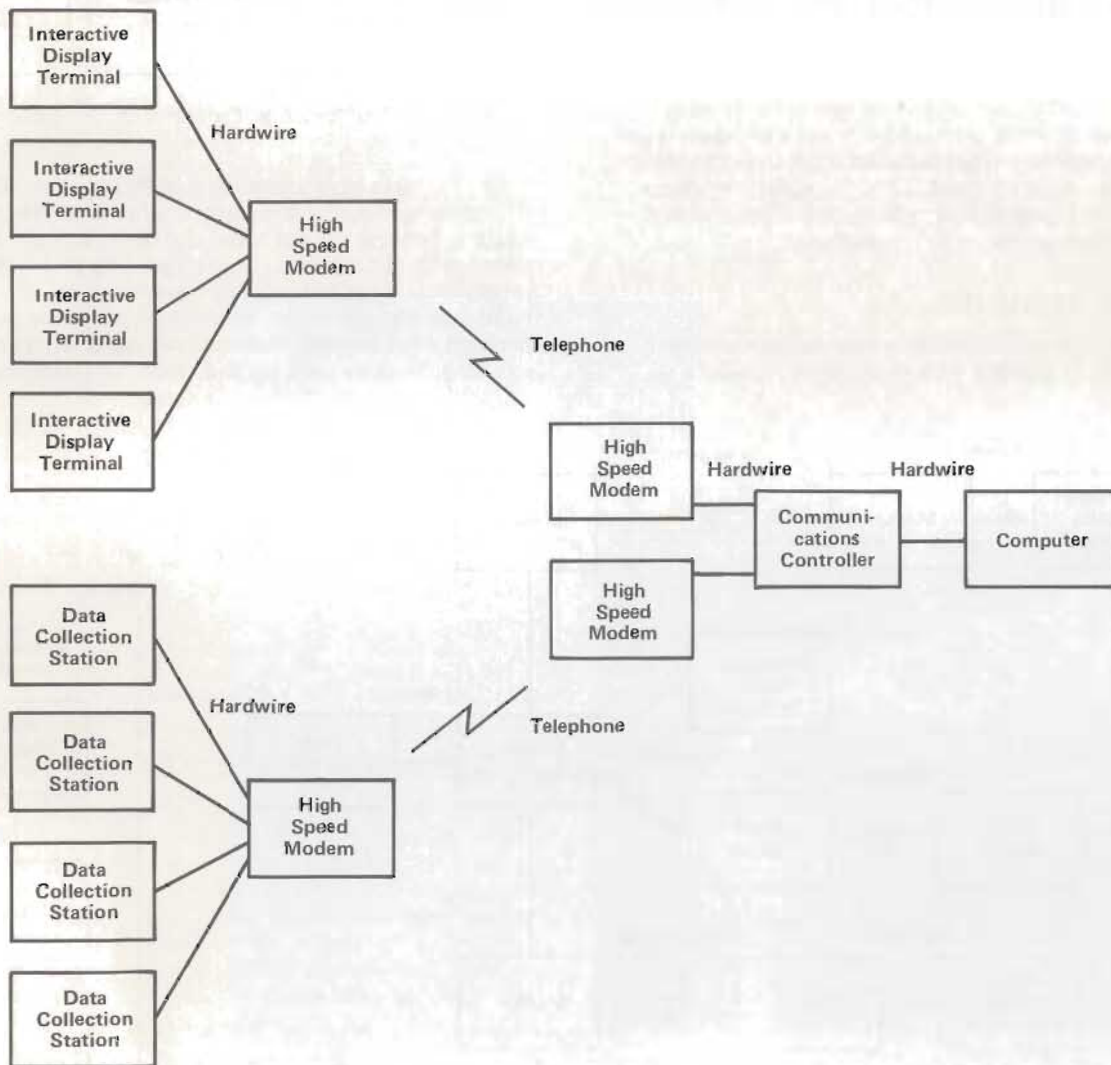

Figure 6-3 Communications Controller in a Network

## STORE-AND-FORWARD

The minicomputer functions as a storage buffer to temporarily store the excess information generated by terminals. The excess information is transmitted to the computer when the data line becomes available.

## HOLD-AND-FORWARD

A process called "polling," described in chapter two, is used to control information coming from the terminals. This is a method of holding information at the terminals until the remote concentrator is ready to receive it. In this way the speed of information coming into the concentrator can never exceed the speed of the data link. Sometimes a combination of store-and-hold is used to concentrate information on a single line.

## PROCESSING DATA

A remote concentrator can be programmed to accept different codes, varying data rates and many types of terminals, or perform synchronous and asynchronous operations. It can manipulate and alter message formats and spacing for maximum utilization of the data link.

## ERROR CONTROL

Error control is another important role for a remote concentrator. When it detects an error in a message, it can halt the message and request the terminal to retransmit. This provides more efficient use of the computer's time when it receives optimum-length blocks of pre-checked, error-free messages from the concentrator.

## INTERACTIVE MODE

In addition to handling traffic, a concentrator can be programmed to interact with an operator to make a

terminal interactive. It can accept inquiries, retrieve information from memory and transmit the information. Figure 6-4 shows a remote concentrator working with a variety of terminals. In general, a concentrator removes the communication load from a computer, saves on-line costs, increases line handling capacity and saves on equipment and programming costs.

## FRONT END PROCESSOR

Front end processing performs many of the functions of a remote concentrator — but at the computation center on the opposite end of the data link (Figure 6-5). It can also perform some of the functions of the central computer, relieving the host computer of its time-consuming polling and addressing chores as well as other operations.

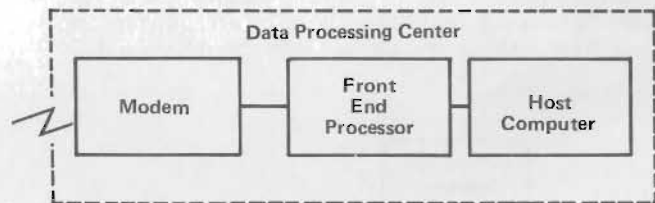

Figure 6-5 Front End Processor in Computer Center

Minicomputers have proven themselves in this role since they possess many of the features of large computers. Some of these features are mass disc and drum storage, large memories and arithmetic units. They can be easily programmed in high-level languages. In addition to communications control, a front-end processor must perform error control, code translation, polling and selecting, message queuing and character-to-message assembly.

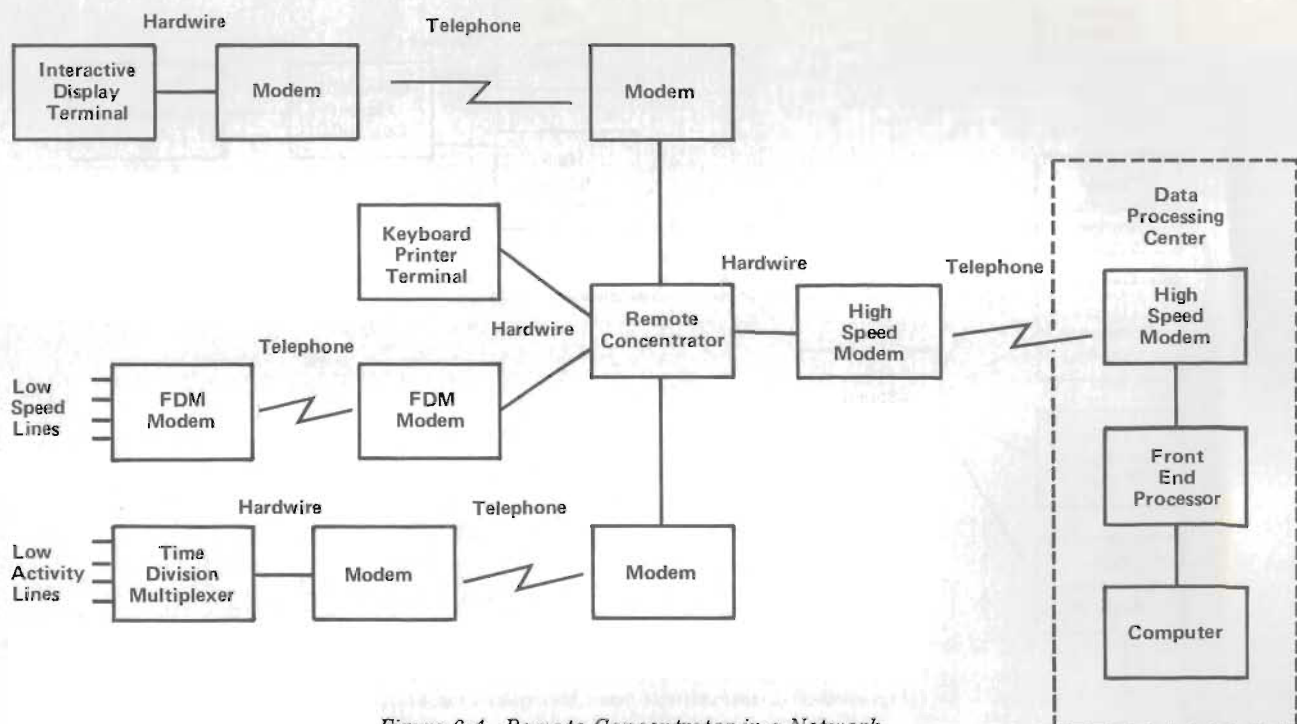

Figure 6-4 Remote Concentrator in a Network

## COMMUNICATIONS CONTROL

In effect, the communications control function is removed from the computer. This provides three main benefits:

- A clean break is made between the communications network and the large computer.
- Removing the communications load from the computer increases its computational power, allowing it to concentrate on the job it does best.
- The communications control functions can be performed more economically by a minicomputer.

Sometimes it is necessary to identify the source terminal of a message. In other situations the data link status and faults may have to be monitored and reported. A minicomputer can be programmed to perform these functions.

By separating communications from computation, future network changes can be handled more easily. New types of terminals, changes in message formats, addition or deletion of message traffic are handled by a minicomputer with minimum effort on computer operations.

## COMPUTER OPERATIONS

When the computer goes off-line, the minicomputer can perform many computer operations. Using its own

peripherals, it can continue to route traffic and collect data in storage for when the computer comes back on-line. When not operating in the communications mode, it can also perform some of the lesser processing operations of the computer.

## HOST COMPUTER

In a cluster network, the "host computer" might be one or more computers at a central computation facility. In a distributed network, it might be one of a number of computers located at widely separated sites. Its function is to accept information, apply a programmed process to the information, then send the results to storage or a terminal. In a smaller network it can be a minicomputer-based system such as the HP 1000 or HP 3000. In a large network it could be an IBM 370/158.

### HP 3000

An HP 3000's purchase price varies from \$120,000 to \$300,000, depending upon the scope of equipment. It has a 16-bit word, with a built-in memory of 64000 (64K) words, also referred to as 128K bytes (a byte is 8 bits). For the data base, a disc provides mass storage of 47 million bytes, and up to eight discs can be used for a total of 376 million (mega) bytes. Figure 6-6 shows an inplant HP 3000 Series II Computer System that is part of a larger company-wide network.

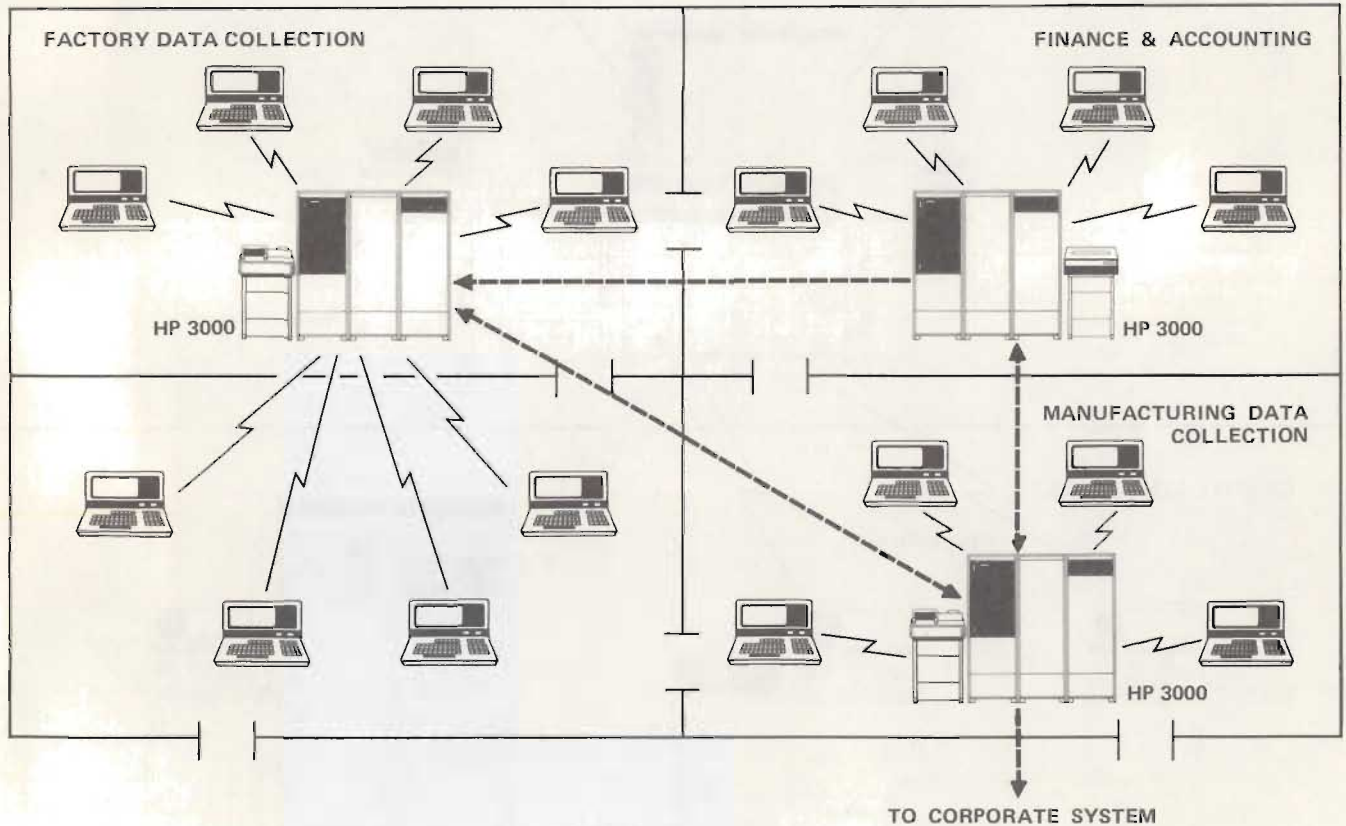

Figure 6-6 HP 3000 Series II In-plant System

# HP 1000

With a price range of \$30,000 to \$80,000, the HP 1000 is designed for tasks in computation, instrumentation and operations management. It can have up to 608K bytes of

main memory and over 100 megabytes of disc memory. It can function alone or as part of a distributed network with satellite systems. Figure 6-7 shows HP 1000's as a central and satellites in a distributed network.

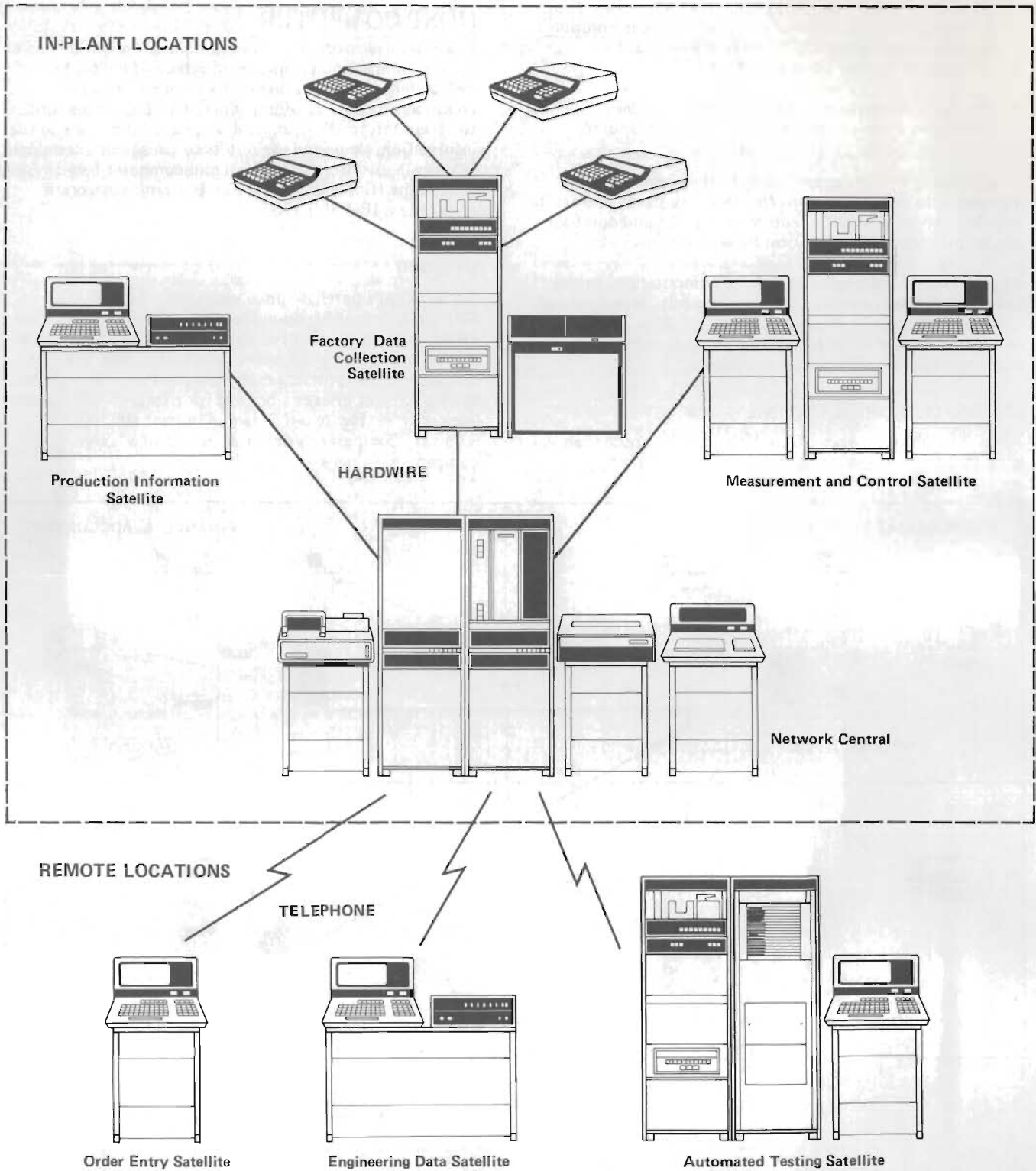

Figure 6-7 HP 1000 Distributed System

## IBM 370/158

The purchase price of an IBM 370/158 ranges from over \$2 million to under \$4 million. It uses 8 to 16 bytes per word, and has a built-in memory of 4 million bytes. Discs can be added for a mass storage capacity of billions of bytes.

## PERIPHERALS

In addition to discs, other peripherals available are magnetic tape for more storage capacity, line printers, card readers-punches, paper tape readers-punches and keyboard printers and displays.

## SOFTWARE OPERATING SYSTEM

A complex software operating system in each host computer serves to control the processing, data base, peripherals and any interaction with other computers. When there is no front end processor, the computer will also contain communications control software for network activity.

## SOFTWARE

Within a Datacomm network there are two types of software. One type is the data processing software resident in the host computer; this performs the computational function. The other type is communications software; this performs the management function of formatting and routing messages, commands, data and status information. Where a minicomputer is used as a front end processor, the data communications software is resident in the minicomputer. Where a minicomputer is not used, the communications software would reside in the host computer. In either case, the communications function remains the same: To manage data flow, interface the communications data stream with the host computer's processing programs and interface with the remote station.

To understand the differentiations between processing software and communications management software, it is necessary to know how each handles the information being transmitted within the network. This is summarized in table 6-1.

Table 6-1 Processor vs Communications Software

Processing Software	Communications Software
Requires data in binary format	Handles data in one of several transmission codes
Requires uncompressed data	Data compressed for efficient transmission
Processes complete blocks of data	Data transmitted in bit-by-bit serial format
Processes only data	Transmits data and line protocol information
Controls own timing	Handles a variety of timing depending upon device and operator speeds.

Communications software operates at four levels:

- Interface
- Line Control
- Network Control
- Operating System

Figure 6-8 shows the relationship between the software levels. In this example the communications software is shown residing in a front-end processor.

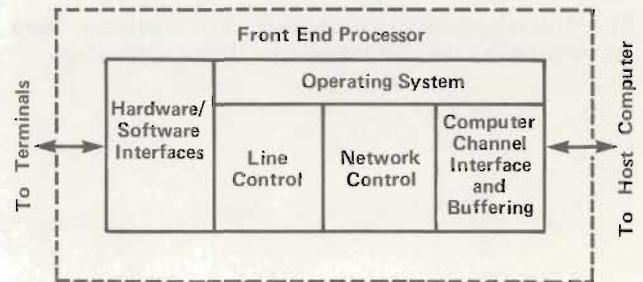

Figure 6-8 Front End Processor Communications Software

## INTERFACE

Information going to or from terminals passes through a line interface. This consists of hardware and "driver" programs which regulate the flow of information. Each type of dissimilar device requires an individual hardware interface and driver program. The drivers serve to transmit control information to the terminals, status of the terminals to the line control software and data both ways. They perform a traffic recognition function.

## LINE CONTROL

The line control software performs a traffic regulation function. While the driver performs a mechanical transfer function, the link control recognizes when information is present, initiates transfer of information over the link, and controls acceptance of information from the link. As with the driver, the line control is not concerned with information context of the message and a separate line control must be provided for each device interface.

## NETWORK CONTROL

For transmission over the link, the network control software performs a formatting operation, creating a single data stream and imposing a message structure upon the information. It constructs standard size blocks of information, adds header and destination information for network use, and may place the block in a channel interface buffer to await transmission in a queue sequence.

## CHANNEL INTERFACE

A channel interface, like the line control, performs a traffic recognition function and also stores information. When a complete block of information is ready for transmission it is held in a buffer until the host computer can accept the information. Since the channel may operate at 100,000 times the speed that information is generated at a terminal, buffering enables a complete message or a block of predetermined size to be assembled for efficient transmission in a single burst.



## OPERATING SYSTEM

Overall management of minicomputer operation is part of the operating system. This can range from routines handling peripheral devices to a complex real-time operating system. In the Datacomm context, one important feature of an operating system is multiprogramming. Because of the slow speed of terminal devices versus the processing speed, an operating system should be able to switch between operations rather than wait for a terminal operation.

## PROCESSING

The processing programs reside in the host computer. They are prepared by the user for each particular application.

## SUMMARY

As we have seen in this chapter, a Datacomm network can be a local, in-plant system or a nation-wide configuration covering thousands of miles. Minicomputer-based distributed systems can provide processing capability at central and remote locations, as well as sharing the workload between locations. By acting as traffic managers, minicomputers also increase network efficiency and reduce line costs.

Since line usage is a large part of Datacomm operation, chapter seven describes the common carriers that provide these lines and some typical costs.

A company that contracts with state or federal government agencies to carry the property of others at regulated charges is called a common carrier. When the property to be carried is information in the form of voice or data, the companies performing this service are called communications common carriers. Interstate traffic is regulated by the Federal Communications Commission (FCC), while intrastate traffic is regulated by equivalent agencies, such as a Public Utility Commission (PUC), within each state. Some states, such as Texas, may have agencies that regulate service in a local area or city.

The services provided by communications common carriers include transmission of printed messages, such as telegrams, as well as the voice, data and facsimile discussed in previous chapters, plus transmission of telemetry, telephoto and television. There are around 3000 such carriers in the United States providing domestic service and several providing international service.

Costs for communications channels vary greatly depending upon the location, degree of reliability required, type of information and speed of transmission. The same grade of service, when intrastate, can have different tariffs in different states. Typically, intrastate rates are higher than interstate rates for equal service. The costs presented in this chapter are examples to provide a general picture of current data communications line rates. New routes, new equipment, inflation and competition all contribute to tariff changes and the figures given here may not be current in the future.

## DOMESTIC CARRIERS

The dominant domestic carrier is the American Telephone and Telegraph Company (AT&T). The Bell System portion of AT&T consists of 23 principal operating companies that handle a half-billion telephone calls during the average business day. There are around 2000 other telephone companies ranging from the General Telephone Company, with several million telephones, down to companies with a few hundred telephones.

Western Union is the only other carrier besides Bell that covers the entire country. Providing telegraph service since 1851, today it offers many other services including data communications.

A growing number of carriers are dedicated to providing data transmission as their main service. These are called specialized carriers, since they specialize in data communications, and either build their own transmission facilities or lease lines from the large carriers.

## INTERNATIONAL CARRIERS

Of the several overseas communications common carriers, the three largest are International Telephone and Telegraph (ITT), Western Union International and RCA Global

Communications. All have greatly increased their data communications capacity in recent years to meet the needs of international data traffic. The regulatory agency for international carriers is the International Consultative Committee on Telephone and Telegraph (CCITT).

## BELL SYSTEM

The Bell System offers a number of services to the data communications user; the main offerings are:

- DATAPHONE
- Wide Area Telephone Service (WATS)
- Leased (Private) Lines
- DATAPHONE Digital Service (DDS)

## DATAPHONE

The most common means of data communications, Bell's DATAPHONE Service allows business machines to use the telephone system in the same manner as people use telephones to communicate. (Computers and remote terminals are called business machines by the telephone companies). The service consists of modems that allow transmission over local or long distance lines, or WATS lines. The user's cost is the same as a regular telephone call, plus a monthly charge for the leased DATAPHONE modem.

A "foreign exchange service" (FX) provides a direct line to a distant exchange area for a flat monthly rate. The user can then make an unlimited number of calls within the distant exchange area without long distance charges. A local number in the distant exchange area is provided to the user, so a call to the user over the direct line is charged as a local call.

One advantage in using switched lines (versus leased lines) is that if the line "goes down" during a transmission another connection can be quickly made. A disadvantage is that switched lines generally have lower transmission quality and speed than conditioned leased lines, but a local copper-wire connection can have the same quality as a conditioned line. However, some modems have automatic adaptive equalizing that adapts the modem's circuits to the switched line characteristics, thereby providing a form of conditioning.

## WIDE AREA TELEPHONE SERVICE (WATS)

Interstate WATS divides the contiguous United States into five zones, with the charges based on the zone-to-zone distance and not on the length or number of calls. Charges are based on the flat monthly rate and a measured-time basis, where overtime rates apply when a specified number of hours are exceeded. Calls are made in a normal manner over the switched (public) network. The five zones to which calls can be placed are relative to the caller and do not include the local zone.

Outward WATS is calls placed to another zone. Inward WATS is calls received from another zone. For interstate calls, both inward and outward WATS have the same rates and zone designations.

Interstate charges are regulated by the FCC. From California, up to 240 hours of "connect time" for nationwide calls (outside of California's zone) costs \$1675 per month, while up to 10 hours per month costs \$225 plus \$19 for each additional hour. Each call is billed a minimum of one minute. Where a customer has more than one line the total connect time for the lines is the basis for billing: For example, with two 10-hour lines where one was used for 12 hours and the other for 7 hours, the billing would be for 19 hours without overtime charges.

Intrastate WATS charges are regulated by each state's Public Utilities Commission or equivalent agency. Since each state has its own rates and policies for intrastate WATS, the following cost examples of California rates apply only within that state. In California, the state is divided into two zones for intrastate WATS, and calls can be inward on one line and outward on another line but not both on the same line. There are different rates for inward and outward WATS. The following examples are for statewide service.

In California, 10 hours per month costs \$265 for outgoing intrastate WATS, plus \$20 for each additional hour; 100 hours costs \$800. Incoming intrastate WATS costs \$330 per month for up to 10 hours, plus \$25 for each additional hour; up to 100 hours costs \$1000.

#### INTERSTATE LEASED (PRIVATE) LINES

The Bell System bases its interstate leased lines rates on a per-mile (airline) charge between rate centers. Rate centers are named after cities, but the area covered is not confined to the city limits, with the mileage computed between city centers. There are two types of rate centers: Category "A" and category "B."

A list of category A rate centers is published by the Bell System, and any area not on that list is automatically a category B rate center. For example, the category A areas in four states are:

<b>California</b>		
Anaheim	Oakland	San Jose
Bakersfield	Redwood City	San Luis Obispo
Chico	Sacramento	Santa Rosa
Eureka	Salinas	Stockton
Fresno	San Bernardino	Sunnyvale
Hayward	San Diego	Ukiah
Los Angeles	San Francisco	Van Nuys
<b>Michigan</b>		
Detroit	Jackson	Pontiac
Flint	Kalamazoo	* Port Huron
Grand Rapids	Lansing	Int. Bdry
Houghton	Petoskey	Saginaw
Iron Mountain	Plymouth	Traverse City

<b>New York</b>		
Albany	Huntington	Poughkeepsie
Binghamton	* Mooers Forks	Rochester
Buffalo	Int. Bdry	Syracuse
* Buffalo Peacebridge	Nassau Zone 5	Westchester Zone 8
Int. Bdry	New York City	

<b>Texas</b>		
Abilene	Fort Worth	Lubbock
Amarillo	Harlingen	Midland
Austin	Houston	San Angelo
Beaumont	Laredo	San Antonio
Corpus Christi	* Laredo Int. Bdry	Sweetwater
Dallas	Longview	Waco
El Paso		

Except for a one-time installation charge of \$54.15 for half duplex or full duplex, all charges are monthly and cover both synchronous and asynchronous operations. There is a \$25 per month charge for each station terminal for the first terminal on a premises; additional terminals after the first on a premises cost \$5 per month. All charges are for service 7 days a week, 24 hours a day. Tables 7-1, 7-2 and 7-3 show the mileage charges between two A rate centers, an A and a B rate centers and two B rate centers. These charges are for data-only service on 3000 series channels. Voice service must be ordered as an option at a charge of around \$7 per terminal.

Leased lines offer savings over switched lines and WATS when transmission is for more than a short time each day. The crossover point in costs varies with the frequency and length of transmissions, time of day and distance. The following example compares current costs for daily transmissions from San Francisco, California, to Denver, Colorado. Charges are based on these factors:

- Daily use for one and two continuous hours
- 21 work days per month, 8 am to 5 pm
- Leased 3002 channel, data only
- Outward WATS from San Francisco

	<b>Cost</b>	
	<b>One Hour</b>	<b>Two Hours</b>
Leased:	\$783.56	\$783.56
Switched (dial):	\$456.76	\$921.48
WATS:	\$413.00	\$802.40

On request, the telephone company will install a four-wire interstate circuit without extra charge as long as it is used for half duplex. The charge is based on the mode of operation, not on the type of physical installation. A four-wire circuit used in the half duplex mode allows the channel not in use to be kept active, thus reducing line turnaround time.

\* International boundary points used only for extending service or from a point in Canada or Mexico.

**Table 7-1 Monthly Mileage Charges Between Two A Rate Centers**

Mileage	Charge
1	\$51.00
2-14	\$51.00 + \$1.80 for Each Mile Over 1 Mile
15	\$76.20
16-24	\$76.20 + \$1.50 for Each Mile Over 15 Miles
25	\$91.20
26-39	\$91.20 + \$1.12 for Each Mile Over 25 Miles
40	\$108.00
41-59	\$108.00 + \$1.12 for Each Mile Over 40 Miles
60	\$130.40
61-79	\$130.40 + \$1.12 for Each Mile Over 60 Miles
80	\$152.80
81-99	\$152.80 + \$1.12 for Each Mile Over 80 Miles
100	\$175.20
101-999	\$175.20 + \$.66 for Each Mile Over 100 Miles
1000	\$769.20
Over 1000	\$769.20 + \$.40 for Each Mile Over 1000 Miles

Where one rate center is an international boundary point, charge is as determined above minus \$25.00.

**Table 7-2 Monthly Mileage Charges Between an A and a B Rate Center**

Mileage	Charge
1	\$52.00
2-14	\$52.00 + \$3.30 for Each Mile Over 1 Mile
15	\$98.20
16-24	\$98.20 + \$3.10 for Each Mile Over 15 Miles
25	\$129.20
26-39	\$129.20 + \$2.00 for Each Mile Over 25 Miles
40	\$159.20
41-59	\$159.20 + \$1.35 for Each Mile Over 40 Miles
60	\$186.20
61-79	\$186.20 + \$1.35 for Each Mile Over 60 Miles
80	\$213.20
81-99	\$213.20 + \$1.35 for Each Mile Over 80 Miles
100	\$240.20
101-999	\$240.20 + \$.66 for Each Mile Over 100 Miles
1000	\$834.20
Over 1000	\$834.20 + \$.40 for Each Mile Over 1000 Miles

Where one rate center is an international boundary point, charge is as determined above minus \$25.00.

**Table 7-3 Monthly Mileage Charges Between Two B Rate Centers**

Mileage	Charge
1	\$53.00
2-14	\$53.00 + \$4.40 for Each Mile Over 1 Mile
15	\$114.60
16-24	\$114.60 + \$3.80 for Each Mile Over 15 Miles
25	\$152.60
26-39	\$152.60 + \$2.80 for Each Mile Over 25 Miles
40	\$194.60
41-59	\$194.60 + \$2.10 for Each Mile Over 40 Miles
60	\$236.60
61-79	\$236.60 + \$1.60 for Each Mile Over 60 Miles
80	\$268.60
81-99	\$268.60 + \$1.35 for Each Mile Over 80 Miles
100	\$295.60
101-999	\$295.60 + \$.68 for Each Mile Over 100 Miles
1000	\$907.60
Over 1000	\$907.60 + \$.40 for Each Mile Over 1000 Miles

Where one rate center is an international boundary point, charge is as determined above minus \$25.00.

## INTRASTATE LEASED LINES

Again, intrastate rates vary from state to state, but they tend to be generally higher than interstate rates. For this reason, interstate rates can be obtained only when there is a demonstrated need for communication across state lines. However, when one part of a circuit crosses a state line, then the entire circuit obtains the interstate rate.

In California, the monthly charge is a total of three factors: airline mileage, channel termination (at the serving central office) and service termination (at the customer's premises). Mileage charges are shown in table 7-4. The channel termination charge is \$10 per month per terminal, and the service termination charge is \$7 per month per terminal. These rates are for a type 3002 channel between two points, or a two-point section of a multi-point channel, for service 7 days a week, 24 hours a day.

**Table 7-4 California Monthly Mileage Charges**

Mileage	Rate per Airline Mile (\$)
0 to 15	4.00
16 to 25	3.75
26 to 50	3.25
51 to 100	2.75
101 to 150	2.25
151 to 300	2.00
301 to 600	1.25
601 and over	0.75

Monthly charges are for voice/data channels. However, to use the voice service a voice/data "transfer key" is required, at \$0.75 per month and a one-time \$8.00 installation charge, as well as a telephone set, at \$1.75 per month and a one-time \$20.00 installation charge.

## DATAPHONE DIGITAL SERVICE (DDS)

A new data transmission service offered by the Bell System, DDS will cover all major metropolitan areas in the United States by 1980. In contrast to telephone line use, where digital data is transmitted in analog format, DDS is designed specifically for the exclusive transmission of digital data, but uses existing telephone company facilities. Information travels from source to destination in its original format without the use of modems. The mode of transmission is full duplex synchronous and four fixed speeds are offered:

- 2400 bps
- 4800 bps
- 9600 bps
- 56000 bps

In place of a modem, the user can opt for one of two interface devices. A Data Service Unit (DSU) provides a standard industry interface that is plug-to-plug compatible with existing modems. It performs such functions as signal regeneration, timing recovery and signal reformatting. Should the user prefer non-Bell equipment to perform the DSU function, Bell furnishes a Channel Service Unit (CSU) that provides remote loopback features and network protection. However, voice cannot be transmitted over digital channels.

The service offers improved performance and reliability because it is designed specifically for digital data and because of the nature of the digital transmission itself. Unlike analog telephone lines, where signals are periodically amplified, digital signals are regenerated, thereby greatly reducing distortion. This allows higher speeds and fewer errors.

Charges are monthly rates and are based upon speed, distance between cities served, and distance of the user from a served city. Between cities where the main offices are located, the monthly rate for a 4800 bps point-to-point full duplex channel is \$0.60 per mile plus a \$40 fixed charge; a similar channel operating at 56000 bps costs \$4 per mile plus a \$125 fixed charge.

In the metropolitan area served by the city, there is a charge for a digital access line to the user's location. There are two rate structures; one for digital access lines up to five miles (Type 1), and another for those over five miles (Type 2). When a user is not near a DDS facility, an analog line with modems on both ends makes the connection to the nearest DDS access point. A Type 1 point-to-point digital access line operating at 4800 bps costs a flat monthly rate of \$85 plus a one-time charge of \$100. At 56000 bps it is \$200 plus a one-time charge of \$150. For a Type 2 line operating at 4800 bps the charges are \$110 monthly, \$0.90 per mile and a one-time charge of \$100; at 56000 bps they are \$250 monthly, \$6 per mile and a one-time charge of \$150. When multipoint operation is required, the extra charge is \$15 per month per station.

## SPECIALIZED CARRIERS

In the past few years a number of companies have been formed to provide specialized common carrier service. These companies provide digital transmission of data over their own communications facilities. Whereas the Bell System modifies its existing facilities to transmit data in digital format, the specialized carriers design, build and operate a complete new digital network. A user can normally make a terminal-to-computer connection in less than one second.

## VALUE ADDED NETWORKS (VAN)

VAN's began operation in 1975 and by 1977 a number of companies will be serving over 20 cities in the continental United States. They are called "value added" because they use the network facilities of common carriers but enhance them by using their own methods of moving data, thus providing more services than the common carriers. Among the advantages they offer are lower error rates and increased efficiency of line usage.

Data is transmitted in units called packets, containing a specified number of characters, and routed through the network by minicomputers in switching centers. Other minicomputers are used as terminal interface processors (TIP), connecting computers and remote terminals into the network, that can make normally incompatible terminal devices capable of working with each other. The TIP divides each message into packets, then sends it through switching centers, via the common carrier facilities, to the destination TIP where the packets are recombined into the original message.

Telenet Communications Corporation is an example of a VAN that began operation in 1975 with service between 16 cities and in 1976 the service was extended to about 30 cities. Users do not have to be located in these cities to use the service; a switched or leased line can provide access to the nearest Telenet facility. A wide range of speeds are offered, from 50 bps to 56000 bps.

Typically, a remote terminal can establish communication with a host computer within one second by entering a simple command at the keyboard. The channel is a "virtual" connection, not a continuous physical connection, with constantly changing paths of travel for the packets containing information. Each packet contains 1024 bits (128 characters) or less. Where a message with 129 characters is transmitted, the last character would go in a packet by itself and the user would be charged for two packets. When dissimilar devices are in communication, the network will perform the necessary speed and code conversions to make them compatible.

Charges are based upon three factors: the number of packets transmitted, the cost of telephone lines, and the use of Telenet facilities. Packet charges are \$0.60 per 1000 packets, each packet containing up to 128 characters of user data. The Bell line charges are as previously described. Within the Telenet network, there is no mileage charge.

The user connects with the local Telenet facility by dialing a public port (not always available) or a private port (always available), or a leased port can be obtained. There are three rate schedules for ports, depending upon the data communications activity in an area: each location served is classified as high, medium, or low density. For example, Chicago and Los Angeles are high density, Denver and San Diego are medium density, and Portland and Seattle are low density. Except for installation, all charges are monthly.

Public dial-in ports in a high density area operating at 110-300 bps cost \$1.40 per hour for the first 1200 hours; in a low density location they cost \$4.80 for the first 200 hours. In all density areas additional 110-300 bps time is charged at \$0.70 per hour. There is no installation charge for public ports.

Monthly charges for private and leased ports vary from \$100 to \$450 depending upon the speed and service required. Installation charges range from \$200 to \$600.

At the host computer, a Telenet Access Controller (TAC) interfaces between the line and the computer. Monthly charges start at \$400 and installation charges start at \$600.

Tables 7-5 and 7-6 summarize the installation charges and monthly costs for a Telenet network with the following factors:

- Location of host computer: Dallas.
- Location of user terminals: Los Angeles and New York.
- Number of terminals: Two in Los Angeles and three in New York.
- Speed of terminals: 1200 bps in Los Angeles and 300 bps in New York.
- Hours of use per month: 70 hours for Los Angeles and 200 hours for New York.

- Type of port: Public dial-in for both user locations.
- Application: Assume this application generates a traffic volume of 1400 packets per hour at each user location.
- The user provides the remote terminals and associated modems or acoustic couplers, the connection to the nearest Telenet port, and computer time.

Table 7-5 Example of Telenet Installation Charges

Los Angeles and New York	
No installation charge for public dial-in ports	
Dallas — Host computer accessed through a Terminal Access Controller (TAC)	
Basic TAC equipment . . . . .	\$ 600
Three 300 bps ports and two 1200 bps ports — minimum charge . . . . .	\$ 200
Speed mix option . . . . .	\$ 100
Two rotary lists @ \$50 each . . . . .	\$ 100
Leased lines and modems between Telenet Dallas office and host computer (estimate) . . . . .	\$ 400
<b>Total Installation Charges:</b>	<b>\$ 1,400</b>

Table 7-6 Example of Telenet Monthly Costs

Los Angeles	
70 hours of 1200 bps public dial-in port service @ \$3.80 per hour . . . . .	\$ 266.00
1400 packets per hour for 70 hours @ \$0.60 per 1000 packets . . . . .	\$ 58.80
New York	
200 hours of 300 bps public dial-in port service @ \$1.40 per hour . . . . .	\$ 280.00
1400 packets per hour for 200 hours @ \$0.60 per 1000 packets . . . . .	\$ 168.00
Dallas	
TAC . . . . .	\$ 400.00
Three 300 bps ports @ \$25 each . . . . .	\$ 75.00
Two 1200 bps ports @ \$50 each . . . . .	\$ 100.00
Speed mix option . . . . .	\$ 30.00
Two rotary lists @ \$20 each . . . . .	\$ 40.00
Leased lines and modems (estimate) . . . . .	\$ 200.00
<b>Total Monthly Costs:</b>	<b>\$ 1,617.80</b>
Network Hourly Cost	
270 hours of service per month @ \$1,617.80 . . . . .	\$ 5.99 per hour

## SATELLITE CARRIERS

Full scale commercial operations via satellite got under way in 1973 when the RCA Satcom system became operational. This provided the first commercial coast-to-coast domestic satellite communications service available in the United States.

Western Union (WU) has Westar satellites in orbit 22000 miles above the earth. WU uses these for its own services as well as leasing them to other carriers such as RCA Satcom and the American Satellite Corporation (ASC). Transmission services provided are for voice, data and television.

The Westar system offers voice grade channels for point-to-point asynchronous data communications at speeds between 300 and 9600 bps. In addition to voice grade service, wideband service is available in bandwidths of 4800 Hz, 24000 Hz and 1.2 million Hz. Error rates are around half that of conventional voice grade terrestrial lines. New HDLC-type line protocols are ideally suited for satellite operations, but many of the older "handshaking" protocols can still use Westar without a significant loss in data volume caused by protocol procedures. However, turnaround time can cause problems with some terminals.

Satellites provide large savings on long distance transmission. A Westar satellite can carry a voice grade transmission from New York to San Francisco at half the cost of a terrestrial line. A typical leased landline cost between the two cities is around \$1650 per month and, in California, a 240-hour WATS line costs \$1675 per month; a similar Westar service costs about \$1100 per month. However, this type of lower cost is available only in several cities with earth stations for direct satellite communication. Voice grade circuits can be extended from cities with earth stations to other areas at WU's regular terrestrial microwave rate: \$1 or less per month per mile plus termination charges.

## SUMMARY

Over short distances, hardware connections, such as cables, can be used for data communications, but most applications require the services of a communications common carrier. Voice/data services are provided by telephone companies, of which AT&T's Bell System is the dominant carrier. Some specialized carriers are developing their own equipment and routes to provide digital-only data service, while others lease common carrier lines and then use their own methods of moving data to provide an enhanced data communications network.

The Bell System, which has provided our examples of service and costs, offers data service over its voice lines — DATAPHONE, WATS and leased — and a digital-only data service over DDS. However, types of service and rates change frequently and the costs stated in this chapter are offered only as current examples.

Satellites are providing large savings in long distance transmission and promise even greater service and lower costs for the future. Other even more exotic transmission methods — laser, fibre optics and waveguides — foretold development of data communications to its ultimate potential.

NOTES

1994

1994

1994

1994

1994

1994

1994

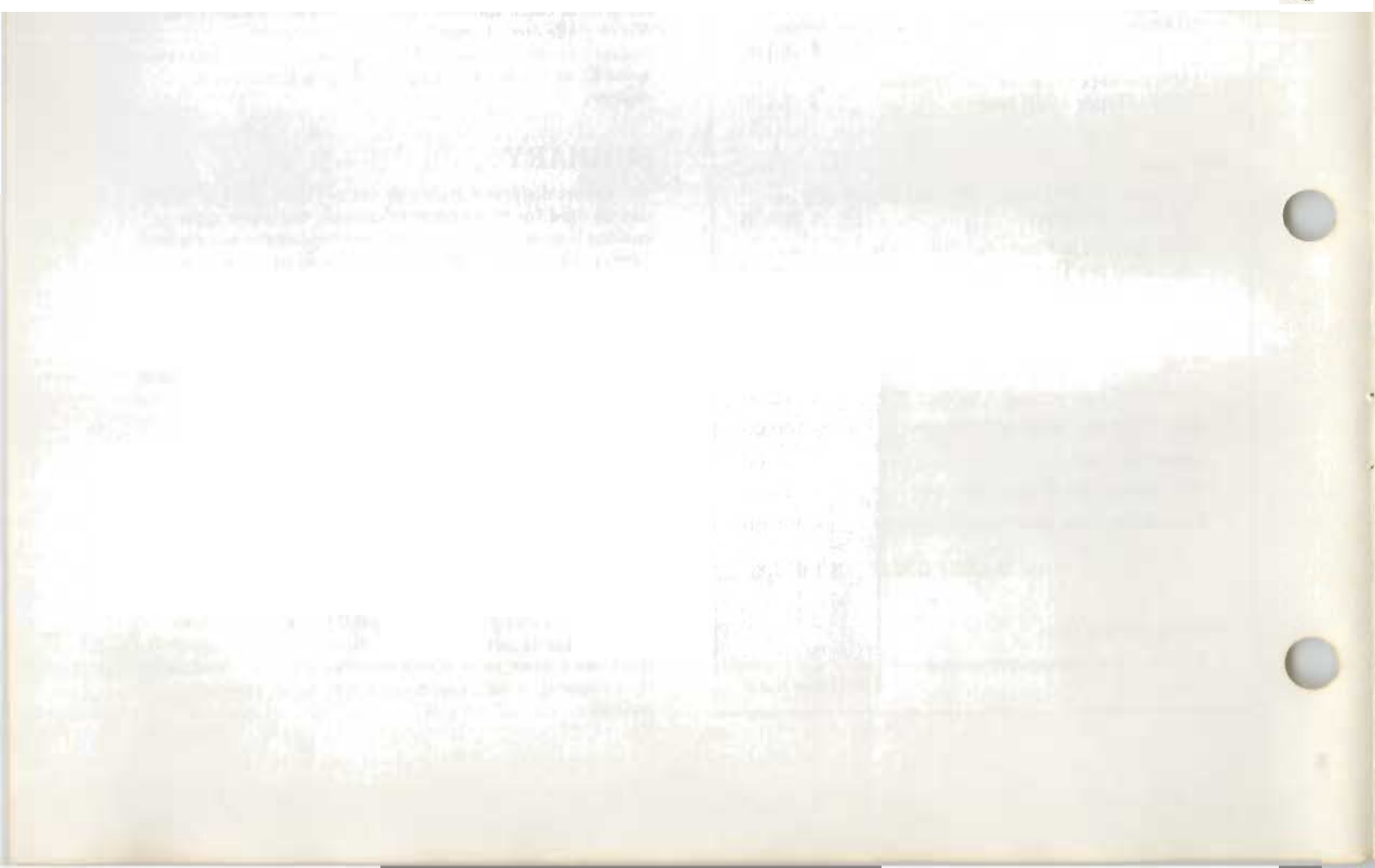

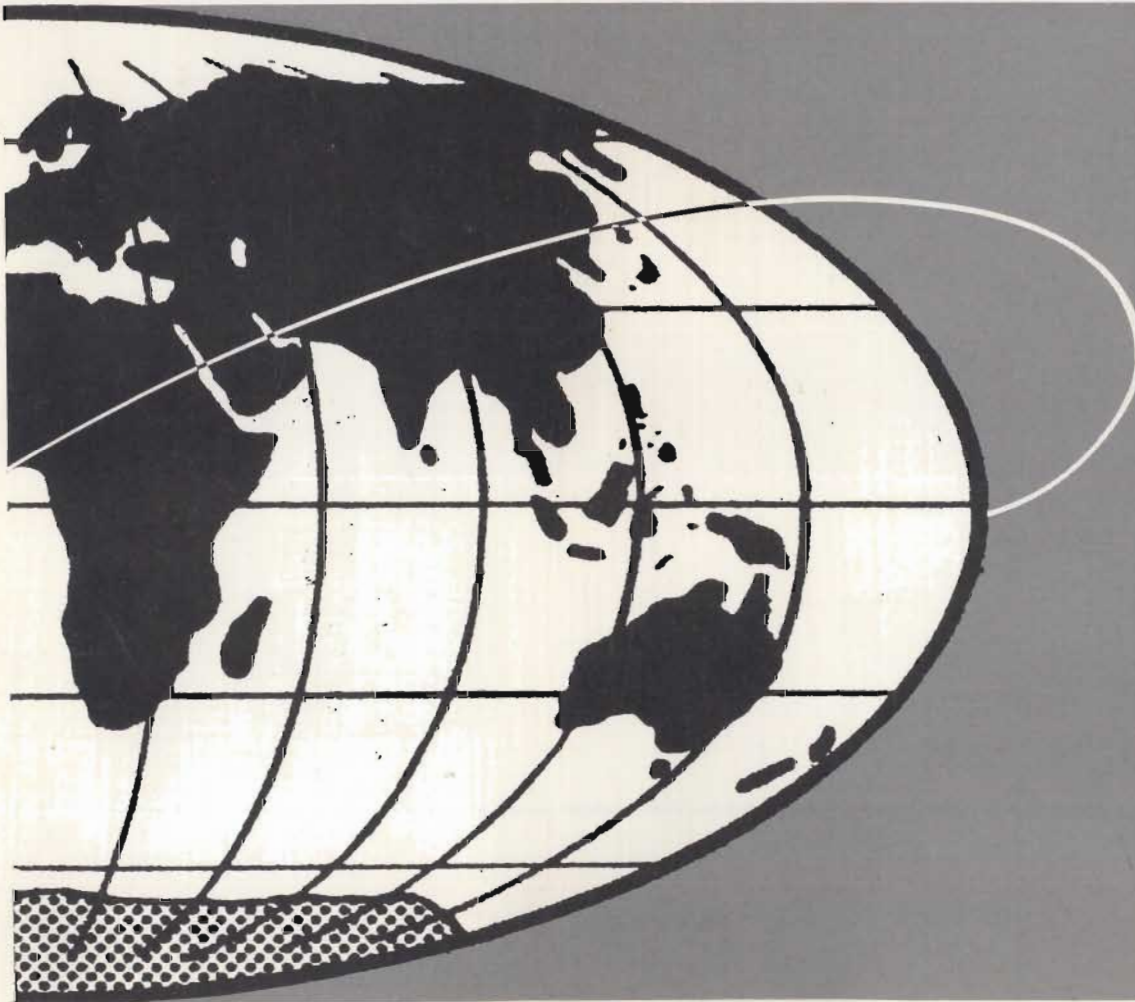

HEWLETT  PACKARD

Sales and service from 172 offices in 65 countries.  
5203 Stevens Creek Blvd., Santa Clara, California 95050

Printed in U.S.A. 1/77  
Part No. 5955-1715