

# LOAD PULL- MEASUREMENT OF LOAD IMPEDANCE OF HIGH POWER DEVICES

DENNIS POULIN  
NETWORK MEASUREMENTS DIVISION  
1400 FOUNTAIN GROVE PARKWAY  
SANTA ROSA, CALIFORNIA 95404



# REAL TIME MANUAL LOAD PULL MEASUREMENT SYSTEM

- SYSTEM FEATURES
- BASIC BLOCK DIAGRAM OF THE SYSTEM
- DISCUSSION OF MEASUREMENT AND DESIGN TECHNIQUE
- TYPICAL DATA
  - LARGE SIGNAL OUTPUT PLANE FOR A GAAS FET
  - CLASS C OUTPUT PLANE FOR A BIPOLAR
  - BIPOLAR OSCILLATOR OUTPUT PLANE
- ACCURACY CONSIDERATIONS
- CONCLUSIONS AND FUTURE WORK

1

## INTRODUCTION

Most microwave designers are familiar with the use of S parameters for design of small signal amplifiers. However, small signal S parameters are useless when a designer is concerned about designing or troubleshooting an oscillator, large signal amplifier or an amplifier operating in a mode other than Class A. In these circumstances, it is necessary to measure the load impedance required under the actual operating conditions. This type of measurement has classically been referred to as a "load pull" measurement.

This paper describes a simple system to obtain this information. The measurement technique is described and a design technique is suggested. Some typical data is discussed for several large signal circuits. Accuracy considerations of the measurement system are also discussed.

## OPTIMUM LOAD VS OUTPUT POWER

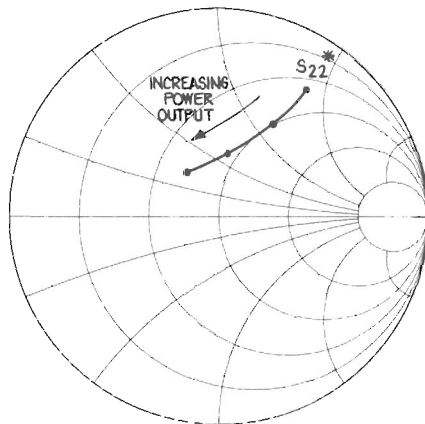

\* SMALL SIGNAL MATCH

2

The problem a microwave designer encounters when dealing with a large signal amplifier or oscillator is that the load impedance required to match the device is a function of output power. The fashion in which the optimum load impedance shifts as a function of output power is unpredictable. This renders small signal S parameters useless for large signal design.

This is a general comparison of the circumstances where S parameters are appropriate and when a load pull measurement is necessary. Load pull is most useful when a device is operated in a nonlinear fashion.

3

## LOAD PULL VS SMALL SIGNAL S-PARAMETER MEASUREMENT

S-PARAMETERS	LOAD PULL
<ul style="list-style-type: none"> <li>• MEASURES INPUT AND OUTPUT SMALL SIGNAL IMPEDANCES AND FORWARD GAIN AND REVERSE ISOLATION</li> <li>• DOES NOT MEASURE DEVICE POWER OUTPUT</li> <li>• ONLY VALID FOR LINEAR DEVICES</li> <li>• ONLY VALID FOR CLASS A OPERATION</li> <li>• ONLY VALID FOR SMALL SIGNAL LEVELS</li> <li>• DIFFICULT TO OBTAIN USEFUL OSCILLATOR DEVICE DATA</li> </ul>	<ul style="list-style-type: none"> <li>• MEASURES LOAD IMPEDANCE REQUIRED TO OBTAIN OPTIMUM POWER OUTPUT FROM A DEVICE</li> <li>• INPUT IMPEDANCE OF DEVICE FOR A GIVEN LOAD CONDITION CAN BE MEASURED</li> <li>• FORWARD GAIN AND POWER OUTPUT MEASURED</li> <li>• MEASURES NON LINEAR AS WELL AS LINEAR DEVICES</li> <li>• MEASURES DEVICES OPERATED IN CLASS A, B OR C</li> <li>• MEASURES DEVICES AT DESIRED LARGE SIGNAL OPERATING POINT</li> <li>• OSCILLATOR DEVICES CAN BE MEASURED AND OPTIMIZED</li> <li>• LOAD SENSITIVITY CAN BE DETERMINED</li> <li>• PARAMETERS OTHER THAN POWER SUCH AS HARMONIC PERFORMANCE CAN BE MEASURED</li> <li>• OPTIMUM LOAD FOR MAXIMUM POWER OUTPUT CAN BE MEASURED FOR ANY INPUT POWER LEVEL</li> </ul>

The result of a load pull measurement is a series of constant output power contours plotted on a Smith Chart which represents all possible load impedances. A load pull measurement is required at each power level and frequency of interest since the load contours are usually sensitive to these variables for most high power devices and oscillators. Hence, it is important that the load pull measurement is made quickly and easily.

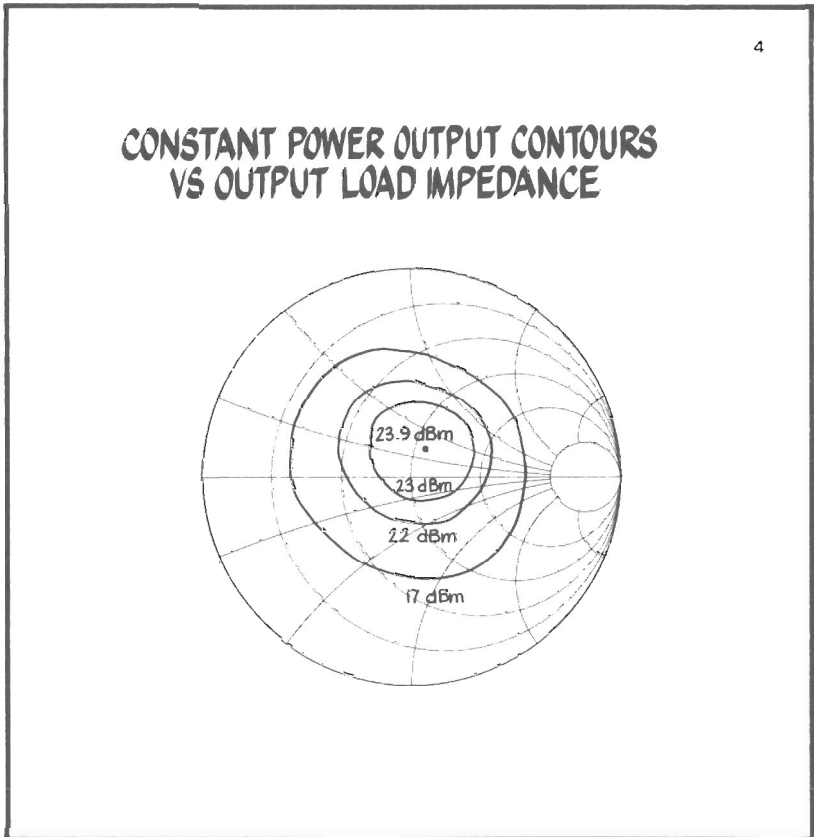

## LOAD PULL BASIC MEASUREMENT SYSTEM

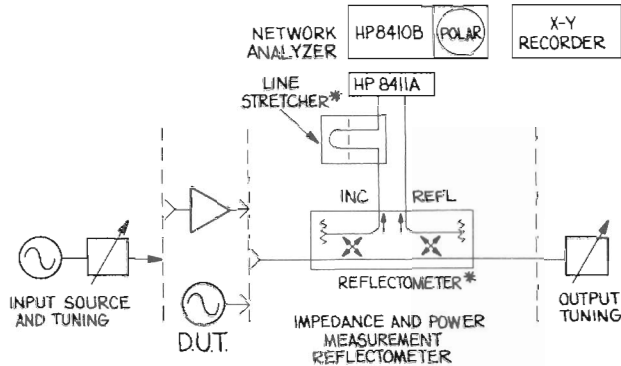

\* REFLECTOMETER = HP 11692D DUAL DIRECTIONAL COUPLER  
 LINE STRETCHER = HP PART NO. 08741-60004

A very straight forward, broadband, load pull system can be assembled with the use of a dual directional coupler reflectometer and parts of a 8409 Network Analyzer. The basic system will operate at any single frequency from 2 to 18 GHz and will make the measurement in real time. The system is rounded out by input and output power meters, a frequency counter and a X-Y plotter to plot the data.

## REAL TIME MANUAL LOAD PULL MEASUREMENT SYSTEM

### SYSTEM FEATURES

- THE SYSTEM IS INHERENTLY BROADBAND, OPERATING AT ANY SINGLE FREQUENCY IN THE 2 TO 18 GHz RANGE.
- SYSTEM CALIBRATION CAN BE CHECKED USING A SHORT CIRCUIT STANDARD.
- LOAD IMPEDANCE IS MEASURED SIMULTANEOUSLY WITH OUTPUT PARAMETRICS SUCH AS POWER-OUT IN REAL TIME.
- THE SYSTEM CAN MEASURE TWO PORT DEVICES AND CIRCUITS AND ONE PORT SIGNAL SOURCES.
- THE SYSTEM CAN BE USED WITH ANY TYPE OF OUTPUT TUNER INCLUDING AN ACTIVE TUNER.
- SYSTEM ACCURACY CAN BE ENHANCED USING CALCULATOR CONTROL AND STANDARD NETWORK ANALYZER CALIBRATION ROUTINES.

A summary of the load pull measurement system features is shown. In particular, the system is inherently broadband and can thus be used as a general measurement system. Also, any type of impedance tuner can be used in conjunction with the measurement system. It is not necessary to have a special or calibrated tuner.

The impedance measurement itself is accomplished with a dual directional coupler reflectometer. The "incident" signal is the signal emerging from the output of the device under test. In the case of an oscillator, the oscillator is its own signal source. In the case of an amplifier, a signal source and an appropriate input tuner must be provided to supply the required RF power. The "reflected" signal will be the portion of the incident signal which has been reflected back from the output tuner. The network analyzer compares the "reflected" signal to the "incident" signal and outputs the information to the polar display in the form of a reflection coefficient. The reference plane is established at the output of the device under test by adjusting the line lengths in the "test" and "reference" lines of the network analyzer.

The RF power measurement is also accomplished in the dual directional coupler. The incident and reflected power are individually measured. The difference between the incident and reflected power in milliwatts is then taken and displayed on a linear meter with a logarithmic scale. A differential power measurement is necessary to eliminate errors caused by the insertion loss of the dual directional coupler. This error will be discussed later on.

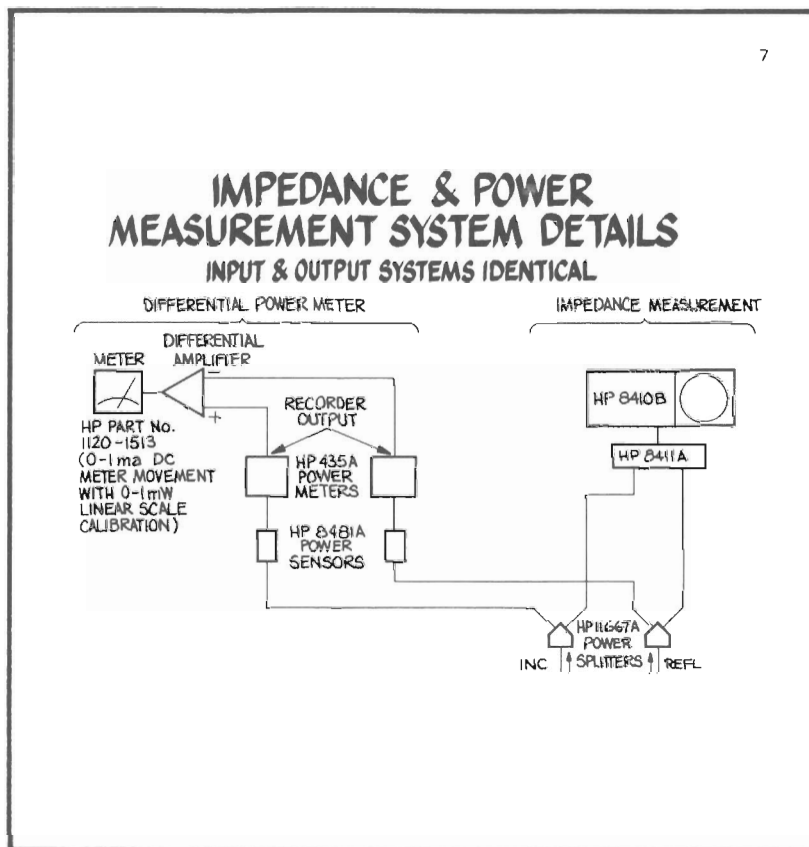

### CALIBRATION

The calibration procedure for the load pull measurement system is similar to that used on a standard network analyzer. The device under test is replaced by a good broadband short circuit and connected to the "input" port. An RF source is connected to the reflectometer at the "tuner" port. The source is swept around the frequency of interest and the line stretcher and the phase and amplitude controls on the 8410B are adjusted to indicate a broadband short circuit on the 8414A polar display.

For a two-port measurement, the input reflectometer is calibrated in a similar fashion. The only difference is that the incident and reflected channels are reversed on the network analyzer.

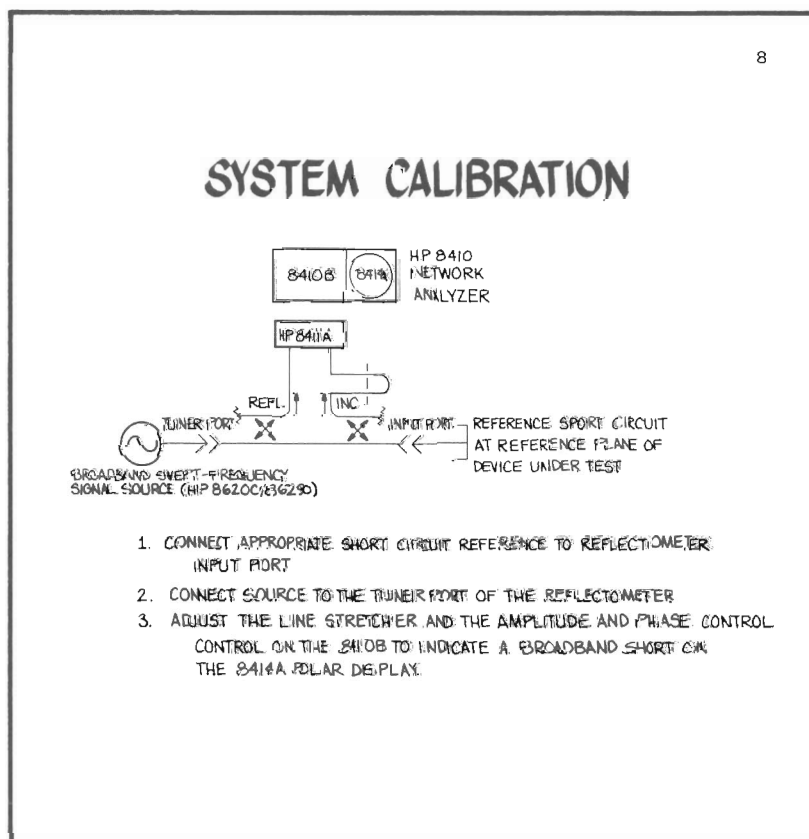

# CALIBRATION TECHNIQUE

## A) CALIBRATION MODE

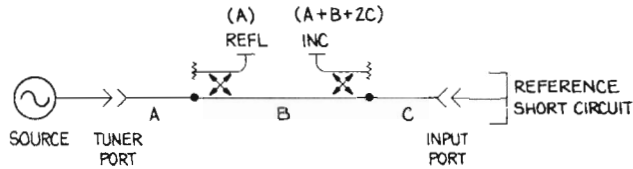

(A, B, C, ARE EITHER ATTENUATIONS IN dB OR ELECTRICAL LENGTHS)

In calibration, the reflectometer is connected backwards. The quantity measured will be the reciprocal of the reflection coefficient of the calibration short connected to the "input" port. However, since the reciprocal of a reflection coefficient of  $1 < \pm 180^\circ$  is still  $1 < \pm 180^\circ$ , the calibration short will be displayed as a short circuit on the polar display. Calibrating in this fashion automatically accounts for the reference plane extension to the D.U.T. and for the amplitude adjustment required on the network analyzer to account for the insertion loss between the D.U.T. and the output tuner.

# CALIBRATION TECHNIQUE

## B) MEASUREMENT MODE

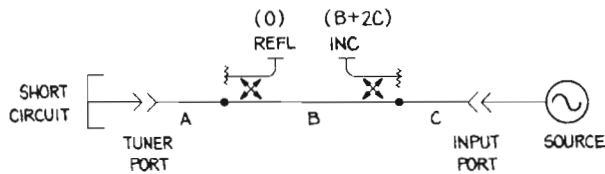

WITH A SHORT CIRCUIT CONNECTED IN PLACE OF THE OUTPUT TUNER THE TEST CHANNEL SHOULD BE  $(2A+2B+2C)$  GREATER THAN THE REFERENCE CHANNEL. THIS IS TRUE SINCE THE REFERENCE = C AND THE TEST =  $2B+3C+2A$ .

## OUTPUT TUNER CONSIDERATIONS

The load pull measurement system described can be operated with any type of output tuner. The magnitude of the load reflection coefficient presented to the device under test is limited by the maximum reflection coefficient of the tuner and the loss between the device under test and the tuner. Some examples of standard output tuners include double or triple stub tuners, movable probe tuners and  $\lambda/4$  slug tuners.

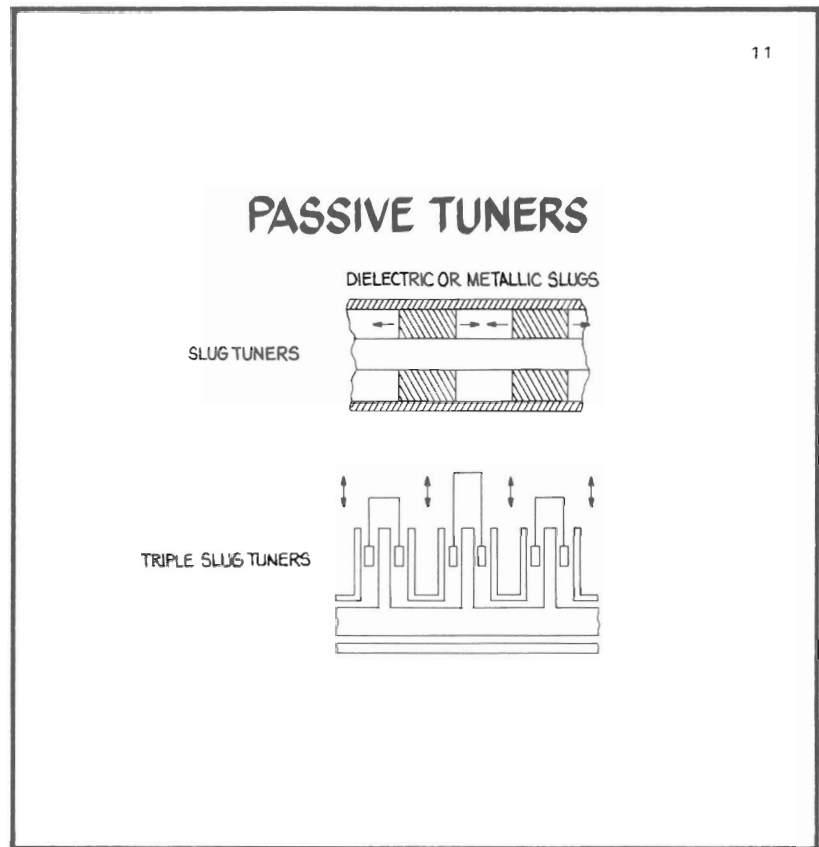

An active tuner can be used if it is necessary to tune to the outside of the Smith Chart. A basic active tuner consists of an amplifier, an attenuator, a phase shifter and either a circulator or a high directivity directional coupler. A signal incident on the tuner is amplified, attenuated, and phase shifted the desired amount and sent back towards the device under test as a "reflected" signal. One consideration to take into account with the active tuner is that it is potentially unstable if  $180^\circ$  of phase shift and a gain of 1 is achieved around the path from the input to the output of the amplifier in the tuner.

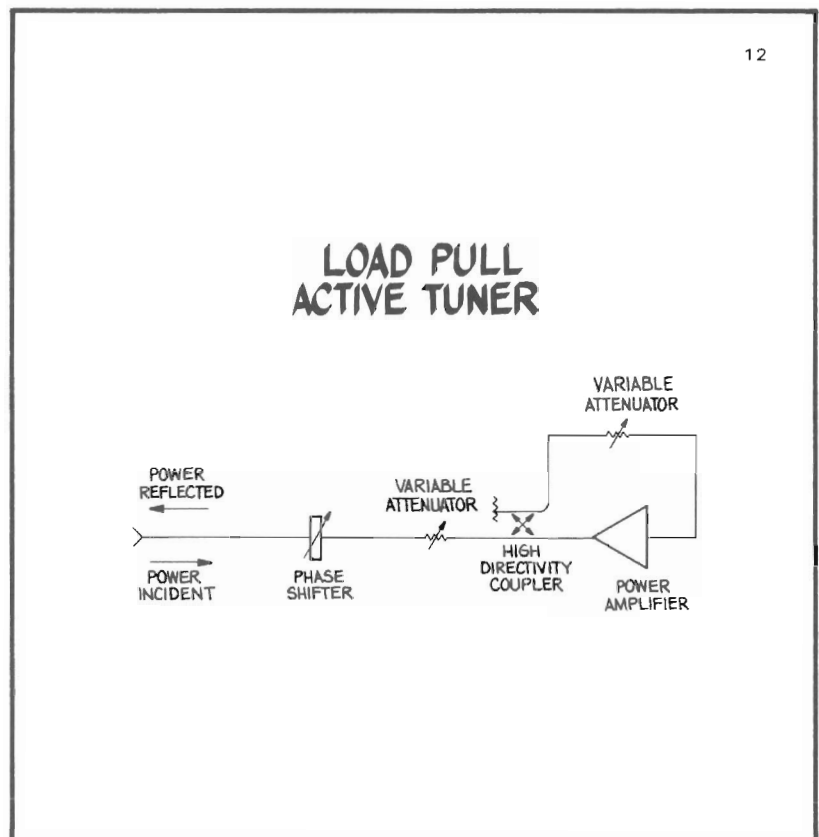

## LOAD PULL TWO PORT MEASUREMENT

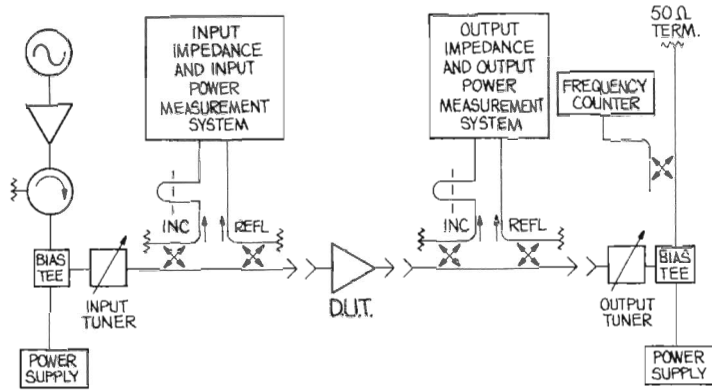

One application of a load pull measurement is the design of the output circuits for a large signal GaAs FET power amplifier. The measurement system setup is shown. Both an input and output reflectometer are used. The input reflectometer is a standard reflectometer and it measures the input impedance of the device as the load impedance is changed. The input power is also measured differentially to obtain the true power delivered to the input of the device.



The designer would start by mounting the device to be measured in a fixture with a  $50\Omega$  line output. The input circuit can either be an appropriate input matching circuit derived from small signal S parameters or a  $50\Omega$  line in combination with an input tuner. The output of the test fixture is connected to the load pull measurement system at the "RF Input" port, the device is powered up, and the appropriate input power is applied. The impedance that the output tuner is presenting to the device under test will be displayed on the polar display and the corresponding output power will be displayed on the output power meter. The input impedance of the device for this load condition will be displayed on the input reflectometer. Both the impedance information and the power output information is recorded on a Smith Chart via an X-Y recorder.

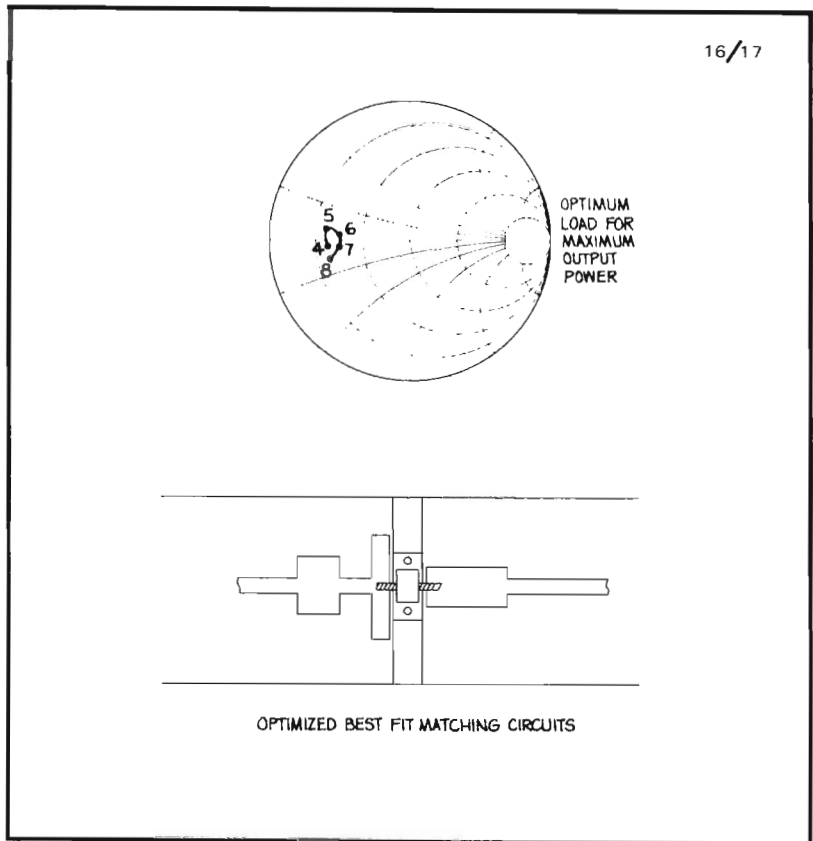
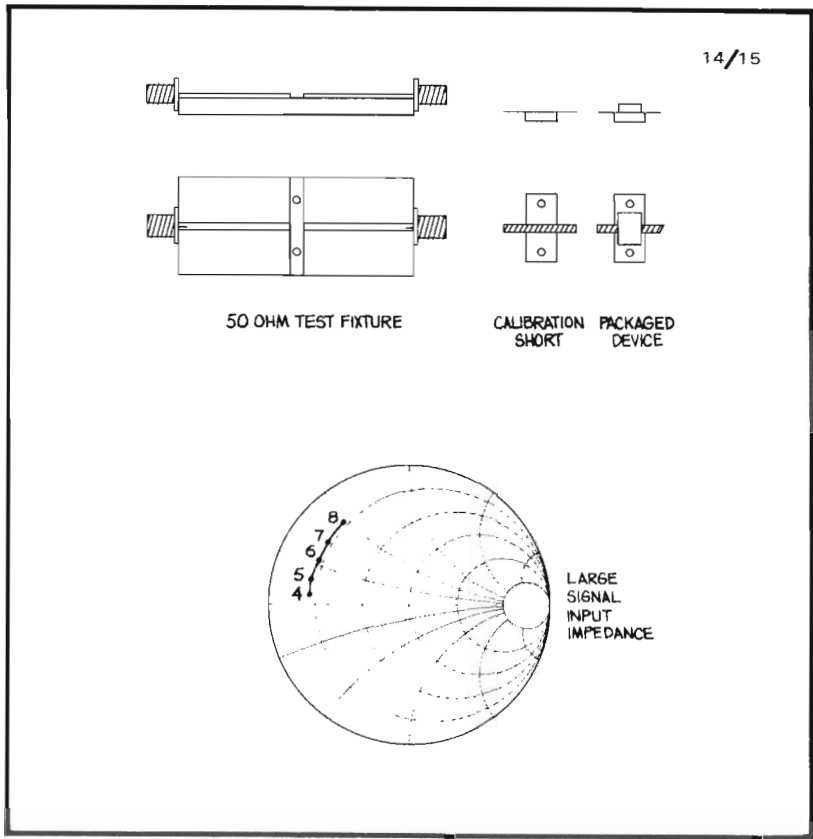

# LOAD PULL GAAS FET AMPLIFIER DATA

18

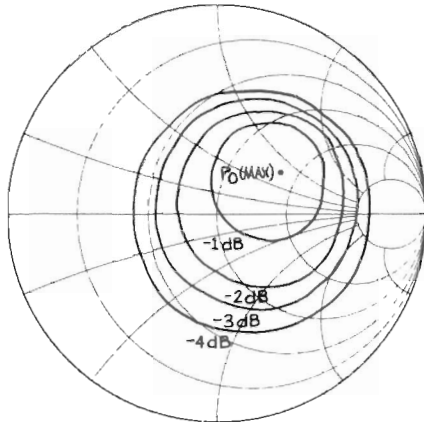

CONTOURS OF CONSTANT OUTPUT POWER VS. LOAD  
IMPEDANCE UNDER LARGE SIGNAL CONDITIONS

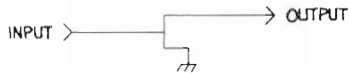

The resultant data will be a set of contours of constant output power on the Smith Chart for the given test condition. An output matching circuit can now be designed for a desired output power by matching to the appropriate impedance point indicated by the load pull data. The load pull data also indicates to the designer how sensitive the output power of the device under test is to output load. An input match can also be designed using the appropriate input impedance information obtained from the input reflectometer.

DESIGN EXAMPLE: BIPOLAR OSCILLATOR

The load pull measurement system can be used to come up with an empirical design of the output circuit of an oscillator. The measurement system setup is shown. The oscillator acts as the RF power source for the system.

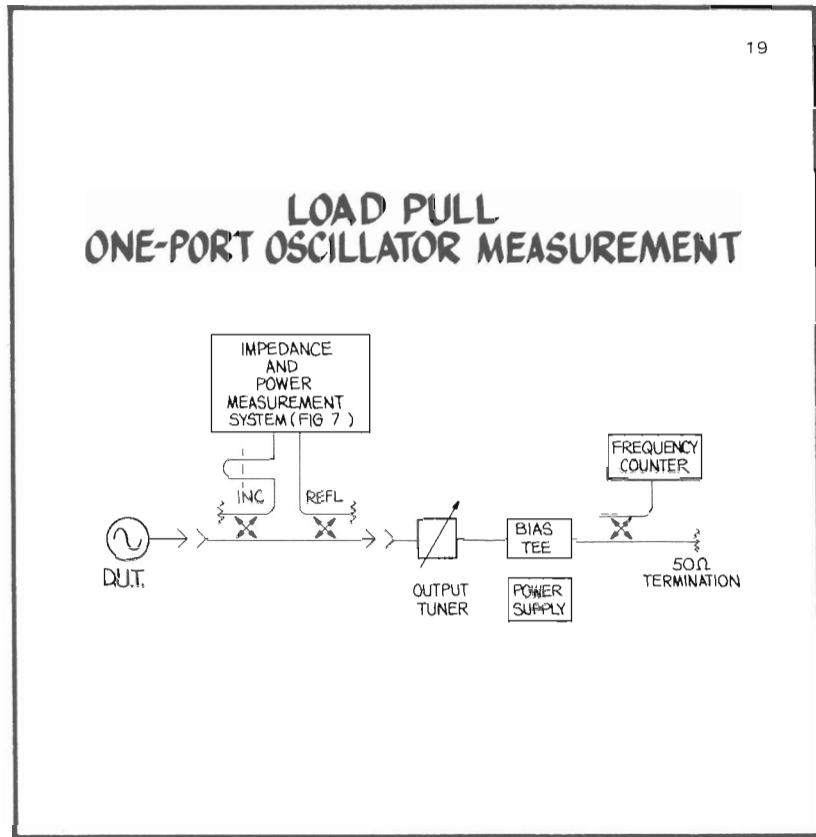

The designer must first determine his basic oscillator topology, feedback circuit and resonator. The oscillator is then built up with a 50Ω line in place of the output matching network. The oscillator is attached to the load pull measurement system at the "input" port of the reflectometer and powered up. The impedance displayed on the polar display will be the impedance presented to the output of the oscillator device. Contours of constant output power can then be drawn on a Smith Chart using the power readings from the output power meter and a X-Y recorder connected to the polar display. In a similar fashion, the range of impedance that the device will oscillate into can also be determined and recorded. The designer can then use the resultant information to lay out his oscillator output circuit.

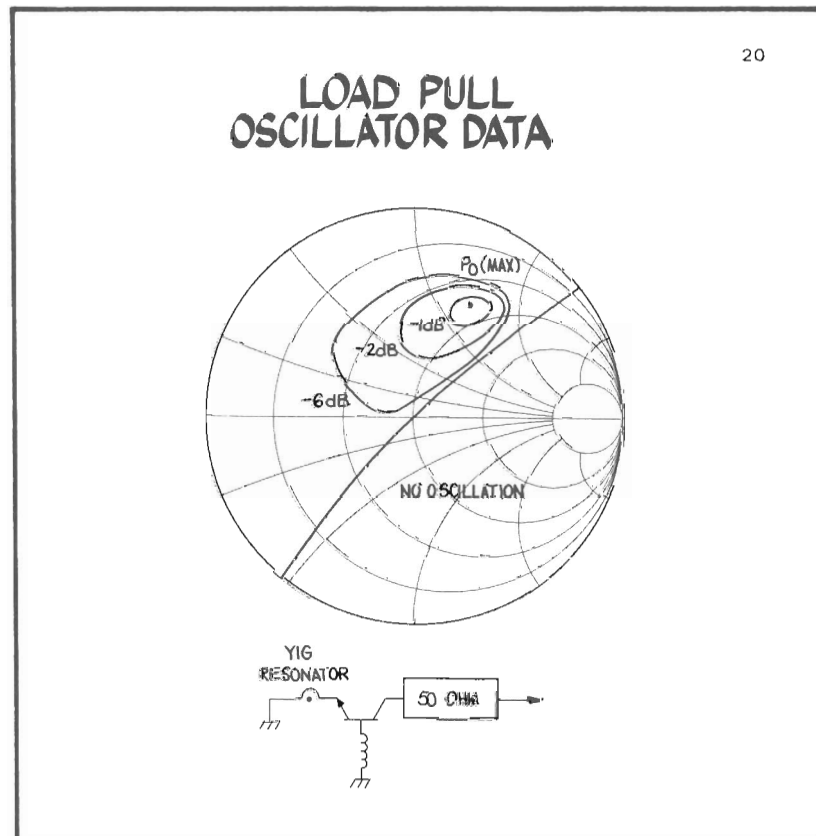

## LOAD PULL DATA FOR BIPOLAR AMPLIFIER OPERATING CLASS C

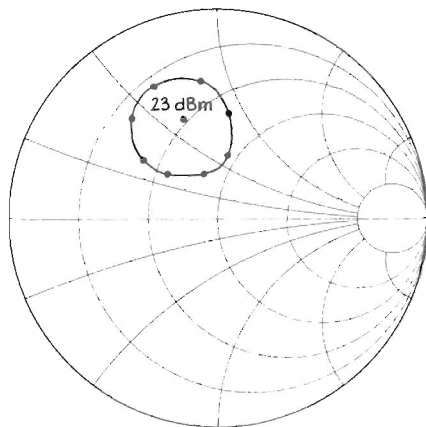

INPUT MATCH OPTIMIZED AT MAX POWER OUT

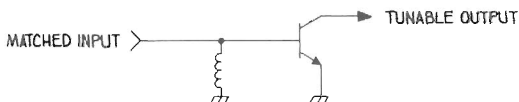

Devices operated in Class C can be measured on the load pull measurement system. The two port setup is used to make the measurement. Input and output impedance information is obtained similar to the case of the GaAs FET power amplifier. This information is then used to design the input and output matching networks for the amplifier. An example of some output load data is shown for a bipolar device operated under Class C conditions.

## HARMONIC LOAD PULL

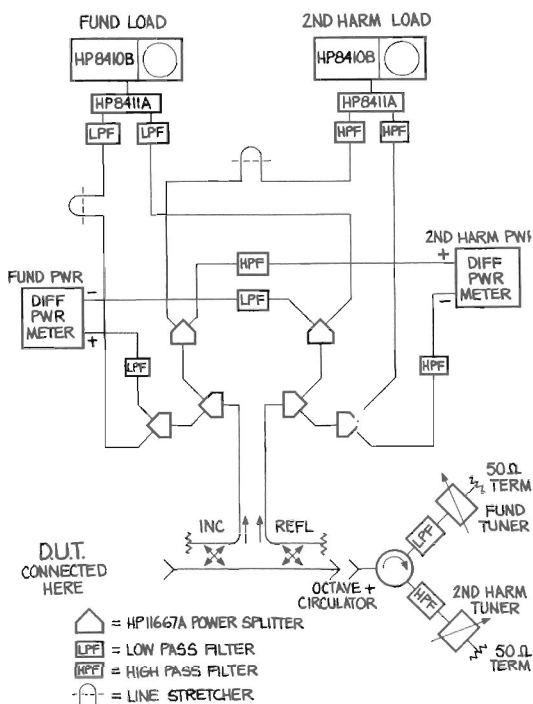

It is sometimes important to know how much second harmonic will be generated in an amplifier or an oscillator as a function of the output load impedance presented at the fundamental and second harmonic. The load pull measurement system can be modified for this measurement with the addition of a frequency sensitive tuner, an additional 8410B, 8411A combination and some power splitters and filters. The second network analyzer is used to measure the impedance presented to the device under test at the second harmonic. The filters in the reference and test channels of the harmonic converters separate the fundamental frequency components of the output impedance from the second harmonic frequency components so that they may be displayed separately. The frequency sensitive tuner is accomplished with an octave-band circulator, a high pass filter, and a low pass filter.

ACCURACY CONSIDERATIONS

The accuracy of the load pull impedance measurement will be comparable to the accuracy of the 8409 Network Analyzer used in a manual mode at a single frequency. The largest source of error in the system will be due to the connection of the device under test to the "input" of the reflectometer test set. Any VSWR in the test fixture of the connection to the test set will cause an ambiguity that is difficult to calibrate out.

The accuracy of the load pull impedance system can be enhanced by automating the system in a fashion similar to the 8409A Network Analyzer. The same type of error models can be used and applied to the load pull system. There is one basic difference between the load pull system and the 8409A Network Analyzer that must be taken into account in the error models, however. This is the fact that during calibration on the load pull system the quantity measured is not  $(\Gamma)$  of the calibration standards but  $(1/\Gamma)$ . Once this is taken into account the error correction can be accomplished in the same fashion as it is on the 8409A used in a reflection coefficient measurement mode.

Another accuracy consideration that must be taken into account is the accuracy of the output power measurement. Ideally, there would be no loss between the output tuner and the output of the device under test. In this case, the insertion loss of the tuner will be  $[10 \log (1 - |\Gamma|^2)]$  where  $\Gamma$  is the reflection coefficient between the tuner and the device under test. In the actual case, there will be some finite loss between the tuner and the device under test. The insertion loss of the tuner will now be both a function of the finite loss and of the reflection coefficient between the device under test and the tuner. This insertion loss will be  $[1 - |\Gamma|^2 (10)^{L/5}]$ , where  $L$  is the loss in dB between the device under test and the tuner and  $\Gamma$  is the effective reflection coefficient between the device under test and the loss-tuner combination. This loss will lead to an error both in the output power measurement and in the load impedance measured if the output power is measured after the output tuner. The differential power measurement eliminates this source of error since it measures the actual power delivered to the load.

## LOAD PULL POWER MEASUREMENT ACCURACY

### IDEAL CASE

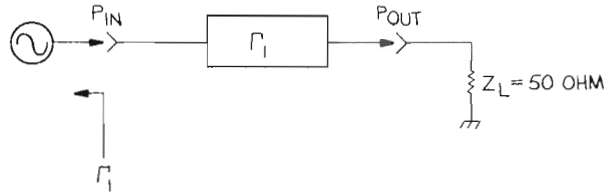

$$\text{INSERTION LOSS IN dB} = 10 \text{ LOG } (1 - |\Gamma_1|^2)$$

## LOAD PULL POWER MEASUREMENT ACCURACY

### ACTUAL CASE

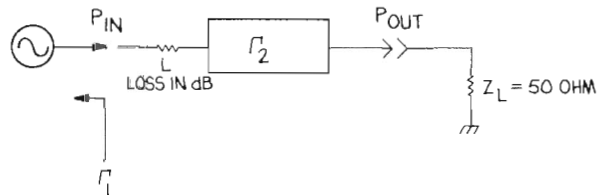

IN ORDER TO ACHIEVE SAME  $\Gamma_1$  AS BEFORE

$$\Gamma_2 = \Gamma_1 (10)^{L/10}$$

$$\text{INSERTION LOSS} = L + 10 \text{ LOG } (1 - |\Gamma_1|^2 [10^{L/5}])$$

THE INSERTION LOSS OF THE TUNER WILL BE A FUNCTION OF THE REFLECTION COEFFICIENT PRESENTED BY THE TUNER. FOR LARGE  $L$ , THERE WILL BE A SIGNIFICANT CONTRIBUTION OF INSERTION LOSS DUE TO THE REFLECTION COEFFICIENT OF THE TUNER.

## BIBLIOGRAPHY

1. CUSACK, J, ETAL "AUTOMATIC LOAD CONTOUR MAPPING FOR MICROWAVE POWER TRANSISTORS"  
IEEE MTT, #12, DEC 1974, PP. 1146 - 1152
2. TAKAYAMA, Y, "A NEW LOAD-PULL CHARACTERIZATION METHOD FOR MICROWAVE POWER TRANSISTORS"  
IEEE MTT- S DIGEST, PP. 218 - 220, JUNE, 1976
3. KELLY, W. M., ETAL "DESIGN OF LINEAR GAAS FET AMPLIFIERS ", CONFERENCE PROCEEDINGS OF THE 7TH EUROPEAN MICROWAVE CONFERENCE, PP 105-109, SEPT. 1977
4. STANCLIFF, R, POULIN, D, "HARMONIC LOAD PULL",  
IEEE MTT-S DIGEST P. 185, MAY 1979

