

Using The 675A/676A Network Analyzer As An Educational Tool

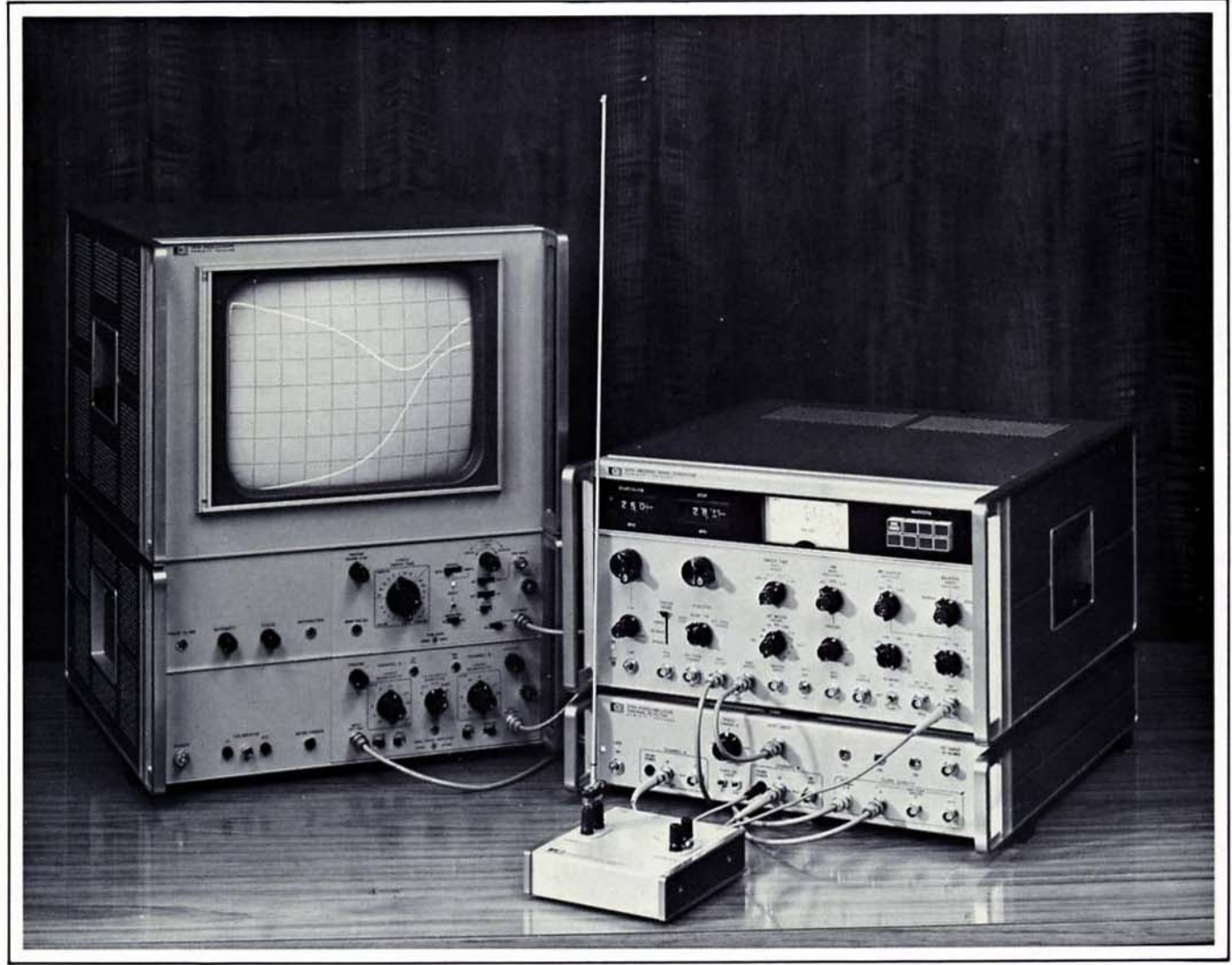

HEWLETT  PACKARD

USING THE 675A /676A NETWORK ANALYZER AS AN EDUCATIONAL TOOL

APPLICATION NOTE 112-2

**COPYRIGHT 1969
HEWLETT-PACKARD COMPANY
LOVELAND DIVISION
P.O. BOX 301
LOVELAND, COLORADO U.S.A.**

TABLE OF CONTENTS

INTRODUCTION	1
APPLICATIONS	1
Complex Impedances	1
Initial Setup and Calibration	1
Driving Point Impedance	2
Transmission Lines	4
Antennas	5
Complex Voltage Transfer Ratios	5
Initial Setup	5
Passive Networks	6
Active Circuit Response	10
Crystal Characterization	12
CONCLUSION	13
BIBLIOGRAPHY	14
APPENDIX	15
A Nichols Chart	15
B Calibration of the 675A/676A Network Analyzer	16

INTRODUCTION

This note is the second of a series which has to do with the use of the 675A/676A. The first contained general information such as calibration procedures, and dealt mainly with some of the basic insertion-loss measurements which the instrument is capable of making.

The frequency range (10 kHz to 32 MHz) of the 675A/676A makes it suitable for frequency and phase response measurements on circuits constructed of standard discrete components (resistors, capacitors, transistors, etc.). The 11138A Impedance Adapter also makes complex impedance measurements possible. Both type measurements, transfer and driving point, can be displayed on a frequency swept basis on a standard oscilloscope. Since this

inherently demonstrative measuring system is also relatively inexpensive, its application as a teaching aid seems particularly attractive.

Much of the subject material encountered in electrical engineering courses and electronic technician courses has to do with the frequency behavior of electrical networks. This note will attempt to demonstrate some of the interesting network responses which might prove useful in the classroom. These should in turn trigger many other possible demonstration ideas in the mind of imaginative instructors.

It is sincerely hoped that the 675A/676A and this note will become a valuable complement to the many excellent electrical engineering texts now in use.

APPLICATIONS

COMPLEX IMPEDANCES

Initial Setup and Calibration

The first step in calibrating the 675A/676A for impedance measurements is to perform the calibration procedure for insertion loss measurements described in Appendix B. After this is completed, connect the HP 11138A Impedance Adapter as shown in Figure 1. This establishes the equivalent circuit shown in fig. 2 for each measurement channel.

In the circuit of Figure 2, virtually all the current, I , flows in the unknown impedance. The resulting voltage drop is proportional to the impedance. Since the same current source is used to drive both channels, any phase shift across an unknown impedance in one channel will appear as a difference in phase compared to the phase shift in the other channel. Hence, the need for two identical channels, one containing an impedance having a known phase shift.

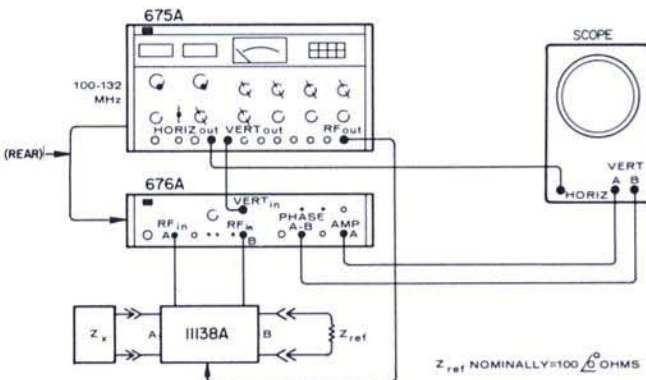
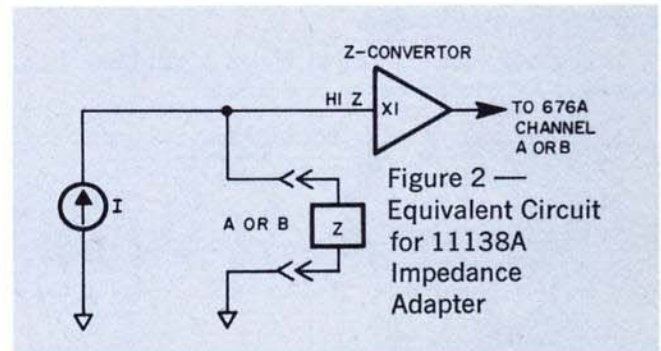

Figure 1 — Setup for Measuring Complex Impedance



After connecting the 675A/676A and 11138A as shown in Figure 1, connect a 100 Ω non-reactive resistor into each channel of the 11138A. This will result in two traces on the oscilloscope, one equivalent to 100 Ω and the other equivalent to 0 $^\circ$. Use the vertical controls of the scope and/or the PHASE CHANNEL A control of the 676A to adjust the position of these traces to some convenient reference line on the scope graticule.

The 11138A is designed to measure impedance magnitudes from 0.3 Ω to 3000 Ω . These magnitudes will be displayed on the oscilloscope as decibels above or below a reference value (100 Ω in the present case). The angle will be in degrees, positive or negative with respect to the 0 $^\circ$ phase reference established. With the vertical sensitivity controls of the oscilloscope set to 0.5 V/cm, the scale factors will be 10 dB/div for magnitude and 50 $^\circ$ /cm for phase. For more sensitive scale factors or for A/B ratio measurements, use with A-B AMPLITUDE SCOPE OUTPUT instead of the A AMPLITUDE SCOPE OUTPUT. A convenient impedance layover is provided as an Appendix to this note, cut it out and affix to the face of the scope for direct readings in ohms.

Driving Point Impedance

When the Network Analyzer is arranged as previously described, it may easily be used to demonstrate the relationship between a transformed impedance function and the measured impedance of a network realized from that function. In general the driving point impedance of Linear, Lumped, Finite, Passive, Bilateral (LLFPB) networks is represented by the transform function

$$Z(s) = \frac{p(s)}{q(s)} = \frac{a_0 s^n + a_1 s^{n-1} + \dots + a_{n-1} s + a_n}{b_0 s^m + b_1 s^{m-1} + \dots + b_{m-1} s + b_m} \quad (1)$$

which can be factored to

$$Z(s) = \frac{p(s)}{q(s)} = \frac{a_0(s + z_1)(s + z_2) \dots (s + z_n)}{b_0(s + p_1)(s + p_2) \dots (s + p_m)} \quad (2)$$

Equation (2) can immediately be plotted in the s-plane as various pole-zero locations

Evaluating equation (2) or Figure 3 will result in a magnitude and phase function of the form

$$Z(s) = \frac{p(s)}{q(s)} = \frac{a_0}{b_0} \frac{M_1 M_2 M_3 \dots}{m_1 m_2 m_3 \dots} \frac{\dots M_n}{\dots m_m} e^{j(\theta_1 + \dots \theta_n - \phi_1 - \dots \phi_m)} \quad (3)$$

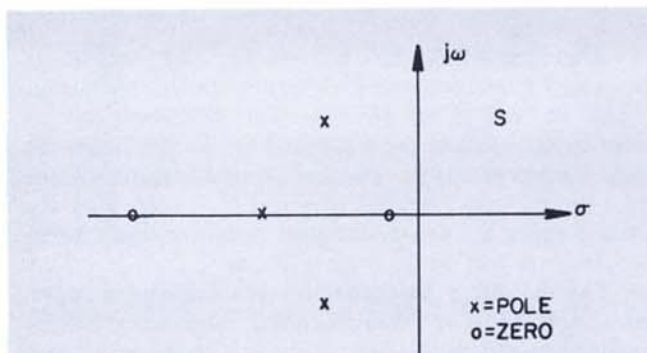

Figure 3 — S-Plane Plot of Impedance Function

Using synthesis techniques a function of the form of equation (2) can be made to yield a network design consisting of resistors, capacitors, and inductors of appropriate values. If this network is actually constructed and its terminals attached to the 11138A Impedance Adapter, its magnitude and phase will be displayed on the oscilloscope as a function of frequency. This plot should correspond closely to a plot of equation (3) if it were evaluated for frequencies for which the realized network has significant response.

An elemental example of Driving Point Impedance might be a basic electrical element such as a capacitor. Equation (2) for this simple case becomes

$$Z(s) = \frac{1}{C_s} \quad (4)$$

where $\frac{a_0}{b_0} = \frac{1}{C}$ $p(s) = 1$, and $q(s) = s$

converting equation (4) to polar form yields

$$Z(j\omega) = \frac{1}{j\omega C} = \frac{1}{\omega C} \angle -90^\circ \quad (5)$$

Similarly evaluating an s-plane plot (a pole at the origin) of equation (4) will produce a value

$$\frac{1}{C} \cdot \frac{1}{\omega} \angle -90^\circ \text{ for each } \omega \text{ evaluated.}$$

If a 1000 pF capacitor is connected to the 11138A Impedance Adapter a frequency dependent display like that of Figure 4 will result, on the associated oscilloscope.

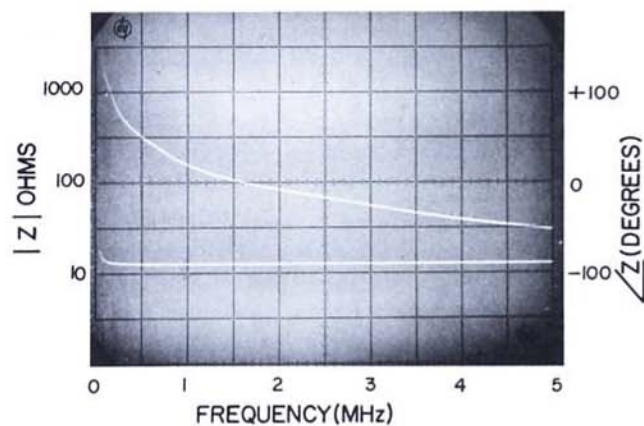

Figure 4 — Driving Point Impedance of a Capacitor

Similar results could be obtained using an inductor or an RC or RL combination.

More interesting results are obtained using a more complex function, for example:

$$Z(s) = \frac{p(s)}{q(s)} = k_1 \frac{s}{s^2 + 2\alpha s + \alpha^2 + \omega_1^2} \quad (6)$$

Equation (6) is a form of equation (1) where

$$k_1 = a_0, \quad n = 1, \quad m = 2, \quad b_0 = 1, \quad b_1 = 2\alpha, \quad \text{and } b_m = \alpha^2 + \omega_1^2$$

This function can be factored to produce

$$Z(s) = \frac{p(s)}{q(s)} = k_1 \frac{s}{(s + \alpha + j\omega_1)(s + \alpha - j\omega_1)} \quad (7)$$

which can be represented in the s-plane as shown in Figure 5.

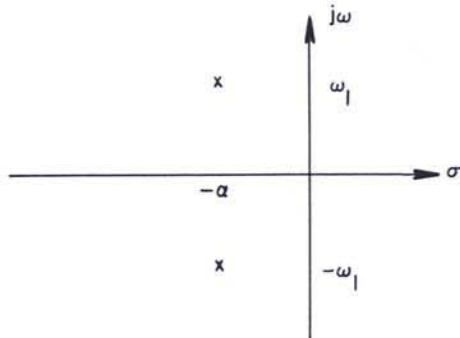

Figure 5 — S-Plane Plot of Equation (7)

One network which may be synthesized from equation (7) is shown in Figure 6.

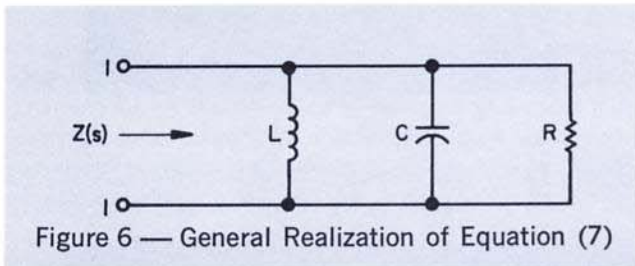

Figure 6 — General Realization of Equation (7)

The driving point impedance of the circuit of Figure 6 is given by:

$$Z(s) = \frac{1}{C} \frac{s}{s^2 + \frac{1}{RC}s + \frac{1}{LC}} \quad (8)$$

Comparing equation (8) to equation (6) it is seen that,

$$2\alpha = \frac{1}{RC} \quad \text{and} \quad \alpha^2 + \omega_1^2 = \frac{1}{LC} \quad k_1 = \frac{1}{C}$$

An evaluation of equation (6) when, written as a function of $j\omega$ or of Figure 5 for all values along the $j\omega$ axis will result in a magnitude function starting at some small value for $\omega = 0$, and increasing to a peak for $\omega = \frac{1}{\sqrt{LC}}$, then decreasing beyond. Furthermore the peak value will equal the value of R at $\omega = \frac{1}{\sqrt{LC}}$. Evaluating the phase in a similar manner will result in a phase function starting at $+90^\circ$ for $\omega = 0$, passing through 0° for

$\omega = \frac{1}{\sqrt{LC}}$, and approaching -90° for higher frequencies.

The effect of various resistance values will cause the rate of transition from $+90^\circ$ to -90° to change.

If the circuit of Figure 6 is constructed using:

- L = 10 μH
- C = 1000 pF
- R = 316, 1000, and 10 kΩ

and this network is connected to the Impedance Adapter a trace similar to that of Figure 7 will result.

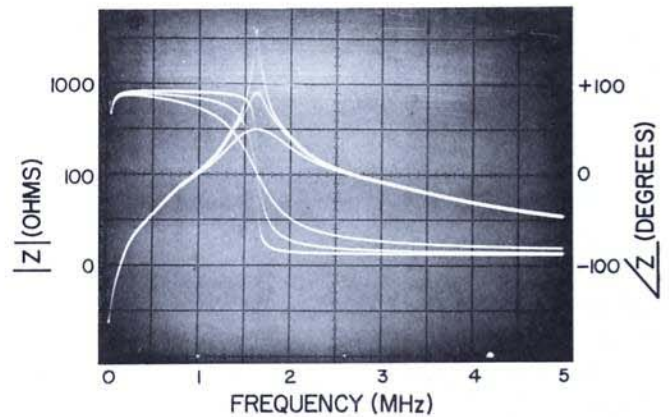

Figure 7 — Driving Point Impedance of RLC Circuit

Since 10 kohms exceeds the dynamic range of The Network Analyzer, the response of the network corresponding to $R = 10 \text{ k}$ in Figure 7, does not reach the required 40 dB above 100 ohms.

A special, but important, case of driving point impedance exists when equation (1) can be factored to produce an impedance function of the following form.

$$Z(s) = K_1 s^\sigma \frac{(s^2 + z_1^2)(s^2 + z_2^2) \dots (s^2 + z_n^2)}{(s^2 + p_1^2)(s^2 + p_2^2) \dots (s^2 + p_m^2)} \quad (9)$$

where $\sigma = 1, 0, -1$ K_1 is a constant; and n and m are integers.

In particular $\sigma = 1$ and $n = m = 2$, equation (9) becomes:

$$Z(s) = K_1 s \frac{(s^2 + z_1^2)(s^2 + z_2^2)}{(s^2 + p_1^2)(s^2 + p_2^2)} \quad (10)$$

The poles and zeros of equation (10) lie along the $j\omega$ axis of the s-plane as shown in Figure 8, the $-j\omega$ axis has been deleted.

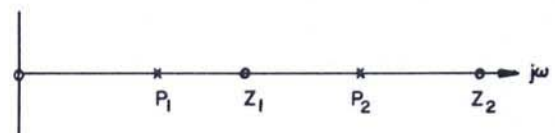

Figure 8 — S-Plane Representation of Equation (10)

If 5, 10, 12, and 17 MHz are chosen as the values for $p_1, z_1, p_2,$ and z_2 respectively, equation (19) can be realized in the "First Cauer" form shown in Figure 9

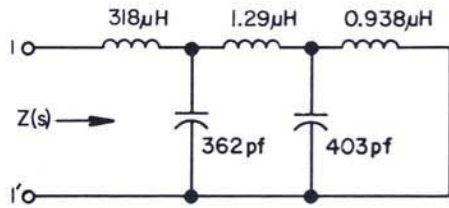

Figure 9 — First Cauer Realization of Equation (10)

When the circuit of Figure 9 is connected to the terminals of the 11138A Impedance Adapter, the magnitude and phase of the driving point impedance, $Z(s)$, will be observed on the associated oscilloscope and will appear as shown in Figure 10.

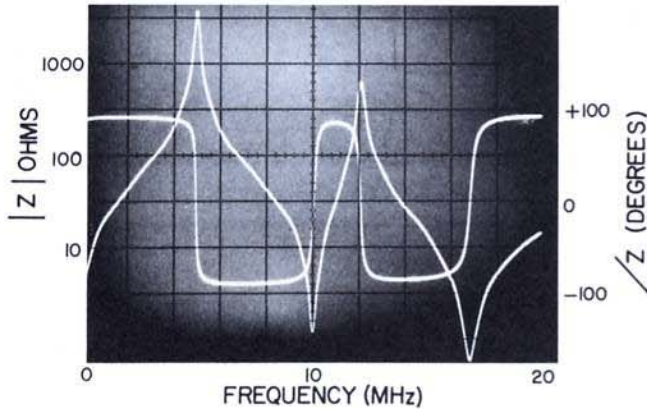

Figure 10 — Impedance of Cauer Network

Figure 10 illustrates the relationship between the measured driving-point impedance of the network, and the corresponding s-plane plot of the rational function defining the network.

Transmission Lines

The general expression describing a transmission line's input impedance is

$$Z = \frac{Z_r + Z_0 \tanh \gamma d}{Z_0 + Z_r \tanh \gamma d} Z_0 \quad (11)$$

where: Z_r = the terminating or receiving end impedance.

$\gamma = \sqrt{(R + j\omega L)(G + j\omega C)}$, the propagation constant

d = distance from sending end to receiving end of line

Z_0 = characteristic impedance of the line.

The propagation constant, γ , is determined by the series resistance and inductance, and the shunt conductance and capacitance which are distributed along the line. For a lossless line

$$\gamma = j\omega \sqrt{LC} \quad (12)$$

When a transmission line is terminated in its characteristic impedance equation (11) becomes

$$Z = Z_0 \quad (13)$$

If a 50 foot length of transmission line, say RG - 58/U coaxial cable, is attached to the Impedance Adapter and is terminated in its characteristic impedance (50 ohms) an impedance measurement such as that depicted in Figure 11 will be presented on the associated oscilloscope.

For convenience 50 ohms has been established as a reference in the same way that 100 ohms was established for previous examples. The figure shows that the line is not precisely terminated since slight deviations from 50 ohms and zero degrees appear over the frequency band being swept.

When the termination of the line is a short circuit equation (11) becomes

$$Z = Z_0 \tanh \gamma d \quad (14)$$

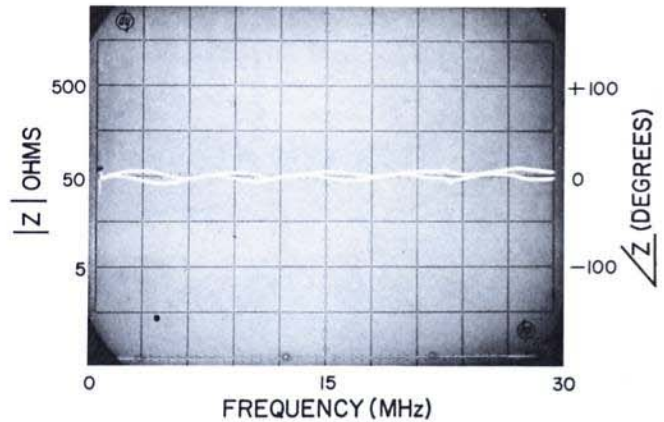

Figure 11 — Impedance of Transmission Line Terminated in its Characteristic Impedance

For the lossless line:

$$Z = jZ_0 \tan \omega \sqrt{LC} d \quad (15)$$

$$\left. \begin{aligned} |Z| &= Z_0 \tan \omega \sqrt{LC} d \\ \angle Z &= \pm 90^\circ \end{aligned} \right\} \quad (16)$$

Figure 12 shows how the line goes through resonance (assumes its characteristic impedance) when $\omega \sqrt{LC} d$

equals $\frac{\pi}{4}(2n - 1)$, where n is a real integer not equal to zero. Likewise, the line alternately approaches zero and infinity when $\omega \sqrt{LC} d$ equals $\frac{\pi}{4} 2n = \frac{\pi n}{2}$. The fact that zero

and infinite impedance is not reached reflects not only the limit of the dynamic range of the 675A/676A, but also the true character of the line. That is, it is not really lossless. This is made more evident by the decreasing amplitude of the impedance peaks as frequency is increased, and by the rounding off of the phase component of the impedance.

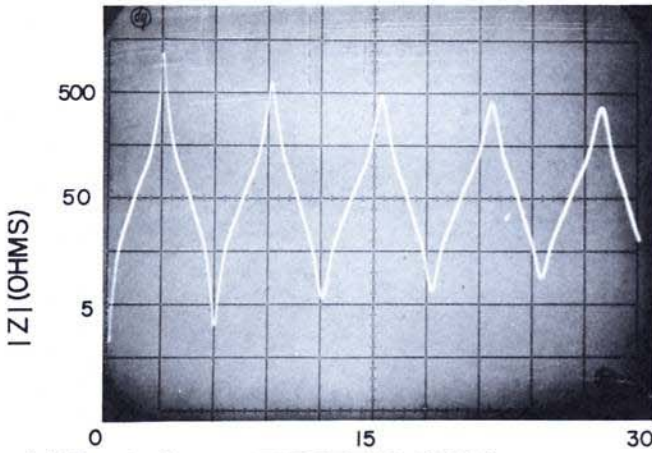

(a) Magnitude FREQUENCY (MHz)

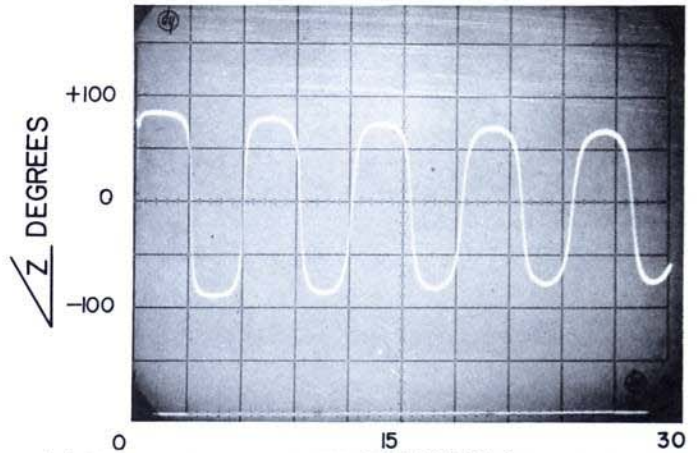

(b) Phase FREQUENCY (MHz)

Figure 12 — Impedance of a Shorted Transmission Line

Antennas

Antennas cannot be easily characterized with simple formulas; however, their driving-point or terminal impedance is easily measured and displayed with the 675A/676A. Figure 13 represents the impedance of a base-loaded antenna.

The figure shows how the antenna's impedance resembles that of a series LC circuit over the restricted frequency range shown. The impedance has zero phase and is therefore purely resistive at a frequency determined by the setting of the loading inductance.

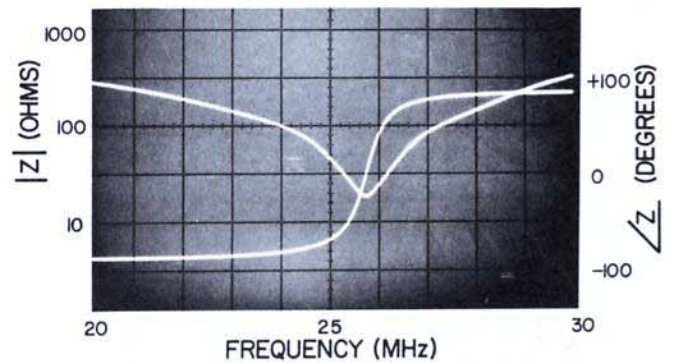

Figure 13 — Antenna Impedance

COMPLEX VOLTAGE TRANSFER RATIOS

Initial Set-up

To make voltage transfer measurements or insertion loss demonstrations, the 11138A Impedance Adapter should be disconnected from the 675A/676A Network Analyzer and the RF OUT terminal of 675A connected to the RF IN terminal of the 676A, all other connections are as shown in Figure 1. With a short length of cable connected between the RF OUT and RF IN terminals of CHANNEL A and CHANNEL B of the 676A Tracking Detector, the Network Analyzer is ready to make insertion loss measurements. Scale factor calibration should be checked according to the procedures outlined in APPENDIX B. When these equipment arrangements are made, two traces will appear on the associated oscilloscope; one represents 0 dB gain/loss, the other 0 degrees phase shift; either or both traces may be adjusted to some convenient reference point on the oscilloscope by adjusting the vertical position controls. In addition the phase trace may be shifted by rotating the CHANNEL

A PHASE control. This control is not a calibrated control and is provided to shift the phase reference point for more convenient viewing of the phase response of the network or circuit being tested. Insertion Loss/Gain tests are performed by connecting the network to be tested into either channel in place of the short calibration cables. If gain is to be measured the Output Attenuators of the 675A Sweeping Signal Generator should be set to a level (in dB below the +10 dB position) as least equal to the expected gain of the device under test; in general the signal levels should be such that saturation of either the device under test or the 676A input circuits is avoided.

For transfer measurements a high impedance load is usually required to measure the output of a network and a constant voltage source is required to drive its input. This condition is approximated by the equipment arrangements shown in Figure 14.

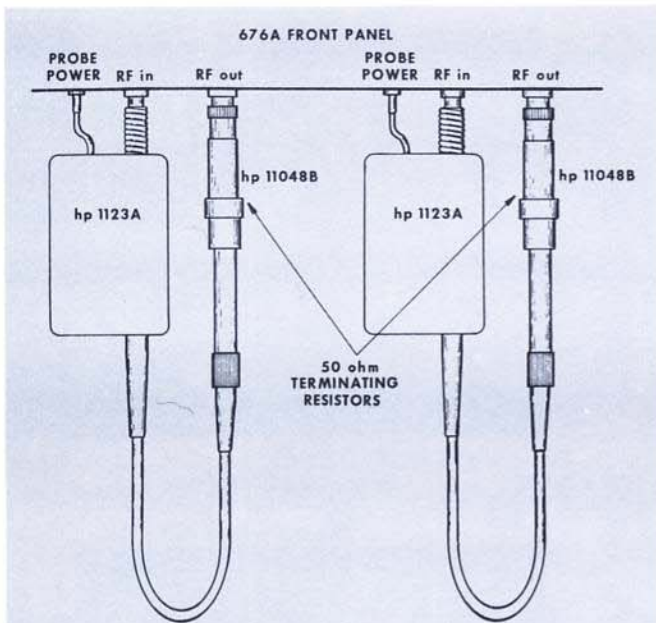

Figure 14 — High Impedance Probe Connections

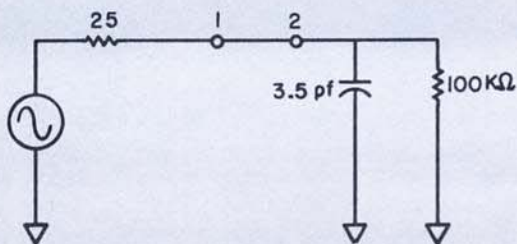

Figure 15 — Equivalent Network Analyzer Circuit when High Impedance Probe is Used

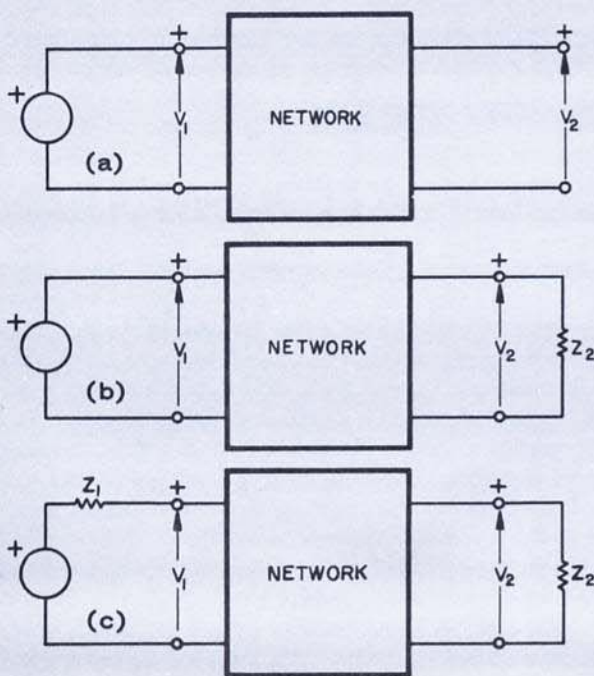

Figure 16 — Principle Circuit Arrangements

When the equipment arrangements of Figure 14 are adopted the equivalent circuit, shown in Figure 15, exists in each channel.

Now a two port network, inserted between points 1 and 2 in the circuit of Figure 15 will be terminated in a high impedance and driven from a low impedance source and the conditions for transfer voltage ratio measurement are approximated. Although two probes are shown in Figure 14, one may be used if the other is replaced with a 4 foot length of 50 ohm coaxial cable. This will equalize the phase difference between channels so that any phase shift measured will be due only to the device under test. To measure the voltage transfer ratio of a network (active or passive) simply connect its input to the 50 ohm terminating resistor (after disconnecting the probe) and its output to the probe. Since the probe has unity voltage gain, calibration and reference level settings are made in the same manner as for the insertion loss set-up and should not need changing when changing from one to the other.

In either insertion loss or transfer measurements the results are available in the form of a DC analog of the response at the four SCOPE OUTPUT terminals of the 676A. The AMPLITUDE A and AMPLITUDE B outputs represent gain or loss scaled to 50 mV/dB while the A-B PHASE output is proportional to the phase shift between the two channels (across the device under test if phase shift between channels is equalized) scaled at 10 mV/degree. The AMPLITUDE A-B is representative of the difference, in dB, between the loss/gain in channel A to that in channel B. This is in reality equal to log A/B expressed in dB. The A-B output is most useful when the normal 10 dB/cm scale must be expanded, since the input to the oscilloscope must be dc coupled an increase in sensitivity will usually move the trace off scale; however, the A-B output, being a differential quantity causes the trace to remain on the scope when high vertical sensitivities are used.

Passive Networks

Three general types of network arrangements are of interest to the student of network analysis. These are illustrated in Figure 16.

A knowledge of the voltage transfer ratio of these circuits is desirable and is often expressed as:

$$G_{12}(s) = \frac{V_2(s)}{V_1(s)} \quad (17)$$

In the case of networks terminated in an open circuit, as in Figure (16a), this voltage transfer ratio is equal to

$$G_{12}(s) = \frac{-y_{12}}{y_{22}} = \frac{z_{12}}{z_{11}} \quad (18)$$

Where y_{12} and y_{22} are the short circuit admittance parameters for the network and z_{21} and z_{11} are the open circuit impedance parameters. The parameters z_{11} and y_{22} are driving point functions and therefore can be expressed in the

form of equation (2); the parameters y_{21} and z_{21} are transfer functions and may or may not have the form of equation (2) as a result, $G_{12}(s)$ can be represented in the s-plane exactly like a driving point function except that zeros (of transmission) may exist in the right half plane. As in the driving point case, the transfer or transmission response can be evaluated by evaluating the function $G_{12}(j\omega)$ for all ω or by evaluating the s-plane plot of $G_{12}(s)$ for all values along the positive $j\omega$ axis. An actual evaluation of networks synthesized from functions of the form of equation (18) can be made using the 675A/676A Network Analyzer and the 1123A High impedance probe, a frequency dependent plot of $G_{12}(j\omega)$ will be presented as two traces on the associated oscilloscope, one representing amplitude response, the other phase response.

If the simple network pictured in Figure 17 is analyzed, expressions for $-y_{12}$, y_{22} , and $G_{12}(s)$ can be obtained

$$-y_{12} = \frac{1}{R} \quad 19(a)$$

$$y_{22} = sC + \frac{1}{R} \quad 19(b)$$

$$G_{12}(s) = \frac{-y_{12}}{y_{22}} = \frac{1/RC}{s + 1/RC} \quad (20)$$

An s-plane plot of equation (20) is shown in Figure 18

The s-plane plot of $G_{12}(s)$ may be evaluated for values along the $j\omega$ axis or $G_{12}(j\omega)$ can be evaluated for frequencies for which the circuit of Figure 18 has significant response. In either case a frequency dependent plot of the evaluation will indicate a constant value of amplitude for frequencies much less than $1/2 RC$ with a gradual decrease to -3 dB at $f_0 = 1/2 \pi RC$; beyond f_0 , the amplitude response rolls off at -6 dB/octave. The phase response will start at zero degrees and pass through -45° at f_0 ultimately reaching -90° .

If the network of Figure 17 is constructed using $C = 1000$ pF, and $R = 532, 319, 228$ ohms (including the 50 ohms of the source it will be connected to) and then connected to a Network Analyzer Channel, so that terminals 1-1' are driven and terminals 2-2' are terminated by the High Impedance Probe, a series of traces, similar to those shown in Figure 19, will be displayed on the oscilloscope as the resistor value is changed.

Figure 19 shows that the expected 3 dB attenuation occurs at $f_0 = 1/2 \pi RC$ for the three values of resistance, it also shows that 45° of phase shift has occurred at those frequencies. The -6 dB/octave roll off is not seen because of the amplitude and frequency scales used.

The voltage transfer ratio for circuits like those illustrated in Figure 16 (b) is:

$$G_{12}(s) = \frac{-y_{12}}{y_{22} + Y_2} \quad (21)$$

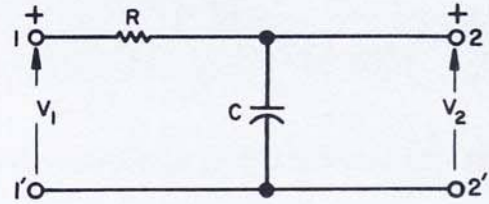

Figure 17 — RC Two Port Circuit

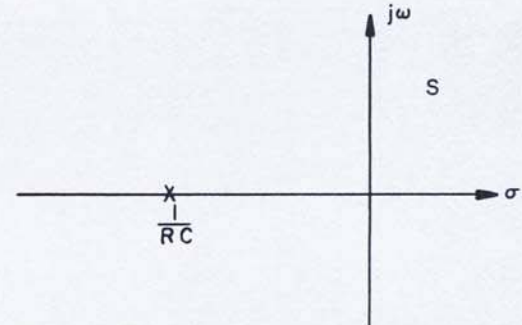

Figure 18 — S-Plane Plot of RC Network

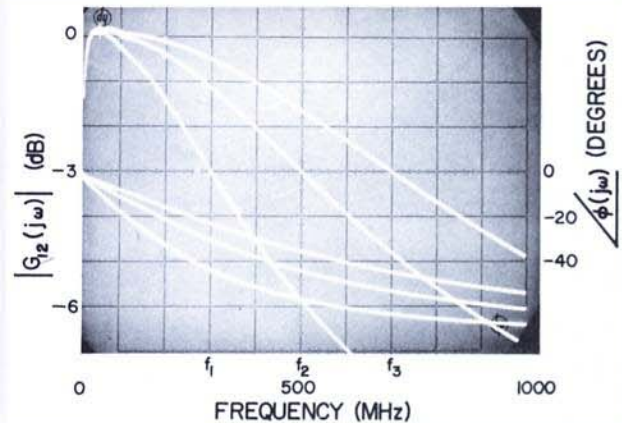

Figure 19 — Network Analyzer Analysis of RC Circuit

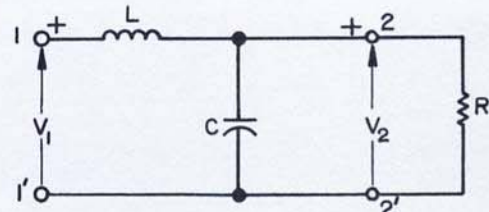

Figure 20 — Terminated LC Circuit

A network whose voltage transfer ratio can be described by equation (21) is shown in Figure 20.

If the network pictured in Figure 20 is analyzed expressions for y_{12} , y_{22} , and $G_{12}(s)$ can be obtained.

Analysis of this circuit yields the following

$$-y_{12} = \frac{1}{sL} \quad (22a)$$

$$y_{22} = sC + \frac{1}{sL} \quad (22b)$$

$$Y_T = \frac{1}{R} \quad (22c)$$

$$G_{12}(s) = \frac{-y_{12}}{y_{22} + Y_T} = \frac{1/LC}{s^2 + \frac{1}{RC}s + \frac{1}{LC}} \quad (23)$$

Equation (23) can be expressed as

$$G_{12}(s) = \frac{K_1}{(s + \alpha + j\beta)(s + \alpha - j\beta)}$$

where

$$K_1 = \frac{1}{LC}, \quad \alpha = \frac{1}{2RC}, \quad \beta = \sqrt{\frac{1}{LC} - \frac{1}{4R^2C}}$$

An s-plane plot of equation (24) is shown in Figure 21

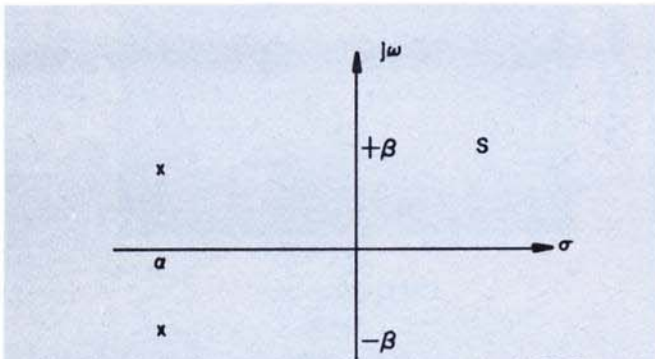

Figure 21 — S-Plane Plot of Terminated LC Circuit

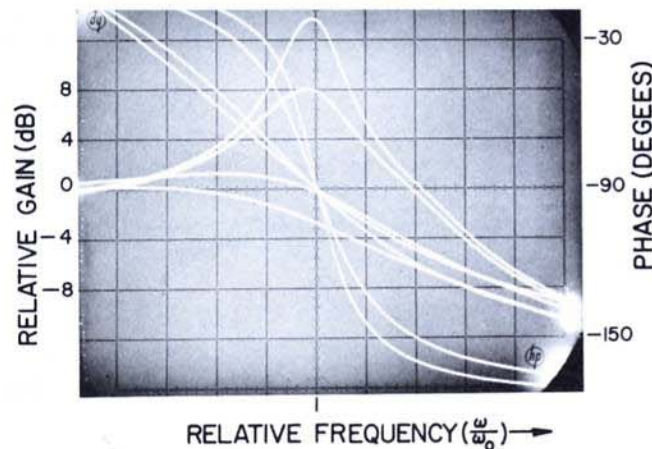

Figure 22 — Response of Terminated LC Circuit

Again $G_{12}(j\omega)$ could be evaluated or the s-plane plot could be evaluated to obtain frequency dependent plots of the phase and gain response of the circuit of Figure 20. If this were done the amplitude response would be seen to rise

from a reference level to a peak at $f_0 = \frac{1}{2\pi\sqrt{LC}}$, the magni-

tude of this peak is dependent on R if the L and C are held constant, specifically

$$|G_{12}(f_0)| = \frac{R/2\pi\sqrt{C}}{L} \quad (25)$$

or

$$|G_{12}(f_0)|_{dB} = 20 \log [R/2\pi\sqrt{C/L}] \quad (26)$$

which is dB above the reference level. After peaking the amplitude response would be seen to roll off at the rate of -12 dB/octave. The phase would start at +90° and shift to zero degrees at f_0 , then continue to -90° at a frequency well beyond f_0 . The rate at which this 180 degrees of phase shift occurs is determined by R.

A circuit such as that depicted in Figure 20 can be constructed so that $L = 10\mu\text{H}$ and $C = 2000 \text{ pF}$. R is made variable so that its effect on circuit response can be seen. When this circuit is connected to the Network Analyzer and swept for a number of values of R the traces shown in Figure 22 will be observed on the oscilloscope.

Figure 22 illustrates the expected response for this circuit in the vicinity of the normalized frequency $\omega/\omega_0 = 1$. The effect of various values of R on phase and gain response is shown.

The circuit arrangement of Figure 16 (c) describes the measurement configuration of the 675A/676A Network Analyzer, when the High Impedance Probe is not used, and in which

$$Z_1 = Z_2 = 50 \text{ ohms} \quad (27)$$

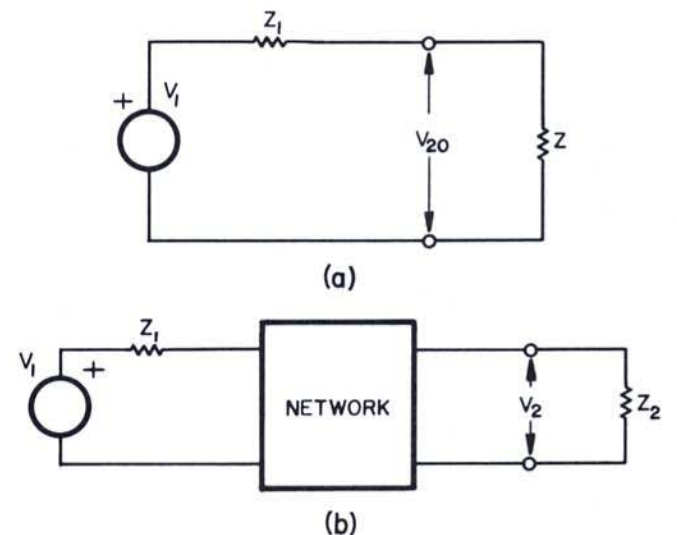

Figure 23 — Insertion Loss/Gain Equivalent Circuit

This circuit arrangement is also frequently found in commercial equipment such as communications filtering circuits. This particular class of circuit is important because of its wide practical use; it is widely used because by specifying $Z_1 = Z_2 = R_o$ throughout an industry, a wide variety of networks providing specified responses can be designed to be inserted into circuits or systems having the standard impedance level. When connected to the Network Analyzer a network interacts with the Analyzer's generator and terminating resistances to produce a particular phase and amplitude response which is identical to the network's response in some other system having the same impedance level. This response relative to a known response (short piece of lossless cable), is measured in dB and is referred to as insertion loss or insertion gain.

Referring to Figure 23, the insertion loss is given by

$$T_{12}(j\omega) = \frac{V_2}{V_{20}} \quad (28)$$

This can be expanded to

$$T_{12}(j\omega) = \frac{V_2}{V_1} \frac{V_1}{V_{20}} = \frac{V_1}{V_{20}} G_{12}(j\omega) \quad (29)$$

if $Z_1 = Z_2 = R_o$, $V_{20} = V_1/2$

and $|T_{12}(j\omega)| = 2 |G_{12}(j\omega)| \quad (30)$

The constant in equation (30) arises from the fact that the reference circuit, actually a resistive divider, has been normalized to produce a 0 dB output.

To demonstrate the importance of the double terminated circuit's terminating resistors consider the circuits of Figure 24. Figure 24 shows that the section of the terminating resistors can, within limits determine the overall response of the network. Conversely when the resistor value is fixed as in a standard impedance system the other network element values can be chosen with, respect to the impedance level, to produce a desired response. An example of this is the circuit of Figure 25.

CIRCUIT	$G_{12}(S) = \frac{V_2(S)}{V_1(S)}$	S-PLANE PLOT
	$\frac{K_1}{S^2 + \omega_0^2}$ (a)	
	$\frac{K_2}{S^2 + 2\alpha S + \alpha^2 + \beta^2}$ (b)	
	$\frac{K_3}{(S + \sigma)(S^2 + 2\alpha S + \alpha^2 + \beta^2)}$	

Figure 24 — Effect of Terminating Resistors on Circuit Response

The component values of the circuit of Figure 25 have been selected to produce a characteristic Chebychev response when placed in a 50 ohm system. The specifications for this network were

- Passband Ripple - 3 dB
- Cutoff Frequency - 5 MHz
- Number of Poles - 5

In addition a small trimmer capacitor was placed across one of the inductors to produce a zero of transmission at a point in the stop band. When this network is connected to the Network Analyzer a trace such as that shown in Figure 26 results

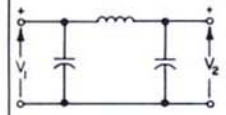
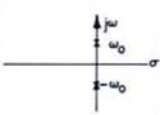
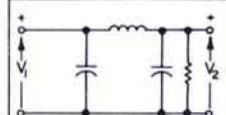
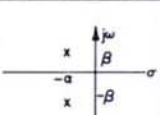
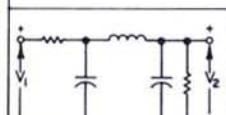
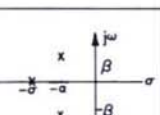
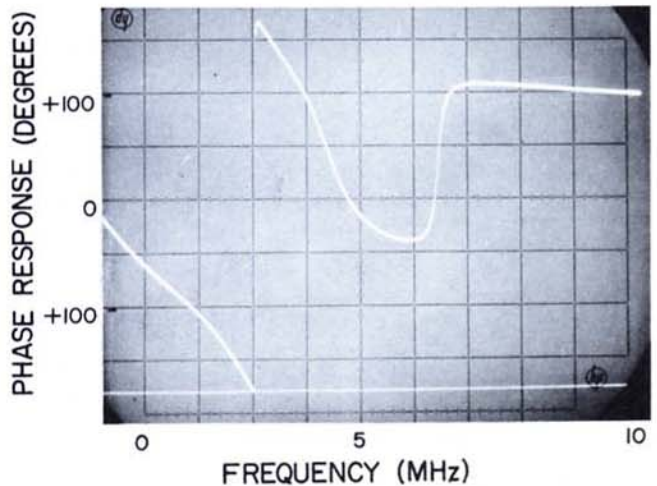
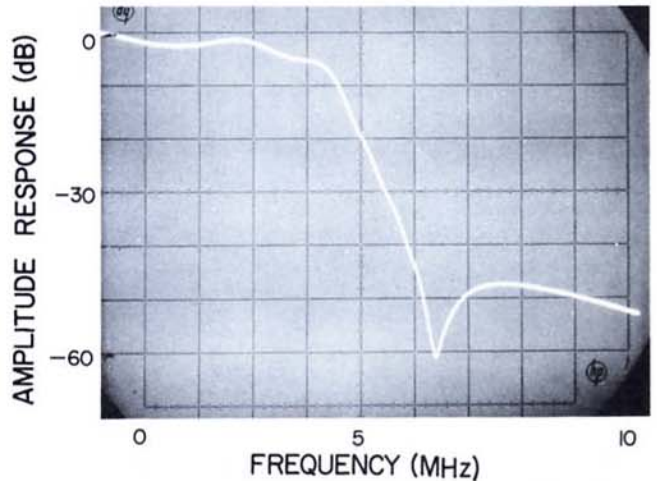
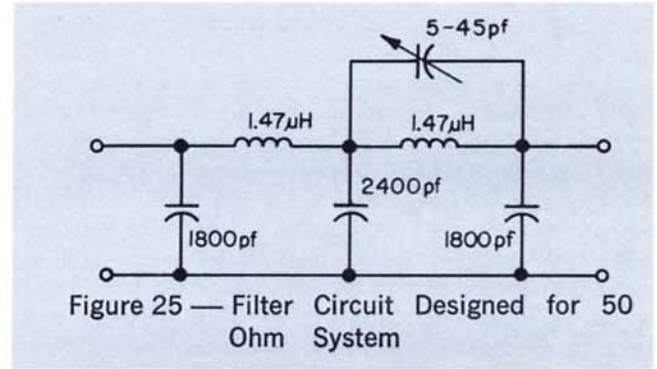

Figure 26 — Low-pass Filter Response

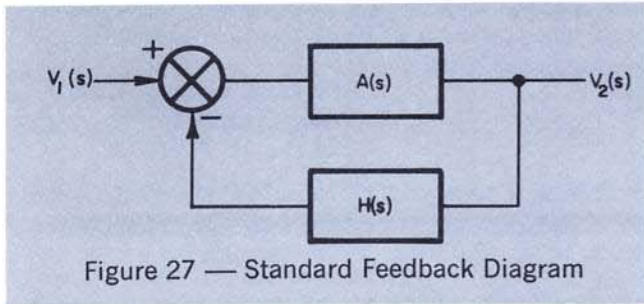

Figure 27 — Standard Feedback Diagram

The Figure shows that the specifications have not been met; however the overall behavior of the circuit is certainly representative of an all pole function. The 180 degrees of phase shift corresponding to the zero of transmission is clearly represented. Apparently this zero is also affecting the pass band response causing the specifications to be missed. This assumption is reinforced by noting that the 450° of phase shift expected in a 5-pole network has not been attained. So the added trap has moved the required poles from their specified position. If this were critical to the design the designer could easily move the position of the offending zero by turning the trimmer capacitor and observing the results as displayed on the oscilloscope.

Active Circuit Response

The response of active circuits is just as important and frequently more interesting than that of passive circuits. Most of the restraints associated with passive circuits (positive realness, etc.) are gone when dealing with active circuits and as a result instability is often a problem. Instability or the threat of it are usually encountered when feedback system design is being performed. Of course many active devices without intentional feedback may be affected by some form of accidental feedback. The standard feedback circuit representation is shown in Figure 27. The response of the feedback system, is given by

$$G_{12}(s) = \frac{A(s)}{1 + H(s) A(s)} \quad (31)$$

if:

$$A(s) = \frac{N_1}{D_1} \quad (32)$$

$$H(s) = \frac{N_2}{D_2} \quad (33)$$

Equation (31) may be expressed as

$$G_{12}(s) = \frac{N_1 D_2}{D_1 D_2 + N_1 N_2} \quad (34)$$

An important class of feedback circuit uses a simple resistive network in the feedback circuit so that

$$H(s) = \frac{N_2}{D_2} = K_1 \quad (35)$$

Similarly many amplifier circuits are of the all pole variety so that

$$N_1 = K_2 \quad (36)$$

When this is the case

$$G_{12}(s) = \frac{K_2}{D_1 + K_1 K_2} \quad (37)$$

A typical case occurs when

$$D_1 = s^2 + 2\alpha s + \alpha^2 + \beta^2 \quad (38)$$

and

$$G_{12}(s) = \frac{K_2}{s^2 + 2\alpha s + \alpha^2 + \beta^2 + K_1 K_2} \quad (39)$$

Equation (39) indicates that the closed loop response of the system it describes will be dependent on K_1 the feedback circuit transfer ratio. When K_1 is very small there is almost no feedback and the circuit response is essentially the same as that of the open loop network. As K_1 increases in value, the overall gain of the circuit decreases and instability begins to appear in the form of peaking. Figure 28 shows the gain and phase response of a circuit similar to that of Figure 27. This network was connected to the Network Analyzer which was adjusted to provide a 10 MHz sweep while the associated dual trace scope was adjusted for the sensitivity necessary to produce the indicated scale factors. The open loop gain of the amplifier was approximately 40 dB. The feedback network was adjusted so that K_1 was equal to -10 dB producing the 10 dB of gain shown. The phase shift (90° at -6 dB) indicates that the system is a two pole type. An increase in the feedback (less attenuation) produces marked peaking. Since this type circuit characteristically exhibits high input impedance and low output impedance, the 50 ohm source of the Network Analyzer RF OUT reasonably approaches being a constant voltage source while the 50 ohm termination of the RF IN terminal does not seriously load the output of the circuit. The High Impedance Probe can be used in the event that 50 ohms loads the output of the circuit under test.

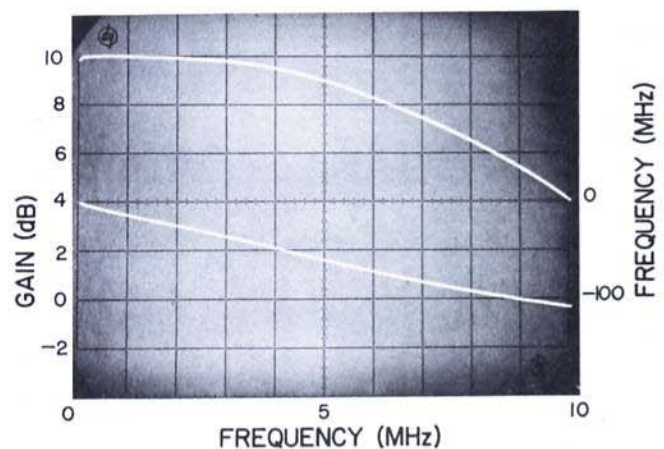

Figure 28 — Feedback Amplifier Response

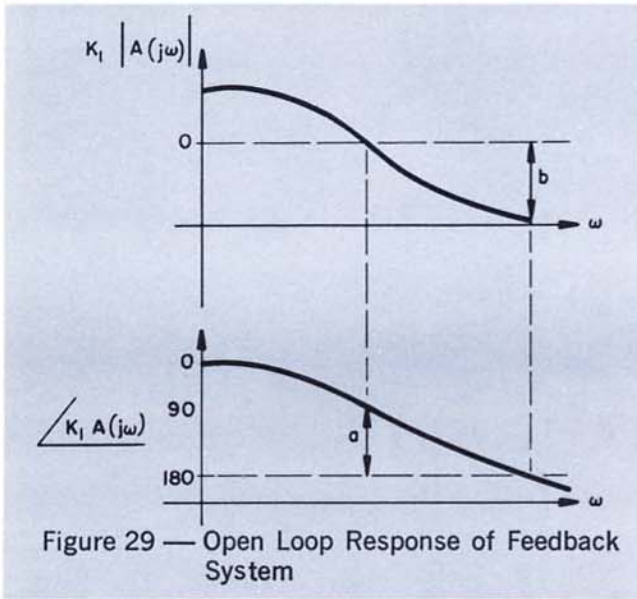

Figure 29 — Open Loop Response of Feedback System

Much can be learned from an examination of the denominator of equation (31). For example if $H(s)A(s)$ or more particularly $K_1A(j\omega)$ is evaluated over a frequency range for which the circuit described by

$$G_{12}(j\omega) = K_1 A(j\omega) \quad (40)$$

has significant response a gain and phase vs frequency response will result which has the general form shown in Figure 29. An examination of Figure 29 indicates a "phase margin" (a) which should be adequate to avoid instability when the loop is closed, it also shows the "gain margin" (b) but little else is readily apparent about the closed loop operation of the circuit. Closed loop performance can be predicted if the data contained in Figure 29 is transferred point-by-point to Nichol's Chart. A typical Nichol's Chart is pictured in Figure 30. The vertical axis of the chart represents open loop log magnitude while the horizontal axis represents open loop phase shift. The internal contours represent closed loop phase and gain. When the open loop response of Figure 29 is plotted on the chart the closed loop performance will be revealed. Since the Network Analyzer outputs represent phase and log magnitude a Nichol's plot of a given feedback system can be made directly and on a swept basis. For maximum resolution an X-Y recorder should be used to which is attached a blank Nichol's chart. An 8 1/2" x 11" sample of such a chart is included as an Appendix to this note. For quicker results, however, the scope can be used. The calibration necessary for a Nichol's display is as follows.

First remove the horizontal sweep connection between the 675A HORIZONTAL terminal and the oscilloscope horizontal channel, connect the horizontal channel of the scope to the A-B PHASE OUTPUT of the 676A. To establish 0 dB at the center of the scale, simply reduce the 675A output by 40 dB (switch 10 dB step attenuator to -30 dBm). Now open-loop gains of up to 40 dB can be measured and displayed on a log magnitude vs phase plot.

Open-loop gains greater than 40 dB can be accommodated by further reducing the output of the 675A. Phase calibration of the Nichol's plot is obtained by operating the 676A CHANNEL A PHASE control until 360° of phase shift exists between channel A and channel B of the 676A. At this point the phase measurement circuits will not be able to distinguish between 360° and 0°, and the PHASE A-B output will switch back and forth between maximum and minimum output. The difference between maximum and minimum is a good indication of 360° of phase shift and, when connected to the horizontal channel of an oscilloscope, will appear as a horizontal line with abrupt corners at each end. Adjust these corners (by means of the scope horizontal gain control) to occupy 8 cm of graticule space. This will give a phase scale factor of 45° per cm. Figure 31 illustrates this.

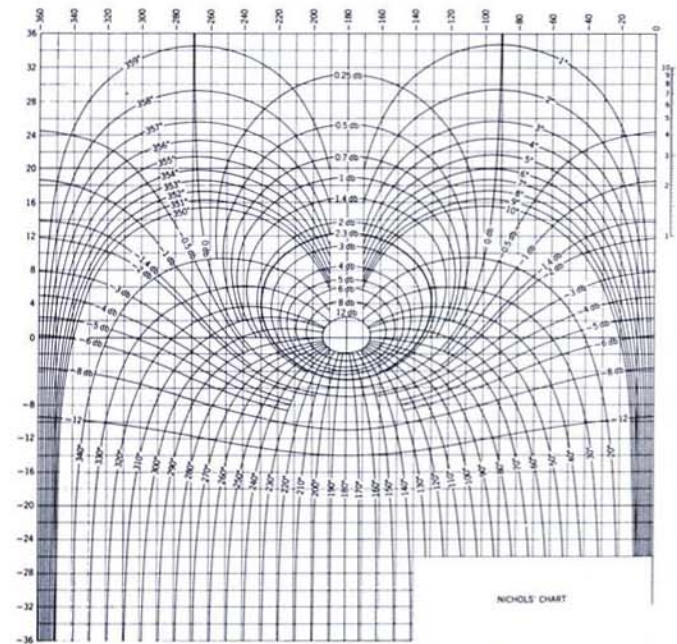

Figure 30 — Nichol's Chart

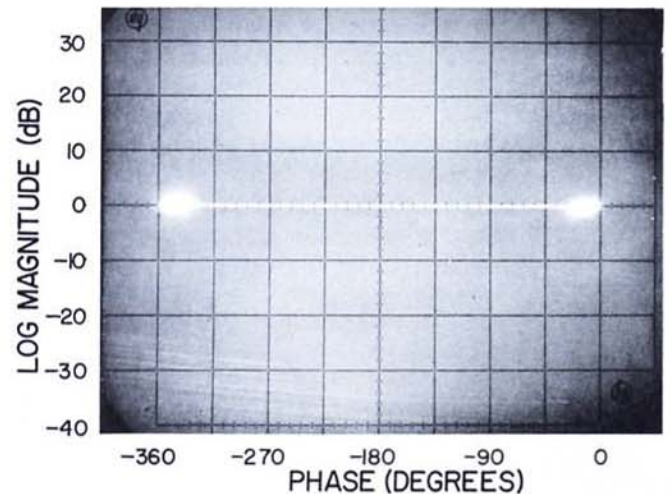

Figure 31 — Scope Calibration for Phase vs Log Magnitude (Nichol's Plot) Measurements

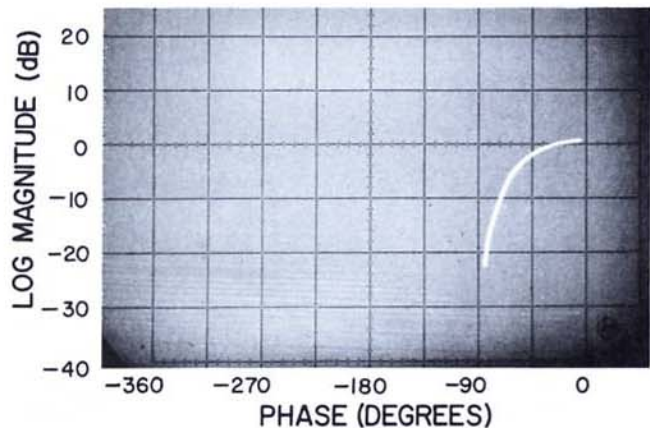

Figure 32 — Log Magnitude vs Phase Plot of Passive One-pole Network

The horizontal and vertical scale factors, established by the previous calibration, define the complex open-loop gain of any device connected into channel A of the 676A. If the device is passive, the gain/phase trace of the device will appear below the 0 dB line. A network having a single pole will produce a trace like that shown in Figure 32.

In Figure 32, frequency corresponds to points along the trace, with zero frequency at zero phase and zero magnitude. Since other frequencies may not be linearly proportional to points along the trace, markers must be used to find the frequency corresponding to a given gain/phase value.

While this type plot contains all the information on the transfer characteristics of a network, its real value is in the analysis of active feedback systems. If the feedback loop of such a system is opened and terminated in its normal terminating impedance, then the open-loop phase/gain response of the system can be used to predict the closed-loop behavior of the system.

This is accomplished by superimposing a Nichol's chart over the log magnitude vs. phase plot of the open-loop gain of the system. A transparent Nichol's chart has been provided as an appendix to this note. It may be cut out and fastened to the face plate of an oscilloscope to give swept closed-loop performance information from the open-loop gain/phase plot of a feedback system. Figure 33 shows the Nichol's plot of three feedback amplifiers and their corresponding closed-loop performance plots.

The gain vs. frequency plot of Amplifier A is not shown since, as the Nichol's plot predicts, it will be unstable. Amplifier B is peaky; the magnitude of the peak is predicted in the Nichol's plot by the constant gain con-

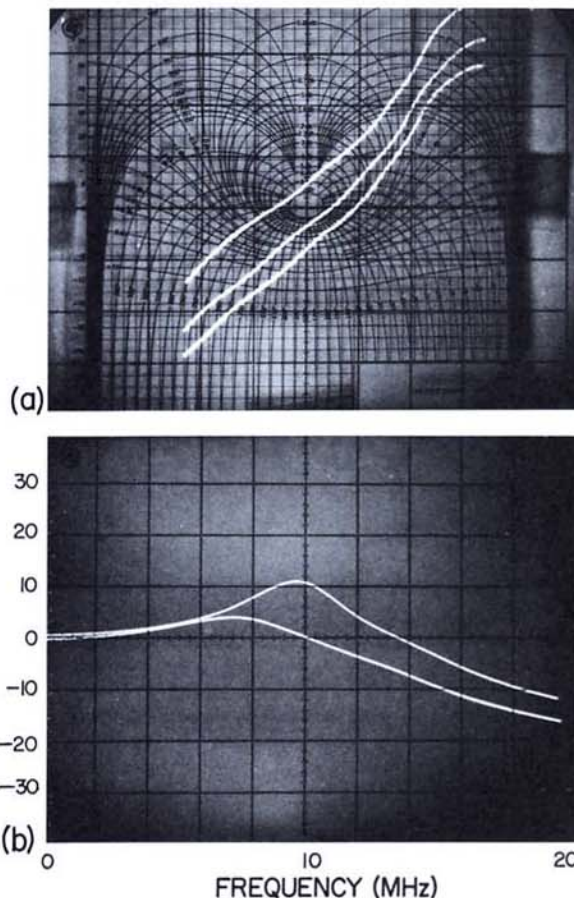

Figure 33 — Nichol's Plot and Gain vs Frequency Plot of Feedback Amplifiers

tour to which the trace is tangent. The frequency where its response begins to peak and falls off is indicated where the trace crosses the 0dB contour. The rate of roll-off is also shown by the way the trace cuts across gain contour lines. The phase shift of each frequency is read from the constant phase contours. The phase and gain margins can be easily read from the Nichol's chart. Amplifier C has been made to roll off more quickly, resulting in a flatter bandpass. This, too, is predicted by the Nichol's chart.

For acceptable accuracy when using this technique, the vertical and horizontal axes of the scope must be carefully adjusted so that the gain and phase outputs of the 676A correctly coincide with the corresponding scales on the Nichol's chart. Even then, errors will be evident near the center of the chart. Care must also be taken not to introduce phase errors in the form of excessive lengths of connecting

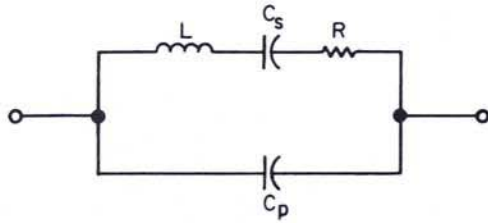

Figure 34 — Equivalent Circuit of Crystal

cable. Ideally, each inch of connecting cable used in channel A should be matched with a corresponding inch in channel B.

The foregoing remarks are applicable to a system having a nonreactive unity gain feedback network. For other values of nonreactive feedback, simply add 1 dB to each internal constant-gain contour for each dB of loss introduced by the feedback network. For reactive feedback networks, a new series of phase and gain contours must be generated which will be uniquely determined by the nature of the complex feedback network.

Crystal Characterization

Piezo electric crystals are widely used in the electronics industry for precise frequency control. Normally, such a crystal may be represented by an equivalent circuit like that of Figure 34.

From Figure 34 it may be seen that two resonant circuits are possible at two different frequencies; a series resonant circuit composed of L, C_s and R, and a parallel resonant circuit composed of L, C_p and R. The resistance R is very small, but nevertheless finite, so that these resonant circuits have very high Q. Figure 35 is an oscillogram of a crystal showing both the resonances as well as the corresponding phase shifts.

Figure 35 clearly shows the two resonances of the crystal. The first (from the left) is the series resonance producing a pole of transmission, and the second is the parallel resonance producing a zero. The phase response indicates the capacitive transmission nature (positive 90°) of the crystal at low frequencies and shows the sharp 180° transitions associated with the poles and zeros of transmission.

The noise in the figure is due to the residual FM of the 675A signal generator. This noise can be completely eliminated by phase locking the 675A/676A to a stable swept source such as the HP 5100B; however, this might be unduly expensive for educational purposes.

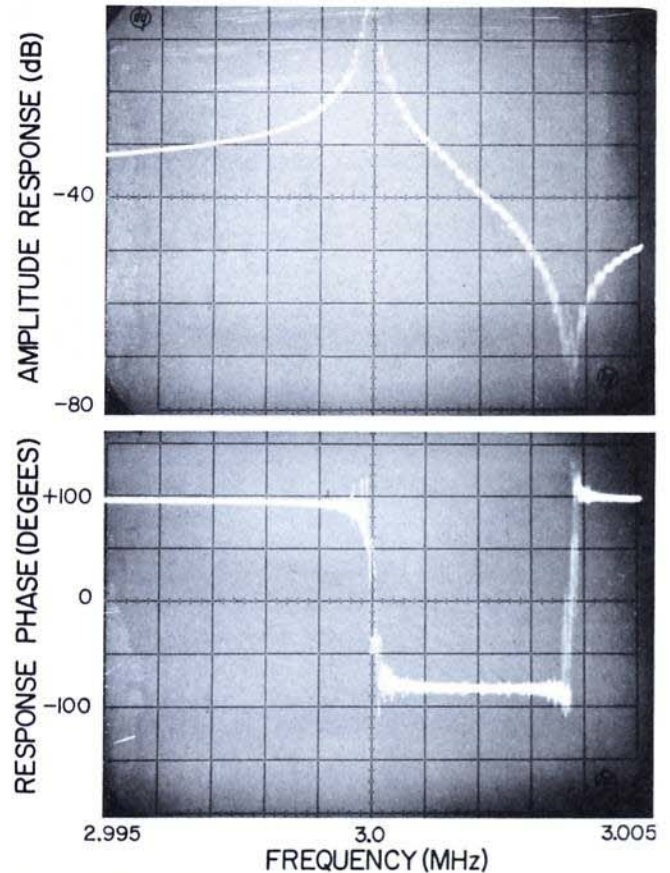

Figure 35 — Complex Frequency Response of Crystal

CONCLUSION

A wide variety of network analysis applications has been suggested in this note and an attempt has been made to connect these examples to the relevant general theory. However, this is just a start, any network that can be built to respond in the frequency range of the Network Analyzer can be analyzed on a swept driving point or transfer basis and can thereby serve to demonstrate actual network behavior to students. Although much of the theoretical discussion involved s-plane representation the instrument is still extremely valuable for making conceptual demonstrations on the technician level.

It is sincerely hoped that this note will serve as a useful aid in using the Network Analyzer to help introduce students to the interesting world of electrical networks.

BIBLIOGRAPHY

Feedback Control System Analysis and Synthesis

D'Azzo and Houpis
McGraw-Hill Book Co.
New York, 1966

Introduction to Modern Network Synthesis

Van Valkenburg
John Wiley and Sons, Inc.
New York, 1964

Linear Network Design and Synthesis

Chen
McGraw-Hill Book Co.
New York, 1964

Transmission Lines and Networks

Johnson
McGraw-Hill Book Co.
New York, 1950

APPENDIX A

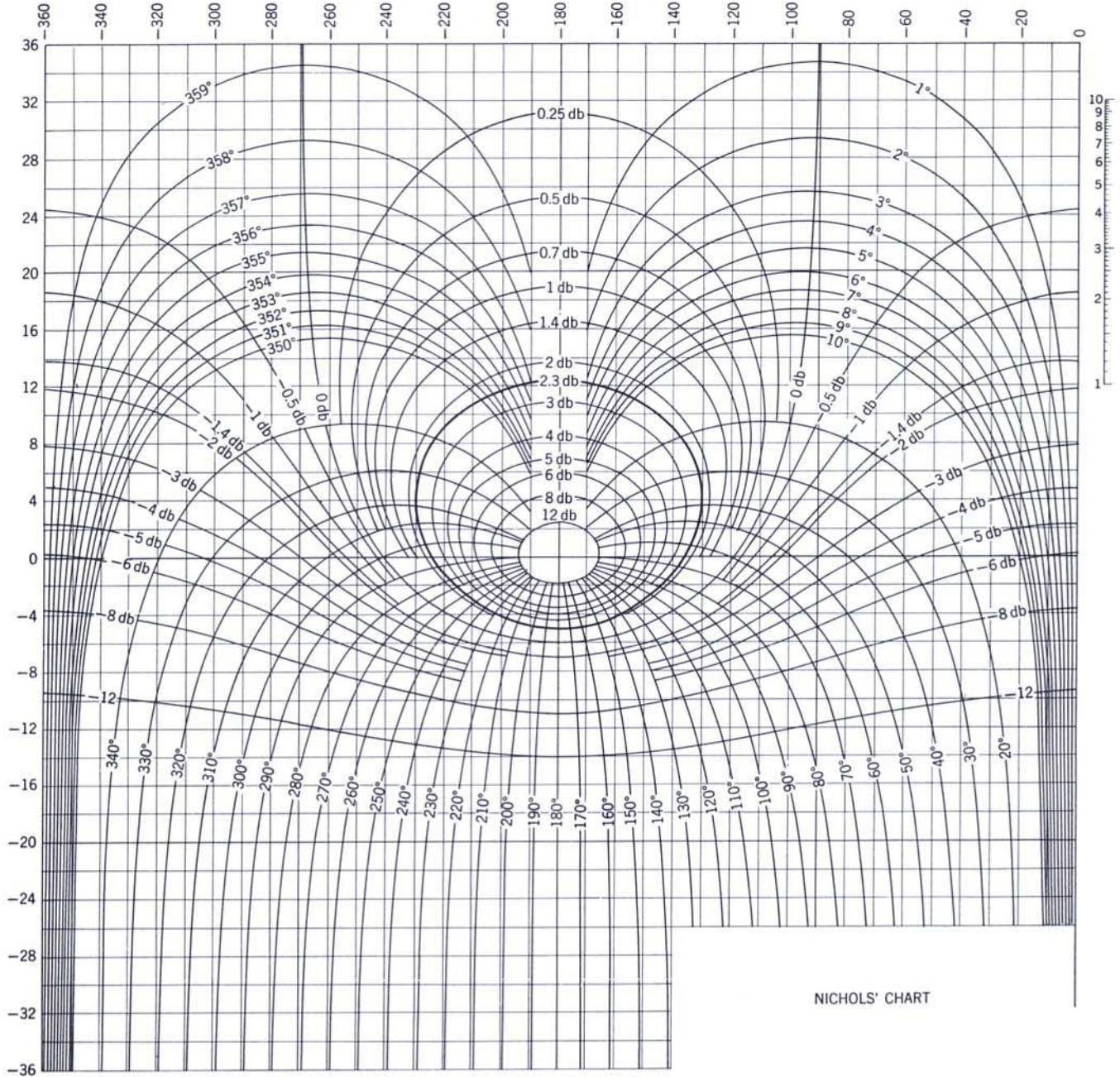

APPENDIX B

CALIBRATION OF THE 675A/676A NETWORK ANALYZER

Figure A-1 illustrates the interconnections required between sweeper, detector, and oscilloscope.

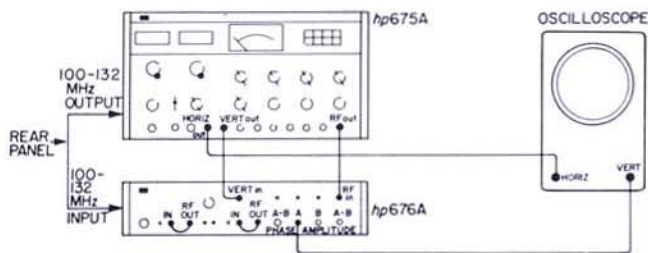

Figure A-1.

To calibrate the 675A/676A, proceed as follows.

1. Set the controls according to Table A-1.

TABLE A-1

**675A/676A System Calibration
Control Settings**

Control	Setting
675A	
Sweep mode	Auto
Function	Start/Stop
10dB switch	+10
Blanking	Vert
1dB switch	0
Marker switch	Off
RF output amplitude	+3 dB
Sweep time	0.1 sec
Start	00.0 MHz
Stop	32.0 MHz
676A	
A channel phase	0°
Oscilloscope	
Sweep	Ext.
Vertical sensitivity	0.5 V/div

2. Connect the oscilloscope to the CHANNEL A SCOPE OUTPUT of the 676A.
3. Adjust horizontal controls so that a trace and retrace are centered about the middle eight divisions of the oscilloscope result.
4. Reduce the 675A RF output 80 dB by rotating the 10dB step attenuator to -70 dB.
5. Adjust the oscilloscope vertical position control so that the trace (not the retrace) registers on the graticule line which is 4 cm below the graticule center line.
6. Restore the 675A to full RF output (+10 dBm).

7. Adjust the 676A CHANNEL A CAL control until the trace registers on the graticule line which is 4 cm above the center graticule line.
8. Rotate the 675A 10dB step attenuator to insure that the trace shifts one cm for each 10 dB ± 1.5 dB.

The 676A B channel can be calibrated in exactly the same manner or, better yet, the following A-B amplitude calibration procedure can be followed.

1. Set the 675A to +10 dBm.
2. Use the 676A A and B CAL controls to adjust the 676A A and B scope outputs to 4.225 V, as read on a digital voltmeter.
3. Set the 675A to -70 dBm and note the difference between the digital voltmeter readings taken at the A and B scope outputs.
4. Set the 675A to 0 dBm and adjust the CHANNEL B CAL control until the same difference, noted in step 3, is achieved.
5. Connect the digital voltmeter to the A-B scope output and check the voltage over 80 dB of range. It should be within +10 mV, i.e., ± 0.2 dB.

When the preceding calibration procedure is completed, the 675A/676A Network Analyzer is ready to make amplitude insertion loss or gain measurements. To prepare the system for making accurate phase shift measurements as well, perform the following steps.

1. Connect the oscilloscope vertical channel to the PHASE A-B SCOPE OUTPUT of the 676A.
2. Adjust the oscilloscope vertical sensitivity for 0.1 V/div.
3. Adjust the scope vertical position control and/or the 676A PHASE CHANNEL A control until the trace registers on the bottom graticule line.
4. Press the 676A 100° button and adjust the PHASE A-B CAL pot until the deflection obtained is a full 10 divisions. The scope vertical position control will have to be manipulated between adjustments to maintain the trace on the bottom graticule.

The foregoing calibration procedures assumed that the display device was an oscilloscope, but an X-Y recorder could be used just as easily.

When an X-Y recorder is used, operate the 675A in manual sweep mode and switch the vertical blanking off. If the recorder is equipped with a pen lift input, connect this to the 675A. Otherwise, manually lift the pen and set the 675A to retrace after one sweep. The sweep rate should be set between 100 sec/sweep and 10 sec/sweep. Unless a dual-trace X-Y recorder is used, two sweeps will be required to record gain and phase for a given network. Do not change any settings except the recorder vertical position control between sweeps; otherwise, frequency registration between the two traces may be lost.



LOVELAND DIVISION