

NETWORK ANALYSIS WITH THE HP 8407A 0.1 – 110 MHz

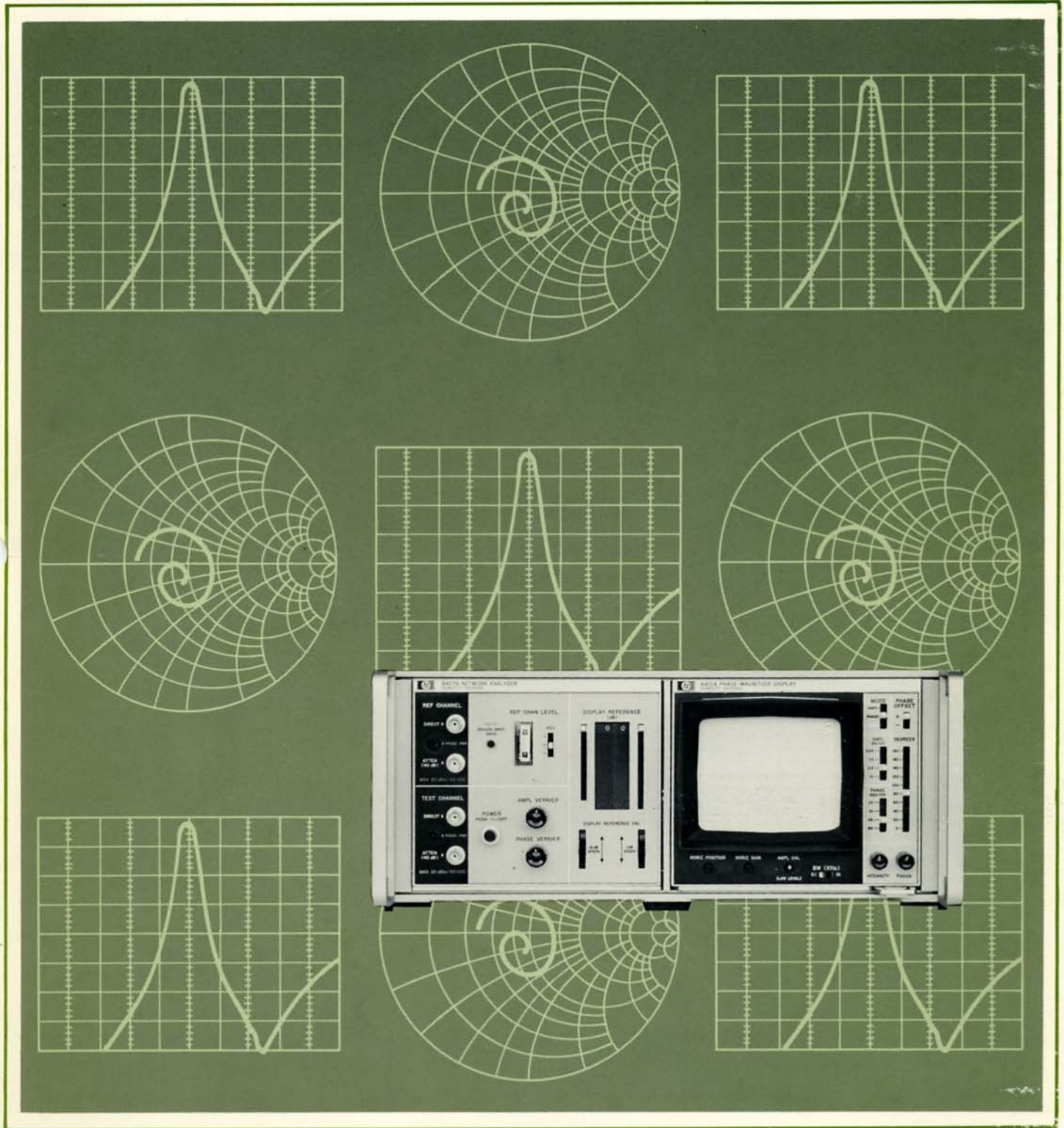

APPLICATION NOTE 121-1

**Network Analysis
with the HP 8407A
0.1 – 110 MHz**

PRINTED FEBRUARY, 1970

HEWLETT  PACKARD

TABLE OF CONTENTS

Section		Page
I	CAPABILITY	1
	Transmission	1
	Reflection	2
	Summary of Applications	3
II	ADVANTAGES	4
	Magnitude	4
	Swept Frequency Capability	4
	Wide Dynamic Range	4
	Broadband Measurement Range	4
	Accurate Measurements	4
	Phase	6
	Impedance	6
	Feedback Amplifiers	7
	Matching Cable Electrical Length	8
	Group Delay	8
	Resonance	9
	Antenna Design	9
III	SYSTEM EQUIPMENT	11
	Source	12
	Transducers	12
	The 11652A Reflection-Transmission Kit	12
	The 11654A Passive Probe Kit	13
	8407A Mainframe	13
	Displays	13
	8412A	13
	8414A	13
IV	FRONT AND REAR PANEL CONTROLS	14
	8407A Front Panel Features	14
	8412A Front Panel Features	14
	8407A Rear Panel Features	15
	8412A Rear Panel Features	15

TABLE OF CONTENTS (Cont)

Section	Page
V TRANSMISSION MEASUREMENTS	16
Measurement Process	16
Measurement Technique	17
Set-Up	17
Vertical Calibration — Magnitude	18
Eliminating Frequency Response	18
Zero dB Set	19
Vertical Calibration — Phase	19
Eliminating Frequency Response	20
Horizontal Calibration — Frequency	20
Measurement	21
Increasing Resolution	22
Bandwidth Switch	22
Transmission Measurement Accuracy	23
Sources of Error	23
Error Terms	23
Magnitude	23
Phase	23
Examples	26
Maximum Accuracy	26
Simplified Case	26
General Case	27
Magnitude	28
Phase	28
VI REFLECTION MEASUREMENTS	29
Measurement Process	29
Measurement Technique	30
Setup	30
Calibrate — 8412A	31
Vertical Calibration — Magnitude	31
Eliminating Frequency Response	32
Zero dB Set	32
Vertical Calibration — Phase	32
Eliminating Frequency Response	33
Horizontal Calibration — Frequency	33
Measurement	34
Increasing Resolution	34
Bandwidth Switch	35

TABLE OF CONTENTS (Cont)

Section	Page
8414A	35
Calibration	35
Low Level Calibration	35
Full Scale Calibration	35
Measurement	36
Increasing Resolution	36
Smith Chart Plots	36
Reflection Measurement Accuracy	37
Sources of Error	37
Error Terms	37
Example: 8412A	41
Magnitude	41
Phase	42
VII QUESTIONS AND ANSWERS	43
Performance Checks	43
Transducers	44
Operation — 8407A	45
Input Connectors	45
Ref Chan Level	46
Display Reference	49
Ampl Vernier; Phase Vernier	49
CRT Adjustment Controls; BW (kHz) Switch	49
Operation — 8412A	50
Mode	50
Phase Offset — Degrees	50
Magnitude and Phase Resolution	50
Dynamic Range	51
Wider Sweep Widths	51
Accuracy	52
Sources	52
VIII THEORY OF OPERATION	53
Phase Lock Loop	53
Signal Processing Circuitry	54
AGC Loop	54
Reference Channel Level Amplifier	55
Signal Divider	55
8412A Block Description	56
Simplified System Block Diagram	57



Transmission Measurement of a Low Pass Filter Using the HP 8407A Network Analyzer, 8412A Phase-Magnitude Display, 11652A Reflection-Transmission Kit and 8601A Generator/Sweeper.

SECTION I CAPABILITY

The HP 8407A Network Analyzer operates from 100 kHz to 110 MHz. It measures the *transmission* and *reflection* properties of RF devices, circuits and systems. The 8407A measures both magnitude and phase. This means that you can determine the frequency response, phase shift and complex impedance of active and passive networks, as well as many other parameters.

TRANSMISSION

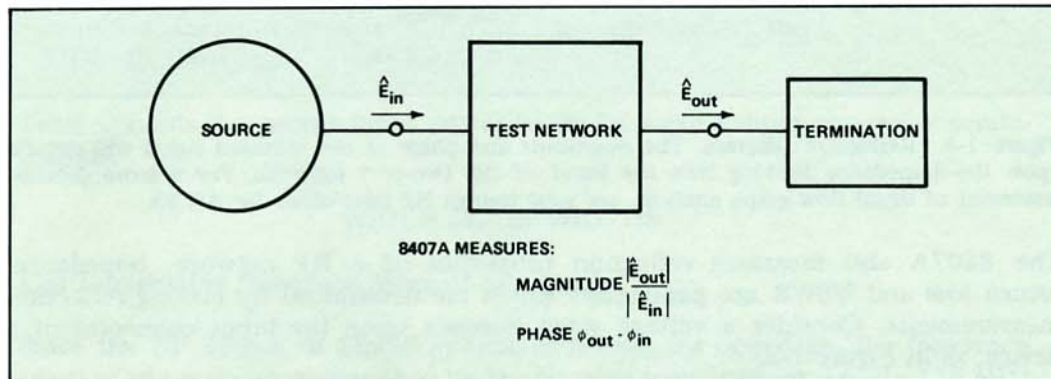

Figure 1-1. Transmission Diagram

The 8407A measures transmission properties of the network, which are basically gain and attenuation. Both the amplitude change and phase shift of the test signal are measured.

Consider the RF network in Figure 1-1, which is placed between a RF source and a termination. The network will operate on the test signal, \hat{E}_{in} , either amplifying or attenuating it, and causing some phase shift. The result is \hat{E}_{out} .

The 8407A measures the ratio $\frac{|\hat{E}_{out}|}{|\hat{E}_{in}|}$ and measures the phase difference between \hat{E}_{out} and \hat{E}_{in} .

Here is an example of a transmission measurement as displayed on the 8412A Phase-Magnitude Display.

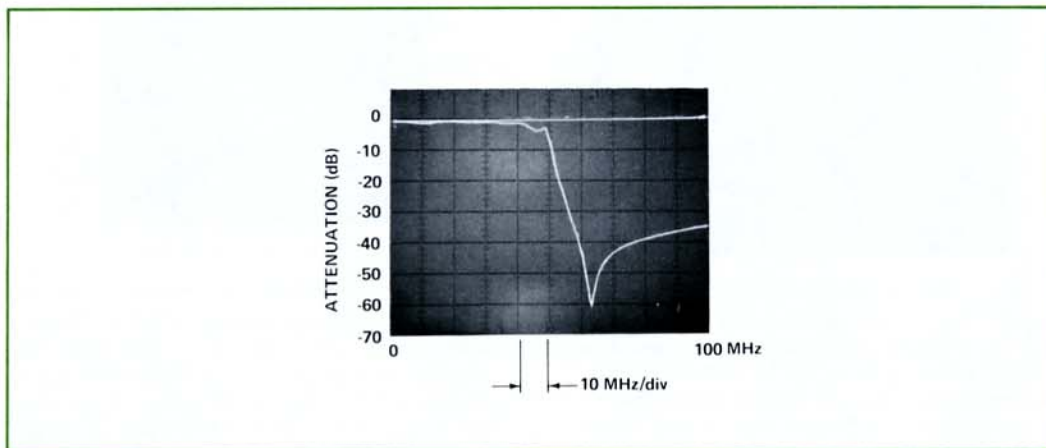

Figure 1-2. Frequency Response of Low Pass Filter from 1 to 100 MHz.
Amplitude calibration is 10 dB/div.

REFLECTION

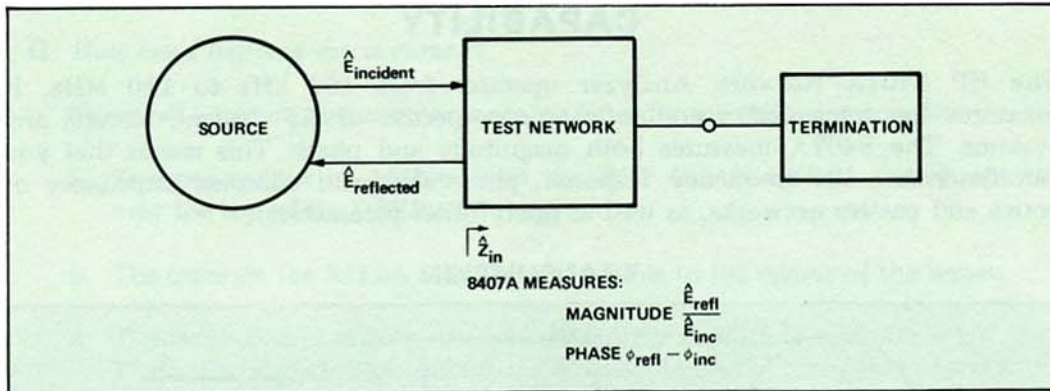

Figure 1-3. Reflection Diagram. The magnitude and phase of the reflected signal will depend upon the impedance looking into the input of the two-port network. For a more detailed treatment of signal flow graph analysis, ask your nearest HP sales office for AN 95.

The 8407A also measures reflection properties of a RF network. Impedance, return loss and VSWR are parameters which are determined by making reflection measurements. Consider a voltage wave incident upon the input connector of a device, as in Figure 1-3.

Depending upon the network's input impedance, some portion of this signal will be transmitted into the network. The remainder will be reflected back towards the source. The ratio of reflected voltage to incident voltage is defined as reflection coefficient, a complex number.

$$\text{Reflection Coefficient} = (\hat{\Gamma}) = \rho e^{j\phi} = \frac{\hat{E}_{\text{reflected}}}{\hat{E}_{\text{incident}}}$$

If you plot reflection coefficient on a Smith Chart, you have complex impedance. The 8407A, when used with the 8414A Polar Display, automatically displays the Smith Chart plot of complex impedance.

The following two diagrams show typical reflection measurements.

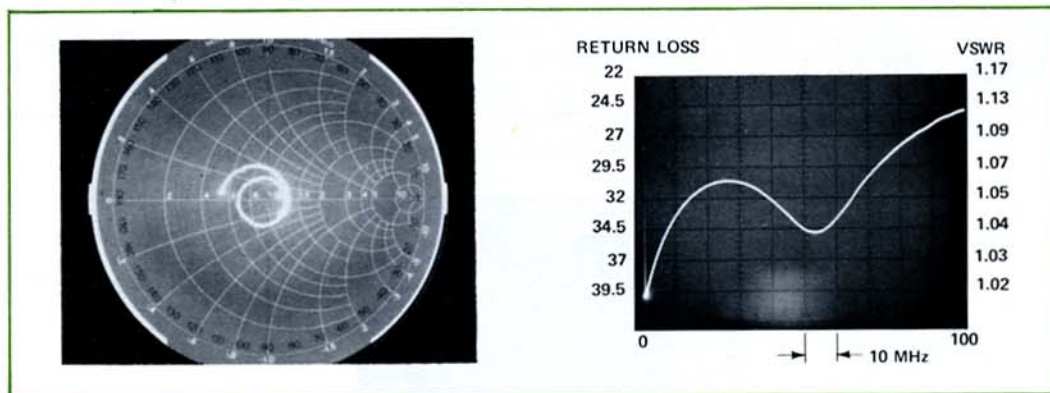

Figure 1-4. This photograph shows the plot of complex impedance of the input to a VHF antenna from 50 to 100 MHz. The darker radial lines and circles are calibrated in reflection coefficient (the outer circle corresponds to $\rho = 1$). The white lines show a Smith Chart presentation of impedance. The display is the 8414A Polar Display.

Figure 1-5. Swept display of return loss of a length of cable from 1 to 100 MHz. The display unit is the 8412A Phase-Magnitude Display. The excellent linearity of the network analyzer system allows you to easily read return loss as a function of frequency.

SUMMARY OF APPLICATIONS

With the 8407A/8412A Network Analyzer you can measure

TRANSMISSION PROPERTIES

GAIN/LOSS

PHASE SHIFT

- Group Delay
- Time Delay
- Electrical Length

REFLECTION PROPERTIES

COMPLEX IMPEDANCE (ADMITTANCE)

REFLECTION COEFFICIENT

RETURN LOSS (VSWR)

These measurements can be made on:

COMPONENTS	DEVICES	SUBSYSTEMS
Filters	Bipolar Transistors	Front Ends
Amplifiers	FET's	IF Sections
Antennas	Diodes	
Cables	Tunnel Diodes	
Couplers	IC's	
Attenuators		
Phase Shifters		
Connectors		

Now that the measurement capabilities of the Network Analyzer have been described, let's answer the question, "What advantages are there in using the 8407A/8412A to characterize networks?"

SECTION II ADVANTAGES

This section first discusses the advantages of making magnitude measurements with the 8407A. Then we review why the phase information you get from the 8407A is so important in network analysis.

With respect to magnitude, the Network Analyzer has the following advantages.

- SWEPT FREQUENCY CAPABILITY (0.1 — 110 MHz)
- WIDE DYNAMIC RANGE (80 dB)
- MORE ACCURATE MEASUREMENTS

By knowing phase, you can determine the following:

- COMPLEX IMPEDANCE
- FEEDBACK PARAMETERS
- ELECTRICAL LENGTH
- GROUP DELAY
- NARROW RESONANCES

MAGNITUDE

What contributions does the 8407A make relative to other magnitude measuring instruments? RF voltmeters, log amplifiers, wave analyzers and crystal detectors are typically found in this frequency range. The 8407A combines the advantages of each one. These advantages are primarily the following:

SWEPT FREQUENCY CAPABILITY

The advantages of making swept frequency measurements rather than single frequency measurements are well known. RF voltmeters and most wave analyzers are limited to tedious point-by-point measurements.

WIDE DYNAMIC RANGE

The 8407A allows you to make measurements on devices having up to 100 dB of dynamic range. The 80 dB display range of the 8412A Phase-Magnitude Display permits you to look at the entire frequency response of most devices, although 100 dB attenuation measurements are possible. Crystal detectors/oscilloscope displays are usually limited to 20–30 dB of dynamic range.

BROADBAND MEASUREMENT RANGE

The 8407A makes measurements from 100 kHz to 110 MHz. This three-decade range permits measurements in the AM, TV, FM, navigational, police and many other bands of commercial use as well as on the IF sections of UHF communication systems. Many wave analyzers are limited to narrower frequency ranges.

ACCURATE MEASUREMENTS

This is perhaps the greatest contribution of instruments like the 8407A which have tracking windows to filter out unwanted signals. (Most RF amplitude measuring devices which make swept measurements have broad input bandwidths.)

The importance of having a tracking detector with wide dynamic range cannot be over emphasized. Here is an example of the different results you can get, depending upon the type of instrument used. This is the frequency response of a low pass filter from 1 – 100 MHz.

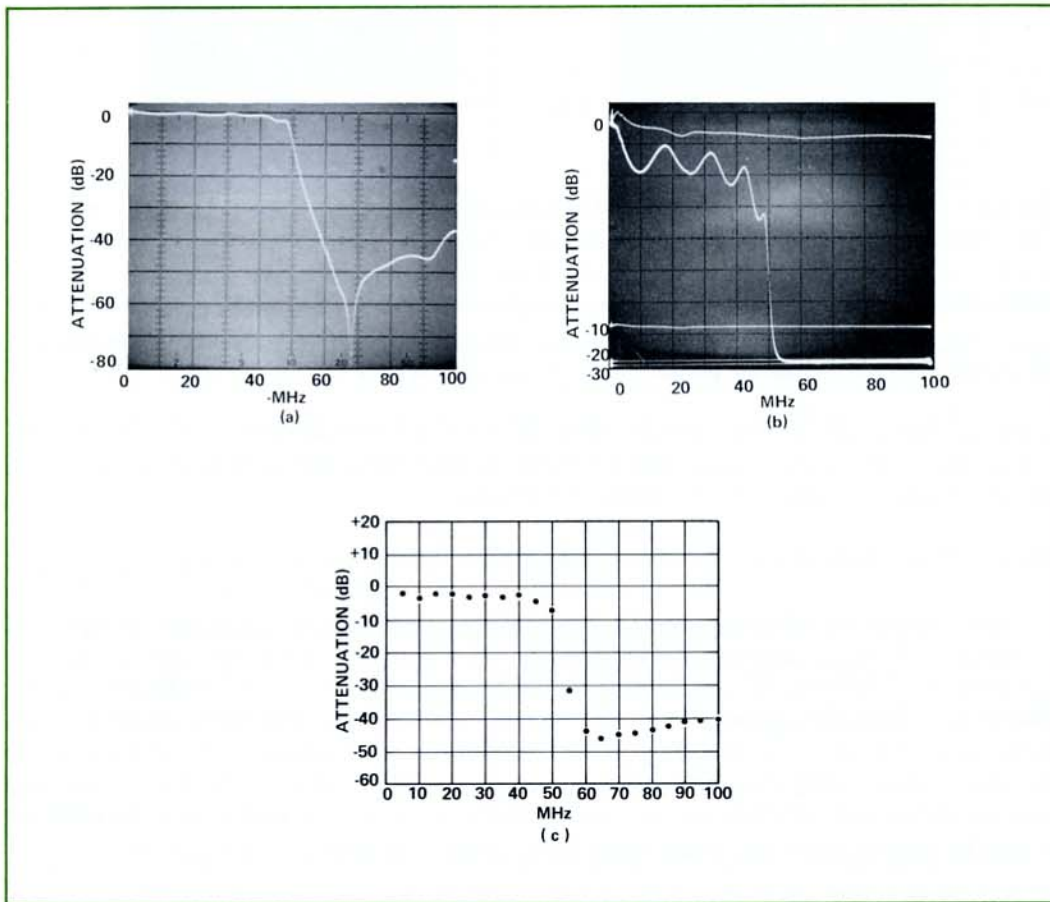

Figure 2-1. Frequency response of low pass filter as measured on (a) HP 8407A, (b) crystal detector and scope, (c) RF voltmeter — point by point.

A glance at these photographs reveals the difference between the three measurements.

Only the 8407A's features of tracking detection plus wide dynamic range measures the true filter response.

The crystal detector, in addition to having a broad input bandwidth, simply does not have the dynamic range to view the notch. You're limited by its sensitivity as to how far down you can see. Notice also that the vertical calibration is not linear in terms of dB.

The RF voltmeter fails to see the notch because harmonics, spurious and noise signals are present in its broadband measurement circuit even when the fundamental is being attenuated by 80 dB. There is also the danger of missing sharp resonances.

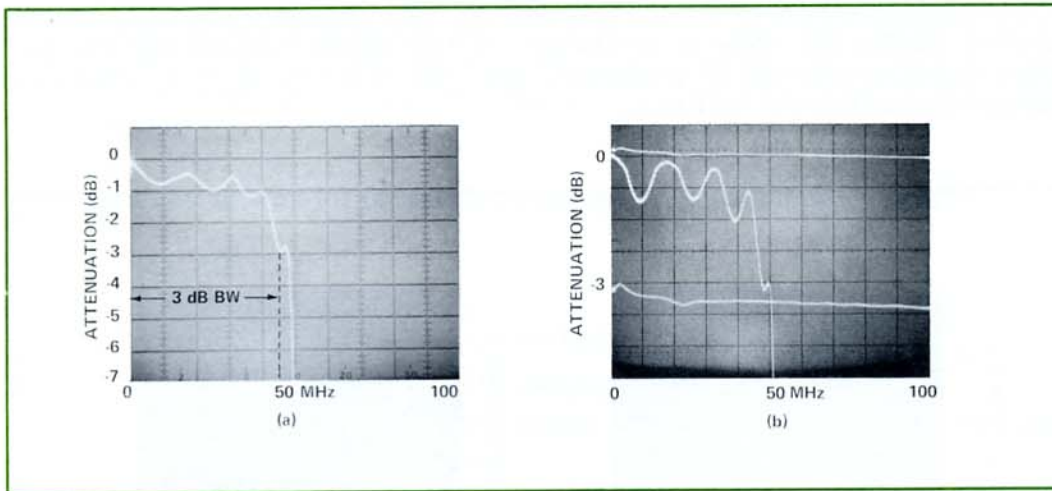

Figure 2-2. Determination of 3 dB BW by (a) 8412A's vertical and horizontal calibration and (b) crystal detector and grease pencil.

Locating the 3 dB points requires you to draw a calibration line at 3 dB (Figure 2-2b). The 8407A eliminates the need for tedious grid lines. Just read the 3 dB, 60 dB or other points directly from the display.

PHASE

We have just seen why the 8407A has made a significant contribution in the area of magnitude vs frequency measurements. If magnitude were the only parameter the 8407A measured, it would still be an important addition to instrumentation. But it also measures phase. Phase is the other half of the unknown signal you are measuring. By knowing phase, you can determine such parameters of a device as its group delay and complex impedance. In addition, phase information enables you to determine whether or not an amplifier is stable, or under what conditions it will be stable. Here are some cases when phase information is important.

IMPEDANCE.

When trying to achieve maximum power transfer across several stages of amplification, the output impedance of one stage must be the complex conjugate of the input impedance of the following stage.

Here is an example of a swept impedance measurement with the 8407A.

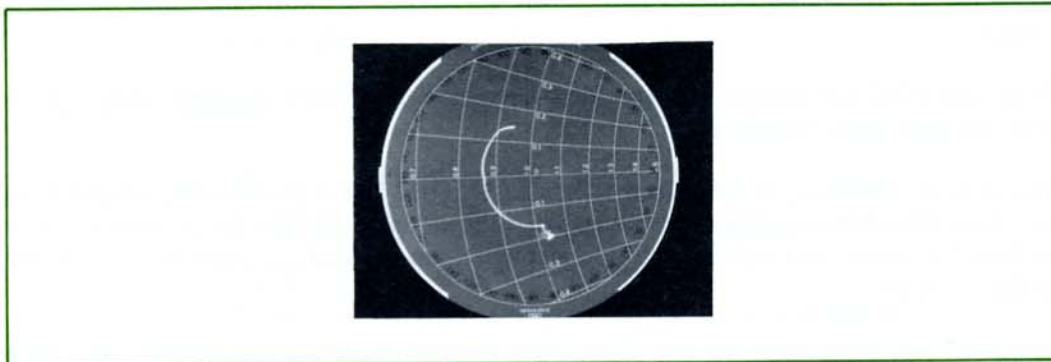

Figure 2-3. Polar Display showing input impedance of closed-loop feedback amplifier. The grid lines are from the expanded Smith Chart overlay supplied with the 8414A. Frequency is from 1 — 40 MHz; outer circle represents 14 dB return loss. ($\rho = 0.2$)

FEEDBACK AMPLIFIERS

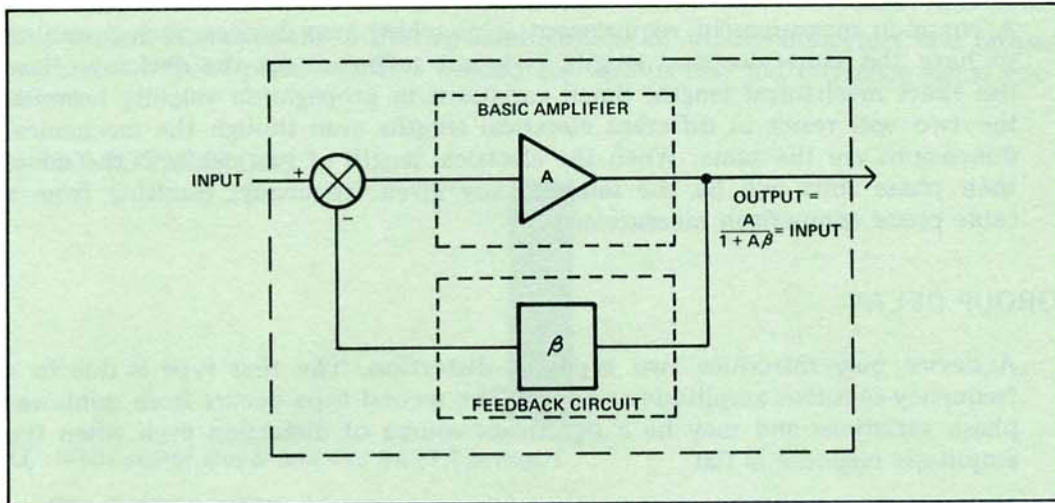

Figure 2-4. Block Diagram Representation of Feedback Amplifier

In designing feedback amplifiers, it is often necessary to plot the amplitude and phase of the loop gain $A\beta$ vs. frequency. Normally, the feedback loop in the amplifier is opened at the input to the basic amplifier and $A\beta$ is measured directly. If a feedback amplifier is to be stable, the loop gain $A\beta$ must fall to 1 (0 dB) before the phase of the output drops 180 degrees and the feedback becomes positive.

If an amplifier just meets the requirements mentioned above, it will only be marginally stable. Even a small temperature change might drive it into oscillation. Feedback designers usually choose a phase or gain margin to ensure stability. For example, when $A\beta$ reaches 0 dB, they may specify that the phase has fallen 135 degrees, providing a 45 degree phase margin.

Feedback amplifiers with specified margins can be designed on paper, but the actual amplifier may not meet desired specifications due to unwanted capacitance, stray coupling, component tolerances, etc. Therefore, it is necessary to build and test prototypes and make any necessary changes. The characteristics of the basic amplifier may not be completely known, so the proper feedback network must be determined experimentally.

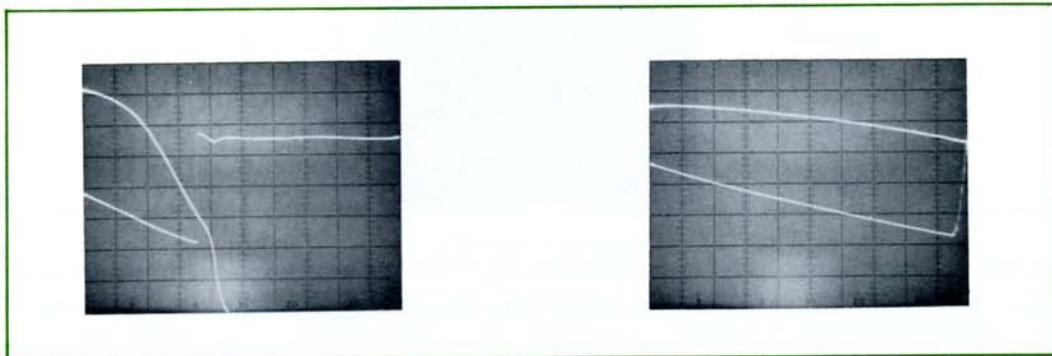

Figure 2-5. Feedback Amplifier. Plotting the open-loop phase-gain margin of a feedback amplifier results in optimizing amplifier stability vs. gain. Adjustment while sweeping yields nearly instantaneous results. On the left is the open-loop feedback response of the amplifier. Amplitude 2.5 dB/div; phase 90°/div. On the right, the closed-loop output of the stabilized amplifier. Amplitude 10 dB/div; phase 90°/div. Sweep is 1 — 50 MHz (5 MHz/div) in both cases.

MATCHING CABLE ELECTRICAL LENGTH

A common measurement requirement is matching two devices, such as cables, to have the same electrical length. It is not sufficient for the device to have the exact mechanical length. Small variations in propagation velocity between the two will result in different electrical lengths even though the mechanical dimensions are the same. When the electrical length of two cables is the same, their phase shift will be the same at any given frequency, resulting from a cable phase comparison measurement.

GROUP DELAY

A device may introduce two types of distortion. The first type is due to a frequency-sensitive amplitude response. The second type occurs from nonlinear phase variations and may be a significant source of distortion even when the amplitude response is flat.

Related to the second type is a phenomenon called “group delay”, which is the transit time of signals through a device. Group delay is defined as

$$\text{Group Delay} = t_d = \frac{|\text{d}\phi|}{360 |\text{d}f|} \approx \frac{1}{360} \frac{|\Delta\phi|}{|\Delta f|} \text{ over any reasonably linear segment}$$

where:

t_d = group delay in seconds

$\Delta\phi$ = incremental phase shift in degrees

Δf = incremental frequency change which produces $\Delta\phi$

It is proportional to the slope of phase versus frequency. When the transit time or group delay is not constant with frequency, phase relationships of the signal components change, and distortion results.

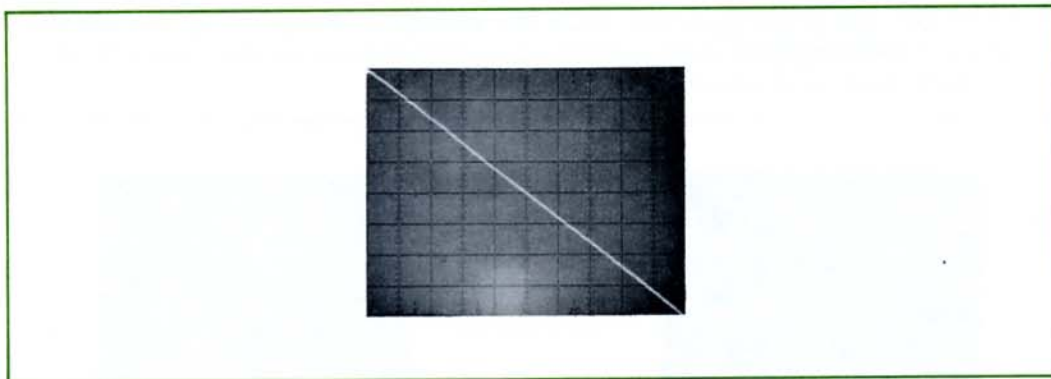

Figure 2-6. Group delay measurement of 50 MHz Bandpass filter at center frequency. $\Delta\phi = 8.0^\circ$; $\Delta f = 100 \text{ kHz}$; $t_d = \frac{|\Delta\phi|}{360 |\Delta f|} = 220 \text{ nsec}$.

Group delay measurements are important in audio- and video-frequency amplifiers and networks. In transmission systems with complex waveforms, such as TV or carrier systems, a linear phase characteristic is necessary to prevent waveshape degradation.

RESONANCE

The 8407A Network Analyzer can be used to determine the resonant frequency of tuned circuits, filters, oscillators and other circuits in the frequency range from 0.1 to 110 MHz. With the 8407A, you can locate the resonant frequency by detecting the zero-degree phase crossover. Historically, the technique has been to locate a maximum or minimum of the amplitude response. The phase detection method is a much more accurate and sensitive method because phase is usually changing very rapidly near resonance, while the amplitude response curve in this region is often essentially flat. Resonance is defined as the frequency at which the phase shift through the device equals the zero-degree phase reference. The circuit is purely resistive at the zero-degree phase crossover point, the reactive components having cancelled out, and is thus resonant.

ANTENNA DESIGN

The Network Analyzer measures the complex impedance of communication antennas, which must be known in order to radiate at the correct power level.

The impedance of an antenna is usually determined by non-swept methods. A variable-frequency current source is used to drive the antenna, and the resulting voltage is measured. The resulting ratio, V/I (both only magnitude quantities), gives the magnitude of \hat{Z} , or Z . But the antenna engineer wants to know the real part of \hat{Z} , $\text{Re } \hat{Z}$, because radiated power is $I^2 \text{Re } \hat{Z}$. Figure 2-8 shows the swept complex impedance of a FM antenna.

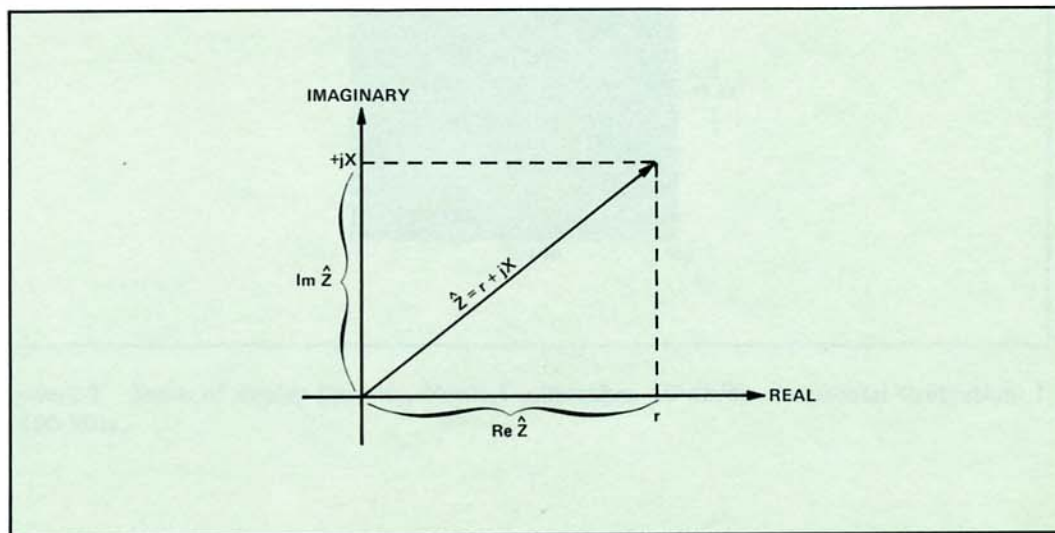

Figure 2-7. Vector Representation of Complex Impedance, Z

To tune the antenna to a desired frequency, an engineer can make adjustments to length or loading and watch the display move. If it is difficult or expensive to tune the antenna to the operating frequency, as happens in occasional installations, he can easily measure the real part of the impedance because $\text{Re } \hat{Z}$ is taken directly from the Smith Chart.

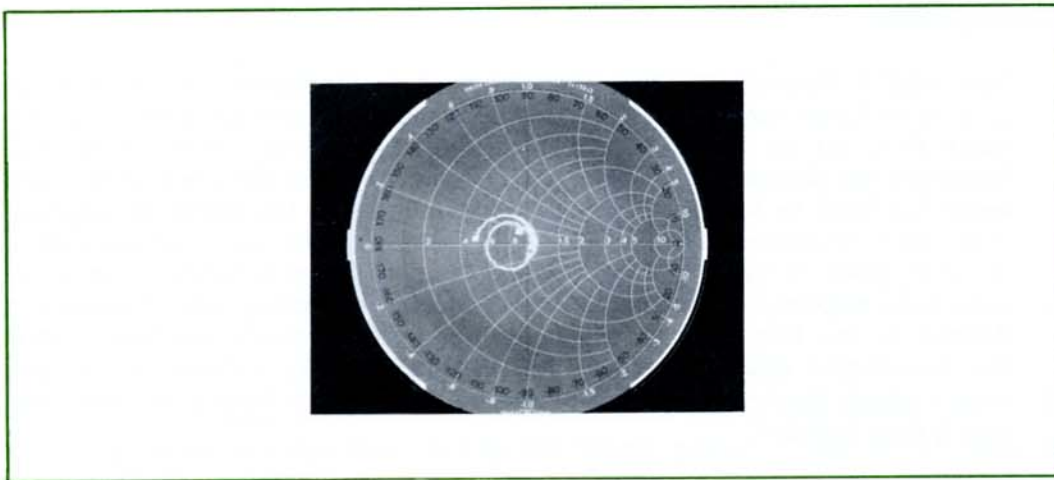

Figure 2-8. Antenna Complex Impedance. A FM antenna was swept over its useable range of 88 to 108 MHz, using the 8414A display with Smith Chart overlay. 50-ohm input Z is desired (the exact center of the display) but the antenna varies from inductive to capacitive over the sweep range. Values of complex impedance can be read directly off the Smith Chart.

This section has discussed some of the ways in which the 8407A Network Analyzer contributes versatility and accuracy to the field of RF measurements.

What is the Network Analyzer system? How does it work? These questions are answered in the following sections.

SECTION III SYSTEM EQUIPMENT

The 8407A Network Analyzer forms the basis of a measurement system which consists of a source, various transducers (depending on the application), the Network Analyzer Mainframe and an appropriate display.

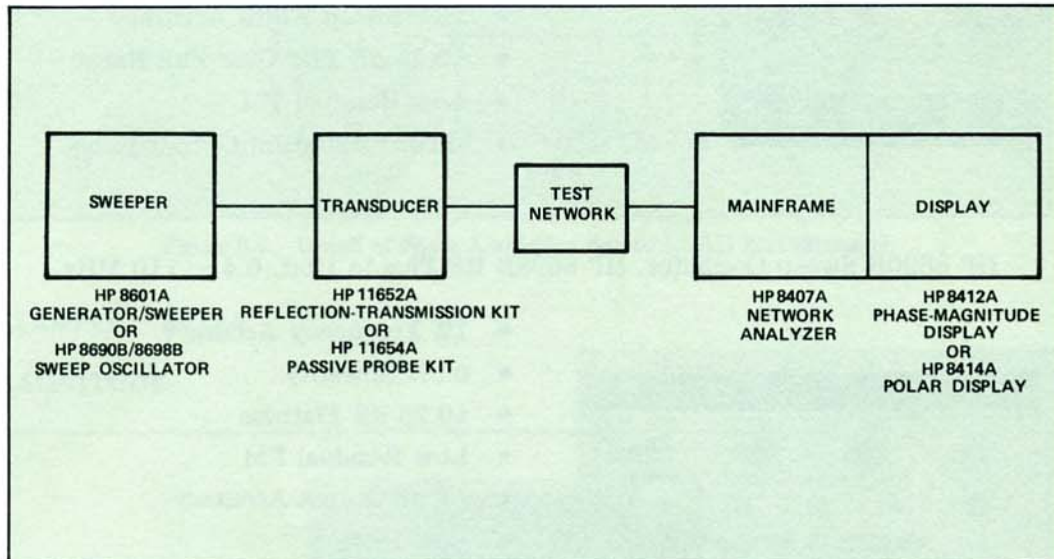

Figure 3-1. Basic Measurement System

Shown below and on the next page is a detailed discussion of the transducer kits and what types of measurements are possible with each.

Here is what you need to construct a complete system.

SOURCE

- HP 8601A, 0.1–110 MHz Generator/Sweeper or
- HP 8690B/8698B 0.4 – 110 MHz Sweep Oscillator/RF Unit

TRANSDUCER

- HP 11652A, Reflection-Transmission Kit and/or
- HP 11654A, Passive Probe Kit

NETWORK ANALYZER MAINFRAME

- HP 8407A

DISPLAY

- HP 8412A, Phase-Magnitude Display and/or
- HP 8414A, Polar Display

Here are some of the features of each item.

SOURCE

HP 8601A Generator/Sweeper 0.1 — 110 MHz



- ± 1 dB Output Accuracy
- $\pm 1\%$ Frequency Accuracy
- $\pm 0.5\%$ Linearity
- $\pm 2\%$ Sweep Width Accuracy
- ± 0.25 dB Flat Over Full Range
- Low Residual FM
- $-110 - +20$ dBm Output Range

HP 8690B Sweep Oscillator. HP 8698B RF Plug-In Unit. 0.4 — 110 MHz



- 1% Frequency Accuracy
- 0.5% Linearity
- ± 0.25 dB Flatness
- Low Residual FM
- ± 1 dB Output Accuracy
- Low Drift
- $-110 - +13$ dBm Output Range

TRANSDUCERS

The following transducer kits are available for signal conditioning.

THE 11652A REFLECTION-TRANSMISSION KIT

The 11652A provides you with all the equipment necessary to make accurate transmission and reflection measurements from 0.1 to 110 MHz. A power splitter and the matched, low-leakage cables assure you of phase matching (so you don't need a line stretcher) and negligible cross-talk. Insertion loss through each arm is 6 dB.

The high directivity directional bridge further adds the capability of swept return-loss (VSWR) and complex impedance (reflection coefficient) measurements. In addition to the power splitter, bridge and matched, low-leakage cables, the kit includes a precision 50-ohm termination and a calibrating short.



THE 11654A PASSIVE PROBE KIT

The 11654A Passive Probe Kit is the answer for probing circuits still in the breadboard stage or which are not characterized by 50 ohms impedance.

The kit includes two each of probe cables, current probe tips, six different voltage probe tips (1:1, 5:1, 10:1, 20:1, 50:1, and 100:1) and a wide variety of accessories for grounding and getting at those “difficult to measure” circuits.

Voltage and current transfer functions can be easily measured using two sets of voltage and current probes.

8407A MAINFRAME

8407A Mainframe — the heart of the system. The 8407A accepts signals from the transducers and processes them for convenient display.

Since the 8407A is a ratiometer, it requires both a TEST and REFERENCE channel. The reference signal is held constant within the instrument and the test signal compared to it. These signals then go to the display where both amplitude and phase are measured.

DISPLAYS

8412A PHASE-MAGNITUDE DISPLAY

The 8412A is an accurate oscilloscope readout. It displays amplitude and phase vs. frequency as in a Bode plot. It has 80 dB and ± 180 degree display range with selectable resolutions up to 0.25 dB and one degree per division, allowing resolution of 0.05 dB and 0.2 degree.

The 8412A is ideal for making transmission measurements of gain or attenuation and phase shift or for measuring return loss (VSWR).

8414A POLAR DISPLAY

The 8414A is a polar display having 30 dB and 360 degree range. If you want Smith Chart displays of complex impedance or reflection coefficient, the 8414A is a natural. The 8414A includes many commonly used Smith Chart overlays.



SECTION IV FRONT AND REAR PANEL CONTROLS

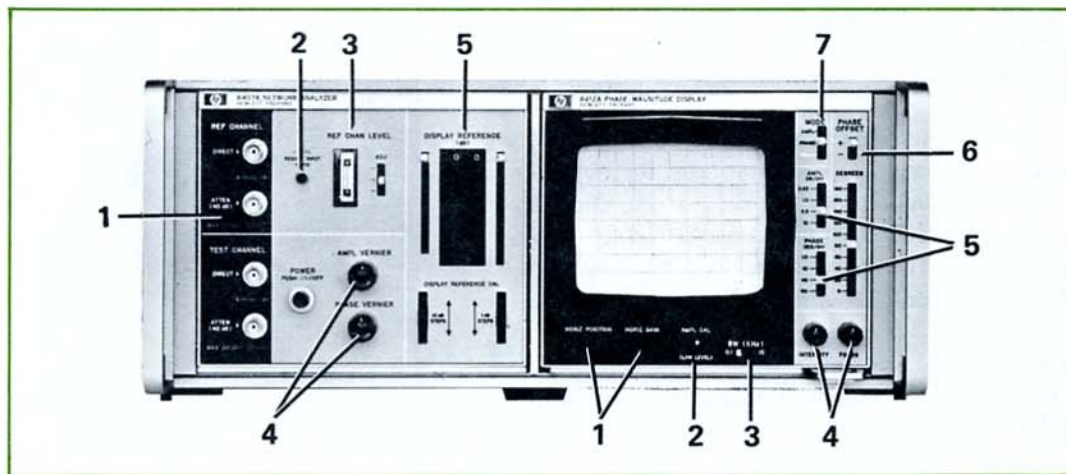

8407A FRONT PANEL FEATURES

1. RF input connectors for reference and test signals. Maximum RF power level is -10 dBm for the direct inputs and +20 dBm for the attenuated inputs. The probe inputs provide bias for active probes.
2. UNCAL light indicates a power overload in the test channel or an excessive test to reference power ratio. Refer to page 46.
3. REF CHAN LEVEL CONTROL. The relative power level in the reference channel is indicated on the meter. The switch controls the gain of an amplifier in the reference channel and so it also affects the meter position. Proper operation of the 8407A is assured when the needle is indicating in the OPERATE range of the meter.
4. AMPLITUDE AND PHASE VERNIERS: These controls enable you to set the amplitude and phase reference positions very precisely.

NOTE

A change in any of the above switch or connector settings after calibration will alter the reference level. The CRT trace must be recalibrated if these switches or connectors are changed.

5. DISPLAY REFERENCE: These switches control the position of the trace on the CRT and permit IF substitution measurements. The thumb wheel switches permit establishing a 0 dB reference level for measurement so that the windows will always indicate the value of gain or attenuation which the reference position represents.

8412A FRONT PANEL FEATURES

1. HORIZONTAL POSITION AND HORIZONTAL GAIN: These controls set the left edge of the trace and the length of the trace, respectively.
2. AMPL CAL (Low-Level): Used to calibrate the CRT trace for low-level signals. See Section 7, page 43.
3. BW (kHz): Two-position switch enables you to filter out high-frequency noise and improve the sharpness of the CRT trace. You must sweep slowly enough to avoid desensitization when the switch is in the 0.1 kHz position.
4. INTENSITY AND FOCUS: CRT trace adjustments.
5. AMPL-dB/DIV and PHASE DEG/DIV. These switches control the resolution of the amplitude and phase traces, respectively.
6. PHASE: These two switches control the polarity and amount of phase offset of the phase trace on the CRT. The position of the two switches always indicates the value of the reference line.
7. MODE: Three-position switch allows you to look at either amplitude trace, phase trace or both simultaneously.

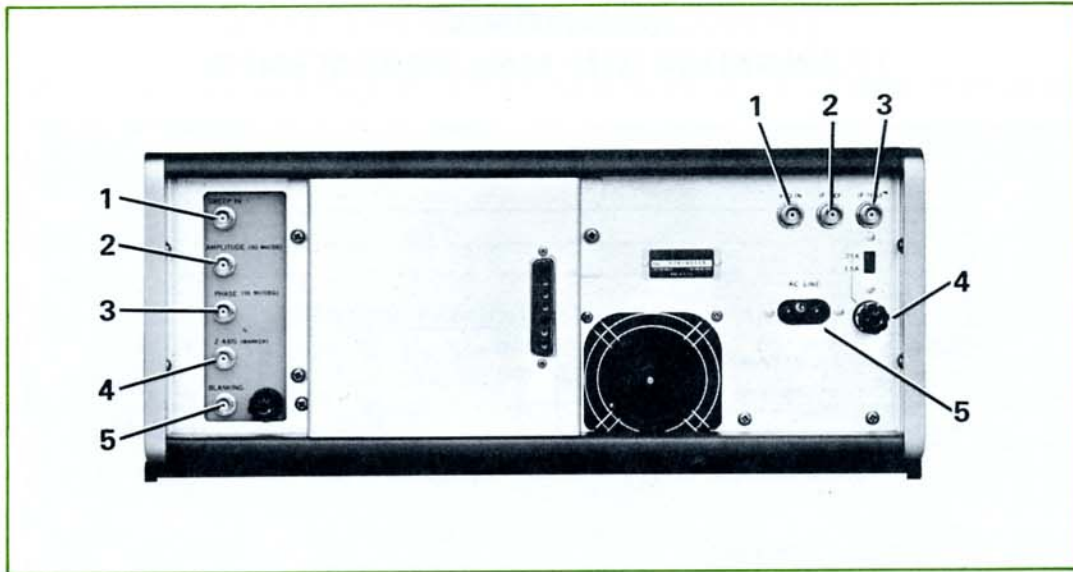

8407A REAR PANEL FEATURES

1. VTO IN: Accepts 200.1 — 310 MHz VTO output signal from either HP 8601A or HP 8698B sweeper. Provides proper signal for phase locking.
2. REF OUT. Constant 278 kHz signal of 1V p-p which is used internally for establishing zero degree reference condition.
3. TEST OUT. 278 kHz signal from test channel which has amplitude and phase information.
4. Fuse holder for 1.5 ampere (115V) or 0.75 ampere (230V) operation.
5. Line cord input (115/230 \pm 10% volts, a.c., 50 — 60 Hz).

8412A REAR PANEL FEATURES

1. SWEEP IN CONNECTOR: Input for sweep signal that goes to horizontal amplifier.
2. AMPLITUDE (50 mV per/dB) OUTPUT: Output is proportional to the amount of dB deflection of the CRT trace from the center of the screen. Since maximum deflection is \pm 40 dB, this output range is from +2 to -2 volts. Output impedance is approximately 1K ohm.
3. PHASE (10 mV per/degree) OUTPUT: Output voltage is proportional to the amount of degrees of deflection of the CRT trace from the center of the screen. Since the upper and lower limits of the screen represent a maximum of 180 degrees from the center of the screen, the output voltage range is from +1.8 to -1.8 volts. Output impedance is approximately 1K ohm.
4. Z-AXIS INPUT: Marker input to Z-axis that intensity modulates the trace, placing a bright dot on the trace at the selected marker frequency with HP model 8690B.
5. BLANKING INPUT: Input for signal from sweeper. The signal blanks the trace during sweeper retrace when sweeper blank switch is OFF. If 5 MHz crystal markers are used, the blank switch must be ON.

SECTION V TRANSMISSION MEASUREMENTS

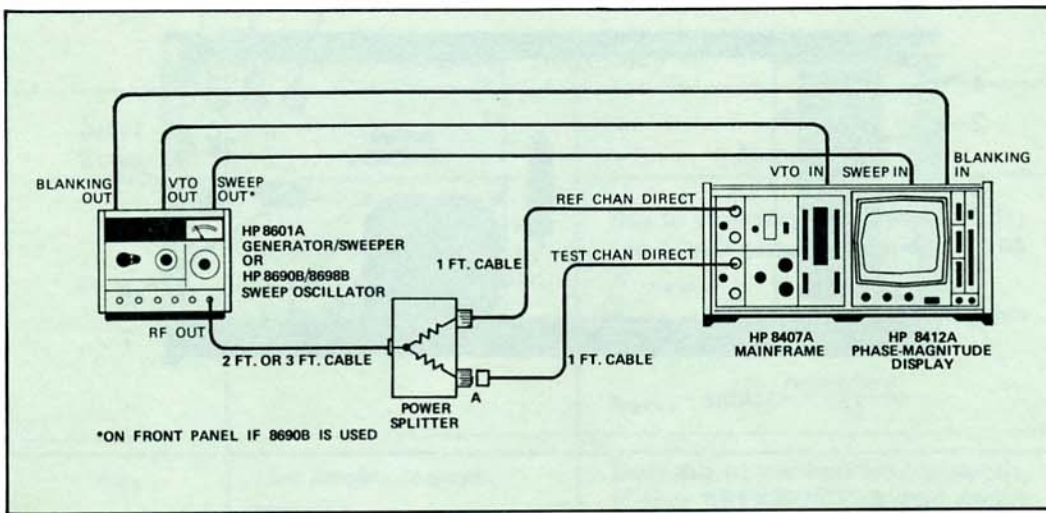

Figure 5-1. Setup for Making Transmission Measurements.

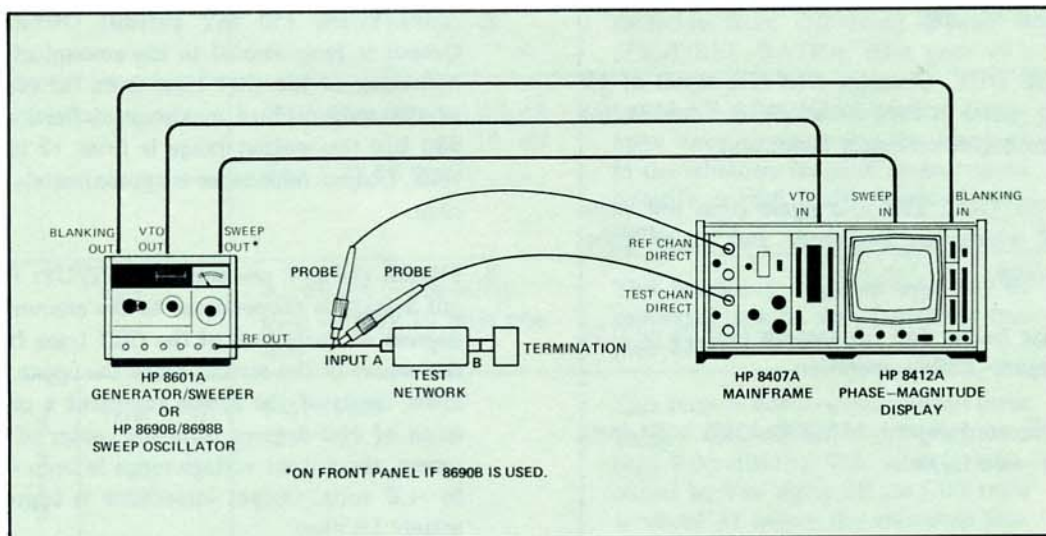

Figure 5-2. Transmission setup if 11654A Probe Kit is used. After calibrating the system, the test probe is moved to point B to make the measurements.

MEASUREMENT PROCESS

The power from a sweeper (either the HP 8601A Generator-Sweeper or the 8690B/8698B Sweep Oscillator) is divided by a power splitter into two different channels. A unity gain (0 dB) and zero degree phase condition is established in the 8407A. A test device is then inserted at point A and the resulting display is a measure of the gain or loss and phase shift of the device under test.

MEASUREMENT TECHNIQUE

There are three steps in making a transmission measurement.

1. SET-UP. Set up the equipment as in Figures 5-1 or 5-2.
2. CALIBRATE. Establish a 0 dB and zero degree reference level on the 8412A and adjust the horizontal trace for a calibrated display.
3. TEST. Insert your test device at point A in Figure 5-1 and read your value of attenuation or gain.

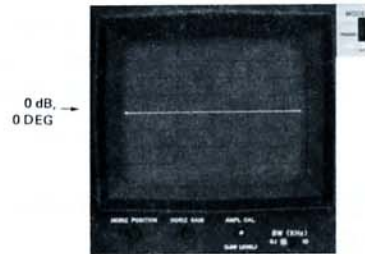

Here is a detailed explanation of these three steps:

SET-UP

1. 11652A (Figure 5-1).

Use the one-foot cable lengths specified for both the REFERENCE and TEST channels. This is to ensure proper phase matching of the two channels. The cables supplied have been matched for this purpose.

11654A (Figure 5-2).

If you're using the probes from the 11654A Passive Probe Kit, your initial setup will be as shown in Figure 5-2.

2. Set Power Level. Decide with how much power you wish to drive your device (anywhere from -10 to -60 dBm). (See page 45 for extension of this requirement.)

Set the sweeper output for 6 dB more than this. (There is a 6 dB loss in the power splitter.) Throughout this section, we assume the sweeper is the 8601A.



3. Adjust the REF CHAN LEVEL Control for a reading in the operate region of the meter. The needle should be set near the top of the OPERATE region.
4. Set Frequency controls on the sweeper for a fast sweep over the frequency range of interest.

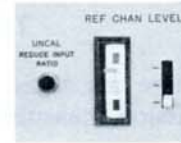

VERTICAL CALIBRATION- MAGNITUDE

The objective is to establish a 0 dB reference level.

1. 8412A MODE to AMPL.
2. 8412A AMPL dB/DIV to 10.
3. Adjust the DISPLAY REFERENCE switch on the 8407A until the CRT trace lines up with the center of the screen. (Make sure 8412A INTENSITY and FOCUS are adjusted properly, and that there is enough gain in the HORIZ GAIN to produce a trace.)

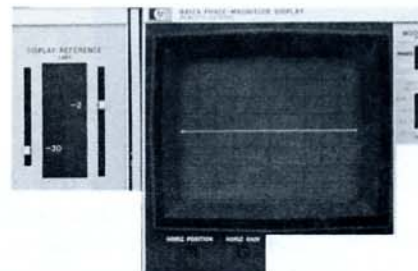

From now on the term “center of the screen” will mean the horizontal graticule line which is midway between the top and bottom graticule lines. This is the position about which the amplitude and phase resolution switches expand the trace on the screen.

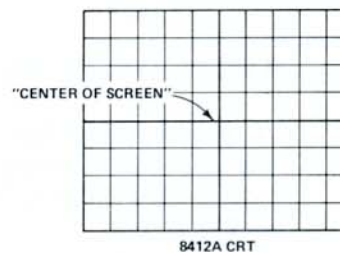

8412A CRT

ELIMINATING FREQUENCY RESPONSE

1. Increase the AMPL dB/DIV switch until you get maximum resolution on the screen, which is 0.25 dB per division. Use your AMPL VERNIER to make sure that the trace is at the center of the screen. The trace you are looking at is the frequency response of your calibrated system. The flat frequency response is one of the most

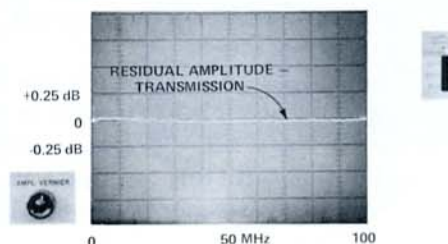

important features of the 8407A. What this means is that the amplitude measurements you make will be very accurate, because your system is not contributing an appreciable amount of error due to frequency response. You should always try to eliminate the frequency response by using the AMPL VERNIER to set the trace exactly on the center graticule for your frequency of interest. Return the AMPL dB/DIV switch to 10.

ZERO dB SET

1. Adjust the DISPLAY REFERENCE CAL thumbwheel until 0 appears in both windows. Throughout the rest of your measurement, the numbers in the windows will tell you how many dB above or below 0 dB reference level the center of the screen is. This will be true for any changes you make in the DISPLAY REFERENCE switches.



This feature of the 8407A allows you to very quickly identify the amount of gain or attenuation at any frequency.

VERTICAL CALIBRATION – PHASE

The objective is to calibrate for zero degree phase shift so that the additional phase shift caused by inserting the test device may be read directly from the CRT.

1. Set the MODE switch to PHASE.
2. Set the PHASE (DEG/DIV) to 90.
3. Adjust the DEGREES switch and the PHASE VERNIER so that the display is very nearly in the center of the screen (You should be able to calibrate with the DEGREES switch in the bottom (0) position.)



ELIMINATING FREQUENCY RESPONSE

Increase the resolution (PHASE DEG/DIV) upward one step at a time, using the PHASE VERNIER to keep the CRT trace in the center of the screen.

The trace on your screen is now displaying the residual phase response of the system. The trace can be set very close to zero over the frequency range of interest. This again shows that you can forget about system frequency response for most applications.

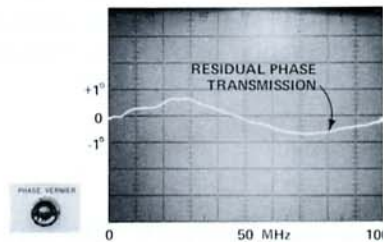

4. Return both the AMPL (DB/DIV) switch and PHASE (DEG/DIV) switch to their bottom positions. Return the MODE switch to the AMPL position.

HORIZONTAL CALIBRATION — FREQUENCY

The objective is to adjust the HORIZ GAIN and HORIZ POSITION controls on the 8412A for a calibrated frequency display.

The horizontal position of the CRT trace depends upon the sweep range. When in the VIDEO mode, you start from 1 MHz instead of 0, so your trace will not start from the left edge of the screen.

Because of the excellent linearity (0.5%) and frequency accuracy (1% of frequency) of the 8601A and the 8698B, you can adjust the trace so that you may read frequency directly off the graticule. The HORIZ POSITION control moves the starting point of the trace and the HORIZ GAIN control sets the length of the trace. The correct setting depends upon which SWEEP MODE you are in. Here are two examples:

VIDEO Mode. The sweep is from 1 — 10 MHz, so you start your trace one division from the left. You are now calibrated for 1 MHz/division.

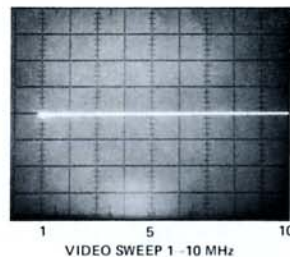

SYM mode. Here we are sweeping 10 MHz, from 45 to 55 MHz, so we use all ten divisions (1 MHz/div).

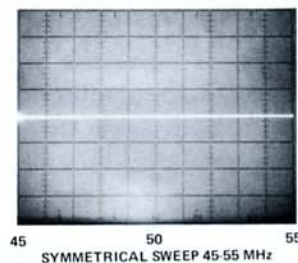

What you have established is a ratio of unity between the reference and test channel and zero degree phase difference between the channels, and you have calibrated the horizontal axis for frequency. You are now ready to make the measurement.

MEASUREMENT

Insert the test device at point A in Figure 5-1. (For a probe measurement, move the probe connected to TEST input to point B in Figure 5-2.)

The screen shows you 40 dB of gain or attenuation. If your test device has more than 40 dB of gain or attenuation, adjust the DISPLAY REFERENCE switch until the entire display appears on the screen.

NOTES

1. Be sure the UNCAL light is not lit. If it is, refer to page 46.
2. Be sure to sweep slowly enough to avoid CRT trace desensitization.

INCREASING RESOLUTION

One of the advantages of the 8407A is being able to observe very small variations in amplitude and phase. The only thing to keep in mind is that the resolution switches (AMPL DB/DIV and PHASE DEG/DIV) expand the trace with respect to the center of the screen, no matter what value of gain or attenuation it represents. Use the DISPLAY REFERENCE switch and the PHASE switch to move the amplitude and phase traces to the center of the screen. Then gradually increase resolution.

NOTE

The maximum resolution for any phase angle from zero to 360 degrees is $10^\circ/\text{div}$. However, the 8412A phase resolution switch has a $1^\circ/\text{div}$ setting to enable you to look at small variations in phase response. Use the PHASE VERNIER and PHASE offset to achieve an on-screen display. This $1^\circ/\text{DIV}$ resolution switch is useful for:

1. Observing small phase variations
2. Measuring group delay
3. Comparing two devices.

The calibrated PHASE and AMPL outputs on the back of the 8412A allow you to increase resolution even further and improve accuracy.

BANDWIDTH SWITCH

Now notice what happens if you set the bandwidth (BW kHz) switch to 0.1 kHz instead of the 10 kHz position. You have filtered out high frequency noise so your trace appears to be a much sharper line.

This means that for very low level measurements you will be able to identify your test signal much easier than you could without this filter.

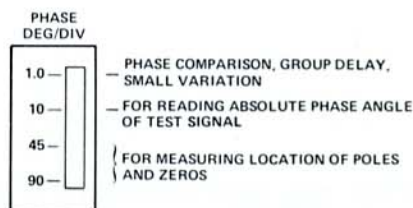

TRANSMISSION MEASUREMENT ACCURACY

Measurement accuracy varies according to each application; this analysis explains the general procedure.

SOURCES OF ERROR

System error can be found in three places:

Transducer (e_T, ϕ_T) This is negligible for transmission measurements.

Mainframe (e_M, ϕ_M) Composed primarily of crosstalk (e_{M_c}, ϕ_{M_c}) DISPLAY REFERENCE excursion (e_{M_d}, ϕ_{M_d}) and frequency response (e_{M_f}, ϕ_{M_f}).

Display (e_D, ϕ_D) This error is due to nonlinearity of the CRT (e_{D_l}, ϕ_{D_l}) and accuracy of log amplifier (e_{D_m}, ϕ_{D_m}). For phase, there are two additional terms: ϕ_{D_o} and ϕ_{D_a} .

ϕ_{D_o} is an error due to the PHASE OFFSET switch.

ϕ_{D_a} is due to the displayed attenuation or gain at the frequency being measured.

Worst case error is then $e_{AMPL} = e_T + e_M + e_D, \phi_{PHASE} = \phi_T + \phi_M + \phi_D$

ERROR TERMS

Hence, for a transmission measurement, the maximum errors* are given by:

MAGNITUDE:

$$e_T \cong 0.$$

$$\begin{aligned} e_{AMPL} &= (e_M + e_D) \\ &= (e_{M_c} + e_{M_d} + e_{M_f} + e_{D_m} + e_{D_l}) \end{aligned}$$

PHASE:

$$\phi_T \cong 0$$

$$\begin{aligned} \phi_{PHASE} &= \phi_M + \phi_D \\ &= \phi_{M_c} + \phi_{M_d} + \phi_{M_f} + \phi_{D_m} + \phi_{D_l} + \phi_{D_o} + \phi_{D_a} \end{aligned}$$

*Errors are seldom worst case but more typically the rms value. In the case of a simple transmission measurement, error is:

$$e_{Amp} = [e_{Mf}^2 + e_{Md}^2 + e_{Mc}^2 + e_{Dl}^2 + e_{Dm}^2]^{1/2}$$

$$\sin^{-1} \phi_{Phase} = [\phi_{Mf}^2 + \phi_{Md}^2 + \phi_{Mc}^2 + \phi_{Dl}^2 + \phi_{Do}^2 + \phi_{Da}^2 + \phi_{Dm}^2]^{1/2}$$

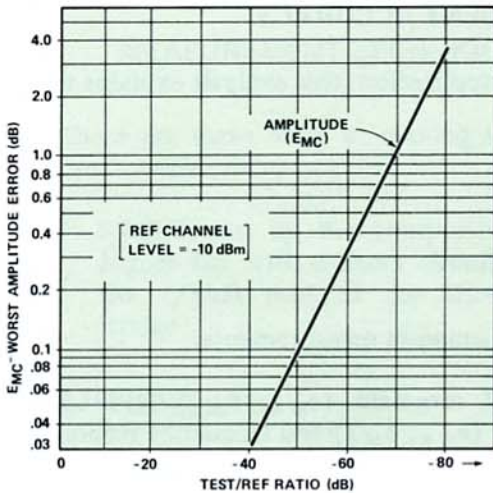

AMPLITUDE

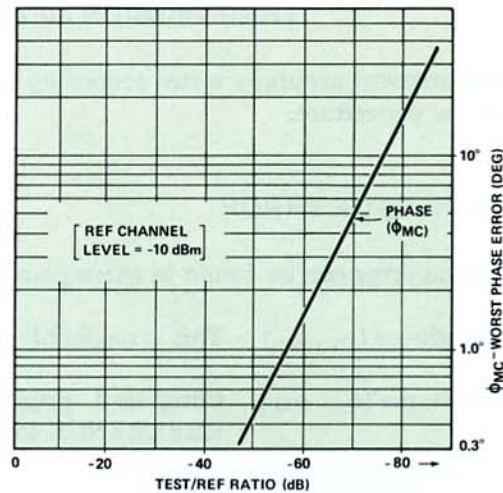

PHASE

Table 5-1. Magnitude

Error Term	Formula	Explanation
$e_{M c}$	(See Amplitude graph above)	Error due to low level residual signals. If your REFERENCE channel level is not -10 dBm, you must account for the difference. For example, if your TEST/REF ratio is measured as -45 dB, but your REFERENCE level is -20 dBm, you would enter the graph with an abscissa of $-45 - 10 = -55$ dB. (Note: REFERENCE level is determined as: Power from sweeper -6 dB).
$e_{M d}$	(0.05 dB/1 dB step; 0.1 dB max) + (0.1 dB/10 dB step; 0.25 dB max)	DISPLAY REFERENCE error. Determine error by observing the numbers in the windows for your measurement (relative to the 0 dB reference position).
$e_{M f}$	0.2 dB 0.1 – 116 MHz 0.05 dB any 10 MHz portion	This frequency response term may be calibrated out at any frequency (see page 18).
$e_{D m} + e_{D l}$	0.08 dB/dB	This term is due to measurement error ($e_{D m} = 0.05$ dB/dB) and display error ($e_{D l} = 0.03$ dB/dB). The value is determined by how many dB the CRT trace is above or below the reference line. This depends upon resolution.

Table 5-2. Phase

Error Term	Value	Explanation
$\phi_{M c}$	(See Phase graph, page 24.)	Phase ambiguity due to low level residual signals. If your REFERENCE channel level is not -10 dBm, you must account for the difference. For example, if your TEST/REF ratio is measured as -45 dB, but your REFERENCE level is -20 dBm, you would enter the graph with an abscissa of $-45 - 10 = -55$ dB. (Note: REFERENCE level is determined as: Power from sweeper -6 dB)
$\phi_{M d}$	0.2°/1 dB step; 1° max 0.5°/10 dB step; 3° max)	Phase error due to position of DISPLAY REFERENCE. (The numbers in the windows indicate how many dB the DISPLAY REFERENCE has been moved relative to the reference position.
$\phi_{M f}$	5° 0.1 — 116 MHz; $\pm 2^\circ$ over any 10 MHz portion	This frequency response error may be calibrated out. See page 20.
$\phi_{D m} + \phi_{D l}$	0.065 deg/deg	This display error is due to measurement ambiguity ($\phi_{D m} = 0.05$ deg/deg) and display linearity ($\phi_{D l} = 0.015$ deg/deg) and may be calibrated out with X-Y recorder using rear output. Determine how many degrees the CRT trace is above or below the reference level (depends on resolution) and multiply by 0.065.
$\phi_{D o}$	0.3°/20° step, 3° max	Phase error due to position of PHASE OFFSET relative to calibration.
$\phi_{D a}$	1°/10 dB, 4° max.	Phase error due to displayed amplitude from the reference position. Amplitude resolution should be returned to 10 dB/div.

There is one additional source of error which depends on insertion mismatch of the test network and the test channel. For test networks having a SWR <1.4, this error is <0.05 dB. You may use the HP "Reflectometer Calculator" to determine this error. Ask your HP field engineer for your complementary calculator.

EXAMPLES

MAXIMUM ACCURACY

The most accurate measurements are made when signal-to-noise ratio is high and CRT errors are kept to a minimum. This means:

1. Reference power = -10 dBm (-4 dBm from sweeper). For gain measurements, the REF CHAN LEVEL meter should be reading as close as possible to the upper end of the white OPERATE region. This means that e_{M_c} and ϕ_{M_c} will be a minimum.
2. Display resolution — always 0.25 dB/div or $10^\circ/\text{div}$ (or $1^\circ/\text{div}$ when applicable). The DISPLAY REFERENCE setting will always indicate the amplitude to the nearest 1 dB, and the PHASE OFFSET switch will be set to within ten degrees of the phase angle.
3. Frequency response is calibrated out ($e_{M_f} = 0$, $\phi_{M_f} = 0$). See pages 18, 20.
4. DISPLAY REFERENCE (dB) switches are the best combination. This means, for example, that if their total is -41 dB, the switches are reading -40 and -1, not -50 and +9.

If your measurement meets these four conditions, you may refer to the example below. If not, you will need to calculate each error term individually (refer to the example, “General Case”).

SIMPLIFIED CASE

Assuming your measurement meets the four conditions above, you may determine your worst case error as follows:

$$e_{A M P L} = e_{M_c} + e_{M_d} + e_{D_m} + e_{D_l}$$

$$\phi_{P H A S E} = \phi_{M_c} + \phi_{M_d} + \phi_{D_m} + \phi_{D_l} + \phi_{D_o} + \phi_{D_a}$$

Suppose your magnitude and phase traces are the following two photos:

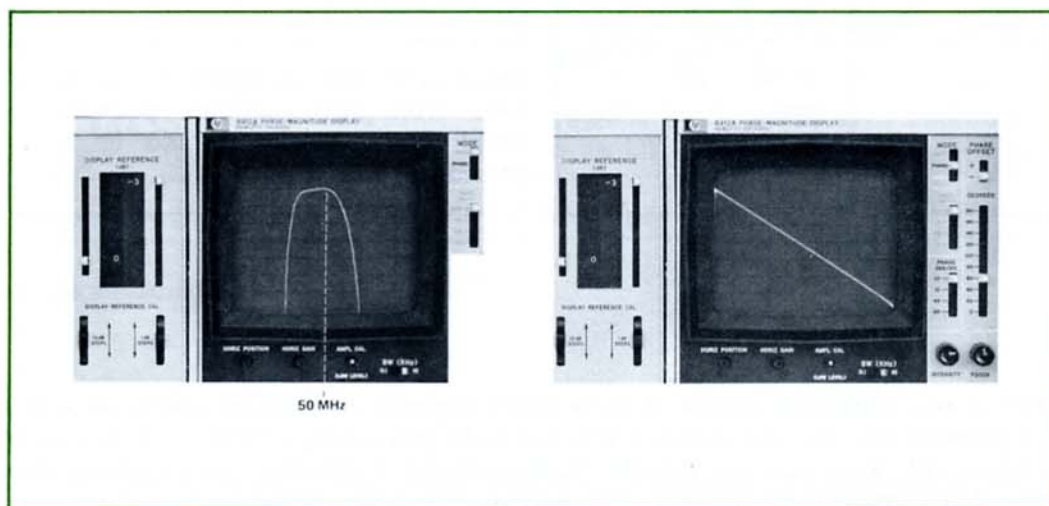

Magnitude at 50 MHz

$e_{M c}$	0	From graph on page 24.
$e_{M d}$	0.10	1 dB/step switch has moved 3 dB (0.1 dB max).
e_D	0.06	Measurement point is 0.75 dB above reference level ($0.75 \times 0.08 = 0.06$).
$e_{A M P L}$	0.16	Worst case amplitude error.

Hence the 50 MHz measurement is -2.25 ± 0.16 dB

Phase at 50 MHz

$\phi_{M c}$	0	From graph on page 24.
$\phi_{M d}$	0.6°	DISPLAY REFERENCE has moved 3 dB
$\phi_{D m} + \phi_{D l}$	0.01°	Displayed phase is 0.2° from center of screen.
$\phi_{D o}$	0.9°	The PHASE OFFSET switch is set 60° from calibration.
$\phi_{D a}$	0.07°	Displayed amplitude is 0.75 dB from reference level ($0.75 \times 1 \text{ deg}/10 \text{ dB} = 0.07^\circ$).
$\phi_{P H A S E}$	1.58°	Worst phase ambiguity.

Hence the measured phase angle is $-60.2 \pm 1.58^\circ$.

GENERAL CASE

What if your measurement is not made under the previous assumptions? In this general case, the system errors must be analyzed individually.

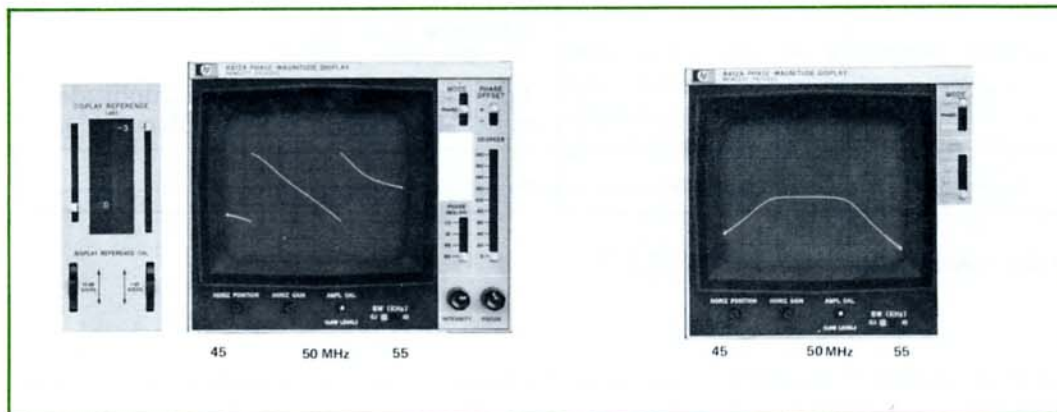

Suppose your trace looks like the above photos. Determine the accuracy of the 16 dB, -165° point measurement (at 46 MHz) as follows from Tables 5-1 and 5-2:

Magnitude

$e_{M c}$	0	The test signal at the point of measurement is 19 dB below the reference level. (REF LEVEL = -10 dBm.)
$e_{M d}$	0 0.1 dB	10 dB/step switch has been moved 0 dB 1 dB/step switch has been moved 3 dB
$e_{M f}$	0 dB	Frequency response ambiguity (could be eliminated).
$e_{D m} + e_{D 1}$	1.28 dB*	Point of measurement is 16 dB below reference line (center of screen); hence $e_D = 0.08 \times 16 = 1.28$ dB.
$e_{A M P L}$	1.38 dB	Worst case error.

So the measurement is $-19 \text{ dB} \pm 1.38^* \text{ dB}$.

Phase

$\phi_{M c}$	0°	From graph on page 24.
$\phi_{M d}$	0.6°	DISPLAY REFERENCE is set to 0, -3 ($0 \text{ dB} \times 0.5^\circ / 10 \text{ dB} = 0^\circ$ $3 \text{ dB} \times 0.2^\circ / \text{dB} = 0.6^\circ$)
$\phi_{M f}$	0°	This error is specified as 5° worst case, but you can quickly calibrate it out at any one frequency (see page 20).
$\phi_{D m} \pm \phi_{D 1}$	10.7°^*	Displayed phase is 165° below reference level ($165^\circ \times 0.065^\circ / \text{deg} = 10.7^\circ$).
$\phi_{D o}$	0	PHASE OFFSET switch has been moved 0 degree with respect to the reference position.
$\phi_{D a}$	1.6°^*	There is 16 dB of displayed amplitude at 46 MHz ($16 \text{ dB} \times 1^\circ / 10 \text{ dB} = 1.6^\circ$).
$\phi_{P H A S E}$	12.9°^*	Worst phase error.

Hence measured phase is $165^\circ \pm 12.9^\circ^*$

*This error could be reduced to approximately 0.2 dB, 3° by using the DISPLAY REFERENCE and PHASE OFFSET to move the traces as close to the center of the screen as possible.

SECTION VI REFLECTION MEASUREMENTS

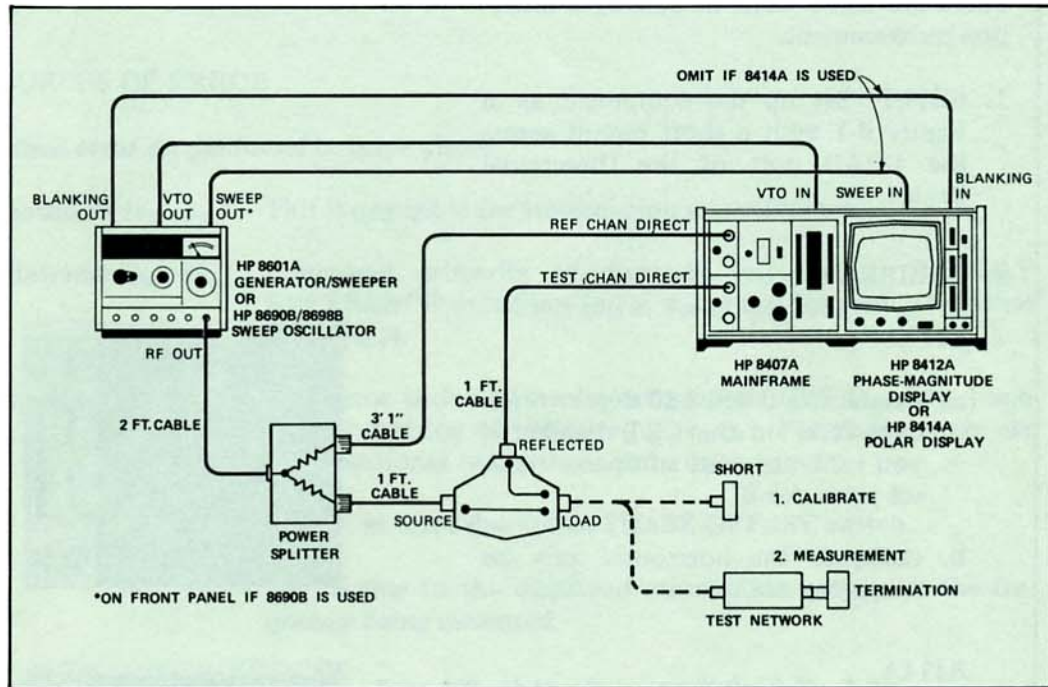

Figure 6-1. Basic Setup for Reflection Measurements

MEASUREMENT PROCESS

Notice that the power from the signal generator is once again split into two channels; a reference channel and a test channel. This time, however, the signal entering the test channel of the 8407A is the reflected signal from the input of a network rather than the transmitted signal through a network. The directional bridge separates the incident signal from the reflected signal.

The 8407A again measures the ratio between the test channel and the reference channel signals. If you use the 8412A plug-in, the CRT trace displays return loss, the ratio of reflected signal to incident signal expressed in dB. It also displays the phase shift of the reflected signal.

If you are using the 8414A Polar Display Unit, its linear readout gives you complex reflection coefficient (or complex impedance, from the Smith Chart overlay).

The 8414A displays $\hat{\Gamma} = \hat{E}_r / \hat{E}_{in}$ in polar form: When $\Gamma = 0$, the beam will be at the center of the screen; when $|E_r| = |E_{in}|$, $\rho = 1$ and the beam will be at the outer edge of the screen. ($\hat{\Gamma} = \rho e^{j\phi}$)

MEASUREMENT TECHNIQUE

There are three steps in making a reflection measurement.

1. **SETUP.** Set up the equipment as in Figure 6-1 with a short circuit across the LOAD port of the Directional Bridge.

2. CALIBRATE

8412A

- a. Establish a 0 dB, 180 degree reference level on the CRT display. If you calibrate with an open circuit, set phase for 0°.
- b. Calibrate the horizontal axis for frequency.



8414A

Adjust gain for a unity reflection coefficient at 180 degrees.



3. **TEST.** Insert your test device at the LOAD port of the directional bridge and read the value of return loss (8412A) or reflection coefficient (8414A).

Here is a detailed explanation of these steps:

SETUP

1. Set up the equipment as shown in Figure 6-1. Be sure you have placed the three foot cable between the power splitter and the REF CHANNEL input, a one foot cable between the REFLECTED port of your directional bridge and the TEST CHANNEL input, and a one foot cable between the other arm of the power splitter and the SOURCE input of the directional bridge. This is to ensure proper phase matching between the two channels.

2. Set Power Level. Decide with how much power you wish to drive your device (anywhere from -16 to -66 dBm). (See Section 9 for an extension of this requirement.)
3. Set the sweeper output for 12 dB more than this. (There is a 6 dB loss in the directional bridge and a 6 dB loss in the power splitter.) Throughout this section, we assume the sweeper is the 8601A.
4. Adjust the REF CHAN LEVEL CONTROL for a reading in the operate region of the meter. The best measurement is made when the needle is near the top of the white OPERATE portion.
5. Set Frequency controls on 8601A/8698B for a fast sweep over the range of interest.



CALIBRATE — 8412A

(If you are using the 8414A, turn to page 35.) The objective is to establish a 0 dB, 180 degree reference and to calibrate the horizontal axis for frequency.

VERTICAL CALIBRATION — MAGNITUDE

1. Set the 8412A controls as follows:

MODE switch to AMPL
AMPL DB/DIV switch to 10
BW (KHZ) to 10

2. Adjust your DISPLAY REFERENCE switch and AMPL VERNIER until your trace is at the center of the screen as shown. Adjust INTENSITY and FOCUS if necessary.

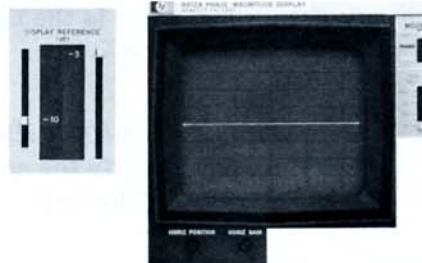

From now on the term “center of the screen” will mean the horizontal graticule line which is midway between the top and bottom graticule lines. This is the position about which the amplitude and phase resolution switches expand the trace on the screen.

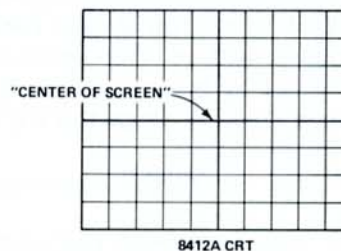

Eliminating Frequency Response

1. Increase the AMPL dB/DIV switch until you get maximum resolution on the screen, which is 0.25 dB per division. Use your AMPL VERNIER to make sure that the trace is at the center of the screen. The trace you are looking at is the frequency response of your calibrated system. The flat frequency response is one of the most important features of the 8407A. What this means is that the return loss measurements you make will be very accurate, because your system is not contributing an appreciable amount of error due to frequency response. You should always try to eliminate the frequency response by using the AMPL VERNIER.

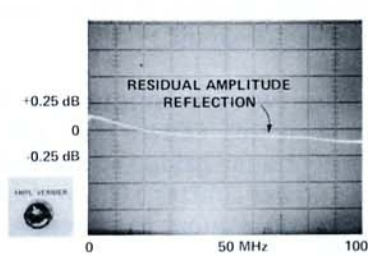

Return the AMPL dB/DIV switch to 10.

Zero dB Set

1. Adjust the DISPLAY REFERENCE CAL thumbwheel until 0 appears in both windows. Throughout your measurement, the numbers in the window will tell you how many dB above or below 0 dB reference level the center of the screen is. This will be true for any change you make in the DISPLAY REFERENCE switch.



This feature of the 8407A allows you to very quickly identify the amount of return loss at any frequency.

VERTICAL CALIBRATION — PHASE

Since we are calibrating with a short, we want to set the display for 180 degrees of phase shift so that additional phase shift caused by inserting the test device may be read directly from the CRT. Here's how:

1. Set the MODE switch to PHASE.
2. Set the PHASE DEG/DIV to 90.

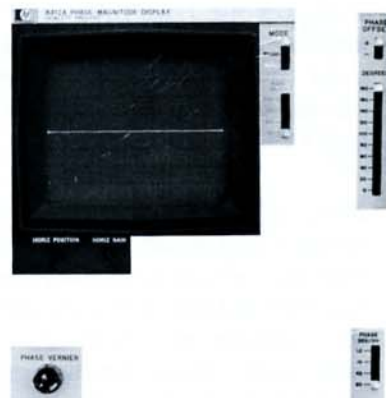

- Adjust the PHASE DEGREES switch to 180 and the PHASE VERNIER so that the display is very nearly in the center of the screen.

Eliminating Frequency Response

- Increase the resolution (PHASE DEG/DIV) upward one step at a time, using the PHASE VERNIER to keep the CRT trace in the center of the screen.

The trace on your screen is now displaying the residual response of the system. The nearly flat trace means that you can forget about system frequency response. You may reduce frequency response to zero degree at any frequency by using the PHASE VERNIER.

- Set the PHASE DEG/DIV switch to its bottom position.
- Return the MODE switch to the AMPL position.

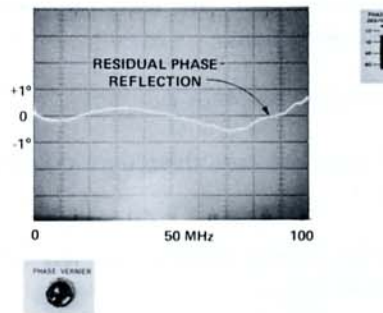

HORIZONTAL CALIBRATION — FREQUENCY

Adjust the HORIZ GAIN and HORIZ POSITION controls on the 8412A for a calibrated frequency display.

Because of the excellent linearity (0.5 percent) and frequency accuracy (one percent of frequency) of the 8601A and the 8698B, you can adjust the trace so that you may read frequency directly off the graticule. The HORIZ POSITION control moves the starting point of the trace and the HORIZ GAIN control sets the length of the trace. The correct setting depends upon which SWEEP MODE you are in. Here are two examples:

VIDEO Mode. The sweep is from 1 — 10 MHz, so you start your trace one division from the left. You are now calibrated for 1 MHz/division.

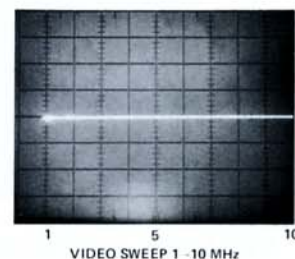

SYM Mode. Here we are sweeping 10 MHz, from 45 to 55 MHz. So we use all ten divisions (1 MHz/div).

What you have established is a ratio of unity between the reference and test channels and 180 degrees phase difference between the channels and you have calibrated the horizontal axis for frequency. You are now ready to make the measurement.

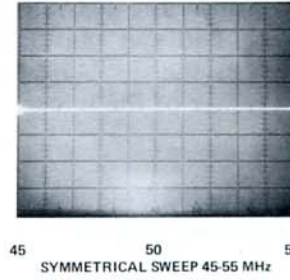

MEASUREMENT

Insert the test device at point A in Figure 6-1.

The screen shows you 40 dB of return loss.

NOTES

1. Be sure the UNCAL light is not lit. If it is, refer to page 46.
2. Be sure to sweep slowly enough to avoid CRT trace desensitization.

Increasing Resolution

One of the advantages of the 8407A is being able to observe very small variations in amplitude and phase. The only thing to keep in mind is that the resolution switches (AMPL DB/DIV and PHASE DEG/DIV) expand the trace with respect to the center of the screen, no matter what value of return loss it represents. Use the DISPLAY REFERENCE switch and the PHASE switch to move the amplitude and phase traces to the center of the screen. Then gradually increase resolution.

NOTE

The maximum resolution for any phase angle from zero to 360 degrees is $10^\circ/\text{div}$. However, the 8412A phase resolution has a $1.0^\circ/\text{div}$ setting to enable you to look at small variations in phase response of the reflected signal. Use the PHASE VERNIER and PHASE OFFSET to achieve an on-screen display.

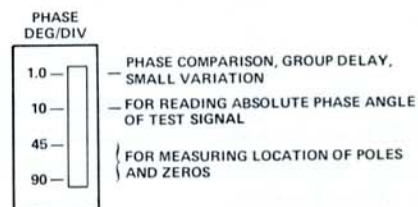

Bandwidth Switch

Notice what happens if you set the bandwidth (BW kHz) switch to 0.1 instead of the 10 kHz position. You have filtered out high frequency noise so your trace appears to be a much sharper line.

This means that for very low level measurements you will be able to identify your test signal much easier than you could without this filter.

8414A

CALIBRATION

The objective is to establish a known reflection coefficient on the screen so that all the measurements you make are made with respect to this known reflection. Since we calibrate with a short circuit, we establish a reflection coefficient of magnitude 1 and phase angle of -180 degrees for all frequencies of interest. Place the short circuit at the load port of your directional bridge.

Low Level Calibration

1. Push the BEAM CENTER button and keep it depressed. Adjust the HORIZ and VERT position controls until the spot is right at the center of the screen. (By pushing this red button, you simulate a perfect 50 ohm load, so you are calibrating for low level signals by making this adjustment.)

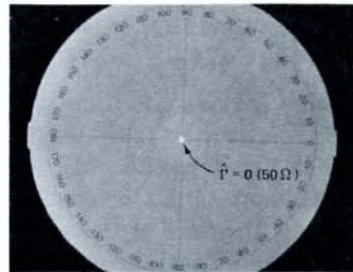

Full Scale Calibration

1. Release the BEAM CENTER. The dot should move to the left of the screen. If it disappears, you probably have too much gain in your test channel, so lower the display reference switches until the trace reappears. (Make sure that you have enough intensity.)
2. Adjust the DISPLAY REFERENCE position switches until the CRT spot is right at 1 at -180 degrees. You may have to use the AMPL and PHASE VERNIERS to accomplish this.
3. Check to see that the 50 ohm position is still valid by pushing the BEAM CENTER.



MEASUREMENT

You have now calibrated the system for impedance measurements and you can look at any of your test devices by simply replacing the short circuit with the test device. If your test device has two ports, be sure the output is terminated.

Increasing Resolution

In order to increase resolution:

1. Set the sweep mode to MANUAL.
2. Adjust the FREQUENCY to the value of interest.
3. Reduce the INTENSITY and adjust the FOCUS for a very small dot.
4. Adjust your DISPLAY REFERENCE attenuator until the dot moves to the outer edge of the screen.

The algebraic sum of your 10 dB step and your 1 dB step attenuator gives you the return loss of the filter at the frequency of interest. You can measure return losses up to 30 dB with this technique, which is the practical upper limit for resolution with the 8414A.

Notice that as you increase the gain in the TEST channel (the DISPLAY REFERENCE switch), the full scale reflection coefficient is no longer unity. Here is a table with some of the values of reflection coefficient that the outer circle becomes with difference amounts of DISPLAY REFERENCE gain.

IF GAIN (dB)	FULL SCALE REFLECTION COEFFICIENT
6	0.5
14	0.2
20	0.1
26	0.05

Smith Chart Plots

You may use the 8414A Smith Chart graphic overlays to read the complex impedance of your test device.

If you wish to make a permanent recording, the HORIZ and VERT outputs of the 8414A are used with a graphic recorder.

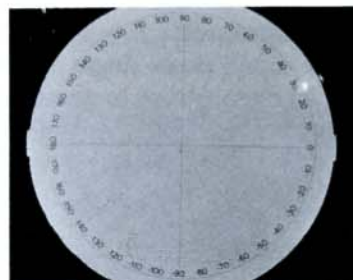

Example of increased resolution. Measurement is $-20 + 6 = 14$ dB return loss at $+27^\circ$.



EXAMPLE OF SMITH CHART PLOT OF IMPEDANCE

REFLECTION MEASUREMENT ACCURACY

Measurement accuracy varies according to each application; this analysis explains the general procedure.

SOURCES OF ERROR

System error can be found in three places:

Transducer (e_T, ϕ_T) Due to directivity of the directional bridge and a term for LOAD port match.

Mainframe (e_M, ϕ_M) Composed primarily of crosstalk (e_{M_c}, ϕ_{M_c}) DISPLAY REFERENCE excursion (e_{M_d}, ϕ_{M_d}) and frequency response (e_{M_f}, ϕ_{M_f})

Display (e_D, ϕ_D) 8412A: This error is due to nonlinearity of the CRT (e_{D_1}, ϕ_{D_1}) and accuracy of log amplifier (e_{D_m}, ϕ_{D_m}). For phase, there are two additional terms: ϕ_{D_o} and ϕ_{D_a} .

ϕ_{D_o} is an error due to the PHASE OFFSET switch

ϕ_{D_a} is due to the displayed attenuation or gain at the frequency being measured.

8414A: Polar Display error is due to CRT non-linearity and measurement inaccuracy. The error is contained within a 3 mm radius of the measurement point. Since the radius of the screen is 50 mm, the display error is always ± 6 percent of the full scale value of reflection coefficient.

The maximum* ambiguity of the measurement would be the sum of all applicable error terms, depending on the display.

*Errors are seldom worst case but more typically the RMS value.

ERROR TERMS

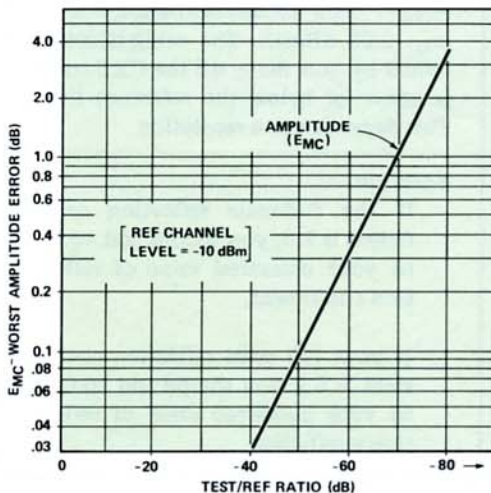

AMPLITUDE

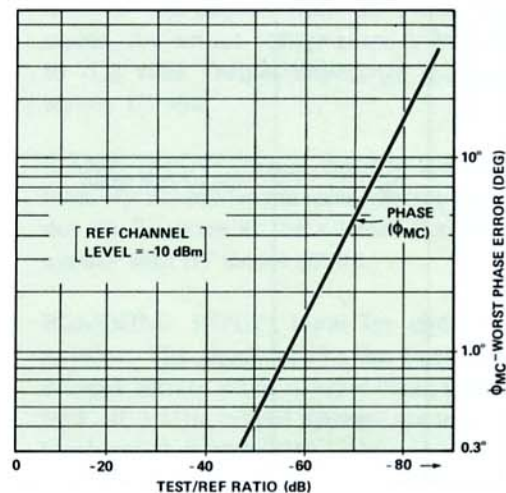

PHASE

Table 6-1 lists the error terms you should use. For e_D , ϕ_D , use the proper term depending on whether your display is the 8412A Phase-Gain Indicator or the 8414A Polar Display.

Table 6-1. Magnitude

Error Term	Formula	Explanation	
e_T	$0.01 + 0.03 \rho^2_{meas}$ (Figure 6-2 is a plot of e_T in dB. Figure 6-3 is a plot of e_T in terms of ρ .)	Due to directivity of the bridge (0.01) and LOAD port mismatch error ($0.03 \rho^2_{meas}$). ρ_{meas} is the magnitude of reflection coefficient $\rho_{meas} = \text{antilog} \frac{\text{return loss}}{20}$	
e_{Mc}	(See Amplitude graph, page 37.)	Error due to low level residual signals. If your REFERENCE channel level is not -10 dBm, you must account for the difference. For example, if your TEST/REF ratio is measured as -32 dB, but your REFERENCE channel level is -30 dBm, you would enter the graph with an abscissa of -32, -20, -12 = -64 dB. (Note: Abscissa = (sweeper deviation from -10 dBm) -18 dB + (TEST/REF RATIO). (See page 44.)	
e_{Md}	(0.05 dB/1 dB step; 0.1 dB max) + (0.1 dB/10 dB step; 0.25 dB max)	DISPLAY REFERENCE error. Determine error by observing the numbers in the windows for your measurement (relative to the 0 dB reference position).	
e_{Mf}	0.2 dB 0.1 – 116 MHz; 0.05 dB any 10 MHz portion	This frequency response term may be calibrated out at any frequency (see page 32).	
8 4 1 2 A	$e_{Dm} + e_{Dl}$	0.08 dB/dB	This term is due to measurement error ($e_{Dm} = 0.05$ dB/dB) and display error ($e_{Dl} = 0.03$ dB/dB). The value is determined by how many dB the CRT trace is above or below the reference line. This depends upon resolution.
8 4 1 4 A	e_D	6% of full scale	Example: If the full-scale reflection coefficient is 1.0, you should add ± 0.06 to your measured value of reflection coefficient. If your full scale reflection coefficient is 0.2 you should add ± 0.012 to your measured value of reflection coefficient.

Table 6-2. Phase

Error Term	Value	Explanation	
ϕ_T	$\sin^{-1} \left(\frac{0.01 + 0.03 \rho_{meas}^2}{\rho_{meas}} \right)$ <p>Figure 6-4 is a plot of ϕ_T as a function of return loss; Figure 6-5 is a plot of ϕ_T as a function of measured reflection coefficient.</p>	<p>Due to the directivity of the bridge (0.01) and mismatch ($0.03 \rho_{meas}^2$)</p> <p>ρ_{meas} = magnitude of reflection coefficient</p>	
ϕ_{Mc}	(See Phase graph, page 37.)	<p>Phase ambiguity due to low level residual signals. If your REFERENCE channel level is not -10 dBm, you must account for the difference. For example, if your TEST/REF ratio is measured as -32 dB, but your REFERENCE channel level is -30 dBm, you would enter the graph with an abscissa of -32, -20, -12 = -64 dB. (Note: Abscissa = (sweeper deviation from -10 dBm) -18 dB + (TEST/REF RATIO). (See p. 44.)</p>	
ϕ_{Md}	$(0.2^\circ / 1 \text{ dB step; } 1^\circ \text{ max})$ $+ (0.5^\circ / 10 \text{ dB step; } 3^\circ \text{ max})$	<p>Phase error due to position of DISPLAY REFERENCE. (The numbers in the windows indicate how many dB the DISPLAY REFERENCE has been moved relative to the reference position.)</p>	
ϕ_{Mf}	$5^\circ \text{ } 0.1 - 116 \text{ MHz } \pm 2^\circ$ over any 10 MHz portion.	This frequency response error may be calibrated out (see page 33).	
8 4 1 2 A	$\phi_{Dm} + \phi_{Dl}$	0.065 deg/deg	<p>This display error is due to measurement ambiguity ($\phi_{Dm} = 0.05 \text{ deg/deg}$) and display linearity ($\phi_{Dl} = 0.015 \text{ deg/deg}$) and may be calibrated out with an X-Y recorder using rear outputs. Determine how many degrees the CRT trace is above or below the reference level (depends on resolution) and multiply by 0.065.</p>
	ϕ_{Do}	0.30/20 degree step, 3° max	Phase error due to position of PHASE OFFSET relative to calibration.
	ϕ_{Da}	$1^\circ / 10 \text{ dB, } 4^\circ \text{ max}$	Phase error due to display amplitude from the reference position. Amplitude resolution should be returned to 10 dB/div.
8 4 1 4 A	ϕ_D	$\text{Sin}^{-1} \left(\frac{e_D}{\rho_{meas}} \right)$ <p>ϕ_D is plotted in Figure 6-6.</p>	<p>This term is minimized by making the measurement as close to the outer edge of the screen as possible. (e_D / ρ_{meas} is then 0.06 $\therefore \phi_D = 3.4^\circ$)</p>

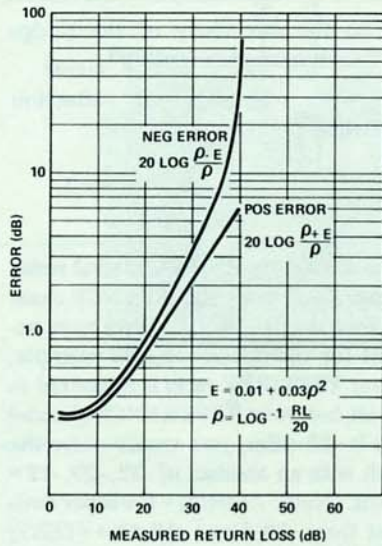

Figure 6-2. Plot of Transducer Error (e_T) as a function of return loss.

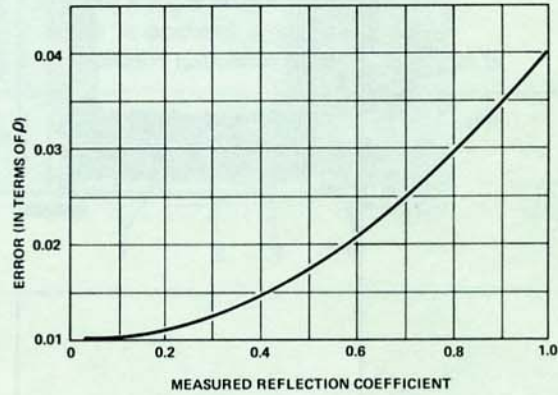

Figure 6-3. Plot of Transducer error (e_T) as a function of reflection coefficient.

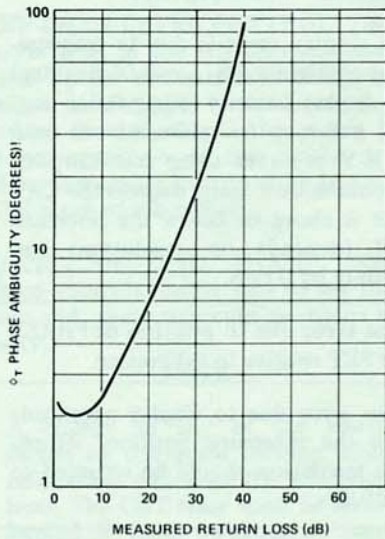

Figure 6-4. Plot of Transducer Phase Error (ϕ_T) as a function of return loss.

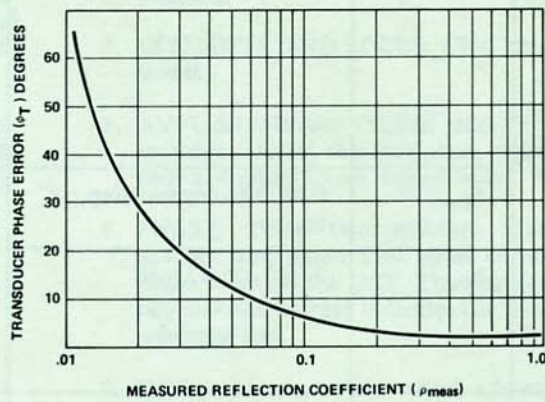

Figure 6-5. Plot of Transducer Phase Error (ϕ_T) as a function of reflection coefficient.

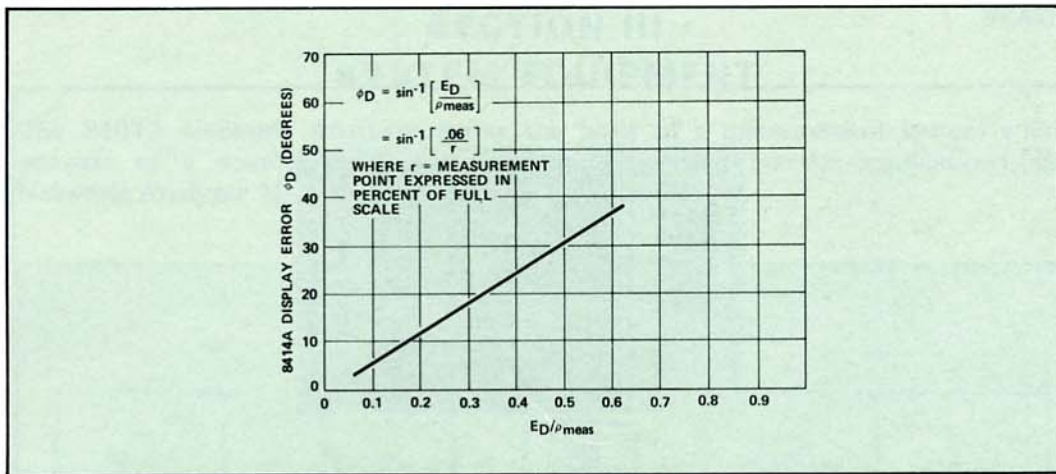
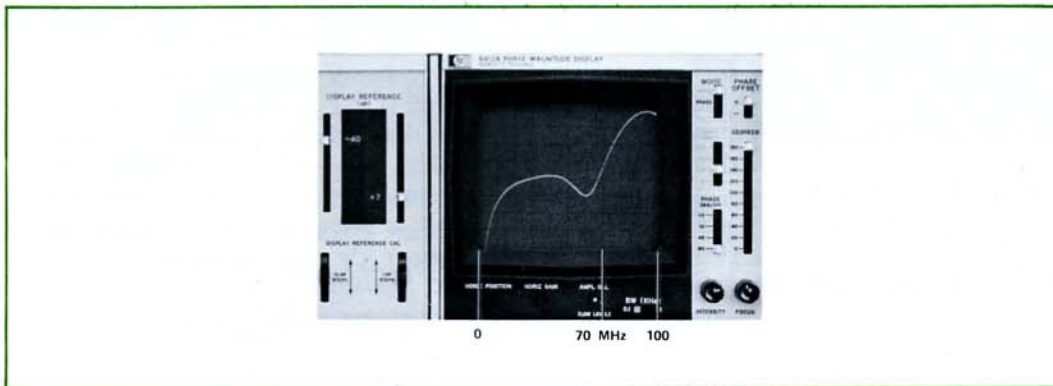

Figure 6-6. Graph of Phase Ambiguity due to LOAD Port Mismatch

EXAMPLE: 8412A
MAGNITUDE

At 70 MHz, the return loss is $-33 + 1.5 = -31.5$ dB. Calculating each error term results in the following table:

e_T	+2.75 -4.2	From Figure 6-2. Use 31.5 as abscissa value and read two values of e_T .
e_{Mf}	0	The frequency response has been observed and calibrated out.
e_{Mc}	0	From graph of e_{Mc} in Table 6-1.
e_{Md}	0.25 0.1	10 dB/step switch is set to -40 1 dB/step switch is set to +7
e_D	0.12	Measurement point is 1.5 dB from reference level.
e_{AMPL}	+3.22 -4.58	Maximum amplitude ambiguity.

PHASE

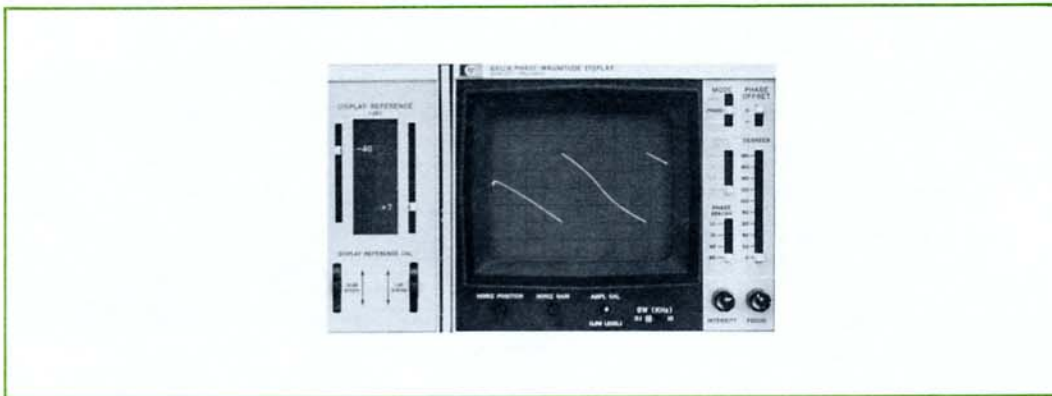

Here is the phase trace corresponding to the above amplitude trace. At 70 MHz, the phase is -74° . The ambiguity is calculated in the following table:

ϕ_T	22°	From Figure 6-4 corresponding to 31.5 dB.
ϕ_{Mf}	0	Frequency response has been calibrated out at 70 MHz.
ϕ_{Mc}	0	From graph of ϕ_{Mc} in Table 6-2.
ϕ_{Md}	$2^\circ*$ 1°	Phase error due to position of DISPLAY REFERENCE $40 \text{ dB} \times \frac{0.5^\circ}{10 \text{ dB}} = 2^\circ$; $7 \text{ dB} \times \frac{0.2^\circ}{1 \text{ dB}} = 1.4^\circ$ but maximum error is 1°
$\phi_{Dm} + \phi_{Dl}$	$4.81^\circ*$	Error due to displayed phase from reference ($0.065 \text{ deg/deg} \times 74^\circ = 4.81^\circ$).
ϕ_{Do}	$3^\circ*$	PHASE OFFSET is 180 degrees from calibration (with short). This error would have been less if we had calibrated with an open.
ϕ_{Da}	0.15	Displayed amplitude from reference position is only 1.5 dB.
ϕ_{PHASE}	$32.96^\circ*$	Maximum Phase Ambiguity

*How could we have improved the accuracy?

1. Selecting a better combination of DISPLAY REFERENCE to reduce ϕ_{Md} .
2. Using PHASE OFFSET to reduce displayed phase from reference level ($\phi_{Dm} + \phi_{Dl}$).
3. Calibrating with an open circuit (PHASE OFFSET would have moved only 60° , reducing ϕ_{Do}).

These three steps would reduce ϕ_{PHASE} by approximately 7.5° .

SECTION VII QUESTIONS AND ANSWERS

PERFORMANCE CHECKS

Q *Are there any performance checks I should make?*

The following performance checks ensure proper operation of the system and only need to be performed every few weeks. The sweep should be full band (1–110 MHz) and the sweeper power level should be -10 dBm.

- a. Follow the normal calibration procedure starting on page 17.
- b. LINEARITY CHECK.

Notice the linearity of the CRT. When you move the left hand switch you advance the trace by one full division or 10 dB. The right hand switch gives you 1 dB increments. Each vertical division represents exactly 10 dB (with the AMPL DB/DIV switch set at 10). You don't need a grease pencil to identify different increments of attenuation. Return the trace to the center of the screen (0 dB position).

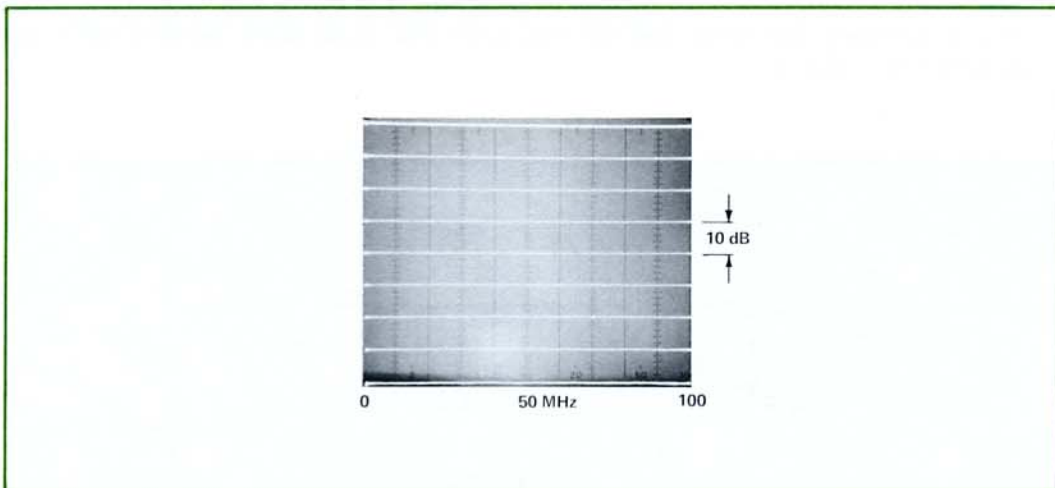

Figure 7-1. Photo of display linearity. Vertical calibration: 10 dB/div. Horizontal Calibration: 1 – 100 MHz.

Should the vertical gain need adjusting, refer to the 8412A Operating and Service Manual.

- c. LOW LEVEL CALIBRATION CHECK.

Move the test channel cable to the ATTEN input. Terminate the DIRECT input with 50 ohms. The trace should drop by 40 dB (four divisions). If it does not, adjust the LOW LEVEL AMPL control until the trace lines up with the bottom horizontal graticule, as in Figure 7-2.



Figure 7-2. Shows how trace should line up with bottom graticule if LOW LEVEL AMPL is adjusted properly.

Return the cable to the DIRECT input.

TRANSDUCERS

Q What is the relationship between input and output power levels of the transducers?

The power splitter has 6 dB of loss in each arm. The directional bridge has 6 dB of loss between the input and the load port, and 6 dB more between the load port and the output.

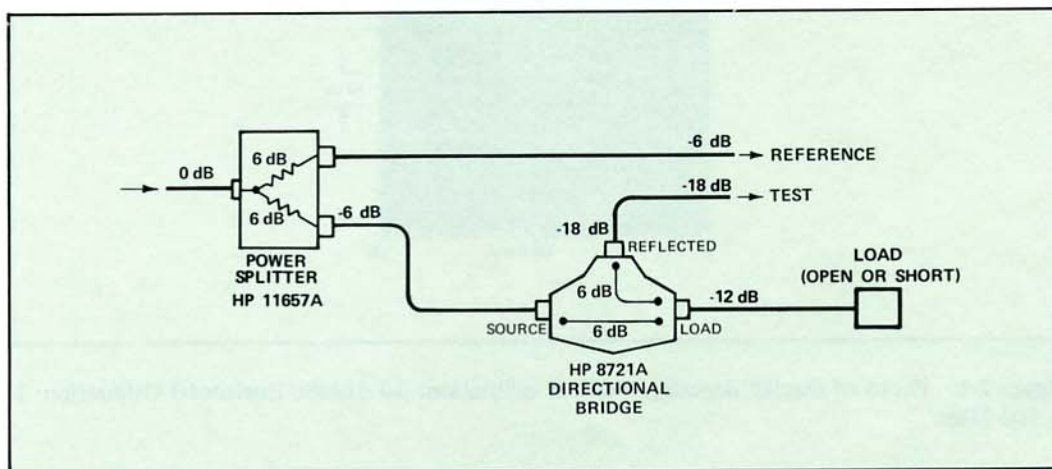

Figure 7-3. Block diagram showing how directional bridge and power splitter affect signal levels in a reflection setup, when load is either an open or short circuit.

Q Why are there special cables for the transducer kit?

The cables supplied with the 11652A Reflection-Transmission kit have been carefully matched for electrical length. They are also shielded to reduce cross-talk.

Be sure to keep them separate from other cables. They have been color coded and marked with a HP Part Number for easy identification.

OPERATION — 8407A

This section discusses the different combinations of input connectors and proper positions of front panel controls needed for various test and reference signal conditions.

INPUT CONNECTORS



Q *What signal levels will the 8407A accept?*

The REFERENCE channel will operate properly for signals between -10 and -60 dBm. If you're using the ATTEN 40 dB input, your REFERENCE signal may be between +20 and -20 dBm. (+20 dBm is the maximum power rating of the system). Damage Level: +26 dBm.

Q *What is the optimum signal level to use?*

For attenuation or reflection measurements, the best signal-to-noise ratio occurs when the reference signal is -10 dBm. Since the crosstalk and noise level of the system is approximately -100 dBm, you may make 80 dB attenuation measurements with good accuracy. For gain measurements, calibrate with the largest signal possible which will still allow the dynamic range you need. Table 7-1 lists the available dynamic range and the proper inputs to use for various sweeper output levels.

Table 7-1. Table of suggested combination of inputs and REF CHAN LEVEL settings for various sweeper output levels. Optimum levels for best signal-to-noise ratio are indicated.

GAIN

Sweeper Output Level (dBm)	Possible Dynamic Range (dB)	REF Input	TEST Input	REF Channel Switch Position
-4	0 to 30	DIR	Atten	Bottom
-24	0 to 50	DIR	Atten	Middle
-44	0 to 40	DIR	DIR	Top
	40 to 70	DIR	Atten	Top
-54	0 to 50	DIR	DIR	Top
	50 to 80	DIR	Atten	Top

ATTENUATION

Sweeper Output Level (dBm)	Possible Dynamic Range (dB)	REF Input	TEST Input	REF Channel Switch Position
+16	0 to 70	Atten	Atten	Middle
	70 to 100	Atten	DIR	Middle
-4	0 to 80	DIR	DIR	Bottom
-24	0 to 60	DIR	DIR	Middle
-44	0 to 40	DIR	DIR	Top

Q *How do you know which combination of input connectors to use?*

Use the DIRECT inputs whenever the signal levels at the input of the 8407A will be -10 dBm or less. If either REF or TEST channel signal is between -10 and +20 dBm, use the respective ATTEN input (see Table 7-1).

After selecting the proper input, always adjust the REF CHAN LEVEL switch until the needle is in the white OPERATE region. For best signal-to-noise ratio, keep the needle near the top of the white range.

Once you have calibrated the system, changing these controls will affect your calibration. (See page 47.)

Q *How can I adjust the thumbwheel switches so that I remain calibrated?*

Please see page 47.

Q *What is the accuracy of the 40 dB ATTEN inputs?*

The value of attenuation is typically 40 dB \pm 0.5 dB.

REF CHAN LEVEL



Q *What do I do if the red UNCAL light comes on?*

The red light will glow if either one of the following conditions exists:

- a. TEST channel level is too high.

Remedy: Reduce the sweeper output level, or change TEST input to ATTEN. Recalibrate for 0 dB at this new setting. (Place termination on DIRECT input.)

- b. Ratio of TEST/REF channels is too high.

Remedy: Change the test channel input to ATTEN and terminate DIRECT input. Recalibrate for 0 dB at this new setting.

and/or:

Increase REF CHAN LEVEL by moving the ADJ slide switch upward or moving the REF input from ATTEN to DIRECT.

Section VIII discusses the measurement process inside the instrument.

Q Suppose I change the combination of DIRECT or ATTEN inputs and the REF CHAN LEVEL ADJ. How can I recalibrate the instrument without having to start over?

- Here are the basic principles (the following ambiguities are typical values):
 - The vertical position of the 8412A CRT display is always *directly proportional* to the test channel signal and *inversely proportional* to the reference channel signal.
 - The ADJ slide switch increases the reference channel signal 20 dB \pm 0.5 dB per step. So moving the slide switch from bottom to top increases the reference channel signal 40 dB \pm 1.0 dB. Hence, the trace on the screen will move up for the following reasons related to the INPUTS or REF CHAN LEVEL:
 1. You move the TEST CHANNEL input from ATTEN to DIRECT.
 2. You move the REF CHANNEL input from DIRECT to ATTEN.
 3. You move the ADJ slide switch downward.

The 8412A trace will move downward for the following reasons associated with the INPUT or REF CHAN LEVEL:

1. You change TEST CHANNEL input from DIRECT to ATTEN.
2. You change REF CHANNEL input from ATTEN to DIRECT.
3. You increase the reference channel signal by moving the ADJ slide switch upward.

Example:

Suppose you calibrate for 0 dB at the center of the screen using both DIRECT inputs. There is sufficient generator power so that the slide switch produces an adequate OPERATE level in the bottom position.

Suppose further that you are testing a device which has 100 dB insertion loss. Your test signal is now buried in noise. How can you make the measurement?

1. Increase sweeper power to +20 dBm. The meter will indicate REF channel is too high.
2. Move REF CHANNEL input to ATTEN. The trace will move up by 40 dB \pm 0.5 dB.
3. Since the REF CHAN LEVEL meter will now be indicating a low signal, you will need to move the ADJ slide switch upward.

CASE 1

If you move the switch up by one notch, the total change in reference channel signal is $-40 \text{ dB} \pm 0.5 \text{ dB} + 20 \text{ dB} \pm 0.5 \text{ dB} = -20 \text{ dB} \pm 1.0 \text{ dB}$. This means the trace will be at a position 20 dB higher than what it was, even though it represents the same ratio as before. In other words, if your trace represented -100 dB before the change of input conditions, you still want it to represent -100 dB after the change. What you must do is change the thumbwheel so that the center of the screen is 20 dB lower than it was

before. For example, suppose that the windows are displaying -60 dB as the value of the center of the screen and you make the above -20 dB change in reference channel level. The trace will move up 20 dB meaning that the center of the screen is now -80 dB. Make the appropriate adjustment in the thumb-wheel.

You must also account for the additional ambiguity of your measurement:*

MAGNITUDE

- ±0.5 dB — ATTEN input accuracy
- ±0.5 dB — ADJ switch accuracy (±0.5 dB per step)
- ±1 dB — AGC error caused by net 20 dB change in reference channel level

- *±2.0 dB — additional ambiguity of measurement

PHASE

- ±2 deg — ATTEN input accuracy
- ±2 deg — ADJ switch accuracy
- ±0.8 deg — reference channel AGC ambiguity

- *±4.8 deg — total additional phase ambiguity of measurement.

CASE 2

Now suppose that the 40 dB drop in the reference channel due to the attenuated input is offset by a 40 dB increase in gain by moving the ADJ slide switch upward two divisions.

The calibration of the CRT remains unchanged and you simply calculate the additional ambiguity of the measurement.

MAGNITUDE

- ±0.5 dB — ATTEN input accuracy
- ±1.0 dB — ADJ switch accuracy for two steps
- 0 dB — AGC change is negligible

- *±1.5 dB

PHASE

- ±2 deg — ATTEN input accuracy
- ±4 deg — ADJ switch accuracy for two steps
- 0 deg — AGC change is negligible

- *±6 deg — Could be calibrated out of the measurement

*These additional ambiguities are typical values only. They may be eliminated if you make these adjustments during calibration, or if you can remove your test device without overloading either channel.

DISPLAY REFERENCE



Q *What do the numbers in the windows mean?*

After calibrating for a 0 dB condition on a particular graticule (usually the center graticule, since the resolution controls always expand the trace with respect to the center), the numbers in the windows will always read the value of gain or attenuation represented by the calibration graticule. (Of course, if the input connectors are changed or the REF CHAN LEVEL-ADJ slide switch is changed, the calibration is no longer valid. Please refer to page 47 for the procedure for recalibrating.

AMPL VERNIER; PHASE VERNIER



Q *When should I use these verniers?*

Only when calibrating or when absolute calibration is no longer important. Using these verniers during the measurement will upset the calibration.

CRT ADJUSTMENT CONTROLS; BW (kHz) SWITCH



Q *What is the BW (kHz) switch for?*

This is a post-detection filter which improves the sharpness of the trace on the screen. Always make sure that you are sweeping slowly enough to avoid desensitization.

Q *What is the AMPL CAL (low level) used for?*

To calibrate the CRT for small test signals. It is needed only occasionally. Refer to page 43.

OPERATION — 8412A

MODE



When in the DUAL mode, the amplitude trace is brighter than the phase trace.

PHASE OFFSET — DEGREES



Q *What should I know about Calibration?*

Phase calibration is usually zero degree for a transmission measurement and 180 degrees for a reflection measurement. After calibrating, the succeeding positions of the slide switch will always indicate the phase value of your calibration graticule. For instance, in the picture above, the calibration graticule represents +80 degrees of phase shift. You would then add or subtract additional phase shift to reach your trace, depending upon whether the trace was above or below your calibration graticule.

NOTE

When making some reflection measurements you can reduce the phase ambiguity of your measurement by calibrating with an open circuit (zero degree reference level). Test signals with phase shifts close to zero degree are thus measured with better accuracy.

MAGNITUDE AND PHASE RESOLUTION



Q *Which phase resolution should I use?*

The phase resolution switch has four settings: 90, 45, 10 and 1 degree per division.

90°, 45°. These positions are most useful for observing general linearity patterns and poles and zeroes of networks.

10°. This is the ideal position for reading absolute phase shift with respect to the reference channel. Use the PHASE OFFSET switch to move the unknown phase angle to the center of the screen. This assures you of best accuracy.

1°. This position is for observing small variations in phase between two frequencies. For example, when calculating group delay or matching cables for phase response, the 1°/div setting allows you to read small phase differences very accurately.

DYNAMIC RANGE

Q *How do I make >80 dB measurements?*

The procedure involves adjusting the power from the sweeper and using the ATTEN inputs. An example of how to make wide dynamic range measurements begins on page 47.

NOTE

When testing amplifiers, make sure the output from the amplifier does not exceed +20 dBm (damage level of the 8407A is +26 dBm).

Table 7-1 lists the proper input power levels for various input connector combinations.

WIDER SWEEP WIDTHS

Q *Can I extend the frequency range of the system?*

Since the HP 8601A or 8698B sweeper is needed for operation, the frequency range of the system is determined by the sweeper specifications, i.e., 1–116 MHz with 8601A; 0.4–110 MHz with 8698B.

Q *What about wider symmetrical sweep widths when using the 8601A?*

Symmetrical sweep widths of greater than 10 MHz are easy to obtain. Just use a dc power supply to apply bias to the EXTERNAL FM input on the sweeper. The sensitivity is 5 MHz/volt, 0 to -22 volts.

Set the mode to VIDEO and adjust the frequency dial to read the desired sweep width plus 1 MHz. (Remember, the sweeper starts at 1 MHz instead of 0 MHz.)

Use an 11 MHz counter, such as HP 5321B, to determine when this video sweep has been shifted to the starting frequency of interest.

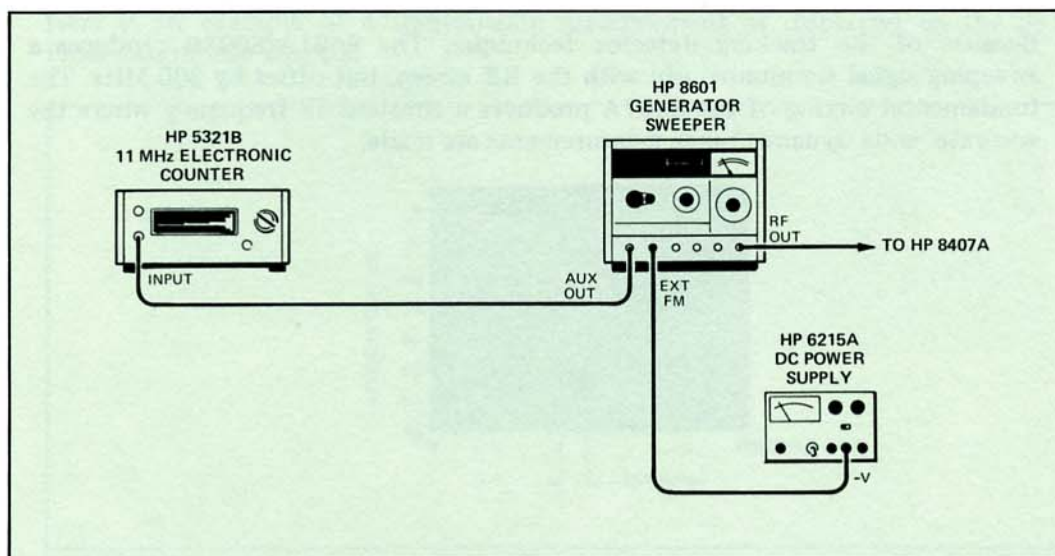

Figure 7-4. Setup for Increasing Symmetrical Sweep Width

ACCURACY

Q *How can I improve my accuracy?*

The most accurate measurements are made under the following conditions:

- a. Sweeper output is -4 dBm, with the REF CHAN LEVEL meter indicating near the top of the OPERATE range.
- b. The trace on the 8412A is as near as possible to the center of the screen.
- c. The resolution is maximum (0.25 dB/div for amplitude, and either 10°/div or 1°/div for phase). The calibrated DC outputs on the rear panel of the 8412A improve resolution and accuracy still further.
- d. Residual amplitude and phase response have been calibrated out.

Q *How can I read frequency more accurately?*

There are auxiliary outputs on the 8601A and 8698B sweepers which can be used with an 11 MHz counter such as HP 5321B Electronic Counter to determine frequency to at least five places.

Q *Can I cancel out the directivity vector?*

This cannot be done since the technique involves using a sliding load. These are not available in the frequency range 0.1–110 MHz.

NOTE

See also the examples of accuracy calculations in the Transmission Measurement and Reflection Measurement sections.

SOURCES

Q *Why must the source used with the 8407A be either an 8601A or 8698B?*

Because of the tracking detector technique. The 8601A/8698B produces a sweeping signal simultaneously with the RF sweep, but offset by 200 MHz. The fundamental mixing of the 8407A produces a constant IF frequency where the accurate, wide dynamic range measurements are made.

SECTION VIII THEORY OF OPERATION

Refer to the last page fold-out.

8407A

The basic scheme of the 8407A circuitry is to convert the sweeping RF signals to a constant IF frequency so that accurate magnitude and phase measurements can be made over a wide dynamic range. Let's look closer.

PHASE LOCK LOOP.

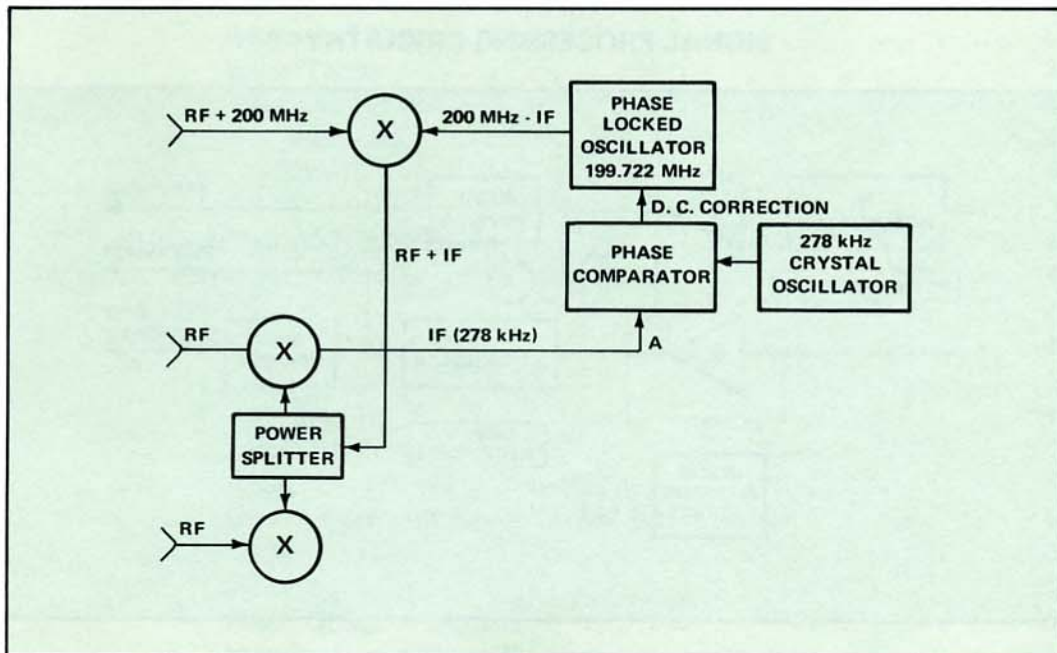

Figure 8-1. Phase Lock Loop

Objective: To convert RF to constant IF frequency. Why?

- a. To simulate a narrow band measurement at any frequency.
- b. To make very accurate substitution measurements.
- c. To make log detection meaningful over a broad frequency range.

Technique:

As the 8601A/8698B is sweeping from 0.1 — 110 MHz, the voltage tuned oscillator (VTO) in the 8601A/8698B is simultaneously sweeping from 200.1 to 310 MHz. In other words, $f_{VTO} = RF + 200 \text{ MHz}$. This signal is fed into one side of a mixer in the 8407A. The other side of the mixer is receiving f_{PLO} , a (200 MHz-IF) signal from the phase locked oscillator (PLO) in the phase lock loop. The difference frequency is retained (RF + IF).

This RF + IF signal is amplified and split into two channels. The two signals then are sent into one side of the input mixers of the 8407A. The other side of the input mixers receives the RF signals from the reference and test channel inputs. The mixing result is a constant IF frequency.

This signal is held at 278 kHz in this way: a sample of the IF signal is always present at point A, which is one side of a phase comparator. This frequency is compared to a very stable 278 kHz crystal oscillator. If the phase lock oscillator (PLO) starts to drift, the IF frequency would start to change. But the phase comparator would send a dc error voltage to the varactor-tuned PLO, causing it to readjust to exactly 200-IF (199.722 MHz).

The end result is always a constant IF of 278 kHz. The frequency tracking has acted like a sweeping 10 kHz filter, eliminating unwanted harmonic and spurious signals.

SIGNAL PROCESSING CIRCUITRY

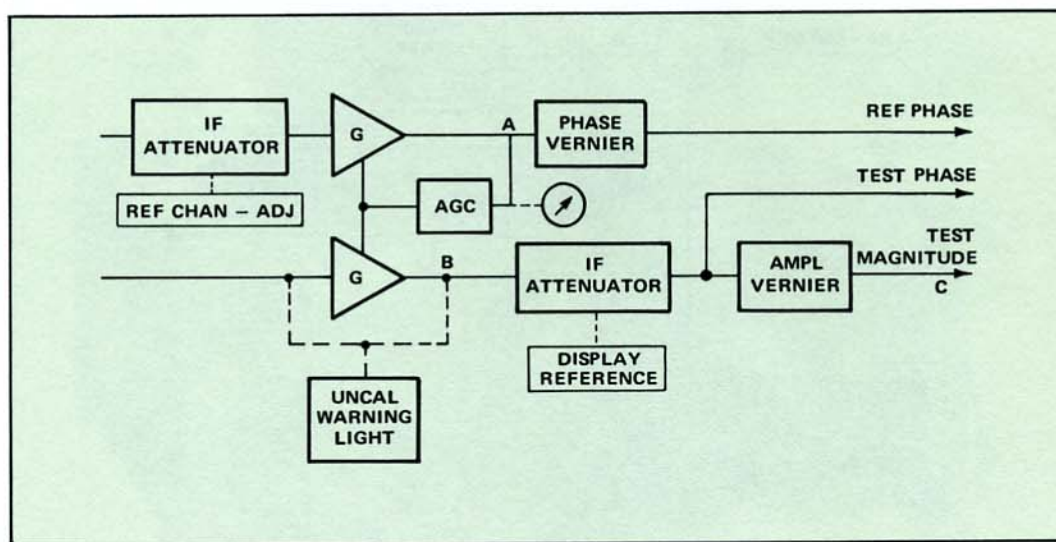

Figure 8-2. Signal Processing Circuitry.

This part of the circuit has several parts, each with a major function.

AGC LOOP

Objective: To normalize out all variations common to both the reference and the test channel.

Why?

1. To obtain a true picture of what the device is doing to the RF signal.
2. To prevent erroneous phase and magnitude responses due to sweeper power variations.

Technique:

A sample of the signal at point A is sent into the AGC loop. The AGC loop keeps the voltage at A constant. Notice that the AGC amplifiers have the same gain and are ganged together. This means that if both the reference and test signals start to rise,

the AGC action produces a decrease in gain of both amplifiers G in order to hold the voltage at A constant.

But look what has happened to the signal level of the test channel. It has remained constant because the rise in test channel signal was just offset by a decrease in gain of G. The effect is to normalize out up to 20 dB variations common to both channels.

This leads directly to the next objective of the AGC loop.

Objective: To provide a voltage directly proportional to test channel signal and inversely proportional to reference channel signal; to make true ratio tests such as gain, loss and reflection coefficient.

Technique:

Suppose you increase the gain in your reference channel by moving the REF LEVEL CONTROL switch upward one notch. This increases the gain in the reference channel by 20 dB. But once again AGC action produces a 20 dB decrease in gain of both G amplifiers in order to hold the signal at A constant.

This time, however, there is no offsetting rise in test channel signal, so the voltage at point B drops by 20 dB. Hence, you have a voltage change at B inversely proportional to the voltage change in the reference channel. Point C is where the magnitude measurement is made. The CRT amplitude trace position is always directly proportional to the voltage at C, which in turn is directly proportional to the test signal and inversely proportional to the reference signal.

REFERENCE CHANNEL LEVEL AMPLIFIER

Objective: To be able to operate with low level inputs. Why?

To allow the user to test the small signal transmission and reflection properties of networks.

Technique:

An amplifier is placed in the reference channel. The gain of this amplifier is controlled from the front panel. The reference signal increases if you move the REF CHAN LEVEL switch upwards. (An increase in signal level in this channel will cause a decrease in the signal level at point B, since point B is inversely proportional to the REF channel signal. The result is the trace on the 8412A CRT will move downward.)

SIGNAL DIVIDER

Objective: To condition test and reference signals for magnitude and phase measurements.

Technique:

The reference channel signal maintains its phase relationship to the test channel and is sent to the 8412A.

The test channel is split into two channels in the mainframe, the test phase and the test magnitude. These two test signals are sent to the 8412A.

8412A BLOCK DESCRIPTION

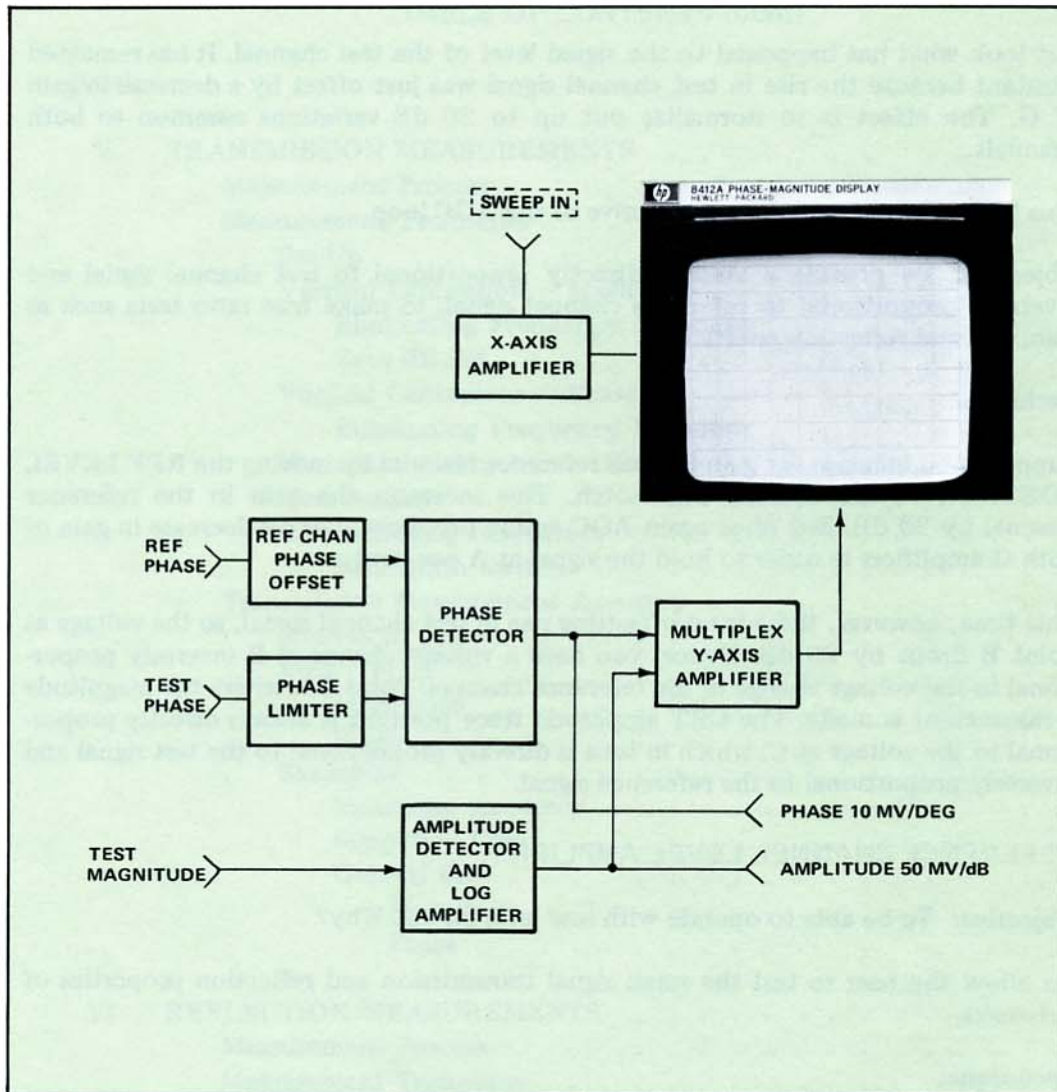

Figure 8-3. 8412A Amplitude and Phase Detection

The 8412A receives three signals from the 8407A mainframe: reference phase, test phase and test magnitude.

REFERENCE PHASE: The reference phase channel goes through the phase offset, is detected and then compared to the test phase signal from the 8407A.

TEST PHASE: The test phase is amplified and limited. Two functions are accomplished.

1. A very fast zero crossing is obtained which is used for the phase measurement.
2. A square wave constant amplitude drive is obtained which is used for the drive signal in the amplitude detector.

TEST AMPLITUDE: The second test channel input, the test magnitude, is detected using the drive from the test phase. The detected magnitude signal is converted to decibels in the log converter. The decibel magnitude information is then multiplexed with the phase information and displayed on the CRT.

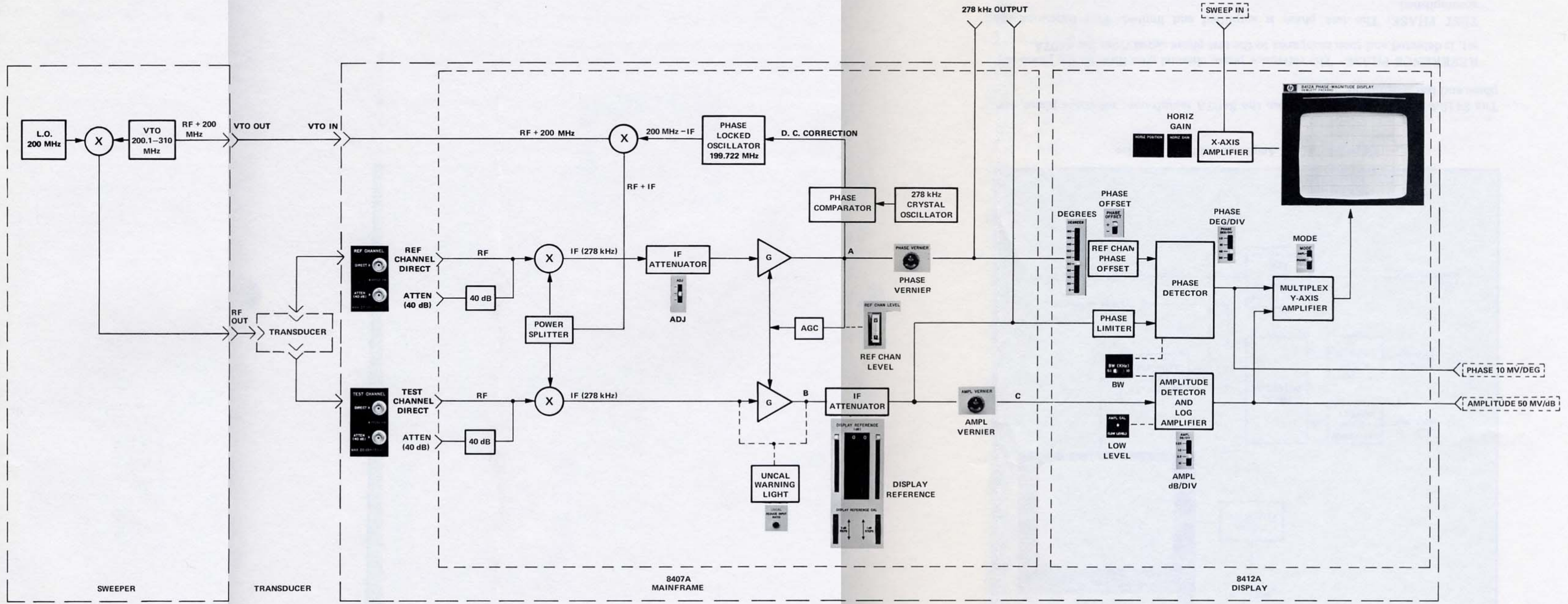

Figure 8-4. Simplified System Block Diagram



For more information, call your local HP Sales Office or East (301) 948-6370 • Midwest (312) 255-9800 • South (404) 955-1500 • West (213) 877-1282. Or, write: Hewlett-Packard, 1501 Page Mill Road, Palo Alto, California 94304. In Europe, Post Office Box, CH-1217 Meyrin 2, Geneva, Switzerland. In Japan, Yokogawa-Hewlett-Packard, 1-59-1, Yoyogi, Shibuya-Ku, Tokyo, 151.