



# Signal Generator APPLICATION NOTE

## HP 8640A/B AN 170-2

JAN 75

## THIRD-ORDER INTERMODULATION CHARACTERISTICS

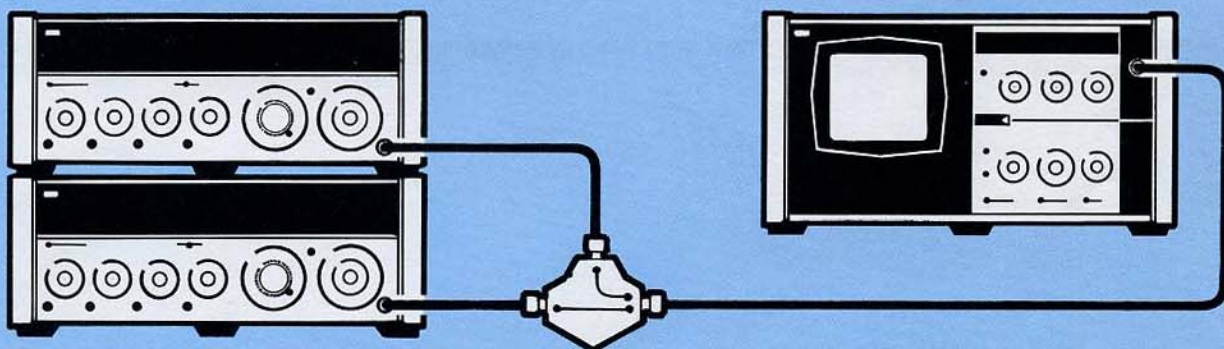

### 1. Introduction

The HP 8640A and 8640B are signal generators which cover the frequency range of 450 kHz to 550 MHz, and can be extended to 1100 MHz with a frequency doubler. These generators provide AM, FM and pulse modulation. The 8640A has a mechanical dial; the 8640B has a built-in counter and phase-lock synchronizer that locks the RF output frequency to the crystal time base used in the counter. Output level range of the 8640A/B is from +19 dBm to -145 dBm (2 V to 0.013  $\mu$ V into 50 ohms). This application note discusses the 3rd-order intermodulation (IM) characteristics of the 8640A/B.

The generator IM characteristics are important in making receiver measurements. In many communication bands, the channel spacing has been reduced resulting in a very crowded spectrum. Stringent requirements have, as a result, been placed on the receiver front end to distinguish between a desired signal and certain combinations of two or more undesired signals. To illustrate this point, let us assume that the receiver is tuned to receive  $f_1$  and that two strong signals at  $f_2 = f_1 + \Delta f^1$  and  $f_3 = f_1 + 2\Delta f^1$  are present in the spectrum. Non-linearities in the receiver's front end may cause these two signals to interact and

produce a spurious signal whose frequency is  $f_1$  (i.e.,  $2f_2 - f_3 = 2f_1 + 2\Delta f - f_1 - 2\Delta f = f_1$ ). The receiver input characteristics which prevent the generation of the undesired signal ( $f_1$  or other frequencies generated in this manner falling within the receiver bandwidth) is called its intermodulation spurious attenuation.

Three signal generators are used to simulate the above condition and to test the receiver's intermodulation spurious attenuation. One generator is tuned to  $f_1$  (desired signal with 1 kHz modulation) and the other two generators are tuned to  $f_2$  and  $f_3$  ( $f_3$  is modulated with 400 Hz) as above. (See appendix for test procedure.) However,  $f_2$  and  $f_3$  may intermodulate in the generators themselves and produce  $f_1$  and thereby give erroneous test results. Therefore, the generators' IM characteristics must be established and should be better than those of the receiver. If they are not, some isolation must be inserted between the generators to reduce their intermodulation products. IM characteristics should also be established when making other receiver tests, such as adjacent channel selectivity and two-tone intermodulation testing.

<sup>1</sup>  $\Delta f$  can be the channel spacing.

## Objective

To measure the 3rd-order IM products of two 8640A/B Signal Generators when their outputs are combined in a resistive coupler with minimum isolation.

## Equipment Needed

Two 8640As or 8640Bs, a spectrum analyzer,<sup>2</sup> and a passive summing network.

## What are 3rd-Order IM Products

When the outputs of two 8640A/B Signal Generators are summed together, as shown in Figure 1, a number of summing products result and appear as new signals. Figure 2 shows the frequency spectrum of summing two such generators where  $f_1$  and  $f_2$  are strong and closely spaced signals. The exact number of these signals and their levels depend on the characteristics of both the summing network and the output stages of the two signal generators where  $f_1$  and  $f_2$  originate. Most of these signals are not particularly significant because they are of sufficiently low level or they are far enough from  $f_1$  and  $f_2$  that they can be easily filtered. However, two summing products,

<sup>2</sup> Such as HP 8553/8552B/141T, 8555A/8552B/141T or 8558B/180's.

i.e.,  $2f_1 - f_2$  and  $2f_2 - f_1$ , are very close to the two signals of interest so they cannot be easily removed by filtering and appear as undesired signals at the output of the summing network.  $2f_1 - f_2$  and  $2f_2 - f_1$  are called 3rd-order IM products (because they are caused by the cube factor in the transfer function of the amplifier). Let's illustrate this point with a brief example. If  $f_1 = 30.0$  MHz and  $f_2 = 30.1$  MHz, then the 3rd-order IM products are 29.9 MHz and 30.2 MHz. Thus, the two signals and the two distortion products fall within a 300-kHz bandwidth.

In the following pages, we will establish the 3rd-order IM products characteristics of the 8640A/B Signal Generator and see how we can minimize this type of product.

## 2. 8640A/B 3rd-Order IM Products

Let's begin by looking at the 8640A/B simplified block diagram shown in Figure 3.

The oscillator in the 8640A/B is a mechanically tuned high-Q coaxial resonator that operates over the frequency range of 230 to 550 MHz. Coverage down to 450 kHz is obtained by switched binary dividers, which divide the oscillator frequency. Each divider section also switches in a low-pass RF filter located after the modulator which re-

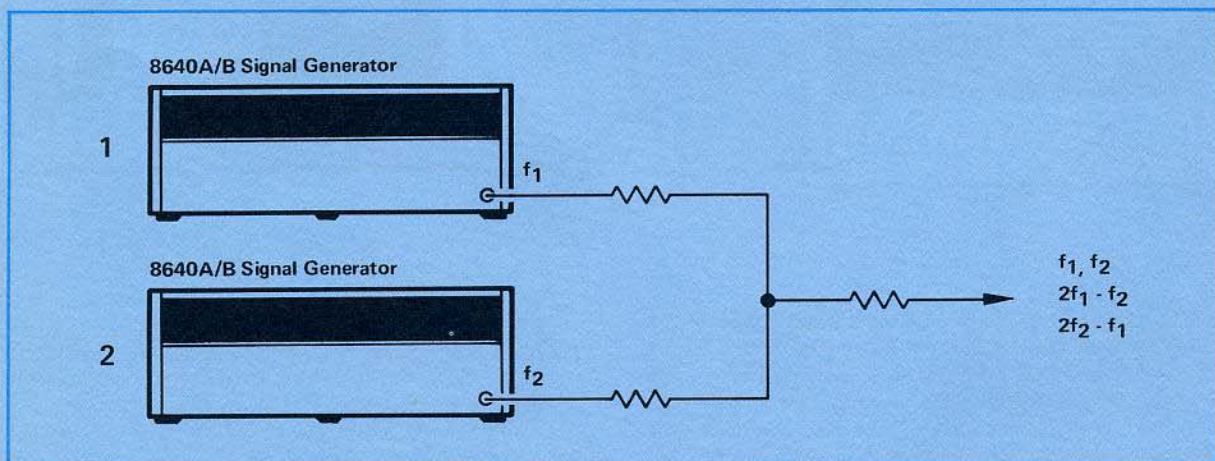

Figure 1. Passive summing of two 8640A/B Signal Generators.

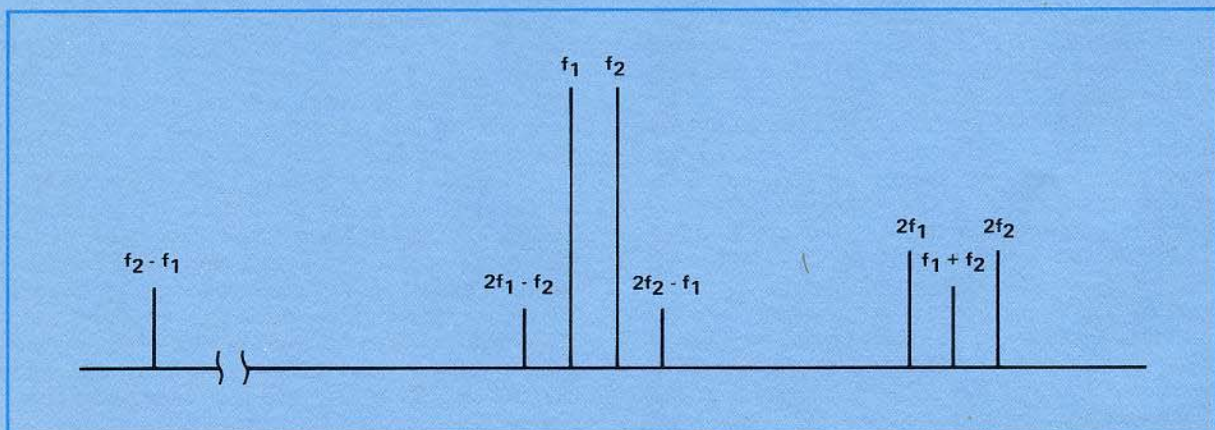

Figure 2. The frequency spectrum of summing two strong and closely-spaced signals.

moves the harmonics from the RF signal. Only one divider/filter network is turned ON at a time; the remaining divider/filter networks are OFF. Thus, unwanted harmonics and subharmonics are easily rejected yielding a clean signal.

The RF signal goes to the RF filter, then to the broadband output amplifier and finally to the 10 dB step attenuator<sup>3</sup> and the RF output port.

The 8640A/B output is levelled to within  $\pm 0.5$  dB. Levelling is accomplished by a conventional, negative feedback ALC loop in which the RF output is sampled by the detector. The output of the detector is compared with the reference voltage from the vernier. The output of the summing amplifier is in turn applied to the modulator as a correction signal to force the output from the detector to equal the reference voltage.

Although the ALC loop is needed under normal use to maintain a constant output level, it affects the level of the 3rd-order IM products as we shall see below. Opening the ALC loop greatly reduces the 3rd-order IM levels. For this reason, a special switch inside the 8640A/B<sup>4</sup> has been provided to disable the ALC loop when desired. In addition, a similar reduction in IM levels can be achieved in the pulse modulation mode. In this mode, the ALC loop is enabled but its bandwidth has been greatly reduced.<sup>5</sup> However, since we do not need a pulsed RF output, a **posi-**

**tive** dc voltage is applied to the front panel pulse input to hold the RF on (RF remains on as long as dc voltage is applied).

Let's connect two 8640A/B generators as shown in Figure 4 and measure their 3rd-order IM levels on the spectrum analyzer.

Each generator sees a 50  $\Omega$  load ( $16.7 + \frac{66.7 \times 66.7}{66.7 + 66.7}$ ). Its output impedance is matched and frequency pulling, if any, is minimal (isolation between the two generators is approximately 6 dB).

The spectrum analyzer is used to resolve the two signals and their intermodulation products. To do this, the analyzer's IF bandwidth must be less than the difference (separation) between the two signals. In addition, the two signals must not generate distortion products (including 3rd-order IM products) in the analyzer,<sup>6</sup> so that we can utilize the full display dynamic range of the analyzer. For most HP analyzers, this means we can measure 3rd-order IM products 70 dB down.

Typical 8640A/B 3rd-order intermodulation product characteristics are shown in Figures 5

<sup>3</sup>In the top two positions of the Output Level Control, there is no attenuation.

<sup>4</sup>ALC-loop ON/OFF switch is located on assembly A26A4.

<sup>5</sup>A 2.2  $\mu$ F capacitor is switched into the ALC loop which greatly decreases its bandwidth.

<sup>6</sup>The signal level into the analyzer input mixer must not exceed the mixer's optimum level (-40 dBm for most HP analyzers). The analyzer's input attenuator should be used to reduce signal levels to the optimum level required.

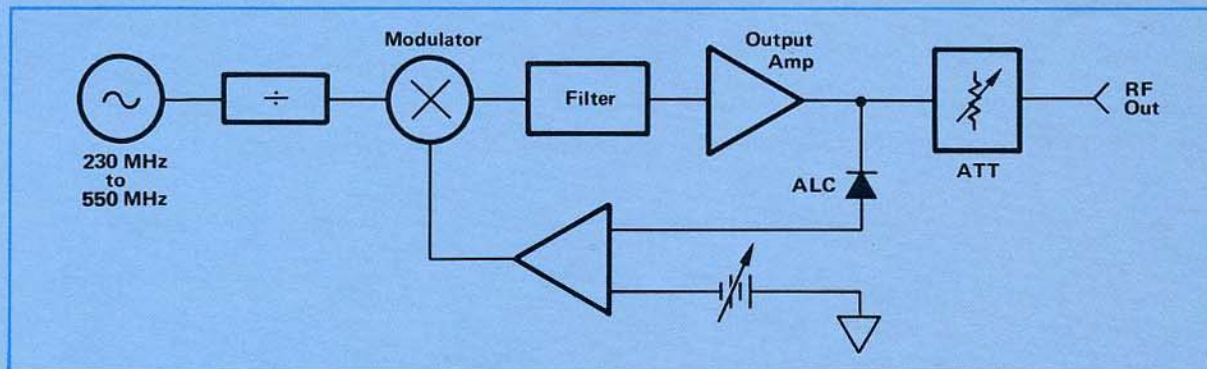

Figure 3. 8640A/B simplified block diagram.

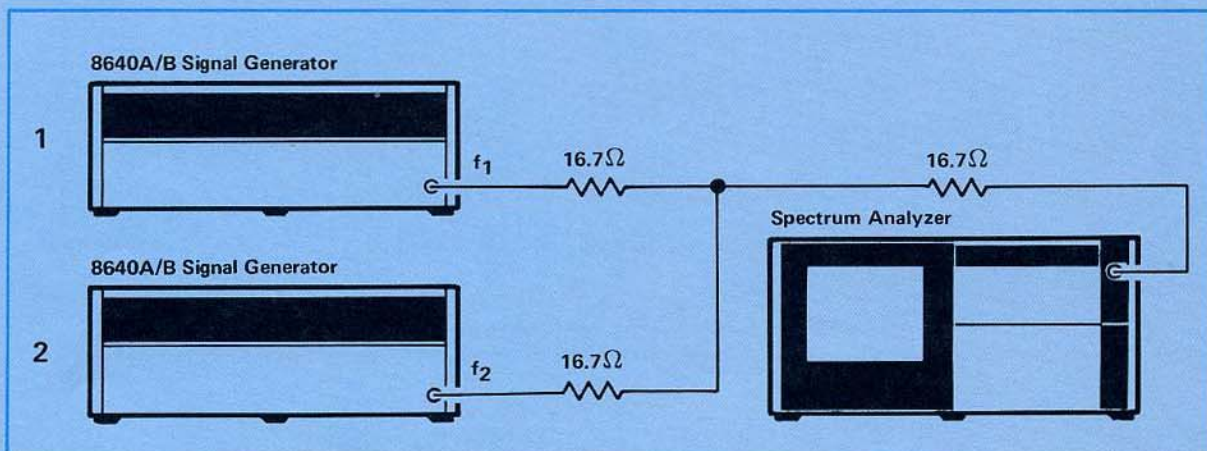

Figure 4. 8640A/B 3rd-order IM measurement test set-up.

and 6. Let's examine these characteristics and draw some conclusions.

### 8640A/B 3rd-Order IM Characteristics

1. At a fixed Output Level, and for a fixed frequency separation (i.e.,  $|f_1 - f_2|$ ), 3rd-order IM products are relatively constant in level up to 120 MHz. Above 120 MHz, their level increases about 4 dB per octave as shown in Figure 5A.

2. Attenuating each generator by some value, e.g. 10 dB, reduces 3rd-order IM products by twice the value, or 20 dB. Thus, if each of the two signals is decreased by 10 dB, the 3rd-order IM products decrease by 20 dB. So, a family of curves similar to Figure 5A can be drawn corresponding to the different output levels of the two signal generators.

3. At a fixed-frequency separation ( $|f_1 - f_2| \leq 200$  kHz), 3rd-order IM products are highest

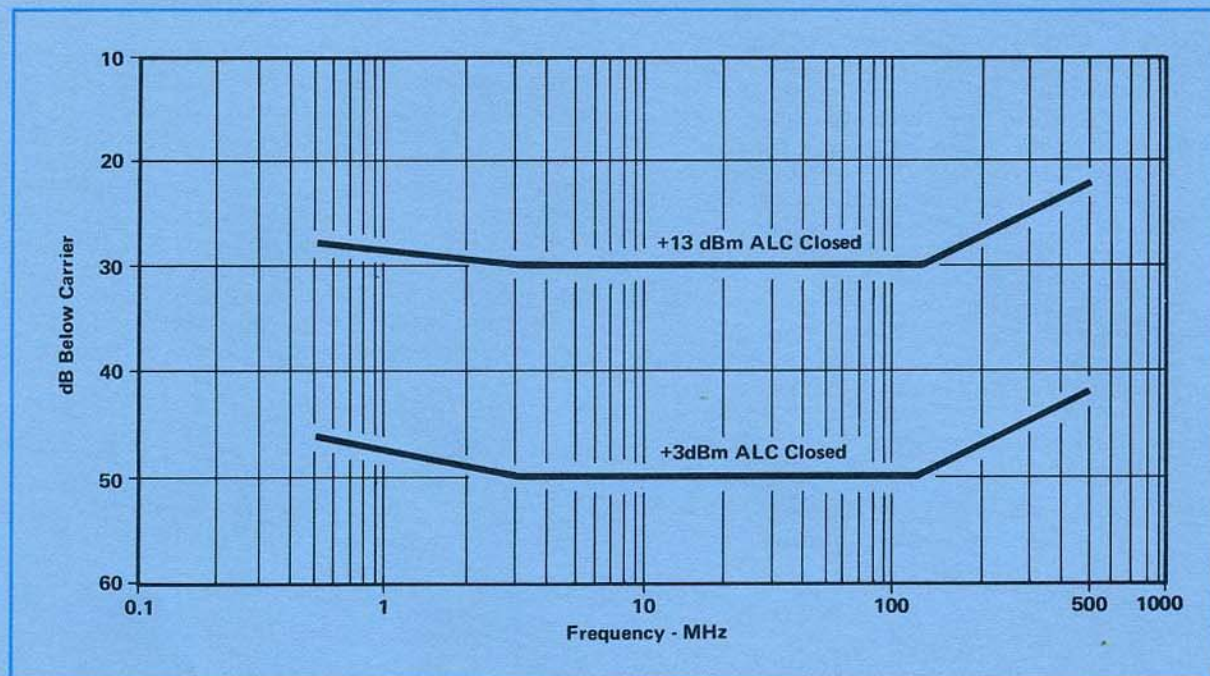

Figure 5A. Typical 8640A/B 3rd-order IM characteristics 0.5 to 512 MHz, at 10-kHz separation, ALC loop closed.

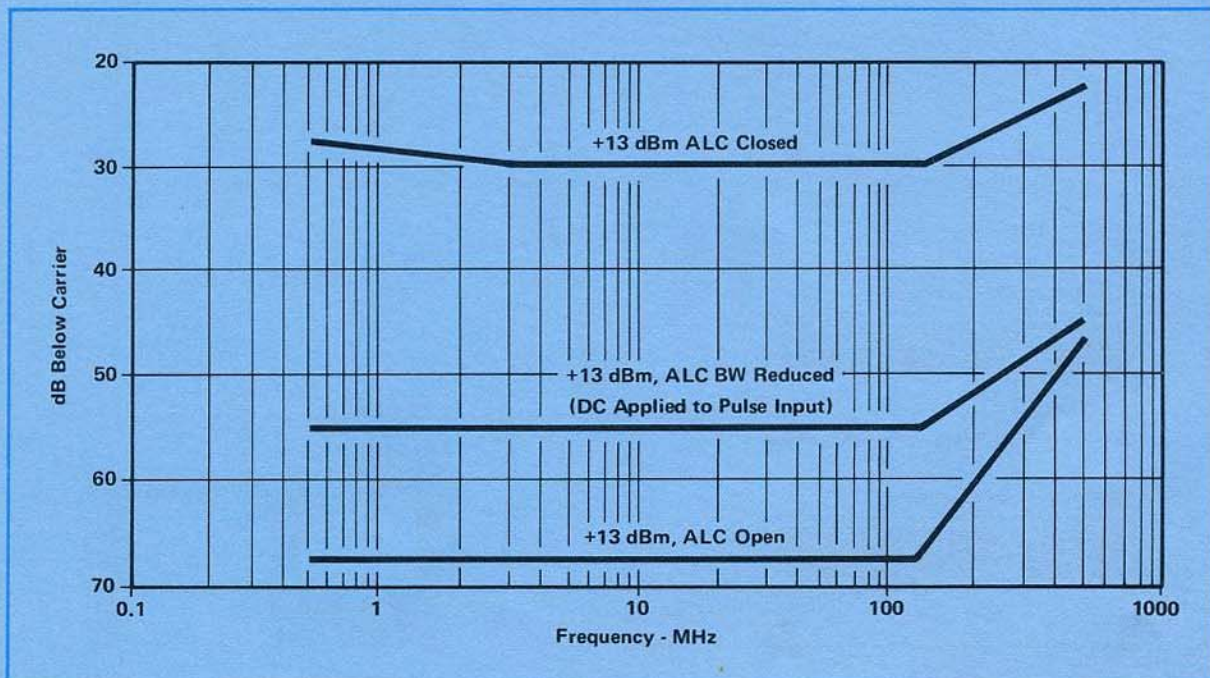

Figure 5B. Typical 8640A/B 3rd-order IM characteristics, 0.5 to 512 MHz, at 10-kHz separation and three ALC loop configurations.

when the ALC loop is closed (normal operation). Their level decreases sharply when the ALC-loop bandwidth is reduced or when the ALC loop is disabled (opened). Figure 5B shows these characteristics.

4. With the ALC loop in normal operation, 3rd-order IM products are high when  $|f_1 - f_2|$  is less than the ALC-loop bandwidth. As the frequency difference increases, 3rd-order IM products decrease in level in such a way as to track the ALC-

loop frequency response as shown in Figures 6A and 6B.

5. At some frequency difference outside the ALC-loop bandwidth, the three IM curves (ALC-closed, ALC-closed/reduced bandwidth and ALC-open) merge as shown in Figures 6A and 6B.

A brief description of how 3rd-order IM products are generated will help in understanding these characteristics.

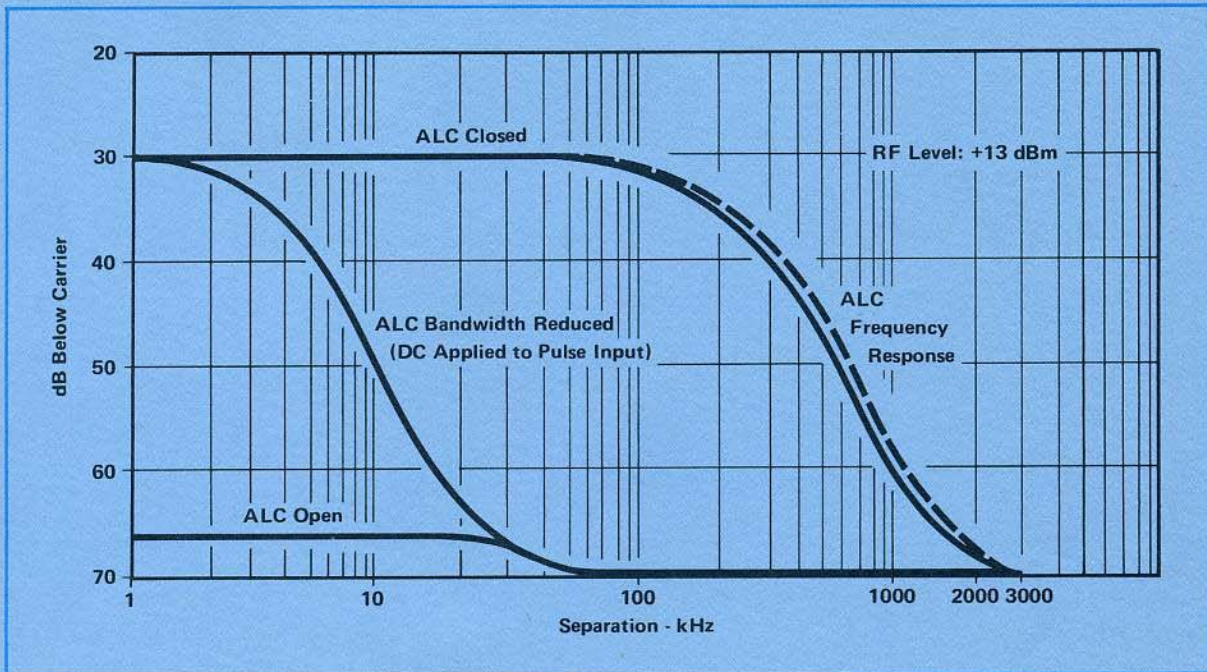

Figure 6A. Typical 8640A/B 3rd-order IM characteristics at 20 MHz as a function of separation frequency.

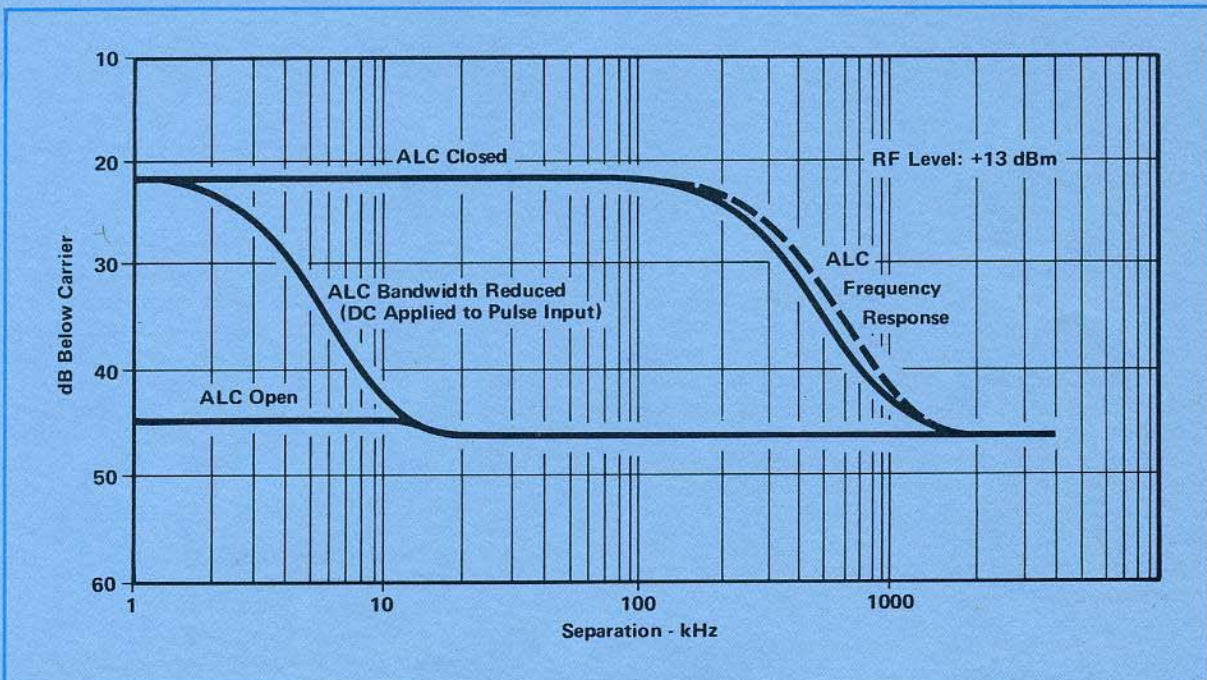

Figure 6B. Typical 8640A/B 3rd-order IM characteristics at 500 MHz as a function of separation frequency.

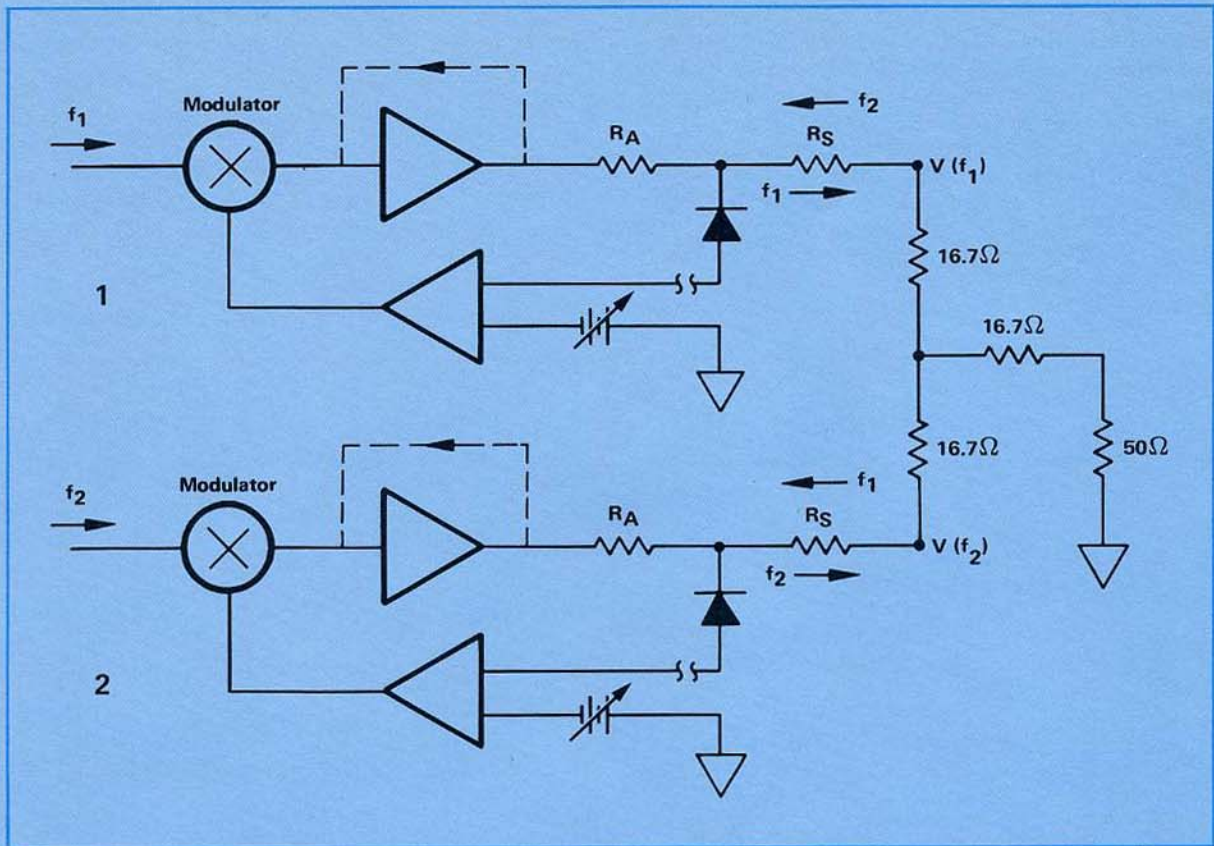

Figure 7. Open ALC-loop configuration.

### Open ALC Loop<sup>7</sup>

Figure 7 shows simplified block diagrams of generator #1 and #2 with ALC loop open. However, since the analysis is identical to both generators we will only consider generator #1.

In general, if an amplifier were perfectly linear, its transfer characteristic would be a straight line and there would be no distortion. However, amplifiers are built with active devices, and nonlinearities in the active devices cause the transfer characteristics of the amplifier to become nonlinear.

Mathematically, the Taylor series expansion can be used to describe the transfer characteristic of the amplifier as follows:

$$V_{out} = V + a_1 V_{in} + a_2 V_{in}^2 + a_3 V_{in}^3 + \dots$$

Thus, if the input signal to the amplifier is a pure sine wave, harmonic distortion caused by the second-, third- and higher-order terms will appear at the amplifier output. Furthermore, if the input to the amplifier contains two or more signals, the amplifier output will include harmonic distortion of each signal plus 3rd-order intermodulation distortion. The latter is caused by the 3rd-order term in the amplifier transfer characteristic ( $V_{in}^3$ ) and its amplitude is related to the  $a_3$  coefficient of the Taylor series expansion plus the level of the two input signals.

In the setup shown in Figure 7, generator #1 is tuned to  $f_1$  while  $f_2$  is imposed at the amplifier output. The internal amplifier feedback loop (dotted line) becomes a path for  $f_2$  and allows  $f_2$  to appear at the amplifier input. Thus,  $f_1$  and  $f_2$  are available at the amplifier input and 3rd-order intermodulation products ( $2f_1 - f_2$  and  $2f_2 - f_1$ ) are created as outlined above. For convenience, let's call products created in this process "direct" IM products. From Figures 5 and 6, we can see that "direct" 3rd-order IM products are 68 dB down up to 120 MHz, and increase to 46 dB down at 500 MHz.

### Closed ALC Loop

Let's first consider the case in which the full-loop bandwidth is used, i.e., the generator is used in the standard CW mode. Again considering only generator #1 as shown in Figure 8 and using the same type of analysis as in the open-ALC-loop case, we can see that the incident voltage splits between the detector and the output amplifier. Looking at the detector input voltage  $V_d$ , we can see that:

$$V_d = K_1 V(f_1) + K_2 \frac{R_A}{R_A + R_S} V(f_2)$$

where  $V_d$ : is the detector input voltage  
 $V(f_1)$ : is the voltage contributed by frequency  $f_1$ .

$K_1, K_2$ : proportionality constants

$V(f_2)$ : is the incident voltage of frequency  $f_2$

$R_A$ : amplifier output impedance

$R_S$ : generator #1 output resistor.

<sup>7</sup> In the open-loop mode, AM% is limited to 30% maximum and the meter accuracy is not specified. Level and FM deviation accuracies are not affected.

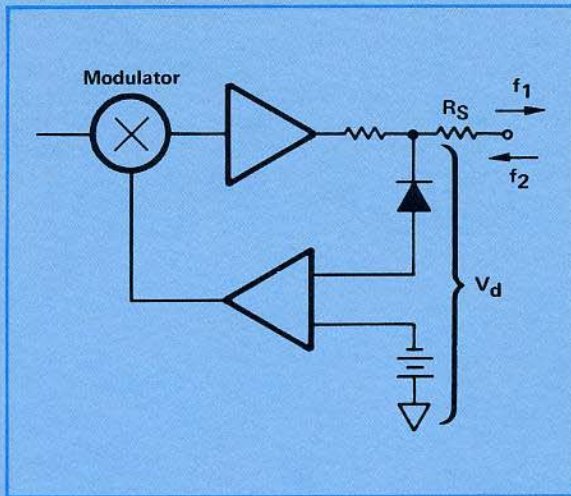

Figure 8. Closed-ALC-loop configuration.

$V_d$  can be represented as shown in Figure 9. Assuming negligible "direct" distortion, the detector senses only amplitude modulation variations, so it assumes that its input signal consists of a carrier  $f_1$  and two "apparent" and equal parts of amplitude modulation (AM) and frequency modulation (FM) at a rate equal to  $f_2 - f_1$  as shown in Figure 10A, i.e., two in-phase upper sidebands and two out-of-phase lower sidebands. The Lower sidebands cancel while the upper sidebands add. The ALC loop removes the apparent AM and leaves a pair of FM sidebands as shown in Figure 10B. The frequency of the upper sideband is  $f_2$  itself and the frequency of the lower sideband is  $f_1 - (f_2 - f_1)$ , or  $2f_1 - f_2$ . Thus, the lower component of the 3rd-order IM pair is created. Let's call this process the "AM Effect" and call products created in this process "indirect" IM products. The FM sidebands are 6 dB below the detector voltage components due to  $f_2$ . The same process goes on in generator #2 where  $f_1$  is incident at the generator output. However, an

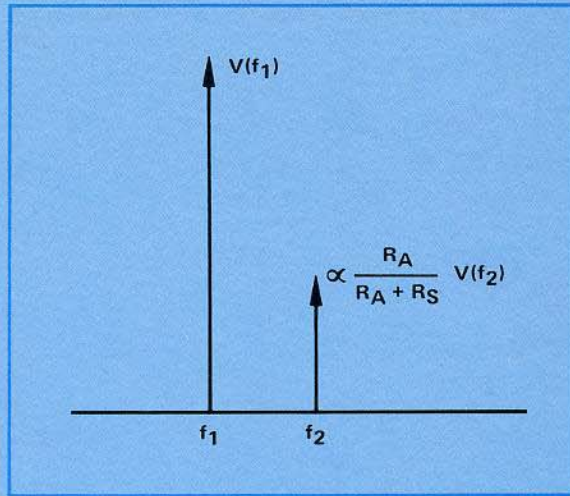

Figure 9. Frequency representation of detector input signal  $V_d$  at generator #1.

upper FM sideband is created at generator #2 and this sideband is the other component of the 3rd-order IM pair. Figure 11A shows the detector voltage and Figure 11B shows the output of generator #2 with the "AM Effect."

Referring to Figure 8 again, the voltage incident at the amplifier of generator #1 also creates "direct" IM products (i.e., part of the incident voltage appears at the amplifier input by way of the amplifier feedback loop as in the open-ALC-loop case). However, with the ALC loop closed, the ALC action attenuates the "direct" products by 6 dB, so most of the IM products measured in the closed-loop case are due to the "AM Effect."

The same type of analysis can be made for the mode of operation in which a dc voltage is applied to the pulse input.<sup>8</sup> However, the ALC-loop bandwidth is greatly reduced, as we indicated

<sup>8</sup>The meter does not read the RF level in this case (the dial scale of the Output Level Control does) because the dc voltage applied has zero repetition rate and the detector turns the meter off. Also the generator cannot be amplitude modulated in this mode.

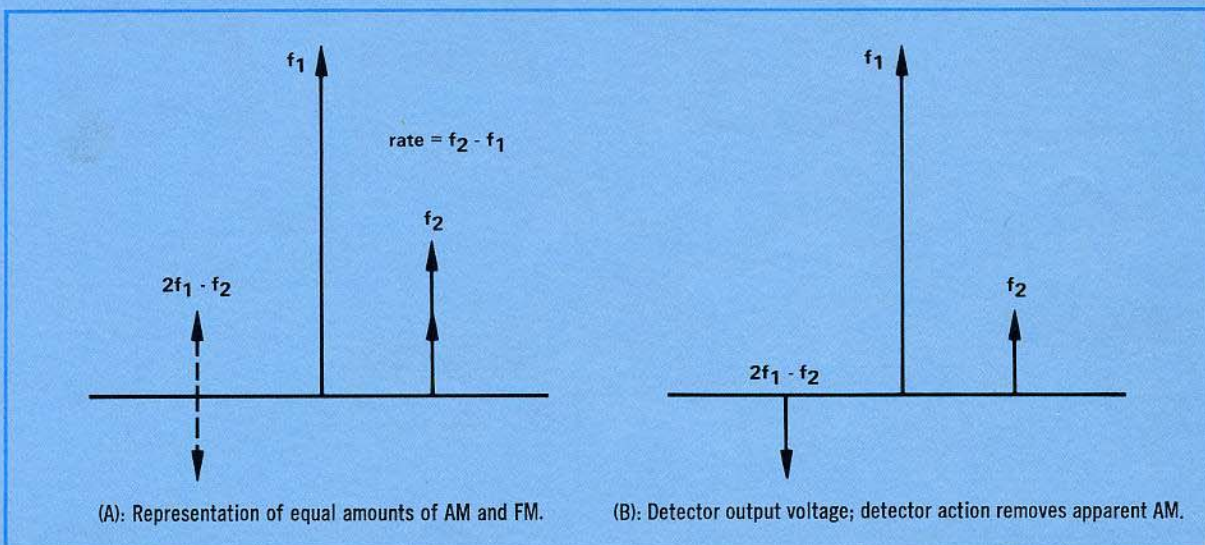

Figure 10. Generator #1 representation.

earlier, and as a result the loop frequency response attenuates the level of the IM products as the frequency difference between the generators falls outside of the loop new 3-dB bandwidth. Typically, the bandwidth in the pulse mode is 3

kHz or less depending on the frequency band, so, as the frequency difference between the generators exceeds 3 kHz, 3rd-IM levels decrease until they reach the level for the open-loop case as shown in Figures 6A and 6B.

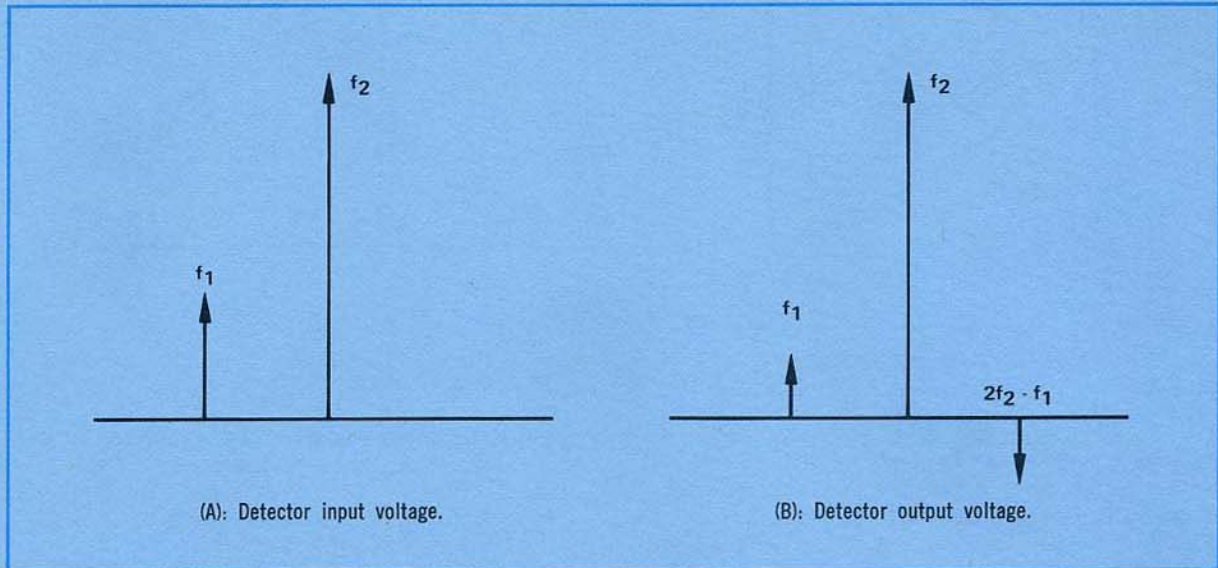

Figure 11. Generator #2 representation.

### 3. Reducing the Generators' 3rd-Order IM Products

We can reduce 3rd-order IM products in three ways:

1. Open ALC loop
2. Reduce ALC-loop bandwidth
3. Increase the isolation between the two generators by using couplers or hybrids.

Opening the ALC loop and reducing the loop bandwidth have already been discussed. Figure

5B shows that at 100 MHz- and 10-kHz separation, for example, 3rd-order IM level has been reduced 33 dB by opening the ALC loop and 24 dB by reducing the loop bandwidth. A similar effect was achieved using the HP 8721A Directional Bridge (0.1-110 MHz) with about 40 dB of isolation between the two generators as shown in Figure 12. Above 110 MHz, the HP 778 Directional Coupler can be used as shown in Figure 13 to provide 30 to 36 dB of isolation. The two CRT photos in Figure 14 show 3rd-order IM with and without the added isolation.

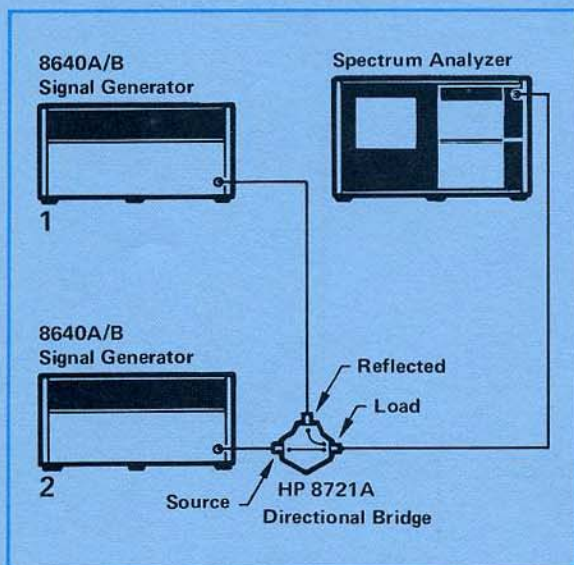

Figure 12. Isolating the two generators up to 110 MHz using a Directional Bridge such as HP 8721A with 40-dB isolation.

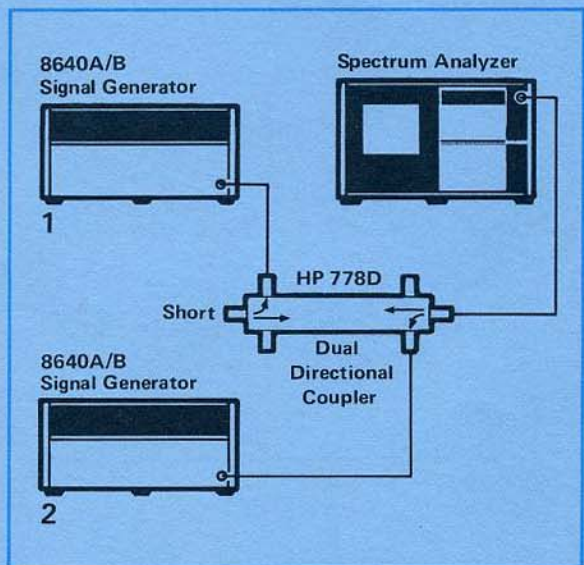
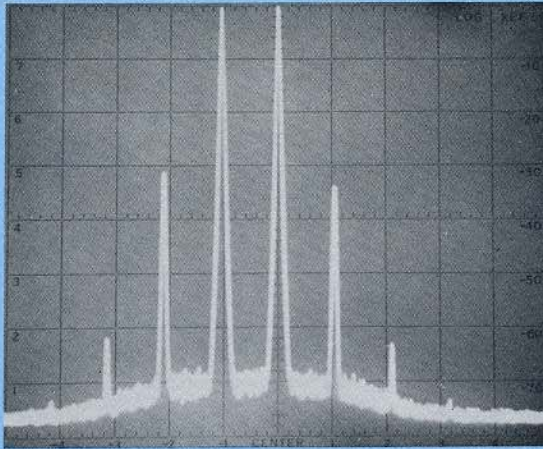
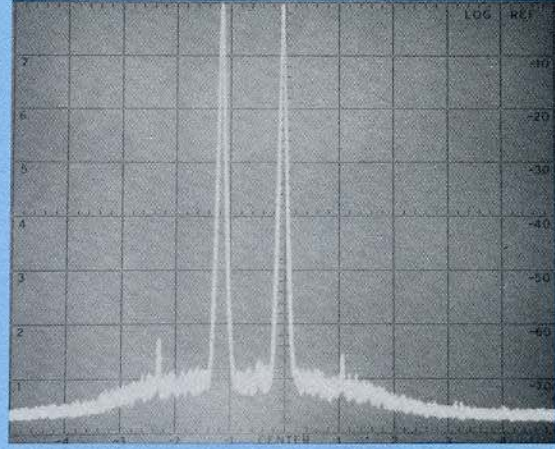

Figure 13. Isolating the two generators above 110 MHz using a Dual-Directional Coupler such as HP 778D with 30 to 36-dB isolation.





No isolation, ALC loop closed.



40-dB isolation using HP 8721A Directional Bridge. ALC loop closed.

Figure 14. The 8640A/B 3rd-order IM products with and without isolation. Both generators are set to +13 dBm.

#### 4. 8640A/B vs. the 608

The 608 Series VHF signal generator has been the standard in signal generators for many years. Even today, the 608 Series is accepted for precision, accuracy and low noise. These generators use tuned-output amplifiers and a waveguide-beyond-cutoff attenuator.<sup>9</sup> This type of attenuator has a large insertion loss (>20 dB).

Above 25 MHz, the 3rd-order IM products generated by coupling two 608E generators with a resistive network are 2 to 10-dB higher in level than those produced by two 8640 generators operated at the same output level. Below 25 MHz, the 608E 3rd-order IM levels decrease and reach 58 dB down at 10 MHz. Figure 15 shows the 608E 3rd-order IM at 10-kHz separation for two levels,

<sup>9</sup> See HP Application Note 170-1.

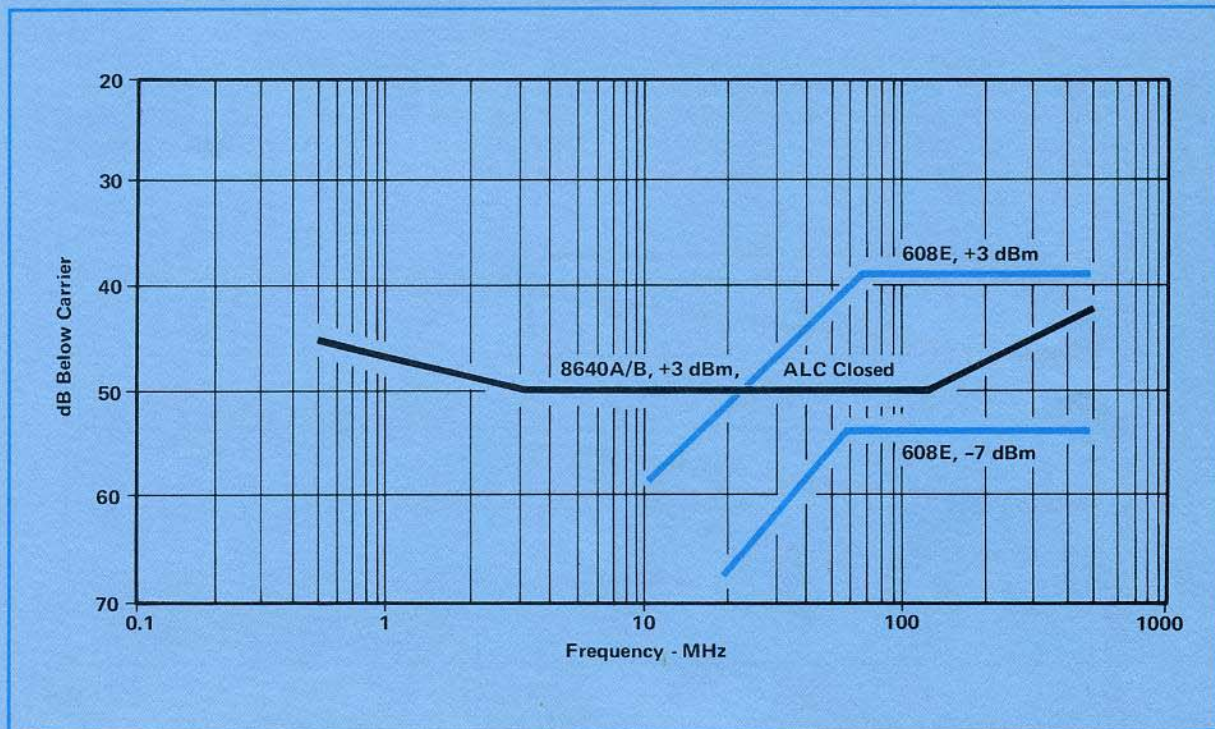

Figure 15. Typical 608E 3rd-order IM characteristics from 10 to 480 MHz at 10-kHz separation. Note the 8640A/B characteristic at the same output level.

+3 dBm and -7 dBm, and compares them with the 8640A/B levels. Figure 16 shows the level of the 3rd-order IM as a function of separation frequency at 40 MHz and 470 MHz.

In summary, the 8040A/B makes an excellent

source for receiver testing. For tests requiring two or three generators, its 3rd-order intermodulation products can be reduced to a level which will enhance the accuracy and credibility of the test.

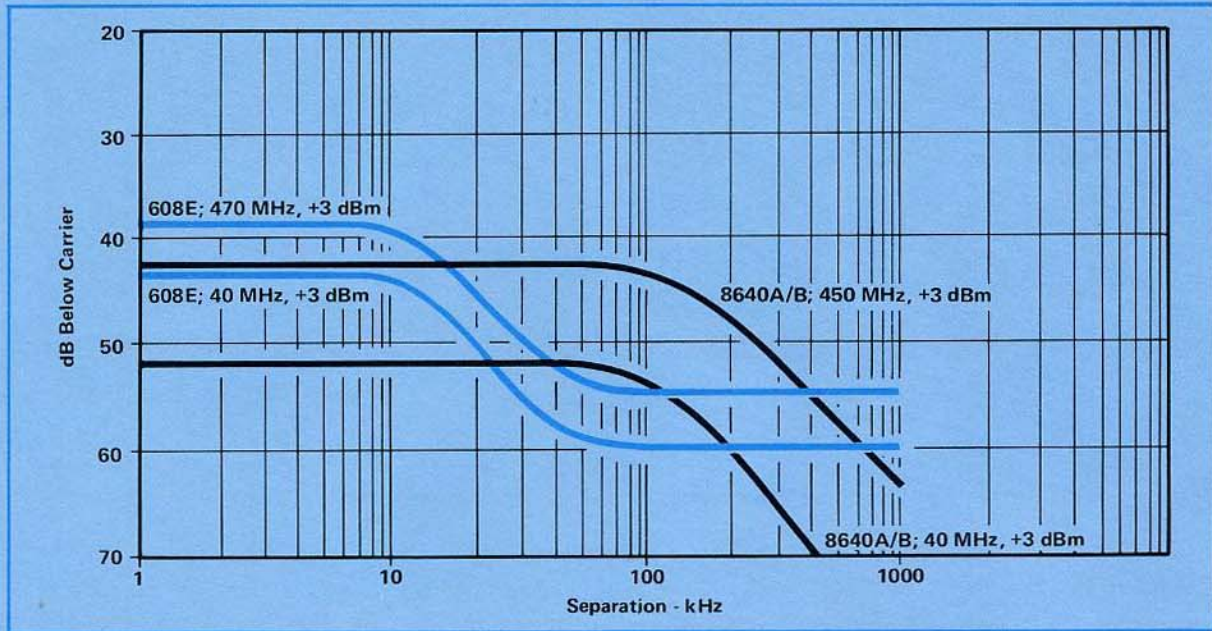

Figure 16. Typical 608E 3rd-order IM characteristics at 40 MHz and 470 MHz as a function of separation frequency. Note the 8640A/B characteristics at the same frequencies and output level.

## 5. 8640A/B Option 002 3rd-Order IM Characteristics

The 8640A/B Option 002 is an internal doubler which extends the generator frequency range another octave from 512 to 1024 MHz and allows AM, FM and pulse modulation across this frequency range.

In general, the Option 002 3rd-order IM characteristics are similar to the standard generator characteristics for the fundamental band (256 to 512 MHz). Intermodulation products are highest when the ALC loop is closed, they decrease when

the ALC loop is either opened or its bandwidth is reduced. The following is a brief description of the IM characteristics in each case.

Figure 17 shows the IM products with the ALC loop closed for two output levels. At +13 dBm RF output, with one generator set to 512 MHz and the other to 512.01 MHz, 3rd-order IM products are typically 27 dB down and they increase at a rate of 4 dB/octave. At +3 dBm RF output, IM products decrease by 20 dB.

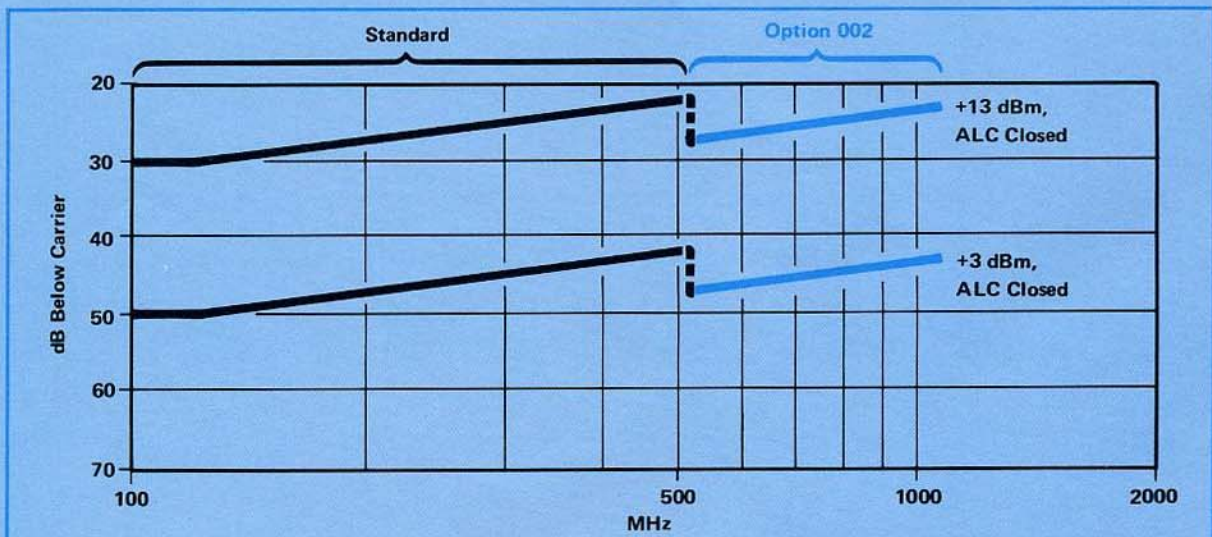

Figure 17. Typical 8640A/B Option 002 3rd-order IM characteristics, 512 to 1024 MHz, at 10 kHz separation, ALC loop closed at +13 dBm and +3 dBm.

If the ALC loop remains closed but its bandwidth is reduced (by applying a positive dc voltage to the pulse input), 3rd-order IM products typically decrease by 24 dB at 512 MHz and 20 dB at 1024 MHz. So, with 10-kHz separation and +13 dBm RF output, IM products are 51 dB down at 512 MHz and increase at a rate of 9 dB/octave as shown in Figure 18.

Figure 18 also shows the IM products when the ALC is opened. At 512 MHz and 10 kHz separation, IM products are 57 dB down and they increase at a rate of 20 dB/octave.

Option 002 IM products vs frequency separation are also affected by the ALC loop as shown in Figure 19. At any single frequency, IM products with the ALC loop closed are relatively constant

up to 100-kHz separation and then roll off. With the ALC-loop bandwidth reduced, IM products are flat up to 3-kHz separation, roll off sharply up to 10 kHz and remain flat until merging with the closed ALC-loop curve. With the ALC loop opened, IM products remain relatively flat throughout.

The Option 002 data above was measured for two generators. When making two tone tests and intermodulation spurious attenuation measurements between 512 to 1024 MHz using Option 002, the IM products should be measured using the same procedure described for the standard generator, i.e., combine their outputs in a matching network and measure the IM levels on the spectrum analyzer.

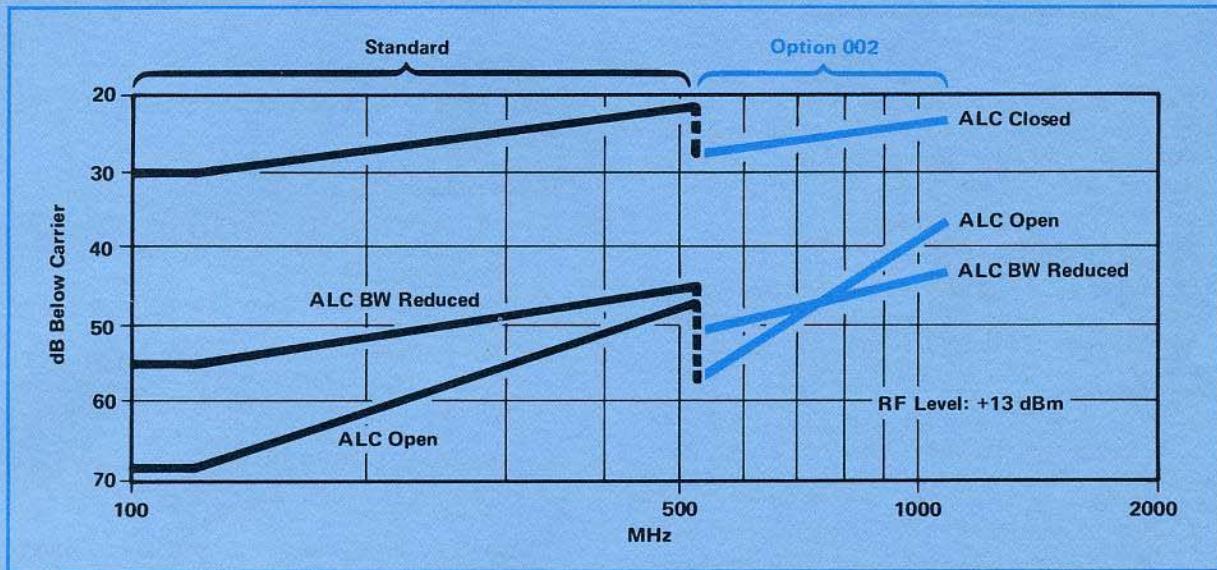

Figure 18. Typical 8640A/B 3rd-order IM characteristics, 512 to 1024 MHz, at 10 kHz separation and three ALC loop configurations.

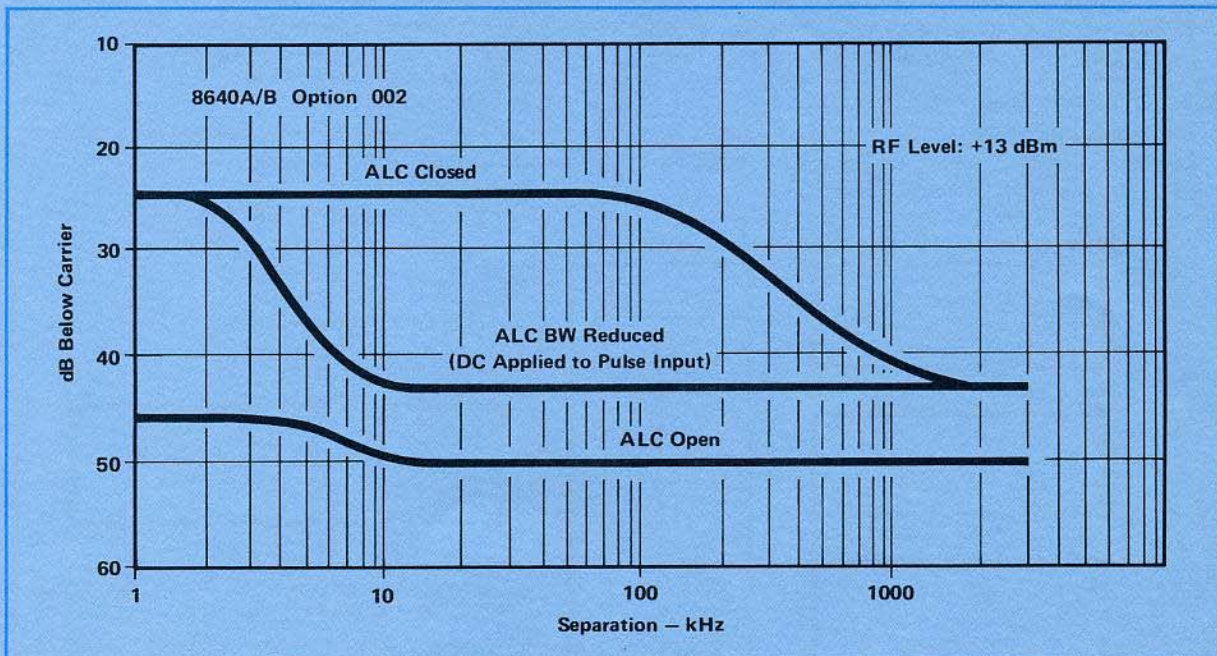
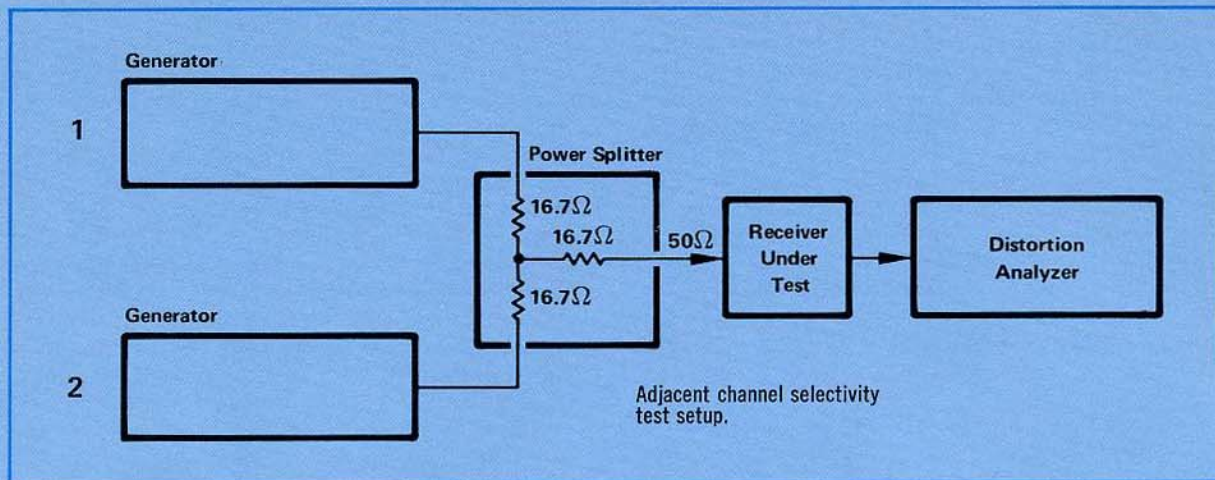

Figure 19. Typical 8640A/B IM characteristics at 900 MHz as a function of separation frequency.

## Appendix



Two common tests made on receivers are adjacent channel selectivity and intermodulation spurious attenuation. The procedures for these tests Per EIA Standard RS-316 are described briefly below.

### Adjacent Channel Selectivity:

Measures ability of receiver to differentiate between a desired modulation signal and modulation signals on adjacent channels.

#### Test Procedure:

1. Turn generator #2 off, set generator #1 to  $f_0$  and modulate with 1-kHz tone at  $\frac{2}{3}$  maximum rated deviation. Set level for 12-dB SINAD.<sup>1</sup>
2. Turn generator #2 on and modulate with 400-Hz tone at  $\frac{2}{3}$  max rated deviation.
3. Tune generator #2 to adjacent channel and adjust its level for 6-dB SINAD<sup>1</sup> with distortion analyzer nulling 1000 Hz tone.
4. Record ratio of generator #2 amplitude to generator #1 amplitude.

### Intermodulation Spurious Attenuation:

Measures ability of receiver to distinguish between a desired signal and certain combina-

tions of 2 or more undesired signals at other frequencies.

#### Test Procedure:

1. Tune generator #1 to  $f_0$  and modulate with 1-kHz tone at  $\frac{2}{3}$  max rated deviation. Adjust output for 12-dB SINAD.<sup>1</sup>
2. Tune unmodulated generator #2 to adjacent channel.
3. Tune generator #3 to next adjacent channel with 400-Hz modulation at  $\frac{2}{3}$  max rated deviation.
4. Increase levels of #2 and #3 equally until SINAD<sup>1</sup> degrades 6 dB. Ratio of level of generator #2 to generator #1 is intermod spurious attenuation.

Third-order intermodulation products outside of the receiver are primarily between generators #2 and #3. Generator #1 level is usually quite low and any intermodulation products caused by this generator will be correspondingly low and fall out of the receiver band. Generators #2 and #3 3rd-order IM products should be characterized before making this test.

<sup>1</sup> SINAD = Ratio of Signal + Noise + Distortion to Noise + Distortion.

$$\text{SINAD(dB)} = 10 \log_{10} \frac{S + N + D}{N + D}$$

