



**PRECISE DC
MEASUREMENTS**

PRECISE DC MEASUREMENTS	1
FUNDAMENTAL TECHNIQUES	5
THE INSTRUMENTS	7
THE MEASUREMENTS	11
THE PROBLEMS	29

Copyright 1969 By **HEWLETT PACKARD COMPANY**

October 1969

PRECISE DC MEASUREMENTS

Precise dc measurements are easier today than they have ever been, and they're getting easier every day. Instruments are more precise, more versatile, easier to use; and there are fewer of them. Yet the basic principles are still the same. There are just a few fundamental techniques and all the seemingly more complicated ones are just applications of them. In this note we present the fundamental techniques, the instruments, the measurements, and of course, the problems. Since most precise dc measurements turn out to be some kind of calibration or another, and since the principles that apply to calibrations apply well to all measurements, we dwell mostly on calibration applications and techniques.

FIRST, WHAT MAKES A MEASUREMENT PRECISE?

A precise measurement is one that will yield the same results each time it is performed; even though performed at two different times of the day, by two different people, in the presence of a changing environment. It is stable, repeatable, reliable, and objective. Once a precise measurement has been established, it can be compared to a standard and its accuracy determined. It then can be used as a calibration standard—used to evaluate other measurements and techniques.

An accurate measurement, by comparison, is a measurement whose results agree with the accepted standard. An accurate measurement is not always a precise one; a measurement may be within 25 parts per million (ppm) of a standard the first time it is made and within 36 ppm 5 minutes later and 47 ppm after a half hour. Two different technicians may make the same measurement and get different results. Such results only show that a measurement was within so many ppm at a certain time when done by a certain person.

Readings within 25 and 47 parts per million of a standard may be quite accurate, but when they vary over such a wide range they aren't necessarily precise. If twenty five such measurements were made over a period of 10 hours and were all within one or two ppm of each other, they would be precise as well as accurate. And the person making the measurements could be confident of his results. The level of precision of a measurement or instrument is seldom specified directly; it can be inferred, however, from some key characteristics of the measurement. They are its stability, its immunity to its physical and electrical environment, and its resolution.

It Must be Stable . . .

The first of these, stability, is a measure of the change in the measurement with respect to time. It has nothing to do with temperature or operating level or any other parameter that might affect a measurement. It's strictly an indication of how the measurement changes with time—a measure of its inherent drift. Most precise instruments have both a short term stability specification involving the time required for several measurements, and a long term stability specification involving several months or a year.

If the short term stability of an instrument were specified as $\pm 2 \mu\text{V}$ per hour any measurement it made within an hour could have as much as $\pm 2 \mu\text{V}$ error due to random drift. Does that mean that the drift error could be $\pm 20 \mu\text{V}$ at the end of 10 hours? Not necessarily . . . most instruments have a long term drift specification that isn't much larger than their short term figure. For example, the long term drift might be $\pm 10 \mu\text{V}$ per day. At first glance the combination of $\pm 2 \mu\text{V}$ per hour and $\pm 10 \mu\text{V}$ per day seems odd. At $\pm 2 \mu\text{V}$ per hour the instrument could conceivably drift $48 \mu\text{V}$ in a day, yet the long term stability is only $\pm 10 \mu\text{V/day}$. The combined figures mean that in any given hour the instrument may change as much as $2 \mu\text{V}$ in either direction, but that after 24 hours the net change will be no more than $\pm 10 \mu\text{V}$. This implies that

the short term drift is mostly random; the output is just as likely to drift up 2 μV as down 2 μV in any given hour. Short term drift is generally not predictable. Long term drift, by comparison, often develops fairly repeatable trends and can be predicted with reasonable certainty.

Many instrument manufacturers include stability data in an accuracy statement like, ". . . accuracy is $\pm 0.004\%$ of reading for 60 days". This means that the instrument was adjusted to agree with a standard at the time of calibration and that it will not drift more than 0.004% in 60 days. Measurements made early in the 60 day period are probably much closer to the standard than those made on the 58th or 59th day. But the operator can only be certain that they are within 0.004% at any time in the 60 day period. No information is given about rate of drift. Such a specification does not mean that the instrument can't make measurements more accurately than 0.004%. If the instrument is compared with a standard just prior to a measurement and has good short term stability it can make measurements nearly as accurately as the standard.

And Immune to Its Environment . . .

Immunity to physical environment is usually expressed in terms of a temperature coefficient and a maximum ambient humidity in which a measurement can be performed with no loss in precision. The temperature coefficient indicates the maximum uncertainty added to the measurement for each unit of temperature change. It does not indicate exactly what change will occur. For example, a temperature coefficient of 4 ppm of reading per $^{\circ}\text{C}$ means that the reading may change by as much as 4 ppm for each degree temperature shift, but doesn't indicate which way it will change, or by how much. So, any change in temperature adds an uncertainty and makes the measurement less precise. The best way to maintain a high level of precision is to operate at a fixed temperature and calibrate all the instruments at that temperature. The only alternative is to select only instruments whose temperature coefficient effects are well within the uncertainty limits you need.

Temperature and humidity are only part of a measurement's environment. The measurement should also be immune to shock and vibration and not sensitive to how the instruments are positioned. Slamming the laboratory door or dropping a screwdriver or moving an instrument a few feet should not affect the measurement.

Immune to Electrical Interference . . .

Ideally, a precise measurement would generate no noise and be immune to the noise around it. But it's a noisy world—there's audio noise, and power line noise, and radio frequency noise, and thermal noise . . . generally instrument manufacturers lump all electrical interference into two main categories: normal mode interference and common mode interference. Normal mode refers to interference in series with, or superimposed on, an input or output, and common mode refers to interference between measurement grounds. Most manufacturers specify an instrument's ability to reject the effects of interference as a ratio of the interference signal to its effect on the measurement. Usually the ratio is in dB. For example, a Normal Mode Rejection specification of 80 dB at 60 Hz means that the effects of 60 Hz noise will be down 80 dB from the noise level, or down by a factor of 10^4 . Only 1/10,000 of the noise will affect the measurement. Instruments with normal mode rejection greater than 90 dB at 60 Hz and common mode rejection greater than 100 dB are quite common.

The ability of the instruments to reject interference is only part of a measurement's noise immunity. Just using instruments with good noise rejection isn't enough. The measurement must be set up to minimize the interference before it ever gets to the instruments. This means careful selection of leads and shielding, location, impedance levels, and connections.

And Have High Resolution . . .

Resolution indicates the smallest part of a measured value that can be effectively detected. It is an important measure of precision; a measurement's uncertainty can be no smaller than the smallest increment that can be resolved. To be certain of a 1%

measurement, you must be able to resolve at least 1%. The greater the effective resolution the more precise the measurement can be.

Usually resolution is expressed in one of three ways: as a unit of measured value as in, ". . . 1.019036 V with resolution of 1 μV ", or as a ratio of the smallest measurable value to the full scale or largest value as in, ". . . resolution of 1 ppm of full scale", or as a number of digits in a measured value as in ". . . resolution of 7 digits". This last expression implies a maximum resolution of one part in 10^7 . Often resolution is mistaken as just the smallest unit in a display or the smallest division on a meter. For an instrument to have a resolution of 1 μV it must be able to detect a change of 1 μV with some certainty. If the meter or display has the capability of indicating a 1 μV change, but has inherent noise of several μV peak to peak the instrument doesn't really have 1 μV resolution. It's effective resolution is really no better than the inherent noise.

Resolution doesn't guarantee precision. If a measurement has uncertainties on the order of 1%, doubling the resolution won't make the measurement more precise. But it will help in determining the nature of the uncertainties. Extra resolution helps to indicate how precise the measurement actually is.

There are a few other features that add to precision, less tangible features—instruments that are easy to use, for example, reduce chances of operator errors and give more consistent, repeatable results. Straight-forward readouts and displays help prevent misinterpretation of the measurement results. A more reliable instrument allows long term data analysis without interruption. Even portability helps by enhancing comparisons with other systems.

FUNDAMENTAL TECHNIQUES

With a set of accurate standards, some precise comparison techniques, and a precise way of generating ratios you can make about any precise dc measurement. In fact, these three things are the foundation upon which most electrical measurements are based.

COMPARISON TECHNIQUES

The simplest kind of comparison is a direct comparison like the null voltage measurement in Figure 1. Here a standard, E_s , is compared directly with an unknown, E_x , with a voltmeter indicating the difference between them. If there is any difference it is attributed to the unknown. The standard is assumed to be accurate and exactly at the voltage it represents. If the difference between E_x and E_s is quite small, as in the case where E_s and E_x are similar devices with one taken as a standard, then the meter need only be sensitive enough to read the difference. The meter's accuracy isn't too important—a fairly large uncertainty in the voltmeter will still be only a small part of the total value of E_x so long as the difference remains small. However, if the difference between E_s and E_x is large the voltmeter must be accurate; if the difference is very large the measurement becomes impractical because the voltmeter must be nearly as accurate as the standard.

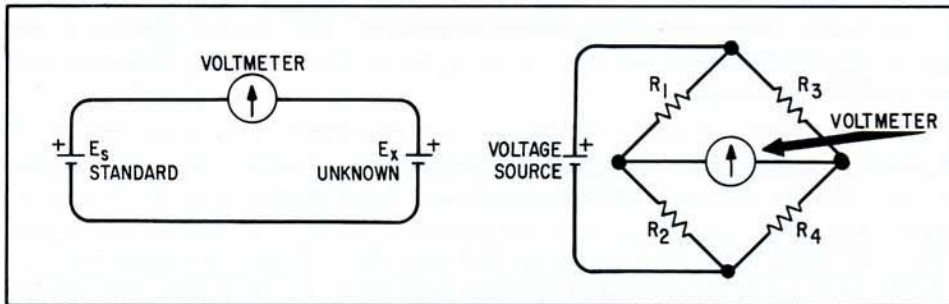

FIGURE 1. Basic Comparison Measurement.

FIGURE 2. Bridge Measurement.

The ideal situation would be to have an adjustable standard with some kind of output indicator. Then the standard could be adjusted to just equal the unknown, and the unknown value could be determined from the standard setting. When the standard and the unknown are equal, or at null, there is no current drawn from E_x . So as a voltage measuring device the standard and voltmeter combination has practically infinite input resistance. Also, the voltmeter becomes just a null detector and contributes almost no error; it need only be sensitive. Its zero uncertainties can contribute some small errors, but these can be eliminated by frequent zero adjustments.

Making the standard adjustable eliminates most of the null detector uncertainties but adds some uncertainties to the standard. An adjustable standard is not as accurate at low outputs as it is at full output; it has nonlinearities, and has limits to its resolution. However, once the standard's uncertainties are considered, there are very few other uncertainties. Defining the standard defines the measurement.

The bridge circuit in Figure 2 represents another comparison technique. Instead of comparing actual quantities it compares ratios. When the ratio of R_1 to R_2 is set equal to the ratio of R_3 to R_4 the voltage across the voltmeter is zero, and the bridge is at null. Like the comparison in Figure 1, its uncertainties are mostly determined by the circuit elements and only slightly dependent on the meter; the meter need only be a sensitive null detector. The bridge circuit is a kind of standard in itself—a standard of equality. It clearly defines the equality of two ratios and defines an exact relationship between the four components. Two components that null the same bridge when alternately mounted in the same position are equal.

The calibration of a digital voltmeter by a dc calibrator is another example of a comparison measurement. The dc calibrator is the standard and the response of the digital voltmeter to be calibrated is the unknown. The difference between the calibrator setting and the voltmeter reading determines the uncertainty. Since the voltmeter is essentially an indicator of its own errors in this comparison, its characteristics determine how precisely it can be calibrated.

STANDARDS AND TRANSFER TECHNIQUES

An electrical standard must be precisely known, immune to just about any disturbance, absolutely constant in value, and easy to duplicate or measure. Good standards don't exist as such; they are made by taking good instruments or devices and completely isolating them and carefully monitoring them. The resulting standard is a very good approximation to an ideal standard, but is often cumbersome, fragile, isolated from a working environment, or otherwise difficult to use. So, there must be a way of using the standard's value without disturbing the standard. This is usually done by referencing some precise instrument to the actual standard and then using it as the standard. The process is called a transfer of the standard.

The transfer of the value of a standard from the standard itself to another instrument is another good example of a comparison technique. Suppose that in Figure 1 E_s is the standard and E_x is to assume the standard value. The transfer can be done in two ways. One way is to make a comparison measurement and from it assign a value to E_x along with a correction factor. An easier way is to use an adjustable supply as E_x , and adjust it to exactly equal the standard value. E_x then is a precise replica of the standard and may be used in its place. Usually E_x and E_s are not in the same place and it is difficult or impractical to bring them together. Then the transfer is made with an intermediate instrument called a transfer standard. The transfer standard is set equal to the actual standard and then carried to the location of the E_x instrument and there used as the standard.

The effectiveness of such a transfer is mostly dependent on the characteristics of the transfer standard. First, the transfer standard should be stable; once it's set to the standard value its setting should remain constant for at least as long as it takes to complete the transfer. Second, it should be immune to its environment—enough so that it could be moved from one place to another with slight changes in temperature and humidity causing only the slightest of variations in its value. Finally it should be immune to noise and common mode interference, it should be easy to adjust, and of course it should be easily portable.

PRECISE RATIO TECHNIQUES

A precise ratio has many uses in calibration and standards facilities because it is so precise and requires no special standard to be accurate. A complete set of precise ratios and only two standards, resistance and voltage, provide the basis for just about any precise dc measurement.

Precise ratios are usually defined by precise resistive dividers. A bridge comparison can be used to set a number of resistors equal to each other and then the resistors can be arranged in a variety of combinations to arrive at the desired division ratios. Ten equal resistors can be arranged to form a 10:1 divider, or 9 of them to form a 9:1, or 9:8 or 9:7 and so on. The ratios attained this way are extremely precise—in fact, they are one of the most precise measurement tools at our disposal today. Ratio dividers with accuracies on the order of 1 ppm and stabilities on the order of a few ppm/month are quite common.

The high precision of ratio dividers comes from the inherent high precision of the bridge technique. The only significant sources of uncertainty come from the bridge components and not from the technique itself. If the bridge null detector is sensitive enough, it can be practically eliminated as a source of error. The significant uncertainties are due to resistor instabilities, lead and terminal resistances, and resolution of resistor adjustments; and these are all usually quite small. Two resistors can be easily set equal within less than 1 ppm of their value, and can be used to establish ratios within about the same uncertainty.

THE INSTRUMENTS

Most of the precise measurements presented in this application note involve only four types of instruments: precise voltmeters, null detectors, transfer standards, and calibration standards. These instruments together with a few laboratory standards provide a complete dc measurement capability.

PRECISE VOLTMETERS

The differential or potentiometric voltmeter represents the most precise voltage measuring technique available today. It contains a stable adjustable voltage source with a calibrated output, a null detector, null detector sensitivity controls, and input range controls. The measurement is made by comparing the input with the adjustable source and adjusting the source to just equal the input, and then reading the input voltage from the source voltage control dials. The two most important characteristics of a differential voltmeter are its stability, both long and short term, and its resolution. Then come its temperature coefficients and noise rejection capabilities. Accuracy, although usually the first specification quoted, is a relative characteristic. If the voltmeter has lots of resolution it can be made as accurate as the most accurate standard available, and if it is quite stable it will stay accurate long enough to make many measurements.

The typical precise differential voltmeter can resolve anywhere from 0.2 μV to 1.0 μV and can display six or seven full digits. Most differential voltmeters have infinite¹ input resistance at null, and many also have recorder outputs that generate a voltage proportional to null detector deflection. They are relatively inexpensive, and provide more precision per dollar cost than any kind of voltmeter.

The precise digital voltmeter is a relatively new entry into the field of precise dc instruments, and offers some significant contributions. It is fast, making several hundred measurements in the time required for an exceptional operator to make one measurement on a differential meter. It is automatic and compatible with digital computers and high speed recording devices. And it is nearly as precise as the differential voltmeters—with resolution as high as 1 ppm of range, and stabilities on the order of 15 ppm/day. Many digital voltmeters have infinite input resistance.

Figure 3 shows the Hewlett-Packard lineup of precise dc voltmeters. Most precise is the -hp- 3420A/B Differential Voltmeter/Ratiometer shown at the top left. It displays 6 full digits with overrange capability; a seventh digit can be read on the meter. Its resolution is 0.2 ppm of range, or 0.2 μV on the 1 V range. Stability is within 1 ppm/hour and 5 ppm/day; temperature coefficient is less than 4 ppm/ $^{\circ}\text{C}$; absolute accuracy is specified at ± 20 ppm for 30 days. In addition to being a precise dc voltmeter it is an equally precise differential ratiometer measuring both voltage ratios and resistive divider ratios. The 3420B can be battery operated to isolate it from ground loops.

The -hp- 740B DC Standard/Differential Voltmeter (bottom left in Figure 3), is a precise dc calibration standard as well as a differential voltmeter, and as a differential voltmeter has infinite ($>10^{10}\Omega$) input resistance on all ranges at all times, regardless of null. In other respects the 740B is comparable to the 3420A/B; it has three lower ranges but one less digit of resolution. Its stability, temperature coefficient, and accuracy are nearly the same.

The -hp- 3462A DC Digital Voltmeter (bottom right in Figure 3) makes a complete measurement with resolution of 1 ppm of range in a little more than a second. It is

¹Although the input resistance is quite high, it is still finite. Generally "infinite input resistance" implies that the input resistance is limited only by the leakage resistance between the measurement terminals. In most instruments this amounts to 10^{10} to $10^{12}\Omega$.

stable within 15 ppm of reading per 8 hours and maintains a specified accuracy of $\pm 0.004\%$ of reading for 3 months. It has autoranging, has binary coded output of each reading, and is remotely programmable. It also has infinite input resistance ($>10^{10}\Omega$).



FIGURE 3. Hewlett-Packard's Precise Voltmeters. At top left is the 3420B Differential Voltmeter/Ratiometer; directly under it is the 740B DC Differential Voltmeter/DC Standard; and on the right is the 3462A DC Digital Voltmeter.

NULL DETECTORS

A null detector or null meter is just an extra-sensitive voltmeter, and its sensitivity is its most important characteristic. The more sensitive it is, the more effective it will be in any given comparison. The absolute sensitivity requirement depends on the measurements intended. Except for a few low voltage comparisons, a sensitivity of a fraction of a microvolt is usually sufficient. But this must be usable sensitivity; sensitivity here is not just the lowest range or the smallest unit on the meter face; it is the smallest unit that can be effectively read. If the meter has inherent peak-to-peak noise equal to third-scale on the lowest range, the sensitivity can be no better than third-scale on the lowest range.

A nullmeter's noise rejection must be good enough to reduce the maximum expected noise signal enough that the noise effects will be less than the necessary sensitivity. That is, if the measurement requires $1\ \mu\text{V}$ sensitivity, and the maximum expected noise is $0.1\ \text{V p-p}$, then the instrument should reduce the noise to less than $1\ \mu\text{V p-p}$, by a factor of 10^5 (100 dB). A nullmeter should be battery operated so that it can be isolated from ground loops and power line noise.

Nullmeter zero instabilities show up as drift in the measurement, so they must be held to a minimum. The nullmeter must have very low zero drift or have provisions for quick zero adjustment or both. Its input resistance isn't too critical so long as it is neither too large nor too small. If the input resistance is too small the nullmeter will load the circuit when the measurement is well off null. If it is too large it may add noise when the measurement is very near null. Most nullmeter's input resistance is high on the higher ranges and lower on the most sensitive ranges.

The Hewlett-Packard Model 419A DC Null Voltmeter, shown in the middle of Figure 4, satisfies all of the null detector requirements mentioned. It can detect differences of a few tenths of a microvolt, has noise rejection greater than 100 dB, and has meter noise less than $0.3\ \mu\text{V}$. It is battery operated, has a recorder output that generates a voltage proportional to meter deflection, and has a pushbutton zero control that allows zero adjustments without disconnecting the input. It also measures dc current with a maximum sensitivity of a few picoamps.

TRANSFER STANDARDS

As we mentioned before, a transfer standard must be very stable, immune to its environment, and easily adjustable and portable. In addition, a good transfer standard should have high resolution of adjustment and be short circuit proof. The -hp- 735A DC Transfer Standard (lower right in Figure 4) easily meets all of these requirements and adds some features of its own. It has outputs for comparing either saturated or unsaturated standard cells and can compare one with the other. It can also convert any

standard cell voltage to 1.00000 V. The 735A is exceptionally stable, with long term stability of less than 10 ppm/month. It can transfer standard cells with uncertainties of only ± 2 ppm and can transfer any standard cell voltage to 1 V with an uncertainty of only ± 10 ppm. Inside, the 735A has a carefully selected zener diode reference maintained at a constant temperature and a precise voltage divider to provide the adjustable outputs.



FIGURE 4. Hewlett-Packard's Calibration Standards and Transfer Standards. On the left are the 741B and 740B Calibration Standards; on the right is the 735A Transfer Standard and behind it is the E02-735A Transfer Standard; the nullmeter in the middle is the Model 419A.

Hewlett-Packard Model E02-735A in the background in Figure 4 is four -hp- 735A's contained in one package and arranged so the mean of all four can be used as a transfer standard. The E02-735A is considerably more stable than the 735A and what drift it has is predictable—within $\pm 1 \mu\text{V}$ of a straight line, 95% of the time, for 120 days. In many applications an E02-735A can be used as a local absolute voltage standard.

CALIBRATION STANDARDS

A calibration standard is a wide range transfer standard, not quite as precise but more versatile, intended for use in a working situation. A good calibration standard should have all the qualities of a good transfer standard plus a few extras—like linearity over a wide range of outputs, load regulation, and ease of operation. Most calibration standards are built from a transfer standard, usually a zener reference, and the buffer amplifiers, dividers, regulators and other circuits necessary to provide a wide range of outputs over a wide range of conditions and loads. A large number are arranged so that they can be used as differential voltmeters, amplifiers, and voltmeters as well as standards.

Hewlett-Packard's two calibration standards are shown in Figure 4. On the top at the left is the hp- 741B AC/DC Differential Voltmeter/DC Standard and directly under it is the -hp- 740B DC Differential Voltmeter/DC Standard. Both function as dc calibration standards, dc differential voltmeters, and precise dc amplifiers. The 741B is also an AC Differential Voltmeter. The 740B is the more precise with 1 ppm of range resolution and accuracy on the order of 25 ppm for 30 days.



THE MEASUREMENTS

Most precise dc measurements turn out to be calibrations; in fact, the most precise dc measurements are calibrations. So most of the measurements presented here are either calibrations or measurements that augment a calibration. Included is a complete description of a versatile calibration system, made from the instruments described so far, that is within a few parts per million of the absolute standards used.

A calibration can be one of two things. In the strictest sense a calibration is a measurement that determines the errors in an instrument and nothing more—no adjustments, no correction factors—just a determination of errors. More generally, though, a calibration refers to both a determination of the errors and an adjustment to correct the errors. In this sense a calibration is aimed at establishing or specifying some particular accuracy for the instrument in question. We make this distinction because the requirements for a calibration are more stringent if the errors are to be measured than they are if the errors are to be just corrected. It's much easier to set an instrument so that it reads the same as a standard than it is to determine exactly what its errors are.

Whether the calibration is to be a measurement or an adjustment it begins with a comparison of the instrument in question and some kind of standard. The comparison can be done in three ways. First, the standard is set to some "test value" and the difference between the test value and the response of the instrument under test indicates the error. Second, the standard is adjusted to make the instrument display some test value, and the difference between the necessary standard setting and the test value indicates the error. And finally, some intermediate instrument, like a null meter, is used to indicate the error.

IF THE CALIBRATION IS AN ADJUSTMENT . . .

If the calibration is an adjustment it is intended to set the instrument in question to a particular accuracy rather than to find out what the accuracy is. Theoretically, if the instrument could be compared to the standard and set exactly equal to the standard it could be specified as having no more uncertainties than the standard. For example, if a dc calibration standard were set to 10.000 V and a digital voltmeter connected to it adjusted to display exactly 10.000 V, then the voltmeter display could have no more uncertainty than the standard setting.

But it's not that simple. There is no guarantee that the two will read the same at some other setting if they read the same at 10.000 V; there is no way of knowing if they will read the same at some other temperature . . . or how long they will stay at the same reading. So the voltmeter can't really be calibrated to the same accuracy as the standard. It is limited by its own resolution and by its stability, temperature coefficients, and nonlinearities.

Consider, for example, calibrating a four-digit digital voltmeter using a six-digit dc calibration standard with a total output voltage uncertainty of $\pm 0.002\%$ of setting. The standard is set to 1.000000 V and the DVM is adjusted so that it reads the same. First, the DVM has two digits less than the standard so it displays 1.0000. Is that 1.000032, or 1.000016, or exactly 1.000000? There's no way of knowing; only the displayed 1.0000 is certain. The last digit in the display occasionally changes by 1 count; the display is 1.0000, then .9999, then 1.0000. That's an uncertainty of 1 count in 10,000 or 0.01%. If the DVM stability is $\pm 0.02\%$ /month and the linearity is 0.01% the best accuracy at the end of the month would be 0.04%. If measurements were made in any environment other than the calibration environment a temperature coefficient correction would have to be added. Finally, the calibration standard uncertainty of $\pm 0.002\%$ must be considered. In this case the additional 0.002% uncertainty is very small compared to the total 0.04% and can't be resolved on the DVM anyway, so it can

be neglected. This four-digit DVM can only be calibrated to $\pm 0.04\%$ regardless of how much better the standard is.

Now consider calibrating a six-digit differential voltmeter to the same calibration standard, and assume that the differential voltmeter has linearity of 0.0005% (5 ppm) and drift of only $0.0005\%/month$. Again, the voltmeter is adjusted to display the same as the standard, and since it has the same resolution its display has the same uncertainty as the standard, $\pm 0.002\%$. Adding drift and linearity gives a total uncertainty of $\pm 0.003\%$ for 1 month, as long as the voltmeter is used in the same environment in which it was calibrated, or at least in a similar one. The voltmeter in this example could be calibrated to a greater certainty if a better standard were available. A transfer standard calibrated to ± 2 ppm ($\pm 0.0002\%$) using a procedure like the one in Figure 7 could calibrate the voltmeter to about $\pm 0.0012\%$ (0.0005% linearity + 0.0005% stability + 0.0002% from transfer standard).

IF THE CALIBRATION IS A MEASUREMENT . . .

The calibration may be intended to compare the instrument in question with its published specifications, as in incoming inspection or periodic maintenance; or it may be to measure totally unknown errors in some new instrument. The calibrations are conducted about the same in both cases, but in the first case the published specifications give a clue to the type of standards needed. In the second case a few more measurements must be made because drift, linearity, noise immunity and temperature coefficients must all be measured.

Measuring an error is just like measuring anything else—the uncertainties in the measuring device must be much smaller than the unit to be measured, enough smaller that they are an insignificant part of the measurement. So in a calibration the errors in the standard should be much smaller than the anticipated errors in the instrument to be calibrated. A good rule of thumb is to keep the standard ten times better than the worst case errors in the instrument . . . if that's possible; a ten to one error reduction just about eliminates calibration uncertainties caused by the standard.

Consider comparing a four-digit digital voltmeter to its total accuracy specification of $\pm 0.03\%$ of reading. The DVM is connected to a six-digit dc calibration standard specified as accurate to $\pm 0.0025\%$ (25 ppm) of setting, and the standard is set to 1 volt; the DVM reads .9998 V. Here the standard is nearly ten times better than the DVM's accuracy specification, so the whole 0.0002 V difference can be considered DVM error. An 0.0002 V error (0.02%) is within the DVM specification.

Suppose the same calibration standard is used to calibrate a five-digit DVM with specified accuracy of $\pm 0.01\%$ of reading. Now the standard is only about four times better than the DVM and its contribution to the difference is significant. When they are connected together and the standard set to 1 volt, the DVM reads .99989 V. There is a difference of 0.00011 V or 0.011% ; it appears that the DVM is out of tolerance. But it might not be—the standard may be 0.002% low and the DVM also 0.009% low resulting in the 0.011% difference. There's no way of knowing for sure. Figure 5 shows how the uncertainties of the standard and the specification of the DVM combine and how to interpret the errors. There are three possible combinations:

- 1.) If the difference between the standard setting and the DVM reading is less than the difference between the allowable errors of the standard and the DVM, then the voltmeter is definitely within its specifications. This is represented by the center portion of the graph in Figure 5 and in this example would be a difference less than 0.0975% (0.01% of DVM — 0.0025% of standard).
- 2.) If the difference between the reading and the setting is greater than the sum of the allowable DVM and standard tolerances the DVM is definitely outside of its specifications. An out-of-tolerance difference would have to be greater than 0.0125%
- 3.) If the difference is between the values given in 1) and 2), that is, greater than the difference between the allowable errors and less than their sum, then it is ambiguous — the DVM may be O.K. and then it may not. The only way to be certain is to calibrate it with a more accurate standard. The shaded regions at the top and bottom of Figure 5 are the ambiguous regions.

The ambiguous differences in Figure 5 are not totally useless. If a reading falls in that region there is no way of telling if the DVM is within its specifications or not, but if it is out of tolerance it can't be out by any more than the standard specification. In the example given, an ambiguous reading could be out of tolerance but not by more than $\pm 0.0025\%$ (25 ppm). So at least you know that the DVM is within 0.0025% of its specification. In many applications that may be acceptable.

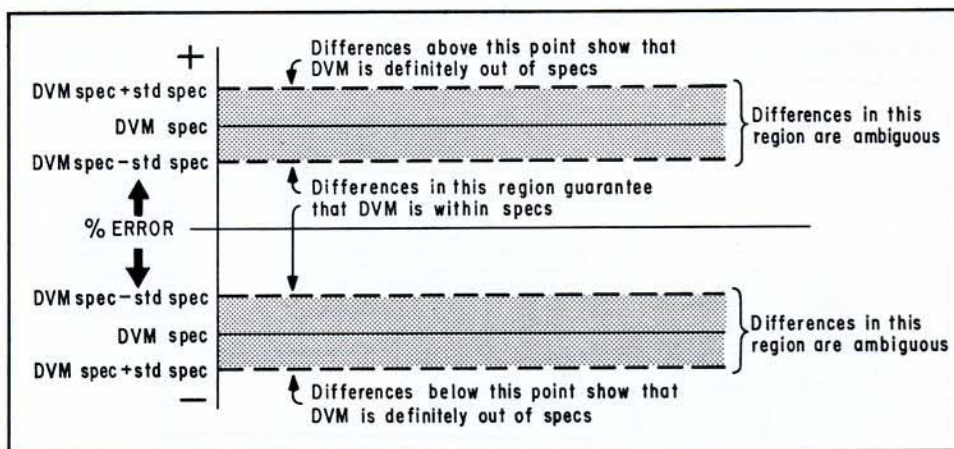

FIGURE 5. Relationship of Standard Specifications to Those of Instrument Being Calibrated.

As the standard accuracy specification gets closer to the DVM specification the ambiguous region in Figure 5 becomes larger, and the standard's uncertainty contribution becomes more significant. If the standard is much less than three or four times as good as the DVM specifications the calibration is not practical because the uncertainties have almost the same magnitude as the calibration.

Calibrating an instrument with an unknown accuracy specification is quite similar to comparing an instrument to a set of known specifications, except there are no specifications to give a clue to the quality of the standard needed. The calibration is done in the same manner by comparing the instrument with a standard and considering the difference between the two as the error. If the error measured this way is considerably larger than the standard uncertainties, then the standard used is adequate. However, if the error is the same order of magnitude as the standard uncertainties, the calibration should be done again with a more accurate standard. The errors noted in the first measurement give a clue to the quality of standard needed.

The calibration by itself is not enough to specify the instrument. Stability, linearity, temperature dependence, noise immunity, and resolution must all be established and added to the calibration. It so happens that the instruments used for the calibration measurement can in most cases be used to determine most of these other qualities.

CALIBRATING A TRANSFER STANDARD

Calibrating a transfer standard involves setting it equal to the best standard available and adjusting its readout to display the standard's certified value. The best standard available is a large group of saturated standard cells maintained in a constant environment. Although individual cells in such a group may drift by as much as a few microvolts over short time periods the drift is almost purely random, so the average of the individual cell outputs remains constant over long periods. The National Bureau of Standards will certify the group's average within about 1 ppm, and the certification is reliable for periods up to one year.

The calibration procedure is a matter of comparing each individual cell in the group with the transfer standard and recording the transfer standard setting necessary for null. This requires a transfer standard that has some kind of display of its output setting, one with at least 1 ppm resolution. After all the cells have been compared, the average of all the readings is compared with the certified average. Any difference between the average of the transfer standard settings and the certified average is the transfer standard's error. The error can be either added as a correction factor or used to

adjust the transfer standard's output. Figure 6 shows the calibration in more detail.

One advantage of this method is that it measures the individual cell voltages while it calibrates the transfer standard. The corrections obtained from the comparison of the averages can be added to each cell reading, and then the corrected cell readings used to maintain a history of each cell. Any high resolution voltmeter could also be calibrated using this method. Such a calibration would be valid only at the cell group's mean value and couldn't necessarily be extrapolated to other values without including voltmeter nonlinearities.

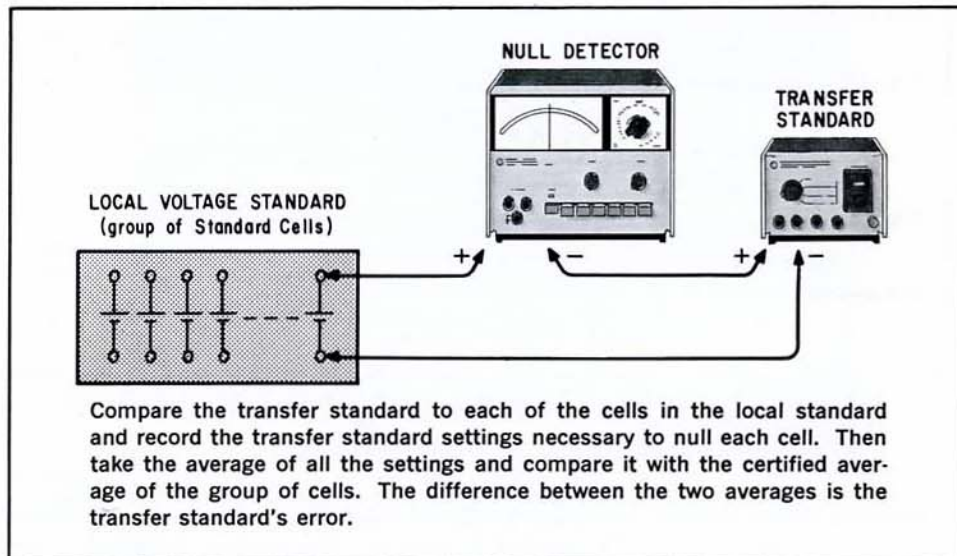

FIGURE 6. Calibrating a Transfer Standard.

CALIBRATING A TRANSFER STANDARD TO 1 VOLT

The calibration just described sets a transfer standard's output exactly to the certified value of the local standard, $1.018\pm$ V. A 1.000000 V output with the same precision, or nearly the same precision, would be much more compatible with most applications. This means converting the output of either the standard or the transfer standard to 1.000000 V and always adds some uncertainty.

The -hp- 735A transfer standard can directly convert a standard cell calibration to 1 volt. First, the 735A is calibrated to a standard using a procedure like the one in Figure 6, and then the front panel switch is set to the 1 V position. This sets the output to 1 volt and adds only 10 ppm uncertainty.

The calibration technique shown in Figure 7 calibrates a transfer standard to 1 V with only about 2 ppm additional uncertainty. In addition to the null meter it requires a stable adjustable voltage source and a precise voltage divider. The divider is connected across the voltage source and together the divider and source make up a second transfer standard.

First, with the divider set for maximum output (ratio of 1.0000) compare the calibrated transfer standard with the output of second transfer standard (voltage source-divider combination), and adjust the voltage source to establish null. This transfers the calibration to the second transfer standard. Then, set the voltage divider to the reciprocal of the transfer standard's calibration — for example, if the transfer standard were calibrated to 1.018763 V the divider should be set to $1/1.018763$ or $.981582$. This sets the output of the second transfer standard to exactly one volt. Finally, adjust the calibrated transfer standard to restore null; then its output will be 1 volt.

The comparison measurements can be made within much less than 1 ppm, and the source and divider won't drift a significant amount during the calibration, so the only significant uncertainties in the final 1 volt setting come from the divider inaccuracy and the original calibration uncertainty. There are commercially available decade voltage dividers with six-digit resolution and specified accuracies of about 1 ppm of full scale setting (for example, the Julie Research Labs Model VDR-106). Since the division

ratio is nearly full scale (.98+) such a divider contributes only about 1 ppm uncertainty. Allowing another part per million for cumulative errors in zero setting, null readings, etc. gives a total uncertainty of 2 ppm. Remember, that's 2 ppm additional uncertainty—any uncertainties in the original calibration of the transfer standard must be added.

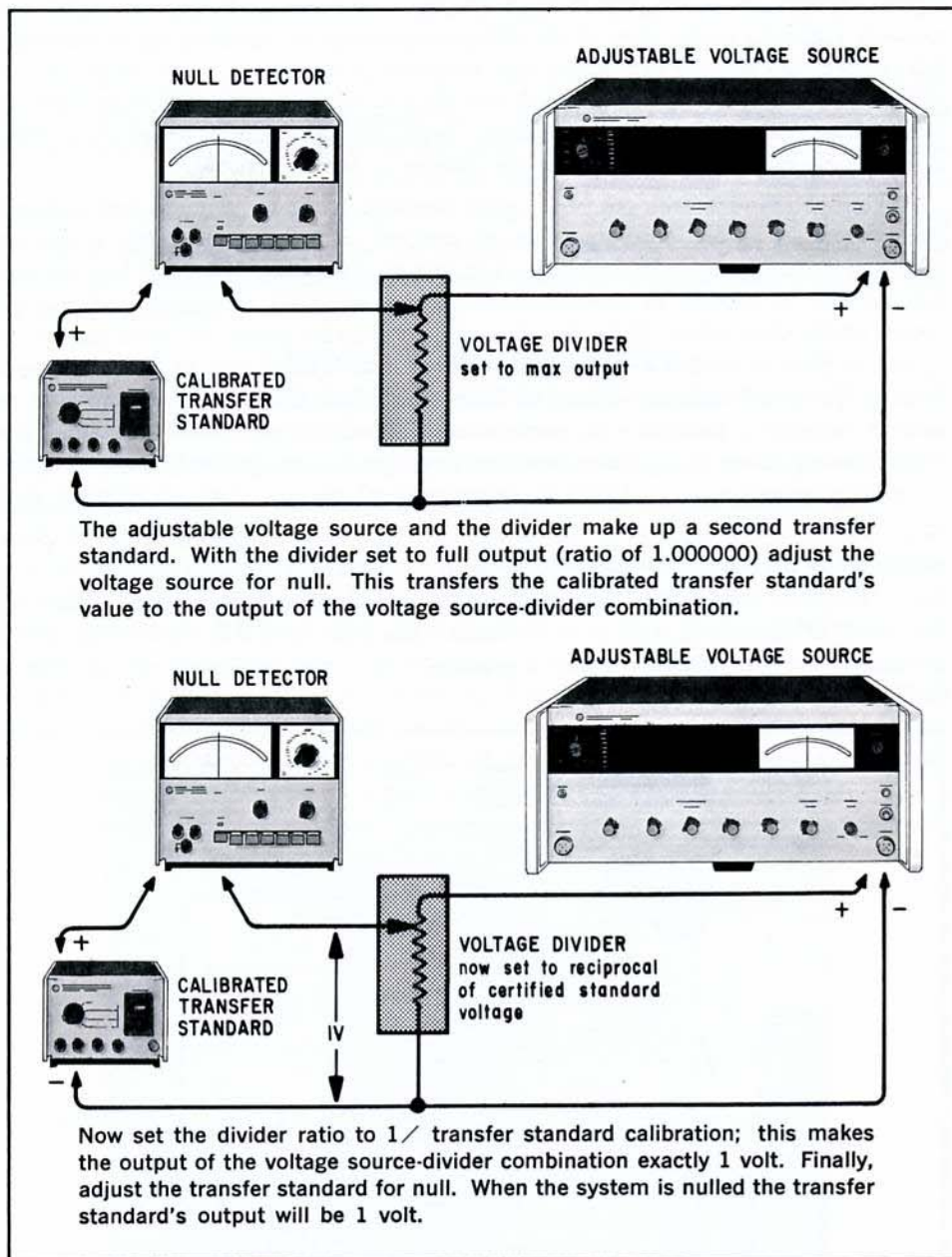

FIGURE 7. Calibrating a Transfer Standard to 1 Volt.

CALIBRATING PRODUCTION STANDARDS WITH A TRANSFER STANDARD

A good transfer standard can mean a big difference in the level of day to day production calibrations. First, a good transfer standard allows the production standard to be easily compared with the local standard at regular intervals. Better data can be maintained and the operators can be more certain of the production standards. Second, a good transfer standard allows calibration of production standards in their own environment. If they must be taken to the standards lab or calibration lab to be calibrated there will always be some uncertainty due to temperature differences between the lab and the production area. Even if the lab is maintained at almost the same temperature as the production area there may be localized temperature differences; the production standard may be in a draft or mounted in a rack with an instrument that generates a lot of heat.

There are several factors to consider when making a transfer from a lab to a pro-

duction area. Most important are stability, temperature coefficient, and turn-on characteristics. Assuming that a transfer standard can be carried to the production location and the transfer made in less than an hour, the effects of instabilities on the calibration will usually be quite small. Most transfer standards have enough thermal insulation that even though changes due to temperature do occur, they occur slowly. Response to small temperature variations is very slow. If the difference between the standards lab or calibration lab temperature and the production area temperature is small its quite likely that the transfer standard could be carried from one place to the other in such a short time that overall temperature effects would be almost negligible. In any case, temperature effects can certainly be minimized by doing the transfer as fast as possible.

Turn-on characteristics can be a special problem. If the transfer standard is disconnected from its power source and then reconnected in the production area it may not return to the same output immediately when its turned back on. If it has a long recovery time it will be affected by environmental changes while it's recovering, and may not return to the same value. If the transfer standard is to be turned off when transported from one place to another it is absolutely essential that it come back to its same value as soon as it's turned back on—within no more than a few minutes. The best way to get around the turn-on problem is to keep the transfer standard on. This means either providing battery power during the transit time or using a battery-operated transfer standard.

Figure 8 shows the -hp- E02-735A being used to calibrate production line standards. Since the E02-735A requires ac line power it is used with a battery-powered ac power source while in transit and then connected to ac line at the location where it is to be used. Transfers can be made in a matter of a few minutes, so the thermal effects and instability effects can be held to a minimum. The E02-735A will transfer the voltage calibration from a standards lab to a production line with additional uncertainties of only about a part per million.



FIGURE 8. Calibrating Production Line Standard with an E02-735A.

USING A VOLTMETER AS A TRANSFER STANDARD

A precise digital or differential voltmeter will work well as a transfer standard if it meets two important requirements. First, its short term stability should be good enough that it won't drift more than the desired uncertainty in the time required to make the transfer. Second, its resolution should be good enough to resolve voltages significantly smaller than the desired uncertainty—if the final transfer is to be within 1 ppm

the voltmeter should be able to resolve a few tenths of a part per million.

The measurement is simple. Just measure the standard with the voltmeter and note the reading; then without changing any of the voltmeter controls or settings, take the voltmeter to the source to be calibrated; connect it to the source to be calibrated; and then adjust the source for exactly the same reading as the standard reading. The source will then be equal to the standard within the short term drift of the voltmeter.

The voltmeter used should have extremely high input resistance so the transfer won't be affected by differences between the source resistance of the standard and that of the instrument being calibrated. If the voltmeter used is a digital voltmeter there will be an additional uncertainty of one count in the least significant digit. This is due to the voltmeter's encoding process. Almost all digital voltmeters arrive at their final reading through a digital counting process and usually the counters involved are uncertain of the last unit counted. Even two measurements of the same source made a second apart can differ by a count.

A PRECISE CALIBRATION SYSTEM

Instruments with specified accuracies of 10 ppm to 30 ppm are now quite common; and they require calibration systems with uncertainties no more than 2 to 6 ppm, systems that are relatively easy to use, and systems that can be used in a production environment. Such a system can be built from the instruments described so far, with one addition—a stable adjustable resistor.

Figure 9 shows the basic system. It contains a stable voltage divider, an adjustable 0 to 1000 V source, a calibrated 1 volt transfer standard, and a null meter. The null meter compares the 1 V from the transfer standard with the 1 V across the bottom 1 k Ω resistor in the divider (R_{ref}). The adjustable source adjusts the current through the divider to keep the 1 V across R_{ref} just equal to the transfer standard output. If all the other resistors in the divider are precise multiples of R_{ref} then all the voltage drops along the divider will be precise multiples of 1 V, and the voltage from any point on the divider to ground will also be a precise multiple of the voltage across R_{ref} .

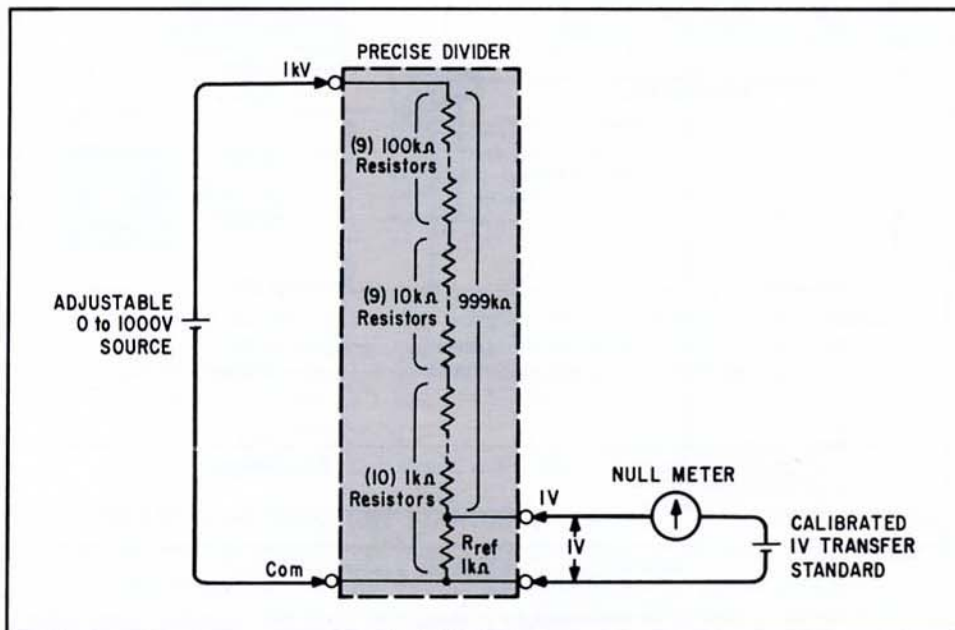

FIGURE 9. Basic Calibration System.

The absolute values of the resistors in the divider are not important. All that is important is that the resistors be precise multiples of R_{ref} . This implies a ratio or matching technique, a technique with inherent high precision. Using such a technique the divider can be built from adjustable standards-type resistors like the Guildline Model 9330A resistors with a resulting uncertainty of less than 1 ppm of division ratio for any division ratio. Using the procedure in Figure 7 an -hp- 735A Transfer Standard can be calibrated to 1 V with uncertainties less than 2 ppm. So, if the voltage source and null-

meter drift can be held to a negligible level the total system uncertainty will be less than 3 ppm, for any output level. Transfer standard and divider drift combined are only on the order of 1 ppm per day so the total uncertainties at the end of a day would still be less than 4 ppm.

This calibration system is quite versatile. As a voltage source it can be used to calibrate voltmeters and other voltage sources. The divider may be used alone for checking linearity and for calibrating dividers or ratiometers. The resistors in the divider may be easily rearranged to make a variety of output combinations and other resistors may be added to increase the number of available outputs.

Building the Divider

The divider described here (Figure 10) will be basically a 1 M Ω series divider with 27 outputs: from 1 V to 10 V in 1 V increments, from 10 V to 100 V in 10 V increments, and from 100 V to 1000 V in 100 V increments. It contains ten 1 k Ω resistors, nine 10 k Ω resistors, and nine 100 k Ω resistors arranged in series. All of the 1 k's are matched; then each of the 10 k's is matched to the series total of the 1 k's; and finally each of the 100 k's is matched to the total of the ten 1 k's and the nine 10 k's.

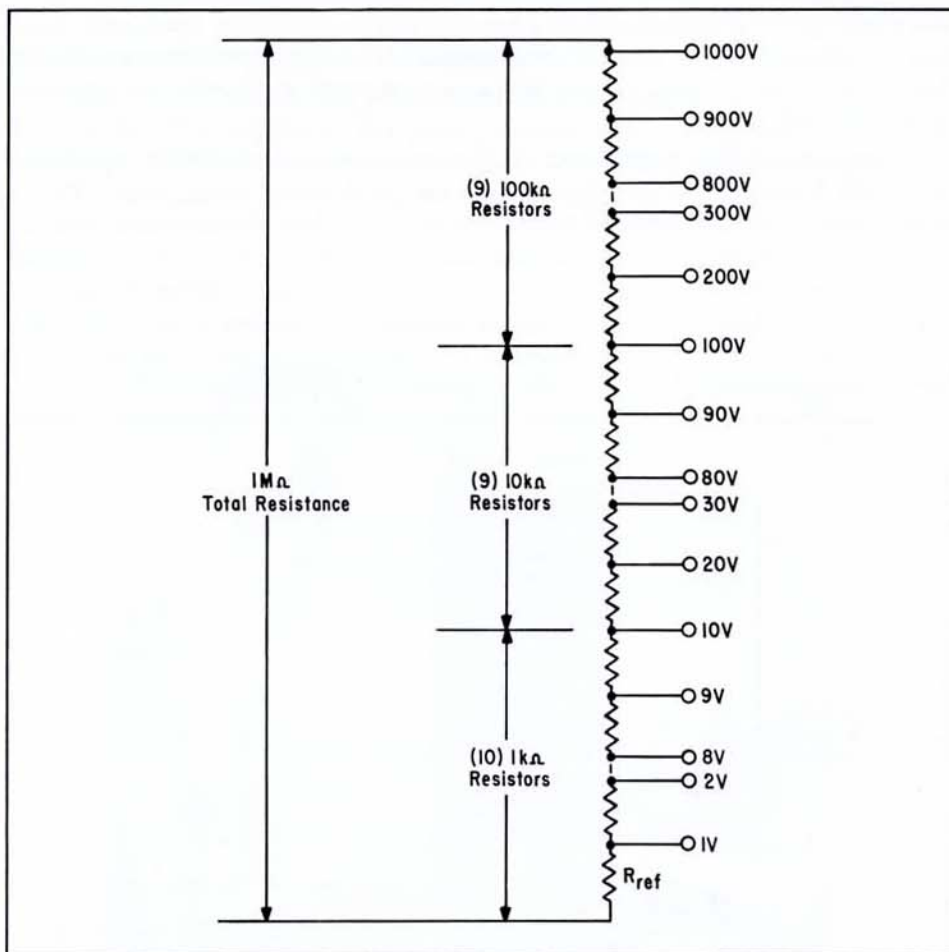

FIGURE 10. Calibration System Divider.

The resistors should be arranged in a thermally insulated container, preferably an oil bath, and the contacts between resistors should be mercury-wetted to reduce contact resistance effects and thermal effects. Both the container and the oil should be kept as clean as possible. Any contamination in the oil can cause leakage problems and seriously degrade the divider accuracy. A divider maintained in a good, clean oil bath will be stable well within 1 or 2 ppm per month.

The Wheatstone bridge technique in Figure 14 is by far the easiest and most accurate resistor matching technique. It requires only a sensitive null meter, three stable adjustable resistors, (R_a , R_b , and R_c in Figure 11) and a dc voltage source. With it a

number of resistors can be set equal to each other within their own resolution of adjustment, the sensitivity of the null meter, and the stability of R_a , R_b , and R_c .

First arrange R_a , R_b , and R_c to form three legs of a wheatstone bridge, and select one of the resistors to be matched as a reference resistor and install it as the fourth leg (R_{ref} in Figure 11). Adjust R_a , R_b , and R_c for null. The bridge itself is now a transfer standard for the reference resistor; any resistor substituted for the reference resistor and adjusted to restore bridge null will be equal to the reference resistor. Finally, substitute each resistor to be matched for the reference resistor and adjust for null.

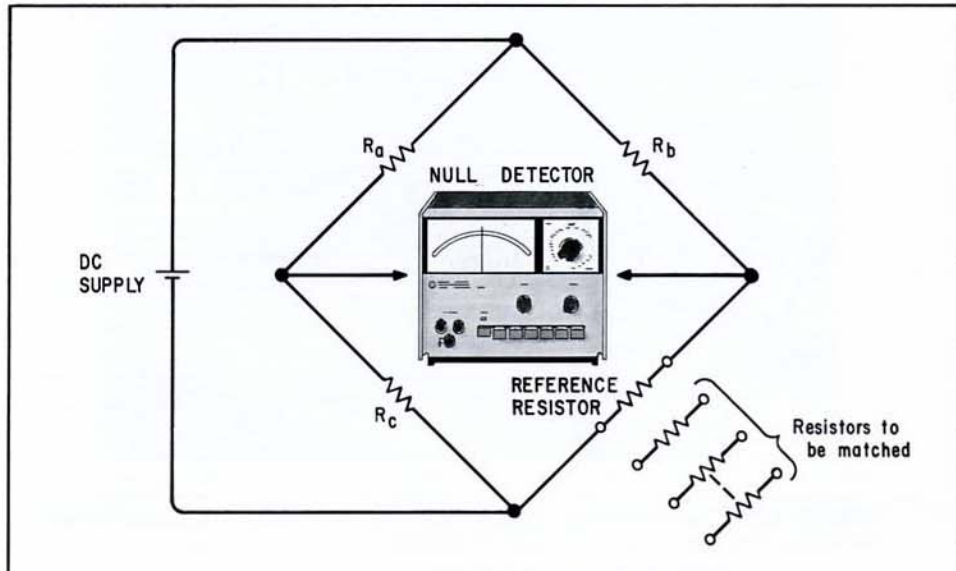

FIGURE 11. Matching Divider Resistors with a Bridge.

Any variation in R_a , R_b , or R_c or any uncertainty in the null meter zero will show up as a matching error. To avoid such errors zero the null meter periodically; and occasionally put the reference resistor back in the bridge, check for null, and make minor adjustments in R_a , R_b , and R_c as necessary. Better still, use resistors comparable to the ones to be matched for R_a , R_b , and R_c ; then their drift will be no more than that of the ones being matched and will have very little effect on the matching accuracy.

Assembling the System

Figures 12 and 13 show the complete calibration system in more detail. The volt-

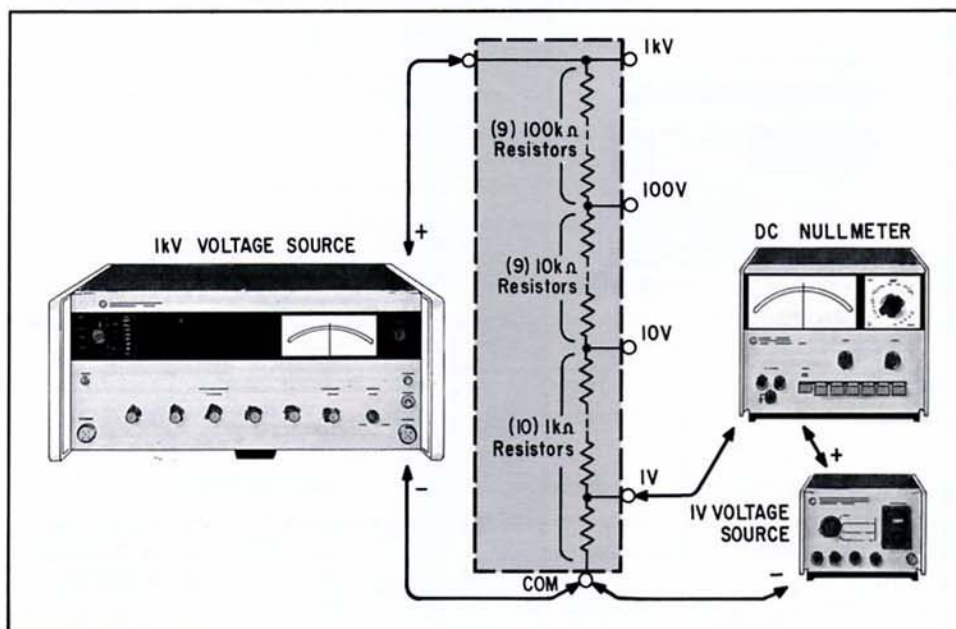

FIGURE 12. A Complete Calibration System.

age source is an -hp- 740B, the null detector is an -hp- 419A, and the transfer standard is an -hp- 735A or E02-735A. All connections to and from the divider or to an instrument being calibrated should be made with Teflon insulated solid copper wire, 20 gauge or larger. Once the system is connected, allow it to stabilize for about 10 minutes and then check the nullmeter zero and check for drift. If the system should drift slightly the drift can be corrected by making slight adjustments in the output of the voltage source to restore null. The system should be maintained at a nearly constant temperature.



FIGURE 13. The Calibration System Showing the Divider Resistors in an Oil Bath.

Calibrating a Calibration Standard

Figure 14 shows a setup for calibrating a precise dc calibration standard. The calibration standard replaces the voltage source and its output is connected to the divider tap corresponding to the calibration voltage. In the example in Figure 14 the calibration voltage is 6 V; if the calibration standard output is exactly 6 V the voltage across R_{ref} will be exactly 1 V and nullmeter will show a null. If the standard output is not 6 V

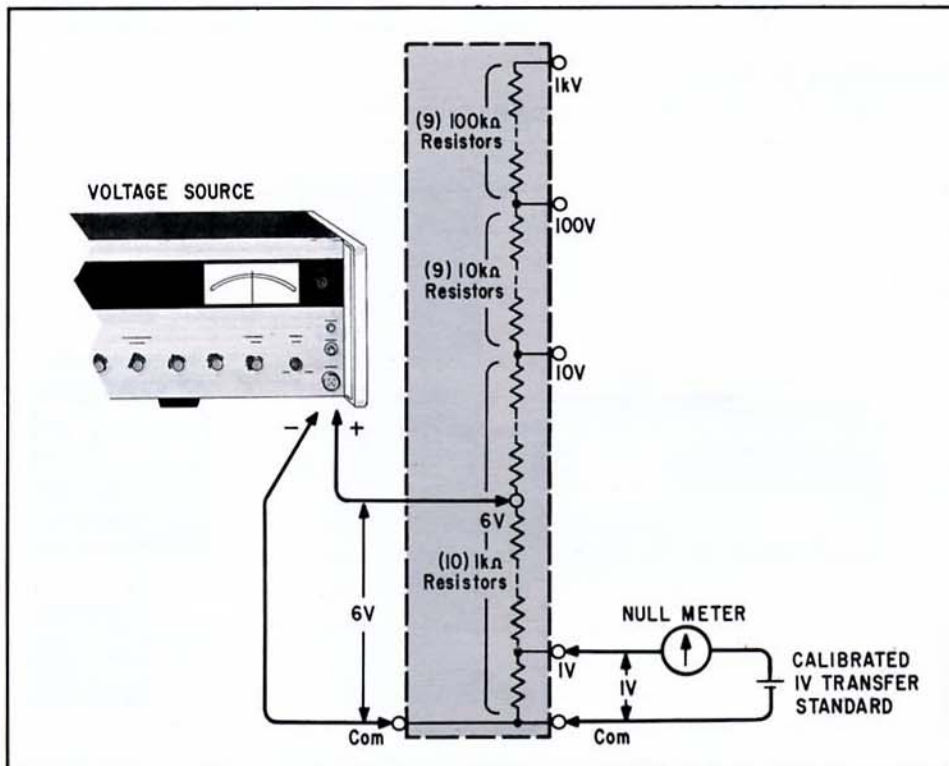

FIGURE 14. Calibrating a Calibration Standard.

the nullmeter will indicate the error. The best way to read the errors is to adjust the standard for null and read the errors from the standard's output dials.

This technique can be used for any voltage level within the range of the divider and it has about the same certainty at all levels. If the divider is matched and the transfer standard freshly calibrated the total calibration uncertainty will be about 2 to 3 ppm of the standard setting.

Calibrating a Precise Voltmeter

The setup used for calibrating a precise calibration standard is ideal for calibrating a voltmeter—just connect the voltmeter to the same tap as the standard (Figure 15) and adjust the standard for null. Since both the voltmeter and the standard are connected to the same tap there is no loading error. Uncertainties in the voltmeter calibration are about two or three parts per million.

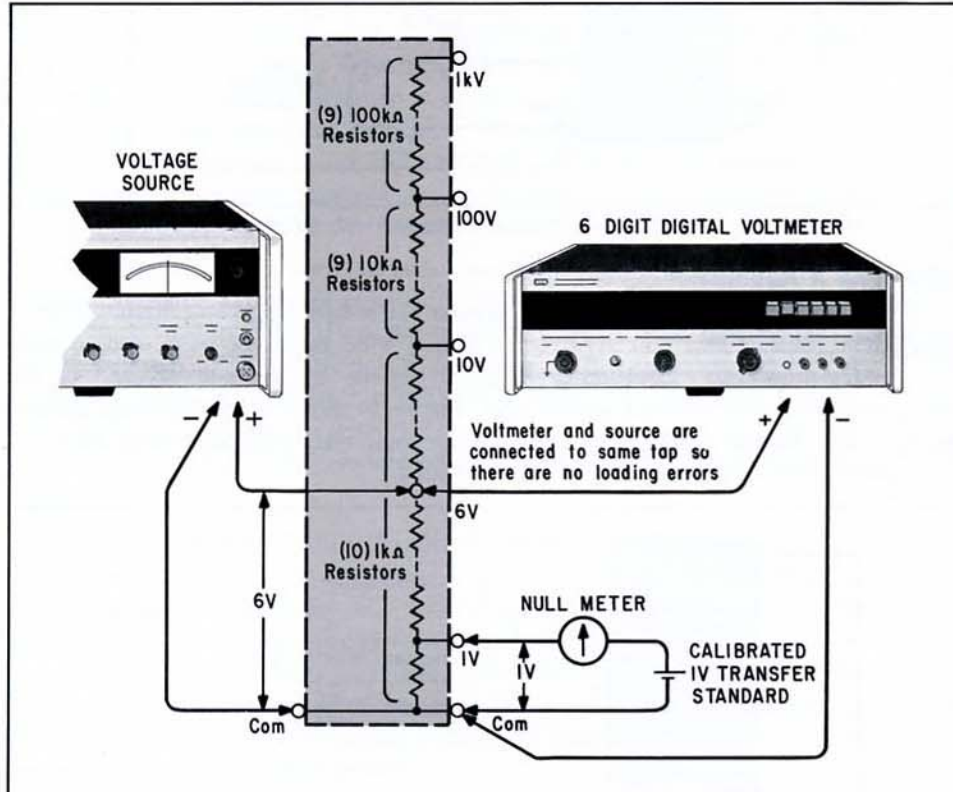

FIGURE 15. Calibrating a Precise Voltmeter.

Another setup is shown in Figure 16. There the source is set to 1000 V and adjusted slightly for null. As long as the voltage across the bottom 1 kΩ resistor is held at exactly 1 V the voltages at all the divider taps will be as accurate as the divider. This setup is a little easier to use, but it isn't immune to loading errors; the input resistance of the voltmeter being calibrated must be 10^6 to 10^7 times greater than the resistance from the tap being used to ground. For example, consider connecting a voltmeter from the 10 V tap to ground. The divider resistance from the 10 V tap to ground is 10 kΩ; the voltmeter's input resistance will shunt the 10 kΩ and cause some shift in resistance and a resulting shift in voltage. As long as the voltmeter's input resistance is 10^6 to 10^7 times as great as the 10 kΩ ($10^{10} \Omega$ to $10^{11} \Omega$) the voltage shift will only be 0.1 to 1 ppm. But if the input resistance is much less the shift can become significant.

Any loading error will show up as an off-null deflection on the nullmeter. Small loading errors can be compensated by making minor adjustments in the source output to restore null; whenever the nullmeter reads null the input to the voltmeter is correct.

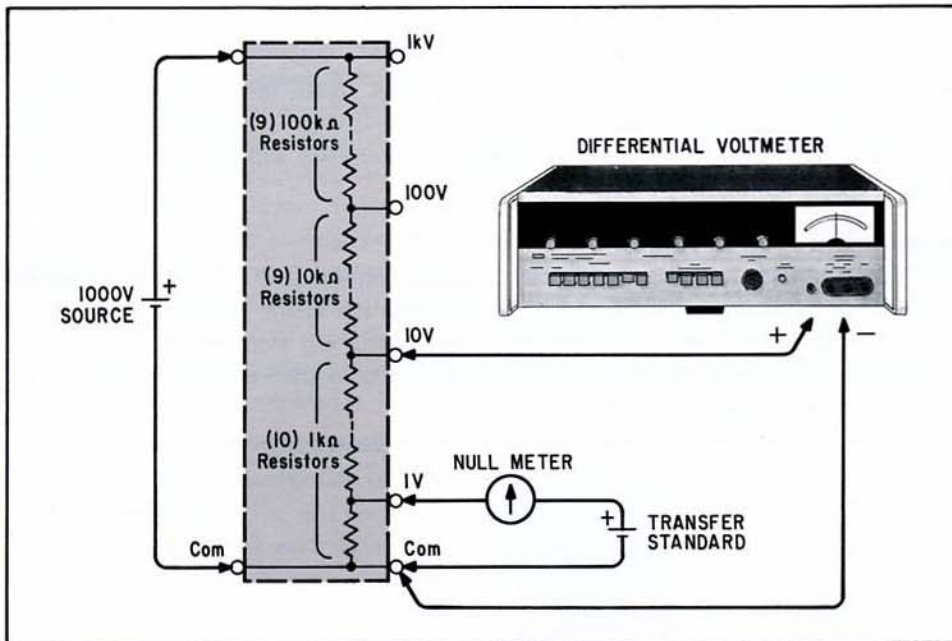

FIGURE 16. Calibrating a Precise Voltmeter with Infinite Impedance.

Calibrating a Ratiometer

The precise ratios established by the divider are ideally suited to calibrating ratiometers. The resistors may be rearranged to form a wide variety of ratios, and in most cases the resulting ratio calibration depends only on the division ratio accuracy of the divider and not on any external sources used. Figure 17 shows the voltage ratio calibration of a high resolution ratiometer that measures only three-terminal voltage ratios, or ratios where both inputs must have the same ground.

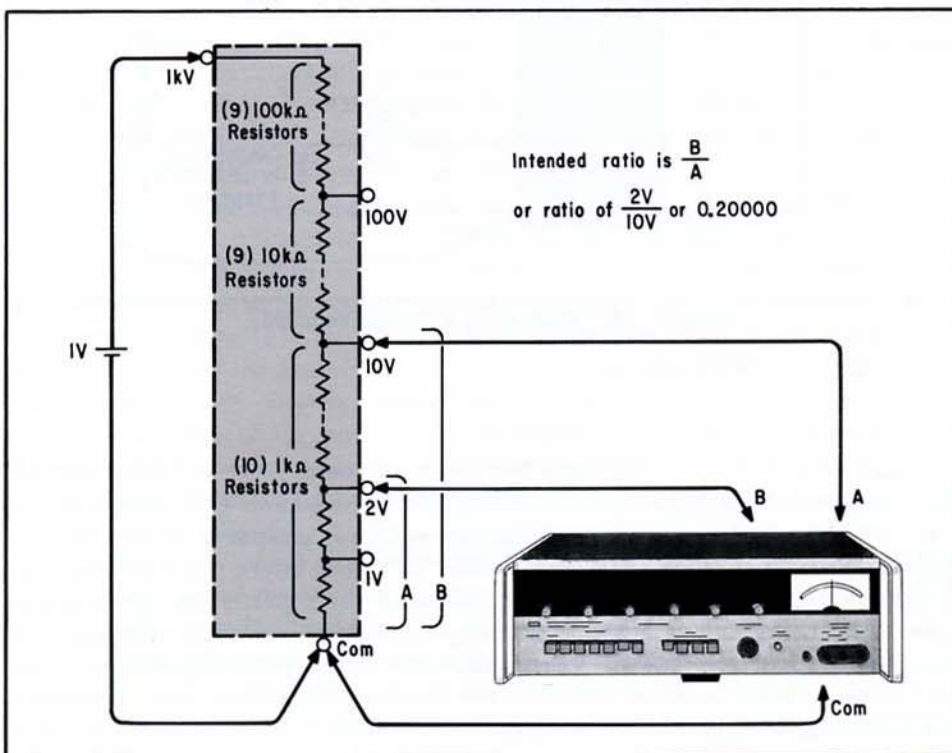

FIGURE 17. Voltage Ratio Calibration of a Three Terminal Ratiometer.

The calibration ratio is 0.2, a ratio of about .2 V to about 1 volt, and its accuracy is determined by the resistor ratios and not at all by the source voltage. The ratio could just as well be 0.24 V to 1.2 V and still be the right calibration.

Figure 18 shows a four-terminal voltage ratio calibration of a digital ratiometer. In the four-terminal case the grounds of the two signals do not necessarily have to be common. Here the whole calibration system is used and the calibration ratio is the ratio of the voltage across one of the 1 k Ω resistors to the voltage across one of the 10 k's or 1 V/10 V or 0.1. By interchanging the "X" and "Y" connections the ratio could be made 10.000. By putting the "X" connections across two of the 1 k's instead of just one, the ratio could be made 0.2. One limitation in setting up ratios is the voltage difference between the "X" ground connection and the "Y" ground connection. A four-terminal ratiometer has a specified maximum allowable voltage between grounds; if that voltage is exceeded the ratiometer could be damaged. The input resistance of the "X" and "Y" inputs can also affect the accuracy of four terminal ratio calibrations if it becomes low enough to cause loading errors.

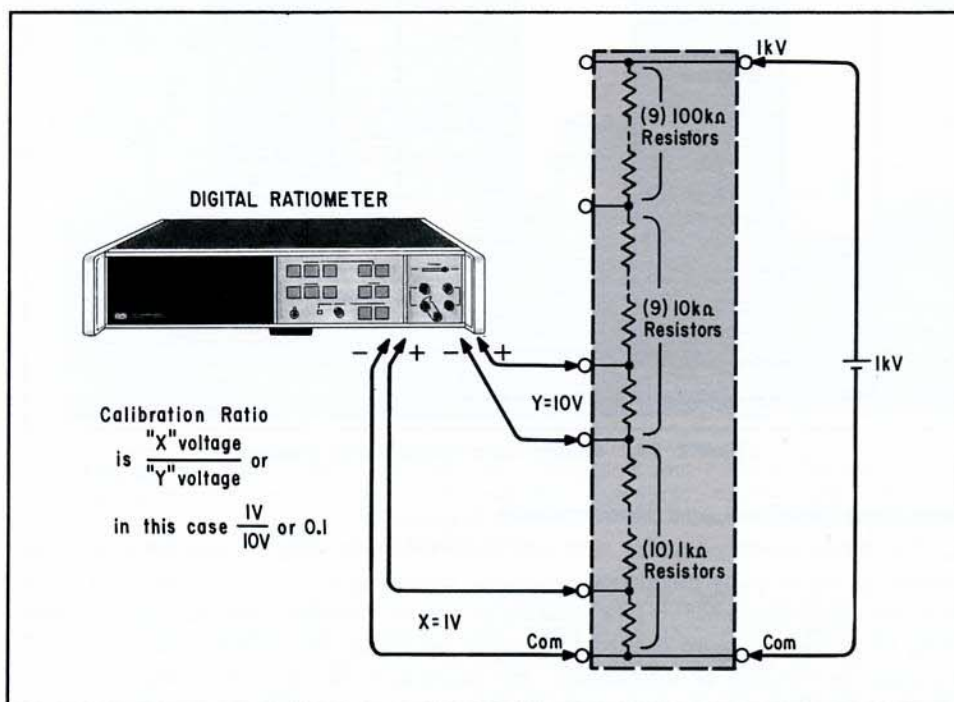

FIGURE 18. Voltage Ratio Calibration of a Four Terminal Ratiometer.

Calibrating a Kelvin Varley Voltage Divider

A Kelvin Varley divider is best calibrated by comparing its division ratios with those of a precise "standard" divider using a bridge arrangement. In Figure 19 the precise divider is one side of the bridge and the output of the divider to be calibrated is the other. One side of the nullmeter is connected to the standard divider output corresponding to the Kelvin Varley divider's setting, and the other side is connected directly to the Kelvin Varley's output. Any nullmeter deflection indicates a difference in division ratios. If the Kelvin Varley divider is adjusted for null it will display its own errors.

R_a and R_b are added to compensate the effects of lead and contact resistance. If the total resistance levels of the standard divider and the Kelvin Varley divider are nearly equal, R_a and R_b need not be actual physical resistors; in that case the contact and lead resistance can be nulled by moving the voltage source connections back and forth along the wires joining the two dividers. If the two resistance levels differ by a factor of 10 or so, R_a and R_b should be small valued, wire wound variable resistors. R_a is adjusted for null with the nullmeter connected between the top of the standard divider and the Kelvin Varley divider output, with the latter set for maximum division ratio. R_b is adjusted for null with the nullmeter connected at the bottom of the standard divider with the Kelvin Varley divider set to zero. R_a and R_b interact, so the contact resistance compensation will probably require repeated adjustments of R_a and R_b .

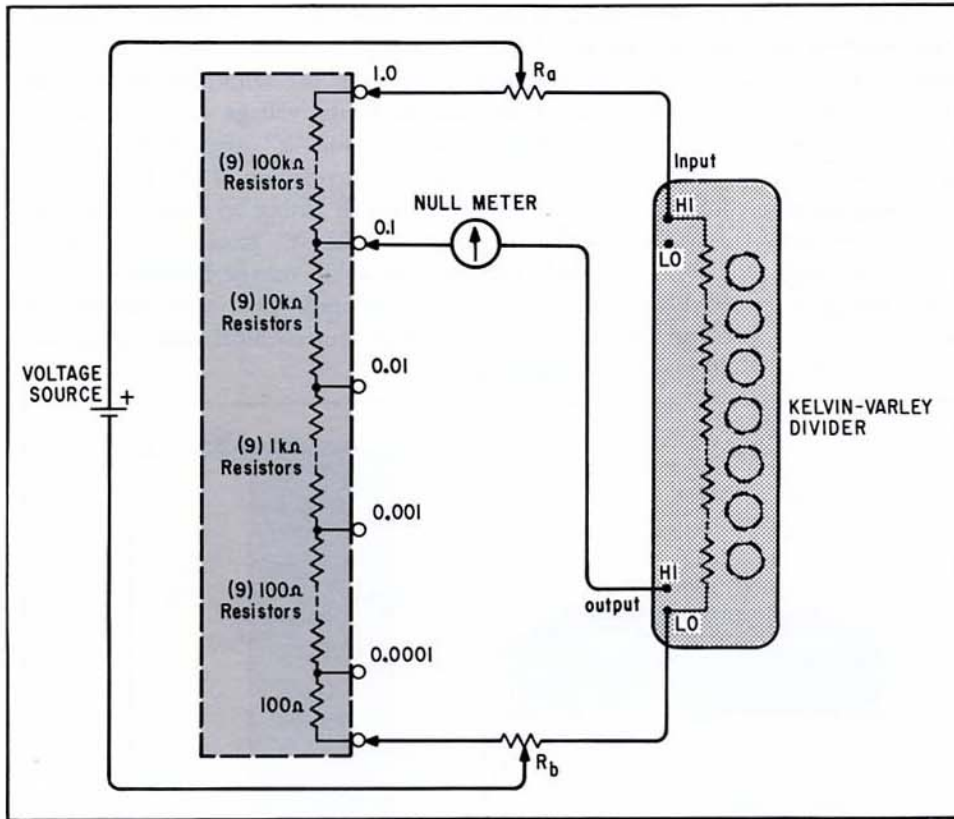

FIGURE 19. Calibrating a Kelvin-Varley Divider.

Some Simplifications and Modifications

The system described so far is an excellent calibration tool, but may be a little too elaborate to use in many production situations. Simpler systems can be assembled using just a few adjustable standards-type resistors in a small, portable container; such systems would, of course, be more limited and would be set up to calibrate some particular instrument or category of instruments. For example, a 900 k, a 90 k, and ten 1 kΩ resistors could be used to provide a system with output voltages of 1 through 10 V in 1 V increments, for checking linearity, and 100 V and 1000 V outputs for checking higher voltage ranges. (See Figure 20). An even simpler system would have only four resistors,

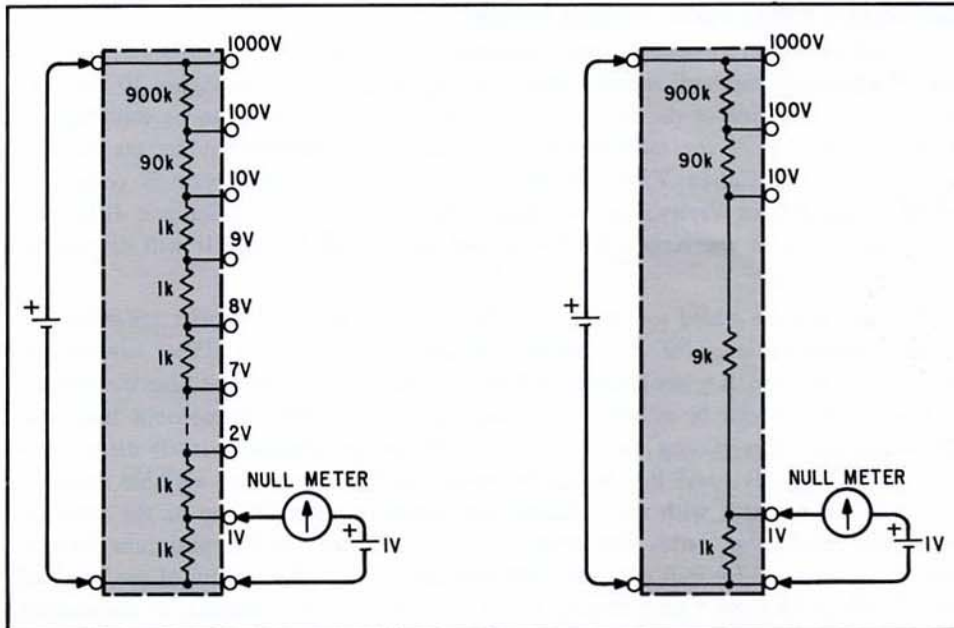

FIGURE 20. Two Simplified Systems.

a 1 k Ω , 9 k Ω , 90 k Ω and a 900 k Ω and outputs of 1 V, 10 V, 100 V, and 1000 V. The major disadvantage of such systems is that their dividers cannot be adjusted by matching and must be calibrated by some other divider using a method like the Kelvin Varley Divider calibration in Figure 19.

A simpler system with the same versatility, and the same inherent accuracy would be one built from simpler and less expensive components. A complete system can be built using ordinary resistors; it can be calibrated by matching, has all the outputs, and is much more portable. Unfortunately it is not nearly as stable, so the resistors must be rematched at regular intervals of a few weeks to a month.

By "ordinary" resistors we mean at least 0.01% resistors with matched temperature coefficients. They are selected at values slightly higher than their intended value, "padded" by parallel resistors to within about 10 ppm of one of the nominal values, and then provided with a parallel adjustment with enough range to adjust them to the nominal value. (See Figure 21). The resistors are installed in some thermally insulated device and then matched to form a precise divider.

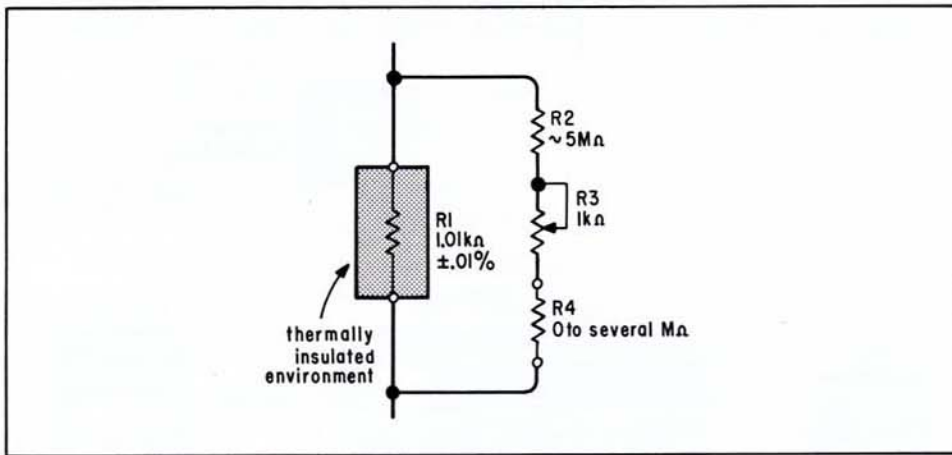

FIGURE 21. A 1 k Ω Adjustable Divider Resistor made from Ordinary Resistors.

STABILITY MEASUREMENTS

A stability measurement compares the instrument or device in question with a standard of known stability and records the difference. It must be done over a long enough time to catch all the instabilities, and it must be done in a constant environment so that instabilities aren't confused with temperature coefficients, humidity effects, power line fluctuations, etc. The relationships between the stability of the standard used and the anticipated stability of the instrument under test are very similar to the relationships between instruments in an ordinary calibration. The stability of standard should ideally be ten times better.

Figure 22 shows two examples. In the top example a sensitive null detector compares the stability of voltage source with the stability of an -hp- 735A Transfer Standard. In the bottom example a differential voltmeter measures the transfer standard output and its recorder output indicates small variations in its reading. The stability of a digital voltmeter would be measured in much the same way using the same transfer standard and a digital recorder. In both of these examples the transfer standard is stable enough that its instabilities won't be confused with those of the instrument under test. Note that in both measurements there is no need for an absolute standard; the standard need only be stable.

Measuring the stability of the transfer standard would not be as easy. Its stability is better than 1 ppm per hour, and there aren't many instruments much more stable. The only standard considerably more stable than 1 ppm/hour would be the mean of a bank of standard cells, but there is no way to continuously compare the transfer standard and the mean of the bank. So the stability of the transfer standard can only be measured by periodically calibrating it and maintaining records.

Measuring variations over a period of time and recording them are just the begin-

nings of a stability measurement. Then comes interpretation of the data. The most precise way and, unfortunately, the most complicated and time consuming way is to use a complete statistical analysis of the data. Statistical analysis yields a "most probable" random short term drift as well as a "most probable" long term trend, if one exists. It also yields a quantitative measure of the confidence of the results. But a statistical analysis requires lots of data taken over long periods of time from many instruments if it is to be meaningful.

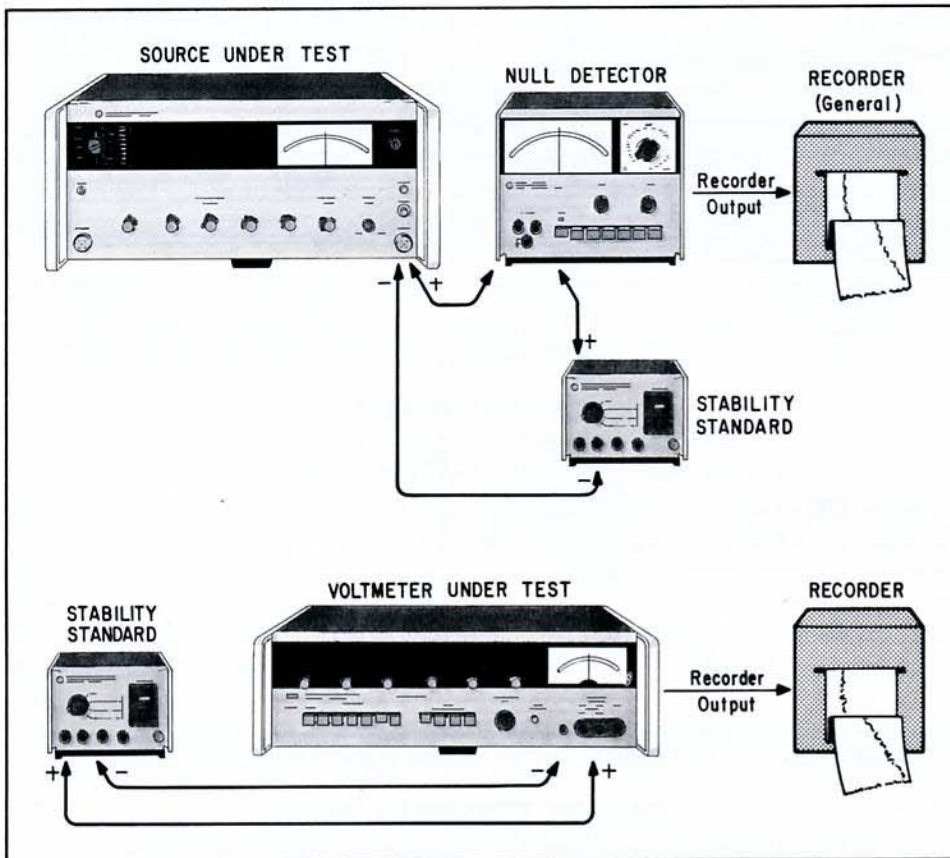

FIGURE 22. Stability Measurement.

If only a few instruments are to be evaluated over a limited time a qualitative analysis is often just as useful as a statistical analysis. Although a qualitative analysis is not as precise it is much easier to do and in many cases yields enough information. It is a matter of carefully observing the data, usually in graphical form, and trying to estimate upper and lower limits between which the values will usually fall.

Figure 23 shows some typical data that might be analyzed. The graph at the top of the page indicates short term variations during a 1 day segment, and the bottom graph shows long term drift for 6 months. Consider the top graph first. At A the instrument is turned on and set for zero error. It immediately jumps up about $17 \mu\text{V}$ and then, after an hour or so, is back near the zero point. The extreme variation during the first hour is probably a combination of turn-on transients and warmup, maybe due to something like an oven coming up to operating temperature; it shouldn't be considered as drift. After the variation at A the instrument stabilizes somewhat, and for about 15 hours remains constant, with errors no greater than $4 \mu\text{V}$ positive and $6 \mu\text{V}$ negative. Note that in the several 1 hour increments marked that the drift in each is on the order of 3 or $4 \mu\text{V}$. These increments were chosen because they are the ones that contain variations with the sharpest slope and represent maximum variations.

A sharp $20 \mu\text{V}$ shift lasting only a minute or so occurs at point B; it is markedly different from the rest of the variations, and is quite a bit larger. It could be drift, but notice that on the lower graph nothing like it occurs through the next 5 months. So it's reasonable to call this a transient variation, probably caused by something external to the

instrument, like a large fluctuation in line voltage. The same is probably true of a fluctuation like the one at C; it is a permanent shift, but not characteristic of the instabilities occurring over the 5 month period. The long term drift appears to have a trend of about $10 \mu\text{V}/\text{month}$ in a negative direction. The appearance of the trend in the first 5 months does not, however, guarantee that the trend will continue, although it does seem likely.

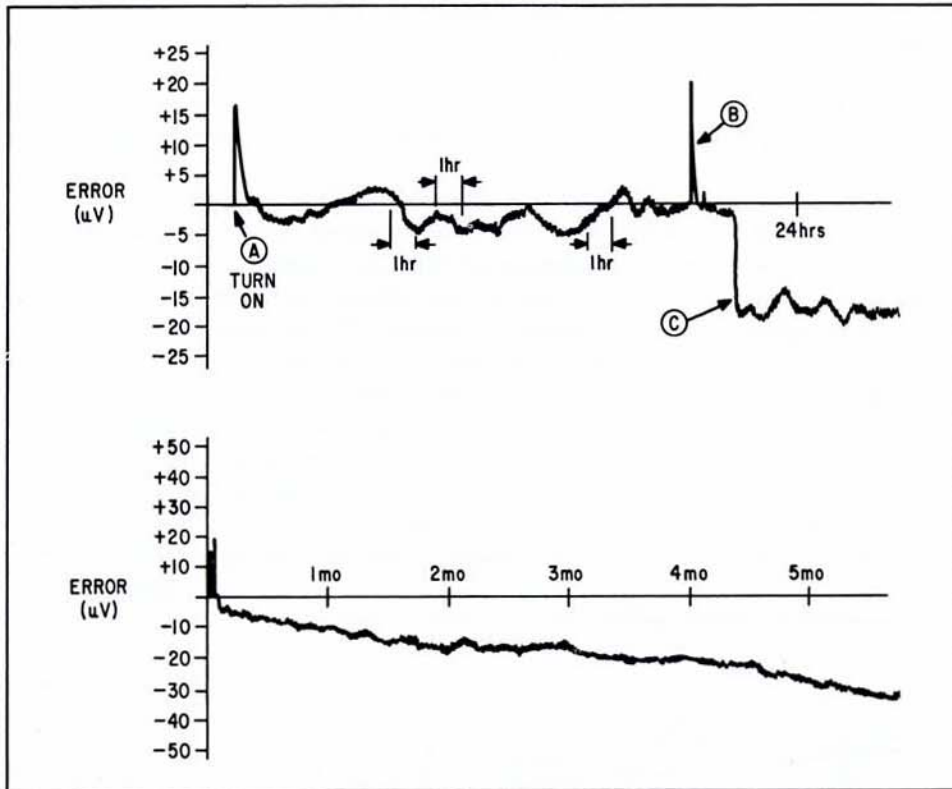

FIGURE 23. Some Typical Stability Data.

The stability figure given to the instrument represented in Figure 23 must be arrived at subjectively. The short term drift could be called "less than $4 \mu\text{V}/\text{hour}$ " with reasonable certainty, just from the data taken during the first 24 hours; but it would be more certain if it were measured over several time periods throughout the whole 5 months. It's generally acceptable to ignore variations like B and C so long as they don't reoccur and cannot be related to the instrument. The A variation could be included as part of a warmup time specification. The long term stability trend shown indicates a $10 \mu\text{V}/\text{month}$ long term stability, and a downward trend, but doesn't supply enough information to guarantee exactly what the downward trend will be—whether it will be linear or how much it will deviate from a linear trend. More measurements of more instruments and a statistical analysis would be necessary to specify the trend. Also, there is no guarantee that the downward trend would continue after 5 months. So the long term stability can only be stated as "within $10 \mu\text{V}/\text{month}$ ".

PRECISE CURRENT CALIBRATION WITH A DIFFERENTIAL VOLTMETER

A differential voltmeter and precise resistor make a good high resolution ammeter for current calibrations. Just connect the precise resistor in series with the unknown current and measure the voltage across it. Since the differential voltmeter's input resistance is infinite at null, it doesn't load the resistor. If the resistor has a decade cardinal value like 100Ω , $1 \text{ k}\Omega$, or $10 \text{ k}\Omega$ the voltmeter will display the results directly in amperes. No calculations are necessary except to place a decimal point. If a voltmeter with finite resistance were used the current would have to be calculated by dividing the voltage reading by the parallel combination of the voltmeter's input resistance and the series resistance.

The "off-null input resistance" of the differential voltmeter determines just how

large the series resistor can be. If the series resistor is near the value of the off-null input resistance, the null detector on the differential voltmeter will not respond properly to deviations from null and will be nonlinear. If the measurement is brought to null the final reading will be just as accurate, but it's difficult to get it to null. An easy solution is to use a meter whose input resistance is always infinite, regardless of null, like the -hp- 740B. The effects of off-null input resistance are discussed in more detail in the next section.

THE PROBLEMS

So far the measurements have been presented in a somewhat streamlined fashion, aimed at presenting the basic ideas of the measurement. There are, however, some problems common to each and every precise dc measurement. They show up as unexplained uncertainties, results that don't agree, or measurements that just don't work. There are thermals, losses in leads, grounding problems, leakage problems, noise problems, and on and on . . . Here we present some of the more common problems along with some simple guidelines to help keep your problems to a minimum.

LOADING ERRORS IN VOLTAGE MEASUREMENTS

Whenever the source resistance of an input voltage source is anywhere near the magnitude of the input resistance of the voltmeter measuring the source there is a loading error. The size of the loading error depends on the relationship between the source resistance and the input resistance. Specifically, the loading error (in percent) is

$$\frac{R_s}{R_s + R_{in}} \times 100 \%$$

where R_s and R_{in} are the source and input resistances, respectively. So, if R_s is known the loading error can be calculated. But the source resistance usually isn't known except in the most general sense. The only way to be completely sure of loading errors is to eliminate them completely by using a voltmeter with very high input resistance. Almost all differential voltmeters have infinite input resistance ($10^{11}\Omega$ to $10^{12}\Omega$) at null and high (1 to 10 megohms) input resistance when they are completely off null. An increasing number of digital voltmeters also have infinite input resistance. Once one of these meters completes a measurement almost no current flows from the source, and there is no loading error.

A word of caution when using a differential voltmeter . . . if the source resistance is nearly the same as the off-null input resistance, the differential voltmeter's nullmeter will not show off-null deviations properly; once the measurement is completed and nulled it will be accurate, but getting to null is a problem. Figure 24 shows why. The voltmeter's nullmeter responds to the voltage across R_{in} , the off-null input resistance; if R_s is the same size as R_{in} in the null meter will detect only about half of the difference between E_s and E_r . So off-null response will be improper. This problem can be eliminated by using a voltmeter whose R_{in} is practically infinite at all times, such as an -hp-740B or one of several high resistance digital voltmeters.

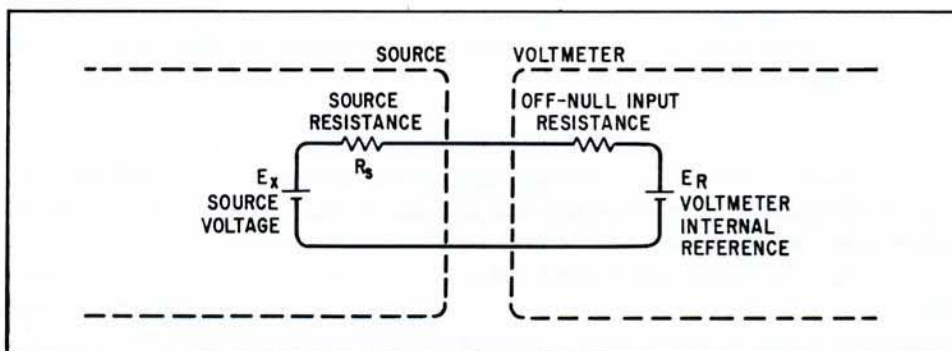

FIGURE 24. Effect of Off-Null Input Resistance.

THERMAL OFFSETS

Thermal offsets show up in every measurement and they are hard to isolate. In a measurement involving several instruments the final result could include the sum of a dozen random thermal voltages with no indication of the thermals. Any junction be-

tween two different metals will generate a thermal voltage; even the junction between two pieces of the same metal can generate a voltage if the two pieces are at different temperatures. It doesn't take a large temperature . . . even touching a junction with your hand can produce an offset of several μV .

Once the thermal offset is detected and located it's not too difficult to correct; finding it is the problem. The first indication to look for is unrepeatable results with good stable instruments, especially if the measurement involves changing connections. If the measurement is in doubt, a good check for thermal offsets is to disconnect the instruments and reconnect them in a different configuration and look for a difference in the results. A marked difference will usually indicate thermals, although it could indicate bad connections.

The next thing to do is take a hot object (like a soldering iron, or even your hand) and touch it to suspect points in the measurement. Touching the suspect points will usually cause some offset to appear, but more pronounced offsets will appear from the trouble spots. Then try to eliminate the thermals located with some of the techniques listed.

1. Avoid thermal junctions; connect brass to brass and copper to copper and silver to silver where possible.
2. Then, if that's not possible, arrange apparent thermals so they oppose each other. A copper to brass thermal has opposite polarity from a brass to copper thermal. So if two brass terminals are connected with a solid copper wire, the thermals at each terminal will have opposite polarity. If both terminals are at the same temperature the offsets will just about cancel each other.
3. Sometimes thermal offsets may be eliminated by generating a small voltage in series opposition to cancel them. One way to do it is to place a small (less than $1\ \Omega$) resistor in series with the lead from which the thermal originates and then connect an adjustable low voltage source across the resistor; the voltage source is adjusted to cancel the thermal.
4. Keep the temperature constant and allow time for the measurement to reach thermal equilibrium before taking any data. Making connections conducts the heat from your hands to circuit elements; touching parts of the circuit with metal objects conducts heat away from the circuits; so allow a few minutes for stabilization after making any modifications. If the temperature is kept constant and the measurement is in thermal equilibrium then the remaining thermal offsets may be removed by zero adjustments or calibration adjustments.
5. Finally if the thermals cannot be effectively removed their effect can be minimized by making the measurement a number of different ways and then averaging the results. For example, a bridge measurement could be made with the resistors in different positions, then with the drive voltage reversed and then with the null meter reversed and then all the different results averaged. The greater the number of combinations used the smaller the effect of the thermals will be.

LEADS AND CONNECTORS

Leads and connectors can produce many problems other than just thermals. The two chief problems are noise pickup and lead and contact resistance. Two wires anywhere near each other will always induce signals in each other to some degree. If they are kept from being parallel, shielded, and kept as far away from each other as possible the amount of induced signal can be kept very small. A wire anywhere near a noise generating source, such as a motor, will pick up noise from the source and the amount picked up is strictly a function of the distance from the source and the size of the wire. A heated wire will generate noise and the amount of noise is a function of the temperature. An ordinary test lead six or seven feet long may have resistance as high as 10 or 20 or maybe 100 milliohms depending on its diameter and composition. 20 milliohms doesn't sound like much by itself, but when put in series with a $1\ \text{k}\Omega$ resistor it amounts to a 20 ppm shift in resistance, and maybe a 20 ppm shift in the voltage. Connections

between terminals and leads can have very high impedances if they are not secure, and usually such high impedances are intermittent. An intermittent high impedance not only interferes with the measurement but also generates noise. These examples are only a few of the problems—there are lots more.

Here are some suggestions. Use shielded leads whenever possible and keep the leads short. Also keep the leads away from each other as much as possible; if they must be close don't run them parallel, but twist them together. Keep motors, fans, ionizing or arcing devices, and any other sources of noise as far away from the leads as possible. Use solid copper wire, 20 gauge or larger, to keep lead resistance down. And finally, keep all connections good and tight and periodically check them.

LEAKAGE, HUMIDITY, AND DIRT

Leakage problems, or problems associated with unintentional current paths in a measurement occur very frequently and are very hard to isolate. As an example of how leakage paths occur and how to guard against them, consider the precise divider used in the last section and the oil bath that holds it. Theoretically the oil bath is a perfect insulator with no conductivity at all; so it doesn't affect the resistors in the divider. But suppose some dirt gets in the oil; ordinarily the dirt won't dissolve in the oil because the oil has very little moisture. But then suppose the ambient humidity goes up . . . more water vapor dissolves in the oil, some of the dirt dissolves in the water and ionizes. Then there are ions in the oil and it will conduct some small amount of current. Its resistance goes down. A $10^{11} \Omega$ leakage path around a 100 k Ω resistor will cause a 1 ppm change in its resistance; it doesn't take much leakage current in the oil bath to seriously affect the divider accuracy. Anytime the combination of humidity and dirt occurs in a measurement it can seriously degrade the measurement. Even surprisingly small amounts of contamination will upset a measurement when the humidity goes up. One properly placed fingerprint at 95% humidity can cause a change of several percent in a 100 k Ω resistor.

Leakage problems, like thermal problems, have no special identifying features. They show up as unexpected results, as unrepeatable results, or sometimes as unusually large loading errors. The best way to check for leakage is to measure isolation resistances directly and compare them with the high impedances where the leakage is suspected. The easiest way to measure is with a high voltage source and a picoammeter as in Figure 25. There the high voltage source applies 1000 V across the oil bath and the picoammeter monitors the current through the bath. A current of 10 pA, for example, would indicate leakage resistance of about 10^{14} ohms, which is acceptable. A quick way to check is to simply blow on the suspected area; the moisture in your breath will aggravate any leakage problems that exist and show some change in measured results. The only way to completely avoid leakage problems is to keep humidity and dirt away from the measurement.

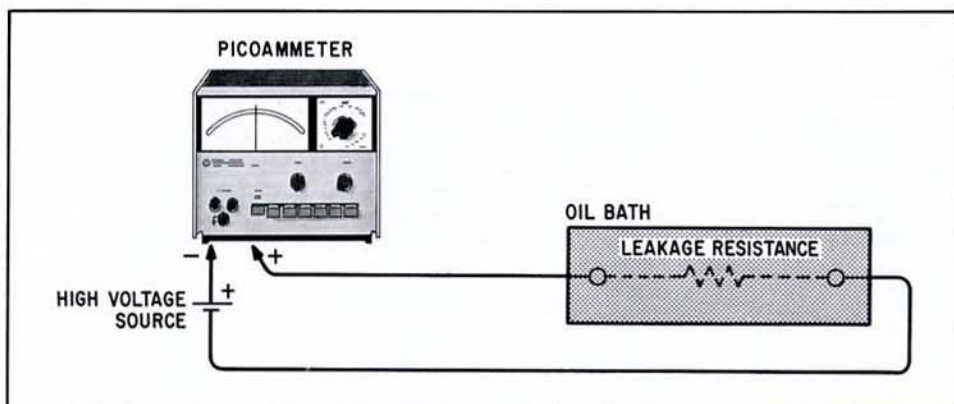

FIGURE 25. Leakage Measurement.

