



# SOLID STATE SWEEP OSCILLATORS

3 MHz to 18 GHz

model  
8620A  
8620B  
8621A  
86200 Series  
86300 Series

TECHNICAL DATA 15 JUN 72

## The HP 8620 Value Family of Sweep Oscillators

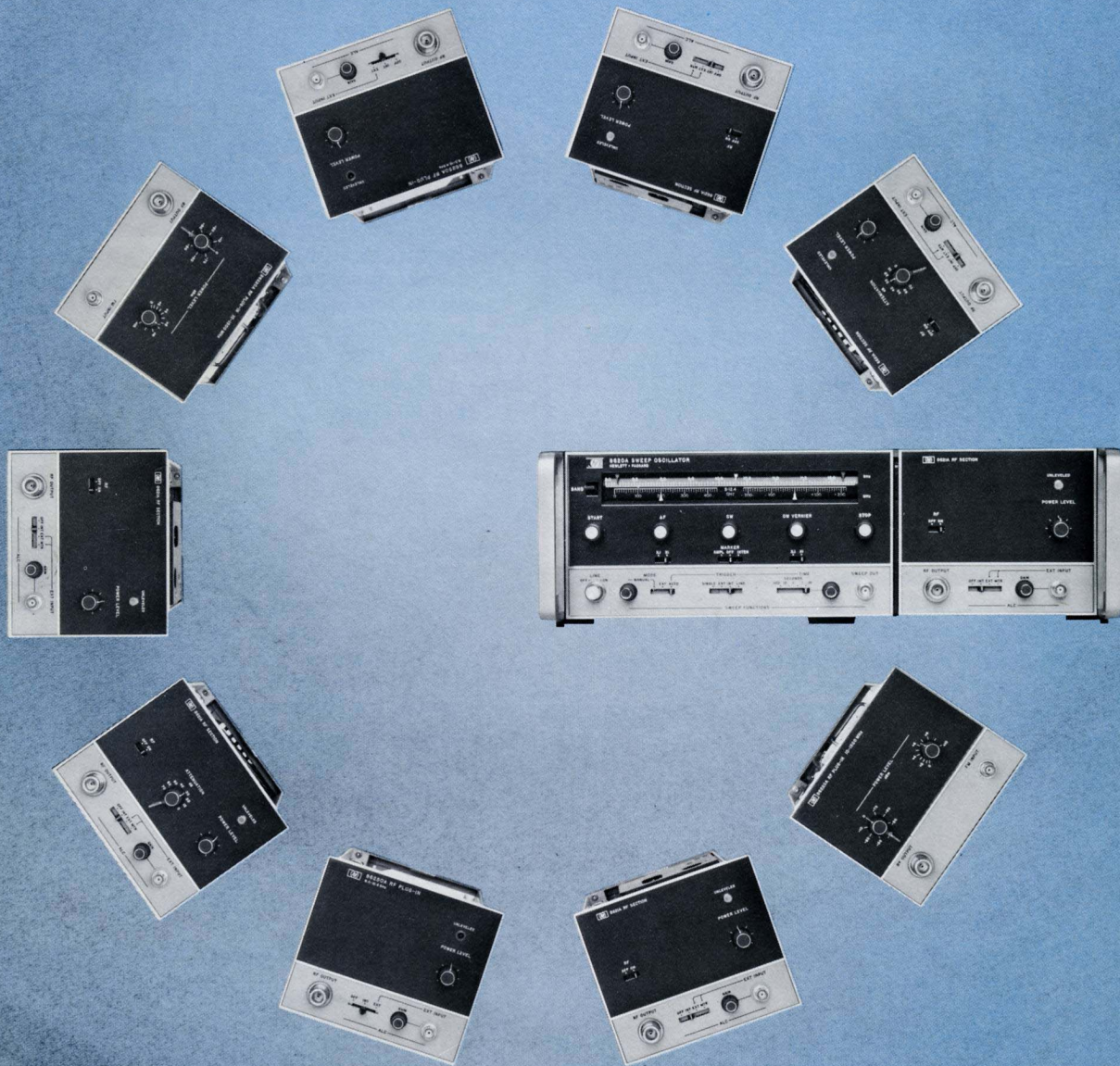

# MAINFRAMES



## FREQUENCY

**Frequency Range:** Determined by band switching lever and RF unit.

## SWEEP FUNCTIONS

**START-STOP Sweep:** Sweeps from START to STOP frequency setting.

**Range:** Both independent settings are fully calibrated and continuously adjustable over the entire frequency range; can be set to sweep either up or down in frequency.

**$\Delta F$  Sweep:** Sweeps symmetrically upward in frequency, centered on CW setting. (CW vernier can be activated for fine control of center frequency on 8620A.)

**Width:** Continuously adjustable from zero to 10% of usable frequency band. Dial scale calibrated directly in MHz. (High resolution zero to 1% scale available on 8620A as selected with front panel switch.)

**CW Operation:** Single-frequency RF output controlled by CW knob.

**Preset Frequencies:** START-STOP sweep end points (and CW frequency on 8620A) can be used as preset CW frequencies in manual sweep mode.

## SWEEP MODES

**Auto:** Sweep recurs automatically.

**Line:** Sweep can be synchronized with the ac power line for power line frequencies of up to 60 Hz.

**External Trigger:** Sweep is actuated by external trigger signal  $>+2$  volts peak,  $>0.5 \mu s$  pulse width and  $<1.0$  MHz repetition rate.

**Sweep Time:** Continuously adjustable in two ranges on 8620B, typically 0.01 to 0.35 and 1 to 60 seconds; continuously adjustable in four decade ranges on 8620A, typically 0.01 to 100 seconds.

**Single Sweep:** Activated by front panel switch.

**Manual Sweep:** Front panel control provides continu-

## 8620A/B COMMON SPECIFICATIONS

(With Single Band RF Plug-in Installed or Multiband RF Drawer and Appropriate RF Source Modules Installed as Necessary)

ous manual adjustment of frequency between end frequencies set in any of the above sweep functions.

**Sweep Output:** Direct-coupled sawtooth, zero to approximately +10 volts, at front panel BNC connector, concurrent with swept RF output. Zero at start of sweep, approximately +10 volts at end of sweep regardless of sweep width or direction. (In CW mode on 8620A, dc output is proportional to frequency.) Source impedance, approximately 10,000 ohms.

**Internal AM:** Square-wave modulation continuously adjustable from 950 to 1050 Hz on all sweep times. On/Off ratio, refer to RF unit specifications.

## GENERAL

### Blanking:

**RF:** With blanking switch enabled, RF automatically turns off during retrace, and remains off until start of next sweep. On automatic sweeps, RF is on long enough before sweep starts to stabilize external circuits and equipment whose response is compatible with the selected sweep rate.

**Display (Z-axis/MKR/Pen Lift Output):** Direct-coupled rectangular pulse approximately +5.0 volts coincident in time with RF blanking is on rear panel.

**Negative (Negative Blanking Output):** Direct-coupled rectangular pulse approximately -5.0 volts coincident in time with RF blanking.



Rear View of 8620B

# MAINFRAMES

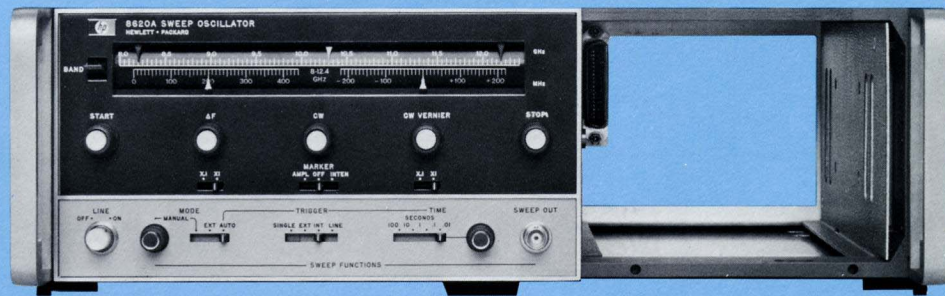

8620A

## 8620A ADDITIONAL SPECIFICATIONS

**Pen Lift:** For use with X-Y recorder. Pen lift signal is available on Z-axis/MKR/Pen Lift connector. In the 8620A this signal is also available on the programming connector.

**Furnished:** 7½-foot (2290 mm) power cable with NEMA plug; rack-mounting kit; 2 spare 3 amp fuses; extender board for servicing; and calibration scale.

**Power:** 115 or 230 volts ±10%, 50 to 400 Hz. Approximately 140 watts.

**Weight** (not including RF unit): Net, 24 lb (11,1 kg). Shipping, 30 lb (13,4 kg).

**Dimensions:**

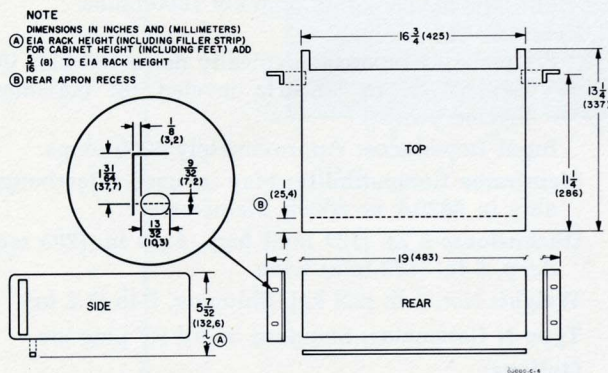

**Frequency Marker:** The constant width frequency marker is fully calibrated and independently adjustable over the entire range and set with the CW/MARKER control. Front panel switch provides for the selection of either amplitude or intensity markers (amplitude modulating the RF output or Z-axis modulating the CRT display).

**Resolution:** Better than 0.25% of RF unit bandwidth.

**Marker Output:** Rectangular pulse, typically -5 volts peak available from Z-axis BNC connector on rear panel. Source impedance, approximately 1000 ohms.

**CW Vernier:** Calibrated directly in MHz about CW setting. CW vernier activated by pushbutton in CW vernier control: ±0.5% or ±5% of full bandwidth selectable with front panel switch.

**External Sweep:** Sweep is controlled by external signal applied to programming connector. Zero volts for start of sweep increasing linearly to approximately +6 volts for end of sweep.

**Remote Band Select:** Frequency range can be controlled remotely by three binary contact closure lines available at programming connector.

### OPTION 001 REMOTE FREQUENCY PROGRAMMING

**Functions:**

**Enable:** One-line binary.

**Frequency:** 1000 points, 12-line BCD.

**Sweep Function:** Automatically in CW mode during remote programming.

**Logic:** 5-volt positive logic or remote contact closure.

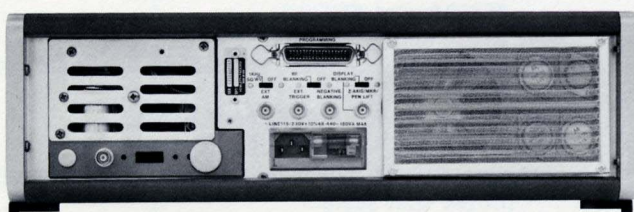

Rear View of 8620A

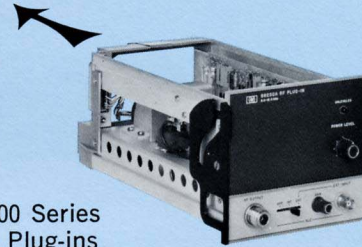

8620A or 8620B

86200 Series  
RF Plug-ins  
3 MHz to 18 GHz

## SINGLE BAND

• High Performance

• Low Cost

### COMMON SPECIFICATIONS 86200 Series RF Plug-ins

**Frequency Linearity:** Typically  $\pm 1\%$ .

**RF Power Leveling:** Internal dc-coupled leveling amplifier provided.

**Internal, Option 001:** Selected by front panel switch; refer to RF plug-in specifications. (Standard on 86220A.)

**External:**

**Crystal Input:** Approximately  $\pm 20$  to  $\pm 250$  mV for specified leveling at rated output; for use with positive or negative polarity detectors such as 780 Series Directional Detectors, 423A and 424 Series Crystal Detectors; polarity switch provided in RF plug-in.

**Power Meter Input:** The 8404A Leveling Amplifier and external AM input on the 8620 Mainframe must be used with all RF plug-ins except the 86260A. It contains an internal leveling amplifier.

**Indicator:** Front panel indicator lights when RF power level is set too high to permit leveling over entire selected sweep range or when operating in unlevelled mode.

**Reference Output:** DC-coupled voltage proportional to RF frequency, compatible with 8410A Network

Analyzer; voltage approximately 5 V/octave; output impedance, approximately 1000 ohms.

**External AM:**

**Frequency Response:** Typically dc to 100 kHz unlevelled, dc to 50 kHz leveled (at maximum leveled power).

**Input Impedance:** Approximately 5000 ohms.

**Mainframe Compatibility:** May be used interchangeably in 8620A or 8620B Mainframe.

**Dimensions:** 5 in. (127 mm) high, 11 $\frac{1}{8}$  in. (295 mm) deep, 6 in. (152 mm) wide.

**Weight:** Net, 5 lb (2,3 kg). Shipping, 7 lb (3,2 kg).

**Type N Connector:** Standard on all RF plug-ins.

**Options:**

**001:** Internal Leveling (refer to RF plug-in specifications).

**002:** 70 dB attenuator, 10 dB steps available in 86210A and 86220A.

**004:** Rear Panel RF Output.

**005:** APC-7 RF output connector available on 86260A.

**010:** Dial Scale for 8620A, No Charge.

**020:** Dial Scale for 8620B, No Charge.

Option 010 or 020 must be ordered to specify proper dial scale.

**SPECIFICATIONS—86200 SERIES RF PLUG-INS**

RF Plug-in Specifications with Unit Installed in 8620A or 8620B Mainframe	86210A	86220A	86230A	86230B	86241A	86242A	86250A	86250B	86260A
<b>FREQUENCY</b>									
<b>Frequency Range:</b>	3 - 350 MHz	10 - 1300 MHz	2.0 - 4.0 GHz	1.8 - 4.2 GHz	3.2 - 6.5 GHz	5.9 - 9.0 GHz	8.0 - 12.4 GHz	8.0 - 12.4 GHz	12.4 - 18 GHz
<b>Frequency Accuracy:</b> (25°C) CW Mode: All Sweep Modes: (for sweep time >100 msec)	±7 MHz ±10 MHz	±10 MHz ±15 MHz	±10 MHz ±15 MHz	±10 MHz ±15 MHz	±30 MHz ±33 MHz	±35 MHz ±40 MHz	±40 MHz ±50 MHz	±40 MHz ±50 MHz	±50 MHz ±70 MHz
<b>Frequency Stability:</b> With Temperature:  With 10% Line Voltage Change: With 10 dB Power Level Change: Residual FM: (in 10 kHz bandwidth) CW Mode:	±600 kHz/°C  ±20 kHz ±20 kHz <5 kHz peak	±600 kHz/°C  ±20 kHz ±20 kHz <5 kHz peak	±500 kHz/°C  ±20 kHz ±2 MHz <7 kHz peak	±500 kHz/°C  ±20 kHz ±1 MHz <7 kHz peak	±650 kHz/°C  ±30 kHz ±1 MHz <7 kHz peak	±750 kHz/°C  ±40 kHz ±4 MHz <15 kHz peak	±1.2 MHz/°C  ±40 kHz ±2 MHz <15 kHz peak	±1.2 MHz/°C  ±40 kHz ±2 MHz <15 kHz peak	±5.4 MHz/°C  ±180 kHz ±6 MHz <25 kHz peak
<b>POWER OUTPUT</b>									
<b>Maximum Leveled Power:</b> <sup>1</sup> (25°C)	+13 dBm <sup>7</sup> (20 mW)	+10 dBm <sup>7</sup> (10 mW)	>+7 dBm (5 mW)	>+10 dBm (10 mW)	>+4 dBm (2.5 mW)	>+8 dBm (6.5 mW)	>+4 dBm (2.5 mW)	>+8 dBm (6.5 mW)	>7 dBm (5 mW)
<b>Power Variation:</b> Unleveled: Internally Leveled (Option 001):  Externally Leveled: <sup>2</sup> Crystal Detector: Power Meter:	<±0.25 dB <sup>4</sup> (Standard)	<±0.5 dB <sup>4</sup> (Standard)	<±3 dB <±1.2 dB <sup>3</sup>  <±0.1 dB <±0.1 dB	<±3 dB <±1.2 dB <sup>3</sup>  <±0.1 dB <±0.1 dB	<±4 dB <±0.7 dB  <±0.1 dB <±0.1 dB	<±5 dB <±1 dB*  <±0.1 dB <±0.1 dB	<±5 dB <±1 dB  <±0.1 dB <±0.1 dB	<±5 dB <±1.0 dB  <±0.1 dB <±0.1 dB	<±4.0 dB Not available  <±0.1 dB <±0.1 dB
<b>Spurious Signals:</b> (below fundamental at specified maximum power) Harmonics:  Nonharmonics:	>27 dB at 13 dBm >40 dB at 0 dBm  >70 dB	>25 dB  >40 dB	>16 dB  >60 dB	>20 dB  >60 dB	>16 dB (3.2-3.8 GHz) >20 dB (3.8-6.5 GHz)  >60 dB	>30 dB  >60 dB	>30 dB  >60 dB	>30 dB  >60 dB	>25 dB  >50 dB
<b>Residual AM:</b> AM noise in 100 kHz bandwidth (below fundamental at maximum power)	>50 dB	>50 dB	>50 dB	>50 dB	>50 dB	>50 dB	>50 dB	>50 dB	>50 dB
<b>Source VSWR:</b> 50 Ω nominal impedance Internally Leveled (Option 001): Unleveled: Typically	<1.2	<1.3	<1.6 2.5	<1.6 3.0	<1.6 2.5	<1.5 1.5	<1.5 1.5	<1.5 1.5	2.0
<b>MODULATION</b>									
<b>External FM:</b> Maximum Deviations for Modulation Frequencies: DC to 100 Hz: DC to 1 MHz: Sensitivity: Nominal FM Mode: Phase-lock Mode:	±15 MHz ±500 kHz  +3.5 MHz/V +3.5 MHz/V	±15 MHz ±500 kHz  +3.5 MHz/V +3.5 MHz/V	±25 MHz ±2 MHz  -4 MHz/V -4 MHz/V	±25 MHz ±2 MHz  -4 MHz/V -4 MHz/V	±25 MHz ±2 MHz  -6 MHz/V -6 MHz/V	±25 MHz ±2 MHz  -6 MHz/V -6 MHz/V	±25 MHz ±2 MHz  -6 MHz/V -6 MHz/V	±25 MHz ±2 MHz  -6 MHz/V -6 MHz/V	±75 MHz <sup>5</sup> ±5 MHz <sup>6</sup>  -20 MHz/V -6 MHz/V
<b>AM:</b> Internal 1 kHz square wave ON/OFF ratio, external AM sensitivity to -10 volts input	>35 dB	>35 dB	>25 dB	>25 dB	>25 dB	>40 dB	>40 dB	>40 dB	>25 dB

\* Tentative

<sup>1</sup> Subtract 0.5 dB for internal leveling, Option 001.

<sup>2</sup> Excluding coupler and detector variations.

<sup>3</sup> At 2 dB below maximum power, level variation internally leveled is <±0.6 dB and externally leveled is <±0.1 dB.

<sup>4</sup> Internal leveling standard. <±0.15 dB (0 dBm leveled output).

<sup>5</sup> DC to 200 Hz.

<sup>6</sup> DC to 200 kHz.

<sup>7</sup> Nominal power output, calibrated in 1 dBm steps. For 70 dB attenuator calibrated in 10 dB steps order Option 002.

### Typical Unleveled Power Output for 86200 Series Singleband RF Plug-ins

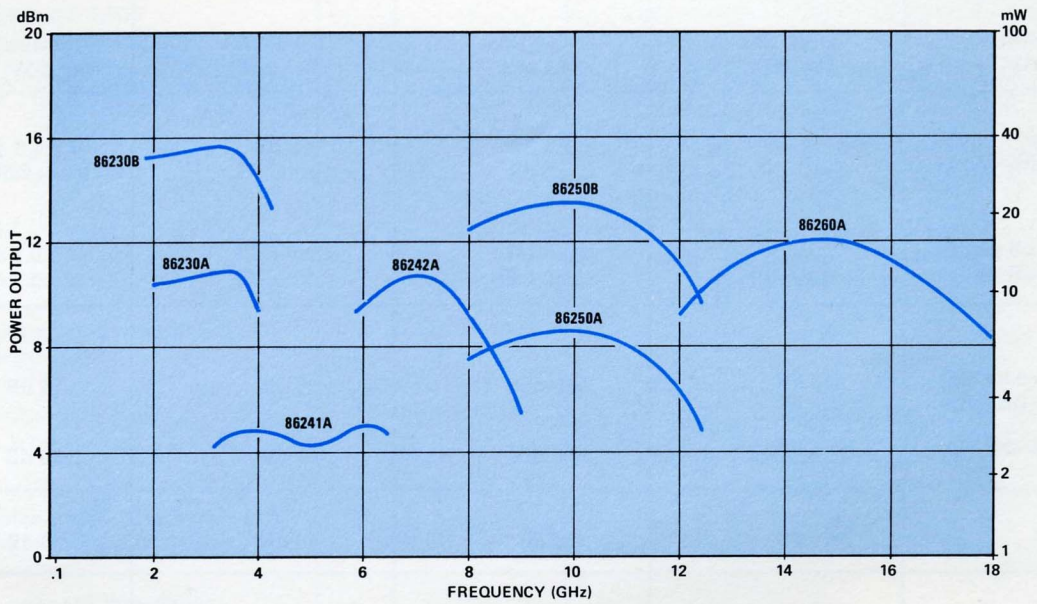

Unfold



8620B or 8620A



8621A RF Drawer

86300 Series  
RF Modules  
100 MHz to 12.4 GHz

## MULTIBAND

- Modular Construction

- Self-Contained

### SPECIFICATIONS Model 8621A RF Drawer

#### Oscillator Capacity:

**Standard:** One RF module and the 86320A Heterodyne Module with multiplexing for this capacity.

**Multiband Capability, Option 100:** Two RF modules and the 86320A Heterodyne Module with multiplexing for this capacity.

#### 70 dB Programmable Attenuator, Option 010:

**Range:** 70 dB in 10 dB steps.

**Accuracy** (including frequency response):

**Insertion Loss:** <0.8 dB.

**For 10 dB:** <±0.5 dB.

**For >10 dB:** <±3% of attenuation.

**Programming Input:** 4-line binary logic, +5 volts or contact closure to ground. (8620A Mainframe only, input available at programming connector.)

**Weight:** Net, 2 lb (0,9 kg).

**RF Power Leveling:** Internal dc-coupled leveling amplifier provided.

**Internal, Option 001:** Selected by front panel switch; refer to RF module specifications. (Standard on 86320A.)

#### External:

**Crystal Input:** Approximately ±20 to ±250 mV for specified leveling at rated output; for use with positive or negative polarity detectors such as 780 Series Directional Detectors, 423A and 424 Series Crystal Detectors; polarity switch provided in RF drawer.

**Power Meter Input:** Switch in RF drawer selects proper compensation for Models 431B/C or 432A/B/C.

**Indicator:** Front panel indicator lights when RF power level is set too high to permit leveling

over entire selected sweep range or when operating in unlevelled mode.

**Reference Output:** DC-coupled voltage proportional to RF frequency, compatible with 8410A Network Analyzer; voltage approximately 5 V/octave; output impedance, approximately 1000 ohms.

**Mainframe Compatibility:** May be used interchangeably in 8620A or 8620B Mainframe.

**Dimensions:** 5 in. (127 mm) high, 11<sup>5</sup>/<sub>8</sub> in. (295 mm) deep, 6 in. (152 mm) wide.

**Weight:** Net, 3 lb (1,4 kg). Shipping, 5 lb (2,3 kg).

#### Options:

**004:** Rear Panel RF Output.

**010:** 70 dB Attenuator.

**100:** Multiband Capability.

### COMMON SPECIFICATIONS 86300 Series RF Modules

**Frequency Linearity:** Typically ±1%.

#### External AM:

**Frequency Response:** Typically dc to 100 kHz unlevelled, dc to 50 kHz leveled (at maximum leveled power).

**Input Impedance:** Approximately 5000 ohms.

**Dimensions:** 4 in. (103 mm) high, 3<sup>3</sup>/<sub>4</sub> in. (95 mm) deep, 3<sup>5</sup>/<sub>8</sub> in. (92 mm) wide.

**Weight:** Net, 3 lb (1,4 kg). Shipping, 4 lb (1,8 kg).

**Type N Connector:** Standard on all RF modules.

#### Options:

**001:** Internal Leveling (refer to RF module specifications).

**010:** Dial Scale for 8620A, No Charge.

**020:** Dial Scale for 8620B, No Charge.

Option 010 or 020 must be ordered to specify proper dial scale.

RF Module Specifications with Unit Installed in 8621A Drawer and 8620A/B Mainframe	SPECIFICATIONS—86300 SERIES RF MODULES							
	86320A <sup>1</sup>	86330A	86331A	86341B	86342A	86350A	86351A	86352A
<b>FREQUENCY</b>								
<b>Frequency Range:</b>	0.1 - 2.0 GHz	1.8 - 4.2 GHz	1.7 - 4.3 GHz	3.2 - 6.5 GHz	5.9 - 9.0 GHz	8.0 - 12.4 GHz	10.7 - 11.7 GHz	8.5 - 10.5 GHz
<b>Frequency Accuracy:</b> (25°C) CW Mode: All Sweep Modes: (for sweep time >100 msec)	±10 MHz ±15 MHz	±10 MHz ±15 MHz	±15 MHz ±20 MHz	±30 MHz ±33 MHz	±35 MHz ±40 MHz	±40 MHz ±50 MHz	±20 MHz ±25 MHz	±20 MHz ±25 MHz
<b>Frequency Stability:</b> With Temperature: With 10% Line Voltage Change: With 10 dB Power Level Change: Residual FM: (in 10 kHz bandwidth) CW Mode:	±750 kHz/°C ±20 kHz ±1 MHz <15 kHz peak	±500 kHz/°C ±20 kHz ±1 MHz <7 kHz peak	±500 kHz/°C ±20 kHz ±1 MHz <7 kHz peak	±650 kHz/°C ±30 kHz ±1 MHz <7 kHz peak	±750 kHz/°C ±40 kHz ±4 MHz <15 kHz peak	±1.2 MHz/°C ±40 kHz ±2 MHz <15 kHz peak	±1.2 MHz/°C ±40 kHz ±2 MHz <15 kHz peak	±1.2 MHz/°C ±40 kHz ±2 MHz <15 kHz peak
<b>POWER OUTPUT</b>								
<b>Maximum Leveled Power:</b> <sup>2</sup> (25°C)	>+13 dBm (20 mW)	>+10 dBm <sup>4</sup> (10 mW)	>+8 dBm <sup>4</sup> (6.5 mW)	>+10 dBm (10 mW)	>+7 dBm (5 mW)	>+6 dBm (4 mW)	>+10 dBm* (10 mW)	>+10 dBm (10 mW)
<b>Power Variation:</b> Unleveled: Internally Leveled (Option 001): Externally Leveled: <sup>3</sup> Crystal Detector: Power Meter:	<±8 dB ±0.7 dB <sup>7</sup> (Standard) <±0.1 dB <±0.1 dB	<±3 dB <±1.1 dB <sup>5</sup> <±0.7 dB <sup>5</sup> <±0.7 dB <sup>5</sup>	<±3 dB <±1.1 dB <sup>5</sup> <±0.7 dB <sup>5</sup> <±0.7 dB <sup>5</sup>	<±4 dB <±0.7 dB <±0.1 dB <±0.1 dB	<±5 dB <sup>3</sup> <±1.0 dB* <±0.1 dB <±0.1 dB	<±5 dB <±1.0 dB <±0.1 dB <±0.1 dB	<±3 dB <±0.5 dB* <±0.1 dB <±0.1 dB	<±3 dB <±0.5 dB* <±0.1 dB <±0.1 dB
<b>Spurious Signals:</b> (below fundamental at specified maximum power) Harmonics: Nonharmonics:	>24 dB <sup>6</sup> >24 dB <sup>6</sup>	>20 dB >60 dB	>20 dB >60 dB	>16 dB (3.2 - 3.8 GHz) >20 dB (3.8 - 6.5 GHz) >60 dB	>30 dB >60 dB	>30 dB >60 dB	>30 dB >60 dB	>30 dB >60 dB
<b>Residual AM:</b> AM noise in 100 kHz bandwidth (below fundamental at maximum power)	>50 dB	>50 dB	>50 dB	>50 dB	>50 dB	>50 dB	>50 dB	>50 dB
<b>Source VSWR:</b> 50 Ω nominal impedance Internally Leveled (Option 001): Unleveled: Typically	<1.6 <sup>7</sup> NA	<1.6 2.5	<1.6 2.5	<1.6 2.5	<1.5 1.5	<1.5 1.5	<1.5 1.5	<1.5 1.5
<b>MODULATION</b>								
<b>External FM:</b> Maximum Deviations for Modulation Frequencies: DC to 100 Hz: DC to 1 MHz: DC to 2 MHz: Sensitivity: Nominal FM Mode: Phase-lock Mode:	±75 MHz ±5 MHz ±2 MHz -20 MHz/V -1 MHz/V	±75 MHz ±5 MHz ±2 MHz -20 MHz/V -1 MHz/V	±75 MHz ±5 MHz ±2 MHz -20 MHz/V -1 MHz/V	±75 MHz ±5 MHz ±2 MHz -20 MHz/V -1 MHz/V	±75 MHz ±5 MHz ±2 MHz -20 MHz/V -1 MHz/V	±75 MHz ±5 MHz ±2 MHz -20 MHz/V -1 MHz/V	±75 MHz ±5 MHz ±2 MHz -20 MHz/V -1 MHz/V	±75 MHz ±5 MHz ±2 MHz -20 MHz/V -1 MHz/V
<b>AM:</b> Internal 1 kHz square wave ON/OFF ratio, external AM sensitivity to -10 volts input	>15 dB	>40 dB	>40 dB	>25 dB	>40 dB	>40 dB	>40 dB	>40 dB

<sup>1</sup> 86320A is a heterodyne unit which must be used in conjunction with the 86330A or 86331A.

<sup>2</sup> Specified at the RF output of the 8621A RF drawer with Option 100. Subtract 0.5 dB for internal leveling, Option 001.

<sup>3</sup> Excluding coupler and detector variation.

<sup>4</sup> 3 dB less when used with 86320A Heterodyne Module.

<sup>5</sup> At 2 dB below maximum power, level variation internally leveled is <±0.6 dB and externally leveled is <±0.1 dB.

<sup>6</sup> At +10 dBm RF power, spurious signals are >30 dB below fundamental.

<sup>7</sup> Internal leveling standard.

\* Tentative



### Typical Unleveled Power Output for 86300 Series Multiband RF Modules

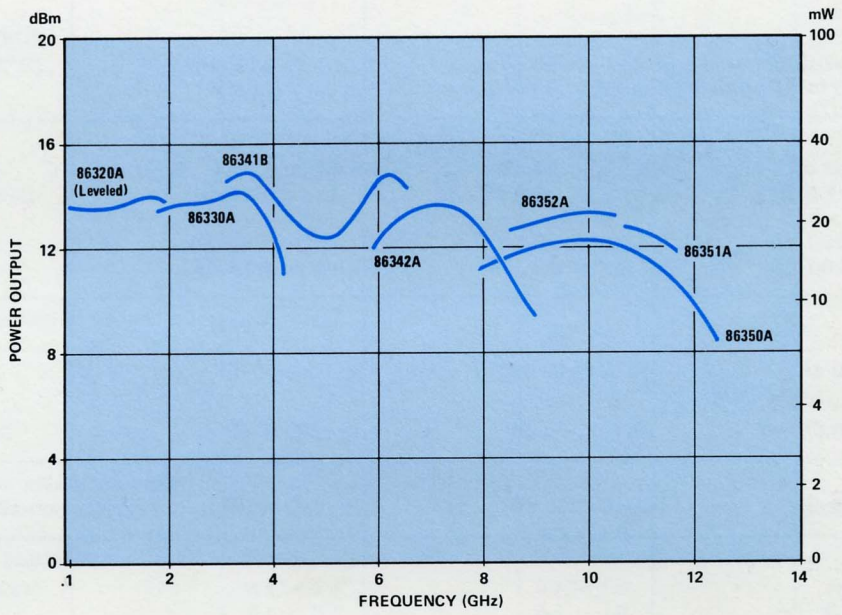

Unfold

## HOW TO ORDER

The 8620 Sweep Oscillator Family offers a wide choice of fully compatible mainframes and RF plug-ins to match any requirement of value and economy.

### CHOOSE A MAINFRAME (Refer to Pages 2 and 3)



**8620B**

OR



**8620A**

Option 001  
(Frequency Programming)

### CHOOSE A PLUG-IN

**SINGLE BAND**  
(Refer to Pages 4 - 5)



**86200\* Series**

- Option 001**  
Internal Leveling
- Option 004**  
Rear RF Output
- Option 010**  
Dial Scale for 8620A
- Option 020**  
Dial Scale for 8620B

OR

**MULTIBAND**  
(Refer to Pages 6 - 7)



**8621A\*\***

and



**86300\* Series**

- |  |   |
|--|---|
| <ul style="list-style-type: none"> <li><b>Option 004</b><br/>Rear RF Output</li> <li><b>Option 010</b><br/>70 dB Attenuator</li> <li><b>Option 100</b><br/>Multiband Capability</li> </ul> | <ul style="list-style-type: none"> <li><b>Option 001</b><br/>Internal Leveling</li> <li><b>Option 010</b><br/>Dial Scale for 8620A</li> <li><b>Option 020</b><br/>Dial Scale for 8620B</li> </ul> |
|--|---|

\* Must order Option 010 or 020 to specify proper dial scale.

\*\* Basic 8621A RF Drawer configured to accept one fundamental RF Module and 86320A Heterodyne Module. Option 100 expands capacity to hold up to two fundamental RF Modules and the heterodyne unit.

### A TYPICAL SYSTEM

A complete sweeper system consisting of a mainframe and a multiband plug-in covering the frequency range from 100 MHz to 6.5 GHz with internal leveling may be ordered as follows:

- 8620A
- 8621A, Option 100
- 86320A, Option 010
- 86330A, Option 010, 001
- 86341A, Option 010, 001