

---

# Service Guide

Publication Number 54913-97023  
September 2013

NOTICE: This document contains references to Agilent Technologies. Agilent's former Test and Measurement business has become Keysight Technologies. For more information, go to [www.keysight.com](http://www.keysight.com).



© Agilent Technologies, Inc. 2007-2013

---

## Infiniium 90000 A-Series Oscilloscopes



---

## Agilent Infiniium 90000 A-Series Oscilloscopes at a Glance

### Ease of use with high performance

The Agilent Infiniium 90000 A-Series oscilloscopes combine unprecedented ease-of-use with high-performance digitizing oscilloscope functionality to simplify your design and analysis measurement tasks.

- Traditional oscilloscope front-panel interface provides direct access to the controls needed for most troubleshooting tasks.
- Graphical user interface with menus, windows, dialogs, and toolbars provides easy access to dozens of configuration and analysis tools, ensuring you can set up and make the most complex measurements.
- All models offer 40 GSa/s sampling rate on all four channels.
- Models with bandwidths from 2.5 GHz to 13 GHz.

### Display shows waveforms and graphical user interface

- Graphical interface allows direct interaction with waveforms, including drag-and-drop positioning and instant waveform zoom.
- Touchscreen display allows oscilloscope operation without an external pointing device.
- Waveforms displayed in color, making correlation easy.
- Current configuration parameters displayed near the waveform display and are color-coded to make identification easy.
- Graphical interface menus and toolbars simplify complex measurement setups.

### Horizontal controls set sweep speed and position

- Main sweep speeds from 5 ps/div to 20 s/div.
- Zoom mode is from 1 ps/div to main time base setting.
- Intensified waveforms on main sweep window make it easy to see what will appear in the zoom window.

### Acquisition and general controls start and stop the scope and do basic setup

- Run and stop controls for continuous or single acquisitions.
- Clear display before one or more acquisitions.
- Default setup and Autoscale set initial configuration.

### Hard disk drive and USB 2.0 port for saving and restoring setups and measurement results

- Store measurement displays for inclusion in reports and test setup guides.
- Store oscilloscope setups to repeat tests another time.
- Hard disk stores oscilloscope operating system.

### Trigger setup controls set mode and basic parameters

- Select Edge, Glitch, or Advanced Modes.
- Choose input source and slope.
- Use graphical user interface to simplify configuration of pattern, state, delay, and violation trigger modes.
- Use auxiliary trigger to increase triggering flexibility.

### Vertical controls set attenuation, and position

- Input attenuation adjustable from 1 mV/div to 1 V/div.
- Color-coded knobs make it easy to find the controls that affect each waveform.

### Marker and quick measurements help measure waveform parameters

- Waveform markers A and B to check voltage or  $\Delta$ -time at any point on the displayed waveform.

---

## In This Service Guide

This guide provides the service documentation for the Agilent Technologies 90000 A-Series oscilloscopes. It is divided into seven chapters.

Chapter 1, "General Information," describes which oscilloscope models are covered by this guide, environmental requirements, and oscilloscope dimensions.

Chapter 2, "Calibration," explains how and when you should run the user calibration procedure.

Chapter 3, "Testing Performance," provides information about testing the oscilloscope to verify that it performs according to specifications.

Chapter 4, "Troubleshooting," provides information about how to identify defective assemblies.

Chapter 5, "Replacing Assemblies," provides instructions for removing and replacing defective assemblies.

Chapter 6, "Replaceable Parts," provides exploded parts diagrams and a list for ordering replaceable parts.

Chapter 7, "Theory of Operation," briefly describes the internal operation of the oscilloscope.

At the back of the book you will find safety notices.



---

# Contents

## **1 General Information**

Instruments covered by this service guide	8
Performance-Enhanced Versus Standard Models	9
Accessories supplied	10
Specifications and Characteristics	10
Environmental Conditions	11
Measurement Category	11
Oscilloscope Dimensions	12

## **2 Calibration**

To run the self calibration	15
-----------------------------	----

## **3 Testing Performance**

Performing Self-Test and Calibration	19
Offset Accuracy Test	21
DC Gain Accuracy Test	29
Analog Bandwidth - Maximum Frequency Check	35
Time Scale Accuracy (TSA)	42
Performance Test Record	44

## **4 Troubleshooting**

To troubleshoot the oscilloscope	51
Primary Trouble Isolation	52
Power Supply Trouble Isolation	55
Under-Voltage Fault	58
Over-Temperature Fault	63
Over-Voltage Fault	66
Display Trouble Isolation	69
To check the backlight inverter voltages	71
To check the display board video signals	72
Front Panel Display Trouble Isolation	73
Front Panel Trouble Isolation	75
Motherboard Verification	76
To setup the BIOS	77
Acquisition/Backplane Assembly Trouble Isolation - Scope Self Tests	78
AutoProbe Board Trouble Isolation	81
To check the keyboard; Trouble Isolation Procedure	82
To check the LEDs	83
Software Revisions	84
To check probe power outputs	85

## **5 Replacing Assemblies**

To return the oscilloscope to Agilent Technologies for service	89
To remove and replace the cover, top plate, and bottom plate	90

## Contents

To remove and replace the front panel bezel and front panel circuit assembly	95
To remove and replace the on/off board	99
To remove and replace the backlight inverter board	101
To remove and replace the touch screen, front deck, and controller assembly	102
To remove and replace the motherboard	105
To remove and replace the acquisition boards/backplane assembly	106
To remove the backplane assembly from the acquisition assemblies	110
To set the calibration factors after replacing the acquisition board	111
To remove and replace the hard disk drive and the hard drive control board	113
Cable removal (for replacing the motherboard)	115
To remove and replace the power supply	120
To remove and replace the fans	121
To remove and replace the power cord	122
To remove and replace the USB or GPIB port	123

## 6 Replaceable Parts

Ordering Replaceable Parts	126
Exploded Views	127
Replaceable Parts List	131

## 7 Theory of Operation

Block-Level Theory	137
--------------------	-----

Instruments covered by this service guide 8  
Performance-Enhanced Versus Standard Models 9  
Accessories supplied 10  
Specifications and Characteristics 10  
Environmental Conditions 11  
Measurement Category 11  
Oscilloscope Dimensions 12

---

## Instruments covered by this service guide

Oscilloscopes manufactured after the date this manual was released may be different from those described in this manual. The release date of this manual is shown on the title page. This manual will be revised when necessary.

If you have an oscilloscope that was manufactured after the release of this manual, please check the Agilent Technologies website at [www.agilent.com](http://www.agilent.com) to see whether a newer version of this manual is available.

The following 90000 A-Series oscilloscopes are covered in this guide.

**Table 1 -1**

---

**Oscilloscopes Covered by this Service Guide**

---

<b>Model</b>	<b>Bandwidth</b>
<b>DSO/DSA91304A</b>	<b>13 GHz bandwidth, 40 GSa/s</b>
<b>DSO/DSA91204A</b>	<b>12 GHz bandwidth, 40 GSa/s</b>
<b>DSO/DSA90804A</b>	<b>8 GHz bandwidth, 40 GSa/s</b>
<b>DSO/DSA90604A</b>	<b>6 GHz bandwidth, 20 GSa/s</b>
<b>DSO/DSA90404A</b>	<b>4 GHz bandwidth, 20 GSa/s</b>
<b>DSO/DSA90254A</b>	<b>2.5 GHz bandwidth, 20 GSa/s</b>

The oscilloscope model can be identified by the product number on the front or rear panel.



## Performance-Enhanced Versus Standard Models

In the fall of 2009, Agilent started shipping performance-enhanced models of the 90000 A-Series oscilloscope. This service guide covers both the standard and performance-enhanced versions of the 90000 A-Series scopes. Any differences between the two versions are noted.

To tell whether the oscilloscope you have is a standard one or a performance-enhanced version, check whether it has one handle or two handles. Standard models have one handle; performance-enhanced models have two handles.

---

## Accessories supplied

The following accessories are supplied.

- Mouse
- Stylus
- Keyboard
- Accessory Pouch
- Front panel Cover
- Calibration Cable (not available or required for the DSO90254A)
- Precision 3.5 mm Adapters (qty 2)(not available or required for the DSO90254A)
- Probe De-skew and Performance Verification Kit, Agilent E2655B
- Power Cord (see parts list in chapter 6 for country-dependent part numbers)
- *User's Quick Start Guide*

---

## Specifications and Characteristics

The following table contains a partial list of specifications and characteristics for the Agilent Infiniium A-Series oscilloscopes. For a full list of specifications and characteristics, refer to the data sheets at [www.agilent.com/find/90000](http://www.agilent.com/find/90000).

Specifications that are pertinent to each test are given in the "Testing Performance" chapter. Specifications are valid after a 30-minute warm-up period, and within  $\pm 5^{\circ}\text{C}$  from the temperature at which the last self-calibration was performed.

Environment	Indoor use only.
Ambient temperature	Operating 5 °C to +40 °C; non-operating –40 °C to +65 °C
Humidity	Operating: up to 95% relative humidity (non-condensing) at +40 °C Non-operating: up to 90% relative humidity at +65 °C
Altitude	Maximum operating altitude: 4,000 m (12,000 ft)
Installation Category	Installation category: 2.
Power Requirements	100-240 V, 47-63 Hz; 800 W max for 4-channel models. 100-240 V, 50 Hz; 100-208 V, 50/60 Hz; 800 W max for 8-channel models.
Voltage Fluctuations	Note that the mains supply voltage fluctuations are not to exceed +/-10% of the nominal supply voltage.

---

## Environmental Conditions

### Overvoltage Category

This product is intended to be powered by MAINS that comply to Overvoltage Category II, which is typical of cord-and-plug connected equipment.

### Pollution Degree

The 90000 Series Oscilloscope may be operated in environments of Pollution Degree 2 (or Pollution Degree 1).

### Pollution Degree Definitions

Pollution Degree 1: No pollution or only dry, non-conductive pollution occurs. The pollution has no influence. Example: A clean room or climate-controlled office environment.

Pollution Degree 2. Normally only dry non-conductive pollution occurs. Occasionally a temporary conductivity caused by condensation may occur. Example: General indoor environment.

Pollution Degree 3: Conductive pollution occurs, or dry, non-conductive pollution occurs which becomes conductive due to condensation which is expected. Example: Sheltered outdoor environment.

---

## Measurement Category



### Measurement Category

The 90000 Series oscilloscope is intended to be used for measurements in Measurement Category I.

### Measurement Category Definitions

Measurement Category I is for measurements performed on circuits not directly connected to MAINS. Examples are measurements on circuits not derived from MAINS, and specially protected (internal) MAINS derived circuits. In the latter case, transient stresses are variable; for that reason, the transient withstand capability of the equipment is made known to the user.

Measurement Category II is for measurements performed on circuits directly connected to the low voltage installation. Examples are measurements on household appliances, portable tools and similar equipment.

Measurement Category III is for measurements performed in the building installation. Examples are measurements on distribution boards, circuit-breakers, wiring, including cables, bus-bars, junction boxes, switches, socket-outlets in the fixed installation, and equipment for industrial use and some other equipment, for example, stationary motors with permanent connection to the fixed installation.

Measurement Category IV is for measurements performed at the source of the low-voltage installation. Examples are electricity meters and measurements on primary overcurrent protection devices and ripple control units.

### Transient Withstand Capability

The maximum transient withstand capability of this instrument is not specified. Do not apply more than 5 volts rms at the oscilloscope's vertical input BNC connectors.

## Oscilloscope Dimensions

The following pictures show the dimensions of the frame.

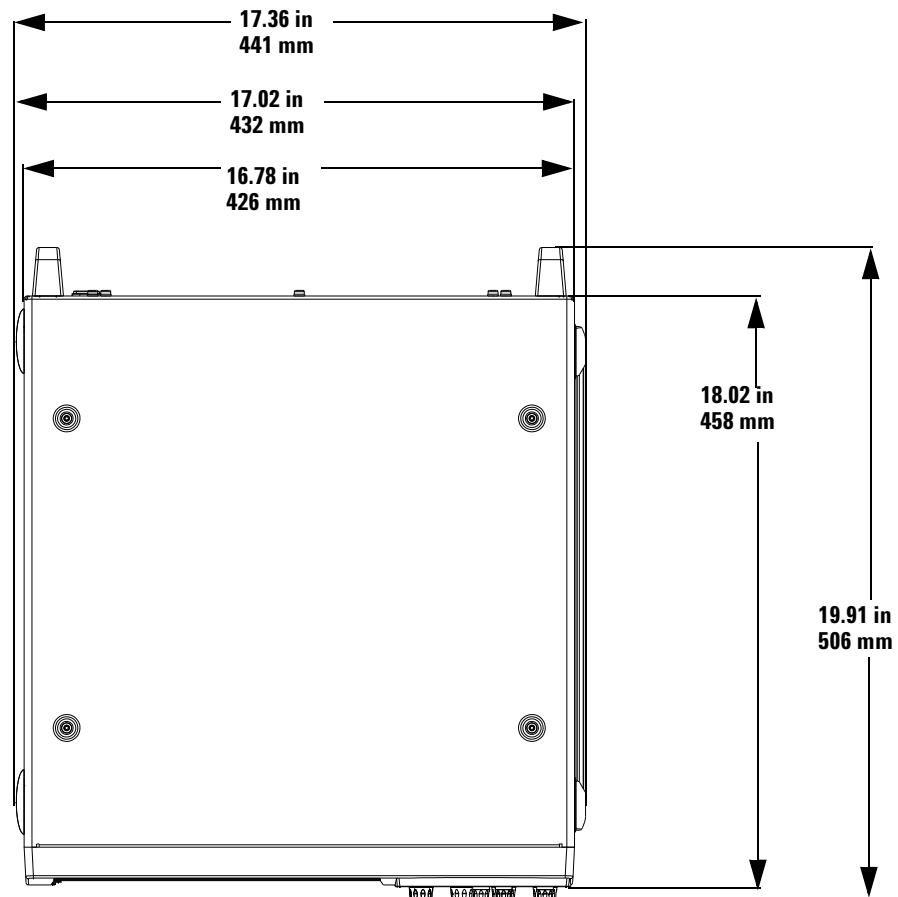
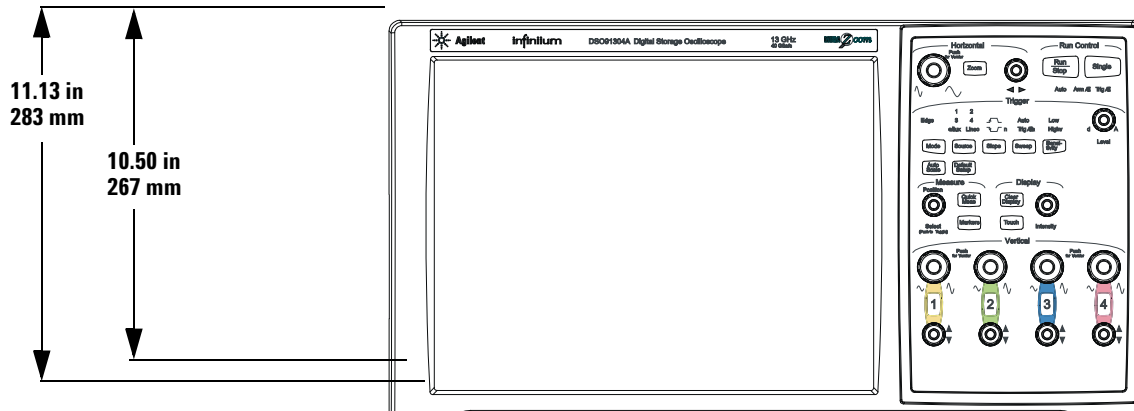

To run the self calibration 15

---

# Calibration

This chapter provides self calibration procedures for the oscilloscope.

## To run the self calibration

**Let the Oscilloscope Warm Up Before Adjusting**  
Warm up the oscilloscope for 30 minutes before starting calibration procedure. Failure to allow warm up may result in inaccurate calibration.

The self calibration uses signals generated in the oscilloscope to calibrate channel sensitivity, offsets, and trigger parameters. You should run the self calibration

- yearly, or according to your periodic needs,
- when you replace the acquisition assembly or acquisition hybrids,
- when you replace the hard drive or any other assembly,
- when the oscilloscope's operating temperature (after the 30 minute warm-up period) is more than  $\pm 5$  °C different from that of the last calibration.

### Equipment Required

Equipment	Critical Specifications	Agilent Part Number
Adapters (2 supplied with oscilloscope except for the DS090254A)	3.5 mm (f) to precision BNC No substitute	Agilent 54855-67604
Cable Assembly	50 $\Omega$ characteristic impedance BNC (m) connectors ~ 36 inches (91 cm) to 48 inches (122 cm) long	Agilent 8120-1840
Cable Assembly (supplied with oscilloscope except for the DS090254A which can use a good quality BNC cable)	No substitute	Agilent 54855-61620
10 MHz Signal Source (required for time scale calibration)	Frequency accuracy better than 0.4 ppm	Agilent 53131A with Opt. 010

### Self calibration

**Calibration time**  
It will take approximately 1 hour to run the self calibration on the oscilloscope, including the time required to change cables from channel to channel.

- 1 Let the Oscilloscope Warm Up Before Running the Self Calibration.  
The self calibration should only be done after the oscilloscope has run for 30 minutes at ambient temperature with the cover installed. Calibration of an oscilloscope that has not warmed up may result in an inaccurate calibration.
- 2 Pull down the Utilities menu and Select Calibration.
- 3 Click the check box to clear the Cal Memory Protect condition.  
You cannot run self calibration if this box is checked. See Figure 2-1.

## Chapter 2: Calibration

### To run the self calibration

Figure 2-1

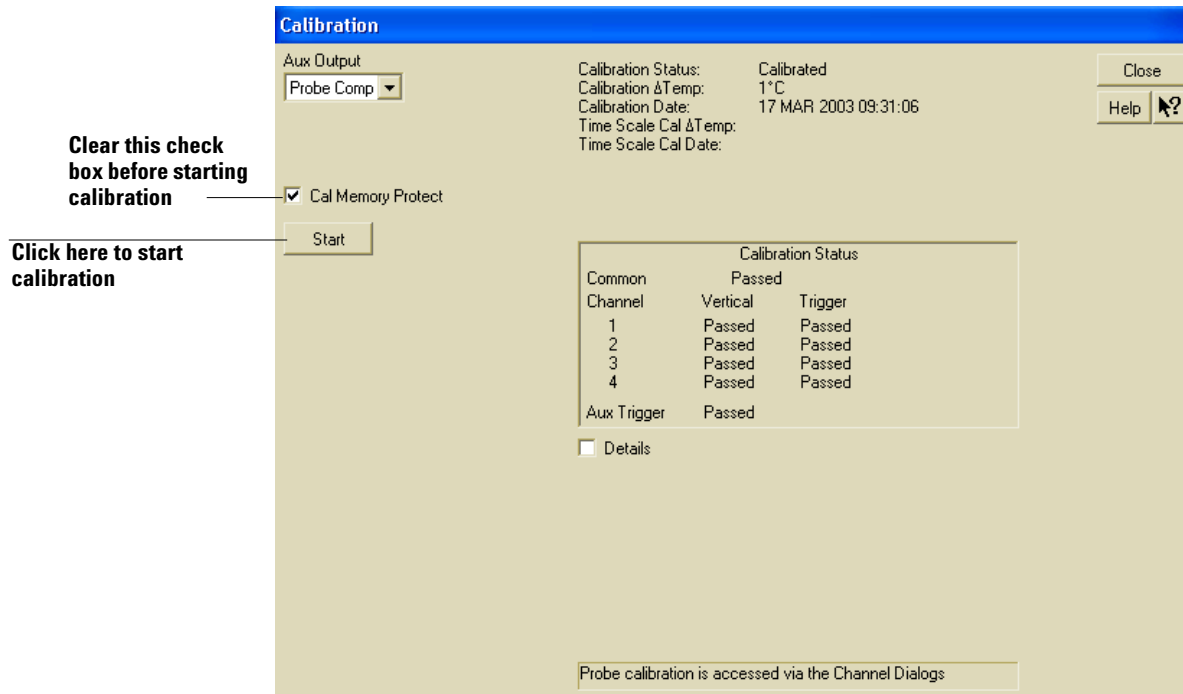

Calibration Dialog Box

- 4 Click Start, then follow the instructions on the screen.

The routine will ask you to do the following things in sequence:

  - a Decide if you want to perform the Time Scale Calibration. Your choices are:
    - Standard Calibration - Time scale calibration is not performed. Time scale calibration factors from the previous time scale calibration are used and the 10 MHz reference signal is not required. The remaining calibration procedure continues.
    - Standard Calibration and Time Scale Calibration - Performs the time scale calibration. This option requires you to connect a 10 MHz reference signal to channel 1 that meets the following specifications. Failure to use a reference signal that meets this specification will result in an inaccurate calibration.

Frequency: 10 MHz  $\pm 0.4$  ppm = 10 MHz  $\pm 4$  Hz  
Amplitude: 0.2 V<sub>peak-to-peak</sub> to 5.0 V<sub>peak-to-peak</sub>  
Wave shape: Sine or Square
    - Standard Calibration and Reset Time Scale Calibration - Factory time scale calibration factors will be used. The 10 MHz reference signal will not be required. The remaining calibration procedure will continue.
  - b Disconnect everything from all inputs and Aux Out.
  - c Connect the calibration cable from Aux Out to channel 1.

You must use the 54855-61620 cable assembly with two 54855-67604 adapters for all oscilloscopes except for the DSO90254A which can use a good quality BNC cable. Failure to use the appropriate calibration cable will result in an inaccurate calibration.
  - d Connect the calibration cable from Aux Out to each channel input as requested.
  - e Connect the 50  $\Omega$  BNC cable from the Aux Out to the Aux Trig on the front panel of the oscilloscope.
  - f A Passed/Failed indication is displayed for each calibration section. If any section fails, check the calibration cables and run the oscilloscope Self Test in the Utilities menu.
- 5 When the calibration procedure is complete, click Close.



Performance Test Interval 18  
Performing Self-Test and Calibration 19  
Vertical Performance Verification 20  
    Offset Accuracy Test 21  
    DC Gain Accuracy Test 29  
    Analog Bandwidth - Maximum Frequency Check 35  
    Time Scale Accuracy (TSA) 42  
Performance Test Record 44

This section documents performance test procedures. Performance verification for the products covered by this manual consists of three main steps:

- Performing the internal product self-tests to ensure that the measurement system is functioning properly
- Calibrating the product
- Testing the product to ensure that it is performing to specification

### **Performance Test Interval**

The procedures in this section may be performed for incoming inspection and should be performed periodically to verify that the oscilloscope is operating within specification. The recommended test interval is once per year or after 2000 hours of operation. Performance should also be tested after repairs or major upgrades.

### **Performance Test Record**

A test record form is provided at the end of this section. This record lists performance tests, test limits and provides space to record test results.

### **Test Order**

The tests in this section may be performed in any order desired. However, it is recommended to conduct the tests in the order presented in this manual as this represents an incremental approach to performance verification. This may be useful if you are attempting to troubleshoot a suspected problem.

### **Test Equipment**

Lists of equipment needed to conduct each test are provided for each test procedure. The procedures are written to minimize the number and types of oscilloscopes and accessories required. The oscilloscopes in these lists are ones that are currently available for sale by Agilent at the time of writing this document. In some cases, the test procedures use features specific to the oscilloscopes in the recommended equipment list. However, with some modification to the test procedures, oscilloscopes, cables and accessories that satisfy the critical specifications in these lists may be substituted for the recommended models with some modification to the test procedures.

Contact Agilent Technologies for more information about the Agilent products in these lists.

## Performing Self-Test and Calibration

- 1** Perform self tests
  - a** Pull down the Utilities menu and select Self Test.
  - b** Select Scope Self Test from the Self Test list.
  - c** Click on Start Self Test to start the self test procedure.

If any of the self-tests fail, ensure that the failure is diagnosed and repaired before calibrating and testing performance.
- 2** Perform calibration. See “To run the self calibration” on page 15.

---

## Vertical Performance Verification

This section contains the following vertical performance verification:

- Offset Accuracy Test
- DC Gain Accuracy Test
- Analog Bandwidth Test

## Offset Accuracy Test

### CAUTION

Ensure that the input voltage to the oscilloscope never exceeds  $\pm 5$  V.

**Let the oscilloscope warm up before testing**

**The oscilloscope under test must be warmed up (with the oscilloscope application running) for at least 30 minutes prior to the start of any performance test.**

### Specifications

<b>Offset Accuracy</b>	$\leq 3.5$ V: $\pm(2\%$ of channel offset + $1\%$ of full scale + 1 mV)
<b>Full scale is defined as 8 vertical divisions. Magnification is used below 5 mV/div. Below 5 mV full scale is defined as 40 mV. The major scale settings are 5 mV, 10 mV, 20 mV, 50 mV, 100 mV, 200 mV, 500 mV and 1 V.</b>	

### Equipment Required

Description	Critical Specifications	Recommended Model/ Part Numbers
Digital Multimeter	DC voltage measurement accuracy better than $\pm 0.1\%$ of reading	Agilent 34401A or Agilent 3458A
Cable Assembly (2 required)	$50\Omega$ characteristic impedance, BNC (m) connectors	Agilent 8120-1840
Adapter	BNC Tee (m)(f)(f)	Agilent 1250-0781
Adapter	BNC (f) to dual banana	Agilent 1251-2277

The offset accuracy specification has two terms  $\pm(\text{offset gain} + \text{zero error})$ . The offset gain specification is  $\pm 2\%$  of channel offset and the zero error specification is  $\pm 1\%$  of full scale. The offset accuracy test procedure tests each of these terms individually.

### Procedure

- Zero Error Test
- 1 Disconnect all cables from the scope channel inputs.
  - 2 Press Default Setup, then configure the scope as follows:
    - a Pull down the Setup menu and select Acquisition.

### Chapter 3: Testing Performance Offset Accuracy Test

- b When the Acquisition Setup window is displayed, enable averaging and set the # of averages to 256 as shown below.

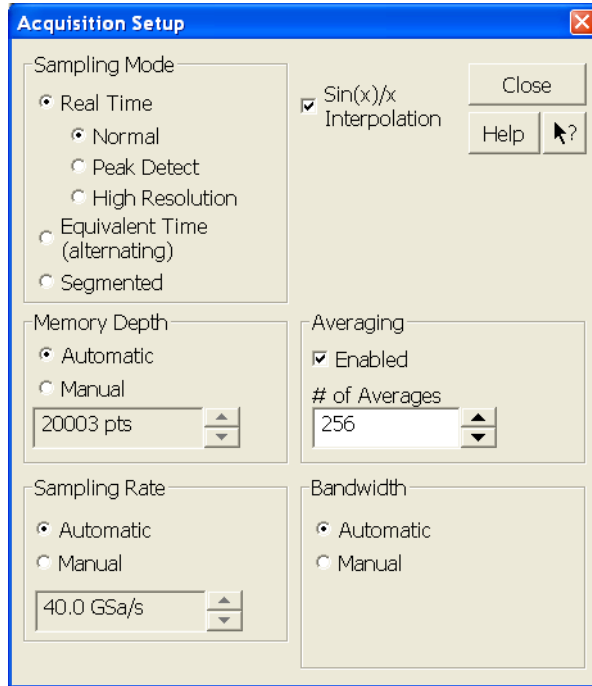

- 3 Configure the scope to measure Average voltage on channel 1 as follows:
- Change the vertical sensitivity of channel 1 to 5 mV/div.
  - Click the V avg measurement on the left side of the screen.

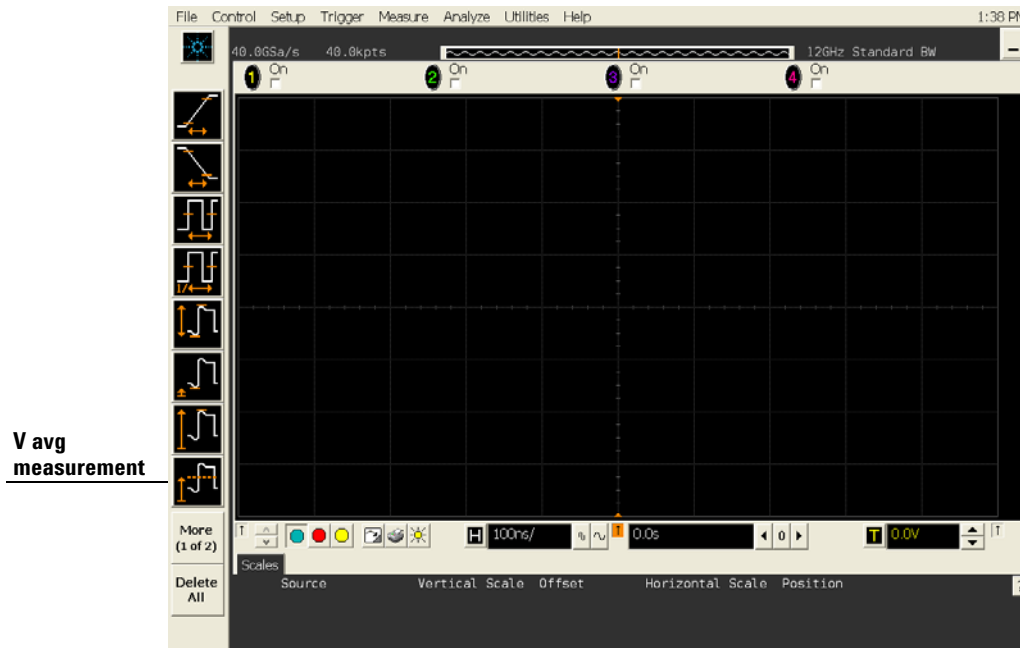

- c When the Enter Measurement Info window is displayed, ensure that the V avg function is set up as follows and then click OK:

Source = Channel 1

Measurement Area = Entire Display

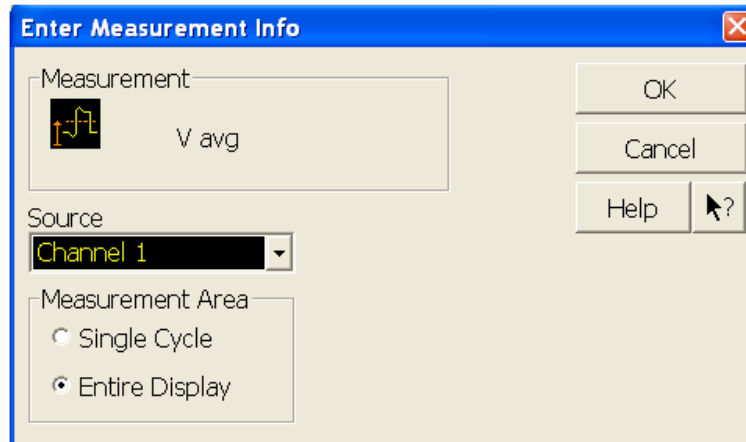

- 4 Press the Clear Display key on the scope and wait for the #Avs value (top left corner of screen) to return to 256. Record the scope's mean V avg reading in the Zero Error Test section of the Performance Test Record.

**Notes**

- For all scope readings in this procedure, use the mean value in the Measurements display area at the bottom of the screen.
- If a question mark is displayed in front of any of the values at the bottom of the screen, press the Clear Display key on the scope, wait for the #Avs value to return to 256 and then record the scope reading.

Record the mean reading



- 5 Change the vertical sensitivity of channel 1 to 10 mV/div, press the Clear Display key, wait for the #Avs value (top left corner of screen) to return to 256 and then record the scope V avg reading in the Zero Error Test section of the Performance Test Record.

**Chapter 3: Testing Performance**  
**Offset Accuracy Test**

- 6** Repeat step 5 for the remaining vertical sensitivities for channel 1 in the Zero Error Test section of the Performance Test Record.
- 7** Press Default Setup, then turn off channel 1 and turn channel 2 display on.
- 8** Configure the scope to measure V avg on Channel 2 as follows:
  - a** Pull down the Setup menu and select Acquisition. When the Acquisition Setup window is displayed, enable averaging and set the # of averages to 256.
  - b** Change the vertical sensitivity of channel 2 to 5 mV/div.
  - c** Click the V avg measurement icon on the left side of the screen.
  - d** When the Enter Measurement Info window is displayed, ensure that the Vavg function is set up as follows and then click OK:  
Source = Channel 2  
Measurement area = Entire Display
- 9** Press the Clear Display key on the scope, wait for the #Averages value to return to 256 and then record the scope's mean V avg reading in the Zero Error Test section of the Performance Test Record.
- 10** Repeat step 9 for the remaining vertical sensitivities for channel 2 in the Zero Error section of the Performance Test Record.
- 11** Repeat steps 7 through 10 for channels 3 and 4.



Offset Gain Test

- 12 Make the connections to scope channel 1 as shown below.

**Connections**

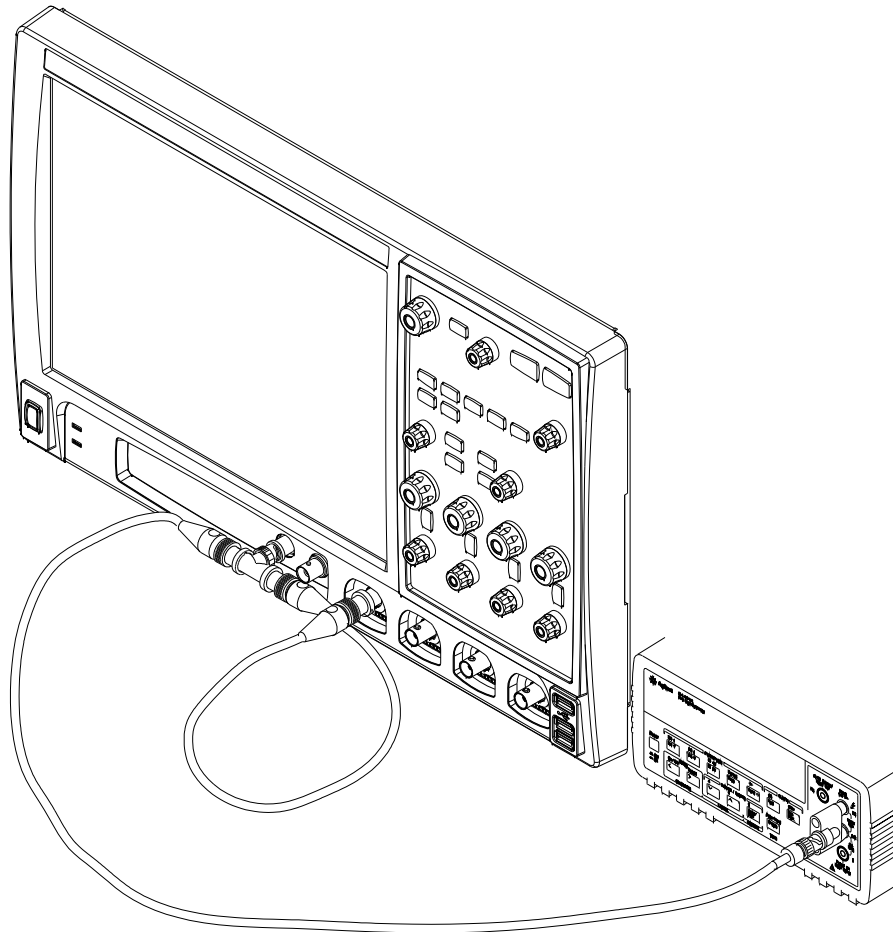

**Notes:**

- Where it is used, it is important to connect the BNC Tee adapter directly to the scope channel input to minimize ground potential differences and to ensure that the DMM measures the input voltage to the scope channel as accurately as possible. Differences in ground potential can be a significant source of measurement error, particularly at high scope sensitivities.
- It also helps to reduce ground potential differences if the scope and DMM are connected to the same AC supply circuit.
- A fairly large number of averages are used in the scope measurements of this section to reduce measurement noise and to reduce the measurement error due to resolution.

- 13 Set up the DMM to perform DC voltage measurements.
- 14 Configure the scope to measure V avg on Channel 1 as follows:
  - a Press Default Setup.

**Chapter 3: Testing Performance**  
**Offset Accuracy Test**

- b** Pull down the Setup menu and select Acquisition. When the Acquisition Setup window is displayed, enable averaging and set the # of averages to 256.
- c** Change the vertical sensitivity of channel 1 to 5 mV/div.
- d** Click the V avg measurement icon on the left side of the screen.
- e** When the Enter Measurement Info window is displayed, ensure that the V avg function is set up as follows and then click OK:
  - Source = Channel 1
  - Measurement area = Entire Display

- 15 Set the channel 1 offset value to 400.0 mV. This can be done using the front panel control or:
  - a Pull down the Setup menu and select Channel 1 or click the Channel 1 setup icon.
  - b Click the Offset control arrows to change the offset value or click on the offset value and enter 400.0 mV in the dialog box.
  - c Enter 400.0 mV in the Enter Offset dialog box.

Channel 1  
setup icon

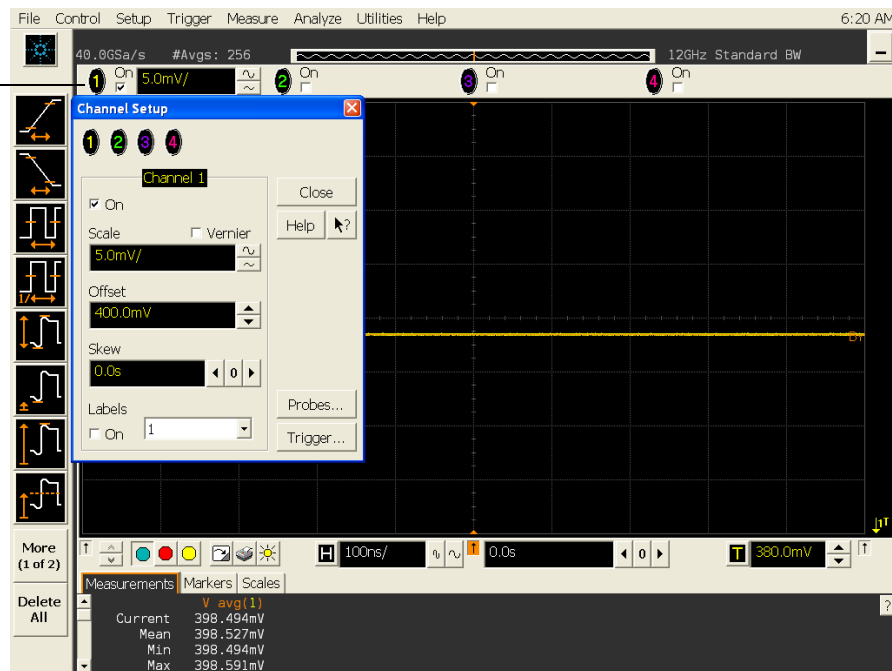

- 16 Set the Aux Out voltage ( $V_{\text{Aux Out}}$ ) to +400.0 mV as follows:
  - a Pull down the Utilities menu and select Calibration.
  - b Change the Aux Output function to DC (top left corner).
  - c Set the Level to 400.0 mV.
  - d Click on Close.

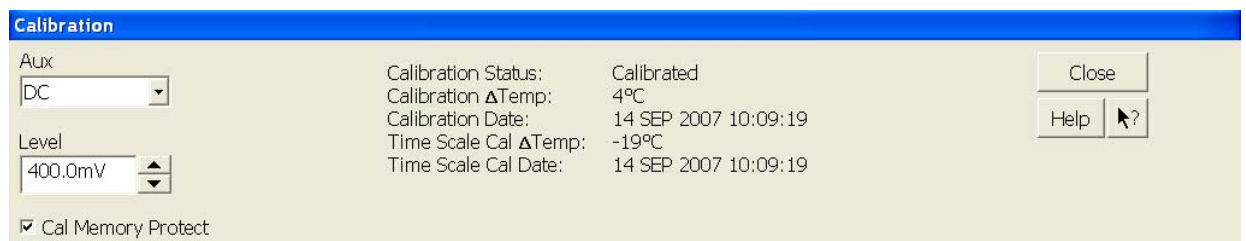

- 17 Press the Clear Display key on the scope, wait for the #Avs value (top left corner of screen) to return to 256 and then record the DMM voltage reading as  $V_{\text{DMM}+}$  and the scope  $V_{\text{avg}}$  reading as  $V_{\text{Scope}+}$  in the Offset Gain Test section of the Performance Test Record.

**Chapter 3: Testing Performance**  
**Offset Accuracy Test**

- 18 Change the channel 1 offset value to -400.0 mV.
- 19 Set the Aux Out voltage to -400.0 mV.
- 20 Press the Clear Display key on the scope, wait for the #Aves value (top left corner of screen) to return to 256 and then record the DMM voltage reading as  $V_{DMM-}$  and the scope Vavg reading as  $V_{Scope-}$  in the Offset Gain Test section of the Performance Test Record.
- 21 Change the channel 1 offset value to 0 mV.
- 22 Set the Aux Out voltage to 0 mV.
- 23 Press the Clear Display key on the scope, wait for the #Aves value (top left corner of screen) to return to 256 and then record the DMM voltage reading as  $V_{DMM0}$  and the scope Vavg reading as  $V_{Scope0}$  in the Offset Gain Test section of the Performance Test Record.
- 24 Calculate the offset gain error using the following expressions and record the value in the Offset Gain Test section of the Performance Test Record. The offset gain error is the greater (maximum magnitude) of either:

$$\left( \frac{V_{scope+} - V_{scope0}}{V_{DMM+} - V_{DMM0}} - 1 \right) 100$$

or

$$\left( \frac{V_{scope-} - V_{scope0}}{V_{DMM-} - V_{DMM0}} - 1 \right) 100$$

- 25 Repeat steps 15 to 24 for the remaining channel 1 vertical sensitivities in the Offset Gain Test section of the Performance Test Record. For each measurement, set both the Aux Out voltage ( $V_{Aux Out}$ ) and the Channel offset voltage to the positive  $V_{Aux Out}$  value and then to the negative  $V_{Aux Out}$  value in the " $V_{Aux Out}$  Setting" column of the Offset Gain Test table in the Performance Test Record for each of the vertical sensitivities.
- 26 Move the Tee connector to the next channel input and repeat steps 15 to 22 for the channels 2 to 4.

---

## DC Gain Accuracy Test

---

### CAUTION

Ensure that the input voltage to the oscilloscope never exceeds  $\pm 5$  V.

**Let the oscilloscope warm up before testing**

**The oscilloscope under test must be warmed up (with the oscilloscope application running) for at least 30 minutes prior to the start of any performance test.**

### Specifications

DC Gain Accuracy	$\pm 2\%$ of full scale at full resolution channel scale
<p><b>Full scale is defined as 8 vertical divisions. Magnification is used below 5 mV/div. Below 5 mV full scale is defined as 40 mV. The major scale settings are 5 mV, 10 mV, 20 mV, 50 mV, 100 mV, 200 mV, 500 mV and 1 V.</b></p>	

### Equipment Required

Description	Critical Specifications	Recommended Model/ Part Numbers
Digital Multimeter	DC voltage measurement accuracy better than $\pm 0.1\%$ of reading	Agilent 34401A or Agilent 3458A
Cable Assembly (2 required)	50 $\Omega$ characteristic impedance, BNC (m) connectors	Agilent 8120-1840
Adapter	BNC Tee (m)(f)(f)	Agilent 1250-0781
Adapter	BNC (f) to dual banana	Agilent 1251-2277

## Chapter 3: Testing Performance

### DC Gain Accuracy Test

#### Procedure

- 1 Make the connections to scope channel 1 as shown below.

#### Connections

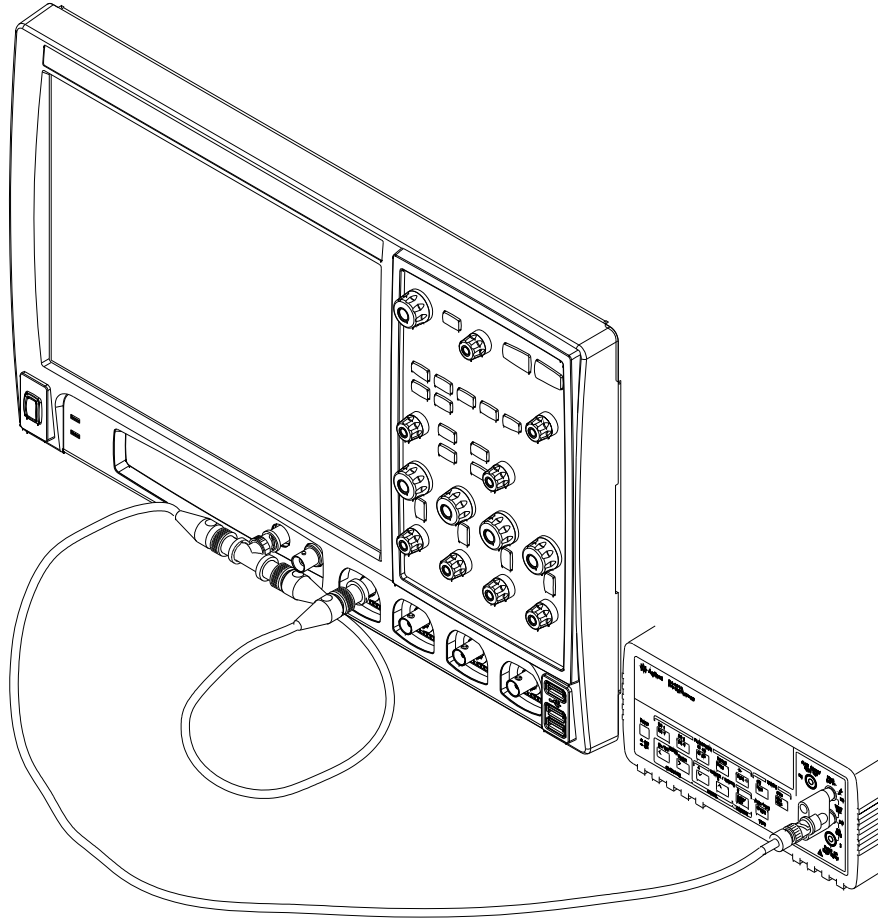

#### Notes:

- Where it is used, it is important to connect the BNC Tee adapter directly to the scope channel input to minimize ground potential differences and to ensure that the DMM measures the input voltage to the scope channel as accurately as possible. Differences in ground potential can be a significant source of measurement error, particularly at high scope sensitivities.
- It also helps to reduce ground potential differences if the scope and DMM are connected to the same AC supply circuit.
- A fairly large number of averages are used in the scope measurements of this section to reduce measurement noise and to reduce the measurement error due to resolution.

- 2 Press Default Setup, then configure the scope as follows:
  - a Pull down the Setup menu and select Acquisition.

- b When the Acquisition Setup window is displayed, enable averaging and set the # of averages to 256 as shown below.

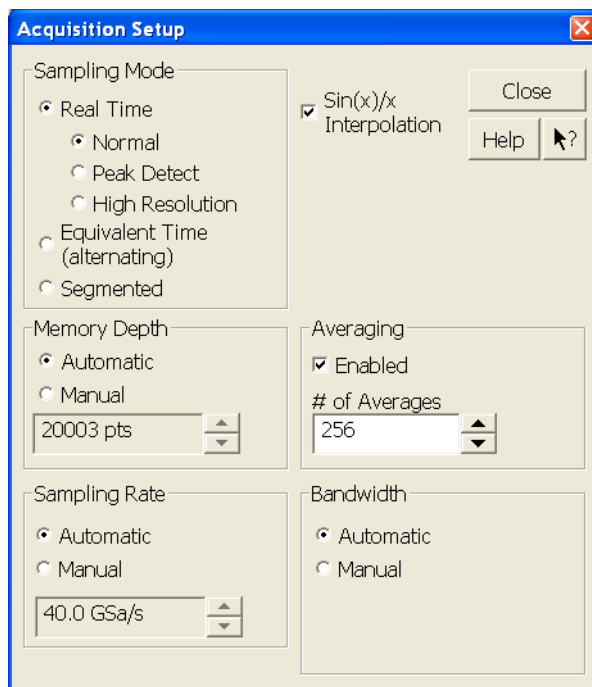

- 3 Set the Aux Out voltage ( $V_{\text{Aux Out}}$ ) to +15 mV as follows:
- Pull down the Utilities menu and select Calibration.
  - Change the Aux Output function to DC (top left corner).
  - Set the Level to 15 mV.
  - Click on Close.

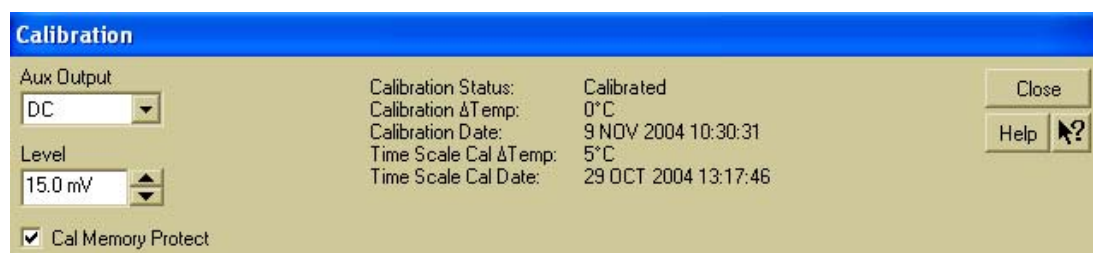

- 4 Set the channel 1 vertical sensitivity value to 5 mV/div. This can be done either using the front panel control or:
- Pull down the Setup menu and select Channel 1 or click the Channel 1 setup icon.
  - Change the vertical sensitivity of channel 1 to 5 mV/div.

### Chapter 3: Testing Performance DC Gain Accuracy Test

- c Select the Vavg measurement as shown below.



- d When the Enter Measurement Info window is displayed, ensure that the V avg function is set up as follows and then click OK:

Source = Channel 1

Measurement Area = Entire Display

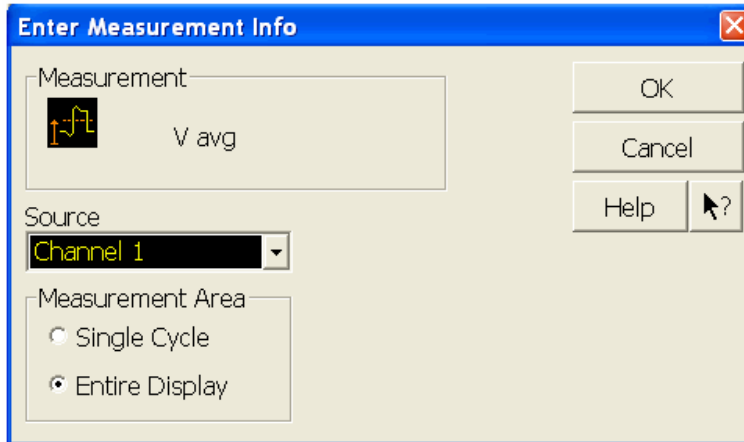

- 5 Press the Clear Display key on the scope, wait for the #Averages value (top left corner of screen) to return to 256 and then record the scope's mean V avg reading in the DC Gain Test section of the Performance Test Record.

#### Notes

- For all scope readings in this procedure, use the mean value in the Measurements display area at the bottom of the screen.
- If a question mark is displayed in front of any of the values at the bottom of the screen, press the Clear Display key on the scope, wait for the #Averages value to return to 256 and then record the scope reading.



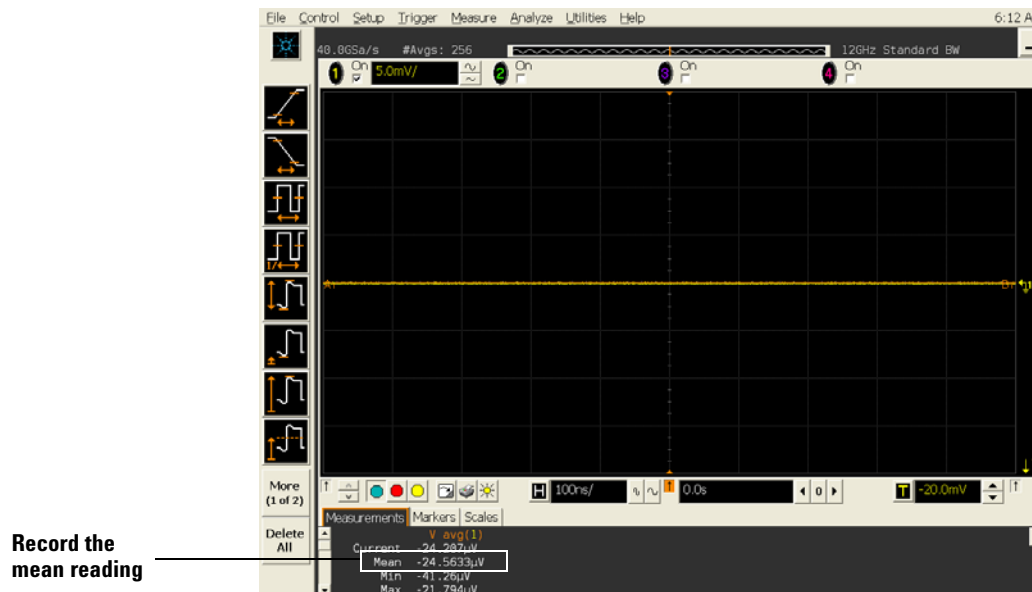

- 6 Change the Aux Out voltage to -15 mV.
- 7 Press the Clear Display key on the scope, wait for the #Avs value to return to 256 and then record the DMM voltage reading and the scope V avg reading in the DC Gain Test section of the Performance Test Record.
- 8 Repeat step 7 for the remaining vertical sensitivities for channel 1 shown in the DC Gain Test section of the Performance Test Record.
- 9 Press Default Setup, then turn off channel 1 and turn channel 2 display on.
- 10 Set the Aux Out voltage ( $V_{\text{Aux Out}}$ ) to +15 mV as follows:
- 11 Configure the scope to measure V avg on Channel 2.
  - a Pull down the Setup menu and select Acquisition. When the Acquisition Setup window is displayed, enable averaging and set the # of averages to 256.
  - b Change the vertical sensitivity of channel 2 to 5 mV/div.
  - c Click the V avg measurement icon on the left side of the screen.
  - d When the Enter Measurement Info window is displayed, ensure that the Vavg function is set up as follows and then click OK:  
Source = Channel 2  
Measurement area = Entire Display
- 12 Press the Clear Display key on the scope, wait for the #Avs value to return to 256 and then record the DMM voltage reading and the scope V avg reading in the DC Gain Test section of the Performance Test Record.
- 13 Repeat step 12 for the remaining vertical sensitivities for channel 2 in the DC Gain section of the Performance Test Record.
- 14 Repeat steps 9 through 13 for channels 3 and 4.

**Chapter 3: Testing Performance**  
**DC Gain Accuracy Test**

- 15 Calculate the offset gain using the following expression and record this value in the DC Gain Test section of the Performance Test Record.

For vertical sensitivities of less than 1 volt use the following equation:

$$DCGainError = \frac{\Delta V_{out}}{\Delta V_{in}} = \left( \left( \frac{V_{scope+} - V_{scope-}}{V_{DMM+} - V_{DMM-}} - 1 \right) \right) \cdot 75$$

For vertical sensitivity = 1 V use the following equation:

$$DCGainError = \frac{\Delta V_{out}}{\Delta V_{in}} = \left( \frac{V_{scope+} - V_{scope-}}{V_{DMM+} - V_{DMM-}} - 1 \right) \cdot 60$$

## Analog Bandwidth - Maximum Frequency Check

### CAUTION

Ensure that the input voltage to the oscilloscope never exceeds  $\pm 5$  V.

Let the oscilloscope warm up before testing

The oscilloscope under test must be warmed up (with the oscilloscope application running) for at least 30 minutes prior to the start of any performance test.

### Specification

Analog Bandwidth (-3 dB)	
DSO/DSA91304A	12.0 GHz, 11.8 GHz at 5 mV/div
DSO/DSA91204A	12.0 GHz, 11.8 GHz at 5 mV/div
DSO/DSA90804A	8.0 GHz
DSO/DSA90604A	6.0 GHz
DSO/DSA90404A	4.0 GHz
DSO/DSA90254A	2.5 GHz

### Equipment Required

Description	Critical Specifications	Recommended Model/ Part Numbers
Microwave CW Generator	Maximum Frequency $\geq 14$ GHz Power range: -20 dBm to +16 dBm into $50\Omega$ Output resistance = $50\Omega$	Agilent E8257D with Opt 520
Power Splitter	2 Resistor Power Splitter Max Frequency $\geq 18$ GHz	Agilent 11667B
Power Meter	Agilent E-series with power sensor compatibility	Agilent E4418B or E4419B
Power Sensor	Maximum Frequency $\geq 14$ GHz Power range: -24 dBm to +16 dBm	Agilent E4413A
Microwave Cable	$50\Omega$ Characteristic Impedance 3.5 mm (m) to 3.5 mm (m) SMA connectors Max Frequency $\geq 18$ GHz	Agilent 8120-4948
SMA Adapters	3.5 mm (m) to 3.5 mm (m) SMA	Agilent E2655-83202
SMA to BNC Adapter	3.5 mm (f) SMA to Precision BNC (No Substitute)	Agilent 54855-67604

## Chapter 3: Testing Performance

### Analog Bandwidth - Maximum Frequency Check

#### Connections

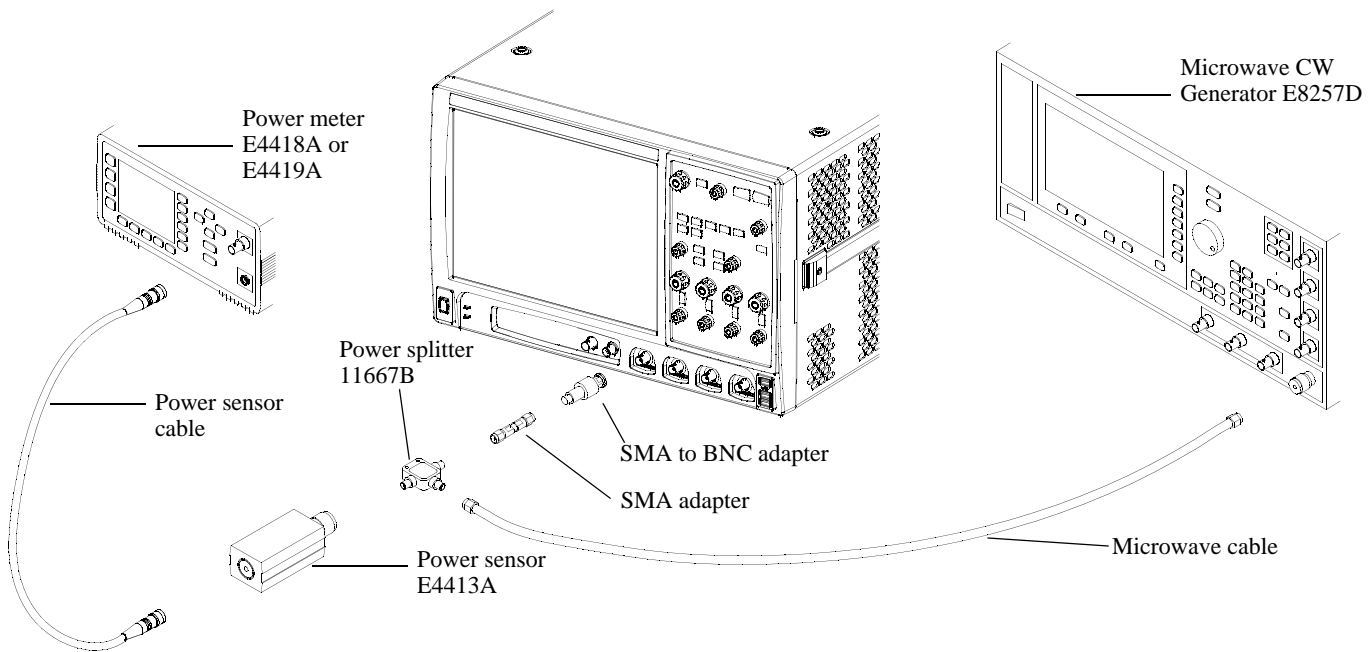

#### Notes

- Connect output 1 of the 11667B splitter to the scope Channel n input directly using the 54855-67604 adapter, without any additional cabling or adapters.
- Connect the power sensor directly to output 2 of the power splitter without any additional cabling or adapters.
- Minimize the use of other adapters.
- Ensure that SMA and 3.5 mm connectors are tightened properly:
  - 8 in-lbs (90 N-cm) for 3.5 mm
  - 5 in-lbs (56 N-cm) for SMA

#### Procedure

- 1 Preset the power meter.
- 2 Ensure that the power sensor is disconnected from any source and zero the meter.
- 3 Connect the power sensor to the power meter's Power Ref connector and calibrate the meter.
- 4 Make the connections to scope channel 1 as shown in the connection diagram above.
- 5 Set up the Power Meter to display measurements in units of Watts.
- 6 Press Default Setup, then configure the scope as follows:
  - a Ensure Channel 1 is displayed and all other channels are turned off.
  - b Set the vertical sensitivity of channel 1 to 5 mV/div.

- c Set the horizontal scale to 16 ns/div (to display 8 cycles of a 50 MHz waveform).



Click here and enter 16E-9

- d Pull down the Setup menu, select Acquisition and then set up the acquisition parameters as follows:

Memory Depth = Automatic  
Sampling rate = Maximum (40 GSa/s)  
Sin(x)/x Interpolation filter enabled  
Averaging = Disabled

- e Pull down the Measure menu, select Voltage and then select V rms.

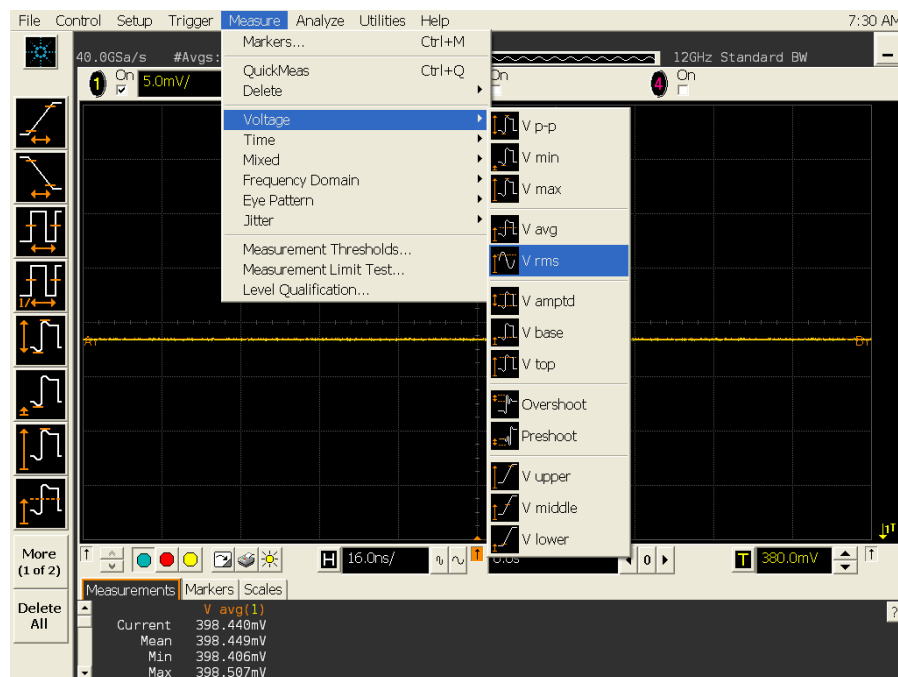

**Chapter 3: Testing Performance**  
**Analog Bandwidth - Maximum Frequency Check**

- f When the RMS voltage measurement setup window is displayed, configure this measurement as follows:  
 Source = Channel 1  
 Measurement Area = Entire Display  
 RMS Type = AC

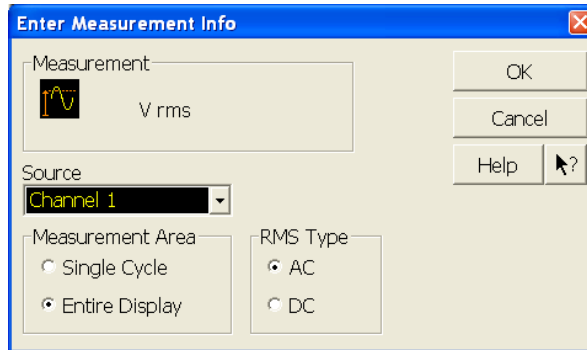

- 7 Set the generator to apply a 50 MHz sine wave with a peak-to-peak amplitude of about 4 divisions.
- Use the following table to determine the approximate required signal amplitude.  
 The amplitude values in the table below are not absolutely required. If your generator is unable to produce the recommended amplitude, then set the generator to the highest value that does not produce a vertically clipped signal on the scope.

**Table 3-1. Nominal Generator Amplitude Settings**

Scope Vertical Sensitivity	Generator Signal Amplitude (Vp-p)	Generator Signal Amplitude (dBm)
5 mV/div	0.02	-30
10 mV/div	0.04	-24
20 mV/div	0.08	-18
50 mV/div	0.20	-10
100 mV/div	0.40	-4
200 mV/div	0.80	+2
500 mV/div	2.0	+10
1 V/div	4.0	+16

- 8 Measure the input power to the scope channel and convert this measurement to Volts RMS using the expression:

$$V_{in} = \sqrt{P_{meas} \times 50\Omega}$$

For example, if the power meter reading is 4.0  $\mu$ W, then  $V_{in} = (4.0 \times 10^{-6} * 50\Omega)^{1/2} = 14.1$  mVrms.

Record the RMS voltage in the Analog Bandwidth - Maximum Frequency Check section of the Performance Test Record ( $V_{in}$  @ 50 MHz).

- Press the Clear Display key on the scope and record the scope  $V_{rms}$  reading in the Analog Bandwidth - Maximum Frequency Check section of the Performance Test Record ( $V_{out}$  @ 50 MHz). For all scope readings in this procedure, use the mean value in the Measurements display area at the bottom of the screen.

**Notes**

- For all scope readings in this procedure, use the mean value in the Measurements display area at the bottom of the screen.
- If a question mark is displayed in front of any of the values at the bottom of the screen, press the Clear Display key on the scope, wait for the #Avgs value to return to 16 and then record the scope reading.

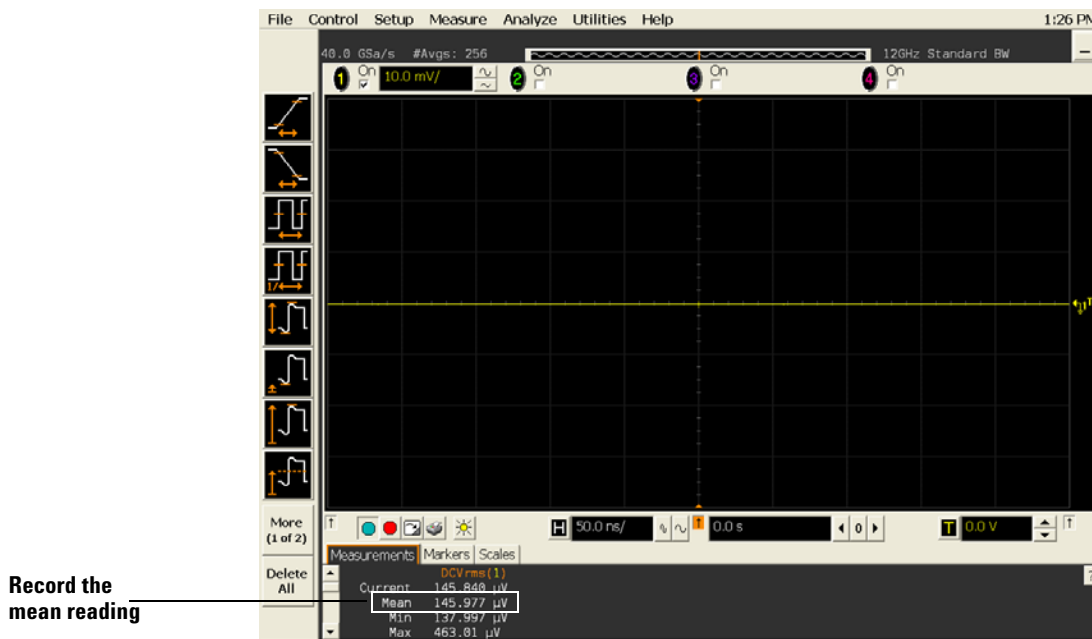

- Calculate the reference gain as follows:

$$Gain_{50\text{ MHz}} = \frac{V_{out @ 50\text{ MHz}}}{V_{in @ 50\text{ MHz}}}$$

Record this value in the Calculated Gain @50 MHz column in the Analog Bandwidth - Maximum Frequency Check section of the Performance Test Record.

**Chapter 3: Testing Performance**  
**Analog Bandwidth - Maximum Frequency Check**

- 11 Change the generator frequency to the maximum value for the model being tested as shown in the table below. It is not necessary to adjust the signal amplitude at this point in the procedure.

Setting	Model		
	DSO/DSA90254 A	DSO/DSA90404A	DSO9/DSA0604A
Maximum Frequency	2.5 GHz	4.0 GHz	6.0 GHz
Scope Time Base Setting	100 ps/div	100 ps/div	100 ps/div
Setting	Model		
	DSO/DSA90804 A	DSO/DSA91204A	DSO/DSA91304A
Maximum Frequency	8.0 GHz	12.0 GHz 11.8 GHz at 5 mV/div	12.0 GHz, 11.8 GHz at 5 mV/div
Scope Time Base Setting	100 ps/div	100 ps/div	100 ps/div

- 12 Change the scope time base to the value for the model under test in the table above.



**Click here and enter time base value from table**

- 13 Measure the input power to the scope channel at the maximum frequency and convert this measurement to Volts RMS using the expression:

$$V_{in} = \sqrt{P_{meas} \times 50\Omega}$$

For example, if the power meter reading is 4.0  $\mu$ W, then  $V_{in} = (4.0 \times 10^{-6} \times 50\Omega)^{1/2} = 14.1$  mVrms.

Record the RMS voltage in the Analog Bandwidth - Maximum Frequency Check section of the Performance Test Record ( $V_{in}$  @ Max Freq).

- 14 Press the Clear Display key on the scope and record the scope V rms reading in the Analog Bandwidth - Maximum Frequency Check section of the Performance Test Record ( $V_{out}$  @ Max Freq).

- 15 Calculate the gain at the maximum frequency using the expression:

$$Gain_{Max\ Freq} = 20 \log_{10} \left[ \frac{(V_{out\ Max\ Freq}) / (V_{in\ Max\ Freq})}{Gain_{50\ MHz}} \right]$$

For example, if ( $V_{out}$  @ Max Frequency) = 13.825 mV, ( $V_{in}$  @ Max Frequency) = 13.461 mV and Gain @ 50MHz = 1.0023, then:

$$Gain_{Max\ Freq} = 20 \log_{10} \left[ \frac{13.825\ mV / 13.461\ mV}{1.0023} \right] = 0.212\ dB$$

Record this value in the Calculated Gain @Max Freq column in the Analog Bandwidth - Maximum Frequency Check section of the Performance Test Record. To pass this test, this value must be greater than -3.0 dB.



- 16 Change the scope set up as follows:
  - a Change the channel vertical sensitivity to 10 mV/div.
  - b Reset the horizontal scale to 16 ns/div (to display 8 cycles of a 50 MHz waveform).
- 17 Change the generator output as follows:
  - a Reset the generator frequency to 50 MHz.
  - b Change the amplitude to the value suggested for this sensitivity in Table 3-1.
- 18 Repeat steps 8, 9, and 10 to measure the reference gain at 50 MHz for this sensitivity.
- 19 Repeat steps 11, 12, 13, and 14 to measure the gain at maximum frequency for this sensitivity.
- 20 Repeat steps 15 to 19 to complete measuring gains for remaining sensitivities for channel 1 in the Analog Bandwidth - Maximum Frequency Check section of the Performance Test Record.
- 21 Move the splitter to channel 2 and change the scope configuration as follows:
  - Ensure Channel 2 is displayed and all other channels are turned off.
  - Set the vertical sensitivity of channel 2 to 5 mV/div.
  - Set the horizontal scale to 16 ns/div (to display 8 cycles of a 50 MHz waveform).
  - Right click on the V rms measurement at the bottom of the screen. When the RMS voltage measurement setup window is displayed, change the source from Channel 1 to Channel 2.

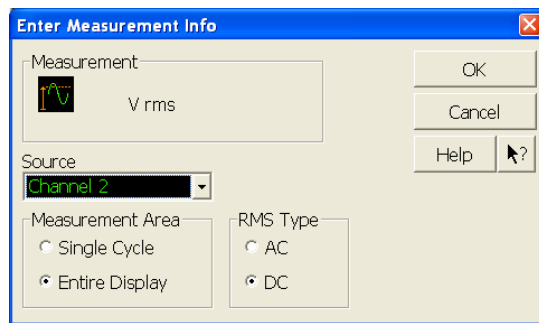

- 22 Repeat steps 7 to 20 to complete measuring gains for channel 2.
- 23 Move the splitter to channel 3 and change the scope configuration as follows:
  - a Ensure Channel 3 is displayed and all other channels are turned off.
  - b Set the vertical sensitivity of channel 3 to 5 mV/div.
  - c Set the horizontal scale to 16 ns/div (to display 8 cycles of a 50 MHz waveform).
  - d Click on the V rms measurement at the bottom of the screen and select Customize. When the V rms setup window is displayed, change the source from Channel 2 to Channel 3.
- 24 Repeat steps 7 to 20 to complete measuring gains for channel 3.
- 25 Move the splitter to channel 4 and change the scope configuration as follows:
  - a Ensure Channel 4 is displayed and all other channels are turned off.
  - b Set the vertical sensitivity of channel 4 to 5 mV/div.
  - c Set the horizontal scale to 16 ns/div (to display 8 cycles of a 50 MHz waveform).
  - d Click on the V rms measurement at the bottom of the screen. When the V rms setup window is displayed, change the source from Channel 3 to Channel 4.
- 26 Repeat steps 7 to 20 to complete measuring gains for channel 4.

## Time Scale Accuracy (TSA)

This procedure verifies the maximum TSA specification for the oscilloscope.

### Description

TSA refers to the absolute accuracy of oscilloscope's time scale. Because TSA depends directly on frequency of a crystal oscillator, it is comprised of two components: an initial accuracy component, and an aging component. The initial accuracy component applies to the oscilloscope's accuracy immediately after a time base calibration, whether performed by at the factory, by a customer, or by an Agilent service center. The aging component scales linearly from the time since the last time base calibration and adds to the initial accuracy component.

### Specifications

TSA is published as a warranted specification, expressed by the following formula. The aging component is specified by the crystal manufacturer while the initial accuracy component represents our best estimate of the final value, which will be determined from subsequent characterization of a large sample of production units.

$$\text{TSA} = \pm(0.4 + 0.5(\text{Years Since Calibration})) \text{ ppm peak}$$

Note that TSA is specified with respect to an absolute standard and therefore its measurement results must be compared against test limits that account for the uncertainties in its measurement results. The total measurement uncertainty of the following test procedure is 0.1 ppm. It is the sum of 0.01 ppm for the test signal's absolute frequency accuracy, 0.04 ppm for the voltage noise and phase noise of the oscilloscope's digitized waveforms, and 0.05 ppm for the residual settling time of the crystal oscillator after the specified 30 minute warm-up time. Therefore, all measurement results need to be better than the specified values by a test margin of at least 0.1 ppm in order to guarantee compliance to the specification.

### Equipment Required

Equipment	Critical Specifications	Recommended Model/Part
Synthesized sine wave source	Output Frequency: $\geq 10$ MHz Output Amplitude: 0 dBm Frequency Resolution: 0.1 Hz	Agilent E8267D PSG
10 MHz frequency reference	Output Frequency: 10 MHz Output Amplitude: 0 dBm Absolute Freq. Error: $< \pm 0.01$ ppm	Symmetricom 58503B
SMA cable	50 ohm characteristic impedance SMA (m) connectors Max Frequency: $\geq 50$ MHz	Agilent 8120-4948
RF cable	50 ohm characteristic impedance BNC (m) connectors Max Frequency: $\geq 50$ MHz	Agilent 8120-1840
Adapters, assorted	3.5 mm (f) to Precision BNC (m)	Agilent 54855-67604

### Connections

Connect the equipment as shown in the following figure.

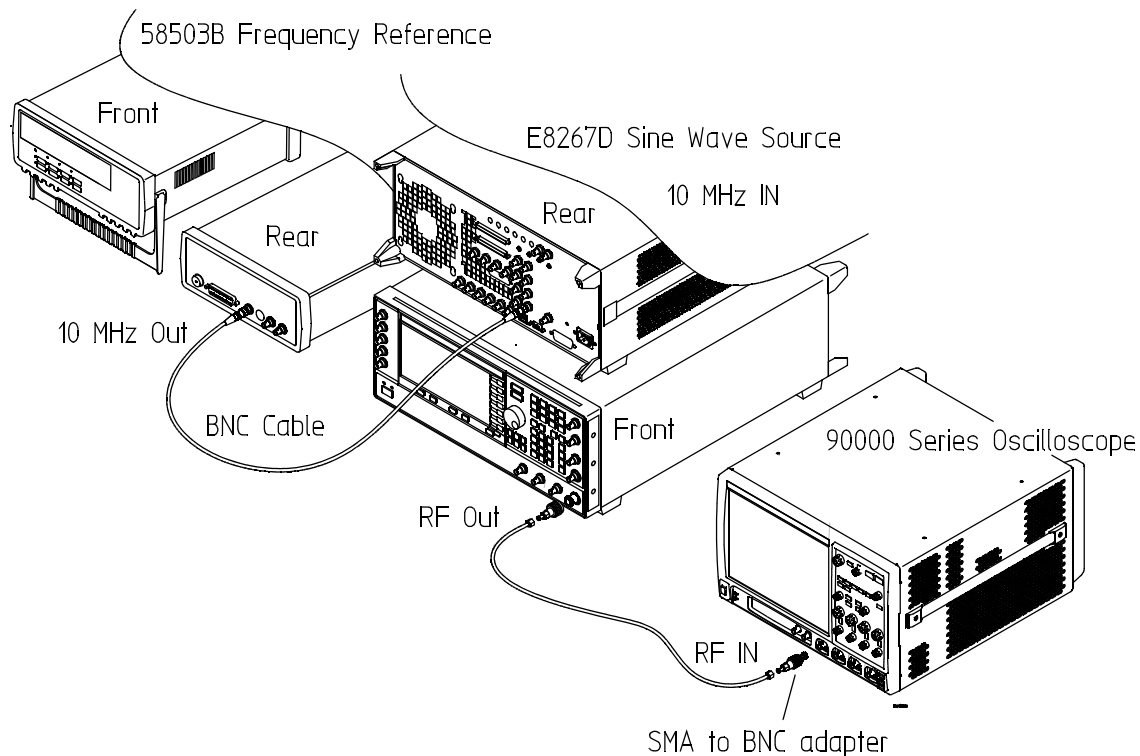

### Procedure

- 1 Configure the sine wave source to output a 0 dBm (600 mVpp) sine wave into 50 ohms with a frequency of 10.00002000 MHz.
- 2 Adjust source amplitude such that displayed sine wave is 600 mVpp.
- 3 Press the **Default Setup** key on the oscilloscope.
- 4 Set channel 1's vertical scale to 100 mV/div.
- 5 Set the oscilloscope sample rate to 100 kSa/s. (The resulting measurement will be aliased.)
- 6 Set the scope's horizontal scale to 20 ms/div.
- 7 Set the measurement thresholds for all waveforms to a fixed voltage level of 0 V and  $\pm 20$  mV hysteresis.
- 8 Enable a frequency measurement on channel 1.
- 9 On the oscilloscope, press **Stop**.
- 10 Press **Clear Display**.
- 11 Press **Run**, wait until 10 acquisitions have accumulated, and then press **Stop**.
- 12 Convert the average frequency value to time scale error by subtracting 20 Hz and dividing by 10 Hz/ppm.
- 13 Record the time scale error value as well as the time since the previous calibration (in years).
- 14 Calculate the specification for Time Scale Accuracy based on the oscilloscope's age using the following formula:  

$$TSA = \pm(0.4 + 0.5(\text{Years Since Calibration})) \text{ ppm peak}$$
- 15 Compare the measured time scale error to the TSA specification. Note that the measurement result should exceed the specified accuracy by at least 0.1 ppm in order to guarantee compliance to the specification.
- 16 Record the results in the Performance Test Record.

---

Performance Test Record

<b>Agilent Technologies</b>		<b>Agilent 90000 Series Oscilloscopes</b>	
Model Number _____		Tested by _____	
Serial Number _____		Work Order No. _____	
Recommended Test Interval - 1 Year/2000 hours		Date _____	
Recommended next test date _____		Ambient temperature _____	

**Offset Performance Test**

**Zero Error Test**

Vertical Sensitivity	Test Limits	Channel 1	Channel 2	Channel 3	Channel 4
5 mV/div	-1.4 mV to +1.4 mV				
10 mV/div	-1.8 mV to +1.8 mV				
20 mV/div	-2.6 mV to +2.6 mV				
50 mV/div	-5.0 mV to +5.0 mV				
100 mV/div	-9.0 mV to +9.0 mV				
200 mV/div	-17.0 mV to +17.0 mV				
500 mV/div	-41.0 mV to +41.0 mV				
1 V/div	-81.0 mV to +81.0 mV				

**Offset Gain Test**

<b>Vertical Sensitivity</b>	<b>V<sub>Aux Out</sub> Setting</b>	<b>V<sub>DMM+</sub></b>	<b>V<sub>DMM-</sub></b>	<b>V<sub>DMM0</sub></b>	<b>V<sub>Scope+</sub></b>	<b>V<sub>Scope-</sub></b>	<b>V<sub>Scope0</sub></b>	<b>Calculated Offset Gain Error</b>	<b>Offset Gain Error Test Limits</b>
<b>Channel 1</b>									
5 mV/div	±400 mV								±2 %
10 mV/div	±400 mV								±2 %
20 mV/div	±400 mV								±2 %
50 mV/div	±900 mV								±2 %
100 mV/div	±1.6 V								±2 %
200 mV/div	±2.4 V								±2 %
500 mV/div	±2.4 V								±2 %
1 V/div	±2.4 V								±2 %
<b>Channel 2</b>									
5 mV/div	±400 mV								±2 %
10 mV/div	±400 mV								±2 %
20 mV/div	±400 mV								±2 %
50 mV/div	±900 mV								±2 %
100 mV/div	±1.6 V								±2 %
200 mV/div	±2.4 V								±2 %
500 mV/div	±2.4 V								±2 %
1 V/div	±2.4 V								±2 %
<b>Channel 3</b>									
5 mV/div	±400 mV								±2 %
10 mV/div	±400 mV								±2 %
20 mV/div	±400 mV								±2 %
50 mV/div	±900 mV								±2 %
100 mV/div	±1.6 V								±2 %
200 mV/div	±2.4 V								±2 %
500 mV/div	±2.4 V								±2 %
1 V/div	±2.4 V								±2 %
<b>Channel 4</b>									
5 mV/div	±400 mV								±2 %
10 mV/div	±400 mV								±2 %
20 mV/div	±400 mV								±2 %
50 mV/div	±900 mV								±2 %
100 mV/div	±1.6 V								±2 %
200 mV/div	±2.4 V								±2 %
500 mV/div	±2.4 V								±2 %
1 V/div	±2.4 V								±2 %

**Chapter 3: Testing Performance  
Performance Test Record**

**DC Gain Test**

Vertical Sensitivity	V <sub>Aux Out</sub> Setting	V <sub>DMM+</sub>	V <sub>DMM-</sub>	V <sub>Scope+</sub>	V <sub>Scope-</sub>	Calculated DC Gain Error	DC Gain Error Test Limits
<b>Channel 1</b>							
5 mV/div	±15 mV						±2 %
10 mV/div	±30 mV						±2 %
20 mV/div	±60 mV						±2 %
50 mV/div	±150 mV						±2 %
100 mV/div	±300 mV						±2 %
200 mV/div	±600 mV						±2 %
500 mV/div	±1.5 V						±2 %
1 V/div	±2.4 V						±2 %
<b>Channel 2</b>							
5 mV/div	±15 mV						±2 %
10 mV/div	±30 mV						±2 %
20 mV/div	±60 mV						±2 %
50 mV/div	±150 mV						±2 %
100 mV/div	±300 mV						±2 %
200 mV/div	±600 mV						±2 %
500 mV/div	±1.5 V						±2 %
1 V/div	±2.4 V						±2 %
<b>Channel 3</b>							
5 mV/div	±15 mV						±2 %
10 mV/div	±30 mV						±2 %
20 mV/div	±60 mV						±2 %
50 mV/div	±150 mV						±2 %
100 mV/div	±300 mV						±2 %
200 mV/div	±600 mV						±2 %
500 mV/div	±1.5 V						±2 %
1 V/div	±2.4 V						±2 %
<b>Channel 4</b>							
5 mV/div	±15 mV						±2 %
10 mV/div	±30 mV						±2 %
20 mV/div	±60 mV						±2 %
50 mV/div	±150 mV						±2 %
100 mV/div	±300 mV						±2 %
200 mV/div	±600 mV						±2 %
500 mV/div	±1.5 V						±2 %
1 V/div	±2.4 V						±2 %

Analog Bandwidth - Maximum Frequency Check

Max frequency: DSO/DSA90254A = 2.5 GHz, DSO/DSA90404A = 4.0 GHz, DSO/DSA90604A = 6.0 GHz, DSO/DSA90804A = 8.0 GHz  
DSO/DSA91204A = 12.0 GHz (11.8 GHz at 5 mV/div), DSO/DSA91304A = 12.0 GHz (11.8 GHz at 5 mV/div).

Vertical Sensitivity	Measurement					
	Vin @ 50 MHz	Vout @ 50 MHz	Calculated Gain @ 50 MHz (Test Limit = greater than -3 dB)	Vin @ Max Freq	Vout @ Max Freq	Calculated Gain @ Max Freq (Test Limit = greater than -3 dB)
<b>Channel 1</b>						
5 mV/div						
10 mV/div						
20 mV/div						
50 mV/div						
100 mV/div						
200 mV/div						
500 mV/div						
1 V/div						
<b>Channel 2</b>						
5 mV/div						
10 mV/div						
20 mV/div						
50 mV/div						
100 mV/div						
200 mV/div						
500 mV/div						
1 V/div						
<b>Channel 3</b>						
5 mV/div						
10 mV/div						
20 mV/div						
50 mV/div						
100 mV/div						
200 mV/div						
500 mV/div						
1 V/div						
<b>Channel 4</b>						
5 mV/div						
10 mV/div						
20 mV/div						
50 mV/div						
100 mV/div						
200 mV/div						
500 mV/div						
1 V/div						

**Chapter 3: Testing Performance  
Performance Test Record**

Test	Limits	Results		
<b>Time Scale Accuracy</b>	<b>Limit</b> Limit is based on years since oscilloscope's last calibration  $TSA = \pm(0.4 + 0.5(\text{Years Since Calibration})) \text{ ppm}$	<b>Calculated TSA Spec</b>  _____	<b>Measured time scale error</b>  _____	<b>Pass/Fail</b>  _____



Safety	50
Tools Required	50
ESD Precautions	50
Default Setup	50
To troubleshoot the oscilloscope	51
Primary Trouble Isolation	52
Power Supply Trouble Isolation	55
Display Trouble Isolation	69
To check the backlight inverter voltages	71
To check the display board video signals	72
Front Panel Display Trouble Isolation	73
Front Panel Trouble Isolation	75
Motherboard Verification	76
To setup the BIOS	77
Acquisition/Backplane Assembly Trouble Isolation - Scope Self Tests	78
AutoProbe Board Trouble Isolation	81
To check the keyboard; Trouble Isolation Procedure	82
To check the LEDs	83
Software Revisions	84
To check probe power outputs	85

---

# Troubleshooting

This section provides troubleshooting information for the Agilent Technologies 90000 Series oscilloscopes. The service strategy of this oscilloscope is replacement of defective assemblies.

## Safety

Read the Safety Notices at the back of this manual before servicing the oscilloscope. Before performing any procedure, review it for cautions and warnings.

---

### WARNING

#### SHOCK HAZARD!

Maintenance should be performed by trained service personnel aware of the hazards involved (for example, moving parts, fire and electric shock). Lack of training and awareness of the hazards could result in electrical shock or other injury. When maintenance can be performed without power applied, the power cord should be removed from the oscilloscope.

---

---

### WARNING

#### INJURY CAN RESULT!

Use caution when working around the cooling fans with the cover removed from the oscilloscope. The cooling fan blades are exposed on one side and can be hazardous. If the procedure allows, replace the cover over the chassis (without screwing it back in place) before turning the oscilloscope on. If the procedure requires you to have the cover off, be careful not to contact these fan blades with any part of your body.

---

## Tools Required

You will need basic electronic troubleshooting tools, including a digital multimeter and a 100 MHz (or faster) oscilloscope.

If you need to remove and replace assemblies, see chapter 6, “Replacing Assemblies.”

## ESD Precautions

When using any of the procedures in this chapter, you must use proper ESD precautions to protect the oscilloscope components from ESD damage. Failure to follow proper ESD control procedures may cause immediate failure or latent damage. Latent damage may result in equipment failure after a period of time. As a minimum, you should place the oscilloscope on a properly grounded ESD mat and wear a properly grounded ESD wrist strap when working on the oscilloscope.

## Default Setup

A Default Setup is provided to return the oscilloscope to a known state. The default setup can be used to undo previous setups so that they do not interfere with the current measurement. Use the default setup when a procedure requires it.

- Press the Default Setup key on the front panel to set the oscilloscope to the default state.

---

## To troubleshoot the oscilloscope

The troubleshooting procedure is used to isolate problems to a faulty assembly. When you find the faulty assembly, use the disassembly and assembly procedures in "Replacing Assemblies," beginning on page 87 to replace the assembly.

The primary procedural tool in this section is the Primary Trouble Isolation section. This section refers to sections in this chapter where the procedures are described in detail.

If you are unfamiliar with this oscilloscope, start with the Primary Trouble Isolation section.

---

## Primary Trouble Isolation

### A Perform power-up.

Connect the oscilloscope power cord and press the power button in the lower left corner of the front panel. If the oscilloscope is working properly, it will start up and the graticule will appear on the screen. The exact appearance may vary depending on the setup selected before the oscilloscope was turned off.

**Figure 4-1**



### Power-on Display

**B** If the oscilloscope shuts down without you pressing the front panel power button, unplug the AC power cord from the rear of the instrument and wait 30 seconds for the +5V standby supply to completely discharge. Then plug the AC power cord back into the oscilloscope, press the front panel power button, and count how many seconds it takes for the oscilloscope to shut off again.

- 1 If it takes approximately two seconds for the scope to lose power, go to the “Under-voltage Fault” section in this chapter.
- 2 If it takes four seconds or more for the scope to lose power, go to the “Over-temperature Fault” section in this chapter.
- 3 If the scope never powers up or shuts off almost immediately, go to the “Over-voltage Fault” section in this chapter.
- 4 If all the steps within these sections have been followed and the oscilloscope still does not turn on, go to the “Motherboard Verification” section in this chapter.
- 5 When the scope is fixed and remains powered up, proceed to step C.

**C** Once the oscilloscope will remain powered up, run the oscilloscope self-tests.

- 1 Select Self Test from the Utilities menu (these are discussed in detail starting on page 78).
- 2 Select Scope Self Tests from the Self Test drop down list box.
- 3 Click the Start Test button and follow the instructions on the screen.

If any of the selftests fail, go to the Acquisition Trouble Isolation troubleshooting

flowchart later in this chapter for further troubleshooting. Otherwise, go to step D.  
**D** Check the front panel response by running the Keyboard and LED self tests. Use this procedure to verify correct keyboard operation.

- 1 Select Self Test from the Utilities menu.
  - 2 Select Keyboard Test from the Self Test drop down list box, then click Start.
- A new window appears with a symbolic representation of the keyboard. See Figure 4-2.

Figure 4-2

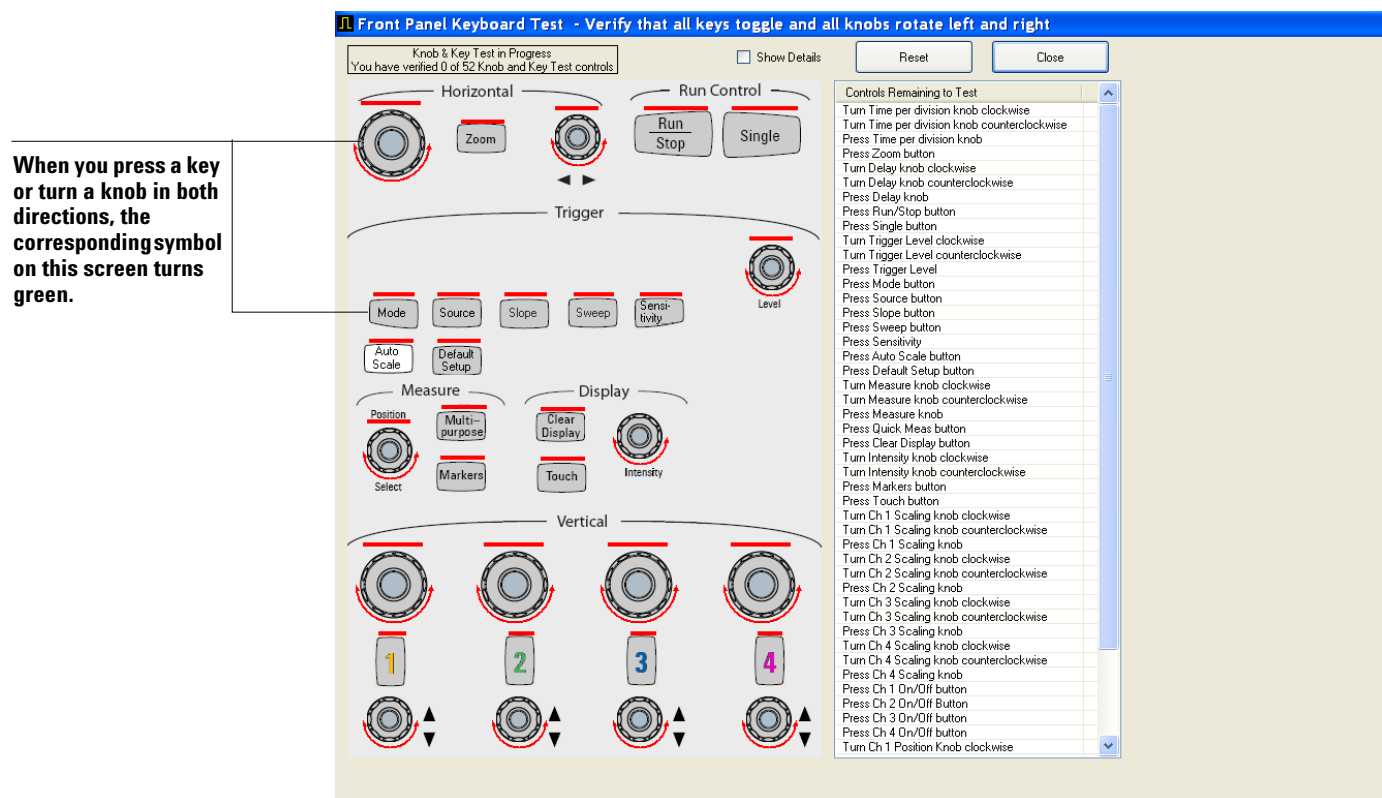

**Knob and Key Self Test Screen**

- 3 Press each key on the keyboard until you have pressed all keys.  
When you press a key or turn a knob, the bar above the corresponding key/knob symbol on the display should change from red to green.
- 4 Turn each knob in both directions until you have turned all knobs.  
When you turn a knob in one direction, half the rotation arrow under the corresponding knob symbol should turn green. When you then turn the knob in the other direction, the entire rotation arrow under the knob symbol should turn green.
- 5 When you are finished, click Close.
- 6 If any of the knobs or keys do not work, go to To check the keyboard; Trouble Isolation Procedure 82.

Use the following procedure to test the front-panel LED (light-emitting diode) indicators.

- 1 Select Self Test from the Utilities menu.
- 2 Select LED Test from the Self Test drop-down list box, then click Start Test.

The LED test screen appears, which shows a symbolic representation of all front panel LED indicators. See Figure 4-3.

**Figure 4-3**

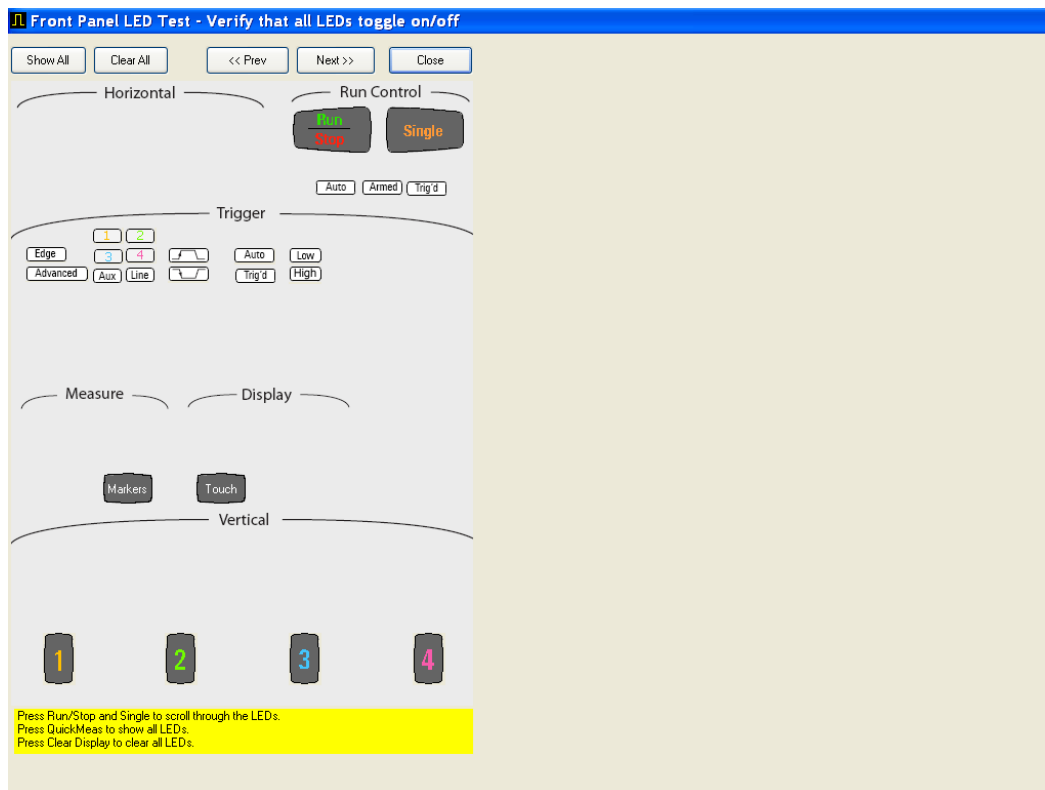

**LED Test Screen**

- 3 Repeatedly press the **Single** button on the front panel to step through and highlight each LED symbol in the test screen. You can also step through the LEDs by pressing the **<<Prev** or **Next>>** buttons on the display screen. Verify that the corresponding LEDs on the front panel are the only ones illuminated. Additionally, pressing the Multipurpose button on the front panel will illuminate all the LEDs while pressing the Clear Display button on the front panel will turn off all the LEDs.
- 4 When you are finished, click Close.
- 5 If any of the LEDs do not work, go to “To check the LEDs” later in this chapter.
- 6 If both tests pass, go to step E.

**E Self Calibration**

- 1 Complete a self calibration by following the procedures in chapter 4.
- 2 If the calibration test fails, look at the details to see the channel associated with the fail. If it is not channel 1 then replace the acquisition board associated with that channel (channels 1 and 2 - lower acquisition board, channels 3 and 4 - upper acquisition board). If it is an error associated with channel 1 then look at the specific cal that failed. If it was a trigger cal, a timebase cal, or an interpolator gain cal then the problem is most likely with the backplane board so replace it. If this does not work then replace the lower acquisition board. If it is a failure associated with channel 1, but is not one of these three types of cals then replace the lower acquisition and if that does not work then try to replace the backplane board. If all four channels have cal failures then it may possibly be a problem with the calibrator located on the backplane board so try replacing that board first. If the calibration test passes, go to step F.

- F** The system is operational. Performance test the oscilloscope using the procedures in chapter 3 of this service manual.

---

## Power Supply Trouble Isolation

---

**WARNING**

**SHOCK HAZARD!**

The maintenance described in this section is performed with power supplied to the oscilloscope and with the protective covers removed. Only trained service personnel who are aware of the hazards involved should perform the maintenance. Read the safety summary at the back of this book before proceeding. Failure to observe safety precautions may result in electric shock

---

---

**WARNING**

**SHOCK HAZARD!**

Once the bulk 12V power supply is removed from the oscilloscope, two AC leads located on the supply are exposed and severe shock can result if touched. Extreme care should be taken to not contact these leads when removing or testing the bulk 12V power supply.

---

For information on how to replace assemblies, see "Replacing Assemblies," beginning on page 87.

Figure 4-4

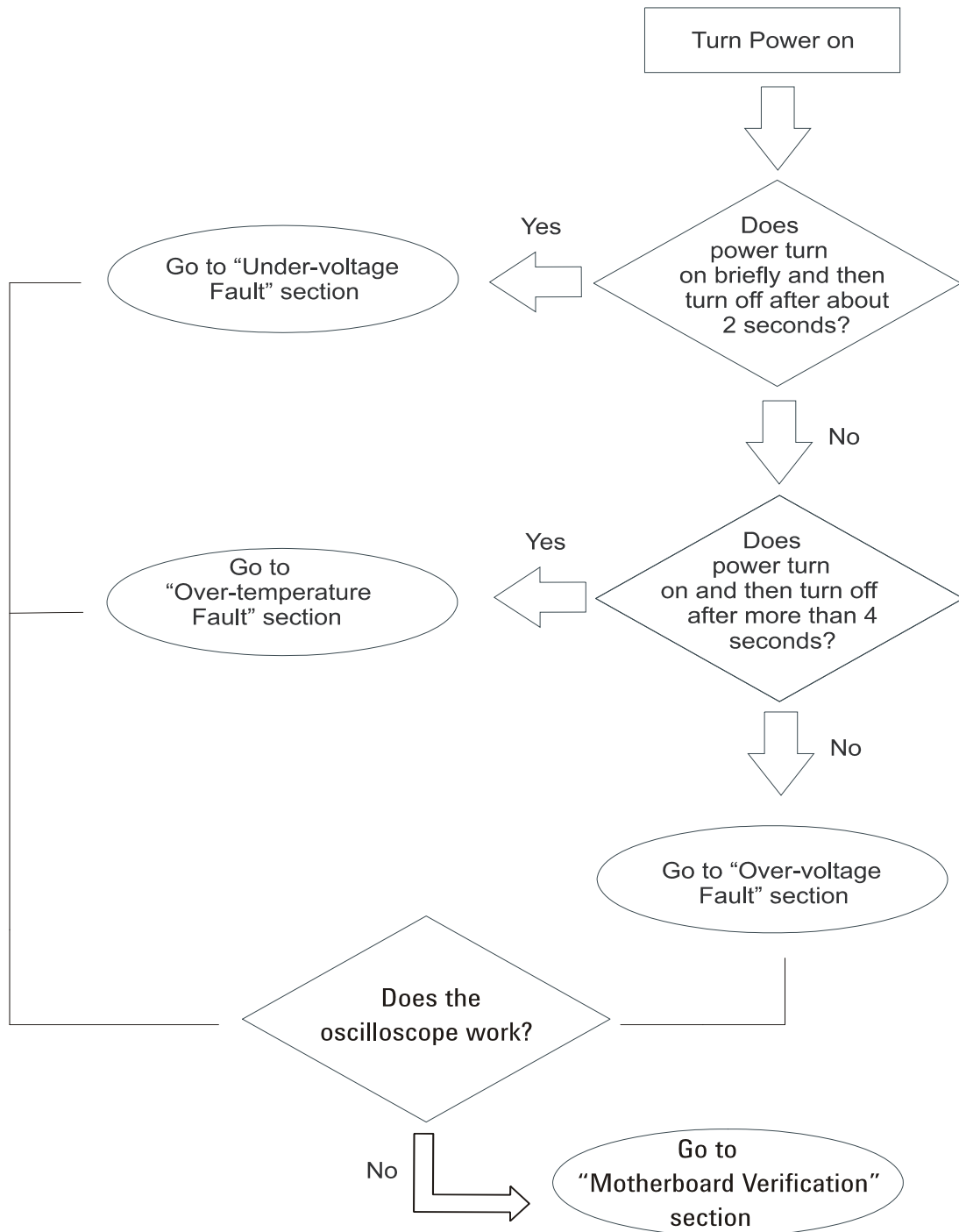



These trouble isolation instructions help isolate the problem to the assembly level when the power system is not operating. Because of advanced power system protection features, the problem may not be with the supply itself, and therefore you will need to work through the procedure systematically to determine the source of the fault. There are three main types of faults: under-voltage faults (a defective power supply is included in this section), over-temperature faults, and over-voltage faults. The following sections will describe each of these faults in detail so you can deduce the reason for your power failure and fix the problem.

The flowchart above also walks you through the diagnostic steps and points you to the correct sections for further details.

If the oscilloscope still will not power on after you have followed the required steps in this Power Supply Trouble Isolation section, refer to the Motherboard Verification section in this chapter for additional diagnosis suggestions.

---

## Under-Voltage Fault

If the oscilloscope turns off without you pressing the front panel power button then the first step is to unplug the oscilloscope so the +5V standby supply can fully discharge (this takes around 30 seconds). Then plug the oscilloscope back in. Press the front panel power button and count how many seconds it takes for the oscilloscope to lose power again (once the oscilloscope loses power, keep it plugged in). If it takes around two seconds then you either have an under-voltage fault on the backplane assembly or one of the two acquisition assemblies or you have a defective bulk 12V power supply. This section walks you through how to determine which of these is the actual problem and how to fix it.

Once you know that it takes about two seconds for the oscilloscope to lose power, the next step is to remove the handle, the outer oscilloscope cover, and the inner top cover. This will expose the motherboard cavity and the top edges of the backplane assembly. There are a series of six under-voltage indicator LEDs located in the upper right corner of the backplane assembly (see Figure 4-5 below). The other LEDs in this section of the backplane assembly indicate over-temperature or fan problems and will be discussed in the Over-temperature Fault section.

**Figure 4-5**

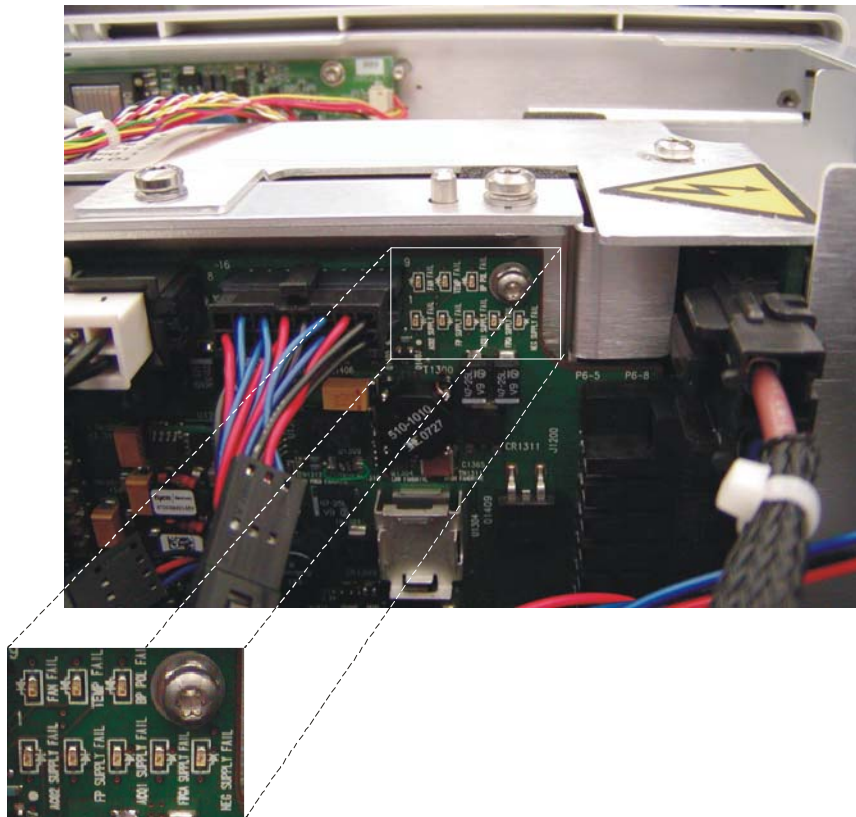

**The white box and subsequent enlargement highlight the section on the backplane assembly where the under-voltage fault LEDs are located.**

Each of these six under-voltage fault LEDs are labeled. If only the ACQ1 SUPPLY FAIL LED is illuminated, replace the channels 3 and 4 acquisition assembly (UPPER ACQ).

If only the ACQ2 SUPPLY FAIL LED is illuminated, replace the channels 1 and 2 acquisition assembly (LOWER ACQ). If any of the following three indicator LEDs are illuminated (BP POL FAIL, NEG SUPPLY FAIL, or FPGA SUPPLY FAIL), replace the backplane assembly.

If the FP SUPPLY FAIL LED is on by itself, there may be a problem with one of the supplies that goes to the front panel assembly or there may be a problem on the front panel assembly itself. Unplug the front panel power-connector (see cable circled in Figure 4-6) and turn the unit on again. See if any of the other under-voltage indicator LEDs on the backplane assembly turn on. If not, the fault is on the front panel assembly and it should be replaced. If either the BP POL FAIL or NEG SUPPLOES FAIL indicator LEDs turn on then replace the backplane assembly and confirm the fault goes away with the front panel power reconnected to the backplane assembly.

**Figure 4-6**



If the unit turns off after two seconds and no under-voltage fault indicator LEDs are illuminated, the bulk 12V supply may be defective and, therefore, might need to be replaced. First verify that the +5V standby potential from the bulk supply is good by confirming the green LED on the motherboard is illuminated. If this LED is not illuminated when AC power is applied to the instrument, the bulk 12V supply might need to be replaced. Be sure to verify the operation of the AC OK and DC OK signals first. The AC OK signal indicates that the applied AC signal is within the specified input range (TTL high logic level indicates AC input is good). It is possible for this signal to indicate the AC input is not within the requested range even though it is correct. The DC OK signal indicates whether the main output from the supply (+12.6V) is good (TTL high logic level indicates the DC output is good). It is possible for this output to be false even though the supply output is correct. Both of these outputs are open collectors and would require a pull-up resistor to some external potential to confirm the output logic level is high or a simple resistance measurement to ground would tell you whether the open collector output transistors are turned off indicating both outputs would be in the logic high state.

It is also possible that there is a short circuit on the bulk 12V supply net somewhere in the system which would also result in the unit now powering on. If this happens, you need to isolate the assembly that is shorted. You can hopefully perform the following diagnostic tasks without having to remove the acquisition or backplane assemblies.

## Chapter 4: Troubleshooting Under-Voltage Fault

First, disconnect the bulk 12V supply (see Figure 4-7), but do not remove the supply from the oscilloscope. On the backplane assembly, measure the resistance across the FET (Q1409) between +12V and ground as shown in Figure 4-10 (Q1409 is located in the upper right hand corner of the backplane) or measure the resistance across the bulk supply input pins on the backplane assembly. Make sure you have the red lead plugged into the HI input and the black lead plugged into the LO or COMMON input of the DVM. On a good backplane assembly, you should measure about 700 ohms. If there is a short on this board, you would measure something very near zero ohms. If there is a short, disconnect the power cable to the front panel (see Figure 4-6) and redo the resistance measurement. If the short is gone, replace the front panel assembly and verify the instrument will now power on. If there is still a short circuit, disconnect the two large connectors that provide power to the motherboard (J1201 and J1202) from the backplane assembly (see the circled cable connections in Figure 4-8) and redo the resistance measurements across the FET (Q1409) or the bulk supply input pins on the backplane assembly. If the short is gone, replace the motherboard assembly and confirm the unit will power on.

Figure 4-7

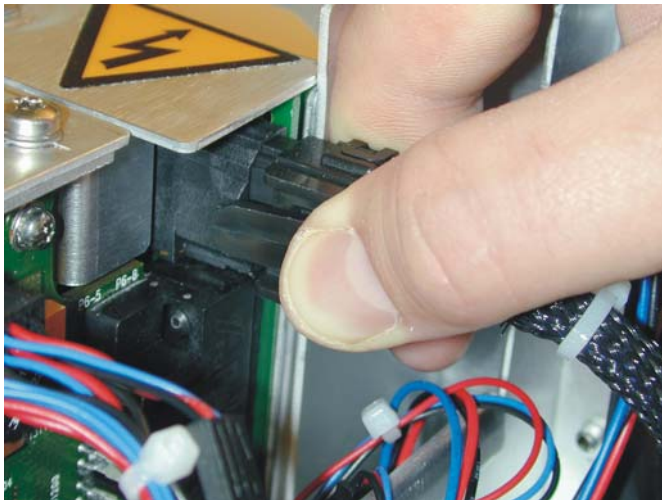
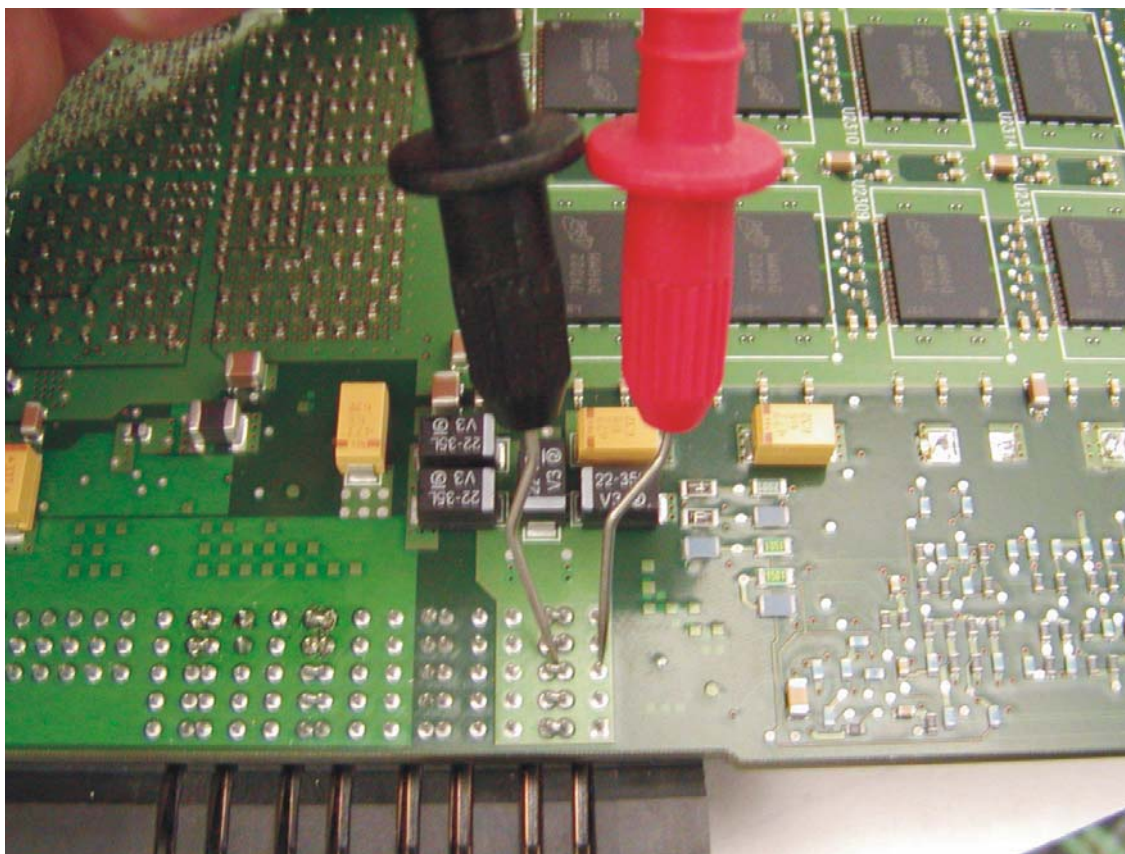

Figure 4-8



If there is still a short circuit, then both acquisition boards need to be removed. Once the acquisition assemblies have been removed and unplugged from the backplane assembly, measure each assembly individually to see if there is a short between the +12V net and ground (see the figure below). The resistance you should see on a good acquisition assembly between the +12V net and ground is about 2000 ohms. Make sure you make the measurement using a DVM with the red lead plugged into the HI input and the black lead plugged into the LO or COMMON inputted the DVM. If there is a short between these two nets, the reading you will get will be very low (near zero ohms). Measure both acquisition assemblies and replace as required.

**Figure 4-9**



**This figure shows how to measure the acquisition assembly resistance between +12V and ground on the back side of the board on the right end of the power connector.**

If no shorts are found on the bulk 12V supply net or if you have fixed all the shorts and the unit still will not turn on then a series of steps need to be followed which includes replacing parts with “known good” ones until the problem has been discovered.

Start by replacing the bulk 12V power supply with a known good supply. If the oscilloscope still does not power on, replace the motherboard with a known good one. If the oscilloscope still does not power on, replace the front panel ON/OFF switch with a known good one. If the oscilloscope still does not power on then it can only be the backplane assembly causing the problem and it needs to be replaced. Once the faulty board or switch is discovered, all previous parts removed from the instrument should be reinstalled as they were not the cause of the problem.

## Chapter 4: Troubleshooting Under-Voltage Fault

Figure 4-10

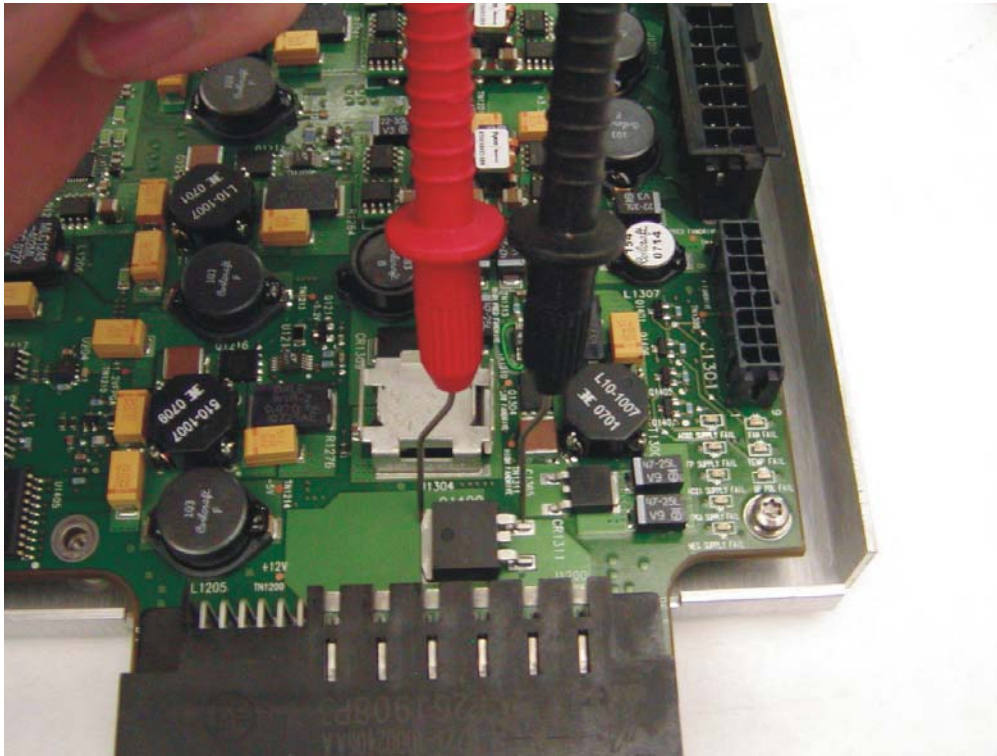

This figure shows how to measure the backplane assembly resistance between +12V and ground across Q1409.

If the oscilloscope still will not power on after you have followed the required steps in this Power Supply Trouble Isolation section (and assuming you have looked through the other two sections included in this Power Supply Trouble Isolation section to ensure your problem cannot be fixed there), refer to the Motherboard Verification section in this chapter for additional diagnosis suggestions.

---

## Over-Temperature Fault

If the oscilloscope turns off without you pressing the front panel power button, the first step is to unplug the oscilloscope so the +5V standby supply can fully discharge (this takes around 30 seconds). Then plug the oscilloscope back in. Press the front panel power button and count how many seconds it takes for the oscilloscope to lose power again (once the oscilloscope loses power, keep it plugged in). If it takes four seconds or more then you likely have an over-temperature fault or a fan fault.

Once you have determined that it takes four seconds or more for the oscilloscope to lose power, the next step is to remove the handle, the outer oscilloscope cover, and the inner top cover. This will expose the mother board cavity and the top edges of the backplane assembly.

There are four fans on the left side of the instrument that are used to cool the instrument. There is also a single fan attached to the backplane assembly that cools the trigger ICs. In order for the instrument to shut down because of a cooling system fault, one of the following condition must exist:

- The circuitry that generates the reference potential for all the fans (the four case fans and the trigger ICs fan) would have to fail. This would result in none of the fans turning and the instrument would shut down.
- The fan that cools the trigger ICs failed or the high side drive circuitry for the trigger ICs fan failed. It could also be that the rotation sensor for the trigger ICs fan failed. This sensor lets the instrument know that the fan is indeed turning. If the sensor is faulty, the instrument may think the fan is not working when in fact it is.
- All four case fans do not turn. It is highly unlikely that all four fans would become faulty simultaneously. The more likely reason for all four fans not turning is that the high side drive circuitry for these case fans failed.

To diagnose a fan failure, first reset the sensing and shutdown logic by removing AC power until the green LED on the motherboard goes out (or just wait 30 seconds). Move around to the left side of the instrument so you can see the case fans (Figure 4-11).

Figure 4-11



## Chapter 4: Troubleshooting Over-Temperature Fault

Once you can see the case fans, apply AC power to the instrument and turn it on if it does not start up automatically. Visually check to see if any of the fans are not turning. If all the fans are not turning, it is probably a problem with the high side drive circuitry for the case fans.

Figure 4-12

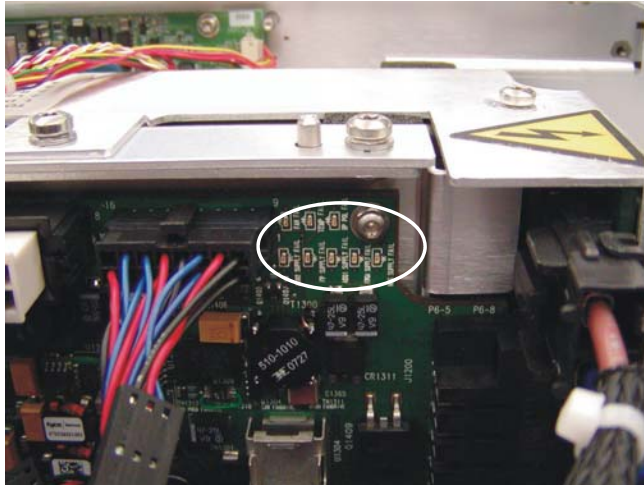

If any of these fans are turning then these fans are probably not the cause of your shutdown problem (you should still replace any fans that are not turning, however). If this is the case, the next step is to see if the FAN FAIL indicator LED is on in the upper right hand corner of the backplane assembly (refer to the circled area in Figure 4-12 above). If this LED is illuminated then that means the system thinks there is a fan failure. Since you have ruled out the case fans as the root of the problem, it may be that the trigger ICs fan has failed. To check this, first reset the logic by removing AC power for thirty seconds again. Then position yourself so you can see the trigger ICs fan on the back plane and, therefore, is somewhat hidden by the acquisition assemblies. You have to look down the backplane board to see it from above (see Figure 4-13 below).

Figure 4-13

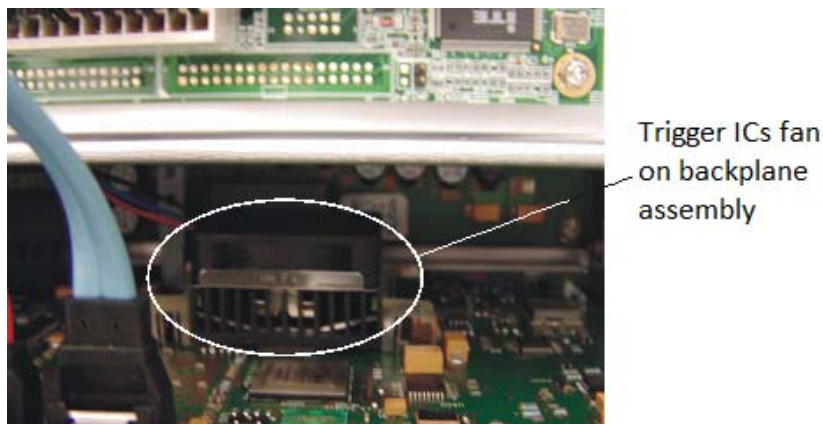

Trigger ICs fan  
on backplane  
assembly

This picture shows the location of the trigger ICs fan from the perspective of looking down the plane of the backplane assembly from above.



Apply AC power and turn the instrument on if it does not start up on its own. Observe whether the trigger ICs fan is turning. If it is not, replace it and redo this part of the diagnostic test. If it is turning and the instrument turns off after four seconds or more then consider the following. If any of the case fans were turning and the trigger ICs fan was turning, the problem is most likely that the rotation sensor on the ICs fan is defective. Replace the trigger ICs fan and redo this part of the diagnostic test. If the instrument stays on after you reset the shutdown logic (by removing AC power for thirty seconds) and powered it back on, then you have fixed the shutdown issue. If the unit shuts down again after you have replaced the trigger ICs fan then the problem could be either that the rotation sensor for all the fans located on the backplane assembly failed or the rotation sensor for the case fans have all failed. This last reason is not very likely, so the first recommendation is to replace the backplane assembly and then redo this part of the diagnostic test.

If, after replacing the trigger ICs fan and the backplane assembly, the unit does not shut down then you have fixed the problem. Simply replace any case fans that were not working and the problem is fixed.

---

**WARNING**

**INJURY CAN RESULT!**

The following procedure has you touch fan hubs with objects or requires the use of objects to stop fan blades from moving. Use caution when working around the cooling fans with the cover removed from the oscilloscope. The cooling fan blades are exposed on one side and can be hazardous. Be careful not to touch the moving blades with any part of your body.

If the unit still shuts down, however, then replace all the case fans and confirm proper operation. To verify proper operation, stop the trigger ICs fan from rotating (simply reach down and touch the hub the fan blades are attached to with some object - be careful not to touch the fan blades with your fingers). The unit will shut down. Reset the logic (by removing AC power for thirty seconds) and make the case fans so they all cannot rotate (for example: either by two people holding the four fan hubs or by inserting an object in between the blades of each of the four fans). Power the unit back on. The oscilloscope should shut down in about four seconds. This confirms proper operation of the fan sensing and shutdown function.

If the unit shuts down and the TEMP FAIL indicator LED is on (refer to the circled area in Figure 4-12 for the location of this LED on the backplane assembly) then one of the scope channels is getting too hot or the temperature sensing circuitry has failed. Normally, you would have to turn the instrument on and leave it on for a while before you would see a shutdown because of temperature. If all the fans are turning, it is highly unlikely that the unit would shut down due to temperature unless the airflow is being restricted or the input air is already too hot to cool the insides of the oscilloscope. If one or more of the case fans has failed, the unit would overheat and shut down, but the oscilloscope would alert the user that one or more case fans has failed and the unit needs to be repaired.

It is a possibility that all the case fans and the trigger ICs fan are working, but the unit still shuts down because of temperature due to one or more of the channels malfunctioning and drawing too much current. In this case, you would need to replace the acquisition assemblies one at a time until you find which assembly is defective. It is also possible for one of the heat sinks on one of the acquisition assemblies' critical parts to become detached and cause that part to over heat and shut down the instrument.

If the oscilloscope still will not power on after you have followed the required steps in this Power Supply Trouble Isolation section (and assuming you have looked through the other two sections included in this Power Supply Trouble Isolation section to ensure your problem cannot be fixed there), refer to the Motherboard Verification section in this chapter for additional diagnosis suggestions.

---

## Over-Voltage Fault

If the oscilloscope turns off without you pressing the front panel power button, the first step is to unplug the oscilloscope so the +5V standby supply can fully discharge (this takes around 30 seconds). Then plug the oscilloscope back in. Press the front panel power button and count how many seconds it takes for the oscilloscope to lose power again (once the oscilloscope loses power, keep it plugged in). If the oscilloscope shuts down almost immediately, it is probably an over-voltage fault.

Once you have determined that the oscilloscope loses power almost immediately, the next step is to remove the handle, the outer oscilloscope cover, and the inner top cover. This will expose the mother board cavity and the top edges of the backplane assembly.

There are three groups of LEDs that indicate over-voltage faults. One group is located near the center of the top edge of the backplane assembly just above the blue and red SATA cables (Figure 4-14).

**Figure 4-14**

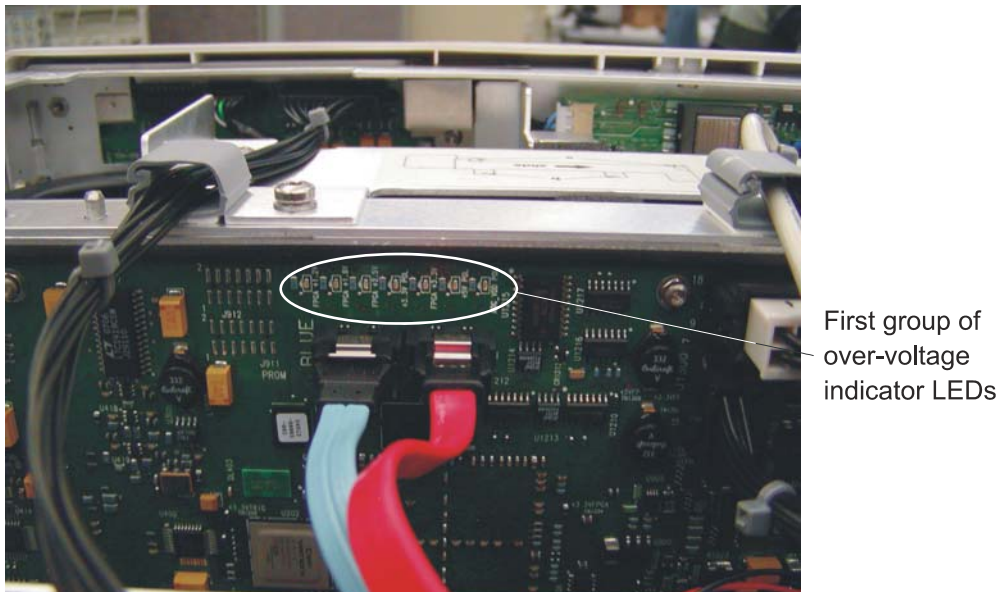

If any of these LEDs are on, the backplane assembly must be replaced.

The other two groups of LEDs that indicate over-voltage faults are located along the edges of the two acquisition assemblies and are visible through the bottom fan opening located on the left side of the oscilloscope (nearest the rear panel - see Figure 4-15 and Figure 4-16).

Figure 4-15



The second and third groups of over-voltage LEDs are located behind this fan

**Fan opening to look through to see the second and third groups of over-voltage indicator LEDs.**

The following picture (Figure 4-16) shows the fan opening with the fan removed. This is done to show where these LEDs are located on the acquisition assemblies and is not required in your actual diagnosis. You will be able to see the LEDs through the fan and it, therefore, does not need to be removed.

**Figure 4-16**

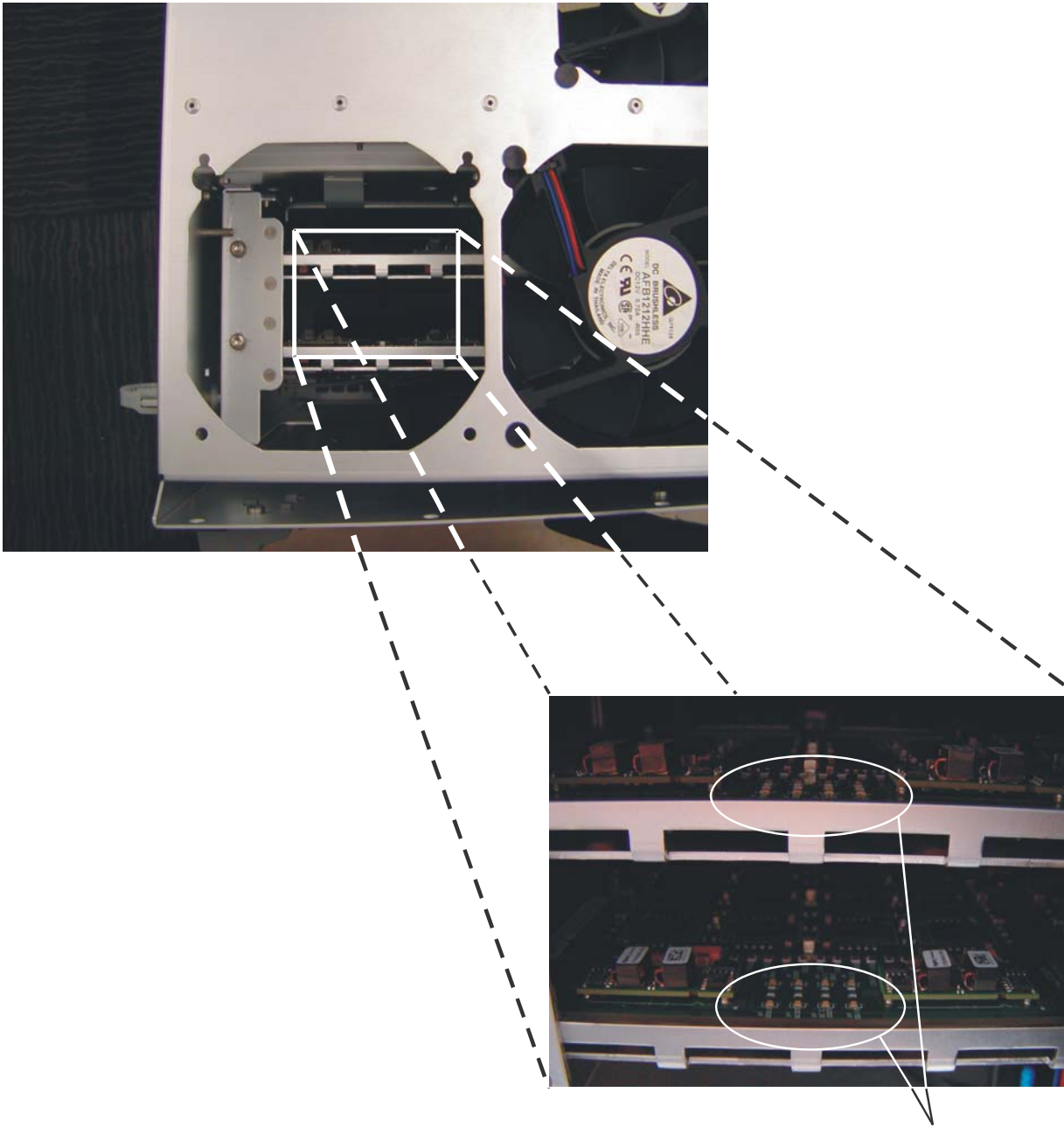

Over-voltage indicator LEDs

The acquisition assembly nearest the bottom of the instrument is the channels 1 and 2 acquisition assembly (LOWER ACQ) while the one above it is the channels 3 and 4 acquisition assembly (UPPER ACQ). If you look through the fan and see any of these over-voltage LEDs illuminated, that acquisition assembly needs to be replaced.

If the oscilloscope still will not power on after you have followed the required steps in this Power Supply Trouble Isolation section (and assuming you have looked through the other two sections included in this Power Supply Trouble Isolation section to ensure your problem cannot be fixed there), refer to the Motherboard Verification section in this chapter for additional diagnosis suggestions.

---

## Display Trouble Isolation

## Chapter 4: Troubleshooting Display Trouble Isolation

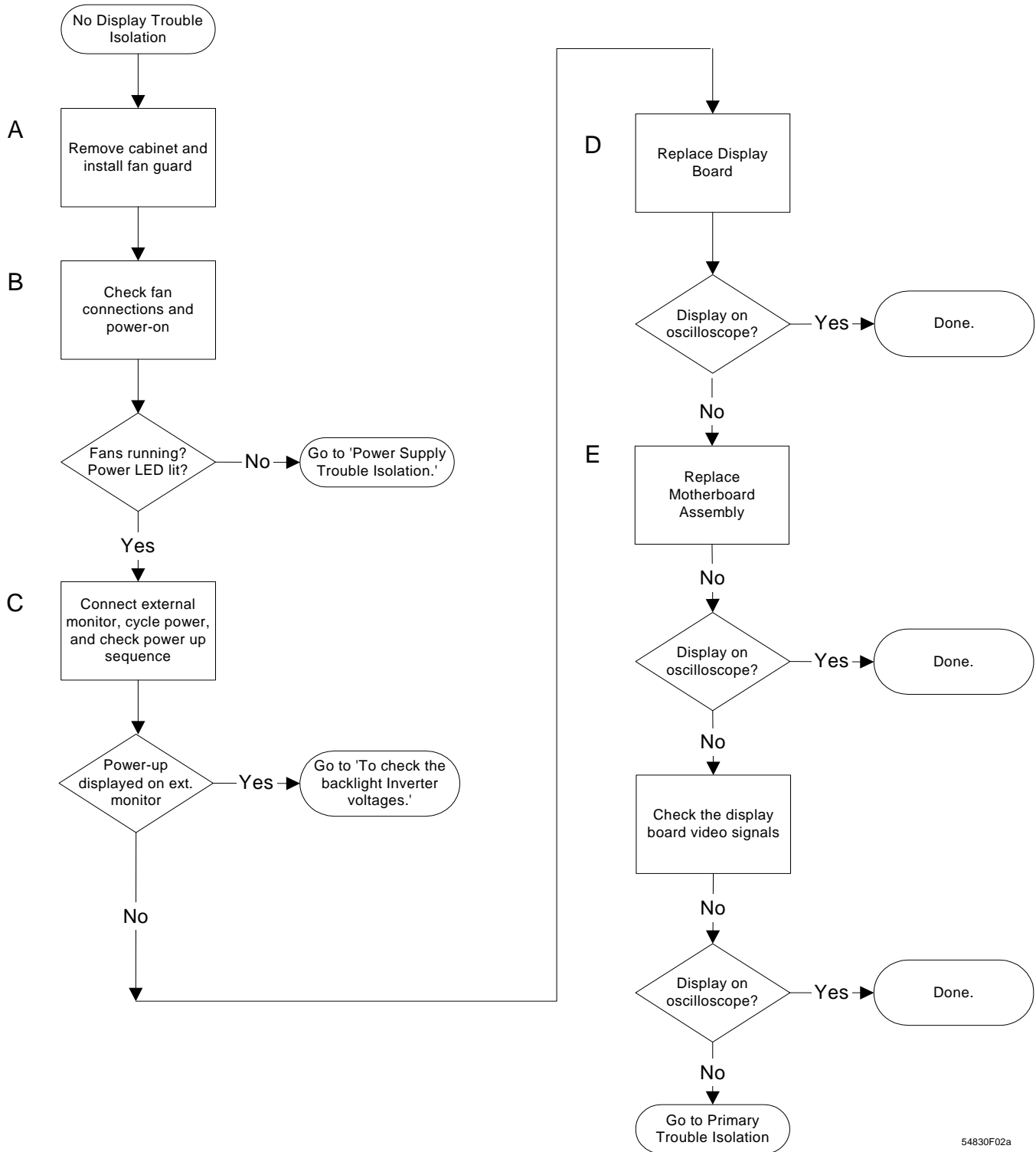

54830F02a

## To check the backlight inverter voltages

The backlight inverter board MP13 is located in the front-left corner of the oscilloscope (as you face the front panel).

- There is an input connector at one side of the board.
- There are two output connectors on the other end of the board, that power the two backlights which are inserted into the flat panel display.

The output voltage is approximately 300-450  $V_{\text{rms}}$ , 40 kHz (measured differentially between the two wires) when the backlight is illuminated. The voltage is approximately 1 kV before the backlight tube is illuminated. A red LED on the backlight inverter board illuminates when the output voltage is present.

When the backlight goes off (when the oscilloscope's operating system switches to screen saver mode) the voltage on pins 1 and 2 (with respect to ground) slowly decays to 0 V.

The outputs are controlled by the input. Notice that input pin 5 goes low to enable the output voltage. These pins can be reached at J1 on the display board MP12.

**Table 4-17**

**Backlight Inverter Board Input Voltages**

Input Pin #	7	6	5	4	3	2	1
Backlight OFF	0 V	0 V	0 V	0 V	0 V	0 V	0 V
Backlight ON	5 V	0 V	2.5 V	0 V	0 V	12 V	12 V

---

## To check the display board video signals

The video signals are checked on the 32-pin connector J2 on the display board MP12. You can use an oscilloscope with a bandwidth of at least 100 MHz to verify the signals. Even-numbered pins are closest to the PC board. If the signals are not present, suspect the display card. If the signals are present and the backlights are on, suspect the flat-panel display as the problem. Note that CLK, A0, A1, A2, and A3 are Low Voltage Differential Signals (LVDS).

**Table 4-18**

<b>Video Signals</b>			
<b>Pin Number</b>	<b>Signal</b>	<b>Pin Number</b>	<b>Signal</b>
1	NC	26	NC
2	CLK-	27	NC
3	CLK (LVDS pair) +	28	NC
4	GROUND	29	NC
5	A3-	30	NC
6	A3+ (LVDS pair)	31	NC
7	GROUND	32	NC
8	A2-		
9	A2+ (LVDS pair)		
10	GROUND		
11	A1-		
12	A1+ (LVDS pair)		
13	GROUND		
14	A0-		
15	A0+ (LVDS pair)		
16	NC		
17	NC		
18	NC		
19	NC		
20	NC		
21	GROUND		
22	GROUND		
23	+3.3 V		
24	+3.3 V		
25	+3.3 V		



## Front Panel Display Trouble Isolation

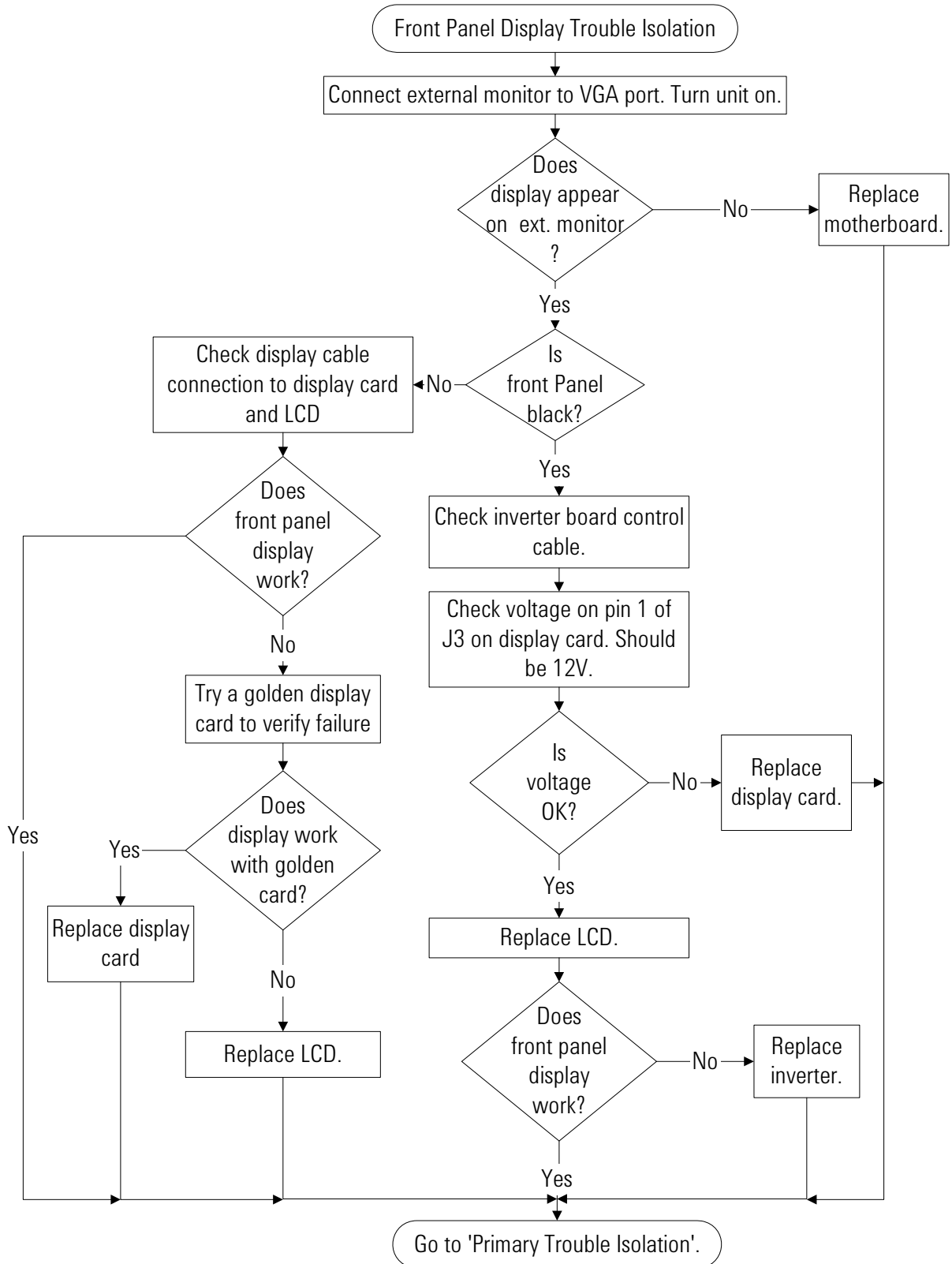

## Chapter 4: Troubleshooting

### Front Panel Display Trouble Isolation

---

**WARNING****SHOCK HAZARD!**

The backlight inverter assembly, which is mounted at the front corner of the oscilloscope near the flat-panel display, operates at 1.65 kV at turn on. DO NOT handle this assembly while it is in operation. An LED on the inverter board illuminates to indicate the presence of high voltage.

---

---

**WARNING****INJURY CAN RESULT!**

Once the cover is removed, the fan blades are exposed both inside and outside the chassis. Disconnect the power cable before working around the fans. Use extreme caution in working with the oscilloscope when the cover is removed. If the procedure allows, replace the cover over the chassis (without screwing it back in place) before turning the oscilloscope on. If the procedure requires you to have the cover off, be careful not to contact these fan blades with any part of your body.

---

For information on how to replace the display parts, see "Replacing Assemblies," beginning on page 87.

---

## Front Panel Trouble Isolation

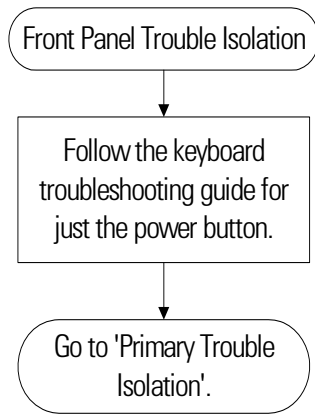

---

## Motherboard Verification

If you have been through the Power Supply Trouble Isolation section of this chapter and the oscilloscope still does not stay powered up, the problem may be with the motherboard. To diagnose this problem, follow these steps.

First remove the handle, outer case, and top shield. Then turn the oscilloscope on. If the unit beeps once after about five to ten seconds but fails to boot up, the motherboard is defective and needs to be replaced. If the unit fails to beep after it is powered on then measure the potential relative to the chassis at pin 9 of J1201 (Figure 4-19). You should measure about 3.3V. If the potential you measure is correct, but the unit still has not beeped and started to boot up, the motherboard is defective and needs to be replaced.

**Figure 4-19**

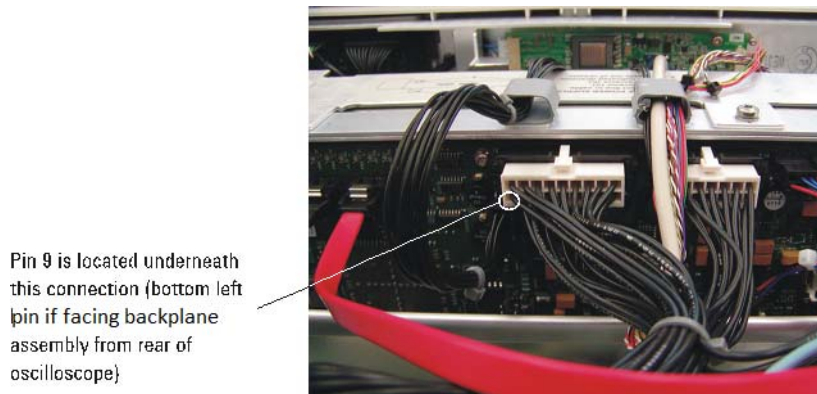

If the potential you measure is not correct, shut the oscilloscope down and unplug the AC cord from the rear of the instrument. Then unplug the front panel power cable (see Figure 4-6), the two large power cables that go to the motherboard (power harness: J1201 and J1202 - see Figure 4-8), and the red and blue SATA cables (J900 and J901) from the backplane assembly. Do not allow the two SATA cables to touch the backplane assembly and cause a short circuit.

Plug the AC power back into the oscilloscope and turn the unit on if it does not come on automatically. Measure the potential relative to the chassis at pin 9 of J1201 again. If you measure the required 3.3V, the motherboard is defective and needs to be replaced. If you did not measure the correct voltage, the backplane assembly is defective and must be replaced. Please be aware that there could be a fault on the motherboard that caused the backplane assembly to fail so before you plug the motherboard cables back into the new backplane assembly, measure the resistance to the chassis from the pin 9 contact in the connector that plugs into J1201. If you measure a very low resistance or a short circuit to the chassis, replace the motherboard and then assemble the instrument and confirm the unit beeps and boots up properly.

## To setup the BIOS

If the BIOS settings become corrupt, the Infiniium oscilloscope PC motherboard will not recognize the hard drive and the oscilloscope may not start. To configure the motherboard BIOS parameters to the default settings, follow these steps:

- 1 Connect the power cable to the Infiniium oscilloscope.
- 2 Connect the external keyboard to the rear panel.
- 3 Press **Delete** when the following prompt appears on the bottom of the screen:

`Press TAB to Show POST screen, DEL to enter SETUP, F12 to select boot device.`

If the prompt does not appear, or the oscilloscope does not appear to be functioning, check the ribbon cable connectors. Otherwise, continue with the next step.

- 4 Go to **Load 15" LCD Defaults** and press **Enter** for optimized values, or go to **Load 8.4" LCD Defaults** and press **Enter** for fail-safe values. Select **Y** to load the defaults, then press **Enter**.
- 5 Go to the **Save and Exit Setup** option and press **Enter** to save and exit the setup. Select **Y** to save and exit, then press **Enter**.

## Acquisition/Backplane Assembly Trouble Isolation - Scope Self Tests

If the Acquisition assemblies or Backplane assembly have been removed by a prior procedure, reinstall them.

Power up the oscilloscope and then go under Utilities > Self Test. Select the Scope Self Test option from the Self Test pull-down menu and then press the Start Test button. If one of these tests fails, look at the error message to see if it displays a channel specific error message (this will be the case in most instances). If it is channel specific and it is not the Timebase Test Group that failed then replace the acquisition board that corresponds to that channel (channels 1 and 2 - lower acquisition board, channels 3 and 4 - upper acquisition board). If it is the Timebase Test Group that failed then replace the backplane assembly.

If the error message does not mention a channel, then refer to the discussions below for the test that failed to see the diagnostic steps. Sometimes there is no action and the technician simply needs to contact the software/hardware teams in order to debug the problem.

Each test also has a section called “Board Level Repair” where the troubleshooting is more detailed than the typical assembly level repair.

### Scope Self Tests

#### *Vertical Test Group*

- **Front End DAC Linearity Test** - This test verifies the linearity of each channel’s front end DAC. If the test finds a problem, it will report a failure for the DAC on the associated channel.
  - **Board Level Repair** - Re-solder or replace the DAC that is failing. If this does not fix the problem, further hardware level debugging is necessary.
- **Front End DAC MaxMin Test** - This test measures the minimum and maximum output voltage values of each channel’s front end DAC. If the test measures any values that are out of the range of expected values, it will report a failure for the DAC on the associated channel.
  - **Board Level Repair** - Re-solder or replace the DAC that is failing. If this does not fix the problem, further hardware debugging is necessary.
- **Otter Register** - This test verifies that all of the Otter preamp registers can be correctly written to and read from. If this test reads any registers whose values are not equal to what they were written to, it will report a failure for the preamp on the associated channel.
  - **Board Level Repair** - Re-solder or replace the Otter preamp that is failing. If this does not fix the problem, further hardware level debugging is necessary.
- **Overload** - This test simulates an overload condition on each channel and verifies that when such a condition exists it immediately generates an interrupt to the host processor. If such a condition is not detected properly, the test will report a failure for the associated channel.
  - There are numerous possible causes for this error. Report the error to the Infiniium software team.

### *Trigger Test Group*

- Trigger Lvl DAC Test - This test has not been implemented yet and currently does nothing.

### *Timebase Test Group*

- Timebase Interpolator Test - This test validates the timebase interpolator hardware by verifying that it is able to produce unique values for different trigger settings. If this test fails, there *may* be a problem with the timebase interpolator IC located on the backplane board. However, this test has many other hardware dependencies so a failure from this test cannot necessarily be associated with any specific hardware failure. Try replacing the backplane board and see if the test will then pass.
  - Board Level Repair - Re-solder or replace the Calisto timebase interpolator IC. If this does not fix the failure, report the error to the Infiniium software team.

### *ADC Test Group*

- ADC Register Test - This test verifies that all of the ADC registers can be correctly written to and read from. If the test reads any registers whose values are not equal to what they were written to, it will report a failure for the ADC on the associated channel.
  - Board Level Repair - Re-solder or replace the ADC that is failing, If this does not fix the problem, further hardware level debugging is necessary.
- ADC Voltage Test Points Test - This test verifies that voltages measured from 32 test points within the Merlin ADC are within their expected range. If any test point is found to be outside of its expected range, a failure is reported for the ADC containing the associated test point.
  - Board Level Repair - The ADC with the associated errors must be replaced.

### *Acquisition Memory Test Group*

- Hedwig MBIST - This test checks the embedded memory in each Hedwig memory controller ASIC for errors. If the errors can be corrected using the redundancy present in the IC, the software will perform the necessary correction.
  - Board Level Repair - If the errors cannot be corrected, the Hedwig IC with the associate errors must be replaced.
- Hedwig Register Test - This test verifies that all of the Hedwig memory controller ASIC registers can be correctly written to and read from. If the test reads any registers whose values are not equal to what they were written to, it will report a failure for the Hedwig with the associated error.
  - Board Level Repair - The Hedwig IC with the associated errors must be re-soldered or replaced.
- Hedwig-DDR Addr & Data Test - This is a fast, condensed check of the DDR2 acquisition memory system. The test uses a complex algorithm to isolate failures with specific address or data lines connecting the Hedwig-DDR2 memory ICs. If there are problems with the control lines connecting the Hedwig-DDR2 ICs or problems with the ICs themselves, many address and data line failures may be reported incorrectly. If there are only a few address and data line failures reported, it can be assumed with fairly high confidence that the reported failures are accurate. If any errors are found, diagnostic information is reported containing the specific address or data lines that *may* be causing the failures as well as the channel number and the schematic part

## Chapter 4: Troubleshooting

### Acquisition/Backplane Assembly Trouble Isolation - Scope Self Tests

identification number associated with the specific ICs causing the failure.

- Board Level Repair - The failures could be associated with either the Hedwig memory controller IC, the DDR2 memory IC(s), or with the address, data, or control lines connecting them. If the test reports failures for most (or all) of the address and data lines associated with a particular Hedwig IC, the failure is most likely associated with one of the control lines connecting the Hedwig to its DDR2 memory ICs. The problem could be with the solder connections between the ICs and the traces connecting them, the individual board traces, or the IC(s) themselves. First, attempt to simply remove and re-solder the suspect ICs. If this does not fix the failures, the problem is most likely with the IC(s). Replace the ICs associated with the reported failures.

#### *Misc. Scope Test Group*

- Temp Sensor Test - This test verifies that all of the temperature sensors in the oscilloscope are reading values within the expected range. Temperature sensors exist for each of the Hedwig memory controller ICs, each of the ADC ICs, and each of the front end ICs. If any temperature sensor measure a temperature that is outside of the expected operating range, a failure will be reported for the IC associated with that temperature sensor.
  - Board Level Repair - This test should never fail since the oscilloscope will automatically shut itself off if it detects an overheating condition. If the test does fail, report the issue to the Infiniium software team.
- Acq Flash RAM Test - This test checks the flash RAM located on the backplane board and each acquisition board for errors. If any errors are found, a failure is reported for the particular flash RAM that was found to be bad.
  - Board Level Repair - Replace the flash RAM that is failing the test.



---

## AutoProbe Board Trouble Isolation

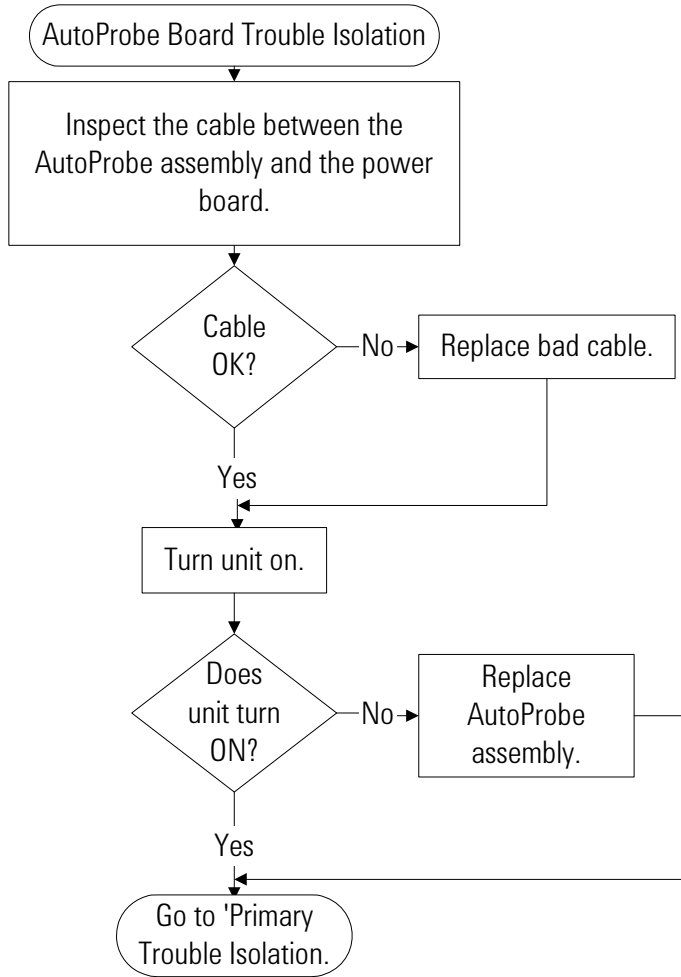

## To check the keyboard; Trouble Isolation Procedure

Use this procedure only if you encounter key failures in the keyboard self test procedure. If any knobs fail, replace the keyboard assembly.

- 1 Disconnect the power cord and remove the cover.
- 2 Remove the front panel assembly.  
See chapter 6 for instructions.
- 3 Remove the keyboard assembly from the front panel assembly. Partially re-assemble the front panel assembly, including the flat-panel display and lens, but omitting the keyboard. Re-attach the partial assembly to the chassis.  
Be sure to reconnect the display video cable and the backlight inverter cables. See chapter 6 for instructions on removing and disassembling the front panel.
- 4 Separate the elastomeric keypads from the keyboard assembly.

---

### CAUTION

**CONTAMINATION CAN CAUSE INTERMITTENT OPERATION!**

Be careful not to contaminate the key side of the PC board or the keypads. Dust and fingerprints on these parts may cause intermittent key operation.

- 5 Set the keyboard assembly on an antistatic electrical insulated surface.
- 6 Connect the keyboard cable to the scope interface board in the chassis.  
You may need to set the chassis on its side to allow proper routing of the cables without straining them.
- 7 Reconnect the power cable and apply power.
- 8 Enable the graphical interface, then start the keyboard test as described in the Primary Trouble Isolation section of this chapter.
- 9 Carefully short the PC board trace, with a paper clip or screwdriver, at each nonoperating key (as determined by keyboard test), and look for an appropriate response on the display.
  - If the display responds as though a key were pressed, replace the elastomeric keypad.
  - If the display does not respond as though a key were pressed, replace the keyboard.
- 10 Re-assemble the oscilloscope.

## To check the LEDs

If you see a failure with the on/off switch backlight LED, replace the ON/OFF board. If the LED will still not illuminate, replace the motherboard and see if this fixes the problem. If the LED still does not work, the last option is to check the on/off cable connecting the ON/OFF board to the motherboard.

If any of the other LEDs are not working on the front panel, the first step is to trouble shoot the acquisition assemblies to make sure they are working. If they are working then replace the keyboard assembly and see if the LEDs will illuminate. If the LEDs will not illuminate, the last step is to reload the oscilloscope software.

When reassembling the oscilloscope all boards that were replaced, but turned out not to be causing the problem should be reinstalled in the oscilloscope.

---

## Software Revisions

- Select About Infiniium... from the Help Menu.

A dialog box appears showing the current version number for the scope software and on-line information system software. This information may be useful when contacting Agilent Technologies for further service information. See Figure 4-20.

**Figure 4-20**

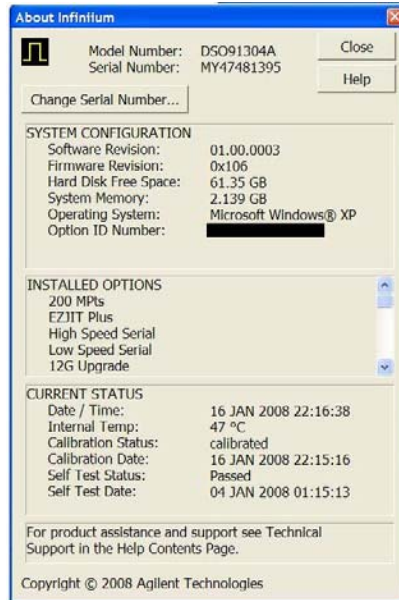

### **About Infiniium... Information**

---

## To check probe power outputs

Probe power outputs are on the front panel, surrounding each BNC input.

**Use the table and figure to the right to check the power output at the connectors.**

**The +12 V and –12 V supplies come from ripple regulator on the power board, and the +3 V and –3 V supplies are developed in three-terminal regulators on the probe power and control assembly.**

**Measure the voltages with respect to the ground terminal on the front panel, located near the Aux Out BNC.**

**Do not attempt to measure voltages at pins 3 through 7.**

Pin	Supply
1	+3V
2	–3V
3	Offset
4	Data
5 & ring	Probe ID
6	Clk
7	R <sub>p</sub>
8	–12 V
9	+12 V

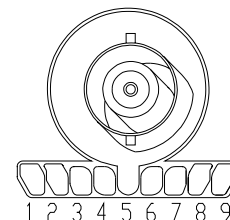

Any failure may be a problem with the probe power and control assembly, the AutoProbe flex cable, the probe power and control cable, or the power board.

**Chapter 4: Troubleshooting**  
**To check probe power outputs**

ESD Precautions	88
Tools Required	88
To return the oscilloscope to Agilent Technologies for service	89
To remove and replace the cover, top plate, and bottom plate	90
To remove and replace the on/off board	99
To remove and replace the backlight inverter board	101
To remove and replace the touch screen, front deck, and controller assembly	102
To remove and replace the acquisition boards/backplane assembly	106
To set the calibration factors after replacing the acquisition board	111
To remove and replace the hard disk drive and the hard drive control board	113
Cable removal (for replacing the motherboard)	115
To remove and replace the power supply	120
To remove and replace the fans	121

---

## Replacing Assemblies

---

# Replacing Assemblies

Use the procedures in this chapter when removing and replacing assemblies and parts in the Agilent Technologies oscilloscopes.

In general, the procedures that follow are placed in the order to be used to remove a particular assembly. The procedures listed first are for assemblies that must be removed first.

The graphics in this chapter are representative of the oscilloscope at the time of this printing. Your unit may look different.

## ESD Precautions

When using any of the procedures in this chapter you must use proper ESD precautions. As a minimum you must place the oscilloscope on a properly grounded ESD mat and wear a properly grounded ESD wrist strap.

---

### CAUTION

**AVOID DAMAGE TO THE OSCILLOSCOPE!**

Failure to implement proper antistatic measures may result in damage to the oscilloscope.

## Tools Required

The following tools are required for these procedures.

- Torx drivers: T10, T20
- Socket wrench: 9/16 inch
- Torque wrench: 3.5 mm (8 in-lbs)
- Medium size (3/16-in) flat-blade screwdriver

---

### CAUTION

**REMOVE POWER BEFORE REMOVING OR REPLACING ASSEMBLIES!**

Do not remove or replace any circuit board assemblies in this oscilloscope while power is applied. The assemblies contain components which may be damaged if the assembly is removed or replaced while power is connected to the oscilloscope.

---

### WARNING

**SHOCK HAZARD!**

To avoid electrical shock, adhere closely to the following procedures. Also, after disconnecting the power cable, wait at least three minutes for the capacitors on the power supply to discharge before servicing this oscilloscope. Hazardous voltages exist on the inverter for the display monitor.

---

### WARNING

**SHOCK HAZARD!**

Read the Safety information at the back of this guide before performing the following procedures. Failure to observe safety precautions may result in electrical shock.

---

### WARNING

**INJURY CAN RESULT!**

Use caution when the oscilloscope fan blades are exposed as they can cause injury.



---

**WARNING**

**SHOCK HAZARD!**

When the bulk 12V power supply is removed from the oscilloscope, two AC leads are exposed. Therefore, the power cable should be disconnected from the bulk 12V power supply before the supply is removed. Caution should also be exercised to not contact these leads as severe shock could result.

---

---

## To return the oscilloscope to Agilent Technologies for service

Before shipping the oscilloscope to Agilent Technologies, contact your nearest Agilent Technologies oscilloscope Support Center (or Agilent Technologies Service Center if outside the United States) for additional details.

- 1** Write the following information on a tag and attach it to the oscilloscope.
  - Name and address of owner
  - Oscilloscope model numbers
  - Oscilloscope serial numbers
  - Description of the service required or failure indications
- 2** Remove all accessories from the oscilloscope.

Accessories include all cables. Do not include accessories unless they are associated with the failure symptoms.
- 3** Protect the oscilloscope by wrapping it in plastic or heavy paper.
- 4** Pack the oscilloscope in foam or other shock absorbing material and place it in a strong shipping container.

You can use the original shipping materials or order materials from an Agilent Technologies Sales Office. If neither are available, place 8 to 10 cm (3 to 4 inches) of shock-absorbing material around the oscilloscope and place it in a box that does not allow movement during shipping.
- 5** Seal the shipping container securely.
- 6** Mark the shipping container as **FRAGILE**.

In any correspondence, refer to oscilloscope by model number and full serial number.

## Chapter 5: Replacing Assemblies

### To remove and replace the cover, top plate, and bottom plate

---

## To remove and replace the cover, top plate, and bottom plate

Use this procedure to remove and replace the cover, top plate, and bottom plate. When necessary, refer to other removal procedures. The pictures in this chapter are representative of the oscilloscope at the time of this printing. Your unit may look different.

- 1 Disconnect the power cable.
- 2 Disconnect all oscilloscope probes and BNC input cables from the front panel.
- 3 Disconnect any other cables, such as mouse, keyboard, printer, USB, or LAN cables.
- 4 Remove the accessory pouch from the top of the oscilloscope if it is attached.
- 5 Remove the two Torx T20 screws securing each side handle. Standard models have one handle; performance-enhanced models have two handles.

Figure 5-1



- 6 Remove the 6 Torx T20 screws that secure the rear feet (three in each foot).

Figure 5-2



- 7 Remove the three Torx T20 screws (located on the rear panel of the oscilloscope - see Figure 5-3) and then turn the instrument on its side and remove the ten Torx T10 screws (located on the underside of the oscilloscope - see Figure 5-4) that attach the cover to the chassis.

**Figure 5-3**



**Figure 5-4**



8 Carefully slide the cover towards the rear of the instrument and off the chassis as shown in Figure 5-5.

**Figure 5-5**



9 Once the cover is removed, you can remove the top plate by removing the

## Chapter 5: Replacing Assemblies

### To remove and replace the cover, top plate, and bottom plate

twelve Torx T10 screws from its edges as shown in Figure 5-6. Then pull back on the top plate and lift off as shown in Figure 5-7.

Figure 5-6



Figure 5-7

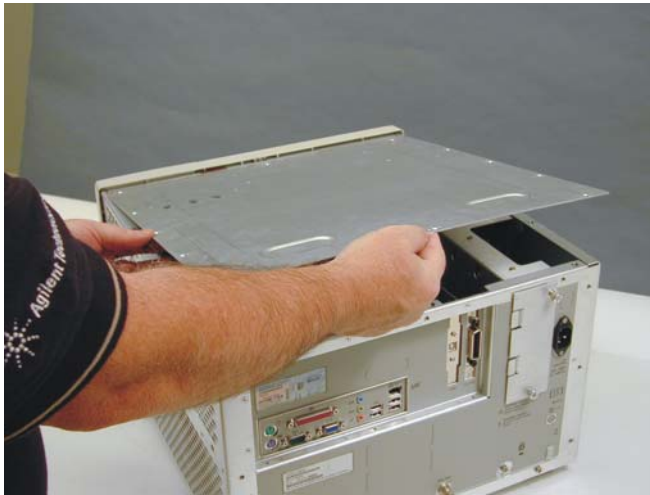

- 10 To remove the bottom plate, flip the oscilloscope upside down and remove the three Torx T20 screws from the bottom panel as shown in Figure 5-8. Then remove the three Torx T20 screws from the bottom edge of the rear panel as shown in Figure 5-9. Slide the bottom panel up and out (Figure 5-10).

**Figure 5-8**



**Figure 5-9**



**Figure 5-10**



- 11** To replace the cover, top plate, and bottom plate, reverse the above procedure. Please note that all sheet metal holes that are supposed to have screws placed

**Chapter 5: Replacing Assemblies**  
**To remove and replace the cover, top plate, and bottom plate**

in them are marked by lines on four sides of the hole as shown in Figure 5-11

**Figure 5-11**



---

**CAUTION**

---

**PROPERLY TIGHTEN HANDLE AND SCREWS!**  
Tighten the side handle screws to 2.4 Nm (21 in-lbs).

---

## To remove and replace the front panel bezel and front panel circuit assembly

- 1 Disconnect the power cable and remove the cover, top plate, and bottom plate as described above in the section on removing the cover, top plate, and bottom plate.
- 2 Disconnect front panel cables.
- 3 Grasp and pull on all 13 knobs located on the front panel to remove them (Figure 5-12).

Figure 5-12



- 4 Use a screw driver to disengage locking tabs located along the edges of the front panel bezel (4 tabs on the side, 1 tab on the top, 1 tab on the bottom) - See Figure 5-13. Once the tabs are disengaged, pull the front panel bezel off (Figure 5-14). **Suggestion:** It tends to be easiest to disengage the side tabs and the top tab. Then pull the bezel off at an angle and flex it until the bottom tab disengages as well.

## Chapter 5: Replacing Assemblies

To remove and replace the front panel bezel and front panel circuit assembly

Figure 5-13



Figure 5-14



- 5 Remove two Torx T10 screws from the front panel printed circuit assembly as shown in Figure 5-15.



Figure 5-15



- 6 Disengage the tabs located along the edges of the control panel faceplate. There are three tabs located along the right hand side (see Figure 5-16). There are two additional tabs located on the top and bottom of the left edge. You will need to look inside the instrument to see these tabs and hence, you need the top and bottom plates removed as discussed in step 1. You can see the top left side tab by looking through the top cavity while you can see the bottom left tab by turning the oscilloscope on its side and looking through the bottom cavity. See Figure 5-17 and Figure 5-18 for pictures of these left side tabs.
- 7 Pull off both the control panel faceplate and front panel circuit assembly together after all the tabs are disengaged. The faceplate and the circuit assembly will not come all the way off the instrument until you disconnect all the cables connected to the front panel circuit assembly. Once the combination of the faceplate and the assembly has been removed, remove the faceplate from the assembly.

## Chapter 5: Replacing Assemblies

To remove and replace the front panel bezel and front panel circuit assembly

Figure 5-16

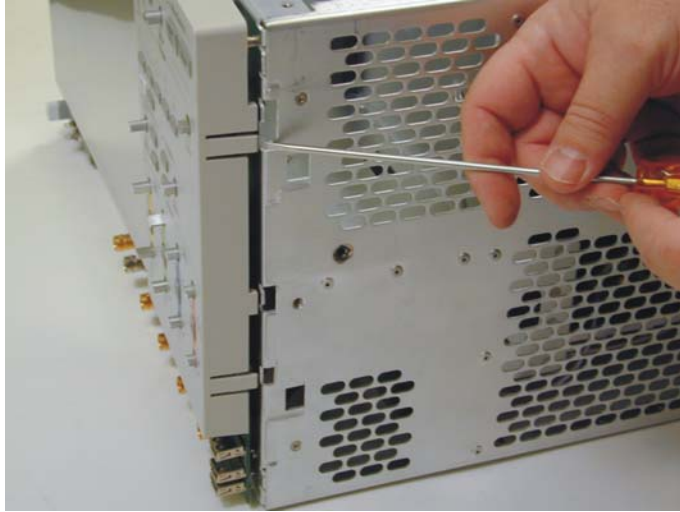

Figure 5-17



This figure shows the top left hand side tab for the control panel faceplate. The view is through the top cavity, standing at the rear of the instrument, and looking towards the front (over the backplane board).

Figure 5-18



This figure shows the other left hand side tab for the control panel faceplate. This view is with the oscilloscope turned on its side and looking at this tab from underneath the instrument.

- 8 To replace the front panel assembly, reverse the above procedure. **Suggestion:** When you get to the part where you have to snap the tabs located on the control panel faceplate back into the chassis, it is best to snap the faceplate and the assembly together first before trying to attach them back to the chassis via these tabs. Once they are attached together, snap down the right hand side tabs first and then the left hand tabs second.

---

## To remove and replace the on/off board

Use this procedure to remove and replace the on/off board. When necessary, refer to other removal procedures.

- 1 Remove the front panel bezel (directions in the previous section).
- 2 Remove the one Torx T10 screw from the on/off board (Figure 5-19).

Figure 5-19

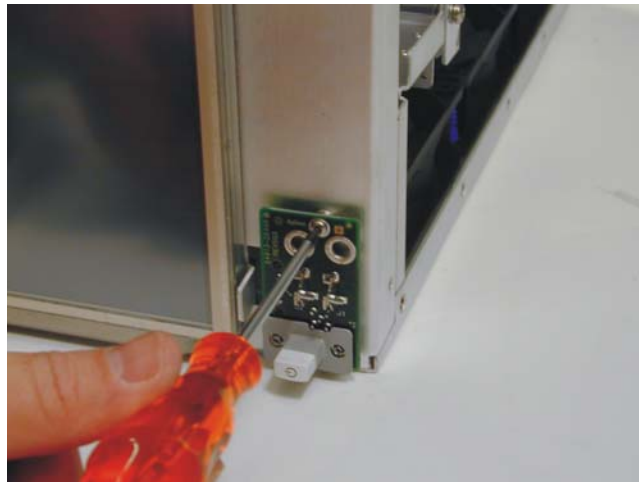

- 3 Pull the board out a little so you can see the cables connected behind it (Figure 5-20). Disconnect these cables and then take the board off.

**Chapter 5: Replacing Assemblies**  
**To remove and replace the on/off board**

**Figure 5-20**



4 To replace the on/off board, reverse the above procedure.

---

## To remove and replace the backlight inverter board

Use this procedure to remove and replace the backlight inverter board. When necessary, refer to other removal procedures. The graphics in this chapter are representative of the oscilloscope at the time of this printing. Your unit may look different.

---

### WARNING

#### SHOCK HAZARD!

The backlight inverter assembly, which is mounted at the front corner of the oscilloscope near the flat-panel display, operates at high voltages from 300-1 kVAC<sub>rms</sub>. DO NOT handle this assembly while it is in operation.

- 1 Disconnect the power cable and remove the cover and top plate.
- 2 Disconnect the cables from the backlight inverter board.

Figure 5-21



The area surrounded by the white circle is the location of the backlight inverter board (this view is from standing at the rear of the instrument and looking towards the backplane assembly).

- 3 Remove two Torx T20 screws that connect the board to the chassis.
- 4 Lift the backlight inverter board out through the top of the chassis.
- 5 To replace the backlight inverter board, reverse this procedure.

---

## To remove and replace the touch screen, front deck, and controller assembly

Use this procedure to disassemble and reassemble the keyboard, touch screen, and flat-panel display. When necessary, refer to other removal procedures. The graphics in this chapter are representative of the oscilloscope at the time of this printing. Your unit may look different.

- 1 Disconnect the power cable and remove the cover, top plate, and bottom plate.
- 2 Remove the front panel bezel and front panel circuit assembly from the chassis.
- 3 Remove the two Torx T20 screw attaching the touch screen to the front deck of the chassis that are located along the left hand side of the screen (Figure 5-22).

**Figure 5-22**

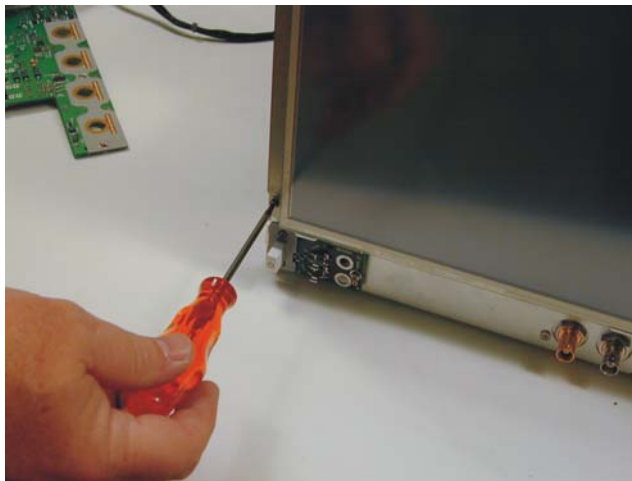

- 4 Disconnect the three cables that are attached to the screen (one is connected to the back of the lower left hand corner of the screen, one is connected to the back of the upper right hand corner of the screen, and the last one is connected to the right edge of the screen) and the copper shielding (Figure 5-23) located in the upper right hand corner of the screen.

**Figure 5-23**

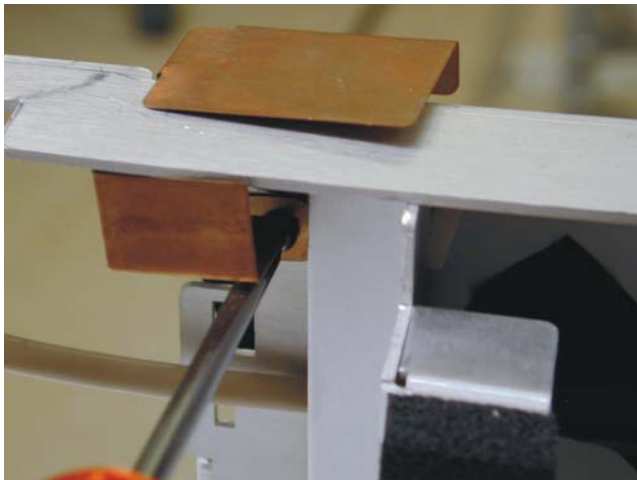

- 5 Pull touch screen off.

- 6 To remove the front deck off the chassis, remove four Torx T10 screws from the front deck (two on the right hand side and two on the left hand side) - See Figure 5-24.

**Figure 5-24**



- 7 Turn the oscilloscope upside down or on its side and look through the bottom cavity to see the SMA connectors attached to the front deck (Figure 5-25). Remove these SMA connectors with a wrench.

**Figure 5-25**

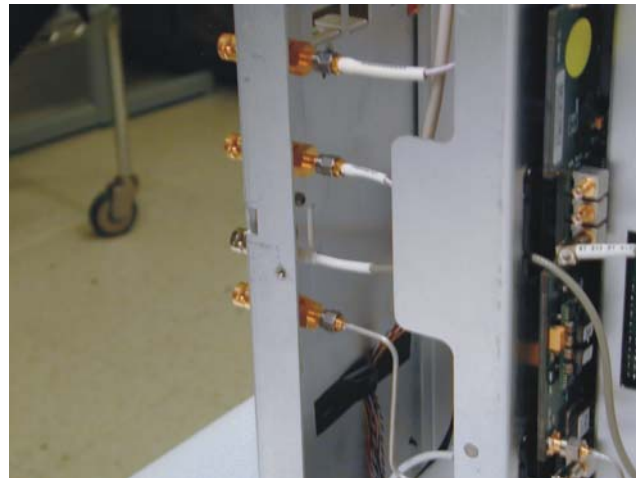

- 8 Feed cables through any openings that are required and remove the front deck from the frame (Figure 5-26).

## Chapter 5: Replacing Assemblies

To remove and replace the touch screen, front deck, and controller assembly

Figure 5-26

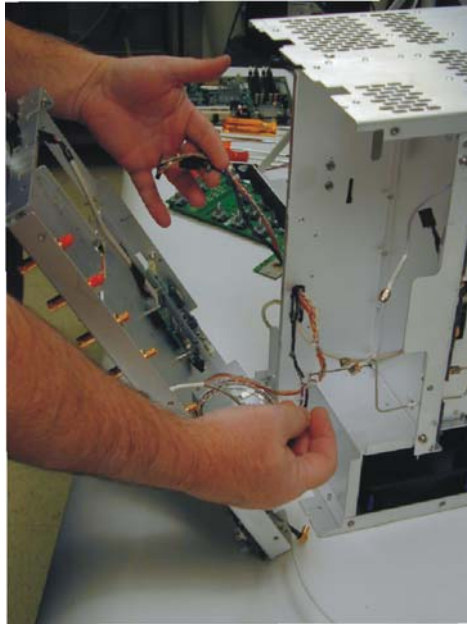

- 9 You can now remove the controller board and backlight inverter board from the back of the front deck if these need to be replaced by removing the Torx T20 screws attached to them.
- 10 To reassemble the front deck and touch screen, reverse the above procedure.  
Note: Before reattaching the front deck to the frame, attach the touch screen to the front deck. This gives you some room to feed cables through the correct holes and attach them to the correct boards. When reattaching the SMA cables, use an 8 lb. torque wrench as shown in Figure 5-27

Figure 5-27



---

### CAUTION

#### PREVENT GLASS BREAKAGE!

Use care when handling the touch screen and the flat-panel display to prevent glass breakage.

Inspect the inside surfaces of the touch screen and the flat-panel display closely for dust, smudges, and fingerprints. Viewing these with line-of-sight 45 degrees to the surface is the best method for seeing subtle flaws. Clean the surfaces of the touch screen with glass cleaner and lint-free lens paper before re-assembly.



---

## To remove and replace the motherboard

- 1 Disconnect the power cable and remove the cover and top plate.
- 2 Disconnect all the cables from the motherboard (see a list of these cables on page 115).
- 3 Remove the Torx T10 screws attaching the motherboard to the frame (Figure 5-28). The motherboard shown below is the one in the standard 90000A models. If you have a performance-enhanced model it will look different, but you still remove the screws from it to lift it out.

**Figure 5-28.**

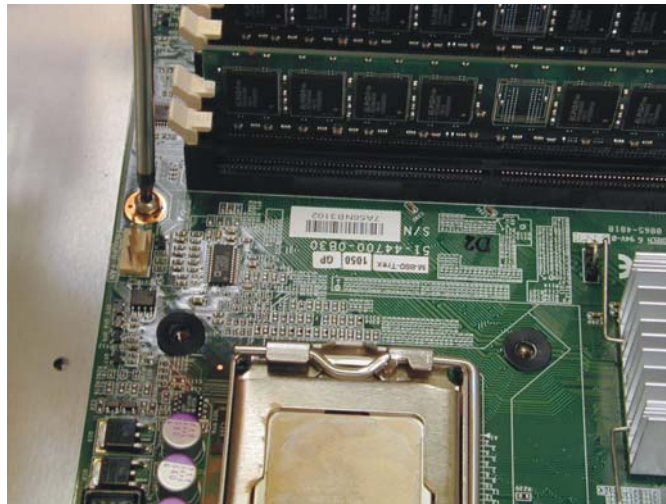

- 4 Pull the motherboard towards the front panel and then lift out.

**Figure 5-29**



- 5 To reassemble the motherboard, reverse the above procedure.

---

## To remove and replace the acquisition boards/backplane assembly

Use this procedure to remove and replace the acquisition boards/backplane assembly. When necessary, refer to other removal procedures. The graphics in this chapter are representative of the oscilloscope at the time of this printing. Your unit may look different.

- 1 Disconnect the power cable and remove the cover, top plate, and bottom plate.
- 2 Remove the motherboard and bulk 12V power supply.
- 3 Turn the oscilloscope on its side and remove the SMAs connected to the bottom of the backplane board (Figure 5-30).

**Figure 5-30**

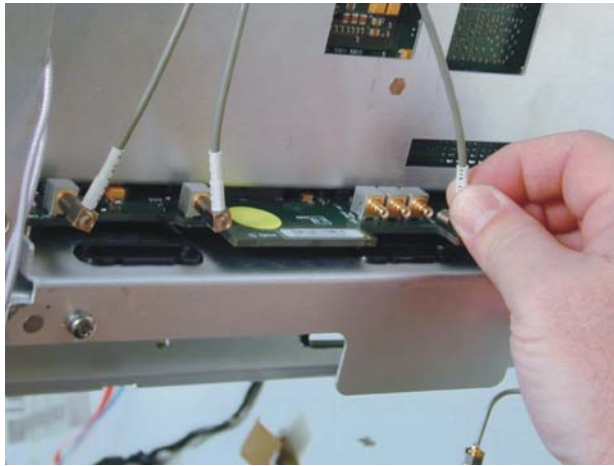

- 4 Disconnect the BNCs from the rear of the instrument using a 9/16 open ended or socket wrench (Figure 5-31).

**Figure 5-31**



- 5 Turn the instrument over so it is positioned upright. Remove the Torx T20 locking screws from the top (underneath where the motherboard used to be) - See Figure 5-32.

**Figure 5-32**

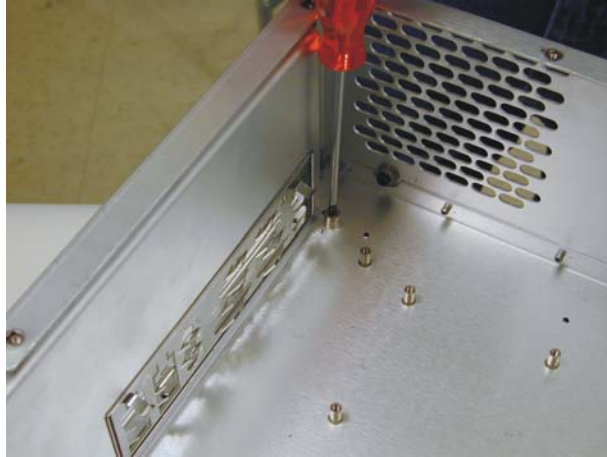

- 6 Remove the Torx T20 screws from the top of the backplane assembly (Figure 5-33).

**Figure 5-33**

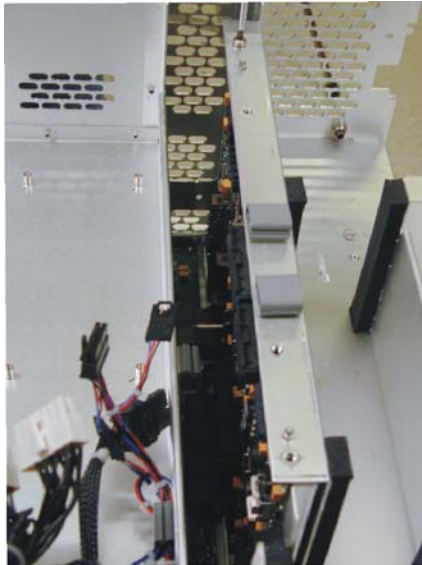

- 7 Flip the instrument so it is upside down or on its side.
- 8 Remove the Torx T20 screws from back lower side of the rear of the instrument (Figure 5-34).

**Chapter 5: Replacing Assemblies**  
**To remove and replace the acquisition boards/backplane assembly**

**Figure 5-34**

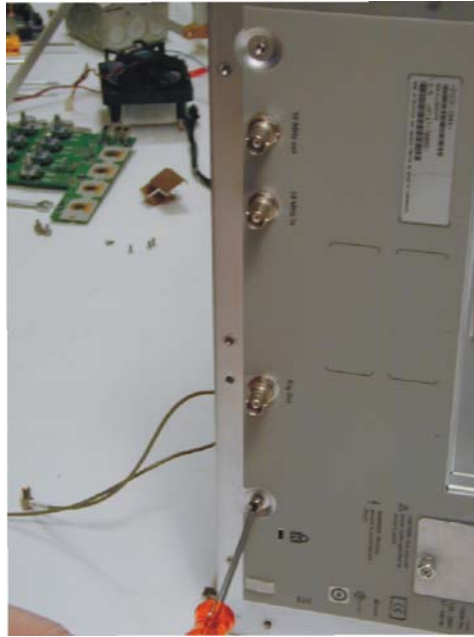

- 9 Remove the two Torx T20 screws from the underside of the backplane assembly (Figure 5-35).

**Figure 5-35**



- 10 If unit is not upside down (if you chose to just lay it on its side), go ahead and flip it upside down right now. Then lift the entire acquisition boards/backplane assembly out of the instrument using the handles on the bottom (Figure 5-36).

**Figure 5-36**



---

To remove the backplane assembly from the acquisition assemblies

- 1 Remove the entire acquisition/backplane assembly as described in the previous section.
- 2 Remove the four Torx T20 screws (two per acquisition assembly) on the side of the backplane assembly (Figure 5-37).

**Figure 5-37**

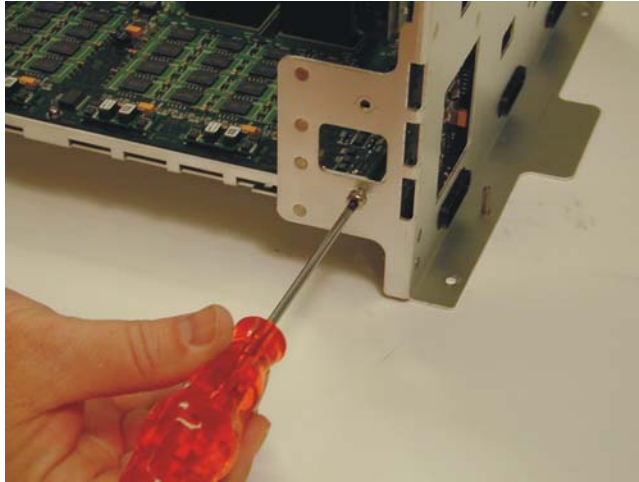

- 3 Gently pry on the sheet metal portions to separate the backplane assembly from each of the acquisition assemblies.
- 4 Remove the Torx T10 screws to remove each of the boards from their respective subassembly chassis (Figure 5-38).

**Figure 5-38**

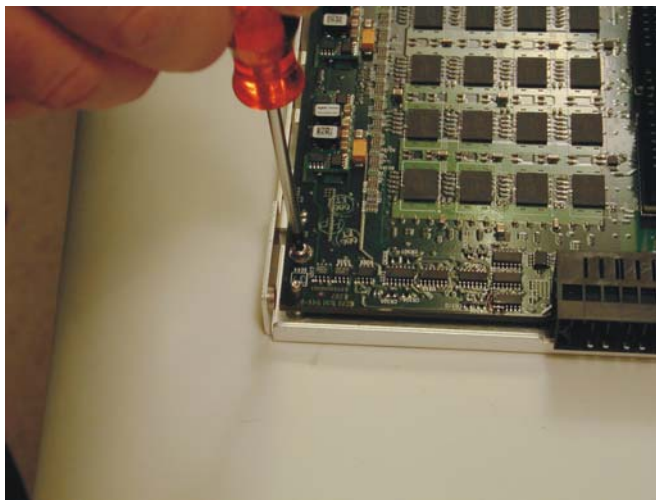

- 5 To reassemble the backplane/acquisition assembly, reverse these instructions.

## To set the calibration factors after replacing the acquisition board

The following procedure must be performed after replacing the acquisition board. This procedure only needs to be performed once after the acquisition board is replaced.

**Let the oscilloscope warm up before testing**

**The oscilloscope under test must be warmed up (with the oscilloscope application running) for at least 30 minutes prior to the start of any performance test.**

### Equipment Required

Description	Critical Specifications	Recommended Model/ Part Numbers
Digital Multimeter	No substitute	Agilent 34401A
10 MHz Signal Source (required for time scale calibration)	Frequency accuracy better than 0.4 ppm	Agilent 53131A with Opt. 010
Cable Assembly	No substitute	Agilent 54855-61620
Cable Assembly	RS-232 (f)(f)	Agilent 34398A
Cable Assembly	50 $\Omega$ characteristic impedance BNC (m) connectors ~ 36 inches (91 cm) to 48 inches (122 cm) long	Agilent 8120-1840
Adapter	BNC Barrel (f)(f)	Agilent 1250-0080
Adapter	BNC shorting cap	Agilent 1250-0929
Adapter (Qty. 2)	No substitute	Agilent 54855-67604
Adapter	BNC (f) to dual banana	Agilent 1251-2277

#### 1 Perform self tests

- a Exit the oscilloscope application.
- b From a command prompt, run the oscilloscope software using the following syntax:  
`c:\scope\bin\agscope.exe -service`

While the oscilloscope is warming up, run the self-test to ensure that the hardware is functioning properly. To run the self-test:

- c Pull down the Utilities menu and select Self Test.
- d Select Scope Self Test from the Self Test list.
- e Click on Start Self Test to start the self test procedure.

If any of the self-tests fail, ensure that the failure is diagnosed and repaired before calibrating and testing performance.

#### 2 Performance calibration.

After the warm up period, calibrate the oscilloscope.

- a Connect the RS-232 cable to the Digital Multimeter RS-232 port and to the RS-232 port on the oscilloscope.
- b Set Digital Multimeter as follows:  
 Interface: RS-232  
 Baud Rate: 9600 Baud  
 Parity: None: 8 bits  
 Language: SCPI

## **Chapter 5: Replacing Assemblies**

### **To set the calibration factors after replacing the acquisition board**

- c** Pull down the Utilities menu and select Calibration.
- d** Uncheck the Cal Memory Protect box to allow calibration.
- e** Click on Start to start the calibration procedure.  
Follow the on-screen instructions as calibration proceeds.



---

## To remove and replace the hard disk drive and the hard drive control board

Use this procedure to remove and replace the hard disk drive. When necessary, refer to other removal procedures. The graphics in this chapter are representative of the oscilloscope at the time of this printing. Your unit may look different.

- 1 Disconnect the power cable and remove the cover and top plate.
- 2 Disconnect the two cables connected to the hard drive.
- 3 Remove the two latch screws located on the rear panel of the oscilloscope (Figure 5-39).

Figure 5-39

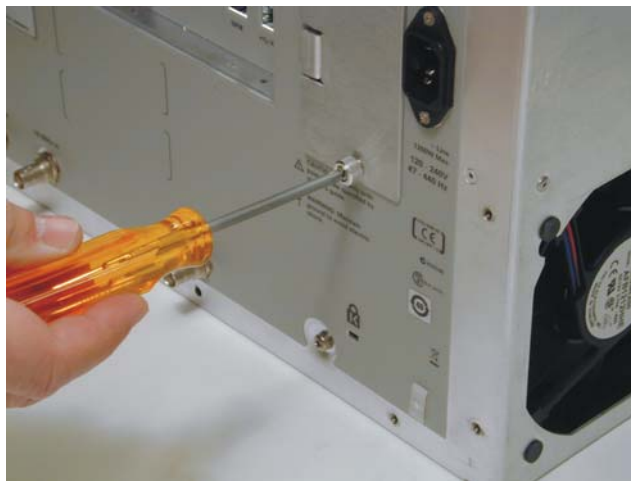

- 4 Pull the hard drive out (Figure 5-40).

Figure 5-40



- 5 To remove the hard drive control board, first remove the hard drive and then when you look in the now empty cavity where it used to be, you will see the board. Remove the two Torx T10 screws holding the board to the frame (Figure 5-41).

## Chapter 5: Replacing Assemblies

To remove and replace the hard disk drive and the hard drive control board

Figure 5-41



- 6 To replace the hard disk drive and hard drive control board, reverse the above procedure.

## Cable removal (for replacing the motherboard)

This section shows the various cables that need to be removed when replacing the motherboard.

- 1 Disconnect the power cable and remove the top cover.
- 2 Disconnect all cables from the motherboard.

Figure 5-42 shows an overview of the cables that need to be removed from the standard 90000 A-Series motherboard. The subsequent pictures show close-ups of each cable. Figure 5-51 shows the performance-enhanced 90000A motherboard so you know where to reconnect the cables. The cables are the same on the performance-enhanced models, but they may connect to the motherboard in different locations. Use Figure 5-42 to determine where they should be connected.

Figure 5-42

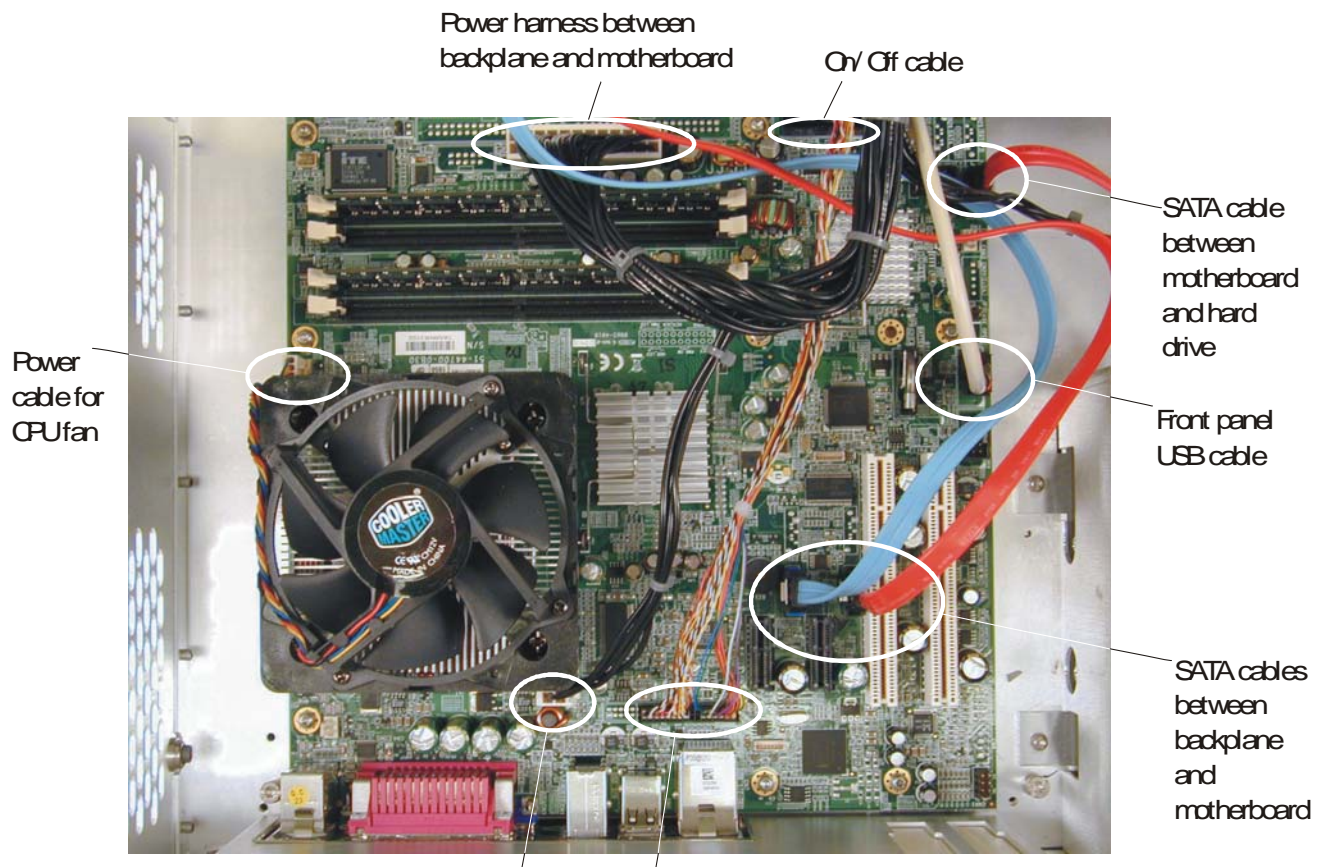

**Chapter 5: Replacing Assemblies**  
**Cable removal (for replacing the motherboard)**

**Figure 5-43**

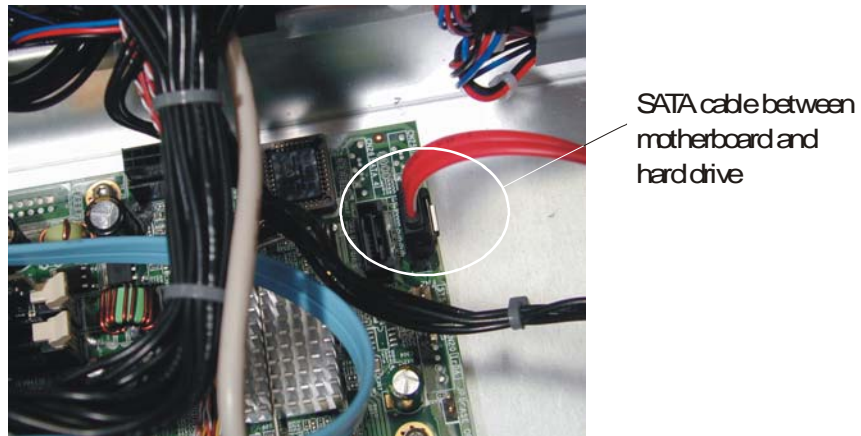

**Figure 5-44**

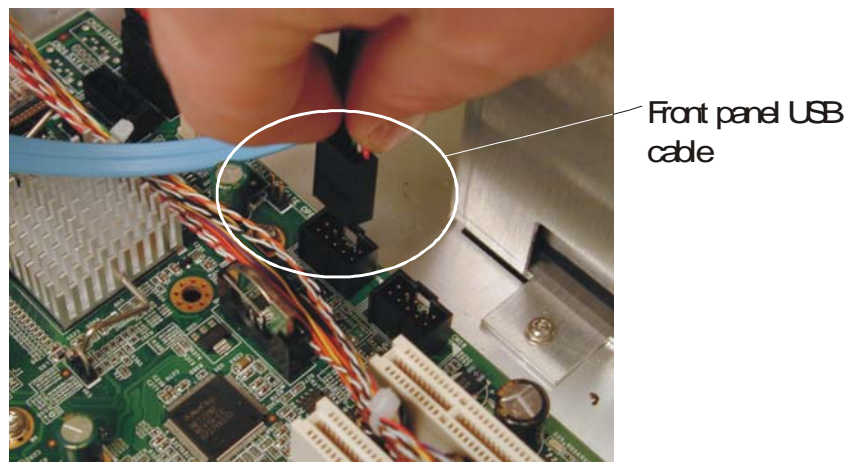

**Figure 5-45**

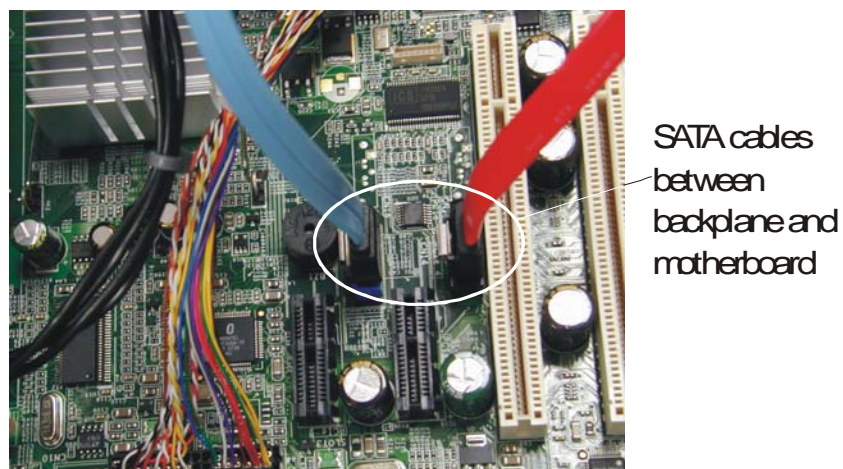

Figure 5-46

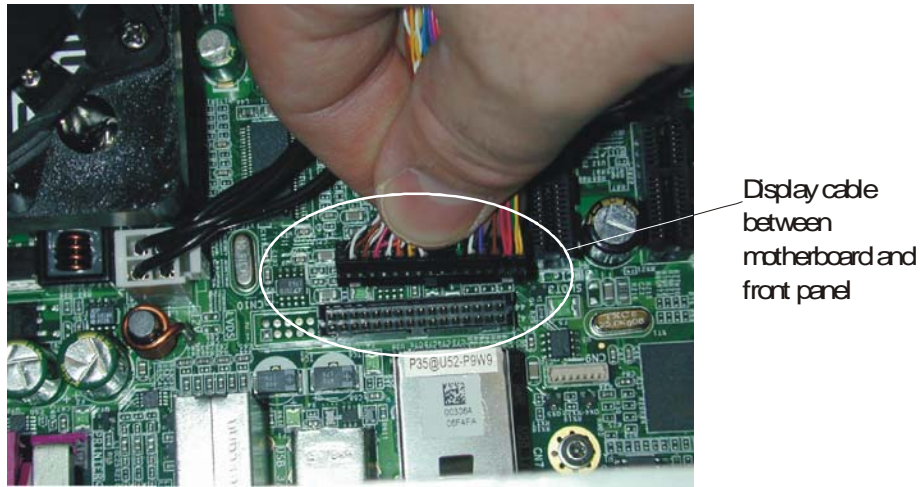

Figure 5-47

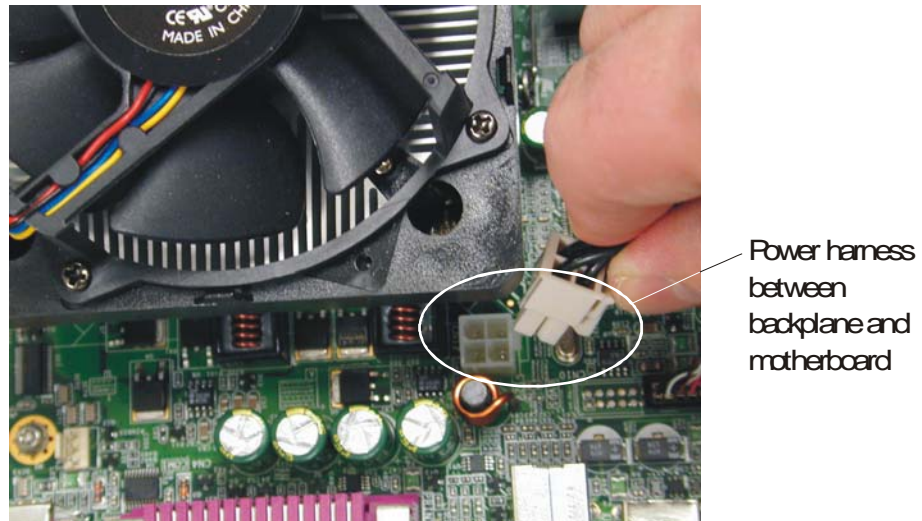
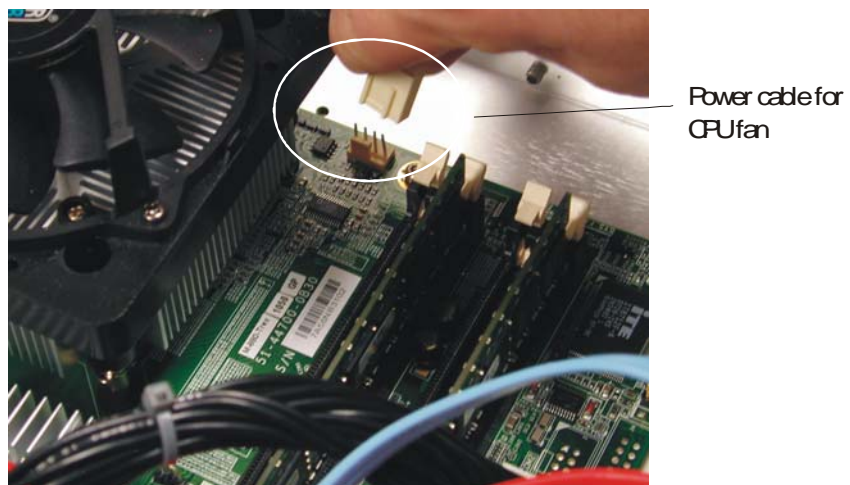
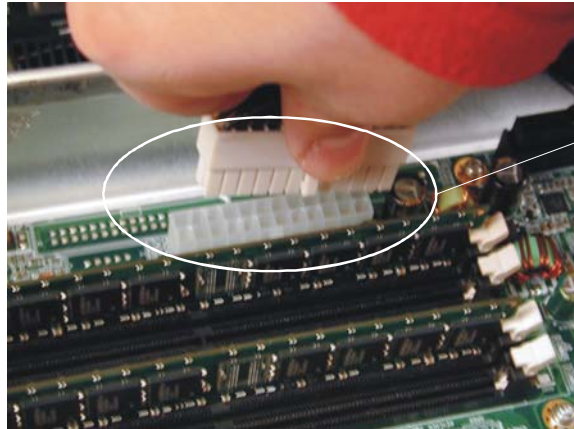

Figure 5-48



**Chapter 5: Replacing Assemblies**  
**Cable removal (for replacing the motherboard)**

**Figure 5-49**



Power harness  
between  
backplane and  
motherboard

**Figure 5-50**

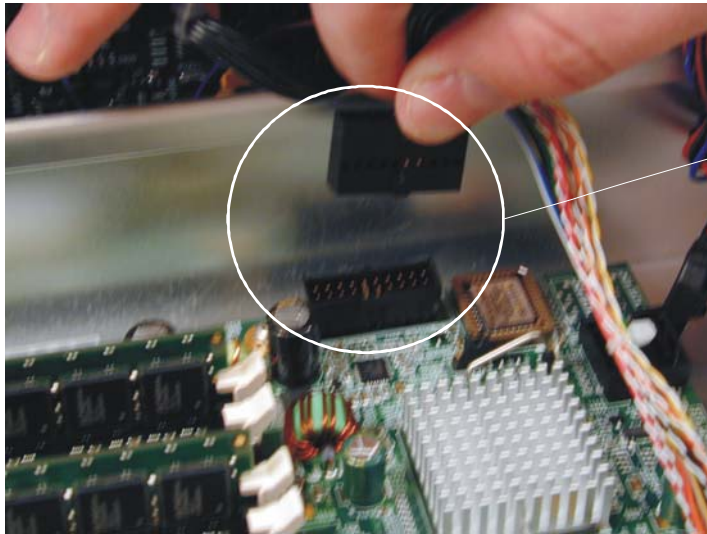

On/Off  
cable

**Figure 5-51 Motherboard and cables in performance-enhanced 90000 A-Series models**



---

## To remove and replace the power supply

Use this procedure to remove and replace the power supply. When necessary, refer to other removal procedures. The graphics in this chapter are representative of the oscilloscope at the time of this printing. Your unit may look different.

---

**WARNING**

**SHOCK HAZARD!**

If the power supply is defective it could have a dangerous charge on some capacitors. This charge could remain for many days after removing power from the supply.

---

**WARNING**

**SHOCK HAZARD!**

When the power supply is removed, two AC leads are exposed. Take extra care not to contact these leads.

- 1 Disconnect the power cable and remove the top cover.
- 2 Disconnect the AC power cable from the bulk 12V power supply.  
The picture below shows where the AC power cable connects to the bulk 12V power supply.

**Figure 5-52**



AC power  
cable into bulk  
12V power  
supply

- 3 Follow the instructions on the label attached to the top of the power supply to remove it.



---

## To remove and replace the fans

---

### **WARNING**

#### **AVOID INJURY!**

The fan blades are exposed both inside and outside the chassis. Disconnect the power cable before working around the fan. Use extreme caution in working with the oscilloscope. Failure to observe these precautions may result in injury.

Use this procedure to remove and replace the fans. When necessary, refer to other removal procedures. The graphics in this chapter are representative of the oscilloscope at the time of this printing. Your unit may look different.

- 1 Disconnect the power cable and remove the cover and top plate.
- 2 Disconnect the fan harness cables.
- 3 Clip off the end of each of the locking buttons (see Figure 5-53) and take the fan out. Repeat for each fan that needs to be replaced.

**Figure 5-53**



---

### **CAUTION**

#### **AVOID OVERHEATING THE OSCILLOSCOPE**

When replacing the fan, be sure the direction of the fan air flow is coming from the inside to the outside of the oscilloscope. Check the flow arrows on the fan and check for proper flow once power is applied to the oscilloscope. Improper air flow can overheat the oscilloscope.

- 4 To install the fan, reverse this procedure.

## To remove and replace the power cord

Use this procedure to remove and replace the power cord. When necessary, refer to other removal procedures. The graphics in this chapter are representative of the oscilloscope at the time of this printing. Your unit may look different.

- 1 Disconnect the power cable and remove the cover and top plate.
- 2 Unplug the power cable from the 12V power supply (refer to Figure 5-52 for the location of this connection).
- 3 Unscrew the power cord connector from rear panel (Torx T10 screws) - see Figure 5-54.

**Figure 5-54**



- 4 Remove the ground screw (Torx T10) on right side of hard drive (Figure 5-55).

**Figure 5-55**



- 5 Pull the power cord out of the instrument.
- 6 To replace the power cord, reverse these directions.

---

## To remove and replace the USB or GPIB port

Use this procedure to remove and replace the USB or GPIB port (GPIB is an option and may not be on your oscilloscope). The procedure is exactly the same for both of these ports so only one will be shown here. When necessary, refer to other removal procedures. The graphics in this chapter are representative of the oscilloscope at the time of this printing. Your unit may look different.

- 1 Disconnect the power cable and remove the cover and top plate.
- 2 Remove the screw from top edge of chassis (Figure 5-56).

**Figure 5-56**

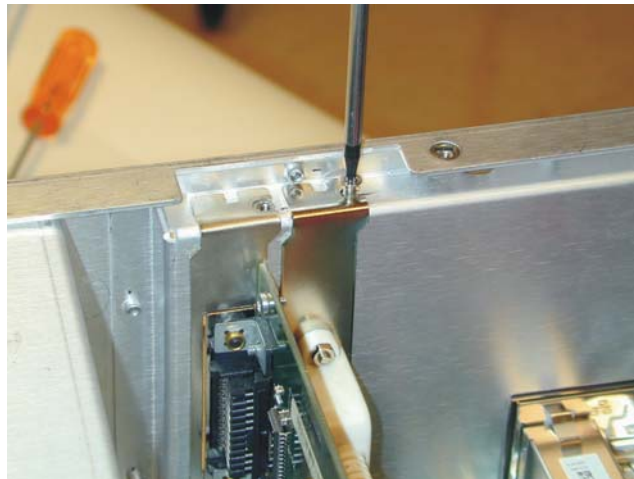

- 3 Undo the connection to the motherboard by disconnecting the cable.
- 4 Pull the port out of the instrument.
- 5 To replace one of these ports, reverse the directions.

**Chapter 5: Replacing Assemblies**  
**To remove and replace the USB or GPIB port**

Ordering Replaceable Parts	126
Listed Parts	126
Unlisted Parts	126
Direct Mail Order System	126
Exchange Assemblies	126
Exploded Views	127
Replaceable Parts List	131

---

# Replaceable Parts

This chapter describes how to order replaceable assemblies and parts for the Agilent 90000 A-Series oscilloscopes. Service support for this oscilloscope is replacement of parts to the assembly level.

---

## Ordering Replaceable Parts

### Listed Parts

To order a part in the parts list, quote the Agilent Technologies part number, indicate the quantity desired, and address the order to the nearest Agilent Technologies Sales Office.

### Unlisted Parts

To order a part not listed in the parts list, include the oscilloscope part number, oscilloscope serial number, a description of the part (including its function), and the number of parts required. Address the order to the nearest Agilent Technologies Sales Office.

### Direct Mail Order System

Within the USA, Agilent Technologies can supply parts through a direct mail order system. There are several advantages to this system:

- Direct ordering and shipping from the Agilent Technologies parts center in California, USA.
- No maximum or minimum on any mail order. (There is a minimum amount for parts ordered through a local Agilent Technologies Sales Office when the orders require billing and invoicing.)
- Prepaid transportation. (There is a small handling charge for each order.)
- No invoices.

In order for Agilent Technologies to provide these advantages, please send a check or money order with each order.

Mail order forms and specific ordering information are available through your local Agilent Technologies Sales Office. Addresses and telephone numbers are located in a separate document shipped with the manuals.

### Exchange Assemblies

Exchange assemblies have been set up for Agilent Service Center use only.

## Exploded Views

### Front Frame and Front Panel

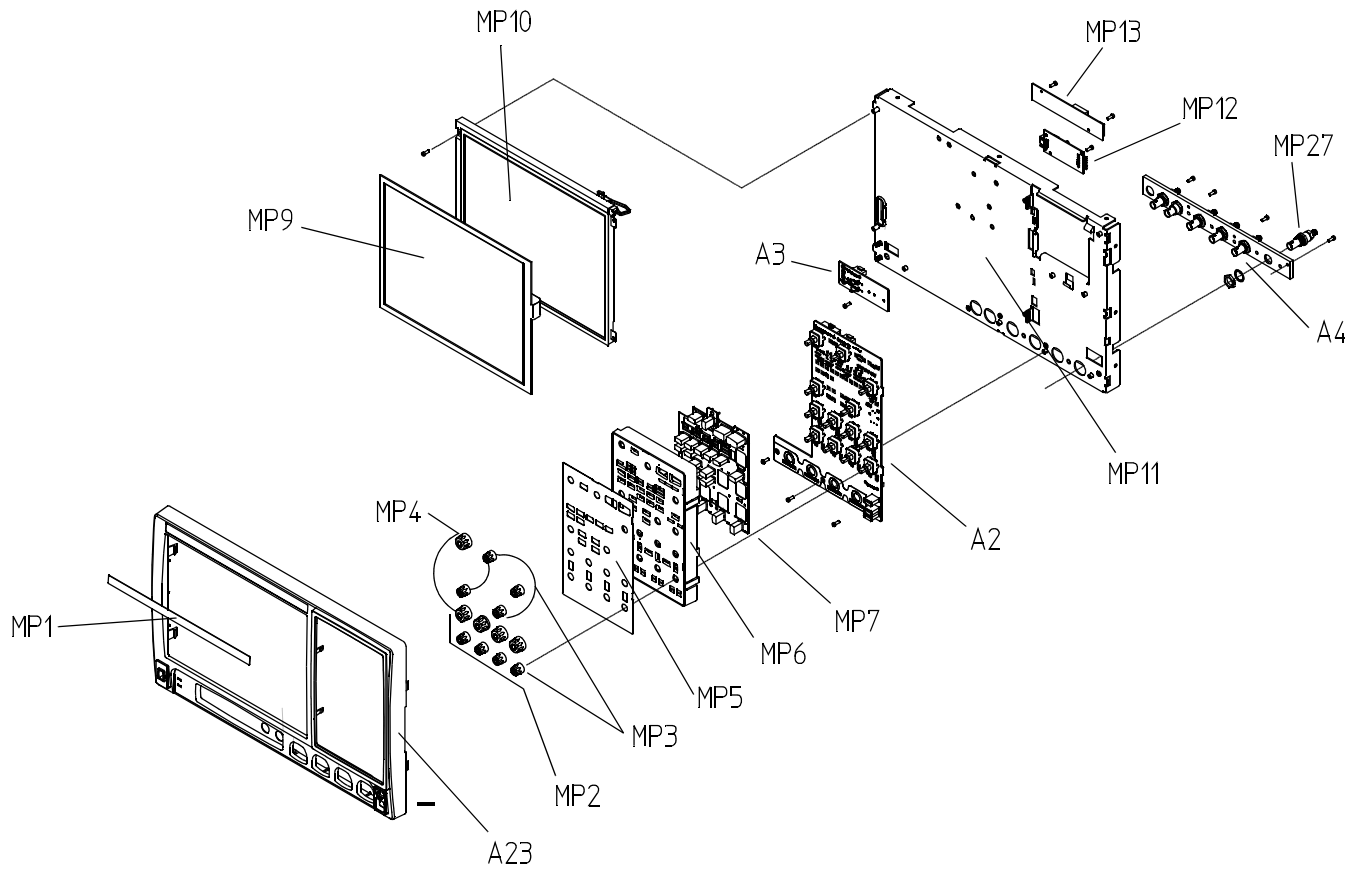

Fan and Acquisition Assembly

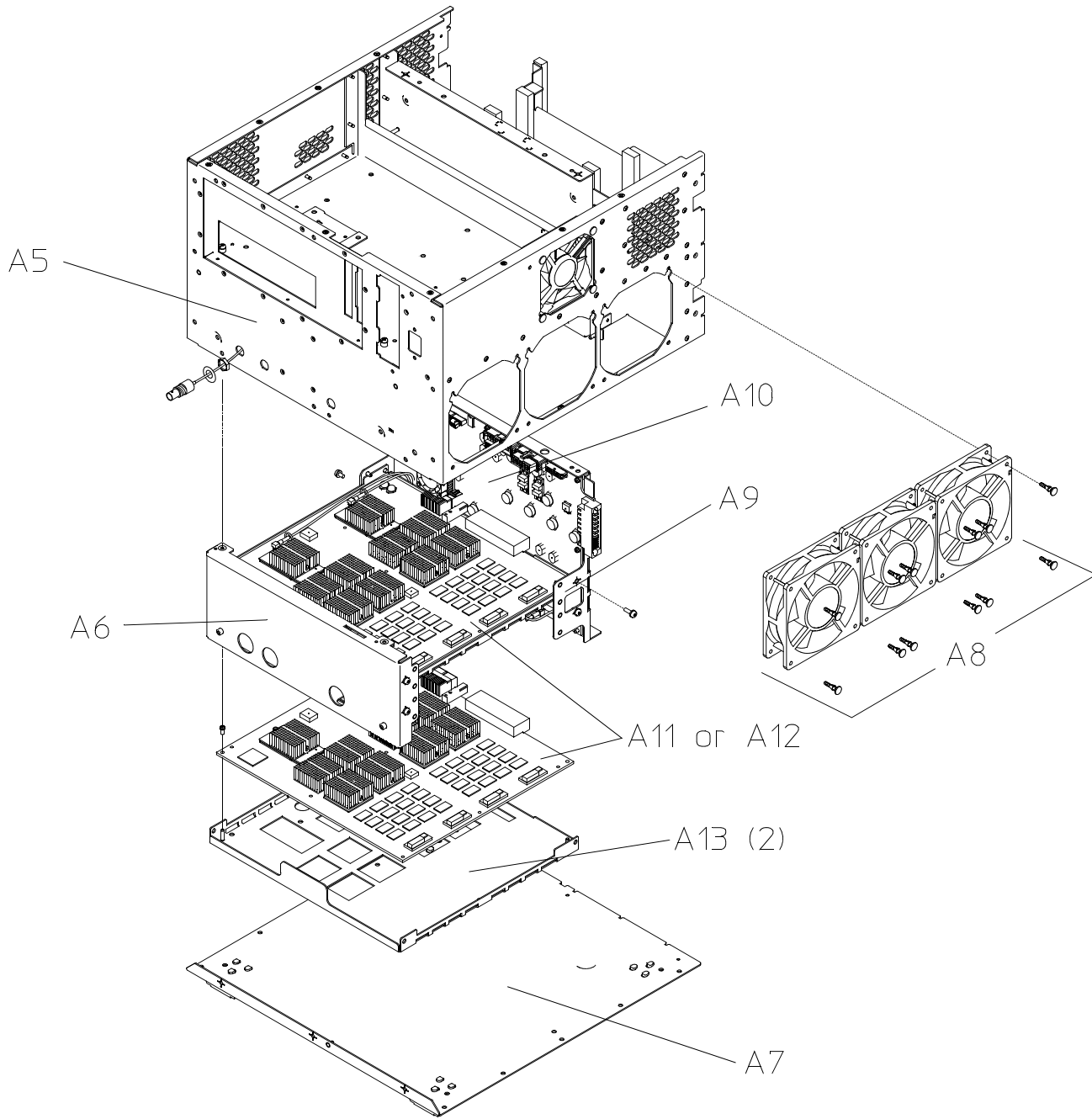



Power Supply and PC Motherboard

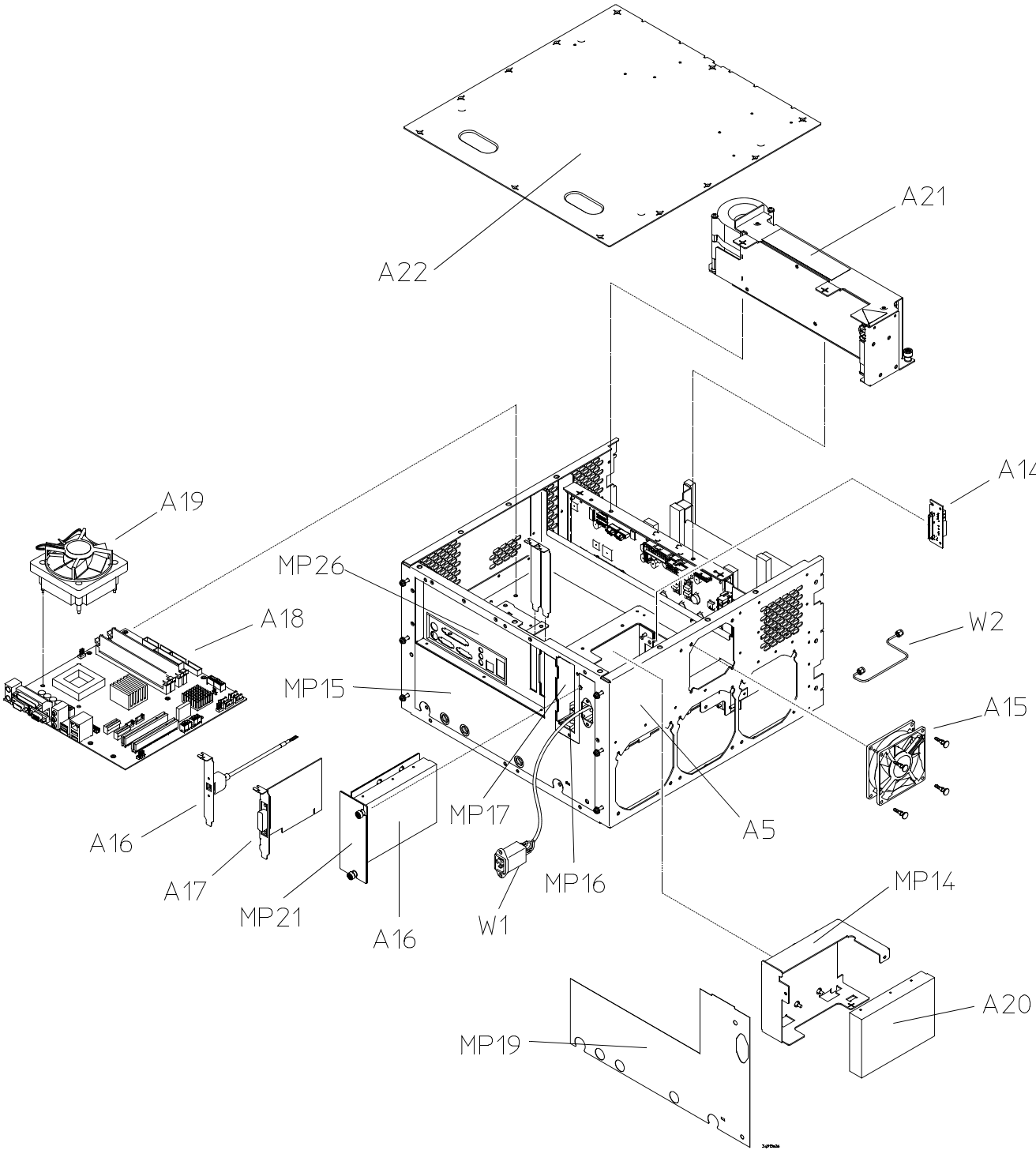

## Chapter 6: Replaceable Parts Exploded Views

### Sleeve and Accessory Pouch

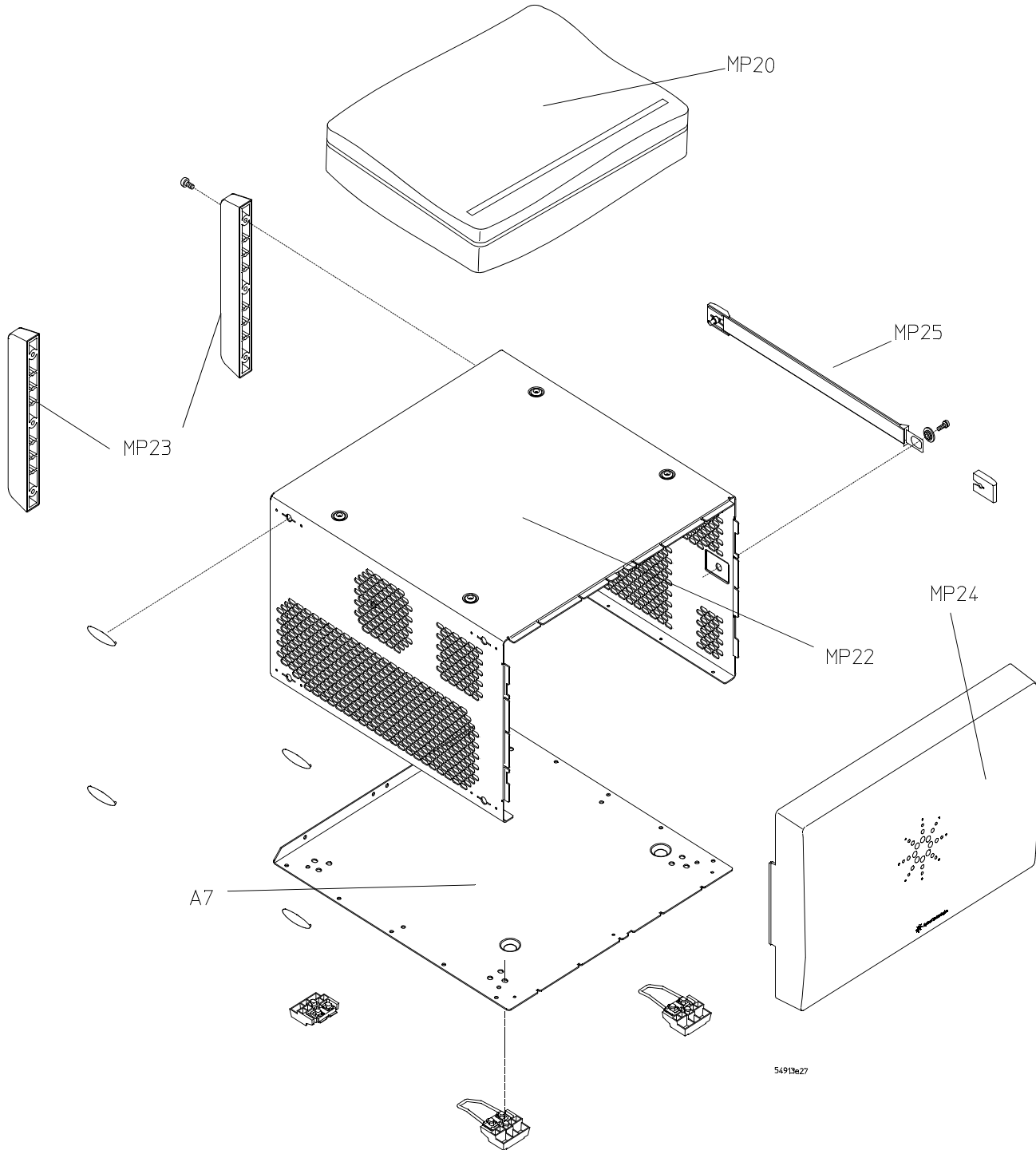

## Replaceable Parts List

The following table is a list of replaceable parts. Information given for each part includes:

- Reference designation
- Agilent Technologies part number
- Total quantity (QTY) in oscilloscope or on assembly
- Description of the part

### Replaceable Parts

Ref. Des.	Agilent Part Number	QTY	Description
A2	54913-66505	1	Tested Front Panel Printed Circuit Assembly
A3	54913-66406	1	On/Off Printed Circuit Assembly
A4	54913-68707	1	Front Panel BNC Assembly
A5	54913-00102	1	Chassis
A6	54913-00201	1	Rear Panel
A7	54913-00203	1	Bottom Panel
A8	54913-68710	1	Fan Replacement Kit 120 MM
A9	54913-00501	1	Backplane Frame
A10	54913-66502	1	Backplane Printed Circuit Assembly - replaced by 54913-66512
A10	54913-69502	1	Backplane Printed Circuit Assembly - Exchange, replaced by 54913-69512
A10	54913-66512	1	Backplane Printed Circuit Assembly - replaces 54913-66502
A10	54913-69512	1	Backplane Printed Circuit Assembly - replaces 54913-69502
A11	54913-66501	2	Acquisition Printed Circuit Assembly 8 GHz and above - replaced by 54913-66511
A11	54913-69501	2	Acquisition Printed Circuit Assembly 8 GHz and above - Exchange, replaced by 54913-69511
A11	54913-66511	2	Acquisition Printed Circuit Assembly 8 GHz and above - replaces 54913-66501
A11	54913-69511	2	Acquisition Printed Circuit Assembly 8 GHz and above - Exchange, replaces 54913-69501
A12	54906-66501	2	Acquisition Printed Circuit Assembly 6 GHz and below - replaced by 54906-66511
A12	54906-69501	2	Acquisition Printed Circuit Assembly 6 GHz and below - Exchange, replaced by 54906-69511
A12	54906-66511	2	Acquisition Printed Circuit Assembly 6 GHz and below - replaces 54906-66501
A12	54906-69511	2	Acquisition Printed Circuit Assembly 6 GHz and below - Exchange, replaces 54906-69501
A13	54913-00502	2	Acquisition Frame
A14	54913-66410	1	RHDD Board Printed Circuit Assembly
A15	54913-68711	1	Fan Replacement Kit 90 MM
A17	82350-66512	1	GPIB Interface Card
A18*	0960-2653*	1	Mother Board Printed Circuit Assembly for M880 (standard models)
A18**	0960-2869**	1	Mother Board Printed Circuit Assembly for M890 (performance-enhanced models)
A19	3160-4243	1	Mother Board Fan w/ heatsink
	54916-04112**	1	CPU Adapter Plate (Required if upgrading to new performance-enhanced motherboard from a standard model. This part is located underneath the heat sink on the motherboard. It is a part of the chassis on standard models.)
A20	54913-68701	1	Replacement HDD for M880/XP-based 90000 Series scopes
A20	54913-83503	1	Infiniium 90000 A-Series imaged hard-drive, version M880-9XB (Service Centers only)
A20	54913-83505	1	Infiniium series Imaged HDD for M890/WinXP (Service Centers only)
A20	54913-68717	1	Replacement Infiniium series Imaged HDD for M890/WinXP
A20	54913-83506	1	Infiniium series Imaged HD for M890/Win7, 500 GB 7200RPM Serial-ATA (Service Centers only)
A20	54913-68718	1	Replacement HDD for M890/Win7-based DS090000 series scopes

**Chapter 6: Replaceable Parts**  
**Replaceable Parts List**

<b>Replaceable Parts</b>			
<b>Ref. Des.</b>	<b>Agilent Part Number</b>	<b>QTY</b>	<b>Description</b>
A20	54932-83501	1	<b>Removable hard drive only: Imaged Solid State HDD for M890/Win7-based 90000 Series scopes (Service Centers only)</b>
A20	54932-68717	1	<b>Replacement Removable hard drive only: Imaged Solid State HDD for M890/Win7-based 90000 Series scopes</b>
A21	54913-68704	1	<b>Power Supply Subassembly</b>
A22	54913-00202	1	<b>Top Panel</b>
MP1*	54913-94310*	1	Label - DSO 91304A (standard models)
MP1*	54913-94311*	1	Label - DSO 91204A (standard models)
MP1*	54913-94313*	1	Label - DSO 90804A (standard models)
MP1*	54913-94314*	1	Label - DSO 90604A (standard models)
MP1*	54913-94315*	1	Label - DSO 90404A (standard models)
MP1*	54913-94316*	1	Label - DSO 90254A (standard models)
MP1*	54913-94326*	1	Label - DSA 90254A (standard models)
MP1*	54913-94325*	1	Label - DSA 90404A (standard models)
MP1*	54913-94324*	1	Label - DSA 90604A (standard models)
MP1*	54913-94323*	1	Label - DSA 90804A (standard models)
MP1*	54913-94321*	1	Label - DSA 91204A (standard models)
MP1*	54913-94320*	1	Label - DSA 91304A (standard models)
MP1**	54913-94330**	1	Label - DSO 91304A (performance-enhanced models)
MP1**	54913-94331**	1	Label - DSO 91204A (performance-enhanced models)
MP1**	54913-94333**	1	Label - DSO 90804A (performance-enhanced models)
MP1**	54913-94334**	1	Label - DSO 90604A (performance-enhanced models)
MP1**	54913-94335**	1	Label - DSO 90404A (performance-enhanced models)
MP1**	54913-94336**	1	Label - DSO 90254A (performance-enhanced models)
MP1**	54913-94346**	1	Label - DSA 90254A (performance-enhanced models)
MP1**	54913-94345**	1	Label - DSA 90404A (performance-enhanced models)
MP1**	54913-94344**	1	Label - DSA 90604A (performance-enhanced models)
MP1**	54913-94343**	1	Label - DSA 90804A (performance-enhanced models)
MP1**	54913-94341**	1	Label - DSA 91204A (performance-enhanced models)
MP1**	54913-94340**	1	Label - DSA 91304A (performance-enhanced models)
MP2	54913-94300	1	<b>Set of Colored Knob Labels</b>
MP3	54913-47401	8	<b>12 MM Knob (also order 54913-94300 if colored label is required for knob)</b>
MP4	54913-47402	5	<b>18 MM Knob (also order 54913-94300 if colored label is required for knob)</b>
MP5	54913-94301	1	<b>Control Panel Label</b>
MP6	54913-40201	1	<b>Control Panel</b>
MP7	54913-41901	1	<b>Control Panel Switch</b>
MP9*	2090-0960*	1	<b>Touch Screen 12.1 in. (standard models)</b>
MP9**	54916-89801**	1	<b>Touch Screen (performance-enhanced models)</b>
MP10	2090-0947	1	<b>LCD Display 12.1 in.</b>
MP11*	54913-00101*	1	<b>Front Deck (standard models)</b>
MP11**	54913-00104**	1	<b>Front Deck (performance-enhanced models)</b>
MP12*	0960-2742*	1	<b>Touch Screen Controller (standard models)</b>
MP12**	0960-2796**	1	<b>Touch Screen Controller (performance-enhanced models)</b>
MP13	0950-4068	1	<b>Inverter Dual Backlight 8-Watt 1-Output</b>
MP14	54913-01202	1	<b>Hard Drive Bracket</b>
MP15	54913-94318	1	<b>Label - Rear Panel w/RHDD</b>
MP16	16902-41201	1	<b>RHDD Guide</b>
MP17	54913-04501	1	<b>RHDD Case</b>
MP18	54913-00103	1	<b>RHDD Deck</b>

Replaceable Parts

Ref. Des.	Agilent Part Number	QTY	Description
MP19	54913-94306	1	Label - Rear Panel without RHDD
MP20	54913-62301	1	Accessory Pouch
MP21	54913-94307	1	RHDD Label
MP22*	54913-04101*	1	Cover (standard models; 1 handle)
MP22**	54916-04101**	1	Cover (performance-enhanced models; 2 handles)
MP23	54913-41001	2	Rear Foot
MP24	54913-44101	1	Front Cover
MP25*	E4400-60026*	1	Handle Assembly (standard models)
MP25**	54916-64901**	1	Handle - Strap Assembly (performance-enhanced models -- order twice if you want to replace both handles)
MP26*	54913-94309*	1	Label - PC i/o (standard models)
MP26**	54916-94309**	1	Label - PC i/e (performance-enhanced models)
MP27	54855-67601	5	Female Connector Assembly coaxial adapter
	54916-22401**	2	Screws for Side Handles (performance-enhanced models)
	54913-94308*	1	Label - PC Rear Panel (standard models)
	54916-94308**	1	Label - PC Rear Panel (performance-enhanced models)
W1	54913-61610	1	Cable - AC Input
W2	54913-61602	1	Cable - semi-rigid auxiliary output
W3	54913-61613	1	Cable - USB Host
W4	54913-61603	1	Cable - PC Power (not shown)
W5	54913-61611	1	Cable - Fan (not shown)
W6	54913-61604	1	Cable - ON/OFF (not shown)
W7	54913-61608	1	Cable - Display (not shown)
W8	54913-61601	4	Cable - Input (not shown)
	54913-61607*	1	Cable - USB Touch (standard models)
	54913-61617**	1	Cable - USB Touch (performance-enhanced models)
	8120-5392	1	Power cord - United Kingdom
	8120-5393	1	Power cord - Australia and New Zealand
	8120-5336	1	Power cord - Continental Europe
	8120-5395	1	Power cord - United States and Canada
	8120-5397	1	Power cord - Switzerland
	8120-5398	1	Power cord - Denmark
	8120-5399	1	Power cord - India
	8120-5400	1	Power cord - Japan
	8121-0955	1	Power cord - Israel
	8120-8390	1	Power cord - Argentina
	8120-8389	1	Power cord - Chile
	8121-1632	1	Power cord - China
	8120-5399	1	Power cord - South Africa
	8121-1660	1	Power cord - Thailand
	8121-1858	1	Power cord - Brazil
	8121-1636	1	Power cord - Taiwan
	8121-1640	1	Power cord - Cambodia

\* Parts marked with a single asterisk are to be used only with the standard models (not performance-enhanced models). For information on how to tell which model you have, refer to page 9.

\*\* Parts marked with a double asterisk are to be used only with the performance-enhanced models (not standard models). For information on how to tell which model you have, refer to page 9.

**Chapter 6: Replaceable Parts**  
**Replaceable Parts List**

Block-Level Theory	137
Power Supply Assembly	139
Monitor Assembly	139
Acquisition System	139
Front Panel	140
Motherboard	142
On/Off Board	142

---

## Theory of Operation

Figure 7-1

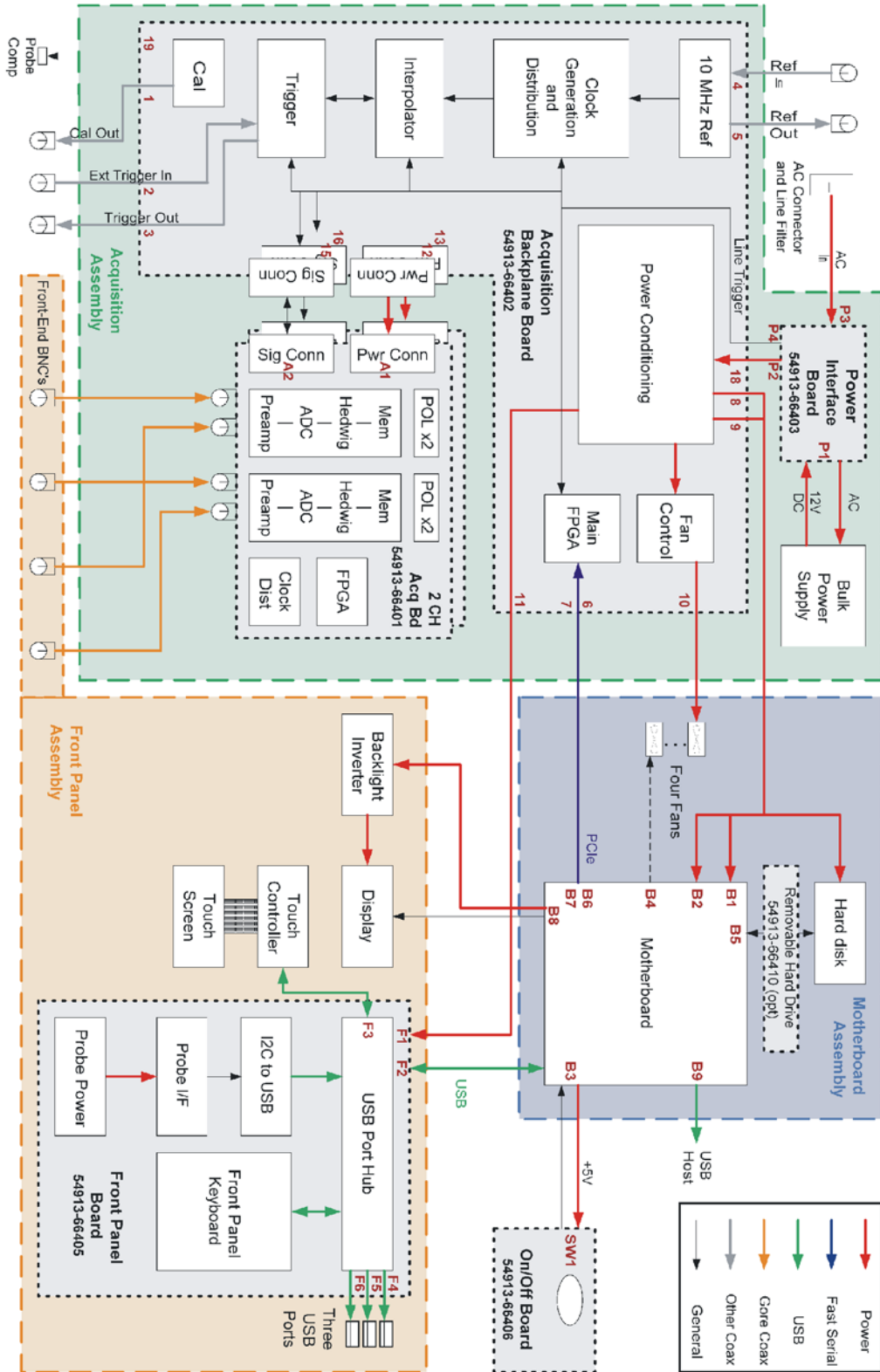

Oscilloscope Block Diagram



---

# Theory of Operation

This *Service Guide* supports troubleshooting the Agilent Technologies oscilloscopes to assembly level. Theory of operation is included only as supplemental information. It is not comprehensive enough for component-level troubleshooting.

---

## Block-Level Theory

### **The front panel provides:**

- Dedicated knobs and pushbuttons for major oscilloscope functions.
- An 12.1 inch (diagonal) color flat panel display for waveform, measurement, and graphical interface display.
- Three front panel USB 2.0 ports.
- Precision BNC connectors for channel input signals.
- BNC connector for auxiliary output signal.
- AutoProbe interface for probe power and probe control.
- A connection for probe compensation.

### **The rear panel provides several connections:**

- The line power input.
- A GPIB connector, for connection to an oscilloscope controller (optional).
- An RS-232 connection.
- A parallel printer connection.
- XGA monitor connection.
- Mouse and keyboard connections.
- LAN 10/1000 connection.
- Auxiliary Trigger Input BNC.
- 10 MHz Reference Output BNC.
- 10 MHz Reference Input BNC.
- TTL trigger output BNC.
- Four rear panel USB 2.0 ports.

The major boards of the oscilloscope are the backplane board and the two acquisition boards (there are several additional minor boards). Figure 7-2 shows the physical layout of the backplane and acquisition boards. The boards are part of a PC system complete with an ATX motherboard, power supply, and LCD display.

Figure 7-2

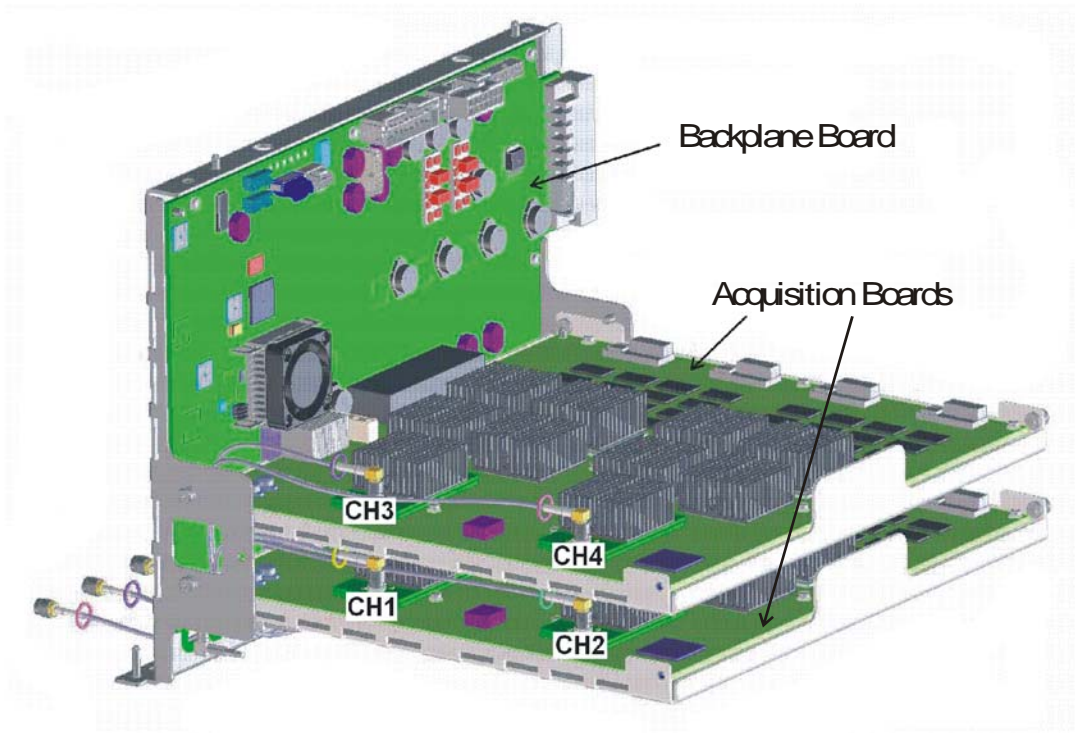

### **Power Supply Assembly**

The AC input to the power supply is 100–240 VAC  $\pm 10\%$ . Maximum input power is 800 W. The AC input frequency is 47 to 63 Hz.

Filtered voltages of +3.3 V, +2.5 V, +1.8 V, +1.2 V, -6 V, -5.2 V, -5 V, and -2.3 V are supplied and distributed throughout the oscilloscope.

### **Monitor Assembly**

The Flat Panel Display (FPD) monitor is a thin film liquid-crystal display (TFT-LCD). This FPD is an 12.1 inch diagonal, 1024 by 768 pixel XGA color monitor.

### **Acquisition System**

There are two acquisition assemblies. The upper acquisition assembly circuitry samples, digitizes, and stores the signals for channels 3 and 4 while the lower acquisition assembly does the same for channels 1 and 2. The acquisition boards contain the TUT modules, the Onboard ADC, the clock distribution, the data management ASICs, the external acquisition memory, the Merlin ADCs, the communication and programming FPGA, and the supporting power supply circuitry. The block diagram for the acquisition boards can be seen in Figure 7-6.

### **Backplane Assembly**

The backplane board is essentially a device on the PCI-Express bus connected by two SATA cables to the motherboard. The backplane board receives +12V power through a distribution board from the supply and all voltage are derived from switches and other circuitry. Most of these are on the backplane board, with some further distribution and generation done on the acquisition boards. Refer to Figure 7-3 for the block diagram of the backplane assembly.

The backplane board uses three identical buses to communicate with three different downstream FPGAs. One is used to control the trigger functions on the backplane board and one is on each of the two acquisition boards. The acquisition board FPGAs are used to program the parts on the acquisition boards. On power-up, after the software recognizes the acquisition boards, the driver loads the trigger FPGA and the acquisition FPGAs using an 8-bit parallel bus with miscellaneous control signals. There is a separate bus for each FPGA so timing problems and reflections could be minimized. After programming is complete, the downstream FPGAs each communicate with the BFPGA using their 8-bit data bus along with a 62.5 MHz communication clock, a 2-bit command bus, a ready signal to the BFPGA, a Data\_valid signal from the BFPGA, and an Interrupt line,

**Figure 7-3**

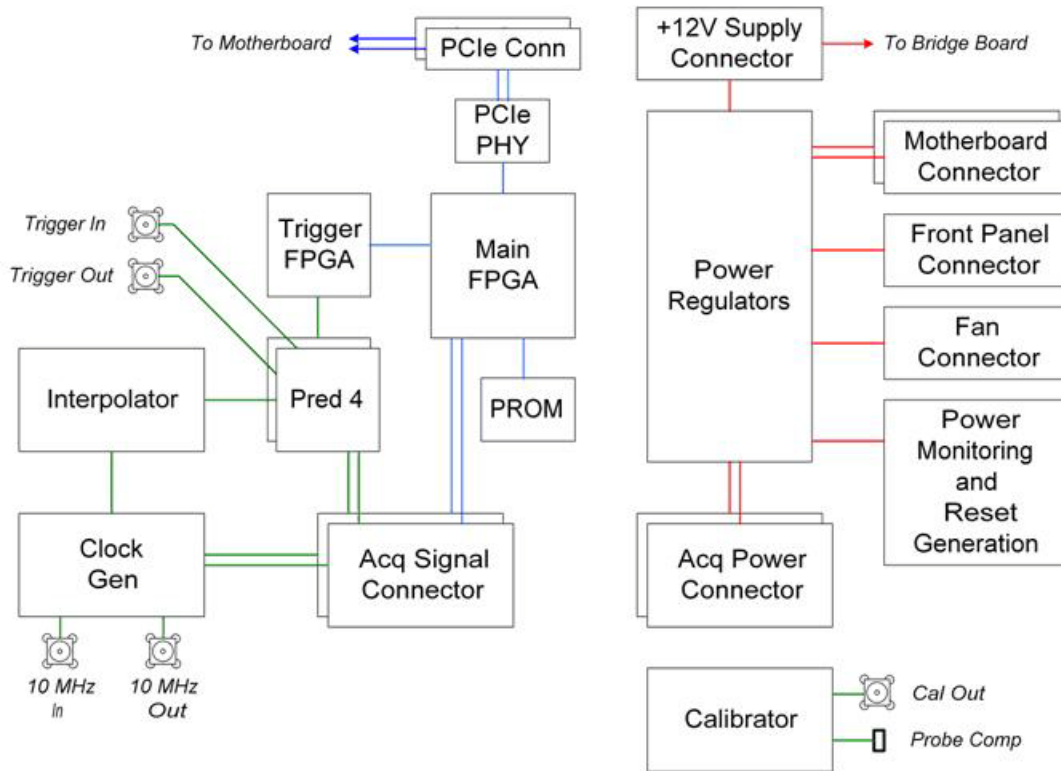

**Backplane assembly block diagram**

**Front Panel**

The front panel board combines functions from the main keyboard and the Autoprobe interface board in a single PCA. Refer to the keyboard block diagram in Figure 7-4.

The keyboard links to the scope PC motherboard through a high-speed USB 2.0 interface. The on-board USB hub serves the PIC microcontroller, the touch screen controller board, and up to three front panel USB connectors for a customer's peripherals.

A conductive element on the inside of each key shorts a gap on the underlying keyboard circuit board. The keyboard controller detects this short and sends the proper keypress information to the system controller on the motherboard.

There are 13 knobs located on the front panel.

Figure 7-4

Keyboard block diagram with key components

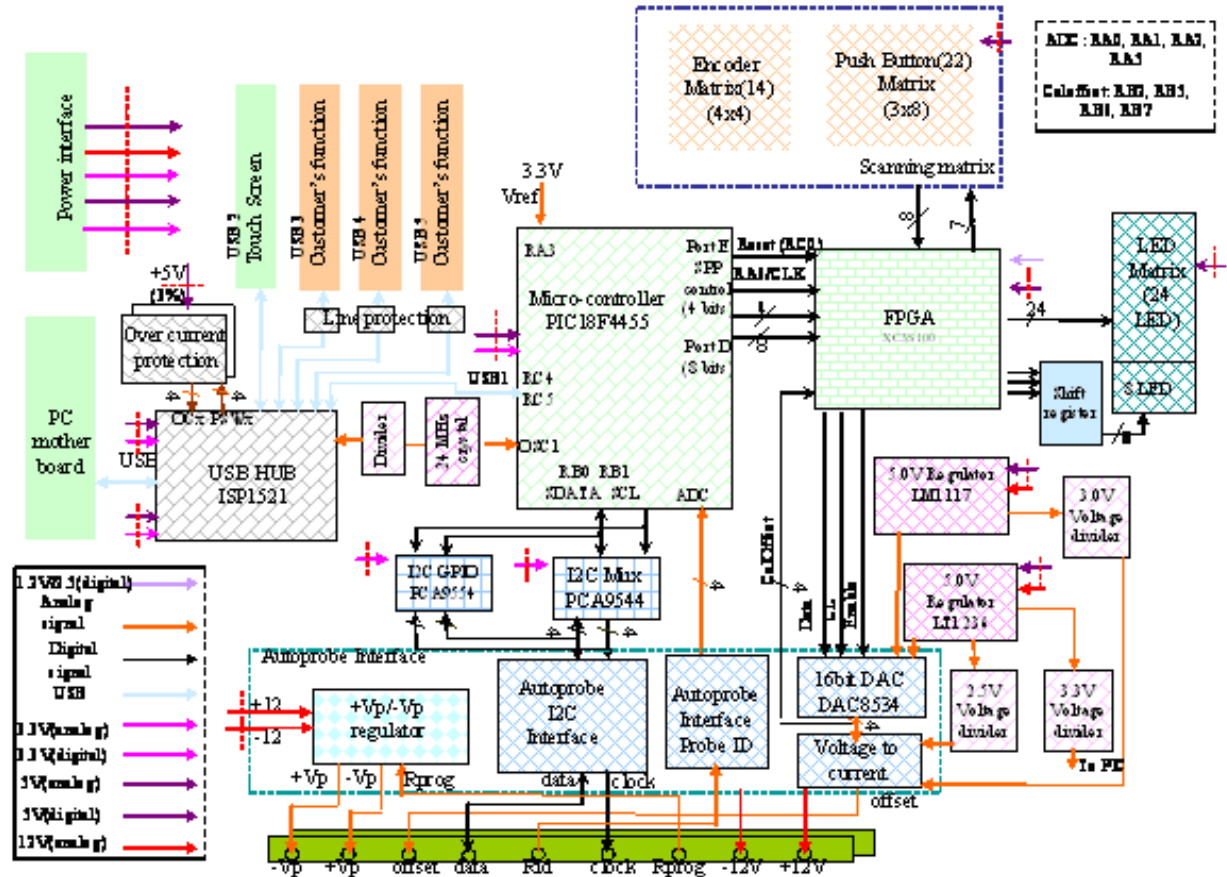

Keyboard block diagram

### Disk Drive

The hard disk drive is a high-capacity, shock-resistant unit. It is used to store the oscilloscope's operating system and certain system configuration data.

The drive can also be used to store and recall oscilloscope setups and waveforms.

## **Chapter 7: Theory of Operation**

### **Block-Level Theory**

#### **Motherboard**

The motherboard provides all system control and interface functions for the oscilloscope. It contains a CPU, ROM, and RAM; keyboard and mouse interfaces, serial and parallel interfaces, CDROM, hard disk drive interface, PCI buses, etc.

#### **Display Board**

The Display Board controls the flat-panel display monitor. It translates the video signals from the motherboard's on-board video system to the Low Voltage Differential Signal (LVDS) signals that drive the monitor.

#### **On/Off Board**

The On/Off board interfaces with the motherboard to provide the on-off switch function and the backplane to provide the probe compensation output. Power indicator LEDs backlight the on-off pushbutton and are driven by the motherboard. The probe compensation lugs connect to the calibrator output on the backplane through an SMB connector coax cable. An ESD protection diode sits on the On-Off board, connecting the signal and ground probe compensation lugs.

#### **Main FPGA**

The main FPGA is the only communication link from the oscilloscope hardware to the PC system. All system controls and data must pass through the main FPGA. It contains a number of registers that can be used to control peripherals, configure, and communicate with other FPGAs, and pass sampled data to the PC. Figure 7-5 shows the main connections to the FPGA. In addition, the FPGA generates PCI interrupts for special events such as front-end overload, the timer done, and a stopped cooling fan.

Figure 7-5

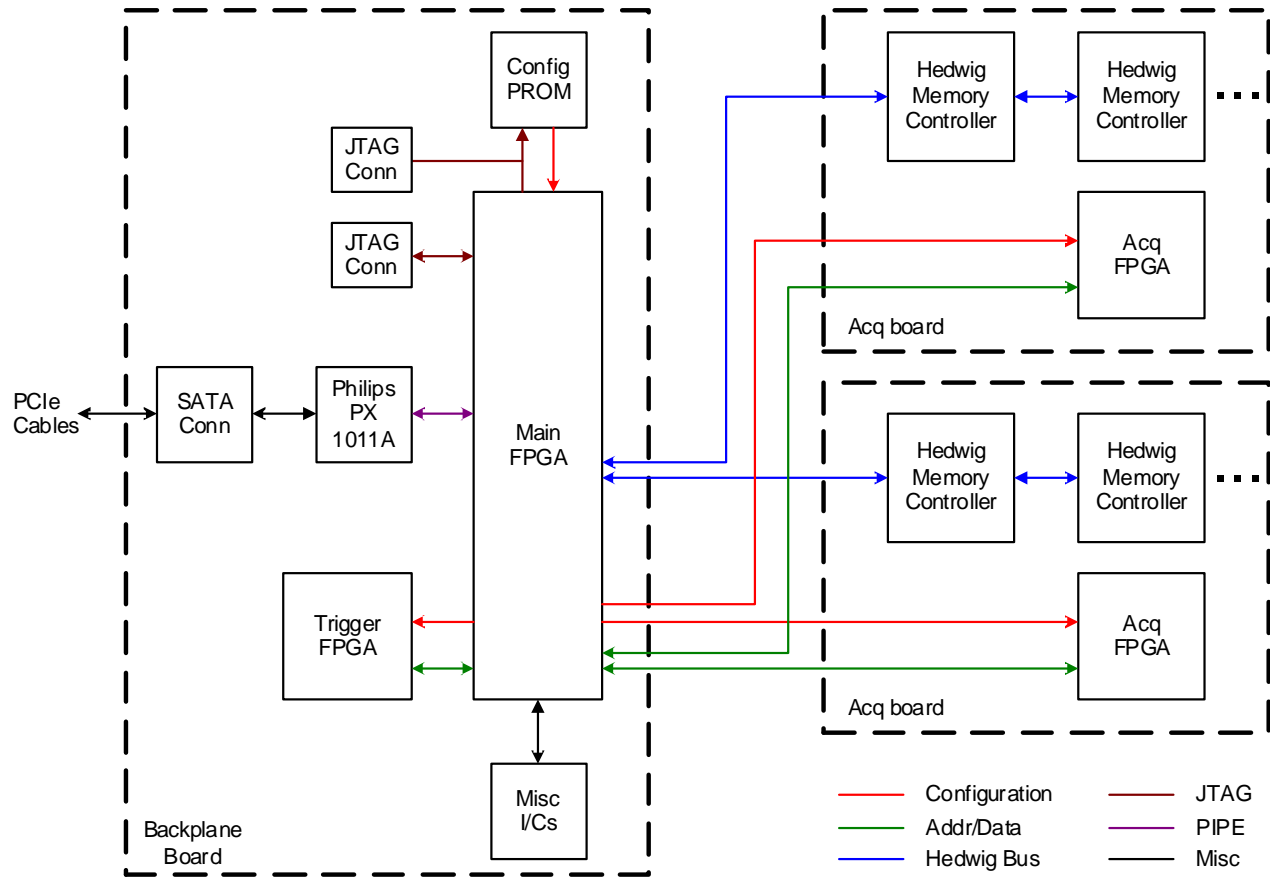

Main FPGA connections block diagram

Figure 7-6

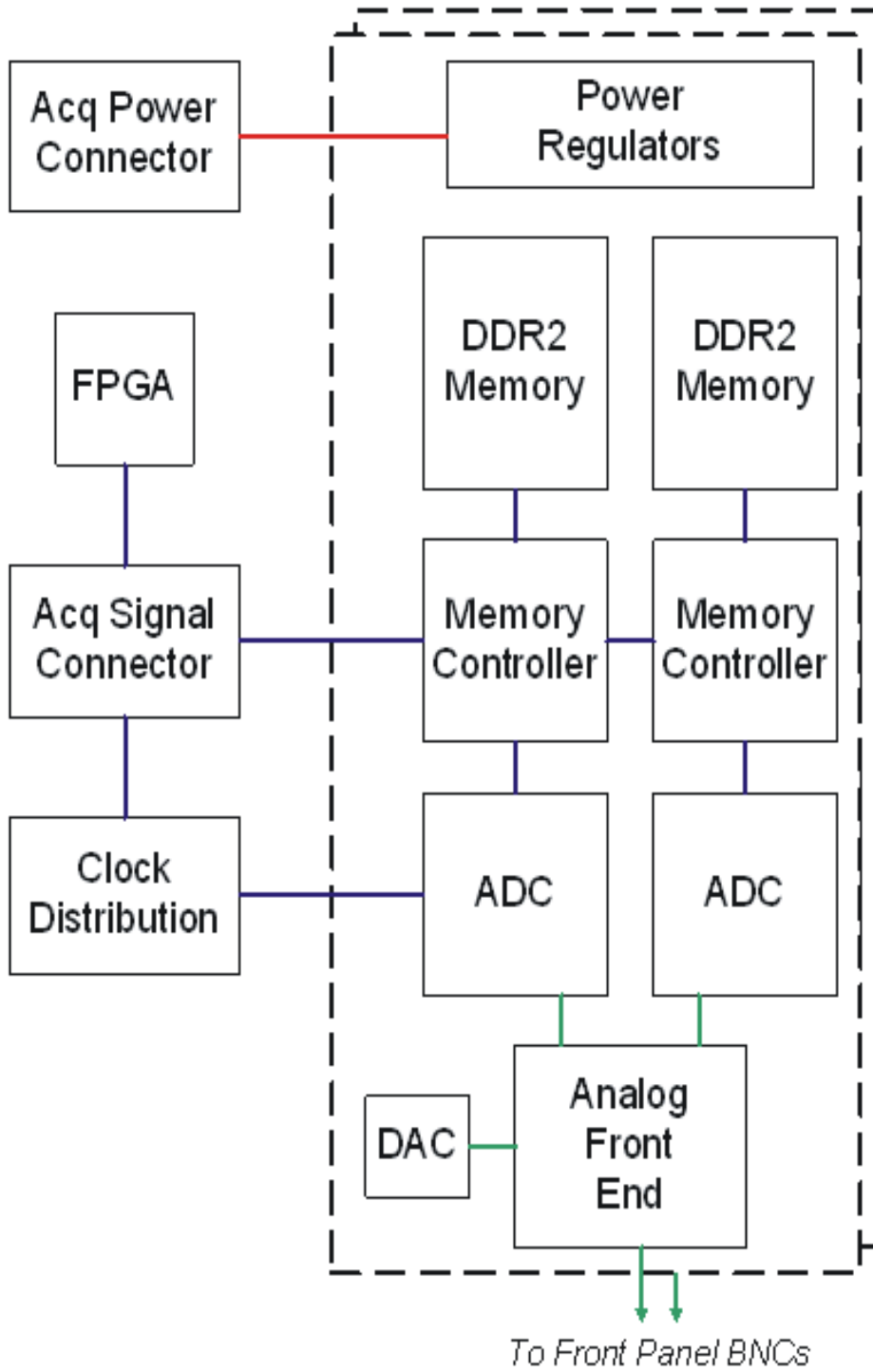

Acquisition board block diagram



# Safety Notices

This apparatus has been designed and tested in accordance with IEC Publication EN 61010-1:2001, Safety Requirements for Measuring Apparatus, and has been supplied in a safe condition. This is a Safety Class I instrument (provided with terminal for protective earthing). Before applying power, verify that the correct safety precautions are taken (see the following warnings). In addition, note the external markings on the instrument that are described under "Safety Symbols."

## Warnings

- Before turning on the instrument, you must connect the protective earth terminal of the instrument to the protective conductor of the (mains) power cord. The mains plug shall only be inserted in a socket outlet provided with a protective earth contact. You must not negate the protective action by using an extension cord (power cable) without a protective conductor (grounding). Grounding one conductor of a two-conductor outlet is not sufficient protection.
- Only fuses with the required rated current, voltage, and specified type (normal blow, time delay, etc.) should be used. Do not use repaired fuses or short-circuited fuseholders. To do so could cause a shock or fire hazard.
- If you energize this instrument by an auto transformer (for voltage reduction or mains isolation), the common terminal must be connected to the earth terminal of the power source.
- Whenever it is likely that the ground protection is impaired, you must make the instrument inoperative and secure it against any unintended operation.
- Service instructions are for trained service personnel. To avoid dangerous electric shock, do not perform any service unless qualified to do so. Do not attempt internal service or adjustment unless another person, capable of rendering first aid and resuscitation, is present.
- Do not install substitute parts or perform any unauthorized modification to the instrument.

- Capacitors inside the instrument may retain a charge even if the instrument is disconnected from its source of supply.

- Do not operate the instrument in the presence of flammable gasses or fumes. Operation of any electrical instrument in such an environment constitutes a definite safety hazard.

- Do not use the instrument in a manner not specified by the manufacturer.

## To clean the instrument

If the instrument requires cleaning: (1) Remove power from the instrument. (2) Clean the external surfaces of the instrument with a soft cloth dampened with a mixture of mild detergent and water. (3) Make sure that the instrument is completely dry before reconnecting it to a power source.

## Safety Symbols



Instruction manual symbol: the product is marked with this symbol when it is necessary for you to refer to the instruction manual in order to protect against damage to the product.



Hazardous voltage symbol.



Earth terminal symbol: Used to indicate a circuit common connected to grounded chassis.

---

# Notices

© Agilent Technologies, Inc. 2007-2013

No part of this manual may be reproduced in any form or by any means (including electronic storage and retrieval or translation into a foreign language) without prior agreement and written consent from Agilent Technologies, Inc. as governed by United States and international copyright laws.

Manual Part Number  
54913-97023, September 2013

Print History  
54913-97023, September 2013  
54913-97022, March 2013  
54913-97007, December 2008  
54913-97004, April 2008  
54913-97002, December 2007

Agilent Technologies, Inc.  
1900 Garden of the Gods Road  
Colorado Springs, CO 80907 USA

## Restricted Rights Legend

If software is for use in the performance of a U.S. Government prime contract or subcontract, Software is delivered and licensed as "Commercial computer software" as defined in DFAR 252.227-7014 (June 1995), or as a "commercial item" as defined in FAR 2.101(a) or as "Restricted computer software" as defined in FAR 52.227-19 (June 1987) or any equivalent agency regulation or contract clause. Use, duplication or disclosure of Software is subject to Agilent Technologies' standard commercial license terms, and non-DOD Departments and Agencies of the U.S. Government will receive no greater than Restricted Rights as defined in FAR 52.227-19(c)(1-2) (June 1987). U.S. Government users will receive no greater than Limited Rights as defined in FAR 52.227-14 (June 1987) or DFAR 252.227-7015 (b)(2) (November 1995), as applicable in any technical data.

## Document Warranty

The material contained in this document is provided "as is," and is subject to being changed, without notice, in future editions. Further, to the maximum extent permitted by applicable law, Agilent disclaims all warranties, either express or implied, with regard to this manual and any information contained herein, including but not limited to the implied warranties of merchantability and fitness for a particular purpose. Agilent shall not be liable for errors or for incidental or consequential damages in connection with the furnishing, use, or performance of this document or of any information contained herein. Should Agilent and the user have a separate written agreement with warranty terms covering the material in this document that conflict with these terms, the warranty terms in the separate agreement shall control.

## Technology Licenses

The hardware and/or software described in this document are furnished under a license and may be used or copied only in accordance with the terms of such license.

## WARNING

A **WARNING** notice denotes a hazard. It calls attention to an operating procedure, practice, or the like that, if not correctly performed or adhered to, could result in personal injury or death. Do not proceed beyond a **WARNING** notice until the indicated conditions are fully understood and met.

## CAUTION

A **CAUTION** notice denotes a hazard. It calls attention to an operating procedure, practice, or the like that, if not correctly performed or adhered to, could result in damage to the product or loss of important data. Do not proceed beyond a **CAUTION** notice until the indicated conditions are fully understood and met.