

Keysight Technologies

What is the difference between an equivalent time sampling oscilloscope and a real-time oscilloscope?

Application Note

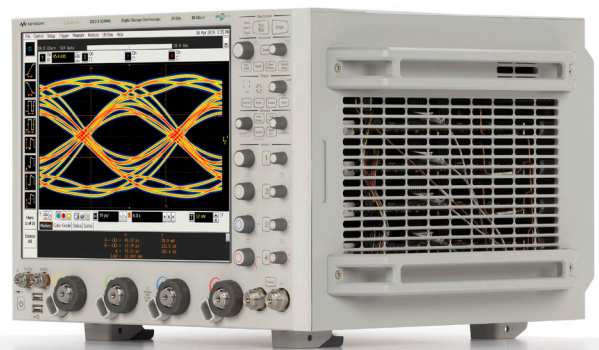

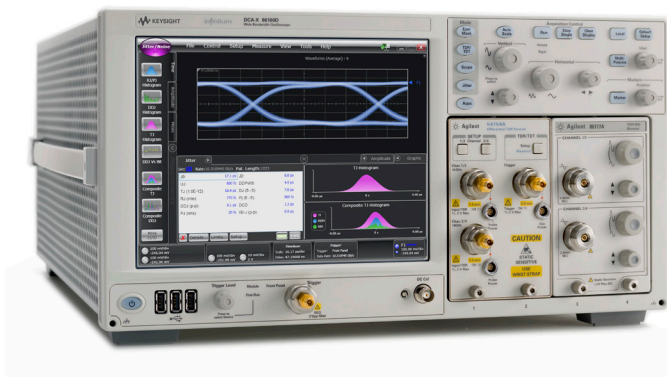

Introduction

In the past, deciding between an equivalent time sampling oscilloscope and a real time oscilloscope was a matter of determining your bandwidth requirements; but with today's high performance instruments that distinction isn't as clear. This document will discuss how each type of scope samples the incoming waveform and explain the trigger requirements. A summary detailing the advantages of each scope is provided at the end.

Real-time oscilloscope

Real-time oscilloscope
as an ADC

A real-time oscilloscope, sometimes called a “single-shot” scope, captures an entire waveform on each trigger event. Put another way, this means that a large number of data points are captured in one continuous record. To better understand this type of data acquisition, imagine it as an extremely fast analog-to-digital converter (ADC) in which the sample rate determines the sample spacing and the memory depth determines the number of points that will be displayed. In order to capture any waveform, the ADC sampling rate needs to be significantly faster than the frequency of the incoming waveform. This sample rate, which can be as fast as 80 GSa/s, determines the bandwidth which currently extends to 63 GHz.

Triggering the real-time
oscilloscope

The real-time scope can be triggered on a feature of the data itself, and often a trigger will occur when the incoming waveform’s amplitude reaches a certain threshold. It is at this point that the scope starts converting the analog waveform to digital data points at a rate asynchronous and very much unrelated to the input waveform’s data rate. That conversion rate, known as the sampling rate, is typically derived from an internal clock signal. The scope samples the amplitude of the input waveform, stores that value in memory, and continues to the next sample as illustrated in Figure 1. The trigger’s main job is to provide a horizontal time reference point for the incoming data.

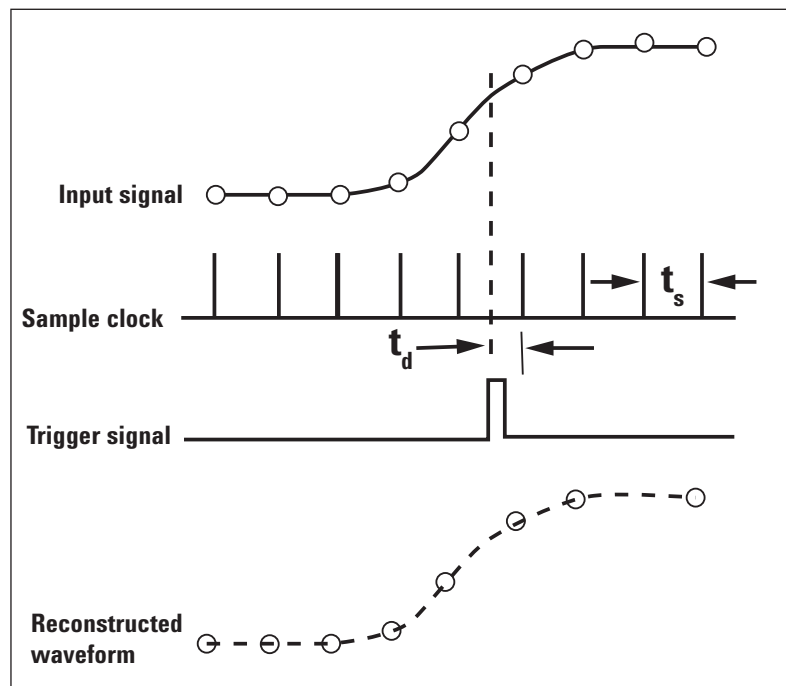

Figure 1 – Waveform acquisition using a real-time oscilloscope

Equivalent time sampling oscilloscope

One sample per cycle

An equivalent time sampling oscilloscope, sometimes simply called a “sampling scope,” measures only the instantaneous amplitude of the waveform at the sampling instant. In contrast to the real-time scope, the input signal is only sampled once per trigger. The next time the scope is triggered, a small delay is added and another sample is taken. The intended number of samples determines the resulting number of cycles needed to reproduce the waveform. The measurement bandwidth is determined by the frequency response of the sampler which currently can extend beyond 80 GHz.

Sampling methodology

The triggering and subsequent sampling of an equivalent time sampling oscilloscope is different from a real-time oscilloscope in some very tangible ways. Most importantly, the equivalent time sampling scope needs an explicit trigger in order to operate, and this trigger needs to be synchronous with the input data. Typically this trigger is provided by the user but, in some cases, the trigger can be obtained using a hardware clock recovery module. The sampling works as follows: A trigger event initiates the acquisition of the first sample, then the scope rearms and waits for another trigger event. The rearm time is approximately 25 μs . The next trigger event initiates the second acquisition and adds a precise incremental delay before sampling the second data point. This incremental delay time is determined by the time base setting and the number of sample points. This process, which is illustrated in Figure 2, is repeated until the entire waveform is acquired.

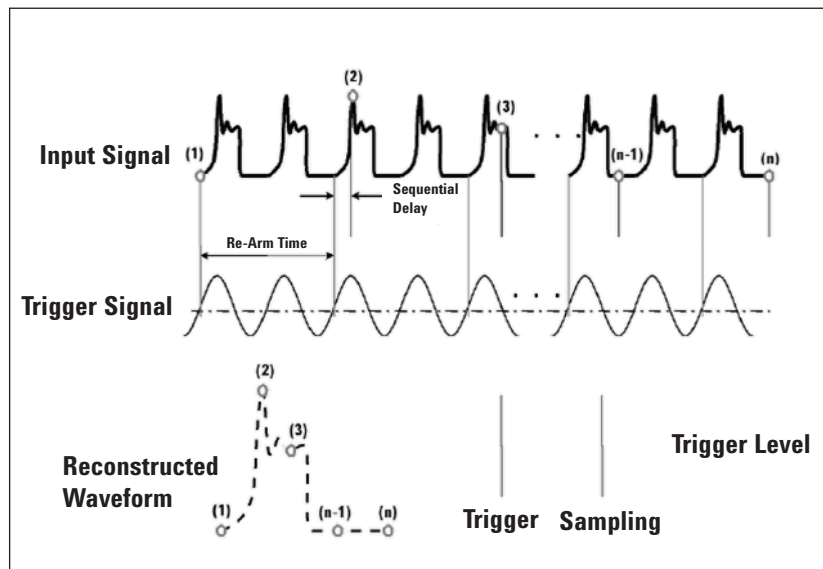

Figure 2 - Waveform acquisition using an equivalent time sampling oscilloscope

Equivalent time sampling oscilloscope (Continuation)

Triggering the equivalent time sampling scope

There are two ways to trigger an equivalent time sampling oscilloscope and each results in a different data viewing format; either a bit stream or an eye diagram. Viewing the individual bits in the signal allows the user to see the pattern dependencies in the system, but does not allow for high resolution with large numbers of bits. In order to view a bit stream, the trigger must only pulse once during the period of the input pattern and must be at the same relative location in the bit pattern for each event. The input signal is then sampled and upon the next trigger event, the incremental delay is added and the bit stream is sampled until the entire waveform is acquired. In order to view a bit stream on an equivalent time scope, you must have a repetitive waveform; otherwise a real-time scope is needed. The triggering process to display a bit stream waveform is shown in Figure 3.

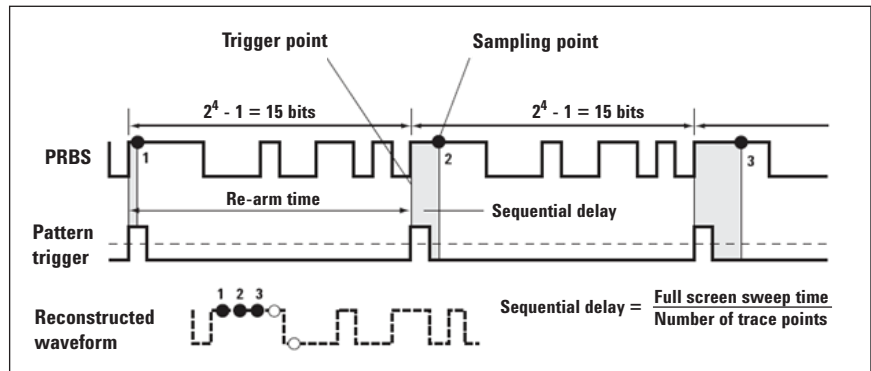

Figure 3 - Sampling Process for a Bit Stream Pattern Waveform

Eye diagram

Creating an eye diagram

The other viewing mode is the eye diagram. This mode does not require a repetitive waveform and can help to determine noise, jitter, distortion, and signal strength among many other measurements. It gives an overall statistical view of the system's performance as it looks at an overlay of every combination of bits in the bit stream. The triggering required for this mode is a synchronous clock signal. At each trigger event, allowing for rearm time, the scope samples the data and builds the combination of all possible 1 and 0 combinations across the screen. Full rate clocks as well as divided rate clocks can be used for the trigger, however if the length of the pattern is an even multiple of the clock divide ratio, the eye diagram will be missing combinations and will therefore be incomplete. In addition, if the data is used as its own trigger, the eye diagram may appear complete, but the scope is only triggered on rising edges of the data pattern. This should be avoided to make accurate eye diagram measurements. The triggering process to display an eye diagram is shown in Figure 4.

Real-time eyes

It is important to note that an eye diagram may also be viewed with newer real-time oscilloscopes. These "real-time eyes" or "single-shot" eye diagrams are constructed using a software recovered clock or an external explicit clock provided by the user. The real-time scope slices the single long capture waveform at times equal to the recovered clock cycle and overlays these bits to recreate the eye diagram.

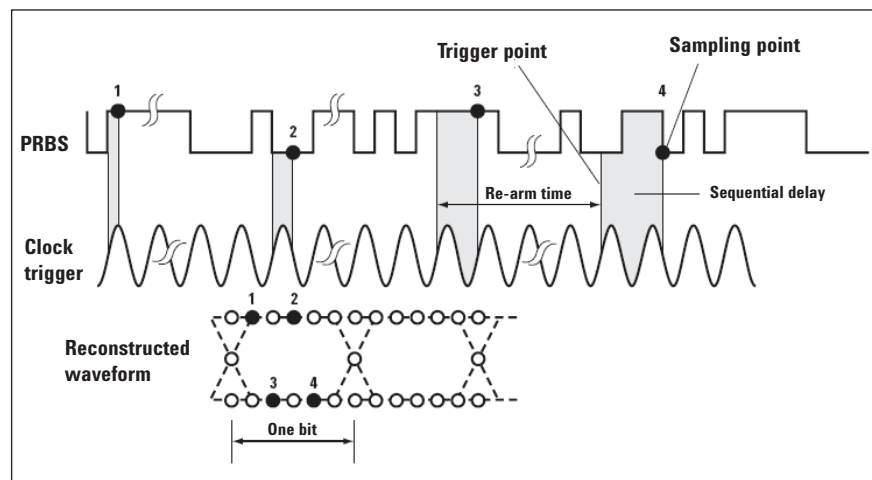
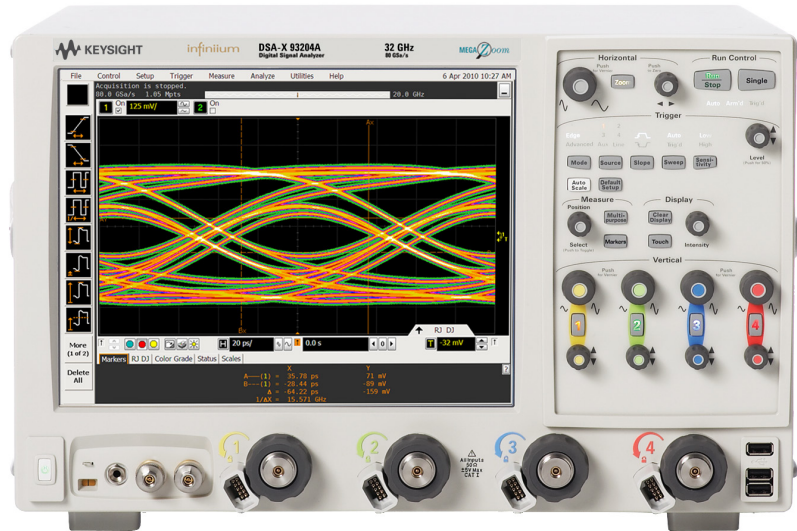

Figure 4 - Sampling Process for an Eye Diagram Waveform

Advantages of real-time scopes

- Able to display one-time transient events
- No explicit trigger needed
- Does not require a repetitive waveform
- Measures cycle to cycle jitter directly
- Large record lengths/ deep memory
- Great for troubleshooting



Advantages of equivalent time sampling scopes

- Lower sampling rate allows higher resolution ADC conversion
- Wider bandwidth
- Lower noise floor
- Lower intrinsic jitter
- Can include front end optical modules
- Can achieve solutions at a reduced cost

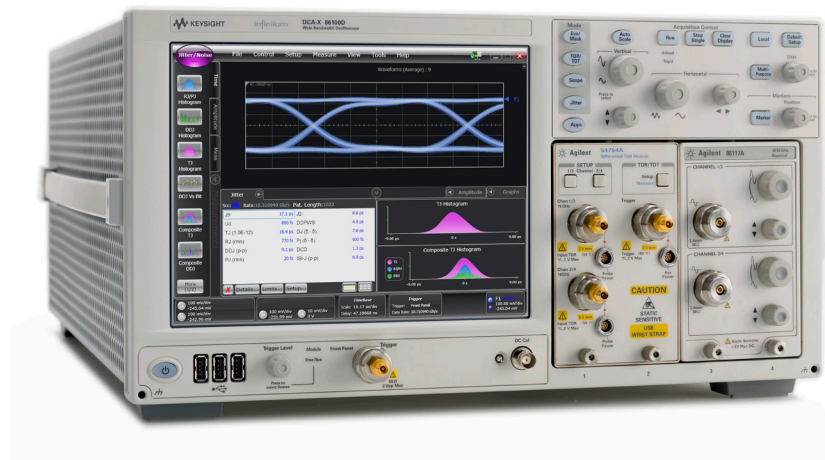

Related literature

Publication title	Publication type	Publication number
<i>Infiniium 90000 Q-Series Oscilloscopes</i>	Data sheet	5989-9712EN
<i>N2807A PrecisionProbe Advanced Kit</i>	Data sheet	5991-0263EN
<i>86100D Wide-Bandwidth Oscilloscope</i>	Data sheet	5990-5824EN
<i>E2688A, N5384A High-Speed Serial Data Analysis and Clock Recovery Software</i>	Data sheet	5989-0108EN
<i>EZJIT Plus Jitter Analysis Software</i>	Data sheet	5989-0109EN

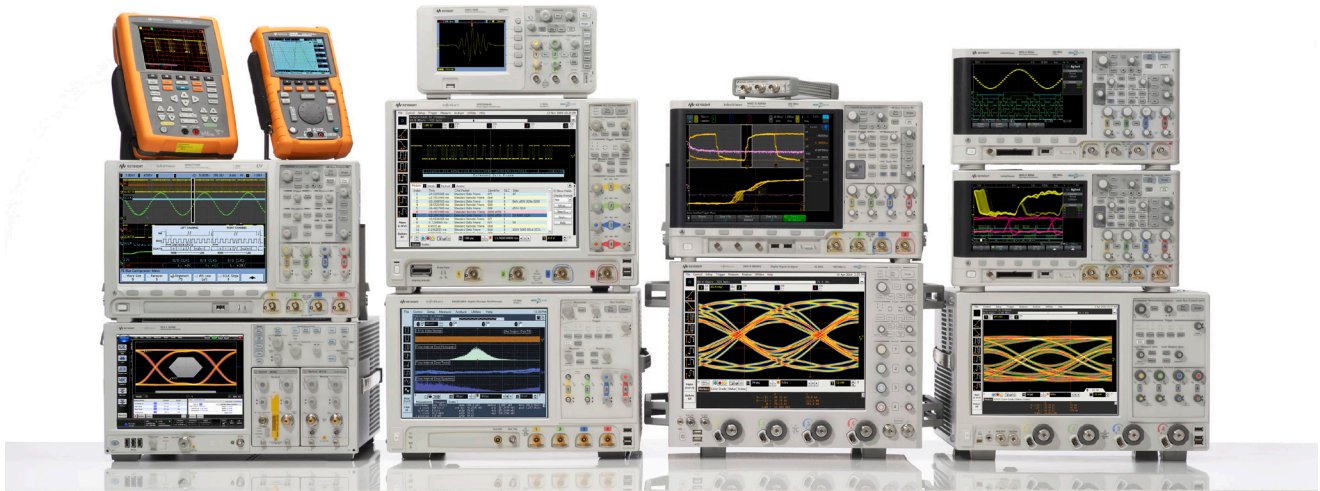

Keysight Technologies, Inc. Oscilloscopes

Multiple form factors from 20 MHz to > 90 GHz | Industry leading specs | Powerful applications

myKeysight

myKeysight

www.keysight.com/find/mykeysight

A personalized view into the information most relevant to you.



www.axistandard.org

AdvancedTCA® Extensions for Instrumentation and Test (AXIe) is an open standard that extends the AdvancedTCA for general purpose and semiconductor test. Keysight is a founding member of the AXIe consortium.



www.lxistandard.org

LAN eXtensions for Instruments puts the power of Ethernet and the Web inside your test systems. Keysight is a founding member of the LXI consortium.



www.pxisa.org

PCI eXtensions for Instrumentation (PXI) modular instrumentation delivers a rugged, PC-based high-performance measurement and automation system.



Three-Year Warranty

www.keysight.com/find/ThreeYearWarranty

Keysight's commitment to superior product quality and lower total cost of ownership. The only test and measurement company with three-year warranty standard on all instruments, worldwide.



Keysight Assurance Plans

www.keysight.com/find/AssurancePlans

Up to five years of protection and no budgetary surprises to ensure your instruments are operating to specification so you can rely on accurate measurements.



www.keysight.com/quality

Keysight Electronic Measurement Group

DEKRA Certified ISO 9001:2008

Quality Management System

Keysight Channel Partners

www.keysight.com/find/channelpartners

Get the best of both worlds: Keysight's measurement expertise and product breadth, combined with channel partner convenience.

For more information on Keysight Technologies' products, applications or services, please contact your local Keysight office. The complete list is available at: www.keysight.com/find/contactus

Americas

Canada	(877) 894 4414
Brazil	55 11 3351 7010
Mexico	001 800 254 2440
United States	(800) 829 4444

Asia Pacific

Australia	1 800 629 485
China	800 810 0189
Hong Kong	800 938 693
India	1 800 112 929
Japan	0120 (421) 345
Korea	080 769 0800
Malaysia	1 800 888 848
Singapore	1 800 375 8100
Taiwan	0800 047 866
Other AP Countries	(65) 6375 8100

Europe & Middle East

Austria	0800 001122
Belgium	0800 58580
Finland	0800 523252
France	0805 980333
Germany	0800 6270999
Ireland	1800 832700
Israel	1 809 343051
Italy	800 599100
Luxembourg	+32 800 58580
Netherlands	0800 0233200
Russia	8800 5009286
Spain	0800 000154
Sweden	0200 882255
Switzerland	0800 805353
	Opt. 1 (DE)
	Opt. 2 (FR)
	Opt. 3 (IT)
United Kingdom	0800 0260637

For other unlisted countries:
www.keysight.com/find/contactus
 (BP-05-19-14)

