

# Keysight Technologies

## Techniques for Precise Power Measurements in the Field

### Using FieldFox Handheld Analyzers

#### Application Note

#### Abstract

This application note will discuss techniques for measuring average and peak power and the associated equipment options available for field testing. As there is a range of instrument types that can measure power, this application note will focus on the two most widely employed RF/microwave instruments, namely, the power sensor and the spectrum analyzer. Measurement examples will include signals such as CW, pulsed and digitally modulated waveforms. It is important to understand the accuracy and limitations of each instrument including factors that can affect the instruments' performance in the field. Comparisons between different power sensors and spectrum analyzers will be presented.



## Introduction

The output power level of a system is the critical factor in the design and performance of almost all radio frequency (RF) and microwave equipment [1]. The transmitted and received power levels determine the overall performance of any communication or radar system. The measurement of signal power is so important that it is measured at every stage of a system beginning with the initial design and prototyping of individual components, during system manufacturing and qualification testing, during on-site system installation and lastly as part of periodic maintenance and troubleshooting in the field.

Given that power measurements have important ramifications to the performance and compliance of a system, it is important that power measurements can be duplicated at different times and at different places. This requires high performance instruments (accuracy) delivering measurements that are stable under various environmental and operating conditions (repeatability). It is also very important that all measured results, regardless of the equipment, have a common agreement as to what is considered an absolute value for the power measurement (traceability).

This application note will discuss techniques for measuring average and peak power and the associated equipment options available for field testing.

# Power Measuring Equipment Configurations

There are a variety of instruments capable of measuring RF and microwave power including power sensors and meters, signal analyzers, spectrum analyzers, and network analyzers [2]. This application note will discuss field-capable instruments, namely, the power sensor and the spectrum analyzer. There are several configurations for connecting a power sensor to a measurement and display system including a traditional power meter, a laptop and a spectrum analyzer. For example, Figure 1 shows different configurations when using combinations of power sensors and spectrum analyzers to accurately measure average and peak power in the field. The power sensor can be configured with a separate power meter, as shown in Figure 1a, or connected to a laptop using a power sensor having a USB port, as shown in Figure 1b. The meter and laptop configurations can support a large number of measurement channels, up to 4 sensors when using a power meter and up to 20 sensors when using a laptop running the appropriate power analysis software.

Another option, shown in Figure 1c, connects a USB power sensor directly to a spectrum analyzer. In this configuration, the spectrum analyzer displays the power measurement thus eliminating the need to carry a power meter or laptop into the field. This spectrum analyzer configuration is very convenient when spectrum testing is also required as part of the system installation, maintenance and/or troubleshooting. One last option, shown in Figure 1d, uses a spectrum analyzer with a built-in channel power meter (CPM) to directly measure the signal power without the need for an external power sensor. In this configuration, the analyzer's tuned receiver measures the average power and a short jumper cable is used to connect the analyzer to the system's test point.

Selection of the power measurement equipment involves a trade-off between accuracy, frequency range, dynamic range, portability, durability and warm-up time. This application note will review the benefits and tradeoffs when using a power sensor and the analyzer's CPM to measure the power of simple and complex signals in the field.



A) Power meter and sensors

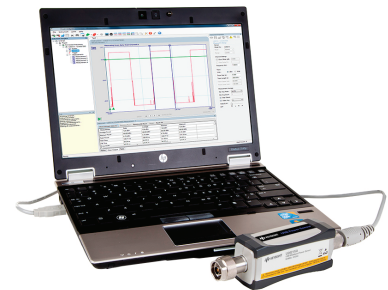

B) Power sensor and laptop



C) Power sensor and analyzer



D) Spectrum analyzer

Figure 1. Equipment configurations for measuring average and peak power

## Power Sensors and Signal Processing

A typical configuration of a power sensor and meter includes a sensor element (detector) followed by analog and digital signal processing components. Figure 2 shows a simplified block diagram of a power sensor and power meter. The sensor element, such as a thermocouple or diode, converts the incoming RF/microwave signal to a DC voltage or low-frequency voltage waveform. The output voltage from the sensor can be on the order of 100 nanovolts (nV) so it is amplified to a high level signal. The amplified signal is then filtered to remove high frequency noise. In some configurations, the bandwidth of the filter is adjustable and can be reduced, to improve the measurement sensitivity, or increased, to improve measurement speed. The analog signal is then digitized using the analog-to-digital converter (ADC). The micro processing unit (MPU) provides additional filtering and time averaging of the sampled waveform. The MPU also interfaces with the user's keypad and controls the meter's display function.

When using a power sensor and separate power meter, the signal processing functions are contained in the meter, as shown in Figure 2 (red box). When using a USB-based power sensor, the signal processing functions are contained in the power sensor (blue box) and a laptop or spectrum analyzer is used as the display. It should be noted that the block diagram shown on Figure 2 is very simplified and the actual signal processing chain includes additional layers of signal conversion, amplification and filtering. Peak power sensors often include additional signal paths for separate processing of average and peak measurements. Additional details can be found in the Keysight Technologies, Inc. Fundamentals of RF and Microwave Power Measurements (Part 2), Power Sensors and Instrumentation, Application Note 1449-2 [3].

In general, power sensors have the highest measurement accuracy but require a zeroing and user calibration to correct for frequency response, temperature drift

and aging of the sensor element. Keysight power sensors and meters include a precision 50 MHz reference oscillator whose output power is controlled with great precision ( $\pm 0.4\%$ ). When using a power meter, the calibration process requires periodic connection of the power sensor directly to the 50 MHz reference connector. When using a Keysight USB power sensor, the 50 MHz reference oscillator is contained within the sensor head and is switched automatically to the sensor element eliminating the need for the operator to connect the sensor to the reference.

There are a variety of different power sensors covering a range of input frequencies and power levels but RF/microwave detectors generally fall into two categories, thermal-based sensors and diode-based sensors. In the next two sections of this application note, the basic technology and operation of these power sensor types will be discussed including their relative sensitivities and dynamic range.

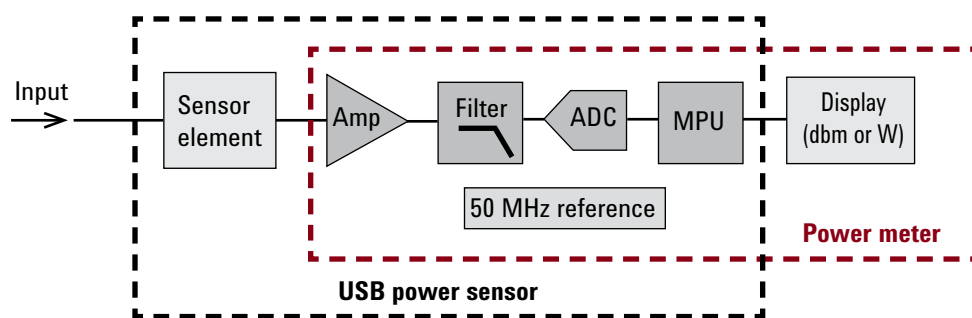

Figure 2. Simplified block diagram of a power sensor and power meter

## Thermal-Based Power Sensors

Thermal-based sensors convert heat generated by the RF/microwave signal into a change in the electrical property of the sensor. These types of sensors include thermistors and thermocouples. Thermal-based sensors respond to the total power in the signal and report the true average power of the signal, regardless of modulation format.

The thermistor was the first power sensor. They function as a power measurement sensor when the input RF signal causes a temperature rise in the sensor which results in a decrease in the sensor's resistance. This change in resistance, and the associated sensor bias, can be accurately measured in a bridge circuit. While thermistors have been slowly replaced by other types of sensors they are still used extensively in metrology and power transfer standard applications in a laboratory environment. For field use, other sensor types are more effective as thermistors have low RF measurement sensitivity, with the measurement floor at approximately  $-20$  dBm, and slow measurement speed. All thermistors require connection to a separate power meter. Thermistors are also sensitive to ambient temperature which makes them difficult to use during field measurements where harsh environments often result in large temperature swings.

Thermocouples also measure power with thermal changes in the sensor. In this sensor type, temperature changes generate a voltage change that can be directly measured by the instrument. Thermocouples are generally more rugged and less sensitive to ambient temperature than thermistors making them a better choice for field measurements. The sensitivity of the thermocouple is slightly improved to approximately  $-35$  dBm but requires a reference oscillator to calibrate for temperature drift and sensor aging. Thermocouples are available in USB-based modules or require connection to a separate power meter.

When measuring high power levels, up to  $+20$  dBm, thermal-based sensors are ideal for measuring the average power of CW and modulated signals. Additional details on the operation and performance of thermistors and thermocouples can be found in the Keysight Fundamentals of RF and Microwave Power Measurements (Part 2), Power Sensors and Instrumentation, Application Note 1449-2 [3].

# Diode-Based Power Sensors

Thermal-based power sensors measure the average power of CW and modulated signals but generally have a limited dynamic range. Diode-based sensors have a much wider dynamic range but have non-linear characteristics which must be characterized and compensated in order to achieve highly accurate measurements of average and peak power. Diode-based sensors rectify and filter the input RF/microwave signal using a diode and capacitor as shown in Figure 3. The input signal sees a 50-ohm load to match the 50-ohm transmission line to the sensor's input over a wide range of frequencies. The diode rectifies the RF voltage waveform and the capacitor provides an initial level of low pass filtering. The output waveform is then amplified, filtered and sampled by the power meter.

Diode-based sensors primarily operate in the "square-law" region where the detected output voltage is proportional to the square of the input voltage and therefore directly proportional to the input power. In this region, the relationship between input power to output voltage is linear, as shown by the straight line in Figure 4. Within this square law region, which extends with an input power that varies from approximately -70 dBm to -20 dBm (50 dB range), both the average and peak power of any modulated waveform can be accurately measured. At higher power levels, above 0 dBm, the diode characteristic is no longer a power-to-voltage relationship but becomes a linear voltage-to-voltage relationship. Between the square-law and linear regions, there is a transition region that occurs over an input power range of -20 dBm to 0 dBm. Operating at power levels above +20 dBm may cause permanent damage to the diode.

Similar to the thermocouple sensors, diode sensors require a reference oscillator for calibration and traceability. For the highest measurement accuracy, diode sensors require a 30-minute warm-up time which could be problematic when attempting to make rapid measurements in the field.

Diode-based power sensors are also extremely sensitive to static discharge and mechanical shock. It is important to follow electrostatic discharge (ESD) safety precautions when handling power sensors.

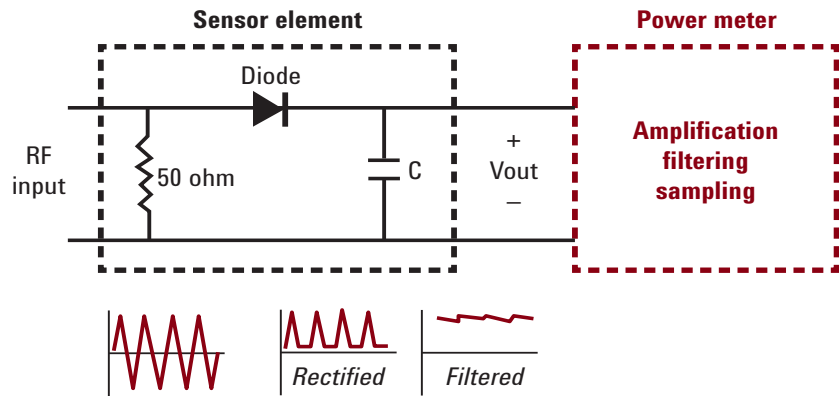

Figure 3. Diode-based power sensor showing diode rectification and filtering of the input RF waveform

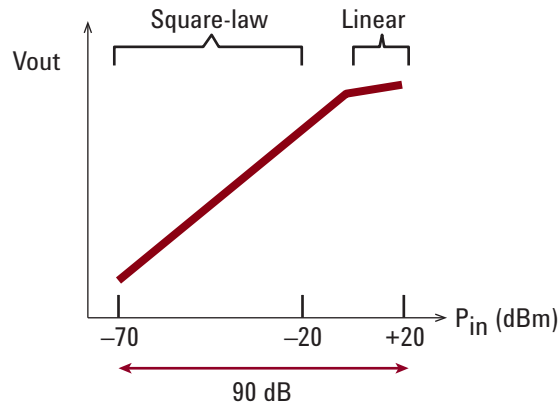

Figure 4. Diode-based sensor output voltage characteristic as a function of input power

# Diode-Based Power Sensors

## Average power of CW Signals using diode-based sensors

Using signal processing techniques, the transition and linear regions can be modeled and power measurements of CW signals can be corrected allowing the sensor's total measurement range to extend over 90 dB. Diode-based sensors include an EEPROM table of correction factors to compensate for the measurements over wide ranges of input powers, temperatures and frequencies. It should be noted that measurements made in the higher-power transition and linear regions are only accurate for CW signals, and thus, these types of sensors are referred to as "CW-only" sensors. There are numerous applications for measuring the power of CW signals including testing frequency sources, such as oscillators and synthesizers, and testing the output power from amplifiers and the associated gain compression. CW-only sensors, such as the Keysight E4412/13A sensor, provide the lowest sensitivity and highest dynamic range of all the sensor types and are generally the lowest-cost sensor for measuring the power of CW signals.

## Average power of modulated signals using diode-based sensors

At high power levels, between approximately  $-20$  dBm to  $+20$  dBm, a standard diode-based sensor will not accurately report the average power of modulated signals, including pulsed and digitally modulated waveforms. Under these high power conditions, the correction factors applied to a diode-based sensor over the transition and linear regions will not be accurate for modulated signals. In this case, the addition of external attenuation would maintain operation in the square-law region but will also reduce the sensitivity, dynamic range and accuracy of the sensor. Another option for measuring modulated signals over a wide dynamic range, while maintaining high accuracy and traceability, is a sensor that includes two measurement paths to maintain diode operation in the square-law region under all power levels. Wide dynamic range sensors, such as the Keysight E9300 E-Series, contain two separate measurement paths, one covering  $-60$  to  $-10$  dBm and one covering  $-10$  to  $+20$  dBm. The higher power path includes an internal attenuator before the diode sensor. Path switching is automatic and provides an innovative technique to always maintain diode operation in the square-law region thus providing high dynamic range, accuracy and traceability for all average measurements.

## Peak power of modulated signals using diode-based sensors

Measuring the peak power of signals with pulsed and modulated signals requires two levels of signal detection [3]. First the RF modulated signal is detected using the diode sensor and converted to a wideband video signal. The video signal represents the time-varying envelope of the modulated waveform. The second layer of detection occurs when the wideband video is sampled at a high rate and further processed. Having individual samples of the envelope, amplitude corrections can be applied to the samples by adjusting the measured power for operation in the square-law, transition or linear regions of the diode sensor. These correction factors are stored internally to the peak power sensor, such is the case for the Keysight E-Series and X-Series peak and average power sensors and P-Series wideband power sensors. The correction factors are also stored to adjust for frequency response and temperature changes.

It is important to note that when using diode-based sensors to measure the peak power of modulated signals, the measurement bandwidth of the sensor/meter must be larger than the bandwidth of the signal under test otherwise peak excursions could be lost due to the response time of the instrument's filters. Additional information relating to peak power and measurement bandwidth will be discussed later in this application note.

# Tuned Receiver Power Measurements

Along with the many power sensor options available for measuring the power of CW and modulated signals, there is a fairly simple technique to measure average power using a spectrum analyzer. The spectrum analyzer is a specific form of a tuned receiver offering improved sensitivity, higher dynamic range and no warm-up time when compared to the thermal-based and diode-based power sensors. The spectrum analyzer will not provide the level of accuracy found in power sensors but modern analyzers, such as the Keysight FieldFox, can provide typical accuracies on the order of  $\pm 0.5$  dB across the entire frequency, temperature and dynamic range of the instrument.

Figure 5 shows a very simplified block diagram of a tuned receiver found in most modern communication receivers and spectrum analyzers. There are several major differences in the tuned receiver architecture when compared to the power sensor/meter architecture previously shown in Figure 2. First the amplitude detector in the tuned receiver, shown in Figure 5 as a diode, is moved further to the right in comparison to the location of the broadband detector in a power sensor that is directly at the front-end. Next, the front-end of the tuned receiver has a downconversion block consisting of a mixer and local oscillator. Also, there is an additional bandpass filter placed before the amplitude detector in a tuned receiver. This architecture is very typical of modern receivers and is known as a superheterodyne receiver.

Heterodyning is the process of translating the center frequency of the original RF signal down to a lower frequency where it can easily be filtered and detected. The “super” refers to translating the frequency to the super-audio range, in other words, above the audio frequency range. Spectrum analyzers, such as the FieldFox, use this architecture to display the power of a signal as a function of frequency whereby a local oscillator is swept across a specified range of frequencies. In some applications, the spectrum analyzer is configured with a stationary local oscillator in a mode called “zero span.” Additional information regarding zero-span mode can be found in the spectrum analyzer user’s guide.

Traditionally spectrum analyzers provided all or most filtering in the analog domain. Modern analyzers place an analog-to-digital converter (ADC) closer to the analyzer’s input and sample the down-converted intermediate frequency (IF) for filtering and detection in the digital domain. As shown in Figure 5, there are two stages of digital filtering. First the digitized IF is filtered using a bandpass filter. In a communications system, this filter bandwidth is typically fixed and referred to as the “channel” filter. In a spectrum analyzer, this filter bandwidth is adjustable and referred to as the “resolution bandwidth” (RBW) of the analyzer. After RBW filtering, the amplitude of the signal is detected and low pass filtered. This stage of low pass filtering is referred to as the “video bandwidth” (VBW) of an

analyzer. In an analyzer with digital IF, the diode detector is actually an algorithm in the firmware processing of the instrument that simulates an ideal square-law detector over all ranges of input power.

One of the main differences between power meters and spectrum analyzers is frequency selectivity. A spectrum analyzer measures the power in a particular resolution bandwidth (RBW). A power sensor is not frequency selective and detects the power in the full frequency range of the sensor including harmonics and any other signal entering the sensor. The lack of an adjustable RBW is the main reason that sensors can only measure down to  $-70$  dBm. A spectrum analyzer on the other hand can measure signals with much lower power by selecting a narrow RBW filter setting. A spectrum analyzer, such as the FieldFox, has sensitivity as low as  $-154$  dBm/Hz and a dynamic range greater than 105 dB. Another advantage when using the FieldFox is no warm-up time as the analyzer contains a unique automatic calibration process, called InstAlign, which provides high measurement accuracy across the full range of power, frequency and temperature. The InstAlign feature utilizes an internal calibration reference and a proprietary amplitude alignment algorithm to automatically improve the accuracy of all amplitude measurements with any changes to instrument settings and temperature.

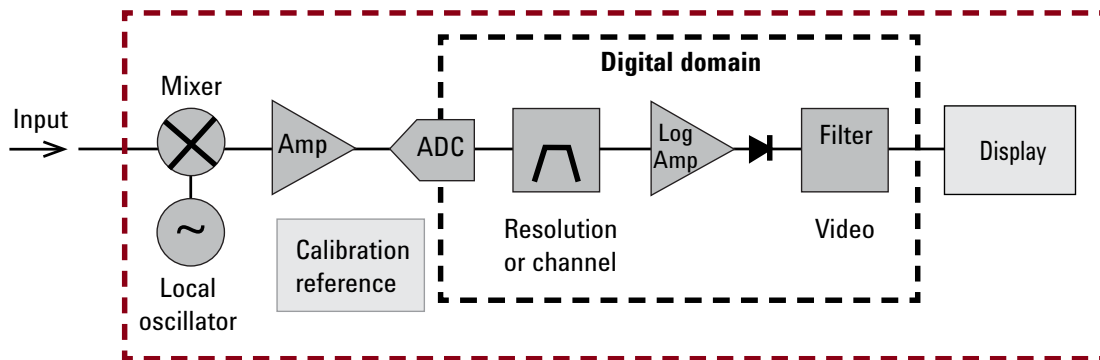

Figure 5. Simplified block diagram of a tuned receiver with digital IF



## Measurement examples of CW and modulated signals

In the next few sections of this application note, measurements of average power will be compared using a power sensor and a tuned receiver (spectrum analyzer). Examples include CW, multi-tone, 32QAM digitally modulated and pulsed. For these examples, a Keysight MXG vector signal generator is configured for a 6 GHz signal with an output power of  $-20$  dBm. The measurements using a power sensor will be performed using a Keysight U2000A USB power sensor connected to the Keysight N9938A FieldFox spectrum analyzer with Option 302. In this first

measurement configuration, shown in Figure 6a, the analyzer is used to display the power sensor measurement directly on the analyzer's display. The second configuration for measuring average power will use the tuned receiver in the N9938A FieldFox with built-in channel power meter (CPM) Option 310. As shown in Figure 6b, a short coaxial jumper cable is required to connect the analyzer's test port to the signal generator's output connector. In this case, the insertion loss of the jumper cable was compensated using the cable loss function on the FieldFox.

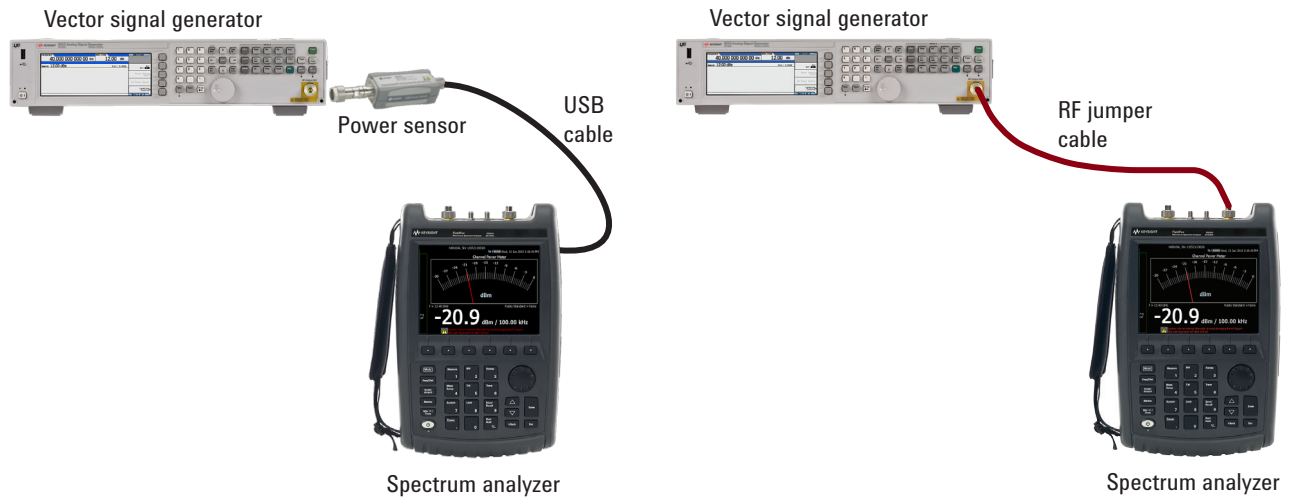

Figure 6. Measurement configurations for comparing the average power using the (a) USB power sensor and (b) tuned receiver with built-in channel power meter

## Measurement examples of CW and modulated signals

### CW measurement example

Continuous wave (CW) signals do not carry any information and are the easiest to measure as the average and peak power are the same and the signal has no bandwidth. In this case, the measuring equipment can use narrow bandwidth filters to improve the sensitivity (noise floor) of the instrument. Figure 7a depicts a typical spectrum analyzer measurement showing the swept frequency spectrum response around the signal under test. In this case, a single tone is observed across a measurement span of 500 kHz. A marker is placed at the peak of the signal using a marker search function. The marker reports the signal peak to be  $-20.08$  dBm. As mentioned, for CW signals the peak and the average powers are the same so the measured value of  $-20.08$  dBm also represents the average power in this CW signal. Figure 7b shows the measured average power using the USB power sensor. Here the power is measured at  $-20.00$  dBm. Figure 7c shows the average power using the channel power meter (CPM) option on the FieldFox. Here the power is measured at  $-20.09$  dBm.

Under these laboratory conditions, all three measurements are within 0.1 dB of each other. It is expected that the power sensor would have the higher accuracy, or lowest measurement uncertainty, but a complete uncertainty analysis would be required to determine the error limits. Keysight provides an application note [4] that outlines the process for calculating the measurement uncertainty when using a power sensor and a spectrum analyzer. Keysight also provides a set of “measurement uncertainty calculators” which are spreadsheets that calculate the uncertainty limits for many of the Keysight power sensors [5, 6]. Using the uncertainty calculator for the U2000A power sensor, the error limits are  $+0.195/-0.204$  dB around a  $-20$  dBm measurement. For the FieldFox CPM, operating under these test conditions, the data sheet reports the typical limits between of  $\pm 0.50$  dB and the specified limits of  $\pm 1.0$  dB. Additional details concerning measurement accuracy will be discussed later in this application note.

It should be noted that the FieldFox built-in CPM measurement requires a selection for the measurement span. This is equivalent to the channel bandwidth of the signal under test. In the example shown in Figure 7c, the span was set to 100 kHz. For this example, the span can be set to any value as a CW signal has no bandwidth. It should be noted that narrow spans increase measurement time while wider spans increase noise and uncertainty.

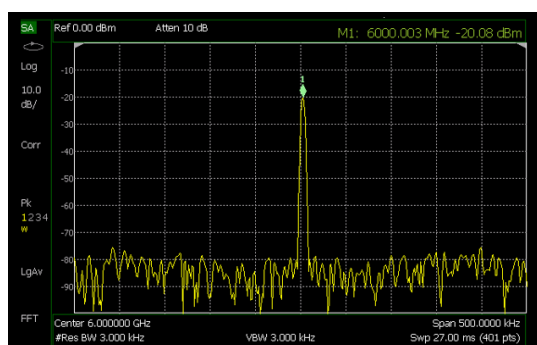

(a)



(b)



(c)

Figure 7. Measurement of CW signal using the (a) spectrum analyzer and marker, (b) power sensor and (c) spectrum analyzer with built-in channel power meter (CPM)

# Measurement Examples of CW and Modulated Signals

## Multi-tone measurement example

In this example, the power from the signal generator is distributed among five individual tones. The tone spacing was configured at 500 kHz. Figure 8a shows the spectrum analyzer display of the measured frequency response of this multi-tone signal. Ideally, if the total power for all the tones is  $-20$  dBm (10 microwatts), then an individual tone has a power of  $-26.98$  dBm (2 microwatts). An average power sensor will measure the average power of the complete signal across all five tones. In this example, the power sensor measures the average power at  $-20.13$  dBm. The built-in channel power meter (CPM) measures the total power at  $-20.2$  dBm. In the CPM measurement, the measurement span must be configured to encompass all five tones. For this example, the minimum CPM span should be at least 2.5 MHz (500 kHz tone spacing multiplied by five tones). In this example, the measurement span was set to 3 MHz.

If the CPM measurement is repeated but this time the span is reduced to 200 kHz, the CPM measurement now only includes the single tone centered at 6 GHz. The displayed CPM reported the power measurement of a single tone at  $-27.1$  dBm which is very close to the theoretical value of  $-26.98$  dBm for a single tone. Making measurements of single tones or specific measurement spans is only possible with a spectrum analyzer based power measurement system. The power sensor has a wideband front-end and is not frequency selective unless an external filter is attached between the sensor and the device under test.

It should be mentioned that the peak power of this complex signal is not equal to the average power. The peak power is related to the phase relationship between the multiple tones as these signals add and subtract over time. Peak power measurements often require a sensor with peak power capability and a video filter wide enough to process all the tones at the same time. For this measurement, the video bandwidth for a peak power measurement would need to be at least 2.5 MHz wide. Peak power measurements will be discussed later in this application note.

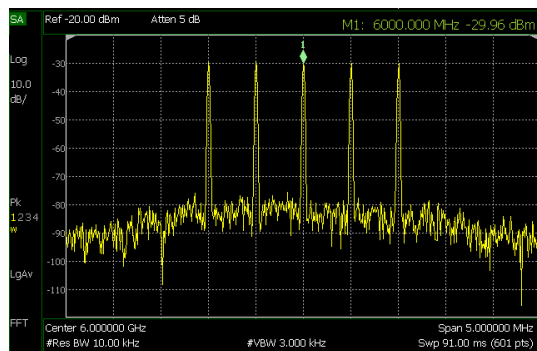

(a)



(b)



(c)

Figure 8. Measurement of a multi-tone signal using the (a) spectrum analyzer, (b) power sensor and (c) spectrum analyzer with built-in channel power meter (CPM)

## Measurement Examples of CW and Modulated Signals

### Digitally modulated measurement example

Here is another measurement example using a digitally modulated signal found in a typical wireless communications system. The signal uses a 32 quadrature amplitude modulation (QAM) with a symbol rate of 5 Msymbols per second (MSPS). The transmitted symbols are filtered to contain the spectrum using a Root Nyquist filter having an alpha factor of 0.5. With these parameters the signal bandwidth is approximately 8 MHz wide as shown in the spectrum analyzer plot in Figure 9a. As shown in Figure 9b and 9c, the power sensor reports an average power of  $-20.00$  dBm and the built-in CPM reports  $-20.07$  dBm using a span of 8 MHz.

In some applications the signal bandwidth may be unknown. In this case, a measurement using a power sensor will report the correct average power as long as the power level and operating frequency range is within the specifications for the selected sensor. When using the built-in CPM on the FieldFox, it is necessary to properly set the measurement span before accurate measurements can be achieved. In this case, reverting to a standard spectrum analyzer measurement will be very useful to determine the signal bandwidth of the unknown signal. Once the bandwidth is determined, the analyzer can be switched back to the CPM and configured with the proper span setting.

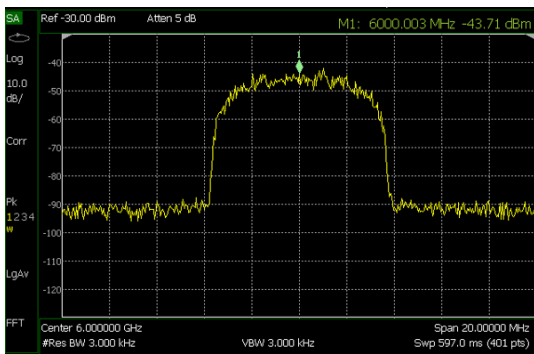

(a)



(b)



(c)

Figure 9. Measurement of a 32QAM signal using the (a) spectrum analyzer, (b) power sensor and (c) tuned receiver with built-in channel power meter (CPM)

# Measurement Examples of CW and Modulated Signals

## Pulsed waveform measurement example

Before discussing techniques to measure peak power and pulsed waveform profiles it is useful to review the basic definitions of pulsed waveforms. Figure 10 shows a simple pulsed waveform having a narrow pulse width and associated period in time. These two parameters are especially important in a radar application where the pulse width determines the resolution of the radar system and the period, also known as the pulse repetition interval (PRI), determines that maximum unambiguous range. The ratio of the pulse width to PRI is called the duty factor (DF).

$$\text{Duty Factor (DF)} = \frac{\text{Pulse Width}}{\text{PRI}}$$

The duty factor, typically expressed as a percentage, is the amount of time that the pulse is "on" relative to the total time between the start of successive pulses. For example, a DF of 10% means the pulse is transmitting for one tenth of the total time. For a periodic pulsed waveform, there is a direct relationship between the peak and average power. The peak power is the average power divided by the DF. For a well defined pulsed waveform,

this relationship allows the peak power to be calculated from an average power measurement.

$$\text{Peak Power} = \frac{\text{Average Power}}{\text{DF}}$$

Figure 11 shows an example of the measured spectrum and average power of a pulsed waveform having a 20 micro-second pulse width and a 20% duty factor. The spectrum analyzer display, shown in Figure 11a, shows a typical "sin(x)/x" response as a function of frequency. The sidebands in the frequency domain continue outside the displayed 1 MHz frequency span. The average power measurement using the power sensor,

shown in Figure 11b, reports a power of -27.01 dBm. The measurement using the CPM reports an average power of -26.8 dBm, as shown in Figure 11c. For the CPM measurement, the span was set to 3 MHz in order to capture most of the sideband energy in the waveform. For this waveform, increasing the measurement span beyond 3 MHz did not show a change in the measured power. The peak power in this 20% DF pulsed waveform can be calculated by increasing the average level by 6.99 dB (10LOG(1/DF)). Using a measured average power of -27 dBm, the peak power is calculated to be -20 dBm which is also the amplitude setting on the vector signal generator.

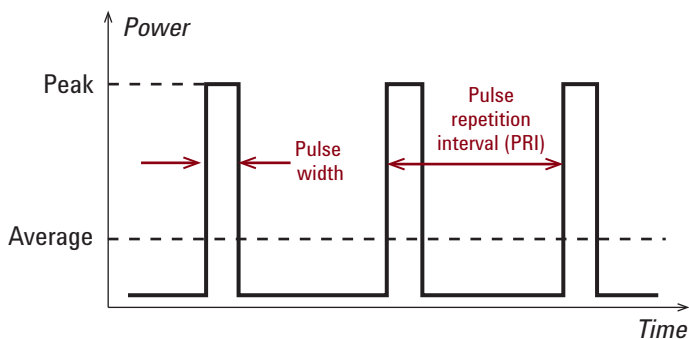
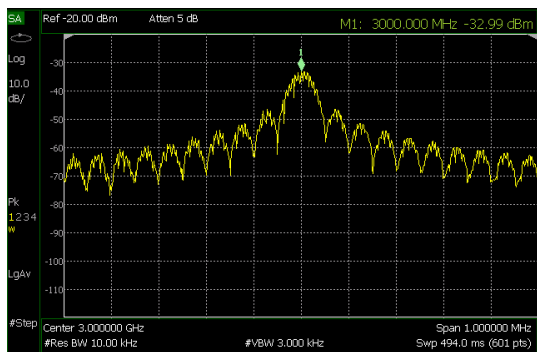
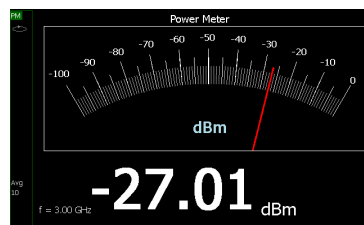

Figure 10. Definition of pulsed waveform parameters



(a)



(b)

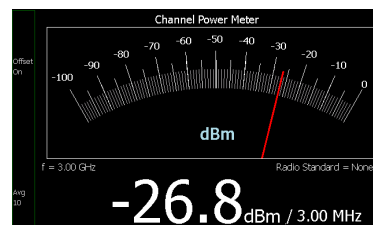

(c)

Figure 11. Measurement of a pulsed waveform with 20% duty factor using the (a) spectrum analyzer, (b) power sensor and (c) spectrum analyzer with built-in channel power meter (CPM)

# Measurement examples of CW and modulated signals

## Detection and filtering in peak power measurements

A power sensor and meter designed to measure peak power has a similar block diagram to an average power sensor. In comparison to an average power sensor, the peak power sensor/meter will have wider video bandwidth and higher sample rates in the ADC to accommodate the rapid transitions found in pulsed and complex modulated waveforms. Figure 12 shows a simplified block diagram of a peak power sensor. In practice, a typical peak power sensor would contain two separate measurement paths, one optimized for measuring the average power and one optimized for measuring the peak power [3].

Examining the measurement path for the peak power function, the sensor can be considered as having a two-layer detection scheme. The first detection occurs at the front-end where the diode rectifies the incoming waveform. As the diode detector is often a wideband device, the rapidly changing envelope of the pulsed waveform will be maintained in the rectified waveform. After detection, the signal is amplified and filtered. Typically, the video filter would have a selectable BW as wide as 30 MHz in some sensors, such as the Keysight P-Series and X-Series sensors. It is important that the video BW is chosen larger than the signal BW otherwise the video filter will smooth, or average, the envelope of the desired waveform. The second layer of detector occurs after video filtering where the ADC continually samples the video at a very high rate, up to 1 Gbps in some peak power meters such as the Keysight 8990 peak power

analyzer. In this second layer of detection, it is important that the ADC is sampling the envelope of the pulsed signal at a high rate in order to faithfully reproduce the shape of the waveform. With a pulsed waveform sampled at a proper rate, the peak power, pulse width, PRI, rise time and fall time characteristics can be easily and directly measured.

As an average power sensor can connect to a variety of instruments, peak power sensors can also interface with power meters, spectrum analyzers, and laptops for acquiring measurements in the field. The next section of this application note shows an example of a peak power sensor connected to a portable spectrum analyzer for measuring the time domain profile of a pulsed waveform.

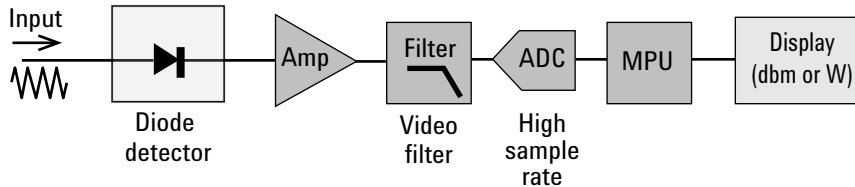

Figure 12. Simplified block diagram of a peak power sensor/meter

## Measurement Examples of CW and Modulated Signals

### Measurement example using a peak power sensor

Figure 13 shows an example of the measured power envelope of a pulsed waveform as a function of time. The input waveform is a pulse modulated 40 GHz signal with a 1 microsecond pulse width and 10% duty factor. This pulse modulated waveform was captured using a Keysight N9344C handheld spectrum analyzer (HSA) connected to a U2020 X-Series USB peak and average power sensor. For this arrangement, only the power sensor needs to be rated to 40 GHz as the spectrum analyzer is only used as a display and control interface similar to a configuration using a

peak power meter. With this type of peak power sensor, an analyzer or peak power meter can display peak power, average power, and other waveform characteristics including rise time and fall times. Markers can be placed on the instrument display to locate specific timing and power levels within the captured waveform. In order to capture the rise and fall time characteristics of a waveform, the video bandwidth of the instrument should be wider than the bandwidth of the waveform. Keysight peak power meters have video bandwidths up to 30 MHz allowing rise and fall times to be measured down to 13 nanoseconds.

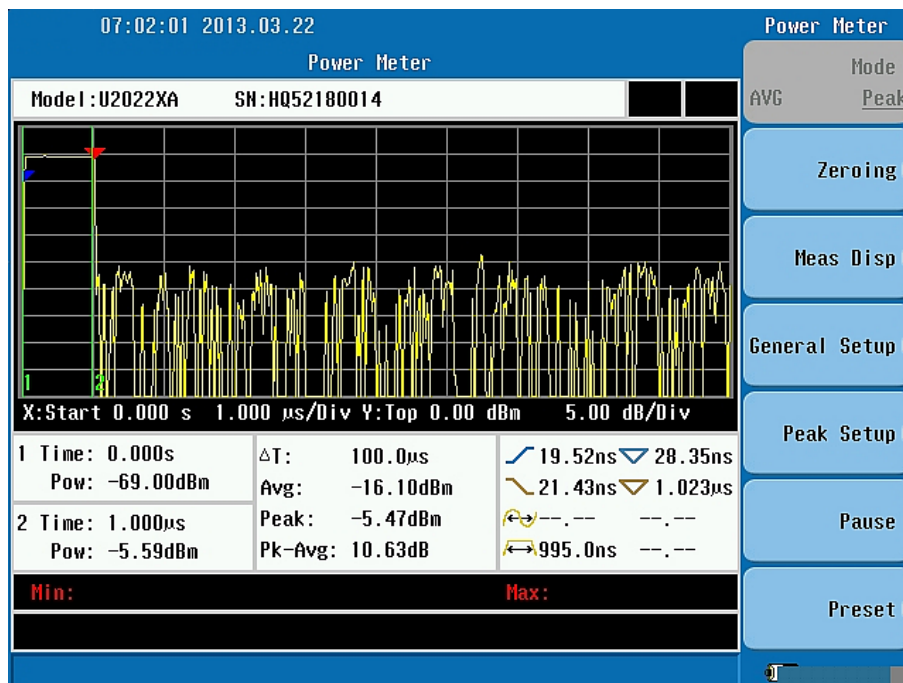

Figure 13. Measurement of a pulsed waveform using a peak power sensor connected to a spectrum analyzer

# Measurement Examples of CW and Modulated Signals

## Beyond peak and average power measurements

Average and peak power measurements may not tell the entire story concerning modulated RF and microwave waveforms. Certain industries, including wireless and broadcast, have unique power measurement requirements which include testing for specific parameters such as adjacent channel power ratio (ACPR), peak-to-average power ratio (PAPR), intermodulation distortion (IMD), occupied bandwidth (OBW), cumulative distribution function (CDF) and time gated measurements to name a few. Many of these measurements require the power sensor to be used in conjunction with software analysis tools such as the Keysight N1918A power analyzer. Several of these parameters, including adjacent channel power, can be directly measured using a spectrum analyzer.

For example, Figure 14a shows a spectrum analyzer measurement of a modulated 17.725 GHz transmission similar to the cable television relay services (CARS) that is licensed to operate in the 17.7 to 19.7 GHz band. The CARS channel spacing in this band is specified at 10 MHz. On this figure, arrows depict the frequency bands for the “main” channel and the three “adjacent” channels above and below the main channel. It is expected that the main transmission will not “spill” a large amount of power into the surrounding frequency channels otherwise the potential for adjacent channel interference may occur. This power spill into the surrounding spectrum could be generated by improper filtering, switching transients and intermodulation distortion. Intermodulation distortion, or spectral re-growth, is often created in the power amplifier of the radio transmitter due to nonlinear effects in the power electronics.

In order to accurately measure the power contained in the adjacent channels, the FieldFox spectrum analyzer includes an adjacent channel power (ACP) measurement function that reports the relative power contained in each of the surrounding channels. Figure 14b shows the ACP measurement for this 17.725 GHz CARS waveform using vertical bars to show a graphical representation of the power contained in each channel. For this measurement, the main channel power, measured over a 10 MHz bandwidth, is  $-19.7$  dBm. The adjoining upper and lower channels have relative power levels of  $-23.25$  dBc and  $-23.26$  dBc respectively. A table below the bar graph lists the absolute and relative channel powers for the three nearest adjacent channels. The FieldFox analyzer also includes a function for occupied bandwidth as part of the Channel Measurements menu. FieldFox channel power measurements can be performed with live or recorded signals. More information can be found in the FieldFox User’s Guide [7].

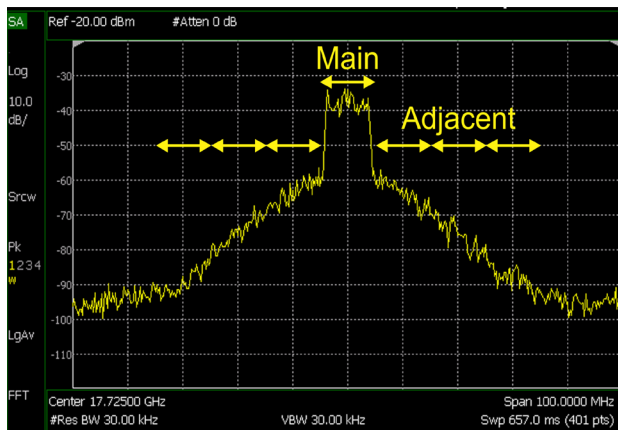

(a)

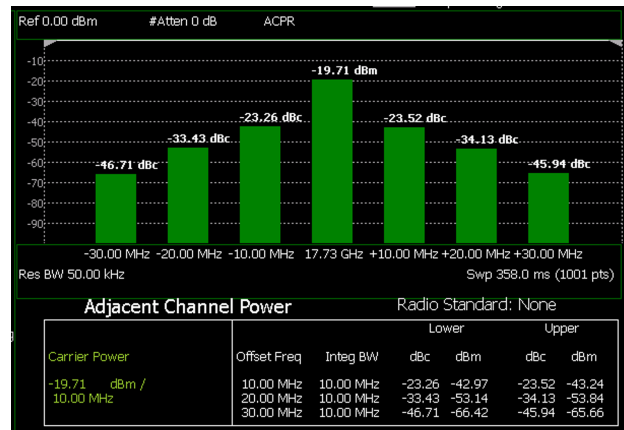

(b)

Figure 14. Measurement of a 17.725 GHz cable television relay service signal showing (a) the frequency spectrum and (b) the adjacent channel power (ACP)



# Measurement examples of CW and modulated signals

## Power measurement accuracy

Of the numerous power sensor types and analyzer configurations discussed to this point, an important question should come to mind, "which power measurement technique offers the highest accuracy?" When comparing different power sensors, the accuracy depends on the sensor technology and the measured power level. Figure 15 shows a comparison of the measurement errors found in three different types of power sensors, the thermocouple, the CW-only sensor and the high dynamic range (DR) sensor. The measured signal is a pulse modulated waveform with a 50 microsecond pulse width and a 5% duty factor. For this graph, the average input power to each sensor is varied between -70 dBm to +8 dBm. The lowest error of all the power sensors occurs in the thermocouple-based sensor but only when the input power is above -30 dBm. At lower power levels, the sensitivity of the thermocouple is reduced and the error rapidly increases. The diode-based

CW-only power sensor has very low error when the amplitude of the input power is below -20 dBm. In this case, the CW-only sensor has high accuracy when measuring modulated signals but only when operating in the square law region of the diode. High dynamic range diode-based power sensors contain two separate paths optimized to maintain operation in the desired square law region. As shown on Figure 15, the high DR sensor has fairly good accuracy across the range of -60 dBm to +8 dBm. For this sensor type, there is a small step in the error curve around -10 dBm. This step is the result of the automatic switching between the sensor's low power and high power measurement paths. It should be noted that in order to reduce the noise effects at the lower power levels, all the power sensor measurements utilized an averaging factor of 64. This large averaging factor also resulted in an increase in the overall measurement time. The power sensors also required a 30-minute warm-up time.

When using the channel power meter (CPM) option in the FieldFox to measure average power, the typical accuracies fall within  $\pm 0.35$  dB across the entire dynamic range as shown in Figure 15. These error limits are also the same for any frequency from 100 kHz to 18 GHz. While the CPM is not as accurate as the power sensor, it does provide the widest measurement range without the need to carry multiple power sensors into the field. More importantly, the CPM achieves these limits immediately upon instrument turn-on eliminating the need for a 30-minute warm-up as required by the power sensors.

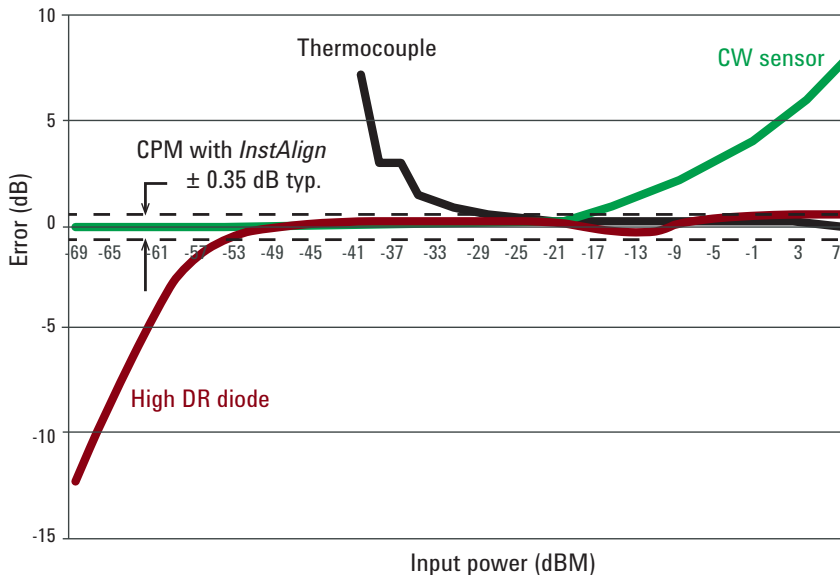

Figure 15. Power measurement error limits using power sensors and FieldFox channel power meter (CPM)

## FieldFox InstAlign

As discussed, the FieldFox spectrum analyzer with built-in channel power meter (CPM) is capable of making highly accurate channel power measurements across the entire frequency range of the instrument. The FieldFox analyzer is also capable of achieving the stated accuracies across the temperature range of  $-10\text{ }^{\circ}\text{C}$  to  $+55\text{ }^{\circ}\text{C}$  and requires no warm-up time. The FieldFox analyzer achieves high amplitude accuracy with a unique feature known as InstAlign. The InstAlign feature utilizes an internal calibration reference and a proprietary alignment algorithm to automatically improve the accuracy of all amplitude measurements with any change to instrument settings and operating temperature. For example, when the FieldFox's internal sensors detect that the instrument's temperature has changed by approximately  $2\text{ }^{\circ}\text{C}$ , an amplitude

alignment is automatically executed as a background process. The net result is that the absolute amplitude accuracy for a power measurement is typically less than  $\pm 0.35\text{ dB}$  up to  $18\text{ GHz}$  and  $\pm 0.5\text{ dB}$  to  $26.5\text{ GHz}$ . Table 1 lists the specified performance and typical values for the FieldFox with CPM. Values for the specifications include guardbands to account for the expected statistical performance distribution, measurement uncertainties, and changes in performance due to environmental conditions. These are the warranted performance numbers when the instrument is within its calibration cycle. As stated, no warm-up time is required in order to achieve the specifications listed in the table. The typical values listed are the expected performance values for an average unit and do not include the guardbands. While the listed CPM

accuracies are not as good as those achievable with a power sensor, the convenience of not having to transport multiple power sensors, and possibly a separate power meter, into the field and waiting 30 minutes for the sensor to warm-up may be a tradeoff that should be considered. Also, at low input power levels, the power sensor requires a very long measurement time while the instrument averages the noisy data for improved accuracy. In comparison, when using a FieldFox with the built-in CPM, the overall measurement time is greatly reduced due to the high sensitivity found in the analyzer's tuned receiver architecture.

*Table 1. Amplitude accuracies when measuring average power using a FieldFox with InstAlign*

Frequency Range	Spec ( $23\text{ }^{\circ}\text{C} \pm 5\text{ }^{\circ}\text{C}$ )	Spec ( $-10\text{ }^{\circ}\text{C}$ to $+55\text{ }^{\circ}\text{C}$ )	Typical ( $23\text{ }^{\circ}\text{C} \pm 5\text{ }^{\circ}\text{C}$ )	Typical ( $-10\text{ }^{\circ}\text{C}$ to $+55\text{ }^{\circ}\text{C}$ )
100 kHz to 18 GHz	$\pm 0.8\text{ dB}$	$\pm 1.0\text{ dB}$	$\pm 0.35\text{ dB}$	$\pm 0.5\text{ dB}$
>18 GHz to 26.5 GHz	$\pm 1.0\text{ dB}$	$\pm 1.2\text{ dB}$	$\pm 0.5\text{ dB}$	$\pm 0.6\text{ dB}$

## Measurement comparison over frequency

Here is another measurement example comparing the average power measured using a power sensor and a FieldFox with built-in CPM. The test signal is supplied by a Keysight PSG microwave signal generator configured as a CW source with an output frequency that is varied from 100 MHz to 26.5 GHz. The power sensor is the E4413A E-Series CW sensor connected to the N1914A power meter. Table 2 shows the measured results for the two test instruments. At 100 MHz the power sensor measured  $-0.07$  dBm. The FieldFox CPM measured  $-0.10$  dBm. Assuming the power meter has the higher accuracy, there is a very small difference of only 3 hundredths of a dB, when using the FieldFox. At 18 GHz, the power meter measured  $-2.90$  dBm and the CPM measured  $-2.84$  dBm, a difference of 6 hundredths of a dB between the two

instruments. The decrease in the measured power level resulted from the increased loss in the test cable that was in place connecting the signal generator to the instruments. Only the signal generator's output frequency and the instrument's test frequency setting were changed during these measurements. At 26.5 GHz, the power meter measured  $-3.75$  dBm and the built-in CPM measured  $-3.71$  dBm, again a very small difference between the two instruments.

While this example was measured in the laboratory under ideal test conditions, the convenience of a single instrument for measuring both power and frequency spectrum may be well suited for challenging environments and test conditions.

*Table 2 Measurement examples comparing the average power measured using a power sensor and a FieldFox with CPM*

Frequency (GHz)	Sensor (dBm)	CPM (dBm)
0.1	$-0.07$	$-0.10$
18	$-2.90$	$-2.84$
26.5	$-3.75$	$-3.71$

## FieldFox rugged to MIL-PRF-28800F Class 2

Measurements in the field typically result in the test equipment being exposed to harsh environmental conditions including extreme heat, cold and humidity. In general, power sensors and power meters are generally designed for laboratory use and are very sensitive to ESD, harsh conditions and abuse. It is advised that power sensors should always be stored in a clean, dry environment.

Knowing that the FieldFox would be operated under these extreme conditions, Keysight designed the instrument to be the most rugged, reliable and highest performance handheld instrument on the market [8]. The FieldFox meets all requirements for MIL-PRF-28800F Class 2 with no exceptions. FieldFox has also been type

designed to meet MIL-STD-810G for explosive environments which is very important for flightline test or environments such as on oil rigs. The water-resistant chassis, keypad and case can withstand salty, humid environments and a temperature range of  $-10$  to  $+55$  °C ( $14$  to  $131$  °F). Gasket-sealed doors protect the instrument interfaces from moisture, and the dust-free design has no vents or fans. FieldFox has been successfully tested to IP53 water and dust ingress protection standards. The case can also withstand shock and vibration, and a specially designed connector bay protects the RF connectors from damage due to drops or other external impacts.

## Conclusion

This application note has introduced measurement techniques and instrument types for average and peak power testing. Power sensors, including thermistors, thermocouples and diode-based sensors offer the highest measurement accuracies but with limited dynamic range, potentially long measurement times and lengthy equipment warm-up requirements. Power measurements using a tuned receiver, such as the FieldFox analyzer with built-in CPM, offer higher dynamic range with slightly reduced measurement accuracy. The FieldFox, with its innovative InstAlign feature, provides typical measurement accuracies of  $\pm 0.35$  dB up to 18 GHz and  $\pm 0.5$  dB to 26.5 GHz. This accuracy is achievable across the temperature range of  $-10$  to  $+55$  °C with no warm-up time. The FieldFox is also far more rugged than typical power sensors which make the FieldFox analyzer ideally suited for harsh environments and test conditions.

## References

- [1] Keysight Application Note, “*Fundamentals of RF and Microwave Power Measurements (Part 1), Introduction to Power, History, Definitions, International Standards & Traceability*,” Literature Number 5988-9213EN, April 2003.
- [2] Keysight Application Note, “*Fundamentals of RF and Microwave Measurements (Part 4), An Overview of Keysight Instrumentation for RF/Microwave Power Measurements*,” Literature Number 5988-9216EN, September 2008.
- [3] Keysight Application Note, “*Fundamentals of RF and Microwave Power Measurements (Part 2), Power Sensors and Instrumentation*,” Literature Number 5988-9214EN, July 2006.
- [4] Keysight Application Note, “*Solutions for Minimizing Measurement Uncertainty and Quick and Easy Estimation of Uncertainty Due to Mismatch*,” Literature Number 5991-0673EN, June 2012.
- [5] Keysight Power Sensor Uncertainty Spreadsheet
- [6] Keysight Power Sensor Uncertainty Spreadsheet for the U2000A
- [7] Keysight “*FieldFox Analyzers N9913A, N9914A, N9915A, N9916A, N9917A, N9918A, N9925A, N9926A, N9927A, N9928A, N9935A, N9936A, N9937A, N9938A User’s Guide*,” part number N9927–90001, May, 2014.
- [8] Keysight White Paper, “*FieldFox Microwave Analyzers 4/6/6.5/9/14/18/26.5 GHz*,” part number 5991-1300EN, November, 2012.

## Carry precision with you.

Every piece of gear in your field kit had to prove its worth. Measuring up and earning a spot is the driving idea behind Keysight’s FieldFox analyzers. They’re equipped to handle routine maintenance, in-depth troubleshooting and anything in between. Better yet, FieldFox delivers Keysight-quality measurements—wherever you need to go. Add FieldFox to your kit and carry precision with you.

Related literature	Number
FieldFox Combination Analyzers, Technical Overview	5990-9780EN
FieldFox Microwave Spectrum Analyzers, Technical Overview	5990-9782EN
FieldFox Microwave Vector Network Analyzers, Technical Overview	5990-9781EN
FieldFox Handheld Analyzers, Data Sheet	5990-9783EN
FieldFox Handheld Analyzer, Configuration Guide	5990-9836EN
FieldFox N9912A RF Analyzer, Technical Overview	5989-8618EN
FieldFox N9912A RF Analyzer, Data Sheet	N9912-90006
FieldFox N9923A RF Vector Network Analyzer, Technical Overview	5990-5087EN
FieldFox N9923A RF Vector Network Analyzer, Data Sheet	5990-5363EN

Download additional application notes, watch videos, and learn more:  
[www.keysight.com/find/FieldFox](http://www.keysight.com/find/FieldFox)

**myKeysight**

myKeysight

[www.keysight.com/find/mykeysight](http://www.keysight.com/find/mykeysight)

A personalized view into the information most relevant to you.

**Three-Year Warranty**

[www.keysight.com/find/ThreeYearWarranty](http://www.keysight.com/find/ThreeYearWarranty)

Keysight's commitment to superior product quality and lower total cost of ownership. The only test and measurement company with three-year warranty standard on all instruments, worldwide.



**Keysight Assurance Plans**

[www.keysight.com/find/AssurancePlans](http://www.keysight.com/find/AssurancePlans)

Up to five years of protection and no budgetary surprises to ensure your instruments are operating to specification so you can rely on accurate measurements.



[www.keysight.com/quality](http://www.keysight.com/quality)

Keysight Technologies, Inc.  
DEKRA Certified ISO 9001:2008  
Quality Management System



**Keysight Channel Partners**

[www.keysight.com/find/channelpartners](http://www.keysight.com/find/channelpartners)

Get the best of both worlds: Keysight's measurement expertise and product breadth, combined with channel partner convenience.

[www.keysight.com/find/FieldFox](http://www.keysight.com/find/FieldFox)

For more information on Keysight Technologies' products, applications or services, please contact your local Keysight office. The complete list is available at: [www.keysight.com/find/contactus](http://www.keysight.com/find/contactus)

**Americas**

Canada	(877) 894 4414
Brazil	55 11 3351 7010
Mexico	001 800 254 2440
United States	(800) 829 4444

**Asia Pacific**

Australia	1 800 629 485
China	800 810 0189
Hong Kong	800 938 693
India	1 800 112 929
Japan	0120 (421) 345
Korea	080 769 0800
Malaysia	1 800 888 848
Singapore	1 800 375 8100
Taiwan	0800 047 866
Other AP Countries	(65) 6375 8100

**Europe & Middle East**

Austria	0800 001122
Belgium	0800 58580
Finland	0800 523252
France	0805 980333
Germany	0800 6270999
Ireland	1800 832700
Israel	1 809 343051
Italy	800 599100
Luxembourg	+32 800 58580
Netherlands	0800 0233200
Russia	8800 5009286
Spain	0800 000154
Sweden	0200 882255
Switzerland	0800 805353
	Opt. 1 (DE)
	Opt. 2 (FR)
	Opt. 3 (IT)
United Kingdom	0800 0260637

For other unlisted countries:  
[www.keysight.com/find/contactus](http://www.keysight.com/find/contactus)  
(BP-07-10-14)