

Keysight Technologies

Using Microwave Switches When Testing High Speed Serial Digital Interfaces

Application Note

Many high speed digital interfaces use multiple lanes to achieve the throughput requirements of their systems. These systems present validation and characterization challenges because of connection requirements, including single-ended as well as differential testing and more lines than oscilloscope channels available. Solving this problem with a switching network will lead to lower test costs, higher reliability, and unattended testing, which managers desire for productivity. This application note addresses the use of these switching networks, their calibration, use of calibration, accuracy that is achievable, degradations that might be encountered, and other considerations such as de-embedding test point access adaptors and 2-port versus 4-port characterization.

Switching Use Cases Addressed

Comments about Case #1

The PC board should use the best materials possible and may (or may not) have the RF connectors close to the pins of the target device to be characterized. In the latter case, there is enough loss to warrant a measurement of the s-parameters of the paths to the RF connectors and to comprehend them in the compensation (or 'de-embedding') process.

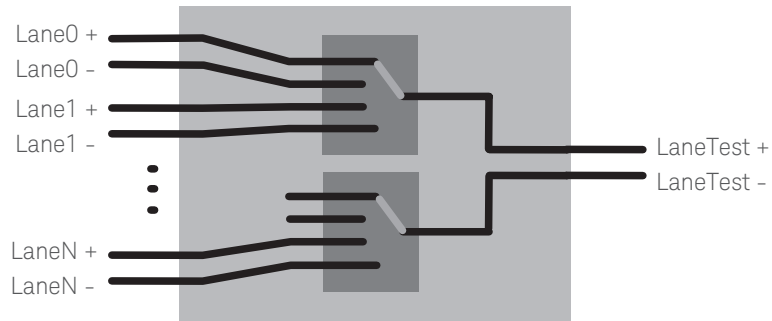

Figure 1. Two multi-port microwave switches can be used to switch high speed differential lanes

There are two primary use cases that will be addressed in this application note. These are identified by the nature of the device under test and, as you will see, determine different steps in the calibration of an intervening network.

Case #1

Device under test is an integrated circuit, and the objective is to measure to the pins of the device. A printed circuit (PC) board is used as test fixture. It breaks out signals to test to standard RF connectors such as SMA.

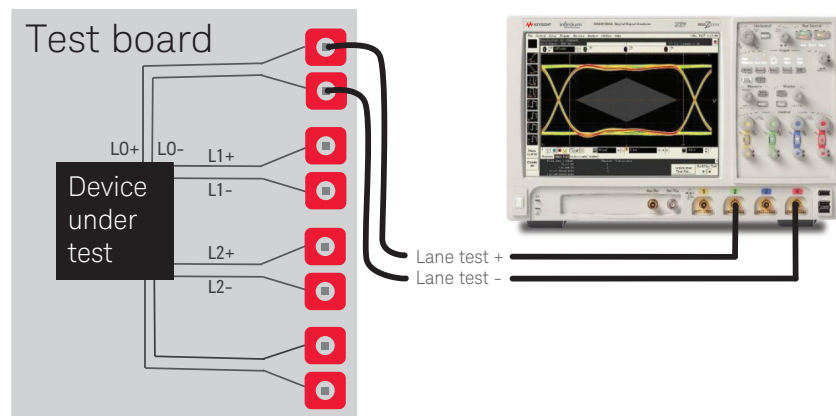

Figure 2. Test device is an integrated circuit on a test board

Comments about Case #2

The performance of this kind of device usually includes the standard digital connector mated pair so the device's performance is measured at the virtual point on the oscilloscope side of that mated pair. The performance of the testpoint adapter may be so good as to be ignored, common to all measured devices by standard decree, or de-embedded if the s-parameter file for it is available. The s-parameter file should comprehend the whole fixture except the connector and connector pins. The connectors' performance for these digital standards does vary considerably, so the mating connector of the adapter – say a plug device – will, in general, be different than what is used for same standard's cable. This fact means there is uncertainty from the measurement to operation in the system. Though rarely considered, it may be handled by a 'fudge factor' or extra margin in a link budget. Another rarely explored fact is that these connectors may have widely-varying common mode transmission characteristics from one vendor combination to the next. Depending on the degree that receiver circuits are immune to common mode, it may make sense to ignore this.

In either case, the switch matrix looks the same and is composed of cabling to and from the network and multi-port microwave switches. Its inclusion in the test cases is shown in Figure 4 and 5.

Case #2

The device under test is a 'system' where the output is through a defined digital connector such as HDMI and DisplayPort. Such systems require a testpoint adapter (test fixture) to break out the lanes to the oscilloscope.

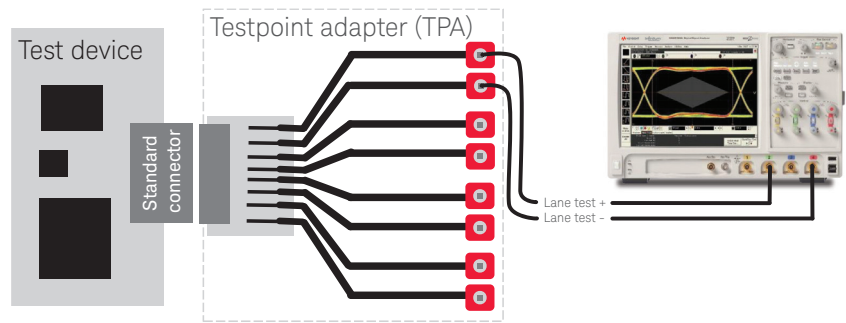

Figure 3. Test device has a digital standard connector, not an RF coaxial launch

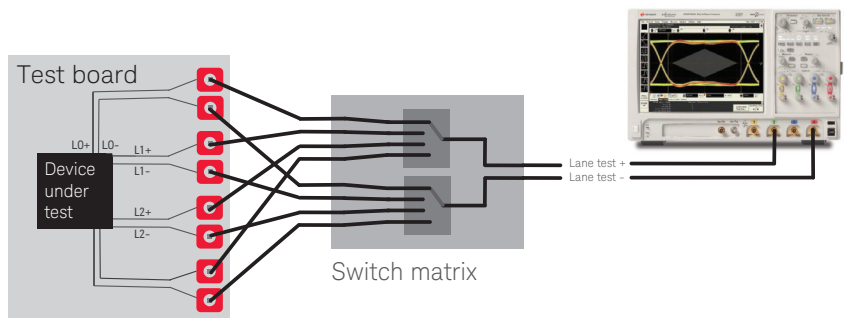

Figure 4. Case 1 with switching network. All lanes are connected to this switch matrix

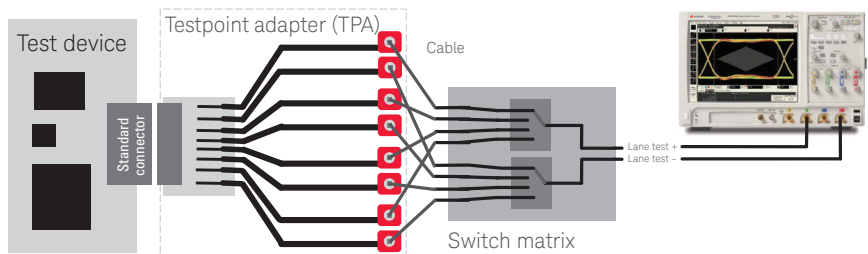

Figure 5. Case 2 with switching network. All lanes are connected to this switch matrix

Test System Requirements

When testing a device directly (when its output is applied directly to an analyzer, such as an oscilloscope) we usually embrace whatever uncertainty the oscilloscope has as being insignificant. Keysight Technologies, Inc. takes pride in delivering products that provide the lowest uncertainty possible to warrant such assumptions, but the wise test engineer will take steps to validate assumptions. To this end, it is useful to create a model of uncertainties in your system. The uncertainties associated with an oscilloscope's acquisition accuracy are its: frequency response, channel-to-channel frequency response tracking, channel-to-channel skew, channel match (return loss), and noise performance. The inclusion of a switch matrix – though we think of it as extending the front panel of the oscilloscope – can degrade these performances considerably, so the task we have is eliminate or mitigate these degradations. Let's summarize the objective:

1. The switch matrix paths are the same length so zero skew is added.
2. The switch matrix paths exhibit flat frequency response at 0 dB and bandwidth greater than the minimum desired.
3. The interaction between the DUT and any path element (cable, switch, oscilloscope) is kept to a minimum.

Let's briefly look at these individually:

1. Skew

A time delay between lines of a pair is called 'intra-pair' skew. Intra-Pair skew results in two degradations of your signal. First, you will see a roll-off of the differential gain frequency response as shown in Figure 6. When the frequency is $0.5/T_{\text{skew}}$ a total destructive addition is seen. When the frequency equals $0.1/T_{\text{skew}}$, the error at that frequency will be about .4 dB, or 5%.

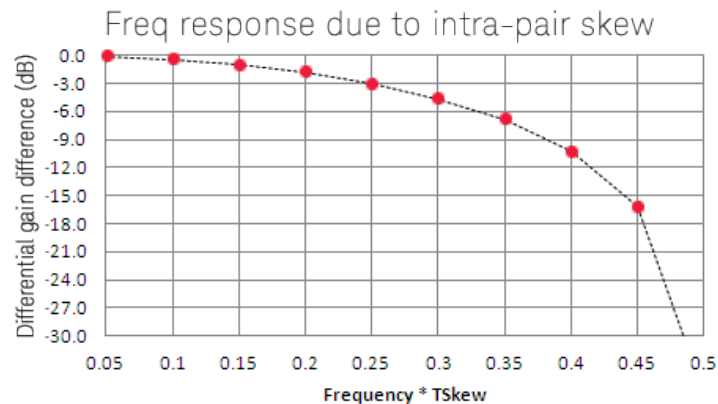

Figure 6. Effect of skew on differential frequency response

Secondly, intra-pair skew creates differential-to-common mode conversions that will distort the waveform. These common mode conversions, along with any common mode signal presence in a signal, will degrade signal parameters and may be especially deleterious in probed measurements.

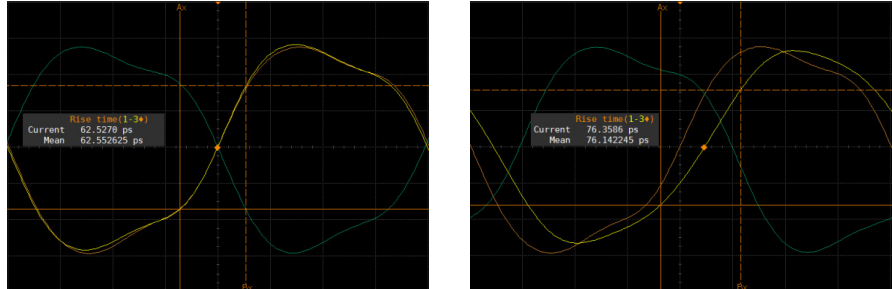

Figure 7. Rise time degradation due to 50 ps of skew. The differential signal is shown in the yellow trace

2. Frequency Response

Distortions in the waveform occur because of frequency response non-flatness in the channel. The distortion can simply be that the differential response of both sides of a lane diminish over frequency either identically, representing a decrease in measurement bandwidth, or not identically, representing a decrease in measurement bandwidth as well as a complex frequency-dependent, differential-to-common mode conversion characteristic.

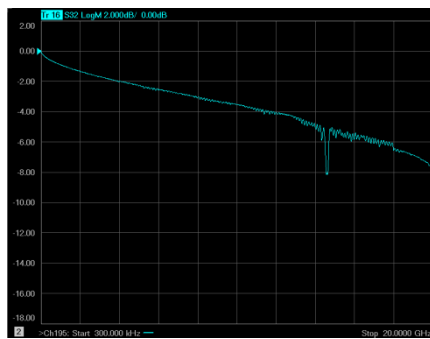

Figure 8. Frequency response (S_{21}) of 2 meters of cable and one microwave switch

3. Interaction

The interaction between blocks in an RF system typically has not been a concern for the validation engineer of digital systems, but it is a must for examination to keep uncertainties to acceptable levels. Let's start with the Figure 9, which depicts a simple transmitter, channel, and ideal receiver of a 2-port system. These are modeled with their flow graph components as well. Using flow graph analysis, the voltage incident upon the receiver, $V_{RX}(f)$ is expressed:

$$V_{RX}(f) = V_{TX}(f) * S_{21}(f) / [1 \pm |\Gamma_{TX}(f)| * |S_{11}(f)|]$$

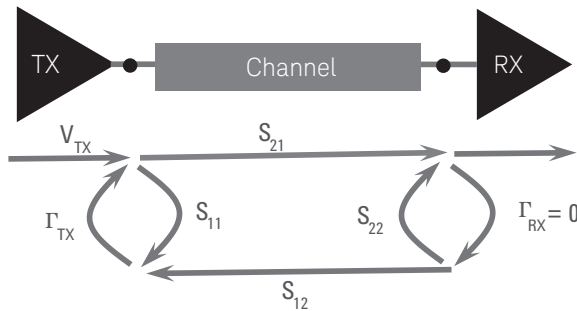

Figure 9. Flow graph analysis of system

If we knew the magnitude and phase of the components in the denominator, we could know the voltage incident on the receiver. However, we generally don't know this, so $1 \pm |\Gamma_{TX}(f)| * |S_{11}(f)|$ represents an uncertainty term, where the uncertainty can be expressed:

$$\text{Uncertainty} \sim |\Gamma_{TX}(f)| * |S_{11}(f)|$$

This relation allows you to set the target for your confidence. If you want no more than 5% uncertainty at a given frequency, then $|\Gamma_{TX}(f)| * |S_{11}(f)|$ must be less than 0.05. A quick example of this would be if your transmitter S_{22} (or Γ_{TX}) is 0.5 (-6 dB return loss), then the channel must have S_{11} better than 0.1 (-20 dB return loss) for 5% uncertainty. Note that the s-parameters are a function of frequency, so your choice of uncertainty value will depend on bandwidth, signal type, and pattern.

With respect to our enterprise of inserting a switch matrix between the device under test and the oscilloscope, what we need to analyze is shown in Figure 10.

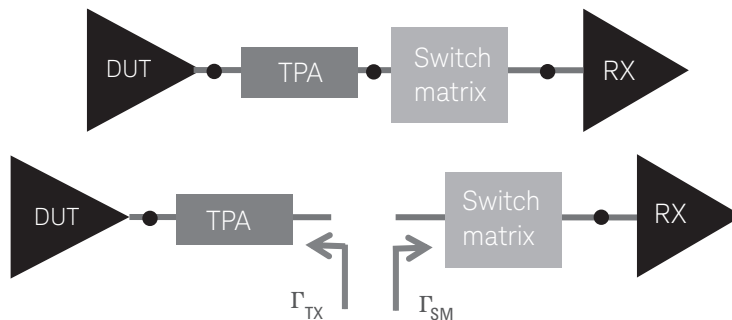

Figure 10. Analyzing interaction between switch matrix/oscilloscope and the device under test and TPA

*If the magnitude of $G_{TX} * G_{SM}$ is less than the uncertainty threshold set, then you are ready to proceed with the implementation of the switch matrix.

*If the magnitude of $G_{TX} * G_{SM}$ is more than the uncertainty threshold set, then other measures must be taken. These actions will be addressed in a later section.

Characterizing and Evaluating the Switch Matrix

Though the switch matrix is a 4-port device, its configuration, measurement, and calibration is generally a 2-port affair. Figure 11 illustrates that instead of requiring 4-port measurement on a VNA, the task can be done with evaluation of the two 2-port paths for the specific lane desired.

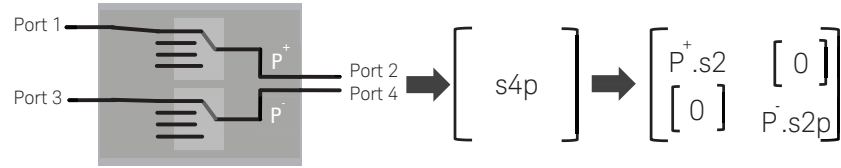

Figure 11. Standard 4-port (16 elements per frequency) representation versus two 2-port .s2p files (4 elements each) with zero matrices representing the crosstalk terms

The P+.s2p and the P-.s2p files are the 2-port evaluations of an arbitrary lane path using two cable-switch-cable combinations as shown in the previous figures (for example Figure 4). Every path for every switch should be evaluated. Evaluate the full .s2p file with focus on the S_{21} and the S_{11} frequency response plots of all paths.

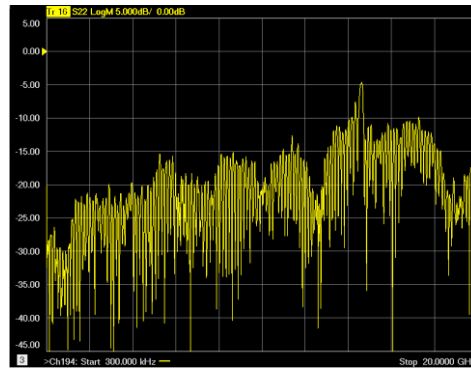

Figure 12. S_{11} measurements for a path

To evaluate the frequency response of the through gain, S_{21} , look for a monotonic characteristic of loss versus frequency with no sudden bumps or dips. Any such dip may occur because of a bad connection that will change over time or a resonant structure in the channel that will vary over temperature and humidity. A frequency dip indicating a poor connection is evident in the S_{21} plot at around 15 GHz. If this is in the measurement bandwidth, it must be addressed and eliminated.

Also find the point of the trace where the trace goes below -12 dB. The lowest ' -12 dB' frequency you find in *all* of the switch paths should be the *maximum* bandwidth you should consider as your measurement bandwidth. At frequencies beyond this point, your measurements may be affected by the signal-to-noise ratio present in the acquisition. Note: the selection of -12 dB is somewhat arbitrary; experimentation with degradation of measurements such as jitter should be performed to establish your specific goals. Also realize that other connective elements such as the test access board or test point access adapter will also have their losses as well, so you should consider the *total path loss* from the source. Note that in Figure 8 the -12 dB point is not the limitation in the VNA measurement to 20 GHz.

Evaluating the return loss, S_{11} , S_{22}

The S_{11} and S_{22} are reflective s-parameters and are indicative of the match to the characteristic impedance of the system. These are the parameters that cause uncertainty in the measurement as discussed in the previous section, and it is desirable to keep them as low as possible. What is most significant is the frequency content of the signal and the return loss at these frequencies (or frequency bands). The return loss characteristic typically fluctuates wildly over frequency, and that is generally no cause for concern. The main issue is the peaks of the return loss curve and where those peaks occur. In the S_{22} plot above, the reflection is about -15 dB or less to about 13 GHz. If this is unsatisfactory, explore the separate elements of the system to find the main contributor. In some cases, you may just need better cables.

Finally, it is a very good idea to evaluate the path delays of the switch matrix. While we endeavor to ultimately calibrate these out, it is a good idea to minimize the spread as a standard engineering practice. It is suggested you keep it to no more than 5 nS (> 1 meter of cable). A way to measure the spread is with a pattern generator and reference clock as shown in Figure 13.

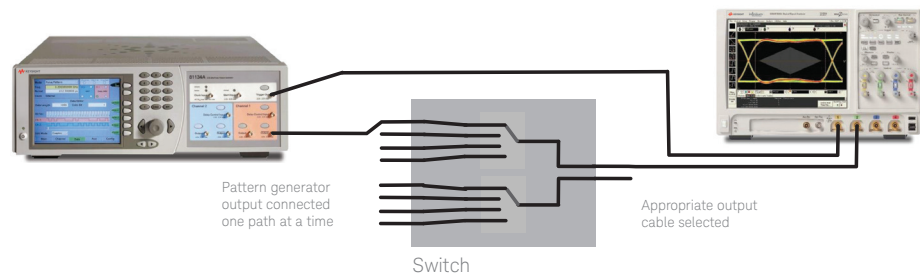

Figure 13. Measuring the time delay spread of all the paths in the switch matrix

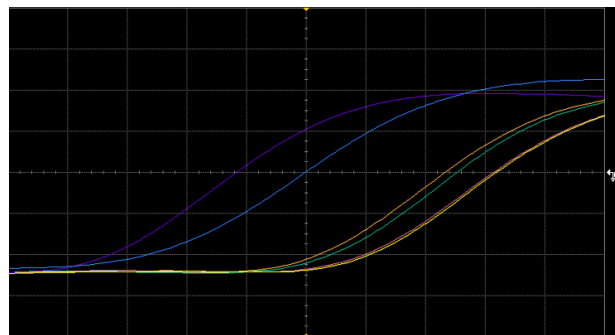

Figure 14. Time delay of paths through one switch. Trace in blue is the reference trigger. The different traces indicate an 88 ps spread for the four paths of the switch being evaluated

Compensating for the Switch Matrix and Cable Network [Switch Matrix Only]

In order to compensate the switch matrix and cabling with the goal of making it look like the network is not there, we have to measure it. This is done in one of two ways:

1. Use a Vector Network Analyzer (VNA), as we did in the previous section – measure each path's s-parameters.
2. Use an Infiniium oscilloscope with PrecisionProbe/Cable hardware and software to measure the insertion loss of the paths.

In either case, we aim to mathematically compensate for the path directly on each acquisition taken. In the simplest example, if we have a switch path with a particular frequency response, we want the oscilloscope to implement a function that is the inverse of that response so the **net gain is unity**. If the channel is characterized by an array of S_{21} values, the compensating transfer function in the frequency domain is an array of S_{21}^{-1} values. Infiniium oscilloscopes have built-in hardware that can implement the compensation in real time with time domain convolution of the compensating filters with the acquisition. The filters are constructed from frequency domain transfer functions and are implemented as FIR filters. These filters can be created using one of two software packages available in Infiniium oscilloscopes: InfiniiSim waveform transformation software and PrecisionProbe/Cable software. In fact, as you will see, filters from both of these packages can be used **simultaneously** on any given oscilloscope channel.

1. Compensating using InfiniiSim Waveform Transformation Software

InfiniiSim is a general-purpose transfer function generator package and can be used in tasks as simple as one block de-embed and embed to tasks as sophisticated as 27-block networks with virtual probing and oscilloscope probe removal.

The process in this case is simple:

- a. Procure a VNA with the frequency coverage desired.
- b. Set up freq resolution and IF bandwidth filtering and averaging.
- c. Calibrate VNA.
- d. Measure the 2-port switch paths one at a time and store the .s2p files with appropriate names to facilitate their recall.
- e. Activate InfiniiSim with 2-port transfer function creation, and select the simple Insertion Loss Removal model.
- f. Insert the .s2p file measured for the path desired, name the transfer function accordingly, and create transfer function. For instance, you might have an .s2p file called 'Lane0plus.s2p' and name the transfer function 'L0plus.tf2.'
- g. When measurements for a given channel use that path, activate InfiniiSim and load the transfer function.
- h. All subsequent measurements for that channel now reflect the compensation of that path.

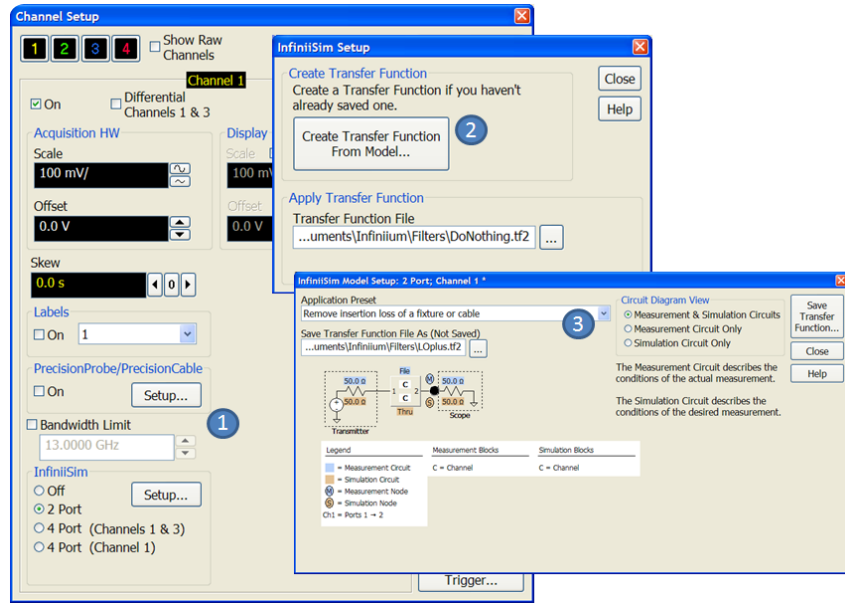

Figure 15. InfiniiSim dialogs: initiating setup and selecting model to use

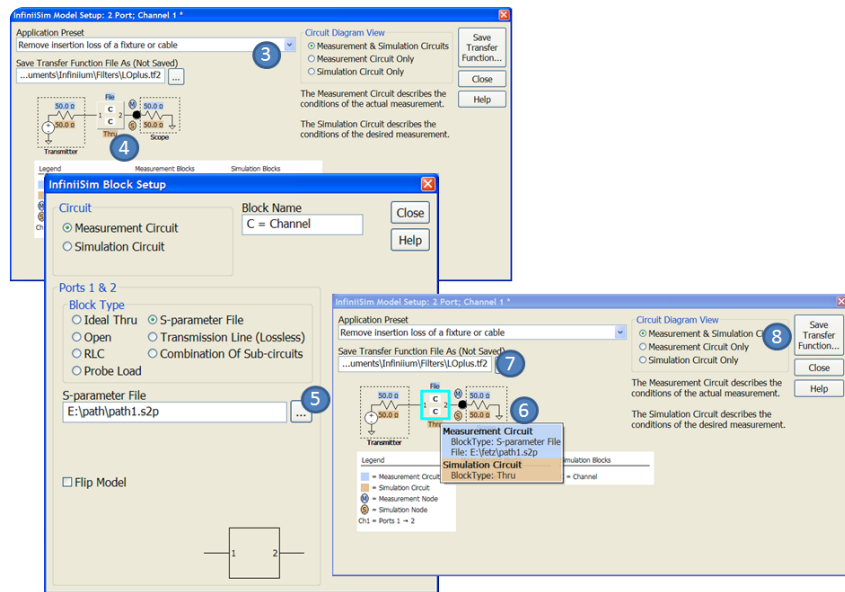

Figure 16. InfiniiSim definition: selecting model, entering s parameter file for circuit element, naming transfer function, and generating the transfer function

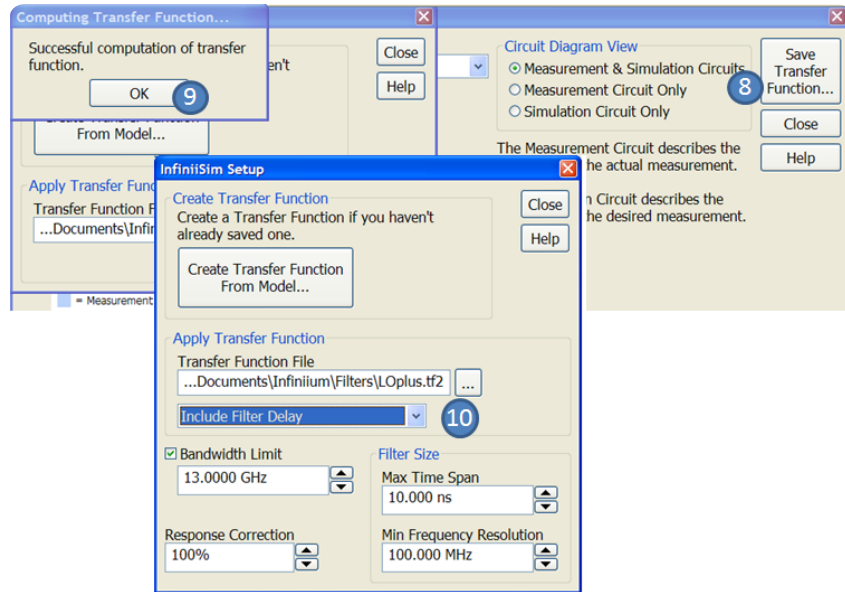

Figure 17. InfiniiSim completed: note successful calculation of transfer function and default parameters used

2. Compensating using PrecisionProbe/Cable Hardware and Software

PrecisionProbe/Cable targets the insertion loss in an oscilloscope or calibrates high accuracy for the AC response of probe heads. In this specific application of the switch matrix, we are interested in the cable calibration capability of PrecisionProbe/Cable. PrecisionCable makes use of a very fast edge to make two measurements. The first measurement is the reference without the switch matrix network, and the second measurement is made after the network's insertion. These two measurements are expressed relative to each other in the frequency domain to obtain a network frequency response. It is this frequency response that drives the transfer function generation for the realtime compensation. It is fairly simple to execute with a wizard connection guide:

- a. Activate PrecisionProbe/Cable in the channel dialog. Ensure license is activated beforehand.
- b. Select 'cable' as the target, and select defaults for delay and automatic bandwidth.
- c. Follow connection prompts for the PrecisionCable hardware (three cables and splitter) to two channels on the oscilloscope. Note: at this point you are creating the PrecisionCable transfer functions, and it doesn't matter what channels are used to do the calibration.
- d. Make the reference measurement.
- e. Insert the switch path between the two cables used when making the reference measurement, and make the measurement with this network in place.
- f. Name the PrecisionCable file, and you are done. Note: you can continue measuring other paths making use of the first reference measurement. This is highly suggested to eliminate time and errors.
- g. Select the oscilloscope channel you want to use to measure the given path, turn PrecisionProbe/Cable on, and select the file you just named.
- h. All subsequent measurements on that channel now reflect the compensation of that path.

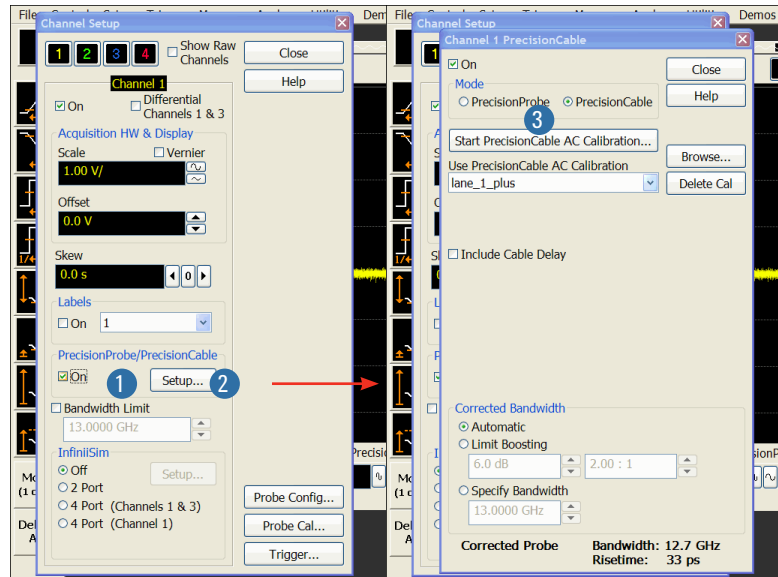

Figure 18. Initiating PrecisionCable calibration

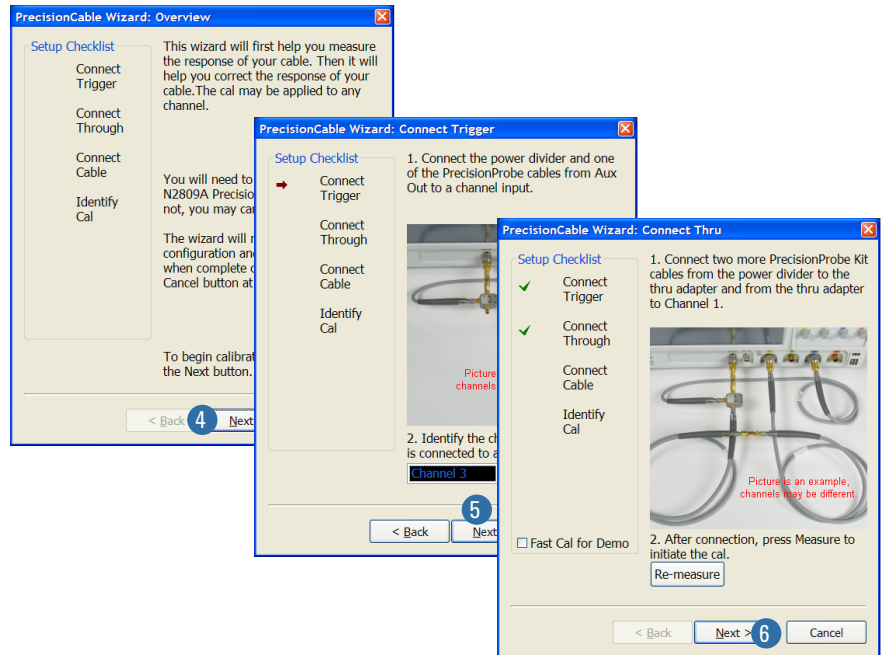

Figure 19. Operating PrecisionCable software

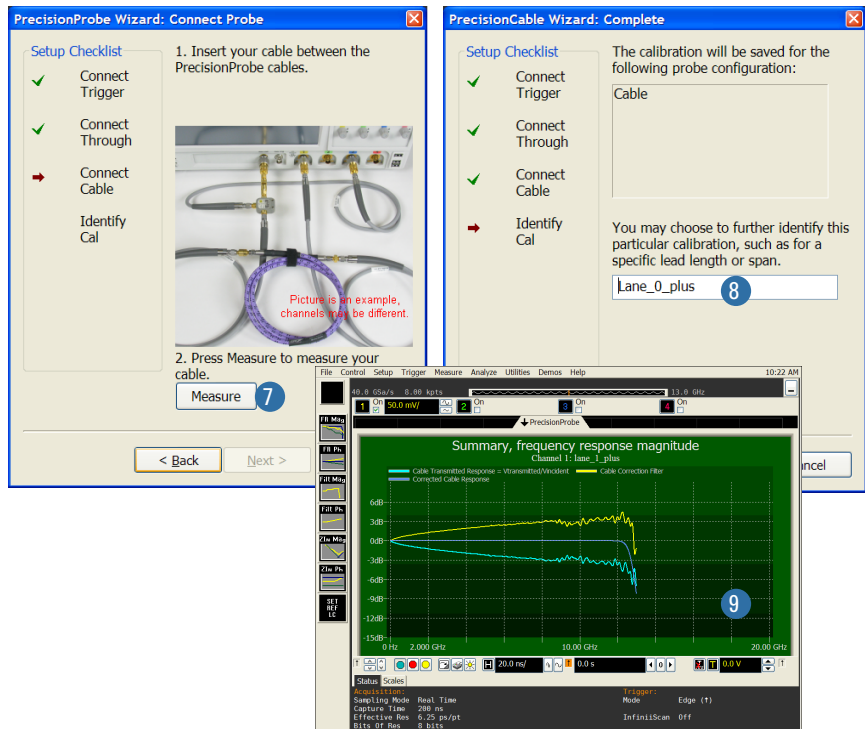

Figure 20. Operating PrecisionCable software

Evaluating Performance of the Path Compensation

It is expected that you will want to validate the compensations that InfiniiSim or PrecisionProbe create because you need to have confidence that the paths are truly flat and your assumptions in measurements are validated. There are a number of ‘tools’ you can use to do this performance validation:

- **Skew evaluation:** This evaluation determines the spread of the corrected path skew. Obviously, we are looking for each line to have the same value in time, so we want a 0 ps nominal value.
- **Step response:** Evaluating the step response is the benchmark manner to understand that the compensation is correct. Implicit in the step response is the frequency response in both magnitude and phase. If either magnitude or phase is not correct, it will manifest in the step fidelity. We can also mathematically process the step information to reveal the frequency response.
- **Before-and-after analysis of waveform:** Once the step response is done, the evaluation is a mere formality, but it should be done with the type of signals you expect to see. This evaluation compares a reference measurement of a typical waveform to a corrected version of it with the switch matrix in place. While it should be obvious that the eye diagram would improve from the uncompensated waveform to the compensated waveform, the eye can be evaluated as well for a quick qualitative assessment. This can be done for all lanes.
- **Noise analysis:** This evaluation characterizes potential degradation you might see because of loss of signal to noise ratio.

a. Skew analysis

Using the setup described in Figure 21, we can measure the before-and-after skew spread.

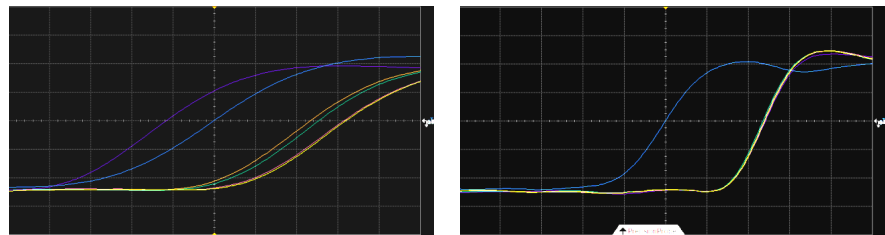

Figure 21. Comparisons of skew before and after compensation with PrecisionProbe (± 2 ps)

b. Step response

Validating the step response requires the generation of a high speed step. We first apply such a step directly to an oscilloscope channel and measure the edge. A diagram of the test setup is shown below.

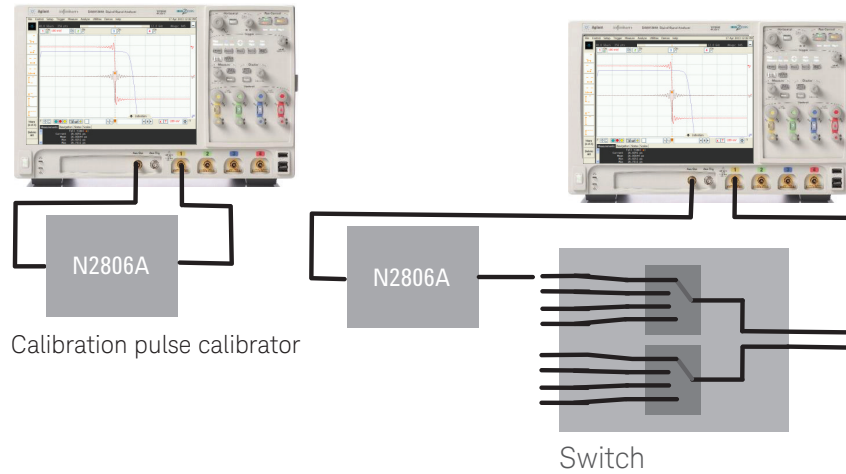

Figure 22. Test setup for verifying step and frequency response

The first measurement is the reference step measurement. A screenshot of this is captured in Figure 23. Note that the fall time of this step is ~24 ps. In order to show insight to its frequency content, we can take the derivative of the falling edge step and then take the FFT of the derivative. Because the derivative function has high frequency response that is linearly increasing with frequency, ideally it will directly counteract the 1/f square wave frequency content of step under FFT assumptions of repetition. It is essentially flat to the bandwidth of the oscilloscope. In our verification, it is not necessary that the frequency response observed is flat. However, it is comforting that the equipment is coming close to ideal.



Figure 23. Reference step with derivative and FFT of derivative

When we observe the step through the switch matrix, we see a definite rounding of the step edges, and the frequency response now looks similar to frequency responses shown when making the VNA measurements. Note the fall time is substantially degraded by about 40%. Now we repeat the measurement with compensation applied, and we find that we have rectified the degradation.

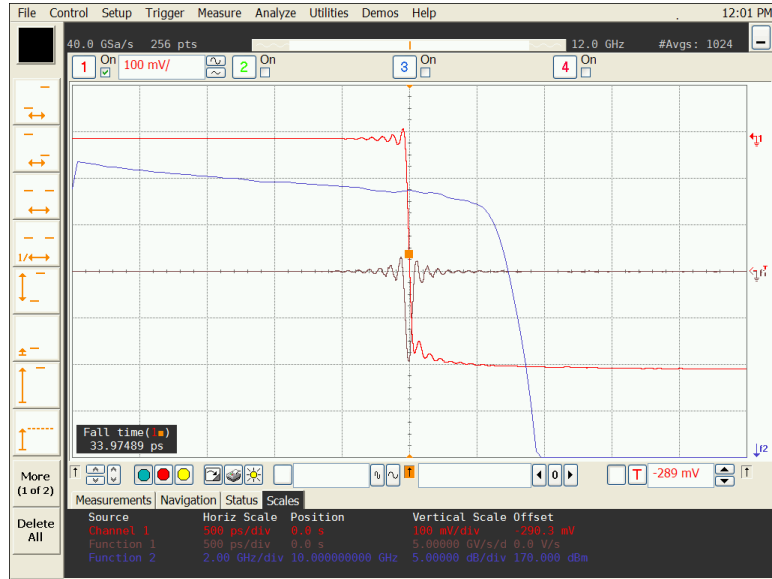

Figure 24. Step through the switch matrix



Figure 25. Compensated step response

Note that in Figure 25 the fall time now is closer to what was originally seen when the step was directly applied to the oscilloscope. Also, the edge characteristic and the benchmark reference frequency response exhibit the same fidelity as the reference measurement.

Note: the frequency response plots shown in Figure 25 indicate a departure from ideal at the lowest frequencies. This is an artifact of the measurement conditions setup, not of actual performance. Lowest frequencies are best captured with longer time records. However, to show fidelity in the high frequency measurement, we are best served with shorter records because they result in better signal-to-noise ratio.

c. 'Before-and-after' analysis

We perform a comparative analysis by subtracting averaged acquisitions of two different measurements and then analyzing the residual error. Using a reference source that preferably has the edge rate you expect, we can select a time domain waveform of a particular sequence of bits (say of a PRBS7 pattern at 2.5 Gbs) and capture an averaged version of it as a reference measurement when the source is directly connected to the oscilloscope. This reference measurement is stored. Afterward, the network is inserted and mathematically corrected, and another averaged waveform is taken and compared with the stored waveform. The comparison is a simple subtraction that, in the ideal case, will yield only oscilloscope acquisition noise over the interval of analysis. Peak-to-peak error, or rms error, can be measured as figure of merit for a given sequence of bits. The measurement setup is shown below. The fixed attenuators shown are used to reduce uncertainty due to difference in match for both measurements.

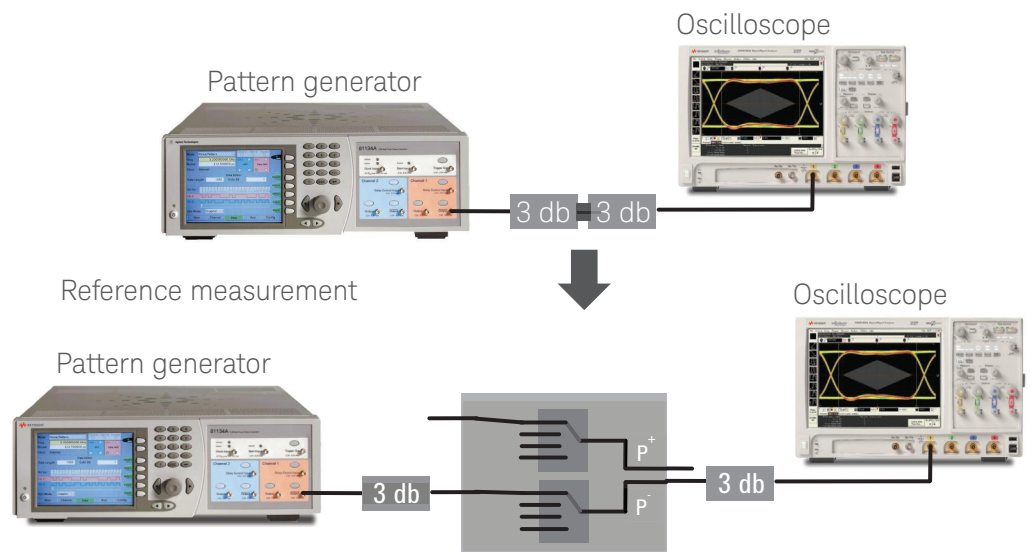

Figure 26. Comparative analysis test setup

Comparative Analysis Results

A 3.3 Gbs PRBS7 pattern was chosen to do the following analysis, but you would choose your own parameters. The PRBS7 pattern is relatively short, so it shows the more salient sequences over a short time interval. In this particular case, the trigger is set to a pulse width of greater than 2.0 ns (7×300 ps). All measurements are averaged by a factor of 256. The reference measurement is shown in the orange trace; the active trace is Channel one in yellow and Function 1 trace represents Channel 1- reference. A comparison is first taken (not shown) of the reference versus reference as a sanity check which yields very low residuals (~ 200 uVolts rms). Then the network is inserted and, again as a sanity check, we measure the reference versus the uncompensated result. Function 1 is shown with 10 mV/Div, the residual error is 12.4 mV rms, and the peak error is more than 20% the peak value of the waveform.

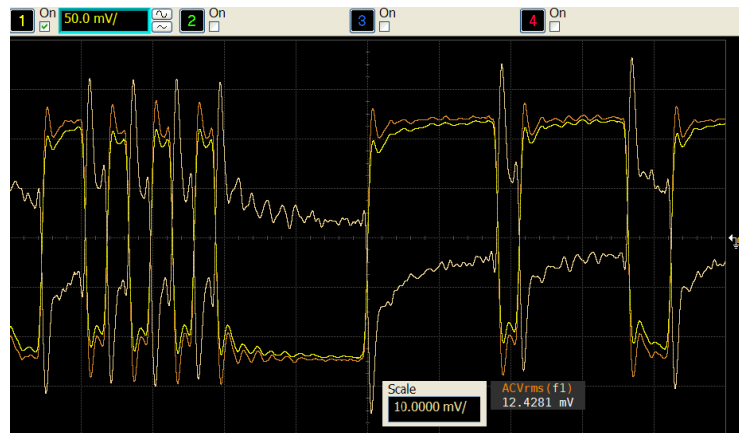

Figure 27. Uncompensated waveform comparisons

The network is left in place, and we then measure the reference versus the compensated result by activating InfiniiSim or PrecisionProbe/Cable. This time Function 1 is shown with 5 mV/Div, the residual error is 1.54 mV rms, and the peak error is about 3% the peak value of the waveform. Driving this residual error to be as low as you can requires s-parameters as accurate as possible, low noise source, more averaging of the waveform, higher fixed attenuation values and utmost care in connection to the network.



Figure 28. Compensated waveform comparisons. Note that reference and compensated waveforms are overlaid

Variants to Compensating the Network

There are a number of variants to the switch network use case that need to be considered.

Case #1 with De-embedding of the Test Board

In this extension of the use case, you are not just interested in removing the effects of the switch matrix and cable network; you want to consider the test board on which the device under test (integrated circuit) sits. There are three possibilities that may be chosen:

a. File created for test board only – use InfiniiSim:

In this scenario you have an .s4p file for the test board and want to include it in the compensation (or de-embedding). This file may be the result of EM software modeling with a design package such as ADS, or you may have measured an unloaded board using a VNA probe station. Regardless of where the file comes from, since you have .s2p's of the switch matrix paths, you will use InfiniiSim to generate the transfer functions. In using InfiniiSim, we will select a 3-block model and put the .s4p file for the board model in the first block and put the two .s2p files in the second block. You then create the transfer function, and afterward all subsequent measurements comprehend the path compensation.

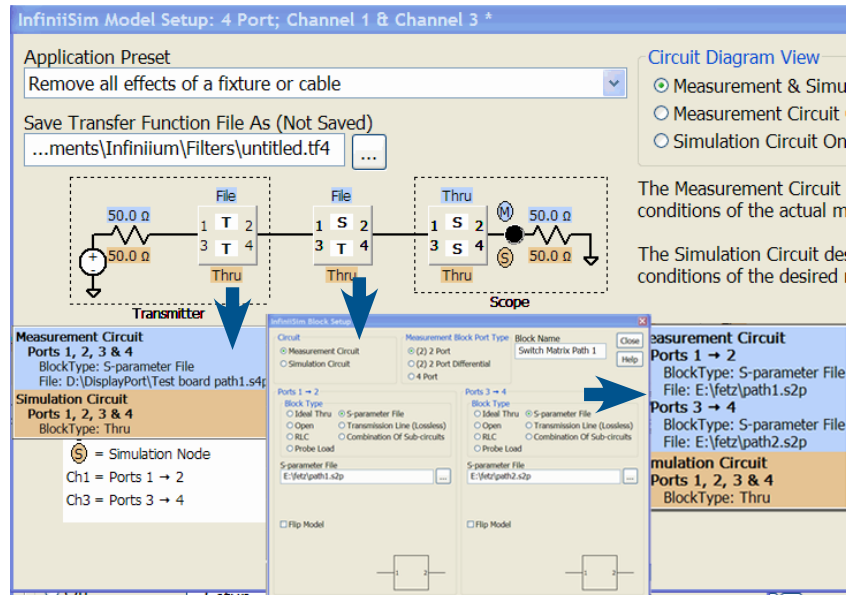

Figure 29. Using .s4p file for test board with two .s2p files for the switch matrix

b. File created for test board only – use InfiniiSim and PrecisionProbe:

In this scenario, you again have the .s4p file of the test board on which your device sits, but you choose to use PrecisionProbe to compensate the switch matrix. In this case, you are making use of two transfer functions that the Infiniium oscilloscope can handle independently. The only new step here is that after you go through the PrecisionCable steps for the switch matrix as already stated, you then activate InfiniiSim using the same procedure as in the switch matrix except you choose 4–port, single-block insertion loss removal, input the board .s4p file into it, and create the transfer function. Now you have two transfer functions being applied simultaneously.

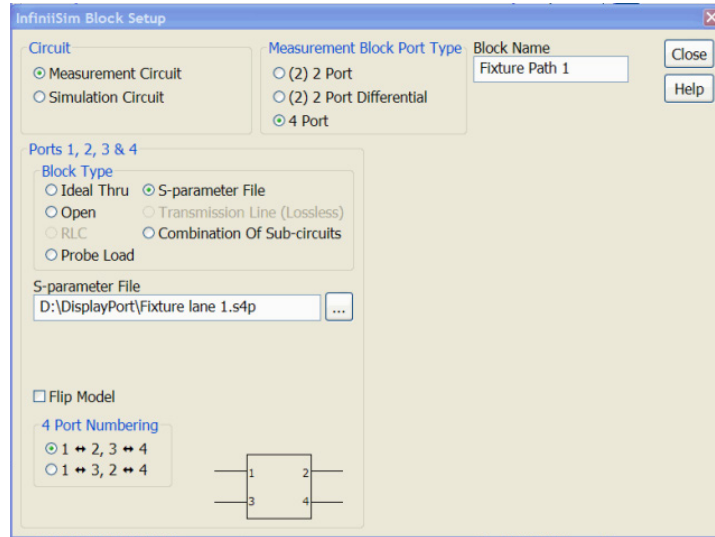

Figure 30. Using InfiniiSim to create the transfer function to remove the effects of the test board

c. File created for test board through to cables connecting the oscilloscope:

In this case, you choose to measure each 4-port path directly with a VNA. The input ports (say, ports 1 and 3) require VNA probes at the output pins (unloaded board assumed), and the output ports (ports 2 and 4) are at the end of the cables that connect to the oscilloscope. This connection would be the most accurate because you would not suffer the uncertainties of two or more separate VNA measurements. However, it is likely a complex setup. The compensation for this is simple as you merely use the resulting .s4p file in a 1-block insertion loss removal model in InfiniiSim.

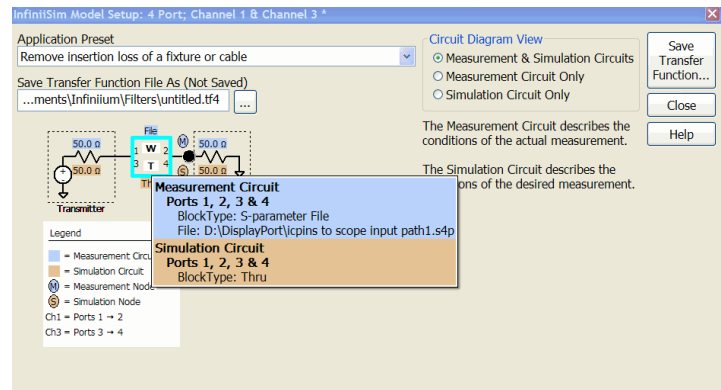

Figure 31. Using a 4-port .s4p for the whole path

Case #2 with De-embed Test Point Adapter

a. File given for test point adapter – use InfiniiSim for the fixture and switch matrix

This model of operation is technically not different from scenario Case #1a above. In this case, the vendor of the test point access fixture has provided an .s4p file, and it is used with the switch matrix .s2p files to build composite paths to de-embed.

b. File given for test point adapter – use InfiniiSim for fixture and PrecisionProbe for switch matrix

This model of operation is technically not different from scenario Case #1b above. You might choose this scenario because the switch matrix is being used for multiple standards with different fixtures being employed. In this case, the test application software may manifest the de-embedding of the fixture using InfiniiSim, so it is a detail that you don't need to explicitly worry about.

Other Considerations

A. What if uncertainty is too great? $\Gamma_{TX} * \Gamma_{SM} > \text{uncertainty limit}$

Earlier, we mentioned that mitigating actions could be taken if you exceed your uncertainty requirements. These measures are:

1. Comprehend impedances of DUT/TPA and switch matrix/oscilloscope to perform true switch network de-embed.
2. Use attenuators in the switch matrix to reduce Γ_{SM} to be in acceptable range.

In the first mitigating step, instead of assuming you only know the approximate magnitude of the source or upstream output impedance, you actually measure it and comprehend it as an S_{22} in InfiniiSim in the block closest to the source. InfiniiSim will calculate the interaction in magnitude and phase so the uncertainty term is eliminated. There is, of course, the uncertainty of the vector network analyzer in two measurements; that now will become the new uncertainty.

The second mitigating step, using attenuators, is an old trick that RF system designers use. By using a fixed attenuator, you can achieve improved match by up to 2X the attenuator value. Figure 32 illustrates this. In this figure, we measure a notably poor return loss and inserted a 3 dB attenuator. You can see that the second trace is almost exactly 6 dB down from the top trace throughout the band of interest.

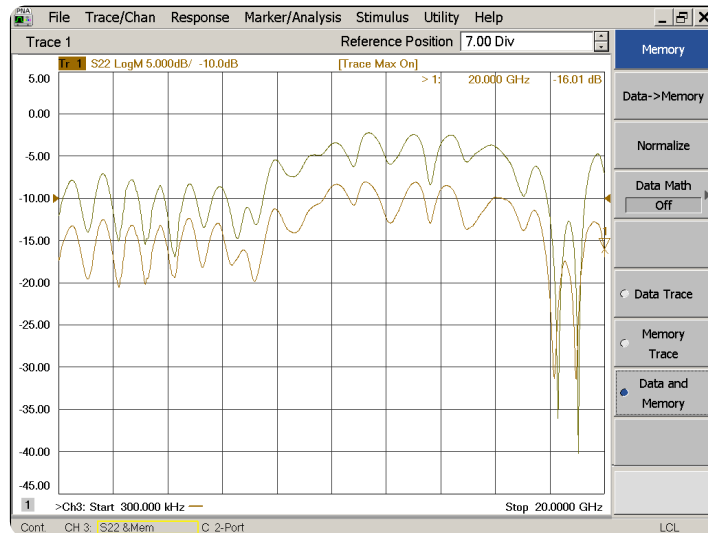

Figure 32. Improving match by using fixed attenuator. Bottom trace reflects same path with 3 dB pad in it

Though not typically done in digital testing, it is a perfectly acceptable technique in most cases. A detraction of using attenuators is the added cost. If you have eight lines (four differential lanes), then you will need eight attenuators. An accuracy concern because of measuring at reduced levels is an issue if you lose signal-to-noise ratio or not. In some cases you might; for instance if the signal is initially very close to full scale, then the signal with a 3 dB pad would likely require the same scale, and you would lose 3 dB of signal-to-noise ratio. If, on the other hand, the signal is not near full scale, adding an attenuator might allow the next higher sensitivity scaling on the oscilloscope and enable a full scale measurement. This would have to be balanced against noise degradation in using the higher sensitivity scaling. Note that Infiniium oscilloscopes have vernier settings for arbitrary scaling, which lets you optimize signal-to-noise ratio. Another potential issue in using fixed attenuators is that you are adding another connector interface that could degrade repeatability over a period of time; if secured adequately, the additional connector is not a problem.

- Using VNA and InfiniiSim: if you measure the attenuated paths with a VNA, there is no difference in the compensation procedure using InfiniiSim than what has already been discussed.
- Using PrecisionCable: if using PrecisionCable capability, there is a significant approach difference. PrecisionCable will not comprehend the attenuator value – just the AC un-flatness. You have to use PrecisionProbe and go into user-defined probe mode and first perform a DC calibration.

B. DDR interposer with switched probe head

A very special case of switching arises when there are many probe heads connected to signals on a test board and these are switched to the oscilloscope for measurement. The issue in this use case is to minimize the number of probe amplifiers that need to be purchased to measure the many signals (up to 18) on a DDR BGA. This case has the probes being switched to the probe amplifiers instead of signals being switched to the channels of an oscilloscope. It is similar to Case 1b above, but it is worthy of further consideration. Figure 33 below shows the overall view of the problem that is being addressed. In order to get to the pins of the DRAM, a BGA probe interposer is inserted between the DRAM and the board. The interposer allows taps off the through connections from top of the interposer connected to the DRAM to the bottom of the interposer connected to the memory board. The interposer construction is a very important part of the measurement system. For more information, see the Keysight application note *Maximizing DDR BGA probe Bandwidth for Superior Signal Fidelity* with the publication number 5990-9761EN.

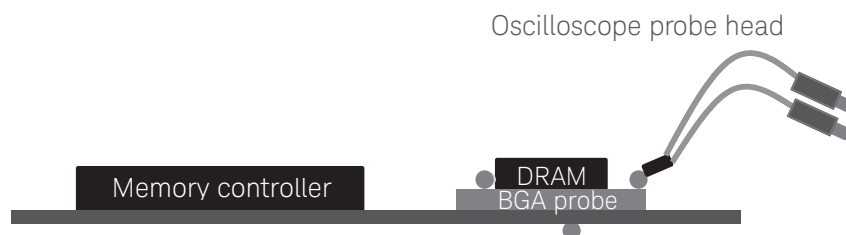

Figure 33. DDR testing

A modified circuit representation of this is shown in Figure 34. Notice that there is a resistor embedded in the interposer and the signal is routed to the probe through a transmission line. The actual implementation of this has interposer transmission lines typically no longer than 0.5 inch.

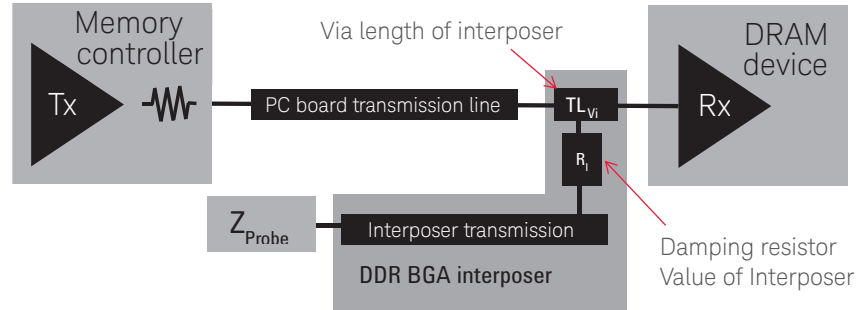

Figure 34. Circuit diagram of DDR interposer

Only one probe is shown in both diagrams, however, the problem that confronts a DDR validation engineer is to measure not just one signal but perhaps 18 or 34. These signals would include two differential signals, DQS and strobe, and 16 or 32 single-ended data signals. The differential signals may be routed directly to the oscilloscope (channels with probe/probe amplifiers), as they are common to all DDR data measurements, however, it is clear there are not enough oscilloscope channels to look at the waveform parametrics of 16 data signals. This situation would clearly be a great candidate for a switch matrix.

This switch matrix issue is a little different than the one presented earlier because the switch matrix is to be located between the oscilloscope probe head and the oscilloscope probe amplifier connected to one oscilloscope channel. It can be done in one of two ways: using single-ended probes or using differential probes. In the first way, the outputs of each single-ended probe go to the N-to-1 switch matrix. In the second way, you would use differential probes and route both outputs of the probes through a switch matrix configured as two N-to-1 switches (as shown throughout this application note). Figure 35 shows both of these configurations.

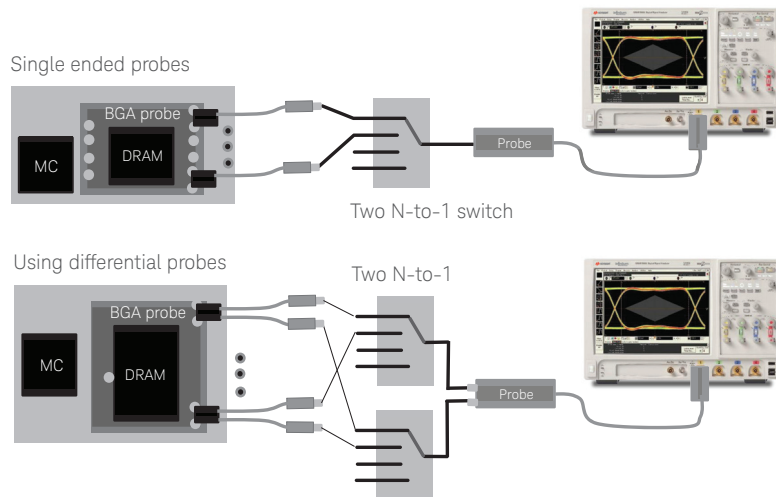

Figure 35. DDR switching

Considerations in choosing the probe configuration are:

- **Probe loading:** differential probe presents lower loading than a single-ended probe.
- **Bandwidth of measurements:** a differential probe bandwidth may be much higher.
- **Routing complexity:** the differential probe switch configuration requires that both paths be phase matched to the probe amplifier.

Care must be taken in the construction of this probe/switch network particularly if the differential implementation is selected. The first step is to ensure the network is phase matched. Using the setup below with a fast pulse, splitter, and de-skewed oscilloscope channels, subtract Ch2 from Ch1 and verify low residual voltage (total signal cancellation is the ideal).

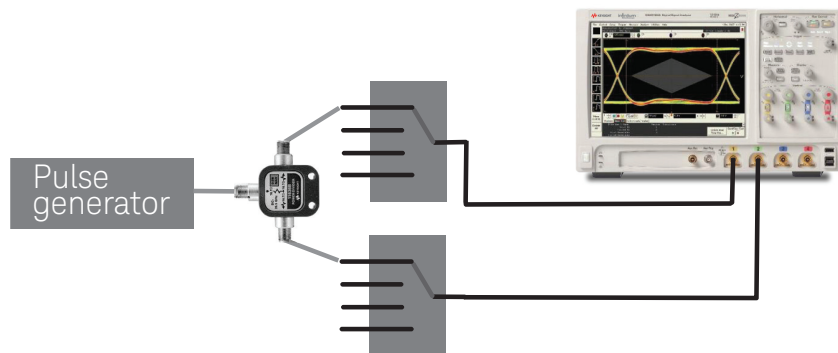

Figure 36. Verifying network between probe head and probe amp

Step two would be to connect the probe amplifier, probe head, and matrix in between and then solder both inputs of the differential probe to ground at the same point. The oscilloscope trace in this setup should be quiet, illustrating an electrically quiet grounding system.

The manner we would calibrate the switch paths is a little different than before. In this case, we calibrate each path as a separate probe using the PrecisionProbe software where we make use of the PrecisionProbe calibration fixture.

At this point we have the probes (probe paths) calibrated, but we have not comprehended the interposer, which is very similar to our fixture or test board in Cases 1 and 2. When using the interposer, however, we are forced to de-embed it with a model where in the other cases it is possible that the fixtures are good enough to not consider. This modeling of the interposer and the generation of the de-embed file using InfiniiSim is discussed thoroughly in the Keysight application note with the publication number 5990-9254EN. Once the transfer function is created in InfiniiSim, we can proceed as earlier with measurements with both PrecisionProbe and InfiniiSim transfer functions active.

C. Switching in applications

Many high speed digital applications can profitably make use of switches so the test framework supports the use, control, and calibration of these switch matrix networks. Applications such as DisplayPort, HDMI, MIPI, DDR, and PCI Express all have multiple lanes that need to be tested. The switch interface is shown in the 'Tools' tab in the standard application menu and will lead to setting up the switch controller, which includes finding it on the network using Keysight IO Libraries and then in the switch resource definition, setup, and calibration screens. These are shown in the Figure 37.

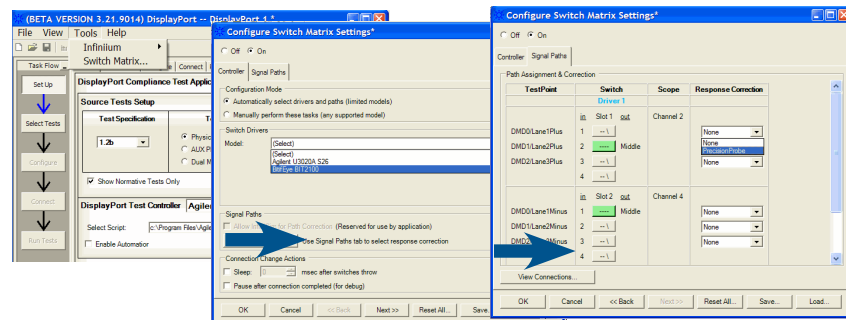
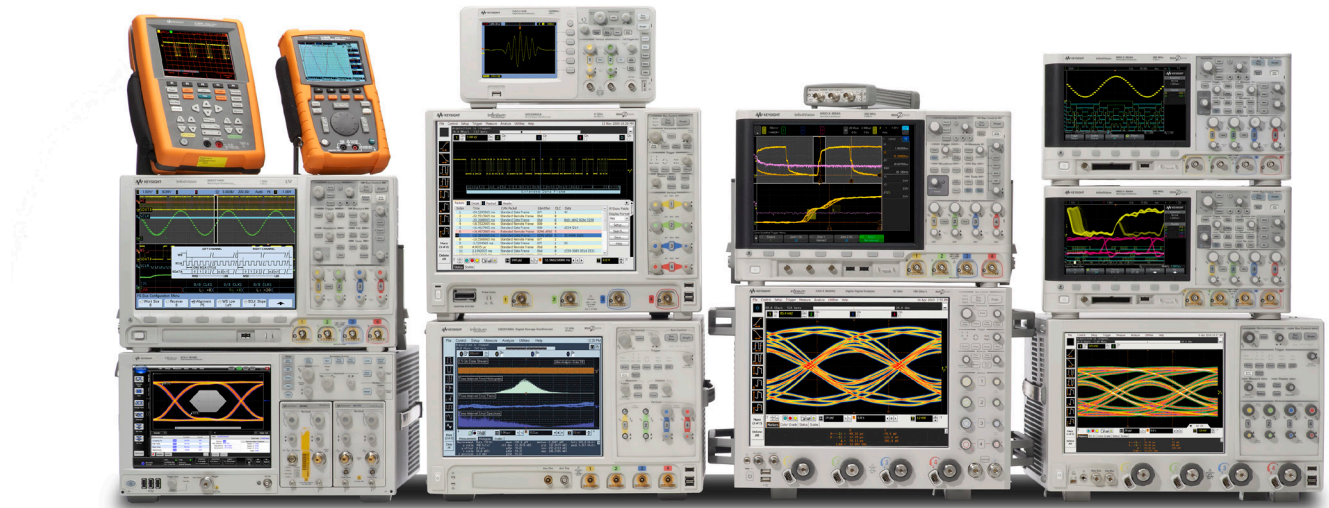

Figure 37. Switch matrix access in standard application (DisplayPort shown) with controller definition and switch path setup

Related Literature

| Publication title | Publication type | Publication number |
|--|------------------|--------------------|
| <i>Practical Application of the InfiniiSim Waveform Transformation Toolset</i> | Application Note | 5990-9254EN |
| <i>De-embedding and Embedding S-Parameter Networks Using a Vector Network Analyzer</i> | Application Note | 5980-2784EN |
| <i>Understanding Oscilloscope Probe Correction</i> | Application Note | 5990-8371EN |



Keysight Oscilloscopes

Multiple form factors from 20 MHz to > 90 GHz | Industry leading specs | Powerful applications

myKeysight

myKeysight

www.keysight.com/find/mykeysight

A personalized view into the information most relevant to you.



www.axiestandard.org

AdvancedTCA® Extensions for Instrumentation and Test (AXIe) is an open standard that extends the AdvancedTCA for general purpose and semiconductor test. Keysight is a founding member of the AXIe consortium. ATCA®, AdvancedTCA®, and the ATCA logo are registered US trademarks of the PCI Industrial Computer Manufacturers Group.



www.lxistandard.org

LAN eXtensions for Instruments puts the power of Ethernet and the Web inside your test systems. Keysight is a founding member of the LXI consortium.



www.pxisa.org

PCI eXtensions for Instrumentation (PXI) modular instrumentation delivers a rugged, PC-based high-performance measurement and automation system.



Three-Year Warranty

www.keysight.com/find/ThreeYearWarranty

Keysight's commitment to superior product quality and lower total cost of ownership. The only test and measurement company with three-year warranty standard on all instruments, worldwide.



Keysight Assurance Plans

www.keysight.com/find/AssurancePlans

Up to five years of protection and no budgetary surprises to ensure your instruments are operating to specification so you can rely on accurate measurements.



www.keysight.com/go/quality

Keysight Technologies, Inc.
DEKRA Certified ISO 9001:2008
Quality Management System

Keysight Channel Partners

www.keysight.com/find/channelpartners

Get the best of both worlds: Keysight's measurement expertise and product breadth, combined with channel partner convenience.

www.keysight.com/find/switching

For more information on Keysight Technologies' products, applications or services, please contact your local Keysight office. The complete list is available at: www.keysight.com/find/contactus

Americas

| | |
|---------------|------------------|
| Canada | (877) 894 4414 |
| Brazil | 55 11 3351 7010 |
| Mexico | 001 800 254 2440 |
| United States | (800) 829 4444 |

Asia Pacific

| | |
|--------------------|----------------|
| Australia | 1 800 629 485 |
| China | 800 810 0189 |
| Hong Kong | 800 938 693 |
| India | 1 800 112 929 |
| Japan | 0120 (421) 345 |
| Korea | 080 769 0800 |
| Malaysia | 1 800 888 848 |
| Singapore | 1 800 375 8100 |
| Taiwan | 0800 047 866 |
| Other AP Countries | (65) 6375 8100 |

Europe & Middle East

| | |
|----------------|---------------|
| Austria | 0800 001122 |
| Belgium | 0800 58580 |
| Finland | 0800 523252 |
| France | 0805 980333 |
| Germany | 0800 6270999 |
| Ireland | 1800 832700 |
| Israel | 1 809 343051 |
| Italy | 800 599100 |
| Luxembourg | +32 800 58580 |
| Netherlands | 0800 0233200 |
| Russia | 8800 5009286 |
| Spain | 0800 000154 |
| Sweden | 0200 882255 |
| Switzerland | 0800 805353 |
| | Opt. 1 (DE) |
| | Opt. 2 (FR) |
| | Opt. 3 (IT) |
| United Kingdom | 0800 0260637 |

For other unlisted countries:
www.keysight.com/find/contactus
(BP-07-10-14)