

Keysight Technologies

OFDMA Introduction and Overview for Aerospace and Defense Applications

Application Note

Introduction

This application note is for Aerospace and Defense (A/D) engineers considering or developing systems using OFDM or OFDMA. Understanding the complexities of OFDM and OFDMA can be challenging, particularly if one has not previously worked with commercial wireless standards. The intent of this application note is to provide a brief introduction to OFDM and OFDMA, with an eye toward the special considerations and environments for A/D applications. The concepts presented in this application note will serve as an initial basis to further understand commercial standards-based OFDM and OFDMA such as LTE using additional reference provided at the end of this application note.

Orthogonal frequency division multiplexing (OFDM) has become attractive for a wide range of commercial wireless systems because it delivers high data throughput in real-world environments, along with spectral efficiency, and link flexibility. OFDM first came into wide use more than a dozen years ago in wireless local area network (LAN) applications and has recently spread rapidly to support wireless mobile voice and data in the form of the 3GPP long-term evolution (LTE) standard and the Worldwide Interoperability for Microwave Access (WiMAX) standard.

The baseband processing power that OFDM demands for both signal generation and demodulation is no longer a barrier to implementation, and in recent years systems have rapidly increased their throughput and efficiency. Commercial systems have implemented progressively wider bandwidths and sophisticated coding and multiplexing schemes to efficiently serve large numbers of users with ever-greater data demands.

OFDM's low symbol rate and multicarrier structure, combined with coding and forward error correction, allow it to operate effectively in channel conditions degraded by interference, jamming, and frequency selective fading.

Because of its multicarrier structure, OFDM is readily extendable to simultaneous multiple-access capability by mapping subcarriers to users in a scheme called orthogonal frequency division multiple access or OFDMA. This multiple access approach is especially attractive because multiple users can be supported in a flexible fashion with only minor changes in the air interface.

In addition, Multiple-Input Multiple-Output (MIMO) techniques can be used with OFDM and OFDMA systems to further improve data throughput in the presence of multipath environments.

This combination of benefits makes OFDM attractive for flexible deployment in Aerospace and Defense (A/D) applications, both terrestrial and marine. One attractive application example is video streaming for improved situational awareness. A/D users could potentially take advantage of sophisticated existing hardware and software solutions that offer proven commercial performance in different physical environments from wide open terrain to complex obstructed urban environments. Off-the-shelf solutions can be configured to meet many different commercial requirements in terms of number of users, required average and peak data rates, cell sizes and configurations, and overall coverage areas. They include not only network infrastructure but a range of handsets and terminals that implement sophisticated roaming features that can include automatic switching to nearby LAN resources when available. This is a powerful benefit when optimizing use of valuable metropolitan area network (MAN) resources.

While these technologies were not designed with A/D applications in mind, particularly in the areas of security and resistance to jamming, they are designed to handle environments with interference and competing spectral users. They could potentially serve as a base layer, to which additional layers for security and robustness or redundancy may be added.

OFDM and OFDMA benefits and flexibility for A/D applications

OFDM is a digital multiplexing scheme that uses considerable digital signal processing (DSP) to implement a large-scale multicarrier transmission technique providing important benefits over real-world transmission channels. OFDM can achieve:

- High data throughput by transmitting on hundreds or thousands of carriers simultaneously and using appropriate signal coding.
- High spectral efficiency by spacing many subcarriers very closely and arranging them to be orthogonal, allowing each subcarrier to be independently modulated.
- High symbol and data integrity by transmitting at a relatively slow symbol rate to mitigate multipath effects and reduce the impact of impulsive noise, and by spreading data streams over multiple subcarriers with symbol coding and forward error correction.
- Robust operation in interference-prone environments due to its spread spectrum structure and tolerance for the loss of a subset of subcarriers.
- A high degree of operational flexibility by allocating subcarriers and symbols as needed along with signal coding schemes to accommodate different channel conditions, and different users with different needs for data rates and other characteristics such as latency and priority or quality of service.
- Multiple access (OFDMA) to support multiple users (radios) simultaneously using flexible and efficient subcarrier allocations

OFDM & OFDMA extensions and enhancements

Technologies such as multiple-input, multiple-output (MIMO), beam-forming, carrier aggregation, and space-time coding (STC) are important in achieving the maximum potential of OFDM implementations. OFDM is readily compatible with these technologies, which can enhance the effective capacity of a channel. This additional capacity may be useful for its own sake, or may be traded for benefits such as increased range, lower latency, or other system priorities.

Several of these technologies will be summarized briefly in this application note with references to direct the reader to more detailed coverage.

Used alone or in combination with enhancements, OFDM can support reliable, flexible, and high-throughput multi-user links in challenging environments. As summarized later in this application note some enhancements may be beneficial specifically for A/D applications because of their potential to enhance link robustness.

OFDM and OFDMA fundamentals

The fundamental operating principle of OFDM and OFDMA is the transmission of symbols on multiple subcarriers which are very closely spaced. Despite the close spacing, the subcarriers are orthogonal, allowing independent streams of symbols to be transmitted on each one.

Though the subcarriers are—in an ideal signal—completely orthogonal, independent and non-interfering, they are not separated by filtering and/or a guard band as are most carriers in signals using single carrier modulation. Indeed, the subcarriers are very heavily overlapped as shown schematically in Figure 1.

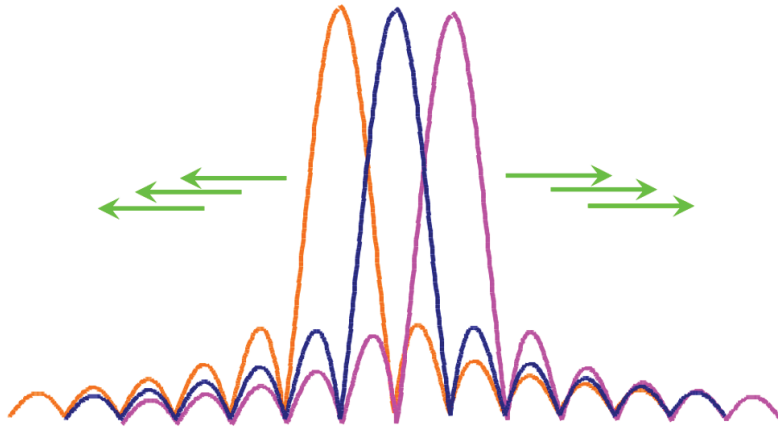

Figure 1. This is a representation of the spectrum of three overlapping OFDM subcarriers. The center of each subcarrier corresponds with a spectral null for each of the other subcarriers, providing the orthogonality necessary to allow independent modulation of each subcarrier.

The key to orthogonality with these overlapping subcarriers is the exact frequency spacing for them such that the main spectral peak of every subcarrier falls on frequencies where all other subcarriers have nulls. This arrangement of interleaved peaks and nulls can be seen as a frequency domain analog of time domain characteristics of Nyquist filters in traditional single carrier modulation. The time domain benefit is zero inter-symbol interference, allowing adjacent symbols to take on independent values. The corresponding frequency domain benefit of OFDM is zero inter-carrier interference and thus independent modulation for each subcarrier.

This independence or orthogonality is achieved without need for the filters or guard bands for each subcarrier that would be needed to prevent interference when using single carrier modulation. The necessary filtering is inherent in the FFT processing used for demodulation, as described later in this note.

The independent modulation of subcarriers extends beyond payload data streams (symbol values) to include the independence of modulation types. As long as symbol timing and subcarrier spacing are correct, each subcarrier can use the modulation type and coding scheme that best suits its needs. Modulation types can even be changed on a symbol-by-symbol basis, including the presence and modulation of pilot subcarriers as will be described later in this note. This high degree of independence and modulation freedom is an enabling characteristic for OFDMA schemes, making it easier to separate elements of the spectrum/time resource for serving multiple users in a flexible fashion.

There is no inherent capacity benefit to this scheme of dividing a payload over a large number of subcarriers, and the channel's "Shannon limit"* is unchanged. However the result of dividing the payload between multiple subcarriers is a proportional decrease in the symbol rate required for each subcarrier. For example, if 100 subcarriers are used, the symbol rate for equivalent transmission (in terms of effective data rate) to single carrier modulation can be reduced to 1/100 of its single-carrier value.

* The maximum rate at which information can be transmitted over a communications channel given conditions such as channel bandwidth, power, and the amount of noise in the channel.

Spreading the information across many subcarriers and using appropriate signal coding for error correction means that the signal is more resistant to narrowband or single-frequency interferers, impulsive noise, and nulls and dropouts due to multipath fading. When interference prevents demodulation of one or more subcarriers and/or symbols the coding and error correction can enable recovery of the original payload stream from the information in the rest of the subcarriers and symbols.

In particular, the dramatically-increased symbol times of OFDM generally extend from a value much shorter than typical delay spread (e.g. single carrier modulation) to one which is significantly longer, dramatically reducing its effects by restricting the effect of the delay spread to one symbol instead of multiple ones. Problems with multipath or delay spread can be further reduced by the common practice of adding a cyclic extension or guard interval to the OFDM symbols, as described later in this application note.

Finally, the OFDM signal structure inherently lends itself to strong (and easier) equalization schemes, which can further reduce the effects of multipath.

OFDM operational challenges

In addition to the computational challenges inherent in signal creation and demodulation, the large number of subcarriers and their close spacing places significant demands on the analog performance of OFDM systems. The combination of many independent subcarriers can create a signal with a high peak/average power ratio and thus requires highly-linear power amplifiers. The close subcarrier spacing requires low phase noise oscillators and synthesizers at both ends of the transmit/receive chain. These demands will be discussed in more detail later in this application note.

OFDM signal structure and generation

It is accurate, but inadequate to explain OFDM demodulation as simply performing a fast Fourier transform (FFT*) on the received signal and converting the vector (IQ) results from each bin to a constellation point and symbol value for that bin. Though the modulation/demodulation process is indeed a straightforward in concept, it is helpful to explain the process in steps from creating the signal to demodulating it.

* The term discrete Fourier transform or DFT is also used for these processing operations. The terms are used interchangeably in this note.

OFDM signal generation steps

The processing required to generate and demodulate OFDM signals in real time may be considerable but the steps are easy to understand if taken in sequence. Here the basic steps will be summarized, followed by brief discussion of the specifics of the more sophisticated implementation of LTE. Figure 2 describes the general process to turn a sequence of payload bits into an OFDM frame. A frame may correspond to an RF burst (after the addition of signal elements such as a preamble) but OFDM signals may be transmitted in a continuous fashion as well.

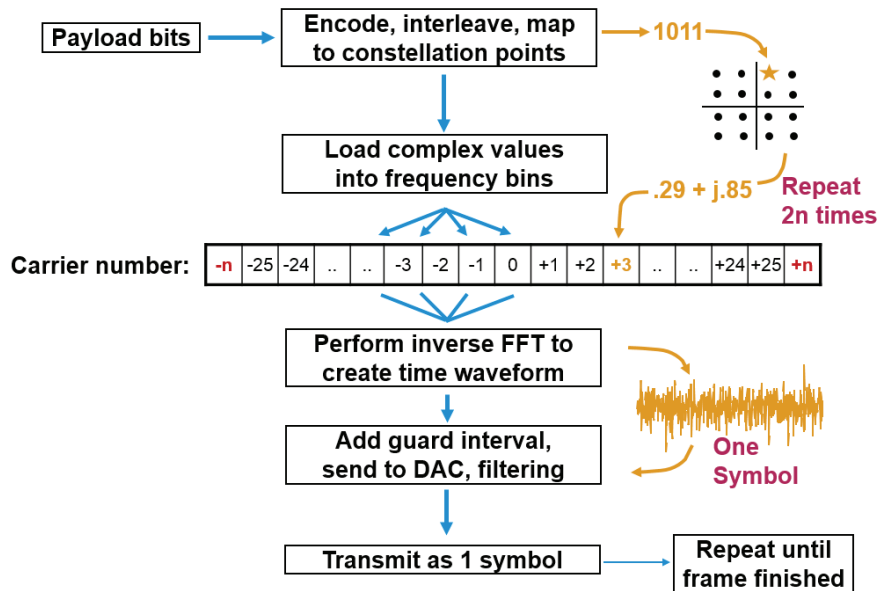

Figure 2. This simplified sequence shows the steps involved in generating an OFDM signal. The OFDM signal begins with an array of complex frequency domain values corresponding to the modulated subcarriers. These frequency domain values are converted to time domain values by an inverse FFT, for RF transmission.

The following summary will describe the most important steps in OFDM signal creation with a single-user example, referring to Figure 2. More sophisticated implementations such as multi-user OFDMA will be discussed next.

- A payload stream in the form of a serial bit sequence is encoded as desired, including processes such as interleaving and forward error correction.
- The resulting bit stream is divided among the data-carrying subcarriers. This can be considered part of the signal coding. In this example $2n$ subcarriers are transmitted, though some are typically assigned as “reference signals” (RS) or pilot subcarriers. RS and pilots do not carry payload data and will be described later in this application note. Data distribution to the subcarriers reflects the modulation type used on the subcarriers and the resulting number of bits/symbol. For 16QAM each symbol represents 4 bits and therefore a single OFDM symbol that uses 48 subcarriers will represent 4 bits x 48 subcarriers = 192 bits.
- For each subcarrier an IQ symbol value is calculated. The result is a set of vector spectrum or frequency domain points for the pilot and data subcarriers, $2n$ in all.
- The $2n$ complex (IQ) frequency domain points are processed using an inverse FFT (IFFT) to produce a time domain segment or time record. Note that the center subcarrier (in some systems multiple subcarriers around the center) is not transmitted in OFDM systems due to the fact that carrier feedthrough generally produces a signal at this frequency and it would interfere with symbol transmission.

- The time domain segments or symbols resulting from the IFFT are extended in length to form a cyclic prefix or guard interval. The extended symbol provides increased multipath immunity, allowing demodulators to adjust their FFT/DFT interval timing slightly to a value that minimizes the effects of multipath delays. Symbol extension techniques and guard intervals will be discussed in more detail later in this application note, in the section on demodulating OFDM.
- The time domain samples composing the extended symbol are sent to a digital to analog converter (DAC), followed by the rest of the symbols that make up a data frame or burst. The result of this process is a sequence of symbols, each made up of the desired number of subcarriers. This defines a (symbol) x (subcarrier) space as shown in simplified form in Figure 3.

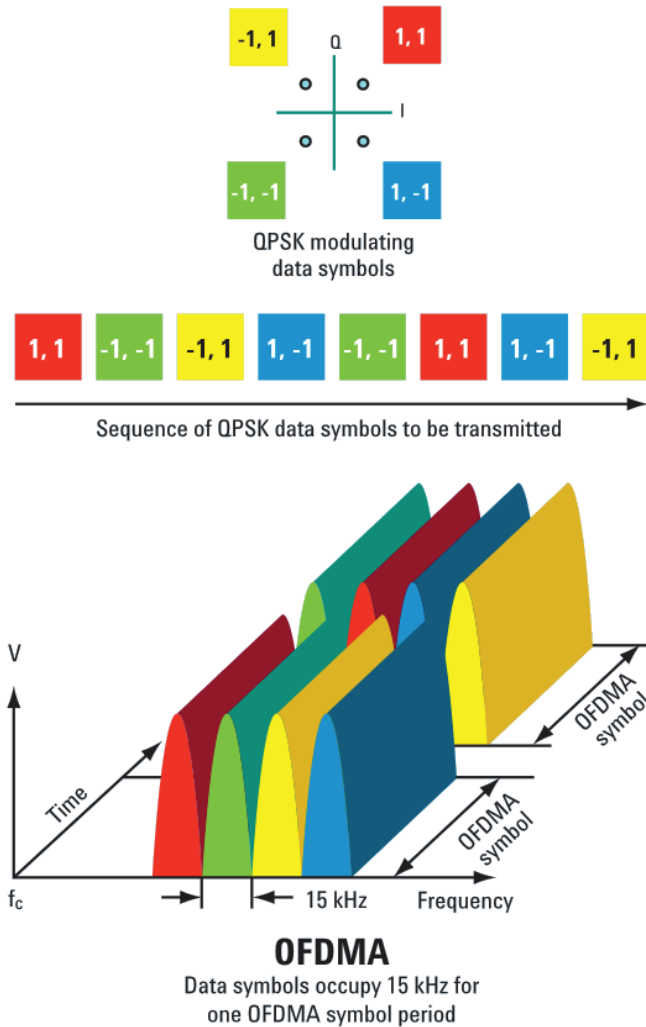

Figure 3. Two symbols of QPSK modulation for four subcarriers are shown in the IQ and time domains and the frequency domain. The OFDM subcarriers are shown as in different colors and as separate spectral elements, reflecting their orthogonality. The 15 kHz subcarrier spacing is typical of the downlink in the 3GPP LTE standard.

* Finally, in some systems a preamble is added to each frame, as described later in this note. The signal is filtered as needed and then upconverted for RF transmission.

Preambles, pilots for synchronization, equalization, control

Preambles (or their equivalent) are important elements of OFDM transmission schemes and are customized to the needs of the system and anticipated channel characteristics. Preambles are used by OFDM receivers to enable and optimize demodulation, and to receive control information to manage system operation. The beginning of the preamble corresponds with the beginning of an RF burst in many OFDM systems.

The beginning of a simple OFDM frame is shown in Figure 4, including preamble symbol(s) in pink and continuous pilot subcarriers or reference signals in green. The pilot or reference signals will be described in more detail later in this note.

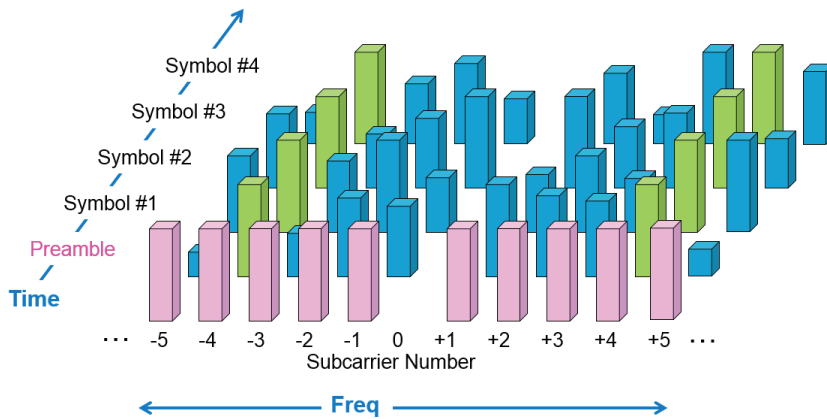

Figure 4. This simplified representation of a portion of an OFDM frame shows the position of the preamble (pink) and pilot (green) subcarriers along with the data subcarriers (blue). Though not shown here, preambles may be more than one symbol in length.

Preambles may be explicitly labeled as such, or may simply be composed of several symbols sent periodically, which are mostly or exclusively composed of synchronization and control information.

Equalization

An important function of preambles and other reference elements of OFDM schemes is to support equalization. The characteristics of the RF channel are constantly changing, and equalization is a primary tool used by receivers—and sometimes transmitters—to compensate for these changes.

OFDM systems lend themselves very well to equalization and channel correction. Their multicarrier nature and related demodulation operations provide the frequency domain processes needed to equalize channel effects. Accordingly, known preambles or reference signals are transmitted periodically in all OFDM systems. Since the receiver knows the magnitude and phase of these transmitted subcarriers it can use them to determine the channel frequency response, and subsequently perform complex (vector or IQ) correction of the signal to compensate for the channel. Errors due to the channel are typically much larger than those in the transmitter. An example of an equalizer training sequence, as measured at a receiver, is shown in Figure 5.

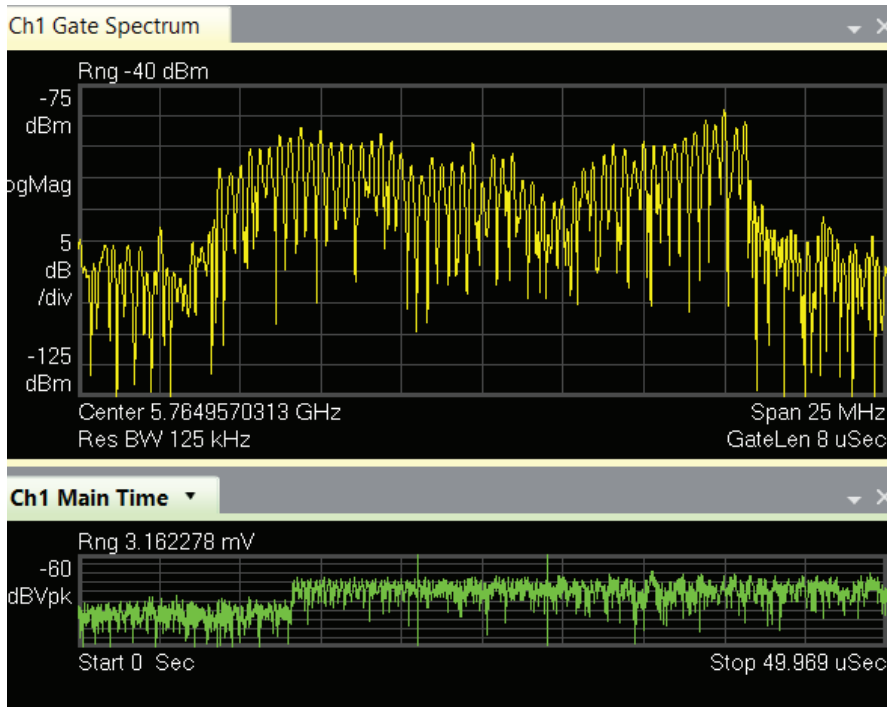

Figure 5. This gated spectrum measurement of the training sequence of an OFDM preamble (top) was measured at a receiver, and the peaks of the subcarriers show the channel amplitude frequency response. The subcarriers were all transmitted at the same amplitude, but the received subcarrier strength varies by almost 15 dB. The bottom trace is the RF envelope, with gate markers.

In the signal shown in Figure 5 a training sequence symbol is transmitted using all OFDM subcarriers, set to the same amplitude. An amplitude measurement is shown here, though the training sequence subcarriers are defined in terms of both amplitude and phase or I and Q. Thus receivers can perform complex frequency response correction in terms of amplitude/phase or I/Q as desired.

Complete signal structure: LTE downlink example

Flexible, high-capacity systems such as LTE combine many of the system elements and processing described here to form OFDM signals with more complex structure. An example of the content and structure of one frame is shown in Figure 6.

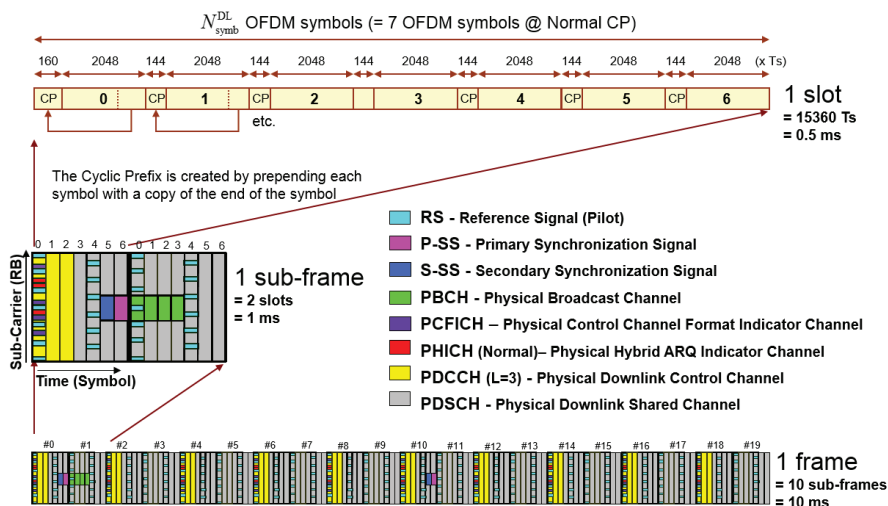

Figure 6. Structure and content of an LTE downlink frame. Each frame consists of 10 sub-frames, each sub-frame consists of two slots, and each slot consists of 7 OFDM symbols. Synchronization and control signals are transmitted primarily at the beginning of each frame, while reference signals (pilots) are transmitted at intervals throughout the frame.

LTE systems are available in frequency-division duplexed (FDD) and time-division duplexed (TDD) versions. The FDD version uses paired frequencies to handle upload and download traffic separately, while the TDD version shares a frequency for both tasks, and the upload/download time ratio can be varied to suit system and user demands.

Note that while many systems use bursted RF transmissions, synchronization and demodulation do not require bursting. Synchronization may be accomplished for continuously-modulated signals by appropriate synchronization signals and receiver processing, though that discussion is beyond the scope of this application note.

OFDMA: a multi-user extension of OFDM

Some OFDM systems serve multiple users solely through TDMA techniques. This is a practical and straightforward approach but is not the most flexible and may not be the most efficient way to handle multi-user demands and optimize the available spectrum and time resources. A simple TDMA scheme is also potentially less secure and may be less robust than a more complex and dynamic allocation of spectrum and time resources.

Orthogonal frequency domain multiple access (OFDMA) is a logical extension of OFDM techniques to serve multiple users efficiently. The available spectral resource is broken up into two orthogonal elements—subcarriers (frequency) and symbols (time)—which can be independently apportioned to users as needed by a central system scheduler. Resource allocation can be pre-arranged or managed on an ad hoc basis to respond to data demands and channel constraints or impairments.

In addition to allowing the efficient trunking of multiple lower-rate users using a shared channel, OFDMA can enable per-user frequency hopping to mitigate the effects of interference, jamming, or narrowband fading.

Sharing the bandwidth and time resources

Figure 7 shows one scheme for OFDMA implementation. This is a simplified view of multiple data rate multiplexing in the LTE standard. This diagram shows a subset, in both subcarriers and symbols, of an OFDMA frame.

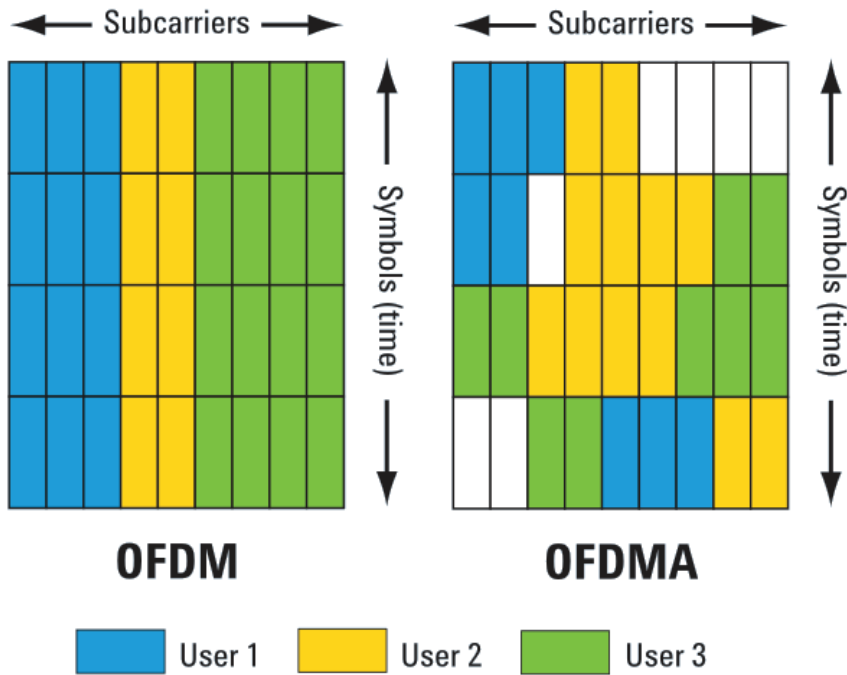

Figure 7. OFDMA is generally implemented by assigning different subcarriers to different users, for specific symbol intervals. Assigning different numbers of subcarriers (potentially with different modulation) can provide different transmission rates to different users and accommodate their varying channel conditions.

In an OFDMA system, subcarriers and symbols for an individual user can be grouped in contiguous or non-contiguous arrangements, or some combination. This flexibility allows the system to respond as traffic demands change, allocating capacity to meet user demands and to implement system priorities. For example a real-time video stream may need a high data rate on a constant basis, while internet access may require higher rates only intermittently, and voice transmission may require nearly continuous low-rate data, albeit with high priority.

OFDMA in the LTE downlink

The RF channel also represents a time resource and, as mentioned previously, the OFDM symbols are generally orthogonal in time in a fashion analogous to the frequency orthogonality of the subcarriers. In an OFDMA system, then, the smallest identifiable element of data transmission is a single subcarrier for one symbol period. However in LTE, WiMAX and other systems the data transmissions are scheduled in larger units consisting of multiple subcarriers for one or more symbol periods. The fundamental spectrum/symbol unit of LTE is the resource block, as shown the form of a resource grid in Figure 8.

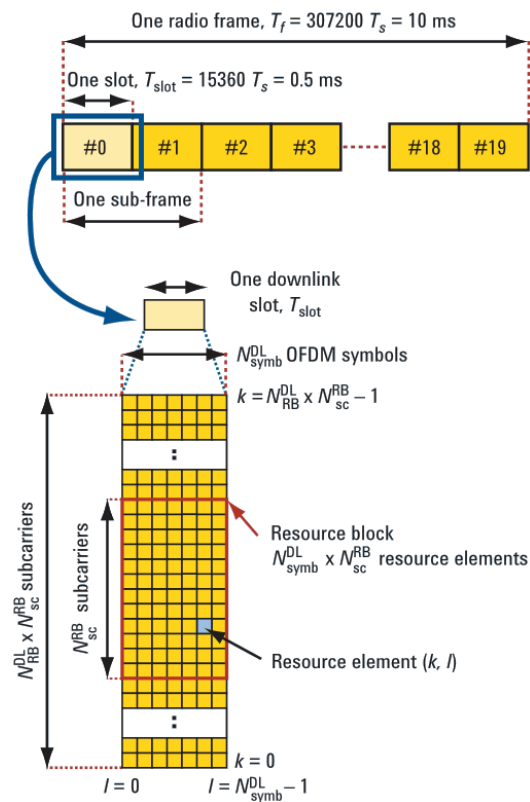

Figure 8. This diagram shows how LTE allocates channel capacity in terms of both time (symbols) and frequency (subcarriers). The resource block is the principal unit of data transmission and consists of 12 adjacent subcarriers for a duration of one slot or 7 symbols.

In LTE, channel resources are allocated by the system scheduler in units of 12 adjacent subcarriers for a duration of 1 slot or 7 symbols. The number of available subcarriers varies according to the channel bandwidth used.

Advantages and disadvantages of OFDMA

As a multiplexing layer in wireless systems OFDMA provides a number of benefits:

- Optimum resource allocation freedom due to orthogonality in both time and frequency
- Flexible and dynamic resource allocation to match user needs and channel conditions
- Increased ability to implement quality of service (QoS) factors such as priority, latency, data rate and error rate
- Potential to avoid pulsed carriers by eliminating the need for TDMA operation
- Reduced transmit power required for low data rate users
- Ability to enable per-user frequency switching or hopping to avoid narrowband fading or interference

However OFDMA operation may also come with disadvantages in some situations. For example in a system with generally continuous transmissions it may be impractical to pause or hibernate signal processing. Timing and frequency accuracy for coordinated use of the channel may be a challenge for low-cost or low-power designs.

A detailed discussion of the tradeoffs of OFDMA is beyond the scope of this application but more information is available in the resources section at the end of this note.

Decoding and demodulating OFDM

Demodulating OFDM signals is generally performed as the reverse of the process used to create them. In particular, the FFT (or DFT) operation is the core demodulation process that converts complex time samples in the radio receiver to complex—typically I/Q but alternatively magnitude/phase—frequency points. These complex frequency points become constellation points which are converted to symbols and then to physical layer data.

Two techniques used in OFDM have particular implications for its expanded use in A/D applications, and they will be covered briefly here. These techniques or technologies are pilot tracking and cyclic extension or guard interval. The techniques have been developed to mitigate typical problems in the RF channel and in transmitters, and are powerful contributors to the success of OFDM systems in challenging real-world environments.

Reference signals and pilot tracking

Reference signals or pilots are dedicated subcarriers, or symbols on specific subcarriers, which do not contain payload data and instead are transmitted with values known to the receiver. They are analogous to equalizer training sequences and they are used to guide demodulation. Because both are signals whose content is known to the receiver, their functions may be combined to optimize received signal quality.

It is important to understand, then, that OFDM signals are demodulated relative to the references, which are presumed to share the impairments of the rest of the modulated signal. This part of the demodulation process is called pilot tracking and it allows the demodulation process to track signal errors and correct for them on a symbol-by-symbol basis.

Because the receiver knows the intended I/Q or amplitude/phase values of the references, it can adjust all other symbols by the same amount required to fix the error it sees in the pilots. In this way, errors of signal amplitude, phase and symbol timing can be removed or “tracked out” as shown in the measurements of Figure 9.

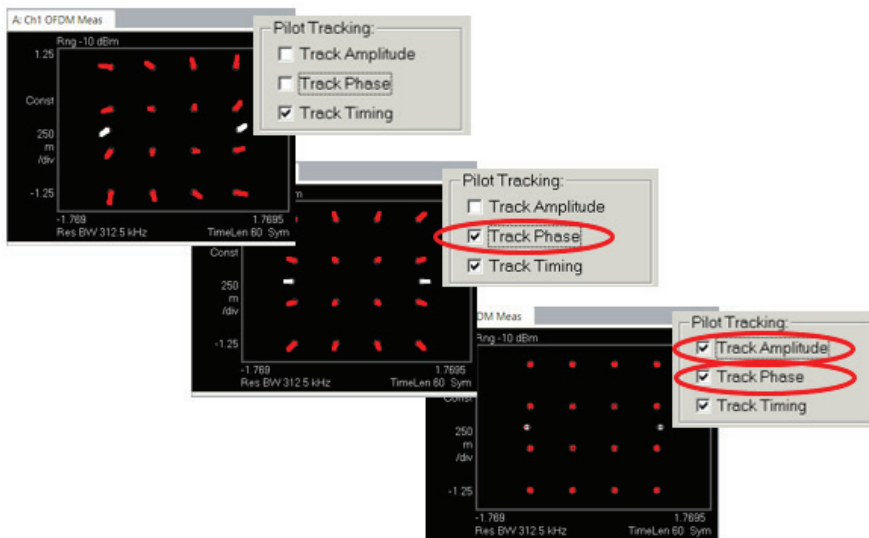

Figure 9 OFDM demodulation controls in the 89600 VSA software allow reference/pilot tracking types to be individually selected as a way to isolate errors when troubleshooting. This signal has both amplitude droop and phase drift during a frame, shared by the pilots (white) and the data symbols (red). Correcting the pilot symbol locations corrects the data symbols as well.

Pilots are transmitted during the data portion of OFDM frames or subframes. They may be transmitted continuously on specific subcarriers, as seen in the 802.11a/g examples discussed previously. In LTE they are transmitted periodically as shown in Figure 6. Since they displace subcarriers that would normally carry payload data there is a tradeoff between mitigating channel and transmitter problems and maximum system efficiency.

Several schemes for optimizing these tradeoffs are shown in Figure 10.

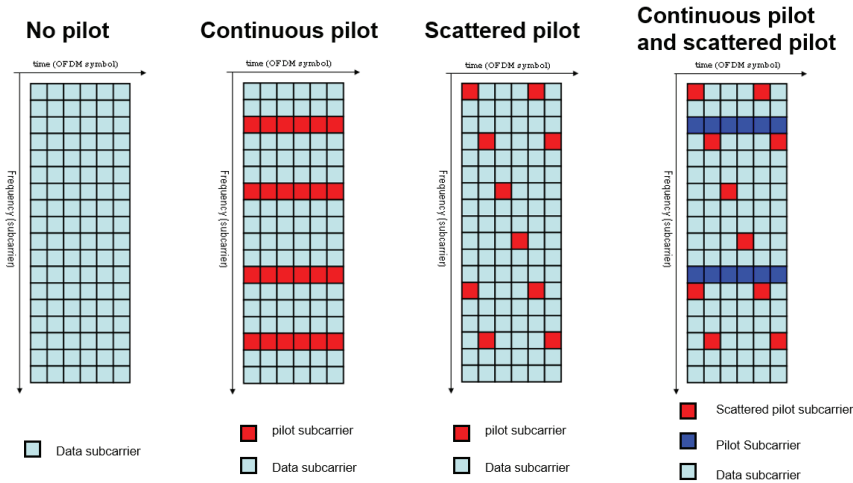

Figure 10. Several schemes for positioning reference signals or pilots in an OFDM frame are shown. Though pilots are shown for every symbol here, systems such as LTE may omit pilots for certain symbols to improve throughput.

The simplest scheme is continuous pilots, where specific subcarriers are always used as pilots during the data transmission portion of a frame. Alternatively, pilots may be “scattered” in a prearranged pattern, to cover the frequency spectrum more evenly and avoid problems where a narrowband interferer matches a continuous pilot frequency. Such interference of a critical signal element could seriously impair demodulation.

Systems may employ both continuous and scattered pilots as a way to handle particularly troublesome impairments.

To improve throughput, systems may be configured to transmit some symbols with no reference signals, where sufficient demodulation reference information can be derived from pilots that are nearby in time and frequency. Finally, systems may employ different operating modes with different pilot structures to handle varying conditions.

Cyclic extension or guard interval

A key advantage in OFDM systems in challenging, real-world radio channels is their potential insensitivity to multipath or delay spread. The long OFDM symbols and the introduction of a guard period between each symbol can eliminate inter-symbol interference due to delay spread. If the guard period is longer than the delay spread in the radio channel, and if each OFDM symbol is cyclically extended into the guard period, the receiver can align its FFT processing interval for demodulation to eliminate the inter-symbol interference.

As summarized in the earlier section on OFDM signal generation, the transmitted symbols are extended in length (time duration) as the transmit frame is assembled. In LTE, for example, this “cyclic extension” process is implemented by copying a portion of the end of a symbol and appending it to the beginning of the symbol as shown in Figure 11.

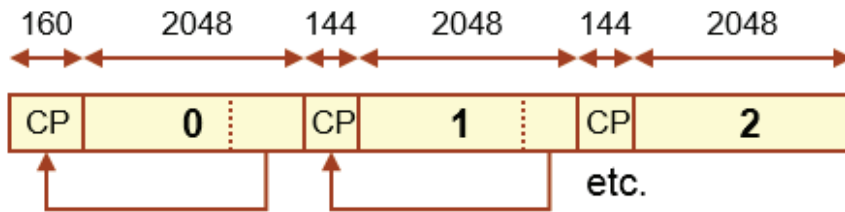

The Cyclic Prefix (CP) is created by prepending each symbol with a copy of the end of the symbol

Figure 11. The normal cyclic prefix configuration in LTE for the first three symbols of a seven-symbol slot is shown here. The cyclic shift extends the effective symbol length, allowing receivers to adjust demodulation timing to remove inter-symbol interference due to delay spread.

OFDMA design and operation challenges

While OFDMA is robust and efficient as a wireless transport layer it also demands high levels of analog and digital performance, and poses considerable challenges to system designers and manufacturers:

- Computational complexity: OFDMA for wideband wireless applications has only become practical in recent years as processor power and efficiency have increased. Nonetheless the DSP requirements are considerable and the continuous nature of processing, even during periods of low traffic, can reduce practical power efficiency and impact battery-operated devices.
- Sensitivity to phase noise and Doppler shift: The close subcarrier spacing of OFDMA places a premium on the frequency stability and accuracy of all oscillators and synthesizers in the transmit and receive chains. Phase noise is often an expensive and power-intensive parameter to improve, so designers must carefully evaluate cost/performance tradeoffs. It is particularly important to understand the degree to which pilot tracking in receivers compensates for close-in phase noise and to focus design effort and cost accordingly.
- Requirement for power amplifier linearity: As described by the central limit theorem, adding a number of independently modulated signals such as OFDMA subcarriers will produce a signal that tends toward the peak/average power characteristics of additive white Gaussian noise (AWGN). Noise-like signals have a high peak/average power compared to typical single-carrier modulation, making them a challenge to amplify efficiently. Power amplifiers with very high linearity are typically more expensive and consume more power, but are needed in OFDMA systems to prevent spectral regrowth or adjacent channel interference and modulation distortion. LTE systems solve this problem in the uplink through the use of SC-FDMA. On the downlink, techniques such as “tone reservation” can significantly improve signal power statistics with only a small impact on throughput due to sacrificed subcarriers.
- Need for precise frequency accuracy and timing alignment: Frequency and pilot tracking in receivers can correct for some transmit frequency and symbol timing errors. Guard intervals may also mitigate problems, though larger guard intervals come at the cost of lower data throughput. OFDMA systems, in particular, place a premium on frequency and timing accuracy associated with the need to coordinate transmissions from multiple users. Unfortunately some corrections cannot be applied together to multiple users. Doppler shift is one example of an error that may be very different from user to user, and a particular challenge to tracking algorithms.

Issues in leveraging OFDMA for A/D applications

As discussed in this application note, OFDMA technologies such as LTE offer proven benefits that may offer potential in matching A/D application requirements. As is often the case with adopting off-the-shelf commercial solutions, there are also potential issues.

- Information Security. The protocol complexity and coding inherent in systems such as LTE offers a limited degree of security that will not be sufficient for all A/D applications. Increased security may be achieved with a customized or re-engineered version of a fully developed technology such as LTE. An alternative approach may be to implement an additional security or encryption layer in base stations and UE. It may also be important to add security to the backhaul elements of the cellular infrastructure.
- Ruggedness of consumer equipment. The commercial equipment tradeoffs in size, weight, cost, environmental ruggedness, and battery life may not be acceptable for some A/D uses. Some custom designs, new versions, or protective equipment may be required for both base station infrastructure and UE/terminals.
- Link robustness. While commercial equipment is designed to operate in crowded spectral environments with considerable potential for interference, it is not designed for deliberate efforts such as jamming. Technologies such as OFDMA may be extended through additional programming for signal coding schemes, more agile subcarrier allocations, band-switching, carrier aggregation, and beam-forming.
- Fixed vs mobile infrastructure. Commercial cellular technologies such as LTE are typically implemented with fixed infrastructure including base stations, antennas, and backhaul links. The infrastructure is typically planned with the aid of drive testing and modeling. A/D applications may require a more ad hoc and open-ended approach, with rapid deployment. Where these issues are a concern, successful implementations of commercial solutions are likely to require customization and validation in real-world conditions.
- Rapid evolution of commercial equipment. The pace of acquisition, deployment, and replacement of commercial equipment is generally rapid, even in the case of cellular base stations. This may create issues with long term support and compatibility in the A/D environment.

MIMO operation for enhanced capacity

Multiple-input/multiple-output (MIMO) is one of the most powerful techniques used in RF communications. In real-world environments, it can provide a substantial increase in channel capacity, and the added capacity can be traded for other system benefits such as greater range or improved link quality. Increases in processing power coupled with MIMO's effectiveness have led to its use in commercial standards such as LTE, 802.11n WLAN, and WiMAX.

MIMO operation requires multiple (two or more) antennas on both the base station and UE, transmitting and receiving independent signals, typically representing separate streams of information. Along with diversity and space-time coding, MIMO is one of many multiple-antenna techniques. However, it is the only one with the potential to deliver a substantial increase in theoretical channel throughput. For example a 2 x 2 MIMO system can potentially increase data throughput by a factor of 1.7 and the data throughput can scale with the number of transmit and receive channels and antennas used.

The LTE and WiMAX standards implement a novel type of MIMO in the uplink direction, known as collaborative MIMO or multi-user MIMO (MU-MIMO). In MU-MIMO separate UEs coordinate their transmissions to behave as if they are a single unit, transmitting separate streams of information.

MIMO may be useful in A/D applications, especially in reflective environments and where maximum data throughput is critical.

Flexible OFDM generation and demodulation

In some A/D applications OFDMA may be the best technological solution, but the specific demands of the application will dictate that a customized OFDM implementation may be necessary. In these situations a productive design/test process will require flexible signal generation and analysis tools and connections between them such as those shown in Figure 12.

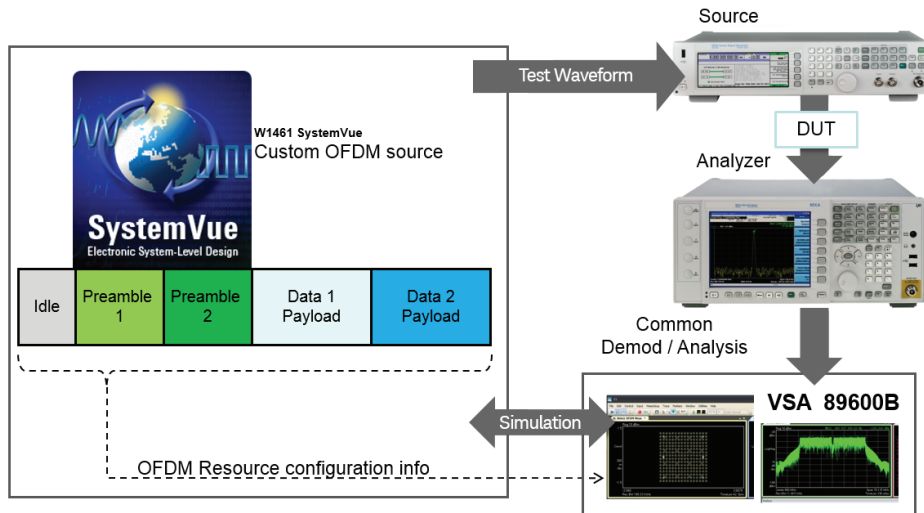

Figure 12. Custom OFDM solutions are available for both signal generation and analysis. Links between these solution elements make measurement configuration straightforward and allow the signal generation-to-analysis design loop to be closed for design productivity.

A flexible and convenient tool for generating custom OFDM signals is a design environment such as Keysight Technologies' SystemVue. It offers tools for physical layer signal generation plus customizable modules to create the necessary physical layer coding blocks for practical data transmission. SystemVue can be used to create signals with very low distortion or signals with known impairments, and can produce signals implementing sophisticated PAPR-reduction schemes such as tone reservation.

Complementary custom OFDM signal analysis is available in the 89600 VSA software, with analysis configuration directly transferred from SystemVue. This software can be used on a variety of signal acquisition platforms including RF signal analyzers, modular signal analyzers, oscilloscopes, digitizers, and logic analyzers. With these platforms custom OFDM signals can be analyzed at baseband, IF, and RF stages, in both analog and digital form.

For more information on custom OFDM solution see the application note "Custom OFDM Signal Generation Using SystemVue" described in the additional resources section of this application note.

Cognitive radio, carrier aggregation, and LTE-Advanced

As described previously, commercial wireless technologies in general and OFDMA technology in particular are progressing at a rapid rate. Some changes take the form of straightforward evolutionary improvements to improve capacity and coverage such as those planned for the LTE advanced standard. Proposed enhancements for LTE advanced include wider, scalable bandwidths, higher-order MIMO operation, additional coding and error correction schemes, relay operation, and pushing increased data rates to cell edges. Detailed explanation of these enhancements is beyond the scope of this application note but is available in literature listed in the additional resources section of this application note.

Several aspects of LTE and LTE advanced can be considered implementations of cognitive radio principles. Dynamic resource allocations by system schedulers and associated mobile feedback schemes are already part of LTE, and other dynamic frequency spectrum access techniques are being discussed.

One technique of potential interest in A/D applications is carrier aggregation, where multiple—potentially non-contiguous—frequency bands are used together to aggregate capacity and provide higher data rates. Managing these spectrum resources effectively and adapting to channel conditions and data requirements is an excellent example of cognitive radio implementation. While these techniques may be implemented in commercial systems to increase capacity and deal with interference or impaired channels, they may also be useful in A/D applications where jamming or interception is a concern.

Summary

Proven commercial OFDM and OFDMA technologies have great potential to serve the needs of A/D applications, either in off-the-shelf form or as modified and enhanced. By understanding OFDM and OFDMA, A/D engineers will be able to choose and leverage these technologies more efficiently and with less risk.

The complexities of OFDM and OFDMA are significant, as discussed in this application note. Differences in standards-based terminology (e.g. pilots, preambles, reference signals) can further compound this, along with advanced topics such as MIMO and carrier aggregation.

This application note has provided a brief introduction to the concepts of OFDM and OFDMA, with an eye toward the special considerations and environments for A/D applications. This initial overview provides a basis to develop an in-depth understanding using more detailed information from the additional resources listed below.

Related literature

LTE:

- *LTE and the Evolution to 4G Wireless Book: Design and Measurement Challenges*, Second Edition can be ordered at www.keysight.com/find/ltebook.
- *Introducing the 3GPP LTE Downlink* - Application Note, Literature number 5989-9846EN
- *3GPP LTE: Introducing Single-Carrier FDMA* - Article, Literature number 5989-7898EN
- *3GPP Long Term Evolution: System Overview, Product Development, and Test Challenges* - Application Note, Literature number 5989-8139EN

Custom OFDM:

- *Creating and Analyzing Custom OFDM Waveforms for Software-Defined Radio (SDR)* Application Note, Literature number 5991-1440EN
- *Making Custom OFDM Measurements Using the Keysight89600B VSA Software with Option BHF* - Application Note, Literature number 5990-6824EN
- *Flexible OFDM Signal Generation, Analysis and Troubleshooting* - Application Note, Literature number 5990-9757EN

Cognitive Radio:

- *Cognitive Radio Algorithm Development and Testing* - White Paper, Literature Number 5990-4389EN

myKeysight

myKeysight

www.keysight.com/find/mykeysight

A personalized view into the information most relevant to you.



www.axiestandard.org

AdvancedTCA® Extensions for Instrumentation and Test (AXIe) is an open standard that extends the AdvancedTCA for general purpose and semiconductor test. Keysight is a founding member of the AXIe consortium. ATCA®, AdvancedTCA®, and the ATCA logo are registered US trademarks of the PCI Industrial Computer Manufacturers Group.



www.lxistandard.org

LAN eXtensions for Instruments puts the power of Ethernet and the Web inside your test systems. Keysight is a founding member of the LXI consortium.



www.pxisa.org

PCI eXtensions for Instrumentation (PXI) modular instrumentation delivers a rugged, PC-based high-performance measurement and automation system.



Three-Year Warranty

www.keysight.com/find/ThreeYearWarranty

Keysight's commitment to superior product quality and lower total cost of ownership. The only test and measurement company with three-year warranty standard on all instruments, worldwide.



Keysight Assurance Plans

www.keysight.com/find/AssurancePlans

Up to five years of protection and no budgetary surprises to ensure your instruments are operating to specification so you can rely on accurate measurements.



www.keysight.com/quality

Keysight Technologies, Inc.
DEKRA Certified ISO 9001:2008
Quality Management System

Keysight Channel Partners

www.keysight.com/find/channelpartners

Get the best of both worlds: Keysight's measurement expertise and product breadth, combined with channel partner convenience.

For more information on Keysight Technologies' products, applications or services, please contact your local Keysight office. The complete list is available at: www.keysight.com/find/contactus

Americas

Canada	(877) 894 4414
Brazil	55 11 3351 7010
Mexico	001 800 254 2440
United States	(800) 829 4444

Asia Pacific

Australia	1 800 629 485
China	800 810 0189
Hong Kong	800 938 693
India	1 800 112 929
Japan	0120 (421) 345
Korea	080 769 0800
Malaysia	1 800 888 848
Singapore	1 800 375 8100
Taiwan	0800 047 866
Other AP Countries	(65) 6375 8100

Europe & Middle East

Austria	0800 001122
Belgium	0800 58580
Finland	0800 523252
France	0805 980333
Germany	0800 6270999
Ireland	1800 832700
Israel	1 809 343051
Italy	800 599100
Luxembourg	+32 800 58580
Netherlands	0800 0233200
Russia	8800 5009286
Spain	0800 000154
Sweden	0200 882255
Switzerland	0800 805353
	Opt. 1 (DE)
	Opt. 2 (FR)
	Opt. 3 (IT)
United Kingdom	0800 0260637

For other unlisted countries:
www.keysight.com/find/contactus
(BP-07-10-14)