

Title & Document Type: 8753A Network Analyzer Operating and Programming Manual

Manual Part Number: 08753-99001

Revision Date: July 1988

Silicon Investigations
Repair Information - Contact Us
920-955-3693
www.siliconinvestigations.com

HP References in this Manual

This manual may contain references to HP or Hewlett-Packard. Please note that Hewlett-Packard's former test and measurement, semiconductor products and chemical analysis businesses are now part of Agilent Technologies. We have made no changes to this manual copy. The HP XXXX referred to in this document is now the Agilent XXXX. For example, model number HP8648A is now model number Agilent 8648A.

About this Manual

We've added this manual to the Agilent website in an effort to help you support your product. This manual provides the best information we could find. It may be incomplete or contain dated information, and the scan quality may not be ideal. If we find a better copy in the future, we will add it to the Agilent website.

Support for Your Product

Agilent no longer sells or supports this product. You will find any other available product information on the Agilent Test & Measurement website:

www.tm.agilent.com

Search for the model number of this product, and the resulting product page will guide you to any available information. Our service centers may be able to perform calibration if no repair parts are needed, but no other support from Agilent is available.

Chapter 1. General

INTRODUCTION

This section of the HP 8753A System Operating and Programming Manual is a complete reference for operation of the HP 8753A network analyzer using either front panel controls or an external controller. The information in this reference is intended to supplement the separately bound tutorial documents in this manual with additional details. It is divided into chapters providing the following information:

- Chapter 1 includes a block diagram and functional description of the HP 8753A system, together with detailed information on data processing flow.
- Chapters 2 through 10 provide detailed information on front panel keys and softkeys, their purpose and use, HP-IB equivalents in parentheses, and expected indications and results. Specific areas of operation described in these chapters include calibration procedures for accuracy enhancement, using markers, limit testing, time domain measurements (option 010), plotting and printing, and saving instrument states.
- Chapter 11 contains information for operating the system remotely with a controller through HP-IB. HP-IB is Hewlett-Packard's hardware, software, documentation, and support for IEEE-488 and IEC-625, worldwide standards for interfacing instruments. Chapter 12 lists HP 8753A error messages, with explanations.

An appendix at the end of the Operating and Programming Reference provides a complete listing of the instrument preset state, a map of the operating softkey menu structure, and an alphabetical index.

This manual also contains the following separately bound documents to provide operating or programming information for the HP 8753A network analyzer:

- The User's Guide provides a tutorial operating introduction to the HP 8753A, showing how the instrument is used for common network measurements. It demonstrates many of the features and capabilities of the system in actual measurement situations.
- The Quick Operating Guide provides a quick review of the softkey menus and manual operation in a separately packaged ring-bound booklet. This guide assumes familiarity with the operation of a network analyzer.
- The HP-IB Introductory Operating Guide provides tutorial instructions for using the HP 8753A with a series 200 or 300 computer as a controller. Familiarity with front panel operation of the HP 8753A is assumed.
- The HP-IB Quick Reference Guide is a programming synopsis for users familiar with HP-IB programming and the basic functions of the HP 8753A.

HP 8753A SYSTEM OVERVIEW

Network analyzers measure the reflection and transmission characteristics of devices and networks by applying a known swept signal and measuring the responses of the test device. The signal transmitted through the device or reflected from its input is compared with the incident signal generated by a swept RF source. The signals are applied to a receiver for measurement, signal processing, and display. A network analyzer system consists of a source, signal separation devices, a receiver, and a display.

The HP 8753A RF vector network analyzer integrates a high resolution synthesized RF source and a dual channel three-input receiver to measure and display magnitude, phase, and group delay of transmitted and reflected power. The HP 8753A option 010 has the additional capability of transforming measured data from the frequency domain to the time domain. Figure 1-1 is a simplified block diagram of the HP 8753A network analyzer system.

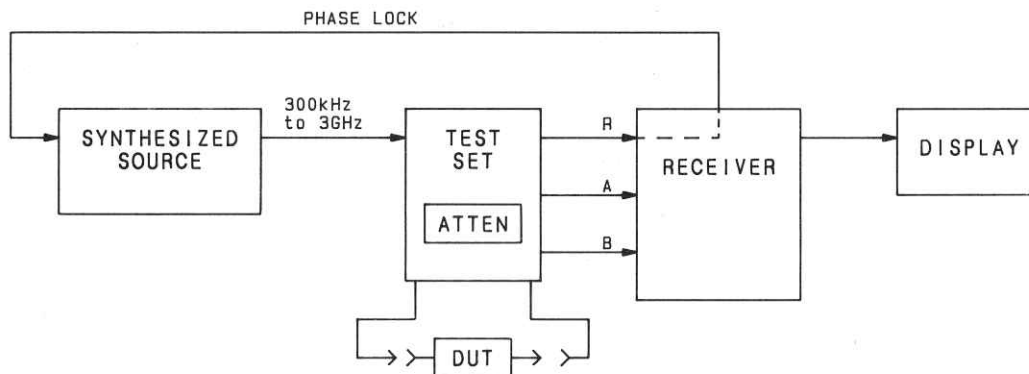

Figure 1-1. Simplified Block Diagram of the HP 8753A System

The built-in synthesized source of the HP 8753A produces a swept RF signal in the range of 300 kHz to 3.0 GHz. The RF output power is leveled by an internal ALC (automatic leveling control) circuit. To achieve frequency accuracy and phase measuring capability, the HP 8753A is phase locked to a highly stable crystal oscillator. For this purpose, a portion of the transmitted signal is routed via the test set or other external coupling to the R input of the receiver, where it is sampled by the phase detection loop and fed back to the source.

A test set provides connections to the device under test, as well as the signal separation devices that separate the incident signal from the transmitted and reflected signals. The incident signal is applied to the R (reference) input, and transmitted and reflected signals are applied to the A and/or B inputs.

The HP 85046A/B S-parameter test set contains the hardware required to make simultaneous transmission and reflection measurements in both the forward and reverse directions. An RF path switch in the test set is controlled by the network analyzer so that reverse measurements can be made without changing the connections to the device under test. The HP 85044A/B transmission/reflection test set contains the hardware required to make simultaneous transmission and reflection measurements in one direction only. The HP 11850C/D three-way power splitter or the HP 11667A two-way power splitter can be used for making transmission-only measurements.

The step attenuator contained in the test set is used to adjust the power level to the DUT without changing the level of the incident power in the reference path. The attenuator in the HP 85046A/B test set is controlled from the front panel of the HP 8753A, and the attenuator in the HP 85044A/B test set is controlled manually.

The receiver block contains three identical sampler/mixers for the R, A, and B inputs. The signals are sampled, and mixed to produce a 4 kHz IF (intermediate frequency). A multiplexer sequentially directs each of the three signals to the ADC (analog to digital converter) where it is converted from an analog to a digital signal to be measured and processed for display on the CRT. Both amplitude and phase information are measured simultaneously, regardless of what is displayed on the CRT.

A microprocessor takes the raw data and performs all the required error correction, trace math, formatting, scaling, and marker operations, according to the instructions from the front panel. The formatted data is then displayed on the CRT. The data processing sequence is described below.

In addition to the HP 8753A and the test set (or power splitter), a measurement may require calibration standards for vector accuracy enhancement, and cables for interconnections. Model numbers and details of compatible power splitters, calibration kits, and cables are provided in the General Information section of this manual.

A detailed block diagram of the HP 8753A is provided in the On-Site System Service Manual, together with complete theory of system operation.

HP 8753A DATA PROCESSING

Overview

The receiver of the HP 8753A converts the R, A, and B input signals into useful measurement information. This conversion occurs in two main steps. First, the swept high frequency input signals are translated to fixed low frequency IF signals, using analog sampling and/or mixing techniques. (Refer to Theory of Operation in the Service section of the On-Site System Service Manual for details.) Second, the IF signals are converted into digital data by an analog-to-digital-converter (ADC). From this point on, all further signal processing is performed mathematically by microprocessors in the HP 8753A. The following paragraphs describe the sequence of math operations and the resulting data arrays as the information flows from the ADC to the display. They provide a good foundation for understanding most of the response functions, and the order in which they are performed.

Figure 1-2 is a data processing flow diagram that represents the flow of numerical data from IF detection to display. The data passes through several math operations, denoted in the figure by single-line boxes. Most of these operations can be selected and controlled with the front panel RESPONSE block menus. The data is also stored in arrays along the way, denoted by double-line boxes. These arrays are places in the flow path where data is accessible, usually via HP-IB.

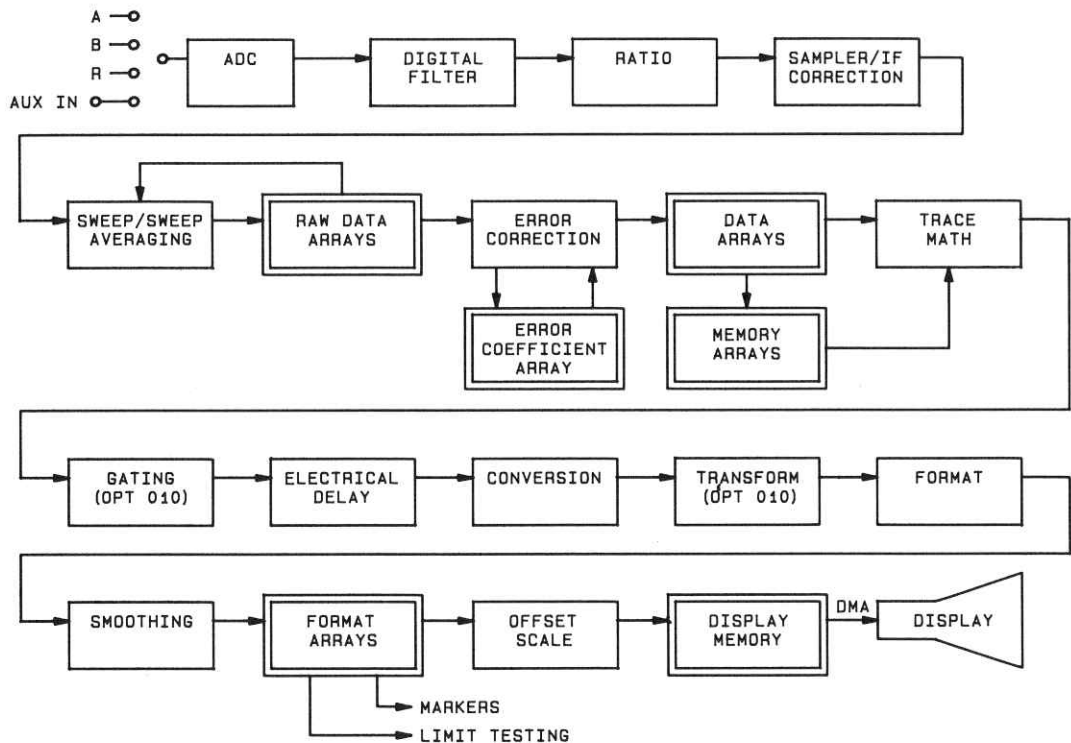

Figure 1-2. Data Processing Flow Diagram

While only a single flow path is shown, two identical paths are available, corresponding to channel 1 and channel 2. When the channels are uncoupled, each channel can be independently controlled, so that the data processing operations for one are different from the other.

Two definitions are necessary:

A "data point" or "point" is a single piece of data representing a measurement at a single stimulus value. Most data processing operations are performed point-by-point; some involve more than one point.

A "sweep" is a series of consecutive data point measurements, taken over a sequence of stimulus values. A few data processing operations require that a full sweep of data is available. The number of points per sweep can be defined by the user. Note that the meaning of the stimulus values (independent variables) can change, depending on the sweep mode, although this does not generally affect the data processing path.

Processing Details

The ADC converts the R, A, and B inputs (already down-converted to a fixed low frequency IF) into digital words. (The AUX INPUT connector on the rear panel is a fourth input.) The ADC switches rapidly between these inputs, so they are converted nearly simultaneously. (Refer to “[MEAS] Key” in Chapter 4 for more information on inputs.)

IF detection occurs in the digital filter, which performs the discrete Fourier transform (DFT) on the digital words. The samples are converted into complex number pairs (real plus imaginary, $R + jI$). The complex numbers represent both the magnitude and phase of the IF signal. If the AUX INPUT is selected, the imaginary part of the pair is set to zero. The DFT filter shape can be altered by changing the IF bandwidth, which is a highly effective technique for noise reduction. (Refer to “[AVG] Key” in Chapter 4 for information on different noise reduction techniques.)

Next, ratio calculations are performed if the selected measurement is a ratio of two inputs (e.g. A/R or B/R). This is simply a complex divide operation. If the selected measurement is absolute (e.g. A or B), no operation is performed. The R, A, and B values are also split into channel data at this point. (Refer to “[MEAS] Key” in Chapter 4 for more information.)

The sampler/IF correction operation is applied next. This process digitally corrects for frequency response errors (both magnitude and phase, primarily sampler rolloff) in the analog down-conversion path. (This operation is not performed during measurement calibration nor with error correction on.)

Sweep-to-sweep averaging is another noise reduction technique. This calculation involves taking the complex exponential average of several consecutive sweeps. This technique cannot be used with single-input measurements. (Refer to “[AVG] Key” in Chapter 4.)

The raw data arrays store the results of all the preceding data processing operations. (Up to this point, all processing is performed real-time with the sweep by the IF processor. The remaining operations are not necessarily synchronized with the sweep, and are performed by the main processor.) When full 2-port error correction is on, the raw arrays contain all four S-parameter measurements required for accuracy enhancement. When the channels are uncoupled (coupled channels off), there may be as many as eight raw arrays. These arrays are directly accessible via HP-IB. Note that the numbers here are still complex pairs.

Vector error correction (accuracy enhancement) is performed next, if a measurement calibration has been performed and correction is turned on. Error correction removes repeatable systematic errors (stored in the error coefficient arrays) from the raw arrays. This can vary from simple vector normalization to full 12-term error correction. (Refer to Chapter 5 for details.)

The error coefficient arrays themselves are created during a measurement calibration using data from the raw arrays. These are subsequently used whenever correction is on, and are accessible via HP-IB.

The results of error correction are stored in the data arrays as complex number pairs. These arrays are accessible via HP-IB.

If the data-to-memory operation is performed, the data arrays are copied into the memory arrays. (Refer to “[DISPLAY] Key” in Chapter 4.)

The trace math operation selects either the data array, memory array, or both to continue flowing through the data processing path. In addition, the complex ratio of the two (data/memory) or the difference (data-memory) can also be selected. If memory is displayed, the data from the memory arrays goes through exactly the same data processing flow path as the data from the data arrays, except for gating and smoothing. (Refer to “[DISPLAY] Key” in Chapter 4 for information on memory math functions.)

Gating is a digital filtering operation associated with time domain transformation (option 010 only). Its purpose is to mathematically remove unwanted responses isolated in time. In the time domain, this can be viewed as a time-selective bandpass or band-stop filter. (If both data and memory are displayed, gating is applied to the memory trace only if gating was on when data was stored into memory.) (Refer to Chapter 8.)

The delay block involves adding or subtracting phase in proportion to frequency. This is equivalent to "line-stretching" or artificially moving the measurement reference plane. (Refer to **[ELECTRICAL DELAY]** under "**[SCALE/REF]** Key" in Chapter 4.)

Conversion transforms the measured S-parameter data to the equivalent complex impedance (Z) or admittance (Y) values, or to inverse S-parameters (1/S). (Refer to "Conversion Menu" under "**[MEAS]** Key" in Chapter 4.)

Windowing is a digital filtering operation that prepares (enhances) the frequency domain data for transformation to time domain. (Refer to Chapter 8, Time and Frequency Domain Transforms.)

The transform operation converts frequency domain information into the time domain when transform is on (option 010 only). The results resemble time domain reflectometry (TDR) or impulse-response measurements. The transform employs the chirp-Z inverse fast Fourier transform (FFT) algorithm to accomplish the conversion. The windowing operation, if enabled, is performed on the frequency domain data just before the transform. (A special transform mode is available to "demodulate" CW sweep data, with time as the stimulus parameter, and display spectral information with frequency as the stimulus parameter.) (Refer to Chapter 8 for details.)

Formatting converts the complex number pairs into a scalar representation for display, according to the selected format. This includes group delay calculations. These formats are often easier to interpret than the complex number representation. (Polar and Smith chart formats are not affected by the scalar formatting.) Note that after formatting, it is impossible to recover the complex data. (Refer to "**[FORMAT]** Key" in Chapter 4 for information on the different formats available and on group delay principles.)

Smoothing is another noise reduction technique, that smoothes noise on the trace. When smoothing is on, each point in a sweep is replaced by the moving average value of several adjacent (formatted) points. The number of points included depends on the smoothing aperture, which can be selected by the user. The effect is similar to video filtering. If data and memory are displayed, smoothing is performed on the memory trace only if smoothing was on when data was stored into memory. (Refer to "**[AVG]** Key" in Chapter 4 for information about smoothing.)

The results so far are stored in the format arrays. It is important to note that marker values and marker functions are all derived from the format arrays. Limit testing is also performed on the formatted data. The format arrays are accessible via HP-IB.

The offset and scale operations prepare the formatted data for display on the CRT. This is where the reference line position, reference line value, and scale calculations are performed, as appropriate to the format. (Refer to "**[SCALE/REF]** Key" in Chapter 4.)

The display memory stores the display image for presentation on the CRT. The information here includes graticules, annotation, and softkey labels—everything visible on the CRT—in a form similar to plotter commands. If user display graphics are written, these are also stored in display memory. When hardcopy records are made, the information sent to the plotter or printer is taken from display memory.

Finally, the display memory data is sent to the CRT display. The display is updated (refreshed) frequently and asynchronously with the data processing operations, to provide a flicker-free image.

Chapter 2. Front Panel and Softkey Operation

INTRODUCTION

This chapter describes how to operate the HP 8753A using front panel controls, and explains the use of softkey menus. It provides illustrations and descriptions of the front panel features, the CRT display and its labels, and the rear panel features and connectors. In addition it provides details of the active channel keys and the entry block.

Functions of the HP 8753A are activated from the front panel by the operator using front panel keys or softkeys. (In this manual, all front panel keys and softkey labels are shown in brackets.) The function currently activated is called the active function, and is displayed in the active entry area at the upper left of the CRT. As long as a function is active it can be modified with the entry block controls. A function remains active until another function is selected.

FRONT PANEL KEYS AND SOFTKEY MENUS

Some of the front panel keys are used to change instrument functions directly, and others provide access to additional functions available in softkey menus. Softkey menus are lists of up to eight related functions that can be displayed in the softkey labels area at the right-hand side of the CRT. The eight keys to the right of the softkey labels area are the softkeys. Pressing one of the softkeys selects the adjacent menu function. This either executes the labeled function and makes it the active function, or causes instrument status information to be displayed, or presents another set of menu labels.

The HP 8753A provides more than 90 softkey menus for control of numerous operating capabilities. Some of the menus are accessed directly from front panel keys, and some from other menus. For example, the stimulus menu accessed by pressing the **[MENU]** key presents all the stimulus functions such as sweep type, number of points, power, sweep time, and trigger. Pressing **[SWEEP TYPE]** presents another menu for defining sweep type parameters, while pressing **[SWEEP TIME]** allows the required sweep time to be entered directly from the number pad. The **[RETURN]** softkeys are used to return to previous menus, while **[DONE]** is used both to indicate completion of a specific procedure and to return to an earlier menu. In this Operating and Programming Reference, the menus available from each front panel key are illustrated in "menu maps" to clearly show the sequence of keys that must be pressed to access each function. The first menu map, in chapter 3, shows the softkey menus accessed from the **[MENU]** key. Detailed descriptions of each softkey function are provided with illustrations of the individual menus.

Generally whenever a menu changes, the present active function is cleared, unless it is an active marker function.

The front panel keys that provide access to softkey menus are grouped in the STIMULUS, RESPONSE, and INSTRUMENT STATE function blocks. The stimulus block keys and softkey menus control all the functions of the source. The response block keys and softkey menus control the measurement and display functions specific to the active channel. The instrument state keys control channel-independent system functions such as copying, save/recall, and HP-IB controller mode, as well as the limit testing and time domain transform (option 010) functions.

In cases where several possible choices are available for a function, they are joined by vertical lines. For example, in the input menu the available inputs and input ratios are listed: A, B, R, A/R, B/R, A/B, and only one can be selected at a time. When a selection has been made from the listed alternatives, that selection is underlined until another selection is made.

Some softkey functions can be toggled on or off, for example averaging, and this is indicated in the softkey label. When one of these functions is turned on, this is indicated by the word ON in capitals in the softkey label. For example, when averaging is on the label reads [**AVERAGING ON off**], and when it is off the label reads [**AVERAGING on OFF**].

Some softkey labels show the current selected status of a function in brackets. These include simple toggle functions and status-only indicators. An example of a toggled function is the [**PLOT SPEED FAST**] or [**PLOT SPEED SLOW**] softkey. The [**IF BW**] softkey is an example of a status-only indicator, where the selected value of the IF bandwidth is shown in brackets in the softkey label.

The functions accessible from the front panel can also be accessed remotely by an external controller using HP-IB. Equivalent HP-IB commands are available for most of the front panel keys and softkey menu selections. The HP-IB programming command equivalent to each front panel and softkey function is provided in parentheses after the first reference. Complete information about HP-IB programming is provided in chapter 11.

The following chapters describe all the front panel keys and softkey menus in detail. The purpose and use of each function is detailed, together with expected indications and results, allowable values, and possible limitations. This information is presented in function block order. Each function block is illustrated and described in general terms. This is followed by information about each front panel key in the function block, together with a map and description of all the menus accessed from that key. Each menu is illustrated, and each softkey function in each menu is explained in detail. A complete map of the softkey menu structure is provided in Appendix A at the end of the Operating and Programming Reference, together with an alphabetical index.

FRONT PANEL FEATURES

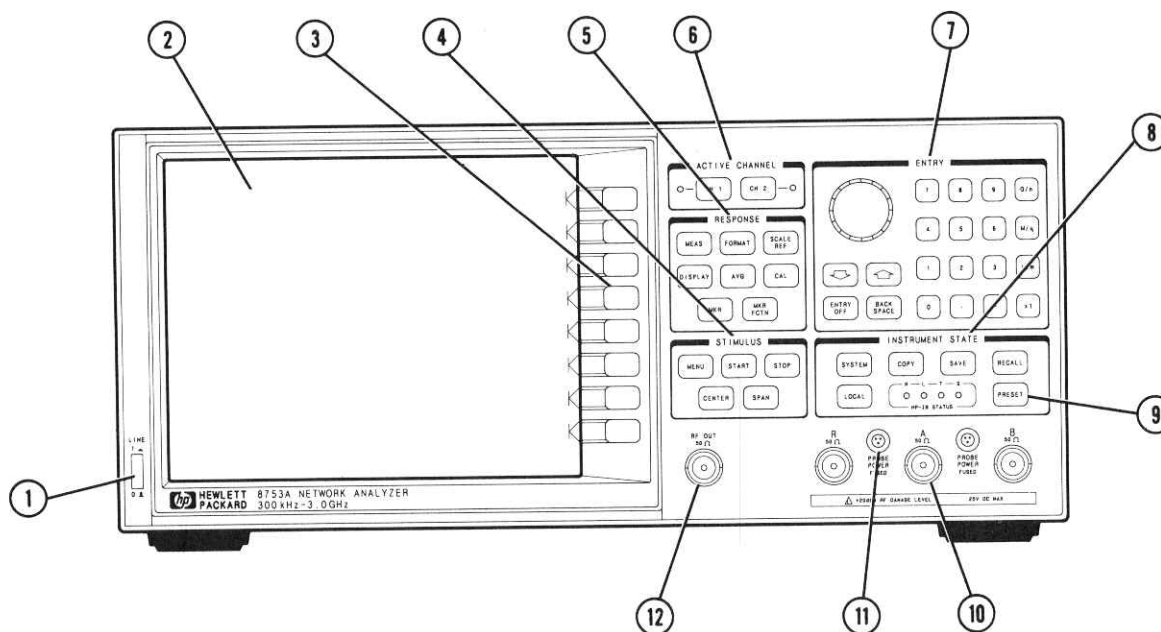

Figure 2-1. HP 8753A Front Panel

Figure 2-1 illustrates the following features and function blocks of the HP 8753A front panel. These features are described in more detail in this and subsequent chapters. Instructions for removal and cleaning of the CRT filter are provided in the Operator's Check section of this manual.

1. LINE switch. This controls AC power to the HP 8753A. 1 is on, 0 is off.
2. CRT display. This is used for display of data traces, measurement annotation, softkey labels, and other information. The display is divided into specific information areas, illustrated in Figure 2-2.
3. Softkeys. These keys expand the capabilities of the HP 8753A with additional functions beyond those of the front panel keys. They provide access to menu selections displayed on the CRT.
4. STIMULUS function block. The keys in this block are used to control the RF signal from the HP 8753A source, and other stimulus functions.
5. RESPONSE function block. The keys in this block are used to control the measurement and display functions of the active display channel.
6. ACTIVE CHANNEL keys. The HP 8753A has two independent display channels. These keys are used to select the active channel. Any functions that are then entered apply to this active channel.
7. The ENTRY block includes the knob, the step [▼][▲] keys, and the number pad. These are used for entering numerical data and controlling the markers.

Chapter 3. Stimulus Function Block

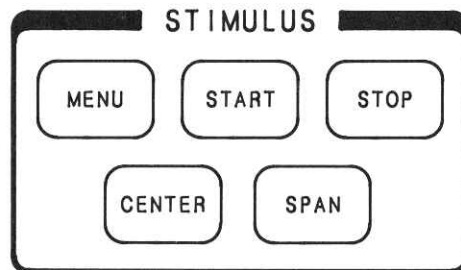

Figure 3-1

The stimulus function block keys and associated menus are used to define and control the source RF output signal to the device under test. The source signal can be swept over any portion of the instrument's frequency and power range. The stimulus keys also control the start and stop times in the optional time domain mode. The menus are used to set all other source characteristics such as sweep time and resolution, source RF power level, the number of data points taken during the sweep, and S-parameter test set attenuation.

[START] (STAR) **[STOP]** (STOP) **[CENTER]** (CENT) **[SPAN]** (SPAN)

These keys are used to define the frequency range or other horizontal axis range of the stimulus. The range can be expressed as either start/stop or center/span. When one of these keys is pressed, its function becomes the active function. The value is displayed in the active entry area and can be changed with the knob, step keys, or number pad. Current stimulus values for the active channel are also displayed along the bottom of the graticule. Frequency values can be set to zero for security purposes, using the display menus.

The preset stimulus mode is frequency, and the start and stop stimulus values are set to the frequency range of the network analyzer. In the time domain (option 010) or in CW time mode, the stimulus keys refer to time (with certain exceptions that are explained in chapter 8, Time Domain Measurements). In power sweep, the stimulus value is in dBm.

Because the display channels are independent, the stimulus signals for the two channels can be uncoupled and their values set independently. The values are then displayed separately on the CRT if the instrument is in dual channel display mode. In the uncoupled mode with dual channel display the instrument takes alternate sweeps to measure the two sets of data. Channel stimulus coupling is explained in this chapter, and dual channel display capabilities are explained in chapter 4, Response Function Block.

[MENU] Key

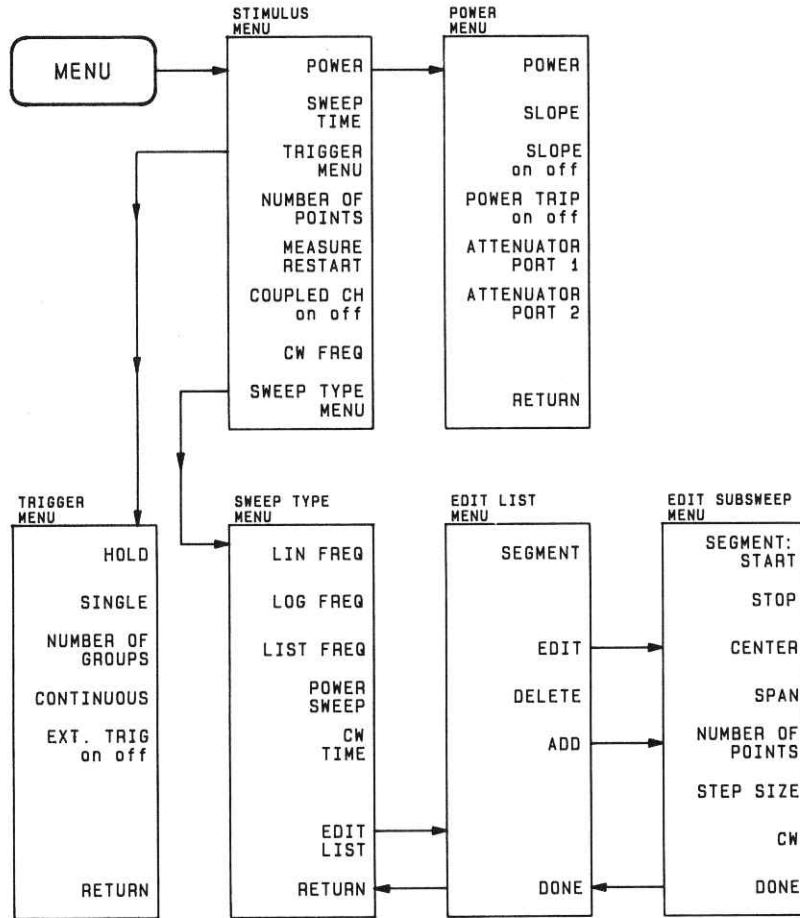

Figure 3-2. Softkey Menus Accessed from the [MENU] Key

The [MENU] (MENUSTIM) key provides access to the series of menus illustrated in Figure 3-2, which are used to define and control all stimulus functions other than start, stop, center, and span. When the [MENU] key is pressed, the stimulus menu is displayed. This in turn provides access to the other illustrated softkey menus. The functions available in these menus are described in the following pages.

Stimulus Menu

The stimulus menu is used to specify the sweep time, number of measurement points per sweep, and CW frequency. It includes the capability to couple or uncouple the stimulus functions of the two display channels, and the measurement restart function. In addition, it leads to other softkey menus that define power level, trigger type, and sweep type. The individual softkey functions of the stimulus menu are described below.

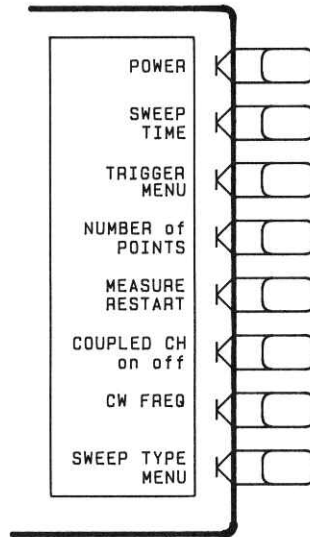

Figure 3-3

[POWER] (POWE) makes power level the active function and presents the power menu, which is used to set the output power level and slope compensation of the source, and control the attenuator in an HP 85046A/B programmable S-parameter test set.

[SWEEP TIME] (SWET) is used to set the sweep time. This refers only to the time that the instrument is sweeping and taking data, and does not include the time required for internal processing of the data. A sweep speed indicator \uparrow is displayed on the trace for sweep times slower than 1.0 second. For sweep times faster than 1.0 second the \uparrow indicator is displayed in the status notations area at the left of the CRT.

The sweep time will increase automatically if the number of points is increased or the IF bandwidth is decreased. Sweep-to-sweep averaging also increases sweep time in dual channel display mode. Other processes such as smoothing, limit lines, error correction, trace math, marker statistics, and time domain affect the sweep repetition rate.

Sweep time also varies according to the sweep type selected, as explained in "Sweep Type Menu."

The following table is a partial guide for determining the minimum sweep time for the listed IF bandwidths and number of measurement points. The values listed represent the minimum time required for a CW time measurement with averaging off. Values are given in seconds.

Number of Points	IF Bandwidth			
	3000 Hz	1000 Hz	300 Hz	10 Hz
11	0.0055	0.012	0.036	1.14
51	0.0255	0.06	0.166	5.3
101	0.0505	0.12	0.328	10.5
201	0.1005	0.239	0.653	20.9
401	0.2005	0.476	1.303	41.7
801	0.4005	0.951	2.603	83.3
1601	0.8005	1.901	5.203	166.5

[TRIGGER MENU] goes to the trigger menu, which is used to select the type and number of the sweep trigger.

[NUMBER OF POINTS] (POIN) is used to select the number of data points per sweep to be measured and displayed. Using fewer points allows a faster sweep time but the displayed trace shows less horizontal detail. Using more points gives greater data density and improved trace resolution, but slows the sweep and requires more memory for error correction or saving instrument states.

The possible values that can be entered for number of points are 3, 11, 26, 51, 101, 201, 401, 801, and 1601. The number of points can be different for the two channels if the stimulus values are uncoupled.

In list frequency sweep, the number of points displayed is the total number of frequency points for the defined list (see "Sweep Type Menu").

[MEASURE RESTART] (REST) aborts the sweep in progress, then restarts the measurement. This can be used to update a measurement following an adjustment of the device under test. When a full two-port calibration is in use, the **[MEASURE RESTART]** key will initiate another update of both forward and reverse S-parameter data.

If the HP 8753A is taking a number of groups (see "Trigger Menu"), the sweep counter is reset at 1. If averaging is on, **[MEASURE RESTART]** resets the sweep-to-sweep averaging and is effectively the same as **[AVERAGING RESTART]**. If the sweep trigger is in **[HOLD]** mode, **[MEASURE RESTART]** executes a single sweep.

[COUPLED CH on off] (COUCOn, COUCoff) toggles the channel coupling of stimulus values. With **[COUPLED CH ON]** (the preset condition), both channels have the same stimulus values (the inactive channel takes on the stimulus values of the active channel).

In the stimulus coupled mode, the following parameters are coupled:

Frequency	Number of points
Source power	Number of groups
Power slope	IF bandwidth
Sweep time	Time domain transform
Trigger type	Gating
Sweep type	

Coupling of stimulus values for the two channels is independent of **[DUAL CHAN on off]** in the display menu and **[MARKERS: UNCOUPLED]** in the marker mode menu. **[COUPLED CH OFF]** becomes an alternate sweep function when dual channel display is on: in this mode the HP 8753A alternates between the two sets of stimulus values for measurement of data, and both are displayed.

[CW FREQ] (CWFREQ) is used to set the frequency for power sweep and CW time sweep modes. If the instrument is not in either of these two modes, it is automatically switched into CW time mode.

[SWEEP TYPE MENU] presents the sweep type menu, where one of the available types of stimulus sweep can be selected.

Power Menu

The power menu is used to set the output power level of the source, to set power slope to compensate for measured power loss with frequency, and to control the programmable attenuator in an HP 85046A/B S-parameter test set.

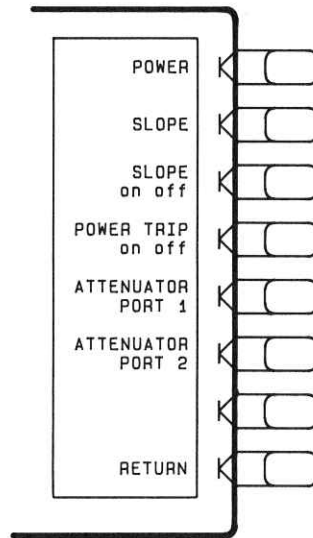

Figure 3-4

[POWER] (POWE) makes power level the active function and sets the RF output power level of the HP 8753A internal source. The HP 8753A will detect an input power overload at any of the three receiver inputs, and automatically reduce the output power of the source to -5 dBm. This is indicated with the message "OVERLOAD ON INPUT (R, A, B)." In addition, the **[POWER TRIP ON]** flag (see below) is set, and the annotation "P↓" appears at the left side of the CRT. When this occurs, toggle the power trip off and reset the power at a lower level.

If the source power is unlevelled at the start or stop of a sweep, the notation "P?" is displayed at the left of the CRT. This indicates that the automatic leveling control circuit of the source is unable to keep the source power leveled to instrument specifications, and the power is therefore potentially uncalibrated. The "P?" notation is removed only after a sweep in which the source power is detected to be leveled at both the start and stop of the sweep. Refer to the On-Site System Service Manual for troubleshooting information.

[SLOPE] (SLOPE) compensates for power loss versus the frequency sweep, by sloping the output power upwards proportionally to frequency. Use this softkey to enter the power slope in dB per GHz of sweep.

[SLOPE on off] (SLOPon, SLOPoff) toggles the power slope function on or off. With slope on, the output power increases with frequency, starting at the selected power level.

[POWER TRIP on off] (POWToN, POWToff) toggles the power trip function on or off. Power trip is a reduced power state triggered by a power overload. It forces the source output power to -5 dBm regardless of the user-specified power level. The trip is set automatically whenever a power overload is detected on an input channel. When trip is on, the annotation "P↓" appears in the status notations area of the display.

To reset the power level following a power trip, toggle the power trip **OFF**, and reset the power level using the **[POWER]** softkey described above.

[ATTENUATOR PORT 1] (ATTP1) controls the attenuation at port 1 of an HP 85046A/B S-parameter test set connected to the HP 8753A. The attenuator range is 0 to 70 dB, controllable in 10 dB steps. Attenuation is used to reduce the signal level at the test port without reducing the reference signal, for example to perform measurements of amplifiers.

The S-parameter test set must be interfaced with the HP 8753A through the test set interconnect cable for the attenuator control signal to be enabled. Note that no warning is given if no test set is present, or if the test set has no programmable attenuator (as in the HP 85044A/B transmission/reflection test set).

[ATTENUATOR PORT 2] (ATTP2) serves the same function for the attenuation at port 2 of the HP 85046A/B S-parameter test set.

[RETURN] goes back to the stimulus menu.

Trigger Menu

This menu is used to select the type and number of the sweep trigger.

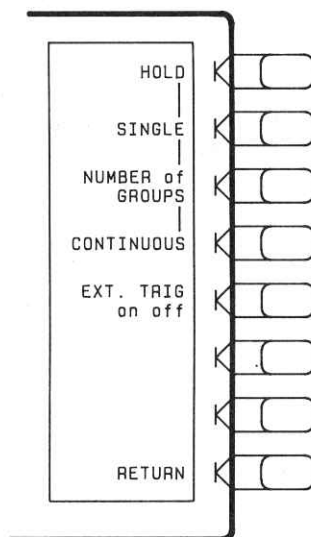

Figure 3-5

[HOLD] (HOLD) freezes the data trace on the display, and the HP 8753A stops sweeping and taking data. The notation "Hld" is displayed at the left of the graticule. If the * indicator is on at the left side of the CRT, trigger a new sweep with **[SINGLE]**.

[SINGLE] (SING) takes one sweep of data and returns to the hold mode.

[NUMBER OF GROUPS] (NUMG) triggers a user-specified number of sweeps, and returns to the hold mode. This function is useful for keeping the test set transfer switch switching in a full two-port calibration. Normally the test set transfer switch is switched only once during the calibration procedure, for protection of the mechanical switch assembly. If a particular application requires that the switch be switched repeatedly, this can be accomplished by setting an appropriate number of groups.

If averaging is on, the number of groups should be at least equal to the averaging factor selected, to allow measurement of a fully averaged trace. Entering a number of groups resets the averaging counter to 1.

[CONTINUOUS] (CONT) is the standard sweep mode of the HP 8753A, in which the sweep is triggered automatically and continuously and the trace is updated with each sweep.

[EXT. TRIG on off] (EXTT) is used when the sweep is triggered on an externally generated signal connected to the rear panel EXT TRIGGER input. The sweep is started with a high-to-low transition of a TTL signal. If this key is pressed when no external trigger signal is connected, the notation "Ext" is displayed at the left side of the CRT to indicate that the HP 8753A is waiting for a trigger. When a trigger signal is connected, the "Ext" notation is replaced by the sweep speed indicator \uparrow either in the status notations area or on the trace.

[RETURN] goes back to the stimulus menu.

Sweep Type Menu

Five basic sweep types are available: linear and logarithmic frequency sweeps in Hz, power sweep in dBm, CW time sweep in seconds, and list frequency sweep in Hz. In the linear frequency sweep mode it is possible, with option 010, to transform the data for time domain measurements using the inverse Fourier transform technique. In the CW time sweep mode, the data can be transformed for frequency domain measurements. Refer to chapter 8 for detailed information about time domain transform with option 010.

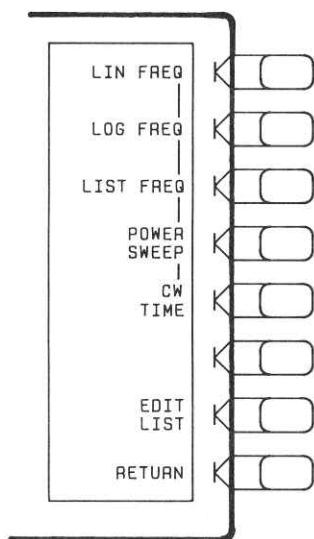

Figure 3-6

[LIN FREQ] (LINFREQ) activates a linear frequency sweep displayed on a standard graticule with ten equal horizontal divisions. This is the default preset sweep type.

For a linear sweep, sweep time is combined with the channel's frequency span to compute a source sweep rate:

$$\text{sweep rate} = (\text{frequency span}) / (\text{sweep time})$$

Since the sweep time may be affected by various factors (see "Stimulus Menu"), the equation provided here is merely an indication of the ideal (maximum) sweep rate. If the user-specified sweep time is greater than 15 ms times the number of points, the sweep changes from a continuous ramp sweep to a stepped CW sweep. Also for narrow IF bandwidths the sweep is automatically converted to a stepped CW sweep.

[LOG FREQ] (LOGFREQ) activates a logarithmic frequency sweep mode. The source is stepped in logarithmic increments and the data is displayed on a logarithmic graticule. This is slower than a continuous sweep with the same number of points, and the entered sweep time may therefore be changed automatically. For frequency spans of less than two octaves, the sweep type automatically reverts to linear sweep.

[LIST FREQ] (LISFREQ) activates a measurement sweep of a list of frequencies specified by the user. This list is defined and modified using the edit list menu and the edit subsweep menu. Up to 30 frequency subsweeps of several different types can be specified, for a maximum total of 1632 points. Refer to "Edit Subsweep Menu" later in this chapter to see how to enter the list frequencies. If no list table has been entered, the message "LIST TABLE EMPTY" is displayed. One list is common to both channels.

When the **[LIST FREQ]** key is pressed the network analyzer sorts all the defined frequency segments into CW points in order of increasing frequency. It then measures each point and displays a single trace that is a composite of all data taken. If duplicate frequencies exist, the HP 8753A makes multiple measurements on identical points to maintain the specified number of points for each subsweep. Since the frequency points may not be distributed evenly across the CRT, the display resolution may be uneven, and more compressed in some parts of the trace than in others. However, the stimulus and response readings of the markers are always accurate. Because the list frequency sweep is a stepped CW sweep, the sweep time is slower than for a continuous sweep with the same number of points.

A tabular printout of the frequency list data can be obtained using the **[LIST VALUES]** function in the copy menu.

[POWER SWEEP] (POWS) turns on a power sweep mode that is used to characterize power-sensitive circuits. In this mode, power is swept at a single frequency, from a start power value to a stop power value, selected using the **[START]** and **[STOP]** keys and the entry block. This feature is convenient for such measurements as gain compression or AGC (automatic gain control) slope. To set the frequency of the power sweep, use **[CW FREQ]** in the stimulus menu. Refer to the User's Guide for an example of a gain compression measurement.

Note that the attenuator switch in the S-parameter test set is not switched in power sweep mode.

In power sweep, the entered sweep time may be automatically changed if it is less than the minimum required for the current configuration (number of points, IF bandwidth, averaging, etc.).

[CW TIME] (CWTIME) turns on a sweep mode similar to an oscilloscope. The HP 8753A is set to a single frequency, and the data is displayed versus time. The frequency of the CW time sweep is set with **[CW FREQ]** in the stimulus menu. In this sweep mode, the data is continuously sampled at precise, uniform time intervals determined by the sweep time and the number of points minus 1. The entered sweep time may be automatically changed if it is less than the minimum required for the current instrument configuration.

In time domain using option 010, the CW time mode data is translated to frequency domain, and the x-axis becomes frequency. This can be used like a spectrum analyzer to measure signal purity, or for low frequency (>1 kHz) analysis of amplitude or pulse modulation signals. For details, refer to chapter 8, Time Domain Measurements.

[EDIT LIST] presents the edit list menu. This is used in conjunction with the edit subsweep menu to define or modify the frequency sweep list. The list frequency sweep mode is selected with the **[LIST FREQ]** softkey described above.

[RETURN] goes back to the stimulus menu.

Edit List Menu

This menu is used to edit the list of frequency segments (subsweeps) defined with the edit subsweep menu, described next. Up to 30 frequency subsweeps can be specified, for a maximum of 1632 points. The segments do not have to be entered in any particular order: the HP 8753A automatically sorts them and lists them on the CRT in increasing order of start frequency. This menu determines which entry on the list is to be modified, while the edit subsweep menu is used to make changes in the frequency or number of points of the selected entry.

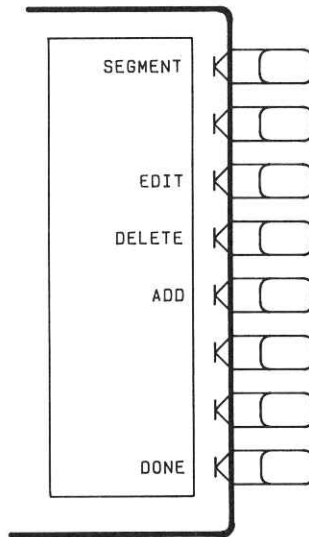

Figure 3-7

[SEGMENT] determines which segment on the list is to be modified. Enter the number of a segment in the list, or use the step keys to scroll the pointer > at the left to the required segment number. The indicated segment can then be edited or deleted.

[EDIT] goes to the edit subsweep menu, where the segment indicated by the pointer > at the left can be modified.

[DELETE] deletes the segment indicated by the pointer >.

[ADD] is used to add a new segment to be defined with the edit subsweep menu. If the list is empty, a default segment is added, and the edit subsweep menu is displayed so it can be modified. If the list is not empty, the segment indicated by the pointer > is copied and the edit subsweep menu is displayed.

[DONE] sorts the frequency points and returns to the sweep type menu.

Edit Subsweep Menu

This menu lets you select measurement frequencies arbitrarily. Using this menu it is possible to define the exact frequencies to be measured on a point-by-point basis. For example the sweep could include 100 points in a narrow passband, 100 points across a broad stop band, and 50 points across the third harmonic response. The total sweep is defined with a list of subsweeps. Up to 30 subsweeps can be defined, with a total of up to 1632 data points.

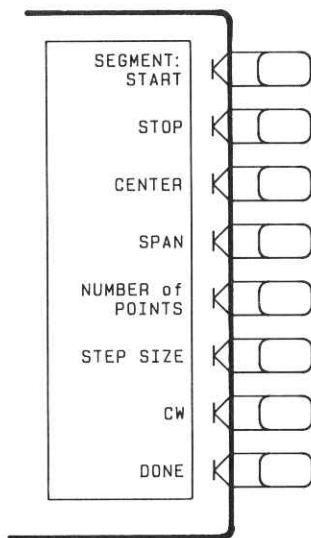

Figure 3-8

The frequency subsweeps, or segments, can be defined in any of the following terms:

- start / stop / number of points
- start / stop / step
- center / span / step
- CW frequency
- CF / delta F / number of points
- CF / delta F / step

The subsweeps can overlap, and do not have to be entered in any particular order. The HP 8753A sorts the segments automatically and lists them on the CRT in order of increasing start frequency, even if they are entered in center/span format. If duplicate frequencies exist, the HP 8753A makes multiple measurements on identical points to maintain the specified number of points for each subsweep. The data is displayed on the CRT as a single trace that is a composite of all data taken. The trace may appear uneven because of the distribution of the data points, but the frequency scale is linear across the total range.

The list frequency sweep mode is selected with the **[LIST FREQ]** softkey in the sweep type menu.

The frequency list parameters can be saved with an instrument state.

[SEGMENT START] sets the start frequency of a subsweep.

[STOP] sets the stop frequency of a subsweep.

[CENTER] sets the center frequency of a subsweep.

[SPAN] sets the frequency span of a subsweep about a specified center frequency.

[NUMBER OF POINTS] sets the number of points for the subsweep. The total number of points for all the subsweeps cannot exceed 1632.

[STEP SIZE] is used to specify the subsweep in frequency steps instead of number of points. Changing the start frequency, stop frequency, span, or number of points may change the step size. Changing the step size may change the number of points and stop frequency in start/stop/step mode; or the frequency span in center/span/step mode. In each case, the frequency span becomes a multiple of the step size.

[CW] is used to set a subsweep consisting of a single CW frequency point.

[DONE] returns to the edit list menu.

Chapter 4. Response Function Block

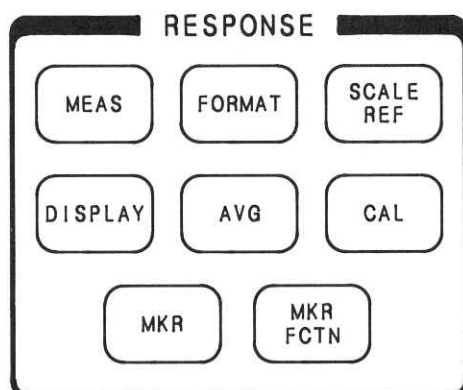

Figure 4-1

The keys in the RESPONSE block are used to control the measurement and display functions of the active channel. They provide access to many different softkey menus that offer selections for the parameters to be measured, the display mode and format of the data, the control of the display markers, and a variety of calibration functions.

The current values for the major response functions of the active channel are displayed in specific locations along the top of the CRT. In addition, certain functions accessed through the keys in this block are annotated in the status notations area at the left-hand side of the CRT. An illustration of the CRT showing the locations of these information labels is provided in chapter 2, together with an explanation.

The RESPONSE block keys and their associated menus are described briefly below, and in more detail in this and the following chapters. General and specific measurement sequences are described in the User's Guide.

The **[MEAS]** (MENUMEAS) key provides access to a series of softkey menus for selecting the parameters or inputs to be measured.

The **[FORMAT]** (MENUFORM) key leads to a menu used to select the display format for the data. Various rectangular and polar formats are available for display of magnitude, phase, impedance, group delay, real data, and SWR.

The **[SCALE REF]** (MENUSCAL) key displays a menu used to modify the vertical axis scale and the reference line value, as well as to add electrical delay.

The **[DISPLAY]** (MENU DISP) key leads to a series of menus for instrument and active channel display functions. The first menu defines the displayed active channel trace in terms of the mathematical relationship between data and trace memory. Other functions include dual channel display (overlaid or split), display focus and intensity, active channel display title, and frequency blanking.

The **[AVG]** (MENUAVG) key is used to access three different noise reduction techniques: sweep-to-sweep averaging, trace smoothing, and variable IF bandwidth.

The **[CAL]** (MENCAL) key leads to a series of menus to perform measurement calibrations for vector error correction (accuracy enhancement), and for specifying the calibration standards used. Calibration procedures are used to improve measurement accuracy by effectively removing systematic errors prior to making measurements. Several different levels of calibration are available for use in a variety of different measurement applications. Each calibration procedure features CRT prompts to guide you through the calibration sequence.

An explanation of vector error correction techniques to enhance measurement accuracy is included with the description of the calibration menus and procedures. Refer to chapter 5, Measurement Calibration, and to the Appendix to chapter 5, Accuracy Enhancement Fundamentals — Characterizing Microwave Systematic Errors.

The **[MKR]** (MENUMARK) key displays an active marker (∇) on the screen and provides access to a series of menus to control from one to four display markers for each channel. Markers provide numerical readout of measured values at any point of the trace.

The menus accessed from the **[MKR]** key provide several basic marker operations. These include special marker modes for different display formats, and a marker delta mode that displays marker values relative to a specified value or another marker.

The **[MKR FCTN]** (MENUMRKF) key provides access to additional marker functions. These use the markers to search the trace for specified information, to analyze the trace statistically, or to quickly change the stimulus parameters.

[MEAS] Key

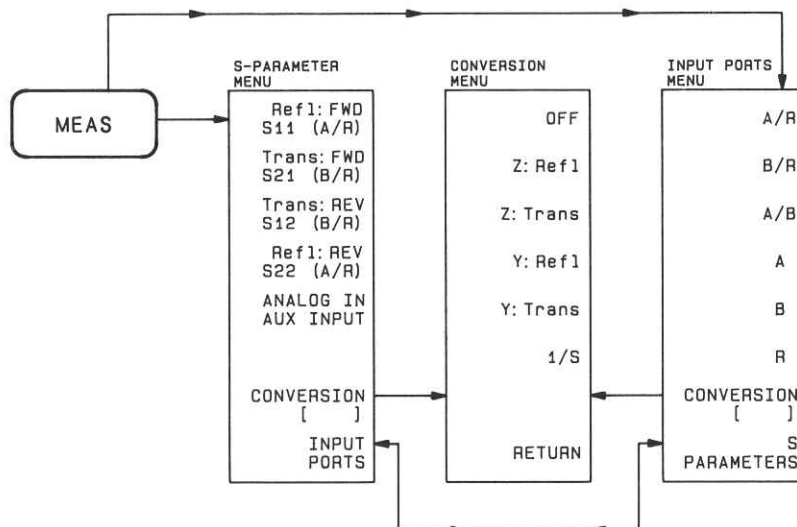

Figure 4-2. Softkey Menus Accessed from the [MEAS] Key

The [MEAS] (MENUMEAS) key leads to a series of softkey menus used to determine the parameters or inputs to be measured. If an HP 85046A/B S-parameter test set is connected, all four S-parameters can be measured with a single connection. Or S-parameters can be measured using a transmission/reflection test set by reversing the device under test between measurements. S-parameters are explained briefly below.

Alternatively, the power ratio of any two inputs or the absolute power at a single input can be measured and displayed, using either test set.

S-parameters can be converted to impedance (Z), admittance (Y), or inverse S-parameters through internal math capabilities of the HP 8753A.

S-Parameters

S-parameters (scattering parameters) are a convention used to characterize the way a device modifies signal flow. A brief explanation is provided here of the S-parameters of a two-port device. For additional details refer to Hewlett-Packard Application Notes A/N 95-1 and A/N 154.

S-parameters are always a ratio of two complex (magnitude and phase) quantities. S-parameter notation identifies these quantities using the numbering convention:

$$S_{out\ in}$$

where the first number (out) refers to the port where the signal is emerging and the second number (in) is the port where the signal is incident. For example, the S-parameter S21 identifies the measurement as the complex ratio of the signal emerging at port 2 to the signal incident at port 1.

Figure 4-3 is a representation of the S-parameters of a two-port device, together with an equivalent flowgraph. In the illustration, "a" represents the signal entering the device and "b" represents the signal emerging. Note that a and b are not related to the A and B input ports on the HP 8753A.

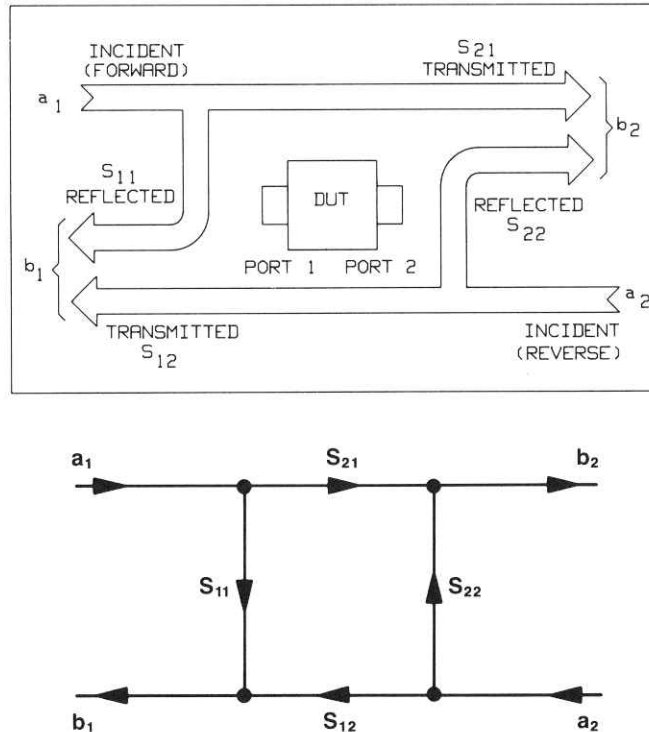

Figure 4-3. S-Parameters of a Two-Port Device

S-parameters are exactly equivalent to the more common description terms below, requiring only that the measurements be taken with all DUT ports properly terminated.

S-Parameter	Definition	Test Set Description	Direction
S_{11}	$\frac{b_1}{a_1} \Big _{a_2=0}$	Input reflection coefficient	FWD
S_{21}	$\frac{b_2}{a_1} \Big _{a_2=0}$	Forward gain	FWD
S_{12}	$\frac{b_1}{a_2} \Big _{a_1=0}$	Reverse gain	REV
S_{22}	$\frac{b_2}{a_2} \Big _{a_1=0}$	Output reflection coefficient	REV

S-Parameter Menu

The S-parameter menu is presented automatically when the **[MEAS]** key is pressed, if an HP 85046A/B S-parameter test set is connected to the HP 8753A or if two-port error correction is on. This menu is used to define the input ports and test set direction for S-parameter measurements. The HP 8753A controls the HP 85046A/B S-parameter test set, and automatically switches the direction of the measurement according to the selections made in this menu. All four S-parameters can be measured with a single connection. The S-parameter being measured is labeled at the top left corner of the CRT.

S-parameter measurements can also be made using an HP 85044A/B transmission/reflection test set, by reversing the device under test after making the forward reflection and transmission measurements. In this case, the softkey labels are changed to indicate the actual input ratios being measured (A/R for reflection or B/R for transmission measurements). Thus **[Refl: REV S22 (B/R)]** becomes **[Refl: REV S22 (A/R)]**, and **[Trans: REV S12 (A/R)]** becomes **[Trans: REV S12 (B/R)]**. However, the annotation in the top left corner indicates the S-parameter being measured.

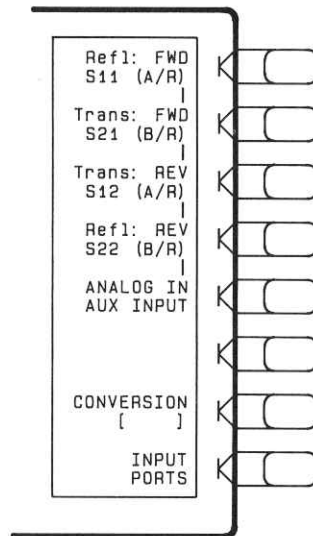

Figure 4-4. S-Parameter Menu

[Refl: FWD S11 (A/R)] (S11) configures the S-parameter test set for a measurement of S11, the complex reflection coefficient (magnitude and phase) of the test device input.

[Trans: FWD S21 (B/R)] (S21) configures the S-parameter test set for a measurement of S21, the complex forward transmission coefficient (magnitude and phase) of the device under test.

[Trans: REV S12 (A/R)] (S12) configures the S-parameter test set for a measurement of S12, the complex reverse transmission coefficient (magnitude and phase) of the device under test.

If another test set, such as an HP 85044A/B transmission/reflection test set, is being used to make S-parameter measurements, reverse the device under test before making this measurement.

[Refl: REV S22 (B/R)] (S22) defines the measurement as S22, the complex reflection coefficient (magnitude and phase) of the output of the device under test.

If another test set, such as an HP 85044A/B transmission/reflection test set, is being used to make S-parameter measurements, the device under test must be reversed before S12 and S22 are measured.

[ANALOG IN] (ANAI) displays a DC or low frequency AC auxiliary voltage on the vertical axis, using the real format. An external signal source such as a detector or function generator can be connected to the rear panel AUXILIARY INPUT connector. (For service purposes, one of numerous internal voltage nodes on the analog bus can be selected for measurement and display. Applications of this function are described in the On-Site System Service Manual.)

[CONVERSION] brings up the conversion menu which converts the measured data to impedance (Z) or admittance (Y). When a conversion parameter has been defined, it is shown in brackets under the softkey label. If no conversion has been defined, the softkey label reads **[CONVERSION OFF]**.

[INPUT PORTS] goes to the input ports menu, which is used to define a ratio or single-input measurement rather than an S-parameter measurement.

Input Ports Menu

The input ports menu is presented when the **[MEAS]** key is pressed if there is no S-parameter test set connected and two-port error correction is not on. This menu is used to define the input ports for power ratio measurements, or a single input for magnitude only measurements of absolute power. Single inputs cannot be used for phase or group delay measurements, or any measurements with averaging turned on.

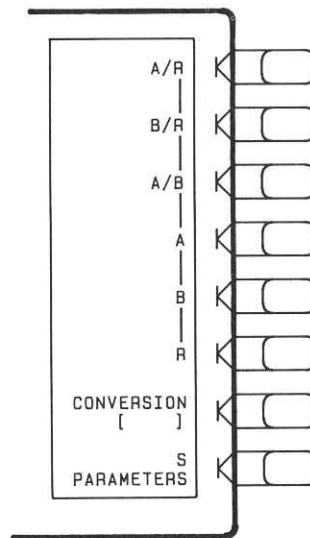

Figure 4-5

[A/R] (AR) calculates and displays the complex ratio of the signal at input A to the reference signal at input R.

[B/R] (BR) calculates and displays the complex ratio of input B to input R.

[A/B] (AB) calculates and displays the complex ratio of input A to input B.

[A] (MEASA) measures the absolute power amplitude at input A.

[B] (MEASB) measures the absolute power amplitude at input B.

[R] (MEASR) measures the absolute power amplitude at input R. The R input is part of the source phase locking scheme, and therefore has a limited dynamic range.

[CONVERSION] brings up the conversion menu, which converts the measured data to impedance (Z) or admittance (Y). When a conversion parameter has been defined, it is shown in brackets under the softkey label. If no conversion has been defined, the softkey label reads **[CONVERSION OFF]**.

[S PARAMETERS] goes to the S-parameter menu, which is used to define the input ports and test set direction for S-parameter measurements.

Conversion Menu

This menu converts the measured reflection or transmission data to the equivalent complex impedance (Z) or admittance (Y) values. This is not the same as a two-port Y or Z parameter conversion, as only the measured parameter is used in the equations. Two simple one-port conversions are available, depending on the measurement configuration.

An S11 or S22 trace measured as reflection can be converted to equivalent parallel impedance or admittance using the model and equations shown in Figure 4-6.

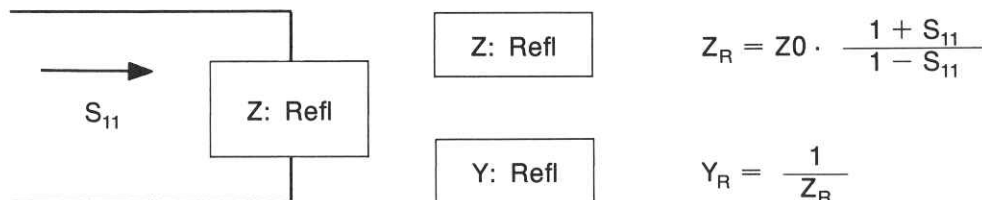

Figure 4-6. Reflection Impedance and Admittance Conversions

In a transmission measurement, the data can be converted to its equivalent series impedance or admittance using the model and equations shown in Figure 4-7.

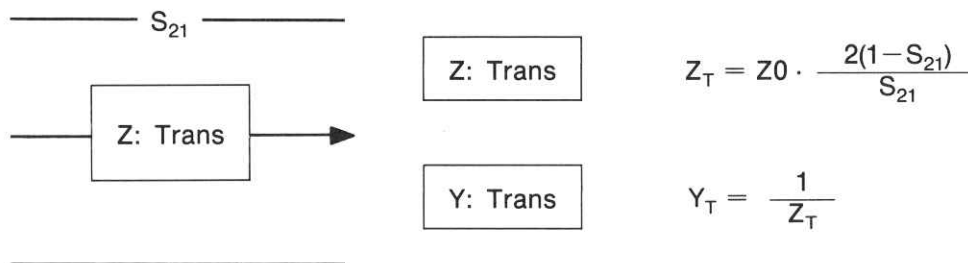

Figure 4-7. Transmission Impedance and Admittance Conversions

Avoid the use of Smith chart, SWR, and delay formats for display of Z and Y conversions, as these formats are not easily interpreted.

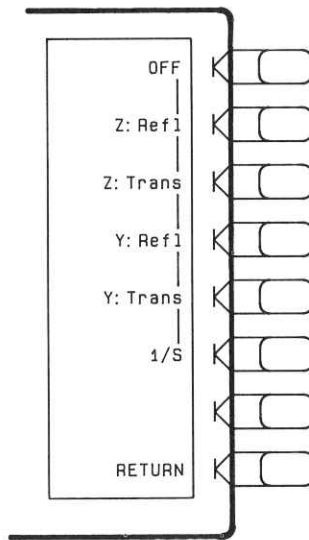

Figure 4-8. Conversion Menu

[OFF] (CONVOFF) turns off all parameter conversion operations.

[Z: Refl] (CONVZREF) converts reflection data to its equivalent impedance values.

[Z: Trans] (CONVZTRA) converts transmission data to its equivalent impedance values.

[Y: Refl] (CONVYREF) converts reflection data to its equivalent admittance values.

[Y: Trans] (CONVYTRA) converts transmission data to its equivalent admittance values.

[1/S] (CONV1DS) expresses the data in inverse S-parameter values, for use in amplifier and oscillator design. A convenient way to check for transistor stability is to compare S11 and 1/S22 on a Smith chart using a dual channel overlaid display (see "Display Menu").

[RETURN] returns to the last menu, either the S-parameter or the input ports menu.

[FORMAT] Key

Format Menu

The [FORMAT] (MENUFORM) key presents a menu used to select the appropriate display format for the measured data. Various rectangular and polar formats are available for display of magnitude, phase, real data, impedance, group delay, and SWR. The units of measurement are changed automatically to correspond with the displayed format. Special marker menus are available for the polar and Smith formats, each providing several different marker types for readout of values (see chapter 6).

The format defined for display of a particular S-parameter or input is remembered with that parameter. Thus if different parameters are measured, even if only one channel is used, each parameter is shown in its selected format each time it is displayed.

The following illustrations show a reflection measurement of a bandpass filter displayed in each of the available formats.

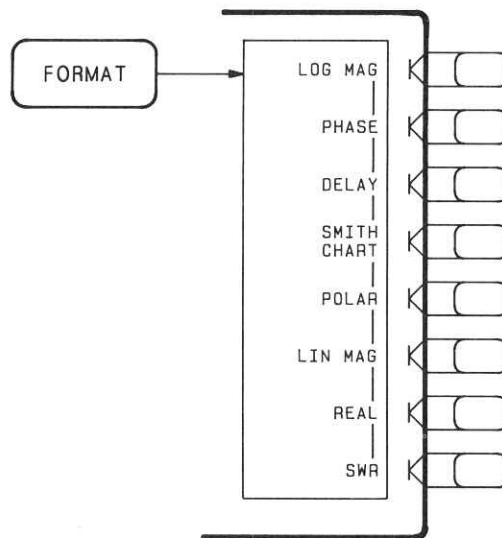

Figure 4-9. Format Menu

[LOG MAG] (LOGM) displays the log magnitude format. This is the standard Cartesian format used to display magnitude-only measurements of insertion loss, return loss, or absolute power in dB versus frequency. Figure 4-10 illustrates the bandpass filter reflection data in a log magnitude format.

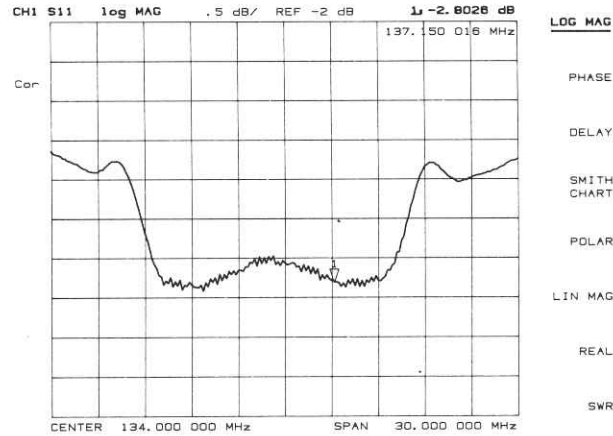

Figure 4-10. Log Magnitude Format

[PHASE] (PHAS) displays a Cartesian format of the phase portion of the data, measured in degrees. This format displays the phase shift versus frequency. Figure 4-11 illustrates the phase response of the same filter in a phase-only format. A measurement of phase response is described in the User's Guide.

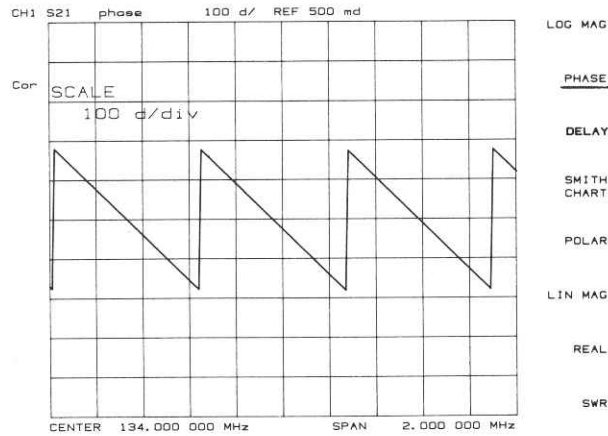

Figure 4-11. Phase Format

[DELAY] (DELA) selects the group delay format (Figure 4-12), with marker values given in seconds. Figure 4-12 shows the bandpass filter response formatted as group delay. Group delay principles are described in the next few pages.

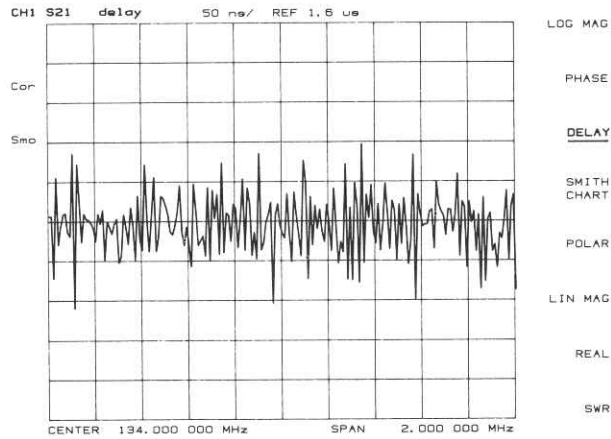

Figure 4-12. Group Delay Format

[SMITH CHART] (SMIC) displays a Smith chart format (Figure 4-13a). This is used in reflection measurements to provide a readout of the data in terms of impedance. The intersecting dotted lines on the Smith chart represent constant resistance and constant reactance values, normalized to the characteristic impedance, Z_0 , of the system. Reactance values in the upper half of the Smith chart circle are positive (inductive) reactance, and in the lower half of the circle are negative (capacitive) reactance. The default marker readout is in units of resistance and reactance ($R + jX$). Additional marker types are available in the Smith marker menu (refer to chapter 6, Using Markers).

The Smith chart is most easily understood with a full scale value of 1.0. If the scale per division is less than 0.2, the format switches automatically to polar.

If the characteristic impedance of the system is not 50 ohms, modify the impedance value recognized by the HP 8753A using the **[SET Z0]** softkey in the calibrate more menu. Refer to chapter 5, Measurement Calibration.

An inverted Smith chart format for admittance measurements (Figure 4-13b) is also available. Access this by selecting **[SMITH CHART]** in the format menu, and pressing **[MKR] [MARKER MODE MENU] [SMITH MKR MENU] [G+jB MKR]**. The Smith chart is reversed and marker values are read out in units of conductance and susceptance ($G+jB$).

Procedures for measuring impedance and admittance are provided in the User's Guide.

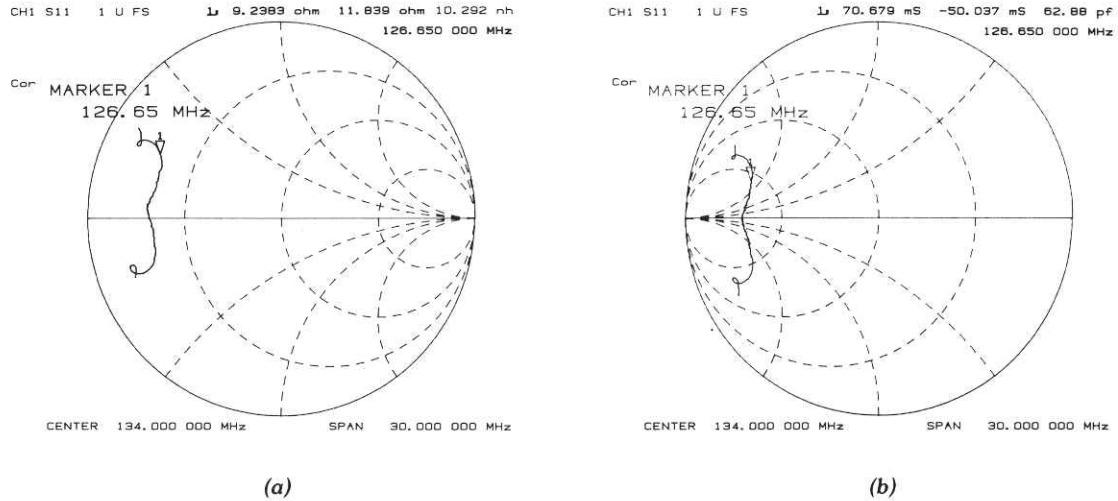

Figure 4-13. Standard and Inverse Smith Chart Formats

[POLAR] (POLA) displays a polar format (Figure 4-14). Each point on the polar format corresponds to a particular value of both magnitude and phase. Quantities are read vectorally: the magnitude at any point is determined by its displacement from the center (which has zero value), and the phase by the angle counterclockwise from the positive x-axis. Magnitude is scaled in a linear fashion, with the value of the outer circle usually set to a ratio value of 1. Since there is no frequency axis, frequency information is read from the markers.

The default marker readout for the polar format is in linear magnitude and phase. A log magnitude marker and a real/imaginary marker are available in the polar marker menu (refer to chapter 6, Using Markers).

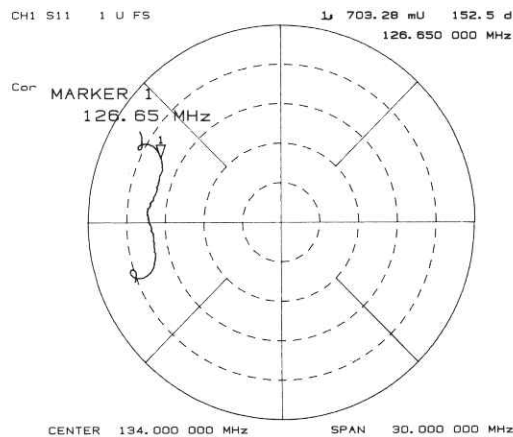

Figure 4-14. Polar Format

[LIN MAG] (LINM) displays the linear magnitude format (Figure 4-15). This is a Cartesian format used for unitless measurements such as reflection coefficient magnitude ρ or transmission coefficient magnitude τ , and for linear measurement units. It is used for display of conversion parameters and time domain transform data.

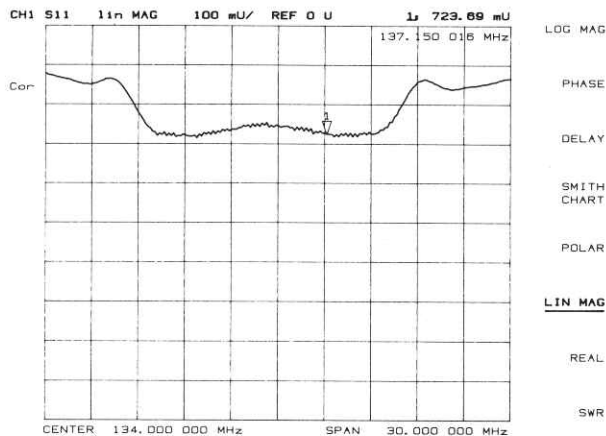

Figure 4-15. Linear Magnitude Format

[REAL] (REAL) displays only the real part of the measured data on a Cartesian format (Figure 4-16). This is similar to the linear magnitude format, but can show both positive and negative values. It is primarily used for analyzing responses in the time domain, and also for display of an auxiliary input voltage signal for service purposes.

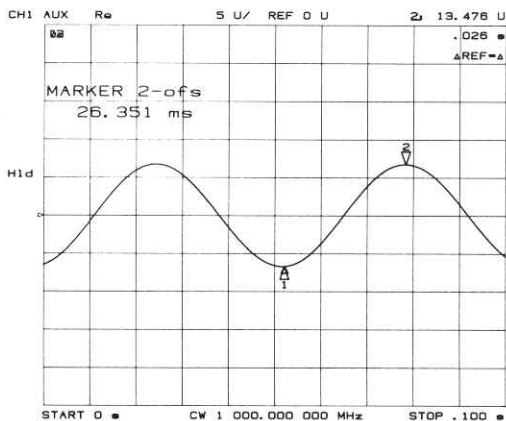

Figure 4-16. Real Format

[SWR] (SWR) reformats a reflection measurement into its equivalent SWR (standing wave ratio) value (Figure 4-17). SWR is equivalent to $(1 + \rho)/(1 - \rho)$, where ρ is the reflection coefficient. Note that the results are valid only for reflection measurements. If the SWR format is used for measurements of S21 or S12 the results are not valid.

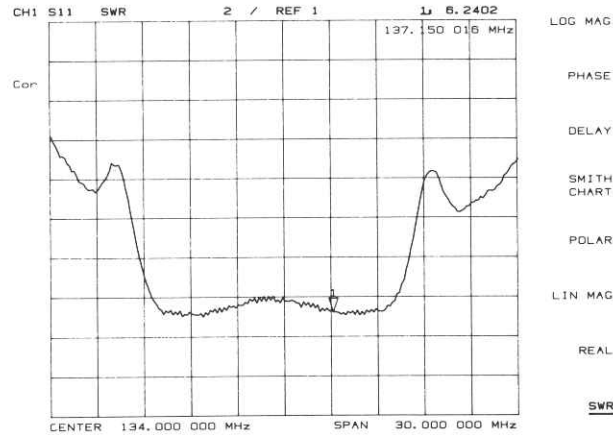

Figure 4-17. Typical SWR Display

GROUP DELAY PRINCIPLES

For many networks, the amount of insertion phase is not as important as the linearity of the phase shift over a range of frequencies. The HP 8753A can measure this linearity and express it in two different ways: directly, as deviation from linear phase, or as group delay, a derived value. Refer to "[SCALE REF] Key" in this chapter for information on deviation from linear phase.

Group delay is the measurement of signal transmission time through a test device. It is defined as the derivative of the phase characteristic with respect to frequency. Since the derivative is basically the instantaneous slope (or rate of change of phase with frequency), a perfectly linear phase shift results in a constant slope, and therefore a constant group delay (Figure 4-18).

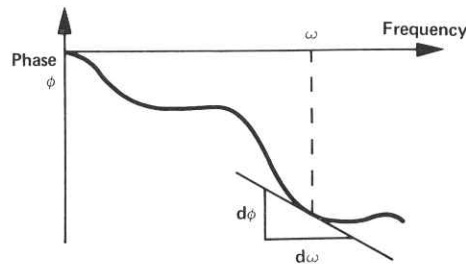
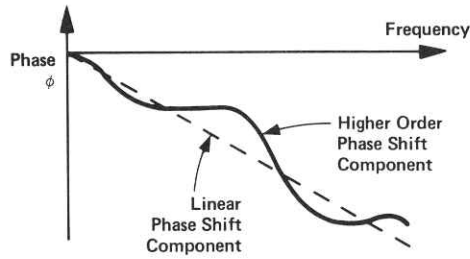

Figure 4-18

Note, however, that the phase characteristic typically consists of both linear and higher order (deviations from linear) components. The linear component can be attributed to the electrical length of the

test device, and represents the average signal transit time. The higher order components are interpreted as variations in transit time for different frequencies, and represent a source of signal distortion (Figure 4-19).



$$\begin{aligned} \text{Group Delay} = \tau_g &= \frac{-d\phi}{d\omega} && \phi \text{ in Radians} \\ &&& \omega \text{ in Radians} \\ &= \frac{-1}{360^\circ} \cdot \frac{d\phi}{df} && \phi \text{ in Degrees} \\ &&& f \text{ in Hz } (\omega = 2\pi f) \end{aligned}$$

Figure 4-19

The HP 8753A network analyzer computes group delay from the phase slope. Phase data is used to find the phase change, $\Delta\phi$, over a specified frequency aperture, Δf , to obtain an approximation for the rate of change of phase with frequency (Figure 4-20). This value, τ_g , represents the group delay in seconds assuming linear phase change over Δf . It is important that $\Delta\phi$ be $\leq 180^\circ$, or errors will result in the group delay data. These errors can be significant for long delay devices. You can verify that $\Delta\phi$ is $\leq 180^\circ$ by increasing the number of points or narrowing the frequency span (or both) until the group delay data no longer changes.

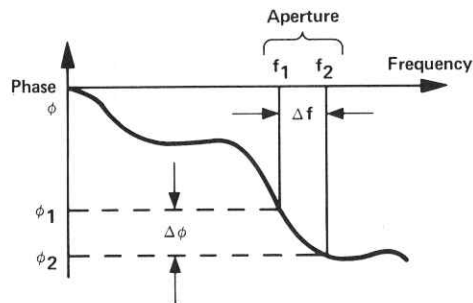

Figure 4-20

When deviations from linear phase are present, changing the frequency step can result in different values for group delay. Note that in this case the computed slope varies as the aperture Δf is increased (Figure 4-21). A wider aperture results in loss of the fine grain variations in group delay. This loss of detail is the reason that in any comparison of group delay data it is important to know the aperture used to make the measurement.

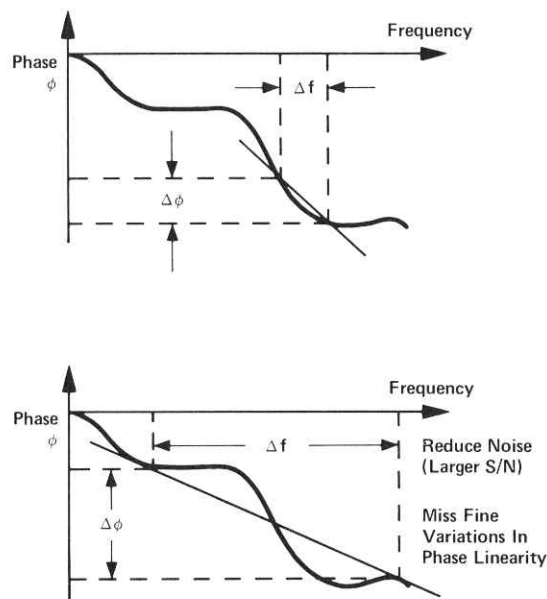

Figure 4-21

In determining the group delay aperture, there is a tradeoff between resolution of fine detail and the effects of noise. Noise can be reduced by increasing the aperture, but this will tend to smooth out the fine detail. More detail will become visible as the aperture is decreased, but the noise will also increase, possibly to the point of obscuring the detail. A good practice is to use a smaller aperture to assure that small variations are not missed, then increase the aperture to smooth the trace.

The default group delay aperture is the frequency span divided by the number of points across the display. To set the aperture to a different value, turn on smoothing in the average menu, and vary the smoothing aperture (see "[AVG] Key"). The aperture can be varied up to 20% of the span swept.

Group delay measurements can be made on linear frequency, log frequency, or list frequency sweep types (not in CW or power sweep). Group delay aperture varies depending on the frequency spacing and point density, therefore the aperture is not constant in log and list frequency sweep modes. In list frequency mode, extra frequency points can be defined to ensure the desired aperture.

To obtain a readout of aperture values at different points on the trace, turn on a marker. Then press [AVG] [SMOOTHING APERTURE]. Smoothing aperture becomes the active function, and as the aperture is varied its value in Hz is displayed below the active entry area.

A group delay measurement procedure is provided in the User's Guide.

[SCALE REF] Key

Scale Reference Menu

The [SCALE REF] (MENUSCAL) key makes scale per division the active function. A menu is displayed that is used to modify the vertical axis scale and the reference line value and position. In addition this menu provides electrical delay offset capabilities for adding or subtracting linear phase to maintain phase linearity.

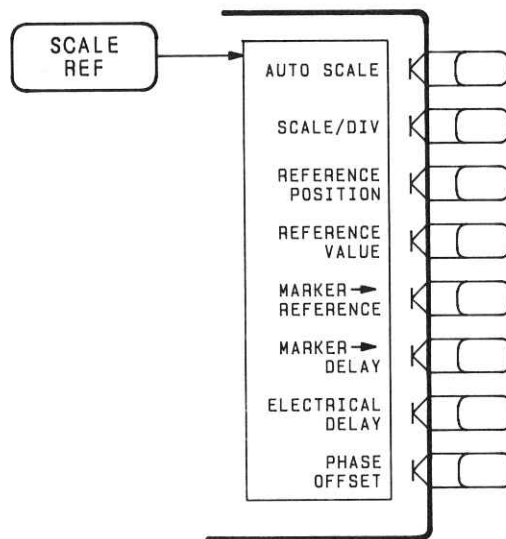

Figure 4-22

[AUTO SCALE] (AUTO) brings the trace data in view on the CRT with one keystroke. Stimulus values are not affected, only scale and reference values. The HP 8753A determines the smallest possible scale factor that will put all displayed data onto 80% of the vertical graticule. The reference value is chosen to put the trace in center screen, then rounded to an integer multiple of the scale factor.

[SCALE/DIV] (SCAL) changes the response value scale per division of the displayed trace. In polar and Smith chart formats, this refers to the full scale value at the outer circumference, and is identical to reference value.

[REFERENCE POSITION] (REFP) sets the position of the reference line on the graticule of a Cartesian display, with 0 the bottom line of the graticule and 10 the top line. It has no effect on a polar or Smith display. The reference position is indicated with a small triangle just outside the graticule, on the left side for channel 1 and the right side for channel 2.

[REFERENCE VALUE] (REFV) changes the value of the reference line, moving the measurement trace correspondingly. In polar and Smith chart formats, the reference value is the same as the scale, and is the value of the outer circle.

[MARKER → REFERENCE] (MARKREF) makes the reference value equal to the active marker's absolute value (regardless of the delta marker value). The marker is effectively moved to the reference line position. This softkey also appears in the marker function menu accessed from the **[MKR FCTN]** key. In polar and Smith chart formats this function makes the full scale value at the outer circle equal to the active marker response value.

[MARKER → DELAY] (MARKDELA) adjusts the electrical delay to balance the phase of the DUT. This is performed automatically, regardless of the format and the measurement being made. Enough line length is added to or subtracted from the receiver input to compensate for the phase slope at the active marker position. This effectively flattens the phase trace around the active marker, and can be used to measure electrical length or deviation from linear phase. Additional electrical delay adjustments are required on DUTs without constant group delay over the measured frequency span. Since this feature adds phase to a variation in phase versus frequency, it is applicable only for ratioed inputs.

[ELECTRICAL DELAY] (ELED) adjusts the electrical delay to balance the phase of the DUT. It simulates a variable length lossless transmission line, which can be added to or removed from a receiver input to compensate for interconnecting cables, etc. This function is similar to the mechanical or analog "line stretchers" of other network analyzers. Delay is annotated in units of time with secondary labeling in distance for the current velocity factor.

With this feature, and with **[MARKER → DELAY]**, an equivalent length of air is added or subtracted according to the following formula:

$$\text{Length (metres)} = \frac{\phi}{F(\text{MHz}) * 1.20083}$$

Once the linear portion of the DUT's phase has been removed, the equivalent length of air can be read out in the active marker area. If the average relative permittivity (ϵ_r) of the DUT is known over the frequency span, the length calculation can be adjusted to indicate the actual length of the DUT more closely. This can be done by entering the relative velocity factor for the DUT using the calibrate more menu. The relative velocity factor for a given dielectric can be calculated by:

$$\text{Velocity factor} = 1/\sqrt{\epsilon_r}$$

assuming a relative permeability of 1.

A procedure for measuring electrical length or deviation from linear phase using the **[ELECTRICAL DELAY]** or **[MARKER → DELAY]** features is provided in the User's Guide.

[PHASE OFFSET] (PHAO) adds or subtracts a phase offset that is constant with frequency (rather than linear). This is independent of **[MARKER → DELAY]** and **[ELECTRICAL DELAY]**.

[DISPLAY] Key

The [DISPLAY] (MENUMDISP) key provides access to the memory math functions, and other display functions including dual channel display, active channel display title, frequency blanking, and display focus and intensity.

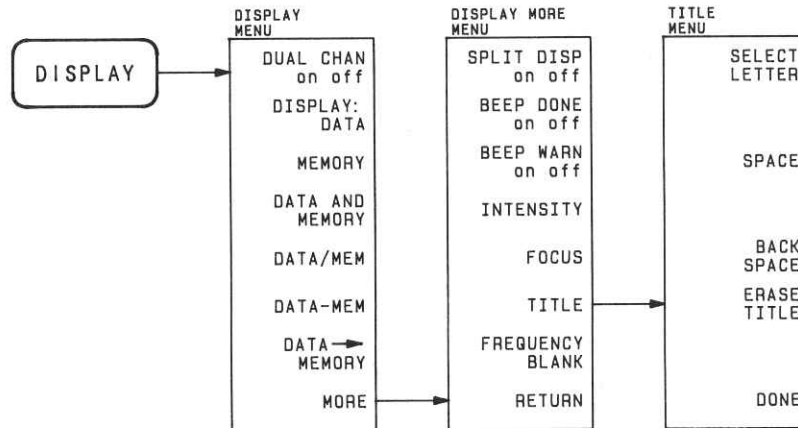

Figure 4-23. Softkey Menus Accessed from the [DISPLAY] Key

Display Menu

This menu provides trace math capabilities for manipulating data, as well as the capability of displaying both channels simultaneously, either overlaid or split.

The HP 8753A has two available memory traces, one per channel. Memory traces are totally channel dependent: channel 1 cannot access the channel 2 memory trace or vice versa. Memory traces can be saved with instrument states: one memory trace can be saved per channel per saved instrument state. Five save/recall registers are available for each channel, so the total number of memory traces that can be saved is 12 including the two active for the current instrument state. The memory data is stored as full precision, complex data. (Refer to chapter 10, Saving Instrument States.)

Two trace math operations are implemented, data/memory and data—memory. (Note that normalization is data/memory not data—memory.) Memory traces are saved and recalled and trace math is done immediately after error correction. This means that any additional post-processing done after error correction, including parameter conversion, time domain transformation (option 010), scaling, etc., can be performed on the memory trace. (Refer to “HP 8753A Data Processing” in chapter 1.) Trace math can also be used as a simple means of error correction, although that is not its main purpose.

All data processing operations that occur after trace math, except smoothing and gating, are identical for the data trace and the memory trace. If smoothing or gating is on when a memory trace is saved, this state is maintained regardless of the data trace smoothing or gating status. If a memory trace is saved with gating or smoothing on, these features can be turned on or off in the memory-only display mode.

The actual memory for storing a memory trace is allocated only as needed. The memory trace is cleared on instrument preset, power on, or instrument state recall.

If sweep mode or sweep range is different between the data and memory traces, trace math is allowed, and no warning message is displayed. If the number of points in the two traces is different, the memory trace is not displayed nor rescaled. However, if the number of points for the data trace is changed back to the number of points in the memory, the memory trace can then be displayed.

If trace math or display memory is requested and no memory trace exists, the message "CAUTION: NO VALID MEMORY TRACE" is displayed.

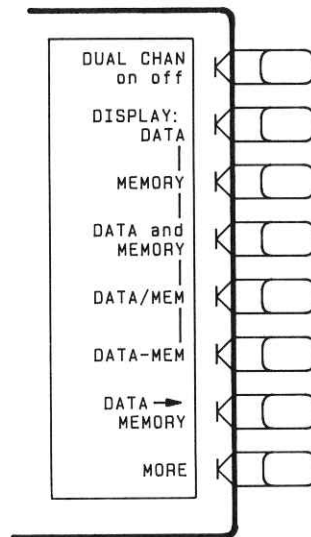
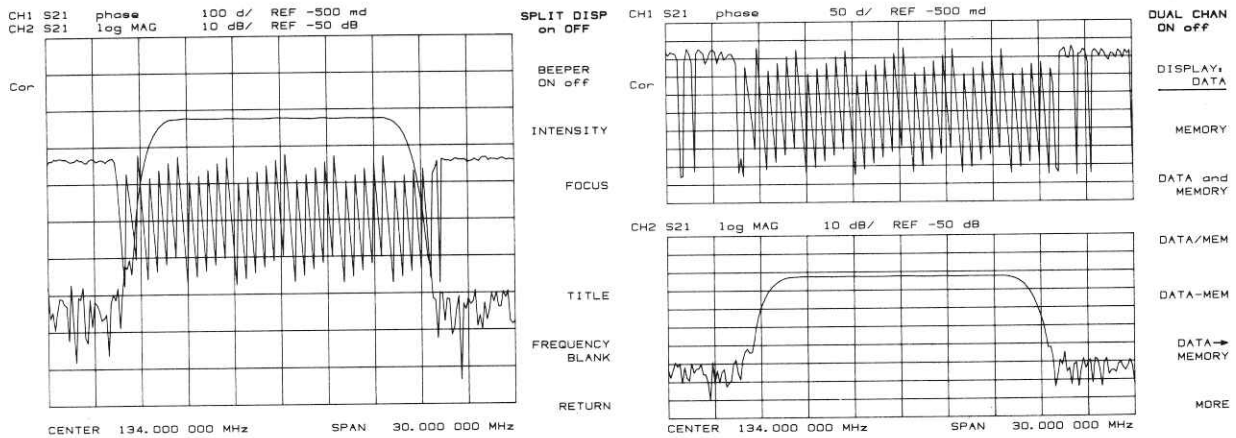

Figure 4-24. Display Menu

[DUAL CHAN on off] (DUACon, DUACoff) toggles between display of both measurement channels or the active channel only. This is used in conjunction with **[SPLIT DISP on off]** in the display more menu to display both channels. With **[SPLIT DISP OFF]** the two traces are overlaid on a single graticule (Figure 4-25a); with **[SPLIT DISP ON]** the measurement data is displayed on two half-screen graticules one above the other (Figure 4-25b). Current parameters for the two displays are annotated separately.

The stimulus functions of the two channels can also be controlled independently using **[COUPLED CH ON]** in the stimulus menu. In addition, the markers can be controlled independently for each channel using **[MARKERS: UNCOUPLED]** in the marker mode menu.



(a) Overlaid Traces

(b) Split Display

Figure 4-25. Dual Channel Displays

[DISPLAY: DATA] (DISPDATA) displays the current measurement data for the active channel.

[MEMORY] (DISPMEMO) displays the trace memory for the active channel. This is the only memory display mode where the smoothing and gating of the memory trace can be changed. If no data has been stored in memory for this channel, a warning message is displayed.

[DATA and MEMORY] (DISPDATM) displays both the current data and memory traces.

[DATA/MEM] (DISPDDM) divides the data by the memory, normalizing the data to the memory, and displays the result. This is useful for ratio comparison of two traces, for instance in measurements of gain or attenuation.

[DATA – MEM] (DISPDMM) subtracts the memory from the data. The vector subtraction is performed on the complex data. This is appropriate for storing a measured vector error, for example directivity, and later subtracting it from the device measurement.

[DATA → MEMORY] (DATI) stores the current active measurement data in the memory of the active channel. It then becomes the memory trace, for use in subsequent math manipulations or display. If a parameter has just been changed and the * status notation is displayed at the left of the CRT, the data is not stored in memory until a clean sweep has been executed. The gating and smoothing status of the trace are stored with the measurement data.

[MORE] leads to the display more menu.

Display More Menu

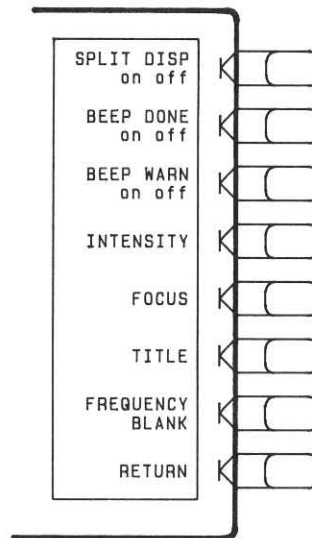

Figure 4-26

[SPLIT DISP on off] (SPLDon, SPLDoff) toggles between a full-screen single graticule display of one or both channels, and a split display with two half-screen graticules one above the other. Both displays are illustrated in Figure 4-25. The split display can be used in conjunction with **[DUAL CHAN ON]** in the display menu to show the measured data of each channel simultaneously on separate graticules. In addition, the stimulus functions of the two channels can be controlled independently using **[COUPLED CH ON]** in the stimulus menu. The markers can also be controlled independently for each channel using **[MARKERS: UNCOUPLED]** in the marker mode menu.

[BEEP DONE on off] (BEEPDONEon, BEEPDONEoff) toggles a low-toned beeper that sounds to indicate completion of certain operations such as calibration or instrument state save.

[BEEP WARN on off] (BEEPWARNon, BEEPWARNoff) toggles the warning beeper. When the beeper is on it sounds a warning when a cautionary message is displayed.

[INTENSITY] (INTE) sets the CRT intensity as a percent of the brightest setting. The factory-set default value is stored in non-volatile memory.

[FOCUS] (FOCU) sets the CRT focus as a percent of the maximum focus voltage. The factory-set default value is stored in non-volatile memory.

[TITLE] (TITL) presents the title menu in the softkey labels area and the character set in the active entry area. These are used to label the active channel display.

[FREQUENCY BLANK] (FREO) blanks the displayed frequency notation for security purposes. Frequency labels cannot be restored except by instrument preset or turning the power off and then on.

[RETURN] goes back to the display menu.

Title Menu

Use this menu to specify a title for the active channel. The title identifies the display regardless of stimulus or response changes, and is printed or plotted with the data. If the display is saved in a register with the instrument state, the title is saved with it.

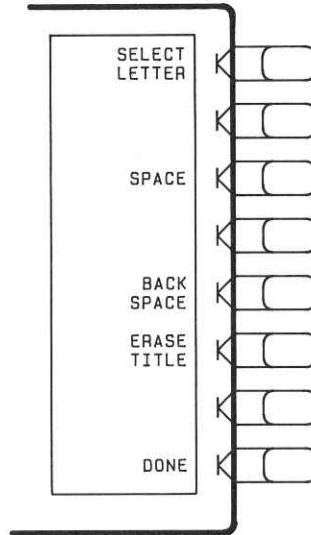

Figure 4-27

[SELECT LETTER]. The active entry area displays the letters of the alphabet, digits 0 through 9, and mathematical symbols. To define a title, rotate the knob until the arrow \uparrow points at the first letter, then press **[SELECT LETTER]**. Repeat this until the complete title is defined, for a maximum of 50 characters. As each character is selected, it is appended to the title at the top of the graticule.

[SPACE] inserts a space in the title.

[BACK SPACE] deletes the last character entered.

[ERASE TITLE] deletes the entire title.

[DONE] terminates the title entry, and returns to the display more menu.

[AVG] Key

The [AVG] (MENUAVG) key is used to access three different noise reduction techniques: sweep-to-sweep averaging, display smoothing, and variable IF bandwidth. Any or all of these can be used simultaneously. Averaging and smoothing can be set independently for each channel, and the IF bandwidth can be set independently if the stimulus is uncoupled.

Averaging computes each data point based on an exponential average of consecutive sweeps weighted by a user-specified averaging factor. Each new sweep is averaged into the trace until the total number of sweeps is equal to the averaging factor, for a fully averaged trace. Each point on the trace is the vector sum of the current trace data and the data from the previous sweep. A high averaging factor gives the best signal-to-noise ratio, but slows down the trace update time. Doubling the averaging factor reduces the noise by 3 dB. Averaging is used for ratioed measurements: if it is attempted for a single-input measurement (e.g. A or B), the message "CAUTION: AVERAGING INVALID ON NON-RATIO MEASURE" is displayed. Figure 4-28 illustrates the effect of averaging on a log magnitude format trace.

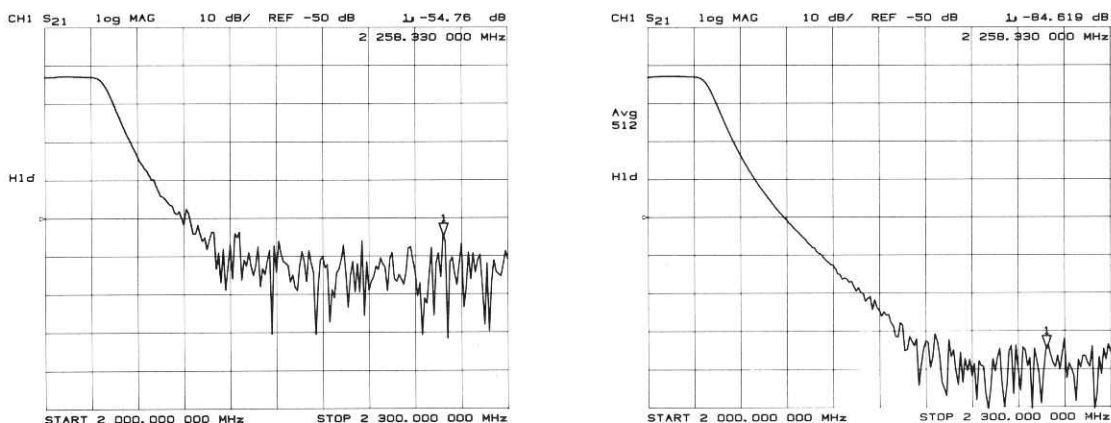

Figure 4-28. Effect of Averaging on a Trace

Smoothing (similar to video filtering) averages the formatted active channel data over a portion of the displayed trace. Smoothing computes each displayed data point based on one sweep only, using a moving average of several adjacent data points for the current sweep. The smoothing aperture is a percent of the stimulus span swept, up to a maximum of 20%.

Rather than lowering the noise floor, smoothing finds the mid-value of the data. Use it to reduce relatively small peak-to-peak noise values on broadband measured data. Use a sufficiently high number of display points to avoid misleading results. Do not use smoothing for measurements of high resonance devices or other devices with wide variations in trace, as it will introduce errors into the measurement.

Smoothing is used with Cartesian and polar display formats. It is also the primary way to control the group delay aperture, given a fixed frequency span (refer to "Group Delay Principles" earlier in this chapter). In polar display format, large phase shifts over the smoothing aperture will cause shifts in amplitude, since a vector average is being computed. Figure 4-29 illustrates the effect of smoothing on a log magnitude format trace.

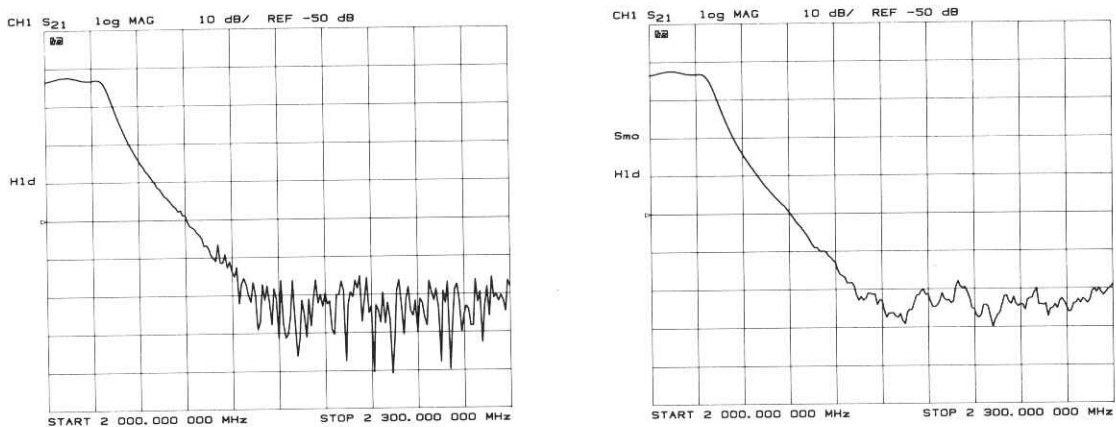

Figure 4-29. Effect of Smoothing on a Trace

IF Bandwidth Reduction lowers the noise floor by digitally reducing the receiver input bandwidth, and works in all ratio and non-ratio modes. It has an advantage over averaging in reliably filtering out unwanted responses such as spurs, odd harmonics, higher frequency spectral noise, and line-related noise. Sweep-to-sweep averaging, however, is better at filtering out very low frequency noise. A tenfold reduction in IF bandwidth lowers the measurement noise floor by about 10 dB. Bandwidths less than 300 kHz provide better harmonic rejection than higher bandwidths.

Another difference between sweep-to-sweep averaging and variable IF bandwidth is the sweep time. Averaging displays the first complete trace faster but takes several sweeps to reach a fully averaged trace. IF bandwidth reduction lowers the noise floor in one sweep, but the sweep time may be slower. Figure 4-30 illustrates the difference in noise floor between a trace measured with a 3000 Hz IF bandwidth and with a 10 Hz IF bandwidth.

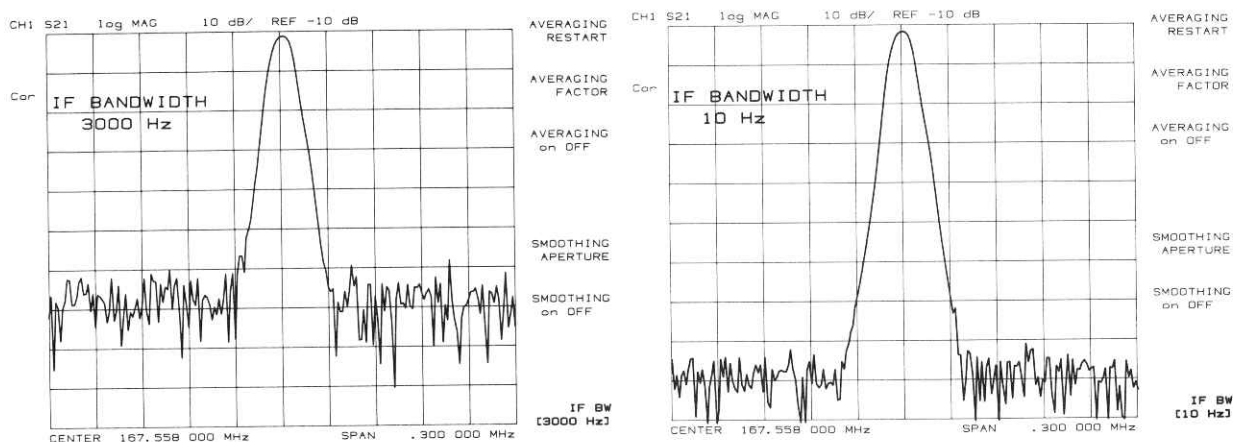

Figure 4-30. IF Bandwidth Reduction

Another capability that can be used for effective noise reduction is the marker statistics function, which computes the average value of part or all of the formatted trace. Refer to chapter 6, Using Markers.

Another way of increasing dynamic range is to increase the input power to the device under test. Refer to the User's Guide for an example.

Average Menu

The average menu (Figure 4-31) is used to select the desired noise-reduction technique, and to set the parameters for the technique selected. It is also used to set the aperture for group delay measurements.

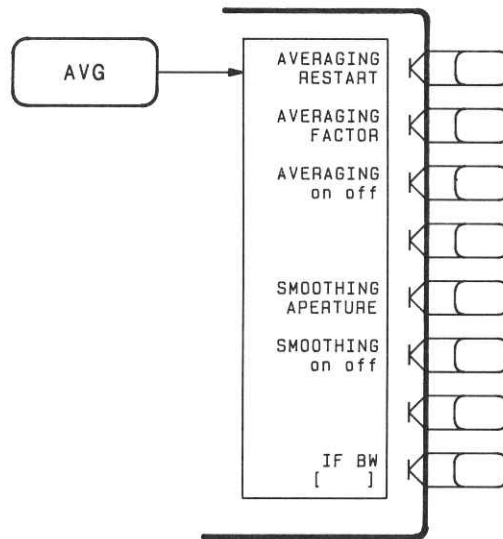

Figure 4-31.

[AVERAGING RESTART] (AVERREST) resets the sweep-to-sweep averaging and restarts the sweep count at 1 at the beginning of the next sweep. The sweep count for averaging is displayed at the left of the CRT.

[AVERAGING FACTOR] (AVERFACT) makes averaging factor the active function. Any value up to 999 can be used. The algorithm used for averaging is:

$$A(n) = S(n)/F + (1 - 1/F) \times A(n-1)$$

where

A(n) = current average
 S(n) = current measurement
 F = average factor

[AVERAGING on off] (AVERon, AVERoff) turns the averaging function on or off for the active channel. "Avg" is displayed in the status notations area at the left of the CRT, together with the sweep count for the averaging factor, when averaging is on. The sweep count for averaging is reset to 1 whenever an instrument state change affecting the measured data is made.

At the start of averaging or following **[AVERAGING RESTART]**, averaging starts at 1 and averages each new sweep into the trace until it reaches the specified averaging factor. The sweep count is displayed in the status notations area below "Avg" and updated every sweep as it increments. When the specified averaging factor is reached, the trace data continues to be updated, weighted by that averaging factor.

[SMOOTHING APERTURE] (SMOOAPER) lets you change the value of the smoothing aperture as a percent of the span. When smoothing aperture is the active function, its value in stimulus units is displayed below its percent value in the active entry area.

Smoothing aperture is also used to set the aperture for group delay measurements (refer to "Group Delay Principles" earlier in this chapter). Note that the displayed smoothing aperture is not the group delay aperture unless smoothing is on. Group delay aperture can be varied without changing the number of points by changing the smoothing aperture and turning smoothing on. Take care not to increase the aperture to the level where group delay data becomes distorted.

[SMOOTHING on off] (SMOOon, SMOOoff) turns the smoothing function on or off for the active channel. When smoothing is on, the annotation "Smo" is displayed in the status notations area.

[IF BW] (IFBW) is used to select the bandwidth value for IF bandwidth reduction. Settable values (in Hz) are 3000, 1000, 300, 100, 30, and 10. Any other value will default to the next allowable value. A narrow bandwidth slows the sweep speed but provides better signal-to-noise ratio. The selected bandwidth value is shown in brackets in the softkey label.

Chapter 5. Measurement Calibration

INTRODUCTION

Measurement calibration is an accuracy enhancement procedure that transfers the uncertainty of standard devices to the uncertainty in measurement of a test device. Since the response of the standards is known to a high degree of accuracy, the system can measure one or more standards, then use the results of these measurements to greatly enhance the accuracy of the measured data.

This chapter explains the theoretical fundamentals of accuracy enhancement and the sources of measurement errors. It describes the different calibration procedures available in the HP 8753A, which errors they correct, and the measurements for which each should be used. An appendix at the end of this chapter provides further information on characterizing systematic errors and using error models to analyze overall measurement performance.

ACCURACY ENHANCEMENT

In any high frequency measurement there are certain measurement errors or ambiguities associated with the system that contribute uncertainty to the results. Parts of the measurement setup such as interconnecting cables and test sets (as well as the network analyzer itself) all introduce variations in magnitude and phase that can mask the actual performance of the device under test.

For example, crosstalk due to the channel isolation characteristics of the network analyzer can contribute an error equal to the transmission signal of a high loss test device. Similarly, for reflection measurements, the primary limitation of dynamic range is the directivity of the test setup. The measurement system cannot distinguish the true value of the signal reflected by the device under test from the signal arriving at the receiver input due to leakage in the system. For both transmission and reflection measurements, impedance mismatches within the test setup cause measurement uncertainties that appear as ripples superimposed on the measured data.

Vector accuracy enhancement, also known as error correction, provides the means to greatly reduce network measurement ambiguities by simulating a perfect measurement system. If it were possible for a perfect measurement system to exist, it would have infinite dynamic range, isolation, and directivity characteristics, no impedance mismatches in any part of the test setup, and flat frequency response. In practice, a perfect network analyzer system is simulated by measuring the magnitude and phase responses of known standard devices, and effectively removing the results from the measurement data of a test device using vector math capabilities internal to the network analyzer.

When this error correction is used, the dynamic range and accuracy of the measurement are limited only by system noise and stability, connector repeatability, and the accuracy to which the characteristics of the calibration standards are known. This is the basic concept of vector accuracy enhancement.

SOURCES OF MEASUREMENT ERRORS

Network analysis measurement errors can be separated into systematic, random, and drift errors.

Correctable systematic errors are the repeatable errors that the system can measure. These are errors due to mismatch and leakage in the test setup, isolation between the reference and test signal paths, and system frequency response.

Random and drift errors are errors that the system itself cannot measure, and therefore cannot correct for. These errors affect both reflection and transmission measurements. Random errors are non-repeatable measurement variations due to noise and connector repeatability. Drift errors include frequency drift, temperature drift, and other physical changes in the test setup between calibration and measurement.

Any measurement result is the vector sum of the actual test device response plus all error terms. The precise effect of each error term depends upon its magnitude and phase relationship to the actual test device response. Random and drift errors cannot be precisely quantified, so they must be treated as producing a cumulative ambiguity in the measured data.

In most high frequency measurements the systematic errors are the most significant source of measurement uncertainty. Since each of these errors produces a predictable effect on the measured data, their effects can be effectively removed to obtain a corrected value for the test device response. For the purpose of vector accuracy enhancement these uncertainties are quantified as directivity, source match, load match, isolation (crosstalk), and frequency response (tracking). Each of these systematic errors is described below.

Directivity

Normally a device that can separate the reverse from the forward traveling waves (a directional bridge or coupler) is used to detect the signal reflected from the device under test. Ideally the coupler would completely separate the incident and reflected signals, and only the reflected signal would appear at the coupled output, as illustrated in Figure 5-1a.

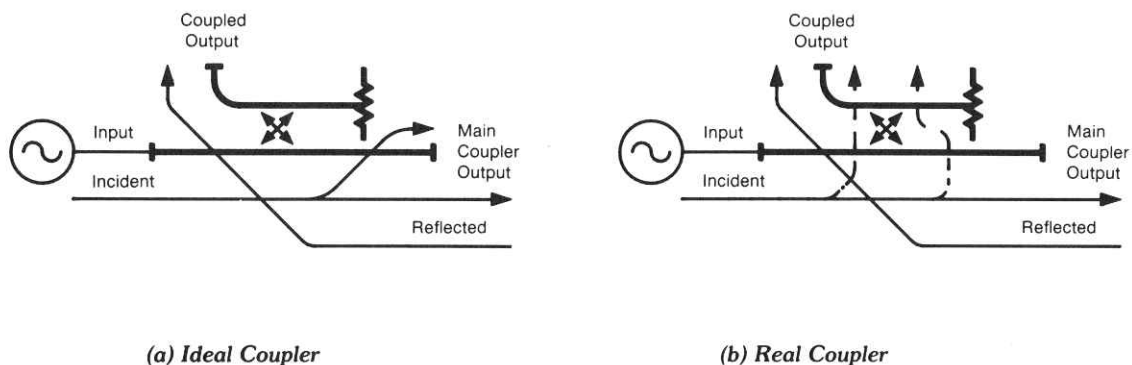

Figure 5-1. Directivity

However, a real coupler is not perfect, as illustrated in Figure 5-1b. A small amount of the incident signal appears at the coupled output due to leakage as well as to reflection from the termination in the coupled arm. Also reflections from the coupler output connector appear at the coupled output, adding uncertainty to the signal reflected from the device. The figure of merit for how well a coupler separates forward and reverse waves is directivity. System directivity is the vector sum of all leakage signals appearing at the network analyzer test input due to the inability of the signal separation device to absolutely separate incident and reflected waves, and to residual reflection effects of test cables and adapters between the signal separation device and the measurement plane. The uncertainty contributed by directivity is independent of the characteristics of the test device and it usually produces the major ambiguity in low reflection measurements.

The uncorrected directivity of the HP 85046A/B and 85044A/B test sets is sufficient for many measurements, especially in measurements of highly reflective test devices. However, the vector accuracy enhancement techniques described in this chapter will produce much greater effective directivity.

Source Match

Source match is defined as the vector sum of signals appearing at the system test input due to the impedance mismatch at the test device looking back into the source, as well as to adapter and cable mismatches and losses. In a transmission measurement, the source match error signal is caused by reflection from the test device that is re-reflected from the source. In a reflection measurement, the source match error signal is caused by some of the reflected signal being reflected back from the source and re-reflected from the test device (Figure 5-2).

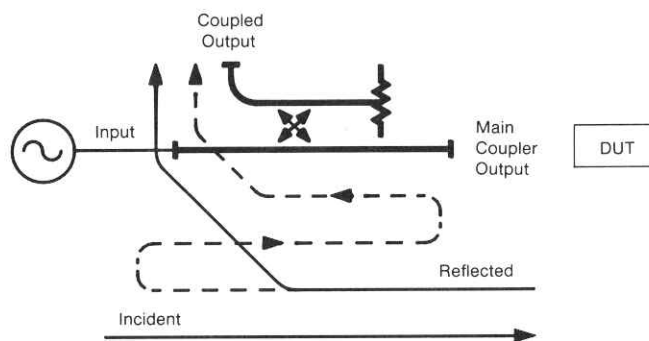

Figure 5-2. Source Match

The uncertainty contributed by source match is dependent on the relationship between the actual input impedance of the test device and the equivalent match of the source, and it is a factor in both transmission and reflection measurements. Source match is particularly a problem in measurements where there is a large impedance mismatch at the measurement plane. The effective source match can be improved considerably by using vector error correction techniques.

Load Match

Load match error results from an imperfect match at the output of the test device. It is caused by impedance mismatches between the test device output port and port 2. As illustrated in Figure 5-3, some of the transmitted signal is reflected from port 2 back to the test device. A portion of this wave may be re-reflected to port 2, or part may be transmitted through the device in the reverse direction to appear at port 1. If the DUT has low insertion loss (for example a transmission line), the signal reflected from port 2 and re-reflected from the source causes a significant error because the DUT does not attenuate the signal significantly on each reflection.

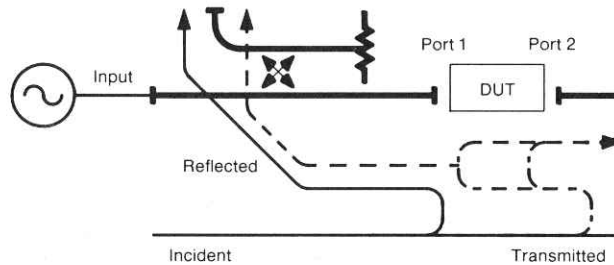

Figure 5-3. Load Match

The uncertainty contributed by load match is dependent on the relationship between the actual output impedance of the test device and the effective match of the return port, and is a factor in all transmission measurements and in reflection measurements of two-port devices. Load match is usually ignored when the test device insertion loss is greater than about 6 dB, because the error signal is greatly attenuated each time it passes through the DUT. However, load match effects produce major transmission measurement errors for a test device with a highly reflective output port. Effective load match can be improved significantly with vector accuracy enhancement.

Isolation (Crosstalk)

Leakage of energy between network analyzer signal paths contributes to error in a transmission measurement much like directivity does in a reflection measurement. Isolation is the vector sum of signals appearing at the network analyzer samplers due to crosstalk between the reference and test signal paths, including signal leakage within the test set and in both the RF and IF sections of the receiver. The signal present at the system test input can also include energy that is coupled from the reference input.

The uncertainty contributed by isolation depends on the characteristics of the device under test. Isolation is a factor in high-loss transmission measurements. However, HP 8753A system isolation is more than sufficient for most measurements, and correction for crosstalk may be unnecessary. For measuring devices with high dynamic range, accuracy enhancement can provide improvements in isolation that are limited only by the noise floor.

Frequency Response (Tracking)

This is the vector sum of all test setup variations in magnitude and phase frequency response, including signal separation devices, test cables and adapters, and variations in frequency response between the reference and test signal paths. This error is a factor in both transmission and reflection measurements. The magnitude and phase frequency response variations and the resultant measurement errors are significantly reduced by using vector accuracy enhancement.

CORRECTING FOR MEASUREMENT ERRORS

In all, there are twelve different error terms for a two-port measurement that can be corrected by accuracy enhancement in the HP 8753A. These are directivity, source match, load match, isolation, reflection tracking, and transmission tracking, each in both the forward and reverse direction. The HP 8753A has several different vector accuracy enhancement routines to characterize one or more of the systematic error terms and remove their effects from the measured data. The procedures range from a simple response calibration to a full two-port calibration that effectively removes all twelve error terms.

The response calibration effectively removes the frequency response errors of the test setup for reflection or transmission measurements. This calibration procedure may be adequate for measurement of well matched low-loss devices. This is the simplest error correction to perform, but also the least accurate.

The response and isolation calibration effectively removes frequency response and crosstalk errors in transmission measurements, or frequency response and directivity errors in reflection measurements. This procedure may be adequate for measurement of well matched high-loss devices.

The S11 and S22 one-port calibration procedures provide directivity, source match, and frequency response vector error correction for reflection measurements. These procedures are best applied to high accuracy reflection measurements of one-port devices or properly terminated two-port devices.

The full two-port calibration provides directivity, source match, load match, isolation, and frequency response vector error correction, in both forward and reverse directions, for transmission and reflection measurements of two-port devices. This calibration provides the best magnitude and phase measurement accuracy for both transmission and reflection measurements of two-port devices, and requires an S-parameter test set.

The one-path two-port calibration provides directivity, source match, load match, isolation, and frequency response vector error correction in one direction. It is used for high accuracy transmission and reflection measurements using a transmission/reflection test set. (The device under test must be manually reversed between sweeps to accomplish measurements in both the forward and reverse directions.)

Figures 5-4, 5-5, and 5-6 illustrate the improvements that can be made in measurement accuracy using a more complete calibration routine. Figure 5-4a shows a log magnitude trace with response calibration only. Figure 5-4b shows the improvement in the same trace using S11 one-port calibration. Figure 5-5a shows the trace on a Smith chart with response calibration only, and Figure 5-5b shows the same trace with S11 one-port calibration.

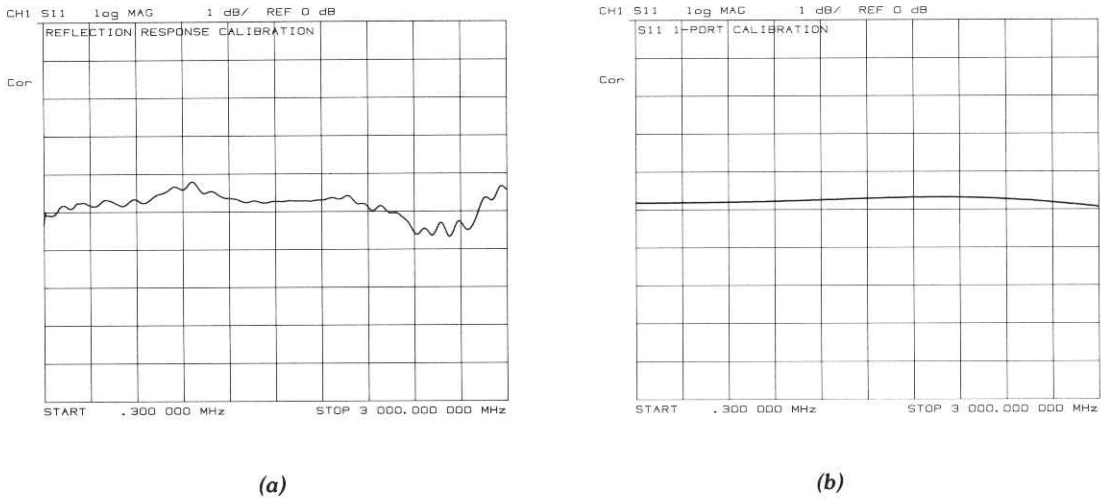

Figure 5-4. Response vs. S11 1-Port Calibration on Log Magnitude Format

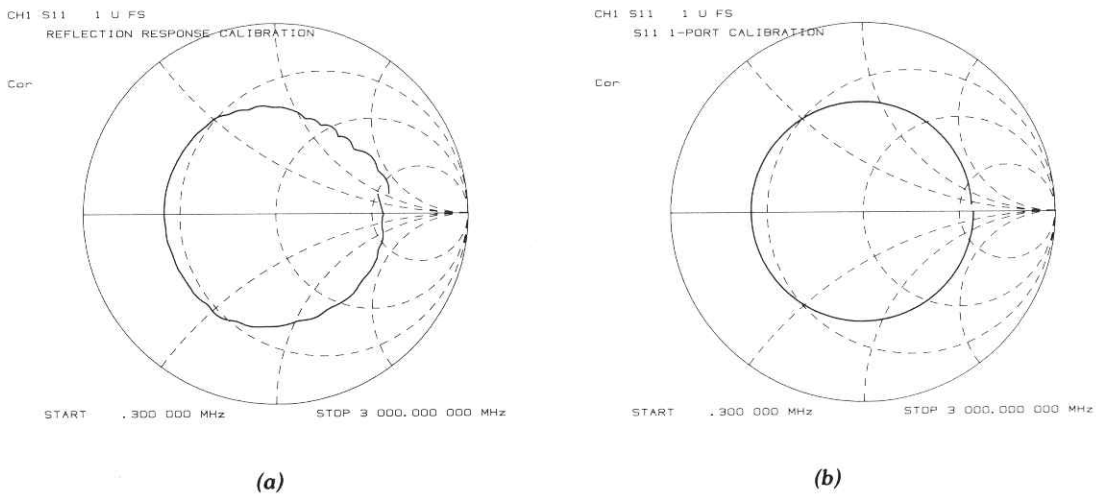
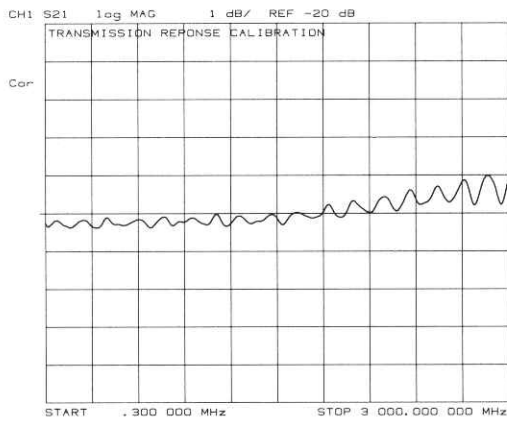
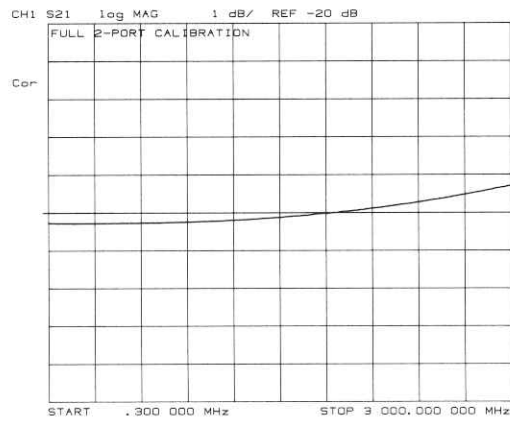

Figure 5-5. Response vs. S11 1-Port Calibration on Smith Chart

Figure 5-6 shows the response of a low-loss device in a log magnitude format, using a response calibration in Figure 5-6a and a full two-port calibration in Figure 5-6b.



(a)



(b)

Figure 5-6. Response vs. Full Two-Port Calibration

All the calibration procedures described above are accessed from the **[CAL]** key and are described in detail in the following pages.

For further explanation of systematic error terms and the way they are combined and represented graphically in error models, refer to the appendix at the end of this chapter, titled "Accuracy Enhancement Fundamentals--Characterizing Microwave Systematic Errors."

After the correctable systematic errors are effectively removed using accuracy enhancement, residual uncertainties remain. In addition to random and drift errors, these include residual systematic errors resulting from imperfections in the calibration standards, the connector interface, the interconnecting cables, and the instrumentation. Refer to "System Performance" in the General Information and Specifications section of this manual. This provides information for calculating the system's total error-corrected measurement uncertainty performance.

[CAL] KEY

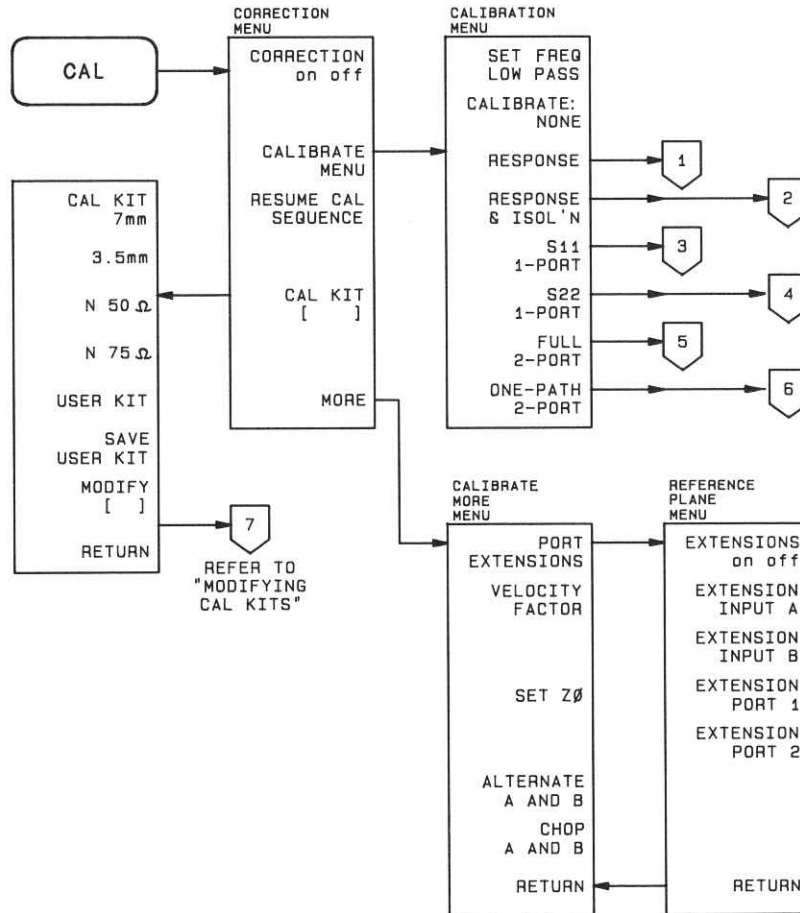

Figure 5-7. Relationship of the Menus Accessed from the [CAL] Key

The [CAL] (MENCAL) key leads to a series of menus that implement the accuracy enhancement procedures described in the preceding pages (see Figure 5-7). Accuracy enhancement (error correction) is performed as a calibration step before measurement of a test device. The HP 8753A uses one of several different procedures to measure the systematic (repeatable) errors of the system and remove their effects from the measured data. The calibration menus and procedures are described and illustrated in the following pages. Each procedure compensates for one or more of the systematic error terms. These range from a simple response calibration that removes the frequency response errors of the test setup to a full two-port vector calibration that removes all twelve error terms. Measurements of standard devices are used to solve for the error terms.

The standard devices required for calibration of the HP 8753A system are available in compatible calibration kits with different connector types. The model numbers and contents of these calibration kits are listed in the General Information section of this manual. Each kit contains at least one short circuit, one open circuit, and two impedance-matched loads. In kits that require adapters for interface to the test set ports, the adapters are phase-matched for calibration prior to measurement of non-insertable and non-reversible devices. Other standard devices can be used by specifying their characteristics in a user-defined kit, as described at the end of this chapter under "Modifying Calibration Kits."

The accuracy improvement of the correction is limited by the quality of the standard devices, and by the connection techniques used. For information about connector care and connection techniques, refer to the Microwave Connector Care Manual or the application note, Principles of Microwave Connector Care. Both of these documents are provided in the HP 8753A Test Sets and Accessories Manual. For maximum accuracy, use a torque wrench for final connections. The techniques for torquing connections and the part numbers for torque wrenches recommended for different connector types are provided in the connector care documents listed above.

Measurement calibrations are valid only for a specific stimulus state, which must be set before calibration is begun. The stimulus state consists of the selected frequency range, number of points, sweep time, output power, and sweep type. Changing the frequency range, number of points, or sweep type with correction on invalidates the calibration and turns it off. Changing the sweep time or output power changes the status notation "Cor" at the left of the screen to "C?", to indicate that the calibration is in question. If correction is turned off or in question after the stimulus changes are made, pressing **[CORRECTION ON]** recalls the original stimulus state for the current calibration.

Up to two sets of measurement calibration data can be defined for each instrument state, one for each channel. If the two channels are stimulus coupled and the input ports are the same for both channels, they share the same calibration data. If the two channel inputs are different, they can have different calibration data. If the two channels are stimulus uncoupled, the measurement calibration applies to only one channel. For information on stimulus coupling, refer to chapter 3, Stimulus Function Block.

Calibration procedures are parameter-specific, rather than channel-specific. When a parameter is selected, the instrument checks the available calibration data, and uses the data found for that parameter. For example, if a transmission response calibration is performed for B/R, and an S11 1-port calibration for A/R, the HP 8753A retains both calibration sets and corrects whichever parameter is displayed. Once a calibration has been performed for a specific parameter or input, measurements of that parameter remain calibrated in either channel, as long as stimulus values are coupled. In the response and response and isolation calibrations, the parameter must be selected before calibration: other correction procedures select parameters automatically. Changing channels during a calibration procedure invalidates the part of the procedure already performed.

In procedures that require measurement of several different devices, for example a short, an open, and a load, the order in which the devices are measured is not critical. Any standard can be re-measured, until the **[DONE]** key is pressed. The change in trace during measurement of a standard is normal.

Response and response and isolation calibrations require measurement of only one standard device. If more than one device is measured, only the data for the last device is retained.

Isolation calibration can be omitted for most measurements, except where wide dynamic range is a consideration. Use the following guidelines:

- > -80 dBm: Omit isolation calibration for most measurements.
- -80 to -100 dBm: Isolation calibration is recommended with approximately 0 dBm into the R input.

- < -100 dBm: Averaging should be on with a recommended averaging factor of 16, both for isolation calibration and for measurement after calibration.

A calibration that is interrupted to go to another menu can be continued with the **[RESUME CAL SEQUENCE]** key in the correction menu.

It is recommended that calibration data be saved, either in internal volatile memory or on an external disc. Refer to chapter 10, Saving Instrument States. If a calibration is not saved, it will be lost if another calibration procedure is selected for the same channel, or if stimulus values are changed. Instrument preset, power on, and instrument state recall will also clear the calibration data.

In addition to the menus for the different calibration procedures, the **[CAL]** key provides access to a series of menus used to specify the characteristics of the calibration standards used. Several default calibration kits with different connector types are predefined, or the definitions can be modified to any set of standards used.

Correction Menu

The correction menu is the first menu presented by the **[CAL]** key, and it provides access to numerous menus of additional calibration features.

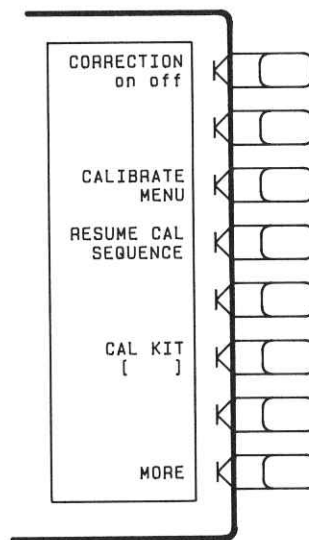

Figure 5-8

[CORRECTION on off] (CORR_{on}, CORR_{off}) turns error correction on or off. The HP 8753A uses the most recent calibration data for the displayed parameter. If the stimulus state has been changed since calibration, the original state is recalled, and the message "SOURCE PARAMETERS CHANGED" is displayed.

A calibration must be performed before correction can be turned on. If no valid calibration exists, the message "CALIBRATION REQUIRED" is displayed on the CRT.

It is recommended that calibration data be saved, either in internal volatile memory or on an external disc, using capabilities described in chapter 10, Saving Instrument States.

[CALIBRATE MENU] leads to the calibration menu, which provides several accuracy enhancement procedures ranging from a simple frequency response calibration to a full two-port calibration. At the completion of a calibration procedure, this menu is returned to the screen, correction is automatically turned on, and the notation "Cor" is displayed at the left of the screen.

[RESUME CAL SEQUENCE] (RESC) eliminates the need to restart a calibration sequence that was interrupted to access some other menu. This softkey goes back to the point where the calibration sequence was interrupted.

[CAL KIT] leads to the select cal kit menu, which is used to select one of the default HP 8753A compatible calibration kits available for different connector types. This in turn leads to additional menus used to define calibration standards other than those in the default kits (refer to "Modifying Calibration Kits," later in this chapter). When a calibration kit has been specified, its connector type is displayed in brackets in the softkey label.

[MORE] provides access to the calibrate more menu, which is used to extend the test port reference plane, to specify the characteristic impedance of the system, to select the optimum receiver sweep mode, and to specify the relative propagation velocity factor for distance-to-fault measurements using the time domain option.

Select Cal Kit Menu

The select cal kit menu is used to select the calibration kit to be used for a measurement calibration. Selecting a cal kit chooses the model that mathematically describes the standard devices actually used. (Refer to the beginning of this chapter, and the appendix at the end of this chapter, for more background on measurement calibrations and error correction.)

The HP 8753A has the capability to calibrate with four predefined cal kits in four different connector types. The models for these cal kits correspond to the standard calibration kits available as accessories for the HP 8753A:

7mm	HP 85031B 7 mm calibration kit
3.5mm	HP 85033C 3.5 mm calibration kit
N 50Ω	HP 85032B 50 ohm type-N calibration kit
N 75Ω	HP 85036B 75 ohm type-N calibration kit

How closely must the model match the actual device? The answer depends on the accuracy required. Certainly *any* calibration provides better accuracy than none at all, yet simple normalization is often quite adequate for many applications. The errors introduced by using the internal 7 mm model with a 7 mm cal kit other than the HP 85031B are vanishingly small. Yet for the highest accuracy, the more closely the model matches the device, the better.

In addition to the four predefined cal kits, a fifth choice is a "user kit" that is defined or modified by the user. This is described under "Modifying Calibration Kits" at the end of this chapter.

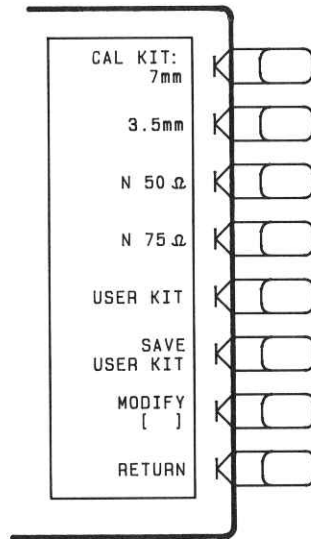

Figure 5-9. Select Cal Kit Menu

[CAL KIT: 7mm] (CALK7MM) selects the 7mm cal kit model.

[3.5mm] (CALK35MM) selects the 3.5 mm cal kit model.

[N 50Ω] (CALKN50) selects the 50 ohm type-N model.

[N 75Ω] (CALKN75) selects the 75 ohm type-N model.

NOTE: If **[N 50Ω]** or **[N 75Ω]** is selected, additional menus are provided during calibration procedures to select the connector sex. (This is the connector sex of the input port, not the actual calibration standard.)

[USER KIT] (CALKUSEK) selects a cal kit model defined or modified by the user. Refer to “Modifying Calibration Kits” at the end of this chapter for information.

[SAVE USER KIT] (SAVEUSEK) stores the user-modified or user-defined kit into memory, after it has been modified.

[MODIFY] (MODI1) leads to the modify cal kit menu, where a predefined cal kit can be user-modified.

[RETURN] returns to the correction menu.

Calibrate More Menu

This menu is used to extend the test port reference plane, to specify the characteristic impedance of the system, to select the optimum receiver sweep mode, and to specify the relative propagation velocity factor for distance-to-fault measurements.

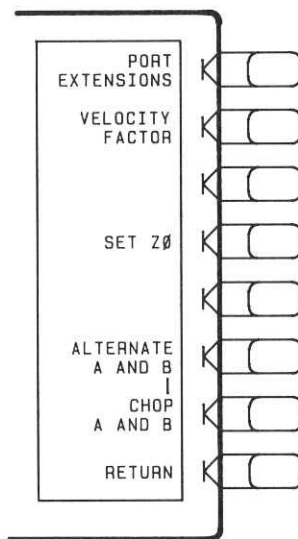

Figure 5-10

[PORT EXTENSIONS] goes to the reference plane menu, which is used to extend the apparent location of the measurement reference plane or input.

[VELOCITY FACTOR] (VELOFACT) Enters the velocity factor used by the HP 8753A to calculate equivalent electrical length in distance-to-fault measurements using the time domain option. Values entered should be less than 1. For example, the velocity factor of teflon is: $V_f = uR = 0.666$.

[SET Z0] (SETZ) sets the characteristic impedance used by the HP 8753A in calculating measured impedance with Smith chart markers and conversion parameters. If the test set used is an HP 85046B S-parameter test set or an HP 85044B transmission/reflection test set, set Z0 to 75 ohms. Characteristic impedance must be set correctly before calibration procedures are performed.

[ALTERNATE A and B] (ALTAB) measures only one input per frequency sweep, in order to reduce spurious signals. Thus, this mode optimizes the dynamic range for all four S-parameter measurements. This is the default measurement mode.

The disadvantages of this mode are associated with simultaneous transmission/reflection measurements or full two-port calibrations: this mode takes twice as long as the chop mode to make these measurements. In addition, the port match changes due to either input A or B being inactive during each sweep, which are in the order of <-55 dB, may affect transmission measurements.

[CHOP A and B] (CHOPAB) measures both inputs A and B during each sweep. Thus, if each channel is measuring a different parameter and both channels are displayed, the chop mode offers the fastest measurement time. This is the preferred measurement mode for full two-port calibrations because both inputs remain active.

The disadvantage of this mode is that in measurements of high rejection devices, such as filters with a low-loss passband (>400 MHz wide), maximum dynamic range may not be achieved.

NOTE: If more dynamic range is desired for a measurement of S21 in either the chop or the alternate mode, a 10 dB attenuator can be connected to input A and another to input R. This improves the crosstalk into input B. The dynamic range of input B is increased, but the usable dynamic range of input A is reduced.

[RETURN] goes back to the correction menu.

Reference Plane Menu

This menu adds electrical delay in seconds to the measurement ports to extend the apparent location of the measurement reference plane to the ends of the cables. This is equivalent to adding a length of perfect air line, and makes it possible to measure the delay response of the device only instead of the device plus the cable.

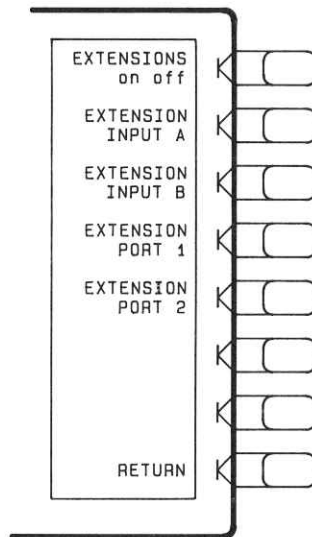

Figure 5-11

[EXTENSIONS on off] (POREon, POREoff) toggles the reference plane extension mode. When this function is on, all extensions defined below are enabled; when off, none of the extensions is enabled.

[EXTENSION INPUT A] (PORTA). Use this feature to add electrical delay in seconds to extend the reference plane at input A to the end of the cable. This is used for any input measurements including S-parameters.

[EXTENSION INPUT B] (PORTB) adds electrical delay to the input B reference plane for any B input measurements including S-parameters.

[EXTENSION PORT 1] (PORT1) extends the reference plane for measurements of S11, S21, and S12.

[EXTENSION PORT 2] (PORT2) extends the reference plane for measurements of S22, S12, and S21.

[RETURN] goes back to the calibrate more menu.

Calibration Menu

The calibration menu is used to select the appropriate accuracy enhancement procedure for calibration before a measurement is performed. Six different calibration routines are available, each of which effectively removes from one to twelve systematic errors from the measurement data. Each calibration procedure features CRT prompts to guide you through the calibration sequence. The available calibrations are described below, and a comparative summary is provided in Table 5-1. Procedures for performing each of the calibrations are provided in the following pages, together with illustrations of the corresponding menus.

Note that all instrument parameters should be established before a calibration procedure is started, including stimulus values, calibration kit, system characteristic impedance Z_0 , and receiver sweep mode. (To modify the characteristic impedance and receiver sweep mode, refer to "Calibrate More Menu".)

NOTE: By convention, when the connector sex is provided in parentheses for a calibration standard, it refers to the sex of the test port connector, not the actual standard. For example, short (m) indicates that the test port connector, not the short circuit connector, is male.

NOTE: The compatible type-N and 3.5 mm calibration kits for the HP 8753A provide open circuits with center conductor extenders. For maximum accuracy in calibration with these devices, follow these steps: First connect the outer conductor by hand and torque wrench. Then insert the center conductor extender into the outer conductor. The fit should be snug but free. Push gently until the center conductors mate.

For measurement of test devices following calibration, refer to the User's Guide.

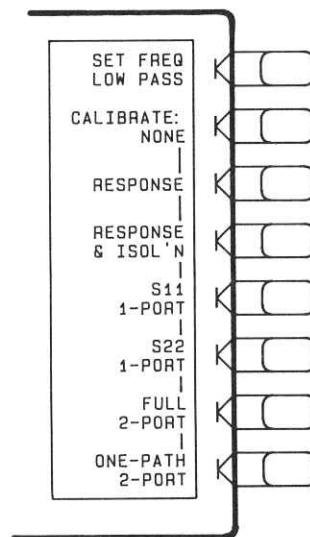

Figure 5-12. Calibration Menu

[SET FREQ LOW PASS] changes the frequency sweep to harmonic intervals to accommodate time domain low-pass operation (option 010). If this mode is to be used, the frequencies must be set before calibration. Refer to chapter 8, Time and Frequency Domain Transforms, for more information.

[CALIBRATE: NONE] is underlined if no calibration has been performed or if the calibration data has been cleared. Unless a calibration is saved in memory, the calibration data is lost on instrument preset, power on, instrument state recall, or if stimulus values are changed.

[RESPONSE] (CALIRESP) leads to the frequency response calibration. This is the simplest and fastest accuracy enhancement procedure, but the least accurate. It effectively removes the frequency response errors of the test setup for reflection or transmission measurements.

For transmission-only measurements or reflection-only measurements, only a single calibration standard is required with this procedure. The standard for transmission measurements is a thru, and for reflection measurements can be either an open or a short. If more than one device is measured, only the data for the last device is retained. The procedures for response calibration for a reflection measurement and a transmission measurement are described in the following pages.

[RESPONSE & ISOL'N] (CALIRAI) leads to the menus used to perform a response and isolation measurement calibration, for measurement of devices with wide dynamic range. This procedure effectively removes the same frequency response errors as the response calibration. In addition, it effectively removes the isolation (crosstalk) error in transmission measurements or the directivity error in reflection measurements. As well as the devices required for a simple response calibration, an isolation standard is required. The standard normally used to correct for isolation is an impedance-matched load (usually 50 or 75 ohms). Response and directivity calibration procedures for reflection and transmission measurements are provided in the following pages.

[S11 1-PORT] (CALIS111) provides a measurement calibration for reflection-only measurements of one-port devices or properly terminated two-port devices, at port 1 of an S-parameter test set or the test port of a transmission/reflection test set. This procedure effectively removes the directivity, source match, and frequency response errors of the test setup, and provides a higher level of measurement accuracy than the response and isolation calibration. It is the most accurate calibration procedure for reflection-only measurements. Three standard devices are required: a short, an open, and an impedance-matched load. The procedure for performing an S11 one-port calibration is described in the following pages.

[S22 1-PORT] (CALIS221) is similar to **[S11 1-PORT]**. It is used for reflection-only measurements of one-port devices or properly terminated two-port devices in the reverse direction: that is, for devices connected to port 2 of the S-parameter test set.

[FULL 2-PORT] (CALIFUL2) leads to the series of menus used to perform a complete calibration for measurement of all four S-parameters of a two-port device. This is the most accurate calibration for measurements of two-port devices. It effectively removes all correctable systematic errors (directivity, source match, load match, isolation, reflection tracking, and transmission tracking) in both the forward and the reverse direction. Isolation correction can be omitted for measurements of devices with limited dynamic range.

The standards for this procedure are a short, an open, a thru, and an impedance-matched load (two loads if isolation correction is required). An S-parameter test set is required. The procedure is described in the following pages.

[ONE-PATH 2-PORT] (CALIONE2) leads to the series of menus used to perform a high-accuracy two-port calibration without an S-parameter test set. This calibration procedure effectively removes directivity, source match, load match, isolation, reflection tracking, and transmission tracking errors in one direction only. Isolation correction can be omitted for measurements of devices with limited dynamic range. (The device under test must be manually reversed between sweeps to accomplish measurement of both input and output responses.) The required standards are a short, an open, a thru, and an impedance-matched load. The procedure for performing a one-path 2-port calibration is described in the following pages.

Table 5-1. Purpose and Use of Different Calibration Procedures

Calibration Procedure	Corresponding Measurement	Errors Removed	Standard Devices
Response	Transmission or reflection measurement when the highest accuracy is not required.	Freq. response	Thru for trans., open OR short for reflection
Response & isolation	Transmission of high insertion loss devices or reflection of high return loss devices. Not as accurate as 1-port or 2-port calibration.	Freq. response PLUS isolation in transmission or directivity in reflection	Same as response PLUS isolation std (load)
S11 1-port	Reflection of any one-port device or well terminated two-port device.	Directivity, source match, freq. response.	Short AND open AND load
S22 1-port	Reflection of any one-port device or well terminated two-port device.	Directivity, source match, freq. response.	Short AND open AND load
Full 2-port	Transmission or reflection of highest accuracy for two-port devices. HP 85046A/B S-parameter test set required.	Directivity, source match, load match, isolation, freq. response, forward and reverse.	Short AND open AND load AND thru (2 loads for isolation)
One-path 2-port	Transmission or reflection of highest accuracy for two-port devices. (Reverse test device between forward and reverse measurements.)	Directivity, source match, load match, isolation, freq. response, forward direction only.	Short AND open AND load AND thru

Response Calibration for Reflection Measurements

The procedure described here uses the menu illustrated in Figure 5-13 to perform a frequency response only calibration with an S-parameter test set for a measurement of S11. It can also be used for S22 by substituting the corresponding softkey in the S-parameters menu.

A similar procedure can be performed with a transmission/reflection test set, using the input ports menu instead of the S-parameters menu (described in chapter 4, Response Function Block).

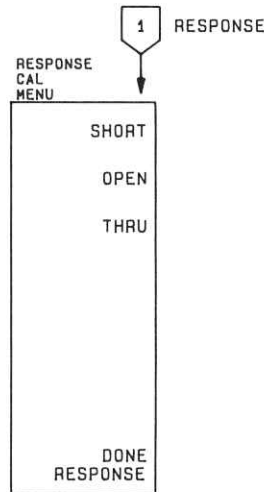

Figure 5-13

- Press **[MEAS] [Ref: FWD S11 A/R]**.
- Press **[CAL]**.
- Select the proper calibration kit. If the connector type or cal kit name shown in the **[CAL KIT]** softkey label is not the same as the calibration kit to be used, refer to "Select Cal Kit Menu."
- Press **[CALIBRATE MENU] [RESPONSE]**.
- At port 1, connect either a short OR a shielded open circuit.
- When the trace settles, press **[SHORT]** or **[OPEN]**, depending on the standard used. (If more than one device is measured, only the data for the last device is retained.)
- The message "WAIT--MEASURING CAL STANDARD" is displayed while the data is measured. The softkey label **[SHORT]** or **[OPEN]** is then underlined.
- Press **[DONE: RESPONSE]**. The error coefficients are computed and stored. The correction menu is displayed with **[CORRECTION ON]**. A corrected trace is displayed.
- This completes the response calibration for a reflection measurement. Now the test device can be connected and measured.

It is recommended that calibration data be saved, either in internal volatile memory or on an external disc. Refer to chapter 10, Saving Instrument States.

Response Calibration for Transmission Measurements

The procedure described here uses the menu in Figure 5-13 to perform a frequency response only calibration with an S-parameter test set for a measurement of S21. To calibrate for a combined transmission and reflection measurement, perform the transmission calibration on one channel and the reflection calibration described above on the other channel.

A similar procedure can be performed with a transmission/reflection test set, using the input ports menu instead of the S-parameters menu (see chapter 4, Response Function Block).

- Press **[MEAS] [Trans: FWD S21 B/R]**.
- Press **[CAL]**.
- Select the proper calibration kit. If the connector type or cal kit name shown in the **[CAL KIT]** softkey label is not the same as the calibration kit to be used, refer to "Select Cal Kit Menu."
- Press **[CALIBRATE MENU] [RESPONSE]**.
- Make a thru connection (connect together the points at which the test device will be connected).
- When the trace settles, press **[THRU]**.
- The message "WAIT--MEASURING CAL STANDARD" is displayed while the S21 data is measured. The softkey label **[THRU]** is then underlined.
- Press **[DONE: RESPONSE]**. The error coefficients are computed and stored. The correction menu is displayed with **[CORRECTION ON]**. Corrected S21 data is displayed.

- This completes the response calibration for a transmission measurement. Now the test device can be connected and measured.

It is recommended that calibration data be saved, either in internal volatile memory or on an external disc. Refer to chapter 10, Saving Instrument States.

Response and Isolation Calibration For Reflection Measurements

The procedure described here effectively removes the frequency response and directivity errors for reflection measurements. The menus illustrated in Figure 5-14 are used to perform a calibration with an S-parameter test set for a measurement of S11. The same calibration can be used for S22 by substituting the corresponding softkey in the S-parameters menu.

A similar procedure can be performed with a transmission/reflection test set, using the input ports menu instead of the S-parameters menu (described in chapter 4, Response Function Block).

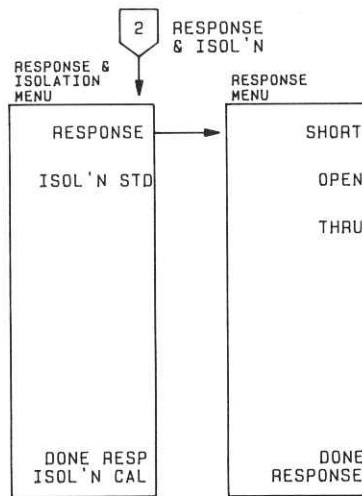

Figure 5-14

- Press **[MEAS]** [Ref: FWD S11 A/R].
- Press **[CAL]**.
- Select the proper calibration kit. If the connector type or cal kit name shown in the **[CAL KIT]** softkey label is not the same as the calibration kit to be used, refer to "Select Cal Kit Menu."
- Press **[CALIBRATE MENU]** **[RESPONSE & ISOL 'N]** **[RESPONSE]**.
- At port 1, connect either a short OR a shielded open circuit.
- When the trace settles, press **[SHORT]** or **[OPEN]**, depending on the standard used. (If more than one standard is measured, only the data for the last device is retained.)
- The message "WAIT--MEASURING CAL STANDARD" is displayed while the response data is measured. The softkey label **[SHORT]** or **[OPEN]** is then underlined.
- Press **[DONE: RESPONSE]**. The error coefficients are computed and stored. The response and isolation menu is displayed.
- Connect the isolation standard to port 1. This is an impedance-matched load (usually 50 or 75 ohms).
- Press **[ISOL 'N STD]**. The S11 isolation data is measured. The softkey label is underlined.
- Press **[DONE RESP ISOL 'N CAL]**. The directivity error coefficients are computed and stored. The correction menu is displayed with **[CORRECTION ON]**. A corrected trace is displayed.

- This completes the response and isolation calibration for correction of frequency response and directivity errors for reflection measurements. Now the test device can be connected and measured.

It is recommended that calibration data be saved, either in internal volatile memory or on an external disc. Refer to chapter 10, Saving Instrument States.

Response and Isolation Calibration for Transmission Measurements

The procedure described here effectively removes the frequency response and isolation errors for transmission measurements of devices with wide dynamic range, using the menus illustrated in Figure 5-14. To calibrate for a combined transmission and reflection measurement, perform the transmission calibration on one channel and the reflection calibration described above on the other channel.

This procedure uses an S-parameter test set. A similar procedure can be performed with a transmission/reflection test set, using the input ports menu instead of the S-parameters menu (see chapter 4, Response Function Block).

- Press **[MEAS] [Trans: FWD S21 B/R]**.
- Press **[CAL]**.
- Select the proper calibration kit. If the connector type or cal kit name shown in the **[CAL KIT]** softkey label is not the same as the calibration kit to be used, refer to "Select Cal Kit Menu."
- Press **[CALIBRATE MENU] [RESPONSE & ISOL'N] [RESPONSE]**.
- Make a thru connection between port 1 and port 2 (connect together the points at which the test device will be connected).
- When the trace has settled, press **[THRU]**. S21 response data is measured. The softkey label **[THRU]** is underlined.
- Press **[DONE: RESPONSE]**.
- Connect impedance-matched loads to port 1 and port 2. Press **[ISOL'N STD]**. The trace is averaged and the S21 isolation is measured. The softkey label is underlined.
- Press **[DONE RESP ISOL'N CAL]**. The S21 error coefficients are computed and stored. The correction menu is displayed with **[CORRECTION ON]**. Corrected S21 data is displayed and the notation "Cor" at the left of the screen indicates that correction is on for this channel.

A similar procedure is used to calibrate for measurement of S12, using the **[Trans: REV S12 B/R]** softkey in the S-parameters menu.

It is recommended that calibration data be saved, either in internal volatile memory or on an external disc. Refer to chapter 10, Saving Instrument States.

S11 1-Port Calibration for Reflection Measurements

This procedure uses the S11 1-port menu illustrated in Figure 5-15 to perform a complete vector error correction for reflection measurements of one-port devices or properly terminated two-port devices. This is a high-accuracy calibration that effectively removes the directivity, source match, and frequency response errors from the measured data. The calibration described here uses an S-parameter test set: a similar procedure can be performed with a transmission/reflection test set, using the input ports menu instead of the S-parameters menu (described in chapter 4, Response Function Block).

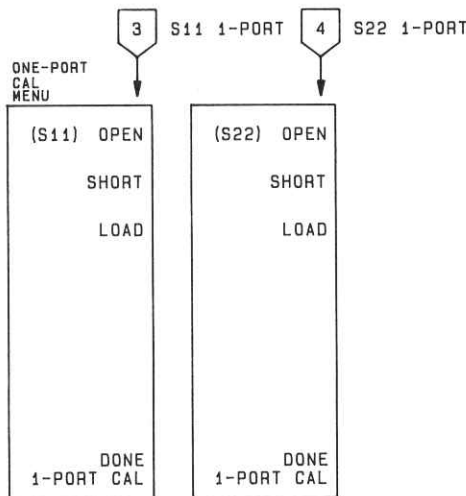

Figure 5-15

- Press **[CAL]**.
- Select the proper calibration kit. If the connector type or cal kit name shown in the **[CAL KIT]** softkey label is not the same as the calibration kit to be used, refer to "Select Cal Kit Menu."
- Press **[CALIBRATE MENU] [S11 1-PORT]**.
- Connect a shielded open circuit to port 1.
- When the trace settles, press (S11) **[OPEN]**.
- The message "WAIT--MEASURING CAL STANDARD" is displayed while the open circuit data is measured. The softkey label **[OPEN]** is then underlined.
- Disconnect the open, and connect a short circuit to port 1.
- When the trace settles, press **[SHORT]**. The short circuit data is measured and the softkey label is underlined.
- Disconnect the short, and connect an impedance-matched load (usually 50 or 75 ohms) at port 1.
- When the trace settles, press **[LOAD]**. The load data is measured and the softkey label is underlined.
- Press **[DONE 1-PORT CAL]**. (If you press **[DONE]** without measuring all the required standards, the message "CAUTION: ADDITIONAL STANDARDS NEEDED" will be displayed.) The error coefficients are computed, and the correction menu is returned to the screen with **[CORRECTION ON]**. A corrected S11 trace is displayed, and the notation "Cor" appears at the left side of the screen.
- This completes the S11 1-port calibration. The test device can now be connected and measured.

It is recommended that calibration data be saved, either in internal volatile memory or on an external disc. Refer to chapter 10, Saving Instrument States.

S22 1-Port Calibration

This procedure performs a complete vector error correction for a reverse reflection measurement of a one-port device or a properly terminated two-port device. It is similar to the S11 1-port calibration except that S22 is selected automatically.

This calibration is used only with an S-parameter test set. For S-parameter measurements in the reverse direction with a transmission/reflection test set use the S11 1-port or one-path 2-port calibration and reverse the device under test between measurement sweeps.

Full 2-Port Calibration for Reflection and Transmission Measurements

This procedure uses the menu sequence illustrated in Figure 5-16 to perform complete vector error correction for measurement of all four S-parameters. This is the most accurate calibration for measurements of two-port devices, and effectively removes all correctable systematic errors in both the forward and reverse directions.

An S-parameter test set is required for this calibration. The procedure automatically switches the test set to select the appropriate S-parameter at each step. A similar two-port procedure can be performed with a transmission/reflection test set using the one-path 2-port calibration.

For protection of the mechanical transfer switch in the HP 85046A/B S-parameter test set, switching occurs only once in a measurement sequence using full two-port error correction. On the first sweep all four S-parameters are measured. On subsequent sweeps, the assumption is made that the reverse parameters have not changed, and only the forward parameters are measured. It is possible to override this protection feature for applications where extreme accuracy is required or in cases where the data changes significantly. To perform an override, use **[MEASURE RESTART]** in the stimulus menu, or for repeated update of all four S-parameters set an appropriate number of groups using the trigger menu. These menus are described in chapter 3.

Isolation calibration can be omitted for most measurements, except where wide dynamic range is a consideration. Refer to the explanation under "[CAL] Key."

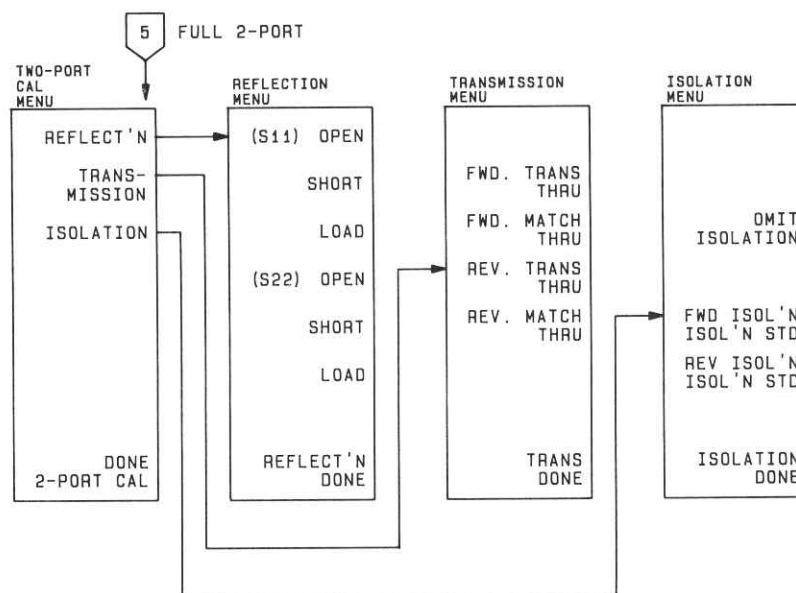

Figure 5-16

- Press **[CAL]**.
- Select the proper calibration kit. If the connector type or cal kit name shown in the **[CAL KIT]** softkey label is not the same as the calibration kit to be used, refer to "Select Cal Kit Menu."
- Press **[CALIBRATE MENU] [FULL 2-PORT] [REFLECT'N]**.
- Connect a shielded open circuit to port 1.
- When the trace settles, press (S11) **[OPEN]**. The open circuit data is measured, and the softkey label **[OPEN]** is underlined.
- Disconnect the open, and connect a short circuit to port 1.
- When the trace settles, press (S11) **[SHORT]**. The short circuit data is measured and the softkey label **[SHORT]** is underlined.
- Disconnect the short, and connect an impedance-matched load (usually 50 or 75 ohms) at port 1.
- When the trace settles, press (S11) **[LOAD]**. The load data is measured, and the softkey label **[LOAD]** is underlined.

- Repeat the open-short-load measurements described above, connecting the devices in turn to port 2 and using the (S22) softkeys.
- Press **[REFLECT'N DONE]**. (If you press **[DONE]** without measuring all the required standards, the message "CAUTION: ADDITIONAL STANDARDS NEEDED" will be displayed.)
- The reflection calibration coefficients are computed and stored. The two-port cal menu is displayed, with the **[REFLECT'N]** softkey underlined.

- Press **[TRANSMISSION]**.
- Make a thru connection between port 1 and port 2 (connect together the points at which the test device will be connected).
- When the trace settles, press **[FWD. TRANS. THRU]**. S21 frequency response is measured, and the softkey is underlined.
- Press **[FWD. MATCH THRU]**. S11 load match is measured, and the softkey is underlined.
- Press **[REV. TRANS. THRU]**. S12 frequency response is measured, and the softkey is underlined.
- Press **[REV. MATCH THRU]**. S22 load match is measured, and the softkey is underlined.
- Press **[TRANS. DONE]**. The transmission coefficients are computed and stored. The two-port cal menu is displayed, with the **[TRANSMISSION]** softkey underlined.

- If correction for isolation is not required, press **[ISOLATION] [OMIT ISOLATION] [ISOLATION DONE]**.
- If correction for isolation is required, connect impedance-matched loads to port 1 and port 2.
- Press **[FWD ISOL'N ISOL'N STD]**. The trace is averaged and the S21 isolation is measured. The softkey label is underlined.
- Press **[REV ISOL'N ISOL'N STD]**. The trace is averaged and the S12 isolation is measured. The softkey label is underlined.
- Press **[ISOLATION DONE]**. The isolation error coefficients are stored. The two-port cal menu is displayed, with the **[ISOLATION]** softkey underlined.

- Press **[DONE 2-PORT CAL]**. The error coefficients are computed and stored. The correction menu is displayed with **[CORRECTION ON]**. A corrected trace is displayed, and the notation "C2" at the left of the screen indicates that two-port error correction is on.

- This completes the full two-port calibration procedure. Now the test device can be connected and measured.

It is recommended that calibration data be saved, either in internal volatile memory or on an external disc. Refer to chapter 10, Saving Instrument States.

One-Path 2-Port Calibration for Reflection and Transmission Measurements

This procedure performs a two-port calibration without an S-parameter test set, using the series of menus illustrated in Figure 5-17. This is a highly accurate calibration for measurements of two-port devices, and effectively removes all correctable systematic errors in one direction only.

Isolation calibration can be omitted for most measurements, except where wide dynamic range is a consideration. Refer to the explanation under “[CAL] Key.”

For measurements of all four S-parameters, the device under test must be reversed between sweeps. The HP 8753A compatible calibration kits contain sets of phase-matched adapters that can be interchanged for measurements of non-insertable, non-reversible devices.

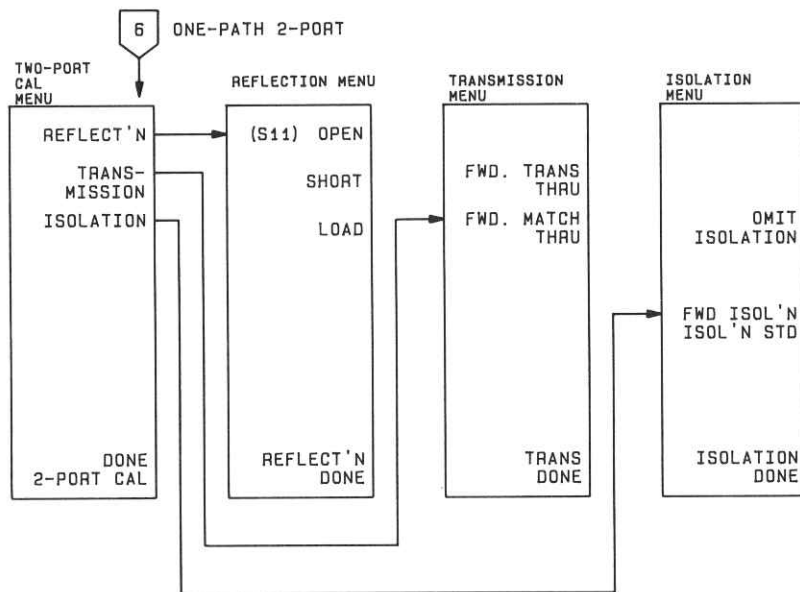

Figure 5-17

- Press [CAL].
- Select the proper calibration kit. If the connector type or cal kit name shown in the [CAL KIT] softkey label is not the same as the calibration kit to be used, refer to “Select Cal Kit Menu.”
- Press [CALIBRATE MENU] [ONE-PATH 2-PORT] [REFLECT’N].
- Connect a shielded open circuit to the test port.
- When the trace settles, press (S11) [OPEN]. The open circuit data is measured, and the softkey label [OPEN] is underlined.
- Disconnect the open, and connect a short circuit to the test port.
- When the trace settles, press [SHORT]. The short circuit data is measured and the softkey label [SHORT] is underlined.
- Disconnect the short, and connect an impedance-matched load (50 or 75 ohms) to the test port.

- When the trace settles, press [**LOAD**]. The load data is measured, and the softkey label [**LOAD**] is underlined.
- Press [**REFLECT'N DONE**]. (If you press [**DONE**] without measuring all the required standards, the message "CAUTION: ADDITIONAL STANDARDS NEEDED" will be displayed.)
- The reflection calibration coefficients are computed and stored. The two-port cal menu is displayed, with the [**REFLECT'N**] softkey underlined.
- Make a thru connection between the test port and the return cable to the network analyzer (connect together the points at which the test device will be connected). Press [**TRANSMISSION**].
- When the trace settles, press [**FWD. TRANS. THRU**]. S21 frequency response is measured, and the softkey is underlined.
- Press [**FWD. MATCH THRU**]. S11 load match is measured, and the softkey is underlined.
- Press [**TRANS. DONE**]. The transmission coefficients are computed and stored. The two-port cal menu is displayed, with the [**TRANSMISSION**] softkey underlined.
- If correction for isolation is not required, press [**ISOLATION**] [**OMIT ISOLATION**] [**ISOLATION DONE**].
- If correction for isolation is required, connect impedance-matched loads to the test port and the return port.
- Press [**FWD ISOL'N ISOL'N STD**]. The trace is averaged and the S21 isolation is measured. The softkey label is underlined.
- Press [**ISOLATION DONE**]. The isolation error coefficients are stored. The two-port cal menu is displayed, with the [**ISOLATION**] softkey underlined.
- Press [**DONE 2-PORT CAL**]. The error coefficients are computed and stored. The correction menu is displayed with [**CORRECTION ON**]. A corrected trace is displayed, and the notation "C2" at the left of the screen indicates that correction is on.
- This completes the one-path 2-port calibration procedure. Now the test device can be connected and measured in the forward direction. When forward measurement is complete, disconnect the test device and manually reverse it, then press the softkey [**PRESS to CONTINUE**], or trigger another sweep using the trigger menu (chapter 3).

It is recommended that calibration data be saved, either in internal volatile memory or on an external disc. Refer to chapter 10, Saving Instrument States.

MODIFYING CALIBRATION KITS

For most applications, use the default cal kit models provided in the select cal kit menu described earlier in this chapter. Modifying calibration kits is necessary only if unusual standards are used or the very highest accuracy is required. Unless a cal kit model is provided with the calibration devices used, a solid understanding of error correction and the system error model are absolutely essential to making modifications. Read the introductory part of this chapter for more information, and refer to the Appendix to Chapter 5 and to "System Performance" in the General Information and Specifications section. Additional information on user-modified cal kits is available in Product Note 8510-5 (HP Part No. 5954-1559).

During measurement calibration, the HP 8753A measures actual, well-defined standards and mathematically compares the results with ideal "models" of those standards. The differences are separated into error terms which are later removed during error correction. Most of the differences are due to systematic errors – repeatable errors introduced by the network analyzer, test set, and cables – which are correctable. However, differences between the model for a standard and the actual performance of the standard reduce the system's ability to remove systematic errors, and thus degrade error-corrected accuracy. Therefore, in addition to the predefined default cal kit models, a "user kit" is provided that can be modified to an alternate calibration standards model.

Several situations exist that may require a user-defined cal kit:

- A calibration is required for a connector interface different from the four built-in cal kits. (Examples: SMA, TNC, or waveguide.)
- A calibration with standards (or combinations of standards) that are different from the predefined cal kits is required. (Example: Using three offset shorts instead of open, short, and load to perform a 1-port calibration.)
- The built-in standard models for predefined kits can be improved or refined. Remember that the more closely the model describes the actual performance of the standard, the better the calibration. (Example: The 7 mm load is determined to be 50.4 ohms instead of 50.0 ohms.)
- Unused standards for a given cal type can be eliminated from the predefined set, to eliminate possible confusion during calibration. (Example: A certain application requires calibrating a male test port. The standards used to calibrate a female test port can be eliminated from the set, and will not be displayed during calibration.)

Definitions

It is necessary to define some of the terms used:

- A "standard" is a specific, well-defined, physical device used to determine systematic errors.
- A standard "type" is one of five basic types that define the form or structure of the model to be used with that standard (e.g. short or load).
- Standard "coefficients" are numerical characteristics of the standards used in the model selected.
- A standard "class" is a grouping of one or more standards that determines which standards are used in a particular calibration procedure.

Procedure

Basically, the following steps are used to modify or define a user kit:

1. To modify a cal kit, first select the predefined kit to be modified. This is not necessary for defining a new cal kit.
2. Define the standards. For each standard, define which "type" of standard it is and its electrical characteristics.
3. Specify the class where the standard is to be assigned.
4. Store the modified cal kit.

For your convenience, blank tables are provided to help organize the standard definitions and standard class assignments of a user-defined cal kit.

Table 5-2. Standard Definitions Table

STANDARD		C0 x10 ⁻¹⁵ F	C1 x10 ⁻²⁷ F/Hz	C2 x10 ⁻³⁶ F/Hz	C3 x10 ⁻⁴⁵ F/Hz	FIXED OR SLIDING	OFFSET			FREQUENCY (GHz)		COAX or WAVEGUIDE	STANDARD LABEL
NO.	TYPE						DELAY ps	LOSS MΩ/s	Z ₀ Ω	MINIMUM	MAXIMUM		
1													
2													
3													
4													
5													
6													
7													
8													

Table 5-3. Standard Class Assignments Table

	A	B	C	D	E	F	G	STANDARD CLASS LABEL
S ₁₁ A								
S ₁₁ B								
S ₁₁ C								
S ₂₂ A								
S ₂₂ B								
S ₂₂ C								
Forward Transmission								
Reverse Transmission								
Forward Match								
Reverse Match								
Response								
Response & Isolation								

Modify Cal Kit Menu

This menu is accessed from the **[CAL]** key (refer to Figure 5-7). This leads in turn to additional series of menus associated with modifying cal kits.

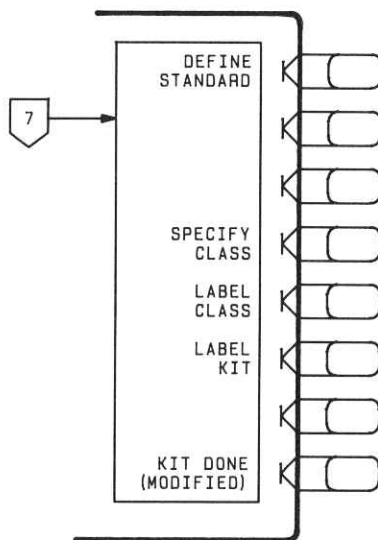

Figure 5-18. Modify Cal Kit Menu

[DEFINE STANDARD] (DEFS) brings up the define standard menus, and allows modification of the standard number. The standard number (1 to 8) is an arbitrary reference number used to reference standards while specifying a class.

[SPECIFY CLASS] leads to the specify class menu. After the standards are modified, use this key to specify a class to consist of certain standards.

[LABEL CLASS] leads to the label class menu, to give the class a meaningful label for future reference.

[LABEL KIT] (LABEK) leads to a menu for constructing a label for the user-modified cal kit. If a label is supplied, it will appear as one of the five softkey choices in the select cal kit menu. The approach is similar to defining a display title, except that the kit label is limited to ten characters. Refer to "**[DISPLAY]** Key, Title Menu" in chapter 4 for details.

[KIT DONE] (KITD) terminates the cal kit modification process, after all standards are defined and all classes are specified. Be sure to save the kit with the **[SAVE USER KIT]** softkey, if it is to be used later.

Define Standard Menus

These menus, illustrated in Figure 5-19, are used to define the model type and model coefficients (characteristics) for each user-modified standard.

Each standard must be identified as one of five "types": open, short, load, delay/thru, or arbitrary impedance.

After a standard number is entered, selection of the standard type will present one of five menus for entering the electrical characteristics (model coefficients) corresponding to that standard type. These menus are tailored to the current type, so that only characteristics applicable to the standard type can be modified.

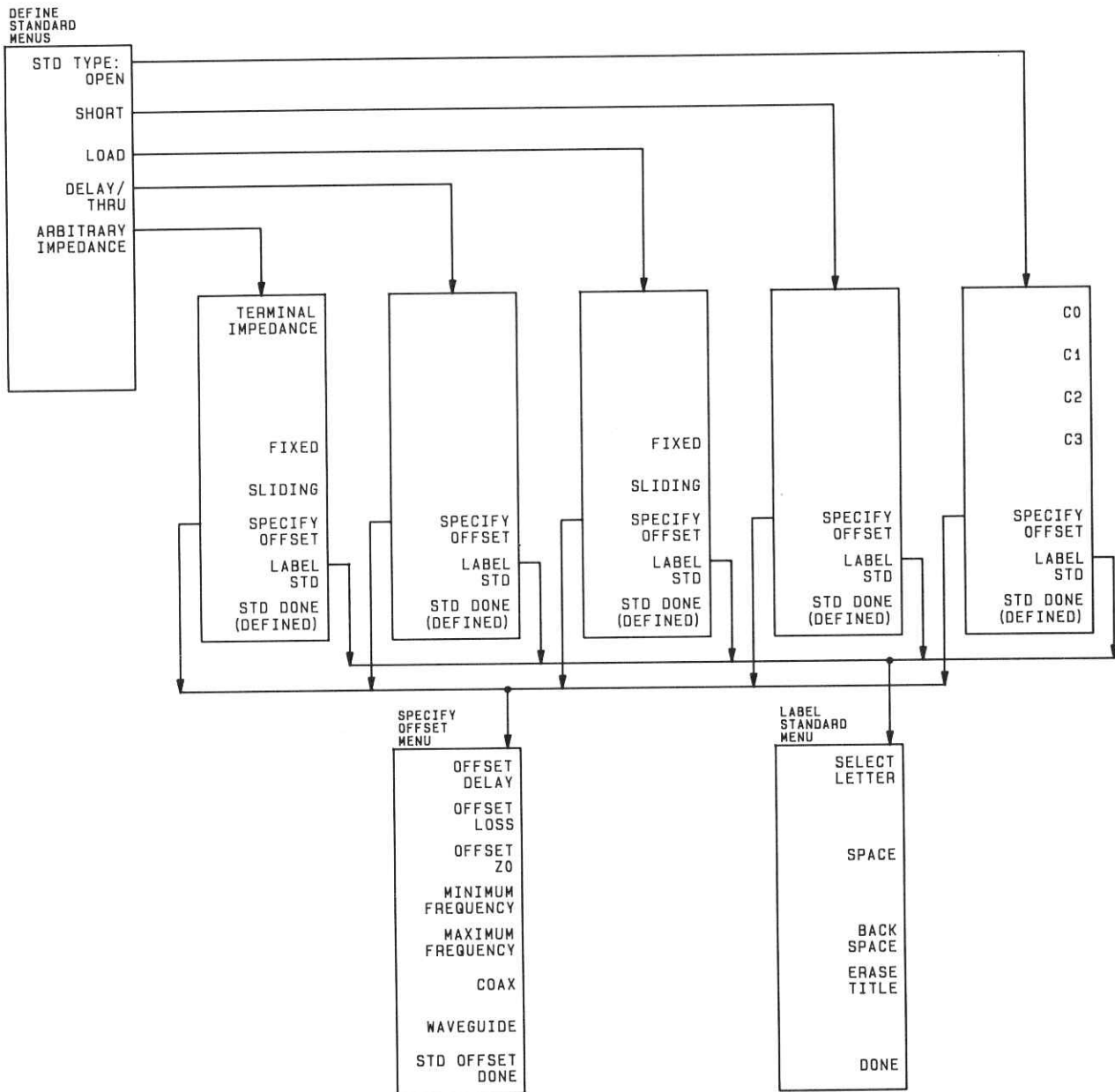

Figure 5-19. Define Standard Menus

Any standard type can be further defined with offsets in delay, loss, and standard impedance; assigned minimum or maximum frequencies over which the standard applies; and defined as coax or waveguide. Press the **[SPECIFY OFFSET]** key, and refer to the specify offset menu.

A distinct label can be defined and assigned to each standard, so that the HP 8753A can prompt the user with explicit standard labels during calibration (e.g. "SHORT"). Press the **[LABEL STD]** key. The function is similar to defining a display title, except that the label is limited to ten characters. Refer to "**[DISPLAY] Key, Title Menu**" in Chapter 4 for details.

After each standard is defined, including offsets, press **[STD DONE (DEFINED)]** to terminate the standard definition.

[OPEN] (STDTOPEN) defines the standard type as an open, used for calibrating reflection measurements. Opens are assigned a terminal impedance of infinity ohms, but delay and loss offsets may still be added. Pressing this key also brings up a menu for defining the open, including its capacitance.

Opens rarely have perfect reflection characteristics because the fringing (capacitance) effects cause phase shift that varies with frequency. These effects are impossible to eliminate, but can be included in the model for the open. The capacitance model is a cubic polynomial, as a function of frequency, where the polynomial coefficients are user-definable. The capacitance model equation is:

$$C = (C0) + (C1 * F) + (C2 * F^2) + (C3 * F^3)$$

where F is the measurement frequency.

The terms in the equation are defined with the specify open menu as follows:

[C0] (C0) is used to enter the C0 term, which is the constant term of the cubic polynomial and is scaled by 10^{-15} Farads.

[C1] (C1) is used to enter the C1 term, expressed in F/Hz (Farads/Hz) and scaled by 10^{-27} .

[C2] (C2) is used to enter the C2 term, expressed in F/Hz² and scaled by 10^{-36} .

[C3] (C3) is used to enter the C3 term, expressed in F/Hz³ and scaled by 10^{-45} .

[SHORT] (STDTSHOR) defines the standard type as a short, for calibrating reflection measurements. Shorts are assigned a terminal impedance of 0 ohms, but delay and loss offsets may still be added.

[LOAD] (STDTLOAD) defines the standard type as a load (termination). Loads are assigned a terminal impedance equal to the system characteristic impedance Z0, but delay and loss offsets may still be added. If the load impedance is not Z0, use the arbitrary impedance standard definition.

[FIXED] (FIXE) defines the load as a fixed (not sliding) load.

[SLIDING] (SLIL) defines the load as a sliding load. When such a load is measured during calibration, the HP 8753A will prompt for several load positions, and calculate the ideal load value from it.

[DELAY/THRU] (STDTDELA) defines the standard type as a transmission line of specified length, for calibrating transmission measurements.

[ARBITRARY IMPEDANCE] (STDTARBI) defines the standard type to be a load, but with an arbitrary impedance (different from system Z0).

[TERMINAL IMPEDANCE] (TERI) is used to specify the (arbitrary) impedance of the standard, in ohms.

[FIXED] (FIXE) defines the load as a fixed (not sliding) load.

[SLIDING] (SLIL) defines the load as a sliding load. When such a load is measured during calibration, the HP 8753A will prompt for several load positions, and calculate the ideal load value from it.

Specify Offset Menu

The specify offset menu allows additional specifications for a user-defined standard. Features specified in this menu are common to all five types of standards.

Offsets may be specified with any standard type. This means defining a uniform length of transmission line to exist between the standard being defined and the actual measurement plane. (Example: a waveguide short circuit terminator, offset by a short length of waveguide.) For reflection standards, the offset is assumed to be between the measurement plane and the standard (one-way only). For transmission standards, the offset is assumed to exist between the two reference planes (in effect, the offset *is* the thru). Three characteristics of the offset can be defined: its delay (length), loss, and impedance.

In addition, the frequency range over which a particular standard is valid can be defined with a minimum and maximum frequency. This is particularly important for a waveguide standard, since its behavior changes rapidly beyond its cutoff frequency. Note that several band-limited standards can together be defined as the same "class" (see specify class menu). Then, if a measurement calibration is performed over a frequency range exceeding a single standard, additional standards can be used for each portion of the range.

Lastly, the standard must be defined as either coaxial or waveguide. If it is waveguide, dispersion effects are calculated automatically and included in the standard model.

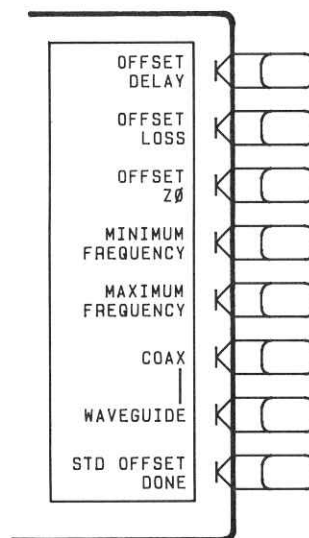

Figure 5-20. Specify Offset Menu

[OFFSET DELAY] (OFSD) is used to specify the one-way electrical delay from the measurement (reference) plane to the standard, in seconds (s). (In a transmission standard, offset delay is the delay from plane to plane.) Delay can be calculated from the precise physical length of the offset, the permittivity constant of the medium, and the speed of light.

In coax, group delay is considered constant. In waveguide, however, group delay is dispersive, that is, it changes significantly as a function of frequency. Hence, for a waveguide standard, offset delay must be defined at an infinitely high frequency.

[OFFSET LOSS] (OFSL) is used to specify energy loss, due to skin effect, along a one-way length of coax offset. The value of loss is entered as ohms/nanosecond (or Gigohms/second) at 1 GHz. (Such losses are negligible in waveguide, so enter 0 as the loss offset.)

[OFFSET Z0] (OFSZ) is used to specify the characteristic impedance of the coax offset. (Note: This is *not* the impedance of the standard itself.) (For waveguide, the offset impedance is always assigned a value equal to the system Z0.)

[MINIMUM FREQUENCY] (MINF) is used to define the lowest frequency at which the standard can be used during measurement calibration. In waveguide, this *must* be the lower cutoff frequency of the standard, so that the HP 8753A can calculate dispersive effects correctly (see "[OFFSET DELAY]" on the last page).

[MAXIMUM FREQUENCY] (MAXF) is used to define the highest frequency at which the standard can be used during measurement calibration. In waveguide, this is normally the upper cutoff frequency of the standard.

[COAX] (COAX) defines the standard (and the offset) as coaxial. This causes the HP 8753A to assume linear phase response in any offsets.

[WAVEGUIDE] (WAVE) defines the standard (and the offset) as rectangular waveguide. This cause the HP 8753A to assume a dispersive delay (see "[OFFSET DELAY]" on the last page).

Label Standard Menu (LABS)

This menu is used to label (reference) individual standards during the menu-driven measurement calibration sequence. The labels are user-definable using a character set displayed on the CRT that includes letters, numbers, and some symbols, and they may be up to ten characters long. The HP 8753A will prompt you to connect standards using these labels, so they should be meaningful to you, and distinct for each standard.

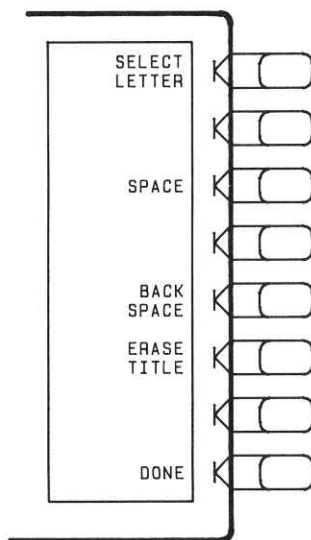

Figure 5-21. Label Standard Menu

Standard labels are created in exactly the same way as titles. Refer to "[DISPLAY] Key, Title Menu" in Chapter 4.

Specify Class Menus

Once a standard is specified, it must be assigned to a standard "class". The class defines where the standard is to be used during calibration. A class often consists of a single standard, but may be composed of more than one standard if band-limited standards are used. (Example: All predefined calibration kits for the HP 8753A have a single reflection standard per class, since all are broadband in nature. However, if there were two load standards – a fixed load for low frequencies, and a sliding load for high frequencies – then that class would have two standards.)

The number of standard classes required depends on the type of calibration being performed, and is identical to the number of error terms corrected. (Examples: A response cal requires only one class, and the standards for that class may include an open and/or short and/or thru. A 1-port cal requires three classes. A full 2-port cal requires 10 classes, not including two for isolation.)

The number of standards that can be assigned to a given class may vary from none (class not used) to one (simplest class) to seven. When a certain class of standards is required during calibration, the HP 8753A will display the labels for *all* the standards in that class (except when the class consists of a single standard). This does not, however, mean that all standards in a class must be measured during calibration. Unless band-limited standards are used, only a single standard per class is required. Note that it is often simpler to keep the number of standards per class to the bare minimum needed (often one) to avoid confusion during calibration.

Standards are assigned to a class simply by entering the standard's reference number (established while defining a standard) under a particular class.

Each class can be given a user-definable label as described under "Label Class Menus."

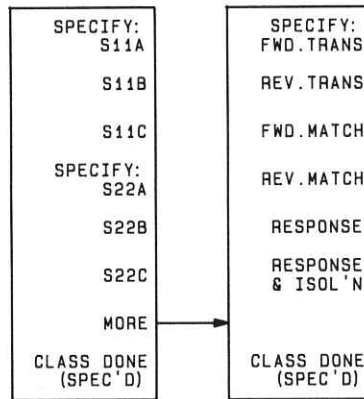

Figure 5-22. Specify Class Menus

[SPECIFY: S11A] (SPECS11A) is used to enter the standard number(s) for the first class required for an S11 1-port calibration. (For predefined cal kits, this is the open.)

[S11B] (SPECS11B) is used to enter the standard number(s) for the second class required for an S11 1-port calibration. (For predefined cal kits, this is the short.)

[S11C] (SPECS11C) is used to enter the standard number(s) for the third class required for an S11 1-port calibration. (For predefined kits, this is the load.)

[SPECIFY: S22A] (SPECS22A) is used to enter the standard number(s) for the first class required for an S22 1-port calibration. (For predefined cal kits, this is the open.)

[S22B] (SPECS22B) is used to enter the standard number(s) for the second class required for an S22 1-port calibration. (For predefined cal kits, this is the short.)

[S22C] (SPECS22C) is used to enter the standard number(s) for the third class required for an S22 1-port calibration. (For predefined kits, this is the load.)

[MORE] leads to the following softkeys.

[FWD.TRANS.] (SPECFWDT) is used to enter the standard number(s) for the forward transmission thru calibration. (For predefined kits, this is the thru.)

[REV.TRANS.] (SPECREVT) is used to enter the standard number(s) for the reverse transmission (thru) calibration. (For predefined kits, this is the thru.)

[FWD.MATCH] (SPECFWDM) is used to enter the standard number(s) for the forward match (thru) calibration. (For predefined kits, this is the thru.)

[REV.MATCH] (SPECREVM) is used to enter the standard number(s) for the reverse match (thru) calibration. (For predefined kits, this is the thru.)

[RESPONSE] (SPECRESP) is used to enter the standard number(s) for a response calibration. This calibration corrects for frequency response in either reflection or transmission measurements, depending on the parameter being measured when a calibration is performed. (For predefined kits, the standard is either the open or short for reflection measurements, or the thru for transmission measurements.)

[RESPONSE & ISOL'N] (SPECRESI) is used to enter the standard number(s) for a response & isolation calibration. This calibration corrects for frequency response and directivity in reflection measurements, or frequency response and isolation in transmission measurements.

Label Class Menus

The label class menus are used to define meaningful labels for the calibration classes. These then become softkey labels during a measurement calibration. Labels can be up to ten characters long.

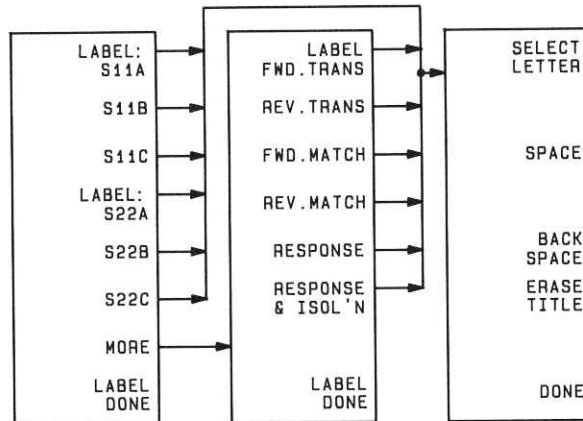

Figure 5-23. Label Class Menus

Labels are created in exactly the same way as display titles. Refer to "[DISPLAY] Key, Title Menu" in Chapter 4.

ACCURACY ENHANCEMENT FUNDAMENTALS—CHARACTERIZING MICROWAVE SYSTEMATIC ERRORS

One-Port Error Model

In a measurement of the reflection coefficient (magnitude and phase) of an unknown device, the measured data differs from the actual, no matter how carefully the measurement is made. Directivity, source match, and reflection signal path frequency response (tracking) are the major sources of error (Figure A5-1).

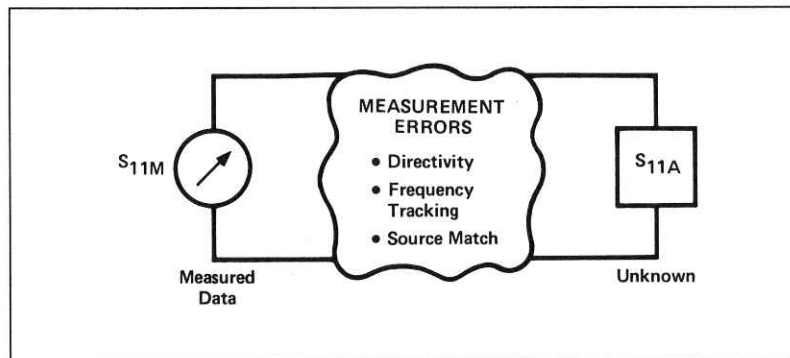

Figure A5-1. Sources of Error in a Reflection Measurement

The reflection coefficient is measured by first separating the incident signal (I) from the reflected signal (R), then taking the ratio of the two values (Figure A5-2). Ideally, (R) consists only of the signal reflected by the test device (S11A).

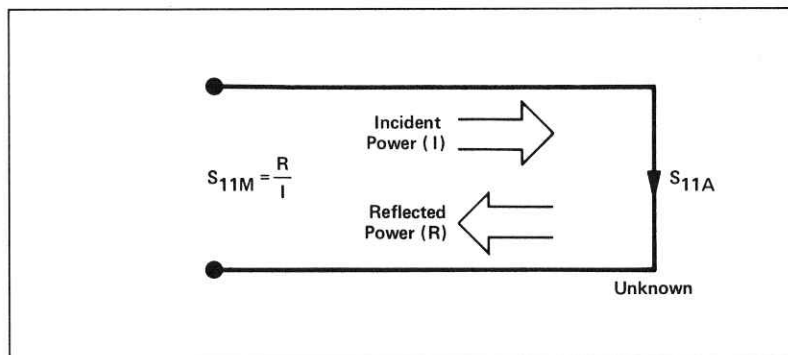

Figure A5-2

However, all of the incident signal does not always reach the unknown (see Figure A5-3). Some of (I) may appear at the measurement system input due to leakage through the test set or other signal separation device. Also, some of (I) may be reflected by imperfect adapters between signal separation and the measurement plane. The vector sum of the leakage and miscellaneous reflections is directivity, EDF. Understandably, the measurement is distorted when the directivity signal combines vectorally with the actual reflected signal from the unknown, S_{11A}.

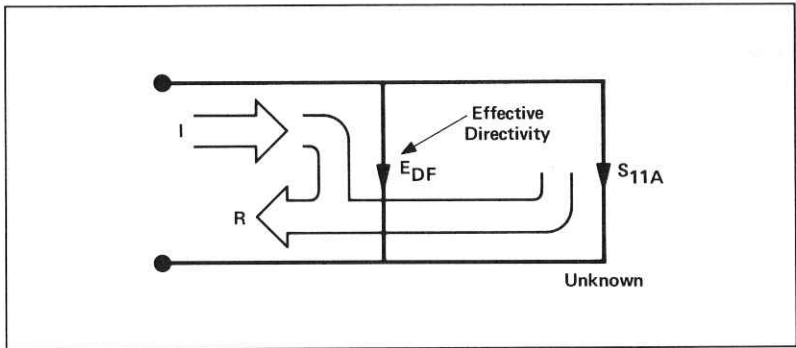

Figure A5-3

Since the measurement system test port is never exactly the characteristic impedance (50 ohms or 75 ohms), some of the reflected signal bounces off the test port, or other impedance transitions further down the line, and back to the unknown, adding to the original incident signal (I). This effect causes the magnitude and phase of the incident signal to vary as a function of S_{11A} and frequency. Leveling the source to produce constant (I) reduces this error, but since the source cannot be exactly leveled at the test device input, leveling cannot eliminate all power variations. This re-reflection effect and the resultant incident power variation are caused by the source match error, ESF (Figure A5-4).

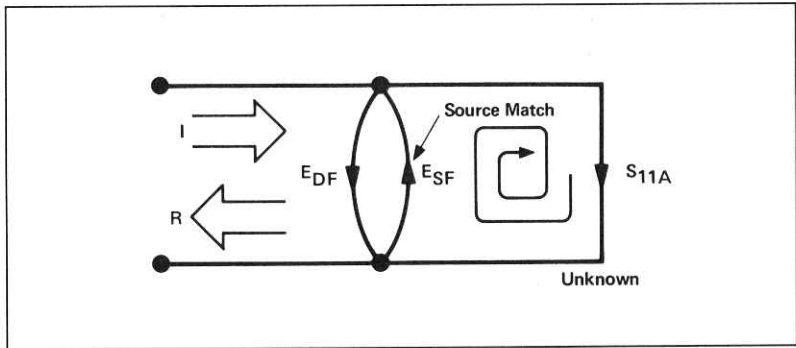

Figure A5-4

Frequency response (tracking) error is caused by variations in magnitude and phase flatness versus frequency between the test and reference signal paths. These are due mainly to imperfectly matched samplers and differences in length and loss between incident and test signal paths. The vector sum of these variations is the reflection signal path tracking error, E_{RF} (Figure A5-5).

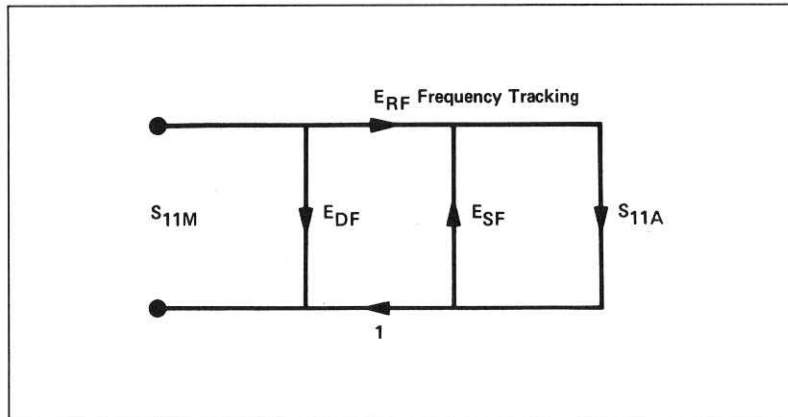

Figure A5-5

It can be shown that these three errors are mathematically related to the actual data, S_{11A}, and measured data, S_{11M}, by the following equation:

$$S_{11M} = E_{DF} + \frac{S_{11A}(E_{RF})}{1 - E_{SF}S_{11A}}$$

If the value of these three “E” errors and the measured test device response were known for each frequency, the above equation could be solved for S_{11A} to obtain the actual test device response. Because each of these errors changes with frequency, it is necessary that their values be known at each test frequency. These values are found by measuring the system at the measurement plane using three independent standards whose S_{11A} is known at all frequencies.

The first standard applied is a "perfect load", which makes $S_{11A} = 0$ and essentially measures directivity (Figure A5-6). "Perfect load" implies a reflectionless termination at the measurement plane. All incident energy is absorbed. With $S_{11A} = 0$ the equation can be solved for EDF, the directivity term. In practice, of course, the "perfect load" is difficult to achieve, although very good broadband loads are available in the HP 8753A compatible calibration kits.

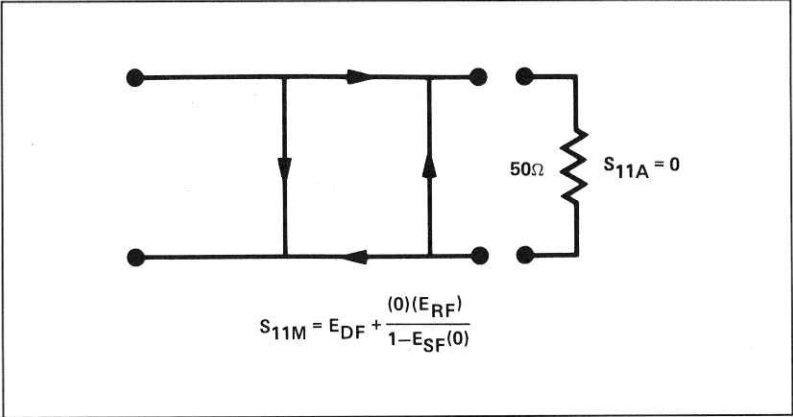

Figure A5-6

Since the measured value for directivity is the vector sum of the actual directivity plus the actual reflection coefficient of the "perfect load," any reflection from the termination represents an error. System effective directivity becomes the actual reflection coefficient of the "perfect load" (Figure A5-7). In general, any termination having a return loss value greater than the uncorrected system directivity reduces reflection measurement uncertainty.

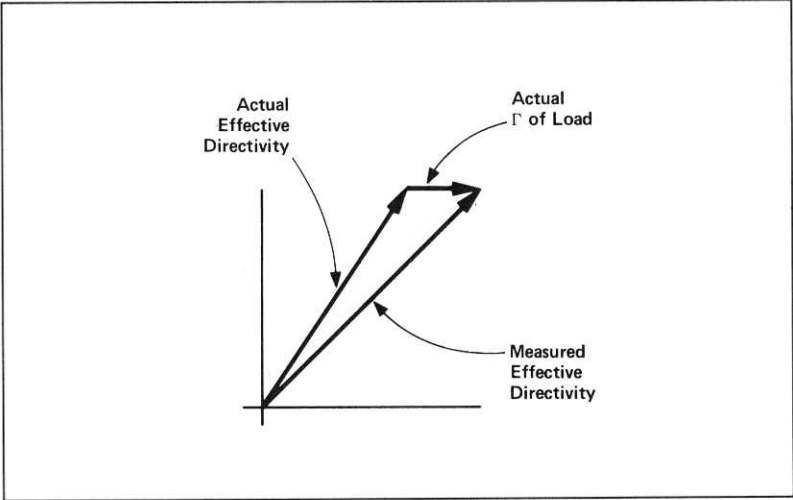

Figure A5-7

Next, a short circuit termination whose response is known to a very high degree is used to establish another condition (Figure A5-8).

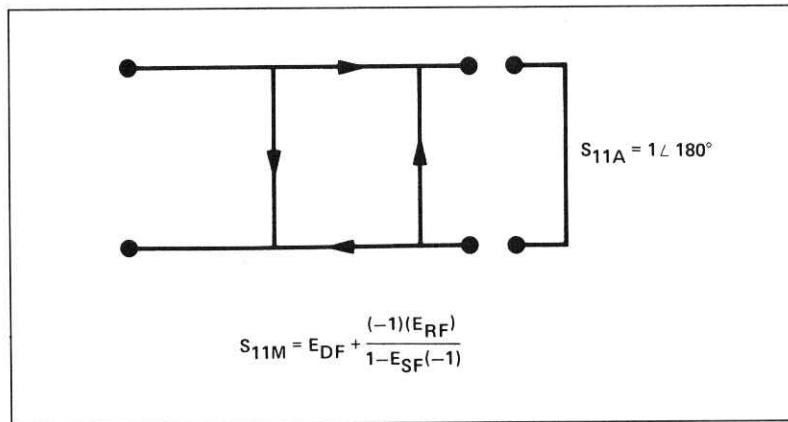

Figure A5-8

The open circuit gives the third independent condition. In order to accurately model the phase variation with frequency due to radiation from the open connector, a specially designed shielded open circuit is used for this step. (The open circuit capacitance is different with each connector type). Now the values for EDF, directivity, ESF, source match, and ERF, reflection frequency response, are computed and stored (Figure A5-9).

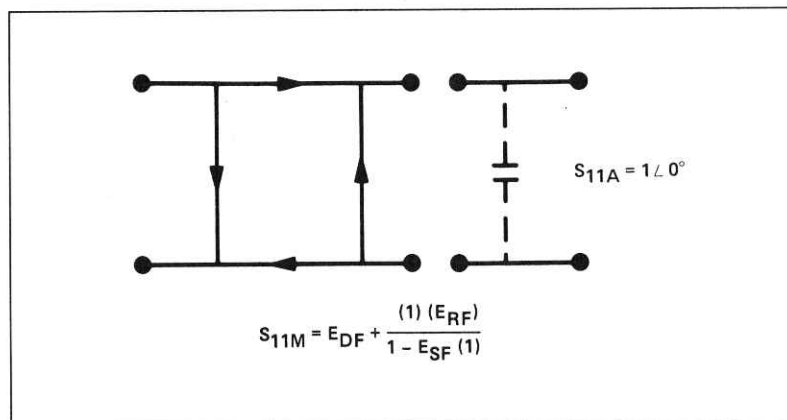

Figure A5-9

Now the unknown is measured to obtain a value for the measured response, S_{11M} , at each frequency (Figure A5-10).

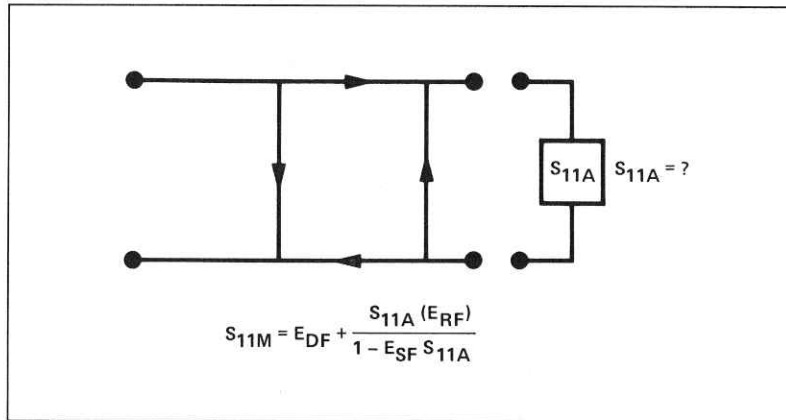

Figure A5-10

This is the one-port error model equation solved for S_{11A} . Since the three errors and S_{11M} are now known for each test frequency, S_{11A} can be computed as follows:

$$S_{11A} = \frac{S_{11M} - E_{DF}}{E_{SF} (S_{11M} - E_{DF}) + E_{RF}}$$

For reflection measurements on two-port devices, the same technique can be applied, but the test device output port must be terminated in the system characteristic impedance. This termination should be at least as good (have as low a reflection coefficient) as the load used to determine directivity. The additional reflection error caused by an improper termination at the test device output port is not incorporated into the one-port error model.

Two-Port Error Model

The error model for measurement of the transmission coefficients (magnitude and phase) of a two-port device is derived in a similar manner. The major sources of error are frequency response (tracking), source match, load match, and isolation (Figure A5-11). These errors are effectively removed using the full two-port error model.

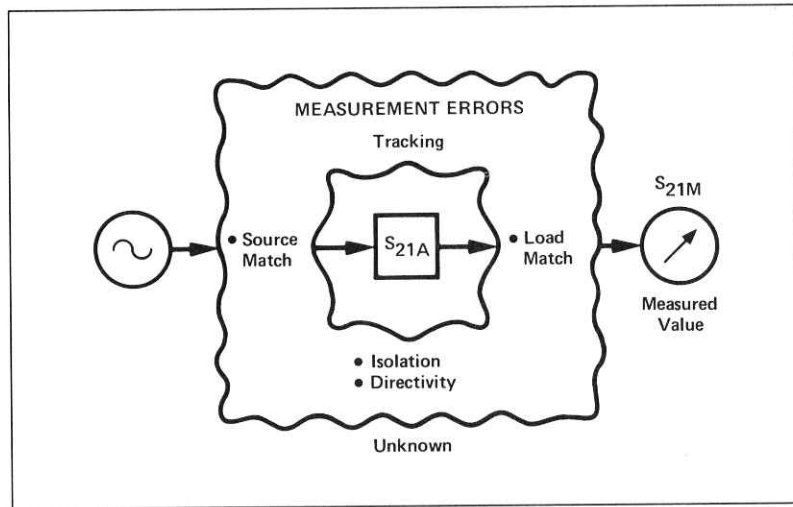

Figure A5-11

The transmission coefficient is measured by taking the ratio of the incident signal (I) and the transmitted signal (T) (Figure A5-12). Ideally, (I) consists only of power delivered by the source, and (T) consists only of power emerging at the test device output.

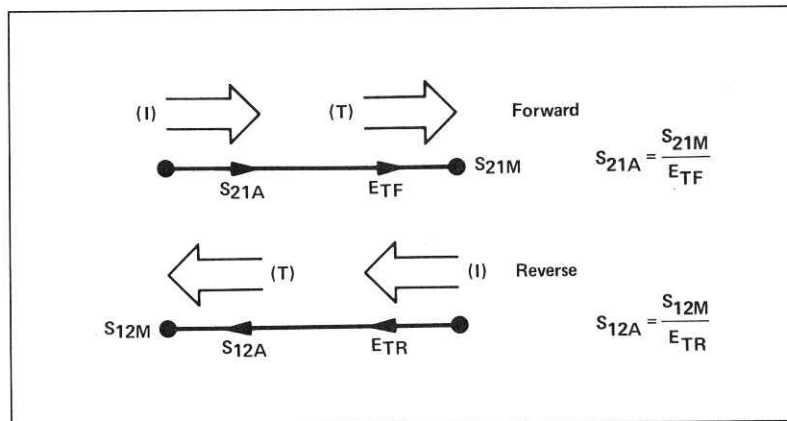

Figure A5-12

As in the reflection model, source match can cause the incident signal to vary as a function of test device S_{11A} . Also, since the test setup transmission return port is never exactly the characteristic impedance, some of the transmitted signal is reflected from the test set port 2, and from other mismatches between the test device output and the receiver input, to return to the test device. A portion of this signal may be re-reflected at port 2, thus affecting S_{21M} , or part may be transmitted through the device in the reverse direction to appear at port 1, thus affecting S_{11M} . This error term, which causes the magnitude and phase of the transmitted signal to vary as a function of S_{22A} , is called load match, ELF (Figure A5-13).

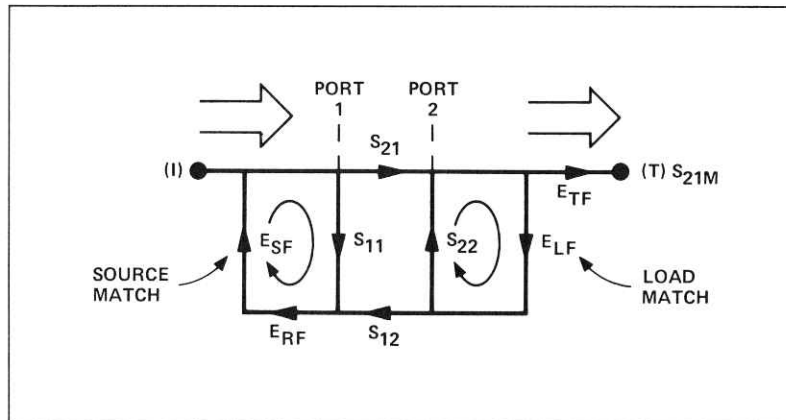

Figure A5-13

The measured value, S_{21M} , consists of signal components that vary as a function of the relationship between E_{SF} and S_{11A} as well as E_{LF} and S_{22A} , so the input and output reflection coefficients of the test device must be measured and stored for use in the S_{21A} error correction computation. Thus, the test setup is calibrated as described above for reflection to establish the directivity, EDF, source match, E_{SF} , and reflection frequency response, E_{RF} , terms for the reflection measurements.

Now that a calibrated port is available for reflection measurements, the thru is connected and load match, E_{LF} , is determined by measuring the reflection coefficient of the thru connection.

Transmission signal path frequency response is then measured with the thru connected. The data is corrected for source and load match effects, then stored as transmission frequency response, E_{TF} .

Isolation, EXF, represents the part of the incident signal that appears at the receiver without actually passing through the test device (Figure A5-14). Isolation is measured with the test set in the transmission configuration and with terminations installed at the points where the test device will be connected.

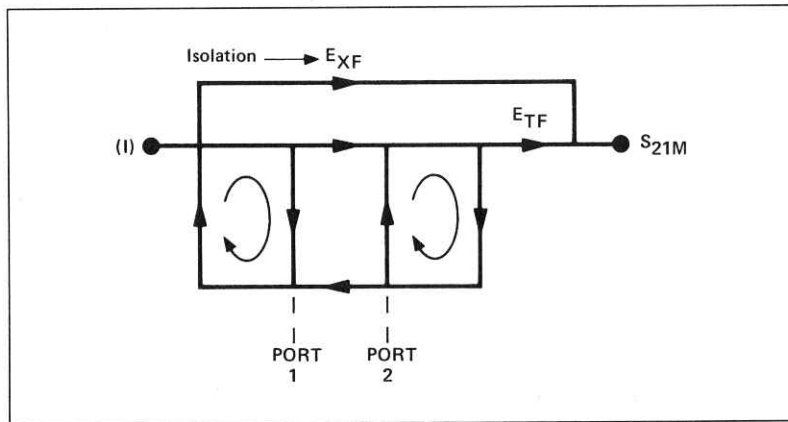

Figure A5-14

Thus there are two sets of error terms, forward and reverse, with each set consisting of six error terms, as follows:

- Directivity, EDF (forward) and EDR (reverse)
- Isolation, EXF and EXR
- Source Match, ESF and ESR
- Load Match, ELF and ELR
- Transmission Tracking, ETF and ETR
- Reflection Tracking, ERF and ERR.

The HP 85046A/B S-parameter test sets can measure both the forward and reverse characteristics of the test device without the need to manually remove and physically reverse it. With these test sets, the full two-port error model illustrated in Figure A5-15 effectively removes both the forward and reverse error terms for transmission and reflection measurements.

The HP 85044A/B transmission/reflection test sets cannot switch between forward and reverse directions, so the reverse error terms cannot be automatically measured. Therefore, with the one-path two-port calibration, the forward error terms are duplicated and used for both forward and reverse measurements by manually reversing the test device.

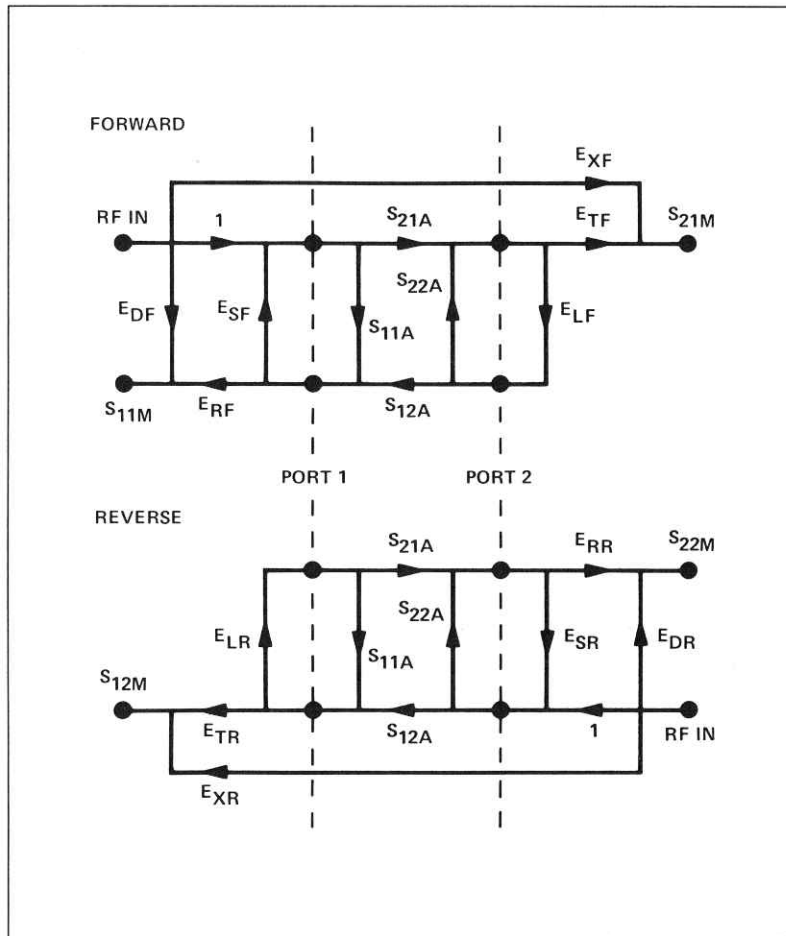

Figure A5-15

Figure A5-16 shows the full two-port error model equations for all four S-parameters of a two-port device. Note that the mathematics for this comprehensive model use all forward and reverse error terms and measured values. Thus, to perform full error correction for any one parameter, all four S-parameters must be measured.

Applications of these error models are provided in the calibration procedures described in chapter 5.

$$S_{11A} = \frac{\left[\left(\frac{S_{11M} - E_{DF}}{E_{RF}} \right) \left[1 + \left(\frac{S_{22M} - E_{DR}}{E_{RR}} \right) E_{SR} \right] \right] - \left[\left(\frac{S_{21M} - E_{XF}}{E_{TF}} \right) \left(\frac{S_{12M} - E_{XR}}{E_{TR}} \right) E_{LF} \right]}{\left[1 + \left(\frac{S_{11M} - E_{DF}}{E_{RF}} \right) E_{SF} \right] \left[1 + \left(\frac{S_{22M} - E_{DR}}{E_{RR}} \right) E_{SR} \right] - \left[\left(\frac{S_{21M} - E_{XF}}{E_{TF}} \right) \left(\frac{S_{12M} - E_{XR}}{E_{TR}} \right) E_{LF} E_{LR} \right]}$$

$$S_{21A} = \frac{\left[1 + \left(\frac{S_{22M} - E_{DR}}{E_{RR}} \right) (E_{SR} - E_{LF}) \right] \left(\frac{S_{21M} - E_{XF}}{E_{TF}} \right)}{\left[1 + \left(\frac{S_{11M} - E_{DF}}{E_{RF}} \right) E_{SF} \right] \left[1 + \left(\frac{S_{22M} - E_{DR}}{E_{RR}} \right) E_{SR} \right] - \left[\left(\frac{S_{21M} - E_{XF}}{E_{TF}} \right) \left(\frac{S_{12M} - E_{XR}}{E_{TR}} \right) E_{LF} E_{LR} \right]}$$

$$S_{12A} = \frac{\left[1 + \left(\frac{S_{11M} - E_{DF}}{E_{RF}} \right) (E_{SF} - E_{LR}) \right] \left(\frac{S_{12M} - E_{XR}}{E_{TR}} \right)}{\left[1 + \left(\frac{S_{11M} - E_{DF}}{E_{RF}} \right) E_{SF} \right] \left[1 + \left(\frac{S_{22M} - E_{DR}}{E_{RR}} \right) E_{SR} \right] - \left[\left(\frac{S_{21M} - E_{XF}}{E_{TF}} \right) \left(\frac{S_{12M} - E_{XR}}{E_{TR}} \right) E_{LF} E_{LR} \right]}$$

$$S_{22A} = \frac{\left[\left(\frac{S_{22M} - E_{DR}}{E_{RR}} \right) \left[1 + \left(\frac{S_{11M} - E_{DF}}{E_{RF}} \right) E_{SF} \right] \right] - \left[\left(\frac{S_{21M} - E_{XF}}{E_{TF}} \right) \left(\frac{S_{12M} - E_{XR}}{E_{TR}} \right) E_{LR} \right]}{\left[1 + \left(\frac{S_{11M} - E_{DF}}{E_{RF}} \right) E_{SF} \right] \left[1 + \left(\frac{S_{22M} - E_{DR}}{E_{RR}} \right) E_{SR} \right] - \left[\left(\frac{S_{21M} - E_{XF}}{E_{TF}} \right) \left(\frac{S_{12M} - E_{XR}}{E_{TR}} \right) E_{LF} E_{LR} \right]}$$

Figure A5-16

In addition to the errors removed by accuracy enhancement, other systematic errors exist due to limitations of dynamic accuracy, test set switch repeatability, and test cable stability. These, combined with random errors, also contribute to total system measurement uncertainty. Therefore, after accuracy enhancement procedures are performed, residual measurement uncertainties remain. "System Performance" in the General Information and Specifications section of this manual provides information for calculating the system's total error-corrected measurement uncertainty performance.

With the use of a reference marker, a delta marker mode is available that displays both the stimulus and response values of the active marker relative to the reference. Any of the four markers or a fixed point can be designated as the delta reference marker. If the delta reference is one of the four markers, its stimulus value can be controlled by the user and its response value is the value of the trace at that stimulus value. If the delta reference is a fixed marker, both its stimulus value and its response value can be set arbitrarily by the user anywhere in the display area (not necessarily on the trace).

Markers can be used to search for the trace maximum or minimum point or any other point on the trace. The four markers can be used together to search for specified bandwidth cutoff points and calculate the bandwidth and Q values. Statistical analysis uses markers to provide a readout of the mean, standard deviation, and peak-to-peak values of all or part of the trace.

Basic marker operations are available in the menus accessed from the **[MKR]** key. The marker search and statistical functions, together with the capability for quickly changing stimulus parameters with markers, are provided in the menus accessed from the **[MKR FCTN]** key.

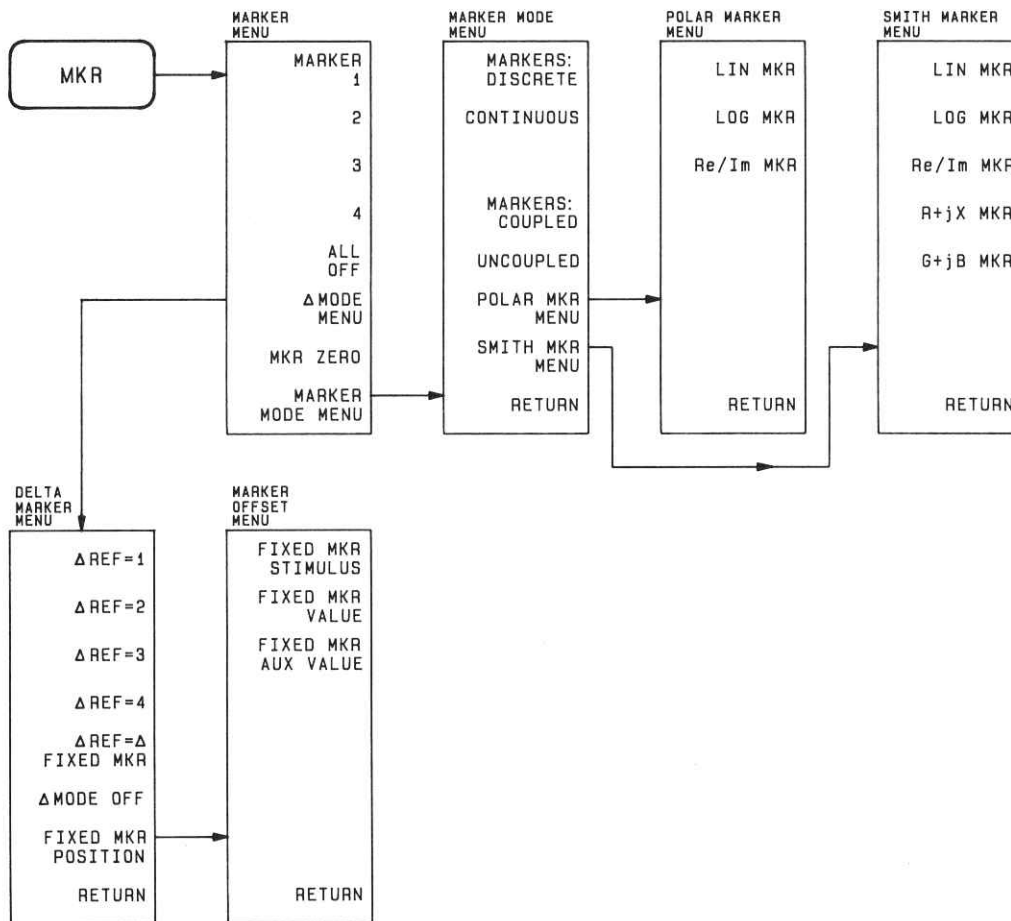

Figure 6-2. Menus Accessed from the **[MKR]** Key

The menus accessed from the **[MKR]** key (Figure 6-2) provide several basic marker operations. These include different marker modes for different display formats, and the delta marker mode that displays marker values relative to a specified value.

Marker Menu

The marker menu (Figure 6-3) is used to turn the display markers on or off, to designate the active marker, and to gain access to the marker delta mode and other marker modes and formats.

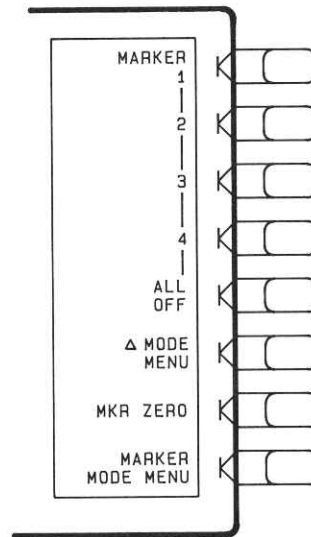

Figure 6-3

[MARKER 1] (MARK1) turns on marker 1 and makes it the active marker. The active marker appears on the CRT as ∇ . The active marker stimulus value is displayed in the active entry area, together with the marker number. If there is a marker turned on, and no other function is active, the stimulus value of the active marker can be controlled with the knob, the step keys, or the number pad. The marker response and stimulus values are displayed in the upper right-hand corner of the screen.

[MARKER 2] (MARK2) turns on marker 2 and makes it the active marker. If another marker is present, that marker becomes inactive and is represented on the CRT as Δ .

[MARKER 3] (MARK3) turns on marker 3 and makes it the active marker.

[MARKER 4] (MARK4) turns on marker 4 and makes it the active marker.

[ALL OFF] (MARKOFF) turns off all the markers and the delta reference marker, as well as the tracking and bandwidth functions that are accessed with the **[MKR FCTN]** key.

[Δ MODE MENU] goes to the delta marker menu, which is used to read the difference in values between the active marker and a reference marker.

[MKR ZERO] (MARKZERO) puts a fixed reference marker at the present active marker position, and makes the fixed marker stimulus and response values at that position equal to zero. All subsequent stimulus and response values of the active marker are then read out relative to the fixed marker. The fixed marker is shown on the CRT as a small triangle Δ (delta), smaller than the inactive marker triangles. The softkey label changes from **[MKR ZERO]** to **[MKR ZERO Δ REF = Δ]** and the notation " Δ REF= Δ " is displayed at the top right corner of the graticule. Marker zero is canceled by turning delta mode off in the delta marker menu or turning all the markers off with the **[ALL OFF]** softkey.

[MARKER MODE MENU] provides access to the marker mode menu, where several marker modes can be selected including special markers for polar and Smith formats.

Delta Marker Mode Menu

The delta marker mode is used to read the difference in stimulus and response values between the active marker and a designated delta reference marker. Any of the four markers or a fixed point can be designated as the reference marker. If the reference is one of the four markers, its stimulus value can be controlled by the user and its response value is the value of the trace at that stimulus value. If the reference is a fixed marker, both its stimulus value and its response value can be set arbitrarily by the user anywhere in the display area. The delta reference is shown on the CRT as a small triangle Δ (delta), smaller than the inactive marker triangles. If one of the markers is the reference, the triangle appears next to the marker number on the trace.

The marker values displayed in this mode are the stimulus and response values of the active marker minus the reference marker. If the active marker is also designated as the reference marker, the marker values are zero.

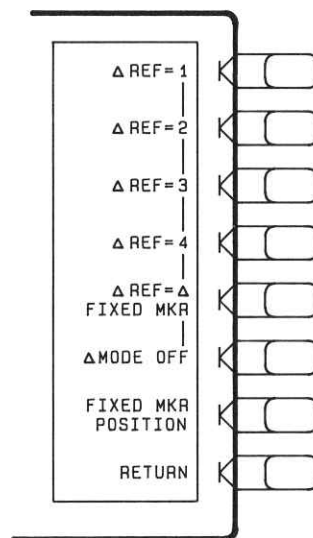

Figure 6-4. Delta Marker Mode Menu

[Δ REF = 1] (DELR1) establishes marker 1 as a reference. The active marker stimulus and response values are then shown relative to this delta reference. Once marker 1 has been selected as the delta reference, the softkey label [Δ REF = 1] is underlined in this menu, and the marker menu is returned to the screen. In the marker menu, the first key is now labeled [MARKER Δ REF = 1]. The notation " Δ REF=1" appears at the top right corner of the graticule.

[Δ REF = 2] (DELR2) makes marker 2 the delta reference. Active marker stimulus and response values are then shown relative to this reference.

[Δ REF = 3] (DELR3) makes marker 3 the delta reference.

[Δ REF = 4] (DELR4) makes marker 4 the delta reference.

[Δ REF = Δ FIXED MKR] (DELRFIXM) sets a user-specified fixed reference marker. The stimulus and response values of the reference can be set arbitrarily, and can be anywhere in the display area. Unlike markers 1 to 4, the fixed marker need not be on the trace. The fixed marker is indicated by a small triangle Δ , and the active marker stimulus and response values are shown relative to this point. The notation " Δ REF= Δ " is displayed at the top right corner of the graticule.

Pressing this softkey turns on the fixed marker. Its stimulus and response values can then be changed using the fixed marker menu, which is accessed with the **[FIXED MKR POSITION]** softkey described below. Alternatively, the fixed marker can be set to the current active marker position, using the **[MKR ZERO]** softkey in the marker menu.

[Δ MODE OFF] (DELO) turns off the delta marker mode, so that the values displayed for the active marker are absolute values.

[FIXED MKR POSITION] leads to the fixed marker menu, where the stimulus and response values for a fixed reference marker can be set arbitrarily.

Alternatively, the current position of the active marker can be entered as the fixed reference by using **[MARKER ZERO]** in the marker menu.

[RETURN] goes back to the marker menu.

Fixed Marker Menu

This menu is used to set the position of a fixed reference marker, indicated on the display by a small triangle Δ . Both the stimulus value and the response value of the fixed marker can be set arbitrarily anywhere in the display area, and need not be on the trace. The units are determined by the display format, the sweep type, and the marker type.

There are two ways to turn on the fixed marker. One way is with the **[Δ REF = Δ FIXED MKR]** softkey in the delta marker menu. The other is with the **[MKR ZERO]** function in the marker menu, which puts a fixed reference marker at the present active marker position and makes the marker stimulus and response values at that position equal to zero.

The softkeys in this menu make the values of the fixed marker the active function. The marker readings in the top right corner of the graticule are the stimulus and response values of the active marker minus the fixed reference marker. Also displayed in the top right corner is the notation " Δ REF= Δ ."

The stimulus value, response value, and auxiliary response value (the second part of a complex data pair) can be individually examined and changed. This allows active marker readings that are relative in amplitude yet absolute in frequency, or any combination of relative/absolute readouts. Following a **[MKR ZERO]** operation, this menu can be used to reset any of the fixed marker values to absolute zero for absolute readings of the subsequent active marker values.

If the format is changed while a fixed marker is on, the fixed marker values become invalid. For example, if the value offset is set to 10 dB with a log magnitude format, and the format is then changed to phase, the value offset becomes 10 degrees. However, in polar and Smith chart formats, the specified values remain consistent between different marker types for those formats. Thus an R+jX marker set on a Smith chart format will retain the equivalent values if it is changed to any of the other Smith chart markers.

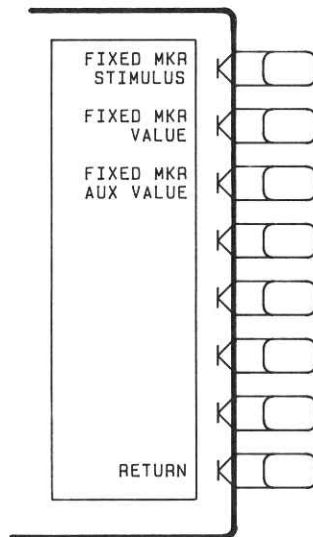

Figure 6-5. The Fixed Marker Menu

[FIXED MKR STIMULUS] (MARKFSTI) changes the stimulus value of the fixed marker. Fixed marker stimulus values can be different for the two channels if the channel markers are uncoupled using the marker mode menu.

To read absolute active marker stimulus values following a **[MKR ZERO]** operation, the stimulus value can be reset to zero.

[FIXED MKR VALUE] (MARKFVAL) changes the response value of the fixed marker. In a Cartesian format this is the y-axis value. In a polar or Smith chart format with a magnitude/phase marker, a real/imaginary marker, an $R+jX$ marker, or a $G+jB$ marker, this applies to the first part of the complex data pair. Fixed marker response values are always uncoupled in the two channels.

To read absolute active marker response values following a **[MKR ZERO]** operation, the response value can be reset to zero.

[FIXED MKR AUX VALUE] (MARKFAUV) is used only with a polar or Smith format. It changes the auxiliary response value of the fixed marker. This is the second part of a complex data pair, and applies to a magnitude/phase marker, a real/imaginary marker, an $R+jX$ marker, or a $G+jB$ marker. Fixed marker auxiliary response values are always uncoupled in the two channels.

To read absolute active marker auxiliary response values following a **[MKR ZERO]** operation, the auxiliary value can be reset to zero.

[RETURN] goes back to the delta marker menu.

Marker Mode Menu

This menu provides different marker modes and makes available two additional menus of special markers for use with Smith chart or polar formats.

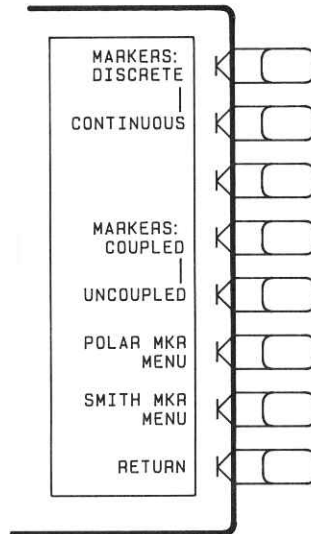

Figure 6-6

[MARKERS: DISCRETE] (MARKDISC) places markers only on measured trace points determined by the stimulus settings.

[CONTINUOUS] (MARKCONT) interpolates between measured points to allow the markers to be placed at any point on the trace. Displayed marker values are also interpolated. This is the default marker mode.

[MARKERS: COUPLED] (MARKCOUP) couples the marker stimulus values for the two display channels. Even if the stimulus is uncoupled and two sets of stimulus values are shown, the markers track the same stimulus values on each channel as long as they are within the displayed stimulus range.

[UNCOUPLED] (MARKUNCO) allows the marker stimulus values to be controlled independently on each channel.

[POLAR MKR MENU] leads to a menu of special markers for use with a polar format.

[SMITH MKR MENU] leads to a menu of special markers for use with a Smith chart format.

[RETURN] goes back to the marker menu.

Polar Marker Menu

This menu is used only with a polar display format, selectable using the **[FORMAT]** key. In a polar format, the magnitude at the center of the circle is zero and the outer circle is the full scale value set in the scale reference menu. Phase is measured as the angle counterclockwise from 0° at the positive x-axis. The HP 8753A automatically calculates different mathematical forms of the marker magnitude and phase values, selected using the softkeys in this menu. Marker frequency is displayed in addition to other values regardless of the selection of marker type.

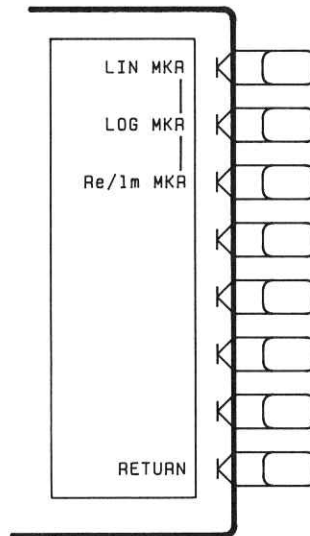

Figure 6-7

[LIN MKR] (POLMLIN) displays a readout of the linear magnitude and the phase of the active marker. This is the preset marker type for a polar display. Magnitude values are read in units and phase in degrees.

[LOG MKR] (POLMLOG) displays the logarithmic magnitude and the phase of the active marker. Magnitude values are expressed in dB and phase in degrees. This is useful as a fast method of obtaining a reading of the log magnitude value without changing to log magnitude format.

[Re/Im MKR] (POLMRI) displays the values of the active marker as a real and imaginary pair. The complex data is separated into its real part and imaginary part. The first marker value given is the real part $M \cos \theta$, and the second value is the imaginary part $M \sin \theta$, where M = magnitude.

[RETURN] goes back to the marker mode menu.

Smith Marker Menu

This menu is used only with a Smith chart format, selected from the format menu. The HP 8753A automatically calculates different mathematical forms of the marker magnitude and phase values, selected using the softkeys in this menu. Marker frequency is displayed in addition to other values for all marker types.

For additional information about the Smith chart display format, refer to “[FORMAT] Key.”

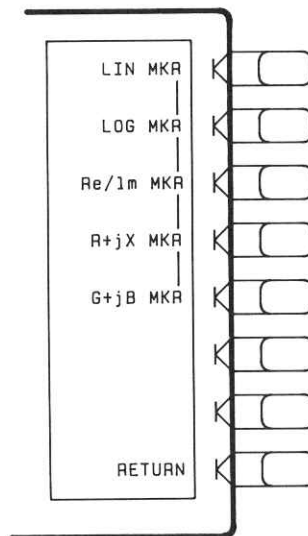

Figure 6-8

[LIN MKR] (SMIMLIN) displays a readout of the linear magnitude and the phase of the active marker. Marker magnitude values are expressed in units and phase in degrees.

[LOG MKR] (SMIMLOG) displays the logarithmic magnitude value and the phase of the active marker. Magnitude values are expressed in dB and phase in degrees. This is useful as a fast method of obtaining a reading of the log magnitude value without changing to log magnitude format.

[Re/Im MKR] (SMIMRI) displays the values of the active marker on a Smith chart as a real and imaginary pair. The complex data is separated into its real part and imaginary part. The first marker value given is the real part $M \cos \theta$, and the second value is the imaginary part $M \sin \theta$, where M = magnitude.

[R + jX MKR] (SMIMRX) converts the active marker values into rectangular form. The complex impedance values of the active marker are displayed in terms of resistance, reactance, and equivalent capacitance or inductance. This is the default Smith chart marker.

The normalized impedance Z_0 for characteristic impedances other than 50 ohms can be selected in the calibrate more menu (chapter 5).

[G + jB MKR] (SMIMGB) displays the complex admittance values of the active marker in rectangular form. The active marker values are displayed in terms of conductance (in Siemens), susceptance, and equivalent capacitance or inductance. Siemens are the international units of admittance, and are equivalent to mhos (the inverse of ohms).

[RETURN] goes back to the marker mode menu.

[MKR FCTN] KEY

The [MKR FCTN] (MENUMRKF) key activates a marker if one is not already active, and provides access to additional marker functions. These can be used to quickly change the measurement parameters, to search the trace for specified information, and to analyze the trace statistically.

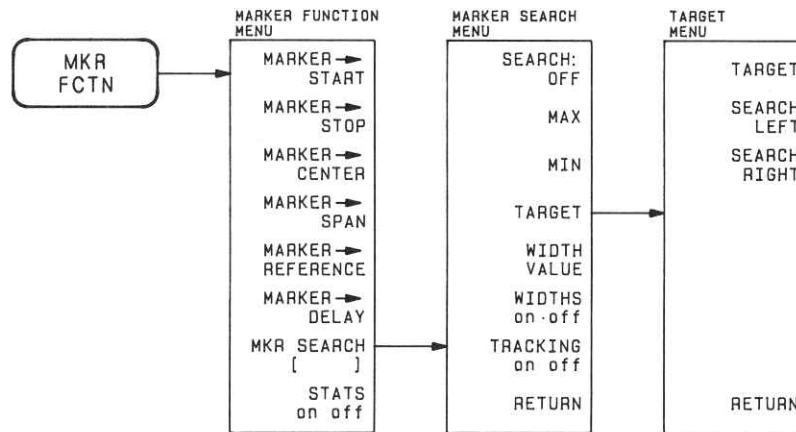

Figure 6-9. Menus Accessed from the [MKR FCTN] Key

Marker Function Menu

This menu provides softkeys that use markers to quickly modify certain measurement parameters without going through the usual key sequence. In addition, it provides access to two additional menus used for searching the trace and for statistical analysis.

The [MARKER →] functions change certain stimulus and response parameters to make them equal to the current active marker value. Use the knob or the keypad to move the marker to the desired position on the trace, and press the appropriate softkey to set the specified parameter to that trace value. When the values have been changed, the marker can again be moved within the range of the new parameters.

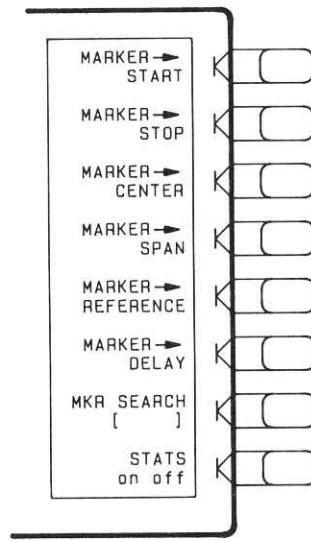

Figure 6-10

[MARKER → START] (MARKSTAR) changes the stimulus start value to the stimulus value of the active marker.

[MARKER → STOP] (MARKSTOP) changes the stimulus stop value to the stimulus value of the active marker.

[MARKER → CENTER] (MARKCENT) changes the stimulus center value to the stimulus value of the active marker, and centers the new span about that value.

[MARKER → SPAN] (MARKSPAN) changes the start and stop values of the stimulus span to the values of the active marker and the delta reference marker. If there is no reference marker, the message "NO MARKER DELTA – SPAN NOT SET" is displayed.

[MARKER → REFERENCE] (MARKREF) makes the reference value equal to the active marker's response value, without changing the reference position. In a polar or Smith chart format, the full scale value at the outer circle is changed to the active marker response value. This softkey also appears in the scale reference menu.

[MARKER → DELAY] (MARKDELA) adjusts the electrical delay to balance the phase of the DUT. This is performed automatically, regardless of the format and the measurement being made. Enough line length is added to or subtracted from the receiver input to compensate for the phase slope at the active marker position. This effectively flattens the phase trace around the active marker, and can be used to measure electrical length or deviation from linear phase. Additional electrical delay adjustments are required on DUTs without constant group delay over the measured frequency span. Since this feature adds phase to a variation in phase versus frequency, it is applicable only for ratioed inputs. This softkey also appears in the scale reference menu.

[MARKER SEARCH] leads to the marker search menu, which is used to search the trace for a particular value or bandwidth.

[STATS on off] (MEASTATon, MEASTAToff) calculates and displays the mean, standard deviation, and peak-to-peak values of the section of the displayed trace between the active marker and the delta reference marker. If there is no delta reference, the statistics are calculated for the entire trace. A convenient use of this feature is to find the peak-to-peak value of passband ripple without searching separately for the maximum and minimum values.

The statistics are absolute values: the delta marker here serves to define the span. For polar and Smith formats the statistics are calculated using the first value of the complex pair (magnitude, real part, resistance, or conductance).

Marker Search Menu

This menu is used to search the trace for a specific amplitude-related point, and place the marker on that point. The capability of searching for a specified bandwidth is also provided. Tracking is available for a continuous sweep-to-sweep search. If there is no occurrence of a specified value or bandwidth, the message "TARGET VALUE NOT FOUND" is displayed.

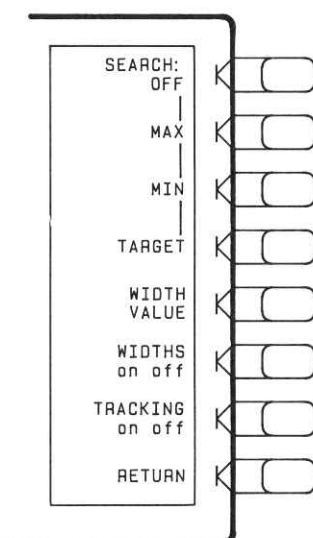

Figure 6-11

[SEARCH: OFF] (SEAOFF) turns off the marker search function.

[MAX] (SEAMAX) moves the active marker to the maximum point on the trace.

[MIN] (SEAMIN) moves the active marker to the minimum point on the trace.

[TARGET] (SEATARG) makes target value the active function, and places the active marker at a specified target point on the trace. The default target value is -3 dB. The target menu is presented, providing search right and search left options to resolve multiple solutions.

For relative measurements, a search reference must be defined with a delta marker or a fixed marker before the search is activated.

[WIDTH VALUE] (WIDV) is used to set the amplitude parameter (for example 3 dB) that defines the start and stop points for a bandwidth search. The bandwidth search feature analyzes a bandpass or band reject trace and calculates the center point, bandwidth, and Q (quality factor) for the specified bandwidth. Bandwidth units are the units of the current format.

[WIDTHS on off] (WIDTon, WIDToff) turns on the bandwidth search feature and calculates the center stimulus value, bandwidth, and Q of a bandpass or band reject shape on the trace. The amplitude value that defines the passband or rejectband is set using the **[WIDTH VALUE]** softkey.

All four markers are turned on, and each has a dedicated use. Marker 1 is a starting point from which the search is begun. Marker 2 goes to the bandwidth center point. Marker 3 goes to the bandwidth cutoff point on the left, and marker 4 to the cutoff point on the right.

If a delta marker or fixed marker is on, it is used as the reference point from which the bandwidth amplitude is measured. For example, if marker 1 is the delta marker and is set at the passband maximum, and the width value is set to -3 dB, the bandwidth search finds the bandwidth cutoff points 3 dB below the maximum and calculates the 3 dB bandwidth and Q.

If marker 2 (the dedicated bandwidth center point marker) is the delta reference marker, the search finds the points 3 dB down from the center.

If no delta reference marker is set, the bandwidth values are absolute values.

[TRACKING on off] (TRACKon, TRACKoff) is used in conjunction with other search features to track the search with each new sweep. Turning tracking on makes the HP 8753A search every new trace for the specified target value and put the active marker on that point. If bandwidth search is on, tracking searches every new trace for the specified bandwidth, and repositions the dedicated bandwidth markers.

When tracking is off, the target is found on the current sweep and remains at the same stimulus value regardless of changes in trace response value with subsequent sweeps.

A maximum and a minimum point can be tracked simultaneously using two channels and uncoupled markers.

[RETURN] goes back to the marker function menu.

Target Menu

The target menu places the marker at a specified target response value on the trace, and provides search right and search left options. If there is no occurrence of the specified value, the message "TARGET VALUE NOT FOUND" is displayed.

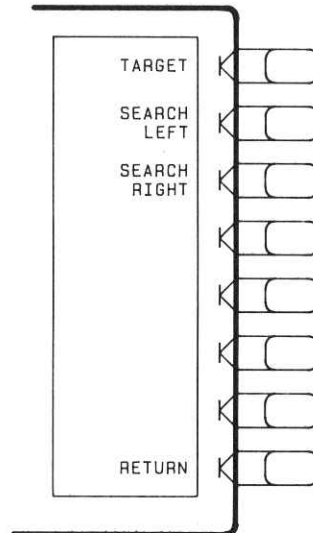

Figure 6-12

[TARGET] (SEATARG) places the marker at the specified target response value. If tracking is on (see previous menu) the target is automatically tracked with each new trace. If tracking is off, the target is found each time this key is pressed. The target value is in units appropriate to the current format. The default target value is -3 dB.

In delta marker mode, the target value is the value relative to the reference marker. If no delta reference marker is on, the target value is an absolute value.

[SEARCH LEFT] (SEAL) searches the trace for the next occurrence of the target value to the left.

[SEARCH RIGHT] (SEAR) searches the trace for the next occurrence of the target value to the right.

[RETURN] goes back to the marker search menu.

Chapter 7. Instrument State Function Block

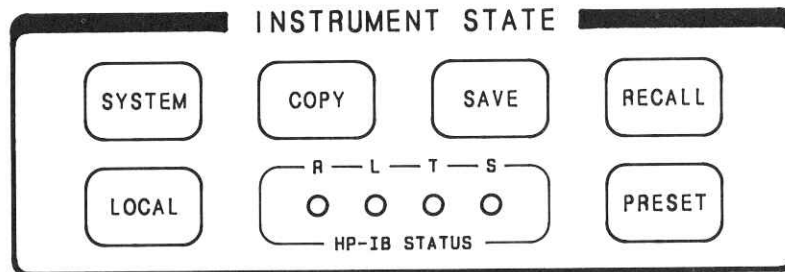

Figure 7-1

The instrument state function block keys and associated menus provide control of channel-independent system functions. These include controller modes, instrument addresses, and HP-IB status information; as well as plotting and printing, and saving instrument states either in internal memory or on an external disc.

The limit testing feature, which compares measured data with user-defined limits, is also available in this function block, as well as the option 010 time domain transform function. In addition, the service menus are accessed from these keys.

This chapter provides a brief outline of the menus accessed from the **[LOCAL]** key, and describes limit lines and limit testing, which are accessed from the **[SYSTEM]** key. Time domain transform is described in chapter 8. The printing and plotting capabilities available using the **[COPY]** key are described in chapter 9. Chapter 10 explains the use of instrument state save registers and external storage files, and the **[SAVE]** and **[RECALL]** keys. Detailed HP-IB information is provided in chapter 11.

[LOCAL] KEY

This key is used to return the HP 8753A to local (front panel) operation from remote (computer controlled) operation. In this local mode, with a controller still connected on HP-IB, the HP 8753A can be operated manually (locally) from the front panel. This is the only front panel key that is not disabled when the HP 8753A is remotely controlled over HP-IB by a computer. The exception to this is when local lockout is in effect: this is a remote command that disables the [LOCAL] key, making it difficult to interfere with the HP 8753A while the network analyzer is under remote control.

In addition, this key gives access to the HP-IB menu, which sets the controller mode, and to the address menu, where the HP-IB addresses of peripheral devices are entered.

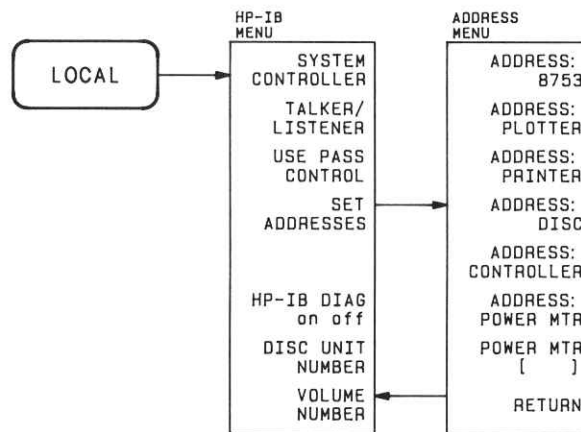

Figure 7-2. Softkey Menus Accessed from the [LOCAL] Key

HP-IB Menu

The HP 8753A is factory-equipped with a remote programming interface using the Hewlett-Packard Interface Bus (HP-IB). This enables communication between the HP 8753A and a controlling computer and other peripheral devices. This menu indicates the present HP-IB controller mode of the HP 8753A. Three HP-IB modes are possible: system controller, talker/listener, and pass control.

Talker/listener is the normal mode of operation. In this mode, a computer controller communicates with the HP 8753A and other compatible peripherals over the bus. The computer sends commands or instructions to and receives data from the HP 8753A. All of the capabilities available from the HP 8753A front panel can be used in this remote operation mode, except for control of the power line switch and some internal tests.

In the system controller mode, the HP 8753A itself can use HP-IB to control compatible peripherals, without the use of an external computer. It can output measurement results directly to a compatible printer or plotter, store instrument states using a compatible disc drive, or control a power meter for performing service routines.

A third mode of HP-IB operation is the pass control mode. In an automated system with a computer controller, the controller can pass control of the bus to the HP 8753A on request from the network analyzer. The HP 8753A is then the controller of the peripherals, and can direct them to plot, print, or

store without going through the computer. When the peripheral operation is complete, control is passed back to the computer. Only one controller can be active at a time. The computer remains the system controller, and can regain control at any time.

Preset does not affect the selected controller mode, but cycling the power returns the HP 8753A to talker/listener mode.

Information on compatible peripherals is provided in the General Information and Specifications section of this manual.

HP-IB Status Indicators. When the HP 8753A is connected to other instruments over HP-IB, the HP-IB STATUS indicators in the instrument state function block light up to display the current status of the HP 8753A.

R = Remote operation.

L = Listen mode.

T = Talk mode.

S = Service request (SRQ) asserted by the HP 8753A.

Complete detailed information on all aspects of HP-IB operation of the HP 8753A is provided in chapter 11.

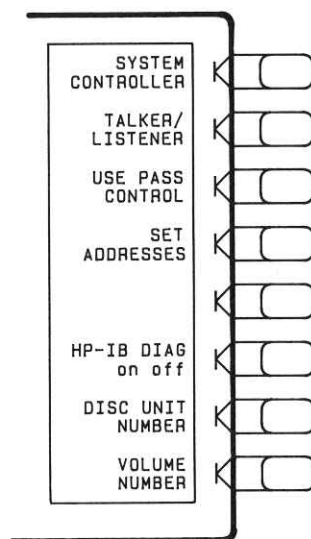

Figure 7-3. HP-IB Menu

[SYSTEM CONTROLLER] is the mode used when peripheral devices are to be used and there is no external controller. In this mode, the HP 8753A can directly control peripherals (plotter, printer, disc drive, or power meter). System controller mode must be set in order for the HP 8753A to access peripherals from the front panel to plot, print, store on disc, or perform power meter service routines, if there is no other controller on the bus.

The system controller mode can be used without knowledge of HP-IB programming. However, the HP-IB addresses displayed in the address menu must match the addresses set in the peripheral instruments.

This mode can only be selected manually from the network analyzer front panel, and can be used only if no active computer controller is connected to the system through HP-IB. If you try to set system controller mode when another controller is present, the message "CAUTION: CAN'T CHANGE—ANOTHER CONTROLLER ON BUS" is displayed. Do not attempt to use this mode for programming.

[TALKER/LISTENER] (TALKLIST) is the mode normally used for remote programming of the HP 8753A. In this mode, the HP 8753A and all peripheral devices are controlled from the external controller. The controller can command the HP 8753A to talk, and the plotter or other device to listen. The HP 8753A and peripheral devices cannot talk directly to each other unless the computer sets up a data path between them.

This mode allows the HP 8753A to be either a talker or a listener, as required by the controlling computer for the particular operation in progress.

A talker is a device capable of sending out data when it is addressed to talk. There can be only one talker at any given time. The HP 8753A is a talker when it sends information over the bus.

A listener is a device capable of receiving data when it is addressed to listen. There can be any number of listeners at any given time. The HP 8753A is a listener when it is controlled over the bus by a computer.

[USE PASS CONTROL] (USEPASC) lets you control the HP 8753A with the computer over HP-IB as with the talker/listener mode, and also allows the HP 8753A to become a controller in order to plot, print, or directly access an external disc. During this peripheral operation, the host computer is free to perform other internal tasks that do not require use of the bus (the bus is tied up by the network analyzer during this time).

The pass control mode requires that the external controller is programmed to respond to a request for control and to issue a take control command. When the peripheral operation is complete, the HP 8753A passes control back to the computer. Refer to chapter 11 for more information.

In general, use the talker/listener mode for programming the HP 8753A unless direct peripheral access is required.

[SET ADDRESSES] goes to the address menu, which is used to set the HP-IB address of the HP 8753A, and to display and modify the addresses of peripheral devices in the system.

[HP-IB DIAG on off] (DEBUON, DEBUOFF) toggles the HP-IB diagnostic feature (debug mode). This mode should only be used the first time a program is written: if a program has already been debugged, it is unnecessary.

When diagnostics is on, the network analyzer scrolls a history of incoming HP-IB commands across the display in the title line. Nonprintable characters are represented as π . If a syntax error is received, the commands halt and a pointer \wedge indicates the misunderstood character. Chapter 11 explains how to clear a syntax error.

[DISC UNIT NUMBER] (DISCUNIT) specifies the number of the disc unit in the disc drive that is to be accessed in an external disc store or load routine. This is used in conjunction with the HP-IB address of the disc drive, and the volume number, to gain access to a specific area on a disc. The access hierarchy is HP-IB address, disc unit number, disc volume number. More information on storing information to an external disc is provided in chapter 10, Saving Instrument States.

[VOLUME NUMBER] (DISCVOLU) specifies the number of the disc volume to be accessed. In general, all 3 1/2" floppy discs are considered one volume (volume 0). For hard disc drives, such as the HP 9133A (Winchester), a switch in the disc drive must be set to define the number of volumes on the disc. For more information, refer to the manual for the individual disc drive.

Address Menu

In communications through the Hewlett-Packard Interface Bus (HP-IB), each instrument on the bus is identified by an HP-IB address. This decimal-based address code must be different for each instrument on the bus.

This menu is used to set the HP-IB address of the HP 8753A, and to enter the addresses of peripheral devices so that the HP 8753A can communicate with them.

Most of the HP-IB addresses are set at the factory and need not be modified for normal system operation. The standard factory-set addresses for instruments that may be part of the system are as follows:

Instrument	HP-IB Address (decimal)
HP 8753A	16
Plotter	05
Printer	01
External Disc Drive	00
Controller	21
Power Meter (service)	13

The address displayed in this menu for each peripheral device must match the address set on the device itself. If the addresses do not match, they can be modified in one of two ways. Either the address in the HP 8753A softkey label for the device can be modified using the entry controls; or the address of the device can be changed using instructions provided in the device manual. The HP 8753A does not have an HP-IB switch: its address is set only from the front panel.

These addresses are stored in short-term non-volatile memory and are not affected by preset or by cycling the power.

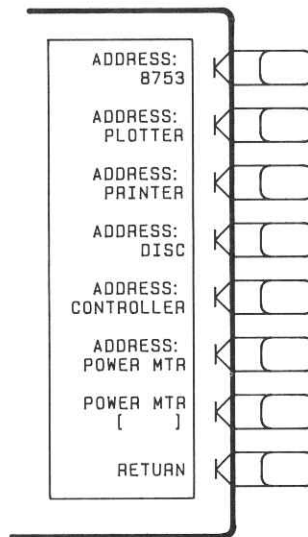

Figure 7-4. Address Menu

[ADDRESS: 8753] sets the HP-IB address of the HP 8753A, using the entry controls. There is no physical address switch to set in the HP 8753A.

[ADDRESS: PLOTTER] (ADDRPLOT) sets the HP-IB address the HP 8753A will use to communicate with the plotter.

[ADDRESS: PRINTER] (ADDRPRIN) sets the HP-IB address the HP 8753A will use to communicate with the printer.

[ADDRESS: DISC] (ADDRDISC) sets the HP-IB address the HP 8753A will use to communicate with the disc drive.

[ADDRESS: CONTROLLER] (ADDRCONT) sets the HP-IB address the HP 8753A will use to communicate with the external controller.

[ADDRESS: POWER MTR] (ADDRPOWM) sets the HP-IB address the HP 8753A will use to communicate with the power meter used in service routines.

[POWER MTR] (POWM) toggles between **[438A]** and **[436A]**. The HP 438A and 436A are the two power meters compatible with the HP 8753A. The model number in the softkey label must match the power meter to be used.

[RETURN] goes back to the HP-IB menu.

[SYSTEM] KEY (MENUSYST)

This key presents the system menu, which provides access to two additional series of menus (three in the option 010).

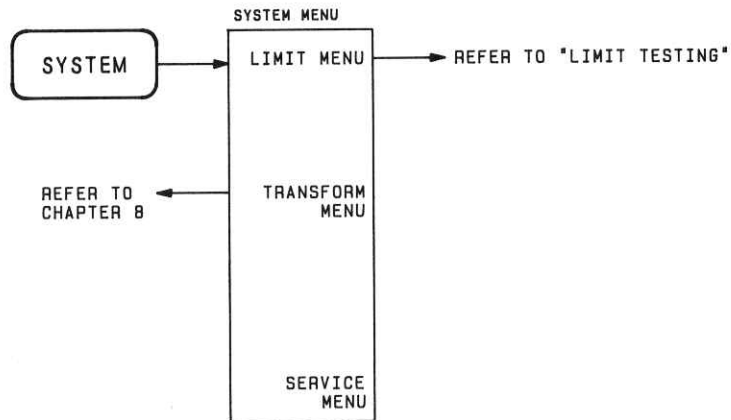

Figure 7-5. The System Menu

[LIMIT MENU] leads to a series of menus used to define limits or specifications with which to compare a test device. Refer to "Limit Lines and Limit Testing."

[TRANSFORM MENU] (option 010) leads to a series of menus that transform the measured data from the frequency domain to the time domain. Time domain modes and features are explained in chapter 8, Time and Frequency Domain Transforms. This softkey is present only in instruments purchased with option 010.

[SERVICE MENU] leads to a series of service menus described in detail in the On-Site System Service Manual.

LIMIT LINES AND LIMIT TESTING

Limit lines are lines drawn on the CRT to represent upper and lower limits or device specifications with which to compare the device under test. Limits are defined in segments, where each segment is a portion of the stimulus span. Each limit segment has an upper and a lower starting limit value. Three types of segments are available: flat line, sloping line, and single point.

Limits can be defined independently for the two channels, up to 15 segments for each channel (a total of 30 for both channels). These can be in any combination of the three limit types.

Limit testing compares the measured data with the defined limits, and provides pass or fail information for each measured data point. An out-of-limit test condition is indicated in five ways: with a FAIL message on the screen, with a beep, by blanking of portions of the trace, with an asterisk in tabular listings of data, and with a bit in the HP-IB event status register B.

Limit lines and limit testing can be used simultaneously or independently. If limit lines are on and limit testing is off, the limit lines are displayed on the CRT for visual comparison and adjustment of the measurement trace. However, no pass/fail information is provided. If limit testing is on and limit lines are off, the specified limits are still valid and the pass/fail status is indicated even though the limit lines are not displayed on the CRT.

Limits are entered in tabular form. Limit lines and limit testing can be either on or off while limits are defined. As new limits are entered, the tabular columns on the CRT are updated, and the limit lines (if on) are modified to the new definitions. The complete limit set can be offset in either stimulus or amplitude value.

Limits are checked only at the actual measured data points. It is possible for a device to be out of specification without a limit test failure indication if the point density is insufficient. Be sure to specify a high enough number of measurement points in the stimulus menu.

Limit lines are displayed only on Cartesian formats. In polar and Smith chart formats, limit testing of one value is available: the value tested depends on the marker mode and is the magnitude or the first value in a complex pair. The message "NO LIMIT LINES DISPLAYED" is shown on the CRT in polar and Smith formats.

The list values feature in the copy menu provides tabular listings to the CRT or a printer for every measured stimulus value. These include limit line and/or limit test information if these functions are turned on. If limit testing is on, an asterisk * is listed next to any measured value that is out of limits. If limit lines are on, and other listed data allows sufficient space, the upper limit and lower limit are listed, together with the margin by which the device data passes or fails the nearest limit. For more information about the list values feature, refer to chapter 9, Making a Hard Copy Output.

If limit lines are on, they are plotted with the data on a plot. If limit testing is on, the PASS or FAIL message is plotted, and the failing portions of the trace that are blanked on the CRT are also blanked on the plot. If limits are specified, they are saved in memory with an instrument state.

An example of a measurement using limit lines and limit testing is provided in the User's Guide.

The series of menus for defining limits is accessed from the [SYSTEM] key. These menus are illustrated in Figure 7-6.

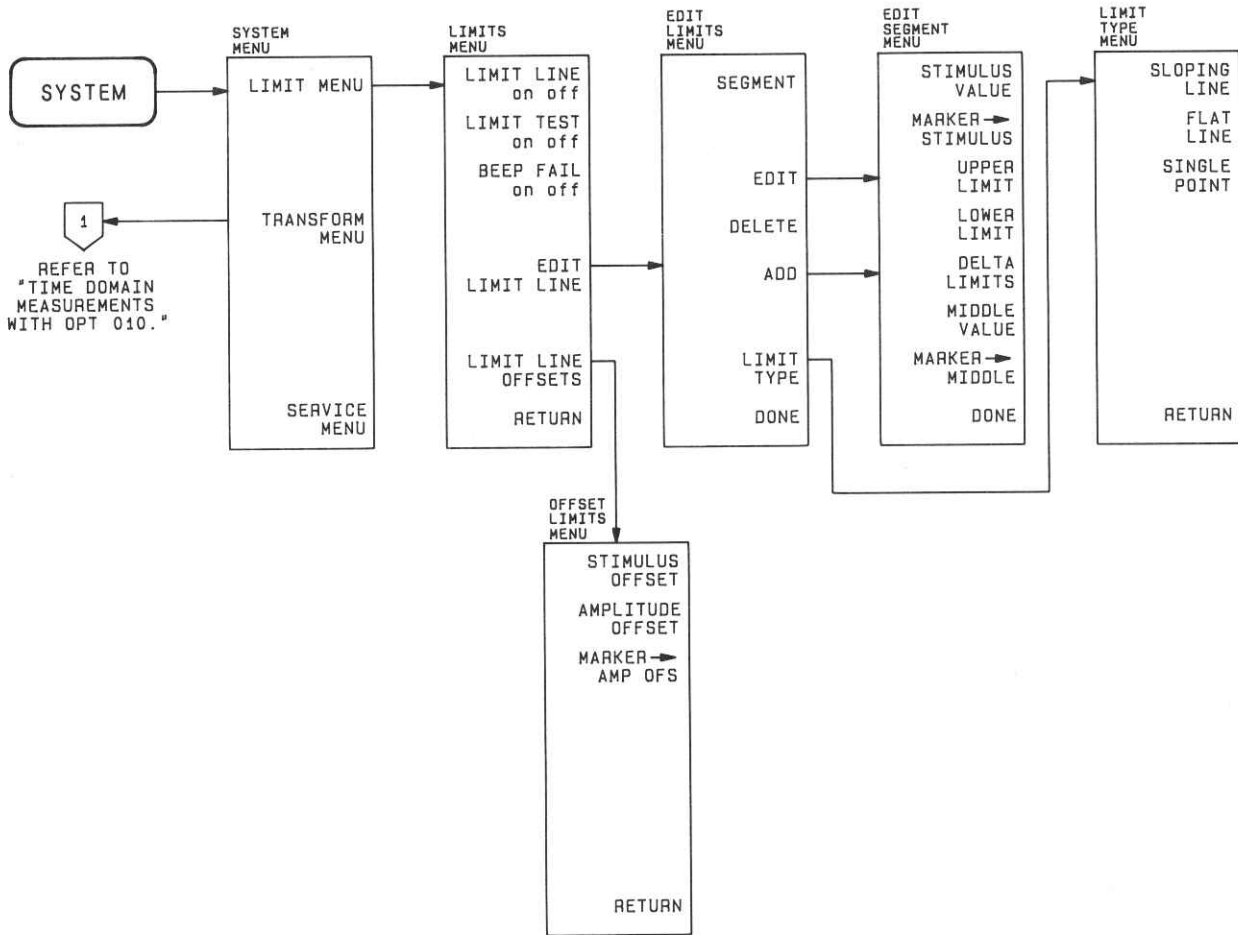

Figure 7-6. The Limit Softkey Menu Series

Limits Menu

This menu independently toggles the limit lines, limit testing, and limit fail beeper. In addition, it leads to the menus used to define and modify the limits.

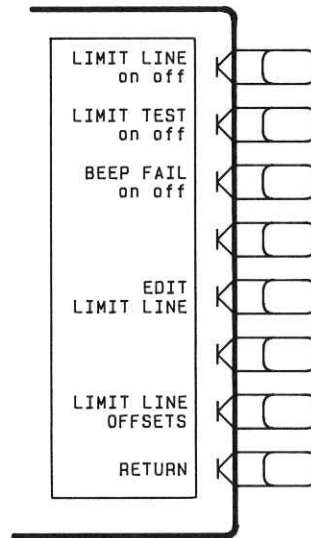

Figure 7-7

[LIMIT LINE on off] (LIMILINEON, LIMILINEOFF) turns limit lines on or off. To define limits, use the **[EDIT LIMIT LINE]** softkey described below. If limits have been defined and limit lines are turned on, the limit lines are displayed on the CRT for visual comparison of the measured data in all Cartesian formats.

If limit lines are on, they are plotted with the data on a plot, and saved in memory with an instrument state. In a listing of values from the copy menu with limit lines on, the upper limit and lower limit are listed together with the pass or fail margin, as long as other listed data allows sufficient space.

[LIMIT TEST on off] (LIMITESTON, LIMITESTOFF) turns limit testing on or off. When limit testing is on, the data is compared with the defined limits at each measured point. Limit tests occur at the end of each sweep, whenever the data is updated, when formatted data is changed, and when limit testing is first turned on.

Limit testing is available for both magnitude and phase values in Cartesian formats. In polar and Smith chart formats, the value tested depends on the marker mode and is the magnitude or the first value in a complex pair. The message "NO LIMIT LINES DISPLAYED" is displayed in polar and Smith formats if limit lines are turned on.

Five indications of pass or fail status are provided when limit testing is on. A PASS or FAIL message is displayed at the right of the CRT. The trace vector leading to any measured point that is out of limits is blanked at the end of every limit test, both on a CRT plot and a hard copy plot. The limit fail beeper sounds if it is turned on. In a listing of values using the copy menu, an asterisk * is shown next to any measured point that is out of limits. A bit is set in the HP-IB status register B.

[BEEP FAIL on off] (BEEPFAILON, BEEPFAILOFF) turns the limit fail beeper on or off. When limit testing is on and the fail beeper is on, a beep is sounded each time a limit test is performed and a failure detected. The limit fail beeper is independent of the warning beeper and the operation complete beeper, both of which are in the display more menu (chapter 4).

[EDIT LIMIT LINE] (EDITLIML) displays a table of limit segments on the CRT, superimposed on the trace. The edit limits menu is presented so that limits can be defined or changed. It is not necessary for limit lines or limit testing to be on while limits are defined.

[LIMIT LINE OFFSETS] leads to the offset limits menu, which is used to offset the complete limit set in either stimulus or amplitude value.

[RETURN] goes back to the system menu.

Edit Limits Menu

This menu is used to specify limits for limit lines and/or limit testing, and presents a table of limit values on the CRT. Limits are defined in segments. Each segment is a portion of the stimulus span. Up to 15 limit segments can be specified for each channel (a total of 30 for both channels). The limit segments do not have to be entered in any particular order: the HP 8753A automatically sorts them and lists them on the CRT in increasing order of start stimulus value.

For each segment, the table lists the segment number, the starting stimulus value, upper limit, lower limit, and limit type. The ending stimulus value is the start value of the next segment, or a segment can be terminated with a single point segment. Limit values are entered as upper and lower limits or delta limits and middle value. As new limit segments are defined the tabular listing is updated, and if limit lines are switched on they are plotted on the CRT.

If no limits have been defined, the table of limit values shows the notation "EMPTY." Limit segments are added to the table using the **[ADD]** key or edited with the **[EDIT]** key, as described below. The last segment on the list is followed by the notation "END."

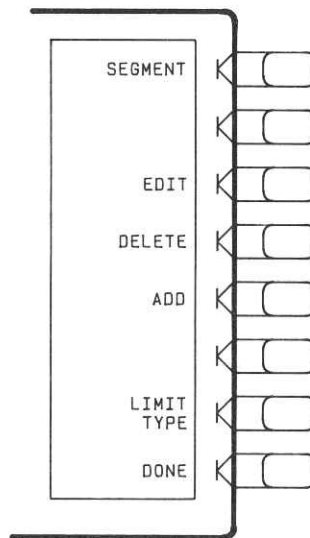

Figure 7-8. Edit Limits Menu

[SEGMENT] specifies which limit segment in the table is to be modified. A maximum of three sets of segment values are displayed at one time, and the list can be scrolled up or down to show other segment entries. Use the entry block controls to move the pointer > to the required segment number. The indicated segment can then be edited or deleted. If the table of limits is designated "EMPTY," new segments can be added using the **[ADD]** or **[EDIT]** softkey.

[EDIT] (SEDI) displays the edit segment menu, which is used to define or modify the stimulus value and limit values of a specified segment. If the table was empty, a default segment is displayed. The default segment is a sloping line with zero limits, and stimulus values that vary according to the current stimulus mode (frequency, power, or time).

[DELETE] (SDEL) deletes the limit segment indicated by the pointer >.

[ADD] (SADD) displays the edit segment menu and adds a new segment to the end of the list. The new segment is initially a duplicate of the segment indicated by the pointer > and selected with the **[SEGMENT]** softkey. If the table was empty, a default segment is displayed, as described under **[EDIT]** above.

[LIMIT TYPE] leads to the limit type menu, where one of three segment types can be selected.

[DONE] (EDITDONE) sorts the limit segments and displays them on the CRT in increasing order of stimulus value. The limits menu is returned to the screen.

Edit Segment Menu

This menu sets the values of the individual limit segments. The segment to be modified, or a default segment, is selected in the edit limits menu. The stimulus value can be set with the controls in the entry block or with a marker (the marker is turned on automatically when this menu is presented). The limit values can be defined as upper and lower limits, or delta limits and middle value. Both an upper limit and a lower limit (or delta limits) must be defined: if only one limit is required for a particular measurement, force the other out of range (for example +500 dB or -500 dB).

As new values are entered, the tabular listing of limit values is updated.

Segments do not have to be listed in any particular order: the HP 8753A sorts them automatically in increasing order of start stimulus value when the **[DONE]** key in the edit limits menu is pressed. However, the easiest way to enter a set of limits is to start with the lowest stimulus value and define the segments from left to right of the display, with limit lines turned on as a visual check.

Phase limit values can be specified between +500° and -500°. Limit values above +180° and below -180° are mapped into the range of -180° to +180° to correspond with the range of phase data values.

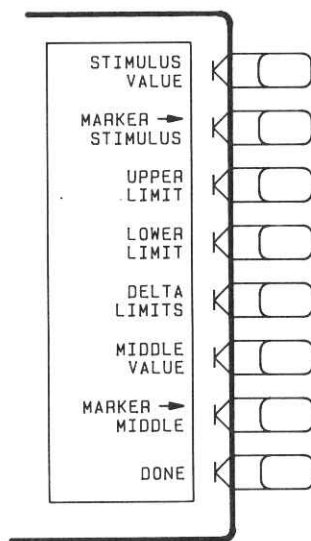

Figure 7-9. Edit Segment Menu

→ **[STIMULUS VALUE]** (LIMS) sets the starting stimulus value of a segment, using entry block controls. The ending stimulus value of the segment is defined by the start of the next line segment. No more than one segment can be defined over the same stimulus range.

[MARKER → STIMULUS] (MARKSTIM) sets the starting stimulus value of a segment using the active marker. Move the marker to the desired starting stimulus value before pressing this key, and the marker stimulus value is entered as the segment start value.

[UPPER LIMIT] (LIMU) sets the upper limit value for the start of the segment. If a lower limit is specified, an upper limit must also be defined. If no upper limit is required for a particular measurement, force the upper limit value out of range (for example +500 dB).

When **[UPPER LIMIT]** or **[LOWER LIMIT]** is pressed, all the segments in the table are displayed in terms of upper and lower limits, even if they were defined as delta limits and middle value.

If you attempt to set an upper limit that is lower than the lower limit, or vice versa, both limits will be automatically set to the same value.

[LOWER LIMIT] (LIML) sets the lower limit value for the start of the segment. If an upper limit is specified, a lower limit must also be defined. If no lower limit is required for a particular measurement, force the lower limit value out of range (for example -500 dB).

[DELTA LIMITS] (LIMD) sets the limits an equal amount above and below a specified middle value, instead of setting upper and lower limits separately. This is used in conjunction with **[MIDDLE VALUE]** or **[MARKER → MIDDLE]**, to set limits for testing a device that is specified at a particular value plus or minus an equal tolerance.

For example, a device may be specified at 0 dB ± 3 dB. Enter the delta limits as 3 dB and the middle value as 0 dB.

When **[DELTA LIMITS]** or **[MIDDLE VALUE]** is pressed, all the segments in the table are displayed in these terms, even if they were defined as upper and lower limits.

[MIDDLE VALUE] (LIMM) sets the midpoint for **[DELTA LIMITS]**. It uses the entry controls to set a specified amplitude value vertically centered between the limits.

[MARKER → MIDDLE] (MARKMIDD) sets the midpoint for **[DELTA LIMITS]** using the active marker to set the middle amplitude value of a limit segment. Move the marker to the desired value or device specification, and press this key to make that value the midpoint of the delta limits. The limits are automatically set an equal amount above and below the marker.

[DONE] (SDON) terminates a limit segment definition, and returns to the edit limits menu.

Limit Type Menu

This menu defines the selected limit segment as a sloping line, a flat line, or a single point.

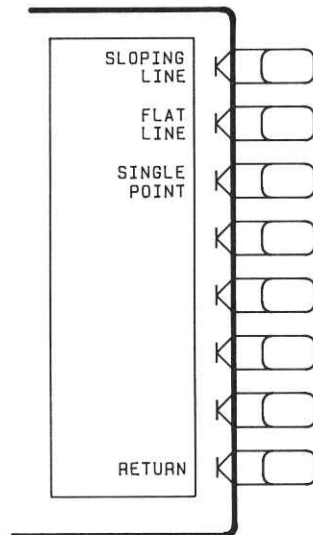

Figure 7-10

[SLOPING LINE] (LIMTSL) defines a sloping limit line segment that is linear with frequency or other stimulus value, and is continuous to the next stimulus value and limit. If a sloping line is the final segment it becomes a flat line terminated at the stop stimulus. A sloping line segment is indicated as SL on the displayed table of limits.

[FLAT LINE] (LIMTFL) defines a flat limit line segment whose value is constant with frequency or other stimulus value. This line is continuous to the next stimulus value, but is not joined to a segment with a different limit value. If a flat line segment is the final segment it terminates at the stop stimulus. A flat line segment is indicated as FL on the table of limits.

[SINGLE POINT] (LIMTSP) sets the limits at a single stimulus point. If limit lines are on, the upper limit value of a single point limit is displayed as ∇ , and the lower limit is displayed as \wedge . A limit test at a single point not terminating a flat or sloped line tests the nearest actual measured data point.

A single point limit can be used as a termination for a flat line or sloping line limit segment. When a single point terminates a sloping line or when it terminates a flat line and has the same limit values as the flat line, the single point is not displayed as ∇ and \wedge . The indication for a single point segment in the displayed table of limits is SP.

[RETURN] goes back to the edit limits menu.

Offset Limits Menu

This menu allows the complete limit set to be offset in either stimulus value or amplitude value. This is useful for changing the limits to correspond with a change in the test setup, or for device specifications that differ in stimulus or amplitude. It can also be used to move the limit lines away from the data trace temporarily for visual examination of trace detail.

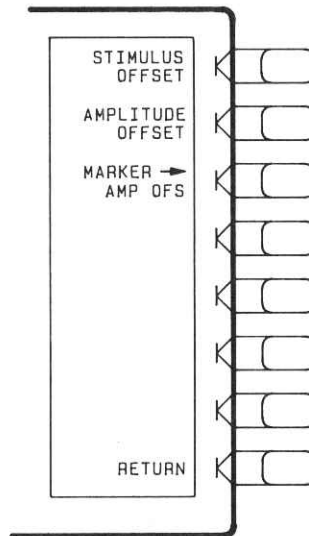

Figure 7-11

[STIMULUS OFFSET] (LIMISTIO) adds or subtracts an offset in stimulus value. This allows limits already defined to be used for testing in a different stimulus range. Use the entry block controls to specify the offset required.

[AMPLITUDE OFFSET] (LIMIAMPO) adds or subtracts an offset in amplitude value. This allows limits already defined to be used for testing at a different response level. For example, if attenuation is added to or removed from a test setup, the limits can be offset an equal amount. Use the entry block controls to specify the offset.

[MARKER → AMP. OFS.] (LIMIMAOF) uses the active marker to set the amplitude offset. Move the marker to the desired middle value of the limits and press this key. The limits are then moved so that they are centered an equal amount above and below the marker at that stimulus value.

[RETURN] goes back to the limits menu.

Chapter 8. Time and Frequency Domain Transforms

INTRODUCTION

With option 010, the HP 8753A can transform frequency domain data to the time domain or time domain data to the frequency domain. In normal operation, the analyzer measures a device under test's (DUT) characteristics as a function of frequency (frequency is the independent variable, and the horizontal display axis is scaled in frequency units). Using a mathematical technique (the Fourier transform), the HP 8753A transforms frequency domain information into the time domain, with **time** as the horizontal display axis. Responses (measured on the vertical axis) now appear separated in time or distance, providing valuable insight into the behavior of the DUT beyond simple frequency characteristics.

NOTE: An HP 8753A can be ordered with option 010, or the option can be added at a later date using the HP 85019A time domain kit.

The transform used by the HP 8753A resembles time domain reflectometry (TDR) measurements. TDR measurements, however, are made by launching an impulse or step into the DUT and observing the response in time with a receiver similar to an oscilloscope. In contrast, the HP 8753A makes swept frequency response measurements, and mathematically transforms the data into a TDR-like display.

The HP 8753A has three frequency to time transform modes:

1. The time domain bandpass mode is designed to measure band-limited devices and is the easiest mode to use. This mode simulates the time domain response to an impulse input.
2. The time domain low pass step mode simulates the time domain response to a step input. As in a traditional TDR measurement, the distance to the discontinuity in the DUT, and the type of discontinuity (resistive, capacitive, inductive) can be determined.
3. The time domain low pass impulse mode simulates the time domain response to an impulse input (like the bandpass mode). Both low pass modes yield better time domain resolution for a given frequency span than does the bandpass mode. In addition, using the low pass modes you can determine the type of discontinuity. However, these modes have certain limitations that are defined in the low pass section of this chapter.

The HP 8753A has one time to frequency transform mode:

1. The forward transform mode transforms CW signals measured over time into the frequency domain, to measure the spectral content of a signal.

In addition to these transform modes, this chapter discusses special transform concepts such as masking, windowing and gating.

GENERAL THEORY

The relationship between the frequency domain response and the time domain response of a network analyzer is defined by the Fourier transform. Because of this transform, it is possible to measure, in the frequency domain, the response of a linear DUT and mathematically calculate the inverse Fourier transform of the data to find the time domain response. The HP 8753A internal computer makes this calculation using the chirp-Z Fourier transform technique. The resulting measurement is the fully error-corrected time domain reflection or transmission response of the DUT, displayed in near real time.

Table 8-1 lists the useful formats for time domain reflection measurements. Time domain transmission measurements are displayed using the linear magnitude or log magnitude formats, as described later in this chapter.

Table 8-1. Time Domain Reflection Formats

Format	Parameter
LIN MAG	Reflection Coefficient (unitless) ($0 < \rho < 1$)
REAL	Reflection Coefficient (unitless) ($-1 < \rho < 1$)
LOG MAG	Return Loss (dB)
SWR	Standing Wave Ratio (unitless)
SMITH CHART	Impedance (ohms)

Figure 8-1 illustrates the frequency and time domain reflection responses of a device. The frequency domain reflection measurement is the composite of all the signals reflected by the discontinuities present in the DUT over the measured frequency range.

NOTE: In this chapter, all points of reflection are referred to as discontinuities.

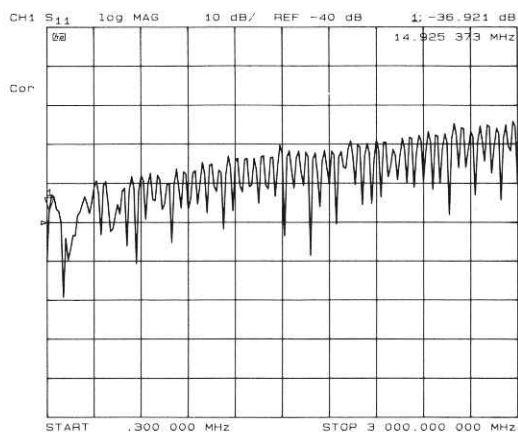

(a) Frequency Domain

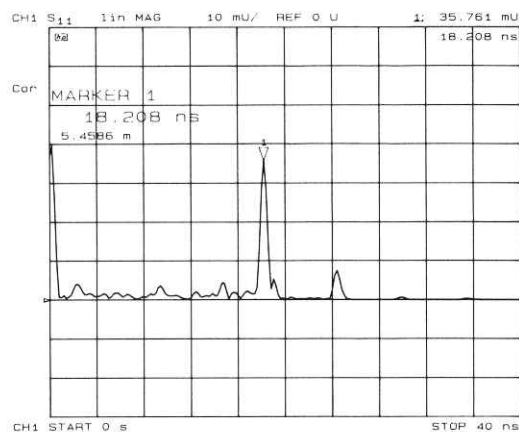

(b) Time Domain Bandpass

Figure 8-1. Device Frequency Domain and Time Domain Reflection Responses

The time domain measurement shows the effect of each discontinuity as a function of time (or distance), and shows that the device response consists of three separate impedance changes. The second discontinuity has a reflection coefficient magnitude of 0.035 (i.e. 3.5% of the incident signal is reflected). Marker 1 on the time domain trace shows the round-trip time to the discontinuity and back to the reference plane (where the calibration standards are connected): 18.2 nanoseconds. The distance shown (5.45 metres) assumes that the signal travels at the speed of light. The signal travels slower than the speed of light in most media (e.g. coax cables). This slower velocity (relative to light) can be compensated for by adjusting the HP 8753A relative velocity factor. This procedure is described later in this chapter.

Figure 8-2 illustrates the transform menu map.

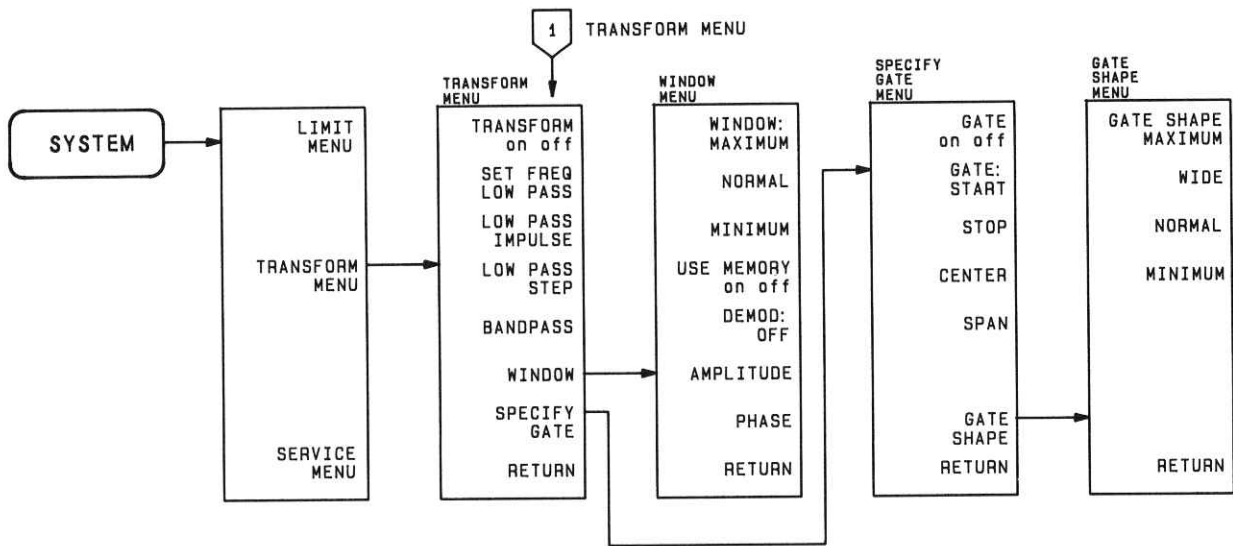

Figure 8-2. The Time Domain Transform Menus

TIME DOMAIN BANDPASS

This mode is called bandpass because it works with band-limited devices. Traditional TDR requires that the DUT be able to operate down to DC. Using bandpass mode, there are no restrictions on the measurement frequency range. Bandpass mode provides the DUT impulse response.

Reflection Measurements Using Bandpass

NOTE: Before making time domain reflection measurements, perform the appropriate calibration.

Example:

1. Press **[PRESET]**.
2. Press **[MEAS] [S11]** and perform an S11 1-port calibration.
3. Connect one or more lengths of cable, with adapters between cable sections, as shown at the top of Figure 8-3.
4. Press **[SYSTEM] [TRANSFORM MENU] [BANDPASS] [TRANSFORM ON]**.
5. Press **[START] [0] [x1]** to select a start time of zero seconds.
6. Press **[STOP] [4] [0] [G/n]** to select a stop time of 40 nanoseconds.

NOTE: In the time domain, the STIMULUS keys (**[START]**, **[STOP]**, **[CENTER]** and **[SPAN]**) refer to time, and can be used to change the horizontal (time) axis of the display, independent of the chosen frequency range. To set the STOP time long enough to let you “see” the end of the cable under test, enter a STOP time of 10 nanoseconds per metre of cable under test. This is a good rule of thumb number that accounts for the approximate round trip time for most cables.

7. Press **[FORMAT] [LIN MAG]** for a display of reflection coefficient versus time (or distance).
8. Press **[SCALE REF] [AUTOSCALE]**.

Figure 8-3 shows the typical frequency and time domain responses of the reflection measurement of two sections of cable.

The ripples in reflection coefficient versus frequency in the frequency domain measurement are caused by the reflections at each connector “beating” against each other.

One at a time, loosen the connectors at each end of the cable and observe the response in both the frequency domain and the time domain. The frequency domain ripples grow as each connector is loosened, corresponding to a larger reflection adding in and out of phase with the other reflections. The time domain responses grow as you loosen the connector that corresponds to each response.

Interpreting the Bandpass Reflection Response Horizontal Axis. In bandpass reflection measurements, the horizontal axis represents the time it takes for an impulse launched at the test port to reach a discontinuity and to return (the two-way travel time). In Figure 8-3, each connector is a discontinuity.

Interpreting the Bandpass Reflection Response Vertical Axis. The quantity displayed on the vertical axis depends on the selected format. The default format is LOG MAG (logarithmic magnitude), which displays the return loss in decibels (dB). LIN MAG (linear magnitude) is a format that displays the response as reflection coefficient (ρ). This can be thought of as an average reflection coefficient of the discontinuity over the frequency range of the measurement. Use the REAL format only in low pass mode. The five common formats are listed in Table 8-1.

NOTE: In the Smith chart format, use the markers to read impedance ($R + jX$) versus time or distance to the discontinuity.

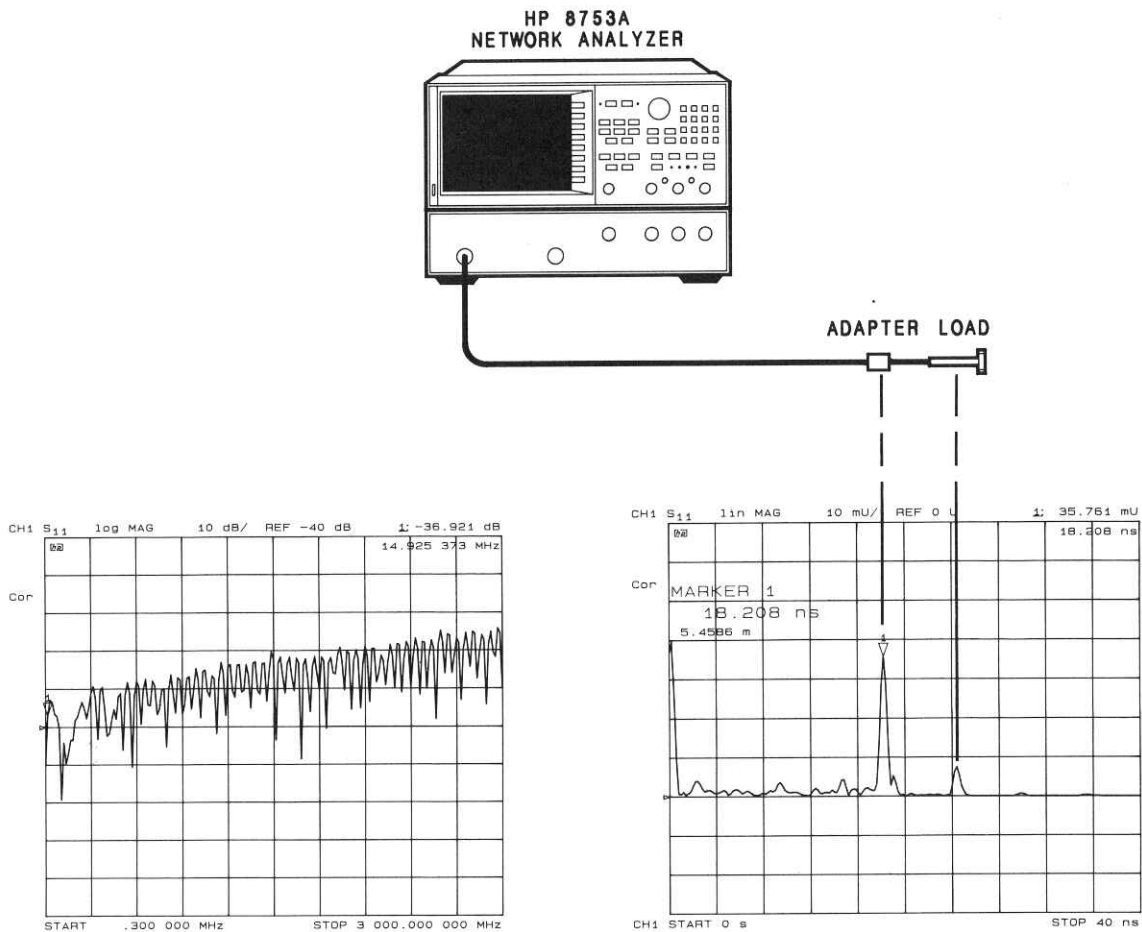

(a) Frequency Domain

(b) Time Domain Bandpass

Figure 8-3. A Reflection Measurement of Two Cables

Adjusting the Relative Velocity Factor

A marker provides both the time (x2) and the electrical length (x2) to a discontinuity. To determine the physical length, rather than the electrical length, change the velocity factor to that of the medium under test:

1. Press [CAL] [MORE] [VELOCITY FACTOR].
2. Enter a velocity factor between 0 and 1.0 (1.0 corresponds to the speed of light in a vacuum). Most cables have a velocity factor of 0.66 (polyethylene dielectrics) or 0.70 (teflon dielectrics).

NOTE: To cause the markers to read the actual one-way distance to a discontinuity, rather than the round trip distance, enter one-half the actual velocity factor.

Transmission Measurements Using Bandpass

The bandpass mode can also transform transmission measurements to the time domain. For example, use this mode to separate the direct and the indirect transmission paths between two antennas.

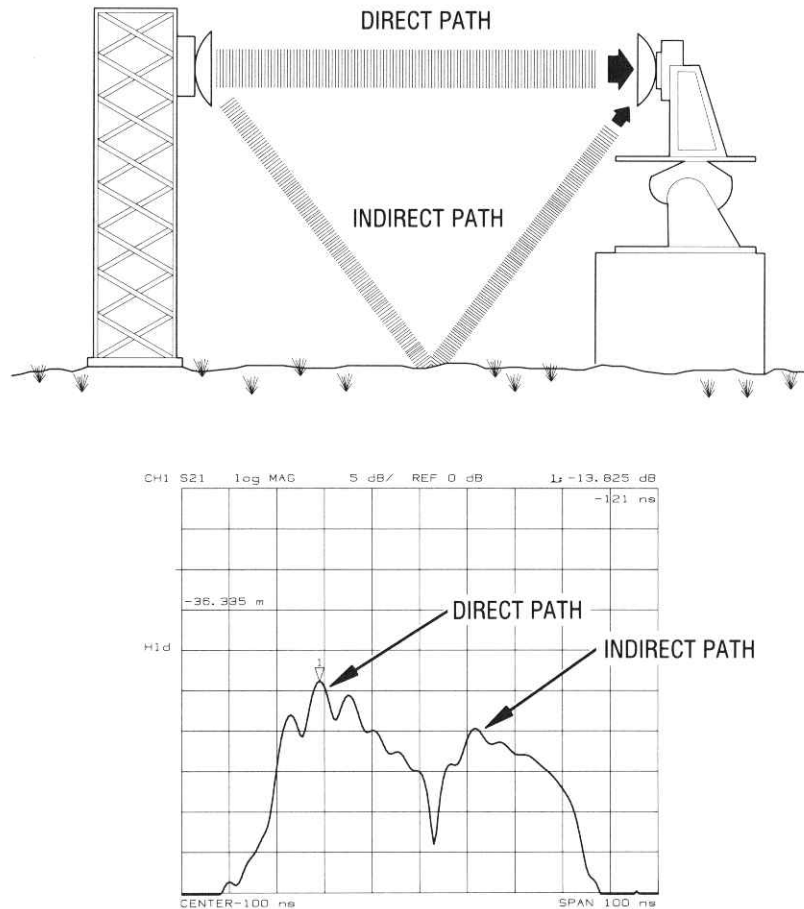

Figure 8-4. Transmission Measurement in Time Domain Bandpass

Interpreting the Bandpass Transmission Response Horizontal Axis. In time domain transmission measurements, the horizontal axis is displayed in units of time. The response of the thru connection used in the calibration is an impulse at time = 0, of unit height (antenna range thru connections require long cables). The actual antenna measurement is displayed relative to the transmission time and the loss of the thru calibration. The time axis indicates the propagation delay between the two antennas. Note that in time domain transmission measurements, the value displayed is the actual delay (not $\times 2$). The marker provides the propagation delay in both time and distance.

Interpreting the Bandpass Transmission Response Vertical Axis. In the log magnitude format, the vertical axis displays the transmission loss or gain in dB; in the linear magnitude format it displays the transmission coefficient (τ). Think of this as an average of the transmission response over the measurement frequency range.

TIME DOMAIN LOW PASS

This mode is used to simulate a traditional time domain reflectometry (TDR) measurement. It gives the user information to determine the type of discontinuity (resistive, capacitive or inductive) that is present. Low pass provides the best resolution for a given bandwidth in the frequency domain. It may be used to give either the step or impulse response of the DUT.

The low pass mode is less general purpose than the bandpass mode because it places strict limitations on the measurement frequency range. The low pass mode requires that the frequency domain data points are harmonically related from DC to the stop frequency. That is, $\text{stop} = n \times \text{start}$ ($n =$ number of points). The DC frequency response is extrapolated from the low frequency data. The requirement to pass DC is the same limitation that exists for traditional TDR.

Setting Frequency Range for Time Domain Low Pass

Before making a low pass mode measurement, ensure that the measurement frequency range meets the $\text{stop} = n \times \text{start}$ requirement mentioned above. The HP 8753A automatically sets the start and stop frequencies to meet this requirement when the **[SET FREQ LOW PASS]** key is pressed. For example, if the stop frequency is 201 MHz and if $n = 201$ points, the HP 8753A sets the start frequency to 1.0 MHz. For convenience in setting the sweep frequency before beginning a calibration, this softkey is in the transform menu and in the calibration menu.

NOTE: If the start and stop frequencies do not conform to the low pass requirement before either low pass mode is selected, the analyzer sets the start and stop frequencies, but because the calibration frequency range is changed, error correction is turned off.

Press **[SET FREQ LOW PASS]** to set the stop frequency as close as possible to the value you entered; the start frequency is set equal to stop/n . For example, if you select 201 points across the display and a stop frequency of 201,000,205 Hz, when you press **[SET FREQ LOW PASS]** the start frequency changes to 1,000,001 Hz and the stop frequency changes to 201,000,201 Hz.

The lowest HP 8753A measurement frequency is 300 kHz. Because of this, for each value of n there is a minimum allowable stop frequency that can be used. That is, the minimum stop frequency $= n \times 300$ kHz. Table 8-2 lists the minimum frequency range that can be used for each value of n when making low pass time domain measurements.

Table 8-2. Minimum Frequency Ranges for Time Domain Low Pass

Number of Points	Minimum Frequency Range
3	300 kHz to 0.9 MHz
10	300 kHz to 3.0 MHz
26	300 kHz to 7.8 MHz
51	300 kHz to 15.3 MHz
101	300 kHz to 30.3 MHz
201	300 kHz to 60.3 MHz
401	300 kHz to 120.3 MHz
801	300 kHz to 240.3 MHz
1601	300 kHz to 480.3 MHz

Reflection Measurements in Time Domain Low Pass

To make measurements in the low pass mode:

1. Press **[PRESET]**.
2. Press **[MEAS] [S11]**.
3. Press **[CAL] [CALIBRATE MENU] [SET FREQ LOW PASS]** and perform an S11 1-port calibration.
4. Connect one or more lengths of cable, with adapters between cable sections. Leave the last cable unterminated (open).
5. Press **[SYSTEM] [TRANSFORM MENU] [LOW PASS STEP] [TRANSFORM ON]**.
6. Press **[START] [0] [x1]** to select a start time of zero seconds.
7. Press **[STOP] [4] [0] [G/n]** to select a stop time of 40 nanoseconds.

NOTE: In the time domain, the STIMULUS keys (**[START]**, **[STOP]**, **[CENTER]** and **[SPAN]**) refer to time, and can be used to change the horizontal (time) axis of the display, independent of the chosen frequency range. To set the STOP time long enough to let you “see” the end of the cable under test, enter a STOP time of 10 nanoseconds per metre of cable under test. This is a good rule of thumb number that accounts for the approximate round trip time for most cables.

8. Press **[FORMAT] [REAL] [SCALE REF] [AUTOSCALE]** to view the step response, as shown in Figure 8-5.
9. Press **[SYSTEM] [TRANSFORM MENU] [LOW PASS IMPULSE] [SCALE REF] [AUTOSCALE]** to view the impulse response, also shown in Figure 8-5.
10. Connect a short circuit to the unterminated cable. Repeat steps 5 and 9 to view the difference between the low pass step response and the low pass impulse response.

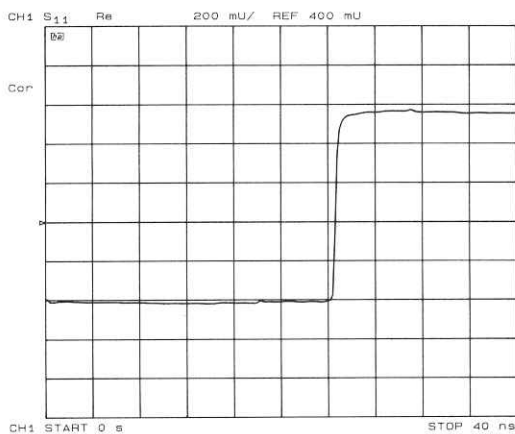

(a) Low Pass Step

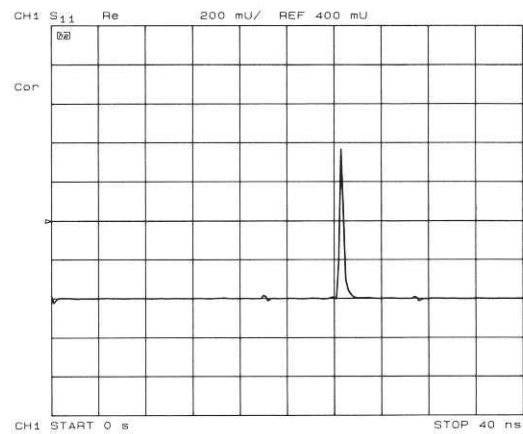

(b) Low Pass Impulse

Figure 8-5. Time Domain Low Pass Measurements of an Unterminated Cable

Interpreting the Low Pass Response Horizontal Axis. The low pass measurement horizontal axis is the two-way travel time to the discontinuity (as in the bandpass mode). Also, the marker displays both the two-way time and the electrical length along the trace. To determine the actual physical length, enter the appropriate velocity factor as described earlier in this chapter under "Adjusting the Relative Velocity Factor."

Interpreting the Low Pass Response Vertical Axis. The vertical axis depends on the chosen format. In the low pass mode, the frequency domain data is taken at harmonically related frequencies and extrapolated to DC. Because this results in the inverse Fourier transform having only a real part (the imaginary part is zero), the most useful low pass step mode format in this application is the real format. It displays the response in reflection coefficient units. This mode is similar to the traditional TDR response, which displays the reflected signal in a real format (volts) versus time (or distance) on the horizontal axis.

The real format can also be used in the low pass impulse mode, but for the best dynamic range for simultaneously viewing large and small discontinuities, use the log magnitude format.

Fault Location Measurements Using Low Pass

As described, the low pass mode can simulate the TDR response of the device under test. This response contains information useful in determining the type of discontinuity present. Review the low pass responses of known discontinuities as shown in Figure 8-6. Each circuit element was simulated to show the corresponding low pass time domain S11 response waveform. The low pass mode gives the device response either to a step or to an impulse stimulus. Mathematically, the low pass impulse stimulus is the derivative of the step stimulus.

Figure 8-7 shows example cables with discontinuities (faults) using the low pass step mode with the real format.

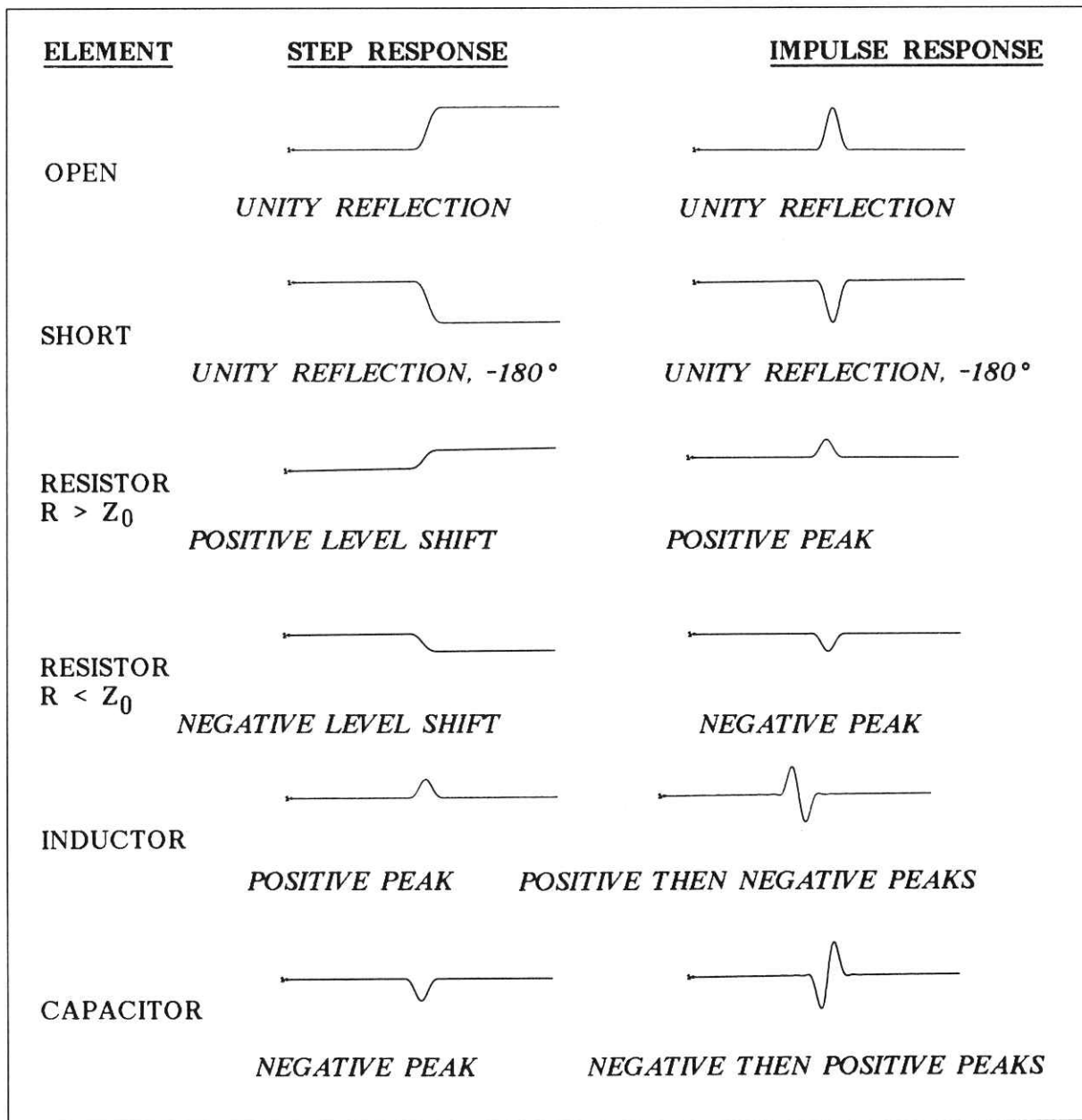
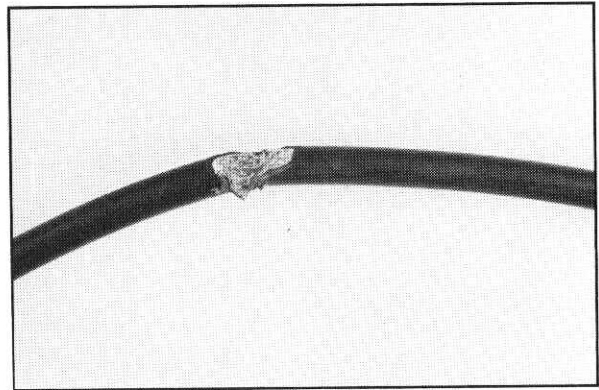
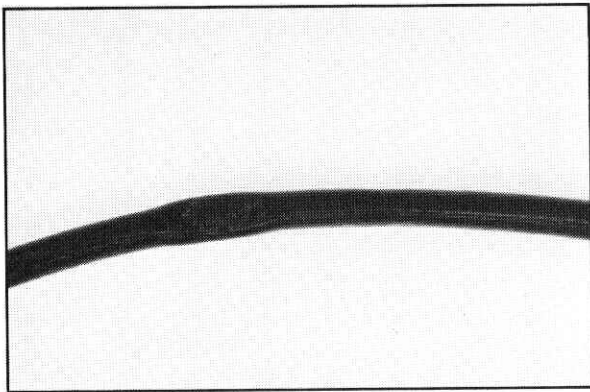
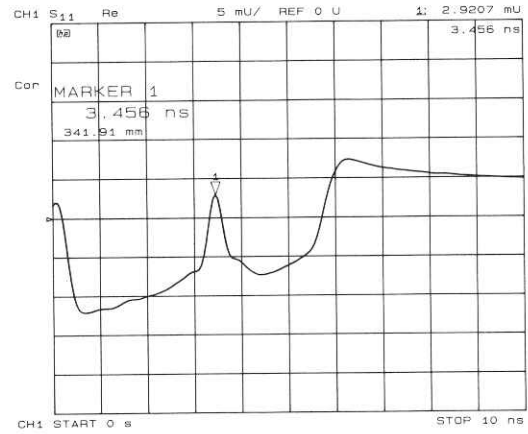
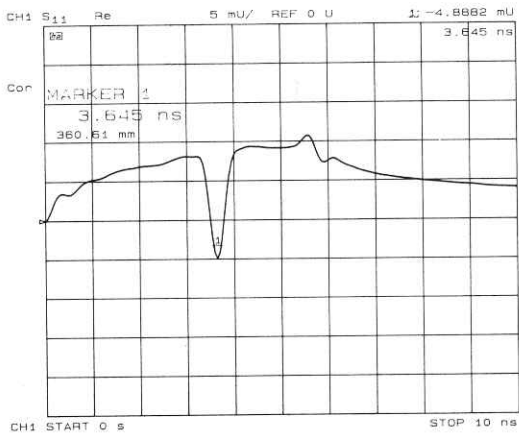

Figure 8-6. Simulated Low Pass Step and Impulse Response Waveforms (Real Format)



(a) Crimped Cable (Capacitive)

(b) Frayed Cable (Inductive)

Figure 8-7. Low Pass Step Measurements of Common Cable Faults (Real Format)

Transmission Measurements in Time Domain Low Pass

Measuring Small Signal Transient Response Using Low Pass Step. Use the low pass mode to analyze the DUT small signal transient response. The transmission response of a device to a step input is often measured at lower frequencies, with a function generator (to provide the step to the DUT) and sampling oscilloscope (to analyze the DUT output response). The low pass step mode extends the frequency range of this type of measurement to 3 GHz.

The step input shown in Figure 8-8 is actually the inverse Fourier transform of the frequency domain response of a thru measured at calibration. The step rise time is proportional to the highest frequency in the frequency domain sweep; the higher the frequency, the faster the rise time. The frequency sweep in Figure 8-8 is from 10 MHz to 1 GHz.

Figure 8-8 also illustrates the time domain low pass response of an amplifier under test. The average group delay over the measurement frequency range is the difference in time between the step and the amplifier response. This time domain response simulates an oscilloscope measurement of the amplifier's small signal transient response. Note the ringing in the amplifier response that indicates an underdamped design.

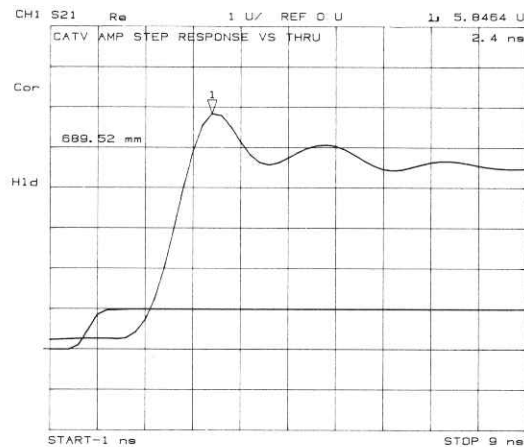

Figure 8-8. Time Domain Low Pass Measurement of an Amplifier Small Signal Transient Response

Interpreting the Low Pass Step Transmission Response Horizontal Axis. The low pass transmission measurement horizontal axis displays the average transit time through the device over the frequency range used in the measurement. The response of the thru connection used in the calibration is a step that reaches 50% unit height at time = 0. The rise time is determined by the highest frequency used in the frequency domain measurement. The step is a unit high step, which indicates no loss for the thru calibration. When a device is inserted, the time axis indicates the propagation delay or electrical length of the device. The markers read the electrical delay in both time and distance. The distance can be scaled by an appropriate velocity factor as described earlier in this chapter under "Adjusting the Relative Velocity Factor."

Interpreting the Low Pass Step Transmission Response Vertical Axis. In the real format, the vertical axis displays the transmission response in real units (e.g. volts). For the amplifier example in Figure 8-8, if the amplifier input is a step of 1 volt, the output, 2.4 nanoseconds after the step (indicated by marker 1), is 5.84 volts.

In the log magnitude format, the amplifier gain is the steady state value displayed after the initial transients die out.

Measuring Separate Transmission Paths Through the DUT Using Low Pass Impulse mode. The low pass impulse mode can be used to identify the different transmission paths through DUTs that have a response at frequencies down to DC (or at least have a predictable response, above the noise floor, below 300 kHz). For example, use the low pass impulse mode to measure the relative transmission times through a multipath device such as a power divider. Another example is to measure the pulse dispersion through a broadband transmission line, such as a fiber optic cable. Both examples are illustrated in Figure 8-9. The horizontal and vertical axes can be interpreted as already described in this chapter in "Transmission Measurements Using Bandpass".

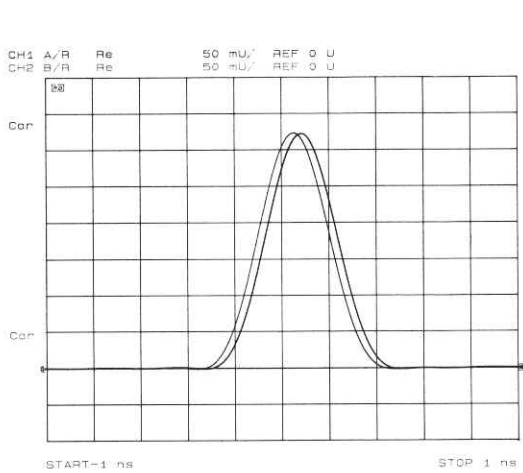

(a) Comparing Transmission Paths through a Power Divider

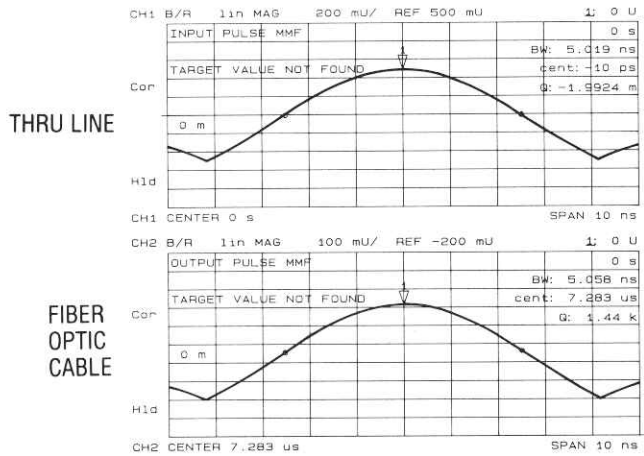

(b) Measuring Pulse Dispersion on a 1.5 km Fiber Optic Cable

Figure 8-9. Transmission Measurements Using Low Pass Impulse

TIME DOMAIN CONCEPTS

Masking

Masking occurs when a discontinuity (fault) closest to the reference plane affects the response of each subsequent discontinuity. This happens because the energy reflected from the first discontinuity never reaches subsequent discontinuities. For example, if a transmission line has two discontinuities that each reflect 50% of the incident voltage ($\rho = .50$), the time domain response (real format) shows the correct reflection coefficient for the first discontinuity ($\rho = .50$), but the second discontinuity appears as a 25% reflection ($\rho = .25$) because only half the incident voltage reached the second discontinuity.

NOTE: This example assumes a lossless transmission line. Real transmission lines, with non-zero loss, attenuate signals as a function of the distance from the reference plane.

As an example of masking due to line loss, consider the time domain response of a 3 dB attenuator and a short circuit. The impulse response (log magnitude format) of the short circuit alone (Figure 8-10) shows a return loss of 0 dB, but the response of the short circuit placed at the end of the 3 dB attenuator displays a return loss of -6 dB. This value actually represents the forward and return path loss through the attenuator, and illustrates how a lossy network can affect the responses that follow it.

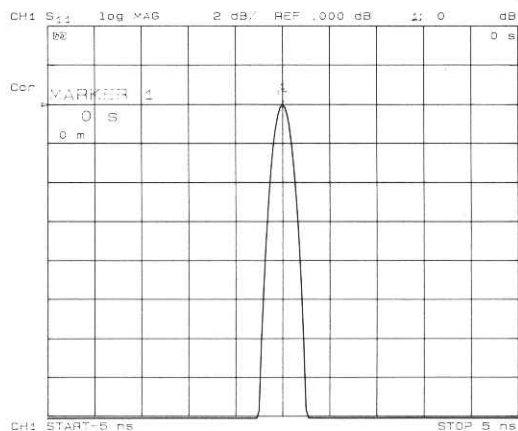

(a). Short Circuit

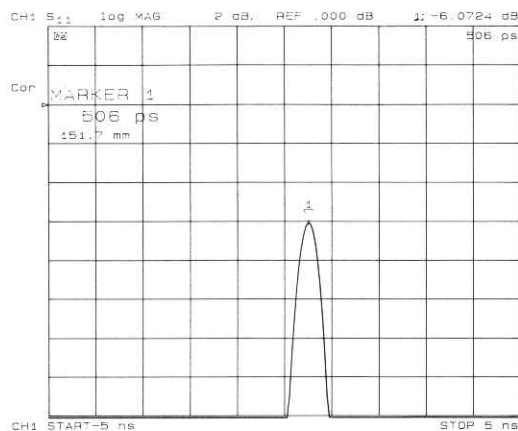

(b). Short Circuit at the end of a 3 dB Pad

Figure 8-10. Masking Example

Windowing

The HP 8753A windowing feature enhances time domain measurements. Windowing is needed because of the abrupt transitions in a frequency domain measurement at the start and stop frequencies. The band limiting of a frequency domain response causes overshoot and ringing in a time domain response, and causes a non-windowed impulse stimulus to have a $\sin(kt)/kt$ shape, where $k=\pi/\text{frequency span}$ (see Figure 8-11). This has two effects that limit the usefulness of the time domain measurement:

1. Finite impulse width (or rise time). This limits the ability to resolve between two closely spaced responses. The effects of the finite impulse width cannot be improved without increasing the frequency span of the measurement (see Table 8-3).
2. Sidelobes. The impulse sidelobes limit the dynamic range of the time domain measurement by hiding low-level responses within the sidelobes of higher level responses. The effects of sidelobes can be improved by windowing (see Table 8-3).

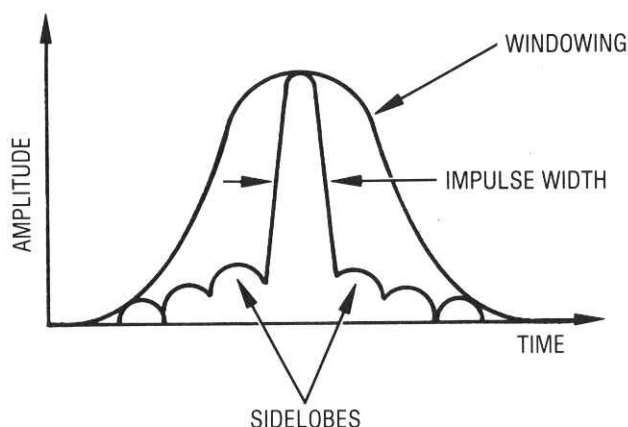

Figure 8-11. Impulse Width, Sidelobes, and Windowing

Windowing improves the dynamic range of a time domain measurement by filtering the frequency domain data prior to converting it to the time domain, which produces an impulse stimulus that has lower sidelobes. This makes it much easier to see time domain responses that are very different in magnitude. The sidelobe reduction is achieved, however, at the expense of increased impulse width. The effect of windowing on the step stimulus (low pass mode only) is a reduction of overshoot and ringing at the expense of increased rise time.

To select a window, press **[SYSTEM] [TRANSFORM MENU] [WINDOW]**. Three windows are selectable using the analyzer softkeys (see Table 8-3).

Table 8-3. Impulse Width, Sidelobe, and Windowing Values

Window Type	Impulse Sidelobe Level	Low Pass Impulse Width (50%)	Step Sidelobe Level	Step Rise Time (10 – 90%)
Minimum	–13 dB	1.20/Freq Span	–21 dB	0.45/Freq Span
Normal	–44 dB	1.92/Freq Span	–60 dB	0.99/Freq Span
Maximum	–90 dB	2.88/Freq Span	–90 dB	1.48/Freq Span

NOTE: The bandpass mode simulates an impulse stimulus. Bandpass impulse width is twice that of lowpass impulse width. The bandpass impulse sidelobe levels are the same as lowpass impulse sidelobe levels.

Choose one of the three window shapes listed above. You can use the knob to select any windowing pulse width (or rise time for a step stimulus) between the softkey values. The time domain stimulus sidelobe levels depend only on the window selected (Table 8-3).

[MINIMUM] is essentially no window. Consequently, it gives the highest sidelobes.

[NORMAL] (selected by **[PRESET]**) gives reduced sidelobes and is the mode most often used.

[MAXIMUM] window gives the minimum sidelobes, providing the most dynamic range.

The purpose of windowing is to make a time domain response more useful for isolating and identifying individual responses. The window is turned on only when a time domain response is viewed, and does not affect a displayed frequency domain response. Figure 8-12 shows the typical effects of windowing on the time domain response of a short circuit reflection measurement.

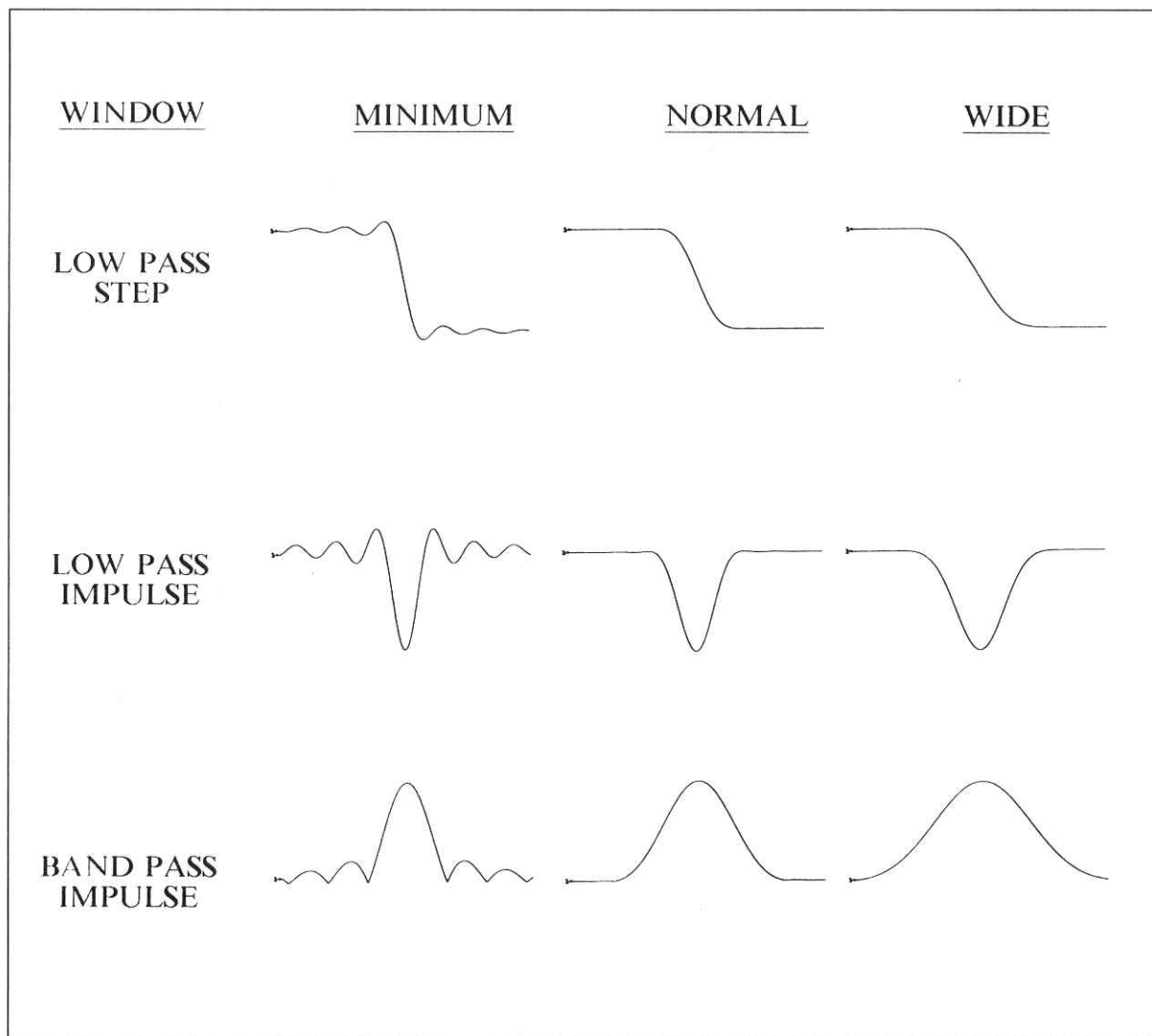

Figure 8-12. The Effects of Windowing on the Time Domain Responses of a Short Circuit

Range

In the time domain, range is defined as the length in time that a measurement can be made without encountering a repetition of the response, called aliasing. A time domain response repeats at regular intervals because the frequency domain data is taken at discrete frequency points, rather than continuously over the frequency band.

Measurement range is equal to $1/\Delta F$ (ΔF is the spacing between frequency data points). Measurement range = (Number of Points - 1)/Frequency Span (Hz).

Example:

Measurement = 201 points
1 MHz to 2.001 GHz

$$\begin{aligned}\text{Range} &= 1/\Delta F \text{ or } (\text{Number of Points} - 1)/\text{Frequency Span} \\ &= 1/(10 \times 10^6) \text{ or } (201 - 1)/(2 \times 10^9) \\ &= 100 \times 10^{-9} \text{ seconds}\end{aligned}$$

The electrical length:

$$\begin{aligned}&= \text{range} \times \text{the speed of light } (3 \times 10^8 \text{ m/s}) \\ &= (100 \times 10^{-9} \text{ s}) \times (3 \times 10^8 \text{ m/s}) \\ &= 30 \text{ metres}\end{aligned}$$

In this example, the range is 100 ns, or 30 metres electrical length. To prevent the time domain responses from overlapping, the DUT must be 30 metres or less in electrical length for a transmission measurement (15 metres for a reflection measurement). The HP 8753A limits the stop time to prevent the display of aliased responses.

To increase the time domain measurement range, first increase the number of points, but remember that as the number of points increases, the sweep speed decreases. Decreasing the frequency span also increases range, but reduces resolution.

Resolution

In the time domain, there are two different resolution terms:

1. Response Resolution
2. Range Resolution

Response Resolution. Time domain response resolution is defined as the ability to resolve two closely-spaced responses, or how close two responses can be to each other and still be distinguished from each other. For responses of equal amplitude, the response resolution is equal to the 50% (-6 dB) impulse width. It is inversely proportional to the measurement frequency span, and is also a function of the window used in the transform. The approximate formulas for calculating the 50% impulse width are given in Table 8-3.

For example, using the formula for the bandpass mode with a normal windowing function for a 1 MHz to 3.001 GHz measurement (3 GHz span):

The 50% calculated impulse width:

$$\begin{aligned}&= 1.2 \times (1/3 \text{ GHz}) \times 1.6 \\ &= 0.64 \text{ nanoseconds}\end{aligned}$$

The electrical length:
(in air)

$$\begin{aligned}&= (0.64 \times 10^{-9} \text{ s}) \times (30 \times 10^9 \text{ cm/s}) \\ &= 19.2 \text{ centimetres}\end{aligned}$$

With this measurement, two equal responses can be distinguished when they are separated by at least 19.2 centimetres.

Using the low pass mode (the low pass frequencies are slightly different) with a minimum windowing function, you can distinguish two equal responses that are about 6 centimetres or more apart.

For reflection measurements, which measure the round trip time to the response, divide the response resolution by two. Using the example above, you can distinguish two faults of equal magnitude provided they are 3 centimetres (electrical length) or more apart.

NOTE: Remember, to determine the physical length, enter the relative velocity factor of the transmission medium under test.

For example, a cable with a teflon dielectric (0.7 relative velocity factor), measured under the conditions stated above, has a fault location measurement response resolution of 2.1 centimetres. This is the maximum fault location response resolution. Factors such as reduced frequency span, greater frequency domain data windowing, and a large discontinuity shadowing the response of a smaller discontinuity, all act to degrade the effective response resolution.

Figure 8-13 illustrates the effects of response resolution. The solid line shows the actual reflection measurement of two approximately equal discontinuities (the input and output of an SMA barrel). The dashed line shows the approximate effect of each discontinuity, if they could be measured separately.

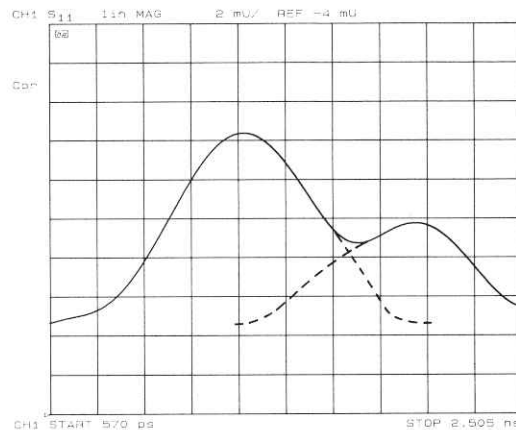

Figure 8-13. Response Resolution

While increasing the frequency span increases the response resolution, keep the following points in mind:

1. The time domain response noise floor is directly related to the frequency domain data noise floor. Because of this, if the frequency domain data points are taken at or below the measurement noise floor, the time domain measurement noise floor is degraded.
2. The time domain measurement is an average of the response over the frequency range of the measurement; if the frequency domain data is measured out-of-band, the time domain measurement is also the out-of-band response.

You may (with these limitations in mind) choose to use a frequency span that is wider than the DUT bandwidth to achieve better resolution.

Range Resolution. Time domain range resolution is defined as the ability to locate a single response in time. If only one response is present, range resolution is how closely you can pinpoint the peak of that response. The range resolution is equal to the digital resolution of the display, which is the time domain span divided by the number of points on the display. To get the maximum range resolution, center the response on the display and reduce the time domain span. Because of this, the range resolution is always much finer than the response resolution.

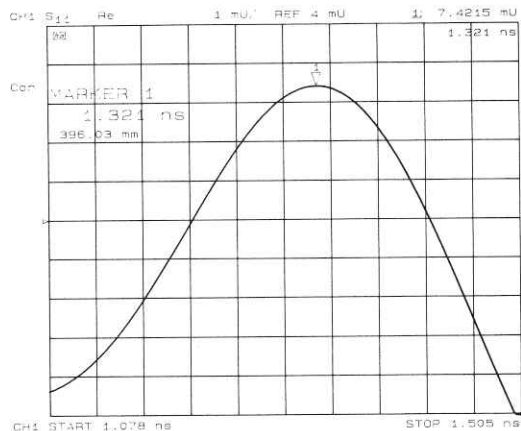
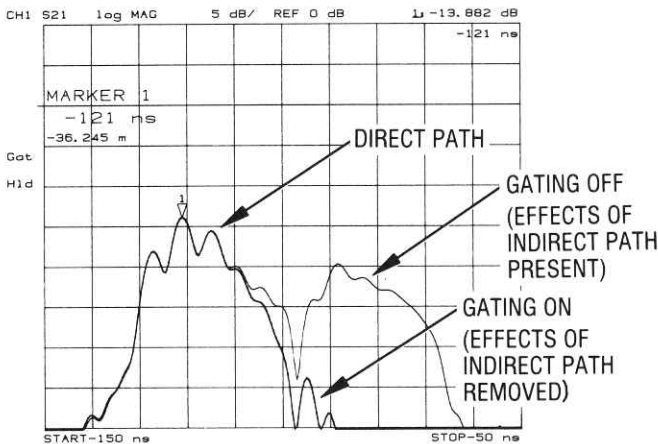
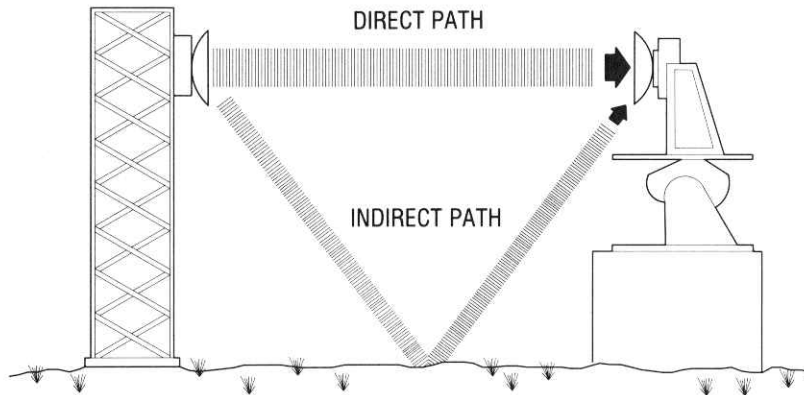

Figure 8-14. Range Resolution of a Single Discontinuity

Gating

Gating provides the flexibility of selectively removing time domain responses. The gated time domain responses can then be transformed back to the frequency domain. For reflection (or fault location) measurements, use this feature to remove the effects of unwanted discontinuities in the time domain. You can then view the frequency response of the remaining discontinuities. In a transmission measurement, you can remove the effects of multiple transmission paths.

Figure 8-15 illustrates the time domain response of an antenna. Gating has been applied to remove the effects of the unwanted response to the ground reflection. With the gate on, only the main (desired) transmission path remains. When the gated response is transformed back to the frequency domain, the display shows the direct path response of the antenna network alone. You would see this response if the antenna was in a perfect anechoic chamber.



(a) Time Domain

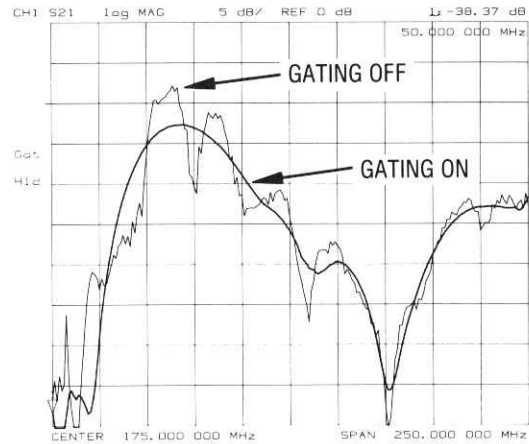

(b) Frequency Domain

Figure 8-15. Antenna Network Transmission Measurement with Gating

Setting the Gate. Think of a gate as a bandpass filter in the time domain (Figure 8-16). When the gate is on, responses outside the gate are mathematically removed from the time domain trace. Enter the gate position as a start and stop time (not frequency) or as a center and span time. The start and stop times are the bandpass filter -6 dB cutoff times. Gates can have a negative span, in which case, the responses **inside** the gate are mathematically removed.

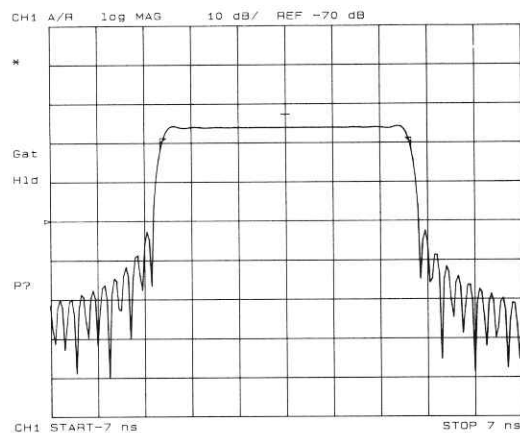

Figure 8-16. Gate Shape

Selecting Gate Shape. The four gate shapes available are listed in Table 8-4. Each gate has a different passband flatness, cutoff rate, and sidelobe levels.

Table 8-4. Gate Characteristics

Gate Shape	Passband Ripple	Sidelobe Levels	Cutoff Time	Minimum Gate Span
Minimum	± 0.40 dB	-24 dB	0.6/Freq Span	1.2/Freq Span
Normal	± 0.04 dB	-45 dB	1.4/Freq Span	2.8/Freq Span
Wide	± 0.02 dB	-52 dB	4.0/Freq Span	8.0/Freq Span
Maximum	± 0.01 dB	-80 dB	11.2/Freq Span	22.4/Freq Span

NOTE: With 1601 frequency points, gating is available only in the bandpass mode.

The passband ripple and sidelobe levels are descriptive of the gate shape. The cutoff time is the time between the stop time (-6 dB on the filter skirt) and the peak of the first sidelobe, and is equal on the left and right side skirts of the filter. Because the minimum gate span has no passband, it is just twice the cutoff time. Always choose a gate span wider than the minimum. For most applications, do not be concerned about the minimum gate span, simply use the knob to position the gate markers around the desired portion of the time domain trace.

TRANSFORMING CW TIME MEASUREMENTS INTO THE FREQUENCY DOMAIN

The HP 8753A can display the amplitude and phase of continuous wave (CW) signals versus time. For example, use this mode for measurements such as amplifier gain as a function of warm-up time (i.e. drift). In the past, drift measurements were often made using strip chart recorders. The HP 8753A can display the measured parameter (e.g. amplifier gain) for periods of up to 24 hours and then output the data to a digital plotter for hardcopy results.

These "strip chart" plots are actually measurements as a function of time (time is the independent variable), and the horizontal display axis is scaled in time units. Transforms of these measurements result in frequency domain data. Such transforms are called forward transforms because the transform from time to frequency is a forward Fourier transform, and can be used to measure the spectral content of a CW signal. For example, when transformed into the frequency domain, a pure CW signal measured over time appears as a single frequency spike (Figure 8-18). The transform into the frequency domain yields a display that looks similar to a spectrum analyzer display of signal amplitude versus frequency.

Forward Transform Measurements

To make measurements using the Fourier transform in the forward direction (from time domain to frequency domain):

1. Press **[PRESET]**.
2. Press **[MEAS]** and select the desired measurement (e.g. A, B, or a ratioed measurement)
3. Press **[MENU] [CW FREQ]**.
4. Set the frequency to the desired value (e.g. center 250 MHz).
5. Press **[SWEEP TYPE MENU]**. The **[CW TIME]** sweep mode is active.
6. Using the **[STOP]** key, enter the time over which you wish to take data (up to 24 hours), and take the sweep.
7. Press **[SYSTEM] [TRANSFORM MENU] [TRANSFORM ON]**.
8. Using **[SPAN]**, set the desired frequency span. The maximum span is 4000 Hz for the default sweep time (100 ms) and number of points (201). The center frequency is the CW frequency entered earlier.

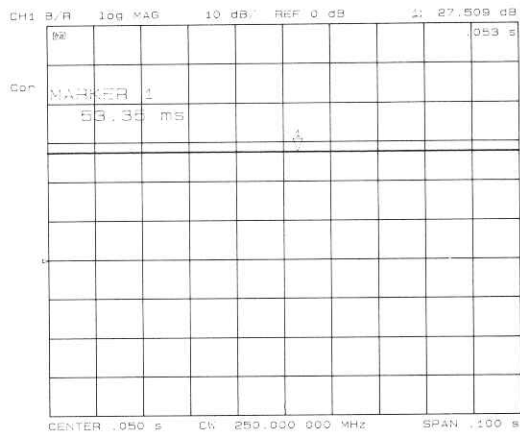

(a) CW Time

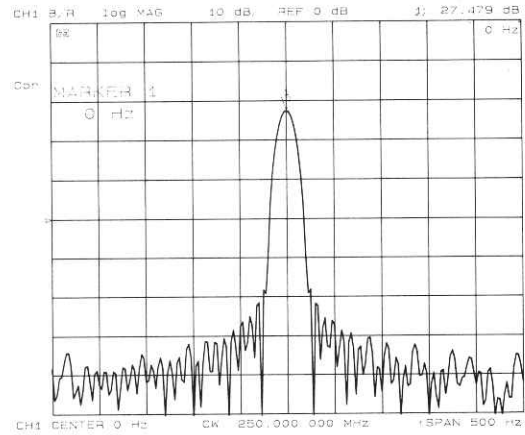

(b) Transform to Frequency Domain

Figure 8-17. Amplifier Gain Measurement

Interpreting the Forward Transform Horizontal Axis. In a frequency domain transform of a CW time measurement, the horizontal axis is measured in units of frequency. This axis has a maximum span of 4 kHz (2 kHz on either side of the CW frequency). The center frequency (with zero offset) is the frequency of the CW time measurement. For example, if you enter a center frequency value of 0 Hz with the transform on, the center of the display shows the CW frequency (250 MHz in the example on the previous page). A positive center frequency value entered with the transform on shifts the CW frequency to the left half of the display; a negative value shifts it to the right half of the display. The span value entered with the transform on is the total frequency span shown on the display. Alternatively, the frequency display values can be entered as start and stop.

Interpreting the Forward Transform Vertical Axis. With the log magnitude format selected, the vertical axis displays dB. Use this format to simulate a spectrum analyzer display. When making a single channel measurement, the HP 8753A displays the absolute power versus frequency.

Demodulating the Results of the Forward Transform

The forward transform can separate the effects of the CW frequency modulation amplitude and phase components. For example, if the DUT modulates the transmission response (S21) with a 500 Hz AM signal, you can see the effects of that modulation (Figure 8-18). To simulate this effect, connect a 500 Hz sine wave to the HP 8753A rear panel EXT AM input.

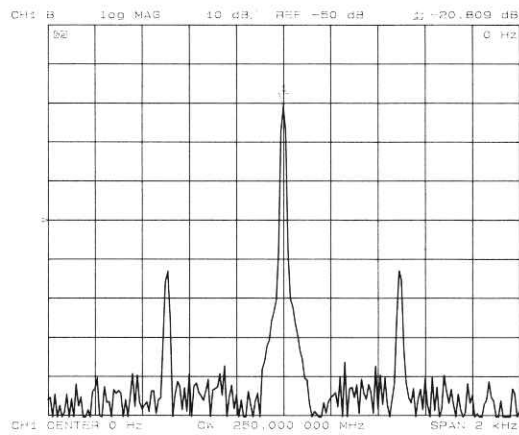

(a) Combined Effects of Amplitude and Phase Modulation

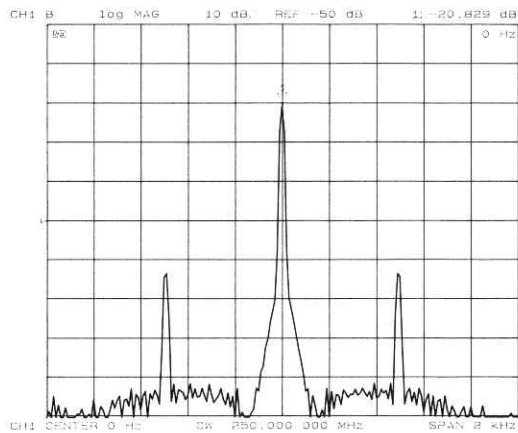

(b) Amplitude Modulation Component

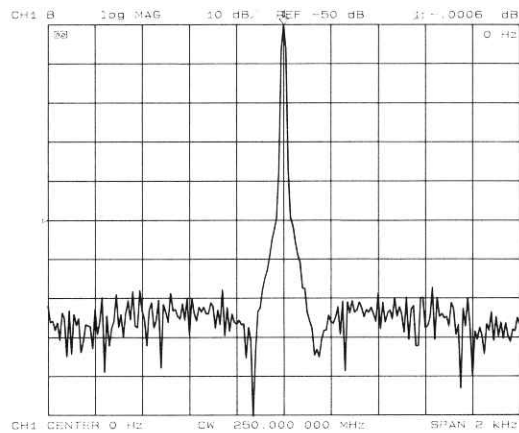

(c) Phase Modulation Component

Figure 8-18. Measuring the Amplitude and Phase Components of DUT-Induced Modulation

Forward Transform Range

In the forward transform (from CW time to the frequency domain), range is defined as the frequency span that can be displayed before aliasing occurs, and is similar to range as defined for time domain measurements. In the range formula, substitute time span for frequency span.

Example:

$$\begin{aligned}\text{Range} &= (\text{Number of points} - 1)/\text{Time Span} \\ &= (201 - 1)/(200 \times 10^{-3}) \\ &= 1000 \text{ Hertz}\end{aligned}$$

For the example given above, a 201 point CW time measurement made over a 200ms time span, choose a span of 1 kHz or less on either side of the center frequency (Figure 8-19). That is, choose a total span of 2 kHz or less.

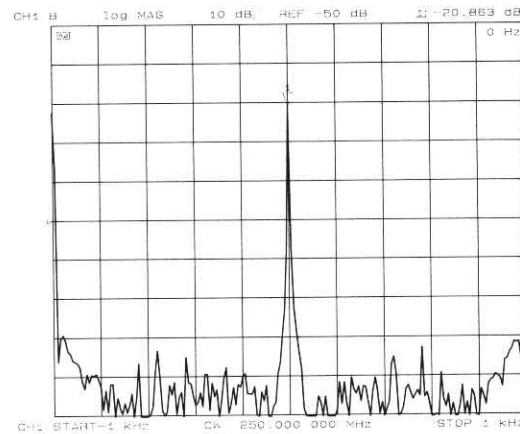

Figure 8-19. Range of a Forward Transform Measurement

To increase the frequency domain measurement range, increase the number of points or decrease the sweep time. Because increasing the number of points increases the sweep time, the maximum range is 2 kHz on either side of the selected CW time measurement center frequency (4 kHz total span). To display a total frequency span of 4 kHz, enter the span as 4000 Hz. The k/m, M/ μ , and G/n keys terminate a selection as millihertz, microhertz, and nanohertz.

Chapter 9. Making a Hard Copy Output

The HP 8753A can use HP-IB to output measurement results directly to a compatible printer or plotter, without the use of an external controller. All displayed information can be plotted to a compatible Hewlett-Packard plotter. Either tables or plots can be copied to a compatible Hewlett-Packard graphics printer. Refer to the General Information and Specifications section of this manual for information about compatible plotters and printers.

To generate a plot or printout from the front panel when there is no other controller on the bus, the HP 8753A must be in system controller HP-IB mode. To take control from the computer and initiate a plot or printout, the HP 8753A must be in pass control mode. If it is not in one of these modes, the message "CHANGE HP-IB to SYS CTRL or PASS CTRL" is displayed. Refer to "[LOCAL] Key" in chapter 7 and to chapter 11 for information on HP-IB controller modes and setting addresses.

[COPY] KEY

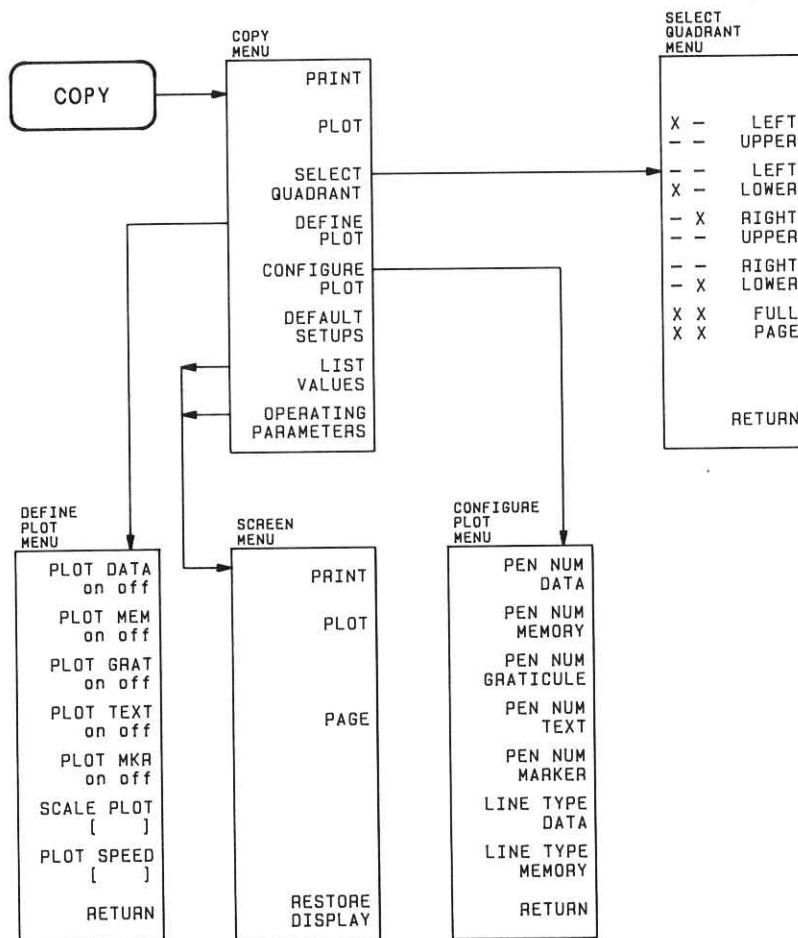

Figure 9-1. Softkey Menus Accessed from the [COPY] Key

The **[COPY]** key provides access to the menus used to control external plotters and printers, and to define the plot parameters.

Copy Menu

The copy menu can be used to copy to a printer or to plot using default plot parameters, without the need to access other menus. For user-defined plot parameters, a series of additional menus is available.

This menu also provides tables of operating parameters and measured data values, which can be copied from the screen to a printer or plotter.

To abort a plot or print, press any front panel key except **[PRESET]**. The HP 8753A will stop the copying process, and the message "CAUTION: PRINT (PLOT) ABORTED" will be displayed. An aborted plot or printout cannot be continued: if a copy is still required, the process should be initiated again.

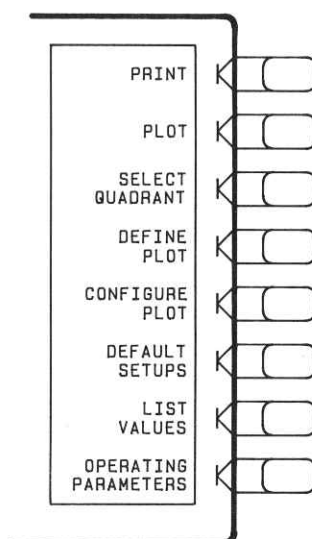

Figure 9-2

[PRINT] (PRINALL) copies the CRT display to a compatible HP graphics printer. Tabular listings or data displays can be printed, although a plotter provides better resolution for data displays. All information from the display is printed except the softkey labels.

[PLOT] (PLOT) plots the CRT display to a compatible HP graphics plotter, using the currently defined plot parameters (or default parameters). Any or all displayed information can be plotted, except the softkey labels. If a printer is not available, tabular listings can be plotted, although plotting is considerably slower than printing.

[SELECT QUADRANT] leads to the select quadrant menu, which provides the capability of quarter-page plots. This is not used for printing.

[DEFINE PLOT] leads to the define plot menu, which is used to specify which elements of the display are to be plotted. This is not used for printing.

[CONFIGURE PLOT] leads to the configure plot menu, which defines the pen number and line type for each of the plot elements. This is not used for printing.

[DEFAULT SETUP] (DFLT) resets the plotting parameters to their default values. These defaults are as follows:

Select quadrant	Full page
Define plot	All plot elements on
Plot scale	Full
Plot speed	Fast
Line type	7 (solid line)
Pen numbers	Default values

Default setups do not apply to printing.

[LIST VALUES] (LISV) provides a tabular listing of all the measured data points and their current values, together with limit information if it is turned on. At the same time, the screen menu is presented, to enable hard copy listings and access new pages of the table. 30 lines of data are listed on each page, and the number of pages is determined by the number of measurement points specified in the stimulus menu.

Up to five columns of data are provided. The specific information listed for each measured data point varies depending on the display format, the limit testing status, and whether or not dual channel display or stimulus coupling is selected. If limit testing is on, an asterisk * is listed next to any measured value that is out of limits. If limit lines are on, and other listed data allows sufficient space, the limits are listed together with the margin by which the device data passes or fails the nearest limit.

[OPERATING PARAMETERS] (OPEP) provides a tabular listing on the CRT of the key parameters for both HP 8753A channels, and presents the screen menu. Four pages of information are supplied. The first two pages list operating parameters. The third page lists marker parameters. The fourth page lists system parameters that relate to control of peripheral devices rather than selection of measurement parameters.

Select Quadrant Menu

This menu offers the selection of a full-page plot, or a quarter-page plot in any quadrant of the page.

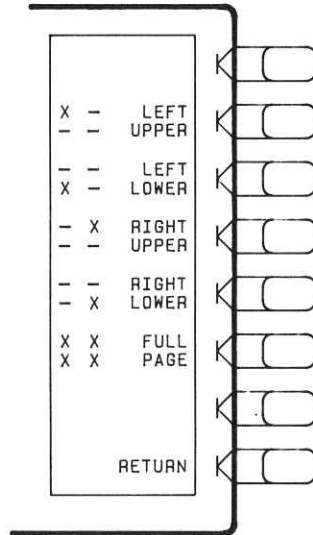

Figure 9-3

[LEFT UPPER] (LEFU) draws a quarter-page plot in the upper left quadrant of the page.

[LEFT LOWER] (LEFL) draws a quarter-page plot in the lower left quadrant of the page.

[RIGHT UPPER] (RIGU) draws a quarter-page plot in the upper right quadrant of the page.

[RIGHT LOWER] (RIGL) draws a quarter-page plot in the lower right quadrant of the page.

[FULL PAGE] (FULP) draws a full-size plot according to the scale defined with **[SCALE PLOT]** in the define plot menu.

[RETURN] goes back to the copy menu.

Define Plot Menu

This menu allows selective plotting of portions of the measurement display. Different plot elements can be turned on or off as required. In addition, different selections are available for plot speed and plot scale, to allow plotting on transparencies and preprinted forms.

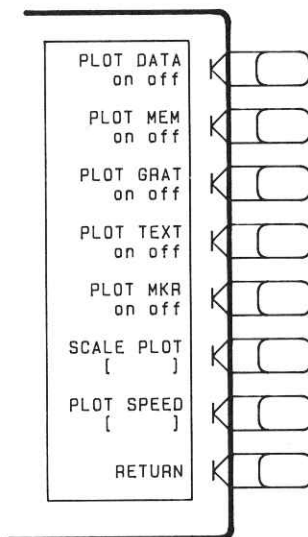

Figure 9-4

[PLOT DATA on off] (PDATAON, PDATAOFF) specifies whether the data trace is to be drawn (on) or not drawn (off) on the plot.

[PLOT MEM on off] (PMEON, PMEMOFF) specifies whether the memory trace is to be drawn (on) or not drawn (off) on the plot. Memory can only be plotted if it is displayed (refer to "DISPLAY Menu" in chapter 4).

[PLOT GRAT on off] (PGRATON, PGRATOFF) specifies whether the graticule and the reference line are to be drawn (on) or not drawn (off) on the plot. Turning **[PLOT GRAT ON]** and all other elements off is a convenient way to make preplotted grid forms. However, when data is to be plotted on a preplotted form, **[PLOT GRAT OFF]** should be selected.

[PLOT TEXT on off] (PTEXTON, PTEXTOFF) selects plotting of all displayed text except softkeys and marker values. (Softkey labels can be plotted from an external controller – refer to chapter 11.)

[PLOT MKR on off] (PMKRON, PMKROFF) specifies whether the markers and marker values are to be drawn (on) or not drawn (off) on the plot.

[SCALE PLOT] (SCAPFULL, SCAPGRAT) provides two selections for plot scale, **[FULL]** and **[GRAT]**. **[FULL]** is the normal scale selection for plotting on blank paper, and includes space for all display annotation such as marker values, stimulus values, etc. The entire CRT display fits within the user-defined boundaries of P1 and P2 on the plotter, while maintaining the exact same aspect ratio as the CRT display.

With the selection of **[GRAT]**, the horizontal and vertical scale are expanded or reduced so that the graticule lower left and upper right corners exactly correspond to the user-defined P1 and P2 scaling points on the plotter. This is convenient for plotting on preprinted rectangular or polar forms (for example, on a Smith chart).

To plot on a rectangular preprinted graticule, set P1 of the plotter at the lower left corner of the preprinted graticule, and set P2 at the upper right corner.

To plot on a polar format, set P1 to either the left (or bottom) end point of a diameter and P2 to the right (or top) end point. The HP 8753A will then compute and set new P1 and P2 values to obtain the current circularity. If P1 and P2 are set to within 10% of already being a perfect square, the HP 8753A will not change the boundaries but will distort the circles to fit the user-defined boundaries.

The procedure for plotting on a Smith chart format depends on the plotter capabilities. Some HP plotters have a 90° rotate feature that enables plotting on a portrait (vertical) format rather than a landscape (horizontal) format. Since most Smith charts are printed in portrait format, this rotate feature should be used prior to setting the P1 and P2 points, as described above for a polar format.

[PLOT SPEED] (PLOSFAST, PLOSSLOW) provides two plot speeds, **[FAST]** and **[SLOW]**. Fast is the proper plot speed for normal plotting. Slow plot speed is used for plotting directly on transparencies: the slower speed provides a more consistent line width. A color plot can be prepared directly on a transparency so that the color is not lost in converting a paper plot to a transparency.

[RETURN] goes back to the copy menu.

Configure Plot Menu

This menu is used to select the pens to be used for plotting different elements of a plot, and the line types for the data and memory traces.

Pen numbers 0 through 10 can be selected (0 indicates no pen). It is possible to select a pen number higher than the number of pens in the plotter used. The convention in most Hewlett-Packard plotters is that when the pen number count reaches its maximum number it starts again at 1. Thus in a four-pen plotter, pen #5 actually calls pen #1.

The default pen numbers for the different plot elements vary between channels 1 and 2, so that when a color plotter is used the plots for the two channels can be identified quickly by their colors.

Line types 0 through 10 can be selected. The line types depend on the model of plotter used. In general, however, line type 0 specifies dots only at the points that are plotted; line types 1 through 6 specify broken lines with different spacing; and lines 7 through 10 are solid lines. Refer to the plotter manual for specific line type information.

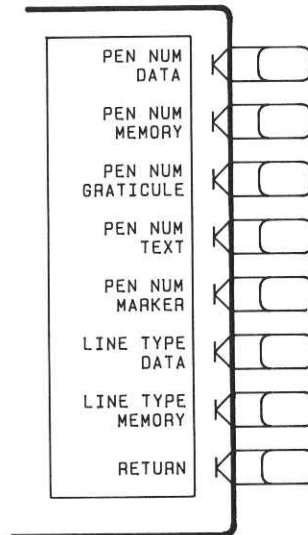

Figure 9-5. Configure Plot Menu

[PEN NUM DATA] (PENNDATA) selects the number of the pen to plot the data trace. The default pen for channel 1 is pen #1, and for channel 2 is pen #2.

[PEN NUM MEMORY] (PENMEMO) selects the number of the pen to plot the memory trace. The default pen for channel 1 is pen #1, and for channel 2 is pen #2.

[PEN NUM GRATICULE] (PENNGRAT) selects the pen number for plotting the graticule. The default pen for channel 1 is pen #3, and for channel 2 is pen #4.

[PEN NUM TEXT] (PENNTXT) selects the pen number for plotting the text. The default pen for channel 1 is pen #1, and for channel 2 is pen #2.

[PEN NUM MARKER] (PENMARK) selects the pen number for plotting both the markers and the marker values. The default pen for channel 1 is pen #5, and for channel 2 is pen #6.

[LINE TYPE DATA] (LINTDATA) selects the line type for the data trace plot. The default line type is 7, which is a solid unbroken line.

[LINE TYPE MEMORY] (LINTMEMO) selects the line type for the memory trace plot. The default line type is 7.

[RETURN] goes back to the copy menu.

Screen Menu

This menu is used in conjunction with the **[LIST VALUES]** and **[OPERATING PARAMETERS]** features, to make hard copy listings of the tables displayed on the screen. To make copies from the front panel, make sure that the HP 8753A is in system controller or pass control mode (see chapter 7).

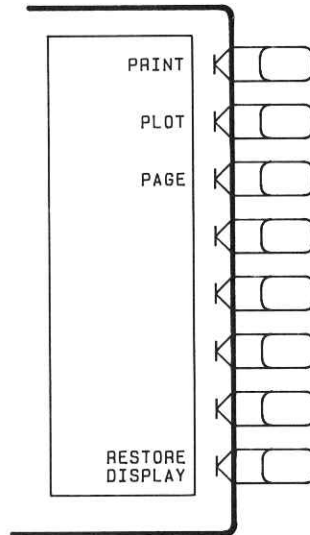

Figure 9-6

[PRINT] (PRINALL) copies one page of the tabular listings to a compatible HP graphics printer connected to the HP 8753A over HP-IB.

[PLOT] (PLOT) makes a hard copy plot of one page of the tabular listing on the CRT, using a compatible HP plotter connected to the HP 8753A through HP-IB. This is much slower than printing.

[PAGE] (NEXP) displays the next page of information in a tabular listing onto the CRT.

[RESTORE DISPLAY] (RESD) turns off the tabular listing and returns the measurement display to the screen.

Chapter 10. Saving Instrument States

INTRODUCTION

The HP 8753A has the capability of saving complete instrument states for later retrieval. It has five internal registers for this purpose, and can use direct disc access as an extension to internal memory. Because instrument states can be of varying complexities, it is possible to fill the available internal memory with less than five states. Also, it is possible to fill memory with instrument states and prevent such memory-intensive functions as two-port error correction, time domain (option 010), or 1601 measurement points.

This chapter discusses instrument state definition, memory allocation, and the treatment of saved calibration data. Refer to chapter 11, HP-IB Remote Programming, for a detailed explanation of external disc storage using an external controller.

The HP 8753A can utilize three types of memory for the storage of instrument states:

- Volatile memory. This is dynamic read/write memory, containing the current instrument state, calibration sets, and the variables listed in table 2. It is cleared upon power cycle to the instrument and, except as noted, upon instrument preset.
- Non-volatile memory. This is CMOS read/write memory, providing short term (minimum 72 hour) storage of data without line power to the instrument.
- External memory. This utilizes disc media for unlimited storage of instrument states, calibration and measurement data.

Table 1. HP 8753A Memory Usage

<p>Non-Volatile Memory Five learn string registers CRT focus and intensity defaults HP-IB configuration User calibration kit definition</p> <p>Volatile Memory (see Table 2) User graphics (500 bytes) Calibration data Current Instrument State Data processing and display</p> <p>External Memory Instrument states Calibration sets Measurement data</p>
--

INSTRUMENT STATES

An instrument state consists of all the stimulus and response parameters that set up the HP 8753A to make a specific measurement. This part of the instrument state is called the learn string and, when saved, is saved to non-volatile memory.

The learn string is an encoded array containing only the data needed to recreate the state. For example, to recreate a frequency list the HP 8753A only needs to save the start frequency, frequency span and number of points in each segment. Each point is not recorded. Thus the size of the learn string is not proportional to the number of points in the sweep.

An instrument state also includes calibration data and memory traces, which do vary in size with the number of points. This data is stored in volatile memory. Note that while calibration and memory trace data will survive an instrument preset, it will be lost when line power to the instrument is turned off.

Calibration sets compete with other instrument processes for volatile memory space. Table 2 contains the memory requirements of calibration arrays and other functions such as list frequency mode and limit testing. As you turn on more functions, it is very likely that more memory space is being used. Use table 2 to approximate free space.

Table 2. HP 8753A User Allocatable Memory (~ 100 KBytes)

Variable	Data Length (bytes)
Calibration Arrays	
Response	$N \times 6 + 52$
Response and Isolation	$N \times 6 \times 2 + 52$
1 Port	$N \times 6 \times 3 + 52$
2 Port	$N \times 6 \times 12 + 52$
Measurement Data	
Raw Data*	$N \times 6 + 52$
Correction Data	$4(N \times 6 + 52)$
2 Port Cal	$N \times 6 + 52$
Data Array*	$N \times 6 + 52$
Formatted Array*	$N \times 6 + 52$
Memory Array*	$N \times 6 + 52$
Scratchpad Array ¹	$N \times 6 + 52$
Display Memory*	
Trace (Data or Memory)	$N \times 2$
(If polar, log frequency, or frequency list mode)	$N \times 4$
Graticule	
Rectangular	196
Semilog	420
Polar	1956
Smith or Inverted Smith	4000
Limit Lines*	32 x number of segments
Operating Modes	
Sampler Correction Arrays ²	$N \times 2$
Smoothing on* (20% aperture, 1601 points)	<2000
Frequency List mode*	$N \times 12$
Log Frequency mode*	$N \times 12$
Time Domain	
FFT Array	
≤51 points	128 x 6
101 points	256 x 6
201 points	512 x 6
401 points	1024 x 6
801 points	2048 x 6
1601 points	2048 x 6
Window & Chirp Array	$N \times 4 + \text{FFT array size}$
Gating Array	$\sim 5/3 \times \text{FFT array size}$

Notes:

N = number of points

* This variable is allocated once per active channel.

¹ Insufficient memory for allocation of this array is not fatal. The array is used to recalculate the data for display anytime formatting factors are changed. If not allocated, trace data will not be redisplayed after a scaling change until a new sweep occurs.

² Not used when error correction is on.

INTERNAL SAVE

A maximum of six instrument states can reside in internal memory at any one time: five saved states and the active instrument state. Calibration sets are linked to the instrument state and measurement parameter for which the calibration was done. Up to 12 calibrations can exist (the actual number may be limited by available memory). When an instrument state is deleted from memory, the associated calibration set is also deleted.

EXTERNAL STORE

With the HP 8753A in system controller mode or pass control mode, it can access an external CS80 disc drive. Storing to external disc records not only the instrument state, but calibration sets and measurement data (see "[**DEFINE STORE**]").

The HP 8753A uses one file name per stored instrument state when communicating with the user via the front panel display. In reality, several files are actually stored to the disc when an instrument state is stored. Thus, when the disc catalog is accessed from a remote system controller, the directory will show several files associated with a particular saved state. See chapter 11, HP-IB Remote Programming, for further information.

If correction is on at the time of an external store, then given certain conditions the calibration set is stored to disc. (Note that inactive calibrations are not stored to disc.) If the active calibration is not titled, a title is generated and used in three places: to internally label the active calibration; as the name of the calibration set file on disc; and referenced in the learn string. If the active calibration is not currently marked "externally stored", the calibration set is then stored to disc. The "externally stored" tag is then applied to the active calibration. In this way, if the same calibration set is active for multiple instrument state saves, duplicate calibration files are not recorded on the disc. The calibration set is stored to disc if either the active calibration title does not appear on the disc or if the "externally stored" tag is not present.

When an instrument state is loaded into the HP 8753A from disc, the learn state is restored first. If correction is on for the restored state, the HP 8753A first searches internal memory for a valid calibration set. (This requires a match between the critical stimulus parameters and calibration title in the learn string and the critical stimulus parameters and calibration title of the calibration set). If a match is found, that calibration set is used. If not, the HP 8753A will attempt to load a calibration set from disc that carries the same title as the one stored for the instrument state. If a match is not found, the message "CAUTION: CALIBRATION REQUIRED" is displayed.

This allows the user to store several instrument states on disc that only utilize one calibration set. That calibration set is loaded from disc upon the initial recall of any of these states. Upon subsequent recall of another of these states, the calibration set is already in memory and does not require reloading. If the user chooses to recalibrate the instrument, the calibration title remains the same. Therefore any of the old instrument states will use the new calibration. If any state is restored to disc, the new calibration set will be written over the old calibration set because it is not marked "externally stored". Or, if a new disc is inserted into the drive and the state is re-stored, the calibration set will again be stored because it will not be found on the disc.

[SAVE] AND [RECALL] KEYS

The [SAVE] key provides access to all the menus used for saving instrument states in internal memory and for storing to external disc. This includes the menus used to define titles for internal registers and external files, to define the content of external files, to initialize discs for storage, and to clear data from the registers or purge files from an external disc.

The [RECALL] key leads to the menus that recall the contents of internal registers, or load files from external disc back into the HP 8753A.

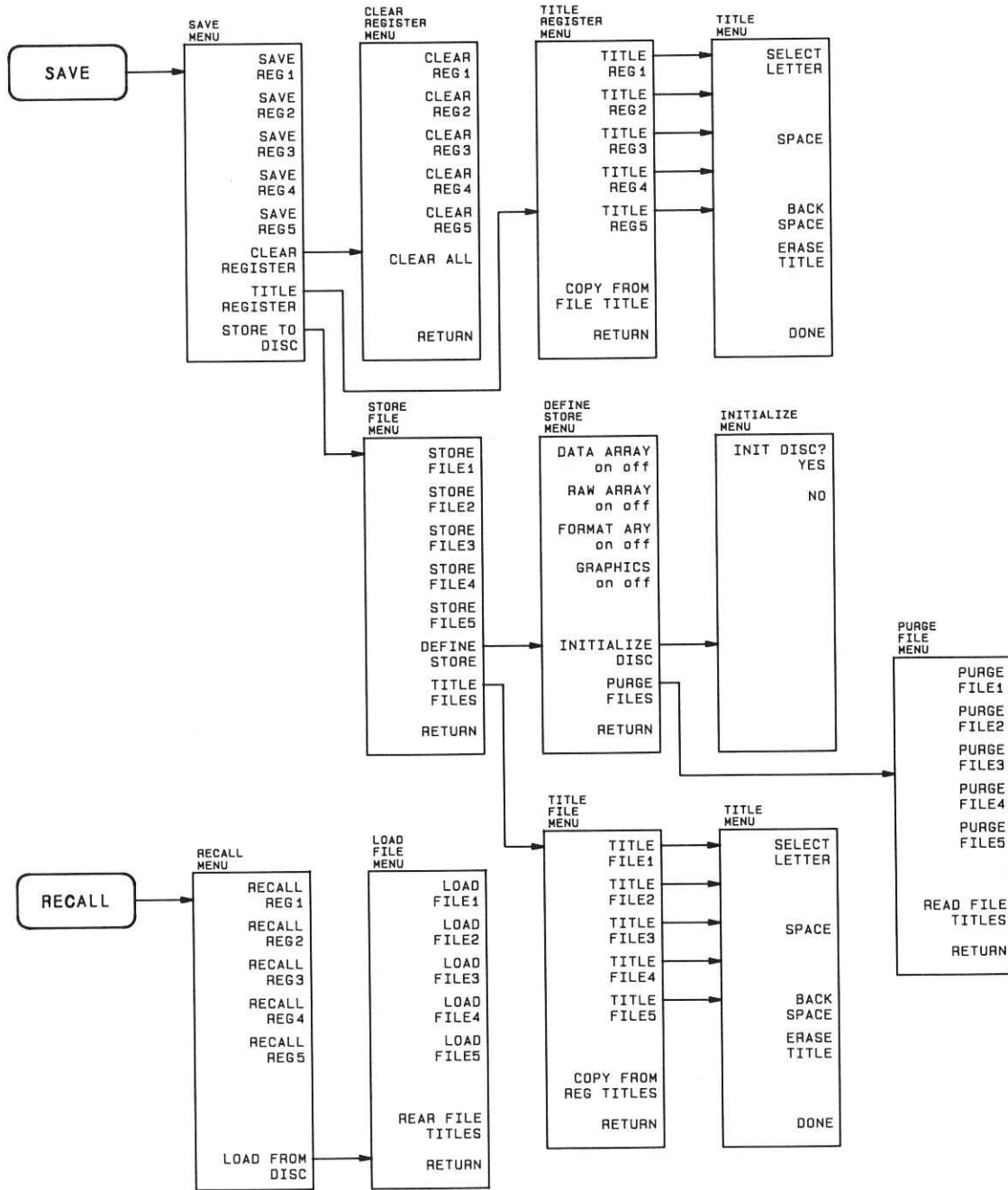

Figure 10-1. Softkey Menus Accessed from the [SAVE] and [RECALL] Keys

Save Menu

This menu selects an internal memory register to store the current instrument state. If a register contains a previously saved instrument state, the softkey label changes to **[RESAVE]**. This is intended to prevent inadvertent destruction of saved states.

This also leads to the series of menus for external disc storage.

The default titles for the save registers are REG1 through REG5, but these titles can be modified using the title register menu and the title menu.

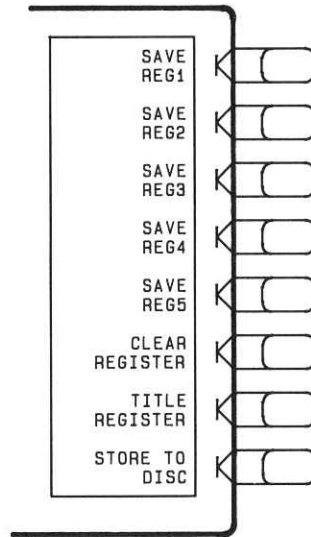

Figure 10-2

[SAVE REG1] (SAVE1) saves the present instrument state in an internal register titled REG1.

[SAVE REG2] (SAVE2) saves the present instrument state in internal register REG2.

[SAVE REG3] (SAVE3) saves the present instrument state in internal register REG3.

[SAVE REG4] (SAVE4) saves the present instrument state in internal register REG4.

[SAVE REG5] (SAVE5) saves the present instrument state in internal register REG5.

[CLEAR REGISTER] leads to the clear register menu, described on the next page.

[TITLE REGISTER] leads to the title register menu, where the default register titles can be modified.

[STORE TO DISC] leads to the store file menu, which introduces a series of menus for external disc storage.

Clear Register Menu

This menu allows unused instrument states to be cleared from save registers, making the assigned memory available for other uses. When an instrument state is deleted from memory, the associated calibration set is also deleted if it is no longer needed by any other state. You can choose to selectively clear individual registers, or clear all registers with one keystroke.

Clearing of registers is performed internally with 100 alternating 0 and 1 rewrite operations over the entire non-volatile portion of the specified register memory.

Only registers that have instrument states previously stored in them are listed in this menu.

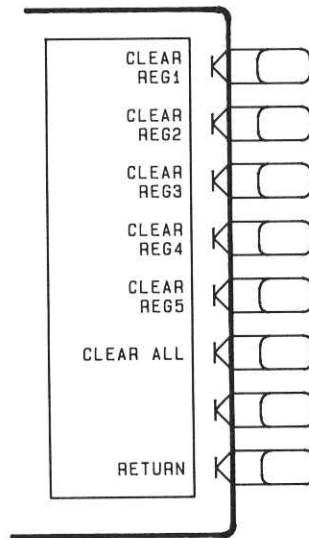

Figure 10-3

[CLEAR REG1] (CLEA1) clears a previously saved instrument state from register 1.

[CLEAR REG2] (CLEA2) clears a saved instrument state from register 2.

[CLEAR REG3] (CLEA3) clears a saved instrument state from register 3.

[CLEAR REG4] (CLEA4) clears a saved instrument state from register 4.

[CLEAR REG5] (CLEA5) clears a saved instrument state from register 5.

[CLEAR ALL] (CLEARALL) clears all instrument states.

[RETURN] goes back to the save menu.

Title Register Menu

This menu can be used to select a register to be retitled. All registers are listed, regardless of whether or not they contain saved instrument states. When any of the title register softkeys is pressed, the title menu is presented and the character set is displayed in the active entry area.

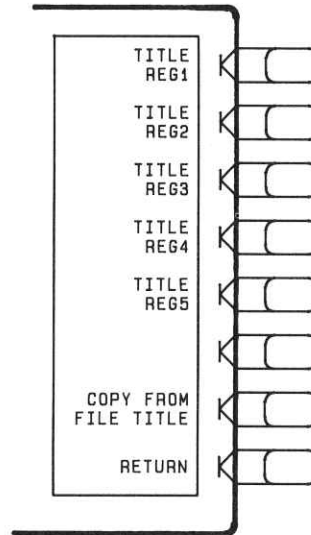

Figure 10-4

[TITLE REG1] (TITR1) selects register 1 to be retitled and presents the title menu and the character set.

[TITLE REG2] (TITR2) selects register 2 to be retitled.

[TITLE REG3] (TITR3) selects register 3 to be retitled.

[TITLE REG4] (TITR4) selects register 4 to be retitled.

[TITLE REG5] (TITR5) selects register 5 to be retitled.

[COPY FROM FILE TITLE] (COPYFRFT) renames the internal registers to match the current names of the store files. For example, the default names of the internal registers are REG1 through REG5. The default names of the store files are FILE1 through FILE5. Pressing this key would rename the internal registers FILE1 through FILE5.

[RETURN] goes back to the save menu.

Title Menu

Use this menu to define a title for the register selected in the title register menu. The title replaces the default register title in the softkey label, and is recalled with the saved instrument state.

This is similar to the menu used to set the display title (described in chapter 4), except that certain restrictions apply. The register title is limited to eight characters. If more than eight characters are selected, the last character is repeatedly written over. The title must be all alpha-numeric, and must start with an alpha character. If the first character selected is not an alpha character, the message "CAUTION: FIRST CHARACTER MUST BE A LETTER" is displayed when the **[DONE]** key is pressed. No special characters or spaces are allowed. If a disallowed character is selected, the message "CAUTION: ONLY LETTERS & NUMBERS ARE ALLOWED" is displayed. (The special characters are used only for the display title.)

The save register title is independent of the display title, which is also saved and recalled as part of the display.

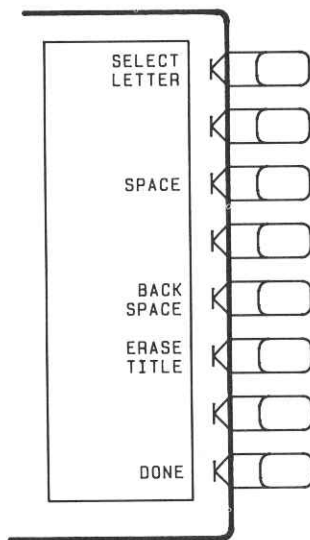

Figure 10-5

[SELECT LETTER]. The active entry area displays the letters of the alphabet, digits 0 through 9, and mathematical symbols. The mathematical symbols are not used in register titles. To define a title, rotate the knob until the arrow \uparrow points at the first letter, then press **[SELECT LETTER]**. Repeat this until the complete title is defined, for a maximum of eight characters. As each character is selected, it is appended to the title at the top left corner of the graticule.

[SPACE]. Do not use this softkey in defining a register title.

[BACK SPACE] deletes the last character entered.

[ERASE TITLE] deletes the entire register title.

[DONE] terminates the title entry, and returns to the title register menu. The new title appears in the softkey label in all applicable menus.

Store File Menu

This menu is used to store instrument states to an external disc rather than to internal memory registers. The HP 8753A can use HP-IB to store directly to a compatible external disc drive, without the use of an external controller. Refer to the General Information and Specifications section of this manual for information about compatible disc drives. Refer to the first part of this chapter for information about disc storage.

To store information on an external disc from the front panel when there is no other controller on the bus, the HP 8753A must be in system controller HP-IB mode. To take control from the computer and initiate a store operation, the HP 8753A must be in pass control mode. If it is not in one of these modes, the message "CHANGE HP-IB to SYS CTRL or PASS CTRL" is displayed. Refer to "[LOCAL] Key" in chapter 7 and to chapter 11 for information on HP-IB controller modes and setting addresses.

If you attempt to store a file and the message "CAUTION: DISC: not on, not connected, wrong addr" is displayed, check the disc drive line power and HP-IB cable connection. Also make sure that the HP-IB address of the disc drive matches the address set in the address menu (see chapter 7 or 11).

The HP 8753A uses one file name per instrument state for communicating with the user via the front panel display. In reality, several files can be actually stored to the disc when an instrument state is saved, depending on the functions being saved. This does not affect operation from the front panel. The default names for the stored files are FILE1 through FILE5. These file names can be modified using the title file menu.

Note that if an instrument state has previously been stored with calibration on, the calibration is remembered and is not stored again, to maximize the storage space available. Refer to "External Store" earlier in this chapter for details.

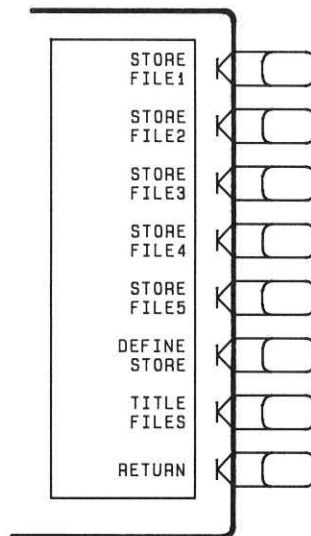

Figure 10-6. Store File Menu

[STORE FILE1] (STOR1) stores the current instrument state in external file 1, together with any data specified in the define store menu (see next page).

[STORE FILE2] (STOR2) stores the current instrument state and specified data in file 2.

[STORE FILE3] (STOR3) stores the current instrument state and specified data in file 3.

[STORE FILE4] (STOR4) stores the current instrument state and specified data in file 4.

[STORE FILE5] (STOR5) stores the current instrument state and specified data in file 5.

[DEFINE STORE] leads to the define store menu. You can use this menu to specify what data is to be stored on disc in addition to the instrument state.

[TITLE FILES] leads to the title file menu, where the default file titles can be modified.

[RETURN] goes back to the save menu.

Define Store Menu

Data and user graphics can be stored on disc along with the basic instrument state. The data can be stored from different points in the data processing flow. It is possible to store raw, error-corrected, or formatted data, or any combination of the three. This menu allows the option of specifying what data is to be stored. Refer to "Data Processing Flow" in chapter 1 for more information about data arrays and the sequence of data processing events.

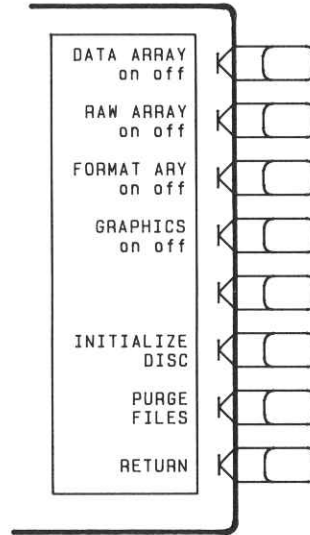

Figure 10-7

[DATA ARRAY on off] (EXTMDATAON, EXTMDATAOFF) specifies whether or not to store the error-corrected data on disc with the instrument state.

[RAW ARRAY on off] (EXTMRAWON, EXTMRAWOFF) specifies whether or not to store the raw data (ratioed and averaged) on disc with the instrument state.

[FORMAT ARY on off] (EXTMFORMON, EXTMFORMOFF) specifies whether or not to store the formatted data on disc with the instrument state.

[GRAPHICS on off] (EXTMGRAPON, EXTMGRAPOFF) specifies whether or not to store display graphics on disc with the instrument state.

[INITIALIZE DISC] (INID) leads to the initialize menu. Before data can be stored on a disc, the disc must be initialized for format compatibility. If you attempt to store without initializing the disc, the message "CAUTION: DISC MEDIUM NOT INITIALIZED" is displayed.

[PURGE FILES] leads to the purge files menu, which is used to purge the information stored on an external disc.

[RETURN] goes back to the store file menu.

Initialize Disc Menu

Initializing a disc prepares it to store data. A disc must be initialized for compatible format before it can be used for storage. This menu initializes discs using LIF (logical interchange format) and CS80 disc hardware protocol. Therefore, a disc initialized by an HP series 200/300 controller, in a CS80 disc drive, will be compatible with the HP 8753A. Only the gray double-sided discs are recommended with the disc drives used for storage.

Initializing a disc removes all existing data. When this menu is presented, the message "INIT DISC removes all data from disc" is displayed. If error messages are encountered, refer to chapter 12, Error Messages, for help.

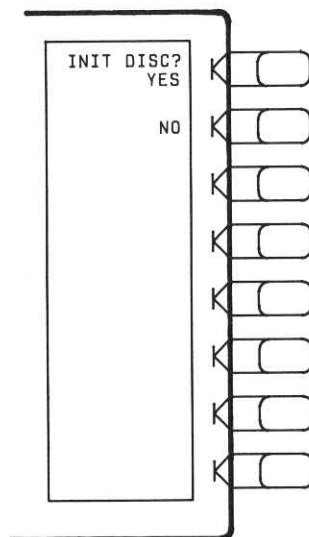

Figure 10-8

[INIT DISC? YES] initializes the disc unit number and volume number selected in the HP-IB menu (see chapter 7). If more than one volume is to be initialized, each volume must be selected and initialized individually.

If the disc is damaged, the message "INITIALIZATION FAILED" is displayed. During the initialization process, the message "WAITING FOR DISC" will be displayed. This is normal.

[NO] leaves this menu without initializing the disc.

Purge File Menu

This menu is used to remove (purge) instrument states from a disc. When the purge file menu is entered, the file titles currently in HP 8753A memory are displayed. (File titles are stored in non-volatile memory.) These titles may or may not reside on the disc currently being used. The file titles can be updated by reading the disc's directory with the **[READ FILE TITLES]** key.

The purge file menu is the disc equivalent of the clear register menu.

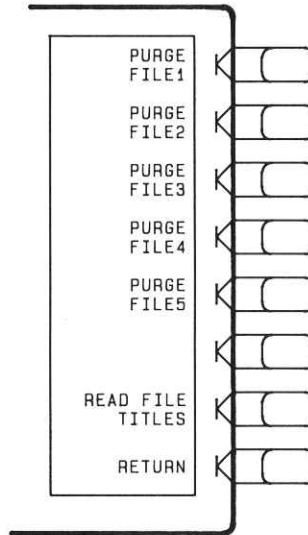

Figure 10-9

[PURGE FILE1] (PURG1) purges FILE1 from disc. If no file of that name exists on the disc, the message "CAUTION: NO FILE(S) FOUND ON DISC" will appear.

[PURGE FILE2] (PURG2) purges FILE2 from disc.

[PURGE FILE3] (PURG3) purges FILE3 from disc.

[PURGE FILE4] (PURG4) purges FILE4 from disc.

[PURGE FILE5] (PURG5) purges FILE5 from disc.

[READ FILE TITLES] (REFT) searches the directory of the disc for file names recognized as belonging to an instrument state. No more than five titles are displayed at one time. If there are more than five, repeatedly pressing this key causes the next five to be displayed. If there are fewer than five, the remaining softkey labels are blanked.

[RETURN] goes back to the define store menu.

Title File Menu

This menu is used to select a disc file to be retitled. When the softkey for the selected file is pressed, the title menu is presented and the character set is displayed in the active entry area. The title menu is described earlier in this chapter. The same restrictions apply to file titles as to internal register titles: that is, a file title is limited to eight characters, must be all alpha-numeric, and must begin with an alpha character.

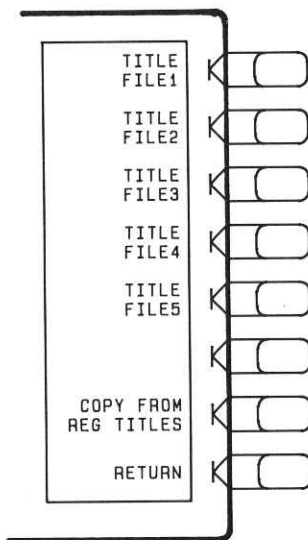

Figure 10-10

[TITLE FILE1] (TITF1) selects file 1 to be retitled, and leads to the title menu.

[TITLE FILE2] (TITF2) selects file 2 to be retitled.

[TITLE FILE3] (TITF3) selects file 3 to be retitled.

[TITLE FILE4] (TITF4) selects file 4 to be retitled.

[TITLE FILE5] (TITF5) selects file 5 to be retitled.

[COPY FROM REG TITLES] renames the store files to match the current names of the internal registers. (It does not alter the names of any files already stored to disc). For example, the default names of the internal registers are REG1 through REG5. The default file names of the store files are FILE1 through FILE5. Pressing this key would rename the store files REG1 through REG5. If you have modified the names of the internal save registers, the modified names would be copied to the store file names.

[RETURN] goes back to the store file menu.

Recall Menu

This menu is used to recall instrument states from internal memory. It is also used to access the load file menu.

When the recall menu is displayed, only the names of those registers containing instrument states are displayed in the top five softkey labels. Any register that does not currently contain a saved instrument state has its softkey label blanked.

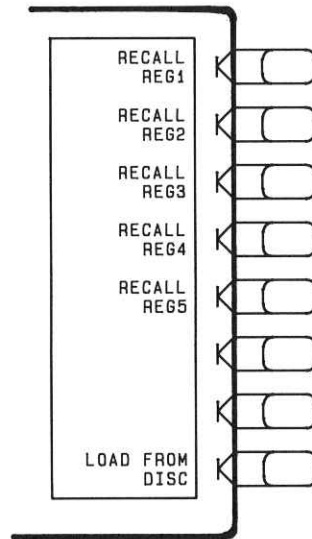

Figure 10-11

[RECALL REG1] (RECA1) recalls the instrument state saved in register 1. The current instrument state is overwritten.

[RECALL REG2] (RECA2) recalls the instrument state saved in register 2.

[RECALL REG3] (RECA3) recalls the instrument state saved in register 3.

[RECALL REG4] (RECA4) recalls the instrument state saved in register 4.

[RECALL REG5] (RECA5) recalls the instrument state saved in register 5.

[LOAD FROM DISC] accesses the load file menu. Use this menu to restore instrument states previously stored to disc.

Load File Menu

This menu is used to search the directory of a floppy disc and to restore instrument states previously stored to that disc.

There are three ways to locate a file on disc.

1. The HP 8753A remembers the names of the last five files it previously found on any disc. (File titles are stored in non-volatile memory.) Therefore, when you enter this menu, the file titles in memory will appear in the top five softkeys, whether or not they reside on the disc currently in the drive.
2. The **[READ FILE TITLES]** key causes the HP 8753A to search the directory of the current disc and display any recognized file titles.
3. From the store file menu, use the **[TITLE FILES]** key to title a store file softkey with the name of the file you want to restore. Return to the load file menu. The title you just created will appear in one of the load file softkey labels. Press that softkey. If the file does not exist, the message "CAUTION: NO FILE(S) FOUND ON DISC" will be displayed. This method is useful only if you know the exact name of the instrument state to be restored. Using **[READ FILE TITLES]** is a more efficient method of finding file names, unless a large number of instrument states have been stored to the disc.

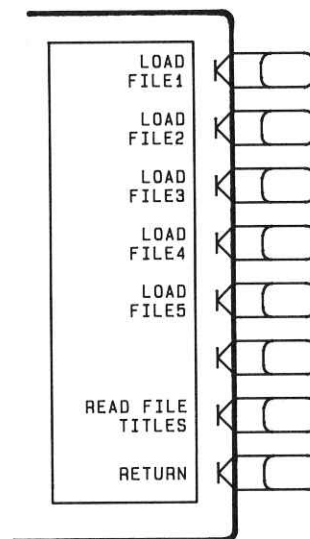

Figure 10-12

[LOAD FILE1] (LOAD1) restores the instrument state contained in FILE1. The current instrument state is overwritten.

[LOAD FILE2] (LOAD2) restores the instrument state contained in FILE2.

[LOAD FILE3] (LOAD3) restores the instrument state contained in FILE3.

[LOAD FILE4] (LOAD4) restores the instrument state contained in FILE4.

[LOAD FILE5] (LOAD5) restores the instrument state contained in FILE5.

[READ FILE TITLES] (REFT) searches the directory of the disc for file names recognized as belonging to an instrument state. No more than five titles are displayed at one time. If there are more than five, repeatedly pressing this key causes the next five to be displayed. If there are fewer than five, the remaining softkey labels are blanked.

[RETURN] goes back to the recall menu.

Chapter 11. HP-IB Remote Programming

INTRODUCTION

The Hewlett-Packard Interface Bus (HP-IB) is a general purpose digital interface system that simplifies the integration of instruments and computers into measurement systems. HP-IB is Hewlett-Packard's implementation of the IEEE Standard 488-1978, ANSI Standard MC1.1, and IEC Standard 625-1. The first part of this chapter is a review of HP-IB fundamentals. For more information regarding the Hewlett-Packard Interface Bus refer to "Tutorial Description of the Hewlett-Packard Interface Bus", HP publication 5952-0156. For more information on the IEEE-488 standard refer to "IEEE Standard Digital Interface for Programmable Instrumentation", published by the Institute of Electrical and Electronics Engineers, Inc., 345 East 47th Street, New York, New York 10017.

This chapter reviews the fundamentals of HP-IB operation and investigates how the HP 8753A is programmed. Programming procedures are developed in a controller-independent manner, although specific examples for HP 9000 series 200 and 300 desktop computers are provided. These examples build on each other, resulting in one larger program that demonstrates many concepts.

HOW HP-IB WORKS

The HP-IB uses a party-line bus structure in which up to 15 devices can be connected on one contiguous bus. The interface consists of 16 signal lines and 8 ground lines in a shielded cable. With this cabling system, many different types of devices including instruments, computers, plotters, printers, and disc drives can be connected in parallel.

Every HP-IB device must be capable of performing one or more of the following interface functions:

Talker

A talker is a device capable of sending device dependent data when addressed to talk. There can be only one talker at any given time. Examples of this type of device are voltmeters, counters, and tape readers. The HP 8753A is a talker when it sends trace data or marker information over the bus.

Listener

A listener is a device capable of receiving device dependent data when addressed to listen. There can be any number of listeners at any given time. Examples of this type of device are printers, power supplies, and signal generators. The HP 8753A is a listener when it is controlled over the bus by a computer.

Controller

A controller is a device capable of managing the operation of the bus and addressing talkers and listeners. There can be only one active controller at any time. Examples of controllers include desktop computers and minicomputers. In a multiple controller system, control can be passed between controllers, but there can only be one *system controller*, which acts as the master, and can regain control at any time. The HP 8753A is a controller when it plots, prints, or accesses an external disc drive in the pass control mode. The HP 8753A is a system controller when it is in the system controller mode. These modes are discussed in more detail in the "Bus Modes" portion of this chapter.

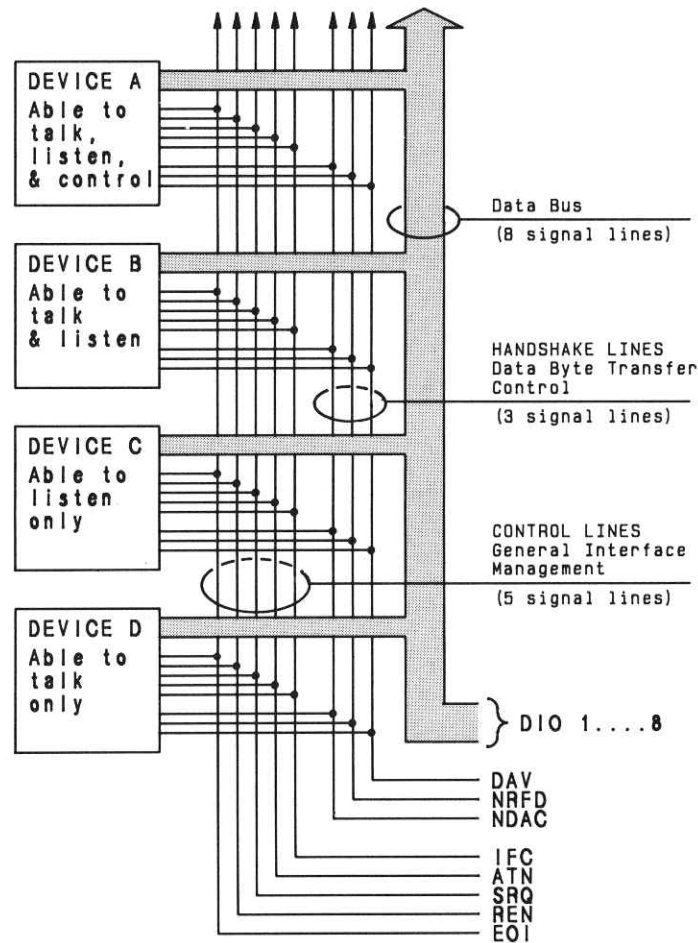

Figure 11-1. HP-IB Structure

Data Bus

The data bus consists of eight bidirectional lines that are used to transfer data from one device to another. Programming commands and data are typically encoded on these lines in ASCII, although binary encoding is often used to speed up the transfer of large arrays. Both ASCII and binary data formats are available to the HP 8753A. In addition, every byte transferred over HP-IB undergoes a *handshake* to ensure valid data.

Handshake Lines. A three-line handshake scheme coordinates the transfer of data between talkers and listeners. This technique forces data transfers to occur at the speed of the slowest device, and ensures data integrity in multiple listener transfers. With most computing controllers and instruments, the handshake is performed automatically, which makes it transparent to the programmer.

Management (Control) Lines. The data bus also has five control lines that the controller uses both to send bus commands and to address devices.

IFC. Interface Clear. Only the system controller uses this line. When this line is true (low), all devices (addressed or not) unaddress and go to an idle state.

ATN. Attention. The active controller uses this line to define whether the information on the data bus is a *command* or is *data*. When this line is true (low), the bus is in the command mode and the data lines carry bus commands. When this line is false (high), the bus is in the data mode and the data lines carry device dependent instructions or data.

SRQ. Service Request. This line is set true (low) when a device requests service; the active controller services the requesting device. The HP 8753A can be enabled to pull the SRQ line for a variety of reasons.

REN. Remote Enable. Only the system controller uses this line. When this line is set true (low), the bus is in the remote mode, and devices are addressed either to listen or to talk. When the bus is in remote and a device is addressed, it receives instructions from HP-IB rather than from its front panel (the **[LOCAL]** key returns the device to local operation). When this line is set false (high), the bus and all devices return to local operation.

EOI. End or Identify. This line is used by a talker to indicate the last data byte in a multiple byte transmission, or by an active controller to initiate a parallel poll sequence. The HP 8753A recognizes the EOI line as a terminator, and it pulls the EOI line with the last byte of a message output (data, markers, plots, prints, error messages). The HP 8753A does not respond to parallel poll.

HP-IB REQUIREMENTS

Number of Interconnected Devices:	15 maximum.
Interconnection Path/ Maximum Cable Length:	20 metres maximum or 2 metres per device, whichever is less.
Message Transfer Scheme:	Byte serial/ bit parallel asynchronous data transfer using a 3 line handshake system.
Data Rate:	Maximum of 1 megabyte per second over limited distances with tri-state drivers. Actual data rate depends on the transfer rate of the slowest device involved.
Address Capability:	Primary addresses: 31 talk, 31 listen. A maximum of 1 talker and 14 listeners at one time.
Multiple Controller Capability:	In systems with more than one controller (like the HP 8753A), only one can be active at a time. The active controller can pass control to another controller, but only the system controller can assume unconditional control. Only one system controller is allowed. The system controller is hard-wired to assume bus control after a power failure.

HP 8753A HP-IB CAPABILITIES

As defined by the IEEE Standard 488-1978, the HP 8753A has the following capabilities:

SH1	Full source handshake.
AH1	Full acceptor handshake.
T6	Basic talker, answers serial poll, unaddresses if MLA is issued.
L4	Basic listener, unaddresses if MTA is issued.
SR1	Complete service request (SRQ) capabilities.
RL1	Complete remote/local capability including local lockout.
DC1	Complete device clear.
DT1	Responds to a group execute trigger in the hold trigger mode.
C1,C2,C3	System controller capabilities in system controller mode.
C10	Pass control capabilities in pass control mode.
E2	Tri-state drivers.

The following codes define capabilities that the HP 8753A DOES NOT HAVE:

T6	No talk-only capability.
TE0	No extended talk capability.
LE0	No extended listener capabilities.
PP0	Does not respond to parallel poll.
C0	No controller capabilities in talker/listener mode.

Bus Mode

The HP 8753A uses a single-bus architecture. The system controller mode allows the HP 8753A to control peripherals directly in a stand-alone environment (without a controller). In automatic systems, the HP 8753A can act either as a basic talker/listener (involving the computer in all peripheral access operations), or as an active controller (requiring that the host controller pass control to the HP 8753A, and that the host accept control when the analyzer returns it after completing its task). The single bus allows both the HP 8753A and the host controller to have complete access to the peripherals in the system.

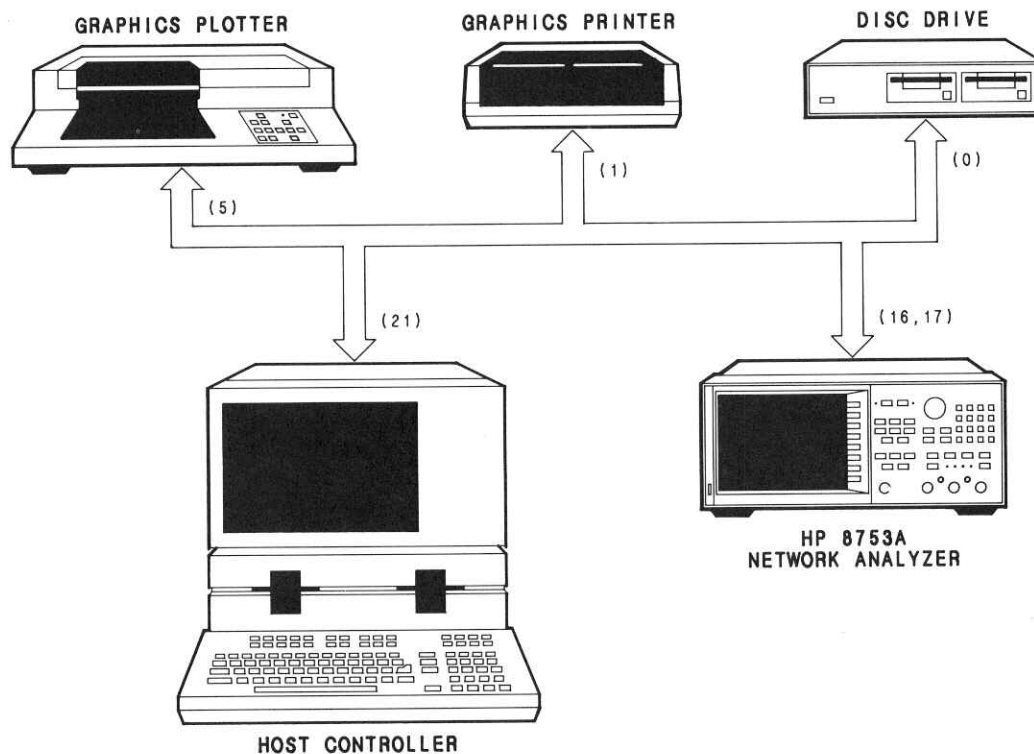

Figure 11-2. HP 8753A Single Bus Concept

Direct Plotting and Printing

The HP 8753A can provide a hardcopy of the display to an HP-IB printer or plotter, without the use of a computer.

Direct Plotting. Trace values and operating parameters can be plotted from the CRT. The HP 8753A can plot to either a digital plotter or a graphics printer. The digital plotter must accept Hewlett-Packard Graphics Language (HP-GL) commands; the printer must be a Hewlett-Packard graphics printer. The "General Information and Specifications" section in this manual provides information on compatible plotters and graphics printers. The correct plotter or printer address must be specified in the address menu, and the HP 8753A bus mode must be set to system controller in the HP-IB menu (see chapter 7).

Direct Printing. A printed listing of the measured data or the current HP 8753A operating parameters can be printed to an HP-IB printer or plotter. The "General Information and Specifications" section in this manual provides information on compatible printers and plotters. Specify the correct printer or plotter address in the address menu, and set the HP 8753A bus mode to system controller in the HP-IB menu.

Direct Access to an External Disc. The HP 8753A can control a CS-80 disc drive over HP-IB, without the use of a computer. This allows you to use a non-volatile medium to save and recall instrument states, data, and calibrations. The "General Information and Specifications" section of this manual provides information on compatible disc drives. Specify the correct disc address in the address menu. In the HP-IB menu, specify the correct disc unit and volume number, and set the HP 8753A bus mode to system controller.

USING HP-IB WITH THE HP 8753A

Setting Bus Mode

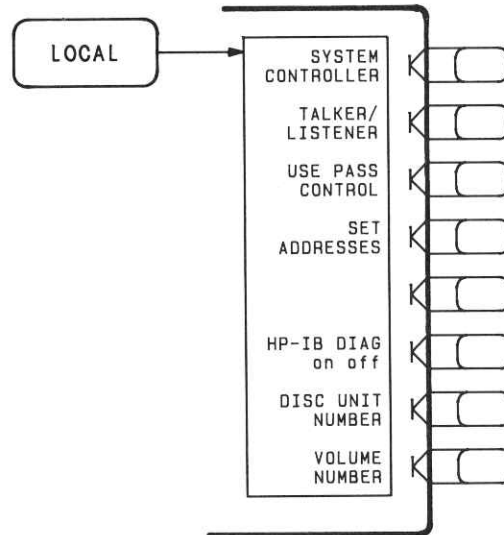

Figure 11-3. Choosing the Bus Mode in the HP-IB Menu

Choose the bus mode in the HP-IB menu. Use the following descriptions to help determine which bus mode to choose.

[SYSTEM CONTROLLER]. This mode allows the HP 8753A to directly plot, print, and control an external disc. This mode can only be selected manually from the analyzer front panel. Use this mode for operation with no computer connected to the HP 8753A. Do not use this mode for programming.

NOTE: Some computers have commands that release the bus data and control lines. This allows the use of the system controller mode for printing or plotting while the computer is connected to the HP-IB. For example, HP 200 and 300 series computers release the bus with:

ABORT 7

LOCAL 7 – Printing/plotting/disc access now possible even with computer connected.

A computer that can not release the data bus lines must be removed from the bus before the HP 8753A can directly plot, print, or control an external disc.

[TALKER/LISTENER] (TALKLIST;). This is the traditional programming mode. Peripheral access (plotting and printing only) is also possible by addressing the HP 8753A to talk, addressing the peripheral to listen, and placing the HP-IB in the data mode.

[USE PASS CONTROL] (USEPASC;). This mode allows you to control the HP 8753A over HP-IB as with the talker/listener mode, and also allows the HP 8753A to take or pass control in order to plot, print, and access a disc. During the peripheral operation, the host computer is free to perform other internal tasks such as data or display manipulation (the bus is tied up by the analyzer during this time).

In general, use the talker/listener mode for programming the HP 8753A unless you desire direct peripheral access. Preset does not affect the selected bus mode, but the bus mode returns talker/listener if power is cycled.

Setting Addresses

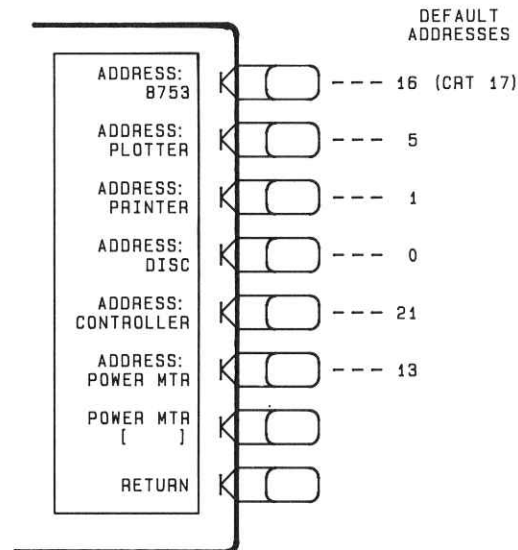

Figure 11-4.

In the address menu, set the HP-IB addresses for HP 8753A peripherals; select **[SET ADDRESSES]** and the appropriate softkey. Figure 11-4 shows the address menu and the default addresses. These addresses are stored in short-term non-volatile memory and are not affected when you press **[PRESET]** or cycle the power (although the **[PRESET]** key must be pressed to implement a change to the HP 8753A address). The **[POWER MTR]** softkey toggles between two HP power meter selections. The power meters are used for service procedures.

NOTE: An address change does not become effective until after the next preset.

NOTE: The HP 8753A display occupies an additional address on the HP-IB. The display address is dependent on the HP 8753A address. To determine the CRT address:

1. Write the HP 8753A address as a 5 bit binary sequence.
2. Complement the least significant bit.

For example, the factory set address:

Factory Select Address:	binary 10000 (16)
Display Address:	binary 10001 (17)

or, an arbitrary address:

Analyzer Address:	binary 01111 (15)
Display Address:	binary 01110 (14)

Response to Bus Commands

The following paragraphs describe the HP 8753A response to computer controller HP-IB commands. Some commands are simple line assertions and are referred to as uniline commands. Other commands, universal commands, affect every device on the bus. Commands that affect only the addressed devices are called addressed commands. The command mnemonics enclosed in { } refer to IEEE nomenclature, not to specific HP 8753A HP-IB commands.

Interface Clear {IFC}. The HP 8753A responds to the {IFC} uniline command by unaddressing and ceasing active control. A system controller uses this command to assume unconditional control. This does not clear the HP 8753A input buffer.

An example in BASIC for HP 9000 series 200 and 300 desktop computers:

ABORT 7 — The HP 8753A unaddresses and goes to idle state (the computer sets {IFC})

Device Clear {DCL, SDC}. The HP 8753A responds to the device clear commands by clearing the input and output buffers. Syntax errors are also cleared. The error queue and status registers are unaffected.

Example:

CLEAR 7 — Universal device clear for all bus devices
CLEAR 716 — Selected device clear for HP 8753A only

Clear Lockout/Set Local. When REN is asserted and the HP 8753A is addressed to listen, the analyzer goes to remote. In remote, all front panel keys are disabled except for the [LOCAL] key. Press [LOCAL] to return the analyzer to local operation. REN false (high) also clears a local lockout condition.

Example:

LOCAL 7 — Enable front panel keys and clear local lockout

Local {GTL}. The HP 8753A selectively goes to local when it receives this command and it is addressed to listen. The change from local to remote does not disturb any front panel values, functions, or local lockout.

Example:

LOCAL 716 — Go to local (local lockout remains active)

Local Lockout {LLO}. This command disables the [LOCAL] key, making it difficult to interfere with the HP 8753A while the analyzer is under remote control. The CLEAR LOCKOUT/SET LOCAL command reactivates the [LOCAL] key.

Example:

LOCAL LOCKOUT 7 — Disable [LOCAL] key

Remote. The HP 8753A responds to a remote message by going into remote after it is addressed to listen, which causes the R (Remote) and L (Listen) status indicators to illuminate on the HP 8753A front panel. In remote, all programming information comes from HP-IB, not from the analyzer front panel.

Example:

REMOTE 7 — Place bus in remote (HP 8753A goes to remote when addressed to listen)
REMOTE 716 — Place only the HP 8753A into remote and address to listen

Serial Poll {SPE, SPD}. The HP 8753A responds to a serial poll by outputting its status byte. To initiate the serial poll sequence, address the HP 8753A to talk and then issue the serial poll enable {SPE} command. To end the sequence, issue a serial poll disable {SPD} command. A serial poll does not affect or clear the status byte.

Example:

```
S=SPOLL (716) — Read status byte into variable S
```

Parallel Poll {PPC, PPU}. The HP 8753A does not respond either to a parallel poll configure {PPC} or to a parallel poll unconfigure {PPU} command.

Trigger {GET}. If in the hold mode, the HP 8753A responds to device trigger by taking a single sweep. If the one path, 2-port calibration is active, the analyzer sets the waiting for GET bits. If waiting for forward GET is set, the HP 8753A assumes the device is connected for forward measurement and takes a sweep when it receives GET. Similarly, if waiting for reverse GET is set, the analyzer assumes the device is connected for reverse measurement. The HP 8753A responds only to selected device trigger (SDT), and does not respond to group execute trigger (GET) unless it is addressed to listen. The HP 8753A does not respond to GET if it is not in the hold mode.

Example:

```
TRIGGER 7 — Universal GET (all addressed listeners; HP 8753A in hold mode)
```

```
TRIGGER 716 — Trigger HP 8753A only
```

Pass Control {TCT}. When the HP 8753A is in the pass control mode and is addressed to talk, it responds to the take control command. To initiate this mode, address the HP 8753A to talk and then send the TCT command. The HP 8753A then takes active control of the bus. If the analyzer was not requesting control it immediately passes control back to its pass control address. Otherwise, the HP 8753A completes its control task, and then passes control back.

Example (more specific examples are presented later in this chapter):

```
SEND 7; TALK 16 CMD 9— Pass control without HP-IB binary (BASIC 2.0)
```

```
PASS CONTROL 716— Pass control with HP-IB binary (BASIC 3.0 and above)
```

Wait loop for control to return:

```
REPEAT  
STATUS 7, 3; S— Read HP-IB status register  
UNTIL BIT (S, 6)— Check active control bit 6
```

PROGRAMMING THE HP 8753A

General Information

The HP 8753A interprets and executes commands as it receives them. If the analyzer receives a command without an operand, it puts the received function in the active area and waits for the operand. An operand is accepted when the HP 8753A receives either units or a terminator. If the analyzer does not receive units, it defaults to basic units. The active function is not turned off until a terminator is received. In the event of a syntax error, the analyzer displays the error, optionally asserts the SRQ line on the bus, recovers at the next terminator, then continues command execution. Characters between the error and the following terminator are lost. Use a device clear (DCL or SDC) to clear syntax errors.

Valid Characters

The HP 8753A accepts ASCII letters, numbers, decimal points, +/-, semicolons, carriage returns (CR), and linefeeds (LF). Both upper and lower case are acceptable. Leading zeros, spaces, carriage returns, and unnecessary terminators are ignored, except those within a command or appendage. Carriage returns are ignored. An invalid character causes a syntax error. Syntax errors are described in more detail under "Status Reporting."

HP 8753A Code Naming Convention

The HP 8753A HP-IB commands are derived from their front panel key titles (where possible), according to the naming convention below.

Convention	Key Title	For HP-IB Code Use	Example
One Word	Power Start	First Four Letters	POWE STAR
Two Words	Electrical Delay Search Right	First Three Letters of First Word First Letter of Second Word	ELED SEAR
Two Words in a Group	Marker → Center Gate → Span	First Four Letters of Both	MARKCENT GATESPAN
Three Words	Cal Kit N 50Ω Pen Num Data	First Three Letters of First Word First Letter of Second Word First Four Letters of Third Word	CALKN50 PENNDATA

Some codes require appendages (on, off, 1, 2, etc.). Codes that have no front panel equivalent are HP-IB only commands, and use a similar convention based on the common name of the function. Where possible, HP 8753A codes are compatible with HP 8510A codes.

Front panel equivalent codes and HP-IB only codes are summarized in the Appendix to Chapter 11.

Units and Terminators

The HP 8753A outputs data in basic units and assumes these basic units when it receives an input, unless the input is otherwise qualified. The basic units and allowable expressions follow; either upper or lower case is acceptable.

BASIC UNITS		ALLOWABLE EXPRESSIONS
seconds	S	Seconds
MS		Milliseconds
US		Microseconds
NS		Nanoseconds
PS		Picoseconds
FS		Femtoseconds
Hz	Hz	Hertz
KHZ		Kilohertz
MHZ		Megahertz
GHZ		Gigahertz
dB	DB	dB or dBm
V	V	Volts

Use terminators to indicate the end of a command to allow the HP 8753A to recover to the next command in the event of a syntax error. The semicolon is the recommended command terminator. For example:

PRESCHAN1S21PHASSING Not recommended, hard to read

PRES;CHAN1;S21;PHAS;SING; Recommended approach

You can also use the line feed (LF) character and the HP-IB EOI line as terminators. The HP 8753A ignores the carriage return (CR) character.

HP-IB Debug Mode

Activating the HP 8753A HP-IB debug mode causes the analyzer to scroll incoming HP-IB commands across the display. Nonprintable characters are represented with a π . If the HP 8753A receives a syntax error, the commands halt, and the analyzer points to the misunderstood character with a "" symbol. This clears only with a device clear. This mode is enabled in the HP-IB menu: press **[LOCAL] [HP-IB DIAG ON]**. Turn debug on from the bus with **DEBUON;**. Turn it off with **DEBUOFF;**.

Input/Output Buffers

The HP 8753A enters data from HP-IB into a 16 character deep input buffer (queue). Once the input buffer is filled, further input data is held up via the handshake process until the HP 8753A processes the commands in the buffer. Output data is placed in an output buffer that is one event long (one output request). Because subsequent output requests override unread data, always read the data out of the analyzer as soon as it is available. The HP 8753A automatically outputs data as it is available, unless it is not addressed to talk.

Held Commands

The HP 8753A cannot process HP-IB commands while executing certain key commands called held commands. Once a held command is received, the HP 8753A reads new commands into the input buffer, but it does not begin the execution of any command until the held command is completed. When the 15 character input buffer is full, the HP 8753A holds off the bus until it is able to process the commands in the buffer.

The operation complete function (see below) allows synchronization of programs with the execution of certain held commands. Enable this function by issuing **OPC**; or **OPC?**; prior to an OPC'able command. The operation complete bit is then set at the completion of the OPC'able command. For example, if **OPC;SING**; is issued, the OPC bit is set when the single sweep finishes. If **OPC?**; is issued, the HP 8753A outputs a 1 when command execution completes. Addressing the HP 8753A to talk after issuing **OPC?**; does not cause an "addressed to talk without selecting output" error, but the analyzer halts the computer by not transmitting the 1 until the command completes. For example, if the HP 8753A is interrogated immediately after **OPC?;PRES**; is issued, the bus halts until the instrument preset completes and the analyzer outputs a 1.

Table 11-1. OPC'able Commands

CHAN1	RAID	STANn
CHAN2	RECA _n	STOR _n
CLEARALL	FEFD	TRAD
DATI	RESPDONE	WAIT
DONE	RST	
EDITDONE	SAV1	
ISOD	SAV2	
NOOP	SAVC	
NUMG _n	SAVE _n	
PRES	SING	

NOTE: Commands that call a calibration class are held if there is just one standard in the class, since such commands trigger a measurement.

OPC (Operation Complete)

The **OPC**; and **OPC?**; commands can be used to determine when a held command has completed. There are two cases when this might be important:

- To have the computer proceed with other tasks while a long process occurs in the HP 8753A (e.g. a two hour CW time sweep).
- To know exactly when the HP 8753A has completed a command, to synchronize with the external world (e.g. to prompt an operator to change calibration standards, or to switch a VHF switch after the end of a sweep).

Because of the HP 8753A input buffer, it is difficult to determine these things without the use of OPC.

When **OPC**; is issued prior to a held command, the HP 8753A reports the completion of the held command by setting bit 0 of the event status register. This can be detected by issuing **ERS?**; and reading back the event status register or, if enabled with the **ESE1**; command, this can be detected at the controller by serial polling the HP 8753A main status byte until bit 5 is set (or, if SRQ interrupts are

enabled with the **SRE32;** command, by creating an interrupt branch). If the held command is the last command in the string (HP 8753A command line), the controller is free until the held command completes (or whenever it next addresses the HP 8753A).

When **OPC?;** is issued prior to a held command, the HP 8753A reports the completion of the held command by outputting a "1" when addressed to talk. The HP 8753A suspends bus operation until the command completes. For example, issuing **OPC?;SING;** followed by an immediate ENTER statement from the controller causes the controller to halt on the ENTER statement until the sweep is completed.

Examples for HP 9000 series 200 and 300 desktop computers:

<code>OUTPUT 716 ; "SWET60S ; ESE 1 ; "</code>	Set sweep time to 60 seconds & enable OPC bit reporting to main status byte.
<code>OUTPUT 716 ; "OPC ; SING ; "</code>	Take a 60 second sweep.
<code>REPEAT</code>	Check status byte until sweep
<code> S=SPOLL (716)</code>	completes. Perform other tasks while
<code>UNTIL BIT (S , 5)</code>	waiting.
<code>OUTPUT 716 ; "SWET5S ; OPC ? ; SING ; "</code>	Take a 5 second sweep.
<code>ENTER 716 ; Dummy</code>	Enter suspends bus operation until sweep is done.

Identify Commands

Several commands are available to determine the HP 8753A identity and software revision over the bus. The **IDN?;** and **OUTPIDEN;** commands return the string "HEWLETT PACKARD,8753A,0,X.XX" (X.XX is the instrument firmware revision). This information is also displayed at power-up.

Interrogate Commands

All of the HP 8753A front panel functions can be interrogated over the bus to determine their current state or value. To do this, append a "?" to the root command. The HP 8753A responds by outputting the state or value in ASCII format. Functions that are settable respond with a single numeric value. On/off functions respond with either an ASCII "1" or "0". Interrogating a function that is not defined for interrogation produces an ASCII "0". Interrogating a function does not put it in the active area.

Array Input/Output

Several arrays of information can be read in/out of the HP 8753A. These include arrays for trace data, memory, and calibration data, and vary in size according to the active channel set-up. The HP 8753A must be in the proper configuration to receive incoming arrays. For example, the analyzer will not accept a 401 point data array if the current channel is set to 201 points. Figure 11-5 is a summary of the HP 8753A processing chain and array locations: chapter 1 provides detailed data processing flow information.

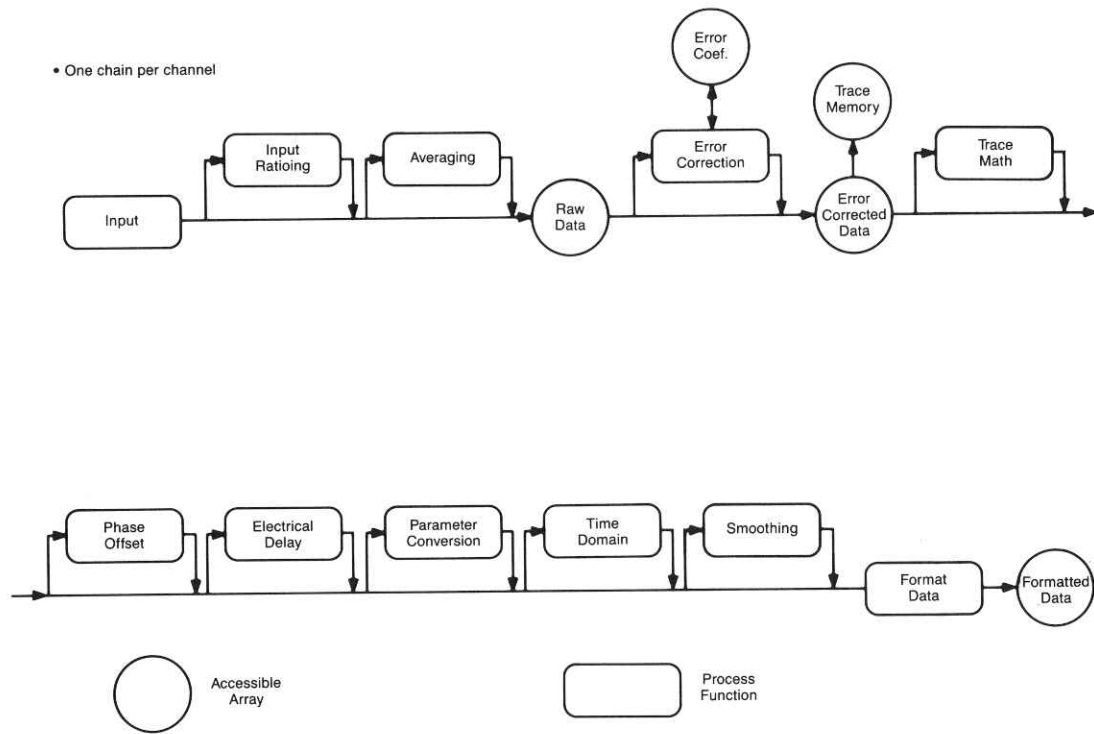

Figure 11-5. HP 8753A Processing Chain

Raw, Data, Memory, and Formatted Arrays

Each array data point is a pair of numbers and normally represents a real/imaginary pair. Because the formatted data array is affected by the current display format, in some display formats (phase, group delay, real, SWR) the second number of each point in the formatted array is set to zero. The corrected data and memory arrays contain error-corrected data if correction is on, but are not affected by subsequent processing such as electronic line stretching. The raw data array is independent of all processing functions except sweep-to-sweep averaging, and the IF bandwidth, and contains all four S-parameters when a 2-port calibration is active.

Data Formats

Arrays are transmitted and received in one of four formats, selected with the **FORM1**;, **FORM2**;, **FORM3**;, or **FORM4**; commands. These commands do not affect non-array transfers (such as marker output). The HP 8753A must be set to the proper format to receive an array. The available formats are:

FORM1; This is the default format, the HP 8753A internal binary format, 6 bytes per data point. The array is preceded by a 4 byte header. The first 2 bytes are the string "#A", the standard block header. The second 2 bytes are an integer containing the number of bytes to follow in the array. FORM1 gives the fastest data transfer; the computer should not analyze the data, but returns it to the HP 8753A at a future time.

FORM2; This is the IEEE 32 bit floating point format, 8 bytes per data point (2 numbers per point). Each number is represented by 1 sign bit, an 8 bit biased exponent, and a 23 bit mantissa. The data is also preceded by the "#A" 2 byte header and the 2 length bytes. This is a fast transfer format with full resolution.

FORM3; This is the IEEE 64 bit floating point format, 16 bytes per data point (2 numbers per point). Each number is represented by 1 sign bit, an 11 bit biased exponent, and a 52 bit mantissa. The data is also preceded by the "#A" 2 byte header and the 2 length bytes. This is a common, high-precision format used in many computers, including the HP 9000 series 200 and 300 desktop computers with FORMAT OFF.

FORM4; This is ASCII floating point format (HP 9000 series 200 and 300 desktop computers with FORMAT ON). The data is output in ASCII format according to standard output syntax. There is no header with this format.

Output Syntax

Data sent by the HP 8753A in response to an interrogation or any FORM4 OUTP_____ command is in ASCII format, with each digit as a separate ASCII byte. The receiving computer must build a number from the entered bytes. Numbers are transferred as fixed length 24 character strings consisting of:

—DDD.DDDDDDDDDDDDDDE-DD

Contents	Meaning
Sign	"—" Negative, Blank Positive
3 Leading Digits	Left of Decimal Point
Decimal Point	
15 Digits	Right of Decimal Point
E	Exponent Notation
Sign	Exponent Sign
Exponent	2 Digit Exponent

INSTRUMENT SETUP

Basic Sequence

Program the HP 8753A in the same manner used to make a manual measurement. First make the measurement from the front panel, using single trigger, and then translate the keystroke sequence to the computer program. This is keystroke equivalent programming. The standard sequence to make an automatic measurement is:

1. Preset
2. Pick a channel
3. Set stimulus parameters
4. Set response parameters
5. Set up limits if desired
6. Calibrate if desired
7. Trigger a measurement
8. Optional transform if desired
9. Input or output data if desired
10. Hardcopy results if desired
11. Store results, states, or calibrations

Preset. Use the preset command (**PRES;** or **RST;**) at the beginning of a program to return the HP 8753A to a known state.

NOTE: To avoid losing the current calibration, save the current state prior to **PRES;** or **RST;**.

Selecting a Channel. Select the channel with the **CHAN1;** or **CHAN2;** command.

Setting Stimulus Parameters. Stimulus parameters are common to both channels unless they are uncoupled by the **COUCOFF;** command. The **POWE;** command sets the power. If an S-parameter test set is present, the power to the device can be further reduced using the **ATTP1nn;** **ATTP2nn;** commands. Select the appropriate sweep type with **LINFREQ;**, **LOGFREQ;**, **LISFREQ;** **POWS;**, or **CWTIME;**. **LINFREQ;** is the fastest sweep type for a given number of points. The **CWFREQ;** command sets a CW frequency and places the analyzer in the CW time sweep mode (unless it is already in the power sweep mode). Once the sweep type is set, the x-axis sweep values can be set with **STAR;**, **STOP;**, **CENT;**, or **SPAN;**.

Although sweep time is set by the **SWET;** command, it automatically increases to accommodate dual channels, more points, a narrower IF bandwidth, calibrations, and certain math processes (e.g. marker statistics). The sweep time does not automatically decrease if a faster state is set. To ensure the fastest analyzer sweep after a state change, reset the sweep time with **SWET0;**.

NOTE: Sweep time is also determined by the characteristics of your device. Sweep times that are too fast will skew the device response and could lead to erroneous trace data.

NOTE: The sweep time is the actual data taking time for the sweep and does not include the band relock times, or the times required for the fractional-N synthesizer and phase lock loop to respond between bands. For example, for a full 201 point sweep from 300 kHz to 3 GHz, with a 3 kHz IF bandwidth, although the sweep time indicates 100 milliseconds, the actual sweep-to-sweep period is about 400 milliseconds.

Entering a List Frequency Table. Enter a list frequency table through keystroke equivalent programming. Once entered, list frequency tables are output and input as part of the instrument learn string. Use the following commands to enter and edit a frequency list table:

EDITLIST;	Turn on edit list mode.
SADD;	Add a segment to the list. As in front panel operation, the last segment is duplicated and the edit menu is displayed.
SEDIn;	Select existing segment n to edit.
SDEL;	Delete present segment.
STARn;	Segment start frequency.
STOPn;	Segment stop frequency.
CENTn;	Segment center frequency.
SPANn;	Segment span frequency.
POINn;	Number segment points.
CWFREQn;	CW frequency point.
STPSIZEn;	Frequency step between points.
SDON;	Segment done. The list is sorted and the table is updated on the HP 8753A CRT.
EDITDONE;	Edit is complete. The actual sweep does not update until this command. A SING; command after this ensures that the new table is complete.

The following program, in BASIC for an HP 9000 series 200 or 300 desktop computer, sets up the HP 8753A source for a 134 MHz SAW filter. One channel sweeps 201 points while the other channel steps through 5 discrete frequencies.

```

10  OPTION BASE 1
20  ABORT 7
30  CLEAR 716
40  OUTPUT 716 ; "PRES ; "
50  OUTPUT 716 ; "HOLD ; POWE 10 DB ; COUCOFF ; "
60  OUTPUT 716 ; "CHAN1 ; POIN201 ; CENT 134 MHZ ; SPAN 30 MHZ ; "
70  OUTPUT 716 ; "CHAN2 ; EDITLIST ; SADD ; CWFREQ 119 MHZ ; SDON ; "
80  OUTPUT 716 ; "SADD ; STAR 124 MHZ ; STOP 144 MHZ ; POIN3 ; SDON ; "
90  OUTPUT 716 ; "SADD ; CWFREQ 149 MHZ ; SDON ; "
100 OUTPUT 716 ; "EDITDONE ; LISFREQ ; "
*
*
```

- LINE 10 — Set the lower bound for arrays (by default, dimensions begin with 0).
- LINE 20 — Cease all bus activity.
- LINE 30 — Clear the HP 8753A buffers.
- LINE 40 — Place the HP 8753A in a known state.
- LINE 50 — Put analyzer in hold trigger mode, set the power level to +10 dBm, and uncouple the channels (in order to use two different stimulus sweeps).
- LINE 60 — Set channel 1 to a 201 point sweep.
- LINE 70 — Begin a frequency list on channel 2. Start with a CW frequency point in the rejectband.
- LINE 80 — Add a three point segment across the passband.
- LINE 90 — End with another CW point in the upper rejectband.
- LINE 100 — Leave the edit list mode and turn on the frequency list sweep.

Setting Response Parameters. Response parameters are always uncoupled between channels, except for IF bandwidth, IF averaging, and the markers (although these can be uncoupled). The response parameters can be set up with the basic sequence **[MEAS]**, **[FORMAT]**, **[SCALE REF]**, **[DISPLAY]**, and **[AVG]**. Select the IF bandwidth and display mode (single versus dual channel) prior to calibration, as they can influence sweep time.

The following program lines demonstrate how to set up the HP 8753A response for insertion loss on channel 1 and and return loss on channel 2:

```
*
*
110 OUTPUT 716;"DUACON;"
120 OUTPUT 716;"CHAN1;S21;LOGM;SCAL 10 DB;IFBW 300 HZ;"
130 OUTPUT 716;"CHAN2;S11;LOGM;SCAL 2 DB;IFBW 300 HZ;"
*
*
```

LINE 110 — Turn on dual display mode.
LINE 120-130 — Set up both channels and scale.

Entering Limit Lines. Enter a limit table through keystroke equivalent programming. Once entered, limit line tables become part of the instrument learn string. Use the following commands to enter and edit a limit table:

EDITLIML;	Turn on edit limit mode.
SADD;	Add a segment to the list. As in front panel operation, the last segment is duplicated and the [EDIT] menu is presented.
SEDIn;	Select existing segment n to edit.
SDEL;	Delete present segment.
LIMSn	Limit stimulus value.
LIMUn	Upper limit value.
LIMLn	Lower limit value.
LIMMn	Middle limit value.
LIMDn	Delta limit value.
LIMTSL;	Sloping limit line type.
LIMTFL;	Flat limit line type.
LIMTSP;	Single point limit type.
MARKSTIM;	Active marker to limit stimulus value.
MARKMIDD;	Active marker to middle limit value.
SDON;	Segment done. The list is sorted and the table is updated on the HP 8753A display.
EDITDONE;	Edit is complete. The actual sweep will not update until this command.

The following program lines create a limit table on channel 1 for the SAW filter:

```
*
*
140 OUTPUT 716;"CHAN1;LIMILINE ON;EDITLIML;"
150 OUTPUT 716;"SADD;LIMTFL;LIMS 119 MHZ;"
160 OUTPUT 716;"LIMM -70 DB;LIMD 6 DB;SDON;"
170 OUTPUT 716;"SADD;LIMTSL;LIMS 123 MHZ;"
180 OUTPUT 716;"LIMM -70 DB;LIMD 6 DB;SDON;"
190 OUTPUT 716;"SADD;LIMTFL;LIMS 129 MHZ;"
200 OUTPUT 716;"LIMM -23 DB;LIMD 2 DB;SDON;"
210 OUTPUT 716;"SADD;LIMTSL;LIMS 139 MHZ;"
220 OUTPUT 716;"LIMM -23 DB;LIMD 2 DB;SDON;"
230 OUTPUT 716;"SADD;LIMTFL;LIMS 145 MHZ;"
240 OUTPUT 716;"LIMM -70 DB;LIMD 6 DB;SDON;"
250 OUTPUT 716;"SADD;LIMTSP;LIMS 149 MHZ;"
260 OUTPUT 716;"LIMM -70 DB;LIMD 6 DB;SDON;EDITDONE; LIMILINE OFF;"
*
*
```

LINE 140 — Enter limit line edit mode on channel 1
LINE 150-160 — Add a flat limit line segment for the lower rejectband. The specification is -70 dB of rejection ± 3 dB.
LINE 170-180 — Add a sloping line segment for the lower skirt.
LINE 190-200 — Add a flat line segment for the filter passband, which should be -23 dB ± 2 dB.
LINE 210-220 — Add a sloping line segment for the upper skirt.
LINE 230-240 — Add a flat line segment for the upper rejectband.
LINE 250-260 — Terminate the final segment with a single point limit.

With the **LIMIMAOF;** command, an entire set of limit lines can be offset by the active marker value (e.g. the top of a filter response). Limit testing requires that limit testing is turned on, and that a limit failure is determined by checking event status register B, bits 3 and 4. Turn on limit test with the **LIMITESTON;** command. Read event status register B with the **ESB?;** command. Refer to "Data Output" in this chapter for an example of limit testing with a controller.

Measurement Calibration. A controller assisted measurement calibration sequence can be done in several ways. A fully prompted calibration over HP-IB follows the same command sequence as a calibration from the front panel.

The general procedure for a one-port calibration is:

1. Select the appropriate calibration kit for the connector type.
2. Select a calibration type, such as **CALIS111;**, a one-port calibration.
3. For 2-port calibrations, you must call a class subdivision with **TRAN;**, **REFL;**, or **ISOL;**
4. Call each class in the cal type, such as **CLASS11A;**
5. If there is more than one standard in the class, select a standard with the **STANA;** ...**STANG;** commands.
6. Use **DONE;** to close a class only when multiple banded standards are required (as with lowband and highband loads).
7. For 2-port calibrations, close the class subdivision with **TRAD;**, **REFD;**, or **ISOD;**
8. After all classes are measured, save the calibration with the appropriate command (listed below). This causes the HP 8753A to calculate the error coefficients and turn correction on.

SAV1; S11, S22 1-port calibrations.
SAVE2; Full, one path 2-port calibrations.
RESPDONE; Response calibrations.
RAID; Response and isolation calibrations.

Table 11-2. Relationship Between Calibrations and Classes

Class	Resp	Resp & Isol'n	S11 1-port	S22 1-port	One Path 2-port	Full 2-port
Reflection: S11A			✓		✓	✓
S11B			✓		✓	✓
S11C			✓		✓	✓
S22A				✓		✓
S22B				✓		✓
S22C				✓		✓
Transmission: Forward Match					✓	✓
Forward Thru					✓	✓
Reverse Match						✓
Reverse Thru						✓
Isolation: Forward					✓	✓
Reverse						✓
Response:	✓					
Resp & Isol: Response		✓				
Isolation		✓				

The following example documents a response calibration on channel 1 and an S11 1-port calibration on channel 2. The type-N 50 ohm calibration kit is used.

```
*
*
270 OUTPUT 716;"CHAN1;CALKN50;CALIRESP;"
280 LOCAL 716
290 DISP " PLEASE CONNECT THRU THEN PRESS [CONTINUE]"
300 PAUSE
310 OUTPUT 716;"OPC?;STANC;"
320 ENTER 716;Dummy
330 OUTPUT 716;"RESPDONE;"
340 OUTPUT 716;"CHAN2;CALIS111;CLASS11A;"
350 LOCAL 716
360 DISP " PLEASE CONNECT OPEN THEN PRESS [CONTINUE]"
370 PAUSE
380 OUTPUT 716;"OPC?;STANB;"
390 ENTER 716;Dummy
400 OUTPUT 716;"CLASS11B;"
410 LOCAL 716
420 DISP " PLEASE CONNECT SHORT THEN PRESS [CONTINUE]"
430 PAUSE
440 OUTPUT 716;"OPC?;STANB;"
450 ENTER 716;Dummy
460 LOCAL 716
470 DISP " PLEASE CONNECT LOAD THEN PRESS [CONTINUE]"
480 PAUSE
490 OUTPUT 716;"OPC?;CLASS11C;"
500 ENTER 716;Dummy
510 OUTPUT 716;"SAV1;MENUCAL;"
520 DISP ""
*
*
```

LINE 270	— Pick the type-N calibration kit and the response calibration type.
LINE 280	— Place the HP 8753A in the local mode.
LINE 290-300	— Prompt operator and wait till done.
LINE 310-320	— Measure standard and keep program from continuing until standard is done.
LINE 330	— Close response calibration.
LINE 340	— Pick the S11 1-port calibration type on channel 2. Display the open softkeys.
LINE 350-370	— Go to local and have operator connect open.
LINE 380-390	— Measure female open standard (test port sex).
LINE 400	— Display the short softkeys.
LINE 410-430	— Go to local and have operator connect short.
LINE 440-450	— Measure female short standard (test port).
LINE 460-480	— Go to local and have operator connect load.
LINE 490-500	— Measure load (only one sex for type-N load).
LINE 510-520	— Calculate error coefficients and save them.

Another approach to automatic calibration is to give the operator total control of the calibration sequence. In this technique, the controller places the HP 8753A in local and waits for the operator to complete the calibration. When the calibration is complete, the operator continues the program. The controller then interrogates the HP 8753A with the **CORR?**; command to see if calibration is on. The controller can also interrogate the calibration types to determine the kind of calibration that was performed.

The following program lines allow an operator to perform calibrations on channels 1 and 2. Some checking is added to demonstrate how the calibration can be interrogated.

```

*
*
270 Ask_ch1:INPUT " Do you wish to calibrate channel 1 ?","Ans$
280 IF Ans$[1,1]= "N" OR Ans$[1,1]="n" THEN GOTO Ask_ch2
290 OUTPUT 716;"CALKN50;CHAN1;CALIRESP; "
300 Cal1:LOCAL 716
310 DISP " Please Calibrate Channel 1 then press [CONTINUE]"
320 PAUSE
330 OUTPUT 716;"CORR?;"
340 ENTER 716;Corr
350 IF NOT Corr THEN GOTO Ask_ch1
360 OUTPUT 716;"CALIRESP?;"
370 ENTER 716;Corr
380 IF NOT Corr THEN GOTO Cal1
390 Ask_ch2:INPUT " Do you wish to calibrate channel 2 ?","Ans$
400 IF Ans$[1,1]="N" OR Ans$[1,1]="n" THEN GOTO Skip
410 OUTPUT 716;"CHAN2;CALIS111; "
420 Cal2:LOCAL 716
430 DISP " Please Calibrate Channel 2 then press [CONTINUE]"
440 PAUSE
450 OUTPUT 716;"CORR?;"
460 ENTER 716;Corr
470 IF NOT Corr THEN GOTO Ask_ch2
480 OUTPUT 716;"CALIS111?;"
490 ENTER 716;Corr
500 IF NOT Corr THEN GOTO Cal2
510 Skip: !
520 DISP ""
*
*

```

- LINE 270 — Ask operator if he wants to calibrate channel 1; put response in a string.
- LINE 280 — If the answer is no then skip this calibration.
- LINE 290 — On channel 1, pick the 50 ohm type-N calibration kit and bring up the response calibration menu.
- LINE 300-320 — Place the HP 8753A in local and wait for calibration to complete.
- LINE 330-350 — If a calibration was not done, go back and give the operator another chance.
- LINE 360-380 — If a response calibration was not done, give the operator another chance.
- LINE 390-400 — If the operator does not want to calibrate channel 2, skip it.
- LINE 410 — Bring up the S11 1-port calibration menu on channel 2.
- LINE 420-440 — Prompt the operator and wait for him to finish the calibration.
- LINE 450-470 — If a calibration was not done on channel 2, give the operator another chance.
- LINE 480-520 — If an S11 1-port calibration was not performed, give the operator another chance.

Reading Out Calibration Coefficients. Read calibration coefficients out of the HP 8753A with the **OUTPCALCnn;** command, according to the selected **FORMn;** format. Table 11-3 defines the coefficients for the various calibration types, which can be entered into the HP 8753A with the **INPUCALCnn;** command. Once re-entered, the calibration can be saved with the **SAVC;** command.

Table 11-3. Calibration Coefficient Definitions

Command	Response	Resp & Isol	1-Port	2-Port ¹
OUTPCALC01; OUTPCALC02; OUTPCALC03; OUTPCALC04; OUTPCALC05; OUTPCALC06; OUTPCALC07; OUTPCALC08; OUTPCALC09; OUTPCALC10; OUTPCALC11; OUTPCALC12;	E_R or E_T	E_D or E_X E_R or E_T	E_D E_S E_R	E_{DF} E_{SF} E_{RF} E_{XF} E_{LF} E_{TF} E_{DR} E_{SR} E_{RR} E_{XR} E_{LR} E_{TR}
Subscripts: First: D = Directivity; S = Source Match; R = Reflection Tracking; L = Load Match; T = Transmission Tracking; X = Isolation. Second: F = Forward; R = Reverse. ¹ This is for a full 2-port calibration. The one-path 2-port calibration duplicates the forward coefficients into the reverse arrays.				

The following example program lines document how the 201 point response and 5 point S11 1-port calibrations can be read from the HP 8753A:

```
*
*
530 ASSIGN @Na TO 716;FORMAT OFF
540 DIM Etf(201,2),Edf(5,2),Esf(5,2),Erf(5,2)
550 INTEGER Header,Length
560 OUTPUT 716;"FORM3;CHAN1;OUTPCALC01;"
570 ENTER @Na;Header,Length,Etf(*)
580 OUTPUT 716;"CHAN2;OUTPCALC01;"
590 ENTER @Na;Header,Length,Edf(*)
600 OUTPUT 716;"OUTPCALC02;"
610 ENTER @Na;Header,Length,Esf(*)
620 OUTPUT 716;"OUTPCALC03;"
630 ENTER @Na;Header,Length,Erf(*)
*
*
```

- LINE 530 — Set up I/O path name for HP 8753A. The format off option lets the controller enter FORM3 data as fast as possible.
- LINE 540-550 — Dimension four arrays for the error terms, two numbers per coefficient. The integers are for the two byte header and the one word length.
- LINE 560 — Tell channel 1 to output the first calibration array with a FORM3 format.
- LINE 570 — Enter the header, length, and coefficient array.
- LINE 580-630 — Repeat the array output for channel 2, all three coefficient arrays.

Modifying Calibration Kits. The mechanics of modifying an existing calibration kit or creating a new one are explained at the end of Chapter 5, "Calibration". For more information on this topic refer to HP Product Note 8510-5. Use front panel equivalent programming to remotely modify calibration kits. Modifying a kit does not affect the permanent description of the kit maintained in ROM. Once modified or created, calibration kits can be output with **OUTPCALK**; and input with **INPUCALK**; Both use the FORM1 format. The kit is output as a fixed length string of no more than 1000 bytes.

The basic sequence for entering a user calibration kit:

1. Pick the user calibration kit with **CALKUSED**;
2. Begin modification with **MODI1**;
3. Define all standards in the kit beginning each standard with **DEFSn**; and ending with **STDD**;
4. Specify the standard classes by defining which standards are in which class. Begin each class with **SPECxxxx**; where **xxxx** is the class name, such as S11A. End each class with **CLAD**;
5. Label the class names with **LABExxxx"yyyyyyyyyy"**; where **xxxx** is the class name and **yyyyyyyyyy** is the class label.
6. Label the kit with **LABK"zzzzzzzzzz"**;
7. Issue the kit done command, **KITD**;
8. Store the new kit with **SAVEUSEK**;

The following program creates a calibration kit description for a hypothetical TNC calibration kit:

```

10  ASSIGN @Na TO 716
20  CALL Tnc_calokit(@Na)
30  END
40  SUB Tnc_calokit(@Na)
50      ! SHORT CIRCUIT VALUES
60  OUTPUT @Na;"PRES;CALKUSED;MODI1;DEFS 1;STDTSHOR;"
70  OUTPUT @Na;"OFSD 0.060208 NS;OFSL 0; OFSZ 50;"
80  OUTPUT @Na;"MINF 0.000 GHZ;MAXF 3 GHZ;"
90  OUTPUT @Na;"COAX;LABS""Short (M)"";STDD;"
100 OUTPUT @Na;"DEFS 2;STDTSHOR;"
110 OUTPUT @Na;"OFSD 0.084292 NS;OFSL 0; OFSZ 50;"
120 OUTPUT @Na;"MINF 0.000 GHZ;MAXF 3 GHZ;"
130 OUTPUT @Na;"COAX;LABS""Short (F)"";STDD;"
140      ! LOAD VALUES
150 OUTPUT @Na;"DEFS 3;STDTLOAD;"
160 OUTPUT @Na;"OFSD 0; OFSL 0; OFSZ 50; MINF 0.000 GHZ; MAXF 3 GHZ;"
170 OUTPUT @Na;"FIXE; COAX; LABS""Broadband"";STDD;"
180      ! THRU VALUES
190 OUTPUT @Na;"DEFS 4;STDTDELA;"
200 OUTPUT @Na;"OFSD 0; OFSL 0; OFSZ 50; MINF 0.000 GHZ; MAXF 3 GHZ;"
210 OUTPUT @Na;"COAX; LABS""Thru"";STDD;"
220      ! OPEN VALUES
230 OUTPUT @Na;"DEFS 5;STDTOPEN;"
240 OUTPUT @Na;"C0 79.4; C1 0.0; C2 40.00; C3 0.00;"
250 OUTPUT @Na;"OFSD 0.060208 NS; OFSL 0; OFSZ 50;"
260 OUTPUT @Na;"MINF 0.000 GHZ; MAXF 3 GHZ;"
270 OUTPUT @Na;"COAX; LABS""Open (M)"";STDD;"
280 OUTPUT @Na;"DEFS 6;STDTOPEN;"
290 OUTPUT @Na;"C0 79.4; C1 0.0; C2 40.00; C3 0.00;"
300 OUTPUT @Na;"OFSD 0.084292 NS; OFSL 0; OFSZ 50;"
310 OUTPUT @Na;"MINF 0.000 GHZ; MAXF 3 GHZ;"
320 OUTPUT @Na;"COAX; LABS""Open (F)"";STDD;"
330      ! SETUP/LABEL CLASSES
340 OUTPUT @Na;"SPECS11A 1,2;CLAD; SPECS11B 5,6;CLAD; SPECS11C 3;CLAD;"
350 OUTPUT @Na;"LABES11A""Shorts"";"
360 OUTPUT @Na;"LABES11B""Opens"";"

```



```

370 OUTPUT @Na;"LABES11C""Load"";"
380 OUTPUT @Na;"SPECS22A 1,2;CLAD;SPECS22B 5,6;CLAD;SPECS22C 3;CLAD;"
390 OUTPUT @Na;"LABES22A""Shorts"";"
400 OUTPUT @Na;"LABES22B""Opens"";"
410 OUTPUT @Na;"LABES22C""Load"";"
420 OUTPUT @Na;"SPECFWDT 4;CLAD;SPECREVT 4;CLAD;"
430 OUTPUT @Na;"SPECFWD 4;CLAD;SPECREVM 4;CLAD;"
440 OUTPUT @Na;"SPECRESP 1,2,4,5,6;CLAD;"
450 OUTPUT @Na;"LABEFWDT"" Thru "";LABEREVT"" Thru "";"
460 OUTPUT @Na;"LABEFWDM"" Thru "";LABEREVM"" Thru "";"
470 OUTPUT @Na;"LABERESP""Response"";"
480 OUTPUT @Na;"LABK""TNC A.1"";"
490 OUTPUT @Na;"KITD;SAVEUSEK;MENCAL;"
500 LOCAL @Na
510 SUBEND
*
*
```

LINE 10	– Set up I/O path name for HP 8753A.
LINE 20-30	– Call the kit definition routine then end.
LINE 40	– Start the subroutine.
LINE 50-90	– Define standard number 1 to be a short and label it a male short.
LINE 100-130	– Define standard number 2 to be a short and label it a female short.
LINE 140-170	– Define standard number 3 to be a load and label it a broadband load.
LINE 180-210	– Define standard number 4 to be a thru and label it.
LINE 220-270	– Define standard number 5 to be an open and label it a male open.
LINE 280-320	– Define standard number 6 to an open and label it a female open.
LINE 330-370	– Define the S11 standard classes and label them.
LINE 380-410	– Define the S22 standard classes and label them.
LINE 420-470	– Define the remaining standard classes and label them.
LINE 480	– Label the new calibration kit.
LINE 490	– Leave the modify menu, store the new user cal kit, and bring up the calibration menu.
LINE 500-510	– Place the HP 8753A back in local and end the program.

Triggering a Measurement. For convenience, use the **HOLD;** trigger mode while setting up the HP 8753A. Use **SING;** to trigger a single sweep measurement when averaging is not required. Use **NUMGn;** for averaged measurements, where **n** is the averaging factor set by **AVERFACTn;**.

The sequence for triggering an averaged measurement:

HOLD;	Hold for set up
AVERFACTn;	Set averaging factor
AVERON;	Turn on averaging
NUMGn;	Trigger n sweeps (Output the data)
AVERREST;	Reset averaging

To begin a new measurement cycle, use the **REST;** command. This command also resets averaging for 2-port calibrated measurements. **REST;** forces the S-parameter test set to re-measure forward and reverse S-parameters when a full 2-port calibration is on. In a one-path 2-port calibration, the analyzer prompts the operator to connect the device for a forward measurement. The **SING;** command has the same effect, but does not restart averaging. A full 2-port calibration makes an entire forward/reverse measurement cycle.

In the hold mode, with a one-path 2-port calibration active, a trigger (GET) command takes a single sweep and initiates the appropriate prompt "CONNECT THE DEVICE FOR FORWARD (REVERSE) MEASUREMENT". Two triggers are required to measure first the forward, and then the reverse parameters. The controller determines when another sweep is needed by serial polling the main status byte and checking the "Waiting for GET" status bits, bits 0 (reverse) and 1 (forward). These bits are set when the analyzer is ready to have the device reversed and cleared by the GET HP-IB command (TRIGGER 716).

The general procedure for triggering 2-port measurements:

1. Place the analyzer in the **HOLD;** trigger mode.
2. Begin new measurement with **SING;**, **REST;**, or **CONT;**.
3. For one-path 2-port calibrated measurements, then:
 - a. Serial poll the HP 8753A until bit 1 is set.
 - b. Issue a GET command (TRIGGER 716).
 - c. Serial poll the HP 8753A until bit 0 is set.
 - d. Issue another GET command (TRIGGER 716).
4. In the **CONT;** trigger mode, subsequent sweeps can be read without a new forward/reverse cycle.

Add the following lines to trigger the filter measurement:

```
*  
*  
640 DISP " CONNECT DEVICE THEN PRESS [CONTINUE]"  
650 PAUSE  
660 OUTPUT 716;"CHAN2;SING;CHAN1;SING;" ! Trigger a sweep  
*  
*
```

Transform (Option 010). With option 010, the error-corrected frequency domain data (linear sweep only) can be transformed to the time domain using the **TIMDTRANON;** command (in the CW time sweep type, the data is transformed into the frequency domain). For low pass mode, the start and stop frequencies must first be set using the **SETF;** command. The **HOLD;** trigger mode produces the fastest transform. The equivalent impulse width (low pass impulse or bandpass) and the equivalent rise time of the source can be changed using the **WINDOWn;** command. Setting **n** to 0 ensures the narrowest impulse or shortest rise time possible. In the hold trigger mode, a data array can also be input to the HP 8753A using **INPURAW;** or **INPUDATA;**. The analyzer then transforms the data. With transform on, the time domain record can be read out as formatted data with the **OUTPFORM;** command. The number of time domain points is always the same as the number of frequency domain points, but never more than 401, although all points are actually used in the transform calculation. Gated frequency domain data is also read out as formatted data.

The following program lines transform the SAW filter measurement into the time domain:

```
*
*
670 OUTPUT 716;"BANDPASS;WINDOW 0 S;TIMDTRANON;STAR -1 US;STOP 6
    US;AUTO;"
*
*
```

Data Output. Data can be output as marker values or as arrays. The **OUTPMARK;** command outputs the active marker values according to the selected format. Three marker values are output, the first two are the marker reading and the third is the marker stimulus value. Use the **OUTPRAWn;**, **OUTPDATA;**, or **OUTPFORM;** command to output arrays. Use **OUTPRAWn;** only if there is a need to apply accuracy enhancement at a future time (in which case the calibration coefficients must also be read), or if all four S-parameters (uncorrected) are desired with a full 2-port calibration on. Use **OUTPRAW1;**, **OUTPRAW2;**, **OUTPRAW3;**, or **OUTPRAW4;** to read the raw values for S11, S21, S12, and S22. Use **OUTPDATA;** for most general error-corrected measurements. Use **OUTPFORM;** to obtain transformed data, gated data, trace math results, electronically stretched phase, smoothed data, or converted parameters. Formatted data changes as a function of the selected display format. The actual data point values are defined for marker and formatted arrays in Table 11-4.

Table 11-4. Output Values as a Function of Display Format

Display Format	Marker Mode	OUTPMARK Value 1, Value 2	OUTPFORM Value 1, Value 2
LOG MAG		dB, *	dB, *
PHASE		Degrees, *	Degrees, *
DELAY		Seconds, *	Seconds, *
SMITH CHART	LIN MKR LOG MKR Re/Im R + jX G + jB	Lin Mag, Degrees dB, Degrees Real, Imag Real, Imag Ohms Real, Imag Siemens	Real, Imag Real, Imag Real, Imag Real, Imag
POLAR	LIN MKR LOG MKR Re/Im	Lin Mag, Degrees dB, Degrees Real, Imag	Real, Imag Real, Imag Real, Imag
LIN MAG		Lin Mag, *	Lin Mag, *
REAL		Real, *	Real, *
SWR	SWR, *	SWR, *	

* Value not significant in this format but is included in data transfers.

Use continuous markers (selected using **MARKCONT**;) for search functions. Place a marker at a particular frequency with the **MARKn** command, or at a particular data bucket with the **MARKBUCKn** command. Turn on marker widths with **WIDTON**; and use **OUTPMWID**; to output the results. Turn on marker statistics using **MEASTATON**; and use **OUTPMSTA**; to output the results. All markers and marker functions are output in the ASCII (FORM4) format.

Use the commands **INPURAWn**;, **INPUData**;, and **INPUFORM**; to input data. Use **TITL**; to enter a title (up to 50 characters).

The following program lines measure the minimum passband insertion loss, 3 dB bandwidth, Q, and peak-to-peak passband ripple of the SAW filter. The effects of leakage and triple-travel are removed with gating. The program also tests against the previously entered limits and warns the operator if the measurement is out of limits. Formatted and unformatted trace data are both read into the computer.

```
*
*
680 OUTPUT 716;"TITL""SAW Filter PFG-134 103A Doug Olney Jan
    24,1986"";
690 OUTPUT 716;"MARKCONT;MARKUNCO;CHAN1;MARK1;SEAMAX; OUTPMARK;"
700 ENTER 716;Mag,Dummy,Stim
710 OUTPUT 716;"GATECENT";Stim;"S;GATESPAN 2.3 US;GATEON;"
720 OUTPUT 716;"TIMDTRANOFF;"
730 OUTPUT 716;"SEAMAX;OUTPMARK;"
740 ENTER 716;Mag,Dummy,Stim
750 OUTPUT 716;"DELR1;WIDV -3 DB;WIDTON;OUTPMWID;"
760 ENTER 716;Bw,Center,Q
770 OUTPUT 716;"WIDTOFF;DELOFF;MARK3;DELR3;MARK4;MEASTATON; OUT-
    PMSTA;"
780 ENTER 716;Mean,Sigma,Pp
790 OUTPUT 716;"MEASTATOFF;MARKOFF;LIMILINE ON;LIMITEST ON;ESB?;"
800 ENTER 716;Esb
810 IF BIT (Esb,4) THEN
820     BEEP
830     DISP " SAW FILTER OUT OF SPECIFICATION"
840 END IF
850 DIM Dat(201,2),Form(201,2)
860 OUTPUT 716;"FORM3;OUTPDATA;"
870 ENTER @Na;Header,Length,Dat(*)
880 OUTPUT 716;"OUTPFORM;"
890 ENTER @Na;Header,Length,Form(*)
*
*
```

- LINE 680 – Title the test.
- LINE 690-700 – Find and measure main acoustic response.
- LINE 700 – Gate around main response.
- LINE 710 – Turn transform off (gate remains on).
- LINE 720-740 – Measure the minimum passband insertion loss.
- LINE 750-760 – Measure marker widths relative to the top of the filter.
- LINE 770-780 – Use the 3 dB points to measure the marker statistics over the passband.
- LINE 790-840 – Turn on limit testing and check to see if the filter passes. If the filter does not pass then warn the operator.
- LINE 850 – Dimension two arrays to hold data.
- LINE 860-890 – Transfer the ungated and gated data to the controller.

Status Reporting. The HP 8753A status reporting structure consists of three registers:

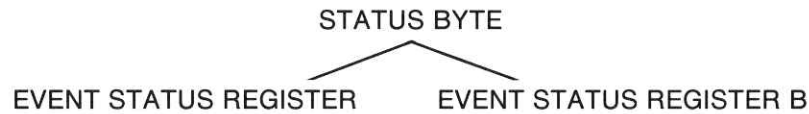

The HP 8753A status reporting hierarchy is shown in Figure 11-6. The top level register is the main status byte, which consists of summary bits. Each bit reports the condition of a lower level register or a queue. If a summary bit is set (equals 1), the corresponding register or queue should be read to obtain the status information and to clear the condition. Reading the main status byte, which can be done with a serial poll or by issuing **OUTPSTAT**;, does not affect the summary bits: they always report the condition of the summarized register or queue.

You can selectively enable each bit in the status byte to generate a service request (SRQ) when set. Setting a bit in the service request enable mask with **SREnn**; enables the corresponding status byte bit to generate an SRQ. For example, **SRE12**; enables bits 2 and 3 and disables the other bits. In this case, the HP 8753A asserts SRQ on an error condition, or if one of the conditions in event status bit B is met and enabled to report to the main status byte.

When enabled to do so with the **ESEnn**; and **ESNBnn**; commands, the event status register and event status register B are summarized by bits in the main status byte. These registers consist of latched bits. The onset of a status condition sets a latched bit and either a read of that register, or the **CLES**; command clears the latched bit. Use the **ESR?**; or the **ESB?**; command to read the registers.

If a bit in the event status registers is enabled and the summary bit in the service request enable register is enabled, an SRQ is generated when the status register bit is set. The SRQ is not cleared until one of four things happens:

1. The event status register is read, clearing the latched bit.
2. The summary bit in the service request enable register is disabled.
3. The event status register enable bit is cleared
4. The **CLES**; command is issued.

NOTE: A GET is sent when status bit 0 or 1 is set.

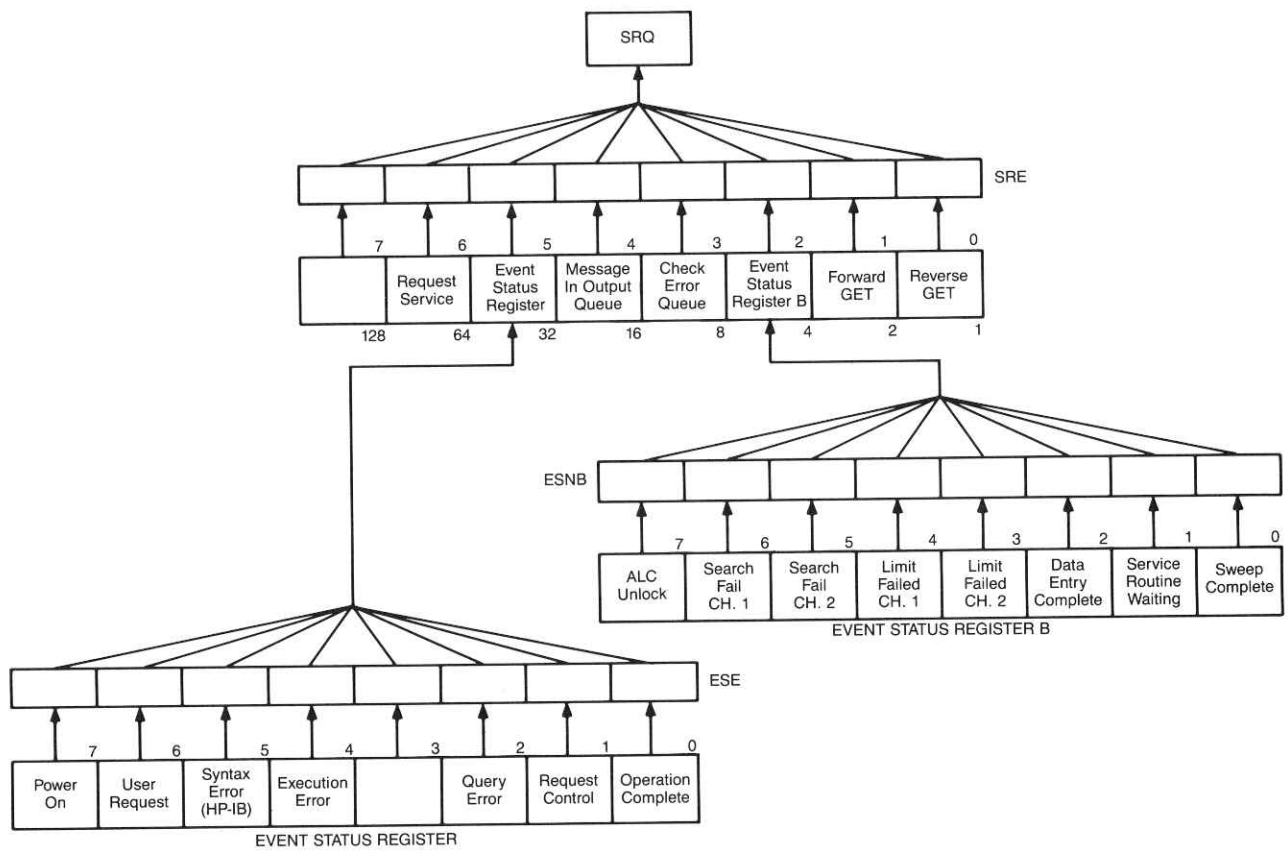

Figure 11-6. Status Reporting on the HP 8753A

The main status byte also summarizes two queues that do not need to be enabled: the output queue and the error queue. When the HP 8753A outputs information, it puts the information in the output queue where it resides until the controller reads it. The output queue is only one event long, and the next output request clears the current data. The summary bit is set whenever data is available in the output queue, and is cleared only by reading the data or by a **PRES;** command.

When the HP 8753A detects an error condition, it displays an error message on the screen, places the error in the error queue, and sets the error queue summary bit in the main status byte. The error queue holds up to 20 errors in the order in which they occur. Read error messages with the **OUTPERRO;** command. The error message output consists of an integer error number followed by the actual error message. The error message is an ASCII string, up to 50 characters long. After all errors are read, the error output is the integer 0 followed by "NO ERRORS". A **PRES;** command also clears the error queue, but a device clear does not.

Table 11-5 summarizes the bits in the main status byte and event status registers.

Table 11-5. Status Bit Definitions

STATUS BYTE

Bit	Name	Description
0	Waiting for reverse GET	A one path, 2-port calibration is active, and the instrument has stopped, waiting for the operator to connect the device for reverse measurement.
1	Waiting for forward GET	A one path, 2-port calibration is active, and the instrument has stopped, waiting for the operator to connect the device for forward measurement.
2	Check event status register B	One of the enabled bits in event status register B has been set.
3	Check error queue	An error has occurred and the message has been placed in the error queue, but has not been read yet.
4	Message in output queue	A command has prepared information to be output, but it has not been read yet.
5	Check event status register	One of the enabled bits in the event status register has been set.
6	Request service	One of the enabled status byte bits is causing an SRQ.

EVENT STATUS REGISTER

Bit	Name	Description
0	Operation complete	A command for which OPC has been enabled completed operation.
1	Request control	The HP 8753A has been commanded to perform an operation that requires control of a peripheral, and needs control of the HP-IB. Requires pass control mode.
2	Query error	The HP 8753A has been addressed to talk, but there is nothing in the output queue to transmit.
4	Execution error	A command was received that could not be executed. Commonly due to invalid operands.
5	Syntax error	The incoming HP-IB commands contained a syntax error. The syntax error is cleared only by a device clear on an instrument preset.
6	User request	The operator has pressed a front panel or key or turned the knob. Works if front panel in local or remote mode.
7	Power on	A power on sequence has occurred since the last read of the register.

Table 11-5. Status Bit Definitions (2 of 2)

EVENT STATUS REGISTER B

Bit	Name	Description
0	Sweep or group complete	A single sweep or group has been completed since the last read of the register. Operates in conjunction with SING or NUMG.
1	Service routine waiting or done	An internal service routine has completed operation, or is waiting for an operator response.
2	Data entry complete	A terminator key has been pressed, or a value entered over HP-IB since last read of the register.
3	Limit failed, Ch 1	Limit test failed on channel 1.
4	Limit failed, Ch 2	Limit test failed on channel 2.
5	Search failed, Ch 1	A marker target search or bandwidth search was executed, but the desired value was not found.
6	Search failed, Ch 2	Same as on channel 1.
7	ALC unlock	The output power went unlevelled at the beginning or end of a sweep. Data may be invalid.

Save/Recall. You can save up to five instrument states in the HP 8753A. States are saved in internal short-term non-volatile memory (except as noted) and include:

- List Frequency tables
- Limit Line tables
- Titles
- Calibrations if on (these are in volatile memory)
- Memory traces (these are in volatile memory)

Save/recall provides the programmer a fast and convenient way to set up the HP 8753A for a test. Clear the save/recall registers with the **CLEARALL**; command; save the save/recall registers with the **SAVEN**; command; and recall the save/recall registers with the **RECA**n; command. Title a register using the **TITRn**"xxxxxxx"; command, where **n** is the register number (1-5), followed by a title of up to 8 characters.

Add the following lines to the SAW test program to save the test setup and current trace:

```
*
*
900 OUTPUT 716 ; "CHAN2 ; DATI ; DISPDATM ; CHAN1 ; DATI ; DISPDATM ; "
910 OUTPUT 716 ; "CLEARALL ; TITR1""SAW123"" ; SAVE1 ; "
*
*
```

- LINE 900 — Put the current data trace into memory on both channels.
- LINE 910 — Clear all the current save/recall registers and save the state under the title "SAW123".

The instrument state is contained in a fixed-length string called the learn string. This string contains the entire instrument state, including front panel settings, frequency list table, and limit tables. The learn string does not contain calibration data, calibration kit definitions, trace data, memory data, or user graphics. Output the learn string using the **UPLEAS**; command. The string is a fixed-length string of no more than 3000 bytes, and can be stored for later re-transmission to the HP 8753A. Modifying the learn string is not recommended due to the complexity of the encoding.

The following program lines read the HP 8753A instrument learn string:

```
*
*
920 OUTPUT 716;"OUTPLEAS;"
930 ENTER @Na;Header,Length
940 ALLOCATE Learn${Length}
950 ENTER @Na;Learn$
*
*
```

LINE 920 — Have the HP 8753A output its learn string.
LINE 930-940 — Enter the header and allocate a string large enough to accommodate the learn string.
LINE 950 — Enter the learn string.

In the pass control mode, you can store and load to an external disc as an extension to the internal memory. Initialize the external disc using the **INID**; command. Several data arrays (raw, data, formatted) can be stored along with the state. The channel memory array is automatically stored if present. These arrays are stored with the FORM3 format. Once stored, the array is automatically re-loaded into the analyzer when the state is re-loaded. The following commands enable the channel data arrays:

EXTMDATA ON;	Enable external data storage.
EXTMRAW ON;	Enable external raw data storage.
EXTMFORM ON;	Enable external formatted data storage.

If the graphics display array is enabled with the **EXTMGRAPON**; command, it can also be stored. This array is stored in the FORM1 format.

The general procedure to access an external disc from the HP 8753A while in remote control is:

1. Display the external disc directory for the operator (optional).
2. Input the instrument state register name to be saved/recalled.
3. Clear registers if required.
4. Title an appropriate store/load register with **TITFn"xxxxxxx"**;
5. Store or load the state with the **STORn**; or **LOADn**; command.
6. Pass control to the HP 8753A.
7. Wait for control to return.

Add the following program lines to the SAW test program to save the SAW test setup and trace memory in external disc memory:

```

*
*
960  OUTPUT 716;"USEPASC;ESE2;"
970  OUTPUT 716;"TITF1""SAW123"";"
980  MASS STORAGE IS ":HP9122,700,0"
990  OUTPUT 716;"DISCUNIT 0;DISCVOLU 0;EXTMDATA ON;STOR1;"
1000 GOSUB Wait_request
1010 SEND 7; TALK 16 CMD 9
1020 GOSUB Wait_return
*
*
2000 Wait_request:!
2010 REPEAT
2020     S=SPOLL(716)
2030 UNTIL BIT(S,5)
2040 RETURN
*
*
2100 Wait_return:!
2110 REPEAT
2120     STATUS 7,6;S
2130 UNTIL BIT(S,6)
2140 OUTPUT 716;"TALKLIST;"
2150 RETURN
*
*

```

- LINE 960 — Place the HP 8753A in the pass control mode. Enable main status byte reporting for the request control bit in the extended status register.
- LINE 970 — Enable external memory storage.
- LINE 980 — Select an HP 9122 type CS-80 disc drive and unit number 0 as the mass storage device.
- LINE 990 — Copy the register title to the external memory register 1 and tell the HP 8753A to store the state.
- LINE 1000 — Go to a routine to wait for a request for control from the HP 8753A.
- LINE 1010 — Pass control to the analyzer.
- LINE 1020 — Wait for control to return.
- LINE 2000-2040 — This subroutine serial polls the HP 8753A until a request control status is reported.
- LINE 2100-2150 — This subroutine monitors the active control status bit of the HP-IB interface status register of the controller.

Figure 11-7 illustrates a typical external disc storage catalog.

The file naming convention:

xxxxxxxxl	FORM1	An instrument state file. This contains the learn string. The xxxxxxxx is the register name (previously set up).
xxxxxxxxna	FORM3	The channel calibration coefficients (if on). The n byte indicates which channel (1 or 2) this array is for. The a byte is the ASCII character for a hexadecimal number (0 to 9, a to c) to indicate which array (of 12 possible) this file contains (e.g. 3 = array 3, B = array 11, 0 = stimulus state string.)
xxxxxxxxRj	FORM3	The raw data array. The j byte identifies the array number (channel 1:1 to 4, channel 2:5 to 8).
xxxxxxxxDn	FORM3	The corrected data array. The n byte is the channel number.
xxxxxxxxMn	FORM3	The memory array (if present).
xxxxxxxxFn	FORM3	The formatted data array.
xxxxxxxxnK	FORM1	The active calibration kit.
xxxxxxxxG0	FORM1	The display graphics array.
xxxxxxxxG1	FORM1	Two arrays per graphics page.

```

:CS80 , 700
VOLUME LABEL: B9836
FILE NAME PRO TYPE REC/FILE BYTE/REC ADDRESS
SAW13          BDAT      3328          1          17
SAW12          BDAT      3328          1          31
SAW11          BDAT      3328          1          45
SAW10          BDAT       256          1          59
SAW1K          BDAT       768          1          61
SAW21          BDAT      3328          1          65
SAW20          BDAT       256          1          79
SAW2K          BDAT       768          1          81
SAWI           BDAT     2304          1          85
SAWG0          BDAT     5376          1          95
SAWG1          BDAT       256          1         117
SAWD1          BDAT      3328          1         119
SAWR1          BDAT      3328          1         133
SAWF1          BDAT      3328          1         147
SAWD2          BDAT      3328          1         161
SAWR5          BDAT      3328          1         175
SAWF2          BDAT      3328          1         189

```

Figure 11-7. Example External Disc Catalog

The following program lines document how to access disc data files directly from an external controller (the learn string file is directly accessible from a controller for copy purposes only and cannot be retransmitted to the HP 8753A). The files that were previously stored by the HP 8753A are read back to the computer. FORM3 data files do not include the usual header and length bytes.

```
*
*
1030  ASSIGN @File to "SAW123D1"
1040  ALLOCATE Disc_dat(201,2)
1050  ENTER @File;Disc_dat(*)
1060  ASSIGN @File TO *
1070  ASSIGN @File TO "SAW123M1"
1080  ALLOCATE Disc_mem(201,2)
1090  ENTER @File;Disc_mem(*)
1100  ASSIGN @File to *
*
*
```

LINE 1030 — Assign a file pointer to the state file.
LINE 1040-1060 — Allocate an array, enter it, and close the file.
LINE 1070 — Assign a file pointer to the memory file.
LINE 1080-1100 — Allocate a real array for the memory array, read the array into the controller, and close the file.

Plotting and Printing. You can plot or print either from the talker/listener mode or from the pass control mode. A plot or print can be initiated either by the controller or by the operator.

The sequence to perform a plot from the talker/listener mode is:

1. Turn softkey plotting off using **PSOFTOFF**; or on using **PSOFTON**;
2. Send **OUTPLOT**; (HP-GL plotters) or **OUTPPRIN**; (graphics printers) to the HP 8753A.
3. Address the HP 8753A to talk.
4. Address the HP-GL plotter to listen.
5. Place the bus in the data mode (ATN false).
6. Wait for the plot or print to complete. The EOI line is asserted with the last byte of the plot or print string. The controller must be capable of detecting the EOI, which is also asserted when the operator aborts a plot.

Add the following lines to the example program to plot the gated SAW response:

```
*
*
1110  OUTPUT 716;"PSOFTOFF;OUTPLOT;"
1120  SEND 7; TALK 16 LISTEN 05 DATA
1130  WAIT .1
1140  Done=0
1150  REPEAT
1160  GOSUB Check_eoi
1170  DISP "WAITING FOR PLOT TO COMPLETE"
1080  UNTIL Done
1090  DISP ""
1200  GOTO End
*
*
2200  Check_eoi:
2210  STATUS 7,7;S
2220  IF BIT(S,11) THEN Done=1
2230  RETURN
*
*
```

LINE 1110 — Tell HP 8753A to output the HP-GL plot string and suppress softkey labels.
LINE 1120 — Address HP 8753A to talk, plotter to listen, and place the bus in the data mode.
LINE 1130 — Wait for **OUTPLOT**; to process (be sure EOI is not still asserted from prior transfer).
LINE 1140-1200 — Wait for plot to complete and go to end.
LINE 2200 — Begin check routine.
LINE 2210 — Read bus control line register 7 and put result in variable S.
LINE 2220 — If EOI is set, set a flag.
LINE 2230 — Return from the check routine.

You can also read the **OUTPLOT**; string directly into the controller, thereby freeing the instrument for another measurement while the controller performs the plot. A string of 25000 bytes is large enough to contain most displays.

To plot in the pass control mode:

1. Place the HP 8753A in the pass control bus mode.
2. The HP 8753A requests control via the request control status bit (bit 1) in event status register B either when it receives the **PLOT**; or the **PRINALL**; command, or when an operator presses the **[PLOT]** key while the HP 8753A is in local mode.
3. Pass control to the HP 8753A. If the HP 8753A receives control before requesting control, it immediately passes control back.
4. Wait for active control to return. The HP 8753A passes control to its pass control address, as determined by the **[ADDRESS: CONTROLLER]** softkey.

Add the following lines to add a pass control mode dump to a graphics printer to the SAW test program. Removing the **PRINALL**; command from line 1110 makes the program wait for the operator to press the **[PRINT]** key.

```
*
*
1110  OUTPUT 716;"PASSCONT;ESE2;PRINALL;"
1120  LOCAL 716
1130  Done=0
1140  REPEAT
1150    S=SPOLL(716)
1160    DISP "WAITING FOR HP 8753A TO REQUEST CONTROL"
1170  UNTIL BIT(S,5)
1080  SEND 7; TALK 16 CMD 9
1090  REPEAT
1200    STATUS 7,6;S
1210    DISP "WAITING FOR PRINTOUT TO COMPLETE"
1220  UNTIL BIT(S,6)
1230  DISP""
1240  OUTPUT 716;"TALKLIST;"
1250  DISP ""
1260  GOTO End
*
*
```

- LINE 1110 — Place the HP 8753A in the pass control mode, enable status reporting for the request control bit, and tell the analyzer to dump the CRT graphics to its printer address.
- LINE 1120 — Go to local (if operator initiated).
- LINE 1130-1170 — Wait for HP 8753A to request control.
- LINE 1180 — Pass control to HP 8753A.
- LINE 1190-1260 — Wait for active control to return by monitoring the active control bit of the controller interface status register. Return the analyzer to talker/listener bus mode.

You can list values by entering the **LISV**; mode, where 30 points are displayed as a single page at a time. The **OUTPPRIN**; (talker/listener) command or the **PRINALL**; (pass control) command sends the page to a printer. For plotters, use the **OUTPLOT**; (talker/listener) command or the **PLOT**; (pass control) command. The **NEXP**; command brings up the next page.

Another (and more flexible) way to list values is to use the **OUTPLIML**; command, or the **OUTPLIMF**; command. The **OUTPLIML**; command outputs the same information as **LISV**;, except that there is no paging. **OUTPLIML**; is a FORM4 transfer, transmitting four numbers per stimulus point: stimulus value, test results, upper limit, and lower limit. The **OUTPLIMF**; command outputs those points containing a limit failure when limit testing is on.

Add the following lines to the SAW filter test program to list the points from channel 2:

```
*
*
1110  DIM List$(30)(50)
1120  OUTPUT 716;"CHAN2;LISV;OUTPLIML;"
1130  ENTER 716 USING "%,K";List$(*)
1140  INPUT "Do you wish to print the results",Ans$
1150  IF Ans$[1,1]="Y" or Ans$[1,1]="y" THEN PRINT USING
      "30(50A,/)";List$(*)
1160  GOTO End
*
*
```

LINE 1110 — Dimension a string array for up to thirty 50-character lines.
LINE 1120 — Place channel in the list mode and output the limit list values.
LINE 1130 — Enter the list. Allow only EOI to terminate the ENTER statement, even if all 30 strings have not been received.
LINE 1140-1160 — Print the list if desired just as displayed.

CRT Graphics. The HP 8753A CRT can be used as a graphics display for displaying connection diagrams or custom instructions to an operator. The CRT accepts a subset of Hewlett-Packard Graphics Language (HP-GL) commands. Determine the CRT bus address by adding 1 to the HP 8753A address if the analyzer address is an even number, or subtracting 1 if it is an odd number. Thus the factory default CRT address for graphics is 17.

Table 11-6 summarizes the graphics commands. Place the HP 8753A in the **HOLD**; trigger mode before generating user graphics. **CS**; turns the measurement display off, and **RS**; turns it back on. Use **PU**; to pick up the pen, and **PA**; to move it. Figure 11-8 shows how the HP 8753A graphics display is scaled. The **LB**; command plots labels. Terminate the label with the ASCII character for decimal 3 (a **[CONTROL] "C"** on HP 200 and 300 series computers). To plot, use **PD**; to put the pen down, and **PA**; or **PR**; to plot. Use **SPn**; to determine pen brightness. To erase the current page of graphics, use the **PG**; command.

Table 11-6. HP 8753A Display Graphics Commands

HP-GL subset:

Command	Description															
AF;	Erases the user graphics display.															
CS;	Turns off the measurement display.															
DF;	Sets the default values.															
LB[<u>text</u>][<u>etx</u>];	Labels the display, placing the symbols starting at the current pen position. All incoming characters are printed until the etx symbol is received. The default etx symbol is the ASCII value 3 (not the character 3).															
LTa;	Specifies line type: <table style="margin-left: 40px;"> <tr><td><u>a</u></td><td><u>line</u></td></tr> <tr><td>0</td><td>solid</td></tr> <tr><td>1</td><td>solid</td></tr> <tr><td>2</td><td>short dashes</td></tr> <tr><td>3</td><td>long dashes</td></tr> </table>	<u>a</u>	<u>line</u>	0	solid	1	solid	2	short dashes	3	long dashes					
<u>a</u>	<u>line</u>															
0	solid															
1	solid															
2	short dashes															
3	long dashes															
OP;	Outputs P1 and P2, the scaling limits: 0,0,5850,4095.															
PAx,y;	Draws from the current pen position x,y. There can be many pairs of x,y coordinates within one command. They are separated by commas, and the entire sequence is terminated with a semicolon.															
PD;	Pen down. A line is drawn only if the pen is down.															
PG;	Erases the user graphics display.															
PRx,y;	Plot relative: draws a line from the current pen position to a position y up and x over.															
PU;	Pen up. Stops anything from being drawn.															
RS;	Turns on the measurement display.															
Slh,w;	Sets the character size, for height h and width w in centimeters: <table style="margin-left: 40px;"> <tr><td><u>h</u></td><td><u>w</u></td><td><u>size</u></td></tr> <tr><td>.16</td><td>.20</td><td>smallest</td></tr> <tr><td>.25</td><td>.30</td><td></td></tr> <tr><td>.33</td><td>.39</td><td></td></tr> <tr><td>.41</td><td>.49</td><td>largest</td></tr> </table>	<u>h</u>	<u>w</u>	<u>size</u>	.16	.20	smallest	.25	.30		.33	.39		.41	.49	largest
<u>h</u>	<u>w</u>	<u>size</u>														
.16	.20	smallest														
.25	.30															
.33	.39															
.41	.49	largest														
SPn;	Selects pen n: <table style="margin-left: 40px;"> <tr><td><u>n</u></td><td><u>brightness</u></td></tr> <tr><td>0</td><td>blank</td></tr> <tr><td>1</td><td>brightest</td></tr> <tr><td>2</td><td></td></tr> <tr><td>3</td><td></td></tr> <tr><td>4</td><td>dimpest</td></tr> </table>	<u>n</u>	<u>brightness</u>	0	blank	1	brightest	2		3		4	dimpest			
<u>n</u>	<u>brightness</u>															
0	blank															
1	brightest															
2																
3																
4	dimpest															

Accepted but ignored HP-GL commands:

IM	Input service request mask
IP	Input P1, P2 scaling points
IW	Input window
OC	Output current pen position
OE	Output error
OI	Output identity
OS	Output status
SL	Character slant
SR	Relative character size

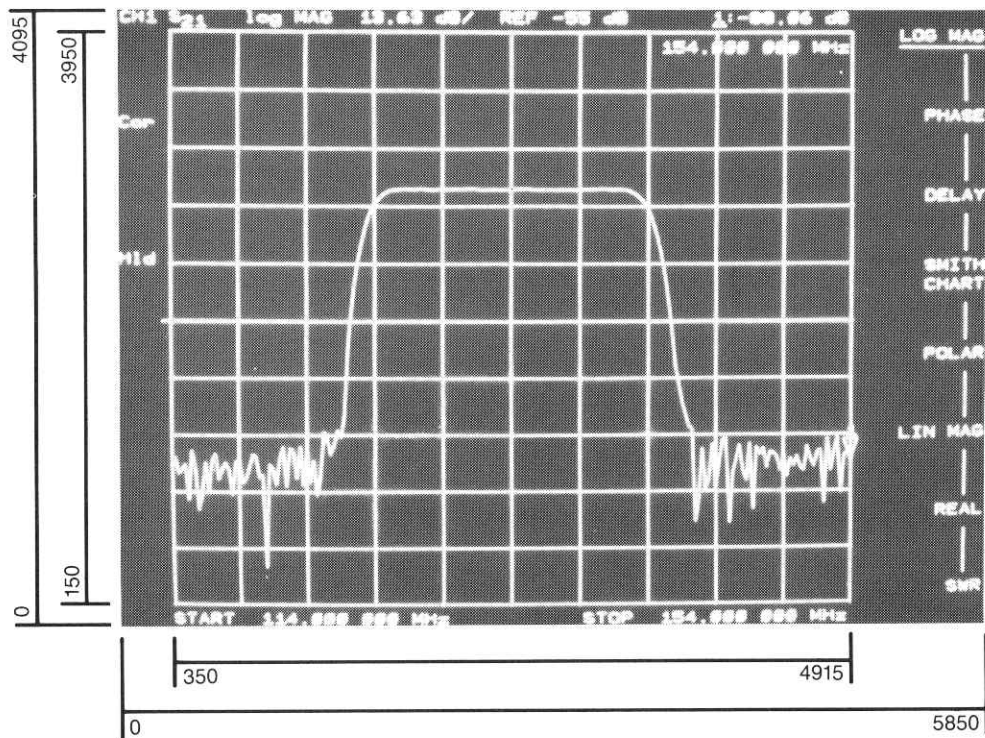

Figure 11-8. Graphics Display Organization

To draw the test block diagram illustrated in Figure 11-9 on the HP 8753A CRT, add the following program lines to the SAW filter test program:

```

*
*
645  GOSUB Draw_setup
*
655  OUTPUT 717;"RS;PG;"
*
*
2300 Draw_setup: !
2310 OUTPUT 717;"CS;PG;LT1;PU;PA1200,2700;PD;"
2320 OUTPUT 717;"PA1200,3300,3800,3300,3800,2700;"
2330 OUTPUT 717;"PA1200,2700;PU;PA1200,3300;PD;"
2340 OUTPUT 717;"PA2200,3400,4620,3400,3800,3300;"
2350 OUTPUT 717;"PU;PA1700,3000;PD;LBo"&CHR$(3)&";"
2360 OUTPUT 717;"PU;PA3200,3000;PD;LBo"&CHR$(3)&";"
2370 OUTPUT 717;"PU;PA2200,3600;PD;"
2380 OUTPUT 717;"LBS-Parameter"&CHR$(3)&";"
2390 OUTPUT 717;"PU;PA2200,3500;PD;LBTest Set"&CHR$(3)&";"
2400 OUTPUT 717;"LT2;PU;PA3190,2950;PD;PA3190,2000;"
2410 OUTPUT 717;"PA2900,2000;PU;PA2100,2000;PD;"
2420 OUTPUT 717;"LBP1ace DUT"&CHR$(3)&";"
2430 OUTPUT 717;"PU;PA1700,2950;pd;pa1700,2000,2000,2000;"
2440 OUTPUT 717;"PU;PA2300,1850;PD;LBHere"&CHR$(3)&";"
2450 OUTPUT 717;"PU;PA1650,1500;PD;"
2460 OUTPUT 717;"LBPpress [CONTINUE] when done"&CHR$(3)&";"
2470 RETURN
*
*

```

To allow the operator to move the marker using the front panel keys while the HP 8753A is under remote control, add the following lines to the SAW test program. This also sets up a softkey for the operator to continue the test.

```

*
*
745  GOSUB Set_mar k
*
*
2500  Set_mar k: !
2510  OUTPUT 716; "ESE64; MENUOFF; WRSK8""[Done]""; "
2520  DISP " SET MARKER WITH KNOB. PRESS [Done] TO GO ON. "
2530  Freq=134000000
2540  Wait_loop: !
2550  REPEAT
2560    S=SPOLL(716)
2570  UNTIL BIT(S,5)
2580  OUTPUT 716; "ESR?;"
2590  ENTER 716; Esr
2600  OUTPUT 716; "KOR?;"
2610  ENTER 716; Key
2620  IF Key<0 THEN
2630    IF NOT BIT(Key, 14) THEN Key=BINAND(Key, 255)
2640    Freq=Freq-(Key*30000)
2650    OUTPUT 716; "MARK1"; Freq; "HZ;"
2660    GOTO Wait_loop
2670  ELSE
2680  IF Key <> 10 THEN GOTO Wait_loop
2690  END IF
2700  OUTPUT 716; "MENUON; MENUMARK;"
2710  RETURN
2720  End: END
*
*

```

- LINE 745 — Go to a routine that allows the operator to move the marker.
- LINE 2500 — Begin the knob routine.
- LINE 2510 — Enable status byte reporting for front panel user requests, turn off the current menu, and label key 8 for the operator.
- LINE 2520-2570 — Wait for a user request (span is set).
- LINE 2580-2590 — Read the extended status register to clear it.
- LINE 2600-2610 — Enter the key code.
- LINE 2620-2670 — If the knob was turned then calculate and set new marker position. Set bit 15 equal to bit 14 to reach the correct negative value.
- LINE 2680-2690 — If the key was not the [Done] key then try again.
- LINE 2700-2720 — Return when the continue key is pressed. Be sure to turn on the menus before continuing.

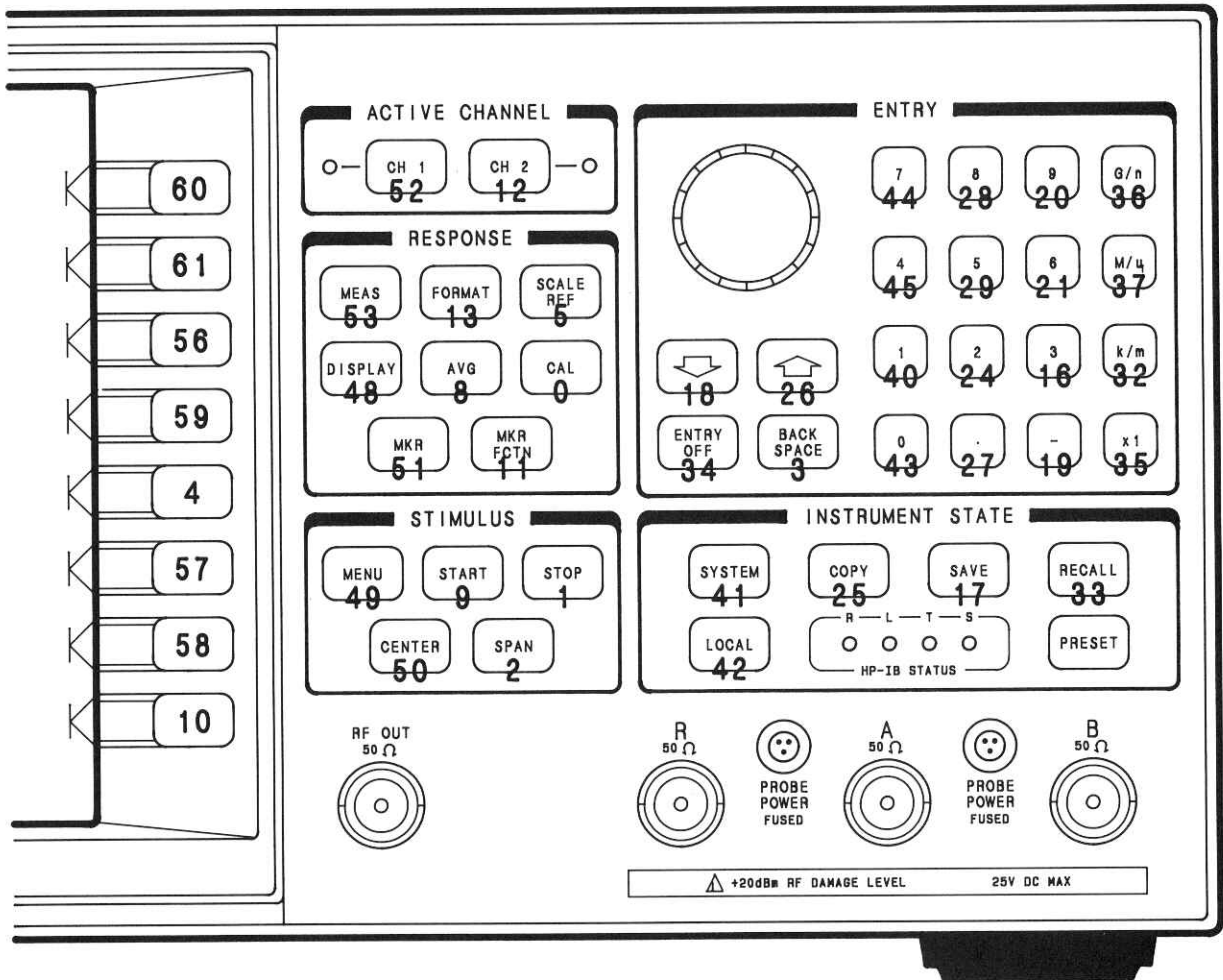

Figure 11-10. HP 8753A Key Codes

APPENDIX A: KEY SELECT CODES FOR THE HP 8753A

This appendix is a functionally arranged table of HP-IB mnemonics that have a direct front panel key equivalent. The functions are arranged alphabetically by front panel hard key.

Keys:

AVG	A-1	MEAS	A-5
CAL-error correction	A-1	MENU	A-6
CAL-calibration kits	A-2	MKR	A-7
CHANNEL	A-4	MKR FCTN	A-7
COPY	A-4	SAVE/RECALL	A-7
DISPLAY	A-4	SCALE REF	A-8
ENTRY	A-5	STIMULUS	A-8
FORMAT	A-5	SYSTEM-Transform	A-8
LOCAL	A-5	SYSTEM-Limit testing	A-9

Column headings:

FUNCTION	The front panel function affected by the mnemonic.
ACTION	The effects of the mnemonic on that function.
MNEMONIC	The mnemonic.
S	Syntax type. See Input Syntax.
?	Interrogate response. If a response is defined, it is listed.
O	OPC'able command.
RANGE	The range of acceptable inputs and corresponding units.

Symbol conventions are:

[]	An optional operand.
D	A numerical operand.
\$	A character string operand, which must be enclosed by quotes.
<>	A necessary appendage.
	An either/or choice in appendages

FUNCTION	ACTION	MNEMONIC	S	?	O	RANGE
AVG						
Averaging	Restart	AVERREST	1			
	Factor	AVERFACT[D]	3	D		0 to 999
	On/off	AVERO<ON OFF>	2	1,0		
Smoothing	Set aperature	SMOOAPER[D]	3	D		0.05 to 20 (%)
	Activate	SMOOO<ON OFF>	2	1,0		
IF bandwidth	Set bandwidth	IFBW[D]	3	D		D=10, 30, 100, 300, 1000, 3000 Hz
CAL-error correction, calibration						
Correction	On/off	CORR<ON OFF>	2	1,0		
Cal sequence	Resume	RESC	1			
Port extensions	Port 1	PORT1[D]	3	D		± 1 s
	Port 2	PORT2[D]	3	D		± 1 s
	Input A	PORTA[D]	3	D		± 1 s
	Input B	PORTB[D]	3	D		± 1 s
	Off	PORE<ON OFF>	2	1,0		

FUNCTION	ACTION	MNEMONIC	S	?	0	RANGE
Velocity factor	Set value	VELOFACT[D]	3	D		0 to 1
Z0	Set value	SETZ[D]	3	D		.1 to 500 ohm
Begin cal sequence	Response	CALIRESP	1	0,1		
	Response and Isol	CALIRAI	1	0,1		
	S11 1-port	CALIS111	1	0,1		
	S22 1-port	CALIS221	1	0,1		
	Full 2-port	CALIFUL2	1	0,1		
	One path 2-port	CALIONE2	1	0,1		
Intermediate cal steps, 2-port cal	Transmission	TRAN	1			
	Reflection	REFL	1			
	Isolation	ISOL	1			
Select response & isol class	Response	RAIRESP	1			
	Isolation	RAISOL	1			
Select reflection class	S11A (open)	CLASS11A	1			See Note 1
	S11B (short)	CLASS11B	1			"
	S11C (load)	CLASS11C	1			"
	S22A (open)	CLASS22A	1			"
	S22B (short)	CLASS22B	1			"
	S22C (load)	CLASS22C	1			"
Select transmission class	Fwd transmission	FWDT	1			"
	Rev transmission	REVT	1			"
	Fwd match	FWDM	1			"
	Rev match	REVM	1			"
Select isolation class	Forward isol.	FWDI	1			"
	Reverse isolation	REVI	1			"
	Omit isolation	OMII	1			"
Select standard in class	Standard A	STANA	1			OPC
	B	STANB	1			OPC
	C	STANC	1			OPC
	D	STAND	1			OPC
	E	STANE	1			OPC
	F	STANF	1			OPC
	G	STANG	1			OPC
Sliding load	Set	SLIS	1			
	Done	SLID	1			
Done with:	Class	DONE	1			OPC
	Isolation	ISOD	1			OPC
	Reflection	REFD	1			OPC
	Transmission	TRAD	1			OPC
Save cal	Response	RESPDONE	1			OPC
	Resp and isol	RAID	1			OPC
	1-port cal	SAV1	1			OPC
	2-port cal	SAV2	1			OPC

FUNCTION	ACTION	MNEMONIC	S	?	0	RANGE
CAL-calibration kits						
Select default kits	7 mm	CALK7MM	1	1,0		
	3.5 mm	CALK35MM	1	1,0		
	Type N, 50 ohm	CALKN50	1	1,0		
	Type N, 75 ohm	CALKN75	1	1,0		
	User defined	CALKUSED	1	1,0		
Modify kit	Modify current	MODH1	1			
Define std. number (begin standard definition)		DEFS[D]	3			
Define standard type	Open	STDTOPEN	1	1,0		
	Short	STDTSHOR	1	1,0		
	Load	STDTLOAD	1	1,0		
	Delay/thru	STDTDELA	1	1,0		
	Arbitrary imped.	STDTARBI	1	1,0		
Define standard parameters	Open cap. C0	C0[D]	3			$\pm 10e-12$ F
	Open cap. C1	C1[D]	3			$\pm 10e-12$ F/Hz
	Open cap. C2	C2[D]	3			$\pm 10e-12$ F/Hz ²
	Open cap. C3	C3[D]	3			$\pm 10e-12$ F/Hz ³
	Fixed load	FIXE	1			
	Sliding load	SLIL	1			
	Terminal imped.	TERI[D]	3			0 to 1 kohm
Define standard offsets	Delay	OFSD[D]	3			± 1 s
	Loss	OFSL[D]	3			0 to 1000 Tohm/s
	Z0	OFSZ[D]	3			.1 to 500 ohm
	Min. frequency	MINF[D]	3			0 to 1000 GHz
	Max frequency	MAXF[D]	3			0 to 1000 GHz
	Coaxial	COAX	1	0,1		
	Waveguide	WAVE	1	0,1		
	Std done	standard defined	STDD	1		
Label std		LABS[\$]	3			10 char.
Specify class	Response	SPECRESP[1,1,...]	3			I=std numbers (all same form)
	Resp & Isol	SPECRESI				
	S11A (open)	SPECS11A				
	S11B (short)	SPECS11B				
	S11C (load)	SPECS11C				
	S22A (open)	SPECS22A				
	S22B (short)	SPECS22B				
	S22C (load)	SPECS22C				
	Forward tran.	SPECFWDT				
	Forward match	SPECFWDM				
	Reverse tran.	SPECREVT				
	Reverse match	SPECREVM				
Class done		CLAD	1			
Label class	Response	LABERESP[\$]	3			10 char.
	S11A	LABES11A[\$]	3			
	S11B	LABES11B[\$]	3			
	S11C	LABES11C[\$]	3			

FUNCTION	ACTION	MNEMONIC	S	?	0	RANGE
	S22A	LABES22A[\$]	3			
	S22B	LABES22B[\$]	3			
	S22C	LABES22C[\$]	3			
	Forward tran.	LABEFWDT[\$]	3			
	Forward match	LABEFWDM[\$]	3			
	Reverse tran.	LABEREVT[\$]	3			
	Reverse match	LABEREVM[\$]	3			
Label kit		LABK[\$]	3			10 char.
Kit done		KITD	1			
Save kit	Into user kit	SAVEUSEK	1			
CHANNEL						
Channel	CH 1 active	CHAN1	1			OPC
	CH 2 active	CHAN2	1			OPC
COPY						
Copy display	To printer	PRINALL	1			
	To plotter	PLOT	1			
Copy display talker/ listener	To plotter	OUTPPLOT	1			
	To printer	OUTPPRIN	1			
List values		LISV	1			
Operating parameters		OPEP	1			
Next page		NEXP	1			
Restore display		RESD	1			
Quadrant	Left lower	LEFL	1	0,1		
	Left upper	LEFU	1	0,1		
	Right lower	RIGL	1	0,1		
	Right upper	RIGU	1	0,1		
	Full page	FULP	1	0,1		
Pen number	Data	PENNDATA[D]	3			0,1,2...10
	Memory	PENNMEMO[D]	3			0,1,2...10
	Graticule	PENNGRAT[D]	3			0,1,2...10
	Text	PENNTXT[D]	3			0,1,2...10
	Marker	PENNMAR[D]	3			0,1,2...10
Line type	Data	LINTDATA[D]	3			0,1,2...10
	Memory	LINTMEMO[D]	3			0,1,2...10
Features to be plotted	Data	PDATA<ON OFF>	2	1,0		
	Memory	PMEM<ON OFF>	2	1,0		
	Graticule	PGRAT<ON OFF>	2	1,0		
	Text	PTEXT<ON OFF>	2	1,0		
	Marker	PMKR<ON OFF>	2	1,0		

FUNCTION	ACTION	MNEMONIC	S	?	0	RANGE
Plot scale	Full page	SCAPFULL	1			
	Graticule to p1,p2	SCAPGRAT	1			
Plot speed	Slow	PLOSSLOW	1			
	Fast	PLOFAST	1			
DISPLAY						
Channels	Dual on/off	DUAC<ON OFF>	2	1,0		
	Split on/off	SPLD<ON OFF>	2	1,0		
Display	Data	DISPDATA	1	0,1		
	Memory only	DISPMEMO	1	0,1		
	Data and mem	DISPDATM	1	0,1		
	Data/mem	DISPDDM	1	0,1		
	Data — mem	DISPDMM	1	0,1		
	Data to mem	DATI	1	0,1	OPC	
Beeper	On done	BEEPDONE<ON OFF>	2	1,0		
	On warning message	BEEPWARN<ON OFF>	2	1,0		
CRT	Intensity	INTE[D]	3	D		0 to 100 percent
	Focus	FOCU[D]	3	D		0 to 100 percent
	Title	TITL[\$]	4	\$		48 char.
Frequency notation	blank	FREO	1			
ENTRY						
Step keys	Up	UP	1			
	Down	DOWN	1			
Entry off		ENTO	1			
FORMAT						
Format	Log mag	LOGM	1	0,1		
	Phase	PHAS	1	0,1		
	Delay	DELA	1	0,1		
	Smith chart	SMIC	1	0,1		
	Polar	POLA	1	0,1		
	Lin mag	LINM	1	0,1		
	Real	REAL	1	0,1		
	SWR	SWR	1	0,1		
LOCAL						
HP-IB modes	Talker/listener	TALKLIST	1	0,1		
	Use pass control	USEPASC	1	0,1		
Debug	Display commands	DEBU<ON OFF>	2	1,0		
Disc drive	Unit	DISCUNIT[D]	3	D		0 to 30
	Volume	DISCVOL[D]	3	D		0 to 30

FUNCTION	ACTION	MNEMONIC	S	?	0	RANGE
HP-IB addresses	Plotter	ADDRPLOT[D]	1	D		0 to 30
	Printer	ADDRPRIN[D]	1	D		0 to 30
	Disc drive	ADDRDISC[D]	1	D		0 to 30
	Controller	ADDRCONT[D]	1	D		0 to 30
Power meter	Address	ADDRPOWM[D]	1	D		0 to 30
	Type	POWM<ON OFF>	2	0,1		On=436A, off=438A.
MEAS						
Input ports	A/R	AR	1	0,1		
	B/R	BR	1	0,1		
	A/B	AB	1	0,1		
	A	MEASA	1	0,1		
	B	MEASB	1	0,1		
	R	MEASR	1	0,1		
S-parameters	S11	S11	1	0,1		
	S12	S12	1	0,1		
	S21	S21	1	0,1		
	S22	S22	1	0,1		
Conversion to alternate parameters	Off	CONVOFF	1	0,1		
	Z:reflection	CONVZREF	1	0,1		
	Z:transmission	CONVZTRA	1	0,1		
	Y:reflection	CONVYREF	1	0,1		
	Y:transmission	CONVYTRA	1	0,1		
	1/S	CONV1DS	1	0,1		
Analog input		ANAI	1	0,1		
MENU (stimulus)						
Power	Level	POWE[D]	3	D		-10 to +25 dBm
	Trip	POWT<ON OFF>	2	1,0		
Time	Specify	SWET[D]	3	D		.01 to 86,400 s
Measurement	Restart	REST	1			
Trigger	Hold	HOLD	1	0,1		
	Single	SING	1		OPC	
	Number of groups	NUMG[D]	3		OPC	1 to 999
	Continuous	CONT	1	0,1		
	External trigger	EXTT<ON OFF>	2	0,1		
Points	Specify	POIN[D]	3	D		3, 11, 26, 51, 101, 201, 401, 801, 1601
Coupled channels	On/off	COUC<ON OFF>	2	1,0		
CW freq	Set value	CWFREQ[D]	3	D		300 kHz to 3 GHz

FUNCTION	ACTION	MNEMONIC	S	?	0	RANGE
Power slope	Value	SLOPE[D]	3	D		0 to 2 dB/GHz
	On/off	SLOPO<ON OFF>	2	1,0		
Test set attenuation	Port 1	ATTP1[D]	3	D		0,10,20...70 dB
	Port 2	ATTP2[D]	3	D		0,10,20...70 dB
Sweep type	Linear	LINFREQ	1	0,1		
	Log	LOGFREQ	1	0,1		
	List	LISFREQ	1	0,1		
	Power	POWS	1	0,1		
	CW time	CWTIME	1	0,1		
Edit list	Begin	EDITLIST	1			
	Add segment	SADD	1			
	Edit segment N	SEDI[D]	3	D		1 to 30
	Done with segment	SDON	1			
	Delete segment	SDEL	1			
	Done	EDITDONE	1		OPC	
Edit segment	Start	STAR[D]	3	D		Stim range, Note 2
	Stop	STOP[D]	3	D		"
	Center	CENT[D]	3	D		"
	Span	SPAN[D]	3	D		"
	Points	POIN[D]	3	D		1 to 1632
	Stepsize	STPSIZE[D]	3	D		Stim range, Note 2
	CW	CWFREQ[D]	3	D		"
MKR						
Select active	1 to 4	MARK<I>[D]	4	D		Stim range, Note 2
	All off	MARKOFF	1	0,1		
Marker zero	Zero offsets	MARKZERO	1			
Delta reference	1 to 4	DELR<I>	2	0,1		I=1 TO 4
	Fixed marker	DELRFIXM	1	0,1		
	Mode off	DELO	1	0,1		
Fixed mkr position	Stimulus	MARKFSTI[D]	3	D		Stim range, Note 2
	Value	MARKFVAL[D]	3	D		Amp. range, Note 3
	Aux value	MARKFAUV[D]	3	D		"
Marker placement	Continuous	MARKCONT	1	0,1		
	Discrete	MARKDISC	1	0,1		
Coupled	Couple channels	MARKCOUP	1	0,1		
	Uncouple	MARKUNCO	1	0,1		
Polar markers	Log	POLMLOG	1	0,1		
	Linear	POLMLIN	1	0,1		
	Re/Im	POLMRI	1	0,1		

FUNCTION	ACTION	MNEMONIC	S	?	0	RANGE
Smith markers	Linear	SMIMLIN	1	0,1		
	Log	SMIMLOG	1	0,1		
	Re/Im	SMIMRI	1	0,1		
	R+jX	SMIMRX	1	0,1		
	G+jB	SMIMGB	1	0,1		
MKR FCTN						
Set function to marker value	Start	MARKSTAR	1			
	Stop	MARKSTOP	1			
	Center	MARKCENT	1			
	Span	MARKSPAN	1			
	Reference	MARKREF	1			
	Delay	MARKDELA	1			
Search	Off	SEAOFF	1	0,1		
	Maximum	SEAMAX	1	0,1		
	Minimum	SEAMIN	1	0,1		
	Target	SEATARG[D]	3	D		Amp. range, Note 3
	Search left	SEAL	1			
	Search right	SEAR	1			
Width search	Value	WIDV[D]	3	D		Amp. range, Note 3
	Search on/off	WIDT<ON OFF>	2	1,0		
Tracking search	On/off	TRACK<ON OFF>	2	1,0		
Statistics	On/off	MEASTAT<ON OFF>	2	1,0		
SAVE/RECALL						
Save Clear	Selected reg	SAVE<I>	2		OPC	I=1 to 5
	Selected reg	CLEA<I>	2			I=1 to 5
	All regs	CLEARALL	1		OPC	
Purge	Selected file	PURG<I>	2			I=1 to 5
Store	To disc	STOR<I>	2			I=1 to 5
Title	Internal reg	TITR<I>[\$]	2			I=1 to 5, 10 char.
	Disc reg	TITF<I>[\$]	2			"
Include with disc registers	Data	EXTMDATA<ON OFF>	2	1,0		
	Raw data	EXTMRAW<ON OFF>	2	1,0		
	Formatted data	EXTMFORM<ON OFF>	2	1,0		
	User graphics	EXTMGRAP<ON OFF>	2	1,0		
Recall	Selected reg	RECA<I>	2		OPC	I=1 to 5

FUNCTION	ACTION	MNEMONIC	S	?	0	RANGE
Load	From disc Register titles	LOAD<I> REFT	2 2			I=1 to 5
Initialize	Disc	INID	1			
SCALE REF						
Scale	Auto Value	AUTO SCAL[D]	1 3		D	See Note 3.
Reference	Position Value Set to mkr	REFP[D] REFV[D] MARKREF	3 3 1		D D	0<D< 10 Amp. range, Note 3
Delay	Set delay Set to mkr	ELED[D] MARKDELA	3 1		D	±1.0 s
Phase	Offset	PHAO[D]	3		D	± 360 deg
STIMULUS						
Stimulus	Center Span Start Stop	CENT[D] SPAN[D] STAR[D] STOP[D]	3 3 3 3		D D D D	Stim range, Note 2. " " "
SYSTEM, Transform						
Transform	On/off	TIMDTRAN<ON OFF>	2			
Set freq	Low pass	SETF	1			
Mode	Low pass impulse Low pass step Bandpass	LOWPIMPU LOWPSTEP BANDPASS	1 1 1		0,1 0,1 0,1	
Window	Maximum Normal Minimum Any value	WINDMAXI WINDNORM WINDMINI WINDOW[D]	1 1 1 3			D State dependent
Window shape Demodulation	Use trace memory Off Amplitude Phase	WINDUSEM<ON OFF> DEMOOFF DEMOAMPL DEMOPHAS	2 1 1 1		1,0 0,1 0,1 0,1	
Gate	On/off Start Stop Center Span	GATEO<ON OFF> GATESTAR[D] GATESTOP[D] GATECENT[D] GATESPAN[D]	2 3 3 3 3		1,0 D D D D	Transform range, Note 2 " " "
Gate shape	Maximum Wide	GATSMAXI GATSWIDE	1 1		0,1 0,1	

FUNCTION	ACTION	MNEMONIC	S	?	0	RANGE
	Normal	GATSNORM	1	0,1		
	Minimum	GATSMINI	1	0,1		
SYSTEM, limit testing						
Limit line	On/off	LIMILINE<ON OFF>	2	1,0		
Limit test	On/off	LIMITEST<ON OFF>	2	1,0		
	Beeper	BEEPFAIL<ON OFF>	2	1,0		
Limit offset	Stimulus	LIMISTIO[D]	3	D		Stim range, Note 2
	Amplitude	LIMIAMPO[D]	3	D		Amp. range, Note 3
	Marker to offset	LIMIMAOF	1			
Edit table	Begin edit	EDITLIML	1			
	Add segment	SADD	1			
	Edit segment D	SEDI[D]	3	D		1 to 15
	Segment done	SDON	1			
	Delete segment	SDEL	1			
	Done with edit	EDITDONE	1			
Edit segment	Stimulus value	LIMS[D]	3	D		Stim range, Note 2
	Marker to stimulus	MARKSTIM	1			
	Upper limit	LIMU[D]	3	D		Amp. range, Note 3
	Lower limit	LIML[D]	3	D		"
	Delta limits	LIMD[D]	3	D		"
	Middle value	LIMM[D]	3	D		"
	Marker to middle	MARKMIDD	1			
	Flat line type	LIMTFL	1	0,1		
	Sloping line type	LIMTSL	1	0,1		
	Single point type	LIMTSP	1	0,1		

NOTE 1:

The class commands are OPC'able if there is only one standard in the class. If there is just one standard, that standard is measured automatically. If there is more than one standard in the class, the class command only calls another menu.

NOTE 2, Stimulus range:

For frequency sweeps: 300 kHz to 3 GHz.
 For power sweeps: -10 to 25 dBm.
 For CW time: 0 to 24 hours.
 For frequency sweep, transform on: $\pm 1/\text{frequency step}$.
 For CW time sweep, transform on: $\pm 1/\text{time step}$.

NOTE 3, Amplitude range:

For log mag: ± 500 dB.
 For phase: ± 500 degrees.
 For Smith chart and Polar: ± 500 units.
 For linear magnitude: ± 500 units.
 For SWR: ± 500 units.
 The scale is always positive, and has minimum values of .001 dB, 10e-12 degrees, 10e-15 seconds, and 10 picounits.

APPENDIX B: HP-IB ONLY COMMANDS

ACTION	MNEMONIC	SYNTAX	DESCRIPTION
MISCELLANEOUS			
Identity	IDN?	1	Outputs the identification string: "HEWLETT PACKARD, 8753A,0,X.XX", where X.XX is the firmware revision of the instrument.
Key	KEY[D]	1	Imitates pressing a key. The data transmitted is the key code, as defined in Figure E.4.
Key code	KOR?	1	Outputs last key code or knob count. If the reply is positive, it is a key code. If it is negative, then set bit 15 equal to bit 14, and the resulting two byte integer is the RPG knob count. It can be either positive or negative. There are about 120 counts per turn.
Move marker	MARKBUCK[D]	2	Moves the marker to the selected point on the trace. On a 201 point sweep, D can range from 0 to 200.
On completion	OPC	1	Reports completion of the last OPC'able command received since OPC ; or OPC? ; was received.
Plot keys	PSOFT<ON OFF>	2	Includes the menu keys in OUTPPLOT ; and OUTPPRIN ; strings.
Revision	SOFR	1	Displays the software revision on the HP 8753A.
Sampler	SAMC<ON OFF>	2	Turns sampler correction off. To be used only when data is being taken to create custom calibration coefficients.
Test Set	TESS?	1	Returns a one if an HP 85046A/B S-parameter test set is present.
INPUT			
Data	INPUDATA[D]	3	Accepts error corrected data.
Formatted	INPUFORM[D]	3	Accepts formatted data.
Uncorrected	INPURAW1[D]	3	Accepts raw data.
	INPURAW2[D]	3	
	INPURAW3[D]	3	
	INPURAW4[D]	3	
Error coef.	INPUCALC<01, 02, . . . 12>		Accepts the individual error coefficient arrays. Issue the command that begins the calibration the coefficients are from (e.g. CALIS11); then input the data. Lastly, issue SAVC ; and trigger a sweep.
Cal kit	INPUCALK[D]	3	Accepts a cal kit.
Learn string	INPULEAS[D]	3	Accepts the learn string.

ACTION	MNEMONIC	SYNTAX	DESCRIPTION
MENUS			
Averaging	MENUAVG	1	
Calibration	MENUCAL	1	
Copy	MENUCOPY	1	
Display	MENUDISP	1	
Format	MENUFORM	1	
Marker	MENUMARK	1	
Meas	MENUMEAS	1	
Marker fctn	MENUMRKF	1	
Off	MENUO<ON OFF>	2	
Recall	MENURECA	1	
Save	MENUSAVE	1	
Scale	MENUSCAL	1	
Stimulus	MENUSTIM	1	
System	MENUSYST	1	
OUTPUT			
NOTE: Except as noted, these commands output data according to the current output format. The data is transmitted in pairs of numbers, the number of pairs being the same as the number of points in the sweep.			
Active funct.	OUTPACTI	1	Outputs value of function in active entry area in ASCII format.
Error coef.	OUTPCALC<01,02 . . . 12>		Outputs the selected error coefficient array from the active channel. Each array is the same as a data array. See Appendix C, Calibration, for the contents of the arrays.
Cal kit	OUTPCALK	1	Outputs the active cal kit, a less than 1000 byte string in form 1.
Data	OUTPDATA	1	Outputs the error corrected data from the active channel in real/imaginary pairs. See Figure E.1, Processing Chain.
Error	OUTPERRO	1	Outputs the oldest error in the error queue. The error number is transmitted, then the error message, in ASCII format.
Formatted	OUTPFORM	1	Outputs the formatted trace data from the active channel in current display units. See Figure E.2 for data transmitted.
Identity	OUTPIDEN	1	Outputs identification string, same as IDN? .
Keycode	OUTPKEY	1	Outputs the code of the last key pressed, in ASCII format. See Figure E.4 for key codes. A -1 is transmitted for a knob turn.
Learn strng	OUTPLEAS	1	Outputs the learn string, a less than 3,000 byte string in form 1.
Limit failures	OUTPLIMF	1	Outputs the limit results as described under OUTPLIML for only those stimulus points that failed.

ACTION	MNEMONIC	SYNTAX	DESCRIPTION
Limit list	OUTPLIML	1	Outputs the limit test results for each stimulus point. The results consist of four numbers. The first is the stimulus value tested, the second is the test result: -1 for no test, 0 for fail, 1 for pass. The third number is the upper limit value, and the fourth is the lower limit value. This is a form 4 transfer.
Limit marker	OUTPLIMM	1	Outputs the limit test results as described for OUTPLIML at the marker.
Marker	OUTPMARK	1	Outputs the active marker values in 3 numbers. The first two numbers are the marker values, and the last is the stimulus value. See Figure E.2 for the marker values.
Memory	OUTPMEMO	1	Outputs the memory trace from the active channel. It is error corrected data in real/imaginary pairs, and can be treated the same as data from OUTPDATA .
Marker stats.	OUTPMSTA	1	Outputs marker statistics: mean, standard deviation, and peak to peak deviation. ASCII format.
Bandwidth	OUTPMWID	1	Outputs results of bandwidth search: bandwidth, center, and Q. ASCII format.
Plot	OUTPPLOT	1	Outputs the plot string in ASCII format. Can be directed to an HP-GL plotter.
Print	OUTPPRIN	1	Outputs a raster display dump in ASCII format. Can be directed to a graphics printer.
Raw data	OUTPRAW1	1	Outputs uncorrected data arrays for the active channel. Raw 1 holds the data unless a 2-port calibration is on, in which case the arrays hold S11, S21, S12, and S22, respectively. The data is in real/imaginary pairs.
	OUTPRAW2	1	
	OUTPRAW3	1	
	OUTPRAW4	1	
Status byte	OUTPSTAT	1	Outputs the status byte. ASCII format.
Display title	OUTPTITL	1	Outputs the display title. ASCII format.
OUTPUT FORMATS			
	FORM1	1	HP 8753A internal format, with header.
	FORM2	1	32 bit floating point, with header.
	FORM3	1	64 bit floating point, with header.
	FORM4	1	ASCII format. No header.
SOFTKEYS			
Press label	SOFT[I]	2	Activates softkey I, I=1 to 8.
	WRSK<1 TO 8>[S]	3	Writes label (10 char) to indicated softkey.

ACTION	MNEMONIC	SYNTAX	DESCRIPTION
STATUS REPORTING			
Clear	CLES	1	Clears the status byte.
Interrogate	ESB?	1	Returns event status register B.
	ESR?	1	Returns the event status register.
	OUTPSTAT	1	Returns the status byte.
Enable	ESE[D]	3	Enables event status register. (0<D<255)
	ESNB[D]	3	Enables event status register B. (0<D<255)
	SRE[D]	3	Enables SRQ. (0<D<255)

Chapter 12. Error Messages

INTRODUCTION

This chapter lists the possible error messages displayed on the HP 8753A CRT or transmitted by the instrument over HP-IB. Each error message is printed in **bold**, accompanied by a note that attempts to clarify the message and/or help the user avoid the problem. Where applicable, references are given to related sections of the operating and service manuals.

ERROR MESSAGES

When displayed, all error messages are preceded with the word **CAUTION** : . That part of the error message has been left off here for brevity. The list appears in alphabetical order.

ADDITIONAL STANDARDS NEEDED

Error correction for the selected calibration class cannot be computed without measuring the necessary standards.

ADDRESSED TO TALK WITH NOTHING TO SAY

An enter command was sent to the HP 8753A without first requesting data with an appropriate output command (such as **OUTPDATA**). The HP 8753A has no data in the output queue to satisfy the request.

AIR FLOW RESTRICTED: CHECK FAN FILTER

An inadequate air flow condition has been detected. Clean fan filter. For most efficient cooling, the instrument covers should be in place. If problem persists, troubleshoot power supplies.

AVERAGING INVALID ON NON-RATIO MEASURE

Sweep to sweep averaging is only valid for ratioed measurements: A/R, B/R, A/B. Other noise reduction techniques are available for single input measurements. Refer to the **[AVG]** key in chapter 4 for a discussion of variable IF bandwidths and trace smoothing.

BLOCK INPUT ERROR

The HP 8753A did not receive a complete data transmission, usually caused by an interruption of the bus transaction: pressing the **[LOCAL]** key, or aborting the IO process at the controller.

BLOCK INPUT LENGTH ERROR

The length header received by the HP 8753A did not agree with the size of the internal array block. Refer to HP-IB Information, chapter 11 for instructions on using HP 8753A input commands.

CALIBRATION ABORTED

The calibration in progress was terminated due to change of active channel.

CALIBRATION REQUIRED

A calibration set could not be found that matched the current stimulus state or measurement parameter. Refer to chapter 5, Measurement Calibrations. Calibration sets can be saved to internal or external memory. Refer to the **[SAVE]** key in chapter 10.

CAN'T CHANGE- ANOTHER CONTROLLER ON BUS

The HP 8753A cannot assume the mode of system controller until the active controller is removed from the bus or relinquishes the bus.

CHANGE HP-IB to SYST CTRL or PASS CTRL

The HP 8753A cannot control another peripheral while in TALKER/LISTENER mode. Refer to the **[LOCAL]** key in chapter 7.

CONTINUOUS SWITCHING NOT ALLOWED

The current measurement states require the HP 85046 S-parameter test set to automatically switch between a forward and reverse measurement, driving test port 1, then test port 2. To guard against undue mechanical wear in the RF switch, continuous switching is not allowed. The **tsH** indicator in the left margin of the display indicates that the instrument has been put in the sweep hold mode due to the test set. Turn dual channel OFF and make one measurement at a time by discretely activating each channel, or use NUMBER OF GROUPS trigger type to enable a limited series of dual channel measurements.

CORRECTION TURNED OFF

Critical parameters in the current state do not match the parameters for the calibration set, therefore correction has been turned off. Critical state parameters are sweep type, start frequency, frequency span, and number of points.

CURRENT PARAMETER NOT IN CAL SET

Correction is not valid for the selected measurement parameter. Refer to chapter 5, Measurement Calibration.

DEADLOCK

A fatal firmware error has occurred. Press the preset key or cycle the line power to reset the instrument.

DEMODULATION NOT VALID

Demodulation is only valid for the CW time mode. Refer to chapter 8, Time and Frequency Domain Transforms.

DISC: not on,not connected,wrong addr

The disc cannot be accessed by the HP 8753A. Verify power to the disc drive and the HP-IB connection between the HP 8753A and the disc. Ensure that the correct disc address is input to the HP 8753A. Refer to the **[LOCAL]** key in chapter 7 for instructions on setting peripheral addresses for the HP 8753A.

DISC HARDWARE PROBLEM

The disc drive is not responding correctly. Refer to the disc operating manual.

DISC MEDIUM NOT INITIALIZED

The disc must be initialized before it is used. Refer to the **[INITIALIZE DISC]** key in chapter 10.

DISC MEDIUM FULL

The store operation will overflow available disc space. Insert a new disc or purge files appearing last in the directory to create free disc space.

DISC IS WRITE PROTECTED

The store operation cannot write to a write-protected disc. Slide the write-protect tab over the write-protect opening in order to write data on the disc.

DISC WEAR-REPLACE DISC SOON

Cumulative use of the disc is approaching the maximum. Copy files as necessary using an external controller. If no controller is available, load instrument states from the old disc and store them to a newly initialized disc using the save/recall features of the HP 8753A. Refer to Save/Recall, chapter 10. Discard the old disc.

EXCEEDED 7 STANDARDS PER CLASS

A maximum of seven standards can be defined for any class. Refer to Modifying Calibration Kits in chapter 5.

FIRST CHARACTER MUST BE A LETTER

The first character of a disc file title or an internal save register title must be an alpha character.

FUNCTION NOT VALID

The requested function is incompatible with the current instrument state.

ILLEGAL UNIT OR VOLUME NUMBER

The disc unit or volume number set in the HP 8753A is not valid. Refer to [LOCAL] key, chapter 7 and the disc drive operating manual for information.

INIT DISC removes all data from disc

Warning! Continuing with the initialize operation will destroy any data currently on the disc.

INITIALIZATION FAILED

Disc initialization failed, usually due to a damaged disc.

INSTRUMENT STATE MEMORY CLEARED

The five instrument state registers have been cleared from memory along with any calibration or calibration kit definitions.

INSUFFICIENT MEMORY

The last front panel or HP-IB request could not be implemented due to insufficient memory space. In some cases, this is a fatal error which can only be escaped by presetting the instrument. See chapter 10 for information on memory allocation.

INVALID KEY

An undefined key was pressed.

LIST TABLE EMPTY

The frequency list is empty. To implement LIST FREQ mode, add segments to the list table. Refer to the [EDIT LIST] key in the sweep type menu, chapter 3.

LOW PASS MODE NOT ALLOWED

Gating with 1601 points is only allowed in bandpass mode.

LOW-PASS: FREQ LIMITS CHANGED

The frequency domain data points must be harmonically related from DC to the stop frequency. If this condition is not true when a low pass mode is selected, the end points of the frequency range are modified as necessary.

MORE SLIDES NEEDED

At least three slides are required to complete the calibration.

NO CALIBRATION CURRENTLY IN PROGRESS

The **[RESUME CAL SEQUENCE]** key is not valid unless a calibration was previously in progress. Start a new calibration. Refer to Measurement Calibration, chapter 5.

NO DISC MEDIUM IN DRIVE

No disc was found in the current disc unit. Insert disc or check the disc unit number stored in the HP 8753A. Refer to the **[LOCAL]** key, chapter 7.

NO FILE(S) FOUND ON DISC

No files of the type created by an HP 8753A save operation were found on the disc.

NO FAIL FOUND

The self-diagnose function of the instrument operates on an internal test failure. At this time, no failure has been detected. Refer to Troubleshooting Reference in the service manual for information on internal tests.

NO IF FOUND: CHECK R INPUT LEVEL

The first IF was not detected during the pretune stage. Ensure that the R input is connected with at least -35 dBm input power to R.

NO LIMIT LINES DISPLAYED

Limit lines are turned on but cannot be displayed on polar or Smith chart display formats.

NO MARKER DELTA - SPAN NOT SET

The **[MARKER → SPAN]** key function requires delta marker mode be turned on with at least two markers displayed. Refer to chapter 6, Using Markers.

NO PHASE LOCK: CHECK R INPUT LEVEL

The first IF was detected at the pretune stage but phaselock could not be acquired thereafter. Refer to the system level troubleshooting in the service manual.

NO SPACE FOR NEW CAL. CLEAR REGISTERS

Insufficient memory is available to store a calibration set. Memory can be freed by clearing a saved instrument state that will result in the deletion of a saved calibration set. Refer to chapter 10 for information on the allocation of memory.

NO VALID STATE IN REGISTER

A request to load an instrument state from an empty register was received over HP-IB.

NO VALID MEMORY TRACE

In order to display or otherwise use the memory trace, a data trace must first be stored to memory. Refer to the **[DISPLAY → MEMORY]** key, chapter 4.

NOT VALID FOR PRESENT TEST SET

The calibration requested is inconsistent with the test set type. This message occurs when (1) a full two port calibration is requested with any test other than an HP 85046A/B, or (2) a 1 port, 2 path calibration is requested with an HP 85046A (this is typically used with transmission/reflection test sets).

ONLY LETTERS AND NUMBERS ARE ALLOWED

Non-alphanumeric characters are not allowed in disc file titles or internal save register titles.

OPTIONAL FUNCTION; NOT INSTALLED

The function you requested requires a capability provided by an option to the standard HP 8753A. That option is not currently installed.

OVERLOAD ON INPUT R, POWER REDUCED
OVERLOAD ON INPUT A, POWER REDUCED
OVERLOAD ON INPUT B, POWER REDUCED

Whenever the power level at one of the three receiver inputs exceeds approximately +2 dBm, the RF OUT power level is reduced to the minimum possible level. A P↓ appears in the left margin of the display to indicate that the power trip function has been activated. To remedy this condition, decrease the power level at the input below 0 dBm. Then turn the power trip off; refer to **[POWER TRIP on off]** key, chapter 3.

PHASE LOCK LOST

Phase-lock was acquired but then lost. Refer to the Troubleshooting reference section of the Service Manual and execute the phase lock diagnostic routine. See Service Modes.

PHASE LOCK CAL FAILED

An internal phase lock calibration routine is automatically executed at power-on, when a drift in pretune values has been detected, and anytime a phase lock problem is detected (loss of lock). This message indicates that phase lock calibration was initiated and the first IF detected, but a problem prevented the calibration from completing successfully. Refer to the Troubleshooting Reference section of the service manual and execute test 48, Pretune Correction.

PLOT ABORTED

Depressing any front panel key causes the HP 8753A to abort the plot in progress.

PLOTTER: not on, not connect, wrong addr

Plotter doesn't respond. Check line power, HP-IB connections. Verify that the plotter address set in the HP 8753A matches the actual address of the plotter. Refer to chapter 7, **[LOCAL]** key, for more information.

PLOTTER NOT READY-PINCH WHEELS UP

The plotter pinch wheels are responsible for clamping the paper in place. With the pinch wheels raised, the plotter indicates a "not ready" status on the bus.

POSSIBLE FALSE LOCK

The instrument is achieving phase lock but possibly on the wrong comb tooth. Refer to the Adjustments and Correction Constants section of the Service Manual and execute pretune correction.

POW MET INVALID

The power meter indicates an out-of-range condition. Check the test set up.

POW MET NOT SETTLED

Sequential power meter readings are not consistent. Verify that equipment is set up correctly. If so, preset the instrument and restart the routine.

POW MET NOT FOUND

Power meter does not respond over HP-IB. Check line power and HP-IB connections to the power meter. Verify that the power meter address and model number set in the HP 8753A matches the address and model number of the actual power meter.

POWER SUPPLY HOT!

The temperature sensors on the A8 Post Regulator assembly have detected an over-temperature condition. Note, the power supplies regulated on that assembly have been shut down.

POWER SUPPLY SHUT DOWN!

One or more supplies on the A8 Post Regulator assembly have been shut down due to one of the following conditions: over-current, over-voltage, or under-voltage.

PRINT ABORTED

Depressing any front panel key causes the HP 8753A to abort output to the printer.

PRINTER: not on, not connect, wrong addr

Printer doesn't respond. Check line power, HP-IB connections. Verify that the printer address set in the HP 8753A matches the actual address of the printer. Refer to chapter 7, **[LOCAL]** key, for more information.

PROBE POWER SHUT DOWN!

The biasing supplies to the probe are shut down due to excessive current draw. Troubleshoot probe.

REQUESTED DATA NOT CURRENTLY AVAILABLE

The HP 8753A does not currently contain the data being requested. This condition occurs when requesting, for example, error term arrays without an active calibration in the instrument.

SELF TEST #n FAILED

Internal test #n has failed. Several internal test routines are executed upon preset of the instrument. The HP 8753A reports the first failure detected. Refer to the Troubleshooting Reference section of the Service Manual for more information on internal tests and the self-diagnose feature.

SLIDES ABORTED (MEMORY REALLOCATION)

Memory was taken for other functions. Reduce memory usage (see chapter 10), then redo sliding loads.

SOURCE PARAMETERS CHANGED

Some of the stimulus parameters of the instrument state have been changed. This is usually due to a request to turn correction on. A calibration set for the current measurement parameter was found and activated. The instrument state was updated to match the stimulus parameters of the calibration state.

SWEEP TIME INCREASED

Sweep time is automatically increased to compensate for other instrument state changes. Some parameters which cause an increase in sweep time are an increase in the number of points, narrower IF bandwidths, and sweep type.

SWEEP TIME TOO FAST

The fractional-N and the digital IF circuits have lost synchronization. Refer to the System Troubleshooting section in the Service Manual for more information.

SWEEP TRIGGER SET TO HOLD

The instrument is in a hold state and is no longer sweeping.

SYNTAX ERROR

An improperly formatted command was received over HP-IB. Refer to chapter 11, HP-IB Information or the Quick Reference Guide for proper command syntax.

SYSTEM IS NOT IN REMOTE

The HP 8753A is in local mode. In this mode, the HP 8753A will not respond to HP-IB commands with front panel key equivalents. It will however, respond to commands which have no such equivalents, such as status requests.

TARGET VALUE NOT FOUND

The target value for the marker search function does not exist on the current data trace.

TOO MANY SEGMENTS OR POINTS

Frequency list mode is limited to 30 segments or 1632 points. Refer to chapter 3 for more information.

TRANSFORM, GATE NOT ALLOWED

Transformation to the time domain is not allowed for sweep types other than linear and CW.

TROUBLE! CHECK SET-UP AND START OVER

Refer to the Adjustments and Corrections Constants section of the Service Manual for the appropriate equipment set up for this routine.

WAITING FOR CLEAN SWEEP

In single sweep mode, the instrument ensures that all changes to the instrument state, if any, have been implemented before taking the sweep. The HP-IB command that the instrument is currently processing will not complete until the sweep completes.

WAITING FOR HP-IB CONTROL

The HP 8753A has been instructed to use pass control (USEPASC). When the instrument next receives an instruction requiring active controller mode, it requests control of the bus and simultaneously displays this message. If the message remains, the system controller is not relinquishing the bus.

WAITING FOR DISC

This message is displayed between the start and finish of a read or write operation to a disc.

WRITE ATTEMPTED WITHOUT SELECTING INPUT TYPE

The data header for the HP 8753A, "#A", was received with no preceding input command (such as INPUDATA). The instrument recognized the header but did not know what type of data to receive. Refer to chapter 11, HP-IB Information or the Quick Reference Guide for command syntax.

Appendix A

PRESET STATE

When the [PRESET] key is pressed, the HP 8753A reverts to a known state. This state is defined in Table A-1, below. There are subtle differences between the preset state and the power-up state. These differences are documented in Table A-2.

When line power is cycled, or the [PRESET] key pressed, the HP 8753A performs a self-test routine. Upon successful completion of that routine, the instrument state is set to the following preset conditions. The same conditions are true following a "PRES;" or "RST;" command over HP-IB, although the self-test routines are not executed.

Table A-1. Preset Conditions (1 of 2)

Operating Parameter	Preset Value	Format Table	Scale	Reference		Marker Offset
				Position	Value	
Stimulus Conditions						
SWEEP TYPE	linear frequency	LOG MAGNITUDE (dB)	10.0	5.0	0.0	0.0
DISPLAY MODE	start/stop	PHASE (degree)	90.0	5.0	0.0	0.0
TRIGGER TYPE	continuous	GROUP DELAY (nsec)	10.0	5.0	0.0	0.0
EXTERNAL TRIGGER	off	SMITH CHART	1.00	—	1.0	0.0
SWEEP TIME	100 milliseconds	POLAR	1.00	—	1.0	0.0
START FREQUENCY	0.300 MHz	LINEAR MAGNITUDE	0.1	0.0	0.0	0.0
FREQUENCY SPAN	2999.7 MHz	REAL	0.2	5.0	0.0	0.0
START TIME	0	SWR	1.00	0.0	1.0	0.0
TIME SPAN	100 milliseconds					
CW FREQUENCY	1000 MHz					
SOURCE POWER	0 dBm					
POWER SLOPE	0 dB/GHz; off					
START POWER	—5.0 dBm					
POWER SPAN	5 dB					
COUPLED CHANNELS	on					
Response Conditions						
PARAMETER (with HP 85046A/B test set)	channel 1: S11; channel 2: S21					
(without HP 85046A/B test set)	channel 1: A/R; channel 2: B/R					
CONVERSION	off					
FORMAT	log magnitude (all inputs)					
DISPLAY	data					
DUAL CHANNEL	off					
ACTIVE CHANNEL	channel 1					
FREQUENCY BLANK	disabled					
SPLIT DISPLAY	on					
BEEPER: DONE	on					
BEEPER: WARNING	off					
NUMBER OF POINTS	201					
IF BANDWIDTH	3000 Hz					
IF AVERAGING FACTOR	16; off					
SMOOTHING APERTURE	1% span; off					
PHASE OFFSET	0 degrees					
ELECTRICAL DELAY	0 seconds (all parameters)					
		Operating Parameter			Preset Value	
		Calibration				
		CORRECTION			off	
		CALIBRATION TYPE			none	
		CALIBRATION KIT			7 millimeter	
		SYSTEM Z0			50 ohms	
		VELOCITY FACTOR			1	
		EXTENSIONS			off	
		PORT 1			0	
		PORT 2			0	
		INPUT A			0	
		INPUT B			0	
		ALTERNATE A and B			ON	
		Markers (coupled)				
		MARKERS 1,2,3,4			1 GHz; all markers off	
		LAST ACTIVE MARKER			1	
		REFERENCE MARKER			none	
		MARKER MODE			continuous	
		DELTA MARKER MODE			off	
		MARKER SEARCH			off	
		MARKER TARGET VALUE			—3 dB	
		MARKER WIDTH VALUE			—3 dB; off	
		MARKER TRACKING			off	
		MARKER STIMULUS OFFSET			0	
		MARKER VALUE OFFSET			0	
		MARKER AUX OFFSET (PHASE)			0 degrees	
		MARKER STATISTICS			off	

Table A-1. Preset Conditions (2 of 2)

Operating Parameter	Preset Value	Operating Parameter	Preset Value
POLAR MARKER	LIN MKR	PLOT DATA	on
SMITH MARKER	R+jX	PLOT MEMORY	on
Limit Lines		PLOT GRATICULE	on
LIMIT LINES	off	PLOT TEXT	on
LIMIT TESTING	off	PLOT MARKER	on
LIMIT LIST	empty	PLOT QUADRANT	full page
EDIT MODE	upper/lower limits	SCALE PLOT	full
STIMULUS OFFSET	0 Hz	PLOT SPEED	fast
AMPLITUDE OFFSET	0	System Parameters	
LIMIT TYPE	sloping line	HP-IB ADDRESSES	last active state
BEEP FAIL	off	HP-IB MODE	last active state
Frequency List		INTENSITY and FOCUS	last active state
FREQUENCY LIST	empty	Test Set Attenuation	
EDIT MODE	start/stop, number of points	PORT 1	0
Time Domain		PORT 2	0
TRANSFORM	off	External Memory Array (Define Store)	
TRANSFORM TYPE	bandpass	DATA	off
START TRANSFORM	-20 nanoseconds	RAW DATA	off
TRANSFORM SPAN	40 nanoseconds	FORMATTED DATA	off
GATING	off	GRAPHICS	off
GATE SHAPE	normal	Service Modes	
GATE START	-10 nanoseconds	HP-IB DIAGNOSTICS	off
GATE SPAN	20 nanoseconds	SOURCE PHASE-LOCKED LOOP	on
DEMODULATION	off	SAMPLER CORRECTION	on
WINDOW	normal	SPUR AVOIDANCE	on
USE MEMORY	OFF	AUX INPUT RESOLUTION	high
		ANALOG BUS NODE	11 (auxiliary input)
Plot			
PEN NUMBER:	Channel 1	Channel 2	
Data	1	2	
Memory	1	2	
Graticule	3	4	
Text	1	2	
Marker	5	6	
LINE TYPE			
Data, Memory	7	7	

Table A-2. Power-On Conditions (versus Preset)

<p>HP-IB MODE is talker/listener.</p> <p>MEMORY and CALIBRATION data of saved registers are cleared.</p> <p>TEST SET: The HP 8753A checks for presence of 85046A/B.</p> <p>INTENSITY and FOCUS values are set to factory encoded values. The factory values can be changed by running the appropriate service routine. Refer to the Troubleshooting Reference section of the service manual.</p> <p>If short term memory is lost prior to power up of the instrument, the following is true:</p> <p>HP-IB ADDRESSES are set to the following defaults:</p> <table> <tr> <td>HP 8753A</td> <td>16</td> </tr> <tr> <td>USER DISPLAY</td> <td>17</td> </tr> <tr> <td>PLOTTER</td> <td>5</td> </tr> <tr> <td>PRINTER</td> <td>1</td> </tr> <tr> <td>DISC</td> <td>0</td> </tr> <tr> <td>DISC UNIT NUMBER</td> <td>0</td> </tr> <tr> <td>DISC VOLUME NUMBER</td> <td>0</td> </tr> </table> <p>INTERNAL REGISTER TITLES are set to defaults: REG1 through REG5.</p> <p>EXTERNAL FILE TITLES (store files) are set to defaults: FILE1 through FILE 5.</p>	HP 8753A	16	USER DISPLAY	17	PLOTTER	5	PRINTER	1	DISC	0	DISC UNIT NUMBER	0	DISC VOLUME NUMBER	0
HP 8753A	16													
USER DISPLAY	17													
PLOTTER	5													
PRINTER	1													
DISC	0													
DISC UNIT NUMBER	0													
DISC VOLUME NUMBER	0													

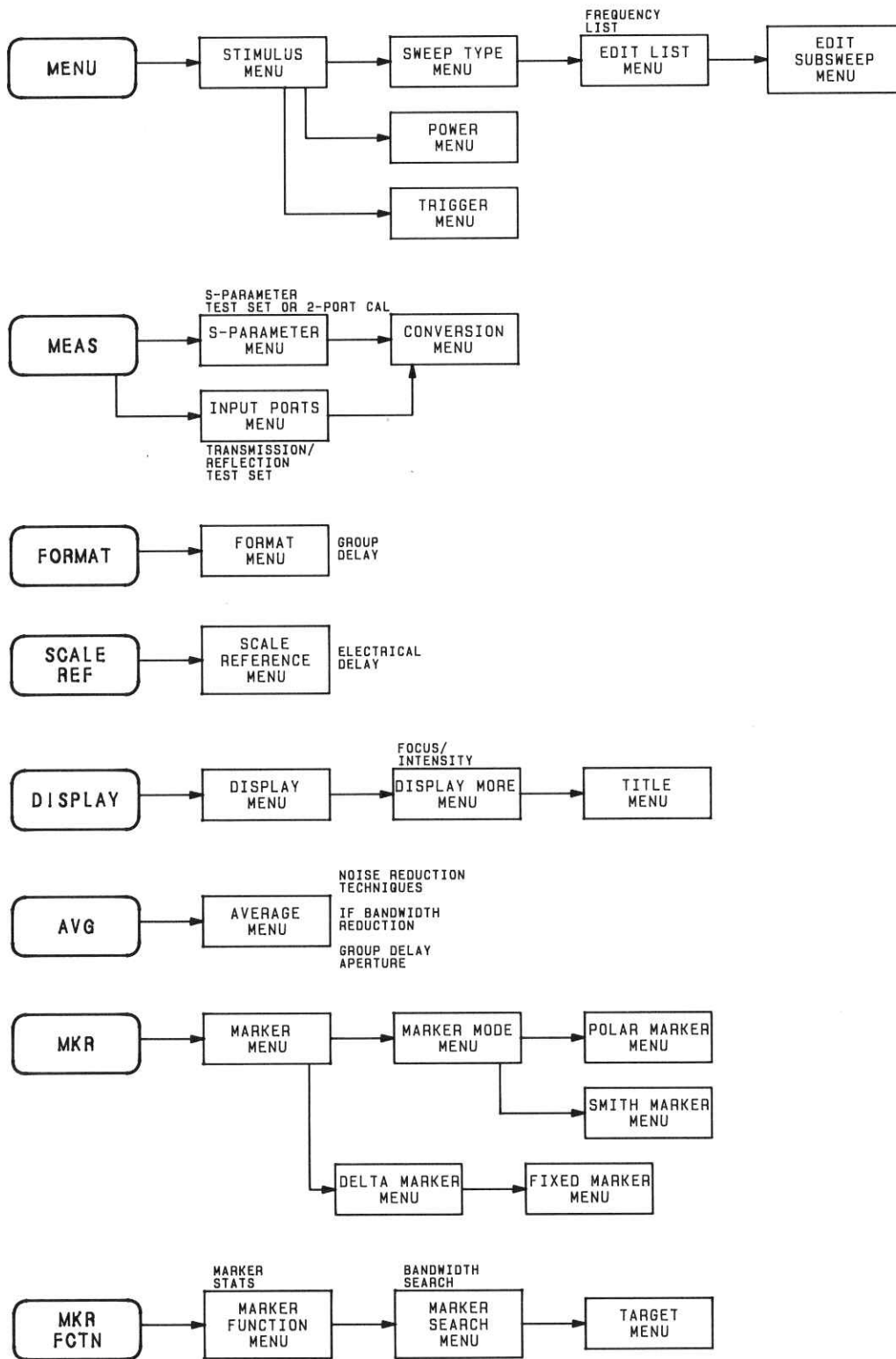

Figure A-1. Operating Softkey Menu Map (1 of 3)

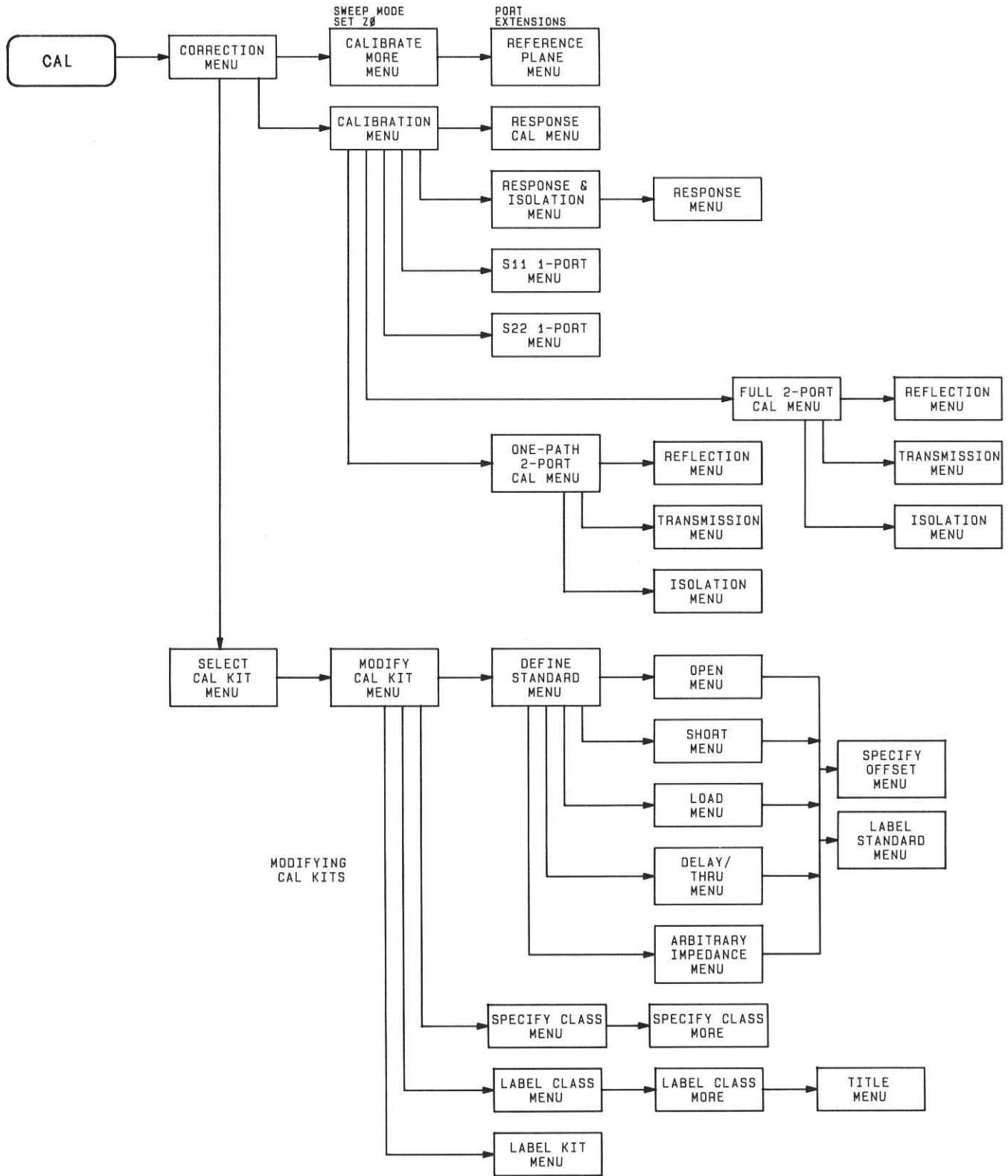

Figure A-1. Operating Softkey Menu Map (2 of 3)

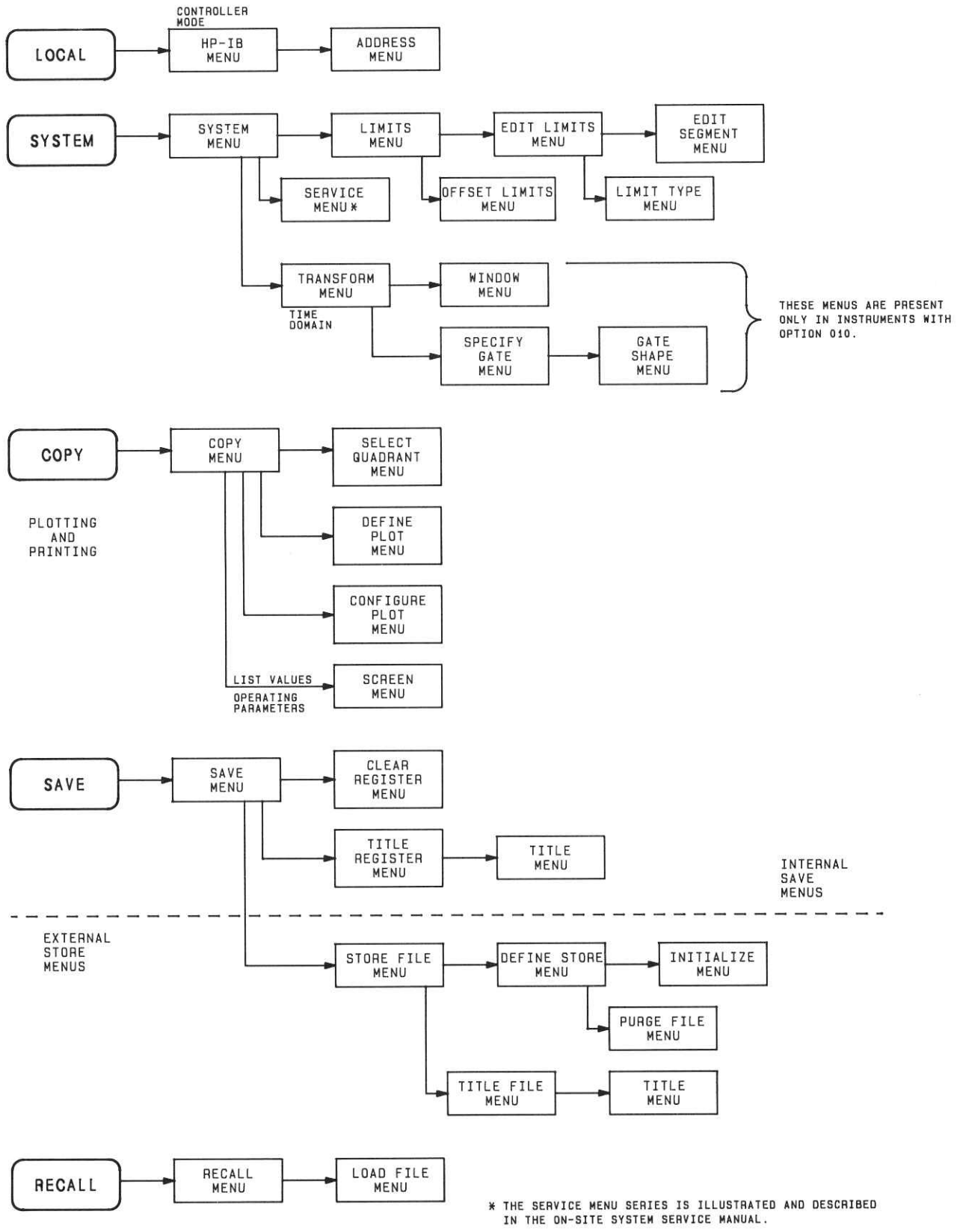

Figure A-1. Operating Softkey Menu Map (3 of 3)

HP 8753A Operating and Programming Reference

INDEX

Aborting a Plot or Printout	9-2	C?	2-5, 5-9	CRT Graphics, Remote	11-40
Accessing Disc Files, Remote	11-37	C2	2-5, 5-24	[CW FREQ] Softkey	3-5
Accessory Model Numbers	1-3	C2?	2-5	[CW TIME] Softkey	3-10
Accuracy Enhancement	5-1	Cable Faults, Low Pass Measurements	8-11	CW Time Mode	8-1
Accuracy Enhancement Fundamentals	A5-1	Calibrate More Menu	5-13	CW Time to Frequency Domain	8-22
Active Calibration Title	10-4	Calibration Coefficients, HP-IB	11-24	Data Array Store	10-12
ACTIVE CHANNEL Keys	2-9	Calibration Kits	5-9	Data Arrays	1-4
Active Entry Area	2-5, 2-6	Calibration Menu	5-15	Data Bus	11-3
Active Function	2-1	Calibration Menu Map	5-8	Data Formats (HP-IB)	11-16
Active Marker	6-1	Calibration Procedures	5-1, 5-16	[DATA → MEMORY] Softkey	4-21
Adapters	5-9	Calibration Set Store	10-4	[DATA – MEMORY] Softkey	4-21
Adding Electrical Delay	5-14	Calibration Standards	1-3	[DATA/MEMORY] Softkey	4-21
Address Capability	11-4	Calibrations/Classes	11-21	Data Output, Remote	11-28
Address Menu	7-5	[CAL] Key	5-8	Data Point	1-4
Addresses, Setting	11-8	[CAL KIT] Softkeys	5-11, 5-12	Data Processing	1-3
Admittance Conversion	4-7	Capacitance	6-9	Data Processing Flow Diagram	1-4
Admittance Measurements	4-12	Catalog, External Disc	11-36	Data Rate	11-4
Admittance Values	6-9	Center Conductor Extenders	5-15	Data vs. Time	3-10
Aliasing (Time Domain)	8-17	[CENTER] Key	3-1	Debug Mode	7-4, 11-12
[ALTERNATE A and B] Softkey	5-13	Center/Span	3-1	Default Cal Kits	5-11
Alternate Sweep	3-5, 5-13	[CH1], [CH2] Keys	2-9	Default Pen Numbers	9-7
Analog Bus	4-6	Characteristic Impedance	5-13	Default Plot Parameters	9-3
[ANALOG IN] Softkey	4-6	Characterizing Systematic Errors	A5-1	Define Plot Menu	9-5
ANSI Standard MC1.1	11-1	Chirp-Z Fourier Transform	8-2	Define Standard Menus	5-30, 5-31
Aperture, Group Delay	4-16, 4-27	[CHOP A and B] Softkey	5-13	Define Store Menu	10-12
Aperture, Smoothing	4-15, 4-27	Chop Sweep Mode	5-13	Del	2-5
[ARBITRARY IMPEDANCE] Softkey	5-32	Circuit Description	1-2	Delay Offset	5-33
Array Input/Output	11-14	Clear Lockout/Set Local	11-9	Delay Response	5-14
Arrays	11-16	Clear Register Menu	10-7	[DELAY] Softkey	4-10
ATN	11-3	Complex Admittance Values	6-9	Delta Marker Mode Menu	6-4
Attenuator Softkeys	3-7	Complex Admittance (Y) Conversion	4-7	Delta Reference	6-4
Automatic Leveling Control	3-6	Complex Impedance Values	6-9	Demodulating Forward Transform	8-23
Automatic Measurement Sequence	11-17	Complex Impedance (Z) Conversion	4-7	Deviation from Linear Phase	4-14, 4-18, 6-11
[AUTO SCALE] Softkey	4-17	Computer Control	7-2	Device Clear	11-9
Auxiliary Response Value	6-6	Conductance	6-9	Direct Disc Access	11-6
Auxiliary Voltage Measurement	4-6	Configure Plot Menu	9-7	Direct Plotting and Printing	11-6
AUX INPUT Connector	2-7, 4-6	Connection Techniques	5-9	Directivity	5-2
Average Menu	4-26	Connector Care	5-9	Directivity Error	A5-2, A5-4
Averaging	4-24	Connector Sex	5-15	Disc Access	10-1
Averaging Algorithm	4-26	Connectors	2-7	Disc Access, Remote	11-37
Averaging Factor	4-26	Continuous Markers	6-7	Disc Catalog	11-36
[AVERAGING RESTART] Softkey	4-26	Control Lines	11-3	Disc Compatibility	10-13
Avg	2-5, 4-26	Controller	11-2	Disc Directory Search	10-14
[AVG] Key	4-24	Controller Mode for External Store	10-10	Disc Files	10-4
[BACK SPACE] Key	2-11	Controller Modes	7-2	Disc Storage, Remote	11-34
Band-Limited Standards	5-33	Controlling Marker Values	6-1	Disc Unit Number	10-13
Bandpass Reflection Measurement	8-4	Controlling Peripherals	7-2	[DISC UNIT NUMBER] Softkey	7-4
Bandpass, Time Domain	8-4	Conversion Menu	4-7	Disc Volume Number	10-13
Bandpass Transmission Measurement	8-6	[COPY] Key	9-1	Discontinuity, Distance to	8-4
Bandwidth Measurement, Remote	11-29	Copy Menu	9-2	Discontinuity, Type of	8-7
Bandwidth Search	6-12	Copying External File Titles	10-8	Discrete Markers	6-7
Beeper, Limit Fail	7-10	Copying Internal Register Titles	10-15	Dispersion Effects	5-33
Beeper, Operation Complete	4-22	Cor	2-5, 5-11	Display Address	11-8
Beeper, Warning	4-22	Correcting for Measurement Errors	5-5	Display Focus	4-22
Blanking Plot Elements	9-6	Correction Menu	5-10	Display Graphics Commands, HP-IB	11-41
Blanking, Frequency	4-22	Coupled Channels	3-4	Display Intensity	4-22
Block Diagram	1-2	Coupled Markers	2-9, 6-7	[DISPLAY] Key, Display Menu	4-18
Bus Commands, Response to	11-9	Coupled Stimulus	2-9, 3-4	Display Markers	6-1
Bus Mode	11-5	Crosstalk Error	5-4	Display Memory	4-19
Bus Mode, Setting	11-7	CRT Display	2-5	Display More Menu	4-22

Display Smoothing	4-24	Frequency Blanking	4-22	Increasing Dynamic Range	5-14
Down Arrow Key [▼]	2-11	Frequency List	3-10	Inductance	6-9
Drift Errors	5-2	Frequency of Calibration Standards	5-33	Initializing Discs	10-13
Drift Measurements	8-22	Frequency Range	3-1	Input Ports Menu	4-6
[DUAL CHAN on off] Softkey	4-20	Frequency Response Error	5-5, A5-3	Input/Output Buffers	11-12
Dual Channel Display	4-20	Frequency Subsweps	3-11	Inputs R, A, and B	2-4
Dual Trace Capability	2-9	Fringing Capacitance	5-32	Instrument Setup, Remote	11-17
EDF	A5-2, A5-9	Front Panel Features	2-3	INSTRUMENT STATE Function Block	7-1
Edit Limits Menu	7-12	Front Panel Key Codes, HP-IB	11-45	Instrument State Save	10-1
Edit List Menu (Frequency List)	3-11	Front Panel Keys	2-1	Instrument States	10-2
Edit Segment Menu (Limits)	7-13	Front Panel Peripheral Control	7-3	Intensity	4-22
Edit Subswep Menu (Frequency List)	3-12	Full 2-Port Calibration	5-5, 5-23	Interface Clear	11-9
Electrical Delay	4-18, 5-14, 6-11	Full Page Plot	9-4	Internal Memory Registers	10-1, 10-6
Electrical Length	4-18, 6-11	[G+ B MKR] Softkey	6-9	Internal Save	10-4
ELF	A5-8, A5-9	[G/n] Key	2-10	Interrogate Commands	11-14
ENTRY Block	2-10	Gat	2-5	Inverse Fourier Transform	8-2
[ENTRY OFF] Key	2-11	Gate Shape Characteristics	8-21	Inverse S-Parameters	4-8
EOI	11-3	Gating	8-20	Inverse Smith Chart	4-12
Equivalent Electrical Length	5-13	Gating, Memory Trace	4-19	Isolating Individual Responses	8-16
[ERASE TITLE] Softkey	4-23	Graphics Commands, HP-IB	11-41	Isolation Calibration, Omission of	5-9
ERF	A5-3, A5-9	Graphics Display Organization	11-42	Isolation Error	5-4, A5-9
Error Coefficient Arrays	1-5	Graphics Store	10-12	Key Code Naming Convention	11-11
Error-Corrected System Performance	5-7	Group Delay Aperture	4-16, 4-27	Key Codes	11-45
Error Correction	5-1	Group Delay Data Distortion	4-27	Key Select Codes	
Error Messages, Alphabetized	12-1 to 12-7	Group Delay Format	4-11	AVG	11A-1
Error Model Equations	A5-11	Group Delay Principles	4-14	CAL	11A-1
Error Models	A5-10	Group Execute Trigger (GET)	11-10	Cal Kits	11A-3
Error Queue	11-32	Handshake	11-3	CHANNEL	11A-4
Error Terms	5-5, A5-9	Hardcopy Output	9-1	COPY	11A-4
Errors Removed by Calibrations	5-17	Harmonic Rejection	4-25	DISPLAY	11A-5
ERS? Event Status Register	11-13	Held Commands	11-13	ENTRY	11A-5
ESF	A5-2, A5-9	Hid	2-5, 3-8	FORMAT	11A-5
Event Status Registers	11-30	Hold Trigger	3-8	HP-IB	11A-1
EXF	A5-9	Horizontal Axis Range	3-1	LOCAL	11A-5
Ext	2-5	HP 85044A/B Transmission/Reflection Test Set	1-3	MEAS	11A-6
EXT AM Connector	2-7	HP 85046A/B S-Parameter Test Set	1-3	MENU	11A-6
EXT REF INPUT Connector	2-7	HP-GL Commands	11-41	MKR	11A-7
EXT TRIGGER Connector	2-7	HP-IB Addresses	7-5, 11-8	MKR FCTN	11A-8
Extending Internal Memory	10-1	HP-IB Connector	2-7	SAVE/RECALL	11A-8
Extending Reference Plane	5-13	HP-IB Debug Mode	11-12	SCALE REF	11A-9
[EXTENSION] Softkeys	5-14	HP-IB Diagnostics	7-4, 11-12	STIMULUS	11A-9
External Disc Access, Remote	11-37	HP-IB Menu	7-2	SYSTEM, Transform	11A-9
External Disc Catalog Example	11-36	HP-IB Only Commands		SYSTEM, Limit Test	11A-10
External Disc Storage, Remote	11-34	Input	11B-1	[k/m] Key	2-10
External Memory	10-1	Menus	11B-2	Keypad	2-10
External Store	10-4	Miscellaneous	11B-1	Knob	2-11
Fan Filter	2-7	Output	11B-2	KOR?	11-43
Fault Location Measurements	8-10	Output Formats	11B-3	Label Class Menus	5-39
File Names	10-10	Softkeys	11B-3	[LABEL CLASS] Softkey	5-30
File Titles	10-17	Status Reporting	11B-4	[LABEL KIT] Softkey	5-30
Fixed Marker	6-3, 6-4	HP-IB Programming	11-1	[LABEL STD] Softkey	5-32
Fixed Marker Menu	6-5, 6-6	HP-IB Requirements	11-4	Label Standard Menu	5-35
Fixed Marker Values	6-5	HP-IB Status Indicators	7-3	Labels, CRT	2-5
Fixed Marker Auxiliary Value	6-6	Identify Commands	11-14	Learn String	10-2, 11-33
Flat Line Limit	7-15	IEC Standard 625-1	11-1	Limit Fail Beeper	7-10
Flow Diagram, Data Processing	1-4	IEEE Standard 488-1978	11-1, 11-4	Limit Lines & Limit Testing	7-8
Focus	4-22	IF Bandwidth Reduction	4-25, 4-27	Limit Lines Entry, Remote	11-19
FORM1, FORM2, FORM3, FORM4	11-16	[IF BW] Softkey	4-27	Limit Margin	7-8, 9-3
Format for Time Domain Bandpass	8-4	IFC	11-3	Limit Type Menu	7-15
Format for Time Domain Low Pass	8-9	Impedance Conversion	4-7	Limit Values	7-13
[FORMAT] Key, Format Menu	4-9	Impedance Measurements	4-11	Limits Menu	7-9
Formatted Array Store	10-12	Impedance Values	6-9	Limits Offset	7-16
Formatted Data Arrays	1-5	Impulse Width	8-15		
Forward Fourier Transform	8-22				
Forward Transform Range	8-25				
Fourier Transform	8-1				

Limits, Entering	7-12	Maximum Standard Frequency	5-34	Peak-to-Peak Marker Values	6-12
[LIN FREQ] Softkey	3-9	Mean Value	6-12	Pen Numbers	9-7
[LIN MAG] Softkey	4-12	[MEAS] Key	4-3	Peripheral Control	7-2
Line Fuse	2-8	[MEASURE RESTART] Softkey	3-4		
Line Stretchers	4-18	Measured Input	2-6	Phase Format	4-10
				Phase Limits	7-13
Line Switch	2-3	Measurement Calibration	5-1	[PHASE OFFSET] Softkey	4-18
Line Types	9-7	Measurement Calibration, Remote	11-20	Phase Shift Linearity	4-14
Line Voltage Selector Switch	2-8	Measurement Errors	5-1	Phase Shift vs. Frequency	4-10
Linear Frequency Sweep	3-9	Measurement Uncertainty	5-1		
Linear Magnitude	6-8	Memory Allocation	10-1, 10-3	Phase Slope	4-18, 6-11
				Phase Values	6-8, 6-9
Linear Magnitude Format	4-13	Memory Arrays	1-5	Plot Elements	9-5
Linear Marker on Polar Format	6-8	Memory Math	4-18	Plot Scale	9-5
Linear Marker on Smith Format	6-9	[MEMORY] Softkey	4-21	Plot Speed	9-6
Linear Phase Shift	4-14	Memory Trace	4-19		
[LIST FREQ] Softkey	3-10	[MENU] Key	4-21	Plotter Line Types	9-7
				Plotter Pen Numbers	9-7
List Frequency Sweep	3-10	Menus Accessed from [MKR] Key	6-2	Plotting	9-2
List Frequency Table, Remote	11-18	Message Area	2-5	Plotting and Printing, Remote	11-37
List Values, Remote	11-39	Microwave Connector Care	5-9	Plotting on Polar or Smith Format	9-7
[LIST VALUES] Softkey	9-3	Microwave Systematic Errors	A5-1		
Listener	11-1	Minimum Amplitude Search	6-12	Plotting on Preprinted Forms	9-6
				Plotting on Transparencies	9-6
Listing Measured Data	9-3, 9-9	Minimum Standard Frequency	5-34	Plotting Parameters, Default	9-3
Load Impedance	5-32	Minimum Sweep Time	3-4	Plotting Parameters, User-Defined	9-5
Load Match Error	5-4, A5-8	[MKR] Key	6-1	Point	1-4
Loading Files from Disc	10-17	[MKR FCTN] Key	6-10		
Local Command	11-9	[MKR ZERO] Softkey	6-3	Polar Format	4-12
				Polar Marker Menu	6-8
[LOCAL] Key	7-2	[M/m] Key	2-10	[PORT EXTENSIONS] Softkey	5-13
Local Lockout	7-2, 11-9	Modify Cal Kit Menu	5-30	Power Level	3-6
Local Operation	7-2	[MODIFY] Softkey (for Cal Kits)	5-12	Power Measurements	4-6
[LOG FREQ] Softkey	3-9	Modifying Cal Kits, Remote	11-25		
[LOG MAG] Softkey	4-10	Modifying Calibration Kits	5-27	Power Menu	3-6
				Power Meters	7-6
Log Magnitude Format	4-10	Modifying Measurement Parameters	6-10	Power Overload	3-6, 3-7
Log Marker on Polar Format	6-8	Multipath Transmission	8-13, 8-20	Power Slope	3-6
Log Marker on Smith Format	6-9	Multiple Controller Capability	11-4	[POWER] Softkey	3-3, 3-6
Logarithmic Frequency Sweep	3-9				
Long Delay Devices	4-15	Noise Reduction	4-24	Power Sweep Mode	3-10
		Non-Volatile Memory	10-1	Power Trip	3-7
Low Pass Frequency Ranges	8-7	Normalization	4-19	Predefined Cal Kits	5-11
Low Pass Impulse	8-8	[NUMBER OF GROUPS] Softkey	3-8	Preplotted Grid Forms	9-6
Low Pass Reflection Measurement	8-8	Number of Points	3-4	[PRESET] Key	2-4
Low Pass Step	8-8				
Low Pass Transmission Measurement	8-12	Numeric Keypad	2-10	Preset, Remote	11-17
		Numerical Readout of Measured Values	6-1	Preset State	A1, A2
Low Pass vs. Bandpass	8-7			Printer Graphics Output, Remote	11-39
Low Pass, Time Domain	8-6	[OFFSET DELAY] Softkey	5-33	Printing	9-2
		Offset Limits Menu	7-16	Printing, Remote	11-37
Magnitude and Phase Values	6-8, 6-9	Offsetting Standards	5-33		
Margin, Limits	7-8, 9-3	Omitting Isolation Calibration	5-9	Print/Plot Controller Modes	9-1
Marker Control Program	11-44	One-Path 2-Port Calibration	5-5, 5-25	Probe Power Connector	2-4
[MARKER → DELAY] Softkey	4-18, 6-11			Programmable Attenuator	3-7
Marker, Fixed	6-3, 6-4	One-Port Conversions	4-7	Programming, Valid Characters	11-11
		One-Port Error Model	A5-1	Propagation Delay	8-6
Marker Function Menu	6-10, 6-11	OPC (Operation Complete)	11-13		
Marker → Maximum	6-12	Open Circuit Capacitance	5-32	Pulse Dispersion	8-13
Marker Menu	6-3	Operand/Terminator	11-11	Purge File Menu	10-14
Marker → Minimum	6-12				
Marker Mode Menu	6-7	Operating Parameters Listing	9-3, 9-9	Q of Bandwidth	6-12
		Optimizing Dynamic Range	5-13	Quarter-Page Plot	9-4
Marker Offsets	6-5	Option 010	8-1	Queue	11-12
Marker Parameters Listing	9-3	Output Queue	11-32		
[MARKER → REFERENCE] Softkey	4-18, 6-11	Output Syntax	11-16	[R + jX MKR] Softkey	6-9
Marker Search Menu	6-12			Random Errors	5-2
Marker Statistics	6-12	Output Values with Display Format	11-28	Range Resolution	8-19
		Outputting Measurement Results	9-1	Ratio Measurements	4-6
Marker Values	2-6, 6-1	Overlaid Traces	4-21	Raw Array Store	10-12
Marker Values, Fixed	6-5	Overshoot in Time Domain Measurements	8-15		
Marker Zero	6-3			Raw Data Arrays	1-5
Markers	6-1, 6-3	P ₁	2-5, 3-6	Reactance	6-9
[MARKERS: COUPLED] Softkey	6-7	P ₂	2-5, 3-6	[READING FILE TITLES] Softkey	10-14, 10-18
		Parallel Poll	11-10	Reading File Titles	10-17
[MARKERS: DISCRETE] Softkey	6-7	Pass Control	11-7, 11-10	[Re/Im MKR] Softkey	6-8
Markers, Remote	11-29	Pass Control Mode	7-2, 7-4		
Masking	8-14	Pass/Fail Indications	7-10	Real Format	4-13
Math Operations	1-4	Pass/Fail Testing	7-8	Real/Imaginary Marker	6-8, 6-9
Maximum Amplitude Search	6-12			Rear Panel Connectors	2-7

Recall Menu	10-16	[SERVICE MENU] Softkey	7-7	Stored Calibrations	10-4
Receiver Sweep Mode	5-13, 5-15	Service Request	7-3, 11-30	Storing to Disc	10-1
Reducing Spurious Signals	5-13	[SET FREQ LOW PASS] Softkey	5-15, 8-7	Storing to Disc, Remote	11-34
Reference Level	2-6	[SET Z0] Softkey	5-13	Susceptance	6-9
Reference Marker	6-2, 6-4	Setting Addresses	7-5	Sweep	1-4
Reference Plane Menu	5-14	Sidelobes	8-15	Sweep Rate	3-9
Reference Position	4-17	Siemens	6-9	Sweep Speed Indicator ↑	3-3
Reference Value	4-17	Signal-to-Noise Ratio	4-24, 4-27	[SWEEP TIME] Softkey	3-3
Reflection Frequency Response Error	A5-3	Single Point Limit	7-15	Sweep Trigger	3-8
Register Titles	10-8, 10-9	Single Trigger	3-8	Sweep Type Menu	3-5
Register Titles, Copying	10-15	Sliding Load	5-32	Sweep-to-Sweep Averaging	4-24
Relative Velocity Factor	5-13, 8-5	[SLOPE] Softkeys	3-6	Sweep-to-Sweep Search	6-12
Remote Measurement Calibration	11-20	Sloping Line Limit	7-15	Switch Protection Override	5-23
Remote Measurement Sequences	11-17	[SMOOTHING on off] Softkey	4-27	SWR Format	4-14
Remote Message	11-9	Small Signal Transient Response	8-12	[SYSTEM] Key	7-7
Remote Programming	11-1	Smith Chart	4-11, 4-12	Symbol Conventions	11A-1
Remote Programming Modes	7-2	Smith Marker Menu	6-9	Syntax Error	11-11
REN	11-3	Smo	2-5	System Controller Mode	7-2, 11-2, 11-7
[RESAVE] Softkeys	10-6	Smoothing	4-24	System Menu	7-7
Residual Uncertainties	5-7, A5-12	Smoothing Aperture	4-25, 4-27	System Overview	1-2
Resistance	6-9	Smoothing, Memory Trace	4-19	System Parameters Listing	9-3
Response & Isolation Cal Procedures	5-20, 5-21	Softkey Labels	2-6	System Performance	5-7, A5-12
Response and Isolation Calibration	5-5	Softkey Menu Map	2-2, A-3	Systematic Error Terms	5-5
Response Cal for Reflection Measurements	5-18	Softkey Menus	2-1	Systematic Errors	5-2, A5-1
Response Cal for Transmission Measurements	5-19	Softkey Programming	11-43	Table of Calibration Procedures	5-17
Response Calibration	5-5	Softkeys	2-1, 2-3	Tabular List of Measured Values	9-3
RESPONSE Function Block	4-1	Source Match Error	5-3, A5-2, A5-8	Take Control Command	11-10
Response Parameters, Remote	11-19	Sources of Error in Reflection	A5-1	Talker	11-1
Response Resolution, Time Domain	8-17	[SPAN] Key	3-1	Talker/Listener Mode	7-2, 7-4, 11-7
Response vs. Full 2-Port Calibration	5-7	Specification Testing	7-14	Target Menu	6-14
Response vs. S11 1-Port Calibration	5-6	Specify Class Menus	5-36, 5-37	Target Value	6-12
Restarting Calibration	5-11	[SPECIFY CLASS] Softkey	5-30	TDR	8-1, 8-7
[RESUME CAL SEQUENCE] Softkey	5-11	Specify Offset Menu	5-33	[TERMINAL IMPEDANCE] Softkey	5-32
RF OUT Connector	2-4	Split Display	4-22	Terminators	2-10, 11-12
RF Output Power	3-6	Spurious Signals	5-13	Test Port Reference Plane	5-13
RF Output Signal	3-1	SRQ (Service Request)	11-3, 11-30	TEST SET INTERCONNECT	2-7
Ringing in Time Domain Measurements	8-15	Standard Class	5-27, 5-36	Test Sets	1-3
S-Parameter Measurements	4-5	Standard Class Assignments Table	5-28	Time and Frequency Domain Transforms	8-1
S-Parameter Menu	4-5	Standard Coefficients	5-27	Time Domain	
S-Parameters	4-3	Standard Definitions Table	5-28	Bandpass Mode	8-1, 8-4
S-Parameter Test Sets	1-3	Standard Deviation	6-12	Low Pass Frequency	5-15
S11 1-Port Calibration	5-22	Standard Devices	5-9, 5-11	Low Pass Step Mode	8-1
S11 and S22 1-Port Calibrations	5-5	Standard for Response Calibration	5-9	Low Pass Impulse Mode	8-1
S11A	A5-1	Standard Labels	5-32	Low Pass	8-7
S11 1-Port Calibration Procedure	5-22	Standard Offsets	5-32, 5-33	Range	8-17
S22 1-Port Calibration Procedure	5-23	Standard Types	5-27, 5-30	Reflection Formats	8-2
Save Menu	10-6	Standards	5-27	Reflectometry	8-1
Save/Recall Menus	10-5	Standing Wave Ratio	4-14	Resolution	8-17
Save/Recall, Remote	11-33	[START] Key	3-1	Transform Menus	8-3
[SAVE USER KIT] Softkey	5-12, 5-30	Start/Stop	3-1	Transform, Remote	11-28
Saving Calibration Data	5-10, 10-2	Start/Stop Power Values	3-10	Gating	8-20
Saving Instrument States	10-1	Statistics, Marker	6-12	Masking	8-14
Saving Memory Trace	10-2	[STATS on off] Softkey	6-12	Windowing	8-15
Scale Factor	4-17	Status Bit Definitions	11-32	Time Start/Stop	8-4
[SCALE PLOT] Softkey	9-6	Status Byte	11-10, 11-30	Time to Frequency Transform	8-22
[SCALE REF] Key	4-17	Status Notations	2-5, 2-6	Title	2-6
[SCALE/DIV] Softkey	4-17	Status Reporting	11-30	Title File Menu	10-15
Scale Reference Menu	4-17	Step and Impulse Waveforms	8-10	Title Menu	4-23
Scattering Parameters	4-3	Step Keys	2-11	Title Menu for Save Registers	10-9
Search Left, Search Right	6-14	Step Size	3-13	Title Register Menu	10-8
Search Tracking	6-13	Stepped CW Sweep	3-9	TNC Cal Kit Example, Remote	11-25
Search [MAX] and [MIN] Softkeys	6-12	STIMULUS Function Block	3-1	Torquing Connections	5-9
[SEGMENT] Softkey	3-11	Stimulus Menu	3-3	Trace Math	1-5, 4-18
Select Cal Kit Menu	5-11	Stimulus Parameters, Remote	11-19	Trace Memory	4-18
Select Quadrant Menu	9-4	[STOP] Key	3-1	Tracking (Frequency Response) Error	5-5, A5-3
Serial Number Plate	2-7	Store File Menu	10-10	Tracking, Marker Search	6-13
Serial Poll	11-10	[STORE TO DISC] Softkey	10-6		

Transfer Switch Protection	5-23	User-Defined Cal Kits	5-27	[Y: Trans] Softkey	4-8
[TRANSFORM MENU] Softkey	7-7	User Graphics	11-40	Z0 Characteristic Impedance	5-13
Transforming Time to Frequency Domain	8-22	[USER KIT] Softkey	5-12	[Z: Refl] Softkey	4-8
Transmission Frequency Response	A5-8	Variable IF Bandwidth	4-25	[Z: Trans] Softkey	4-8
Trigger Menu	3-8	Vector Accuracy Enhancement	5-1	[x1] Key	2-10
Triggering Measurement, Remote	11-27	Velocity Factor	4-18, 8-5	1/S] Softkey	4-8
Two-Port Error Model	A5-7	[VELOCITY FACTOR] Softkey	5-13	2-Port Cal without S-Parameter Test Set	5-25
Two-Way Travel Time	8-9	Volatile Memory	10-1	3 dB Search	6-12
Uncoupled Markers	6-7	[VOLUME NUMBER] Softkey	7-4	75 Ohm Systems	5-13
Uniline Commands	11-9	Warning Beeper	4-22	* in Table of Measured Values	7-8, 9-3
Units Terminators	2-10, 11-12	Waveguide Standards	5-33, 5-34	; Semicolon	11-12
Universal Commands	11-9	Wide Dynamic Range Devices	5-9	? Interrogate	11-14
Unleveled Power	3-6	[WIDTH VALUE] Softkey	6-12	[Δ MODE MENU] Softkey	6-3
Unwanted Response, Removing Effects of	8-20	[WIDTHS on off] Softkey	6-13	Δ REF = Δ	6-3, 6-4
Up Arrow Key [▲]	2-11	Windowing	8-15	π Non-Printable Characters	7-4
User-Allocatable Memory	10-3	[Y: Refl] Softkey	4-8	↑ Sweep Speed Indicator	3-3